

June 1986  
£1.20

# EMM

ELECTRONICS & MUSIC MAKER  
THE MUSIC TECHNOLOGY MAGAZINE

## PETER GABRIEL

Technology's Champion Speaks Out

## ROLAND JX10

Return of the Big Synth

## RUPERT HINE

The Art of Production

## SECONDHAND SYNTHS

Buying Without Tears

## YAMAHA PF70/80

FM Comes to Pianos

## FULL REVIEWS

Of C-Lab Recording Software; Yamaha  
MEP4 Processor; BEL BD240 Delay

# THE KEYBOARDS OF THE YEAR WILL BE DELAYED – DIGITALLY

**KORG POLY 800  
AWARDED "BEST  
BUDGET SYNTH"  
BY M.R.A.\*  
AND NOW  
UPDATED**



## POLY 800 MKII

- Built-in 64 program digital delay
- Built-in 1000 note poly sequencer
- Programmable bass and treble controls
- 8 voice plus chord memory function
- 64 programs (expandable to 256 via MIDI MEX8000 memory expander)
- Mains or battery operation
- RRP £599

**KORG DW8000  
VOTED  
"KEYBOARD  
OF THE YEAR"  
BY  
MELODY  
MAKER**



## DW 8000

- Built-in 64 program digital delay
- Fully touch sensitive keyboard
- 256 waveform combinations give both digital clarity analog warmth.
- 64 program (256 with MEX 8000).
- 4 key assign modes plus portamento and auto-bend
- Advanced MIDI arpeggiator
- RRP £1209

# KORG®

Korg is synthesizers, vocoders, expanders, MIDI sequencers, drum machines, rack effects, tuners, pedal effects and more. For further details on the complete range contact:  
Korg (UK) 32 Gordon House Road, London NW5 1NE

\* Music Retailers Association.

CHASE

10<sup>th</sup>  
ANNIVERSARY

# Celebration Sale

10 SENSATIONAL YEARS - HUNDREDS OF SENSATIONAL SAVINGS

## PIANO BARGAINS

### CHASE DP30 PIANO

The new budget version of the world famous DP80, the DP30 offers four families of Piano sounds ranging from a mellow fine piano to many important synthesizer sounds. You simply select a family and alter it to suit your taste, by changing the Filter Sensitivity control on the front panel. You can also add Chorus and change the Bass and Treble controls. One master tuning knob. The dynamic range of the keyboard goes from subtle to powerful with the professionally tailored action.



R.R.P. £749  
CHASE PRICE £599  
SALE PRICE  
**£349**



### CHASE DP80 PIANO

12 incredible Piano Voices, the ability to create your own and a keyboard response you can tailor to your touch. THE VOICES. Sit down at the Chase DP-80 and you'll discover the world's most popular pianos are at your fingertips. Six presets function in two modes, the first six being more traditional acoustic and electric piano sounds, the second six offering more brilliantly defined sounds not normally associated with acoustically oriented instruments. FREE SECTION. The seventh preset enables you to control the very special Free Filter Section. This section lets you create your own piano sounds, plus many expressive synthesizer voices individually coloured by the energy you direct into the keyboard. THE FEEL. The DP-80 has a true dynamic keyboard that you can adjust to suit your style and touch. You don't have to conform to it, the DP-80 conforms to you.



R.R.P. £1049  
CHASE PRICE £799  
SALE PRICE  
**£449**



## MIDI BARGAINS

### CHASE DK80 SYNTH



This dynamic, bitimbric stereo synthesizer with built-in sequencer is a revelation. The DK80 has 12 voices and is packed with excellent features such as double sound generation, fully dynamic touch sensitive keyboard, a 2 track polyphonic sequencer, user-definable split point and MIDI. An outstanding professional's instrument at an incredibly low price.

R.R.P. £799  
CHASE PRICE £699  
SALE PRICE  
**£499**



### CHASE EX80 SYNTH MODULE

Virtually an 8 voice DK80 without the keys, the EX80 Module includes a real time two track sequencer, memory, dynamics capability, etc. At this price no keyboard with MIDI should be without one.



R.R.P. £549  
CHASE PRICE £449  
SALE PRICE  
**£299**



## BIT BARGAINS

### CHASE BIT SYNTH

The top selling synthesizer with the top selling sounds. Digital access control combined with analogue filtering gives that extra warmth and versatility. Add touch sensitivity, the ultimate in sound selectivity, memory, white noise, splits, doubling, detune etc. - all programmable and MIDI and you've got to be talking about the Chase Bit 99. Undoubtedly the tops for sound, the tops for value. Now you've no excuse to finish up with a second rate synth.

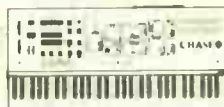

R.R.P. £1099  
CHASE PRICE £899  
SALE PRICE  
**£649**



### CHASE BIT SYNTH MODULE



All the famous Chase Bit sounds are here in what is basically a Chase Bit 99 without the keyboard. Full MIDI implementation. Warms up the sounds of a DX7 or any other synth, guitar, etc. with MIDI. Fully programmable. Full dynamics. Adds splits to your keyboard even if it has none. Many other superb features from this top value module.

R.R.P. £949  
CHASE PRICE £749  
SALE PRICE  
**£499**



*Cut out the vouchers!  
Cut down the cost!*

Chase are 10 years old this month and to celebrate we are giving 3 great offers to everyone who buys one of these star lines - this month only!

- 1 Unbeatable Price Promise. You can't buy cheaper or we'll refund the difference.
- 2 An extra £50 off with the celebration voucher.
- 3 A Free Weekend break for 2. Valid in hotels throughout the country - all you need to pay is for your meals.

Call in for these and many other sensational offers that we'll be giving away to celebrate 10 sensational years.

# FREE WEEKEND

This voucher entitles the bearer to a Free Weekend stay for 2 in your choice of Golden Key Hotels when you purchase one of the starred keyboards in this advertisement. Full details of hotels and conditions available in our showrooms. Valid until 30/6/86.

# £50 OFF

This voucher entitles the bearer to £50 off the price of any of the starred keyboards in this advertisement. 1 voucher only per single purchase. Valid until 30/6/86.

**OPEN LATE  
NIGHT THURS  
'TIL 9.00pm**

# CHASE



All goods subject to availability. Prices correct at going to press.

CHASE LONDON | Tues Sat 10.00am - 5.30pm  
22 Chiswell Street, Off Euston Road, NW1  
Tel: 01-257 7628/7449

CHASE BIRMINGHAM | AM (Mon-Sat) 10.00am - 5.30pm  
10 Priory Circusway, Tel: 021-234 5116

CHASE MANCHESTER | Mon-Sat 10.00am - 5.30pm  
58 Oldham Street, Off Piccadilly, Tel: 061-236 6794/5

# Contents

E&MM June 1986 Volume 6 Number 4

## Comment

4

'Made in Japan' has a new meaning after a trip to the homeland of the DX7.

## Newsdesk

8

Among this month's notable happenings: the Yamaha's 'X-perience' hands-on show, a new MIDI converter from UMI, and the latest on this year's British Music Fair.

## Back Issues

92

Back to E&MM's dim and distant past, with a rundown of what we covered in the magazine's first three years on the shelves.

## Drawmer Midman

32

MIDI routing, filtering and syncing are all handled by this new British 'black box'. Simon Trask checks it out.



## Communique

12

The other pages feature our opinions, this one features yours.

## Interface

14

You have the questions, we have the answers - to all matters technical.

## Appraisal

### Yamaha RX21L

30

Trevor Gilchrist takes a look at Yamaha's Latin adaptation of their RX21. Is it as usable as its more conventional brother?

## Yamaha PF70/80 Pianos

36

The PF10 and 15 proved how well FM voicing is suited to the electronic piano. Now those instruments have been updated, and Simon Trask has been listening to the results.

## C-Lab Software

66

Do we need another German software package for the Commodore 64. The C-Lab company think we do, and after playing with their first system, Simon Trask finds himself agreeing.

## Roland JX10 Polysynth

# 70

Put two JX8P synths in one box, add a few new facilities, and you have a giant of a synthesiser that harks back to the polyphonic instruments of old. *See on Trask (again) tests a glorious anachronism.*

## Yamaha MEP4 Processor

# 80

Simon Trask somehow finds time to examine the most sophisticated MIDI event processor of the lot. Are its facilities usable?

## MUSIC

## Jazz Woodroffe

# 18

Robert Plant's right-hand man and technology-friend talks to Tim Goodyer about samplers, studios and discharges.

## Bel BD240 Sampling Delay

# 38

Long sample times and astounding sound quality characterise Bel's range of mid-price delay units. But as Ian Waugh discovers, there are some important omissions, too.

## Rupert Hine

# 44

One of Britain's most versatile producers talks about working with Howard Jones, forming a new band, and the importance of communication. Paul Tingen listens.

## Polysynth Checklist

# 59

The lowdown on current polysynths, voice expanders and controller keyboards in this month's instalment of our unique buyer's guide.

## E&MM MIDIThru

# 77

Can't afford your own MIDI Thru box? Steve Hartwell's simple circuit does the same job, and costs under a tenner.

## Secondhand Polysynth Guide

# 23

Whether you can't afford to indulge yourself in this month's Polysynth Checklist or simply prefer something that's now out of production, E&MM's guide to things secondhand could save you a lot of time and trouble.

## Casio Mono Mode

# 86

Baffled by MIDI Mode 4 on the Casio CZ synths? Paul Wiffen plots a path through one of modern technology's minefields, and explains how to get the best from it.

## Patchwork

# 90

Casio CZ101, Yamaha DX21 and Korg Poly 800 feature in the readers' synth sound page. Plus a review of Skyslip's latest DX7 ROM cartridges.

STUDIO

Technology



## Peter Gabriel

# 52

In a career spanning nearly 20 years, Gabriel has done everything from fronting Britain's best-known pomp rock band to manipulating ethnic music using modern technology. Dan Goldstein talks to a man of many talents.

## MADE IN JAPAN

After years of gentle cajoling, a select few of the UK's music press finally coaxed a trip to the Land of the Rising Yen out of a major synth manufacturer. The company was Yamaha, the time was early May, the journey was exhilarating.

Initially, it seemed likely the Japanese industrial giant had invited us (plus a score of the country's leading musical instrument retailers) as part of a spectacular publicity exercise to promote another range of new gear. In the event, the new gear wasn't forthcoming, and Yamaha's people concentrated instead on wining and dining the assembled party to an outrageous degree, the intention being to extend a warm 'thank you' to the dealers and press men who had supported the company and its machines over the last few years.

Food and drink apart, the trip included visits to a number of Tokyo retail shops, and a quick tour round two production lines in the provincial town of Hamamatsu. The first line dealt with DX synthesisers, the second with acoustic grand pianos.

On entering the first building, I expected to see an army of industrial robots working on a network of conveyor belts similar to that shown in Nissan's current TV advertising campaign. How wrong I was.

Unbelievably, every rear-panel socket on a DX7 is drilled by hand, every key installed individually by the same method, and after assembly, every synth is tested with the help of an oscilloscope and an antiquated piece of (un)scientific equipment known as the human ear.

Above the DX line, large scoreboards show the staff's production targets for the day and how close they are to reaching them at any given time. If the targets aren't met at the end of the

working day, the staff have to work unpaid overtime until they are – but such is the dedication and commitment of the workforce, that situation rarely occurs.

We were frogmarched rapidly past all this activity, but as we reached the halfway point of the building's production facility, the party came to a standstill. The rest of the line was being used to build new instruments, we were told, and we could go no further. No photography was allowed, either.

By contrast, piano production Yamaha-style is an extremely modern process in which automation and computer technology play a vital role. As vast eight-foot-six Joannas are transported automatically by unmanned trolleys from one part of the plant to another, a few highly skilled workers (none of whom looks as though they have been involved in making pianos for less than a decade) shape, fit, fine-tune and check the thousands of parts that go to make up each concert grand, each one supplied by a robot arm.

Again, the dedication of the workforce is obvious, and leads to an infectious enthusiasm not only for the pianos, but for music itself. As a company, Yamaha do much to ensure that their workers are as interested in music as the people who buy their products. Many of the staff attend Yamaha Music Schools, so the people who build the DXs have a genuine interest in the instruments that extends beyond the usual idea of 'doing a good job'.

In common with many other Japanese corporations, Yamaha also encourage their workers to comment on their products and the manner in which they are constructed. These comments are considered by the relevant parties at regular meetings, and where appropriate,

changes are made swiftly.

But consulting a production workforce is one thing; asking the opinion of pro musicians is quite another. Like many of their competitors, Yamaha have been criticised in the past for not listening enough to the musicians who buy their instruments and use them every day.

To combat this, one of the above-mentioned retail stores is now equipped with a 24-track recording studio that's used by working musicians, and an R&D lab in which grievances are aired, instruments are compared, and modifications are made.

The system has obviously worked well, for while we were in Japan, Yamaha confirmed that three similar R&D operations would shortly be opening in London, Paris and New York.

The London setup is due to open this summer and will be located off Regent Street in the West End. It'll be a place where working musicians and recording engineers – whether resident in the capital or on tour there – can experiment with Yamaha's latest innovations in a musical context, and pass judgement on them.

Obviously, an R&D studio that incorporates the machines of only one manufacturer isn't going to answer every musician's prayers overnight. But it is a step in the right direction. Yamaha spoilt the DX7's ship for a ha'porth of tar when they omitted to backlight its all-important liquid crystal display. Yet it's taken three years of protest from the musicians' community to get the company to produce an expensive retrofit to cure the problem.

With R&D facilities like the one in Tokyo operating worldwide, that sort of thing should never happen again. ■

Editor Dan Goldstein Production Editor Trish McGrath Reviews Editor Simon Trask Music Editor Tim Goodyer Consulting Editor David Ellis  
Art Editor Stuart Catterson Deputy Art Editor Eddie Allen Art Assistants Sam Masters, Lynn Cooper, John Waterson Photography Matthew Vosburgh, Tim Goodyer  
Illustrators Len Huxter, Clive Goodyer Consultants (Music) Annabel Scott, Patrick Moraz, Warren Cann, Ian Boddy, Paul Tingen  
Consultants (Technology) Nigel Lord, Paul Wijfen, Ken McAlpine, Jay Chapman, Steve Howell, Trevor Gilchrist, Paul White, Paul Williams  
Advertisement Manager Tony Halliday Classified Ad Manager Lynn Cowley Ad Production Manager Shaun Barrett Ad Production Assistant Claire Wiles  
Accounts Manager Lester Johannes Accounts Secretary Sonja Betts Mail Order/Subscriptions Cheryl May, Sarah Ludman  
Director Dennis Hill Publisher Terry Day

Electronics & Music Maker is published by Music Maker Publications, Alexander House, 1 Milton Road, Cambridge CB4 1UY. ☎ (0223) 313722. Typeset by Goodfellow & Egan, Cambridge. Colour origination by CL Enterprises, St Ives, Cambs. Printed by Thomas Reed Printers, Sunderland. Distributed by Magnum Distribution, London. All material is subject to worldwide copyright protection, and reproduction or imitation in whole or part is expressly forbidden. All reasonable care is taken to ensure accuracy in the preparation of the magazine but Music Maker Publications cannot be legally responsible for its contents. The Publishers cannot assume responsibility for the return of unsolicited manuscripts, photographs, artwork, or projects. Permission to reproduce printed circuit board layouts or to market kits commercially must be sought from the Publisher.

Subscription UK & Eire £15.50, Europe & Overseas (surface) £16.20, Europe (airmail) £23.50, Overseas (airmail) £37.50. Binders £3.95 (inc. postage).

© Copyright 1986 Music Maker Publications Limited

# THE LARGEST MUSIC STORE IN ESSEX

# WORLD RADIO History Music

## NOW OPEN



## What's in <sup>Super</sup> store

### ELECTRIC PIANO CENTRE

Analog, Digital or Sampled, choose from ROLAND, SAS, HP and EP Series. YAMAHA CP, PF and YPR Series, TECHNICS, KORG, CASIO and the New ENSONIO SDP-1. All on demonstration now... try before you buy!

### SUBSTITUTE DRUMMERS

Largest selection available including ROLAND TR727, TR707, TR505, CR8000 and DR-110. YAMAHA RX11, RX15, RX21 and RX21-L. KORG DDM220 and 110. Plus the Amazing New CASIO RZ-1 In Stock Now.

### REAL DRUMMERS

Choose from over 40 Drum Kits by YAMAHA, PEARL, TAMA, PREMIER, HAYMAN, ROGERS, LUDWIG etc. Also Electronic Drums and Percussion from ROLAND, SIMMONS, TAMA, PEARL, MULTIKLONE and ULTIMATE PERCUSSION.

### AMPLIFICATION

Whether you want MARSHALL, PEAVEY, SESSION, FENDER, CARLSBRO, or ROLAND, we have the largest selection at the lowest prices.

### GUITARISTS

Try the New IBANEZ and SHADOW MIDI guitar control systems for a totally new dimension in Sound! Also available the full range of effects pedals from BOSS, ARIA, IBANEZ and YAMAHA. Plus Rack Processors and equipment.

### SAX MANIACSI

Expert advice available on all Brass and Woodwind Signal Processors, including Harmonizers, Vocoders, Doublers, Octave Shift and Pitch-to-Voltage Synthesizers. Also Brass and Woodwind Instruments. Accessories and Tutors available.



**Aria** STAR DEALER FOR SOUTHEND  
Guitars, Basses & Accessories

**Ibanez** MAIN DEALER FOR SOUTHEND  
Guitars, Basses & Hi-Tech Products  
ALSO Tama Drums

**wem** MAIN DEALER FOR SOUTHEND  
Public Address & Sound Reinforcement

**Fender** SOUNDHOUSE CENTRE  
Guitars, Basses & Amplification

**PAiste** SOUND CREATION CYMBAL CENTRE FOR ESSEX  
Cymbals, Gongs & Percussion

**CASIO** PRO KEYBOARD CENTRE  
Keyboard Synthesizers & Hi-Tech products

**SEQUENTIAL** MAIN DEALER FOR S.E. ESSEX  
Keyboards, Synthesizers & Sound Sampling

**Pearl** DRUM CENTRE  
Professional Drums & Percussion

**CARLSBRO** MAIN DEALER FOR SOUTHEND  
Amplification & PA equipment

**Marshall** MAIN DEALER FOR S.E. ESSEX  
Amplification & integrated Bass Systems

**ensonio** MAIN DEALER  
Keyboards & Sound Sampling

**TASCAM** PRO SERIES DEALER FOR S.E. ESSEX  
Reel-to-Reel and Cassette Multitrack Recording

**P** DRUM & PERCUSSION CENTRE FOR SOUTHEND  
PREMIER

**PEAVEY** MAIN DEALER FOR S.E. ESSEX  
Amplification, PA and accessories

**AKAI** MAIN DEALER  
Keyboards, Sound Sampling & Hi-Tech products

**KORG** KEY CENTRE FOR SOUTHEND  
Keyboards & Hi-Tech products

**Roland** CONTEMPORARY KEYBOARD CENTRE FOR SOUTHEND  
Keyboards, Synthesizers and Sound Sampling. Hi-Tech and Studio products. Boss Pedals, Effects & Accessories. HP Series Home Pianos.

**YAMAHA** MAIN DEALER AND HI-TECH CENTRE FOR S.E. ESSEX  
Keyboards, Synthesizers & FM Pianos. Professional Drums & Percussion. Guitars. Basses & Acoustics. Pro Audio and Home Recording. Music Computers & Hi-Tech products.

108-110 SOUTHCHURCH RD, SOUTHEND  
**SOUTHEND 619615**

**FUTURE MUSIC PRICE PLEDGE! – PHONE ANY BRANCH FOR DETAILS!**

**Roland**

**NEW! ALPHA JUNO 1! 6 VOICE POLYSYNTH**



**£575**

All new cosmetics terrific sounds! Fantastic value! Look at these features: 49 notes, 63 memories, 16 character LCD display  
New LSI chip gives complex waveforms! New Dial System! Limited supplies in stock.  
Call for demo.

**NEW! ROLAND MC500 MICRO COMPOSER**

Micro composer with built-in 3.5" disc drive. Holds 100,000 notes per disc. Internal memory capacity 40,000 notes. Alpha Dial, LCD display, MIDI.

**£799**

**COMING SOON!!! NEW SUPER JX10 POLYSYNTH £1899**

Super JX10, the ultimate analogue polysynth! 76 keys! 12 voice weighted keys! built in sequencer! dual and split! 50 presets! 50 memories! MIDI! Alpha dial! Call for availability



**NEW TR505—£249!**  
16 PCM voices, 48 preset, 48 program memories, 6 tracks, LCD display, MIDI



**FANTASTIC NEW BOSS PEDALS**

DIM-C—Dimension C  
DD-2—Turbo-overdrive  
HF-2—High band flanger

DIM-C—£99  
DD-2—£47  
HF-2—£69

**ROLAND DRUMS OPEN EVENING**  
at London Shops!  
Phone for details

**Roland**

**NEW! ALPHA JUNO 2! TOUCH SENSITIVE POLYSYNTH**



Touch sensitive polysynth 64 programs, 64 presets, 16 character LCD display, new LSI chip gives complex waveforms. New Alpha dial system! 76 note keyboard

**£799**

**HS60! 6 VOICE POLYSYNTH WITH BUILT IN SPEAKERS £595!**

On board 8 watt amplifier and speakers - MIDI - 128 memories! 61 keys, LFO, DCO, HFF, VCF, VCA, ENV and Chorus. 16 MIDI channel select buttons. Connects with any MIDI equipped synth or sequencer, Optional Recorder/Rhythm Composer/ MIDI Thru Box



**ROLAND SRV2000 STEREO DIGITAL REVERB £1099**

Incredible Sophistication unbelievable Price. MIDI Controllable - Totally Programmable - 99s Delay! Look at these features: 24 memories! Parametric EQ control for room size PRG delay, Gate/Damping, reverb time MIDI + 6 integrated display, stereo output of up to 99 seconds! Many other features! **IN STOCK NOW**



**MKS-7 SUPER QUARTET**

Consists of 2-voice polyphonic Melody section, a 4-voice polyphonic Chord, a monophonic Bass and Rhythm. MIDI velocity messages increase or lower sound. Slider control address sensitivity. One hundred preset sounds for Melody section, 100 for Chord, 20 for Bass. 11 PCM digital sounds for Rhythm

**NEW ROLAND RD1000 DIGITAL PIANO**



The most realistic and economical digital piano yet! Sounds incredible! 16 voices! 88 note keyboard! MIDI! Call for further details

**NEW MKS20 DIGITAL PIANO TACK MODULE!** Rack mount version of RD1000, see above) same specification but no keyboard

10 BADDOW RD.  
CHELMSFORD  
ESSEX  
0245 352490  
0245 353878

85 ST. MARYS ST.  
SOUTHAMPTON  
HAMPSHIRE  
0703 226798

104-6 ELM GROVE  
SOUTHEA  
PORTSMOUTH  
HAMPSHIRE  
0705 820595

**FUTURE**



**KORG**

**POLY 800 Mk II**



1000 note polyphonic sequencer, programmable digital delay, up to 1024 miliseconds, programmable Eq, 6 point envelopes

**NEW EX8000 PROGRAMMABLE SYNTH MODULE £POA**

Expander version of the amazing DW8000. Many many features. Phone for details.

**DVP-1 DIGITAL VOICE PROCESSOR**

Features MIDI, 5 note programmable harmonizer, pitch shifter, 8 internal waveforms, 64 programs, 16 bit digital technology.

**£895**



**SPECIAL OFFER**

Korg MIDI pedal board and SDD2000 sampler delay. Special deals £POA Call for details.

**SEQUENTIAL**

**CALL FOR DELIVERY ON PROPHET VS AND 2002**

**PROPHET VS DIGITAL VECTOR SYNTHESIZER £2175**



The Prophet VS digital vector synthesizer features 8 voices with each voice composed of 4 digital oscillators. 200 programs via ROM and RAM cartridges. MIDI. Up to 128 waveforms. Velocity and pressure sensitive 5 octave keyboard with programmable split. Many innovative features - call in for details.

**PROPHET 2000 DIGITAL SAMPLING KEYBOARD £2175**



Up to 16 splits/touch sensitive weighted keyboard formats own disc/6 second sampling at 21KHz - 10 secs at 15KHz/Extremely sophisticated

**PROPHET 2002 DIGITAL SAMPLING MODULE £1795**

Rack mount version of the Prophet 2000. Same specification but without keyboard.

**MULTITRAK £695**



Sequential's new advanced polysynth, now at all-time low price. Touch sensitive, powerful on-board sequencer, multi-timbral, MIDI.

**TOM £499**



The advanced digital drum machine now at this ridiculous price

**FUTURE MUSIC PRICE PLEDGE! – PHONE ANY BRANCH FOR DETAILS!**



**FUTURE MUSIC PRICE PLEDGE! – PHONE ANY BRANCH FOR DETAILS!**



**YAMAHA**

**FANTASTIC NEW PRODUCTS!**

**DX27 £499**



A regular key version of the DX100. Its features and specs are nearly identical to the DX100 so you can use it as a MIDI on line controller keyboard.

**QX21 DIGITAL SEQUENCE RECORDER £259**

This high-performance 2-track digital sequencer is capable of recording anything you play on a Yamaha DX synthesizer or other MIDI keyboard, complete with touch response (velocity), pitch bend, modulation, and other function parameters, 6000 to 8100 note memory, 7 character LED display, MIDI.

**MCS2 MIDI CONTROL STATION £POA**

MIDI magic! There is so much to tell you about this product we simply don't have the space. A million new ways to use MIDI. Call us and we'll explain.

**SPX90 DIGITAL MULTI EFFECTS PROCESSOR £599!**

One of the most exciting new products to appear for years! Features include reverb, early reflection, delay, echo, modulation control, auto pan, vibrato, reverb & gate, pitch change, freeze, ADR gate, compression, parametric EQ, flange, phase, MIDI RC7 Remote controller available soon!

**MEP4 MIDI EVENT PROCESSOR £POA**

The MEP4 has a myriad of uses in MIDI recording. In the studio it can do such things as removing unwanted controller information from a sequencer track, delaying MIDI clock messages, or assisting in MIDI midtown. 60 program memory, 16 character LCD display.

**NEW YAMAHA SDS PEDAL RANGE – Superb Quality, Super Low Price!**

Compressor .....£39  
Distortion .....£39  
Overdrive .....£39  
Chorus .....£59  
Flanger .....£59  
Graphic EQ .....£59



**YAMAHA**

**HI-TECH EXCELLENCE!!!**



**DX21 £649**  
128 Pre-programmed voices, 32 performance memories, MIDI, 8 note polyphonic



**DX100 £349**  
DX100 battery operated FM Synth mini keys 129 voice ROM, 8 note polyphonic, 49 notes, ideal MIDI control synth.



**REV 7 £899**

Yamaha break the price performance barrier with the brand new REV 7! 19" rack mount and with remote, simulates 307 reverb characteristics! New LSI chips give up to 15 early reflections and 99.9 milliseconds of initial delay. Parametric EQ, MIDI, 30 x presets, stereo, 60 user memories!!!



**QX1 MEGA SEQUENCER SUPER PRICE**

Incredibly sophisticated state of the art data storage, the most powerful yet! 8 Polyphonic channels, built in disc drive with one editing. Best Yet!

**KX88 MOTHER KEYBOARD**



Yamaha invent the ultimate in MIDI remote keyboards! Light and portable yet full of features! 88 notes, wood keys, beautiful light 19 different control effects, 192 parameter change possibilities. THE ULTIMATE



**TX7 FM TONE GENERATOR £499**

**QX21 SEQUENCER £1295!  
TX816 INCREDIBLE PRICE – PHONE!**

**QX7 DIGITAL SEQUENCE RECORDER £299  
MT44D Multitrack Recording Systems PHONE**



**MUSIC**

44-6 PRESTON RD.  
BRIGHTON  
SUSSEX  
0273 675983/4

202 NEW KINGS RD.  
FULHAM  
LONDON SW6  
(Emp. Putney Bridge Tube)  
01-736 4771

173 KENTISH TOWN  
ROAD  
LONDON NW1  
01-267 3786  
01-485 1448



**ensoniq**

**FANTASTIC NEW PRODUCTS**

**ENSONIQ DIGITAL PIANO**



Use multi-sampled grand piano waveforms first instrument! 76 keys, touch sensitive, MIDI. 12 other sounds include electric piano, twinky tonk piano. Call in for demo. **£1080**

**SQ1 DIGITAL SEQUENCER SYNTHESIZER**



**£1080** 8 voice polyphonic/polyrhythmic, 3 oscillators, per voice 80 character display, 40 programs, 8 tracks, 2400 notes up to 10,000 with cart, MIDI sequencer.

**MIRAGE DIGITAL SAMPLING KEYBOARD**



5 octave, velocity sensitive keyboard, 8 voice polyphonic, 16 different samples, up to 8 seconds, 3.3" disk drive, on board sequencer, MIDI. **£1320**

**MIRAGE DIGITAL MULTI-SAMPLER (RACK MOUNT)**



**£1080** Rack mount version of Mirage keyboard, MIDI. See above for spec.

**NEW ALESIS**

**THE FANTASTIC NEW MIDIVERB – £399!!**

Completely digital, the Midiverb offers a powerful range of 63 room programs in full stereo. Everything from small rooms to full halls. Decay times from 0.2 to 20 seconds as well as gated and reversed programs for special effects, plus MIDI. In stock at all Future Music branches



**Fostex**

**MODEL 80 MULTITRACK RECORDER**

Fostex pioneered eight tracks on quarter inch. This unique format offers convenience and economy of operation with audio mastering quality. This unique fourth generation Personal Multitrack recorder and uses microprocessor control technology to achieve smoother, faster working accessories.

Model 80 audio quality is light and clear, the result of no frills electronic circuit design and the incorporation of the latest Dolby 'C' noise reduction. Every feature is included to make the process of recording and overdubbing, faster and even more manageable for working musicians.

- Redesigned cosmetics with bargraph meters
- SMPTE timecode track
- Improved signal to noise ratio + 20dB
- Record on all 8 tracks
- MIDI interface for controlling synths

**450 MULTITRACK RECORDING MIXER**

The Fostex 450 mixer is designed to complement the Model 80 recorder in versatility, quality and speed of operation. It has a total of seven busses, but it's designed to work eight tracks. Efficiently and economically. The state of the art in Personal Multitrack.

Like all Fostex products it's carefully designed and made. Sensible colour coding and light weight are important physical features. Electronically and operationally there's innovation throughout. Every feature for mixing and monitoring has been included to provide a fast console for music or production applications.

- Completely redesigned cosmetics and routing system
- Bar graph integral meters
- Pre and post 3 band parametric eq
- In line monitoring
- Input solo
- 2 aux sends
- Phantom powering

**MODEL 20 MASTER RECORDER**

Based on the same transport as the Model 80 Multitrack, the Model 20 Master recorder offers unique facilities to anyone mastering for production.

The standard mastering two track, two channel format is supplemented by a third, cue channel, located in the centre of the tape, intended for recording and playback of SMPTE time code. This feature, coupled with full synchroniser compatibility, puts all of the potential of advanced production techniques into the hands of the user.

The proven cost benefits of the compact Fostex transport, and the incorporation of up to date facilities opens up a new range of opportunities in multitrack.

Until now, synchronisation of SMPTE and MIDI, of music and video, was reserved for select, top of the market studio operations. Now Fostex puts this link to the future within reach of every working studio and musician.

- Matching cosmetics to model 80 & 450
- Bargraph integral meters
- 15 & 7.5 ips speed
- Warspeed!
- Easy editing
- Dolby C
- SMPTE



**FOSTEX PRICE RISE!  
SOME MODELS AVAILABLE AT THE OLD PRICE**



**FUTURE MUSIC PRICE PLEDGE! – PHONE ANY BRANCH FOR DETAILS!**

World Radio History

## YAMAHA'S XPERIENCE

A little London sunshine graced Yamaha's 'Hands On Show' recently. Plenty of smiling faces told the story of a smooth-running event – from both manufacturer's and punter's point of view alike. In fact it was hard to



believe that Yamaha were in the market to sell anything at all, as the emphasis fell firmly on information rather than intimidation.

The full range of hi-tech Yamaha gear – from the glories of a KX88/TX816/QX1 arrangement, to a modest DX100 – was set up, and available to all members of the public to investigate as they saw fit. Throughout the day there were talks covering everything from the nuances of the DX100 (delivered by Ken Campbell), to the sins of FM itself (courtesy of Martin Tennent).

Tony Wride and the DX Owners' Club were in evidence handing out friendly information and free RAM cartridges, much to the delight of their recipients. Also to the delight of their recipients went a DX100, KX5 and TX7, and RX21L; the prizes of a free draw open to all comers.

Drummer Micky Barker took a prestige spot with the first public appearance of Yamaha's new electronic kit, and any shortcomings of the demonstration due to incomplete equipment or lack of familiarity with it,

were more than compensated for by Barker's skill and Dave Bristow's FM programming. Bristow's stunning bell-into-choir patch is quickly becoming a legend in its own showtime.

Bristow himself made sure that the highlight of the day was in no doubt with an appearance of the all-star band, 'Boiler', featuring Bristow, accompanied by drummer Barker, guitarist John Etheridge and the giant Yamaha Corporation on everything from instrumentation to PA. Together they put in a blistering set with Etheridge wandering bar-ward at one point, to demonstrate the inestimable usefulness of the radio pick-up on his guitar.

Nice one Yamaha, same next year? ■ Tg

## VENUE FOR THE BRAVE

Coincident with her new LP, 'Home of the Brave', Laurie Anderson has made a film. No great surprise really, when you consider that the album is the film soundtrack.

Directed by Ms Anderson herself, 'Home of the Brave' is basically footage of one of her shows. But don't be deceived – a Laurie Anderson show is a show, not to be confused with the overblown productions some egocentric stars would have us believe are shows. In it she investigates and exploits the rhythmic and harmonic merits of music hand-in-hand with those of dance, mime and evocative visuals. In this she is assisted by such dignitaries as part-time Talking Head Adrian Belew, and full-time sage William S Burroughs.

If you're in a rut with your music and could use a little inspiration, or simply want an entertaining evening out, the name's Laurie Anderson. ■ Tg

## SWITCH TO MIDI

The latest labour-saving invention from Skyslip is a MIDIs witch. A simple unit, the MIDIs witch allows one MIDI Input to be connected to either of two MIDI Outputs (or one MIDI In to have one of two MIDI Outs routed to it). Additionally there is an On/Off switch disconnecting the Ins and Outs. Skyslip reckon it'll save a lot of lead swapping in a comparatively straightforward MIDI set-up – without breaking the bank.

More from Rock City Music, 10 Mosely Street, Newcastle-upon-Tyne. ☎ (0632) 324175, or White Electric Music, 5 Stockton Road, Sunderland. ☎ (0783) 78058. ■ Tg

## SHULZE FAN CLUB

Anyone interested in joining the official Klaus Schulze fan club could do worse than to contact Mix Music, as they've recently taken control of the operation.

The fan club offers special prices on CDs, LPs, cassettes, badges and T-shirts to its members; annual membership fees – including photos, biographies and a poster – are £5 for ▶

# LATEST GEAR

# KNOCKOUT PRICES

## BLAM KEYBOARDS

Roland Alpha Juno I	525.00	Yamaha PF80	999.00
Roland Alpha Juno II NEW	799.00	Piano and midi controller 88 keys	
Roland JX8P		Yamaha PF70	899.00
NEW LOW PRICE!		Piano and midi controller 6 keys	
Yamaha DX100	349.00	Yamaha KX5	139.00
Yamaha DX27	499.00	Reminiscent of the old	
Yamaha DX21	649.00	Korg Poly 800	525.00
Yamaha DX7	1249.00	Mk II NEW	649.00
Yamaha DX5	1995.00	Korg DW6000	999.00
Yamaha TX7		Korg DW8000	
Expander	449.00		
Yamaha KX88	1099.00		
Midi controller			
Yamaha TX816	3099.00		
Super expander			

ASK ABOUT OUR AMAZING CASIO DEALS! Ensoniq ESQ Synth Available Now

## CRASH SAMPLING

Ensoniq Mirage	1295.00
Keyboard and advance samplers guide	
Ensoniq Mirage Sampler Module with Midi	995.00
Prophet 2000 Keyboard Discs available now	1995.00
Akai S612: Samplers & Disc Drive - Ask about our new low price!	
Yamaha YSS-100 Sampling Sensation	£179
New Akai S900 in stock now!	

## KER POW DRUM MACHINES & SEQUENCERS

Roland TR505	NEW 225.00	Yamaha RX15	449.00
Roland TR707	499.00	Yamaha RX11	699.00
Roland TR727 Latin		Yamaha QX21 Sequencer	259.00
Roland MSQ700	469.00	Yamaha QX1 Sequencer	1295.00
Yamaha RX21	599.00	Korg SQD1 Sequencer with disc drive	245.00
Yamaha RX21L Latin	245.00		
Roland MC500 Sequencer - Casio R21 Drum Machine in Stock Now!	245.00		

## SMACK HOME-RECORDING

Fostex X15	245.00	Yamaha MT1K NEW!!	449.00
Fostex 260	699.00	Yamaha SPX90 NEW!!	599.00
Fostex Model 80	1575.00	Alesis Midi verb	399.00
Fostex 450 Mixer	699.00		
Tascam Portatone	399.00	Mics & Accessories by Boss	
Tascam 244	BUY NOW AND	Accessit Fostex - Tascam	
Tascam 246	BEAT THE	Yamaha Sennheiser - AKG	
Tascam 388	PRICE INCREASE	Shura - Audio Technica	
Buy any Tascam Portastudio, get 10 Free Cassette Tapes!		Mixers by AHB Soundtracs	
		Studiomaster - Ram Dynamix	

## POW AMPS

Peavey Backstage Plus		Carlsbro Homet 45 Lead	
Peavey Studio Pro 40		Carlsbro Colon 90 Twin	
Peavey Bandit 65		Carlsbro Homet 45 Bass	
Peavey Special 130		Carlsbro 45 Cobra 90 Bass	
Peavey TK065		Carlsbro Homet 45 Keyboard	
Peavey TNT 130		Carlsbro Cobra 90 Keyboard	
Peavey KB100		Carlsbro Marlin 150 P.A.	
Peavey KB300		Carlsbro Cobra 90 P.A.	
Hi-Watt amps in stock			

ALL AT LOW PRICES

## BIFF GUITARS

Westone Thunder Jet	245.00	Aria TA 30	210.00
Westone Spectrum ST	155.00	Aria TA 50	299.00
Westone Spectrum MX	175.00	Aria Heritage Bases in stock!	
Westone Spectrum DX	199.00	Aria Rs Deluxe	310.00
Westone Spectrum GT	149.00	John Taylor	175.00
Westone Thunder Jet Bass	149.00	Yamaha SG200	349.00
Westone Spectrum STB Bass	149.00	Yamaha SG1300T	599.00
Westone Spectrum DXB Bass	179.00	Yamaha SG2000	399.00
Westone Spectrum GTB Bass	225.00	Yamaha SA800	679.00
Aria Wildcat	199.00	Yamaha SA1200	365.00
Aria Knight Warrior	325.00	Yamaha SE700	339.00
Aria Laser Series in Stock!		Yamaha BB1100s	339.00
		Yamaha BB300	175.00

PLUS Ibanez - Tokai - Squier - Hondo All at Knock-out Prices!

## ProShop

Open at Addlestone (just off Junction 11 M25) and Oxford. Visit our special demonstration studio where you can hear and try the very latest '8 and 16 track recording equipment and accessories plus all that's new in sampling technology, Drum machines and Sequencers, phone now and book an appointment for that special individual attention!

ABC Pro Shops  
Oxford (01865) 724870  
Addlestone (0932) 58675

## THUMP DRUMS

Secondhand Specials (ESHER BRANCH)	
Broadway 4 piece kit	£95
Premier Elite 7 piece kit	£399
Premier Royale 7 piece kit	£395
Pearl Pro 5 piece kit	£445
NEW Premier APK 5 piece kits	£445
Zildjian Cymbals - massive selection - 20% Off	
Cases, Sweatshirts, spares, tutors, stands, pedals	
Electronic & Practice kits in stock	

● LATE NIGHT Thursdays till 7.00pm  
● Instant Credit - floor limit £1,000!  
● If you see a genuine advertised price we'll match or beat it. You can't buy cheaper!

# ABC music

Don't waste a second, contact us below!

14-16 High Street  
Addlestone Surrey  
(Just off Junction 11- M25)  
0932 40139/54877  
324 Farnham Road Slough  
(Just off Junction 6 - M4)  
0753 822754 Radio History

56 Surbiton Road  
Kingston Surrey  
(near Kingston Polytechnic)  
01-546 9877  
44 St Clements  
Oxford  
0865 725221

Drum Woodwind & Brass Dept  
96 High Street  
Esher Surrey  
0372 66195

► UK residents, £7 for European residents and £8 for overseas.

More from Mix Music, 33 Peel Road, North Wembley, Middlesex, HA9 7LY. ■ Tg

## DX7 – THE LIGHT DAWNS

Yamaha answer their critics once again with the announcement of a backlit LCD kit for the DX7; £50 is all you need to alleviate peering at indecipherable characters in the half-light of a stage. The retrofit requires no soldering and may be ordered from any Yamaha Combo Keyboard Stockist.

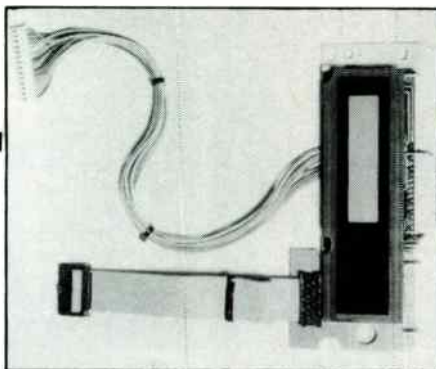

## CONVERSION

UMI have added their own offering to the ever-increasing number of MIDI-to-CV converters currently on the market. Capable of handling CV, Gate and VCA/VCF information,



the ConVerter also doubles as a MIDI channel converter. And the price? A mere £245. More from The London Rock Shop, 26 Chalk Farm Road, London, NW1 8AG. ☎ 01-267 7851. ■ Tg

## THEY'RE GETTING YOU THERE

With the second re-vamped British Music Fair getting perilously close, British Rail have some good news for us for a change.

They tell us there is to be a new high-speed InterCity service linking northwest and south-east England. The new service will be up and running in time for the fair and will provide a regular link from Manchester or Liverpool through Stoke, Birmingham, Coventry, London Kensington Olympia, Gatwick Airport, Brighton, Newhaven, Folkstone to Dover. It should even please your parents as BR reckon on having everyone home again by 10.35pm. There will also be Tube connections for the period of the show making life ridiculously easy.

The BMF will run from 29 July to 3 August; the first three days are trade only, whilst the August dates are open to the public. Opening times are 9am to 6pm. Don't miss it. ■ Tg

## MIXING IT

The fledgling Icon Designs have a new mixer to add to their ever-expanding line of products. The A4 Mixer is a compact 6-into-2 stereo mixer with input level controls, two

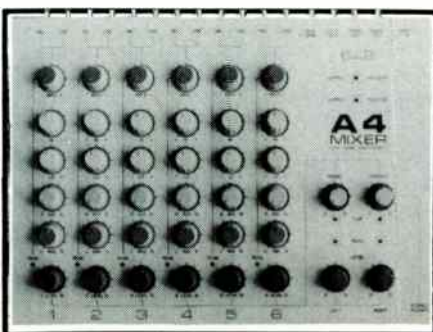

band equalisation panning and an auxiliary pre-fade send channel. At £170 the unit is intended for home recording or stage mixing rôles. More from Icon Designs, 423 Newmarket Road, Cambridge. ☎ (0223) 61293. ■ Tg

## WELCOME TO THE MIDI SET

Any Amstrad CPC owners feeling left out in the cold by the MIDI set have just become eligible for membership. This passport to new friends and experiences takes the form of the DHCP Electronics MIDI interface. The interface itself costs £50 with a CZ editing package available in both cassette and disk formats (£15 and £25 respectively). There is also a library of voices for the CZs at £15 for each 32-voice package.

A sequencer package, along with similar packages for use with Yamaha and Korg synths, are planned for the near future. More from DHCP Electronics, 32 Boyton Close, Haverhill, Suffolk, CB9 0DZ. ☎ (0440) 61207. ■ Tg

## SOMETHING NEW FROM SYNTECH

Just in from California are three new software packages from Syntech (whose Studio 1 sequencing package for the CBM64 we looked at last November), all of which are designed to run on the Commodore 64/128.

The first of these, Song Player, is an extension of Studio 1, which allows up to 28 songs to 'autoload' in a live situation to get around those embarrassing pauses while data is loading from disk. The second, Keyboard Controller, allows you to turn any MIDI keyboard into a master controller of up to 16 MIDI devices; one hundred patches store setups of MIDI volume, wheel, pedal and footswitch information.

Lastly, DX/TX, gives on-screen control of all Yamaha FM products, from the TX7 upwards, in two modes: Librarian, which allows you to load and save DX programs in batches of 32 as well as move individual sounds around; and Program Editor, which gives visual representations of the FM parameters and permits easy programming of sounds and Functions. A footswitch which plays direct into the Commodore's joystick port is also available to automatically start load and edit routines.

But Syntech's expertise doesn't just restrict itself to software. Along with the above packages, we have news of a Chroma-to-MIDI hardware interface which allows Rhodes Chroma owners to tap into the wonderful world of MIDI. And on a fairly high level too – even Mono Mode (Mode 4) is catered for allowing full use of the Rhodes' eight-voice multi-timbral capability.

Unfortunately, we still have no final confirmation on UK distribution, but Syntech can be contacted directly at 23958 Craftsman Road, Calabasas, California 91302, USA.

Prices in US dollars: Song Player \$99.95, Keyboard Controller \$149.95, DX/TX Master \$149.95, Chroma-to-MIDI interface \$349.95. ■ Pw

# Rod Argent's Keyboards

20 DENMARK STREET,  
LONDON WC2,  
TEL: 01-379 6690 (SALES)  
01-240 0085 (SERVICE)

## SEQUENTIAL



SEQUENTIAL PROPHET VS: Vector synthesis? Dan Dare would have loved it! ▲

*360 Systems*

360 SYSTEMS MIDI BASS: Let your ears do the buying, and choose from over 40 great sounds. ▼



## Roland

ROLAND RD1000: They call it structured adaptive synthesis. We don't know what it means but it sounds wonderful. 3 piano sounds, harpsichord, clav, Rhodes and more. ▼

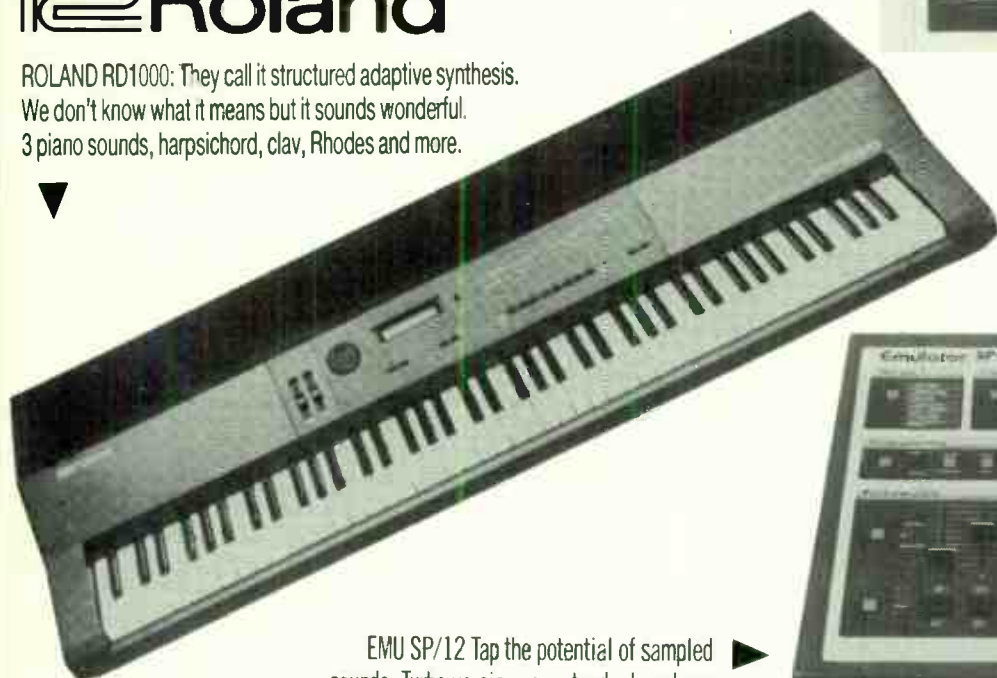

## AKAI

AKAI S900: The friendliest sampler this year. All the spec, and the memory, and easy to use. ▲

EMU SP/12 Tap the potential of sampled sounds. Turbo version now standard, and you won't believe the price. ▶



**E-mu Systems, Inc.**

STEINBERG RESEARCH – The best computer sequencer/sequencer software available. 16 and 8 track for Commodore, 24 track for Atari.

# COMMUNIQUE

Write to: Communiqué, E&MM, Alexander House, 1 Milton Road, Cambridge CB4 1UY.

## Dear E&MM

### Weighing It Up

Weighted keyboards – great! MKB1000, KX88 – great, not perfect, but great!

Gone are the days when a synthesiser keyboard was simply a set of electronic switches designed to bring forth the voice of a couple of analogue oscillators via a low-pass filter. At last the synthesiser is an instrument, and is (largely) receiving the respect due to one. But I think there's a point here that's being missed. All instruments (no matter how traditional or old fashioned) have their quirks – their own individual strengths and weaknesses – in sound and playing technique. And so it is with the synthesiser: it has never been an 'incomplete' instrument awaiting the arrival of a weighted keyboard, and touch sensitivity; a synthesiser has always been a valid instrument with all its shortcomings.

How many times have we read of keyboard players commenting on the discomfort of playing a 'brass' synth patch from a weighted keyboard? The lesson appears to have been lost, it's become quite natural for a synthetic brass sound to emanate from an unweighted keyboard – often without so much as velocity sensitivity to give it any conviction. Surely there is a legitimate place for both types of synth in the modern player's arsenal. Neither gives its user complete control of the sounds at its disposal (and let's not get involved with foot pedals and breath controllers just yet), and both has its strengths and weaknesses.

If you're still in doubt consider this: how much of a rebellion is documented over the arrival of the harpsichord by the long-standing organ fraternity? They're both keyboards, and they require drastically different playing techniques. I dread to even contemplate the dubious pleasures of playing a harpsichord sound from a weighted keyboard controller.

■ Louise Mitchell  
Brighton

## Dear E&MM

### Points of Review

Perhaps I'm out of step with the times, but, though I read E&MM from cover to cover, I find some of the reviews somewhat difficult to follow. It seems to me that the magazine has

become a 'definitive' work for those of us who take an interest in electronic music.

In these days of constant updating and upgrading in the electronics market, it is important that those of us who wish to assess and maybe purchase from time to time have some means of comparing performance and facilities from review to review.

Might I suggest a standard format for each type of instrument (keyboards/synths, drum machines, samplers and so on), so that one could obtain a picture of each type of facility? Sadly, magazines like 'What Keyboard' produced over-simplified and frequently inaccurate reviews which didn't help at all.

The review standards in E&MM are generally good, but the phrase 'but more of that later' sometimes leaves one in a state of confusion. Perhaps a little less of the enthusiasm and trendy chat and a little more objectivity would help to make things more orderly!

■ Mark Ballamy  
Guildford

## Dear E&MM

### I Write the Songs

What does Steve Troughton think he's talking about? The wonderful world of MIDI – what ever happened to music?

First of all, where does a self-confessed novice to MIDI get the cash to lay out on a DX21, Multitrak, CZ5000, MSQ700 and RX11? OK, so we don't know the background to the situation, and I'm probably devaluing my point of view by mentioning it, but it sounds well dodgy to me.

So what is my point? I'll tell you, he's made half of it himself already: 'As the proud owner of three MIDI polysynths, one MIDI sequencer and one MIDI drum machine, I am utterly perplexed and confused. To get my musical ball rolling I have to make so many connections, adjust so many parameters and sort out so many operational problems I just might as well be using a load of gear that isn't compatible at all.'

The concept of universal compatibility is all very well, one might even say idealistic, but just where does that leave the music – remember song and lyric writing? The music was, after all, the original impetus for all this spectacular innovation. It is only to realise

musical ideas that drum machines, sequencers and a hundred and one other awe-inspiring little gems were designed in the first place. Don't get me wrong, I don't condemn technology, synths or any new form of sound-production you care to name. It's the idea of a supposedly 'helpful' communication system getting in the way of the very thing it was intended to further that bugs me.

The best music comes from the gut, and if it takes two days instead of two minutes to make its way out then it's past its best and probably getting pretty rancid. I'm not suggesting we abandon the MIDI system, but let's try to keep it in perspective. Let's get back to basics and make music the highest priority; in fact let's simply get back to making music.

■ Mick Perrett  
Reading

## Dear E&MM

### Glass Works

It is thanks to a review in E&MM, way back in 1984, that I became interested in the music of the modern American composer and performer, Philip Glass. Since then I've been attempting to obtain more information, scores, and recordings by this unique man.

My investigations have involved me in correspondence with organisations in both Europe and America, and with books such as the excellent 'American Minimal Music' and whilst I have obtained recordings issued by CBS, Island and Virgin in the UK, and by Tomato in France, I am still unable to obtain recordings of the early works published on Chatham Square and Shandar.

Do you know of any possible sources for these early recordings? I'd also like to contact any readers who own these records and may wish to sell them.

Incidentally, for anyone who's interested, a helpful source of avant-garde recordings is the New Music Distribution Service, 500 Broadway, New York NY 10012.

■ P Davies  
Merseyside

As far as we can ascertain, the recordings you're looking for are no longer available, but we'll be pleased to pass on any correspondence we receive from any readers who would like to help. ■

# The One-Stop Recording Shop

## FOSTEX MODEL 80 8-TRACK MULTITRACK RECORDER

Fostex, the pioneers of 8-track recording on 1/4" tape, have created a new masterpiece for home and studio recording – the unique Model 80.

Complete synchronisation with SMPTE-controlled, professional video recorders and MIDI music sequencers can be achieved with Fostex's add-on sync units. Until now, advanced production facilities with accurate syncing and combined auto-location have only been available in expensive editing suites. The introduction of low-cost video cameras and computer-generated graphics open up possibilities for total control of your creative output in a professional studio environment at home.

Powerful transport control features such as autolocate with 2 memory locations, search to zero or memory location 1, shuttle from location 2 back to 1 plus autoplay from memory 1 or 2 are all standard features, although only normally found on more expensive professional multitrack recorders. The combination of 15 ips tape speed and Dolby C noise reduction produces a tight, clean sound that is immediately recognisable as "professional." Quite simply, the Model 80 is unique, so why not come and check it out for yourself? No appointment is necessary but a courtesy call will ensure a personal demonstration... Make your music our business!

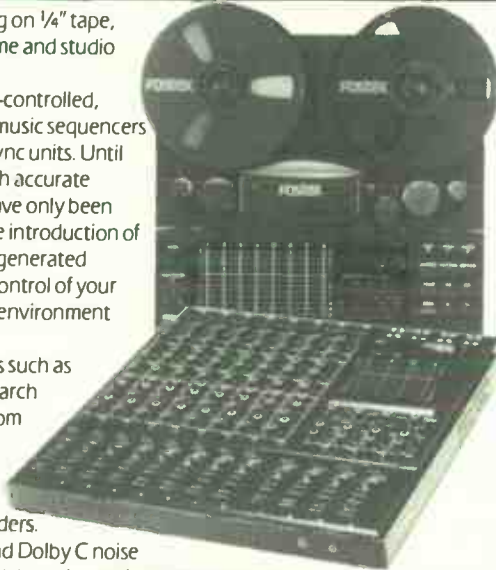

## PORTASTUDIO? from £245

FOSTEX: X-15 Babytracker.....	£245
YAMAHA: MT-44D cassette.....	£399
TASCAM: Porta-One.....	£399
FOSTEX: 260 Multitracker NEW.....	£699
TASCAM: 244 Portastudio.....	£699
TASCAM: 246 Portastudio.....	£899
YAMAHA: MT-1X, NEW.....	£449

## 8 TRACK? from £1575 inc vat...

FOSTEX: A-8 1/4" reel-to-reel Dolby C  
 FOSTEX: 350 8-4-2 mixer for A-8 system  
 FOSTEX: 3060 meter bridge for 350 mixer  
 We usually have second-hand A-8 systems in stock from customers who have traded up to 16 track and beyond. The NEW FOSTEX system is always on display..... from £1995:  
 FOSTEX: NEW Model 80 SMPTE-compatible 1/4" recorder with sim 8-track recording.  
 FOSTEX: NEW 450 8 into 4 desk for Model 80 system. No meter bridge required.  
 FOSTEX: NEW Model 20 1/4" 2-track Master mixdown with SMPTE compatibility.

## SPECIAL VALUE LINES!

### NEW ALESIS MIDIVERB ONLY £395

Stereo digital reverb with 60 presets including gated sounds. Fits Boss micro rack for 19" rack mounts



### NEW FOSTEX 260 4 track multitracker cassette

Two aux sends  
 Real time LCD counter  
 More comprehensive EQ and monitoring  
 Angled casing  
 Four LED ladder level displays  
 Price £720 inc. VAT



### NOW ON DEMONSTRATION

### SPECIAL PURCHASE ROLAND MKB1000

Mother Keyboard, 88 keys, brand new boxed. Limited quantity. £899 inc VAT. SORRY NO MAIL ORDER - PERSONAL CALLERS ONLY

### SAMPLING UNITS

PROPHET 2000.....	£2195
PROPHET 2002 Rack.....	£1895
PROPHET 2000/2002 sound library	
ENSONIQ MIRAGE.....	£1295
ENSONIQ MIRAGE Rack.....	£995
ENSONIQ MIRAGE sound library	
disks 1-16.....	£15 each
ENSONIQ/COMMODORE 64 visual editing systems	
AKAI Rack sampler & disk drive.....	£799
YAMAHA VSS100 keyboard.....	£179
BOSS RSD10 sampler/DDL.....	£199
BOSS DSD2 pedal.....	£150



### BOSS MICRO-RACK SERIES

High quality signal processing units – ideal for Home Recording.

	RRP	OUR PRICE
RDD-10 Digital Delay.....	£175	£149
RPH-10 Phaser.....	£130	£115
RBF-10 Flanger.....	£130	£115
RGE-10 Graphic Equaliser.....	£130	£115
RCL-10 Compressor/Limiter.....	£130	£115

Above units require Boss PSA-220 mains  
 New RPO10 pre-amp/para EO..... £129  
 New RSD10 sampler/DDL..... £199

### OUTBOARD EFFECTS & ACCESSORIES

<b>DIGITAL REVERBS:</b>			
ROLAND SRV-2000.....	£1100	ALPHEX C aural exciter.....	£299
YAMAHA REV-7.....	£949	ROLAND Dimension 'D'.....	£299
YAMAHA SPX90.....	£599	BOSS RPH-10 Phaser.....	£115
ALESIS MIDIVERB.....	£395	BOSS RBF-10 Flanger.....	£115
<b>SPRING REVERBS</b>		BOSS Rack for 2 units (=9").....	£20
VESTA FIRE RV-3.....	£213	BOSS Multi unit rack.....	£45
ACCESSIT SPRING.....	£145	BOSS CE-300 Stereo Chorus.....	£199
<b>DIGITAL DELAYS</b>		ACCESSIT Rack for 3, 6 or 9 units.....	£25
ROLAND SDE-3000.....	£799	BOKSE Clock sync unit.....	£396
ROLAND SDE-1000.....	£399	JMS CV & Gate to MIDI.....	£219
IBANEZ DMD-2000.....	£525	ROLAND MIDI ch filter.....	£199
VESTA FIRE DIG-411.....	£213	ROLAND MIDI input selector.....	£69
DIGITECH 1 9 SECS.....	£251	ROLAND output ch selector.....	£79
BOSS RDD-10.....	£149	QUARK MIDI Link 999.....	£299
<b>GRAPHIC EQUALISER</b>		QUARK MIDI Link 448.....	£179
YAMAHA Q1031 31 band.....	£199	plus many, many more	
YAMAHA Q2031 dual 31.....	£399	<b>COMPRESSOR/LIMITERS &amp; GATES</b>	
IBANEZ GE-3101 31 band.....	£229	DRAWMER DL-221.....	£396
FOSTEX 3030 10 band.....	£179	DRAWMER DS-210 Dual gates.....	£339
<b>OTHER RACK UNITS</b>		YAMAHA GC-ZU20.....	£229
IBANEZ HD-1500 HARMONISER.....	£495	BOSS RCL-10.....	£115
		<b>DRUM MACHINES</b>	
		ROLAND TR505.....	£225
		YAMAHA RX21.....	£249
		YAMAHA RX21L.....	£249
		YAMAHA RX15.....	£449
		ROLAND TR707.....	£465
		ROLAND TR727.....	£465
		YAMAHA RX11.....	£699
		CASIO RZ1 New.....	£349

**JUST ARRIVED THE AMAZING NEW RANGE OF TECHNICS PIANOS**  
 Call in for demo

### NEW PRODUCTS

IBANEZ DD-700 DDL 1024ms.....	£225
IBANEZ DD-1000 Dual DDL.....	£370
MTR DNG-One Dual Noise gates.....	£224
DRAWMER MidiMan intelligent MIDI.....	£453
VESTA FIRE DIG-412 128 programme DDL.....	£443
ACCESSIT Aural Exciter.....	£80
STEINBERG Mirage editing software.....	£120
STEINBERG MIDI Matrix routing box.....	£149
STEINBERG C-64 s'ware on E-Prom from.....	£177
SEQUENTIAL Prophet 2000 sound library.....	£99
RITTOR Yamaha DX-7 ROMs x 2.....	£49.95
PASSPORT Mastertracks Apple s'ware.....	£199
OBBERHEIM Stretch DX MIDI retrofit.....	£498
AKAI ME-25C MIDI note separator.....	£99
AKAI ME-30P MIDI prog. patch bay.....	£99
C-LAB Supertracks C-64 s'ware.....	£110

TEL: 01-267 5381/7851

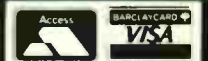

FOSTEX \* TASCAM \* QUAD \* TANNOY \* ROLAND \* YAMAHA \* BOSS \* ACCESSIT \* VESTA-FIRE \* DRAWMER \* SHURE \* AKG

# The London Rock Shop

MAKE YOUR MUSIC OUR BUSINESS!

Your questions answered by E&MM's resident team of experts. If you have a query about any aspect of music technology, or some information that might be useful to other readers, write to Interface at the editorial address.

**A** I'm the lucky owner of a Böhm digital drum machine. One disadvantage of the machine is its poor interfacing facilities. I have, however, got hold of instructions from the manufacturer

on how to get 24 pulses per quarter note, and I'd like to pass them on to other owners of the machine.

All you do is this. Looking at the cassette interface PCB from underneath, break the

track at the point marked 1, and solder a wire from point 2 to point 3. This will give you 24 pulses per quarter note.

■ Ole H Overli  
Norway

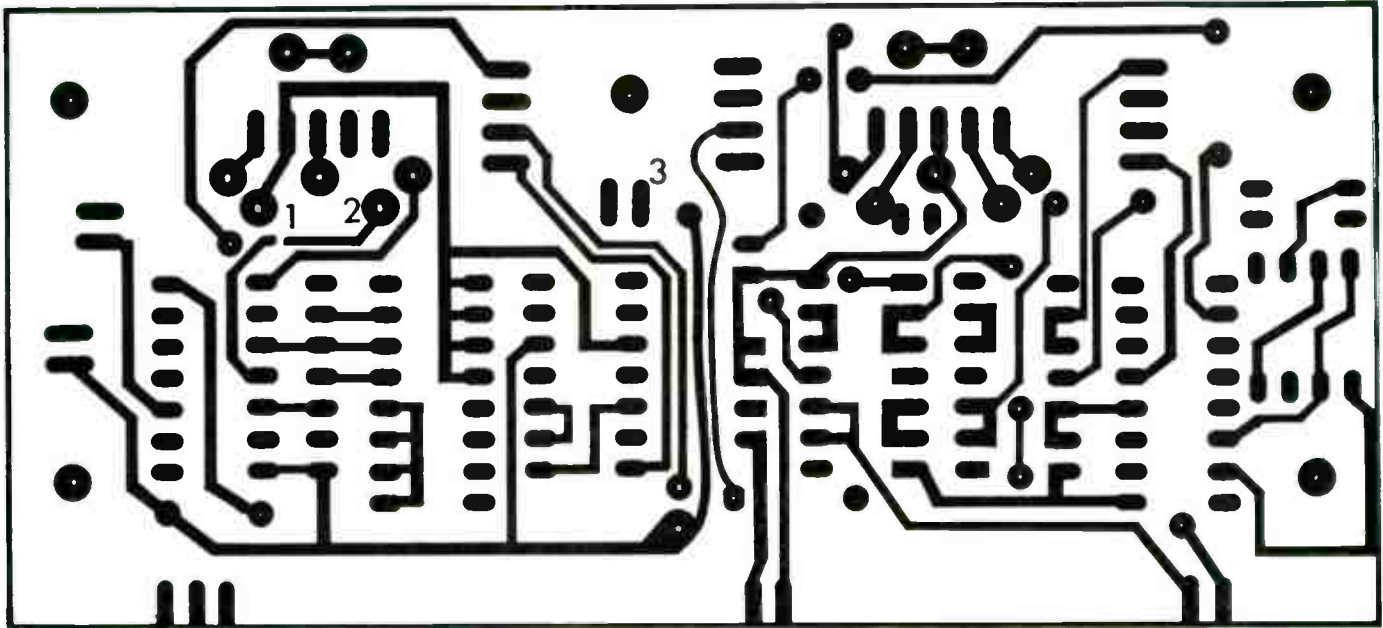

**Q** It's nice to see that professional quality instruments are now coming into the sort of price range a home musician has access to. I once had a two-manual electronic organ, but have recently bought a DX21 synthesiser which is giving me hours of fun and pleasure. It also drives me mad at times!

Being something of a newcomer to the delights of sound synthesis, I'd be grateful for some help on a couple of queries. First, are there any books available on how to get the best out of FM synthesisers? And are there any cassettes of new DX21 sounds available?

■ Andrew D Walker  
Manchester

**A** There's one book which has been kicking around for a while: 'Yamaha DX7 Digital Synthesiser' by Yasuhiko Fukuda, published by Music Sales at £7.95, and reviewed in E&MM April '85. Don't worry that it's not specifically for the 21: there's still plenty that you can learn from it.

The same goes for Jay Chapman's 'Understanding the DX7' series of articles which we published in 1984. (See last month's Back Issues page for details of how to get hold of copies.)

Also fairly imminent is a book by the father of FM synthesis, John Chowning, and Yamaha demonstrator Dave Bristow. That combination alone suggests this book should be a winner. We'll be bringing you the

news as soon as we can lay our hands on a copy.

We suggest you get in touch with the DX Owner's Club and see if they're working on any sound data tapes for the 21 (and also keep a lookout for individuals offering data tapes for sale in our own Free Ads section). The Club has recently undergone a change of proprietorship, with the centre of operations moving from Tony Wride's beleaguered Yorkshire PO Box to Yamaha's UK headquarters. Their address is Mount Avenue, Bletchley, Milton Keynes, Bucks, MK1 1JE, and that's where you should send all enquiries regarding membership and so on.

Meanwhile, our Patchwork pages are beginning to attract DX21 sounds from readers, so keep an eye out.

■ St

**Q** Is an Aural Exciter better than a graphic equaliser for recording and copying cassette tapes? In particular, what effect will they both have on reducing any tape hiss when recording?

■ Alan Pearson  
Derby

**A** First of all, an Aural Exciter and graphic equaliser perform completely different functions. An exciter artificially creates and adds harmonics not present in the original input signal, based on those that are already there. On the other hand, a graphic equaliser facilitates cutting or

boosting of localised frequency bands within the audio spectrum (the number of bands and consequent flexibility of the unit varies from model to model). Hence, the treated signal from an exciter will contain elements not present in the input signal whilst a graphic will only modify those elements that are present to begin with.

The choice of treatment is, therefore, largely dependent on the quality of recording you are dealing with. If they are lacking in 'top' to begin with, a graphic will have little to work on except bass and tape hiss, whilst an exciter will replace some of that missing sibilance. In the case of a bright recording – a Dolby encoded signal replayed without Dolby, for example – a graphic may be used to selectively suppress tape hiss with only a minimum of treble loss in the signal.

Of course, a graphic may be used to boost frequency bands as well as suppress them. This makes it possible to re-balance a recording in a way not possible with an exciter, and makes it an entirely more useful beast in the recording, as opposed to copying, of tapes. But that's another story. ■ Tg

**Q** Though my Roland JX8P and I get on very well most of the time, I'm rather confused about one thing: why do I end up with a keyboard but no sound if I turn MIDI local control off from the front panel? What use is this feature? ►

■ Suzanne Taylor  
Weston-Super-Mare





**A** Your JX is silenced because local off disconnects the control path from keyboard to voice circuitry. Now that might seem rather pointless in itself – after all, synths do have volume controls – but your performance is being sent over MIDI Out, while your JX's voices can still be played via MIDI In. As a simple verification of this, connect a MIDI cable from Out to In on the JX: suddenly you'll be playing the JX's voices again, but via MIDI instead of through internal routing.

This might still seem a little pointless. But imagine that you've expanded your MIDI setup to include a MIDI signal processor (such as Yamaha's MEP4, reviewed in this issue), with the MIDI output of your JX routed through the processor and back into the JX. Turning local off means that your synth's voice circuitry will only respond to the MIDI-processed signal – if you want to mix processed and unprocessed signals, turn local back on again.

But perhaps the more common use for local off is with a MIDI sequencer in conjunction with another MIDI instrument. Local off releases all your JX's voices to be played from the sequencer while you're recording into the sequencer from the JX keyboard; it also means that you can be playing a part on another instrument at the same time without imposing your JX's own sounds. So local off is a practical if not immediately obvious

aspect of MIDI, to be switched in and out as required – which may be never, but it's there should you require it.

■ St

**Q** I'm thinking of investing in a MIDI sequencer but am a bit confused by all this talk of tracks and MIDI channels. How analogous is a 16-track MIDI sequencer to a 16-track tape machine?

■ John Walton  
Swansea

**A** The fundamental difference between a tape machine and a MIDI sequencer is that the former records the actual sounds that you make (whether they're emitted from a grand piano or a penny whistle) whilst the latter records a stream of digital codes which merely represent your performance.

Two basic 'limitations' of MIDI-based recording follow from this. Firstly, you always need instruments in order to play back your sequences – which normally means the instruments you recorded the sequence with, set to the patches that you want to use. Secondly, you can never transcend the limitations of an instrument: a six-voice synth can only ever play six

notes at once, and a monotimbral synth can only ever play one sound at a time. Neither of these limitations apply to tape-based recording, of course, because it's the sounds themselves that are put down on tape.

There is a flip side to this situation, however: because a recorded sequence doesn't determine which instruments play which parts, nor which specific sounds are used to play those parts, you can alter these around very easily at any time. But the degree of editing control you have over MIDI data in a sequencer is far greater than the control you have over music recorded on tape. As an example, many sequencers allow you to record patterns that can then be chained together in any way you want – an operation which typically requires the minimum of fuss. The equivalent operation with tape would require a lot of splicing.

Now to this business of tracks and MIDI channels. Many sequencers allow you to assign one MIDI channel to a sequencer track, but this doesn't mean they're one and the same thing. Typically each track can be set to any one of MIDI channels 1-16, which allows you to route tracks to particular instruments. Because any number of tracks can be routed along the same MIDI channel, you can independently record several different parts to be played on the same instrument. So tracks don't have to equate to MIDI channels, nor to instruments. ■ St

**A** With reference to the Powertran DDL conversion project (E&MM June '85), it's come to light via Mr M Adams of Leeds that there's an error in the project, inasmuch as 2K of memory is 'missing' from the DDL when the mod is fitted.

Here's the remedial action: only two wire

links are required, both on the DDL PCB (see diagram enclosed). Bend pins 1 and 2 of IC4 and pin 5 of IC12 out from their sockets. Connect one wire link between pin 2 of IC4 and pin 5 of IC12, and the other from pin 1 of IC4 to pin 8 of IC16 (note this pin should be left in place in the socket – do not bend it out).

There, that wasn't too painful, was it? I apologise to anyone else who may have noticed the 'missing' 2K and spent many sleepless nights worrying about it!

■ Patrick Shipsey  
Alderbury

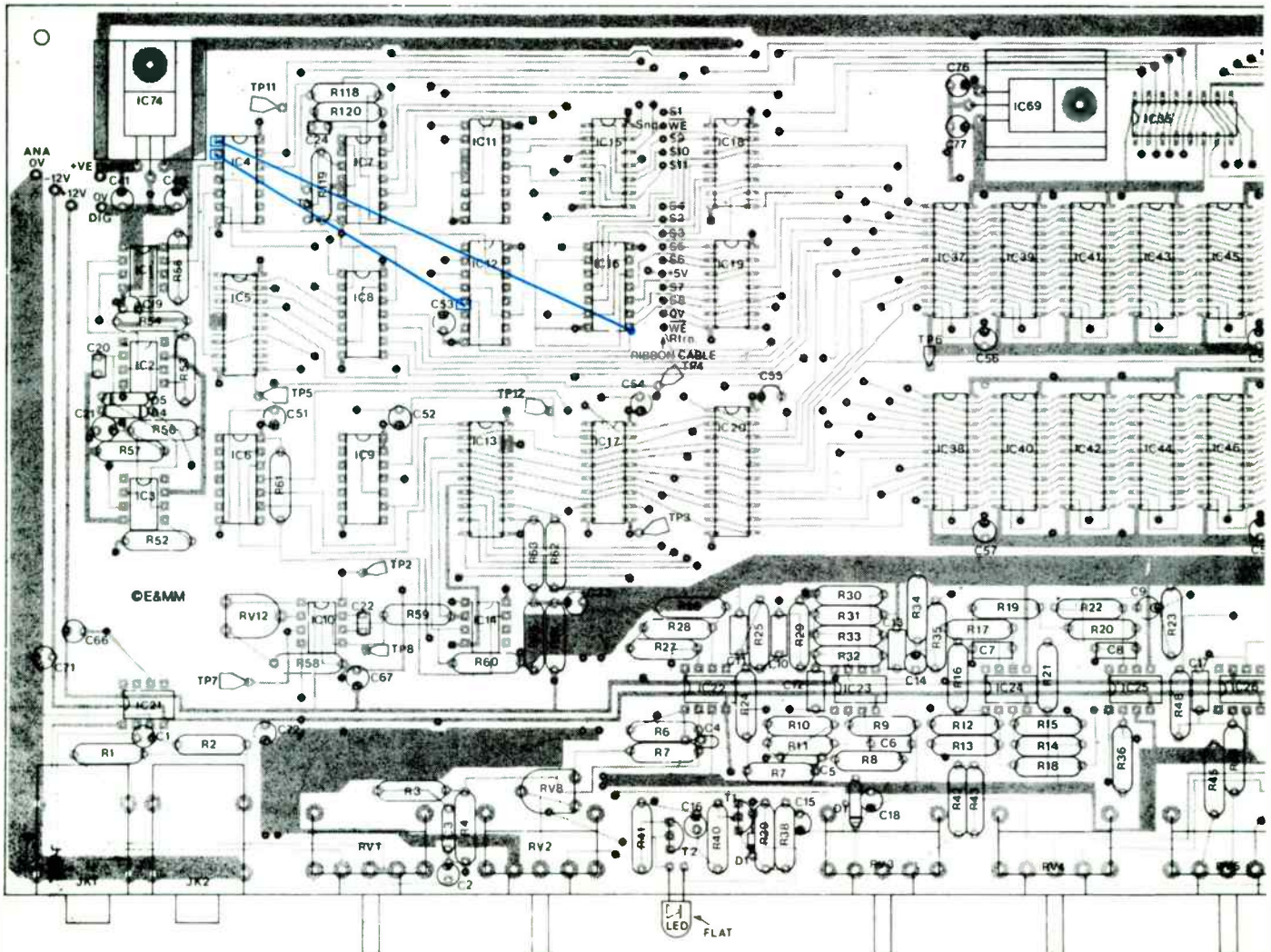



# TELECOMMS

A DIVISION OF MIKE DEVEREUX MUSIC LTD.

# THE UK'S FASTEST MAIL ORDER SERVICE

## KEYBOARDS

NEW

### NOW IN STOCK

ALPHA JUNO 1	£575
ALPHA JUNO 2	£799
ROLAND RS09 Strng Synth	£199
KORG Poly 800	£399
KORG EX800 Expander Low Price	£199
KORG EX800 (6 Voice) Synth	£599
KORG DW8000 (6 Voice) Synth	£925
KORG DW8000 (8 Voice) Synth	£525
KORG POLY 800 MK 2	£172
YAMAHA VSS100 Sampler	£1199
YAMAHA DX27 FM Synth	£499
YAMAHA DX27 (New)	£349
YAMAHA DX100 (129 Voice FM)	£599
YAMAHA DX21 Synth	£199
CASIO MT800	£199
CASIO MT400V	£199
CASIO CT 320 SR	£210
CASIO MT210	£99
CASIO MT52	£749
CASIO CZ5000	£399
CASIO CZ1000 Lowest UK Price	£295
CASIO CZ101 Lowest UK Price	£199
CASIO SZ-1 Sequencer	£199
CASIO MT800 Lowest UK Price	£249
CASIO CK 500	£29.95
CASIO RA3 Ram	£48.00
CASIO RA5 Ram	

## CASIO SZ1

Special price £199

Digital multi track sequencer provides a 4 track sequencer for any midi keyboard. Real time or manual note by note record.



## THE NEW ALESIS MIDIVERB

Now in stock

£395



## BOSS PEDALS/EFFECTS

### NEW PEDALS!

DC2 Dimension C	£129
HF2 High Band Flanger	£89
BOSS BF2 Flanger	£89
BOSS OD1 Overdrive	£49
BOSS HM2 Heavy Metal	£55
BOSS CE2 Chorus	£79
BOSS CE3 Stereo Chorus	£85
BOSS DS1 Distortion	£55
BOSS SD1 Super Overdrive	£59
BOSS GE7 Graphic	£79
BOSS DF2 Distortion/Feedback	£59
BOSS DD2 Digital Delay	£139
BOSS DM3 Delay	£99
BOSS SP1 Spectrum	£39
BOSS NF1 Noise Gate	£49
BOSS CS2 Comp Sustain	£85
BOSS OC2 Octaver	£59
BOSS VB2 Vibrato	£59
BOSS PH1R Phaser	£85
BOSS PH2R Phaser	£89
BOSS PC2 Percussion Synth	£59
BOSS HC2 Handclapper	£59
BOSS DP2 Damper	£15
BOSS PSA240 Mains Adaptor	£19
BOSS ACA220 Mains Adaptor	£19
BOSS PSM5 Pwr supply for max 10 pedals	£65
BOSS FS1 Footswitch	£16
BOSS FS2 Footswitch	£20
BOSS DSD 2 Digi Delay Sampler	£160
BOSS MS100 100 watt Monitor speaker	£99
BOSS MSA 100 Stand adaptor for above	£28
BOSS Carry Case Inc PSM 5	£129

## MICRO RACK SERIES

### New Items:

RPQ 10 Parametric Eq	£129
RSD 10	£199
BOSS BMR5 Micro Rack	£45
BOSS RDD10 Digi Delay	£149
BOSS RCL10 Comp Limiter	£115
BOSS RGE10 Graphic Eq	£115
BOSS RPH10 Phaser	£115
BOSS RBF10 Flanger	£115

## OTHER PEDALS

IBANEZ Digital Flanger	£120
IBANEZ Digital Chorus	£120
IBANEZ Digital Delay	£129
CARLSBRO Profex ADR1 Shop soiled	£249
ROSS Power Supply 6 9 12 volt	£10.50
MELOS DE1 Digital Echo	£79
EC500 Super Echo Unit	£86
KORG Signal Delay	£99
SCHALLER Volume Pedal	£20
MIR Cry Baby Pedal W/AH Vol	£49.95
TORQUE Spring Revert Unit	£58
ROCKBOX Chorus Delay Distortion	£135

## TUNERS

BOSS TU60	£35
BOSS TU12	£49.99
BOSS TU12H Chromatic tuner	£45
BOSS TU120	£65
KORG GT60x	£30
KORG Chord Comp Keyboards and Guitars	£34
KORG DT-1 7 Oct Tuner	£60
ARION	£29.95

## SPECIAL OFFER

KORG DDM220 Percussion M/C £179

## ROLAND DB-66 DR. BEAT DIGITAL METRONOME

LIMITED QUANTITY



£48

LOW, LOW PRICE!

## DRUM MACHINES AT SPECIAL PRICES

ROLAND TR707 percussion	
ROLAND TR727 percussion	£450.00
ROLAND TR505 New!	£450.00
ROLAND Octapad 8 pad w/midi control	£225.00
BOSS DR110	£399.00
SIMMONS SDS1 used (inc eeprom)	£119.00
UP Drum Pads (pair inc stands)	£149.00
YAMAHA RX21 New Drum Machine	£95.00
	£249.00
YAMAHA MTIX M/Track Recorder	£495
GOODMANS GCD500 Compact Disk	£199
ONKYO 8037 Stereo Amp (50 Watt)	£138
ONKYO 8057 Stereo Amp (80 Watt)	£199
TASCAM Porta 1 (mini 4 track)	£399.00
TASCAM M246 4 Track Portastudio Deluxe	£999.00
TEAC W440C Twin Cassette Deck	£199.00



## KEYBOARDS, AMPS & COMBOS

We stock complete Carlsbro & Marshall range at best U.K. prices.

CARLSBRO Stingray Chorus Keyboard Amp	£199.00
CARLSBRO 150 Keyboard Amp	£280.00
CARLSBRO 150 Keyboard Combo	£299.00
CARLSBRO 90 Keyboard Combo	£198.00
CARLSBRO Hornet 45 Keyboard Combo	£474.00
CARLSBRO 150 Keyboard Combo	£270.00
VOX Venue 100W Keyboard Combo	£99.00
MARSHALL 5302 20W 1 x 10 Combo	£87.00
MARSHALL 5301 12W 1 x 10 Combo	

## JAMO QUALITY MONITORS

NEW

JAMO 70 Compact 70W (Pair)	£69.90
JAMO 90 Compact 90W (Pair)	£99.90
JAMO 366 Monitor 300W (Pair)	£299
JAMO 566 Monitor 500W (Pair)	£499

Ideal for studio, disco & PA applications

## HEADPHONES & MICS TECHNICAL PROJECTS DM120

Headphones and Quality Boom Mic

£37

We can thoroughly recommend this headphone and mic combination

Guitar Practice Headphones	
BEYER 302 Headphones	£19.95
BEYER DT320 Headphones	£27.00
BEYER DT330 Deluxe Headphones	£30.00
BEYER DT109 w/boom mic	£37.00
BEYER M300 NCS mic	£77.00
BEYER M400 NCS mic	£89.00
AUDIO TECH PRO 2 mic	£122.00
AUDIO TECH ATM 4t mic	£21.48
ALTA DM 1000C Dual 1mm mic	£85.00
	£25.00



## SPECIAL PRICES ON BOSE

## MONITORS/P.A.

BOSE 301 Music Monitor (Pair)	£269.00
BOSE 205 Music Monitor (Pair)	£198.00
BOSE 201 Music Monitor (Pair)	£169.00
BOSE #02 Series II Speakers (Pair)	£799.00
BOSE 302 Bass Bins (Pair)	£1,195.00

# SAME DAY DESPATCH

(SUBJECT TO AVAILABILITY)

# HOTLINE (0705) 660036

GOODS SHIPPED WORLDWIDE FAST - TELEX 869 107 TELCOM G

TELECOMMS, 189 LONDON ROAD, PORTSMOUTH, HANTS PO2 9AE  
USE YOUR CREDIT CARD (AMERICAN EXPRESS, ACCESS OR VISA) FOR IMMEDIATE DESPATCH



# MAN AT WORK

Jezz Woodroffe's keyboard-playing career has taken him from music-store owner to regular member of Robert Plant's new band. In that time, his skilful, unpredictable playing style and fine programming ability have won him admiration from all quarters. We discover more about the man, his keyboards and his studio.

Interview & Photography *Tim Goodyer*

Even if it's hardly the first one you'd think of in a discussion of well-known contemporary keyboard players, the name Woodroffe will certainly be familiar to musicians in and around Birmingham. A music shop (sadly now defunct) bearing that very name once added fuel to the burning dreams of local musicians, Duran Duran amongst them. Wide-eyed teenagers would make a weekly exodus to spend their Saturday mornings ogling the contents of the best-stocked keyboard showroom for miles around, and listening to words of wisdom from the resident demonstrator. One man went in to buy a keyboard and left with a keyboard player: the man was Robert Plant, the keyboard player and demonstrator, Jezz Woodroffe.

Once Led Zeppelin's front-man, Plant had maintained a fairly low profile since the death of drummer John Bonham, and the subsequent dissolution of the band. A long-term project by the name of The Honeydrippers provided him with a flexible outlet for most of his musical energy in many small clubs, and helped preserve his name and popularity in the intervening period.

Then, impressed by the playing talents of Woodroffe, Plant sensed the time was right to begin again. Under pressure to resurrect the past triumphs of Zeppelin, Plant risked the loss of his following by lending a deaf ear to the words of 'Stairway to Heaven', and moving on to musical pastures new. It was a risk, as Woodroffe now readily agrees.

'What we did was so totally different, yet it was the same voice and it was the same Robert on stage. He was very brave to do that, but on the other hand, if he hadn't done that, he wouldn't have done anything. With somebody like David Bowie or Peter Gabriel, you've got no idea what they're going to do next – and it's the same with Robert.

'I'm very proud of what I've done with Robert, and if we don't do anything else, that's OK.'

And the risk paid off. Around them, Plant and Woodroffe assembled some of the most respected names in the business: Phil Collins and Cozy Powell on drums, Robbie Blunt on guitar and Paul Martinez on bass. A fine album, *Pictures at Eleven*, resulted.

Since then there have been two further LPs: *The Principle of Moments* – spawning the single 'Big Log' which made number 11 in the British charts back in '83 – and *Shaken 'n' Stirred* with Richie

Hayward moving in on drums.

All three albums feature Woodroffe in the joint rôle of keyboard player and co-songwriter. The gold and silver discs that brighten the walls of Woodroffe's home studio attest to the success of his music, while the synthesisers that surround us do the same for his love of technology.

Woodroffe's long-standing love affair with things synthetic has grown from the formative cries of MiniMoogs and Odysseys, to embrace today's digital wonders. Those with a particularly sharp eye (and a keen memory) will recognise him as the man seen posing with four Jupiter 8s in a certain Roland advert a while back. Unfortunately, the ad attracted more than its fair share of criticism.

'I had people asking Roland: "Who's that posing bastard with all those Jupiters he doesn't own?" But they were all mine – and I needed them at the time!'

Since then, two of those JP8s have been sold off as being redundant, along with one of a pair of PPGs and attendant Waveterm. The remaining PPG now forms the heart of Woodroffe's working setup.

'The PPG is the most creative instrument that exists as far as I'm concerned. I was originally going to buy a Fairlight; I even went to the factory in Sydney to look around and ordered one. But the PPG system had just come out then and when I heard it, I cancelled the Fairlight order!'

The PPG in question is a 2.3, though it's accompanied by an original series Waveterm, not a Waveterm B. Time for an update?

'Rather than update it, I'd like to take other things a step further. There is no limit to what you can do with this system as it is; you can never explore all its possibilities even if you spend 24 hours a day on it. The Waveterm B is 16-bit sampling whereas this is only 12, but that's not what it's about for me. It's more important what you do with technology than what you own. It's much more important to get as much out of something as you can, before you think about replacing it with something else.'

'I don't know where technology will take us next, and I don't think it's important either. Using technology to be creative is fine, but I can't see any other reason for having it.'

The two remaining JP8s are not in evidence at the time of our meeting, but a Roland MKS80 E&MM JUNE 1986



Super Jupiter module and MPG80 programmer sit atop an MKB1000 Mother Keyboard. These cater for Woodroffe's analogue requirements, whilst a Korg DW6000 now fills the gap left by a departed DX7 and DX9.

'It took me about six weeks to crack the algorithms and operators, but when it came to using them in the studio it was a complete joke, so I went for the Korg because the access is so fast.'

None of this would be possible without our old friend MIDI, of course. But MIDI plays a greater part in the studio than the simple linking of keyboards. A Roland SBX80 Sync Box is on hand to cater for Woodroffe's involvement in writing music for films and videos – and provides a central communication point for MIDI messages. The situation is further complicated by the Programmer hogging the only MIDI Out on the Super Jupiter, without offering anything in return. The result of all this is a severe test on the flexibility of MIDI, and one that poses Woodroffe a few problems.

'MIDI on the PPG has nothing to do with MIDI on anything else. You can link two keyboards together, but they lock up after they've taken a certain amount of information, so it might as well not exist.'

Sad words from a man who has, in the course of his career, forsaken

the banks-of-keyboards approach in favour of an economical system that's of more musical value – even if it doesn't look quite so impressive. A Godwin string synth, one member of the older generation, is present in the studio, and looks rather incongruous alongside the PPG. Woodroffe is quick to come to its defence.

'The Godwin did all the orchestration for 'Big Log' and 'Moonlight in Samosa'. You just can't get that sort of sound out of the PPG. Sampled cellos sound great, but they just don't work the same way that the Godwin does.'

Good old technology, but what of the sampling? The quality of sampling is rising almost as quickly as its cost falls, and it's all too easy to become obsessed with the idea of reproducing natural sounds more and more convincingly. But with the notable exception of drum sounds, this is the lowest priority on the Woodroffe list.

'You have to use sampling creatively for it to be of any value. If you sample something as a recognisable sound and reproduce it as a recognisable sound, then I'm not sure that's a particularly good idea. Unless you're going to use samples out of range, then it's a waste of time sampling choirs and things.'

He illustrates the point with a sampled cello that assumes koto-like tones in an unnaturally high ▶

▷ register. Woodroffe's PPG library disks are filled with unusual (though always usable) samples from as disparate sources as the Nelson Riddle Orchestra, used to great effect on 'Too Loud', to Bongo Joe playing an oil drum with brushes.

Colouration and distortion of sound come into their own here: 'I've done some sampling off Compact Disc but I like samples to sound a bit different, and if you use a bad way of recording them they can sound really good. It's nothing to do with the quality of what you've heard, it's what you're creating with the machine you've got.'

Sounds like a good case for buying a cheap sampler to me.

'Cheap sampling keyboards are a brilliant idea. They're not going to sound like the real thing anyway, so you could end up getting interesting sounds very easily. If I had a spare hundred quid I'd be out buying one of the little Casios; as it is, I'm thinking of getting one of their sampling drum machines.

'I don't think drum sounds have to be that good. Look at Prince's single 'Kiss': the sounds on that are awful, but it's a great single. I like really horrible snare drum sounds, 'cos they work – as long as you don't try to make them sound like good snare drum sounds.

And the drum samples?

'The minute Phil Collins puts his snare drum through a reverb unit on Compact Disc we'll have it in the Waveterm, thank you', he says, patting the PPG like a favourite child.

'One thing that really annoys me, though, is the number of good drummers that hate drum machines. They should be the very people that like them. Rather than the machine being a substitute for them, think what they could do with that sense of rhythm and the background to playing a drum-kit if it were applied to a drum machine. It would be unbelievable.

'Richie Hayward is one of the best drummers in the world. But any time I switched a drum machine on, he'd do a big moody thinking I was trying to replace him. So I asked him if he'd got a drum machine; the answer was no. I said: "go and get a Linn, get anything you like, learn to program it and come and show me what you can do." It gets me mad!'

With the sequencing power of both the PPG and a Korg SQD1 at his disposal, a full 24-track recording setup seems a little excessive for the Woodroffe home studio. But where a simple eight- or

16-track affair would be enough for many musicians, this one owns a fully-blown Aces MT24 two-inch, 24-track recorder, complete with accompanying mixing desk.

Woodroffe has abundant enthusiasm for the system ('Aces are currently building me an autolocate with SMPTE which will be fab'), and believes that, even if he wasn't involved in the film and video scoring that pays him some useful extraackers, he would still need a 24-track setup.

'I had an eight-track, but I found I could spend hours creating something on it and then not be able to take it any further. If you use a sync code to lock the sequencers to the tape, you've got seven free tracks that you can't physically get at, because the synths are already in use.

'When you've got something onto tape you can take a bit out, you can take all of it out, you can cut great chunks out of the tape, change the EQ, put it on a different channel, put reverb on it...you can do anything, within reason. And then you can take it with you anywhere in the world – stick it in a briefcase and take it to Sarm West and go "waaah!". You can get other people in to play on it – even musicians! There's no more of this: "the demo was great, what a shame we haven't actually got it on tape."'

Being unable to recapture the essence of a musical idea is a problem we've all encountered before now, but Woodroffe is quick to dispel the illusion that wide recording tape can provide all the answers. The keyword here is 'atmosphere'.

'I've got a Roland SRV2000 for reverb – it's a great tool, one of the best things I've bought, but I've just ordered a couple of spring reverbs as well. They're pretty awful apart from the fact that when you're trying to create some kind of atmosphere, you want different types of reverb, and that's a cheap way of doing it *instantly*. The Roland will do all that, but not at the same time: you can get the sound you want, record it, and then record the reverb on a different channel, but in those 20 minutes the inspiration you needed of being in the Taj Mahal has gone.

'Phil Collins did 'In the Air Tonight' on eight-track at home and then transferred it to 24-track. If he hadn't been able to do that, there wouldn't have been any 'In the Air Tonight', and Phil Collins wouldn't be a multi-millionaire.'

Woodroffe has plans for a commercial studio sometime in the

future, and the MT24 has been chosen as a likely basis for that, too. But his enthusiasm for recording doesn't continue into the world of the portable four-track, a breed of machine which, despite its ability to make listenable home recordings a practical proposition for thousands of musicians, is far from earning a place in Woodroffe's good books.

'I think the last thing a keyboard player working with a really tight budget needs is a tape recorder. You've really got to go for something like the little Casio sequencer. You're far better off being able to create something that you can re-use at a later date, and which you can take into a studio and dump straight down onto tape.'

As for Woodroffe's own sequencers...

'The PPG's sequencer is incredibly complicated; it's a 12-month job to learn what *not* to do with it. Even when you understand it, it's still a very long process building up a sequence. The Korg SQD, on the other hand, will sequence anything. It's so quick and simple to use, you can use it just like a tape recorder.

'A lot of the sounds I get off the Super Jupiter are beautiful things to sequence. Unfortunately, you can't send a sequence out from the PPG over MIDI – it doesn't work.

'But you can get bogged down in the whole thing in the end. I've always thought keyboard players were a different breed to other musicians. We always seem to be slightly more sophisticated than everyone else, because there are lots of complicated computer codes in our brains. When we're playing we have different kinds of problems to overcome, we have to remember tremendous quantities of numbers which have nothing to do with music. And we daren't get them wrong, because the difference between 11 and 12 can be catastrophe whereas the difference between F and F# is only a dischord. Pressing the right buttons is actually more important than playing the right chords!'

With the association with Robert Plant having reached a natural pause, Woodroffe has begun making plans for an album with Toyah, and is also involved with ex-Black Sabbath bassist Geezer Butler.

'That should be quite interesting, because it'll be heavy rock and I haven't done that for a while. But the Toyah thing is what I'm really looking forward to. If I can get both things working so that they don't clash with each other, I'll be happy.' ■



*New  
Recording  
Room.*



*the  
Amazing  
New Keyboard  
Department.*



*New  
Portable  
P.A. Centre.*



*Rock 'n'  
Roll  
Room.*

Fostex B16  
Fostex 80  
Fostex 260  
Tascam 38  
Tascam 388  
Seck 16.8.2  
Ram 16.8.2  
Alessis Midi verb  
Yamaha SPX90  
Yamaha MT1X  
Accesit exciter  
Dynamix 16.4.2  
Dynacord DRP16  
Plus many more

Akai S900  
Akai S612  
Sequential Prophet VS  
Sequential Prophet 2000  
Yamaha PF70  
Yamaha DX27  
Yamaha QX21  
Ensoniq Sampled Piano  
Mirage Expander  
Mirage  
Korg EX8000  
Korg DW8000  
Korg Poly 80011  
Plus many more

Bose 80211  
Bose 302  
JBL  
Carlsbro Taurus  
Dynamix 16-2  
Seck 6-2  
Seck 12-2  
Carlsbro Marlin 300  
Dynacord Eminent  
Dynamix Powered Mixer  
Mega Mini bass cabs  
Carlsbro Monitor systems  
Plus many more

Fender strats  
Westone guitars  
Westone basses  
Ibanez guitars  
Ibanez basses  
Session 4x10  
Session 1x12  
Fender London Reverb  
Sidekick Reverb 20  
Carlsbro 150 Bass Combo  
Dynacord Digital  
Lead Combo  
Dynacord Bass Combo  
Carlsbro Valve Combo  
Plus many more

*We've grown.  
We've had to  
We've now got twice the space  
twice the stock.  
We've introduced a home recording  
room with the accent on  
'Hands on' rather than Hands off'  
Fully equipped, all running  
all ready  
We've got a keyboard department  
cramped with the latest technology:  
whether you want sampling,  
digital or analog: whether you  
want to spend £50 or  
£5000 we can give you the  
choice; we can give you the  
answers we can give you  
the best price.*

*Our new Portable PA Centre  
is designed with the user in mind.  
We stock a complete  
across-the-board range letting  
you get the best from  
your budget.*

*The Rock 'n' Roll room is  
overflowing with guitars and  
basses, amps cabs combos spares  
everything! Having separated  
each department we can offer  
personal demonstrations no more  
keyboard V guitar battles!*

*Our price policy is simple  
We just won't be beaten. We  
feel we've now got it right  
The right products, the right  
atmosphere, the right price.  
Come and see for yourself.*

*Holiday Music* LIMITED

579 HIGH ROAD LEYTONSTONE E11 4PB TEL 01-558 2666

THE  
**MT SERIES**  
FROM ACES

# Make a name for yourself without paying for one



“I'd used Aces equipment before, so when I was looking around for a recorder, I tried out the MT24 – it seemed to do all the right things, so I got one into my own studio and that seems to be working out well. Considering what the Aces machine can do, its price beats all the other makes I looked at.” Jezz Woodroffe, February 1986.

There's plenty of recording equipment around that's got a big name. And a big price tag to match.

But take a look at the MT Series from Aces. The name may not be too familiar, but compare this range with some big-name machines and you'll soon see we've got it taped!

The MT Series offers recording studios and musicians the reliability, flexibility and performance that is often beyond their budgets.

Ideal for the mobile studio or permanent arrangement, these machines are easy to service and line-up and will produce the high quality master tapes you demand. So it was for good reasons that recording artist Jezz Woodroffe specified the MT 24 multitrack recorder from Aces for his own studio.

If you're aiming to make a name for yourself, you'll also find Aces is a name well worth remembering! So contact us for more details on the MT Series now.

**Aces**  
Sound  
Professionals

Aces (UK) Limited, Featherbed Lane, Shrewsbury, Shropshire. SY1 4NJ. Tel: (0743) 66671 Telex: 35188 Aces G.



# SOMETHING OLD



*something new...*

For those of you on a limited budget, we present a much-requested guide to buying secondhand polysynths. So read on for the thoughts and experiences of the E&MM collective...

**T**he excitement of reading about a new polysynth and all its groundbreaking facilities is more often than not quickly tempered by discovering its cost and subsequent unavailability. Undeterred, keyboard players worldwide continue to beg, steal or borrow (frequently from record companies) the necessary cash to continue to exploit hi-technology regardless of the consequences.

But there's more to technology than the industry's latest feat. Machines that are years out of date, technologically speaking, don't immediately cease producing good noises simply because their day of media attention has drawn to a close. Indeed, some long-since obsolete instruments are still in common use and a few are even more

sought after now than they were in their heyday. Even if this is not the case, there's often a lot of mileage left in a synth if the user is prepared to take a little care over its use.

Yes, we're talking secondhand. There's no shame in buying secondhand and, with a little care, no disappointment either. An older instrument is a less unknown quantity than a brand new one that may subsequently prove to be hopelessly unreliable or greatly bettered in facilities and price one month later (with corresponding effect on morale and resale value).

So how do you go about finding such a bargain? Firstly, as with any new synth, it helps if you know what you want from your intended purchase. Knowing what's available and what it

will do for you is also of paramount importance. What's available can be ascertained from a number of good sources: E&MM's own 'free ads' along with local newspapers and the weekly music press are a good start. From these it's not too hard to judge typical selling prices for the majority of items. Additionally there is Julian Colbeck's *KEYFAX Guide to Electronic Keyboards* which lists exhaustively mono and polysynths, remote keyboards, samplers, sequencers and computers along with their facilities.

Here, along with a subjective opinion of its present-day worth, is a selection of the more popular instruments on the secondhand polysynth market, along with the issue in which it was reviewed, where applicable. ▶

## AKAI AX80

Never gained the recognition due to it. Versatile and flexible with two DCOs, a lowpass VCF, HPF, VCA, two EGs and no less than four LFOs. Touch responsive and with features such as EG rate scaling and a unique visual display of programmed parameters using very attractive fluorescent bargraphs enabling you to see exactly what is going on in a patch. The AX80 doesn't have a particularly characteristic sound but is very versatile, producing a gamut of sounds from fruity brass and bass to some very convincing PPG impersonations. It lacks a chorus unit which would do something to rectify its inability to be as lush as other synths, but this is nothing a chorus pedal won't sort out. A nice looking, nice sounding synth with a stunning piano sound that can be quite convincing if used properly, and at a secondhand price of £500-£600 it is certainly worth a look – you may well be pleasantly surprised. *Reviewed December '84.*

## ARP OMNI/OMNI II

A curious hybrid from the now sadly defunct ARP operation. It was their first attempt to break into the polysynth market and was actually based on their wonderful string synth, the raw, un-

## ARP QUADRA

Another ARP hybrid in that it contained the aforementioned string synth and processing filters and envelope shapers. Additionally, it had a monophonic bass synth and a lead line synth section. Also featured is a stereo phase shifter/ensemble section and an on-board arpeggiator – a first for ARP. Beloved by Tony Banks for his 'wash of sound' backing chords – also a fave of Joe Zawinul – so it comes highly recommended by them. Worth giving a good going over though before buying, as you may become disappointed later.

## CASIO CZ RANGE

Bloody silly price for a synth of this calibre even when new. Secondhand there are 101s for as little as £200 or so. Incredible sounds from the tinkly digital (*à la* PPG), to fat, analogue sounds. Easy to use and program and with an amazing MIDI implementation, whereby in the Mono mode you can have four separate sounds at once with each voice assigned to a separate MIDI channel. It also has Tone Mix facilities for layering sounds monophonically – including two separate sections for polyphonic layering of sounds. All CZ synths feature the same voice architecture and sound exactly the same, and this inno-

an Oberheim. Sadly, the MIDI is not up to much but, with its extensive touch sensitivity, it makes a good 'players' synth. Two VCOs, a gutsy lowpass filter, VCA and two EGs, plus two individually assignable LFOs not to mention touch-sensitivity control over tone and level, pulse width and EG attack times make it an excellent proposition. *Reviewed November '84.*

## CHASE BIT 99

Souped up version of the Bit One. Improved MIDI, and programmable noise level but basically the same synth. Also available as an expander in the form of the Chase Bit 01. *Reviewed October '85.*

## ELKA SYNTHEX

One of our team here (no names, no pack drill) still maintains that this was the best polysynth ever made. Not a lot were sold at the original price of £3,299, but as the price came down and MIDI became available, more people took advantage of its fat analogue strings and brass and its neo-digital sounds, created through its fascinating Ring Mod, Sync and PWM capabilities. Many big names (Geoff Downes, Jean-Michel Jarre, Keith Emerson) were not put off by the Elka name: nor should you be!



processed waveforms of which could then be processed by an onboard VCF, VCA, EG section. Non-programmable and limited in that the processing section comprised only one VCF, VCA and EG for the whole keyboard, but that didn't stop it producing some well impressive sounds. Worth investigating, especially at its current secondhand price of £200 or so.

cusious looking beast comes highly recommended. *CZ101/1000 reviewed January '85. CZ5000 reviewed June '85. CZ3000 reviewed February '86.*

## CHASE BIT ONE

Great sound, full and warm, with more than a passing resemblance to that of

Obtainable now for under a grand, you should definitely check it out if you get the chance.

## EMS POLYSYNTHI

Horrendous colour scheme, unimpressive sound. Totally polyphonic with one VCF. Lousy keyboard and little to com-  
E&MM JUNE 1986

mend it. No wonder it failed. Not often seen – perhaps that's just as well.

## KORG POLYSIX

A six-note six-voice analogue, the Polysix is programmable, and easy to use thanks to good old-fashioned knobs and switches. On a par with the Junos, the Polysix suffered by being born just before MIDI was introduced, and a retrofit never came to its rescue. Though lacking a Noise Generator and with only 32 memories, the inbuilt Chorus, Phase and Ensemble effects will help you create some great sounds – could easily fool someone that you have a Prophet or something. Current silly prices make it worth your attention. A nice one. *Reviewed August '82.*

investigation if your budget is severely limited. *Reviewed February '84.*

## MOOG POLYMOOG

Moog's initial venture into polyphony. Each voice contains two VCOs and a VCA/EG combination and is totally polyphonic and velocity sensitive. Sadly, only one VCF, but it does have an impressive on-board parametric EQ section. Non-programmable except that you can store one edit of an existing preset, but even that is lost on power-down. Lots of outputs from each separate section making it good for layered effects. They currently sell for around £600 or less so check it out.

## OBERHEIM 4 VOICE

THE original. Four (or eight) independent synths in one rather cumbersome package. Its main advantage over its counterparts was that each voice was a totally separate entity allowing full multi-timbrality. Also, each voice had total access to the CV and Gate inputs allowing control by some sequencer or other (an Oberheim and an old Roland MC4 would be a vicious combination). But all these features would be useless if the sound itself was lacking but, thankfully, the Oberheim voice module is probably one of the best synthesisers ever built and the sound of this machine is fat and a half. Available for as little as £300 – buy one!



## KORG POLY61

Although this had two DCOs (the Polysix only had one) per voice, it doesn't sound as good to my ears as the Polysix or any of the other synths in this range. Has parameter access with a very low resolution for some important parameters. Check it out to avoid disappointment – who knows, you may not like it. MIDI available as a retrofit or as standard on the POLY61M. *Reviewed March '83.*

## KORG POLY800

Cheap, cheerful and loved by many but one VCF for the whole keyboard is rather limiting on a synth nowadays, although the EGs are very good. Handy built-in sequencer which, unlike the JX3P, transmits over MIDI making it possible to 'drive' other MIDI synths which is useful. At around £300, worth E&MM JUNE 1986

A preset version of the above, the Polymoog Keyboard, had some nice sounds even if a bit limited. Instant Gary Numan for £350 or so.

## MOOG MEMORYMOOG

No less than three VCOs per voice, the famous Moog filter, two punchy EGs with key scaling and a very versatile modulation section giving it the fattest sound you can imagine. Likened to six MiniMoogs but somehow lacking in some respects. MemoryMoog Plus has MIDI and inbuilt sequencer making it more flexible in a MIDI set-up. Sadly, it's rather an unstable and unreliable beast but, at £800 or so, this has to be a real bargain for anyone handy with an oscilloscope. Look out particularly for one of the few MemoryMoog Pluses which made it to this country; their MIDI/sequencer update also made the instrument more reliable. *Reviewed February '83.*

## OBERHEIM OBX

Hot on the heels of the Prophet 5, the OBx offered a fully programmable 8-voice synth with two VCOs, a VCF, VCA and two EGs per voice and it had the famous fat Oberheim sound. Lush strings, rude brass and nasty bass sounds to be had amongst many others. Nowadays, it might appear a bit limited in terms of real synth facilities but nothing can really compete with the sheer quality of sound it makes which is lush and warm and suitable for any musical style.

## OBERHEIM OBSX

A preset version of the OBX with the same fat sound. It was non-programmable but you could program it from an OBX but, as those are in short supply, you might find that the sounds you have are not to your taste and you may be stuck with a duffer.



## OBERHEIM OBXa

A split/layer version of the OBX in the new blue livery. More features, same sound. Speak to Tom Bailey in The Thompson Twins about them – he uses one all the time – the famous Twins bass sound is all OBXa as are most of their other sounds (excepting the Fairlight noises, of course). Highly recommended especially at the going rate of £800 or so.

## OBERHEIM OB8

Further updates brought us this little gem. Basically, it had an extra 'page' which turned the control panel into another control panel full of interesting modulation and performance facilities. Also highly recommended. *Reviewed January '84.*

## PPG WAVE SERIES

Unique and original. Each voice has digital oscillators capable of producing over 1000 incredible waveforms via its wavetables. These can be then further processed by standard VCF and VCA sections. The digital clarity of the waveforms makes it cut like a knife even at a Motorhead gig. Expensive (prices start at about £1700) but worth it for a classic original. Available in three forms, the Wave 2 which has one oscillator per voice, the Wave 2.2 which has two plus the ability to be used with a Waveterm, and the Wave 2.3 which is a multi-timbral version of the 2.2 and with more capabilities with the Waveterm. *Wave 2 reviewed July '81. Wave 2.3 & Waveterm reviewed May '84.*

## ROLAND JUPITER 4

A four-voice job with one VCO per voice. Not unlike the Juno 6 but with two EGs instead of the Juno's one. Powerful sound and a nice arpeggiator with a wonderful 'random' setting for

some bizarre effects. Looks odd and has only eight user-programmable memories, but has a nice full sound thanks to its VCOs instead of the more 'clinical' DCOs. Good secondhand price makes it worth having a look at.

## ROLAND JUPITER 8

Roland's answer to the OBX and Prophet 5. An 8-voice synth with keyboard split and layering facilities and versatile arpeggiator (including the random feature of the Jupiter 4). Two VCOs, a VCF, an HPF, VCA and two EGs, keyboard scaling, oscillator sync plus LFO. Capable of a lot of great sounds, especially strings and bass, and it seems to be holding a good price around the £1000 mark which is a testament to its capabilities. Versatile and reliable. Can't go wrong at the right price.

## ROLAND JUPITER 6

A MIDI version of the Jupiter 8 though lacking in some of the finer points. Very nice indeed. Lush, versatile sounds with lots of facilities including two LFOs, EG rate scaling, multi-mode filter and FM

facilities. Looks good too. Unfortunately, the LEDs have a habit of packing up and the MIDI is limited. At £850 or thereabouts, a good buy if your MIDI needs are not extensive. *Reviewed April '84.*

## ROLAND JUNO 6/60

A classic, budget polysynth with a sound that quite belies the fact that it is a very basic synth with a voice architecture similar to the old SH09 monosynth. Six-voice, onboard chorus, integral arpeggiator and the 60 is programmable. So, all in all, a good sounding machine, ideal for novices and more experienced players. At the going rate of £300, they are definitely a bargain. *Juno 6 reviewed July '82, Juno 60 reviewed December '82.*

## ROLAND JX3P

Another Roland classic. Strange they've discontinued it as it's appeared on so many hit singles and has probably helped a lot of bands get that elusive record deal. Versatile with plenty of character and warmth, and with a neat sequencer that is easy to use (if a bit





limited in its note storage). Easily programmed, even without the optional PG200 programmer. The MIDI is not ideal being OMNI reception and transmitting on Channel 1 only, so be careful if you wish to incorporate it into an extensive MIDI system. Considering the price, one of the best little synths ever made. Silly prices at the moment. *Reviewed August '83.*

### ROLAND VOCODER PLUS

Not really a true polysynth but worth inclusion. Amazing choir sound and healthy strings, as well as an unmatched vocoder – quite highly sought after by those who have used them and so they retain their price quite well. Expect to pay around £500 if you can catch one, which is not a lot less than their original selling price many years ago.

### SCI PROPHET 5

The original programmable polysynth, which many top artists still swear by, viz. Peter Gabriel. Poly-mod section makes it very flexible and versatile. Full sounding yet capable of some impressive clangs and other FM-type noises. Early models had some tuning problems (as well as limited portamento/glissando facilities), but this is generally deemed to give a more characteristic sound than the later revisions. At £800 they are certainly worth having, especially for an original.

### SCI PROPHET 600

Supposedly a MIDified version of the 5 but, to be honest, it doesn't have the same quality sound or features – but don't ignore if the price is right. Similar voice architecture plus an onboard sequencer (which is practically useless as it doesn't sync to anything – although Argent's have a software update to add MIDI sync). *Reviewed April '83.*

### SCI SIXTRAK

The first 'budget' synth from the makers of the Prophets. Sadly, only one VCO per voice made its sound capabilities considerably more limited than its predecessors but it was multi-timbral (but not with individual voice outputs, I'm afraid, though you can get it modified) and had an onboard sequencer that was actually quite good. Limited but nice for writing with. *Reviewed March '84.*

### YAMAHA CS40

A funny creature. Looks like a piece of G-Plan furniture. Sounds OK but not a world beater.

### YAMAHA CS60/50

A scaled down version of the CS80 (see later). Nice sound, very distinctive. Limited touch sensitivity but, at the right price (around £300) they are certainly worth investigation. Major difference

sure, with individual control for each voice. Basically two synths in one, each one comprising a VCO, a lowpass VCF, a highpass VCF, two EGs, VCA plus a ring modulator and chorus unit. Big, impressive and very distinctive sounding. Sadly, non-programmable although you could set four banks of mini sliders underneath the control panel for a sort of quasi-programmability. A 'real' instrument thanks to its stunning weighted keyboard and takes some application to learn to actually 'play' it. Currently going for as little as £600 (it was originally over £4000) and so has got to be a bargain. The only drawback is that it's a big bugger and needs a few hefty roadies – but it looks great resident in your studio. Probably the only rival with the Prophet 5 for the affections of the majority of stars. A truly amazing synth – just check out any work by Vangelis or Eddie Jobson.

### YAMAHA DX9

Scaled down DX7. Fewer operators and algorithms and no touch sensitivity but, when all is said and done, it does sound



between the two is that the CS60 is eight voice, the CS50 four voice. Looks nice but a little bulky.

### YAMAHA CS80

A truly original piece of gear. Fully touch sensitive, both velocity and pres-

equally as good as a 7 so worth a look if you're short of the readies and can't quite stretch to the big brother. Its main advantage is that whilst it sounds as good, it is even easier to program and has cassette storage of sounds which is a hell of a lot cheaper than RAM cartridges. A classy sounding synth for quite silly prices at the moment. *Reviewed July '84.* ■

**BUY ON INTEREST FREE H.P.**

IPSWICH COLCHESTER

ONE HOUR FROM LONDON

**HOT NEW PRODUCTS**

**THE FANTASTIC YAMAHA DX27**

DX 27 Digital Programmable Algorithm Synth 192 Presets **£499**

BUY ON INTEREST FREE H.P.



**RX21 THE NEW BUDGET PRICED DRUM COMPOSER**

**RX21L Latin Percussion Unit £249**



**DX100**

Superb new FM Synth from Yamaha 192 preset voices Only **£349**



**YAMAHA REV 7**

Digital Reverb & Midi **£999**

**YAMAHA DX21**



BUY ON INTEREST FREE H.P.

128 PRE PROGRAMMED VOICES. 32 MEMORIES. 8 NOTE MIDI POLYPHONIC SYNTHESISER **£649**

**THE ONE & ONLY YAMAHA DX7**



BUY ON INTEREST FREE H.P.

THE ALL TIME FAVOURITE

**YAMAHA TX7**

FM Tone Generator Midi equipped 32 voice memories Special offer **£495**

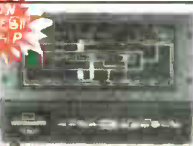

**YAMAHA PF70**

76 Key Midi equipped FM Electronic Piano Real piano feel - real piano sound Unreal piano price of only **£899**



**YAMAHA PF80**

Same as PF70 but with 88 keys **£999**



**YAMAHA QX7**

Digital Sequence Recorder with Midi Special offer **£299**



**SPX 90 - Digital Multi Effect Processor/Reverb**

Effects include Reverb, Early reflection, Delay, Echo, Modulation, Auto Pan, Vibrato, Pitch change, Reverb and gate, Freeze, Compression, Parametric Eq. Price **£599**

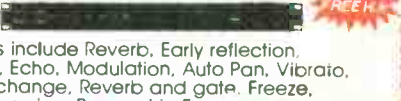

**QX21**

Midi Sequencer **£259**

**YAMAHA MT1X**

Multitrack Cassette Recorder New Model **£449**



**Roland**

**ALPHA JUNO I**

The very latest synth an affordable price from Roland at In Stock Now **£525**



BUY ON INTEREST FREE H.P.

**JX8P**

Midi Polysynth



Price **£1149**

**JUNO 106**

programmable Poly Synth with Midi including stand in stock **£599**

**PAD8 OCTAPAD**

The first midi compatible pad controller Touch sensitive **ONLY £399**

BUY ON INTEREST FREE H.P.

**HOT NEW PRODUCTS**

TR505 Digital Drum Machine 16 Voice 6 Track **£225**  
Alpha Juno II Synthesizer Touch sensitive with after touch **£799**

BUY ON INTEREST FREE H.P.

**TR707 RHYTHM COMPOSER**

Stores 64 rhythm patterns Velocity sensitive Midi Individual outputs etc SUPERB VALUE AT ONLY **£499**

BUY ON INTEREST FREE H.P.

**SRV 2000 DIGITAL REVERB £1100**

**MKS7 Super Quartet**

The most sophisticated sound module ever made **£950**

BUY ON INTEREST FREE H.P.

**BOSS MICRO-RACK EFFECTS**

1/2 rack width  
RDD10 Delay **£149**  
RCL10 Comp/Limiter **£115**  
RBF10 Flanger **£115**  
Digital Sampler **£199**  
RGE10 Eq **£115**  
RPH10 Phaser **£115**

**BOSS PEDALS**

HPFI Flanger **£89**  
Dimension C **£129**  
OD2 Turbo overdrive **£59**  
DSD2 Digital Sampler **£160**  
DD2 Digital Delay **£139**  
CF3 Stereo Chorus **£85**  
BF2 Flanger **£89**  
DM35 Analog Delay **£99**  
CS2 Compressor **£65**  
DS1 Distortion **£55**

**Ibanez**

**New Range**

RG110 **£222** RG440 **£359** RS 530 **£349**  
RG140 **£237** AM 70 **£329** RS 135 **£185**  
RG430 **£357** RS 1300 **£299** MC 924 **£635**

**Aria**

**NEW RANGE**

Cat **£169** Wildcat **£199**  
Straycat **£189** Knight Warrior **£329**  
Cat Bass **£179** LEB Classic **£239**  
Straycat Bass **£209** LEB Bass **£199**

**KRAMER**

Baretta (USA) **£585** Focus 3000 **£415**  
Carrera (USA) **£595** Striker 100 **£239**  
Focus 1000 **£359** Striker 200 **£255**  
Focus 2000 **£395** Striker 300 **£265**

**HAMER**

Gary Moore Special Sale Price **£699**  
Steve Stevens Model Sale Price **£619**

**Jay Dee**

Jaydee Basses  
Mark King Model **£796**  
Roadie Active **£645** Roadie **£455**

**Rickenbacker**

- 329 Liverpool 21 fret short scale 3 pickup, semi hollow body **£585**
- 330 Thinline semi acoustic, 24 fret 2 pickup, dot inlay, mono **£595**
- 350 Liverpool 24 fret full scale 3 pickup, semi hollow body **£655**
- 360 Deluxe thinline, semi acoustic, stereo, inlaid neck **£675**
- 4003 Bass - Roundwound strings, stereo bound body & neck, full inlay **£669**

BUY ON INTEREST FREE H.P.

**Fender**

The New Fender 70s Strat **£299**  
The New Fender Standard Strat **£399**  
The New Fender Standard Tele **£395**  
The New Fender Deluxe Strat **£599**  
Squier Strats **£249**  
Squier Teles **£235**  
Limited Edition Re-issues of Jazzmaster, Tele Thinline.

BUY ON INTEREST FREE H.P.

## TASCAM

### THE NEW TASCAM 388



BUY ON INTEREST FREE H.P.

is the first complete 8 channel recording system, consisting of a full function 8x8x2 mixer with a full servo controlled 8-track reel to reel recorder. Compact yet professional. Price **£2495**

### THE NEW 246 PORTASTUDIO

with 6 input full function mixer and 4 channel 2-speed DBX cassette recorder. All for **£979**



BUY ON INTEREST FREE H.P.

### PORTA ONE



BUY ON INTEREST FREE H.P.

4 Track Cassette  
Just **£399** + 10 FREE TAPES

244 Porta Studio  
Parametric EQ, DBX.  
Now only

**£699**



38 8 Track Reel to Reel P.O.A.  
DX4D 4 channel dbx **£270**  
122B Stereo rack mount cassette **£585**  
234 Syncassette **£640**  
225 Syncassette **£240**  
M2A Mixer **£270**  
M09 Mixer **£185**

BUY ON INTEREST FREE H.P.

### EASY FAST INTEREST FREE H.P. SERVICE

#### GOODS REQUIRED

The Customer Full Names: \_\_\_\_\_

Mr/Mrs/Miss \_\_\_\_\_ Age \_\_\_\_\_

Full names of spouse (if signing): \_\_\_\_\_

Home Address \_\_\_\_\_

Postcode: \_\_\_\_\_

How long? \_\_\_\_\_ Phone No: \_\_\_\_\_

Previous address (if less than 3 years) \_\_\_\_\_

Marital Status Married  Single  Number of Dependents

Accommodation House  Flat

Buying  Renting  With Parents  Monthly Amount £ \_\_\_\_\_

Name and address of Landlord or Mortgage Holder: \_\_\_\_\_

Name and address of Employer: \_\_\_\_\_

Position \_\_\_\_\_ How Long? \_\_\_\_\_

Net Income £ \_\_\_\_\_ Monthly  Weekly  Only  Commission

Previous employer (if less than 3 years): \_\_\_\_\_

Position \_\_\_\_\_ How long? \_\_\_\_\_

Bankers: \_\_\_\_\_

Branch Address: \_\_\_\_\_

Type of account Current  Savings  Deposit  Loan

Account No: \_\_\_\_\_

Just fill in the above and return to either of our shops and your application will be processed immediately.

YOUR PASSAGE TO THE EAST

ASK FOR FREE GIFT

96 High Street  
Colchester  
(0206) 65652  
/570630

41 St Nicholas Street  
Ipswich (0473) 54996

PLEASE SEND ME IMMEDIATELY :-

NAME \_\_\_\_\_  
ADDRESS \_\_\_\_\_  
PHONE No. \_\_\_\_\_  
I ENCLOSE CHEQUE/CREDIT CARD NUMBER  
AND GOODS WILL BE DESPATCHED  
POST HASTE! T-Shirts/Sweat Shirts  
Available. Ring for details.  
E8MM/6/86

## AKAI

S612 Sampler & MD280 **£799**  
S900 8 Voice Polyphonic Digital Sampler **£1599**  
AX73 73 Key Controller Keyboard **£379**  
MX73 73 Key Controller Keyboard **£499**  
VX90 6 Voice Rack Mount Synthesizer **£499**  
CPZ 1000 Midi Recorder & System Controller **£1699**

## Marshall

100w Valve Master Vol Amp **£360**  
50w Valve Master Vol Amp **£294**  
100w Valve Switchable Split Channel & Reverb **£411**  
4x12 Cabs 300w **£294**  
12w Practice Combo **£80**  
30w Guitar Combo **£163**  
50w Guitar Combo **£265**  
75w Guitar Combo **£283**  
100w Guitar Combo **£359**  
50w Guitar Combo (Valve) **£313**  
New 42 watt Mini Stack

BUY ON INTEREST FREE H.P.

Bass & Keyboard Amps in stock — Phone

## TRACE

AH 500w Amp Head with GP11 Preamp **£755**  
AH 350w Amp Head with GP11 Preamp **£675**  
AH 250w Amp Head with GP11 Preamp **£595**  
AH 150w Amp Head with GP11 Preamp **£440**  
11" 5 150w plus GP11 1 x 15 Combo **£719**  
1110 150w plus GP11 1 4 x 10 Combo **£704**  
1813 1 x 18 and 1 x 10 Cab **£440**  
1043 4 x 10 Cab **£330**  
1513 1 x 15 Cab 8Ω **£315**  
1514 1 x 15 Cab 8Ω **£330**

BUY ON INTEREST FREE H.P.

## Fostex

X15 Multi-Tracker **£259**  
250 4-Track Cassette **£599**  
A80 8-Track Recorder **£1575**  
450 Mixer **£699** Accessit Stereo Reverb **£115**  
Accessit Noise Gate **£42**  
Accessit Compressor **£42**  
SECK 6/2 Mixer **£295**

BUY ON INTEREST FREE H.P.

## PEAVEY

Audition Guitar 12w **£95**  
Back Stage Plus Guitar Combo - 35w **£159**  
Bandit Guitar Combo 65w **£279**  
Special Guitar Combo **£379**  
MX Guitar Combo 130w **£499**  
Encore Guitar Combo 65w **£379**  
Century Bass Head 100w **£225**  
Mark IV Bass Head 300w **£469**  
KB 100 Keyboard Combo 65w **£279**  
KB 300 Keyboard Combo 130w **£465**  
XR400 100w PA **£375**  
XR500 130w PA **£399**  
TKO65 Bass Combo 65 watts **£269**  
TNT130 Bass Combo 130w **£389**  
300 Watt Bass Combo **£569**

BUY ON INTEREST FREE H.P.

## CARLSBRO

Martin 150 PA **£275**  
Cobra 90w Bass Combo **£223**  
Cobra 90w Kbd Combo **£289**

BUY ON INTEREST FREE H.P.

# Yamaha RX21L Drum Machine

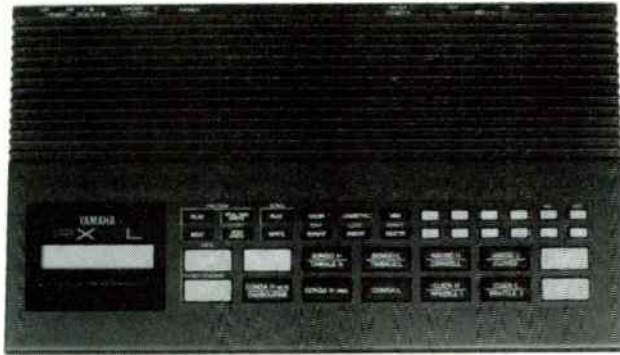

Some things are, I suppose, inevitable. The Yamaha family has been added to once more and grows in the same, logical manner to which we're all becoming accustomed. Yamaha are now so adept at supplying the right, natty little product at the right, natty little price that it's almost possible to set your watch by the company's frequent product launches.

The RX21L is their latest offering and is basically an RX21 with 16 latin voices in place of the nine traditional 'kit' sounds. All its functions, displays and little 'ins and outs' (for want of a better collective term) are identical in almost every way to its sister machine, and owners of same can expect to take just a couple of minutes to become familiar with the few, mainly 'instrument select' functions, that are different.

With the 21L, Yamaha have chosen to allocate more of the machine's memory to providing these 16 voices than to pattern storage. As a result, whilst seven extra voices make the machine that much more useful, its pattern storage is reduced to 50% of that of the RX21; from 100 patterns to (yes, you guessed it), 50.

Of these, 29 are pre-programmed in the factory, though they can obviously be preserved on cassette – which takes 15 seconds – before your eager fingers begin rewriting and editing everything. As for the usefulness of the presets, well, no danger of any hit records, but great as building blocks for more personalised rhythmical adventures.

String all these adventures together and you have a 'song'. The 21L has a separate song memory which will accommodate a total of 256 patterns in four songs, ie. 64 patterns per song (or any other combination you want to use, up to a total of 256). Considering the fact that the RX21 boasts an impressive capacity of 512 patterns per song you begin to wonder where all that memory has in fact been syphoned off to, but in practice, 64 measures is still a pretty usable amount and if you really do need more then you've simply gotta expect to pay more.

Anyway, take it as read that all but these features are repeats of those on the RX21 (reviewed back in last September's issue) and let's get on to the voices.

All sixteen of the instruments provided are

of absolutely exceptional quality, with a slight reservation about the tambourine and, oddly enough, the cowbell which are both somewhat less convincing than their companions. All are digitally-encoded morsels of the real McCoy and list as follows; two bright little bongos, pitched rather high but at their bouncing best when supported by the rest of a mix; two crisp, powerful timbales; three hearty conga voices, one of which is muted (as if played with one hand damping the skin); claves; a cowbell and a tambourine – and then the three pairs of instruments which, for me, really make this machine come alive.

Firstly, there are high and low agogos which bring a little 'tunefulness' to the overall proceedings, sounding as they do like a cross between a high-pitched, miniature cowbell and a lightly-struck milk bottle. Secondly, high and low cuicas (pronounced cuicas) add a little fun and authentic variety to the proceedings. The cuica sound is somewhat difficult to describe – but imagine a pair of mating geese rubbing two balloons together... Lastly, a short whistle and, yes, a longer whistle, the sounds of which, thankfully, I shouldn't need to describe to anyone.

So, put the whole lot together and what have you got? Well, considering none of its voices are repeats from other Yammy boxes, it could make an excellent (though obviously less flexible) companion for any MIDI drum machine. Listening to the 21L completely dry and flat, the colour and immediacy of the sounds is still very striking, and when you consider that an attempt to recreate (with Real People) the sound that this unassuming little box is capable of producing on its tod, would mean recruiting a competent six or seven-piece rhythm section...

At a suggested retail price of £229, Yamaha have managed to produce a bite-sized, MIDI equipped, and simple-to-use Latin percussion machine. The manual is superb and the sounds are unnervingly 'real'. Apart, perhaps from a shaker and a backlit LCD display, what more could you want? ■ Trevor Gilchrist

Price RRP £269 including VAT  
More from Yamaha-Kemble, Mount Avenue,  
Bletchley, Milton Keynes, Bucks MK1 1JE. ☎  
(0908) 71771



# AKAI INSPIRED TECHNOLOGY

## S 900



We also stock the S612 sampler at only £649, now with Audio Trigger option.

## S 900

An 8 voice, 12 Bit, Rack Mount Sampling Unit, boasting an internal memory of 750k, which can be allocated to 32 different wave-samples, a built in 3.5" disk drive and a full 12 seconds @ 16k bandwidth expandable up to 48 seconds at a sample rate of 10kHz. 8 voice polyphonic or 8 independent sound outputs, which can be triggered via MIDI, or with an optional PCB, by 8 audio inputs. Individual looping/ADSR/loudness control. 8 direct lineouts or a stereo mix. Further software & hardware is available for, waveform editing, converting the S900 into an 8 voice sinewave synthesiser, and finally a 13 second 16k bandwidth digital recorder, with overdub and punch in/out facilities. It all adds up to an amazing machine at £1,599.

## ME 25S

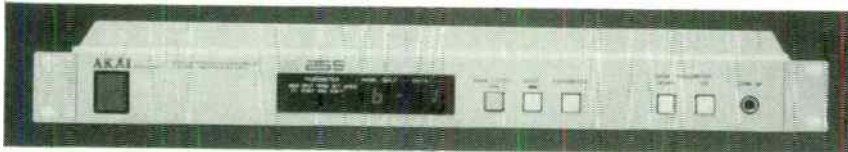

## ME 25S

ME 25S is a single rack mount unit, which will effectively convert your own MIDI keyboard (e.g. DX7, JX8P, AX80 etc) into a master keyboard, with up to 4 split points/overlaps, MIDI channel assignable, +/-3 octave shift, 128 programme changes, 64 programmable memories. Wheel control can be assignable to any one split area. A sophisticated unit at an amazing £99.

## ME 30P



## ME 30P

Single unit rack mount, programmable MIDI patchbay, 4 inputs, 8 outputs (MIDI Thru), 8 storable programmes, giving up to 15 sets of input/output patches. This unit frees you from that tiresome problem of changing MIDI leads, and at a fraction of the cost of other similar units. £99.

## MX 73



## MX 73

A 73 note velocity sensitive, MIDI master keyboard with 100 internal memories, up to 4 split points/overlaps, each area can control separate MIDI channels, velocity, octave shifts. 4 programmable sliders and switches which can be assigned to various controls. A versatile tool for controlling MIDI data £499.

## TEST DRIVE THE NEW AKAI RANGE TODAY AT...

*Pro-Shop*

**ABC MUSIC PRO-SHOP**  
14-16 HIGH STREET · ADDLESTONE · SURREY KT15 1TN ·  
TELEPHONE 0932 59675 · (SITUATED — JUNCTION 11 M25)

**ABC MUSIC**  
56 SURBITON ROAD · KINGSTON ·  
TELEPHONE 01-546 9877

**ABC MUSIC PRO-SHOP**  
44 ST. CLEMENTS · OXFORD OX4 1AG ·  
TELEPHONE 0865 724820 ·

**ABC MUSIC**  
324-326 FARNHAM ROAD · SLOUGH ·  
TELEPHONE 0753 822754  
World Radio History

**ABC MUSIC**  
**AKAI ROADSHOW HITS**  
**ADDLESTONE**  
**MONDAY JUNE 30th**  
**CALL FOR FREE TICKETS**  
**AND DETAILS.**

# Drawmer MIDMAN Processor

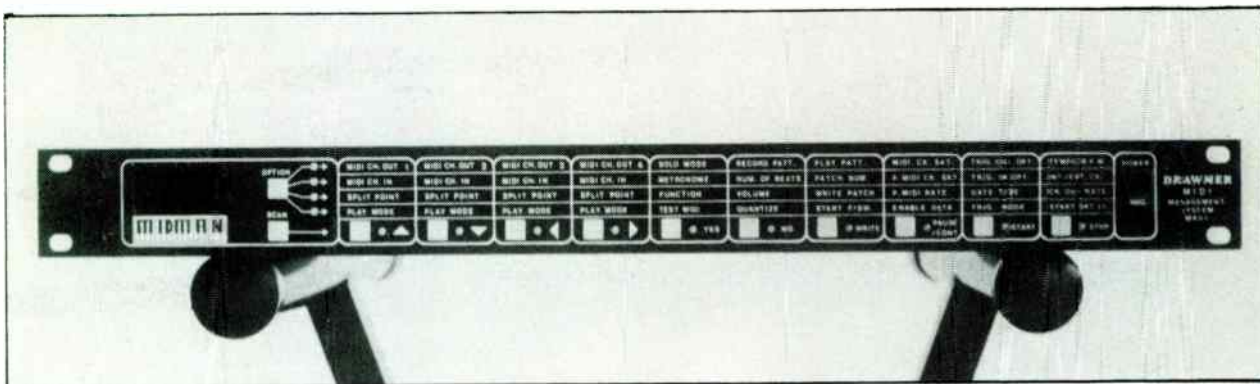

With the inroads that MIDI is making into studio environments these days, the entry of a company well known for its audio signal processors into the MIDI signal processing market is not surprising. Drawmer's 19" rack-mounting M401 MIDI Management System involves itself in MIDI signal routing, but also offers extensive synchronising and triggering facilities for MIDI and non-MIDI instruments, and the ability to record rhythm patterns which can subsequently be 'superimposed' on sound material. All of the MIDMAN's parameters and pattern data can be stored in 32 programs and later recalled by front panel selection, footswitch or MIDI patch changes.

MIDI routing via the MIDMAN is facilitated by a single MIDI In, four MIDI Outs and two MIDI Thrus. The unit's rear panel also sports sockets for two momentary footswitch inputs, trigger and audio outputs, an audio/trigger input, clock in and out, and start/stop out.

Each MIDI Out can be assigned its own MIDI receive and output channels, split-point value and play mode. Play mode has multiple options which basically revolve around whether notes held down are to be played normally or only when triggered by another source, and whether notes will be triggered over the whole keyboard or only the split section. Play mode (which is Out specific, remember) also allows you to convert a specific incoming patch number to any other patch number (both in the range 1-128).

Five categories of MIDI data can be disabled: aftertouch and mod wheel (together), pitch-bend, patch changes, controller codes and system exclusive data. These aren't Out-specific, so you couldn't disable sustain for one instrument but not another, for instance. A pity, that.

Another useful feature which sadly isn't Out-specific is MIDI volume level. When you consider that Yamaha's MEP4 (reviewed elsewhere in this issue) allows you to accomplish all sorts of data manipulations for each of four channels, and C-Lab's 16-track sequencer (also reviewed in this issue) allows you to manipulate velocity levels in real time for all 16 tracks separately, the MIDMAN appears rather less flexible.

Turning to MIDI synchronisation, it's possible to send MIDI clocks along with performance data to any individual Out or to Outs 1 and 2. In this way you could run a sequencer or drum machine off a particular Out, synchronised to the MIDMAN's internal clock or to any other clock that is controlling

the system.

There's also a programmable MIDI clock output, which can be sent to any individual Out or to Outs 3 and 4. The 24 ppqn MIDI clock rate can be divided by 1, 2, 3, 4, 6, 8, 12 or 24, allowing you to run MIDI sequencers and drum machines at a variety of rates. It's a feature which could lead to all sorts of interesting possibilities.

The MIDMAN can choose from three clock sources: internal, external and external MIDI. Non-MIDI clock can be set to cover all the standard rates and more. Relevant start and stop information for sequencers and drum machines will be sent by the MIDMAN for each type of output. It's also possible to use one of the footswitches or the trigger input to trigger sequences. Either a +5V pulse or an audio signal may be applied to the Trigger In jack - allowing sequencers and drum machines (or the MIDMAN's own patterns) to be triggered from a wide variety of sources. MIDI timing pulses in sync with either an audio source or a division of the clock can be sent, together with an appropriate pulse at the trigger out and audio out jacks (the last-mentioned can be used to trigger equipment such as Drawmer's DS201 Dual Gate). Drawmer have given the MIDMAN a sophisticated set of trigger output possibilities (including the ability to delay the trigger placement in units of 1/24th of a beat) which will no doubt become a much-used feature in studios.

The MIDMAN includes the ability to record 32 rhythm patterns of up to 99 beats each, in eight sets of four (one assigned to each Out). With 32 program memories, that adds up to a lot of patterns. The idea is that you record the rhythms you want (effectively up to four superimposed rhythms) complete with velocity, and subsequently 'superimpose' any notes you want on these rhythms.

Understandably, given the manufacturer's studio equipment background, the MIDMAN is most at home in a studio environment, where its extensive triggering, syncing and rhythm programming options should ensure frequent use. On the other hand, its MIDI processing options are less flexible than those of Yamaha's MEP4, which is perhaps better suited to use in a purely MIDI keyboard-based setup.

■ Simon Trask

Price £395 plus VAT

More from Drawmer Sales and Marketing, Unit 4, Brook Lane Business Centre, Brook Lane North, Brentford, Middlesex TW8 0PP. ☎ 01-847 2890

# EXPLORE CREATIVITY!



## "THE BOX"

A new MIDI multi-effects/sequencer box for keyboardists! Create sequences, chords, arpeggios, delays, special effects and more. Self contained, no computer required! Includes battery back-up... \$299.00



## SYNTHESTRA

The next step... MIDI sequencing and control software in one! Control and synchronize 16 MIDI devices from a "master" keyboard. Controls a complete MIDI studio! For Apple IIe/+... \$120.00



## DX-1 SAMPLER

A flexible, low cost digital sound sampler for your Apple IIe/+ . Record, modify and sequence any sound. MIDI, sound analysis & graphics options available. New low price... \$249.00

WRITE OR CALL FOR FREE BROCHURES

Decillionix, P.O. Box 70985  
Sunnyvale, CA 94086 USA  
(408) 732-7758

# the perfect beat..

**NEW 60 MIN. RHYTHMIX CASSETTE TAPES**



**£7.99**

inc. VAT, P&P

Each tape contains no less than 16 modern drum rhythms, ranging from ballad to rock, from funk to disco. Each track with its own count-in, musically arranged eight bar phrases and fills (for verses and choruses) and track listing describing beat and duration. Ideal for songwriting/composing, for practising or simply backing/accompaniment. RHYTHMIX tapes are designed for all active musicians also a must for the studio.

RHYTHMIX tapes have been specifically produced for MUSIC MAKER PUBLICATIONS and feature a leading professional session drummer. RHYTHMIX tapes will be produced as an ongoing series. Volume 1 available now - send cheque/postal order made payable to

MUSIC MAKER PUBLICATIONS LTD., ALEXANDER HOUSE,  
1 MILTON ROAD, CAMBRIDGE CB4 1UY,  
or use credit card Hotline (0223) 313722 ACCESS/BARCLAYCARD.

# FD&H

138-140 CHARING CROSS ROAD  
LONDON WC2H 0LD  
MUSICAL INSTRUMENTS 836-4766  
SHEET MUSIC 836 9741

The MUSIC WEST END MUSIC STORE!

## FANTASTIC OFFER ON ALL JMS RMS 2H MIDI INTERFACE

£89 NOW ONLY

**£50**

For use with Commodore 64 or Spectrum computers

## RMS 12H MEMORY EXPANDER

giving you 4 internal memory banks loaded with 192 new DX7 sounds at the unrepeatable price of

**£88**

## SOUND LIBRARY

6 memory banks each with 32 sounds giving you 192 new sounds for your DX7 in floppy disc format

HALF PRICE **£25**

## RMS 28C SCOREWRITER

Prints all your music recorded on the JMS 12 track studio (included in the special package) and transposes to any key for all instruments. Package includes Scorewriter, Eprom, + 12 track studio, all for

**£199 ONLY**

and there's more

**ALL OTHER JMS PROGRAMMES**

# 50% OFF



## SPECTRUM

MIDI INTERFACE

£59.95 with tape/MIDI and pulse sync. STEP SEQUENCER £38.95 music score + 24,000 events, full edit, chords easily entered MULTITRACKER - £38.95 real time, 8 poly tracks, bar

chaining, looping overdub with real time/step time input. DATA BASE SYSTEM £22.95 MIDI data base system displays save reload patch info songs etc works with most synths.

## CASIO CZ EDITOR + SOUNDS £22.95

wave forms graphics, dump to tape library of 96 new voices to load into the editor

## TX7/DX7 EDITOR £24.95

Graphics, wave forms dump to tape. LIBRARY £24.95 new sounds save to tape

**CUSTOMISED SOFTWARE AND HARDWARE CAN BE PRODUCED FOR ALL MIDI APPLICATIONS.**

## SYNC CONVERSION BOXES

Computer controlled tape/mode/5V pulse specialised version available £59.95

For further details please write (SAE) or phone:

# XAI SYSTEMS

10 Sunnybank Road, Wylde Green, Sutton Coldfield, West Midlands B73 5RE. Tel: 021-382 6048. (Closed Wednesdays)



### ALPHA JUNO 1

Great New Looks Great New Sounds  
Rolands Cheapest Polysynth



### ALPHA JUNO 2

Great new touch sensitive polysynth:  
64 preset voices, 64 programmable +  
64 on optional cartridge, MIDI, the  
best ever touch sensitive UNDER £800



### JX8P

2 Oscillators, touch sensitive, MIDI,  
beautiful sounds at an AMAZING NEW  
LOW PRICE



### SUPER JX10

The brand new Roland flagship. The ultimate  
analogue machine, 76 keys, 12 note poly,  
layered and split sounds, built in sequencer,  
touch sensitive + MIDI of course £POA



### RD1000 DIGITAL PIANO

88 fully weighted wooden keys, 16 note  
polyphonic MIDI, SAS sound generation,  
incredibly accurate grand piano sound and  
feel, including stand £POA

### MKS20 DIGITAL PIANO MODULE

Exactly the same facilities as RD1000 without  
the keyboard SUGGESTED PRICE £1199

### MKB200

61 note MIDI keyboard controller  
SUGGESTED PRICE £599



**MC500  
MICRO  
COMPOSER**  
40,000 notes internal  
memory + 100,000  
notes on 3.5" disc +  
MIDI SUGGESTED  
PRICE £799



### PLANET P

MIDI piano module. Was £900  
TO CLEAR £299



### TR505

Fantastic new digital drum machine,  
16 PCM voices inc Latin sounds + MIDI  
with a SUGGESTED PRICE OF ONLY £225



**TR707 DIGITAL DRUM MACHINE**  
MIDI, separate outputs, on board mixer,  
great sound.

**TR727 DIGITAL PERCUSSION  
MACHINE** Same as 707 but with Latin  
sounds. A great combination with:

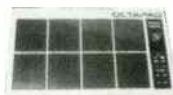

### PAD-8 OCTOPAD

8 touch sensitive pads, to trigger any MIDI  
drum machine or synth etc.

SUGGESTED PRICE £399

★ SPECIAL PACKAGE DEALS AVAILABLE ★

### BOSS EFFECTS PEDALS

The complete range of these market leaders  
always in stock at the very best prices!!

### SRV2000 STEREO DIGITAL REVERB

This is the really serious reverb, unmatched  
quality and facilities. Incredible new  
low price £POA

### SDE 1000 DIGITAL DELAY

### SDE 2500 DIGITAL DELAY

(Progs + MIDI)

### SDE 3000 DIGITAL DELAY

(programmable)

### BOSS CE300 Super Chorus

### BOSS

### MICRO RACK SERIES

Low budget  
high quality  
processors



RDD 10 Delay.....	£149
RSD 10 Sampler/Delay (2 sec).....	£199
RCL 10 comp/limiter.....	£115
RGE 10 graphic EQ.....	£115
RBF 10 flanger.....	£115
RPW7 multi power supply.....	£64
BMRS rack.....	£45



**G77/GR77B**  
BASS GUITAR SYNTH.  
NEW LOW PRICE!!



# MUSIC VILLAGE

HEAD OFFICE & MAIN SHOWROOM: 10 HIGH ROAD, CHADWELL HEATH,  
(Near ROMFORD, ESSEX) Tel: 01-599 4228 01-598 9506

★ NO DEPOSIT INSTANT CREDIT UP TO £1500 ★ ACCESS ★ VISA ★ AMEX ★ DINERS ★ MAIL

# KORG<sup>®</sup>



### DW8000

VOTED KEYBOARD OF THE YEAR 8 note poly, digital  
waveform, touch sensitive, built in digital delay,  
arpeggiator, MIDI, terrific spec £POA

### DW 6000

6 NOTE POLYSYNTH NEW LOW PRICE!!

### DVP-1 DIGITAL VOICE PROCESSOR

Vocoder/Harmoniser, polyphonic, pitch  
shift, 1 octave, MIDI, unique product £POA



### SDD 2000 SAMPLING DIGITAL DELAY

64 effects memories, up to 4368 M.seconds  
delay and sampling, MIDI, Was £799  
SPECIAL OFFER £399



### SDD 1000 SAMPLING DIGITAL DELAY

Sampling, sequencer and trigger, overdub  
effects, up to 2048 M.seconds delay and  
sampling was £499 SPECIAL OFFER £299

NEW KORG PRODUCTS  
COMING SOON DSS-1 Sampling  
synth & SG-1 sampling grand  
piano RING FOR DETAILS



### EX800

Programmable module, exactly the same  
facilities as DW8000 without the keyboard



### POLY 800 MkII

New programmable polysynth 8 voice, 64 programs,  
built-in programmable digital delay, and EQ, built in  
1000 note sequencer, MIDI, great price!

### POLY 800 MkI,

TO CLEAR INCREDIBLY LOW PRICE



### SQD-1 MIDI SEQUENCER

15,000 note internal memory + 30,000 notes  
on disc, independent record, edit and  
playback on all 16 MIDI channels



KORG EFFECTS PEDALS  
COMPLETE RANGE IN STOCK  
AT 35% OFF!!

# ensoniq

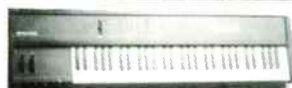

**MIRAGE SAMPLING KEYBOARD**  
Still the most cost effective sampling keyboard  
around including advanced sampling guide and discs  
SUGGESTED PRICE NOW ONLY £1320



**ENSONIQ SAMPLED PIANO**  
6 octave fully weighted keys, real piano sounds,  
touch sensitive, 10 voice, + MIDI, ONLY  
SUGGESTED PRICE £1080



**MIRAGE  
MULTI SAMPLER EXPANDER**  
As above but without the keyboard, 8 voice, built in  
sequencer, disc drive, touch sensitive, MIDI  
SUGGESTED PRICE £1080



**NEW ENSONIQ  
SYNTH/SEQUENCER**  
very powerful new synthesiser from Ensoniq, split  
keyboard, layerable sounds, touch sensitive  
sequencer, MIDI, 24 oscillators,  
SUGGESTED PRICE ONLY £1080

# AKAI



### NEW S900 MIDI

Light voice, 12 bit, velocity sensitive 3.5" disc drive,  
6 octave range, multi sampling, maximum 48  
seconds sampling time. SUGGESTED PRICE £1599



### S612 + MD280 DISC DRIVE

6 voice, 12 bit velocity sensitive, MIDI, complete  
rack sampling package  
AT AN AMAZING NEW LOW PRICE!!

# CASIO.

**NEW RX1 DIGITAL SAMPLING DRUM  
MACHINE** 800 milliseconds sampling time for single  
sample or split between a  
maximum of 4 samples,  
12 PCM sounds,  
10 separate  
outputs, on board  
mixing, MIDI,  
incredible spec  
for only £395

**NEW RZ1 DIGITAL SAMPLING DRUM  
MACHINE** 800 milliseconds sampling time for single  
sample or split between a  
maximum of 4 samples,  
12 PCM sounds,  
10 separate  
outputs, on board  
mixing, MIDI,  
incredible spec  
for only £395



# THE INCREDIBLE PRO FM PRODUCTS AT AMAZING NEW LOW PRICES



1985 TOP DEALER AWARD



**KX88 MOTHER KEYBOARD**  
The ultimate MIDI keyboard controller, 88 fully weighted keys, all facilities + great feel! **Now only £1099**



**TX816**  
8 DX7 modules in 19" rack. The ultimate FM weapon **NOW ONLY £3099**



**RX21 - MIDI Digital Drum Machine**  
also RX21L Latin Percussion with 16 PCM Percussion notes **BOTH AT NEW LOW PRICES!**



**PF70 AND PF80 FM ELECTRONIC PIANOS**  
76 or 88 notes, weighted action, 10 voices, editing, MIDI, stereo tremolo and chorus, **PF70 £899 PF80 £999**  
★ INTEREST FREE CREDIT AVAILABLE ★  
★ CP70B Electric Grand. To Clear £199 ★



**DX5**  
76 keys, more powerful than 2 DX7's **Now only £1999**

**TX216**  
2 DX7 modules in 19" rack **NOW ONLY £1299**

**TF1**  
Add on modules for TX216 **NOW ONLY £299 EACH**



**RX11**  
29 PCM voices, MID, separate outputs, RAM port, the BIZ! **UNBELIEVABLE**  
**NEW LOW PRICE!! RX15 15 PCM voices at NEW LOW PRICE!**



**MT1X 4 TRACK CASSETTE**  
MV special package deal includes FREE power supply + FREE microphone + FREE headphones **ONLY £449**



**DX7**  
The Industry Standard, always in stock at the best price

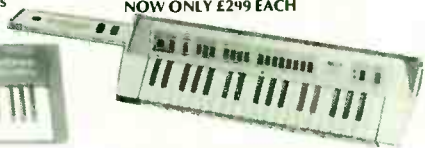

**KX5** ludicrously cheap touch sensitive MIDI keyboard controller **ONLY £130**  
**SPECIAL PACKAGE DEAL** consisting of DX100 AND KX5 + touch sensitive voice tape, gives you the cheapest touch sensitive synthesis available **ONLY £429**

**DIGITAL MULTI EFFECT PROCESSOR**  
Incredible product which gives you up to 100 seconds of digital reverb + delay, modulation, auto pan, reverb & gate, pitch change, sampling, compression, MIDI, etc. etc. **ONLY £599**



**TX7**  
FM tone generator new low price for this DX7 in a box!

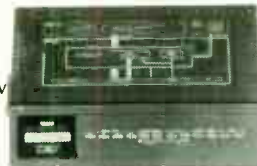

**QX1 MEGA SEQUENCER**  
80,000 notes dipolyphonic, tracks built in disc drive, full editing facilities **NOW ONLY £1299**



**REV 7**  
The programmable MIDI, digital reverb **AMAZING NEW LOW PRICE!**



**NEW YAMAHA SDS EFFECTS PEDALS - GREAT QUALITY AT SILLY PRICES!!**



**DX21**  
8 note poly, split keyboard or layered sounds, MIDI



**DX27**  
192 voices, FM, MIDI, polysynth, 61 full size keys

PLEASE RING OUR CHADWELL HEATH BRANCH FOR DETAILS OF INCREDIBLE PACKAGE DEALS!!

# WE GUARANTEE THE LOWEST PRICES!!

230 HIGH STREET, BARNET, HERTS.  
Tel: 01-440 3449 01-440 3440

8-9 BURLEIGH STREET, NEAR GRAFTON CENTRE, CAMBRIDGE  
Tel: 0223 316091/65093 (FORMERLY CAMBRIDGE ROCK)

ORDER ANYWHERE ★ SECURICOR DELIVERY ★ WORKSHOP WITH 2 ENGINEERS ON SITE ★ HIRE ★

## TASCAM



### SPECIAL PACKAGE DEALS

- EG Porta 1 + free power supply + free carry case + free headphones only **£399**
- 244 Portastudio ..... **Best UK Price**
- 246 Portastudio ..... **Best UK Price**
- 234 Rack 4 Track ..... **Best UK Price**
- 225 Syncasel..... **£225**



- 38 1/2" 8 track ..... **Best UK Price**
- 388 1/4" 8 track
- Portastudio..... **Best UK Price**
- 34 1/4" 4 track ..... **Best UK Price**
- 32 1/4" 2 track ..... **Best UK Price**
- M216 16-4-2 mixer ..... **Best UK Price**
- M208 8-4-2 Mixer ... **Best UK Price**

## Fostex

**MODEL 80 + 450 MIXER**  
The only 8 track package for under **£2000**



MAINFRAME 3 TIER ALUMINIUM KEYBOARD STANDS **ONLY £99**

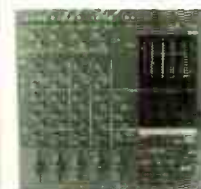

**FOSTEX 260 4 TRACK MULTI-TRACKER**  
2 aux sends, parametric EQ, switchable Dolby C **£699**



**X15 4 TRACK CASSETTE**  
+ free power supply + headphones **£259**



sound technology



**NEW ALESIS MIDIVERB**  
MIDI controlled stereo digital reverb, 63 presets, up to 20 seconds reverb time, + gated and reverse gate sounds All for just **£395**

- Alesis XT Digital Reverb ..... **Best UK Price**
- Alesis XTC Digital Reverb ..... **Best UK Price**
- Aphex Aural Exciter Type C ..... **£299**
- Baker Clock Sync Unit ..... **£395**
- Symetrix S25 Dual gated comp/limiter ..... **£349**

## SIMMONS



**NEW SIMMONS SDS 1000 KIT**  
3 sampled snare sounds (excl. hardware) **SUGGESTED RETAIL PRICE £699**

- SDS9 complete with leads & stands ..... **£1199**
- SDS1 inc. mounting kit, tom, snare & cassette ..... **£169**
- SDS200 complete with leads & stands ..... **£314**
- SDS400 complete with leads & stands ..... **£481**
- SDS800 complete with leads & stands ..... **£551**
- MTM MIDI interface, incredibly sophisticated..... **£599**
- TMI MIDI interface..... **£250**
- SDS 200 watt electronic drum combo ..... **£550**
- SDS8 used, mint condition ..... **£399**

## OTHER SIGNAL PROCESSORS

- Vesta Fire Dig 420 sampling delay..... **£299**
- Vesta Fire Dig 411 dig delay..... **£195**
- Vesta Fire RV3 stereo reverb..... **£199**
- Vesta Fire RV2 stereo reverb..... **£249**
- Accessit stereo reverb..... **£139**
- Accessit compressor..... **Special Offer £36**
- Accessit Noise Gate..... **Special Offer £36**
- Accessit Exciter..... **Special Offer £36**
- CBS Reverb..... **Special Offer £112**

## MIXERS

- RAM RM10 10-8-2 - RAM RM16 16-8-2
- MTR 6-2 - MTR 12-2 - MTR 6-4-2
- MTR 12-8-2 - DYNAMIX 6-2 - DYNAMIX 12-2

**LOWEST UK PRICES**

**MICS & HEADPHONES**  
AKG - SHURE - BEYER  
SENNHEISER - AUDIO  
TECHNICA - ALL AT  
**THE BEST PRICES**

**AMPLIFICATION**  
BOSE - JBL - TANNOY  
MARSHALL - CARLSBRO  
SESSION - ROLAND  
FENDER - YAMAHA  
LANEY - ETC, ETC.

# THE DX PIANOS

Hot on the heels of the successful PF10 and PF15, Yamaha unleash two new electronic pianos that use a couple of the DX synths' greatest strengths – FM for clear sound and MIDI for good connections. Do they make the piano's future rosier? *Simon Trask*



**W**hen Yamaha introduced their original PF10 and PF15 electric pianos (reviewed in E&MM August '84), MIDI had yet to become firmly established, and neither instrument sported the five-pin DIN. But the situation has changed, and nowadays it's not just synths that are MIDI'd; every variety of home organ and home keyboard has sprouted the dreaded socket, and now you can even MIDI your grand piano if you wish.

Cue Yamaha's new MIDI'd electronic pianos, the PF70 and PF80. Like the original PFs, the new machines are 76-note (A-C) and 88-note (E to G) versions of the same instrument. Both are 16-note polyphonic and both sport suitably professional-feeling (whatever that might mean) weighted keyboards for those players with pianistic inclinations.

But whereas the original PFs were very much stand-alone instruments, the inclusion of MIDI on the 70 and 80 makes them candidates for the role of master keyboard, alternatives to voiceless keyboard controllers such as Oberheim's Xk and Yamaha's KX88. Owners of the original PFs needn't tear their hair out in frustration, however; the Forte MIDImod for the PFs 10 and 15 is now available in this country.

The PFs are heavy. If you tried slinging one of these round your neck, you'd end

up crushed to death. Maybe that's the price to pay (the weight, not death) for rugged construction and a substantial keyboard.

So what are the sounds that the new PFs have to offer? Well, there are ten in all: three pianos, four electric pianos, harpsichord, vibes and clav. Given Yamaha's recent track record in the voicing department, you'll not be surprised to learn that these sounds are FM-generated, not sampled.

The piano sounds are more electronic than acoustic, but an effective bunch nonetheless: one is a smooth, full-bodied sound, while another has more the character of an earlier pianoforte, and the third is a phased 'electric grand' sound.

The electric piano sounds range from a rich phased Rhodes type to a hard, bright, brittle sound. The harpsichord is convincing, if a little on the light side – more French than German, if you know your early instruments. The inclusion of a complimentary 'heavy' sound might have been useful (the earlier PFs had two harpsichord voices), though on the other hand, most musicians would probably prefer the extra piano sound, and the PF keyboard isn't ideally suited to harpsichord-playing anyway.

The vibes are pretty effective when

adjusted to either a mellow or bright sound (courtesy of the inbuilt EQ, of which more later), and, of course, work particularly well sent through the PF's tremolo effect.

Finally, the clav is suitably bright, spiky and funky.

**P**reset sounds like the ones just described have instant appeal, but have a tendency to become dull after a while – especially if they're few in number. Luckily, both PFs have stereo chorus and tremolo effects built in, and whilst the former is a simple on/off affair, the latter incorporates adjustable speed and depth parameters. Both treatments can easily be switched in and out from dedicated front panel controls, and are programmable for each of the ten patches.

The three-band equaliser, activated by three sliders on the front panel, allows you to create a wider variety of timbral variation. Settings aren't programmable per patch, but the easy front-panel access allows you to set up different sounds very quickly.

And talking of front-panel access, the PFs' function parameters are organised in a fairly accessible way, though the limited

display facilities afforded by the familiar two-digit LED are an irritation; surely Yamaha could have fitted a backlit or fluorescent LCD?

Parameters are divided into those that are common for all the PFs' patches, and those that are patch-specific. The former include master tune and transpose functions, along with common MIDI transmit and receive channels.

You can switch the attack-velocity response of the PF's own sounds on or off for each patch. This is useful, for instance, on the harpsichord sound. Harpsichords aren't exactly renowned for their touch-sensitivity, and it already feels strange enough playing a harpsichord on a piano-type keyboard, so every little helps. It's also possible to adjust the overall volume level of each PF sound, which can be useful where some sounds are inherently louder than others.

As befits a piano-style instrument, the PF has three pedal inputs: for sustain, soft and key-hold. The first of these will be familiar to most keyboard players, and using one of Yamaha's fancy FC4 or FC5 piano-type footswitches, it's possible to have four sustain levels which progressively alter the amount of sustain damping. The soft pedal does what it says, ie. mutes the notes played; the intensity of this effect can be programmed (0-8) for each patch.

The key-hold pedal is equivalent to the 'third pedal' found on more upmarket acoustic pianos. When depressed, it sustains only the notes that are playing, subsequent notes not being held – no longer do you need three hands for playing those ambitious classical and ELP pieces. Yamaha supply only their FC8 sustain footswitch as standard with the PFs, so you'll have to fork out a few more pennies to take full advantage of these foot-bound capabilities.

Like the original PFs, the 70 and 80 have an internal stereo amplifier and speaker system (rated at 18 watts per channel), which automatically cuts out when you insert headphones and may be switched off if you choose to use external amplification via the stereo outputs on the rear panel. Yamaha have even included an external audio input on the back panel, which means you can play a drum machine or another keyboard, say, through the PF70's internal speaker system along with the PF itself. It's a logical extension of having internal speakers in the first place, I suppose, and no doubt useful for anyone who'd rather splash out on a second instrument than on external amplification.

**S**o what about the PF's qualifications as a controller keyboard? First, the (potentially) bad news. The keyboard itself is sensitive to attack

velocity, as you'd expect, but not to pressure. Aha, I hear you say, but what sort of piano is pressure-sensitive? Not many, I grant you. But the point is that you may well want to take advantage of pressure-sensitivity on slaved MIDI instruments (for a volume swell or a filter sweep, or whatever else your particular instruments allow for), and if you do, the



PF keyboard won't be of much help.

On the plus side, you can define internal and/or MIDI splits. This *doesn't* mean you can play two sounds at once on the PF, but setting an internal split-point (which can be anywhere on the keyboard) allows you to restrict the Yamaha's own sound to either an upper or lower section of the keyboard. So you could, for instance, be playing a PF piano sound on the upper section of the keyboard, and a DX7 bass sound via MIDI on the lower half. A sensible idea, all in all.

This feature really comes into its own when used in conjunction with the MIDI split. Again, you can set a split-point anywhere on the keyboard, but the PFs don't allow you to have *overlapping* MIDI and internal split-points – setting one automatically sets the other to the same value. One section of the keyboard (you decide which) is set to the MIDI transmit channel, while the other half is set to that channel number plus one.

Other MIDI features include separately-definable send and receive channels (1-16), note-event on/off (useful in conjunction with the internal split), patch-change on/off, pitch-bend range (receive only) and MIDI merge.

Each of the piano's patches can be allocated its own patch number (0-99) to be transmitted over MIDI when the patch is selected, which lessens the problem of aligning patches on different instruments which employ different counting systems for their memory locations; it's also possible to send a patch change manually from the PFs' front panel, which can be useful if you want to step through more than one slave patch for a PF sound.

You'll probably have noticed by now that the PFs don't include pitch-bend and mod wheels. OK, so you don't expect to find them on a piano, and maybe Yamaha were afraid that their inclusion would give the PFs a low-cred rating among traditionally-minded piano fans. But consider again these pianos' possible role as MIDI controllers: you might want to use mod and pitch-bending effects while

playing or recording synth parts. Yamaha have thought of this, though, and have produced the MCS2 (yet to be reviewed in these pages) which you plug in between the PF and any slave instrument/sequencer, and which allows you to insert pitch-bend and mod data into the MIDI event stream using its own pair of performance wheels.

And just in case you're wondering what the 'MIDI merge' is, it allows incoming data on MIDI In to be mixed with your performance on the PF keyboard, and sent over MIDI Out. This is an interesting feature which allows you, say, to mix sequence data with your live playing, or to control slave instruments from both the PF and another MIDI machine simultaneously. This could be useful if you wanted to, for instance, use the PF's piano-type weighted keyboard for some parts and a synth-type keyboard for other parts, or to switch quickly from one set of sounds to another without having to do any re-routing.

**L**ike their predecessors, the PF70 and PF80 are well-constructed, solid-sounding instruments with a wide enough range of sounds to satisfy those after a piano-type instrument as opposed to the (supposedly) endless sonic delights of a synthesiser. Whether or not you're going to prefer Yamaha's FM piano sounds to those of Technics' PCM versions, Ensoniq's samples, and Roland's SAS impressions is a question only you – and a fair bit of time spent playing and listening to each of them, I'd say – can answer.

With their newly-discovered MIDI facilities, these PFs are a viable proposition as controller keyboards in a MIDI setup, and can, of course, be used in MIDI recording.

The impending crop of new electronic pianos is ample evidence that the ol' Joanna is far from dead, and these new Yamahas, for their part, are evidence that digital synth technology has just as important a role to play in furthering the cause of traditional instruments as it has in shaping new ones. ■

Prices PF70 £899, PF80 £999; both RRP's including VAT  
More from Yamaha-Kemble, Mount Avenue, Bletchley, Milton Keynes, Bucks MK1 1JE.  
☎ (0908) 71771

# BEL SYSTEM

As the demand for sampling digital delay lines becomes more widespread, many machines are compromising sample length for sound quality, or vice versa. We test a British machine, the Bel BD240, that does neither. *Ian Waugh*



**T**he trouble with reviewing effects units is that you can easily become carried away (and some of us should, I know) with the sounds they help to produce. A simple echo unit can keep me amused for hours; let me loose on a digital delay-cum-sampler and you've lost me for days.

Some while ago, Bel introduced just such a range consisting of three models: the BD80, BD240 and BD320. The figures refer to the maximum delay/sampling time available in tenths of a second, and are shown on the LED display at switch-on. Just in case you forget, the display stays there for a full minute (30 seconds on the BD80) while random data from memory is dumped, so make sure the unit is switched on *before* you start your hour in the studio. The standard units have far less memory, but you can add to this in three stages with the help of plug-in boards. Some links must be removed during the process, but they don't constitute anything the average musician/E&MM reader couldn't handle.

It was the BD240 with a full 23,830ms (that's nearly 24 seconds to you) delay which found its way into my grubby hands. It's nicely designed, being two 19"-rack units high and finished in matt grey. The extra height over the fashionable 1U design has more than aesthetic value, as it means there's plenty of room in which to select functions and alter values – no ergonomic fiddliness here. Unlike the current digital-access, increment/decrement brigade, the Bel has lots of buttons to push and knobs to twiddle, so I might as well get down to describing them and their functions.

The delay or sampling time is indicated in the LED window and set by pressing

four buttons. Two of the buttons are for counting up and two for counting down, with fast and slow versions for each. In everyday use, I found the display didn't respond very quickly or accurately to the buttons: it was sometimes necessary to jab at them to reach the exact time required. In fact, I even managed to get the BD240 to oscillate between 2999 and 3000ms. A veritable niggle, especially when you're experimenting with effects and altering the times constantly.

With such a wide delay range, there are few common studio effects the Bel can't produce. No hints are given – either on the unit or in the manual – as to which delay ranges produce said effects, but the chances are a prospective purchaser would know these things already.

The Input and Output controls have to be tweaked carefully to produce the best results, but then the manufacturer who comes up with self-adjusting level controls will do very well, thank you. The Bel's Input socket is balanced, but you can unbalance it quite easily.

A Delay Phase button changes the phase of the delay signal, and a Feedback Phase button changes the phase of the feedback signal. Two Oscillator controls – governing speed and depth – sweep the delayed signal up and down, while an LED gives a visual indication of the speed.

Using these three controls, some pretty impressive chorus, flanging and ADT effects can be produced. A Filter button attenuates the high frequencies when the feedback signal re-circulates for a more natural echo. Add a Dry/Delay Mix control and another for Feedback level and you have a neat, comprehensive delay machine which, thanks in part to those modulation and phasing options, is a good bit more versatile than much of its

immediate competition.

A switch labelled 'Delay X2' doubles the delay time but halves the bandwidth. On the BD240, this gives you almost 48 seconds' worth of delay at 9kHz: almost long enough for half a song, and certainly long enough to sample a jingle. If only you could save these samples...

**O**nto the sampler proper. There are no simple Record, Hold or Playback buttons on the BD240, omissions which betray the machine's DDL origins. Sync, Start/Stop and Hold buttons take their place, and these must be used together in cunning – and not terribly obvious – combination in order to produce sampled sounds.

To record a sample, you proceed as follows. Ensure the Loop Reset switch is in Normal position, press the Sync button, set your required sampling time, turn down the Feedback switch, press the Bypass switch to bypass the delay circuitry, wait until the LED decimal point is steady, press the Start/Stop button and then press the Hold button. To play back, press the Bypass button again to re-enable the delay circuitry, and press the Start/Stop button to play the sample. If the Sync button is released, the sound loops. When the Loop Reset Switch is in the Normal position, the sample plays through to its end, ignoring any attempts to re-trigger it; in the Reset position, each re-trigger causes the sample to play from the beginning.

All in all, the above process does seem like a bit of a palaver, especially when so many samplers are becoming more straightforward to use. I'm sure the ►



## Sound-Sensation!

MIDI-Expander DYNAMIC 12/24



**Bohm** — The MIDI-Specialist  
Postfach 2109 · 4950 Minden · 0571/5045-0

### ADD 98 EXTRA VOICES TO YOUR ORGAN

- 98 perfect preset voices, from Piano through Strings to popular Organ and interesting Synthesiser sounds.
- Standard MIDI modes + Bohm-Extra-Mode to allow simultaneous playing of many presets.
- 12/24 notes playable polyphonically.
- Voices produced by PM techniques.
- Programmable sounds.
- Touch-sensitive keying through suitable keyboard.
- Cassette interface.
- Stereo output through two Mono Standard Jack sockets.
- Voice selection through external footswitch.

**BASIC KIT PRICE £452**

MIDI Expander  
Dynamic 12/24  
Order No. 36 680.

Send for free brochure to Bohm  
U.K. Agents  
See below:

**Bohm**  
organ kits

SWANKIT INSTRUMENTS, Chantry Park,  
Henfield, W. Sussex BN5 9JE.  
Tel: Henfield (0273) 494238

CRESTBEAM LTD., 389 Aspley Lane,  
Nottingham, NG8 5RR.  
Tel: (0662) 296311

SWANKIT MIDLANDS.  
Tel: Wolverhampton (0902) 42629

## MICROFLEX CABLE AND NEUTRIC CONNECTORS COME TOGETHER TO MAKE FORMULA ONE HI-TECH CONNECTING CABLES

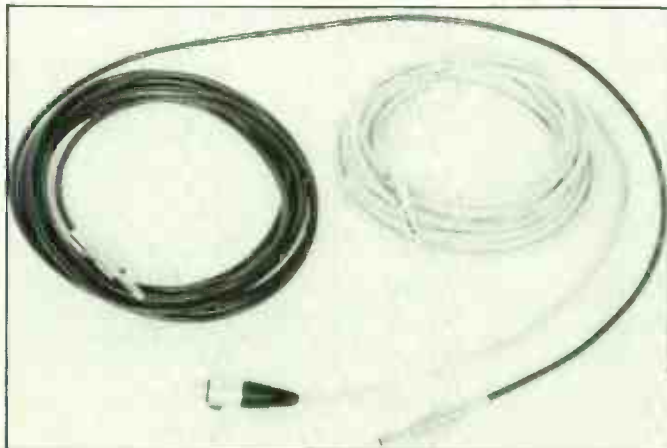

Suitable for studio, home recording,  
on stage, or anywhere that quality  
is the first concern.

**CUSTOM MADE TO YOUR SPECIFICATION**

Contact:

**FORMULA ONE MUSIC, PO Box 21,  
Bury Lancashire. Tel: 061-764 9360**  
TRADE ENQUIRIES WELCOME

Where do you go to choose a **JBL** P.A.?



You go to the place where you can compare  
all the **market leaders**.

You go where you're confident of the **best deal**  
to suit your budget.

You go where you get the **back-up** you'd expect;  
friendly, technical and practical advice.

You go to the new Portable P.A. Centre.  
Come and hear the difference.

*The  
Portable  
P.A. Centre.*

**Holiday Music** LIMITED

579 HIGH ROAD LEYTONSTONE E11 4PB TEL 01-558 2666

▶ whole sampling procedure could have been made simpler, but that said, the process is far simpler than it reads.

A more irritating gripe is the lack of an audio trigger to get the sampling ball rolling. In other words, you have to press the Start/Stop button fractionally before the beginning of the sample you want to take – which means that if you want to record the attack portion of a sound properly, you need pretty nifty fingers. In practice, this means it can take an age to capture a perfect sample, so a serious omission there, I'm afraid.

Once you've got a sample inside the Bel, however, you can do a number of things with it. You can make it loop by releasing the Sync button, but there is invariably a glitch at the start of the sample. This may be acceptable on long samples, but it precludes the possibility of generating a long note from a short sample, for instance, and won't be appreciated by users for whom ultimate fidelity is paramount.

There's also a simple editing facility by which several samples can be played one after the other. This is done by recording each sample with a successively shorter sample time. The Bel's memory remembers information stored above the delay time, so reducing it does not automatically lose it, as long as you're pressing down either the Sync or the Hold buttons. A number of novel effects can be produced in this manner, but the dreaded glitches still appear between samples.

**L**t would have been nice to be able to chop the sample up and take slices out of it. As it is, reducing the time after recording a sample removes time from the start. And you still can't get rid of the glitches.

On the credit side is an Overdub facility, which is great for building up thick sounds such as big choirs or rich strings. All you do to start this process is to mix some of the existing sample with the new one, by setting the Feedback control to around 2 or 3. By adjusting the Input and Feedback levels you can vary the mix, though if you make a mistake, it's back to square one.

The modulation oscillator can be used to affect the samples, as can the X2 button which, when used in conjunction with the Pitch control, can produce a pitch range of over two octaves up or down. So now you know how Barry Humphries does it.

To make the most of any sample, you need to be able to play it back at different pitches and the BD range, in common with other samplers, lets you plug in a keyboard to do this. In the case of the BD240, said keyboard has to be a 1V/octave model, and the (always monophonic) playback range is limited to

around two octaves. Few of today's synthesisers offer a CV output, but my favourite music shop, Rock City, came to the rescue with a Roland SH101.

Try as I might, however, I couldn't get the SH101 to tempt the BD240 into responding to anything other than its very lowest octave, and even that did not produce a perfect scale. The moral seems to be to check that your 1V/octave source falls in the range the Bel responds to – take it along with you and try before you buy.

There's no MIDI connection on the BD240 and that, again, is a sad omission. Many potential users – be they primarily musicians or studio engineers – may have a 1V/Octave keyboard in the cupboard under the stairs, but many more will have part-exchanged them for something housing a MIDI socket. After all, MIDI connections are generally more reliable, pitch-wise, than their traditional analogue counterparts.

**Specification**  
*“Halving the bandwidth gets you almost 48 seconds' worth of delay at 9kHz: almost long enough for half a song, and certainly long enough to sample a jingle.”*

Other gadgets and gizmos as yet unmentioned include an external audio trigger socket, which triggers the sample whenever a suitable audio signal is applied. This is useful for connecting things like drum-machine triggers, and there's no doubt that good old-fashioned analogue technology does this job just as efficiently as the MIDI kind. Outputs include a Direct Out, a Delay Out and a Mix Out, each having a jack and an XLR socket – fine for patching into either a recording mixer or live PA.

**W**ith a bandwidth of 18kHz, sound quality should be high, and subjectively the BD240 lives up to the promise of its paper specification. In fact, I'd say it's one of the best-sounding DDLs available, and for that reason, obviously well-suited to studio use.

On the whole, sound quality is one of the Bel's strongest points. In addition, there's the extraordinarily long delay and sampling time, the ease of use in most areas except sampling, and the reputation of a company with long experience of producing sturdy, reliable machines for professional environments.

But the debit list is also a long one. The lack of MIDI may not bother some studio owners, but to keyboard-playing musicians and, to some extent, modern small recording studios, the missing five-pin DINs may prove critical.

On a similar tack, programmable memory locations are also a major and important omission. Their inclusion obviously requires a fair amount of chip memory and software-writing on the designers' part, but the benefits they provide – preset effects to act as a basis for user-programming, instant storage and recall of favourite patches – are too great to be forsaken at the altar of R&D costs. If the BD240 had memories – even just eight or 16 – and they were selectable via MIDI, it would be a whole lot more useful both live and in the studio. There's nothing in the way of external memory connection, either, so you can't dump the contents of the Bel's memory to an outside storage medium such as cassette or disk.

Curiously enough, it's precisely these sorts of modern facilities that will shortly be offered by Bel's new BDE series of upmarket digital effects processors. The BDE2400 and BDE3200 offer the same sampling times and bandwidth figures as the BD240 and BD320 respectively, but add an 89-patch programmable memory, MIDI control of pitch and pitchbend, and the option of a dual disk drive for external memory storage. Intriguingly, they promise comprehensive built-in sequencing sections, too.

As it stands, the BD240 is a fine starting point for sound-processing experimentation, and offers a sampling facility that doesn't sacrifice quality for length.

But it lacks the sort of controllability that other modern machines can offer in abundance, and if that's the area of performance that appeals most to you, Bel's BDE series shows more promise. ■

## D A T A F I L E

### *Bel BD240 Digital Delay Processor*

Specification 6/12/18/24 seconds delay/sample at maximum 18kHz bandwidth  
Controls LED Display, Record, Play, Overdub, Loop, Pitch, Phase Selection, Filter, Oscillator  
Interfacing CV (1V/octave) and Trigger In, External Audio Trigger, Input, Direct Out, Delay Out, Mix Out.  
Price 6sec version £1400; extra 6sec card £500 each; 24sec £2800; all prices excluding VAT

More from Studio Equipment Distribution, 29 Guildford Street, Luton, Beds LU1 2NQ. ☎ (0582) 452495

Thanks to Tom Cleugh and the boys at Rock City for their help with the loan of ancillary equipment for use in this review.

Every Instrument  
you've ever dreamed of...



SEE THEM!



HEAR THEM!



PLAY THEM!

Alive with *FREE*  
Concerts, Demonstrations  
and Celebrities

AT THE

Olympia 2 – London  
1-3 August 1986  
10:00 a.m. – 7:00 p.m.

Admission: Adults £3.00  
Children £1.50  
UNDER 14

BRITISH  
MUSIC  
FAIR

Let's make  
music



# The UK's big

At Rock City we offer you the best in selection, service and prices, on all your musical requirements. Drums, Guitars (electric, classical and basses), P. A. (including mixers, power amps, enclosures), Home Recording (including 4 track, reverbs, delays), as well as your Hi-tech needs.



## YAMAHA

We specialise in all Yamaha Products. We stock all Yamaha Products. We offer the best deals on all Yamaha Products. The nearest thing to Yamaha in Japan is Rock City in Newcastle.



### SPX90 Digital Multi Effects Processor £599

The product of the year? Reverb, Early reflection, Delay, Echo, Modulation, Auto Pan, Vibrato, Reverb and Gate, Pitch Change, Freeze, ADR Gate, Compression, Parametric Eq all in one 19" rack. Need we say more...

### MT1X £449

Amazing New 4 Track Portastudio £445

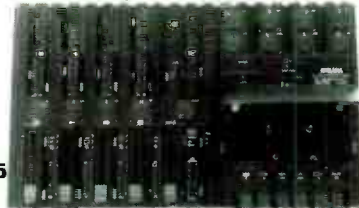

#### KEYBOARDS

### DX21

including Free Voicings  
**£649**



### DX27 Polysynth £499

### DX100 Polysynth £349



### DX7

including free sustain portamento pedal and new sounds

**DX7 - PHONE US FOR BEST EVER PACKAGE**

### DX5

including two free RAMS



### STAR BUY



**DX1**  
This unique synth now available - limited supply  
**£POA**

### £999 KX88 MOTHER KEYBOARD



### PF70/ PF80

Electric Pianos  
**PF70 £899**  
**PF80 £999**



### NEW VSS100

Sound Sampling for under **£180**



#### SEQUENCERS

### QX21 New £259

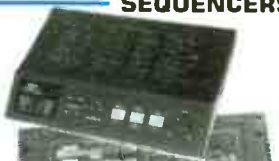

### QX7 STAR BUY



### QX1 Mega sequencer STAR BUY



#### EXPANDERS

### TX816 £POA



### TX7 DX7 Expander £POA

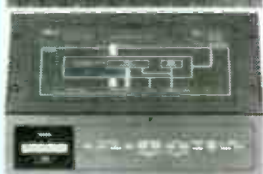

#### DRUM MACHINES

### RX11 SPECIAL PRICE



### RX21 Digital Drums £249



### RX21L Digital Latin £249



#### NEW SE GUITAR RANGE

Full range in stock now at Rock City

SE150 .....	<b>£169</b>
SE250 .....	<b>£239</b>
SE350 .....	<b>£299</b>
SE350H (with locking trem) .....	<b>£299</b>
BB5000 (5 string bass) .....	<b>£879</b>

### WXY5/10

Drivers by Wireless System  
**WXY5 £499**  
**WXY10 £799**



### MEP4 MIDI Event Processor £POA



### MCS2 MIDI Control Station £POA

### REV7 Reverb £899

### REV1 Reverb £POA



### P2075 Power Amp

75 watt Superb Quality Ultra new technology  
**£299**



**NEW RANGE YAMAHA MICROPHONES IN STOCK** Astonishing Clarity from £79 Call for details

#### MUSIC COMPUTER

**SOFTWARE ACCESSORIES**

YRM305-DX21 voicing programmer for CX5 .....	<b>£39</b>
YRM501-FM music composer 2 .....	<b>£39</b>
YRM502-FM voicing program 2 .....	<b>£39</b>
GAD-Graphic Artist program .....	<b>£49</b>
SFG05-FM tone generator MIDI disk option .....	<b>£95</b>
VPA01-Playcard program .....	<b>£53</b>
CR01-Card reader for VPA01 .....	<b>£26</b>

#### SDS EFFECTS

Overdrive .....	<b>£39</b>
Distortion .....	<b>£39</b>
Chorus .....	<b>£54</b>
Flanger .....	<b>£54</b>
Compressor .....	<b>£39</b>
Graphic Eq .....	<b>£54</b>

#### DRUMS

### YAMAHA SERIES DRUMS

Yamaha 8000/900 Series Drums always in stock - Amazing quality - Superb response - As used by every big name under the sun - as well as Martin Stafford



**PHONE ROCK CITY FOR THE BEST DEALS - 0632-324175. PHONE ROCK CITY**  
**YAMAHA • ROLAND • AKAI • SIMMONS • CASIO • ENSONIQ • KORG • OSC**  
**FENDER • GIBSON • MARSHALL • AHB • DYNACORD • SECK**

# gest music store

'TRY WHEN YOU BUY GUARANTEE'. If you buy mail order from Rock City and are not completely satisfied with your product, we will exchange it for any other product of a similar value as long as you return it to us within 14 days.

## Roland

### NEW ALPHA JUNO 1

Polysynth RRP £575  
Rock City Price £525



### NEW ALPHA JUNO 2

Polysynth £799



### NEW JX10

Monster Polysynth  
£1899



### NEW MKB200

MIDI Keyboard Controller  
£599



NEW RD1000  
Digital Piano £2499



NEW MKS20 Digital Piano  
Module £1199



NEW S-10  
Sampling Keyboard  
£POA



NEW S-50  
Sampling Keyboard  
£POA



TR707  
Digital Drums  
RRP £549 Rock City Price  
£499

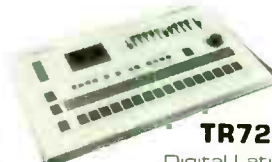

TR727  
Digital Latin  
RRP £549 Rock City  
Price £469



NEW  
MC500  
Micro  
Composer  
£799



NEW  
TR505  
Digital Drums  
£225



NEW  
PG300  
Programmer  
£199



NEW  
CK100  
Keyboard  
Combo  
RRP £579  
Rock City  
Price £499

## AKAI

### AKAI MG1212

The most amazing multitrack system money can buy. Akai's MG1212 is available at only a very small number of outlets. We can supply nationally on hire at very competitive rates.

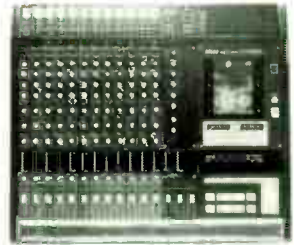

AKAI S612 Sampler....

..... £799

AKAI S900 Sampler....

..... £1595

Also available:  
AKAI MIDI RACK EFFECTS  
- Phone for prices

## SIMMONS

Full range always  
in stock  
Phone for details

## SEQUENTIAL

Full range always  
in stock  
Phone for details

## CASIO

Full range always  
in stock  
Phone for details

## HOME RECORDING

Phone us for best deals  
on YAMAHA - AKAI  
- FOSTEX - TASCAM -  
REBIS - VESTAFIRE -  
MTR - AHB -  
RSD STUDIOMASTER

## Skyslip Music



RAM  
64 memory,  
compatible for  
RX11, DX7, DX5  
ONLY £59.99



ROM  
64 new sounds,EPROMs  
available to build sound  
banks. Cartridge  
£49.99 Add on  
banks 1 to 5  
£15.41 each



MIDI SWITCH  
A simple but effective switching unit  
for the small scale MIDI user. One  
MIDI IN switchable to one of two  
MIDI OUT's or one MIDI OUT which  
can receive data from one of two  
MIDI IN'S £28.50 MIDI foot switch  
available soon



# ROCK

FOR THE BEST SERVICE - 0632-324175  
• SEQUENTIAL • ALESIS • APHEX •  
• CARLSBRO • ETC. ETC.

INSTANT CREDIT  
AVAILABLE Subject  
to status written  
details available on  
request

MOSLEY STREET  
NEWCASTLE UPON TYNE  
NE1 1DE TEL: 0632 324175

# THE THINKING MAN'S GUIDE TO PRODUCTION



Howard Jones and Tina Turner are just two of the artists to have benefitted from the production skills of Rupert Hine, whose career behind the faders now spans 14 years. In addition to producing and arranging, Hine is a talented songwriter in his own right. Here he discusses his attitude to sound and sound-manipulation, among other things.

## Interview *Paul Tingen* Photography *Matthew Vosburgh*

**T**he parameters of my musical work are based on 99% of all popular music being wallpaper', says Rupert Hine, candidly. 'I cannot possibly contribute to that. It's what almost everybody is doing.'

'There are so few people who are in any way concerned with making music for the communication of ideas. To me, that's so vital I can't even feel it to be necessary to specify what these ideas should be, even when they would be in support of things I wildly disapprove of. But I feel a real responsibility in working in this business. Most people in rock music think it's sufficient to open their mouths and sing about missing their baby. I think every time you open your mouth in public, you should have something to say, something with some purpose, some relevance or some meaning.'

Yes, Rupert Hine is a man with a cause. The precise nature of that cause is something we'll come back to later, but ideology aside, Hine is a remarkably friendly man who does his utmost to make his guests feel at ease: most of the time, his awkward, angular face wears a broad smile.

We are in Farmyard Studios in north-west London, which Hine owns together with drummer Trevor Morais and wife, and where all of his recent production efforts were recorded, as well as his last three solo albums and his forthcoming solo venture, the *Thinkman* project.

Indubitably, Hine is one of the most successful record producers in Britain today. He is responsible for the production of two tracks on Tina Turner's *Private Dancer* album, the entire recorded output of *The Fixx* and Howard Jones (save the latter's recent 'No-one Is To Blame' duet with Phil Collins), Chris De Burgh's best-selling *Man on the Line*, two *Saga* albums, and 60-odd other albums – some successful, others less so – spanning a production career of over 14 years.

Despite his remarkable achievements in the producing field, Hine's own recorded output has remained fairly obscure – thanks, perhaps, to what Hine calls 'The Producer's Syndrome'...

'My previous albums have been, I think rather unfairly, labelled "the successful record producer gets a

chance to make his own record". For someone who has always held his own work to be stage one of communication, it's a bit daunting to have it put to one side as being just a flip piece of fun.'

'The motivation behind *Thinkman* is to break away from that. I wanted to present my views at a much more up-front level, with an active group that are out and playing, in which I might be playing live myself. I'm not the integral, essential, performing animal. But the songs have been written and arranged by me here, with contributions from the band.'

The members of the band – Leo Hurl (keyboards and vocals), Andy Paris (bass and vocals), and J McArthur (drums and vocals) – are all relatively unknown musicians. Hine has his reasons for this.

'I wanted to start from scratch, with people who were interested in the ideas behind the songs. They are all people who are in some business of communication. Some of them are actors or writers as well as musicians. So it's four people who are involved in all kinds of areas – film, journalism, theatre. We form the core group around which guest musicians might be gathered.'

'*Thinkman* the band is a first stage towards *Thinkman* the film, which will be made with one of Island's film companies. The film will go much farther than our songs are able to.'

**S**o, *Thinkman* is quite an involved venture. Hine adds that it also features a loose organisation of approximately 40 people, working in various parts of the communications industry. What, then, is the motivation behind all this?

'Our aim is to bring about a greater realisation of the conditioning that the media puts upon us. That's the easiest way of putting it. Of course the media are doing positive and useful jobs, but what we're saying can be represented as follows: "don't believe everything you read". I know this might seem so trite that it's almost ridiculous. And yet such a vast percentage of the population believes what they see because it's on TV, or that what they read in a paper with some authority like *The Times* is actually true just because *The Times* says so.'

'And there are many editors who

publish articles with an absolute goodness of faith and are quite unaware that a story, long before it gets to them, might be full of warped truth, possibly also done in good faith.'

Perhaps Hine's message can be summarised by saying that everything you read, see or hear in the media is at best an interpretation of the truth and not the truth itself. As much as this feature, itself, is no more and no less than an interpretation of the things Rupert Hine said on an evening in early 1986, over a vegetarian meal with a very good French red wine. Well, it's always useful to remember.

The *Thinkman* album is called *The Formula*. It features Stewart Copeland on drums, Jamie West-Oram of *The Fixx* on guitar and Liza Dalbello on vocals. It's a collection of fairly straightforward pop songs but, as usual, these are spiced up by a clutch of typical Rupert Hine sound-manipulations like tape loops, sampling and hundreds of little details almost impossible to trace. The songs do sound as though they're being played by something like a band. And Hine's voice – uttering the social commentary of girlfriend Jeanette Obstoj's lyrics – is more relaxed and natural than before.

'I wanted to be more seductive than threatening on this album', he explains.

'On the previous three albums I treated my voice with some harmonising and various mic techniques, to get a slightly disembodied effect. I used that voice to create an alter-ego.'

Those previous three albums are *Immunity* (1981), *Waving Not Drowning* (1982) and *The Wildest Wish to Fly* (1983). They marked Hine's comeback as a solo artist, after he'd released two solo long-players on Purple Records – *Pick a Bone* and *Unfinished Pictures* – back in the early seventies.

*Immunity* is a brilliant, disturbing album, a collection of wildly anarchistic songs on which even the few straightforward instruments present are hardly ever put to their normal use. It's a record full of surprise, gloom and not a little anger, and is more the striking for it. Hine explains some of the philosophy.

**I**n 1980 I felt very frustrated with the record business. Everything was steering right back to the mid-seventies after the fresh anger of the punk and new-wave period. Now, in 1986, it's totally the same as ten years ago, where music in most people's lives has no greater function than a light-bulb; they walk into a room and together with the lights, they switch the music on. In 1980, it was clear things were going to go that way again, lacking meaning and with a great stress on style instead.

'Style is a form of presentation, but

too often it is also 100% of content. So I started to see analogies with the film industry. Why is it that people will readily go and see a film that is harrowing and disturbing, and three days later tell how marvellous that film was? Why is it that regular everyday people will sit through a major heavy movie and accept it, and yet won't accept music on a similar plane? Of course there is a place for dance music but at some moments you might sit back and think: "huh, all this music is so trivial, it's all so superficial, now I want to sit in front of my loudspeakers for 40 minutes and feel like I do when I go to the movies. I want to sit there in my room and if that music disturbs me, then that's worthwhile."

'Immunity was an expression of anger at the fact that this didn't seem to be possible with the record business. It was an absolute outburst from Jeanette and me, which is why I like it so much. It was very much a state of affairs in our minds. The central theme of the album is the fight against apathy. All the songs basically said: "For God's sake, don't just sit there! Don't accept what you see on the TV as being the truth, don't accept what you're being told the way a child would." We felt frustrated that so many people had what I'd call secondhand opinions.'

Soundwise, *Immunity* is an exploration into new areas – as indeed almost all of Hine's work, solo or otherwise, has been. Though he was quickly branded as 'the Master of the Fairlight', he has never owned one, and didn't start to work with sampling until the Thinkman project. Instead, he worked (and continues to work) with tape loops...

'I might play through a whole song, either drumming or hitting various kinds of assorted percussion, then take out the four or eight or 16 bars which I like the best, and loop them.'

In this way, 'Psycho-surrender' features a rhythm-track made up of knives, forks, and various other domestic sounds, as well as a solo made out of a yawn. The rhythm sound on 'Samsara' is two different sets of traffic noise, filtered through controlled voltage.

'My main stance was to try to avoid the usual', Hine concludes.

'I wanted to make recording different. The prime way that was done was by avoiding musical instruments, and starting with the vocal instead of a rhythm track. Then I worked from the top down.

'I'm really not interested in musical instruments as such. If there are other devices that can achieve musical and sound goals more interestingly, then mostly I prefer them. But if you use too many unrecognisable sounds, you suddenly long to offset all those sounds with something that's truly recognisable. If you're working with five tracks of abstract sounds, they will

"There are so few people concerned with making music for communicating ideas; most rock musicians think it's enough to open their mouths and sing about missing their baby."



sound even *more* original if you set them against a track of beautifully-recorded acoustic guitar, a real classic instrument. And now, suddenly, the other sounds that were just lost in a bizarre world have a purpose and a genre.'

**A**fter *Immunity* came *Waving Not Drowning*, an album very much an extension of its predecessor – still good, but without the original's sparkling impact. Then came *The Wildest Wish to Fly*, sonically and structurally more easily identifiable than before, and including the odd surprising – and unsuccessful – attempt to create a hit single.

'We were a bit put off, perhaps even depressed, with the fact that people strongly argued that the earlier music was not easy on the ear. Obviously, we expected it to some degree. But we found it a little daunting that even people with whom we felt aligned said there was basically no point in making those two albums unless we had hit singles. That's a thing I have to deal with when I'm producing artists every other day of the week. But we believed an album to be really communicative and enjoyable en route as well.

'In the end *Wildest Wish* had a couple of goes at 'singly' tracks, but they weren't good enough for that very, very finite singles area. So there are tracks on the album that are stumbling between the two, which have not gone far enough to really work as a single, but that have also left the real depth and intensity of my previous work.'

Hine and Obstoj had a hit single once, though, with Quantum Jump's 'The Lone Ranger'. They also wrote one song on Tina Turner's *Private Dancer* (16million sales plus, worldwide), and have been commissioned to write several songs for Turner's forthcoming album, for which the production task is divided between Hine and Terry Britten.

'Jeanette is very much a writer of words, and I am indigenously a writer of music' says Hine, explaining the collaboration. 'I somehow grasp an emotion very comfortably in music, but always feel a little bit awkward in putting the same emotion or idea into words. To work with a lyricist, you have to share an understanding of what you're going to write about before you start.

'But the thing is to get a *debate* going between music and lyric. That can be very powerful. When music and lyrics work at their best for me is when they create a third thing. Sometimes you can set the lyrics at odds with the music, which creates a song which is definitely greater than the sum of its parts. Then there's a suggestion that fills in all kinds of lines in between the words; there's a kind of dichotomy. It's hard to do that yourself, all on your own. For me it's easier to discuss the pros and cons with Jeanette.'

In a similar vein, Hine is also a firm believer in 'instant songwriting'. 'I'm sure most of the recording songwriters who read this magazine will agree that the things they like the best, and the longest, are the things they did the



fastest. If you're writing or recording songs that you spend days and days on, they end up beautifully crafted. Everything is in the right place, the song is very neat and tidy, and you sort of end up being pleased with yourself on a level of craft, but maybe a little disappointed on the level of art. I use the word art to mean the soul of a song, the communicative aspect, the motivation; by craft I mean technique. Often, those songs that were written in a rush, that just came out in an hour or in ten minutes, are the ones that stay really true to you over the years. Those songs are like good-quality snapshots.'

**E**nough, then, about the sadly obscure side of Rupert Hine's musical output. What of the most celebrated part of his work – production? If his main concern is communication, how does he judge the people who approach him to have their records produced?

'The most important thing for me is that the music is properly meant. It has to be written and performed with conviction: people have to mean what they're saying. If that's not true then it just doesn't go any further. And I have to say that 90% of the demos I get sent to me sound like people who think of music in terms of a job. It's as if people are saying: wouldn't it be fun to earn a living from making records, because it's better than a day-to-day job – which of course it is. But the world is full of that kind of music, and I don't want to be responsible for yet another artist in the forum, just wanting to be a star, wanting to make money or whatever.

'Rule number two is that a project should in some way present a challenge for me personally, because then I'll know that I can give my best. And I also have to have the feeling that I have something to add. A lot of people have suggested that I work with Peter Gabriel, but I think he produces his albums perfectly: I like them too much. Peter manages somehow to get his ideas across very well, so there's no place for me there.

'By the same analogy I feel that Kate Bush, who's also extremely talented and an original writer and someone who's trying to communicate, does not produce her albums well. She's not getting the best out of herself and her songs. I'd really like to produce her, because I know in my heart that I could get an album that would be so much more communicative – and I don't mean commercial. She falls short so many times that it's very frustrating listening to her. She's a classic example of someone who lacks the objectivity to sit back and decide that one song is communicating well, while another song isn't.'

As far as rule number one goes, Hine obviously means what he says. Over the last year he's been approached by 23(!) bands who've *already* had Top Three

albums and singles released all over the world. He consents to only one name of those 23 being published in this interview, because there the falling-out was mutual: The Rolling Stones.

But if Hine is so concerned about meaning and content, what's he doing producing a brawn-and-biceps band like Saga, or a lightweight like Howard Jones? There is a sigh. The producer has obviously heard this one before.

'With Saga, the main reason for working with them was the challenge argument. They approached me because *Immunity* was their favourite album, and when I refused they came over and tackled me face to face, and threw down the glove. It was then that I was intrigued to see what I could contribute to the music of this typical North American band. Could I make an exciting album out of this ordinary music?

'I thought the first album we did together, *Worlds Apart*, succeeded very well in that. Perhaps the second, *Heads Over Tales*, was a mistake. The challenge was gone and although it was musically rewarding, it was on the lyrical side that it fell short for me.

'With Howard Jones it's a different thing altogether. In my view he is one of the most extraordinary phenomena in today's record industry. Of all the people I've worked with, he is the most committed to what he's trying to do – which is to use music to present his views as simply and directly as possible.

'The fight against negativism is Howard's main cause. His lyrics are some of the most poignant, most emotional and most direct of any artist in this decade that I can think of. The phenomenal amount of mail he gets from his fans is to me a glorious proof that the musical setting of an important message doesn't have to be as intense as, perhaps, I so often feel it should be.

'But having done two albums together, we both felt the need for new challenges, so he's going to work with another producer for his next album.'

**J**ones, then, evidently satisfies Hine's need for honest, direct communication. Perhaps surprisingly, the producer gets even more enthusiastic when the conversation turns to his most famous – and most recent – artist collaborator, Tina Turner.

'I have mainly a songwriter's interest in Tina. Compare it with film: I'm like a screenwriter who gets a chance to write for, say, Dustin Hoffman. I mean, what better talent is there at the moment to project an emotional song than Tina Turner? She has the most extraordinary effect on people who write songs for her, as you can see on her last album.

'David Bowie has written an excellent song for her new album, and Jeanette and I are in the process of writing a third song for her. It's

extremely inspiring to work with her. She has the rare gift of taking a song that you wrote for her, and in the space of seconds, making that song sound like she wrote it herself. She *consumes* a song at such a level that when she throws it back at you, she seems to deny that the writer or producer had anything to do with it. I can only say that it's the most stunning experience I've ever had in the studio. So it's almost an addiction from a professional point of view.'

Mind you, Hine wouldn't be working with Turner now if he hadn't earned his reputation working with less inspiring singers and musicians. More than anything else, that reputation hinges on his abilities as a sound wizard.

At the beginning of the interview, Hine had complained about 'all those technical people' who ask him about every specific sound they can find on any of the records he has produced. Hine finds this sort of talk uninteresting, mainly because it is so out of keeping with his wish to renew his work continuously by searching for new methods. And in any case, he usually forgets the specific effects and treatments he's used in the past.

But regardless of his personal attitudes, Hine has a reputation for working in what could be described as a hi-tech area. If his main aim is communication, what is his fascination with electronic gadgets?

'I feel they're the most natural means to an end for me. They are the tools that I work with because of my natural curiosity in constantly manipulating sounds. As I've said, I'm not so much interested in musical instruments as such, and there are areas of musical technology which have opened up so many extraordinary avenues for exploring sound in its purest form, that it's become a real fascination for me.

'I'm the first to admit that those areas can take over, and you have to check yourself on that. But it's essential that

"Music in 1986 is the same as it was ten years ago. It serves no greater function than a light-bulb: you walk into a room and together with the lights, you turn the music on."

you be as much of a 100% producer as you can be. At the moment, the electronic side of music is advancing at such a pace that all that most of us can do is keep up with these extraordinary advancements.

'What many people are guilty of

doing at the moment (including, at times, myself) is getting stunned by new equipment. We use it lightly for a short while before being stunned by the next piece. This inevitably means we are never masters of any of these processors. You can easily end up being completely sidetracked, and sent from one side to the other by the next attractive toy, rather than taking hold of one of them and trying to master it, become its most forthright exponent. Because if you make a personal tool out of an instrument, it will never go out of date.'

**I**n his sonic experimentation, and especially in the areas of tape loops, AMS-triggering and sound treatment, Hine is aided by sound engineer Stephen W Taylor, friend and ally for the last five years.

'We challenge each other in doing things differently every time. He's now at a stage where he's creating sounds which are greater than I've envisaged them, which in turn stimulates me to new ideas. It's creative and fruitful, working together. We find lots of excitement in the completely hit-and-miss process of experimentation.

'That's why we never used a Fairlight, because we felt it was far too orderly. You have to do everything in the order that the programmer originally designated. I don't like the idea of being forced into someone else's parameters.

'To me, the Emulator II is the best example yet of a flexible sampling tool, where the programmer's intention is at such a low level that you feel you are truly using the machine in your own way.'

Hine's currently-favoured working method is to use the sequencer part of a Linn 9000 as a 32-track recorder. An MDB Window Recorder acts as a modern equivalent to all the tape-looping, and is triggered from the Linn. On the Thinkman album, other instruments used included a PPG Wave 2.2, some DX7s and a Prophet T8, which he describes as still 'the best analogue synth around at the moment'.

And in the percussion area, Hine admits to having a real phobia about recognising sounds from drum machines.

'I never include the sound of a drum machine itself; I always use drum sounds which I've recorded myself. In fact, I feel that drum sounds in general have been overrated for a while. People have been going to a certain producer just for a certain drum sound. The danger has been that albums were starting to sound very much alike.

'But now I think we've had the cure for completely artificial drum sounds. My guess is that '86 and '87 will see the full variety of approaches to recording drums living happily together.'

In that area of music-making, at least, Rupert Hine is optimistic. ■

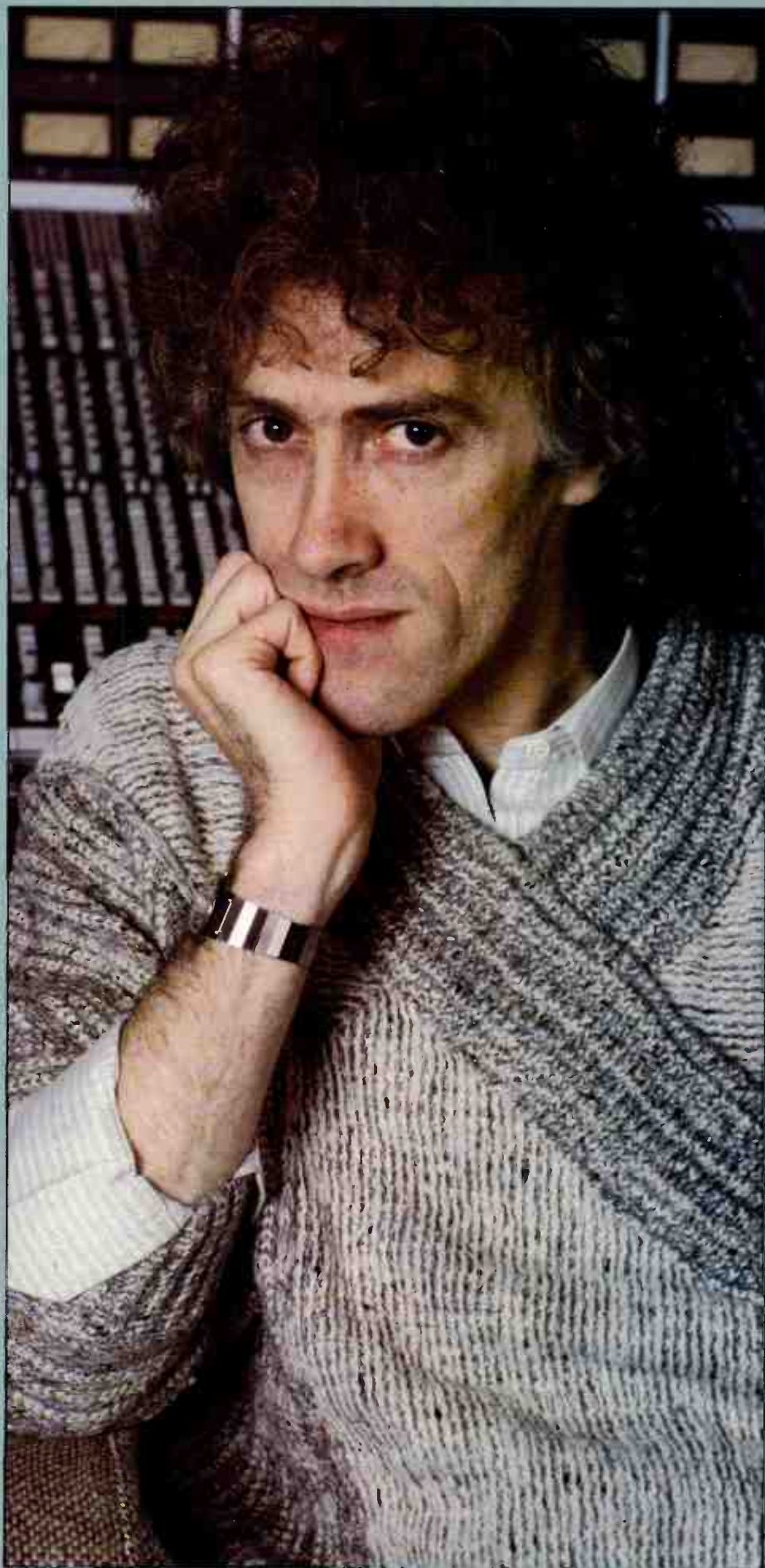



FROM A FIVE STROKE ROLL TO A FIVE PIN DIN

MTM. THE TOTAL PERCUSSION INTERFACE

SIMMONS

MTM — 8 CHANNEL, PROGRAMMABLE MIDI-TRIGGER-MIDI INTERFACE. 16 FUNCTION PROCESSING OF INCOMING AUDIO AND MIDI DATA TO TRIGGER AND MIDI OUT. PROGRAMMABLE EFFECTS INCLUDE ECHO, STEPPED SEQUENCE, DYNAMICALLY CONTROLLED SPLIT AND LAYERED CHORDS, PROCESS, TRIGGER ROUTE, MIDI AND EFFECT DATA ALL STORABLE. 20 FACTORY AND 99 USER PATCHES. 10 PROGRAMMABLE SEQUENCES OF PATCH CHANGES, FORWARD-REVERSE FOOTSWITCH INCLUDED.

World Radio History  
SIMMONS ELECTRONICS LIMITED, ALBAN PARK, HATFIELD ROAD, ST. ALBANS, HERTFORDSHIRE. TEL. 0727 36191.

FROM  
ABSOLUTE  
BEGINNER  
ABSOLUTELY  
BRILLIANT



CASIO

➤ The amazing new Casio CZ230S makes the world of synthesiser music available to everyone. It doesn't matter whether you're just learning to play or whether you're a real keyboard king, the CZ230S transposes you to a completely new level of playing.

Forget the need for complicated programming or setting wave envelopes, the CZ230S has 100 preset tones already programmed in for you, including ensemble and percussion effects ranging from standard piano to realistic explosions. All PD sourced sounds are available at the touch of a button.

The CZ230S also has a built-in rhythm machine that lets you programme in any of 12 PCM percussion sounds including snare, bass, high hat, tom tom and even handclap for perfect backing.

There are also 20 auto-rhythms to choose from that offer everything from hard rock to waltz, so whatever you're playing you can find the perfect accompaniment.

So you can keep your creations, a song memory function lets you store up to 199 bars of rhythm patterns. You can also combine the preset patterns with your own originals and match the rhythm

exactly with whatever you're playing. Naturally, everything you play can be transferred to cassette for long-term storage.

Unlike ordinary synthesisers, the CZ230S has its own monitor-speaker so it can be played without an amp. The sound quality is incredible and just has to be heard to be believed. MIDI terminals allow you to connect it up to other keyboards or instruments for a really powerful effect.

The CZ230S really is a complete synthesiser that can be played by literally anyone. Try one out at your Casio dealer for a demonstration, or send us the coupon for more details. It really could be the start of something.

See your Casio dealer for a demonstration, or send us the coupon for more details. ■

-----  
To Casio Electronics Co. Ltd., Keyboards Division, Unit 6, 1000, North Circular Road, London NW2 7JD. Telephone: 01-450 9131.

Please send me full details of the new Casio CZ230S  Tell me my Casio Dealer.

Name \_\_\_\_\_

Address \_\_\_\_\_  
\_\_\_\_\_

Telephone \_\_\_\_\_ E&MM I

**CASIO**®

THE NEW CASIO CZ230S £345.00 (RRP) AVAILABLE AT MOST GOOD MUSIC STORES

# TECHNOLOGY'S CHAMPION



Peter Gabriel, man of a thousand disguises and a hundred musical styles, discusses the effect modern technology has had on his work, and gives some advice to adventurous musicians hoping to follow in his footsteps. Interview *Dan Goldstein* Photography *Matthew Vosburgh*

**A**fter a career spanning nearly two decades, Peter Gabriel is still one of rock music's major talents. His calm, intelligent songwriting – comprising an appealing sense of melody with lyrics that range from the celebratory to the disquieting – has been an inspiration to generations of musicians, even though Gabriel himself would claim to be proficient on only one instrument: the flute.

He began his career fronting a five-piece public-school pop combo in the late sixties. The band was called Genesis, and under the auspices of entrepreneur Jonathan King, it was an almost unmitigated disaster.

However, the arrival of progressive rock appealed to the creative instincts of Gabriel and keyboardist Tony Banks, and with the addition of Steve Hackett on guitar and Phil Collins on drums,

Genesis became one of the most adventurous bands of their era. In the early seventies, the band unleashed a succession of albums containing complex, classically-inspired rock pieces the like of which had scarcely been heard before. The discs were accompanied by some ground-breaking live shows, which saw Gabriel placing the emphasis on image and theatre, more than a decade

before the video promo 'discovered' those elements and gave them a permanent place in the marketing of pop.

But *The Lamb Lies Down on Broadway* proved to be Gabriel's last album with Genesis when it appeared in 1974. Constricted by the band's massive instrumental virtuosity which was gradually pulling the emphasis away from soulful performance, Gabriel quit the band just as it was beginning to enjoy mass success.

His first album without Genesis, titled simply *Peter Gabriel*, was a cosmopolitan mixture of songs from a huge range of musical sources, robbed of any real continuity by the production excesses of Bob Ezrin. Some songs – notably the apocalyptic 'Here Comes the Flood' – survived Ezrin's penchant for kitsch gimmickry and over-elaborate arrangement, and a single – 'Solsbury Hill' – did sufficiently well to bring the name of Peter Gabriel into the homes of thousands, outside the band with which he had always been associated.

Gabriel's second LP, which carried the same title as its predecessor and featured a similar front-cover design in keeping with the artist's intention to produce a series of records similar to a volume of magazines, saw a radical change in style, with Robert Fripp at the faders, and a bigger emphasis on the emerging synth technology of the late seventies. Yet if anything, the second album didn't have quite the songwriting genius that Gabriel had exhibited in the past, and with the honourable exceptions of 'Mother of Violence' and 'White Shadow', it was a case of too much technique, not enough artistry.

All those ills were cured with the arrival of the third PG album. With Steve Lillywhite co-producing, and the likes of Kate Bush, Phil Collins and Paul Weller playing, the third incarnation of *Peter Gabriel* was a magnificent collection of haunting, delicate and occasionally beautiful material. Collins' full-frontal gated drum sound was thrown into light relief by the ingenious omission of all hi-hats and cymbals, and synthesisers – with US session keyboardman Larry Fast at the controls – played a bigger part than ever.

The irresistibly catchy 'Games Without Frontiers' gave Gabriel his biggest hit yet in the singles charts, but on the album, the two most significant tracks were the marimba-jive of 'No Self Control' and the long, ethnic lament of 'Biko'. Those two songs were evidence of Gabriel's new-found desire to investigate the possibilities of 'other musics' – ancient African, Latin, Indian, and Balinese forms, among others, that

would form the basis of his fourth album, released in the autumn of 1982.

Before that, Gabriel had been a guiding light behind the formation of WOMAD (World of Music Arts and Dance), whose aim was to bring musical cultures from throughout the world into people's homes in Britain, Europe and the US. WOMAD'S first major live event was a disaster, but a one-off reunion gig with Genesis a year later eased Gabriel's financial problems, and now WOMAD is flourishing.

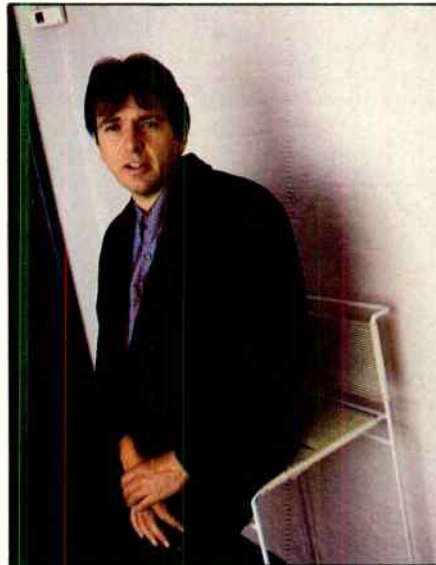

Paradoxically, it was Gabriel's acquisition of the highest musical technology then available – the Fairlight CMI – that enabled him to realise his dream of combining ancient ethnic musical forms with one another. His fourth album saw what was almost the abandonment of traditional song structures, in favour of a looser, but still rigidly composed, style in which no musical influence – from whichever era and whichever part of the globe – seemed out of place.

Yet the album was panned by the critics who had decided they'd had enough of Gabriel's western intellectualism, and there was no sequel to 'Games Without Frontiers' in sight.

Three-and-a-half years later, Gabriel is just about to release his fifth album, which breaks with tradition by actually having a name – *So*. By comparison with the third and fourth LPs, it's a more conventional album, with Gabriel's strength in traditional songwriting coming to the fore on the single, 'Sledgehammer' and the raucous, scathing dance workout of 'Big Time'.

Quieter, more elusive tracks such as the immaculate 'Mercy Street' and the desperate 'Milgrims 37', show more obvious evidence of Gabriel's collaboration with Eno engineer Daniel Lanois, who produced the latest album after doing the same job on last year's

*Birdy* film soundtrack, which saw Gabriel craftily remixing and manipulating previously-recorded material to create a hypnotic, atmospheric melange of different sound textures.

In person, Gabriel is a quiet man, unassuming and softly spoken. His conversation is a little disjointed at first, but as soon as a favourite topic comes up, his face lights up with anticipation, and the words start to flow more freely.

Above all else, he gives the impression of a man who is proud of his achievements, but who has yet to become so conceited as to feel he has done all there is to do. Gabriel is honest enough to admit that he wishes he had done many things in his career a little differently, but in an artist so full of conflicting ideas and motivations, perhaps that's not surprising.

*The new album has been a long time coming. Can you give us some idea of why it took so long to produce?*

Well, there's a variety of reasons. The first is that I've been in the music business for a long time now, and I've got no real desire to be part of the rock 'n' roll production circus, which is album, tour, album, tour. I wanted to follow up other projects. In this case I was doing some touring, then I mixed the live album, and then I did a bit more touring. Then I did the soundtrack for *Birdy*, and after that I did a little bit of travelling: I got to Brazil a couple of times, and then to Senegal, which was fantastically exciting for me.

*Armed with a tape recorder, no doubt.*

That's right, yes: 'Whitey With Machine'. You can do a lot of that sampling in your armchair at home, but it's a lot more fun to travel a bit.

Only one of the things I recorded while I was away actually ended up on the album – the Brazilian percussion on 'Mercy Street'. That's based on a traditional rhythm called Forro, which apparently originated from parties which British and Irish immigrant railway workers used to hold when they were building the railway lines in Brazil. These parties were 'for all', and the Brazilians, who couldn't speak English that well, turned it into 'Forro'.

'Don't Break This Rhythm' is the song in its original form: the two share the same rhythm track. I completely re-wrote the verse and the words, and I felt that 'Mercy Street' and 'Don't Break This Rhythm' were different enough to warrant putting out separately, so that's why one is on the album while ▶

▷ the other is the B-side of 'Sledgehammer'.

*Do you have any problems coming up with material, or is there an excess of it?*

There's always an excess of ideas. But finishing material is a bitch for me. I'm very bad at finishing lyrics off. Getting the ideas and scribbling the first few lines is easy, but from

---

**"I've always needed someone to bounce ideas off. I've never liked the idea of calling my records 'solo albums', because all the people I work with contribute ideas."**

---

there on, it takes me a long while because I'm constantly re-writing. I think I'm my own best critic when it comes to music, but lyrically, I feel I have a few shortcomings.

*The new album is more conventional than the last: it doesn't spring as many surprises. Did you consciously go back to more traditional forms and structures?*

In songwriting, the answer is yes. That's partly as a result of doing the *Birdy* soundtrack, where I was working purely with atmosphere and no lyric. Having done a bit of that, I was more turned on by the idea of getting back to the song side of things.

'Sledgehammer' is definitely an attempt to re-create sixties soul style. Certain sections of 'Don't Give Up' have gospel elements. In some ways I'm still very keen on the craft of songwriting, but my loyalties are split between trying to explore and develop the songwriting aspects, and then the other side which deals more with soundscape and atmosphere.

*In the past you've succeeded in blending those two things very well. It seems to me that this time, the two interests have been split.*

The things on the new album are subtler, yes. But there are some sound things there that I'm proud of, and I think there's some good work that Daniel Lanois and the other musicians did in terms of building pictures.

*What sort of ideas did Dan Lanois give you? His forte seems very much to be sound treatments.*

I'd been recommended him for *Birdy* for basically those reasons, yes. And because that worked well and we built up a good working relationship, I asked him to do this album – though that wasn't the original intention.

But he also functioned as a traditional producer as well:

criticising material, encouraging me to work in certain areas and so on.

I've always needed someone to bounce ideas off. I've never liked the idea of calling my records 'solo albums', because all the people I work with contribute ideas. I've done one or two sessions on my own, but for the four albums I've always worked with separate

producers. And in reality, even if you work only with an engineer, that engineer is contributing ideas anyway, so it's just a matter of how you label it.

If I wasn't writing the stuff, that might be different. But I don't like having to worry too much about the mechanics. Because I normally take so long over the writing, I need some feedback in the more general production areas.

*You mentioned soundscaping. Where was the album recorded?*

All at my home studio, except for one week that we did in New York. The real pleasure of having a studio setup of my own is that I can experiment in a way that I could never afford to do in a commercial studio.

The setup is a 24-track now. We had two 24-track machines at one point, mainly to do a sort of alternate reel system, which gives you a reel on which to develop percussion or vocal ideas, and then you fly two or four tracks back from that onto the main working reel. But I had horrendous synchronisation problems that probably cost about four weeks of the album. It was incredibly frustrating and upsetting.

In the end we got so fed up with it that we hired in a Mitsubishi 32-track digital, which had sufficient tracks for us to do everything on one reel. The Mitsubishi worked well for us. I'd love to do an A-B against the Sony system.

For all the bullshit, the only thing I trust is being blindfolded and choosing between two or three sound sources. With the tests we ran, I actually preferred bass and drums on the analogue; whether it was distortion or not, there was something giving that sense of power which I enjoyed better. But the clarity on the highs, the presence and the transparency of the digital wins out in those areas.

I think the digital people still have

some way to go. Probably what will happen is that the techniques will be further refined, and then people will hark back to the sound of the early digital.

The album wasn't mastered digitally. We started off working with a Sony PCM-F1, but we had some problems putting clicks on it, and the half-inch analogue proved more reliable, so we used that.

I got into the effects processing side much more heavily when I did *Birdy*. But I'm still mainly using the AMSs and Quantecs that I've had for a while. I'm not a great fan of the Lexicon, though the Yamaha REV1 I like: it has some things the Quantec doesn't, even though it covers much the same areas.

I'd never really entered the world of treatment chains the way I did with Daniel. The drum sound at the start of 'Milgrims 37' is one of the most striking examples of that, I think; it's something Dave Botteril set up with the AMS because Daniel was away. It's fascinating to see how the character of treatments changes as they are put through other treatments, and how their position in the chain affects the end result. But you need music that has enough space to hear that type of detail; it has to be sparse, and I think the album is quite sparse in a way.

*Sticking with technology, but moving onto the music side, is there anything you used this time around that you didn't use three years ago? Technology has moved ahead a fair bit...*

The only new things were the Emulator II and the Linn 9000, though I didn't have time to get into the Linn properly before I started recording. Part of the catch with these things is that you do need time to get to know them. If the equipment arrives after you've started recording, you have to take it out of the studio to get to grips with it, which I didn't feel like doing in this instance.

There's one synth that I'd used a little bit on my first album, but which Daniel Lanois re-introduced me to, and that is the Yamaha CS80. It has a great breathiness to it – human breath and its musical uses have always fascinated me – and a kind of organic character which I like.

But otherwise it's mainly Fairlight and Prophet 5. There's quite a lot of what I'd call a cheap organ sound, which I'm very fond of. And there's also a fair bit of 12-string guitar, which I'd avoided using since Genesis days, but which I have a different attitude towards



now. I've always been a great fan of any instrument which can create two sounds that are slightly out of tune with each other, and the beating which results from that.

Similarly, there are some things recorded at two different speeds on 'Mercy Street', which ring in a magical way to me.

*You were one of the first people to realise the potential of computer technology in making music. What kindled your interest initially?*

Well, I'd always dreamed of a machine that allowed you to sample sounds and then play them from a keyboard, long before the Fairlight had even appeared.

I can remember Larry Fast telling me about this Australian guy who

of giving you normal keyboard information, it could give you, say, vibrato. Or you could have two sounds or 16 sounds, so that the melody is switching between voices, and the internal composition is continually changing.

If these parameters were built up layer by layer and in real time, it would be like doing a dub mix: you'd have an idea and then just go for it. That kind of smash 'n' grab energy could give sound-sampling personality, and help to define character through performance.

If you have the same four-note sequence and you're using the same DX7 preset or whatever, then your version of that is going to be very similar to the next person's. But if you had 20 or 30 different

*So far, it seems a lot of the newer techniques haven't resulted in very much musical or technical change. Are you excited about things like sampling technology becoming accessible to a much broader range of people?*

Oh yes. I think it's absolutely fantastic.

There's always a temptation to copy what already exists when you're presented with new tools for the first time, because you don't have any other set of references. But through time, working with the equipment you have gives you some insight into its quirks and its personality, and that in turn can make you think in different ways.

The wonderful thing about all this technology – which has so far been available only to the fortunate few – becoming available to, we hope, everybody with a home computer, is that anybody who wants to be a musician can be a musician. You don't need to spend years training, and you can get great sounds to develop things with almost immediately.

I think as we go on from the sort of new ambient music that is beginning to come out from the fringes now, that there will be a sort of home-made hybrid which comes out of sampling technology and so on.

The most important thing is that more and more people become involved with creative processes. One idea is that you have your own mixing facilities with your home computer, so that instead of just getting someone's album and listening to it passively, you can override the master and start doing your own mix, your own interpretation of your favourite record.

*Interactive art...*

Exactly. It's sometimes difficult to draw the line between where your art ends and somebody else's art begins. That's a problem which is besetting sampling at the moment, and there are no easy answers to it. But I do know that if a composer creates a piece of music in four sections, and a listener then rearranges those sections so that they run in a different order, then that listener has done something more rewarding than simply sitting in front of the hi-fi and being spoon-fed.

I think the same is going to happen in the visual arts as well, because we're just starting to see video synthesisers appearing now, and they'll soon be open to as wide a

---

**"The CS80 has a great breathiness to it – human breath and its musical uses have always fascinated me..."**

---

was working on a Carly Simon session and trying to sell this strange box. That guy was Peter Vogel, and he was having a really hard time because no-one was interested in the concept of sampling then. But Larry picked up on it, and for me it was a sort of fantasy come true.

*Are there any tasks which you feel today's technology isn't accomplishing, but which might be possible soon?*

There's one thing in particular that's concerned with samplers. Now I think that, particularly if you listen to a lot of tacky records, there's not enough *performance* being put into samples. That's partly the fault of the machines themselves, and partly the fault of the people using them.

What I would like to see developed is the idea of a layered performance. It starts from the theory that when you're playing a piece of music in real time, you respond differently because of your adrenalin and because you're functioning in a different way than you would if you were analysing a sequence on Page R or whatever.

When player pianos were really popular, there were great pianola *players* who were able to express a piano roll very well. They had certain parameters – volume, sustain, speed and so on – that they could influence.

With the sort of system I'm talking about, the first pass would let you sort out the basic composition and correction work, while the second pass would let you use a keyboard simply as an interface for performance: instead

expression parameters that you could define in this sort of real time, layered performance, then your version *could* be radically different to your friend's version.

I haven't expressed it very well, but there's definitely something there that's just crying out to be developed.

*That sort of thing is starting to happen with MIDI master keyboards like the Yamaha KX88, which offer a whole load of parameters that can be assigned to different sorts of controllers – pedals, wheels and so on.*

Yes. But that's still a little way from what I'm talking about because it takes so much time to program all those parameters for each sound or set of sounds. What you really need to be able to do is press two buttons and say: 'Go!'. It also confines you to the keyboard, whereas my system would allow you to use whichever interface you were most proficient at using, be it the keyboard, guitar, drums, maybe even dance movement or something like that.

Putting MIDI on a grand piano is also a step in the right direction. I've only tried it a couple of times but it is very immediate, very oriented towards performance. But the system doesn't have the technology to cope with storing different sets of parameters. What I'd ideally like to see is a system that allowed you to store a whole set of parameters, remove them from their initial context, and then use them as a blueprint for future work, like a sort of stencil or mask. That could be quite interesting, I think.

# STUDIOMASTER

## SERIES II

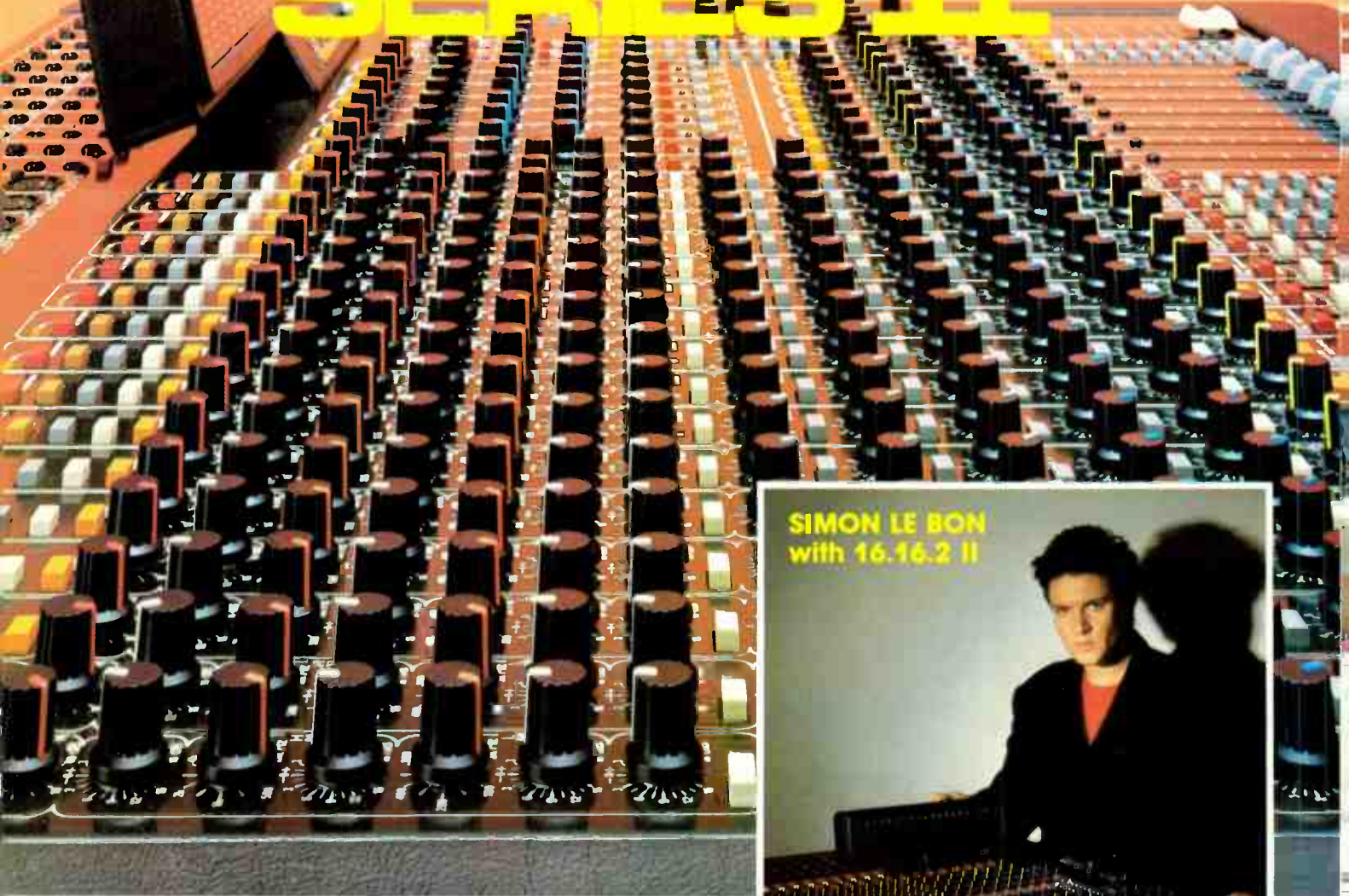

Main picture 16.16.2 II

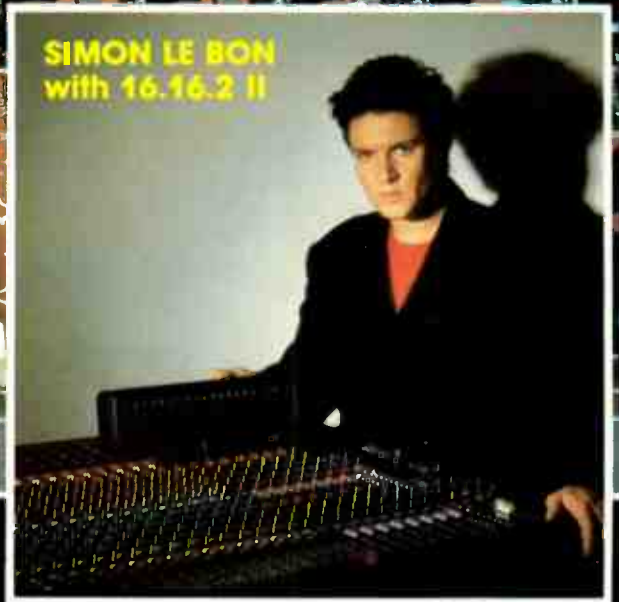

*Studiomaster Series II ~  
tomorrow's mixing capabilities today*

Studiomaster Series II mixers have been researched and designed with all the shortcomings of other mixing consoles in mind.

The Series II offers MIDI controlled automated muting of input channels and auxiliary returns: a facility which leaves you free to adjust effects and faders during mixdown while channel and auxiliary status is sequentially changed via an external computer.

Other outstanding features include 4-band overlapping parametric equalisation, 6 auxiliaries, discrete phantom power, separate studio cue and control room monitor mixes, expandability of input channels and multi-track tape monitoring to meet your future requirements etc. etc.

Series II are available as 16.4.2 (12 track monitoring optional), 16.8.2 (16 track monitoring optional), 16.16.2 (24 track monitoring optional). All may have a further 16 inputs added.

For more information or detailed literature contact your nearest Studiomaster dealer or Studiomaster direct.

# STUDIOMASTER

Studiomaster House, Faircharm Trading Estate, Chaul End Lane, Luton, Beds LU4 8EZ

☎ 0582 570370 TELEX: 825612 STUDIO G FAX: 0582 570242

World Radio History

market as the audio synthesiser.

For kids and for any non-professional people, the opportunities are going to be there, and I think it'll be a lot more challenging. It should, in the long run, encourage the growth of some strange entertainments, outside of the main commercial marketplace.

*That sounds almost like a return to the Victorian idea of the family gathering around the piano for an evening's entertainment. People could start to make their own entertainments in the home in a way they haven't done for some while...*

Yes. I think that's one of the most positive things about it, that people start to become active consumers rather than passive ones.

At the moment I think there's a slight negative factor, though, in what I term the bedroom effect. What's happening is that the young musician is sitting at home with a Portastudio, surrounded by keyboards and drum machines, and not interacting with other people at all. I'd strongly encourage anyone who's doing that to work with other

yes. At the moment I'm still working with the Series II Fairlight, though I'm very keen to get into the new version as soon as I can. But I know that getting to grips with the Series III will be like going back to school again.

At the same time, it's partly the responsibility of the manufacturers to make their devices more and more accessible to dumbos such as myself.

What I really hate is the sort of technical elitism, whereby people ruffle their feathers because they have a few technical tricks up their sleeve that nobody else on the block can do. It's such bullshit. You don't have to understand how a car works to be a good driver and to get from A to B. So although I'd never take anything away from the people who do have great technical knowledge – and there are people like that who can deliver some great music, too – I don't think it should be an elitist role.

I happen to think that simplicity is the hallmark of good design. So even though the technical operations of a machine may be

now. Even 'Don't Give Up', which is essentially a ballad, still has a groove which I think is very unusual. It ends up sounding like a normal song, but the musical ideas behind it are quite strange.

There's so much to learn out there. I feel very much like a novice, a naïve enthusiast. But I quite enjoy that. Going to Senegal was great. The people were very welcoming, and I felt a sense of community with the local musicians straight away. The music is vibrant and vital and un-self-conscious in a way that modern rock music isn't.

*Moving closer to home, do you listen to a lot of contemporary chart or dance music?*

Some of it. Tears for Fears brought me the Blue Nile tape which I think is great, they're a really good band. They've now got a second album which is due out sometime. But they're another act that takes its time – they're not exactly fast.

Actually, it annoys me sometimes that there's so much pressure on us to come up with new albums quickly. If a novelist wants to take seven years over writing a new book, then nobody gets on his back asking for it sooner. I don't see why rock musicians should be any different. Some people can turn out an album in seven days, others take seven years. And in the end that isn't too important, anyway; what matters is what's on the record, not how long it took to produce.

*If you can see that far ahead, have you any idea what is your next move likely to be?*

Well, I'd like to do a bit of playing live again, because I still enjoy it. I'll certainly be out touring by the end of the year, if not before. The question is whether I do a big visual show or whether I do something more down-to-earth. And there are a couple of benefit gigs I've been asked to play this summer, which I'll probably do.

*On the recording side, do you see yourself continuing to split your musical personality in two with future releases?*

Probably. There's a whole load of bits and pieces that have got left around in the last 18 months that I'd like to develop as atmosphere pieces. But I'd also like to do an album which is much more traditional. I like good pop songwriting, so it's possible that there could be more Peter Gabriel pop songs. ■

---

**“What's happening is that the young musician is sitting at home with a Portastudio, surrounded by keyboards and drum machines, and not interacting with other people at all.”**

---

musicians, because I'm sure that what I do has been made a lot stronger just through working with other people. Creating music alone can work in some cases, but you always get this aura of someone's private room: I think sometimes a blast of fresh air tends to make for a more attractive picture.

The problem is that collaborating with other musicians isn't always that easy. Drums, for instance, are a critical thing. I've worked with some of the best drummers in the world and none of them can keep time as well as the cheapest drum machine; but what they put in as musicians, in terms of feel, can be a lot more than most drum machines. And having the patience to program that kind of feel into a drum machine, even where it's possible, isn't easy.

*That leads us on to the problem of getting caught up in modern instruments that can be too complex for their own good. With a system such as the Fairlight, which is constantly offering the user another 16 sets of possibilities at every turn, do you feel the technology can end up being a distraction?*

It certainly can be a distraction,

complex, it should still be child's play to use, because all it's really offering you is another set of choices each time, and there's nothing so difficult about that.

*How closely do you still ally yourself with the movement that wants to bring world music together, and put it in front of as wide an audience as possible?*

Oh, I'm very close still, yes. Instigating WOMAD is one of the things I'm most proud of, out of all the things I've done. I'm no longer involved in the organisation, but that isn't necessarily what I'm good at anyway. I'm very pleased because after a potential bankruptcy, there's now talk of big things happening.

I think, in more general terms, that our music will benefit enormously from having that presence around us – music culture from different countries. Reggae has influenced some of our music and now has a minority but firm hold over certain sectors, and it's good to see that the Virgin Megastore has a huge rack full of different sorts of African music.

I know that coming across new visions and new groups has liberated my writing. That's still happening

## Newark Technical College

The Department of Music & Musical Instrument Technology offers for students with the relevant practical and musical background a 2 year full-time course in

### MUSICAL INSTRUMENT ELECTRONICS

leading to a BTEC National Diploma in Musical Instrument Technology and subsequently, if required, to higher level technician and degree courses.

The Department also offers full-time 3 year courses in

### PIANO TUNING MAINTENANCE & REPAIRS VIOLIN MAKING & REPAIRING (Newark School of Violin Making) WOODWIND MAKING & REPAIRING

An OPEN DAY will be held on Tuesday, 24 June 1986.

For details and application forms please write to The Principal, Newark Technical College, Chantry Park, Newark, Notts. Tel. Newark 705921.



**Nottinghamshire  
County Council**  
County Hall · West Bridgford  
Nottingham NG2 7QP

## ARTHUR LORDS PROFESSIONAL KEYBOARDS

It is our policy to be as competitive as possible on all our prices and in most circumstances we can better, or match any genuine advertised price.

### SYNTHS

Roland Alpha Juno 1	Roland S10 sampler - in soon	Casio CZ230S
Roland Alpha Juno 2	Yamaha CS01 + BC1 - £115	Casio CZ101
Roland Juno 106	Yamaha DX100	Casio CZ1000
Roland JX-3P (demo) £625	Yamaha DX27	Casio CZ3000
Roland JX-8P + PG800	Yamaha DX21	Casio CZ5000
Roland HS60	Yamaha KX5 - £199	Casio CT6500

### ELECTRIC PIANOS

Roland HP20	Roland RD1000 - in soon	Yamaha PF70
Roland EP50	Yamaha YPR6	Yamaha PF80
Roland HP100	Yamaha YPR8	Yamaha CVP Series
Roland HP350	Yamaha CLP20	Technics PX series
Roland HP450	Yamaha CLP30	incl. the Super PX1
Roland HP5500 - now in	Yamaha CLP50	Bentley EP6

### COMBO AMPS

Casio AS20 - £79
Technics SYT15 - £160
WEM 100W - £270
WEM 150W - £320

### EASY TO FIND EASY TO PARK

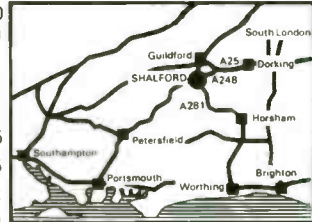

### DRUM MACHINES

Boss DR110	£125
Roland TR505	£225
Roland TR707	in stock
Roland TR727	£469
Yamaha RX21	£225
Yamaha RX21L	£225
Viscount R64	£275
Casio RZ1	£399
Technics DP50	£575

### KEYBOARDS

ORCHESTRAL	MINI
Yamaha PSR15.....£179	Yamaha PSS160.....£69
Yamaha PSR11.....£179	Yamaha PSS260.....£99
Yamaha PSR21.....£229	Yamaha PCS30.....£99
Yamaha PSR1.....£299	Yamaha PSS450.....£129
Yamaha PSR50.....£399	Yamaha PSS360.....£149
Yamaha PSR60.....£499	Yamaha PSS460.....£149
Yamaha PSR70.....£599	Yamaha VSS100.....£179
Casio CT102.....£129	Yamaha PCS500.....£249
Casio CT310.....£199	Casio SK-1.....£89
Casio CT320.....£199	Casio MT21.....£59
Casio CT430.....£275	Casio MT90.....£99
Casio CT410V.....£295	Casio MT100.....£129
Casio CT6000.....£POA	Casio MFT210.....£179
Technics K300.....£350	Casio MT86.....£179
Technics K350.....£480	Casio MT500.....£199
Technics K450.....£599	

### SEQUENCERS

Roland MSQ100	£425
Casio SZ1	£245
Yamaha QX21	£259

### MULTITRACKERS

Yamaha MT1X	- £499
Vesta MR10	- £285
Cuteck MR404	- £480

### EFFECTS

Dod Graphic EQ	79.95
Dod Reverb	£175.95
Dod Chorus	£89.95
Dod Flanger	£89.95
Dod Delay	£119.95
Dod Sampler	£259.95
Dod USA metal	£79.95
Dod Compressor	£69.95
Dod Harmonic Enhancer	£75.95
Boss Sampler	£156.00

### BOSS MICRO RACK

SERIES IN STOCK	
ALESIS MIDIVERB 19" RACK	
MTR Stereo Reverb	£221
MTR Stereo Graphic	£98
MTR Reverb/Delay	£162
Roland SDE2500 MID	
Digital Delay	£499

3/5 KINGS RD SHALFORD Nr. GUILDFORD  
SURREY GU4 8JU Tel Guildford (0483) 570088

We run a fast and efficient  
MAIL ORDER SERVICE  
Access & Barclaycard welcome

OPEN TUESDAY TO SATURDAY 9.30-5.30

# tantek



Today's music makes heavy demands on out-board processors - so choose carefully.

In the TANK range of modular audio processors, we put performance and flexibility first. For example our Digital Sampler Delay (illustrated) features: 15KHz bandwidth up to 1.4 sec. Decay or Sampling up to 8 sec • 86 dB input and dynamic range • Full sample editing and over dubs • Single or loop play • 6 octave CV keyboard range. Velocity sensitive dynamics.

Compare the quality, performance and compare the prices.

SUB RACK	£47.95
POWER UNIT	£42.95
PRO-GATE	£55.95
MIC. PRE AMP	£54.95
DIGITAL SAMPLER	£299.95
DYNAMIC NOISE FILTER	£55.95
COMP. LIMITER	£62.95
PARAMETRIC EQ	£55.95
INFINITE FLANGER	£85.95
MULTI DELAY	£110.95
PSYCHOACOUSTIC ENHANCER	£62.95

prices include VAT and Postage (within UK).

## tantek

DON'T COMPROMISE - CHOOSE TANK for free brochure (0438) 310120 or write to  
TANK Business & Technology Centre  
Dept. EMM Bessemer Drive  
Stevenage, Herts. SG1 2DX



# Checklist

## E&MM's buyer's guide to end all buyer's guides, with a rundown of all polysynths, voice modules and remote keyboards currently available and soon to be unveiled.

**P**olyphonic synths, voice expanders and controller keyboards are listed in this month's instalment of the only regularly published, regularly updated price guide in the modern musical instrument scene.

If this is your first flick through E&MM's pages, you'll soon see that Checklist is more than just a price guide in the conventional sense. Because as well as listing all available instruments and their typical selling prices, we also include brief specification details, and the comments – for, against, and summing-up – of E&MM's reviewing team where appropriate. That way, you get some idea not only of which machines are available, but also of their relative specifications and how they compare in performance terms.

Back in February, when we last published the synth version of Checklist, the world was bating its breath as the Frankfurt music fair

loomed on the horizon, and the musical instrument manufacturers were preparing to unleash another barrel-load of new synthesisers.

But now that Frankfurt has been and gone, it's clear we're going to have to wait for some while before many of those new instruments start to appear in UK music stores. Sequential's Prophet VS, which we reviewed exclusively last month, has only just entered full production in the States as this issue of E&MM goes to press. And as yet, there's no sign of Akai's new AX73 synth, the Oberheim Matrix 6R module, Roland's up-market JX10 poly (reviewed elsewhere this issue), the Ensoniq ESQ1, or the Kawai K3 – all of them interesting-looking devices.

Next month, we move from machines that create sound to machines that record it, with a round-up of sound-samplers. Stay tuned.

## POLYSYNTHS

### AKAI

**AX73** – £699 Six-voice, two-oscillator per voice analogue polysynth; five-octave velocity-sensitive keyboard, stereo chorus; synth section and chorus can be used to edit samples from S612 and forthcoming S900. ● *To be reviewed.*

**AX80** – £799 Eight-voice, two-oscillator per voice analogue polysynth; 32 preset and 64 programmable onboard voice memories, five-octave velocity-sensitive keyboard. + *Three LFOs, chord memory, good keyboard, excellent bar graph system makes digital parameter access more user-friendly; doesn't really possess any sonic character of its own; recent price reduction makes Akai's first synth more attractive than it previously was. Yer pays yer money....* ● *Reviewed December '84.*

### CASIO

**CZ101** – £345 Four/eight-voice, two/one DCO per voice, Phase Distortion polysynth; 16 preset and 16 programmable voice memories, four-octave miniature keyboard. + *Excellent range of both 'analogue' and 'digital' synth sounds, five-octave MIDI-compatible octave range, voice layering, comparatively easy to program, built-in ring modulator, 16-voice RAM cartridge storage, eight-stage transient envelopes, fine MIDI implementation; small, short keyboard, awkward bend wheel; revolutionary*

*Phase Distortion principle offers value for money without sonic compromise – if you can stand the mini-keyboard.* ● *Reviewed January '85.*

**CZ1000** – £495 Spec as for CZ101, but with full-size, four-octave keyboard. + *The professional's Casio: nothing around to beat it for versatility, ease of programming and MIDI features at this price level.*

**CZ3000** – £695 Spec as for CZ5000, but without sequencing facilities and memory dumping to tape. + *Not just a clever bit of Casio re-packaging, synth is genuine alternative to top-of-range 5000, for people who'd prefer not to have to pay for sequencer.* ● *Reviewed February '86.*

**CZ5000** – £975 Eight/16-voice, two/one oscillator per voice Phase Distortion polysynth; 32 preset and 32 programmable voice memories, five-octave keyboard, built-in eight-track step- and real-time sequencer. + *Twice the 101/1000's synth facilities means correspondingly greater sound potential, excellent multitrack sequencer is far more than just last-minute afterthought, useful multitimbral MIDI implementation; undynamic keyboard, no separate outputs for multitimbral voices; the last word in Phase Distortion synthesis, and it works a treat – so don't let the name put you off.* ● *Reviewed June '85.*

**CZ1** – £TBA 16-voice Phase Distortion polysynth, similar spec to CZ3000, but with touch-sensitive keyboard. ● *To be reviewed.*

### CHASE

**Bit 99** – £649 Six-voice, two-oscillator per voice analogue polysynth; 63 programmable

voice memories, five-octave velocity-sensitive keyboard. + *Superb range of analogue sounds, both acoustic and electronic, plenty of keyboard performance options; no sequencing or arpeggiation features; all in all, probably the best budget analogue poly, now has better MIDI implementation and programming facilities than 8it One predecessor, and at a lower price, too.* ● *Reviewed October '85.*

**DK70** – £349 Portable synth with spec similar to DK80. ● *To be reviewed.*

**DK80** – £499 Six-voice, two-oscillator per voice analogue polysynth; 10 programmable and 40 preset voice memories, velocity-sensitive five-octave keyboard. + *More facilities for the money than just about anything; 40 fixed memories, basic sound could be better; astonishing value, especially now that distribution has changed hands from SIEL to Chase, even if first impressions might not be all that favourable.* ● *Reviewed April '85.*

### CHROMA

**POLARIS** – £999 Six-voice, two-oscillator per voice analogue polysynth; 132 programmable voice memories, five-octave velocity-sensitive keyboard. + *Good, rich analogue sound, neat onboard sequencer, extensive interfacing facilities include wide range of MIDI options; complicated to use, overpriced, some design priorities now outdated; a synth with a lot of potential for those with enough patience to exploit it, but the competition is already too tough, thus price now dropping like a stone.* ● *Reviewed November '84.*

### ELKA

**Synthes** – £999 Eight-voice, two-oscillator per voice analogue polysynth; 40 preset and 40 programmable voice memories, five-octave keyboard. + *Considerable (but largely ignored) sonic versatility, split and layering facilities using two MIDI channels, onboard four-track sequencer, digital ring mod; not much, though it won't sound like a DX7; good facilities for its (recently reduced) asking price: if this is your sound, go for it.* ● *Reviewed December '82.*

**LX600** – £TBA New analogue polysynth. Available autumn. ● *To be reviewed.*

**LX900** – £TBA New digital polysynth. Available autumn. ● *To be reviewed.*

### ENSONIQ

**ESQ1** – £TBA Eight-voice, three-oscillator per voice digital polysynth; 32 digitally sampled or synthesised preset waveshapes, 40 programmable voice memories, expandable to 120 via cartridge, five-octave keyboard, built-in eight-track polyphonic sequencer. Available summer. ● *To be reviewed.*

### KAWAI

**K3** – £TBA Eight-voice, two-oscillator per voice digital polysynth; 32 preset digitally sampled waveforms, 1 user-programmable waveform, 50 preset voice memories, 100 programmable voice memories on RAM cartridge, five-octave touch- and velocity-sensitive keyboard. Available summer. ● *To be reviewed.*

## KORG

**Poly 800 MkII** – £499 Six-voice, two-oscillator per voice analogue polysynth; 64 programmable voice memories, four-octave keyboard. **+** Competitive price, three six-stage envelopes, onboard sequencer and chorus unit now supplemented by programmable digital delay; **–** still only one filter for all six voices, short keyboard, no expander version on horizon; **–** the world's best-selling polysynth gets a new lease of life thanks to better factory presets and a flexible DDL – very much the machine to beat in the budget analogue synth stakes. ● Reviewed April '86.

**DW6000** – £699 Six-voice, two-oscillator per voice, digital waveform generation polysynth; 64 programmable onboard memories, five-octave keyboard. **+** First synth to combine clarity of digital voicing with easy access of analogue synth configuration, six-stage VCA & VCF envelopes, built-in chorus; **–** keyboard has no velocity or aftertouch sensitivity, poor feel of performance control joystick; **–** the polysynth world's biggest technological compromise – but it works, and you can pick it up very cheaply now. ● Reviewed March '85.

**DW8000** – £1075 Similar in spec to DW6000, but with pressure- and velocity-sensitive keyboard, built-in DDL. **+** Factory presets are more impressive than 6000's, DDL is more than just a gimmick, dynamic keyboard makes a big difference; **–** feel of keyboard and joystick could be better, digital access system little improved by new panel layout; **–** corrects most of the DW-6000's faults, yet costs less than its predecessor did when it was launched –

therefore a real contender. ● Reviewed November '85.

manufacture, so demand is already outstripping supply. ● Reviewed January '86.



## OBERHEIM

**Matrix 6** – £1750 Six-voice, two-oscillator per voice analogue polysynth; 100 single and 50 multipatch voice memories, velocity- and pressure-sensitive five-octave keyboard. **+** Unparalleled complexity and versatility of synth section means huge quantity of different available sounds, quality is good, too; **–** of all the synths that shouldn't have digital parameter access, this one has the worst programming compromise; **–** traditional analogue poly that makes brilliant use of modern technology, makes Oberheim quality affordable thanks to new Japanese

**Matrix 12** – £4599 Spec similar to that of two Xpanders controlled by dynamic keyboard – see Xpander entry for details. ● Reviewed June '85.

## OCTAVE PLATEAU

**Voyetra 8** – £3999 Eight-voice, two-oscillator per voice analogue polysynth; 100 programmable voice memories, velocity- and pressure-sensitive five-octave keyboard. **+** Excellent sonic potential in the American analogue tradition, built-in polyphonic sequencer and arpeggiator, comprehensive split and layering facilities; **–** hideously

# THE MIRAGE VISUAL EDITING SYSTEM

'MORE QUALITY SOFTWARE FROM STEINBERG RESEARCH'

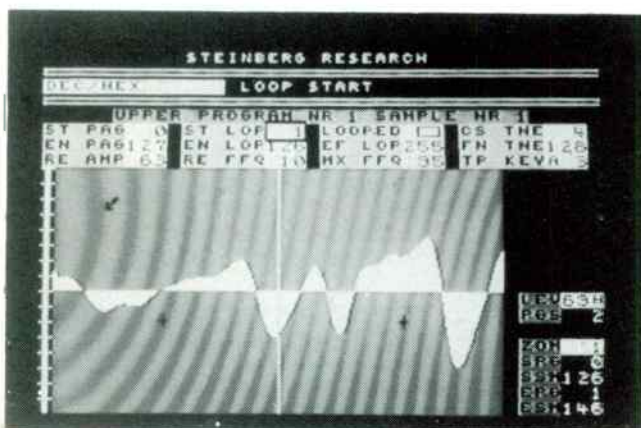

- **PARAMETER DISPLAY SCREEN** for setting all programme and configuration parameters
- **MASOS PARAMETER WINDOW** for setting all MASOS parameters
- **MASOS FUNCTION WINDOW** for setting all MASOS functions
- **WAVESAMPLE EDIT PAGE**
  - Displays wavesamples – Highlight any section by zooming in up to a max of 30 times
  - Set loop points – Draw your own waveforms using the Commodore keyboard or joystick
- **KEYMAP DISPLAY** used when multisampling to assign different areas of the keyboard to different samples

## THE MIRAGE TERMINAL EDITOR (MTE) FOR THE COMMODORE 64

At last a software package enabling you to get the most out of sampling on the Mirage. Following in the Steinberg tradition the MTE has been designed first and foremost for ease of operation. Each of the 3 pages present the Mirage functions in an easily understandable format allowing accurate and precise control over your samples. The MTE runs with both the Mirage keyboard and expander and is compatible with all MASOS versions.

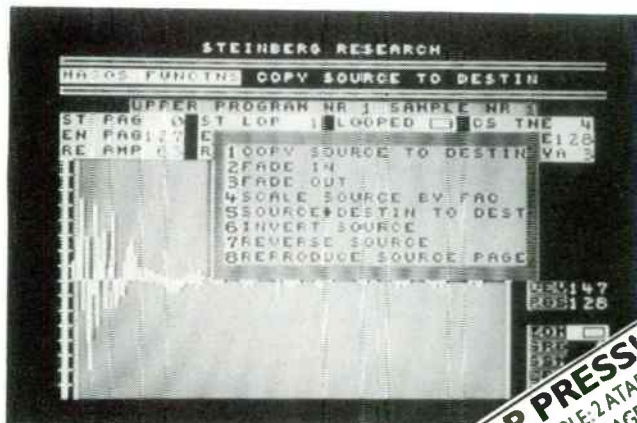

**STEINBERG RESEARCH**

See this system at your local OSC dealer or contact



Oxford Synthesiser Company Ltd.,  
5 Gladstone Court, Gladstone Road,  
Headington, Oxford OX3 8LN  
Tel: 08675 5277 Telex: 83147 att: OSCAR

**STOP PRESS!**  
NOW AVAILABLE: 2 ATARI  
520/1040 ST PACKAGES,  
PLUS 2 NEW COMMODORE  
64/128 PACKAGES

involved system of parameter access makes editing a real chore, dollar-inflated price-tag, difficult to get hold of in UK; **+** competent, professional synth system – at a price. ● Reviewed October '83.

## ROLAND

**Alpha Juno 1 – £575** Six-voice, one-oscillator per voice analogue polysynth; 64 preset and 64 programmable voice memories, four-octave keyboard. **+** Best-sounding Juno yet, light weight and compact size, backlit display; **+** short, non-velocity sensing keyboard, sound lacks individual character, 'Alpha dial' doesn't make digital access system much easier; **+** takes state of the Juno art appreciably further, but see Juno 106. ● Reviewed January '86.

**Alpha Juno 2 – £799** Spec as for Alpha Juno 1 but with five-octave, velocity-sensitive keyboard. **+** Better suited to role of main poly instrument than the Alpha Juno 1, but for correspondingly more money. ● Reviewed February '86.

**Juno 106 – £699** Six-voice, one-oscillator per voice analogue polysynth; 128 programmable voice memories, five-octave keyboard. **+** Ease of use, built-in chorus; **+** beginning to sound a little dated; **+** a classic among budget polysynths, to some degree overshadowed by new Alpha Junos, but proper, non-digital controls mean it's still a contender. ● Reviewed May '84.

**JX8P – £1199** Six-voice, two-oscillator per voice analogue polysynth; 64 preset and 32 programmable onboard voice memories, five-octave pressure- and velocity-sensitive keyboard. **+** Another example of Roland

squeezing new sounds out of old design techniques (the 8P competes with the best of the analogues), voltage controlled mixer section, RAM cartridge voice storage, good MIDI implementation; **+** only eight memories hold aftertouch and performance data, requires optional PG800 programmer for sound editing to become straightforward;



**+** lacks character, but ultimately a rewarding and versatile analogue poly that proves Roland aren't going to be left behind without a fight. ● Reviewed February '85.

**JX10 – £1899** 12-voice, two-oscillator per voice analogue polysynth; 64 preset voice memories, 64 internal programmable voice memories, expandable to 128 via cartridge, touch- and velocity-sensitive 76-note keyboard. Available summer. ● Reviewed this issue.

## SEQUENTIAL

**MAX – £399** Six-voice, one-oscillator per

voice, multi-timbral analogue polysynth; 80 preset voice memories, four-octave keyboard. **+** As SixTrak; **+** also as SixTrak, but not readily user-programmable without CBM64 and software; **+** tries to be computer peripheral and voice expander in one, succeeds in being neither. ● Reviewed January '85.

**SixTrak – £499** Six-voice, one-oscillator per voice multi-timbral analogue polysynth; 100 programmable sound memories, four-octave keyboard. **+** Unique (in this price range) multi-timbrality extends to built-in six-channel sequencer, 'stack' mode and MIDI; **+** awkward parameter adjustment, short keyboard, synth doesn't actually sound too impressive; **+** in the process of being displaced by newer MAX and MultiTrak, therefore very cheap. ● Reviewed March '84.

**MultiTrak – £799** Six-voice, one-oscillator per voice analogue polysynth; 100 programmable voice memories, five-octave, velocity-sensitive keyboard. **+** Adds 'pro-

A1 GIANT NEW SHOWROOMS OPENING SOON GIVING YOU AN EVEN BETTER CHOICE

3-7 MEALHOUSE BROW  
STOCKPORT  
TEL: 061-429 8777

# A1 MUSIC

88 OXFORD STREET  
MANCHESTER  
TEL: 061-236 0340

GOOD PRICES AND EVEN BETTER FOR CASH – CASH TALKS AT A1

### THE LATEST IN 4 TRACK RECORDERS

**Fostex X-15**  
multitrack ..... £269  
**Teac Porta-one** ..... £425  
**Yamaha MT-1X** ..... £499

### Roland WE DESIGN THE FUTURE

Roland Alpha Juno 1 £499  
Roland JX8P ..... £1050  
Roland Sh101 with  
modulation & band  
grp ..... £220  
Roland Juno 106 ..... £599  
Roland MKB300 ..... £795  
Roland MKB1000G ..... £1500  
Roland HS60 ..... £799

ALPHA JUNO 2 £799

### NEW ROLAND TR505 DRUM MACHINE £225

Drum & percussion sounds  
together: 48 programmable  
patterns, tape save load facilities

### KEYBOARD SALE

	RRP	SALE PRICE
Siel DK600 - Expander	£1239	£799
Sielak String Machine	£400	£199
Korg Poly 61 M	£899	£650
Roland Combo Piano	£450	£299
Yamaha C5-150	£299	£199
Eigam Carousel	£199	£99
Roland SH-101	£229	£220
Eigam Carousel	£199	£99
Moog Source	£699	£399
Sequential Pro-One	£350	£225
Sequential Multitrack	£1565	£699
JVC KB700	£639	£599

### AKAI

S612 MIDI Digital Sampler +  
MD280 disc drive an incredibly  
priced..... £799  
Also new S900 sampler ..... £1596  
MIDI programmable patch bay £99  
MIDI note splitter ..... £99

### Vesta FIRE £322

**THE FOSTEX X-15 MULTITRACK £245**  
Now in Stock, the New MR-10  
Multitrack Recorder The MR-10 has a total  
of 10 inputs making it an extremely flexible tool  
for anyone involved in multitrack production

### SOUND TECHNOLOGY AGENTS THE NEW MIDIVERB £399

The Alexis Midiverb, one of the most competent  
digital reverb systems available – and at a  
staggeringly low price.  
Also in stock XTC delay aural exciter  
multitron delay.

### SIMMONS

SIMMONS + MIDI OPENS DOORS TO A WHOLE  
NEW PERCUSSION EXPERIENCE!

THE ELECTRONIC DRUMS OF THE FUTURE

SOS1000 (new model)	£649.99
SDH1 new drum tubular rack	£99.99
SDS200	£314.99
SDS400	£481.23
SDS800	£551.99
SDS1	£169.99
SDS9	£199.99

ALL KITS ON DEMO THRU FULL P.A. RIG

### Karshall A WORLD BEATER IN AMPLIFICATION DEALS FOR CASH

100W Master Volume	£360.00
100W Valve Twin Channel	£360.00
50W Valve New Super Bass	£294.00
300W 4 x 12 Lead Angled	£254.00
250W 1 x 15 bass cab	£171.00
150W 1 x 15 Bass Extension Cab	£149.00
140W 4 x 10 Lead Angled	£160.00
50W 2 x 12 Split Channel Combo	£303.00
12W 1 x 10 Master Vol Combo	£83.00
12W 2 x 12 Split Channel Combo	£74.87
50W 1 x 15 Keyboard Combo	£320.00

### YAMAHA Hi-Tech Dealer

DX7 ..... £1249 RX21 ..... £249  
DX27 ..... £649 RX21L ..... £249  
DX27 ..... £499 RX15 ..... £449  
DX100 ..... £349 RX11 ..... £599

### KX88 MOTHER KEYBOARD

88 Notes wood keys, beautiful feel! 19 different  
control effects the ultimate

**TX816 Expander/Tone generator**  
Imagine the limitless possibilities of 8 DX-7's  
available at your fingertips! Phone for prices.

### TRANCE ELLIOT

Endorsed by all leading bass players  
including, Mark King, Pino Paladino and John  
Carliano

GP7 4x10 combo	£613
GP7 amp head	£350
GP11 amp head	£440
GP11 AH250 amp head	£595
GP11 Graphic pre-amp	£250
1004 4x10 cab	£300



HP/Instant Credit  
Part Ex. Welcome!  
ALL PRICES INCLUDE VAT AT  
CURRENT RATE. PHONE WITH  
ACCESS/BARCLAYCARD NO. FOR  
FAST MAIL ORDER

A1 SHOWROOMS OPENING SOON MAKING US THE BIGGEST STORE IN THE NORTH

► *professional' facilities to SixTrak spec; doesn't add anything better in the sound department; new low price, and the only choice if you value sequencing and MIDI facilities above sheer sonic potential.* ● Reviewed May '85.

**Prophet VS** – £1899 Eight-voice polysynth using new Vector Synthesis technology; 128 preset waveforms, four waveforms mixable in any combination at any one time, programmable 12-parameter envelope, five-octave, velocity-sensitive keyboard, arpeggiator, stereo chorus. **+** Vector Synthesis system uniquely versatile in this price sector, vast range of sounds available almost instantly, joystick makes parameter and performance control a doddle; **-** VS system isn't very predictable, takes a lot of time to get to know properly; **-** potentially as revolutionary as Yamaha's DX machines, offers huge potential for sound creation and manipulation, shows what can be done when contemporary microprocessor control is allied to musical commonsense. ● Reviewed May '86.

## WERSI

**MK1 II** – £TBA 16-voice polyphonic Fourier Synthesis polysynth; five-octave velocity- and pressure-sensitive keyboard. To be reviewed.

## YAMAHA

**DX100** – £349 Eight-voice, programmable FM digital polysynth, 192 internal factory

preset sounds, 24 programmable voice memories, 96 performance memories, four-octave mini keyboard. **+** Excellent sounds (many shared with DX21), portability, performance memories, mains and battery operation, velocity-sensitive via MIDI; **-** small size makes programming fiddlier than ever, professionals won't like small keys; **-** potentially, the synth that could bring FM to millions of non-musicians, makes an excellent MIDI voice expander for pro players. ● Reviewed February '86.

**DX27** – £499 Specs as for DX100, but with full-sized, five-octave keyboard. ● To be reviewed.

**DX21** – £699 Eight-voice, programmable FM digital polysynth; 128 internal factory preset sounds, 32 programmable voice memories, 32 performance memories, velocity-sensitive over MIDI, five-octave keyboard. **+** Broad selection of factory sounds that rival DX7's for quality, useful voice-specific performance memories, inclusion of split and dual modes, probably easier to program than first-generation DXs, cheap; **-** undynamic keyboard, no cartridge storage facilities, could still do with a better display; **-** only the first in Yamaha's three-pronged assault on the march of the budget polysynth, and mightily impressive, shows company haven't been resting on DX7 laurels. ● Reviewed August '85.

**DX7** – £1250 16-voice, fully programmable FM digital polysynth; 32 voice memories, five-octave velocity- and pressure-sensitive keyboard. **+** Immense sonic and programming versatility still unmatched by any competing instrument, vast range of custom-designed hardware and software now avail-

able to accompany it from a variety of sources; **-** a real pig to program, hence many preset sounds becoming clichéd, still niggling doubts about its ability to recreate fat, traditional analogue synth sounds; **-** an industry standard like no synth before it, and justifiably so – if only it was as easy to edit as it is to listen to...

**DX5** – £1999 FM digital polysynth, spec similar to two DX7s with additional performance memories; 76-note touch- and velocity-sensitive keyboard. **+** Excellent sound and facilities; **-** beaten on price by Yamaha's own DX7/TX7 combination; **-** now you've a choice between convenience and cost, though sizeable back orders for the DX5 indicate some people are wealthier than is good for them. ● Reviewed October '85.

## EXPANDERS

### AKAI

**VX90** – £TBA Similar facilities to AX80 poly, but in 19" rack-mounting format. ● To be reviewed.

### CHASE

**Bit 01** – £499 Similar in spec to Bit 99 poly, in rack-mounted casing. **+** Puts excellent analogue sounds in a modular format well-suited to the needs of digital synth owners,



**D O N ' T**  
miss an issue



There's nothing worse than rushing round to your local newsagent, hard-earned £1.20 in hand, only to find that a load of other musicians have beaten you to the store's allocation of E&MMs. You scour the bookshelves for hours, you ask the girl behind the counter if there are any at the back of the shop, you even try the Swedish magazine importer round the corner – all to no avail.

The reason for this is simple. Only one musicians' magazine has been looking at music technology thoroughly, accurately and objectively for over four years. Only one musicians' magazine has the reputation for carrying the most authoritative appraisals of new music hardware and software. And only one musicians' magazine has consistently inquiring, informative interviews with the people that are applying new technology to today's music. That magazine is the one you're holding in your hands now, but as anyone who's lived through the above story will know, getting it there isn't always that simple.

But fear not. You can save yourself this monthly agony by subscribing to E&MM direct. That way, you stand a good chance of getting each month's issue in your hands before it even reaches the bookshelves, let alone disappears from them again. So say goodbye to the newsagent Grand Prix: clip the coupon now.

Please send me the next 12 issues of E&MM, beginning with the .....issue.  
I enclose a cheque/postal order/bankers' draft\* for £15.50/£16.20/£23.50/£37.50\*, made payable to Music Maker Publications.

My name is .....

My address is .....

.....Postcode.....

Send to Mail Order Department, E&MM, Alexander House, 1 Milton Road, Cambridge CB4 1UY.

UK & Eire £15.50; Europe & Overseas (surface mail) £16.20; Europe (airmail) £23.50; Overseas (airmail) £37.50. Payment from overseas subscribers (including Eire) should be covered by a bankers' draft in pounds sterling.

\*Please delete as applicable



factory presets are sonically matched to corresponding Bit 99 voices, rack-mounting convenience; ■ a little pricier next to Bit 99, still the odd MIDI hiccup; ■ stands out as being the most cost-effective analogue unit in its price bracket. ● Reviewed July '85.  
**EX80** – £299 Similar in spec to DK80 poly, but only monotimbral. ■ Incredibly cheap, so lots of features for your money, cartridge storage facility unexpected on a machine of this price level; ■ presets are identical to DK80's, hence more than a few sonic disappointments; ■ currently one of the cheapest ways into analogue MIDI synthesis, and a godsend to the impoverished – it's not brilliant, though. ● Reviewed July '86.

## KORG

**EX800** – £249 Identical in spec to Poly 800: 64 programmable voice memories, built-in sequencer. ■ All the plus and minus points of the original Poly 800, but now ridiculously cheap, thus a splendidly affordable analogue expander. ● Reviewed September '84.  
**EX8000** – £TBA Identical in spec to DW8000: built-in digital delay. ● To be reviewed.

## OBERHEIM

**Xpander** – £3945 Six voice polyphonic analogue/FM digital hybrid synthesiser; 31 LFOs, 30 EGs, 12 oscillators, 90 VCAs, 100 programmable voice memories, recognises MIDI pressure and velocity information. ■ Vast range of sounds both analogue and digital, easier to program than most digital access designs, matchless programming versatility;



■ only the cost; ■ brilliantly conceived and superbly built – if you can afford it, don't hesitate.

**Matrix 6R** – £999 Modular version of Matrix 6 polysynth, see separate entry for details. Available summer. ● To be reviewed.

## ROLAND

**MKS10** – £895 Sixteen-voice polyphonic piano-family voice module, velocity- and pressure-responsive, 16 preset voice memories. ■ Neatly styled, built-in chorus/flanger helps strengthen sound output; ■ eight voices accessible through mother keyboard only, expensive for what it is; ■ only really of value if you've got a keyboard – and a playing technique – that'll do it justice. ● Reviewed October '84.  
**MKS20** – £1200 Piano module using new SAS resynthesis system of sound-generation. ● To be reviewed.  
**MKS30** – £775 Same overall spec as discontinued JX3P poly, but 64 programmable voice memories, responds to velocity and

pressure information. ■ It doesn't sound bad; ■ requires optional PG200 programmer for conventional analogue 'pot' control; ■ as modules go, not particularly inspiring. ● Reviewed October '84.

**MKS80** – £1800 Similar spec to discontinued flagship Jupiter 8, but improved: eight-voice polyphony, two oscillators per voice, 64 voice memories and 64 patch preset memories onboard, fully responsive to velocity and aftertouch information. ■ Wonderful range of analogue-type sounds, optional RAM packs can hold 128 voices or patch presets; ■ again, requires optional programmer (this time the MPG80) for editing not to be a chore; ■ an excellent package, notably good value next to other Roland modules, but price puts it firmly in the professional league. ● Reviewed October '84

## YAMAHA

**TX7** – £599 Identical in spec to DX7, with addition of performance memories for each

# Monkey Business

MUSICAL EQUIPMENT

**ROLAND**

- Axis Remote Keyboard.....£399
- EP50 MIDI piano.....£549
- Juno 1 synth.....£499
- Juno 2 synth.....£799
- JX3P synth.....£Special offer!
- New JX10 synth.....£1899
- New MC-500 Micro composer.....£799
- New MKB-200 Mother keyboard.....£625
- MKS-7 Super quartet module.....£950
- New MKS-20 Digital piano module.....£1299
- MKS-80 Super Jupiter module.....£1549
- MPC-300 Programmer for MKS-80.....£349
- PG-300 Programmer for Juno's.....£199
- New RD1000 Digital piano.....£2499
- New Sampling keyboards  
—coming soon!!
- Juno 106 synth.....£485
- SH101 Mono synth.....£225
- Juno 6 Synth s/hand.....£375
- SH09 Mono synth s/hand.....£125
- CSQ60 Sequencer, s/hand.....£95
- MSQ100 MIDI sequencer.....£299
- PR800 MIDI Sequencer.....£99
- MKS-10 Piano module.....£599
- SVC-350 Vocoder.....£599
- SDE-1000 Digital delay.....£399
- SDE-2500 Digital delay.....£449
- SDE-3000 Digital delay.....£749
- SRV2000 Digital reverb.....£1099
- GI2 Guitar synth x-demo.....£1695
- GI2 Bass synth x-demo.....£1795
- TR505 Digital Drums, MIDI.....£225
- TR707 Digital drums, MIDI.....£499
- TR727 Latin percussion.....£399
- PAD-8 MIDI Octapad.....£399
- MPU 101 MIDI/CV interface.....£199

ALL PRICES INCLUDE VAT

**KORG KEY CENTRE**

- Poly 800 Mk1 synth.....£399
- Poly 800 Mk11 synth.....£499
- DW6000 polysynth.....£599
- DW8000 polysynth.....£995
- EX8000 expander module.....£849
- EX800 expander module.....£199
- New DVP-1 voice processor.....£799
- RK100 remote keyboard.....£399
- SQD-1 MIDI recorder.....£599
- PS5-50 super section.....£375
- DDM110 digital drums.....£175
- DDM220 digital percussin.....£145
- MR16 digital rhythm source.....£299
- KMX rack mount mixer.....£199
- SDD2000 digital delay.....£335
- SDD2000 digital delay.....£499
- GT60X guitar tuner.....£29
- DT1 chromatic tuner.....£45
- MEX memory expander.....£199
- KMS MIDI synchroniser.....£175

**AKAI PRO DEALER**

- New S-900 sampler.....£1599
- S612 sampler + disc drive.....£799
- AX80 polysynth.....£799
- New AX73 polysynth.....£699
- New AX73 mother keyboard.....£499
- New VX30 expander.....£499
- New MPX820 prog. mixer.....£1299
- New CPZ1000 computer system.....£1699
- ME255 note separator MIDI.....£99
- ME30P patch bay MIDI.....£99
- ME10D MIDI delay.....£99
- ME15F dynamics controller.....£99
- ME20A sequencer MIDI.....£99

Full range of sample sounds in stock!

**FOSTEX**

- MOD80 8 track recorder.....£1699
- MOD80LS 8 track recorder.....£1575
- MOD20 2 track recorder.....£899
- 260 New 4 track recorder.....£699
- X15 4 track recorder.....£245
- 450 8/4 mixer.....£699
- MN15 mixer/compressor.....£49
- TS15 sync box.....£59
- 6301 powered monitors.....£129
- T20 headphones.....£45
- 4030 synchroniser.....£1495
- 4035 sync controller.....£517
- 4050 auto locator.....£899
- 8700 SMPTE generator.....£179
- MOD80 remote.....£59
- MOD80 footswitch.....£14
- A/C adaptor for X15.....£34
- X15 footswitch.....£9

**HOME RECORDING MACHINES**

- Tezcon 4 track cassette, VU meters EQ, Dolby C noise reduction.....£385
- Tezcon power supply.....£25
- Fostex X15, s/hand.....£199
- Yestfire 4 track cassette, VU meters EQ, DBX with power supply.....£325
- Cutec MR404 high speed mains powered 4 track with EQ and DBX.....£481
- Clarian high speed 4 track with 1/4 noise reduction, mains powered.....£549
- MT44 system complete, s/hand.....£399
- Aria 4 track high speed 19" rack mounted assette recorder.....£495
- Yestafire MK-1 6 channel, 4 track, 11" rack mounted high speed DBX.....£689
- Akai 4000DS Mk11 two track reel to reel, s/hand.....£99

**19" RACK UNITS**

- Yamaha REV7 reverb.....£899
- Boss CE300 chorus.....£195
- Boss DE200 delay.....£295
- Tamec Madrack D7 delay.....£299
- Dynacord 8 memory delay.....£399
- VestaKaz sampler/delay.....£295
- JHS digital delay.....£245
- JHS delay/reverb.....£269
- JHS spring reverb.....£79
- Yamaha GC2020 comp/limiter.....£279
- MXR dual 15 EQ s/hand.....£245
- Ibanez DMS500 delay.....£265
- Ibanez DM1100 delay.....£299
- Ibanez HD1500 harmonizer.....£495
- Cutec stereo graphic.....£98
- Cutec delay/reverb.....£142
- Aria stereo reverb.....£199
- Acas E15E stereo graphic.....£187
- ADO patch bay.....£59
- Trace Elliot GP11 pre-amp.....£250
- Dynacord digital reverb.....£399

**MICRO RACK UNITS**

- Boss BMRS micro system rack.....£45
- Boss RDD10 digital delay.....£149
- Boss RCL10 comp/limiter.....£115
- Boss RGE10 graphic EQ.....£115
- Boss RBF10 flanger.....£115
- Boss RPH10 phaser.....£115
- Boss RAD10 19" rack adaptor.....£20
- Boss RPO10 parametric EQ.....£115
- Boss RSD10 sampler/delay.....£199
- Boss RPW7 multi power supply.....£64
- Boss Individual power supplies.....£18

Instant no deposit H.P. available (APR 36-4) Part-ex welcome Visa/Access

66 Victoria Road, Romford, Essex (0708) 754548 or 25919

& 351 London Road (A13) Westcliff-on-Sea (0702) 332743

▶ voice. **+** A logical upgrade for all DX7 owners; **-** but not so much fun if your controlling synth is analogue, as you won't be able to program it without software; **=** Yamaha's most economical route to FM duplication. ● Reviewed April '85.  
**TX216** – £1899 Two DX7s (or one DX5) in rack-mounted format, with facility for adding TF1 modules (one DX7's worth) at £449 each. For comments see **TX816**.  
**TX816** – £3999 Essentially eight DX7 voicing modules in one rack, each with its own MIDI connection. **+** Who could say no to eight DX7s? **-** MIDI implementation could be better, difficult to get to know properly; **=** the ultimate FM music synthesiser – no self-respecting studio should be without one. ● Reviewed May '86.

touch-sensitive keyboard with four-way keyboard split, MIDI clock, built-in synth section. ● To be reviewed.

## KORG

**Rk100** – £375 Three-and-a-half octave portable keyboard with volume, pitchbend, modulation controllers, 64 voice selectors. **+** Price, spec includes thoughtful touches like lockable MIDI connectors; **-** octave range sacrificed in the cause of portability, no dynamics; **=** one of the best-value 'poser's' keyboards currently available.

## OBERHEIM

**Xk** – £998 Five-octave, touch- and velocity-sensitive keyboard, 100 user-programmable assignment memories, built-in arpeggiator, chord and hold facilities. **+** Well thought-out and durable, plenty of memory to store MIDI setups in; **-** a bit pricey, especially when you add VAT; **=** an impressive performer, but competition is stiff, and getting stiffer all the time. ● Reviewed May '86.

## ROLAND

**Axis 1** – £799 Three-and-a-half octave portable keyboard with volume, pitchbend, modulation controllers, velocity- and pressure-sensitivity, 120 voice selectors. ● To be reviewed.

**MKB200** – £599 New 61-note controller keyboard, sensitive to velocity and aftertouch. ● To be reviewed.

**MKB300** – £699 76-note mother keyboard, velocity-sensitive, split and layering facilities, 128 voice selectors, volume, pitchbend, modulation controls. **+** Sturdy construction, looks; **-** price; **=** overshadowed, in most respects, by **MKB1000**.

**MKB1000** – £999 Velocity- and pressure-sensitive 88-note keyboard, overall volume, pitchbend, modulation controllers, 128 voice selectors, MIDI split and layering facilities. **+** Excellent action from weighted wooden keys, superlative construction; **-** no individual level controls, lack of remote programming facilities, price; **=** another professional people's product, though even they might find its acquisition hard to justify.

## YAMAHA

**KX5** – £199 Identical in spec to **KX1**, but miniature keys. ● To be reviewed.

**KX1** – £699 Three-and-a-half octave, velocity- and pressure-sensitive keyboard, volume, pitchbend, modulation controllers, 32 voice selectors. ● To be reviewed.

**KX88** – £1299 88-note velocity- and pressure-sensitive weighted keyboard, 17 user-assignable performance controllers, split and layering facilities. **+** Vast range of performance options, onboard programming facilities coupled with user-assignable parameter control area, keyboard adds new dimension to many DX voices; **-** keyboard has slightly spongy feel absent on **DX1**; **=** more of what a master keyboard should be, but is a piano-type keyboard the best medium for applying aftertouch? ● Reviewed May '85. ■

## CONTROLLERS

### AKAI

**MX73** – £499 Six-octave, velocity- and pressure-sensitive, weighted-action splittable keyboard; 96 voice selectors. ● To be reviewed.

### CHASE

**Bit MasterKeyboard** – £549 Six-octave keyboard sensitive to velocity and aftertouch, MIDI filtering facilities, built-in sequencer, three-way keyboard split. ● To be reviewed.  
**DK700 MasterSynth** – £799 Five-octave

# GREAT SOUNDS

SOUND DISKS FORMATTED AND MAPPED FOR:

	PROPHET 2000 256K £19.95	PROPHET 2000 512K £29.95	EMULATOR II 512K £29.95	MIRAGE £14.95	AKAI S900 £29.95	CONTENTS
SongWriter	√*			√		Drums, Bass, Guitar, Rhodes, Synths, Stabs
SongWriter Plus		√*	√		√	As above plus Strings, Brass & Piano
Yamaha Grand Piano (9ft)		√	√		√	88-note via MIDI ON PRO 2000, 61-note on E2
Big Drums	√		√	√	√	Ambient Drums, mapped for MIDI Drum Making Machine Control
Alternative Drum Sounds	√		√	√	√	Replacement sounds for above disk
Wal Fretless/Fretted Bases	√		√	√	√	Separate and Combined Wal Warm Bass Sounds w/chorus
Sax Section		√	√		√	Baritone, Tenor, Alto and Soprano Sax Combined
Mapping Disk	√			√		Allows you to sample straight into pre-defined maps
Chapman Stick	√		√	√	√	The Tony Levin Sound, Bass and Treble Split

\*The Songwriter disks for the 2000 are best used with a MIDI sequencer

All disk fully set up and looped (where appropriate) using Digidesign Sound Designer Software by E&MM contributor & session programmer Paul Wiffen.

E&MM accepts no responsibility on disks sent outside UK for damage by Customs X-ray examination etc.

Please send me the following \_\_\_\_\_ disks for the:

- Prophet 2000 256K at £19.95 each  
 Prophet 2000 512K at £29.95 each  
 Emulator II at £29.95 each  
 Mirage at £14.95 each

1 \_\_\_\_\_  
 2 \_\_\_\_\_  
 3 \_\_\_\_\_  
 4 \_\_\_\_\_  
 5 \_\_\_\_\_

Send to E&MM Sound Disks, Music Maker Publications, Alexander House, 1 Milton Road, Cambridge CB4 1UY ☎ 0223-313722

I enclose a cheque/PO (made payable to Music Maker Publications) for:

£ \_\_\_\_\_

Name \_\_\_\_\_

Address \_\_\_\_\_

\_\_\_\_\_

\_\_\_\_\_

\_\_\_\_\_ ☎ \_\_\_\_\_

# MIDMAN

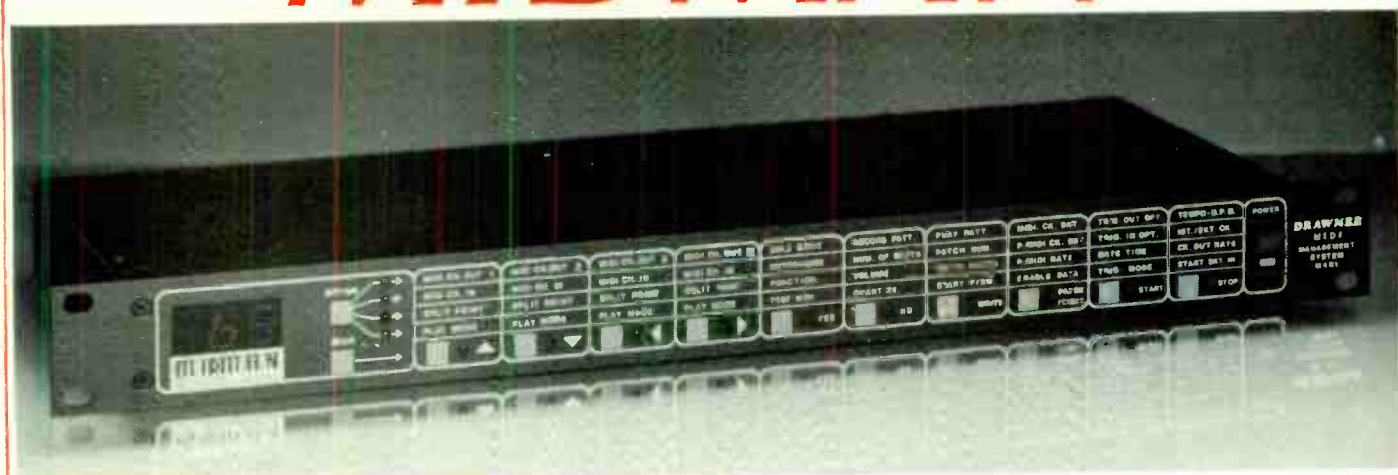

## *Making the most of MIDI*

### **M401—MIDI MANAGEMENT SYSTEM**

Let the Drawmer MIDMAN solve your MIDI management problems at the touch of a button

Whether you're in the studio or live on stage the MIDMAN offers a versatile solution to many keyboard routing and triggering problems. MIDI routing should be fast and repeatable, so the MIDMAN gives you

32 memories to store your routing patches. There's also a comprehensive **Triggering Output** section for driving external arpeggiators, **sequencers** and **drum machines** from MIDI, audio or off-tape pulse sources.

And that's not all. The MIDMAN includes its own **programmable dynamic rhythm pattern sequencer**: Tap out a rhythm on your MIDI keyboard and record the pattern complete with velocity data. Playing back the pattern then superimposes the dynamic rhythm onto your keyboard playing – **sounds exciting – it is!**

Here's a selection of the numerous features to be found on the new MIDMAN from Drawmer.

- MIDI ROUTING WITH CHANNEL AND PROGRAM CHANGE
- PROGRAMMABLE KEYBOARD SPLIT POINTS
- MIDI DATA FILTERING
- 32 MEMORIES FOR PATCH STORAGE
- 11 TRIGGER OUTPUT MODES
- AUDIO AND PULSE TRIGGER INPUTS
- TRIGGER GATE TIME CONTROL
- 3 CLOCK OPTIONS
- 99 BEAT RHYTHM PATTERN CAPACITY
- INDIVIDUAL RHYTHMS FOR EACH MIDI OUT SOCKET
- TEMPO CONTROL IN B.P.M.
- BEAT QUANTISATION
- DYNAMIC RHYTHM PATTERN RECORD/PLAYBACK
- FOOTSWITCH CONTROL OF PARAMETERS
- 1× MIDI IN
- 2× MIDI THRU
- 4× MIDI OUT
- AUDIO/TRIGGER INPUT
- CLOCK IN/OUT
- STOP/START OUT
- 2× FOOTSWITCH CONTROLS
- 30-285 BEATS PER MINUTE TEMPO
- VARIABLE CLOCK PULSE RATES
- FULL 16 MIDI CHANNEL ASSIGNMENT

For more details on the MIDMAN and worldwide distribution, write to:

# **DRAWMER**

DRAWMER, Sales & Marketing, Unit 4,  
Brook Lane Business Centre, Brook Lane North,  
Brentford, Middlesex TW8 0PP. Tel: 01-847 2890

# MULTITRACKING ON A BUDGET

The C-Lab SuperTracker looks like just another German sequencing package for the Commodore 64. But delve deeper into the software and a number of novel features come to light, and they're useful, too. *Simon Trask*

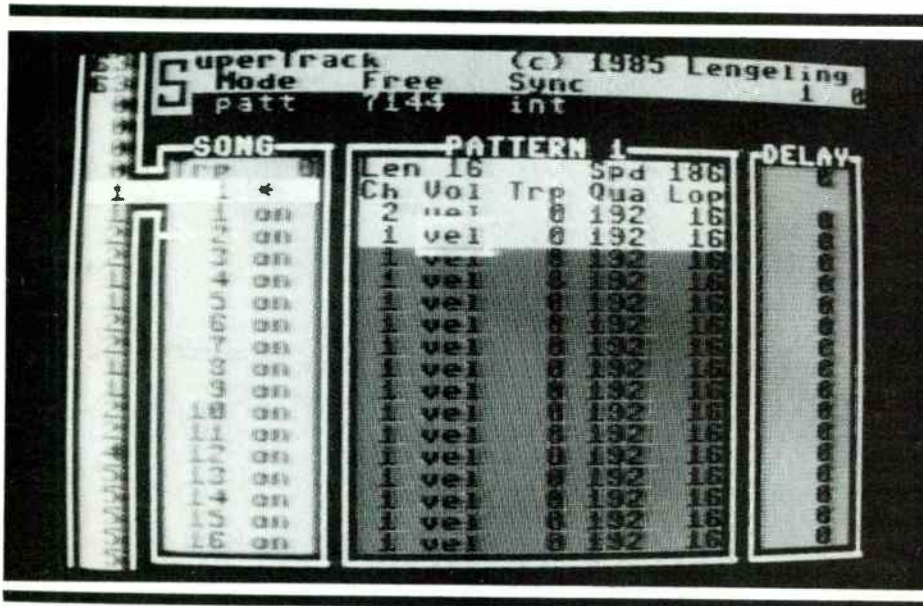

Usually, I only get a sense of *déjà vu* when the alarm clock goes off in the morning. But a new 16-track sequencing package for the Commodore 64 from German company C-Lab has changed all that. For truth to tell, there's a striking similarity between the C-Lab and the Steinberg Pro 16 sequencing package reviewed in E&MM February – though the new package is different enough to have its own character. A good idea is a good idea is a good idea, I guess.

Like Pro 16, the C-Lab SuperTrack confines all its essential operations and information to a single screen, with a sensible layout paying great dividends in both ease of use and accessibility. Operation of the sequencer has been kept fairly straightforward, and the tape-style approach to recording that Pro 16 adopted so successfully is to be found in the C-Lab package as well.

SuperTrack also follows Pro 16 in being realistically priced, and in having MIDI and Sync interfaces (the former offering three switchable Out/Thrus) which you can buy separately. But C-Lab have gone one further in allowing a number of different MIDI interfaces (including Steinberg's) to be used with SuperTrack, which is an encouraging move.

Apparently, C-Lab also have a scorewriting package (imaginatively titled ScoreTrack), though a date for its availability in the UK has yet to be fixed.

SuperTrack's pocket-sized manual is a lot

better than it looks like it should be, but some of the explanations leave a lot to be desired; fortunately, C-Lab importers Sound Technology are currently engaged in producing an addendum which should clarify all the confusing bits.

The sequencer offers 64 patterns, each consisting of 16 tracks, which may be chained into a single 256-step Song; storage capacity is 8633 events. Recording can be in real or step time, and a punch-in/out facility has been included, similar to the Pro 16's in that it's controlled from the Commodore's QWERTY keyboard – though in SuperTrack's case, it's activated by pressing the Shift Lock key, which does at least leave both your hands free for playing. A footpedal option would definitely be more useful, however.

It's becoming increasingly common for sequencers (and SuperTrack is no exception) to include a 'mix' facility, whereby incoming data from your master instrument is merged with any sequence data and sent on MIDI Out. This is valuable because you can hear parts on the instrument(s) they're intended for. On SuperTrack, the facility is available all the time, which means you can hear a new part on the instrument(s) you want it to be played on at any time during recording, playback and 'idling' modes.

The main display presents you with a Song table, a Pattern table and a Delay table. The first is presented in the same scrolling column fashion as on Pro 16, with 24 steps on-

screen at a time; changing song steps and pattern numbers is accomplished using the 64's function keys, again as on Pro 16.

Anyone in a position to use both sequencers (in a studio, say) shouldn't have much trouble adjusting from one to the other.

SuperTrack allows you to turn individual tracks within a pattern on or off (even while a sequence is playing), and to set each track to any of MIDI channels 1-16. Velocity range is also controllable for each track within a pattern, on a scale of 1-15. What this allows you to do is adjust volume levels (in real time, if you wish) on touch-sensitive instruments, and it comes in handy balancing two parts on the same instrument, for instance. It's also useful in compensating for any discrepancies in MIDI velocity response (the DX7, for instance, tends towards an extreme response when controlled via MIDI).

Tempo is individually programmable for each pattern, which affords a nice element of flexibility when chaining patterns together. Other track- and pattern-specific parameters are transposition ( $\pm 31$  semitones in semitone steps), quantisation (all the way from crotchets to 192nd notes, including triplets) and looping. Quantisation values for each track can be altered without affecting the recorded data.

The Loop parameter allows you to specify the length of each track (in beats) for looping. Setting a track loop to the pattern length means that it won't loop within the pattern, but equally, you can define a four-beat loop, say, in a much longer pattern, which is a valuable way of saving on memory (not to mention effort).

SuperTrack's limit of 255 beats for each pattern illustrates a limitation common in pattern-based sequencers, namely that they all presume you will build up your music bit by bit; anyone thinking of recording lengthy improvisations will be in for a bit of a disappointment. What's more, if your method of generating ideas is to improvise at the keyboard and you'd like then to be able to isolate particularly successful moments for further work, you'll be in for a shock on two counts, as SuperTrack doesn't allow you to isolate parts of a track (by copying the relevant parts onto a spare track, say).

The C-Lab sequencer includes two further facilities which can help to cut down on memory usage (always useful with the ►

# RAM

## more in your



### YAMAHA DX7 - DX5 DXI - RXII

### With a SR64 VOICE RAM

#### 'The Professional Choice'

- 64 voice capacity (twice as many as the original RAM for the same price!)
- Sophisticated automatic write protection circuitry (no memory dumps)
- Ultra-fast second writing time (15 times faster than the original)
- Dual Format capable (DX & RX Data together)
- Unlimited number of write/erase cycles (no burn out)
- Unique double-ended design eliminates switching problems
- Available in five distinctive colours (Red, Black, Silver, Blue and Green) for easy identification
- Rugged, road-proof, anodised aluminium case for maximum protection - lasting good looks
- Lithium power battery for long life (conservatively rated at 6 years)
- Gold-plated contacts and automated assembly for life long reliability
- Built to the highest specification and fully guaranteed

## £85 INC. VAT

Available from the following dealers:

London: Argents Keyboards - Chromatix - Gigsounds - London Rock Shop - Music Village - Chappells of Bond Street - Rose Morris Shop - The Keyboard Shop; Andertons of Guildford; Wigan: Back Alley Music; Manchester: Al Music; Epsom: Bootleg Music; Scotland: Sound Control; Torquay: City Music; Birkampstead: Graham Webb Music; Bingley: JSG; Blackpool: Sound Centre; Heald Green: Sounds Great; Glasgow & Edinburgh: Grants Music; Bath: Duck, Son and Pinker; Hounslow - Project Electronic Music; Glasgow - McCormacks; Birmingham - Jones & Crossland; Cambridge - Music Village; Leeds - Winfield Music; Leeds - Kite Keyboard Technology; ABC (all branches).

# SOUND SALES



### THE AUDIO PEOPLE

Orchard Cottage, Church Hill, Ravensden, Beds. MK44 2RL  
Telephone: Bedford (0234) 771 189

## AKAI KEY FACTORS



**S 900** 8-voice Digital Sampler, up to 48 sec sampling with a max. of 32 different samples or Split Point Programmes. 3.5 Disc Drive, plus much, much more. "The Guvnor" **£1599\***



**ME 30P** MIDI programmable Patch Bay. Fully programmable MIDI Patch Bay, allowing 3 programmes to be stored and up to 15 sets of input and output patches may be instantly preset and recalled, and look, only **£99\***



**MX 73** MIDI Keyboard Controller, 73 note velocity sensitive keyboard, programmable key split, plus wheel, bend, octave shift, volume, sustain and more, 100 prog. memory **£499\***

### PRICE PROMISE

WE WILL MATCH OR BEAT MOST GENUINELY ADVERTISED PRICES ON THE SPOT\*\*



**ME 25S** Programmable MIDI note separator, turns a none key/spit keyboard into a key/spit keyboard when used in conjunction with another MIDI equipped unit. 64 programmable memories with 4 splits available, can be used as a Sequential Programme Changer and Octave Transposer. Just what the doctor ordered. **£99\***



**AX 73** 6 voice programmable Polyphonic Synthesizer. 100 programmable sounds, 73 note velocity sensitive keyboard. Exclusive external input for sample: editing and combinations. Full MIDI spec. **£699\***



**VX 90** 6 voice programmable Polyphonic Rack Mount Synthesizer. Spec. as AX 73 above, excellent unit, excellent price. **£499\***

\* Prices quoted are manufacturers recommended retail and are for your comparison

Britain's Largest Musical Retailer  
We guarantee the best deal.

- PART EXCHANGE
- INSTANT CREDIT

(Subject to status, written quotations on request)

\*\* Subject to Availability



OPENING TIMES:  
Mon-Fri 9.30am-6.00pm  
Saturday 10.30am-5.30pm

SHEFFIELD  
720 City Road  
Tel: (0742) 640000

LEICESTER  
22 Humberstone Road,  
Tel: (0533) 24183

NOTTINGHAM  
11-13 Hockley  
Tel: (0602) 581888

NORWICH  
2 Sovereign Way,  
Tel: (0603) 666891

MANSFIELD  
182-184 Chesterfield Rd North  
Tel: (0623) 651633

# Colt

▶ relatively limited memory of eight-bit machines like the C64). One of these allows you to define 'ghost tracks', which are tracks that play the music data of another track but apply their own parameters to it. Thus where you want, for instance, the same part played an octave lower or higher on the same or another synth, with a different velocity level and perhaps a delay effect as well, you can do it without duplicating the music data in memory.

The second facility is potentially even more valuable. It allows you to define track on/off settings for each song step, which means the same pattern can have different tracks active depending on its position in the song. So instead of duplicating track data in different patterns, you could build up one 'composite' pattern and pare it down depending on your requirements at any given stage in the song.

The package allows you to copy any track to any other track (in the same or any other pattern), but omits a pattern-copying

---

**Facilities** "Like many sequencers, SuperTrack makes a virtue of shielding the user from lower-level MIDI operations. But it also includes a MIDI Event Editor page which offers greater control."

---

facility; there's also no facility for copying all pattern parameters to other patterns, though mute on/off settings can be copied to all higher patterns.

Like any MIDI sequencer, SuperTrack lets you bounce down any number of tracks onto one track, simply by connecting MIDI Out to MIDI In and recording onto the relevant track in real time – though it's a rather unsatisfactory procedure. There's also a facility for bouncing down two adjacent recorded tracks onto the lower of the two – to bounce track eight onto track seven, say. It's quick, but it's also irreversible, as your upper track is wiped clean instantly. And because SuperTrack (in common with many other MIDI sequencers) assigns only one MIDI channel to a track, you're effectively limited to bouncing down parts which use the same MIDI channel; a bounced-down track will take on all the other track-specific characteristics (such as velocity range and transposition) of the 'master' track. Still, it's a useful facility so long as you use it with care.

**A**s you build up your tracks, you may well be grabbed by the sudden desire to isolate a particular track. SuperTrack includes a Solo facility which allows you to do just this, though not while you're recording or playing back. The only parameters that SuperTrack allows you to alter in real time are track on/off, track velocity range and pattern tempo.

The Delay table to the right of the display allows you to delay individual tracks in steps of 192nd notes, up to a value of 255. This means setting a value of 48 will delay a track by a crotchet duration – relative to the

current tempo, of course. This doesn't affect the actual track data, but merely delays its readout; a delayed track will play on into the next track (which, remember, will itself be delayed).

There's also a track-shift function, which actually shifts the MIDI data in memory according to a value specified in the Delay table; this value may be applied repeatedly to generate some fairly long delays, but you lose data at the end of a track using this method. You can also shift data back towards the beginning of the track, so providing you haven't lost anything off the end, you can recover your original performance.

The SuperTrack's step-time recording follows what is by now a familiar procedure, whereby you select a step value, play a single note or chord for each step, and press the space bar once for each step. Any tracks already recorded and not muted will be heard in step (ie. your) time.

Step-time editing is non-existent unless

you're prepared to delve into the deeper workings of MIDI using C-Lab's Event Editor page, of which more anon.

Song mode allows you to enter a single 16-track pattern for each of its 256 steps – a bit like splicing together pieces of tape, but a lot less messy. In addition to the step-specific track muting mentioned earlier, you can also

---

**Conclusions** "SuperTrack offers full MIDI syncing and includes song pointers, which means it can be slaved to tape via a SMPTE-to-MIDI unit – great for professional use."

---

define a pattern transposition value for each step and decide whether sync information for controlling drum machines, say, is to be conveyed – this can be useful if you don't want a rhythm track at a particular point in a song. It's also possible to define up to eight autolocate cue points, which can act as handy shortcuts to any step in a song (or perhaps to the beginning of each song, if you've divided the generous 256 steps into several songs). These appear to be for internal use only, so SMPTE-MIDI autolocation isn't a possibility.

**M**IDI recording packages such as Pro 16 and UMI make a virtue of shielding the user from lower-level MIDI operations. C-Lab's package does the same, but also includes a MIDI Event Editor page which gives you the sort of control over your musical input previously found only in Joreth Music's package for the C64 (reviewed in E&MM May '85).

If the thought of dealing with MIDI on anything like intimate terms sends you into a

cold sweat, don't worry – you need never encounter the Editor page so long as you don't press 'E'. But if you are interested, the page is well laid-out, features MIDI commands that are translated into English and are consequently readily understandable, and allows you to alter the positioning and duration of individual notes down to as little as 192nd-note resolution.

Most usefully, you can insert, delete and alter note, velocity, patch-change and controller information with a degree of precision otherwise unattainable in software of this kind. What's more, the Editor page is valuable for diagnosing what your MIDI instruments are really saying to one another.

You can save and load either complete songs (ie. all the data) or individual tracks to disk. Tracks can be loaded back into any track position in any pattern, which is obviously rather useful – but why no pattern save and load? You can get a directory listing of your disk at any time, and also format a disk and delete, rename and validate individual files.

It's unlikely that you'll want to use the SuperTrack sequencer in isolation. The ability to sync to tape is – fortunately – pretty much *de rigeur* on sequencers nowadays, and SuperTrack includes standard tape sync via its Sync interface. Other non-MIDI sync possibilities are 48ppqn clock out and a choice of 48 or 24ppqn in, plus Roland DIN sync.

But consider, also, the possibility of slaving your sequencer to tape using SMPTE code. Even if you can't afford the expense of this method, you may well want to take your

sequences to a professional studio that uses your favourite sequencing package (it's starting to happen), and they'll almost certainly be using SMPTE as well.

SuperTrack offers full MIDI syncing: start, stop, and continue commands and (crucially) MIDI song pointers, which means it can be slaved to tape via a SMPTE-to-MIDI unit – great for professional use.

And 'professional' is the key word here. C-Lab's SuperTrack deserves to be taken seriously by anyone involved in keyboard-based recording, in whatever capacity and for whatever purpose. Its virtues are ease of use, flexibility and power, and you can hardly ask for more than that. If you've been thinking of taking the plunge into MIDI sequencing, there's never been a better time – and C-Lab's package should be high on your list of possible choices. ■

Prices SuperTrack sequencer £115, MIDI interface £79, Sync interface £106; all RRP's including VAT  
More from Sound Technology, 6 Letchworth Business Centre, Avenue One, Letchworth, Hertfordshire SG6 2HR. ☎ (0462) 675675

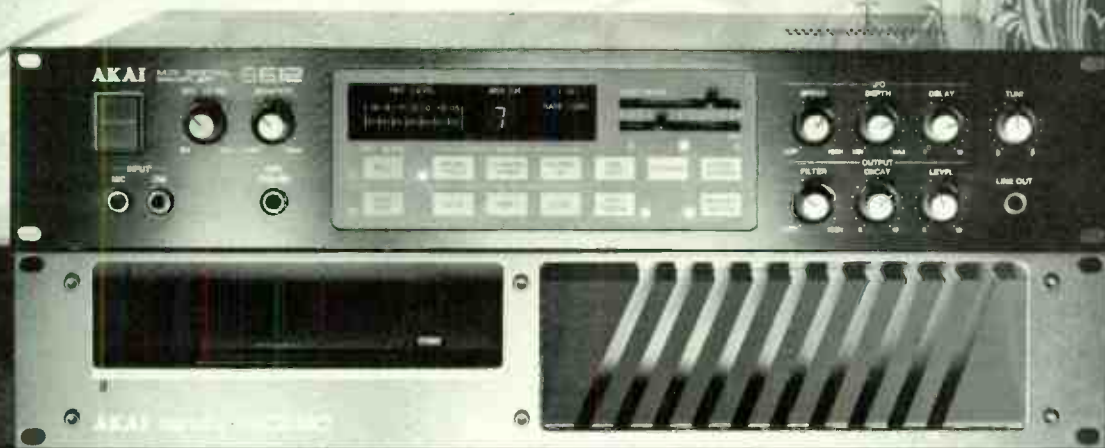

# Sample an LA sound in Deptford and play it at Dingwalls.

Sampling is a process that allows you to store and memorise a wide range of sounds from musical instruments to a variety of natural sounds. You can then play them musically via any MIDI synthesiser.

And AKAI's S612 is a first-leading the way in MIDI digital sampling.

It's a tremendous step for musicians, producing a high quality clear sound that is perfect in the studio or on the stage.

At under £800 (far less than any available alternative) it's an effective way of getting into sampling. By connecting it to your MIDI keyboard, sampled sounds

can be produced with six-voice capability over a five octave range.

The smart, sleek two unit high, 19-inch rack mounted S612 is extremely easy to use. To capture a sound you simply press the 'NEW' button!

And you can sample, overdub, loop, select MIDI channel and load and save sounds onto the quick loading memory disc drive.

With AKAI's library of sound combined with your own sampling, your synthesiser will be able to produce up-to-the-minute sounds.

It's far cheaper than flying to L.A.

*Now with audio trigger option.*

## The S612 sampler

**AKAI**  
professional

For your nearest stockist call our Special Information line Tel: 01-897 2487

Akai(UK) Limited - Electronic Music Division, Haslemere Heathrow Estate, Silver Jubilee Way, Parkway, Hounslow, Middlesex TW4 6NQ. Tel: 01-897 6388 Telex: 892555 AKAIUK G.

# R E T U R N O F T H E BIG SYNTH

Roland's latest polysynth combines the hardware of two JX8P's, but adds many new features which are unavailable elsewhere. Does it stand up as a complete instrument in its own right? *Simon Trask*



**W**ith the ever-broadening range of synthesis options available to keyboard players nowadays, it's all too easy for instruments to end up discarded before their time. However, Roland's latest synth, the 12-voice JX10, shows a refreshing faith in familiar technology – more specifically the voice architecture of the company's popular JX8P (reviewed in E&MM February '85). In sonic terms it's two JX8Ps combined, with Split and Dual performance modes and a whole host of programmable internal and MIDI performance features. To this already impressive spec, Roland have added an onboard real-time sequencer and the enigmatically-named 'Chase Play', of which more anon.

Appropriately enough for its price tag, the JX10 has been given a 76-note keyboard with attack velocity and channel aftertouch sensitivity. These dual dynamic attributes were still rare when we reviewed the JX8P, but nowadays are pretty *de rigueur* on any upmarket synth. Release velocity and polyphonic

aftertouch are still all too rare, however, and Roland haven't seen fit to include them on their latest. But importantly, the 10's shallow-travel keyboard is pleasing and responsive to the touch, firm and yet agile.

The new Roland's front panel includes one of the most intelligible and informative displays to be found on a synth in the form of a 32-figure fluorescent LED affair, and the well-organised front panel strikes a good balance between accessibility (complete with many dedicated buttons) and economy. The company's much-vaunted 'alpha dial', which is used for altering parameters and values, still fails to convince, however – in practice it's an awkward device with neither the immediacy or flexibility of the familiar combination of slider and +/- buttons. In contrast, the 10's numeric keypad offers very quick access.

For the posers of this world the Roland's sleek appearance and black-and-grey finish really look the business. More

importantly, the JX is a solidly-constructed instrument which should be able to take a few knocks – though watch those overhanging keys.

Roland have given their latest JX the ability to access 100 sounds internally (50 of which are preset on ROM) and a further 50 on M64C RAM cartridge. That's a healthy number, easily expandable with further cartridges – though at £85 per cartridge you'd be better off storing sounds to computer via MIDI, keeping your cartridge(s) for your live set.

The ability of a synth to organise its sounds and to communicate with other instruments in musically meaningful ways is increasingly important, and this is an area in which the JX10 leaps ahead of its predecessor. For the new JX includes 64 Patch memories onboard and a further 64 on cartridge along with the sounds. These Patches (Roland call individual sounds Tones, just to confuse things) can call up two sounds onto the keyboard and define how these will be used: ie. in Whole (with



either the Upper or Lower sound), Split or Dual modes. Front-panel selectors allow you to instantly switch from one mode to another, which can effectively give you many more sonic combinations than the 10's storage capacity would seem to allow.

The JX's Patches allow you to define a healthy number of features. Transposition (over a  $\pm$  two-octave range), detune, hold on/off, LFO modulation depth, portamento on/off and pitch-bend on/off can each be set individually for Upper and Lower sounds in each Patch. It's also possible to set the effect that aftertouch will have on vibrato, brilliance and volume for both sounds in a Patch, together with a total volume level, Upper and Lower splitpoints (which can be overlapped), portamento time and pitch-bend range. And in addition to the standard dual voicing mode you can choose to cross-fade between the two sounds (using aftertouch) or select between one or the other sound depending on the velocity with which you strike the keys; in the latter instance you can even decide where the changeover point will be on the basis of the splitpoint value (which is of course otherwise inoperative in dual mode).

*Facilities "Where Chase Play differs from a standard DDL is that you can use two different sounds to create otherwise unobtainable effects."*

Six Patch-programmable key assign modes (independently programmable for Upper and Lower sections) allow you to decide how the JX's voices will be assigned to the keyboard. Two poly modes allow for either normal performance, with each voice playing through its allotted release time, or a style in which each new note clips the release time of the current note. Unison assigns two voices to a key, making each keyboard section three-voice polyphonic; one mode plays each voice at the same

pitch, the other sets them an octave apart. Mono modes turn each of the Upper and Lower keyboard sections into monophonic synths, with either a single voice or all six voices stacked up on a single note – great for those blistering solos.

Further adding to the performance flexibility of the JX10 are two assignable continuous controllers which may be activated either from dedicated front-panel sliders or footpedal inputs, together with an assignable footswitch controller. The continuous controllers can be assigned to either Upper/Lower volume balance, portamento time, total volume, Upper MIDI volume or Lower MIDI volume. As its name implies, total volume governs the JX10's volume and that of other MIDI instruments (making it useful as a master fade control), while MIDI volume by itself is a handy way of balancing the volume of slave instruments against that of the JX in real time.

The footswitch controller can be assigned to step sequentially through the JX's Patches or turn portamento, chase play, Upper hold or Lower hold on/off.

Unusually, Roland have given the JX10 separate stereo outs for Upper and Lower sounds, along with a stereo mix output, mono outs and a single 'total mix' – a comprehensive selection which should satisfy a variety of requirements.

**T**he JX's voice architecture has the virtue of familiarity if not of originality – and that's no bad thing in this case. There are two DCOs per voice, two ADSR envelope generators, an Oscillator Mixer, LFO, VCF and VCA, together with the familiar Roland chorus (offering a choice of 'rich' and 'expansive' settings!).

Each DCO offers a choice of four 'traditional' waveforms (sawtooth, square, noise and pulse) and may be tuned over four octaves. Pitch can be modulated by either the LFO (which offers sine, square or random waveforms) or the envelopes (which can be set

positively or negatively) and the two oscillators can be cross-modulated. You can mix the levels of the two DCOs, and control DCO2's level from keyboard velocity – which allows you to introduce specific effects or significantly alter the timbre of a sound from the strength of your touch on the keys.

Even though the front panel Edit Map lists all the Tone parameters for ready reference, there's no denying that calling up parameters one by one into the central display can become a trifle laborious. Fortunately, Roland have for some while been producing sleek little boxes with knobs and sliders on them. These plug into a certain number of the company's synths and give you all the accessibility, speed of operation and ease of comprehension you've come to expect from an analogue as opposed to a digital front panel. Not surprisingly the JX10 can use the PG800 programmer that was originally designed for the JX8P. You do have to fork out extra pennies for the privilege, but the PG800 is worth its weight in gold...

The JX10 offers plenty of those warm 'analogue' sounds for which Roland are justly famous (though the 10 is actually an analogue/digital hybrid), and a number of the best sounds from the JX8P are to be found on the new instrument. And while 50 presets (half of the internal memory) might seem a slightly high proportion, Roland have made sure that these include a fair cross-section of sounds, and more importantly that many of the sounds are classic Roland which you'll probably want to keep and use frequently. Thus there are plenty of those warm electric pianos and silky strings (the latter including the sublime 'Soundtrack' from the JX8P), together with some punchy synth bass sounds, wonderfully delicate oriental-style percussion voicings, a very ethereal pipe organ and some abrasive brass sounds.

The programmable sounds are a less consistent bunch, but in part this seems to be because Roland have included sounds which work most effectively when combined with another sound in Dual mode. Roland have chosen to construct dual voicings for almost all their factory-

Roland JX10 has two Edit Maps, one showing Tone parameters, the other Patch parameters.

EDIT MAP													
PATCH									MIDI				
SYSTEM	AFTER TOUCH	UPPER MODULE	LOWER MODULE	CHASE PLAY	MIDI SEND (OPTION)	SYSTEM	UPPER	LOWER					
11	U/L BALANCE	21	VIBRATO	31	UPPER CHANNEL	10	CHANNEL	30					
12	DUAL DETUNE	22	BRILLIANCE	32	LOWER CHANNEL	11	PROGRAM CHANGE	31					
13	UPPER SPLIT POINT	23	VOLUME	33	UPPER PROGRAM CHANGE NO.		AFTER TOUCH RECEIVE	32					
14	LOWER SPLIT POINT			34	LOWER PROGRAM CHANGE NO.		LOCAL	33					
15	PORTAMENTO TIME			35	UPPER VOLUME		PITCH BEND	34					
16	BEND RANGE			36	LOWER VOLUME		MODULATION	35					
17	KEY MODE			37	KEY MODE		PORTAMENTO	36					
18	TOTAL VOLUME			38	SPLIT POINT		HOLD	37					
				41			MIDI VOLUME	38					

# Music Maker Publications Simply More to Read

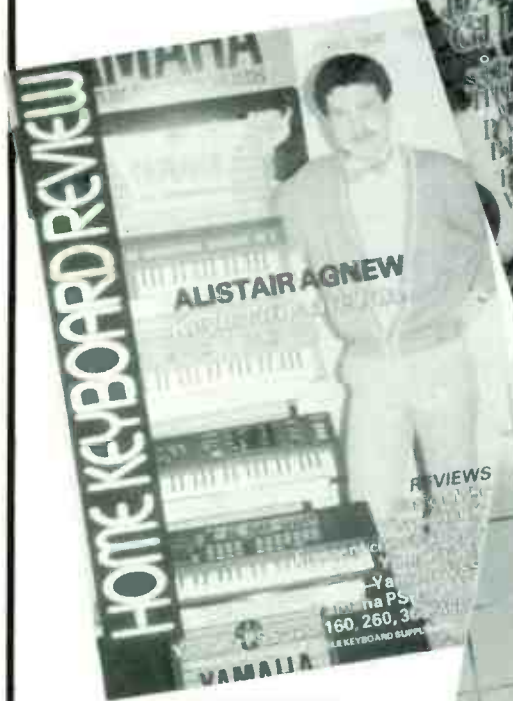

## HOME KEYBOARD REVIEW

The home keyboard and organ player is exclusively catered for in this stylish monthly

## GUITARIST

Britain's only specialist guitar-playing magazine – for electric and acoustic players, guitarists and bassists



## E&MM

**Electronics & Music Maker**  
The world's biggest music technology magazine – for the modern keyboard player and synth programmer

## RHYTHM

For the modern drummer and drum machine user. The perfect beat that completes an unbeatable music family

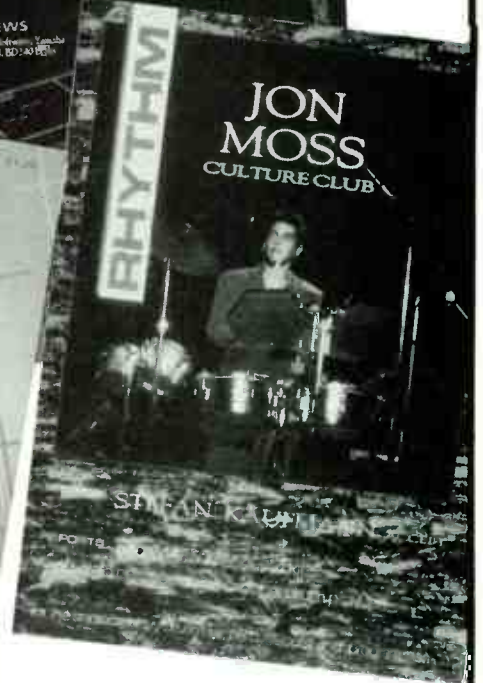

## HOME & STUDIO RECORDING

The magazine that takes the mystery out of recording at home – from 4 tracks to 24.

## ON SALE AT ALL LEADING NEWSAGENTS

**Quality, authority, style and sheer readability put Music Maker Magazines to the forefront in the most musically orientated market in Europe. Whether you're a musician or musical instrument supplier, Music Maker titles give you 100% of what you want, SIMPLY – MORE MAGAZINE.**

**For further details of direct subscriptions ring Cheryl on 0223 313722 or drop her a line at:  
Music Maker Publications: 1 Milton Road, Cambridge CB4 1UY**

▷ programmed Patches, which has paid off in showing the instrument to good advantage.

The Patch and programmable Tone memories can be transferred between synth and M64C cartridge in one go (and similarly sent and received over MIDI), but you can also transfer individual Patches and individual Tones to any memory positions you want.

**Specification** "In addition to the standard dual voicing mode, you can choose to cross-fade between the two sounds using aftertouch..."

**T**he inclusion of an onboard sequencer (single track, real-time only) may seem superfluous given the current proliferation of dedicated and computer-based sequencers, yet its accessibility and

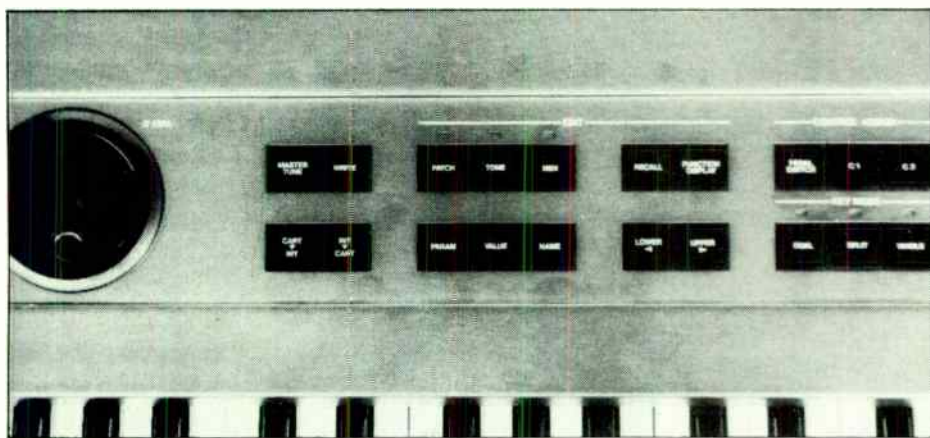

simple operation make it a useful feature to have around.

There are only two parameters: sequence repeat on/off and sequence tempo. And of course, once you've recorded your sequence you're free to play over it using the remaining JX voices; what's a pity is that you can't assign the sequence to one sound in Dual mode and play over it with the other sound.

It's worth noting that the 10 has no onboard sequence memory; in order to record anything you need either Roland's M16C or M64C cartridge. These can record approximately 400 and 1600 notes respectively, but they're not exactly the cheapest form of sequence storage – all the more reason to commit your lasting musical thoughts to an external sequencer, using the internal sequencer for trying out ideas.

The Chase Play feature turns out to be none other than our friend of recent Korg acquaintance, the built-in DDL. Well, almost. The new JX doesn't achieve its delay effects by processing an audio signal; instead, there's some clever real-

time manipulation of the synth's voices to give DDL-type effects. This approach does mean that you're tied to the JX's voice limit, but for many uses that's not too much of a problem.

Chase Play works in Dual mode only, sounding the Upper tone as you play a note and delaying the Lower tone. Three modes allow you to choose between a one-off Upper/Lower delay for each note played, Upper followed repeatedly by Lower, or alternation between Upper and Lower. Where this differs from a standard DDL is that you can use two different sounds (perhaps at different transpositions) to create otherwise unobtainable effects.

Two further parameters govern delay time (up to four seconds, variable over 100 steps) and delay level, the latter governing the number of repeats for each note played – with the maximum being just over 100. Hey presto, you've got a sequenced drone pattern from playing one note. In practice Chase Play is an extremely versatile feature, made all the more useful by being Patch-programmable.

**R**oland have long been one of the most thorough manufacturers when it comes to putting MIDI on their instruments, and the JX10 is no exception. MIDI parameters that are Patch-programmable allow Upper and Lower sections to each be given their own MIDI transmit channel (which needn't be the same as the receive channel) or set to no transmit, and to each send their own program change number (1-128) and MIDI volume level when a patch is selected – the last-mentioned can help to balance sounds on master and slave instruments. It's also possible to set a MIDI channel transmit splitpoint independently from the JX's own splitpoint(s), allowing for greater flexibility in creating sound textures.

A useful (and original) feature of the JX10 is the ability to assign a separate channel for Patch program changes as opposed to Tone program changes. Thus you can change Upper and Lower Tone memories independently of Patch memories, enabling you to associate

several Tones with each Patch. MIDI parameters that can be set on or off independently for Upper and Lower sections (but not for each Patch, unfortunately) are program change, aftertouch, pitch-bend, modulation, portamento, hold, volume and local. What's also a pity is that there's no option to control the two JX sounds independently (from a sequencer, say) when in Dual mode.

Time for conclusions, and they're not difficult to reach. The JX10 is a professional instrument of the first order which proudly joins the ranks of the megasynths. If you're looking for a master instrument, it's a role that the 10 fulfils admirably.

There are, of course, other worthwhile instruments vying for your attention which occupy the same price bracket as the 10. Known quantities are Yamaha's DX5 (with a recently reduced price tag) and Oberheim's Matrix 6, whilst as yet still something of an unknown quantity is Sequential's Prophet VS.

In these innovation-conscious (some would say novelty-conscious) times, it is tempting to ignore anything that doesn't offer the very latest in technological prowess. The JX10 is certainly familiar territory both sonically and in its range of programming possibilities, yet that needn't be a shortcoming. The latest JX makes damn good sounds, and in other respects it offers as much if not more than many other synths currently on the market. It's an extremely well-thought-out and flexible instrument that's above all responsive to musical needs both in the sounds that it makes and in the way that it allows you to organise those sounds internally and in conjunction with other MIDI instruments. Ignore it at your peril. ■

## DATA FILE

### Roland JX10 Polysynth

Keyboard 76-note, E-A, velocity and pressure sensitive

Voicing 12-voice polyphonic, 2 DCOs per voice; Whole, Split, and Dual modes

Memory 50 preset Tones, 50 user-programmable Tones; 64 Patch Memories

External Storage Memory Cartridge M64C stores 50 Tones, 64 Patch memories and 1600 notes of sequence data; M16C the same but 400 notes of sequence data

Display 32-character LED

Interfacing Stereo/Mono Outs for Upper and Lower; Total Mix output; MIDI In, Out, Thru; Hold Pedal; Control Assign Jack × 3; Headphones

Dimensions 1186(W) × 375(D) × 101(H) mm

Weight 14kg/30lb 14oz

Prices RRP JX10 £1899, PG800 £235, M16C cartridge £45, M64C £85, all prices include VAT

More from Roland UK, Great West Trading Estate, 983 Great West Road, Brentford, Middlesex TW8 9DN. ☎ 01-568 4578

# NOW THEY SPEAK THE

The introduction in 1983 of Yamaha PF Series pianos revolutionised the world of electronic pianos. Now the new PF80 and PF70 spin it around once again.

Identical to each other except for the number of keys\*, both models naturally offer the renowned acoustic feel of Yamaha weighted-action, velocity-sensitive keyboards. And,

as you might expect, the ten new preset sounds are the brilliantly life-like product of advanced FM digital programming. But these new PFs are more than mere electronic pianos.

They can also be used as MIDI Controller Keyboards offering a high degree of flexibility and expression via 16 programmable performance and MIDI functions. For instance, a user-definable split point, which allows the upper and lower



# LANGUAGE...

halves of the keyboard to transmit to different MIDI channels, thus providing individual control of two separate MIDI keyboards simultaneously.

Add to this features like the new 'acoustic-feel' incremental Soft and Sustain pedals, pitch transpose, built-in tremolo and chorus, 3-band EQ and integral stereo speakers, and you'll begin to see just why the PF80 and 70 are more than mere electronic pianos.

PF80 - 88 keys; PF70 - 76 keys



**YAMAHA**  
MUSICAL INSTRUMENTS

4/E BLETCHLEY, MILTON KEYNES, BUCKS, MK11JE  
Tel: 04202 24111 Ansaphone (0908) 649222

# At Last! A RAM & ROM Price Breakthrough

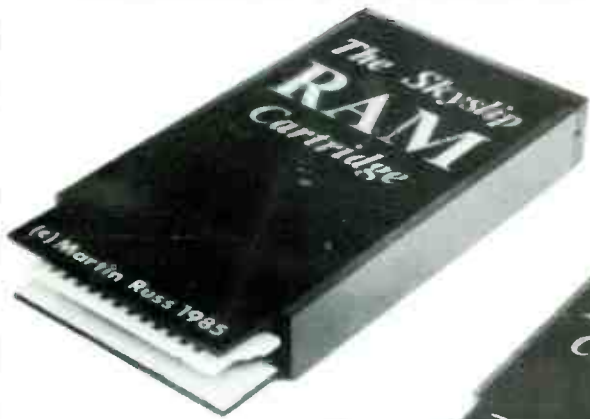

◀ The Skyslip RAM Cartridge is designed to provide two banks of 32 permanent memories. Simple bank switching and automatic write protection/memory protect switch are featured. An unlimited number of read/write cycles are possible. A 10 year battery provides stand-by power and can be replaced at the end of this period. Supplied as a RAM Cartridge which plugs into the DX7 Cartridge slot. No modifications are needed to the DX7. Full user instructions on its use are included. Cartridge £59.99

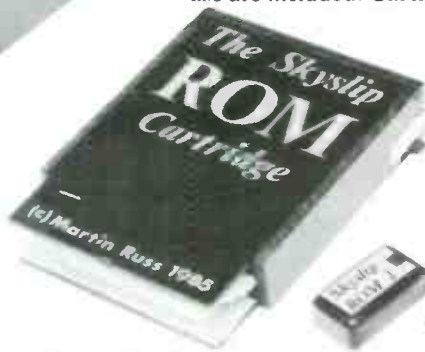

◀ The Skyslip ROM Cartridge system is designed to enable cost-effective voice libraries to be developed by users. Supplied as an EPROM Cartridge with a ZIF socket for ROM Modules, as well as comprehensive instructions. Cartridge £51.88

**NEW!** MIDI SWITCH



### SKYSLIP MIDI-SWITCH

A simple but effective passive switching unit for the small scale MIDI user. Three MIDI sockets (two of which are paired) can be used in two different configurations. Either One MIDI IN switchable to One of Two MIDI OUT's or One MIDI OUT which can receive data from One of Two MIDI IN's allowing for maximum flexibility. The unit is supplied in a small, sturdy case with full instructions. £28.50

MIDI Footswitch available soon.

◀ Add on banks 1/2/3/4/5 for ROM. A wide selection of sounds are available on these banks at £15.41 each

Skyslip products are available from:

MUSIC INN, Nottingham; AUDIO ENGINEERING, Dublin; HONKY TONK MUSIC, Southend; ROCK CITY, Newcastle; A1 MUSIC, Manchester; CARLSBRO SOUND CENTRES, Everywhere; LONDON ROCK SHOP, London; WHITE ELECTRIC, Sunderland; KINGFISHER MUSIC, Fleet; SOUND CONTROL, Glasgow & Edinburgh; GIGSOUNDS, London; BONNERS, Eastbourne, or contact:

## Skyslip Music

10 Mosley Street, Newcastle-upon-Tyne, NE1 1DE  
Telephone: 0632 324175

Trade enquiries welcome for UK and abroad

# MICROVOX LOOKS GOOD..... SOUNDS BETTER!



Professional digital sampling for under £250 - it sounds incredible, doesn't it! But then MICROVOX is rather special.

Connect MICROVOX up to a Commodore 64 or 128 computer and disk drive, and sample any sound you like, at one of 8 different sampling rates (maximum 42kHz 20kHz bandwidth). Use the waveform editor to change the sample then play it back at a different pitch (or backwards) using the computer keys, or any MIDI keyboard. Up to 16 voices can be held in memory and accessed by the 2000-note sequencer - but samples can also be stored on disk.

Just £229.95 buys the MICROVOX hardware and software (reckon on spending £500 if you don't already have the computer and disk). Input and output filters eliminate aliasing and quantization noise, whilst companding gives effective 10-bit resolution. A high quality digital delay is included as standard and the MICROVOX PRO upgrade package allows you to generate other special effects such as harmonizing, phasing and flanging. MICROVOX PRO also features auto-looping and velocity sensitivity!

We reckon that MICROVOX is the best sampler that you can buy under £1000. But don't just take our word for it: ELECTRONIC SOUNDMAKER said 'there's never been a better reason for owning a Commodore - COMMODORE HORIZONS said 'I'm going to buy one' and FEARGAL SHARKEY couldn't wait to get his hands on one!

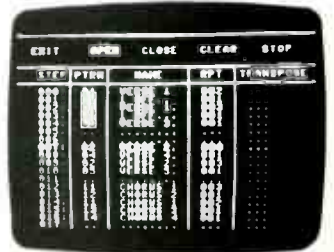
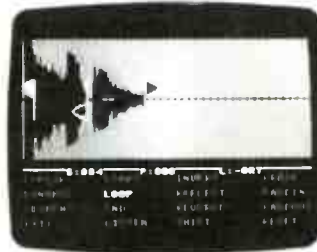

SUPERSOFT, WINCHESTER HOUSE, CANNING ROAD, WEALDSTONE, HARROW HA3 7SJ Tel: 01-861 1166

# E & M M MIDI THRU



**Fancy a MIDI Thru box but can't afford to buy one from an established manufacturer? Then build one yourself in an evening and save yourself a small fortune into the bargain.**

*Steve Hartwell*

To begin at the beginning, a MIDI Thru box takes one MIDI output, and splits it into a number of identical MIDI Outs, in this case six. A commercially available 'black box' designed for this purpose costs in the region of £40-£60, but the E&MM MIDI Thru will cost you about £3.50 – excluding the case and power supply. The question is – do you need it? Well, a MIDI Thru box is essential if you have equipment that lacks a built-in MIDI Thru, or if you want to avoid the signal delays and degradation inherent in using a chain of MIDI instruments.

The MIDI Thru's circuit is shown in Figure 1. The MIDI signal comes in through SK1, and is decoupled from the rest of the circuit by the opto-isolator (IC1). The use of opto-isolators is an essential part of the MIDI spec as it prevents earth loops, but it also results in signal degradation. To help overcome this, the MIDI signal is next sent through a Schmidt inverter (IC2), which 'squares up' the waveform. The signal now has to be inverted again (IC3) to make it into an exact replica of the signal applied to the input.

The circuit requires a stabilised 5V supply. This is obtained by using a commercial 9V supply and a Zener diode. Capacitor C2 is used to smooth out the ripple on the supply whilst C1 removes the high-frequency noise. Diode D3 is there to prevent the circuit being damaged if the power supply is connected the wrong way round. The circuit was tested using a Roland PSA220 and a Korg KAC360, though any nominal 9V supply (eg. Maplin YB23A) should work fine.

When it comes to construction, the veroboard layout is shown in Figure 2. Make all the wire links and breaks in the copper tracks first. If the circuit doesn't work, it's most likely to be a missing link that's at fault, so check carefully at this stage.

Next, insert the resistors and then the diodes and capacitors, making sure they're put in the right way round. The ICs should be inserted last, again taking care to insert them the right way round.

The socket required for the 9V supply will obviously depend on the power supply you use (the Korg and Roland models use 2.1mm power plugs). The socket I used connects the positive rail to the case which I had earthed through a metal DIN socket, thus shorting out the supply. I got round the problem by using plastic DIN sockets and leaving the case at 9V. If you can, it's better to use an insulated power socket and earth the case so as to provide greater noise immunity.

The MIDI Thru is intended to be used in any situation where you need to drive a number of MIDI instruments from just the one output. The most common situation will probably be one in which you're using a master keyboard or sequencer to drive a number of synths and/or expanders. The output of the master device is connected to the input of the MIDI Thru box, and all the slave devices are connected to the outputs of the Thru box.

Having saved a few quid on the MIDI Thru box you might just be able to afford the musical instruments to plug into it! ■

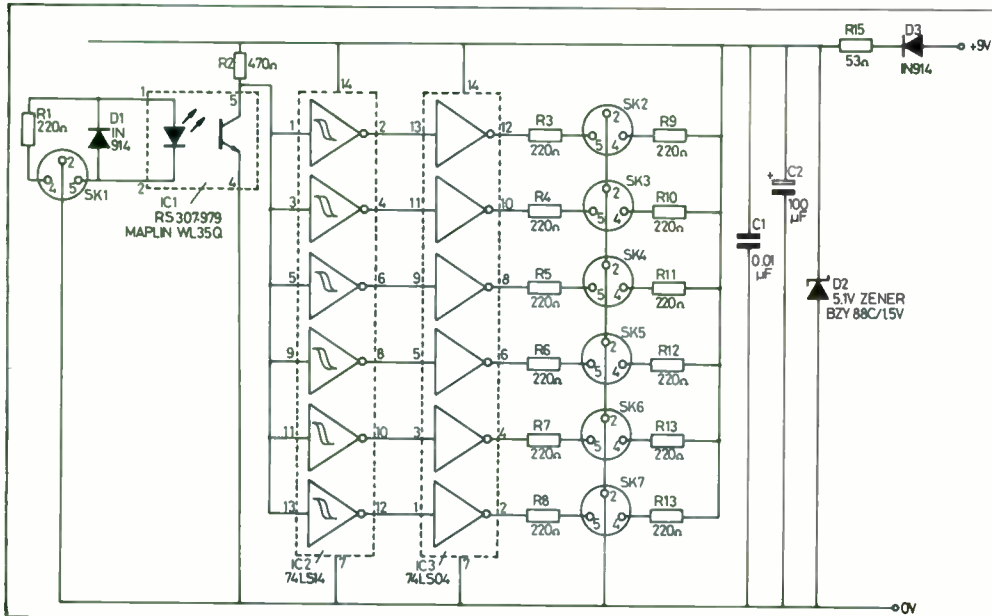

**Parts List**

R1, R3, R4, R5, R6, R7, R8, R9, R10, R11, R12, R13, R14

R2

R15

C1

C2

D1, D3

D2

IC1

IC2

IC3

7x five-pin DIN, 180° chassis mounting sockets

Power supply

Case

Power supply socket to suit

Veroboard, 16 rows by 32 holes

Figure 2.

# The REMARKABLE YAMAHA



Alan Parsons • Swanyard Studios • Island Studios  
 Tyne Tees TV • Nick Kershaw • Manor Mobile • Genesis •  
 Power Plant Studios • Battery Studios • Howard Jones.



220Ω 10% 1/8W

470Ω 10% 1/8W

53Ω 10% 1/2W

0.01μF polystyrene

100μF 25V electrolytic

1N914

BZY88C/5.1V

RS 307-979, Maplin WL35Q

74LS14

74LS04

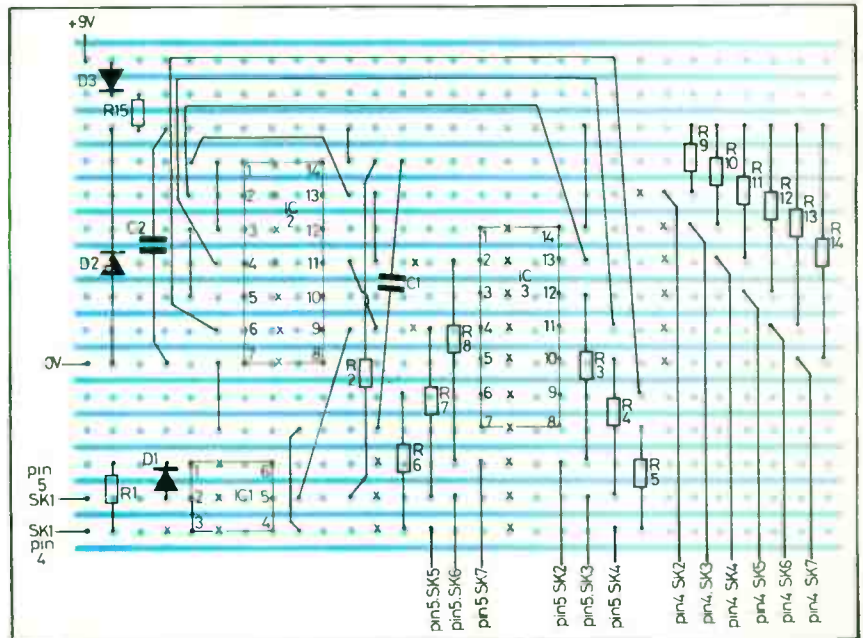

Figure 1.

# SPX90 & REV 7....



the  
professionals  
choice  
for

**WHAT  
HAVE ALL  
THESE GOT IN  
COMMON?**

**Call HHB on  
01961 3295  
to find out!**

HHB Hire & Sales, Unit F, New Crescent Works,  
Nicol Road, London NW10 9AX Tel. 01-961 3295 Telex 923393



# JUNCTION

Yamaha's MEP4 is the most comprehensive MIDI processor yet devised. Its black-box exterior conceals a wealth of facilities to manipulate MIDI data, but are they sufficiently easy to use to be worthwhile?

*Simon Trask*



**N**ow that expanders and mini-keyboard synths are entering into common usage, the role of a master instrument is becoming increasingly important, and increasingly demanding. Many synths are simply not well suited to fulfilling this role, and in a sense they shouldn't be expected to.

A dedicated controller keyboard is one way of solving this problem, a new-generation electronic piano is another, while a third is to interpose a MIDI 'black box' between your main instrument and the rest.

The last option is where Yamaha's new MEP4 comes in. There are similarities of front-panel operation and styling (including a 16-character backlit LCD, thank goodness) between this and Yamaha's other new signal-processor, the SPX90 (reviewed in last month's *E&MM*).

But that's about as far as those similarities go, because apart from the obvious difference that one processes audio data while the other manipulates MIDI data, the MEP4 is conceptually a far harder nut to crack than a unit like the SPX. And the 30 factory preset effects that Yamaha have thoughtfully included on the MEP4 (in a 60-voice RAM) may cause confusion to many, simply because the unit's effects demand that your MIDI instrument setup is configured appropriately, and that all your instruments are capable of transmitting and receiving the controller codes that some of these presets make use of.

When you disentangle the MEP4 from its

packaging, you discover an example book with program charts and system setups for all 30 presets, which is invaluable – though it doesn't suddenly make the MEP4 a breeze to use.

Fortunately, you don't have to plunge in at the deep end with the MEP4. At its most basic level, the machine acts as nothing more sophisticated than a simple five-way MIDI Thru box. This is achieved by pressing the Bypass button on the unit's front panel, thus sending the data on MIDI In straight to the four MIDI Outs on the back panel as well as to the Thru. So the MEP4 can start working for you as soon as you get it out of its box, which is no more than you should expect, after all.

Pretty soon, however, you'll be wondering why you paid £345 for a simple Thru box, and that's the time to start finding out what the MEP4 can really do for you.

Figure 1 shows the basic layout of the MEP4. Four independent processors receive data from the single MIDI In, and can send the results of their own operations to any one of four MIDI Outs; the Thru fulfils its normal role of passing on incoming data unchanged, which means you could, for instance, chain two MEP4s together. As well as directing the output of each processor to a separate Out, you can route up to four processors to one Out, allowing the creation of composite effects.

What you can't do is send the output of a particular processor to more than one MIDI Out, so if you want to layer an effect, you have to double the effect on two processors or daisy-chain your synths.

**B**ut what are these enigmatic processors? Figure 2 illustrates the components that go to make up each processor: remember there are four of these running in parallel, each with its own settings of the same parameters. Each processor can be switched on and off from dedicated front-panel buttons, which is a useful way of removing a particular instrument from the action, or of isolating part of a composite effect.

Starting at the left-hand end of the diagram, the Channel Filter allows you to assign a processor to any number of MIDI channels, from one up to the full 16. At the other end of the chain, the Output Assigner allows the result of the processor's actions to ▶

# DOUGIE'S

Music Store

5-7 CHESTER ROAD, NORTHWICH, CHESHIRE  
TELEPHONE 0696 782522  
OPEN 10-6, LATE NIGHT THURSDAYS

THE DEDICATED KEYBOARD CENTRES...



# FLASH STREET ELECTROMUSIC

(ABOVE JAMM STUDIOS)  
END OF GT. MOOR ST  
BOLTON, LANCs.  
TELEPHONE

0204 397893

## Roland

JX3P	A	£450
JX8P		£7
JX10		£7
ST10/50		£7
Alpha Juno I		£7
Alpha Juno II		£7
TR505		£7
TR707		£7
MC500		£7
Juno 6	A	£319
Juno 60	A	£550
Juno 106	X	£579
EP50	X	£499
EM101	X	£199
CR78	A	£150
SVC350	X	£399
MPU401		£99
Promars	B	£129
SH09	B	£129
SH101	A	£119
MKS20		£7
MKB1000/MKS10 & MKS30	X	£1500 the lot!

## KORG

Poly 800 II	X	£450
Poly 800 I	A	£350
Poly 61	B	£350
EPS1	X	£450
MKB Bs pedals		£199
SDD1		£7
DVP-1		£7
RK100 (red) boxed		£199
DW6000		£599
DW8000		£7
CX3 org	B	£250
SDD2000	X	£399
MS10		£89
KMT60 (midi bx)		£45
KPR77	A	£99
DDM110	A	£145
Vocoder	A	£250
PSS50	X	£250
GR1 reverb	X	£199
MR16	X	£250
Lambda		£345
Sigma	B	£150
700 mono	B	£99
700S mono	B	£129

## SEQUENTIAL

Prophet I	A	£199
Prophet 600	A	£699
Prophet 5.3	NEW	£1299
Prophet 2000	ALL	
Prophet VS	IN	
Prophet 2002	STOCK	
Prophet T-8	X	£1600
800 Seq	A	£99
E1B/Dr chip (drumtracks)		£39

## ensonia

Mirage Module  
Mirage Keyboard } IN STOCK  
ESP-1 Piano  
ESQ-1 Synth



Matrix 6	£7
Matrix 6R	£7

## AKAI

AX73	£7
S612	£7
ME10D	£99
ME15F	£99
ME30P	£99
ME20P	£99
S900	£7
CPZ1000	£7
MPX820	£7

## CASIO

SZ-1	} GOOD PRICES
RZ-1	
CZ101	
CZ3000	
CZ5000	
SK-1	

## AMPLIFICATION

Vox Venue	X	£299
Peavey KB100		£269
Peavey KB300		£7
Rhodes 100w 2x12 cabs		each £125

## OTHERS...

Fostex X15	£245
Fostex 260	£699
Fostex 80	£7
Fostex 450	£499
Accessit Range	
ARP Prod GX	£99
ARP Solus	£199
Moog Source	£199
JEN SX1000	£50
Crum Perf	£199
Hohner Duo	£199
Wurlly E/Pno	£345
Oct Kitten	£89
Dynacord P16	£299
Dynacord MCC1	£199
Alesis Midiverb	£379
Shadow Midi Gtr system	£7
STEINBERG..STEINBERG Pro 16 (disc or Eprom)	
TNS Scorer CZ/Mirage EdiotS	
ALL IN STOCK & WORKING!!!	

ABBREVIATION CODE  
A - AS NEW, 12 MONTHS GUARANTEED  
B - GOOD SECONDHAND CONDITION AND 6 MONTHS GUARANTEED  
C - WELL USED BUT WORKING WELL (JUST LIKE CHANGES) GUARANTEED BY MUTUAL ARRANGEMENT  
? - YOU'LL HAVE TO FIND THE PRICE OUT FOR YOURSELF!  
X - EXHIBITION CONDITION AS SEEN AND 12 MONTHS GUARANTEED  
B&D - STILL IN UNOPENED CARTON I.E. BETTER THAN NEW  
NO ABBREV - BRAND SPANNING NEW



WANTED INP/EX DEALS: COMM 64S, SCI SIXTRACKS, MOOG PRODIGYS, ARP SYNTHS, ROLAND JUNOS ETC, ANY SECONDHAND K/BDS IN GOOD CONDITION - PHONE DOUGIE ON 0696 782522. ACCESS/VISA/AMEX/DINERS. PS HOW COME THAT WHEN A NEW DRUMMER COMES TO DOUGIES THEY'RE AMAZED BY THE SIZE OF THE KEYBOARD STOCK? DOESN'T ANY OTHER STORE HAVE SUCH A GOOD SELECTION?

# MIDI-LINK

making MIDI manageable

Are you struggling to make MIDI quick and easy to use? Are you getting tired of reaching round the back of your synths to re-plug DIN cables every time you want to reconfigure your system? If so, then one of the Quark MIDI-LINKS is for you. Via thumbwheel switches, the 999 allows up to 9 controllers to address up to 9 slaves (independently or simultaneously) on 9 separate busses. Alternatively, there is the MIDI-LINK 448, which using rotary switches allows 4 controllers to address 8 slaves on 4 busses. Ideal for the smaller MIDI system in both flexibility and price. Available from most leading music stores

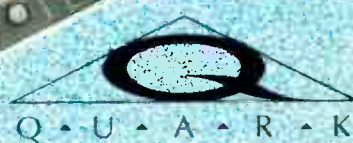

Quark Ltd., 16-24 Brewery Road, London N7 9NH. Telephone: 01-609 8282

▷ be sent on any single MIDI channel, and/or offset from its current channel number by a constant amount, and then sent to any one of the four MIDI Outs.

It's worth bearing in mind that the MEP transmits its processed MIDI data on a maximum of four MIDI channels; should you require further channel capacity (which you may well do if you're using multi-timbral synths or samplers), you'll need a second MEP4 connected via the Thru.

The Data Presetter allows you to select a patch number, pitch-bend value and two controller-code values, which are all sent on the selected MIDI channel whenever a new MEP4 program is called up. Thus, you can trigger up to four different patch numbers, on any channels, for every incoming patch number. This is the same facility offered by

**Presentation "When you disentangle the MEP4 from its packaging, you discover program charts and system setups for all 30 presets — which are invaluable."**

Dynacord's MCC1, but with the added advantage that MEP4 memories don't have to be aligned with specific patches — more on this later.

The pitch-wheel setting is perhaps most useful for zeroing the effect of the wheel, while Yamaha's examples commonly use the two controller codes for zeroing the modulation wheel and setting the volume pedal to maximum. Resetting controllers is a

program is selected or a processor is turned on or off.

All of which should ensure you don't get droning notes at any time when using the MEP4 — a reassuring thought.

The Message Filter allows you to filter out any of nine categories of MIDI message from the data stream. These are: note-off, note-on, polyphonic aftertouch, control changes, program changes, channel aftertouch, pitch-bend, channel mode messages and system messages. Aside from choosing which data goes to which slave instruments during performance, you can also use this section as a means of removing unwanted data (say, pitch-bend data) from a sequencer track.

The Delay Processor allows you to delay transmission of all MIDI data passing through it for up to three seconds, selectable in millisecond increments. Like Akai's ME10D MIDI Digital Delay (reviewed E&MM November '85), this is only a single delay. But unlike the Akai, the MEP4 allows you to group all four processors together for a single four-note delay — still within the three-second limit. This makes the delay quite flexible, but the MEP4's routing limitations mean you can't send the composite effect to more than one MIDI Out. Pity.

I've left till last what is probably the most flexible and currently unique aspect of the MEP4: the Data Modifier. Unfortunately, this is also the section in which you come most intimately into contact with actual MIDI data, so you really need to know about MIDI if you're not to get lost.

With the Data Modifier, you can alter any MIDI messages (one per processor) apart from channel mode and system messages, in up to four ways. 'Altering' can mean anything from changing a particular value to changing the entire message. And you can convert messages which have specific data values, so that one particular note, for instance, can be used to trigger any result the MEP4 is capable of creating.

There are six ways in which you can modify a message (and remember you can combine them in up to four steps): Expand, Step, Offset, Reverse, Limit and Convert. The first five of these modify data bytes only; Convert is the one that allows you to change a message completely.

Expand allows you to multiply a data value by any value from 1/16 to 16. This could be a useful way of, say, altering the velocity range of notes on a particular channel.

Step allows you to filter particular messages whose data byte isn't a multiple of a specified value, which could come in handy for cutting down on data generated by continuous controllers.

Offset allows you to add a fixed value (–127 to +127) to any data byte. The most obvious use for this is to create parallel octave, fifth or fourth effects — though any interval is possible.

Reverse allows you to reverse MIDI data for any specified message around a selected fixed middle-point. You could use this, for ▷

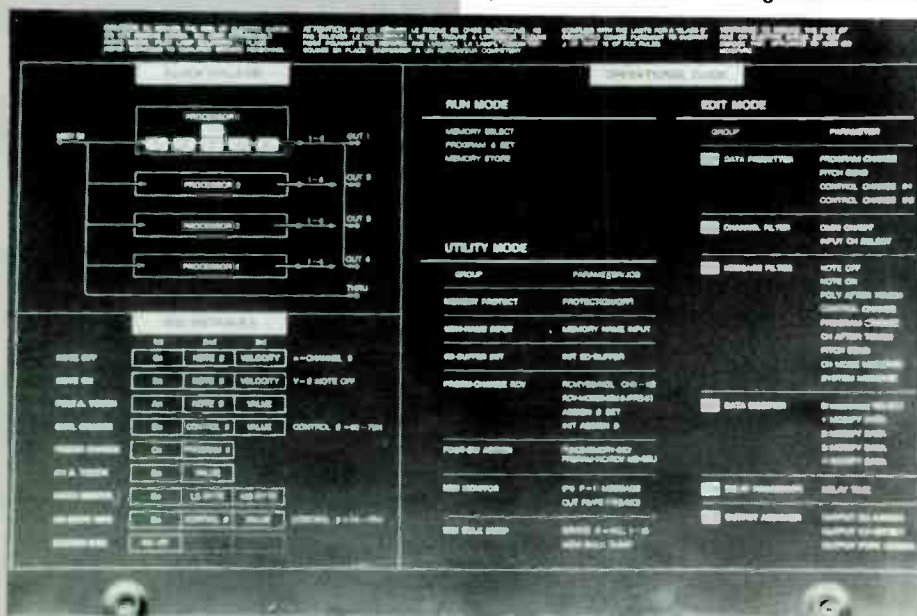

useful task, and it's a pity Yamaha haven't allowed for a few more of these codes to be transmitted.

However, what is useful is that the MEP4 transmits sustain pedal-off messages together with note-off messages for all notes currently active, in a healthy variety of circumstances including whenever a new

**ensoniq MIRAGE II**

Using the latest in digital technology, the Mirage lets you play real instrument sounds, either from Ensoniq Sound Library Diskettes or sounds you've created yourself. The Mirage also features 37 playback parameters to give you a wide range of control over the envelopes, filters, modulation, tuning and keyboard effects. To fully utilize its performance, studio and sampling features, the Mirage offers a full range of MIDI functions, including after touch and breath control from external MIDI controllers.



£1320

**ensoniq MIRAGE**

The Mirage digital multi-sampler has all of the performance and sampling features of the Mirage digital sampling keyboard - without the keyboard. It's a complete polyphonic eight voice instrument with a musical range of 5 octaves. Includes a disc formatter, advanced sample guide.



£1080

**ensoniq ESQ 1**

The ESQ-1 is an 8-voice polyphonic, polytimbral synth with a rich and full sound that can only be accomplished with 3 oscillators per voice. There is a choice of 32 multi-sampled and synthetic waveforms for a nearly unlimited variety of sounds and effects. Included are sampled waveforms of piano, strings and brass instruments - creating a synth unlike any other in character and realism.



£1080

**The Ensoniq Piano**

The Ensoniq Piano... to say it sounds grand is only the beginning. It uses multi-sampled grand piano waveforms to produce the first completely accurate piano sound from an electronic instrument. In addition to grand piano, there are digitally sampled electric piano, mamba, electric bass and upright bass waveforms in the Piano's memory. Acoustic piano variations include bright and mellow timbres, as well as honky tonk piano. There are also bright and mellow electric piano variations, plus two mamba sounds, vibes, percussion and mallet - 12 completely real sounds available at the push of a button.



£1080

**AKAI S900 MIDI DIGITAL SAMPLER**

Eight voice polyphonic digital sampler. Using 12 bit linear technology, the S900 comes complete with a 3.5" disc drive fitting into a 19" 3U rack mount. 8 voice polyphonic and 8 individual line outs, 6 octave range. 750K memory giving 12 seconds of 40Khz sampling rate.



Our price £1599

**AKAI ME30P MIDI** programmable patch bay **£99**  
**AKAI ME25S MIDI** programmable note separator **£99**

**TECHNICS PX1 DIGITAL PIANO**  
 A versatile and superb sounding new instrument that has to be heard to be believed **£3599**

**ALESIS MIDIVERB**  
 SUPERB STEREO DIGITAL REVERB FOR ONLY **£395**

**CASIO KEYBOARDS -**  
 Ideal for MIDI sequence set-ups  
 4 separate mono voices simultaneously!

● Keyboard/49 keys (5 octaves)	● Sound Source: PD (Phase Distortion) sound source system	● Voices: 8 (using 1 DCO) or 4 (using 2 DCOs)	● Tone Memories (Presets): bank of 16 (presets)	● Tone Memories (Programmable): bank of 16 (internal)	● External Memories (RAM Cartridge): bank of 16 (cartridge option)	● Compare Arise: 1 (compare/recall)	● Programmer Section: preset, internal, cartridge, compare/recall, tone select 1-16.	RRP	OUR PRICE
CZ1000	£499							£399	£399
CZ101	£399							£399	£295

**ALWAYS IN STOCK AND AT THE BEST PRICES:**  
**YAMAHA** - DX100, DX27, DX21, DX7, QX21, Sequencer, TX7 Expander, PF70X, PF80 pianos, RX21, RX21 Latin. RX15, RX11  
**CASIO** - SZ-1 sequencer, CZ3000, CZ5000  
**KORG** - SQD1 sequencer, DW8000, EX8000 expander  
**AKAI** - S612 digital sampler + disc drive **£799 complete**  
**SEQUENTIAL** - Prophet 2000, 2002 Expander, Prophet VS

**CASIO RZ-1 DIGITAL SAMPLING RHYTHM COMPOSER**



This striking unit boasts 100 pattern memories, 20 song memories, individual outputs and volume controls, and MIDI in, out and thru. Twelve powerful PCM preset sounds are available with programmable accent and mute functions. Auto-compensate allows the user to correct patterns from 1/2 beat per bar to 1/96 per bar - And if that isn't enough, four sample memories are provided, each with a sample time of 200 ms. All four can be chained together to provide one sample memory of 800 ms or paired off to give two sample memories of 400 ms each. Tape dump is provided not only for patterns and song memories, but also for samples and those samples can be input via the rear panel mic/line socket at a sampling rate of 20KHz. A back-lit LCD, together with easy to read front panel graphics complete what is surely the most expressive drum unit to be seen on the market for some time.

RRP £399

**YAMAHA MT1X 4 TRACK RECORDER/MIXER**



The MT1X combines a four-track cassette recording mechanism with a full-function 4-channel mixer. The mixer section includes tape-mic/line input selectors on each channel, level adjustment for mic and line input, auxiliary send and master return inputs for effects processing, and a separate monitor section with level and pan controls for each track. Simultaneous 4 track record facility!

£449 RRP

RRP £599

**YAMAHA SPX-90 DIGITAL MULTI-EFFECTS PROCESSOR**



The SPX90 has an exciting range of 30 ROM preset effects, each with as many as 9 controllable parameters to choose from. The built-in RAM memory capability lets you store up to 60 personalized effects with your original title for easy recall. For stunningly close-to-natural vibrance and warmth the programs include full Reverb, Early Reflections and Delay/Echo effects capabilities, and for fine tonal tailoring there is even a digital Parametric Equalization program. Modulation effects like Chorus and Stereo Flange, for example, provide, fuller sound. Special effects include Freeze (known as sampling), Pitch Change, Gate Reverb, ADR Noise Gate, and Auto Pan. MIDI compatibility is now standard equipment for the latest effects processors. Thus, the SPX90 will not only accept program changes. Some programs like Freeze and Gate Reverb can also be triggered via MIDI. Another great feature lets you control pitch changes from a MIDI keyboard.

£200-£2000 NO DEPOSIT, INTEREST FREE CREDIT (0% APR) AVAILABLE ON MOST ITEMS - RING FOR DETAILS  
 ★ ALL TRANSACTIONS CAN BE CONDUCTED OVER THE TELEPHONE

● MAIL ORDER - ACCESS, BARCLAYCARD, VISA, AMEX, DINERS. Sales can be conducted over the 'phone. Bank drafts, Building Society cheques and postal orders will take 5 working days to clear before

goods can be sent.  
 ● FULL 12 months parts and labour warranty - DELIVERY (Securicor). £12 for any number of items  
 ● All prices include VAT (overseas buyers exempt)

**DX OWNERS CLUB** - members enjoy additional discount, plus many other benefits.  
 Ring for details. (Please quote your membership number on all correspondence).

**BONNERS**

12A GROVE ROAD, EASTBOURNE, EAST SUSSEX  
 ☎ 0323 639335/645775 - (CLOSED WED PM)

Figure 1.

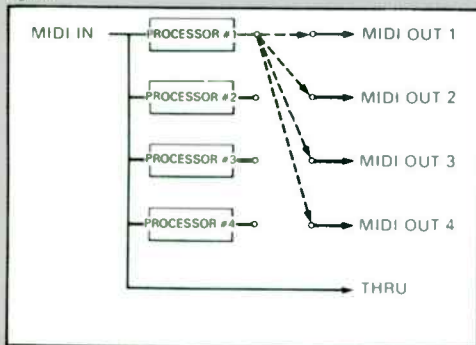

Each Processor looks like this inside

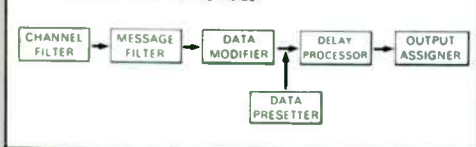

Figure 2.

▷ instance, to crossfade between two instruments (which would require more than one processor), or to create reverse keyboard effects *à la* Zawinul Prophet 5.

Limit is where you get to set up four-way splits. For each processor you can define an upper and a lower limit, which gives you the sort of flexibility otherwise only found on Oberheim machinery. It's worth bearing in mind that such a composite effect doesn't allow you to create any other effects, as each processor's Data Modifier can only process one MIDI message at a time.

Convert, as mentioned earlier, allows you to change one message into another. For instance, channel aftertouch can become volume or pitch-bend data; a sustain pedal-on message can become a note-on instruction to trigger a bass drum on a MIDI drum machine; data ± keys can be used to trigger keyboard octave-shifts (by sending minimum or maximum pitch-bend values); and a specific note-on or velocity value can be used to trigger any effect—options which introduce an interesting pseudo-random procedure.

It's a pity, though, that you can't convert to System messages such as start, stop and continue or song-select, for remote control of sequences from any MIDI code.

Being able to specify up to four operations (a Convert function must always come last) allows for even more sophisticated possibilities, while you can always send the same data to two processors, treat it differently, and send the results out of just a single MIDI Out.

I'll repeat the warning, though: you really do need to know your MIDI codes (in hexadecimal, too) if you're not to get hopelessly lost in this area of the MEP4. Even then, it can require some effort to think through exactly what's happening, or what you might be able to do.

But what's so sensible about the MEP4 is that you can use it in a modular fashion, utilising all its other capabilities and only approaching the Data Modifier section when you feel ready for it.

Maybe Yamaha should have included a quick way of switching each section in and out for the currently-selected processor. That would have allowed you to isolate particular sections while trying to find out why that reverse keyboard effect with multiple delays is causing your keyboards to give a convincing interpretation of Mount Vesuvius erupting.

One facility which may help you diagnose such drastic errors is the MIDI monitor, which allows you to see the output of any processor and any of the four MIDI Outs. As the user manual honestly points out, it's feasible that you could overload the MIDI bus by sending multiple continuous controller data over a single MIDI Out—in which case the MEP4 will dutifully cry on your shoulder and inform you of its problems.

**A**ll the above settings are storable in 60 programs, each of which can be given its

own nine-character name. Given the variety of uses you can put the MEP4 to, I wonder if even this many will be enough.

You can assign program-selection to any one of the 16 MIDI channels, which is obviously necessary when running the MEP4 from a sequencer or an instrument with multi-channel sending of data. You can also dedicate a particular track on a sequencer to selecting MEP4 programs, thus making patch-changing independent of any particular instrument part.

For maximum flexibility, any MEP4 program can be assigned to any incoming MIDI program number from 1-128, with settings being stored in a program assignment table. There's also a footswitch input for stepping through programs—as they are either in memory or in the program assignment table.

Yamaha have given the MEP4 the ability to send and receive parameter data for all 60 programs over MIDI, which is obviously useful for transferring data between two MEP4s. The other possibility lies in storing the MEP4's programs via computer, but that of course needs someone to come up with the right software for the right computer (ie. your one). Still, Yamaha have provided a clearly laid-out data chart on which you can inscribe your most profound data-manipulation thoughts.

All in all, the MEP4 gives you a MIDI Thru junction box, a multiple patch-selector box, a fine set of sound layering and splitting abilities, the most comprehensive MIDI delay line currently available, a MIDI data filter, channeliser and re-router, and a MIDI data manipulator that gives you so many options, it'll be a long time before you work through all its practical applications.

At the same time, the unit's ability to create seemingly unpredictable (though ultimately understandable) effects is another of its attractions—though maybe you need to be a bit perverse to appreciate that.

Front-panel operation of the MEP4 is extremely straightforward (helped by the informative display), and allows you to find your way around all the parameters with the minimum of fuss. The only annoyance is the Yamaha's inability to send each processor's output to any, rather than one, of its MIDI Outs.

If you're prepared to make the not inconsiderable effort to become conversant with the MEP4, you will not be disappointed. It's the most flexible and powerful MIDI signal processor currently available, and as such, will allow you to manipulate your keyboard setup in ways you'd never thought possible. Who said technology gets in the way of creativity? ■

Price RRP £345 including VAT  
More from Yamaha-Kemble, Mount  
Avenue, Bletchley, Milton Keynes, Bucks  
MK1 1JE. ☎ (0908) 71771

# LOGITECH PRESENT...

## CSDD1 – Controlled Sampler & Digital Delay

- ★ 64K byte memory
- ★ Sample/delay up to 4 seconds
- ★ Full audio bandwidth (16KHz)
- ★ 1 Volt/octave Control Voltage
- ★ Overdubbing facilities
- ★ Internal/external/manual triggers

**ONLY £289**

Only available from LOGITECH  
Send cheque or PO for £289 (inc VAT & P&P)

## STAGE MATE – Remote FM Link

- ★ Tune in on any standard VHF FM tuner
- ★ Use for live work, rehearsals or busking
- ★ Matched for any guitar pick-up/microphone
- ★ Avoid that wiring/cable laying/leads

Not licensable in the UK

**ONLY £35**

Only available from LOGITECH  
Send cheque or PO for £35 (inc VAT and P&P)  
Phone LOGITECH on 01-794 5441  
for further information or write to:  
**Logitech, 310 Finchley Road, London NW3 7AG**



## AT LAST... A MIDI INTERFACE FOR THE AMSTRAD CPC RANGE OF COMPUTERS

The **DHCP Electronics MIDI Interface** offers an inexpensive way of controlling **MIDI** instruments from the **Amstrad CPC** range of computers.

The **interface** is contained in a black-finished metal case which plugs into the **Amstrad user-port**, and has a through connector for other peripherals. **MIDI** connections for **IN**, **OUT**, and **THROUGH** are by standard **Din** sockets. Connection and implementation instructions are supplied with each unit.

The initial software package concentrates on the **Casio CZ Synthesisers** and features:

- ★ Menu-driven Software ★ Full-screen Voice Monitor
- ★ Comprehensive Voice Editor ★ Voice Library Editor (32 voice)
- ★ Single-key Entry ★ Graphic Waveforms ★ Store Voices to Disc/Tape.

Cost of **MIDI interface** £50.00 inc VAT & P&P  
**CZ Editor Package**

£25.00 disc version – £15.00 cassette version  
inc VAT & P&P

Pre-programmed libraries of 32 voices £15.00  
each inc VAT & P&P

Leads can be supplied to order – prices on request

**Real-time** and **step-time** sequencer packages are planned for release in coming weeks.

Further packages for **Korg** and **Yamaha** synthesisers are also planned. Any requests for additional software or information are welcome.



AVAILABLE ONLY FROM DHCP ELECTRONICS SEND CHEQUE OR PO TO:  
**DHCP ELECTRONICS**

32 Boyton Close, Haverhill, Suffolk CB9 0DZ  
Tel: 0440 61207

**DEALERS ENQUIRIES WELCOME**

## YAMAHA MTIX

Amazing new 4 track  
portastudio

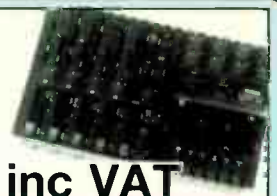

**ONLY £498 inc VAT**

### THE NEW FULLY TUNEABLE SCINTILLATOR

Once experienced this superb sound enhancement system is impossible to live without. In fact we are so confident that you will agree, we're offering a money back guarantee. What have you got to lose?

**ONLY £199 PLUS VAT**

#### A SMALL SELECTION FROM OUR CURRENT STOCKS:

Boss SBX 10 Sync Box	£259
Vesta KOZ0 MIDI 1	£114
MTR DNG1 Noise Gate	£237
Yamaha SPX90 Multi Effect Processor	£529
RSD Series II desks	£88
DeltaLab full bandwidth digital delays	£139
Alesis Midiverb	£342
Aphex Studio Dominator	£342
Accessit Autoplanner	£88
Fostex 260 Multitracker	£607
Casio RZ1	£344
Alesis XTC 16K bandwidth reverb	£607
Roland TR505	£194
Vesta Fire MR10 multitracker	£285
MTR 2 series mixers	£88
Yamaha stereo compressor/limiter	£199
Sony PCM501 digital mastering, in stock	£425
32 way patchbays only	£35
Vestafire 1 sec digital delay (full bandwidth)	£180
Bokse US8 Synchronizer	£395
Cutec 2x10 graphic EQ	£75
Qu-Play – programmable remote for B16	£299
Qu Play programmable remote for A80	£169

PLUS  
RSD, YAMAHA, DIGITECH, ART, DYNAMIX, MTR, VESTAFIRE, CUTEC,  
ACCESSIT, APHEX, SYMMETRIX, BEYER, FOSTEX, ROLAND, CASIO, REVOX,  
TANNOY . . . AND MUCH MUCH MORE

**RING NOW FOR DETAILS**  
(\*All prices exclude VAT)

### SECONDHAND & EX-DEMO BARGAINS

<b>RECORDING EQUIPMENT</b>	
Drawmer Noise Gate	£250
Seck 18>8>2	£925
Tascam Model 44 prof. 4 track	£1400
Eventide Harmonizer	£750
Tascam 34 4 track	£600
ACES 24 track with autolocate, Hi tech	£9000
Slapback Scintillator	£165
Sennheiser 421 mic	£99
Casio CZ5000 Great sounds & massive sequencer	£600
RSD 16>8 desk	£699
Aces 18:16 desk, slightly scratched	£1050
Alesis XTC Digital Reverb	£525
Digitec 2 second delay – full bandwidth	£189
MXR 01A digital reverb, latest software, immaculate	£799
Rev 7	£850
Symetrix 511 single ended noise reduction	£450
Bel BD80 sampler/delay – full triggering facilities	£475
Yamaha DX7	£899
Gibson Les Paul anniversary, mint	£449
RSD 16–16–2, mint	£1199
MXR headphone amps	£10
Yamaha Compressor/Limiter	£169
Loads of S/H mics & stands	£88
Bel BD320	£725
Fostex A80 8 track only 3 weeks old, immaculate	£1275
QuPlay (for B16)	£199
Tannoy DTM8s	£299
Ram RM10 Mixer (ideal for Fostex A8)	£475

(\*All prices exclude VAT)

### We also Stock Cassettes – Ring For Prices

Do you find that your recordings sound great on site but lousy when played on another system? I will spectrum analyse the control room (or bedroom!) and insert a graphic equaliser in the monitor system. The difference will astound you. Your tapes can sound great anywhere – not just in the control room!

Prices from £99 + VAT (inc stereo 10 band graphic)  
Demonstration cassette available

If you're thinking of starting a commercial 8 or 16 track studio give me a ring – At Thatched Cottage I proved it *could* be done. In the last 3 months I have helped 9 new studios open and start making money – my experience could help you. – RING NOW!

NEW 24 track studio now fully operational – only £13.00 per hour. Why not bring along your multitrack and use the studio as a mixdown suite (We offer more outboard gear than any other UK studio).



# Thatched Cottage Audio

Telephone Dave on

**Bedford (0234) 771166/771259**

**Thatched Cottage Audio,  
Cross End, Thurleigh, Beds.**

CREDIT FACILITIES NOW AVAILABLE

# GETTING THE MOST FROM... **MONO MODE**

## *Part 1: The Casio CZ Series*

Casio CZ polysynths are the affordable face of digital synthesis, and boast features none of the competition can match. One of these is an innovative use of MIDI Mode 4, which allows the CZs to act as up to eight independent monophonic synths. Here's the first of an occasional series of features which shows you how to exploit such facilities to the full. *Paul Wiffen*



The Casio CZ101 and its big brother, the CZ1000: different-size keyboards but exactly the same innards.

**I**f, as the owner of a Casio CZ synthesiser, you rushed out and bought the SZ1 sequencer as soon as it was

available, then you'll already have been able to benefit from the multi-timbral capability of your synth. Because the SZ1 sneakily accesses the CZs in MIDI Mode 4 without telling you too much about what's going on, you may well have been happily making the most of Mono Mode without even having heard of it.

First, let's take a brief look at the ►



various MIDI Modes available. In the 1.0 MIDI spec, the four possible Modes are referred to in **two** different ways: very simply, as Modes 1, 2, 3 and 4, and then more expansively, as combinations of Omni, Poly and Mono Modes.

As the Poly configuration is not used in Mode 4, we'll get that over with first. A synthesiser in Poly Mode transmits and receives MIDI data on only one of the 16 available channels, unless Omni Mode is also switched on (in which case it'll bravely try to play all incoming data).

Omni Mode only affects the receive status of the instrument in question, and causes it to 'look at' all 16 MIDI channels at once.

In Mono Mode, the synthesiser assigns different voices to different MIDI channels and, provided Omni is switched off, actually divides all the machine's voice channels into separate instruments. MIDI Mode 4 is defined as 'Mono on, Omni off' – the situation I've just described.

So, when a CZ synth is switched to Mode 4, you can happily use a MIDI sequencer to get four (or eight, with the 3000 and 5000) monophonic lines running each with its separate sound program. This is referred to as 'multi-timbral' operation.

Suprisingly few synthesisers offer this facility, even though it's now over three years since the first machine to offer this capability appeared. That instrument was the Rhodes Chroma, and its multi-timbral capability was only available if you used the Chroma-to-Apple II interface.

A year later, Sequential made this facility a prime feature of their Traks system synths, with the entire family of SixTrak, Max and MultiTrak offering it as standard. They've continued this tradition on the Prophet 2000/2002 samplers, with 16 different sounds (the theoretical limit of one MIDI In Socket) all now available simultaneously.

Finally, one of the many innovative aspects of the Oberheim Xpander and Matrix 12 synths was their ability to act as six (or 12) individual voices, using the various different methods of synthesis available independently on each.

But multi-timbrality is still the exception, not the rule. And at Casio's end of the market, they're still the only people getting to grips with it.

If you're using the SZ1 sequencer, Casio provide you with all the details you need to get the most out of the combination. But if you're the proud owner of a sequencer made by another manufacturer, then the information

you need may well be harder to come by.

Before tackling the channel assignment on the sequencer you're using, you need to put the CZ into the correct Mode – Mode 4. Now, the Casio synths don't implement Omni Mode, so we don't need to worry about this. All that's required is to put the CZ into Mono Mode. This is achieved by pushing the two buttons marked Solo (in the Mono area of the Programmer section) and MIDI, in either order. Make sure the LED above 'Solo' is lit. When you've done this, the LCD should be showing:

---

M I D I C H = 0 1 , V 0 = 0 1  
P R O G C H A N G E = E N A

---

unless you've already accessed this Mode since you switched the instrument on.

**T**he CZ is now in Mode 4. The programmer section should be showing the timbre number selected for the first of the four multi-timbral voices (V0=01), MIDI program-changes are enabled and the MIDI base channel is 1, which means that voice 1 is ready to receive on channel 1. The other three voices will be looking at the next three channels up ie. voice 2 assigned to channel 2, voice 3 to channel 3, and voice 4 to channel 4. If we change the base channel number then all the assignments will move up. For example, if you use the Value  $\Delta$  switch to change the base channel number (the cursor should already be under the number for M I D I C H =), then you'll see the number for the voice channel (V0=) stepping up each time you increase the base channel.

If you now move the cursor to the voice number (press the  $\triangleright$  button once so that the cursor is under the V0= number) and then use the  $\Delta$  button repeatedly, you'll see that the display steps up through the next three channel numbers, above the figure shown by the M I D I C H = display. So by using the  $\Delta$  and  $\nabla$  buttons when the cursor is below the V0= number, you can always check exactly which four MIDI channels the CZ is looking at. To change the base channel, use the  $\triangleleft$  button to put the cursor back under the M I D I C H = number.

When you're stepping through the V0= numbers, the LEDs in the Programmer section show which patch

is assigned to which voice. Now, you won't discover this when you access Mono Mode for the first time after power-up, as all four voices will be set to factory preset 1. Try changing the timbres on the programmer section in between changing the V0= numbers. As you step back down, you'll see the LEDs on the programmer changing to show the different timbres assigned to each MIDI channel.

And if you play the keyboard, you'll find that not only can you hear the sound assigned to the MIDI channel shown next to V0=, but that if you attach another MIDI device, the CZ is transmitting on that particular channel, program changes, bend wheel and all!

Stepping up and down, then, not only changes the sound which can be played from the keyboard, but also the MIDI channel the CZ is sending on. And should you change the channel while you're holding down a note (thereby 'losing' a note-off command on that channel and causing a drone), the synth automatically transmits an all-notes-off command as you alter the channel number.

We can now select the various timbres we want to use in two different ways: either on the machine itself, or remotely via MIDI. The former we have already looked at – you simply step up to the appropriate MIDI channel number and then set the sound for that channel, listening to your choices via the keyboard as you go. But if you change timbre whilst recording with a MIDI sequencer, you can record a MIDI patch-change instruction on the sequencer track which is controlling that channel. Do this for all the MIDI channels you're using, and when the time comes to replay the sequence (on stage, for example), all you need do on the CZ is set the appropriate MIDI channels, and the MIDI data sent through will do the rest.

What this means is that with a 'passive' MIDI sequencer (ie. one that simply records incoming MIDI data as it comes, without re-assigning channels or filtering out program-changes and pitch-bend data), you can make all the necessary set-up changes on the CZ itself. By simply switching between the V0= numbers, you can be sure that everything is being recorded exactly as you want to hear it. And when you start overdubbing the second, third and fourth parts, you'll hear the previously recorded parts played back. Several sequencers of this type are available, notably the Roland MSQ range and  $\blacktriangleright$

► Yamaha's QX7 and QX21.

If you have a sequencer which obliges you to specify MIDI channels on the unit itself, you'll have to be careful to make sure that the channels you've set on the CZ match those on the sequencer. Similarly, take care that numbers correspond if you have to enter the required program-change as a number for each track because your sequencer won't record them direct from the CZ. This is not as simple as it might sound, as MIDI program-change numbers actually start from 0. Table 1 shows a chart to help sort things out. This should help you ensure that you get the sounds you want from each particular channel.

Deciding which sounds you actually use is really up to you, and a bit beyond

the scope of this piece, but a typical set-up on a CZ101 might be:

MIDI channel	Timbre	Number
04	Bass Line	8
05	Percussion	16
06	String Line	4
07	Trumpet	2

**S**etting this up from scratch (ie. CZ power-up) entails following this procedure (the instructions in brackets are for those whose sequencer does not record incoming MIDI channel data and/or program changes):  
 Press Solo switch  
 Press MIDI switch  
 Press  $\Delta$  switch 3 times

Set sequencer track 1 ready to record (Set MIDI channel 4)  
 Select Preset 8 on programmer (Enter MIDI program change 07)  
 Record Bass Line  
 Press  $\triangleright$  switch  
 Press  $\Delta$  switch  
 Set sequencer track 2 ready to record (Set MIDI channel 5)  
 Select Preset 16 on programmer (Enter MIDI program-change 15)  
 Record Percussion part  
 Press  $\Delta$  switch  
 Set sequencer track 3 ready to record (Set MIDI channel 6)  
 Select Preset 4 on programmer (Enter MIDI program-change 03)  
 Record String line  
 Press  $\Delta$  switch  
 Set sequencer track 4 ready to record (Set MIDI channel 7)  
 Select Preset 2 on programmer (Enter MIDI program change 01)  
 Record Trumpet part

On the CZ3000 and 5000, simply continue this procedure until you've assigned timbres for the extra four channels available. You don't, of course, need to select the MIDI channels or the timbres that I've suggested here. Just remember that to set the base MIDI channel, you need to ensure that the cursor is under the MIDI CH= number. In addition to the preset examples used above, you can use internal memory timbres or, on the 101/1000 models, even those stored on cartridge – provided you remember to insert the same cartridge when you come to replay the sequence at a later date.

The CZ series is a good introduction to the delights of mono mode, not simply because of their low price range but because their implementation is very straightforward. Other manufacturers have pushed the boundaries of mono mode further, but their innovation often makes things more complex. As we come across other instruments where mode 4 is particularly rewarding, we will run similar instructional features. In the meantime, other instruments to look out for with regard to mono mode experimentation are the Oberheim Matrix range, the Prophet samplers and also the Rhodes Chroma in conjunction with Syntech's new Chroma-to-MIDI interface (see this month's *Newsdesk*). ■

Table 1

MIDI Prog Change No	CZ3000/5000	CZ101/1000	
00	Tone No	Tone No	
01	Preset A1	Preset 1	
02	Preset A2	Preset 2	
03	Preset A3	Preset 3	
04	Preset A4	Preset 4	
05	Preset A5	Preset 5	
06	Preset A6	Preset 6	
07	Preset A7	Preset 7	
08	Preset A8	Preset 8	
09	Preset B1	Preset 9	(1 & Select)
10	Preset B2	Preset 10	(2 & Select)
11	Preset B3	Preset 11	(3 & Select)
12	Preset B4	Preset 12	(4 & Select)
13	Preset B5	Preset 13	(5 & Select)
14	Preset B6	Preset 14	(6 & Select)
15	Preset B7	Preset 15	(7 & Select)
16	Preset B8	Preset 16	(8 & Select)
	Preset C1	Preset 1	
31	Preset D8	Preset 16	(8 & Select)
32	Memory A1	Internal 1	
33	Memory A2	Internal 2	
34	Memory A3	Internal 3	
35	Memory A4	Internal 4	
36	Memory A5	Internal 5	
37	Memory A6	Internal 6	
38	Memory A7	Internal 7	
39	Memory A8	Internal 8	
40	Memory B1	Internal 9	(1 & Select)
41	Memory B2	Internal 10	(2 & Select)
42	Memory B3	Internal 11	(3 & Select)
43	Memory B4	Internal 12	(4 & Select)
44	Memory B5	Internal 13	(5 & Select)
45	Memory B6	Internal 14	(6 & Select)
46	Memory B7	Internal 15	(7 & Select)
47	Memory B8	Internal 16	(8 & Select)
48	Memory C1	Internal 1	
63	Memory D8	Internal 16	(8 & Select)
64	Not recognized	Cartridge 1	
65	Not recognized	Cartridge 2	
66	Not recognized	Cartridge 3	
67	Not recognized	Cartridge 4	
68	Not recognized	Cartridge 5	
69	Not recognized	Cartridge 6	
70	Not recognized	Cartridge 7	
71	Not recognized	Cartridge 8	
72	Not recognized	Cartridge 9	(1 & Select)
73	Not recognized	Cartridge 10	(2 & Select)
74	Not recognized	Cartridge 11	(3 & Select)
75	Not recognized	Cartridge 12	(4 & Select)
76	Not recognized	Cartridge 13	(5 & Select)
77	Not recognized	Cartridge 14	(6 & Select)
78	Not recognized	Cartridge 15	(7 & Select)
79	Not recognized	Cartridge 16	(8 & Select)

# THE WORLD CUP FILE

## THE ROAD TO MEXICO

Action-packed with colour on all 24 Teams. In-depth reports on how they qualified and their chances of lifting the trophy.

An invaluable reference book and a fabulous souvenir for your armchair seat to the greatest event in the soccer calendar.

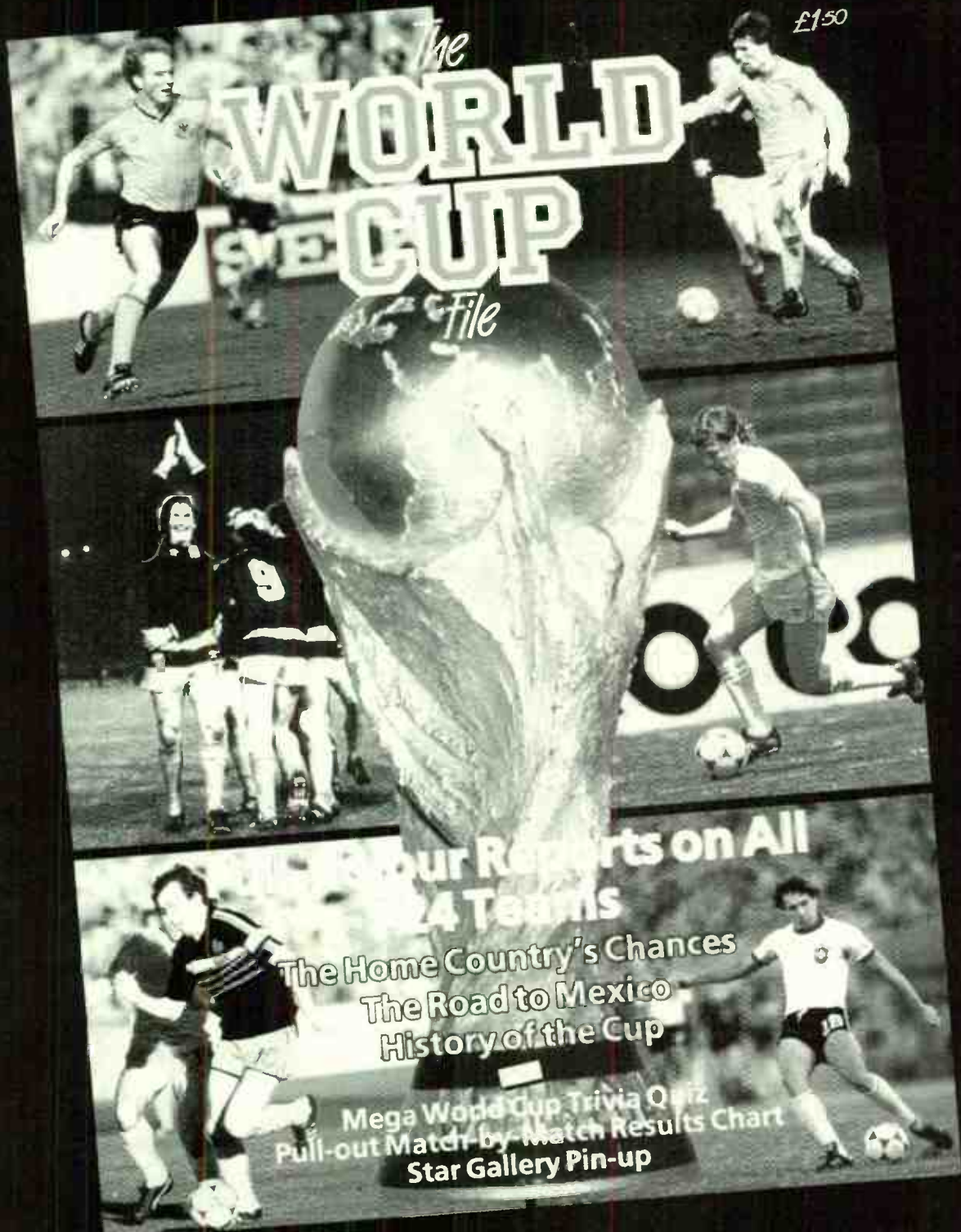

**AT YOUR NEWSAGENT NOW! ONLY £1.50**

Also available by sending £1.70 (£1.50 + 20p postage)

To: Popular Publications Ltd, Alexander House, 1 Milton Road,  
Cambridge CB4 1UY. Cheques or Postal Orders please, payable to  
Popular Publications Ltd.

True to our word, this month's Patchwork takes a look at four new DX7 ROM packs from Skyslip. If you'd like us to feature any sound libraries (cartridge, disks, cassettes, chips and so on) for your particular synth, then drop us a line and we'll do our best.

Don't forget that if your patch gets published, a free year's subscription will wing its way to your front door with our compliments. Send us your favourite sounds on a copy of an owner's manual chart (coupled with a blank one for artwork purposes), including a good description of your sound and its musical purpose in life – and don't forget to include your full name and address on each chart.

The address to send to: Patchwork, E&MM, Alexander House, 1 Milton Road, Cambridge, CB4 1UY. ■

## Casio CZ101/1000 Clavinette Tim Barr, Dunfermline

Tim actually christened his sound 'Heavy Metal Clavinette', referring to it as a little earthier and gutsier than the delicate textures we usually feature – but we didn't want to put anyone off...

Both DCOs are used in order to take advantage of the CZ's ability to access four usable sounds by selecting various combinations of Line Select, in this case HM Clavinette (1+1), Organ Pipe Bass (1), Piano (2), and Piano/Organ (1+2). Our favourite was the main sound ('great for thick basslines and really heavy clav riffs'), but the others are quite useful nonetheless, particularly the Piano/Organ option. ■

## Yamaha DX21 Percussive Piano Mike Landers, London NW2

A warm welcome then to the DX21 (well, if you're tired of FM patches, send us something else!). Mike suggests that his 'Percussive Piano' lends itself readily to experimentation, such as switching off operators 3+4 thus leaving a muffled piano, or by adding operator 3 giving more of an organ quality to the voice. ■

### PARAMETER

LINE SELECT	MODULATION		DETUNE				VIBRATO				OCTAVE	
	RING	NOISE	+/-	OCTAVE	NOTE	FINE	WAVE	DELAY	RATE	DEPTH	+/-	RANGE
1+1 <small>(1.2+2.1+1)</small>	ON	OFF <small>(ON/OFF)</small>	+	0 <small>(0-3)</small>	07 <small>(0-11)</small>	04 <small>(0-80)</small>	1 <small>(1-4)</small>	33 <small>(0-80)</small>	55 <small>(0-80)</small>	23 <small>(0-80)</small>		0 <small>(+/-) (0-1)</small>

### 1

#### DCO 1

WAVE FORM	
FIRST	SECOND
2 <small>(1-8)</small>	3 <small>(0-8)</small>

E N V (PITCH)								
STEP	1	2	3	4	5	6	7	8
RATE	50							
LEVEL	00							
SUS/END	END							

#### DCW 1

KEY FOLLOW
7 <small>(0-9)</small>

E N V (WAVE)								
STEP	1	2	3	4	5	6	7	8
RATE	97	43	50	52				
LEVEL	99	79	74	00				
SUS/END		SUS						

#### DCA 1

KEY FOLLOW
0 <small>(0-9)</small>

E N V (AMP)								
STEP	1	2	3	4	5	6	7	8
RATE	99	21	61					
LEVEL	99	00	00					
SUS/END								

### 2

#### DCO 2

WAVE FORM	
FIRST	SECOND
1 <small>(1-8)</small>	0 <small>(0-8)</small>

E N V (PITCH)								
STEP	1	2	3	4	5	6	7	8
RATE	00	00						
LEVEL	02	00						
SUS/END	END							

#### DCW 2

KEY FOLLOW
0 <small>(0-9)</small>

E N V (WAVE)								
STEP	1	2	3	4	5	6	7	8
RATE	92	44						
LEVEL	80	00						
SUS/END	END							

#### DCA 2

KEY FOLLOW
3 <small>(0-9)</small>

E N V (AMP)								
STEP	1	2	3	4	5	6	7	8
RATE	99	33	86					
LEVEL	99	00	00					
SUS/END			END					

7	4	Triangle	35	0	0	0	0	OFF	6	0	AMP	OP
											0	4
											0	3
											0	2
											0	1
ALGO	TRIG	WAVE	SPEED	DELAY	PMD	AMD	SYNC	PITCH	AMPL	EG BIAS	KEY	VELOCITY
RIE/HM	BACK								TU/DI			
1	2	3	4	5	6	7	8	9	10	11	12	13
												14
												15
												16

OSCILLATOR	ENVELOPE GENERATOR								PITCH ENVELOPE GENERATOR							
POLY	PITCH	PORTAMENTO			FOOT CONTROL		WHEEL RANGE		BREATH RANGE				CHORUS	TRANS-	VOICE	
MONO	BEND	MODE	TIME	FOOT SW	VOLUME	SUSTAIN	PITCH	AMP	PITCH	AMP	PITCH	BIA	BIA	POSE	NAME	
Poly	4	FTP	0	ON	40	ON	50	0	0	0	50	0	OFF	C3	Perc. Piano	





“...you must remember this...”

E&MM has covered so much ground over the last few years, just missing one issue can cause large gaps in a reader's knowledge of contemporary music technology. But if you have missed an issue or two, don't panic. Help is on hand in the form of E&MM's Mail Order Department, who can offer you 1984/5/6 Back Issues at just £1.40 including post and packing. Earlier issues – the ones listed here – are even cheaper: just £1. Those prices are relevant to the UK and surface mail delivery to Europe and Overseas, but if you are overseas, you can get your missing issues sent air mail by adding an extra £2 per magazine.

And don't despair if you want to read something in an issue that's sold out. Photocopies of articles from sold out issues *only* are available at just 50p each. So, orders please (sterling cheques/POs payable to Music Maker Publications) to the Mail Order Department at the editorial address (it's at the front of the mag). Please allow 28 days for delivery, as the mail order people are a busy lot these days. Next month's issue will contain a rundown of what we've covered from Jan '84 right up to date, so see next month's E&MM for what's been happening in more recent times...

## 1981

### MARCH Sold Out

Music BBC Radiophonic Workshop Appraisal Yamaha SK20 Technology Using Microprocessors, Advanced Music Synthesis (VCOs, FM), DIY Spectrum Synth, DIY Hifi Sub-bass Woofer

### APRIL

Music Warren Cann (Ultravox) Technology Using Micros Pt2, Programming Micros, Advanced Music Synthesis (PWM), DIY Spectrum Synth Pt2, Syntom 1 Studio DIY DI Box

### MAY

Music Tim Souster Appraisal Apple Music System Technology Using Micros Pt3, DIY Spectrum Synth Pt3 Studio DIY Noise Reduction Unit

### JUNE

Music David Vorhaus Appraisal Fairlight CMI, Yamaha PS20 Technology Using Micros Pt4 Studio DIY MOSFET Amp

### JULY Sold Out

Music Duncan Mackay Appraisal PPG Wave 2 Technology Using Micros Pt5

### AUGUST

Music Irmin Schmidt Appraisal Resynator Synth, Casio VLI Technology Harmonics, DIY PA Signal Processor Pt1

### SEPTEMBER Sold Out

Music Kraftwerk Appraisal Linn LM1 Technology Using Micros Pt6, DIY PA Signal Processor Pt2 Studio DIY Noise Gate

### OCTOBER

Technology Using Micros Pt7, DIY Harmony Generator, DIY Effects Link FX1 Studio dbx Explained

## NOVEMBER

Music Landscape Appraisal Casio MT30, Roland GR300 and CPE800 Technology Using Micros Pt8, Speech Synthesis, Phasing, DIY Auto Swell Pedal

## DECEMBER Sold Out

Music Rick Wakeman, *Orchestral Manoeuvres in the Dark* Appraisal Yamaha CS70M, Vox Custom Bass & Custom 25, Roland CR5000 & CR8000, Elka-Orla X50, Vox AC30, alphaSyntauri Technology DIY Synclock Studio Fostex 250, ElectroVoice Mics

## 1982

## JANUARY

Music Tangerine Dream Appraisal Casio 701, Teisco SX400, Aria TS400, MCS Percussion Computer, Passport Soundchaser Technology Flanging, DIY Spectrum Synth Update Pt1, DIY Volume Pedal Studio Beyer Mics

## FEBRUARY

Music Ike Isaacs Appraisal Korg Trident, Roland TR606, Tokai ST50 and PB80 Technology Polysequencing on ZX81, Yamaha GS1&2 (FM) Explained, Digital Delay Line Pt1, Spectrum Synth Update Pt2 Studio Fostex A8, AKG Mics

## MARCH Sold Out

Music Klaus Schulze, Robert Schröder, Kraftwerk 'Computer World' Music Appraisal Firstman SQD1, SCI Pro One Technology DIY Digital Delay Line Pt2 Studio Tascam 124AV, DIY Power 200 Speakers

## APRIL

Music Martin Rushent (Human League) Appraisal Korg MonoPoly, Roland TB303 Technology DIY MF1 Sync Unit Studio Fostex 350, DIY MultiReverb

## MAY

Music Holger Czukay, Depeche Mode Appraisal Moog Source & Rogue Technology DIY Soft Distortion Pedal Studio DIY Quadramix

## JUNE

Music Jean-Michel Jarre, Classix Nouveaux Appraisal Emulator, Carlsbro Minifex Technology DIY Panolo, DIY Multisplit

## JULY

Music Ronny with Warren Cann & Hans Zimmer, J-M Jarre 'Magnetic Fields' music Appraisal Roland Juno 6, Peavey Heritage, Steinberger Bass Technology DIY Universal Trigger Interface

## AUGUST

Music Kitaro, Jon Lord Appraisal Synergy, Korg Polysix, Shergold Modulator 12-string, Yamaha Pro-FX Technology DIY Guitar Buddy practice amp Studio Tascam 244 Portastudio, DIY 8201 Line Mixer

## SEPTEMBER Sold Out

Music Richard Pinhas Appraisal Yamaha CS01, Jen SX1000, Casio 1000P, Fender Squier, Carlsbro Stingray, Pearl Effectors Studio DIY Comp-Lim & Twinpak

## OCTOBER Sold Out

Music Kate Bush, Ken Freeman Appraisal Fender Vintage Series, Rhodes Chroma, Kay Memory Rhythm Technology Performance Controls

## NOVEMBER Sold Out

Music Patrick Mora Bill Nelson Appraisal Yamaha PC100, Technics SXX250, Casio MT70, Hohner P100, JVC KB500, Gibson Firebird 2, Alligator AT150 Technology DIY Sweep EQ, Robert Moog Studio AHB 1221 Mixer

## DECEMBER Sold Out

Music Cliff Richard Appraisal Elka Synthes, Crumar Stratus, Tokai Bases, The Kit Technology DIY Canjak Studio Shure PE Mics

1983

## JANUARY

Music Richard Barbieri (Japan) Appraisal Westone Bass, BGW 750C Amp, Korg EPS1, Clef BandBox, Zildjian Cymbals Technology DIY Synblo

## FEBRUARY

Music Isao Tomita, Human League Appraisal Synclavier II, Memory-Moog, Novatron, LinnDrum, Simmons SDS6, Klone Kit, Movement Drum Computer 2, Korg KPR77, Powertran Polysynth, Vigier Guitars Technology DIY Synbal, DIY Caltune Studio Pearl Mics

## MARCH

Music Klaus Schulze, Michael Karoli, Francis Monkman, Bernard Xolotl, Chris Franke Appraisal RSF Kobol Expander, Korg Poly 61, BGW 7000 Amp, Ibanez Pedals, Tokai Flying V Technology DIY Shaper Studio Aria Mics



## APRIL

Music Naked Eyes, Gabor Presser Appraisal Casio 7000, SCI Prophet 600, Chroma/Apple Interface, Eko Bass pedals, Vox guitars Technology DIY Syntom II

## MAY

Music Keith Emerson Appraisal Roland MC202, Carlsbro Cobra 90 Kbd Combo, M&A K1/B Kit Technology Introducing MIDI, DIY MicroMIDI (interface for Spectrum) Studio Fostex X15, Echo Unit Supplement (13 reviews incl Roland SDE2000, Fostex 3050, Korg SDD3000), DIY Active Speaker

## JUNE Sold Out

Music Steve Hillage, Arthur Brown Appraisal Synclavier II, Synton Syrinx, E-mu Drumulator, Vestafire Dual Flanger, Aria AD05 Delay Technology DIY OMDAC Studio Suzuki Mics, Clarion and Cutec four-tracks

## JULY

Music Marillion, Hans Zimmer Appraisal Kawai SX210, Aria U60 Deluxe BBS, Deanward VA30K Amp, MXR Omni FX Technology Yamaha DX synthesisers, Digital Signal Processing Pt1, DIY Tap Tempo Studio Milab Mics Trident VFM Mixer

## AUGUST Sold Out

Music Bill Nelson, Hubert Bognermayr, Barclay James Harvest Appraisal Roland JX3P/PG200, OSCar, 360 Systems Digital Kbd, MPC Music Percussion Computer, Yamaha SG200, Fender 100W Stage Lead, Frontline FX Technology Digital Signal Processing Pt2

## SEPTEMBER Sold Out

Music Peter Vettese Appraisal Prophet T8, Oberheim DX drums, SCI Pro-FX 500, Rickenbacker 360, 12-string & TR75 GT Combo Technology Music Composition Languages Pt1, Sounding Out the Micro Pt1, DIY Synclap



## OCTOBER Sold Out

Music John Miles, Andrew Powell Appraisal Yamaha DX1, OctavePlateau Voyetra 8, SIEL Opera 6, MXR 185 Drum Computer, Ross Pedals, Fender Elite Precision Bass 1, Steinberger six-string Technology Sounding Out the Micro Pt2, Speech Synthesis, Digital Signal Processing Pt3, DIY Mains Distribution Board

## NOVEMBER

Music Tony Banks, John Foxx Appraisal Seiko Digital Keyboards, Eko EM10, UCI Sequencer for SCI Pro One, Doctor Click, Klone Kit 2, Ibanez HD1000, Korg KMX8 Mixer, Ibanez RS315SC Guitar Technology Music Composition Languages Pt2, Software Envelope Generator (ZX Spectrum), MUZIK 81 (ZX81), Digital Signal Processing Pt4

## DECEMBER Sold Out

Music Gary Numan, Psychic TV, Philip Glass Appraisal Prophet T8, Yamaha PC1000, Carlsbro AD1 Echo Technology Decillionix DX1 (Apple sound-sampler), DIY Valve Driver

# SELL IT FOR NOTHING

with a free classified ad in **Electronics & Music Maker**

## Keyboards

**AKAI AX80** touch-sensitive polysynth, fluorescent bar data readout, reluctant sale. £499 + flightcase. David ☎ (04946) 5528.

**ARP AVATAR** monosynth expander for sale, classy sounds, ideal with MC202, MC4 or monosynth. £185. Steve ☎ (0222) 21802 or 01-350 0340.

**ARP OMNI II** Classic strings/synth/bass, needs some cosmetic attention. £180 ono. ☎ Glasgow 041-942 0870 after 6pm.

**BEGINNER'S BARGAIN** Crumar Stratus polysynth, unplayed, immac. boxed with case, manuals, pedal. £225 delivered. Dewi ☎ (0222) 24658.

**BIT ONE** six-voice polysynth, split and dual functions. MIDI. £530. ☎ Wakefield (0924) 361364.

**BIT ONE** £550. RV2 Dual reverb £190. Micro-sound 64 synth (full-size) for CBM64, £120. Teac X-3R Auto-reverse R/R. £290. ☎ 01-249 9569.

**BIT ONE** £460 ono, excellent condition. Would swap for SCI Multitrak or plex for Mirage. Marc ☎ Bath 782516, after 5pm.

**BIT 01 EXPANDER** beefy sounds, amazing facilities, excellent MIDI. As new. £370. Steve ☎ (0222) 21802 / 01-350 0340.

**BIT 99** £550, boxed. Carlsbro Hornet 45 kbd amp. £145. Both virtually unused, together £675. ☎ 01-857 4456.

**CASIO 501** polyphonic kbd, rhythms, 20 instruments, auto chord. 345-note memory expandable, only £120. ☎ (0562) 850407.

**CASIO CT202**, f/cased, with pedals, immac. £125. Washburn Eagle guitar, black, phase switching, lovely. Dave ☎ (0603) 52275.

**CASIO CT202** 49 presets, Yamaha MR10 drum m/c, Jen SX1000. All pristine. £235 the lot. ☎ Barnsley (0226) 715203.

**CASIO CT6000** touch sensitive, digital rhythms, great sounds, Chrome stand included cost. £730, sell £395. ☎ Greenock (0475) 35043.

**CASIO CT6000** digital kbd, with 30 voices, 20 rhythms, MIDI, touch sensitivity, stand, vgc. £350 ono. ☎ (0532) 744994.

**CASIO CZ101** plus hard case, vgc. Wasp for Yamaha CX5 (also good condition). ☎ Bath (0249) 713910.

**CASIO CZ101 RAM** £220. Casio MT400V, £120. Jen Piano, £80. Farfisa organ, £90. ☎ (0597) 4391 after 6pm.

**CASIO CZ101** + mains adaptor. £180. Korg Super Section, hardly used. £190. Andrew ☎ Hemel Hempstead (0442) 212300, eves.

**CASIO CZ101** boxed, as new, with power supply. £250 ono. Julie ☎ (0602) 706649.

**CASIO CZ101** digital synth, condition as new, home use only, plus mains lead, one RAM cartridge. £200. ☎ 01-301 2424.

**CASIO CZ1000** still boxed, as new £300. ☎ Scunthorpe (0724) 762190.

**CASIO CZ1000** adaptor and practice amp, excellent condition. £300. ☎ (0622) 64384 eves.

**CASIO CZ1000** two months old, home use only, £310 ono. ☎ 01-848 7224 (Hayes), eves.

**CASIO CZ1000** £350. Korg MS20, SQ10, £175. Swaps considered (MIDI Modules, MSX disk drive, Vocoder). Paul ☎ (077478) 4335.

**CASIO CZ5000** polysynth, new condition, £550 for quick sale. Oscar lead synth £300. ☎ 061-429 9323.

**CASIO CZ5000** polysynth, MIDI, brand new with stand £600. Sean ☎ 01-669 0944, after 5pm.

**CASIO CZ5000** MT70, SH101, DDM110, KMS30, digital delay, Cutec MR402 4-track, Cobra 90, £1850. Ian ☎ Farnborough, Hants 513183.

**CASIO MT41** never gigged, willing to swap for DX7 with low mileage, or £39. Mark ☎ 01-301 3084. Please!

**CASIO MT100** kbd, with graphic equalizer, 49-note, 20 sounds, 12 rhythms, auto-accompaniment, transformer. ☎ (0272) 874333.

**CASIO MT400V** poly, boxed, as new, great sounds, with filters, only £150. Ian ☎ Basingstoke (0256) 462609, 6-9pm.

**CASIO MT800** poly, speakers, ROM pack, ideal analogue fill-in, + chorus, kbd split, recording facility. P/x possible, £180 ono. Mike ☎ 01-883 7860 eves.

**CASIO MT800** 12 preset, rhythms, ROM memory, excellent condition, £170 with £30 amp inc. ☎ (0494) 774868.

**CASIO POLYPHONIC** kbd, rhythms, memory, bar chord reader, full-size kbd, auto-accompaniment, bargain £110. ☎ Kidderminster 850407.

**CASIO 1000P** perfect condition, £150 ono, or will swap for good kbd amp. ☎ (0740) 30374 after 6pm.

**CLEF MICROSYNTH** 2 VCOs, £80. Three years of E&MM back issues, mint, offers! Tim ☎ 01-968 6387.

**CHROMA POLARIS** synth, MIDI, 6 voices, etc. flight cased, boxed unused guaranteed, £725. ☎ 01-504 9960 eves.

**CRUMAR ROADRUNNER** 2 electric piano, has occasionally three faulty keys hence price. £90 ono. ☎ 051-644 0992.

**DIGISOUND MODULAR SYNTH** 31 modules (7VCO, 4VCF, 4VCA, 7EG etc), inc 4-oct kbd, 4 speakers, 2 power amps, complete with 4 cabinets £500. ☎ Lodge Hill (0689) 49265.

**ELKA STRING** machine in need of attention, therefore any offer under £40 accepted. Herts area. Rod ☎ Garston 677922.

**E&MM BASS PEDALS** CV-Gate control of synths. Guyatone graphic EQ pedal. Pedals, £55. EQ £35. Ian, 15 Brays Lane, Coventry.

**E&MM VOCODER** assembled main board and set of small boards blank. Details, offers. ☎ 021-523 6752, eves.

**FELLOW KEYBOARD** players. Poly 800, unscathed! £250. One lady owner, moving to greater things. Call Linda ☎ 01-599 2831.

**HAMMOND M102** factory split, Vortex cabinet, works perfect, gone DX7 and Mirage so must go. Offers! ☎ Bexhill 224515.

**HELPISTILL ROADMASTER** electric acoustic piano, real action, suit club, studio, gigs, folds into flightcase, £595 ono. ☎ (0472) 361725.

**JEN SYNX 508** polysynth, 64 memories, five-oct kbd, sequencer. £250. ☎ 01-841 9786.

**JEN SX1000** synth, and overlay voice cards. £50. Chris ☎ Marlow (062 84) 73393 eves/weekends.

**JEN SX1000** vgc. £75. Kay drum machine (programmable) £40, or swap for DDL. M Duddridge, 18 Durlough Road, Bridgewater, Somerset.

**JEN SX1000** £50. Chris ☎ Marlow (06284) 73393.

**KORG MONO/POLY** in reasonable condition, although slightly scratched, sounds great, with manual, £220 ono. Can deliver. Adam ☎ 01-561 7805 eves.

**KORG MONO/POLY** £260. Roland Drumatix £100. Yamaha CS5 £110. B M Parkinson, 61 School Street, Barrow-in-Furness, Cumbria.

**KORG POLYSIX** Delta, P5550 Super Section, KMX8, 8-ch stereo mixer, twin stand, cases, any sensible offers. ☎ (0203) 310808.

**KORG POLYSIX** £300, inc case. 32 memories, chorus, unison mode, data cassettes. ☎ 01-689 8372 (Thornton Heath, Surrey).

**KORG POLY 800** immac, home use only, c/w hard case, foot pedal, leads and manual. ☎ (033) 981 334.

**KORG POLY 800** home use only, immac, under guarantee, holiday forces sale, £275 ono. ☎ 031-336 6287 eves.

**KORG POLY 800** £300 or exchange for TX7, DX21. Korg percussion unit, £110. Fender twin amp £250. ☎ (099387) 318.

**KORG POLY 800** excellent condition, home use only, hardly used, £300 ono. ☎ Barton (0652) 32740.

**KORG MS10** synth, £80. Jen strings £60. Both in good condition. ☎ Romford 45592 after 6pm.

**KORG MS50** £140. MS20 £160. SQ10 £110. Simmons SDS 4, £120. Custom interface £50. Must sell. ☎ Bexhill (0424) 213474.

**KORG 700S** classic monosynth, with sweet sounds and Star Wars' styling. Home use only, £75 ono. ☎ 01-586 7307.

**MOGLIBERATION** polysynth, with hardcase, vgc, offers. Korg MS10 synth £115 ono. Boss DR55 drum m/c, £45 ono. Tony ☎ 021-426 4814 eves.

**MOOG SOURCE** £230, or swap Casio CZ101 or Ibanez Harmonics. Korg MS50 £170. Andy ☎ (0482) 853446 about 6pm.

**MOOG SOURCE** with memories, vgc, f/case included, £320 ono. ☎ (0294) 61258.

**MOOG SOURCE** with f/case and manual, perfect £300 or p/x for Prodigy plus cash. ☎ 01-882 8901.

**MOOG SOURCE** excellent condition, boxed, manual, home use only, for the Moog sound, £200 ono. Martin ☎ 01-903 4611, (03744) 65674.

**OVERHEIM MATRIX** 6 £1499, rack-mounted £895. Matrix 12 £3300. Xpander £1995. All unopened! Brand new. Zac ☎ (0865) 54704.

**OVERHEIM OBI** great bass/lead sounds, eight memories, f/case, in top ten in Keyfax Keyboard Guide, £350. ☎ 01-281 1918.

**OVERHEIM OBX** 8-voice, fattest analogue sound around, inc f/case, pedals, manuals. £900. ☎ 01-624 5404.

**OCTAVE CAT SRM**, as new, £190. Wasp synth, Spider sequencer and Caterpillar kbd, £100. ☎ Bradford (0274) 601423.

**OSCAR** mint condition, £300. ☎ Gary 01-708 3114.

**OSCAR MIDI**, f/c, £300. Wasp £60. Clef drum m/c £30. DDM220 £100. DX7 £850. X15 + PSU £180. Patrick ☎ (0272) 573261.

**OSCAR MIDI**, £325. Casio CZ101 plus cartridge, £230. Korg EX800 £150. PX MKS30. Yahaya ☎ 01-603 6655.

**OSCAR duo-synth**, home use only, £200. Gary ☎ 01-708 3114, days.

**POWERTRAN TRANSCENDENT** polysynth, 4-voices, home use only, offers. R E Thompson, 17 Slade Gardens, Norton, Swansea, West Glam. ☎ (0792) 404013.

**RACK CASE** Multiplex: 2 unused boxed Roland TB-14Vs, RRP £250 each, from me £190 each ono. ☎ (07357) 5327.

**ROLAND JUNO 6** living room use only, £300. Also Drumatix plus power supply £100. ☎ 01-949 5819 after 6pm.

**ROLAND JUNO 6** + ST305 drum m/c, and stand, excellent condition. Swaps or £330. Trev ☎ (0582) 596292.

**ROLAND JUNO 6** good condition, £270 ono. ☎ Bexhill (0424) 210988.

**ROLAND JUNO 6** perfect condition, hard case, can deliver, £300. ☎ Durham (0385) 782377, Mon-Fri eves.

**ROLAND JUNO 6** £300. Fostex X15 £200. MC202 £100. Strat Copy £60. Casio MT68 £80. ☎ 01-421 1513 after 6pm.

**ROLAND JUNO 6** good condition, £235. Will swap for RX21, TR808 or TR909. ☎ Ulverston, Cumbria (0229) 53746.

**ROLAND JUNO 6** used twice at home only, immac condition, £250 for quick sale. ☎ Orpington (0689) 57588.

**ROLAND JUNO 60** case, manuals, £395. Yamaha PS6100, 66 rhythms, multifunction kbd, boxed, stand, etc. £695. ☎ (0772) 323303.

**ROLAND JUNO 106** six months old, perfect condition, still boxed, £395. Dave ☎ York (0904) 34626.

**ROLAND JUPITER 6** + stand, £750. SCI CBM64, MIDI interface £85. MC202 + TR606, £190. Will split, £900 the lot. Kevin ☎ (0992) 39775.

**ROLAND JUPITER 8** £950. OP8 £100. MTR100 £75. Sycologic API interface £100. Roland TR808 £200. ☎ (0223) 60486.

**ROLAND JUNO 106** immac £490. ☎ Manchester 061-223 0239.

**ROLAND JX3P** vgc, boxed £360. Rina ☎ 01-546 5933 anytime.

**ROLAND JX3P** + PG200, £495. Casio CZ101 £240. Yamaha CX5 + 3 ROMs, £285. Home use only, all vgc and boxed. Steve ☎ (0792) 51182, 0800-1600 hrs.

**ROLAND JX3P** plus PG200 programmer and hard case, LFO trigger pedal, never gigged, £440 ono. Steve ☎ (0603) 401933.

**ROLAND JX6P** + PG800, £850. TR707 £350. CR78 £150. CX5 Ukbd, ROMs, £300. All mint, all ono. Mark ☎ (0935) 824738.

**ROLAND PROMARS** programmable synth, 18 switchable sounds, compatible with MC202 MicroComposer, immac £175. ☎ Upminster (04022) 26512.

**ROLAND RS09**, TR606, Bell 100W PA + big cab. Offers or MIDI swaps (TX7?). Jason ☎ (0706) 217260.

**ROLAND SH09** £140. Casio CT202 £100. Both excellent, can deliver. ☎ (0978) 760638. Please leave name and number.

**ROLAND SH101** with MGS1 manual power supply, very good condition, £160 ono. Wanted CZ101/1000 p/x possible. Nick (0703) 446113.

**ROLAND SH101** blue, MGS1 handrip, f/case, cable, and manual. All excellent condition, £160 quick sale. ☎ (0621) 817252.

**ROLAND SH101** with grip £135 ono. Casio CT101 with stand £85 ono. Martin ☎ (0473) 827680.

**ROLAND SH101**, MC202 MicroComposer, TR606 Drumatix, boxed, PSUs, manuals, etc. £295, split possible. ☎ Whitley Bay 091-253 2460 eves.

**ROLAND SH101** perfect condition, plus hand grip and strap, only £140. Simon ☎ 01-847 4708.

**ROLAND SH101** box, instructions, grip, £120. DDM110 digital rhythm £120. Both with adaptors. Hayes ☎ 01-841 7350.

**ROLAND SH101** monosynth. Boss PSU. Home use only, £140. ☎ Ruthin (082 42) 2513 eves.

**ROLAND SH101**, case and MGS1, £175. Boss DR110 + Feldstein 110/606 manuals, £75. Jen SX1000 £65. ☎ (0205) 61173.

**ROLAND SH101** with modulation grip, strap and power supply, all in original boxes, £120. Simon ☎ 01-504 3260.

**ROLAND SH101** monosynth with sequencer, hard grip, etc. £140. Excellent condition, still boxed. Simon ☎ Brighton 558093 eves.

**ROLAND SYSTEM 100** kbd, expander, and sequencer £200. Also HH 100W amp, £100. ☎ Lancs (0257) 452303.

**SCI PROPHET** 2002, £1699. Prophet 2000, £1795. Both brand new, unopened. Zac ☎ (0865) 54704.

**SCI PRO ONE** £150 ono. SH101 £75, SH09 £75. Solina strings, Korg drum m/cs, any offers. ☎ Ware 3149.

**SCI PRO ONE** powerful sound, home use only, mint, sell £160. Marc ☎ Preston 763723.

**SCI PRO ONE** £190. Korg MS10 £90. TR909 £350. All boxed with manuals, home use only. ☎ Boston (0205) 62929.

**SCI SIX-TRAK** polysynth, MIDI, sequencer, voice stack, excellent condition, still boxed, £400. ☎ Milton Keynes (0908) 569732.

**SCI SIX-TRAK** vgc, one year old, home use only, £400. ☎ (0604) 843793.

**SCI SIX-TRAK** £390. Home use only. ☎ Manchester 061-223 0239.

**SEVEN-OCTAVE PIANO** floor standing, made from Maplin kit, electronics not working, any offer accepted. Cardiff ☎ (0222) 756055 eves.

**SWAP DX9** for Multitrak, Prophet 5, CZ5000, Sixtraks with! TR808, 909 or 606. Ian ☎ (0703) 778276, 6pm.

**SWAP POLY 61** for MIDI synth, anything considered, must work, or £400. 34 Amherst Road, Plymouth PL3 4HH.

**SWAP POLY 800** boxed, for OSCar (MIDI). Also sell Roland TR909, boxed, £325 ono. Neil ☎ (04215) 68523 eves.

**TEISCO S110F** monosynth, 2VCO, as new, boxed with manual, (unwanted gift), £150 or offer. Fry ☎ Abergavenny (0873) 4218.

**TEISCO SX400** polysynth, touch sensitive kbd, memories £300 ono. Realistic six-channel mixer, VUs, £70. ☎ Telford 501355.

**WASP SPECIAL** and Caterpillar kbd, £70 the pair, or swap for Bassline or Korg MS50. Dave ☎ (0743) 54829.

**YAMAHA CP30P** electric piano, stereo, touch sensitive, weighted keys, good condition, can deliver, £275 ono. ☎ Woking (04862) 67933.

**YAMAHA CP70B** mini grand, as new, also f/cases for same, £3000. ☎ (0698) 384288.

**YAMAHA CP70B** fully f/cased, excellent condition, £1400. Marc ☎ IOW (0983) 872401 office hours. Leave message, calls back.

**YAMAHA CS5** monosynth, vgc, £60 or swap Akai 4000DS or similar. Ian ☎ Derby 73029.

**YAMAHA CS10** monosynth, 3-oct, immac, home use only, £120. Casio CT403, 4-oct, 285 sounds, drums, £125. ☎ Southend (0702) 525389.

**YAMAHA CS30L** mono, f/cased, stand, true dual channel, stable oscillators, 3EG, blistering analogue sound, £135 ono. ☎ (0484) 544711.

**YAMAHA CS30L** monosynth, 2VCO, 2VCF, 2VCA, 3EG, LFO, ring modulator, noise, powerful analogue sound, £380 ono. ☎ Kenilworth (0926) 56670.

**YAMAHA CS40M** duophonic, very comprehensive programming, 20 programs, as new, never gigged, £400 ono. ☎ (044 46) 41708.

**YAMAHA CS70M** polysynth, sequencer, magnetic cards, pedals, custom built case. ☎ Leeds (0532) 589449.

**YAMAHA DX5** immac, home use, unplayed, all factory supplied accessories, boxed, guarantee, £1300. Garry ☎ 01-960 4634 after 6pm.

**YAMAHA DX7** £900. Juno 60, JSQ60, f/case, £450. Echotec MX99 £40. PEP800 8:4:2 mixer, £260. Kevin ☎ (06284) 74752.

**YAMAHA DX7** only six months old, home use only, boxed, immac with RAM cartridge, £900. ☎ (0438) 721909.

**YAMAHA DX9** £425. Roland JX3P £425. Akai 4000DS £60. Onkyo 50W stereo amp, £55. ☎ (0234) 60005 eves.

**YAMAHA DX9** breath controller, tape, manual, unplayed, £430. Korg Vocoder, £150. Boss Dr Rhythm DR110, £80. ☎ Medway 404050.

**YAMAHA DX9** immac, £450, or swap for MultiTrak, CZ1000, S21, Chroma Polaris or JX3P. Ian ☎ Southampton 778276.

**YAMAHA DX9** absolutely perfect condition, home use only, plus X-stand, £400, no offers please. ☎ (0424) 212744.

**YAMAHA DX21** hardly used, 8-months old, home use guaranteed, £495. Also KX5, £95. ☎ Shropshire (Midlands) (07462) 2971.

**YAMAHA DX21** polysynth, with breath controller, home use only, £550. Dave ☎ 021-443 4441 eves.

**YAMAHA DX21** vgc, quick sale, £465. Also Fame Mastercaster guitar, Khaler Tremolo kbd hardware, must sell £125. ☎ (0602) 303646.

**YAMAHA ELECTRIC** mini grand piano (no covers), £1500. Emulator I + disks, £1950. Perfect condition. Cathy ☎ 01-631 5221.

**YAMAHA PF10** touch-sensitive piano, f/cased, free stand if required, £360. Could deliver to London. ☎ (0243) 773940.

**YAMAHA PF15** good condition, with f/case, £640. ☎ 01-368 7071.

**YAMAHA PF15** electric piano, hardly gigged, £650. Also two Yamaha KS50 combos, four inputs, £500. ☎ Brighton (0273) 685669.



**YAMAHA PF15** £700. 30W stereo mixer amp plus speakers. £150. Parris, 124 Chelston Avenue, Yeovil, Somerset, BA21 4PR.  
**YAMAHA PS20** kbd, excellent condition, £160. Doncaster (0302) 61672, after 6pm.  
**YAMAHA PSR70** FM kbd, MIDI, stereo, programmable PCM drums, kbd/split, recorder, with adaptor, as new, £485 ono. ☎ 01-977 9531.  
**YAMAHA PS6100** FM voices, PCM rhythms, home use only, £680 ono. Scott ☎ Cardiff (0222) 736339, any time.  
**YAMAHA SK20** excellent condition, superb organ, strings, polysynth, a bargain for £250. Tony ☎ (0733) 64424.  
**YAMAHA VS5100** sampling kbd, two months old, as new, save £20. Selling price £154. ☎ Southfleet, Kent 3956.

## Sampling

**AKAI SAMPLER** + disk drive, with disks, £500. Yamaha DX9 £400. MT44D £200. RX11 £300. All immac. Paul ☎ 091 9442.  
**ENSONIQ MIRAGE** plus disks, unwanted gift, £1100 ono. ☎ (0232) 662753 after 5pm.  
**ENSONIQ MIRAGE** and Jupiter 6, both unused, £875 and £625 respectively, or £1400 for both, Jim ☎ Glasgow 041-429 7561.  
**GREENGATE DS-3** sampler, latest software, looping loads of sounds controlling computer, monitor, disk drive, computer, software, £1250 ono. ☎ 01-767 5851.  
**KORG SDD1000** DDL, 2s sample, home use, rarely used, £280. No reasonable offer refused, must go. John ☎ 061-336 8440.  
**POWERTRON MCS1** sampler/DDL, maximum bandwidth 12kHz, maximum length 8s, MIDI or CV control. RRP £699, offers! Carrin ☎ 01-460 1773.  
**POWERTRON MCS1** MIDI digital delay sampler, £450 or swap for RX11 or SCL Drumtraks. ☎ 01-582 8548.  
**SAMPLING TAPES** studio produced, highest quality Chrome cassettes, stunning sounds you can afford! ☎ (0723) 583899 after 6pm.  
**SAMPLES!** two high quality cassettes, dozens of amazing isolated sounds, two hours worth, extensive. £20 set. Al ☎ 01-451 5787.  
**SCI PROPHET 200** less than a year old, immac condition, £1900, inc./case. Tim ☎ (0222) 390943.

## Sequencers

**ROLAND BASSLINE** excellent condition, selling due to lack of programming knowledge, £120 ☎ 01-471 5797 eves.

**ROLAND MC202**, modified Drumatix, Boss Handclap, £240. Help given understanding Japanese manuals! Will split. Martin ☎ 01-866 6069.  
**ROLAND MC202** 2-channel MIDI sequencer, £110 ono. Roland 201 Space Echo £180 ono. ☎ 01-435 5789.  
**ROLAND MC202** plus SH101 plus Sync 24 to MIDI Converter, £250 ono. Peter Goodwin ☎ 061-483 6309.  
**ROLAND MC202** as new, boxed with manuals, £100. ☎ Blackpool (0253) 723270.  
**ROLAND MSQ100** digital MIDI sequencer, superb, £200 only, will deliver. ☎ Leeds (0532) 638965.  
**ROLAND MSQ100**, little use, £280 ono. ☎ (0923) 53728/42574.  
**ROLAND MSQ100**, boxed with power supply, mint condition, £250. ☎ (0383) 738886.  
**YAMAHA QX7** MIDI sequencer, mint condition, £215. ☎ Brighton 34030.  
**YAMAHA QX21** digital MIDI sequencer, six weeks old, boxed, excellent condition, £230 ono. ☎ Guildford (0483) 65757.  
**YAMAHA QX21** brand new, boxed etc, £220. ☎ 01-609 1616.

## Recording

**ACCESSIT GATE** compressor equaliser, 2 companders, £80. Swap SH101/DDM220 Tascam PE20EQ £35. Swap Tanteck module. ☎ 01-549 5422.  
**AIWA** £330. Cassette deck, £55. Left-handed, Westone Thunder 1A, (active) bass, mint, £110. ☎ (0273) 493659 (Sussex).  
**AUDIO TECHNICA** RMX64 4-track, 6-channel cassette, ultimate portastudio, loaded with features, forced sale, hardly used, £840. ☎ 01-977 3522.  
**BEYER M201** microphone, few months old, cost £115. Accept £55. Steve ☎ 01-450 7418.  
**BOSS DD2** digital delay, boxed, immac, £99. ☎ 01-221 8978.  
**COMPLETE RECORDING** set-up, customised Studiomaster 20.4.2, Teac A3440 with new heads, RX9 dbx unit, £1400 ono/swaps. ☎ 01-472 7788.  
**CUTEC MR402** 4-track cassette, little used, £280 ono. Casio SZ1 4-track MIDI sequencer, £170 ono. Bill ☎ (04302) 3204.  
**DYNACORD DIGITAL REVERB** £400. Yamaha DDL1500 delay £290, or exchange for TX7 or DX21 synth. ☎ (099387) 318.  
**DYNACORD DRP16** digital reverb, £300. Roland Modular 100 (101, 102 exp), £200, TR606 £70. Bruce ☎ (0482) 703168.  
**FOSTEX 250** Multitracker £450. Clef Master

Rhythm programmable drum m/c. £50. ☎ (0707) 872436.  
**FOSTEX A8** £850. Yamaha MT44D plus MTR 6.4.2, £295. Fostex X15, £160. MM 8.2, £120. All perfect. ☎ (06284) 74752.  
**FOSTEX A80/450**, Yamaha SPX90, Digital Master, Neumann U87 and Beyer mics, and lots more for hire. ☎ Wirral 051-334 1749.  
**FOSTEX B16** £2595, B16 remote £95, half-inch Ampex 456, £15. ADC stereo graphic 12-band/channel, £59. ☎ (0602) 414892.  
**FOSTEX B16** + AHB 16:8:16 System 8 mixer, home use only, £3750 ono. Paul ☎ 01-278 9223 days.  
**FOSTEX X15** as new, £190. Jon ☎ Ruislip 31409.  
**FOSTEX X15** PSU, remote switch, £200. Accessit effects 3 + PSU, £100. ☎ (0597) 4391 after 6pm or weekends.  
**GBS REVERB** stereo XLR model, £150 ono. Two accessit compressors with 4-way power unit, £80 ono complete. ☎ (0342) 23094.  
**GBS REVERB** stereo balanced version, £130. Roger-Meyer professional noise gate, £50. Sony TC-U2 stereo cassette deck, £40. ☎ 01-472 7788.  
**H+H 12:2** mixing desk, Anthony ☎ 01-767 5851.  
**IBANEZ DM1100** digital delay, £160. Roland TR909 drum m/c, £220. Audioline Spectrum Analyser £100. ☎ (0226) 756512 S. Yorks.  
**IBANEZ DH1000** digital harmoniser and delay £220. Ibanez MD1000 digital delay £130. MXR flanger/doubler £170. Swap/px? ☎ 01-472 7788.  
**IBANEZ** rack-mounting effects unit, flanging, reverb, echo, chorus etc. Excellent, £185. ☎ 091-266 3433.  
**IBANEZ HD1000** harmoniser/delay/flanger/chorus. Very versatile digital multi-effects processor, £225. Steve ☎ (0222) 21802 or 01-350 0340.  
**JBL L96** speakers (£700), £339. Fender Rhodes Stage 73, £219. Korg DDM220, still boxed, £119. The lot, £600. ☎ 01-360 5620.  
**MELOS DEI** analogue echo, mint condition, hardly ever used, never giggered, £50 ono. Mike Brooks, 21 Ridgy Lane, Luton, Beds LU3 2AD.  
**MICROPHONES** large selection, ring for prices, 20 reels 10 1/2". Ampex 406/456 1/4" tape, used one, £80. ☎ 01-472 7788.  
**MM 8:2** mixer, £110. John ☎ 01-980 2302.  
**MPC SYNC TRACK** £25. Sync-to-MIDI converter, £25. Tascam PE20 4x4 parametric £50. Pioneer RT707 mastering machine, £250. ☎ Bath 336273.  
**PROFESSIONAL 4-CHANNEL** multitrack tape deck like Teac 3340, excellent condition, £215, or swap Casio CZ101. ☎ 091-266 3433.  
**RAM 16:8:2 MIXER** brand new, unused, boxed £590 ono. Steve ☎ 01-409 2466 X270, work.  
**REVOX A77** stereo tape recorder with varispeed, £300 ono. Roland MC202 microcomposer with case, £90. Anthony ☎ (0707) 324079.  
**STUDIOMASTER 16:8:2** absolutely immaculate, boxed with manual, home studio use only, £975. ☎ Leeds (0532) 487698.  
**TASCAM 34** open reel, 4-track, excellent quality and condition, £650. ☎ Bloxwich (0922) 479414.  
**TASCAM 34** 4-track reel-to-reel, unused, £750 ono. Spare tape, Jim ☎ (0772) 34694 (Preston).  
**TASCAM 144** portastudio, new head, just serviced, foam case, £295 ono. Yamaha PF10 piano, offers. ☎ Sheffield (0742) 589068.  
**TASCAM 244** 8-months guarantee; CZS000, sound condition; DX27, 11 months guarantee. £1500 together, will split. Frank ☎ 051-645 6319.

**TASCAM PORTA ONE** adaptor, manual, strap and cardboard box, simply perfect. £325 oqno. Nick ☎ Huddersfield 549009.  
**TEAC A108** 2-track, £100. Tony ☎ 01-348 6394 after 6pm.  
**TEAC 3440** + RX9, songwriting use only, 50 hours, as new, will split. ☎ Bolton 47321.  
**TEAC 3440** vgc, home use only, boxed, manuals, £520. Stereo noise reduction (companding) £45. ☎ (05386) 680 (Staffs).  
**TEAC A3440**, RX9 dbx unit, new heads, both for £650 or consider interesting swap. ☎ 01-472 7788.  
**TEAC A3440** immaculate condition, limited home use, £600. M+M Studio fifty combo, as new, £100. ☎ Oxon (0844) 52144.  
**URGENT 1/2"** tape required, new or used. Steve, 20 Castle Irwell, Salford, M6 6DB. ☎ 061-764 0753, w/ends.  
**VESTA FIRE RV1** reverb, home use only, £100. ☎ 01-994 9415.  
**VESTA FIRE RV3** reverb, built-in gates & limiters, 4 months old, guaranteed, £150. Bruce ☎ Leeds (0532) 780954.  
**YAMAHA R1000** digital reverb, as brand new, home use only, crystal clear reverb at £360. David ☎ (0579) 62809.  
**YAMAHA R1000** digital reverb, mint condition, boxed, manual, superb quality, deliver London/Surrey, £310 ono. ☎ (0252) 721264.  
**TRUCKER 100W PA** complete with matching cabs(2), 4-channels (8 inputs), send/return jacks, reverb etc, vgc, £235 ono. ☎ 01-221 8978.  
**YAMAHA KS50** pair keyboard combos, hardly giggered, four inputs each, top quality sound, £500 pair. ☎ Brighton (0273) 685669.

## Personnel

**DRUMMER WANTED** for gigging band in Petersfield area. Rock, pop, anything played. Craig or Bruce ☎ (0730) 67167.  
**ENTHUSIASTIC** 4-track owning sixth former seeks UNPAID recording experience with professional studio and Croydon musicians. Daniel ☎ 01-657 0308.  
**FEMALE VOCALISTS** wanted by unusual band. Johnny ☎ (0203) 503042.  
**HOME STUDIO OWNER** available for part or full-time engineering sessions in London-based studio. Nick ☎ 01-360 5620.  
**KEYBOARD PLAYER** required by gigging jazz funk band, Cambridge area. Experience essential. Steve ☎ (0223) 835300 eves.  
**KEYBOARD PLAYER** required must be innovative, good technique, polyphonic, contributing ideas and work to band with potential. ☎ 01-472 7788.  
**NIICY** my love, about 1 1/2 months!!!! With all my love forever. J.  
**SOFTWARE ENGINEER** seeks freelance work, 21 years experience, hardware interfacing development, MIDI, ASM, C, Pascal, etc. ☎ (0252) 873876.  
**SOLO ARTIST** seeks Svengali, eg. Trevor Horn, Napier Bell or the person who manages Bucks Fizz. ☎ 051-677 3691.  
**WANTED** excellent guitarist and female vocalist to join songwriter/musician. Modern songs, record company interest. ☎ (0342) 23094.

## APPOINTMENTS

# KAWAI

**KAWAI (UK) LTD**  
**SYNTHESIZER/ELECTRONIC**  
**KEYBOARD**  
**SALES REPRESENTATIVE**

We require the services of a first class electronic keyboard sales representative. He must have a proven sales record and should be a good player, fully capable of effective demonstration of the fabulous new Kawai electronic keyboard range (world annual sales exceed £200,000,000). The applicant should be in the age group 25-40 years, be prepared to travel and get on well with people.

As befits working for one of the world's largest manufacturers of high quality musical instruments, an excellent salary, sales bonus and pension contribution will be paid. A company car and medical insurance will be provided.

Apply in confidence to:

**The Managing Director, Kawai UK) Ltd.,**  
**Woodland Point, Wootton Mount, Bournemouth.**  
**Tel: (0202) 296629**

# E&MM

## FREE CLASSIFIED

## ORDER FORM

Fill in the form to a maximum of 18 words (one in each box), and send it to: *E&MM Free Ads, Music Maker Publications, Alexander House, 1 Milton Road, Cambridge CB4 1UY.* Please print clearly in BLOCK CAPITALS. The ad must reach us on or before **Friday, June 6** for inclusion in the July '86 issue of E&MM - late arrivals will be printed in the next available issue.

Please include this ad in the ..... section.

1	2	3
4	5	6
7	8	9
10	11	12
13	14	15
16	17	18

# Classified

Rates for 1986: Lineage 35p per word (min 12 words);  
 Box No. 80p extra. Display: £15.00 per single cm. column.  
 All prices are subject to VAT at 15% All lineage  
 advertisements must be pre-paid. Closing date: 6 weeks  
 preceding cover date. Advertisements are accepted subject to the  
 terms and conditions printed on the advertisement rate card (available  
 on request).

## SAVE IT! AT City Music

Save your hard earned cash at City Music! Phone our Hot Line now for your **FREE FACT FILE** of instruments and City Music **SAVE IT** prices on **YAMAHA & ROLAND!**



### NOW IN STOCK

MT1X MULTITRACK .....	£449
SPX90 MULTI EFFECTS .....	£599
RX21L LATIN RHYTHM .....	£249
PF-70 PIANO .....	£899
PR-80 .....	£999
QX-21 DIGITAL REC .....	£259



### NOW IN STOCK

ALPHA JUNO 1 .....	£575
ALPHA JUNO 2 .....	£799
EM101 SYNTH MODULE .....	£275
HP5500 PIANO .....	£2200
TR505 RHYTHM .....	£225
TR707 RHYTHM .....	£499

### HOTLINES

LONDON AREA:  
 01-863 1841  
 DEVON/CORNWALL:  
 0752 673166  
 CHANNEL ISLES:  
 0534 78901

#### TO ALL DS3 AND DX1 OWNERS

Turn your sampler into a synthesiser!!  
 Frequency Modulation/Envelope/  
 Harmonic Drawing Fractal Synthesis -  
 A suite of software from The Music Suite.  
 £25.50 inc P&P. Cheques/POs to:  
 The Music Suite, Glanrafon House, Cenarth,  
 Newcastle Emlyn, Dyfed, Wales SA38 9JN

**CROFT ELECTRONICS** Repairs to professional keyboards, tape machines and amplifiers. 01-586 0357.

**SAMPLER TAPES** 2 high quality chrome cassette tapes specially formatted for sampling. The two tapes contain nearly 200 sounds - snares, bass drums, bass sounds, strings, orchestral, pianos, effects, choirs etc. Only £15 the pair including P&P from Metronome Studios, 5 Wimpole Street, Chatteris, Cambs. Tel: 03543 3949.

**160 SUPERB NEW SOUNDS** for DX21, DX27, DX100 owners. Better than presets! only £12.95 inclusive. DX Sound

## Loudspeaker Cabinet Fittings

From Adam Hall Supplies:

- Coverings & frets
- Flight case parts
- Celestion power speakers
- Rean jacks & fittings
- P&N stands

Send 30p PO/cheque for illustrated catalogue

ADAM HALL  
 SUPPLIES LTD  
 Unit M,  
 Carlton Court,  
 Grainger Road,  
 Southend-on-Sea  
 Essex



## JAZZ, ROCK & STUDIO MUSIC SUMMER SCHOOL

at the Guildhall School of Music & Drama,  
 London Sunday 27 July - Friday 1 August, 1986  
 Many activities including:  
**Intensive Recording Engineers** course in Professional 16-track studio plus work on Live Sound & Recording.  
 (Limited places available - apply NOW!)  
**Intensive Practical course** for all instruments, tutors inc:  
 Rod Argent, Henry Thomas\*, Geoff Nichols\*, Tim Stone, Chucho Merchan, Isaac Guillory etc  
 \*musicians from  
 BBC's 'Rockschool' programmes  
 Advanced Arrangers Workshop  
 Accommodation available  
 Contact:  
 Cheryl King, 2 Lordship Park, London N16 5UD  
 Tel: 01-800 5684 NOW!

## SOUND LIBRARY FROM 10p A SOUND!!!

Chrome cassette of  
 30 example sounds £3.00  
 Sampling Guide £1.00  
 Custom Sounds & supplies of  
 blank disks and tapes.  
 Send SAE for list.

## ADO

4 Auckland Court, London SE27 9PE

## OLD WHITE EXCITER

Very old, collectors item, home abuse only. Has unfortunately seen better days. Now just makes strange noises and gets hot.

Offers to:

**OLD BILLS MUSIC**  
 5 STOCKTON ROAD, VINE PLACE,  
 SUNDERLAND, TYNE & WEAR

Library, 1 Warwick Road, Eccleston, Nr Chorley, Lancs. Tel. 0257 452303.

**TR707 or TR909:** A fine collection of 192 modern dance beats/measures on **DATA-CASSETTE** including documentation for £16. Also 64 hard DX7 voices for **TX7** on **DATACASSETTE** for £20. Specifying machine, send cheque to **DEGREE ZERO**, PO Box 909, London SE22 80L

**YAMAHA CX5 OWNERS** turn your music computer into a powerful drum machine. 48 excellent drum and percussion voices plus 48 varied effects, all original, available on cassette. Phone 0202 690740 for details.



## M&A

### SERIES 4 MIXER

Series 4 modular mixer. 5-band EQ. 4-9 auxiliaries. True 16-bus architecture. low noise. expandable to 50/50/16/2. Modules from £75 (kit £55) plans and circuits: Series 4 £9.50. Send 17p for catalogue of modules, patchbays, S/H bargains, circuits.

K-Tek, PO Box 172A,  
 Surbiton KT6 6HN  
 01-399 3990

## SITUATIONS VACANT

### BEDFORDSHIRE EDUCATION SERVICE

**TVEI:** Scale 4 teacher. A new post is being advertised to develop the creative use of music technology and allied computer skills using a new mobile unit. An energetic teacher/composer/technologist is sought who will teach on the mobile unit in the Authority's five TVEI pilot schools. The successful candidate must be the holder of a current driving licence. The appointment is to commence from 1 September 1986 and is for two years in the first instance. Further details and an application form may be obtained from the Chief Education Officer, reference FETV, County Hall, Bedford.  
 The Council is an equal opportunity employer, and welcomes applications from members of ethnic minority groups, disabled persons and all other sections of the community.

## HIRE

### TS SOUND SYSTEMS

The Musicians Music Store  
 For all your requirements  
 as a musician!  
 Instruments, Backline, Effects, PA  
 (100-30K watts)  
 and most other things  
**HIRE OR SALES**  
**TEL: 061-624 7087**

### XENON HIRE

TASCAM 38 + RAM 16/4/2 1/2  
 FOSTEX A80 + 450 1/4  
 Also available:

1 Ensoniq Mirage sampler .....	£25
2 Yamaha DX7, Roland JK-8P .....	£18
3 Yamaha Rev 7, stereo reverb .....	£20
4 Yamaha RX11, SPX90 effects .....	£15
5 Revox, Aphex Exciter .....	£10
6 Simmons SDS9, SDS5 .....	£25
7 244 Portastudio, Yam rev .....	£10

Delivery available, no VAT  
**01-542 0675**

**E&MM CLASSIFIEDS**  
**PHONE LYNN COWLEY**  
**ON 0223 313722**

## ADVERTISERS INDEX

A1 Music .....	61
ABC Music .....	9, 31
Aces .....	22
Akai UK .....	69
Argents .....	11
Arthur Lord Keyboards .....	58
Bonnors .....	83
British Music Fair .....	41
Calrsbro Sound Centre .....	67
Casio .....	50, 51
Chase Musicians .....	1
DHCP Elec. .....	85
Decillionix .....	33
Dougies .....	81
Drawmer .....	65
Ensoniq UK .....	IBC
FD&H Music .....	33
Formula One .....	39
Future Music .....	6, 7
HBB .....	78, 79
Holiday Music .....	21, 39
Honky Tonk Music .....	5
Icon Designs .....	15
Kawai UK .....	95
Logitech .....	85
London Rock Shop .....	13
Monkey Business .....	63
Music Village .....	34, 35
Newark Tech .....	58
Oxford Synth Co .....	60
Quark Ltd .....	81
Rock City Music .....	42, 43
Rose Morris .....	IFC
Simmons .....	49
Skyslip Music .....	76
Soho Soundhouse .....	15
Sound Sales .....	67
Studiomaster .....	56
Supersoft .....	76
Swankit Inst. .....	39
Tantek .....	58
Telecomms .....	17
Thatched Cottage Audio .....	85
Time Machine .....	15
TOA .....	OBC
XRI Systems .....	33
Yamaha MI .....	74, 75



## Choosing the right sampling keyboard is an open and shut case.

There are lots of reasons why you see more Mirages on stage and in studios than any other sampling keyboard. Besides being affordable, the Mirage can perform musical tricks\* other keyboards can only envy.

The Ensoniq Sound Library now contains over 300 distinct sounds—from grand piano and strings to synthesizer and screaming electric guitar—all on fast-loading standard 3.5" diskettes. The Mirage can also sample any sound you can get a mike on, opening a whole new universe of sonic possibilities. And for serious samplers there are sound editing programs available for all major personal computers.

If your setup already includes a MIDI keyboard or controller, consider the Mirage Digital Multi-Sampler. It's designed specifically for MIDI performance and studio use and it's everything a Mirage is... without the keyboard.

Visit your authorized Ensoniq dealer today. See and hear why twice as many musicians have chosen the Mirage over all other multi-samplers combined.

\*If seeing a waveform in half or pulling an entire string section out of a disk sounds like your kind of magic, a Mirage can make you a wizard. The Mirage Digital Multi-Sampler retails for \$1395—the Mirage Digital Sampling Keyboard... \$1695.

**ensoniq®**

ENSONIQ Corp, 263 Great Valley Parkway, Malvern, PA 19355 □ Canada: 6969 Trans Canada Hwy., Suite 123, St. Laurent, Que H4T 1V8 □ ENSONIQ Europe, 65 Ave de Stalingrad, 1000 Brussels □ Japan: Sakata Shokai, Ltd., Minami Morimachi - Chu-O Building, 6-2 Higashi-Tenma, 2-Chome, Kita-Ku, Osaka, 503

# HOW FAR WILL YOU GO TO GET HIGH QUALITY ELECTRONIC INSTRUMENT MIXING WITH MIDI PATCHING?



## HOW ABOUT 19 INCHES?

Introducing the new D4 electronic music mixer from Toa.  
The first 19" rackmountable system incorporating a MIDI patch bay.

The highly versatile D4 – a four input stereo mixer –  
meets all your live performance and studio needs.

Combine it with the D4-E, a matching 6-input expander,  
to discover the full capabilities of a 10-input system.

For full technical details please write to or telephone  
Toa Electronics Limited.

Toa Electronics Limited, Tallon Road, Hutton Industrial Estate  
Brentwood, Essex CM13 1TG Tel: 0277 233882  
Toa Electronics Europe GmbH, Eiffestr. 74 D-2000 Hamburg 26  
West Germany Tel: (040) 2506091  
Toa Electronics Inc, 480 Carlton Court, South San Francisco CA. 94080  
U.S.A. Tel: (415) 588-2538  
Toa Electronics Inc, 10712, 181 Street, Edmonton, Alberta  
Canada T5J 1K8 Tel: (403) 489 5511

## FIFTY YEARS OF PROFESSIONAL SOUND

A.B.C. MUSIC, ADDESTONE, IESHER, KINGSTON; A.1 MUSIC, MANCHESTER, ALLBANG & STRUMMIT, LONDON W.C.2; AUDIO SERVICES, STOCKPORT;  
BILL GREENHALGH MUS.C, DEVON; BIRD SOUNDS, BELFAST; BOOTLEG MUSIC, EPSOM; CARLSBORO SOUND SERVICES, NOTTINGHAM, MANSFIELD,  
SHEFFIELD, NORWICH; CASH GUITARS, BOURNEMOUTH; CITY MUSIC, TORQUAY; COVENTRY SOUND SERVICES, COVENTRY; COOKES BAND INSTRUMENTS, NORWICH;  
CURLY MUSIC, LIVERPOOL; DOUGIES, NORTHWICH; E.S.S., BARNET; F. D. & H. MUSIC, LONDON W.C.2; FREEDMANS, LEYTONSTONE; GIG SOUNDS, STREATHAM,  
CATFORD; GUITAR WORKSHOP, BRISTOL; H.H.B. HIRE & SALES, LONDON N.W.10; J.S.G., BINGLEY; JONES & CROSSLAND, BIRMINGHAM; MALVERN AUDIO,  
WORCESTERSHIRE; MONKEY BUSINESS, ROMFORD, SOUTHEND; MUSIC CRAFT, EDGWARE ROAD, MUSIC STOP, WOLVERHAMPTON; MUSICAL EXCHANGES,  
BIRMINGHAM; MUZO'S, BIRMINGHAM; PETER BONNER, EASTBOURNE; PROJECT ELECTRONIC MUSIC, HOUNSLOW; ROCK CITY, NEWCASTLE; ROSE MORRIS,  
LONDON W.C.2; SESSION MUSIC, "OOTING" SOUND CENTRE, CARDIFF; SOUTHERN MUSIC, BRIGHTON; STUDIO 34, BRISTOL; TURNKEY SHOP, LONDON W.C.2.