

# MUSIC Maker

## ECHO UNIT

The latest instruments from Korg, Cutec, DeltaLab, Fostex, Ibanez, MXR, Ursa Major, JHS, Roland, Yamaha and Evans.

## SUPPLEMENT

# KEITH EMERSON

- ★ INTRODUCING THE MIDI
- ★ POWER AMP SURGERY
- ★ MICROCOMPOSING WITH ROLAND
- ★ HOME STUDIO ACTIVE SPEAKER
- ★ AMDEK FLANGER MicroMIDI

★ 12-PAGE ★  
GUITAR BUYERS GUIDE





PROGRAMMABLE POLYPHONIC SYNTHESIZER JU-60

5-octave, 6-voice polyphonic synth with a patch memory of 56 of your own sounds protected by a battery back-up (8 patches × 7 banks). Digital control oscillator (DCO) gives perfect tuning. 6VCFs, 6VCAs and 6ENVs. Facility to edit while you play. Tape interface. Patch shift system lets you shift patch numbers sequentially by a foot pedal. Other features include key transpose, auto arpeggio and octave transpose. Two different chorus effects for ensemble and tone cabinet effects. Can interface via OP-8 to MC-4 Microcomposer. (H-165 cable). A slave Juno-60 can be controlled through a master Juno-60 (H-172 cable.)



 **Roland**

Roland (UK) Ltd., Great West Trading Estate,  
983 Great West Road, Brentford, Middx. TW8 9DN.  
Telephone: 01-568 4578



# 12 MONTHS INTEREST FREE CREDIT



## CRUMAR STRATUS POLYPHONIC SYNTHESISER

The Crumar Stratus is the first polyphonic synthesiser that satisfies the needs of both the creative synthesist and the multi-keyboard player. It offers a powerful array of sound, from the explosive to the expressive. And yet the majority of control comes from the keys you play, not the dials you turn. The heart of this outstanding versatility is found in the six actively engaged Filters and Envelopes that span the keyboard. These generate true polyphonic capability, letting you depress as many keys simultaneously as you want. Most polyphonic synthesisers are limited by their 5 or 6 voice capability. Go beyond that and notes drop out. The Stratus also features unique trigger modes (both Multiple and Mono) which allow you to turn on the Oscillator Glide, reset the LFO delay and alternate between the sawtooth and the square waves all directly from the keyboard. You can retrigger a particular effect whenever a new note is played, even though other keys are depressed. With most other poly-synths you can only play one sound at a time, but with the Stratus you can play 3 separate sounds simultaneously from the polysynth section, organ section and string section for multilayering effects. There are other noteworthy qualities to the Stratus, like two independent oscillators, continuously variable and invertible envelopes and polyphonic resonances. But we suggest you experience this 'synful' sound for yourself at Chase. At a price under £500, it's a devilishly exciting way to burn up a stage. Instrument comes complete with carrying case.

R.R.P. £900  
CHASE PRICE  
**£499**

**INTEREST FREE CREDIT**  
Deposit **£55** EQUIVALENT TO ONLY  
12 Monthly Payments **£37**  
TOTAL CREDIT PRICE **£499** **£8.54** APPROX PER WEEK FOR 52 WEEKS

This superb offer allows you to 'pay as you play' without it costing you a penny in interest charges - and combined with the current price reductions gives you an unbeatable deal.

GET A WHOLE NEW SOUND AT CHASE FOR LESS THAN **£9 PER WEEK**

Come in and try a Crumar... and walk away with more sound per pound.

# CRUMAR

THE WORLD'S No1 SYNTHESISERS

## CRUMAR TRILOGY POLYPHONIC SYNTHESISER

Crumar's Trilogy combines polyphonic synthesiser, strings and organ sounds in one instrument, then lets you combine them in any proportion for limitless creative potential. Usually we do not think one single instrument should do everything or be everything to the professional musician, but with the TRILOGY natural events 'led' us to betraying this ideal. Accordingly, Crumar have created the most complete polyphonic synthesiser the musician would wish to have. Big, fat, aggressive, todays sounds combined with some unique features such as alternating waveform keyboard, trigger and invertible envelopes in a polyphonic format. Add to these, a comprehensive, easy to use bank of programmable presets (which may be altered to your own taste), together with two super string sections, and an organ section, and you have all the ingredients to make the TRILOGY live up to our highest expectations. Instrument comes complete with carrying case.



R.R.P. £1300  
CHASE PRICE **£799**

**INTEREST FREE CREDIT**  
Deposit **£91** EQUIVALENT TO ONLY  
12 Monthly Payments **£59**  
TOTAL CREDIT PRICE **£799** **£13.82** APPROX PER WEEK FOR 52 WEEKS

## CRUMAR COMPOSER POLYPHONIC SYNTHESISER

The Crumar Composer polyphonic synthesiser has four separate sections which can be used at the same time (1) The lead line solo synth section, (2) The polyphonic synthesiser section, (3) The organ section and (4) The String section. All these sounds in these sections can be varied, mixed and played at the same time to give a multi-layering of sound effects. THE LEAD LINE SOLO SYNTH section has facilities to create your own sounds together with seven presets which can be altered. The Free section includes an envelope generator: Attack - Decay - Sustain - Release. Filter: Envelope amount - Cut off - Resonance. This section also has a split keyboard facility and a lower or upper note parity together with a pitch wheel to bend notes up or down. Other facilities include: Portamento - Touch sensitive keyboard - Solo breath control allowing the player to control the envelope and the filter by blowing technique. THE ORGAN SECTION has four separate organ sounds. Separate volume and decay controls for percussion on 4 foot and or 2 2/3 foot. Separate sustain length control. Also has a built in Rotary Sound System with slow or fast selector. THE POLYPHONIC SYNTH SECTION: Fully polyphonic programmable synthesiser, which includes preset sections and free sections. Free sections include Envelope generator: Attack - Decay - Sustain - Release. Filter: Envelope amount - Cut off - Resonance. Oscillator 1: Transpose (1 octave down) - Wave form selector (saw tooth square). Oscillator 2: Transpose (1 octave down) - Wave form selector (saw tooth - square) - Detune. Cancel Poly Modulation controllable by wheel. Poly Breath Control. Allows the player to control the Envelope and filter by blowing technique. THE STRING SECTION has 16 feet and 8 feet sound which can be played individually or mixed. Tone of strings can be varied from Timbre controls. Separate variable controls for Crescendo and Sustain for phasing in effects. OTHER FEATURES include separate outputs for each of the four sections. A voice mixer section consisting of separate volume control for Solo Synth, Poly Synth, Strings and Organ sections together with a Master Volume control. Instrument comes complete with carrying case.



R.R.P. £1300  
CHASE PRICE **£799**

**INTEREST FREE CREDIT**  
Deposit **£91** EQUIVALENT TO ONLY  
12 Monthly Payments **£59**  
TOTAL CREDIT PRICE **£799** **£13.82** APPROX PER WEEK FOR 52 WEEKS

# ... STOP PRESS ...

**HUNDREDS MORE SPECIAL OFFERS (inc.)**

	R.R.P.	CHASE PRICE
<b>CRUMAR PIANOS</b>		
ROADRUNNER PIANO	£300	<b>£229</b>
ROADY PIANO	£400	<b>£279</b>
DP-80 PIANO	£1300	<b>£999</b>
BABY GRAND PIANO	£1799	<b>£1149</b>
<b>CRUMAR KEYBOARDS</b>		
PERFORMER ORGAN	£500	<b>£379</b>
MULTIMAN S/2 KEYBOARD	£800	<b>£599</b>
TOCCATA ORGAN	£500	<b>£329</b>
<b>OCTAVE SYNTHS</b> (Slightly shop soiled)		
OCTAVE CATS	£950	<b>£349</b>
OCTAVE KITTENS	£580	<b>£249</b>

# CHASE

LONDON SYNTHESISER CENTRE

**LONDON** 22 Chilton Street, off Euston Road, London NW1. Tel: 01-387 7626-7449.  
**LEICESTER** Union Street, off High Street, Leicester LE1 4HA. Tel: 0533 59634.  
**MANCHESTER** 58 Oldham Street, off Piccadilly, Manchester M4 1LE. Tel: 061-236 6794-5.  
**BIRMINGHAM** 10 Priory Queensway, Birmingham, B4 6BS. Tel: 021-236 8146.  
 OPENING HOURS Tues Sat (inc.) 10.00am - 5.30pm. Please note our stores are closed on Sunday and Monday. All goods subject to availability.



## KEYBOARDS

★ **ROLAND:** JUPITER 8, JUNO 60, JUNO 6 polyphonic synthesisers, SH-101, SH-09, SH-2, mono synths. 100M modular synth system. EP 6060 and Piano Plus el. Piano range. Microcomposer MC4B, digital sequencers, TB-303 bass line. Plus all the latest goodies detailed opposite.

★ **SEQUENTIAL CIRCUITS:** The amazing new PROPHET 600 now in stock and on demo. This incredible 2 VCO per note, 6-voice polysynth features a built-in polyphonic sequencer and midi interface. PROPHET 5 (rev 3.3) and PRO-ONE still going strong!

★ **KORG:** Latest from Korg is the new POLY 61 polysynth with 2 VCO per note and 64 memories. Modern design with digital control, chord memory, unison, arpeggiator. POLYSIX and MONO-POLY available from stock.

★ **CASIOMAGIC:** Casio never cease to amaze with their wide range of keyboards. The latest model, CT-7000 actually features multi-layer, polyphonic digital recording! PT-30, MT-11, MT-41, MT-45, MT-65, MT-70, CT-101, CT-202, CT-405, CT-501, CT-1000P, CT-602, PT-20, VL-1 all on display.

Plus: Rhodes, JVC, Yamaha, Memorymoog, Moog 'Rogue', Korg pianos. Please send 25p in stamps for colour brochures of our keyboard range.



★ **LONDON'S LARGEST ROLAND STOCKIST — IF ROLAND MAKE IT, WE SELL IT!**

★ The very latest models revealed at the Frankfurt International Music Trade Fair in February:

JUPITER 6: 6-voice polysynth with midi interface  
 JX-3P: Programmable, preset and polyphonic synth  
 PG-200: Synthesiser programmer for JX-3P  
 MC-202: Baby microcomposer: 2 voice with SH-101 miniature synth built-in

**NEW MODULES FOR 100M MODULAR SYNTH:** Portamento controller, 4-band parametric EQ, 4 x signal gate.

CUBE 40CH, 60CH: Cube combos with built-in chorus.

SST 40, 60, 80: Full range loudspeaker cabinets.

BOSS TU-12: Chromatic tuner with digital processing  
 ★ These new goodies complement the staggering amount of keyboards, amps, guitar synthesisers, Boss effects and Amdek computer peripherals from the Roland range.

★ The London Rock Shop will not only give you 'sound advice at a better price but also professional demonstrations of the very latest technology.

01-267 5381  
 01-267 7851

# London Rock Shop

Open 7 days a week.

26, Chalk Farm Road, London NW1.

## AMPS, CABS + COMBOS

★ **TRACE ELLIOTT:** The Rolls-Royce of bass amplification. We are recently appointed sole London agents for this great bass gear. Our stock includes preamp, power amp, combo (1 x 15" and 8 x 10") set-ups to choose from (subject to availability).

★ **AMPEG SVT BASS STACK:** 300 watts of pure valve power. Sole London agents for this recently updated tower of power.

★ **SESSIONETTE:** The boogie man's back relief! At last, a British made combo that packs a real punch with soft overdrive at low volumes and wails when you wind it up. 75 watt output with a Celestion 12" speaker that can handle the sting in its tail. At only £250 you've got to give it a try. Optional footswitch available for clean/dirty channel change. STOP PRESS: New 'SESSION' back-relieving bass combo due soon!

★ **ROLAND:** Cube 20, 40, 60, 100, 60B Cube 40k, 60 keyboard, 40ch, 60ch chorus Jazz Chorus JC 50, JC 120 Spirit 10, 15B, 30, 50, 30B, 50B Bolt 30, 60, 100 E/V Boss MA-1, MA-5, MA-15, MS-100

★ **OHM:** 'PUKKA' 60 watt bass combo with compression, 'TRAMP' bass and guitar practice combos under £100. New 125 watt keyboard mixer combo and 125 watt bass combo.  
 Plus: Gallien-Krueger, Carlsbro keyboard combos, V-amp, Bose, Hiwatt, Yamaha, Fender, Vox, Electro-Voice

## Fostex

★ **LONDON'S MUSICAL MULTITRACK CENTRE:**

X15: Baby multitracker, incredible at only £299!

250: Cassette multitracker with Dolby C noise reduction.

A-8: 8-track 1/4" tape recorder with Dolby C.

A-2: 2-track 1/4" tape recorder for master mix-down.

350: 8/4/2 multitrack mixer plus 3060 meter bridge.

3050: Digital delay (270ms) with modulation/flanging/chorus.

3030: Dual 10-band stereo graphic equaliser.

2050: 8 + 2 line mixer for sub-mix or monitor mix.

6301: 10 watt self-powered, portable mini monitors.

3180: NEW stereo reverb with 24ms pre-delay.

3070: NEW stereo compressor/limiter expander.

★ Simply turn up at our door and we will give you a full demo of how, why and what for... musical multitracking with Fostex may be easier than you think. For an outlay of around £500 (which includes Accessit accessories) the results are staggering with up to 10 sounds layered together. Why not let us show you how?

## GUITARS AND BASSES

★ **TOKAI REPLICAS:** You can't keep a good copy down! Mid-fifties and early sixties vintage guitars in original (Flamingo Pink, Sunburst) and new (Metallic Red and Blue) colours. Fretted and fretless jazz basses in Black, White and Metallic Red with Rosewood fingerboards. Prices start at around £200, tweed cases £59 extra. Why buy a copy when you can buy a lovingly reproduced replica?

★ **ROLAND GUITAR SYNTHESISERS:** GR-300 blue floor unit features switchable pitch changing (over 1 octave +), automatic Minimoog type vibrato, filter sweeps with variable attack/decay, built-in compressor for added susmin. Choice of four guitar controllers: G-202: with humbuckers (white, blue or red). G-303: Fitted neck, humbuckers (left-handed available). G-505: U.S.A. type with trem. (Metallic Blue, Metallic Red, Sunburst). G-808: Neck through body, humbucking pickups.

★ **IBANEZ:** 'Musician' and 'Roadster' active basses and 'Artist' guitars.

★ **ARIA:** New series SB bass and 'Cardinal' guitar.

Plus: Steinberger (when available), Fender Squier, Fender U.S.A., Gibson, Westone... selected models only.

## RECORDING EQUIPMENT

**IBANEZ:** DM 1000: 900ms delay/flanger/chorus.

**KORG:** SDD 3000: Digital Delay-1023 MS, 9 program memories.

**ROLAND:** SDE 2000: Digital Delay-670 MS, delay/flanger/chorus.

**CUTEC:** 1024 MS, Digital Delay with extra Sub Delay — new!

**MXR:** Dual limiter/compressor, pitch shift doubler.

**VESTA FIRE:** Rack-mount spring reverb.

**ACCESSIT:** Stereo spring reverb + controller.

**ACCESSIT:** Compressor/Noise gate/Dual sweep equaliser

**ACCESSIT:** Patch bay/Headphone splitter/Dual 15w power amp.

**YAMAHA:** Analog echo, chorus, flanger: E 1005, E 1010.

**YAMAHA:** Producer Series: Stereo mixer 6/2, Headphone amp.

**BEYER, SENNHEISER:** Range of studio headphones.

**AKG:** D80, D190, D310, D320, D330 microphones.

**SHURE:** Complete range of new PE series microphones.

**SHURE:** Undyne 517, Unisphere 588, SM57, SM58 mikes.

**SENNHEISER:** MD421-U + **AUDIO TECHNICA:** Microphones.

**AMPEX:** Grand Master 1/4" tape + **TDK:** cassette tapes.

**D.I. BOXES:** Lead testers: Whirlwind cables: Switchcraft plugs.

**DRUM UNITS:** Roland, 'The Kit', Mattel Synsonics.



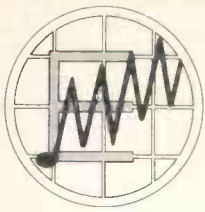

# Electronics & Music Maker

May 1983

Volume 3

Number 3

## SPECIAL FEATURES

**Keith Emerson** ..... 12  
Tracing past to future ventures with one of the world's keyboard greats, including: The first publication of his title music for 'Inferno', video and LP reviews and keyboard music to play.

**IMS Preview** ..... 8  
Some of the exhibits at this year's International Music Show.

**Guitar Buyers' Guide** ..... 51  
UK, American and Japanese guitars listed with model numbers and prices.

## contents

**Microcomposing with Roland**..... 70  
The new MC-202 MicroComposer examined in depth.

**Introducing the MIDI** ..... 92  
A look at the new, exciting Musical Instrument Digital Interface.

## REGULAR FEATURES

**Music Maker Equipment Scene** ..... 28. 31  
New products for the music business.

**Concert Review** ..... 67  
10 CC, LGT, Mainframe, Ian Boddy.

**Talking Shop** ..... 80  
Honky-Tonk Music.

**America** ..... 89  
New products from the States.

**The Electronic Keyboard Part 2.** ..... 96

## INSTRUMENT REVIEWS

**Echo Unit Supplement** ..... 33  
Ursa Major 8X32 Digital Reverb..... 34  
Korg SDD 3000 ..... 36  
Ibanez DM 1000 ..... 38  
Evans SE-810 and MX-99 ..... 39  
Fostex 3050 ..... 40  
Cutec CD-424 ..... 42  
DeltaLab Effectron ADM-64 ..... 43  
Roland SDE 2000 ..... 44  
Yamaha R1000 ..... 44  
MXR Delay System II ..... 45  
Echotec ET-100 and MX-99 ..... 47

**Tape Recorder**  
Fostex X15 Multitracker ..... 30

**Accessories**  
Technical Projects DI boxes ..... 64  
Boss TU-12 Tuner ..... 87

**Amplifier**  
Carlsbro Cobra 90 Keyboard combo 78

**Percussion**  
M&A K-1/B Percussion Synthesiser 82

**Keyboards**  
Yamaha Portasound MP1 ..... 100

## PROJECTS

**MicroMIDI** ..... 84  
Computer control for MIDI-equipped instruments.

**Amdek Flanger Kit** ..... 104  
Build and modify this versatile effects unit.

**Home Studio Active Speaker** . 106  
High quality monitors for the home recordist.

## NEWS

News & Events ..... 6  
Readers' Letters ..... 7  
Crossword Competition ..... 75  
Video Music ..... 102  
Classified ..... 112

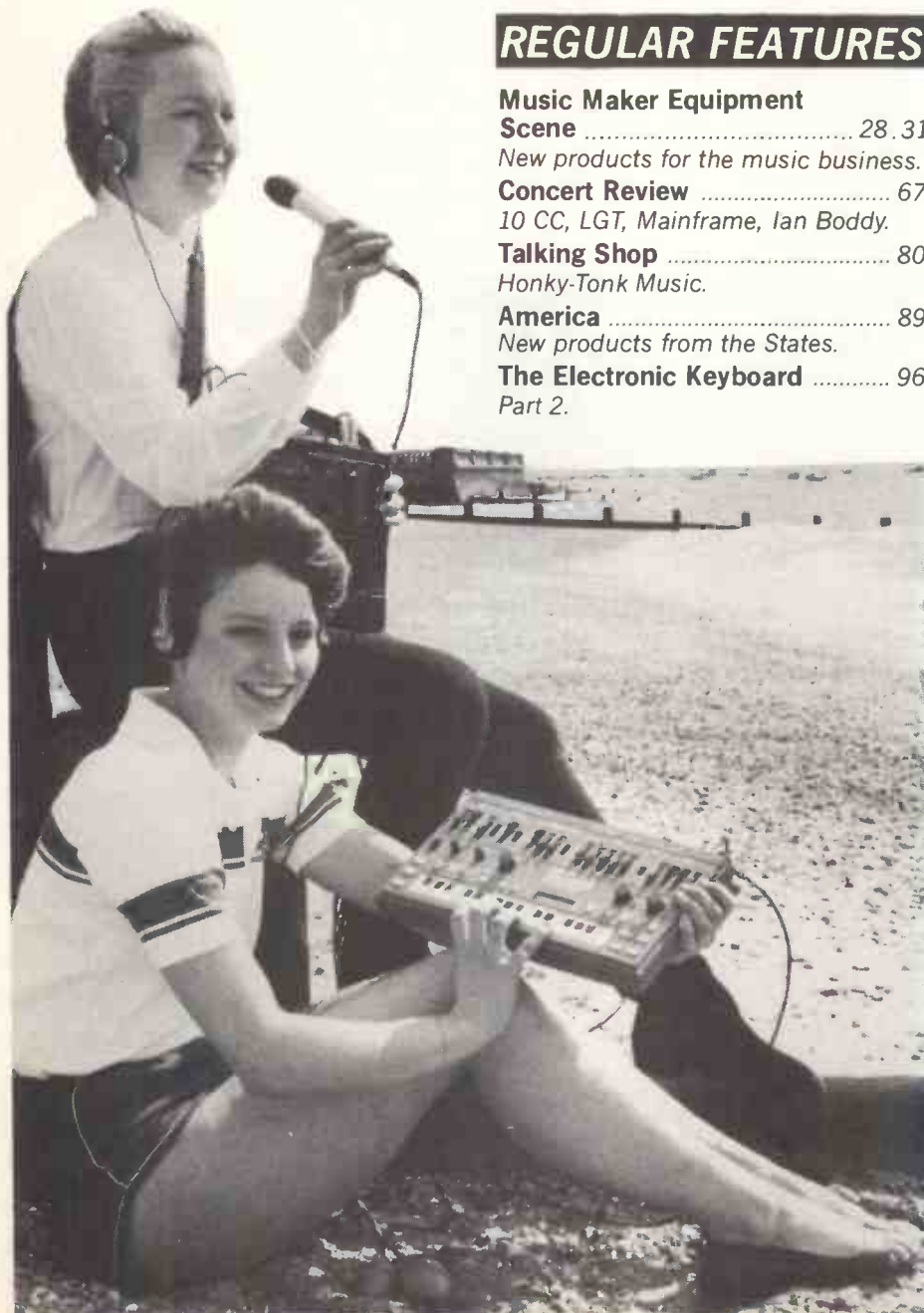

Portable music with Fostex X15 and Roland MC-202!

## EDITORIAL

A few years ago, carrying around a delicate micro, a synth and a multitrack tape machine on your own would have been quite a handful. Then came the big swing towards producing smaller keyboard instruments, followed by the first 4-track cassette recorder — the Teac Portastudio. Several companies including RSD, Fostex, Yamaha, Cutec and Clarion have also recognised this potentially lucrative area of home recording. Meanwhile, although micro chips were being used in a growing number of synths, there

was little chance of tucking the full system under your arm and taking it wherever you went.

Two new products are destined to open up this 'compose-record-anywhere' concept — the Roland MC-202 MicroComposer and the Fostex X-15 Multitracker. Both these instruments will be featured with other micro-composing machines in a special 3-day event in London during August, where I'll be giving practical lectures on this fast developing area of music-making.

Our MicroMidi link is the first interface of its kind to be made

available. Manufacturers of MIDI linkable instruments should contact us about our MIDI development program.

Finally, our last reader survey listed Keith Emerson as one of the most important musicians to interview, so you'll find Keith's valuable contribution quite lengthy, but very informative. As one of the great Rock composer/players of our time, his diverse writing skills can be an inspiration to us all.

MIKE BEECHER  
(Editor)

### Publisher

Terry Day

### Editorial & Production

#### Editor

Mike Beecher

#### Assistant Editor (Electronics)

Ken McAlpine

#### Assistant Editor (Music)

Mark Jenkins

#### Art Editor

Pat Haylock

#### Editorial Assistant

Toni Markwick

#### Secretary

Lin Barkass

#### Administration

Pauline Straker

#### Technical Assistant

Lesley Foster

### Consultants

#### Electro-Music

Keith Emerson  
Robert Moog  
Hubert Bognermayr  
David Ellis  
Tony Bacon  
Dave Crombie  
Alan Townsend  
Patrick Moraz  
Rick Wakeman  
Dave Bristow  
Bruno Spoerri  
Peter Maydew

#### Keyboard

#### Wind

#### Guitar

#### Percussion

#### Organ

#### Stage Equipment

#### Projects

Warren Cann  
Ken Lenton-Smith  
Ben Duncan  
Paul Bird  
Robert Penfold  
Paul Williams  
Peter Kershaw  
Jeff Macaulay  
Glenn Rogers

#### Microprocessors

#### Hi-Fi

#### Studio Technician

**Editorial Offices** 282 London Road  
Westcliff-on-Sea, Essex SS0 7JG  
Tel: (0702) 338878/338015

**Advertisement Manager** Tony Halliday  
Tel: 01-527 3376

**Advertisement Offices** Electronics & Music  
Maker, Hillcroft House, 16 The Avenue  
Highams Park, London E4 9LD  
Tel: 01-527 3376

**Publishers** Glidecastle Publishing Ltd  
282 London Road, Westcliff-on-Sea  
Essex SS0 7JG

**Distributors** Spotlight International  
Spotlight House, near 1 Benwell Road  
London N7 7AX  
Tel: 01-607 6411

**Printers** Thomas Reed Printers Ltd  
(Sunderland and London)

**Typesetters** Quillset (Southend)

**Subscriptions Rates for 12 issues:**  
UK £15.50; Europe & Overseas (Surface)  
£16.20; Airmail (and Europe) £23.50;  
Airmail (outside Europe) £37.50.

**Binders** £3.95 inc p&p. Overseas add 35p extra  
covered by bankers draft in pounds sterling.

#### Copyright

All material is subject to world wide  
Copyright protection, and reproduction or  
imitation in whole or part is expressly  
forbidden. All reasonable care is taken to  
ensure accuracy in preparation of the  
magazine but Glidecastle Publishing Ltd  
cannot be held legally responsible for its  
contents. The Publishers cannot assume  
responsibility for the return of unsolicited  
manuscripts, photographs, artwork or projects.  
Permission to reproduce printed circuit board  
layouts commercially or marketing of kits  
must be sought from the Publisher.  
©Copyright 1983 Glidecastle Publishing Ltd.



# ALLAN-GORDONS

OF WALTHAMSTOW. Tel.: 01-520 3706/8642  
32 MARKHOUSE ROAD, WALTHAMSTOW, LONDON E17



### AMPLIFIERS

Marlin 150W rev PA ..... £199  
Marlin 300W rev PA ..... £280  
Cobra 90W rev PA ..... £158  
Keyboard 90W head ..... £158  
Keyboard 90W combo ..... £209  
Bass 90W head ..... £124  
Bass 90W combo ..... £199  
Lead 90W combo ..... £199  
Stingray Lead Combo ..... £290  
Stingray Bass Combo ..... £249  
Stingray Bass Head ..... £149  
Pro Bass Head ..... £225  
Echo Pedal £98 ADR1 £259



### ELECTRIC GUITARS

Thunder I Guitar ..... £103  
Thunder I Active Nat. .... £119  
Thunder I Active  
Gloss ..... £130  
Rainbow I Semi-Acc. .... £174  
Thunder IA Bass Nat. .... £119  
Thunder IA Bass  
Gloss ..... £127  
Thunder IIA Bass ..... £226  
**EX DEMO'S**  
Thunder II ..... £109  
Thunder III ..... £169  
ALL MODELS AVAILABLE  
AT DISCOUNT PRICES



### ELECTRIC GUITARS

Squier Strat 57 ..... £207  
Squier Strat 62 ..... £214  
Squier Tele 52 ..... £179  
Squier Prec. 57 ..... £198  
Bullet inc. case ..... £144  
Bullet bass inc. case ..... £193  
**ACOUSTIC GUITARS**  
F65 ..... £75 F75 ..... £99  
Californian Malibu ..... £129  
**AMPLIFIERS**  
Twin reverb ..... £475  
Princeton II rev ..... £258  
Fender 75 ..... £279



### SPEAKER SYSTEMS

#### BASS SPEAKER CABS

1x15 100W £91 150W £108  
2x15 200W £142 300W £175  
2x10' 200W top cab ..... £126

#### PA CABINETS

1x10 + horn ..... £95  
1x12 + horn ..... £90  
3-way systems ... from £195

#### CAB WITH EV DRIV.

1x15 200W £170 2x15 £295  
2x10 300W £230 2x12 £275

### Microphones

Shure 517SA Hi Imp £24.50  
Shure 517SB Lo Imp £24.50  
PE15L Lo Unisphere ..... £45  
PE15H Hi Unisphere ..... £45  
Shure SM57 Lo Imp ..... £69  
Shure SM58 Lo Imp ..... £89  
AKG D80 Lo Imp ..... £20  
AKG D190E Lo Imp ..... £42  
Electro-Voice PL88 Hi ..... £60  
Electro-Voice PL88 Lo ..... £57  
Boom Stand ..... £18

#### CABLES EXTRA

15' Mike Lead ..... £6.50  
15' Mike Lead Heavy ..... £8  
25' Mike Lead Heavy ..... £11



Noise Gate ..... £45.82  
Distortion plus ..... £35.86  
6 Band Graphic ..... £46.65  
10 Band Graphic ..... £79.74  
Micro Flanger ..... £61.10  
Omni ..... £439  
**COMMANDE SERIES**  
Stereo Chorus ..... £48.10  
Stereo Flanger ..... £51.93  
Overdrive ..... £31.20  
Sustain ..... £38.66  
Pre-amp ..... £28.40  
Time Delay ..... £74.34  
Phaser ..... £42.61



BF2 Flanger ..... £63  
CE2 Chorus ..... £59  
CE3 Chorus ..... £64  
CS2 Comp/Sustain ..... £47  
DS1 Distortion ..... £41  
SD1 Super O/D ..... £41  
OD1 Overdrive ..... £44  
PH1 Phaser ..... £49  
DM2 Delay ..... £83  
DR55 Dr Rhythm ..... £83  
BCB6 Pedal Case ..... £47  
KM400 4CH K/Mixer ..... £56  
KM600 6CH K/Mixer ..... £94  
KM60 6CH ST Mixer ..... £206



### EFFECTS PEDALS

FG-01 Flanger ..... £55  
CH-02 Chorus ..... £52  
PH-03 Phaser ..... £39  
CO-04 Compressor ..... £37  
OD-05 Overdrive ..... £35  
CE-22 Chorus Ensemble £94  
AD-33 Analog Delay ..... £114  
PH-44 Stereo Phaser ..... £70  
DS-06 new distortion ..... £43  
Regulated power supply. £25.  
Pedal Board complete  
with 5 pedals ..... £265

## MAIL ORDERS

Carriage & Packing Charges

Pedals £2, Mikes £2, Carlsbro £12

Guitars £12, Speaker Cabs

(Phone)

OR PHONE

AN ORDER

MON-SAT

10-6



FREE catalogue. SEND TODAY

MR/MRS/MISS ADDRESS

MIKES  FENDER  PEAVEY   
ALLAN GORDON CABS   
CELESTION  PEARL   
BOSS  WESTONE   
CARLSBRO   
MXR



# CASIO®

## A great deal, from a name you can trust

- Free trial for two weeks
- Separate mail order warehouse for an efficient 24 hour service
- 18 months full guarantee
- All models on demo in our West End store
- Interest free credit available on all items



**PT-20** Monophonic with seven digital preset voicings and 508 note sequencer. 12 pattern rhythm machine. Chord keys. 99 different chords available. Sequencer records lead line and chords. Built in speaker. Line out jack. Pitch control. Auto power off function.  
**Our Price £49**  
 RRP £59 Inc. P+P

**PT-30** A transposable monophonic mini-keyboard with eight digital preset voicings and a cassette interfaceable 508 note sequencer for lead line and chords. Sequencer has sub-group and edit facilities and sequences can be dumped in 45 seconds using the optional TA-I cassette interface. LCD display showing notes and transpose level. 12 pattern rhythm machine. 99 different chords available. Chord keys. Built in speaker. Line out jack. Pitch control and auto power off function. **Our Price £69**  
 RRP £79 Inc. P+P



**MT-41** 3 octave, 8 note polyphonic with 22 remarkably faithful preset voicings, including one of the best electronic piano sounds available today plus brass, strings, flutes etc. 6 pattern rhythm machine with fills. Bass keys give 4 octave capability. Vibrato and sustain. Auto bass accompaniment. Pitch control. Built in speaker and line out jack. **Our Price £89**  
 RRP £99 Inc. P+P

**MT-65** 8 note polyphonic with 20 digital preset voicings and 2 variable envelope functions used separately to give variation to existing voices, e.g. slow attack piano, key click violins, or together for unique new sounds and cross modulation effects. Also: vibrato, delayed vibrato, sustain and reverb effects. 12 rhythm drum machine with BD, tom, snare, HH, cymbal and claves. Chord accompaniment. Pitch control, built in speaker and line out jack. **Our Price £149**  
 RRP £175 Inc. P+P



**Massive investment in research and development has resulted in a sound quality/reality unavailable in equipment many times the price.**

... the first comparison that comes to mind is the PPG Wave's digital effects. Obviously the same degree of control over the effects doesn't exist, but the unusual envelopes and internal movement of the sounds bear some resemblance to a machine which costs about 20 times the price of the MT-65, and that can't be bad...

ref: EMM Mar '83 on the MT-65

**CT-7000**  
 5 octave Full size keyboard. 20 sounds including piano, strings, brass, organ and vibes. Built in 3 track sequencer. 12 pattern rhythm machine 7 different stereo effects. Cassette dump for sequences. Vibrato and sustain  
**Our Price £525**  
 Inc. P&P

**CT-1000P**  
 Full size polysynth with variable feet, envelope and modulation, 127 note arpeggiator/sequencer.  
**Our Price £325**  
 Inc. P+P

**CT-202**  
 4 octave full size keyboard, 49 voices. Vibrato, sustain. Gig machine.  
**Our Price £275**  
 Inc. P+P

**MT-45**  
 8 note poly. 4 octaves, (1 1/2 for melody 2 1/2 for chords). 8 sounds. Accompaniment and arpeggios. Vib, sus, 8 rhythm patterns.  
**Our Price £99**  
 Inc. P+P

### Accessories

CS-D Double Stand	£35.00	TA-I Cassette interface	£19.50
CS-H Stand	£30.00	SP-E Sustain Pedal	£25.00
VP-E Volume Pedal	£25.00	MT Hard Case	£ 6.50
		CT Hard Case	£40.00

### Additional Keyboards

MT-11	£49.00
VL-1	£35.95
VL-5	£79.95
CT-501	£325.00
CT-602	£345.00
CT-101	£195.00
MT-70	£199.00
MT-405	£ 275

- \* Money refunded if not satisfied after two weeks
- \*\* Free Securitor or Royal Mail 24 hour delivery on all items.
- \*\*\* Phone or write for further details.

**Soho**  
**SOUNDHOUSE**

**Soho Soundhouse Mail Order**  
**Freepost 38**  
**London**  
**W1E 6QZ**

NO  
 STAMPS  
 REQUIRED

24 hr. Telephone Ordering Service 01-434 4456

Name \_\_\_\_\_ Address \_\_\_\_\_ Tel \_\_\_\_\_

To: Soho Soundhouse Mail Order Freepost 38 London W1E 6QZ

Please send me Model No(s) \_\_\_\_\_

I enclose cheque/ postal order for £ \_\_\_\_\_

debit my Access/Visa account No. \_\_\_\_\_

# News & Events

## Musicians

**Supertramp** announce their first line-up change in eight years with the departure of Roger Hodgson for a solo career. The band are to play live in June, however: full details from A&M Press Office on 01-736 3311. **Cliff Richard**, featured in E&MM Dec. '82, has a new LP on EMI called "Dressed for the Occasion". Recorded live at the Royal Albert Hall with the London Philharmonic Orchestra, it features Cliff with Graham Jarvis (drums), Mark Griffith (bass), David Cooke (synths) and Steve Gray (pianos). The **Klaus Schulze** Tour dates have at last been finalised, and are Wednesday 20th April, Lewisham Concert Hall (01-690 3431/6512); Thursday, 21st April, Manchester Hacienda Club (061-236 5051); Friday, 22nd April, Hatfield Forum (96-71217); Tuesday, 26th April, Coventry Cathedral (Coventry 29553/27597). A possible additional date is Guildford University, Saturday, 23rd April. Guest musician will be Rainer Bloss, and Schulze's 'Audentity' album is now available on the Illuminated label. Further information from what is now the official Schulze Fan Club at Inkeys, 50 Durell Road, Dagenham, Essex RM9 5XU. **Flowmotion 4** is available with articles on Psychic TV, Neutronium, Ron Geesin, Throbbing Gristle and more, in addition to album reviews, news and comment. Flowmotion cassettes and their vinyl compilation album are also detailed. Contact 1 Bentley Grove, Meanwood, Leeds LS7 4AT; price 50p. **Tangs for TOTP?** Music and Video Week have recently introduced a European singles chart, based on returns from various continental radio stations. Recently a run-down of the chart was featured on BBC-1's Top of the Pops, and it is hoped that the section will be expanded in the near future. Since many of the more interesting European groups tend to figure in the chart — Tangerine Dream's 'Tatort' theme music was one notable example — it's possible that the present dreary content of TOTP will be enlivened over the next few months. **Kraftwerk** tour dates in support of their new album 'Techno-pop' are London Hammersmith Odeon, Thursday & Friday, 16/17 June, and London Lyceum, Sunday & Monday, 19/20 June. EMI Press Office, Tel. 01-486 4488. TDK's **Battle of the Bands** was won on Saturday 9th April by Kent Soul band Sugar Ray Five. Despite good performances from more forward-thinking groups such as Moscow and Umo Vogue, the obvious chart potential of the band following the success of Dexy's Midnight Runners resulted in a near-top score. **Jason Martz** is selling his

popular Mellotron/Electronics LP 'The Pillory' via Neoteric Music. Send 5 dollars 99 plus 3 dollars postage to Box 41436, Los Angeles, Ca. 90041, USA. **The Brixton Ace**, latterly the venue for Whatever You Want appearances of Depeche Mode, Fad Gadget and many others, continues to promote a wide variety of musical styles. Punk and reggae dominate in the next few weeks, with further details available on 01-274 4663 or 737 2886.

## Business

**Circolec** have moved to larger premises at Unit 4, Windmill Trading Estate, Comonside East, Mitcham, Surrey. Apart from a construction service for Powertran kits they are service engineers for Videomaster TV games, and undertake PCB assembly, circuit design and PCB artwork layout, prototype manufacture and development and other services. Their new telephone number is 01-646 5686.

## Computing

**Currah Computer Components** of Hartlepool are expanding with three new members on their technical staff. Products include a VOICE synthesiser, the 220M mini-digital cassette recorder and a range of hardware accessories for several home computers. Contact Robin Ashby, 0632 323535. **Tandata** have formed a new design consultancy intended to recruit a dozen staff for internal and external research projects. Additionally they have appointed Keith Allan, previously of Zycor, as Technical Manager. Further details 01-546 5144. **Epson** have introduced the new 192K 'QX 10' desktop computer, and provided us with another opportunity to publish a photo of Miss World Mariasela Alvarez Lebron. At the QX10's launch she is pictured with comedian Frank Carson, Epson Sales Manager John Patterson, and the computer itself which is backed by software from Peachtree and Pearl. Further details 01-900 0466.

## Dates

Leeds Electronics Show, 5th-7th July, Leeds University 0799 26699. Music Scene 83, 27th May-1st June, Bristol Ex. Centre, Bristol 572624. Cable Systems, 10th-12th May, Wembley Conf. Centre 09274 28211.

## Instruments

**Trident Audio** are to cut costs of their prestigious mixer range in 1983. Apart from the Trimix, 80B and 70 ranges, Trident handle the VFM now with Series 80 styling, at £999 for the 16.4.2, £1150 for the 16.8.2 and £1800 for the 20.8.16. Prices are

Miss World and EPSON QX10.

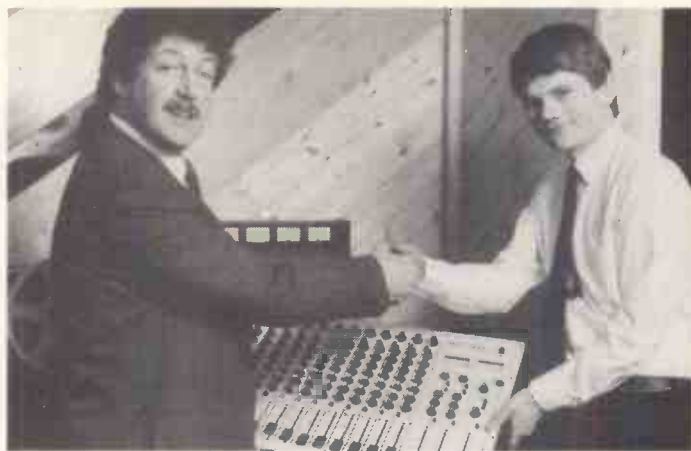

Ian Frost receiving his 1221 mixer.

exclusive of VAT. Details from Alexander Public Relations, Tel. 01-693 4880. **Roland UK** are raising prices as the pound falls against the yen. New prices including VAT put the SH-101 at £299; the Juno 6 at £799; the Juno 60 at £1199; the Jupiter 6 at £2250; the TR606 Drumatix at £250; the TR808 at £765; the GR300 Guitar Synth at £600, and MC4B microcomposer at £1999. **Soundtracs** announce their S series mixers, bringing the total number of models available to 13. Recently Soundtracs have supplied Swedish National Radio, Stockholm, with a 24/4/2 model against both American and Swedish opposition, and continue to expand their operations, now covering 28 countries. The new S series product comprises 16/2/1, 16/4/2 and 24/4/2 designs, with quasi-parametric EQ, balanced inputs, inject point on all inputs and subgroups and up to 8 track return monitoring. For further details on the S series and the Omni range, contact Soundout Labs Ltd, 91 Ewell Road, Surbiton, Surrey KT6 6AH. Tel. 01-339 3392. **Fane Acoustics** have formed a new Professional Products Division to deal with their up-market chassis loudspeaker and audio devices range. The new division will help to keep pace with American, European and Far East demand, and will instigate research in new areas. A brochure is available from Fane Acoustics, Pro Products Division, 286 Bradford Road, Batley WF17 5PW. Tel. 0924 476431. **Moog Music** have announced a polyphonic sequencer and computer interface retrofit for all existing MemoryMoogs. The polysequencer will be contained within the instrument, and stores and chains both sequences and program changes. Moog have also decided to adopt the MIDI system for which we publish the Micromidi interface this month. The MIDI allows the Memory-Moog to interface with any other MIDI-equipped instrument or with a computer, for which extensive software will be available. Further information from your local Moog dealer. **Denon** hi-fi equipment is now to be distributed by Hayden Labs. The range includes five cassette decks, a



Klaus Schulze.

range of amps from 40 to 100W, two tuners, a 'distinctive' range of turntables, and a selection of cartridges and cassette tapes. Further details Tel. 0753 888447. **AKG** continue to expand their range of microphones with the D125, intended to handle high sound levels without distortion, and 'The Tube', a condenser design using a 6072 electronic valve as featured in the popular CK12 mic. Further details from AKG, Brunhildengasse 1, A-1150 Vienna, Austria, or local dealers. **CLEM**, the Contact List of Electronic Music, is going to press at the end of April. Send brief details of your musical activities for free entry, or contact at the following address for subscription details; CLEM, PO Box 86010, North Vancouver, British Columbia V7L 4J5, Canada. **BAEC**, the British Amateur Electronics Club, has its April newsletter out now, and plans an exhibition in Penarth in July. Details from Cyril Bogod, 'Dickens', 26 Forrest Road, Penarth, South Glamorgan.

## Events

**Music Scene '83**, to be held from May 27th to June 1st in Bristol Exhibition Centre, features displays from leading instrument manufacturers and retailers such as Biggles Music, laser displays, guitar workshops, live music and more. Admission is £1.50 Saturday-Monday and £1.00 on the other days. Details Bristol 572624. Winner of our recent **Allen & Heath mixer** competition was Ian Frost of Romiley, Cheshire. He intends to use the 1221 design with his group 'Straight Line', and is seen here at the presentation with AG Cheetham, MD of Audio Services who kindly made the presentation on behalf of E&MM and AHB.

## IN BRIEF

**Don Larking Audio Sales** have the complete contents of a 24-track studio for sale at a bargain price. In addition to Studer A80 24 tracks and Harrison 36/36 console there's a CMI Fairlight, Jupiter 8 and Steinway grand piano included. For further details and a list of items in the package, with a current value in excess of £220,000, phone 0582 450066.

**Laserium** at the London Planetarium has a new programme based entirely on music by The Beatles, running on Friday, Saturday and Sunday evenings throughout the summer. Laserock 2 is performed on other evenings, featuring music by Pink Floyd, The Tubes, Bill Bruford, Gary Numan, Genesis, Led Zeppelin and others. Recorded details on 01-935 3726.





# Readers Letters

Send to: Readers' Letters, Electronics & Music Maker  
282 London Road, Westcliff-on-Sea, Essex SS0 7JG.

## Fairlight

Dear Sirs,

I read with interest the March issue of your magazine and in particular, an article by Francis Monkman and his comments on the 'Fairlight Computer Musical Instrument' (C.M.I.) and Synclavier II.

We are grateful for this comment that the "Fairlight is far more pleasing as a whole package", but he did make some other points on which I would like to comment for your readers' interest.

Conceptually, 'The Fairlight' is a "Computer Musical Instrument" (C.M.I.) as distinct from solely a Digital Synthesiser like the Synclavier II. This implies fundamental differences in the systems design philosophy and hardware requirements.

FM based digital synthesisers must do very high speed calculations in real-time to achieve complex synthetic sounds and do not require large amounts of memory to store sounds. The C.M.I. on the other hand manipulates very large amounts of previously computed (or sampled) digitally stored sound waveform. This is then blended and manipulated in real-time with less computational overhead than is necessary for digital synths. This concept allows ANY sound to be produced in real-time because any waveform, regardless of complexity can be stored in the (large) Random Access Waveform memory. Here, waveforms can be further manipulated, blended with other sounds, re-drawn, re-computed and so on. On playback, groups of waveforms can be manipulated and blended in real-time, giving a very high degree of real-time sound control.

From a practical point of view "Natural" (psycho-acoustically organic-like) voices cannot easily be synthesised in real-time even using 16 bit mini-computers and this is apparent when one listens to the sum total of sounds available on these type of machines.

Where the goal is to produce complex Synthetic type sounds, the Digital Synthesis technique is efficient and allows effective real-time control. Variations of this technique are used in Synclavier I and II, Synergy, Yamaha GS-1, Crumar Development System and Prism. These systems are (to varying degrees) capable of producing dozens of "Natural-like", sounds including a variety of classical and popular instrument sounds. From a practical viewpoint, these "Natural" sounds are not simple to design, and are normally supplied in the sound library from the manufacturer.

Systems using Waveform manipulation for polyphonic production of sampled sounds are the Fairlight, P.P.G. Waveterm (although I am not sure if this is functional yet) and the Emulator. Synclavier II has optional hardware which digitises sounds onto a winchester disc drive in real-time. This can be played back monophonically under speed control (pitch) from the keyboard. However, this does not distract from the fact that Synclavier II is primarily an FM

synthesiser; control functions are for the most part inoperative when using sample to disc, because the latter is in effect behaving as a high quality digital tape recorder with pitch control.

On the technical side, 'The Fairlight C.M.I.' contains four microprocessors and two of them are configured to operate on opposite clock-phases into common memory which, in this context, provides ample processing power for manipulating waveforms.

Regarding Mr Monkman's query about synthesising something like an analogue filter sweep on the 'Fairlight'. I must admit that our promotional literature doesn't mention capabilities of this type, though you can be assured it is a trivial matter. It is done using fourier waveform computing techniques and allows up to 32 "harmonics" to be individually controlled by separately "drawn" complex envelopes. The "sweep" can be manually controlled in real-time by using one of the live controllers to selectively move through the waveform.

I hope this information maybe of interest to your readers, and we continue to enjoy the unique technically oriented musical format of your magazine.

Kim Ryrie  
Managing Director  
Fairlight Instruments Pty. Ltd.

## Emersonia

Dear Sirs,

I read with interest that Keith Emerson had joined the magazine's team of consultants. I have enjoyed his work as a composer and synthesist over the years and would be interested in having some information about his instruments and future work. I would like to know what modules are included in his Moog Modular system. I read elsewhere that he had some custom modules built by Robert Moog. I would like to know what keyboards were used on 'Inferno' and 'Nighthawks' and which tracks on 'Nighthawks' featured the Fairlight C.M.I. I would also like to know his opinions on the C.M.I. I was surprised to find that his latest album 'Honky' was more in the style of later E.L.P. music and would be interested to know if he plans performing any of this music in future. I would also be interested in obtaining a copy of his Piano Concerto (manuscript). Is this published yet? I hope these questions can be answered either in an interview or in an open letter from Mr Emerson. He has, undoubtedly, been a great influence on many synthesists and keyboard players.

I would also like to say thank you for covering such a wide range of synthesiser music in the magazine. I especially enjoy the articles on more advanced analogue synthesis. With the growth of digital equipment it seems that analogue modular synths are being forgotten. I for one will continue using them because I feel they offer some things and elements

of control that a digital synthesiser cannot. Digital synthesisers seem capable of purity and clarity of sound but do not seem capable of a certain amount of unevenness and 'dirt'. They both have their place in today's music. I was glad to see you published the review of the R.S.F. Kobol Expander. It is a pity R.S.F. synths aren't more widely known as they offer tremendous possibilities for a reasonable cost. Any young synthesist looking for more 'modular' sounds would do well to check out the R.S.F. range. Their Expander II is particularly interesting and features Gate Delay, another ADSR, Ring Mod., another LFO, mixer and another voltage processor. Also the programmer may be used as an analogue sequencer. Both these items are around £200.

Anyway, thanks for a good magazine.

Tim Lewis  
Cardiff

*Most of your questions on Keith Emerson's career should be answered by this month's special feature. We appreciate the concept of modular analogue synthesis and have plans in this direction for some time in the future.*

## Courses

Dear Sirs,

As the Course Director for a number of T.E.C. Courses concerned with education for the music industry I would like to take advantage of your offer to pass such information to your readers. (March, Electronics & Music Maker.)

The Department of Musical Instrument Technology at The London College of Furniture situated in London's East End in Commercial Road, tutors a number of full-time courses in Musical Instrument Technology, of which one is concerned with electronics. A T.E.C. Diploma course in Musical Instrument Studies followed by a T.E.C. Higher Diploma course in Musical Instrument Technology covers three major subject areas as Electronics, Keyboard Instruments and Stringed and Wind Musical Instruments. The courses provide a broad supporting education with specialisms in Modern Fretted Instrument Making, Early Fretted Instrument Making, Piano Technology, Early Woodwind, Violin, Early Stringed Keyboard Instruments and Electronics.

The electronics group are given a basic electronic course in the Diploma with a menu consisting of Mathematics at three levels, Electrical Principles at two levels and Electronics at two levels. Additionally a third level unit known as 'Electronic Techniques in Music' provides an 'appetizer' for the greater deployment of electronics to musical applications which is to be found in the Higher Diploma. Subjects such as Musical Science, Acoustics and Electro-acoustics are included in the supporting units, together with other units of Digital Techniques and Integrated Circuits. The Diploma and Higher Diploma Courses are each of two years' duration.

One day per week is given to specific applications of electronics to the music industry in the Higher Diploma and additional project work is encouraged.

The use of a 16 track recording facility and a Fairlight CMI in company with many effects units and synthesisers in the department, enable a fine electro-acoustic music facility to be beneficial to the many talents of our students.

It would be true to say that the greater majority of our past students

are now enjoying practical and musically orientated applications of electronics mostly in Europe and the UK, in work such as Development for Production, Studio Maintenance, Musical Industry Service, Broadcasting-technician services and sometimes copy for E&MM!

We in the Department of Musical Instrument Technology at the London College of Furniture, 41 Commercial Road, London E1 1LA will be pleased to respond to any of your readers' enquiries.

Robert Gould  
Course Director  
London College of Furniture

Dear Sirs,

With reference to the letters from Iain Dunn, Alastair Johnson, and P. W. Yendle in the March issue of E&MM, your reply omitted to mention the B.Mus (Tonmeister) degree at the University of Surrey. This course is specifically aimed at the recording industry and attempts to produce musically educated sound engineers.

Emphasis is placed on 'hands-on' experience and recordings are made within the University (the Music Dept gives weekly recitals) and also on location using the mobile facilities. In addition, the department has an 8-track studio including Sony digital equipment.

Those interested in computer music are catered for by an Apple II with ALF 9-voice and Mountain Hardware music systems with a second Apple and an Alpha Syntauri system on order. Tuition is provided by Robin Maconie, part-time lecturer and researcher in computer generated melody.

The course lasts four years with the third year spent working in industry. Competition is stiff with only eight places available each year and entry standards are high; A-levels of BBC are required in Music, Physics and Maths respectively.

Further details are available from the Music department.

Roger King  
Guildford

## Interfacing

Dear Sirs,

I am a keen sixteen-year-old keyboard player and have a Moog Prodigy and Casio CT-1000P. Could you please tell me if it is possible to increase the range of sound by using either as a 'slave' on the other? I have already tried putting the Casio in the 'Keyboard-in' socket in the Moog, and taking a line out from the Moog to my amp (a 60W Loco-Aria amp, Model 4102), but only the Moog comes through.

Andrew Miller  
Dollar

*Unfortunately the Moog Prodigy and Casiotone CT-1000P cannot be 'slaved' together. The dedicated microprocessor used in the Casio makes connection to another instrument difficult. The 'Keyboard In' socket on the Prodigy accepts a control voltage and not an audio signal input, which is why only the Moog could be heard. A Filter Input could be added to the synthesiser allowing the Moog filter to modify the sounds from your Casio. The Casio does lack a rich waveform, but treating it through a Chorus or Flanger should improve things. (The Amdek range of effects units is ideal — see Nov. '82 and May '83 issues.)*

*We hope in the near future to publish a project that will permit the Casio range of keyboards to be interfaced with other keyboards.*



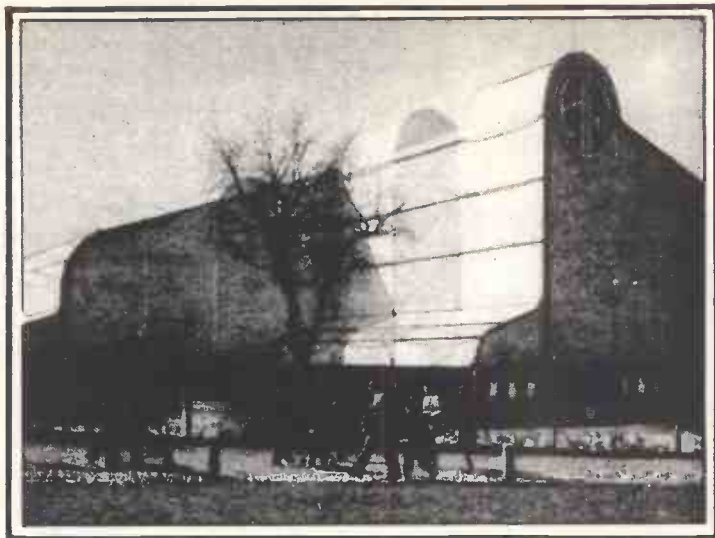

## April 29-May 3 1983 Alexandra Pavilion

**T**his year's International Music Show has been expanded and moved to the Alexandra Palace and Park complex, which offers a 40% increase of exhibition space. Capital Radio and the Radio One Roadshow will be broadcasting live from the show, and last year's 26,000 attendance figure is expected to double. Various special tie-ups and exhibits have been arranged to make this year's IMS more popular than ever.

Musicians Union members can gain half-price admission, as can members of the AA. An all-inclusive ticket and travel price is available at any British Rail station, and attractions include live music, a funfair, circus, barbecue and fireworks each night.

The show will provide a shop window for many branches of the music industry. The independent record companies have been

particularly enthusiastic, and several labels will be taking along their star performers. In addition there'll be displays of hi-fi, video, musical instruments, sheet music, amplification and recording equipment.

In addition to the futuristic Alexandra Pavilion itself, the IMS will use three marquees, the nearby bandstand and parts of Alexandra Park. The whole event is being organised by Kane Kramer and Westside Events, who can be contacted on 01-254 4474/249 7141. Below we detail just a few of the exhibits and attractions of this year's International Music Show.

### Ticket information

Each day, £2. All five days, £5. Children ½ price.

Opening day £1.50. Times: 10.30 a.m.-10.30 p.m. each day.

Tickets available from Westside Events Ltd, 73 De Beauvoir Road, London N1 5AU. Cheques payable to Westside Events.

About 200 exhibitors are expected to take part, with Radio One's Roadshow broadcasting on Bank Holiday Monday and the Capital Radio Cruiser on Saturday and Sunday.

**Casio Electronics UK.** Casio will be showing their range of portable keyboards, including it is hoped the programmable CT-1000P and the new multi-channel recording CT-7000. Guests of honour may include members of the Human League, who popularised Casio products such as the VL-tone and MT-30 on their top-selling album 'Dare'.

**Rosetti** will have their own marquee and will be displaying their range of Gibson guitars. In addition there'll be a selection of amplification on hand, and the show organisers hope it will be possible to 'make all the row you like!' thanks to a careful use of screening and soundproofing.

**Paiste Cymbals** will be on show along with the Melanie Drum range. The Melanie Fan-tom and its derivative the Tri Fan-tom continue to be popular, and various workshops and demonstrations will be arranged for these and other percussion instruments.

**Capelle Music** were formed in August 1982 by the French parent company SA Capelle, and feel that the time has come to thank all their dealers for helping in the rapid expansion of their business in the UK. Apart from the powerful Turbosound drum range, Capelle also deal with Vigier guitars, as reviewed in E&MM.

**Elka-Orla** will be showing off their Professional keyboards range, with the emphasis naturally enough on the impressive Synthex, a splittable polyphonic synth with four built-in monophonic sequencers. Also on the stand will be **Wal Basses**, built by the Electric Wood company, who will be represented by Martyn Phillips and Paul Wiffen.

**Match-Pik** is a new guitar pick design distributed in the UK by Dee Jay Music Enterprises. Coming in a book-match style packet, Match-Piks can be snapped off one by one when desired. Each of the six picks in each packet is virtually identical to all the others, with a colour-coded choice of

Extra-light, Light, Light-medium, Medium, Heavy and Extra-heavy. A Pik-Holder is available to clip a packet of Match-Piks to a microphone stand. Dee Jay Music Enterprises, 11 Chessing Court, Fortis Green, London N2. Tel. 01-883 8055.

**Manson Guitars** will be on display, together with Hi-Watt Amplification. Many of the smaller manufacturers will be able to take advantage of the budget display area, which will allow less well-off concerns to demonstrate their instruments in a relaxed, sound-proofed setting without the necessity of hiring a complete stand.

**OSC** is the newly-formed Oxford Synthesiser Company, who have their OSCAR programmable synthesiser/sequencer on show.

**Dep International** is a merchandising company dealing with pop band UB40. Many other independent labels and their associated merchandising companies are expected to appear, including Ace, Chiswick, Harbour, and RCA's Carrere label.

**Staccato drums** are being re-launched in the UK. They'll be demonstrated by Chris Slade, ex-of Manfred Mann, Uriah Heep and Gary Numan's band. The Thunderhorn fibreglass drum will be of particular interest.

**Kinkade Brothers** will be exhibiting their handmade guitars, which have recently attracted attention after being used by The Stranglers. Hugh Cornwell uses a Model P acoustic guitar finished in black, while Jean-Jacques Burnel has been using a full scale fretless acoustic bass, again finished in black. Contact SG & WJ Kinkade, 18 Clevedon Terrace, Cotham, Bristol BS6 5TX. Tel 0272 43279.

**Marshall** have their own sound-proofed area booked in order to demonstrate their amplification range. Several celebrities are expected to turn up to help with displays and workshops.



Strangler Hugh Cornwell & Kinkade.

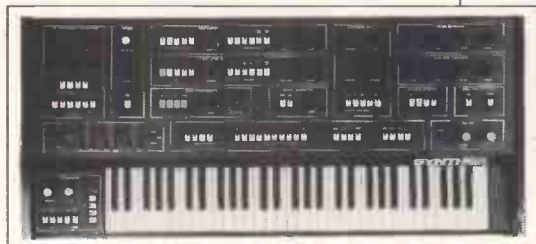

Vigier guitars.

Elka Synthex.



Marshall amps.

**IMS Information Hotline 01-254 4474**



# CARLSBRO SOUND CENTRES LTD



## SYSTEM 8



For more than a decade, Allen & Heath have established themselves as a leader in the field of innovative audio design. This has been possible only by constant re-evaluation of current trends and techniques in sound production and by keeping fully abreast of the latest technological advances in that area.

It is against this background that A&H confidently launch their new SYSTEM 8 Mixer range.

Features normally found only on desks many times the price are fitted as standard on SYSTEM 8 - and with no compromise in design. A logical control layout, high grade components and substantial all-steel construction make for a mixer that is both a pleasure to use and rugged and dependable in action.

Whether for multitrack or stage sound, SYSTEM 8 is the cost effective choice for the professional.



# AHB



Price	
12-8	£1,193 inc VAT
16-8	£1,365 inc VAT
16-16	£1,599 inc VAT
16-4	£1,249 inc VAT
Ex 8	£575 inc VAT
inc power supply	



Stylish in looks and superb in performance, these three babies offer outstanding value for money.

Available in 6, 12 and 18 input versions, the 21 SERIES boasts the useful feature of a separate mono output derived from the main stereo mix.

Another Plus is the incorporation of an extensive interface facility to ensure accurate compatibility with external equipment, and enables two or more mixers to be linked together for single flexible operation. A separate power supply unit keeps nasty hum fields at bay, letting the sound come through clean and clear.

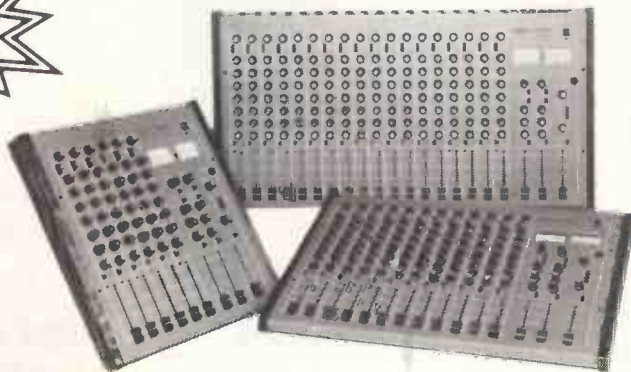

Price	
6-2-1	£425 inc VAT
12-2-1	£549 inc VAT
18-2-1	£725 inc VAT
inc power supply	



### ORDER BY PHONE

Quote Your Credit Card Number For Immediate Despatch

Hot Line



182/184  
Chesterfield Rd  
North  
Mansfield  
NG19 7JD

11/13 Hockley  
Nottingham  
NG1 1FH

720 City Rd  
Sheffield  
S2 1GJ

22/32  
Humberstone Rd  
Leicester  
LE5 0AR



# MUSIC SCENE

## EXHIBITION & MUSIC FESTIVAL

## BRISTOL EXHIBITION CENTRE

**BANK HOLIDAY  
WEEKEND**

**MAY 27th - JUNE 1st**

**LIVE MUSIC**

**EVERY DAY!**  
**& Workshops & Guest  
appearances by  
INTERNATIONAL  
MUSICIANS**

**EXHIBITORS INCLUDE:**

- MUSIC PUBLISHERS
- LEADING INSTRUMENT MANUFACTURERS
- RECORDING STUDIOS
- ELECTRONICS
- LASER EFFECTS
- DISCOTHEQUE EQUIPMENT
- LIGHTING
- SOUND EQUIPMENT

**all the  
NEW!!!**

instruments:

- ★ ORGANS!
- ★ GUITARS!
- ★ DRUMS!
- ★ SYNTHS!
- ★ PIANOS!

THE SOUNDS OF

the CLASSICS  
Rock  
POP  
FOLK  
COUNTRY  
JAZZ

ROLAND  
PREMIER  
MARTIN  
FENDER  
EMINENT  
CASIO  
GORDON SMITH  
GUILD  
CARLSBRO

**COME & PLAY  
all the  
NEWEST EQUIPMENT  
at  
THE SHOW!**

the  
**LARGEST**  
& most exciting  
**MUSICAL SHOP WINDOW**  
in the West...  
it's all at MUSIC SCENE '83

**GUITAR PLAYERS**  
WEDNESDAY JUNE 1st  
GUITAR DAY

**FREE WORKSHOPS &  
DEMONSTRATIONS  
from TOP MUSICIANS**

Come & see how it's done...

OPENING TIMES 12 NOON - 9 PM  
for 6 days

ADMISSION ONLY

FRI/TUE/WED £1.00  
SAT/SUN/MON £1.50

Children under 14 yrs 1/2 PRICE

**THE SHOW FOR ALL MUSICIANS & MUSIC LOVER**



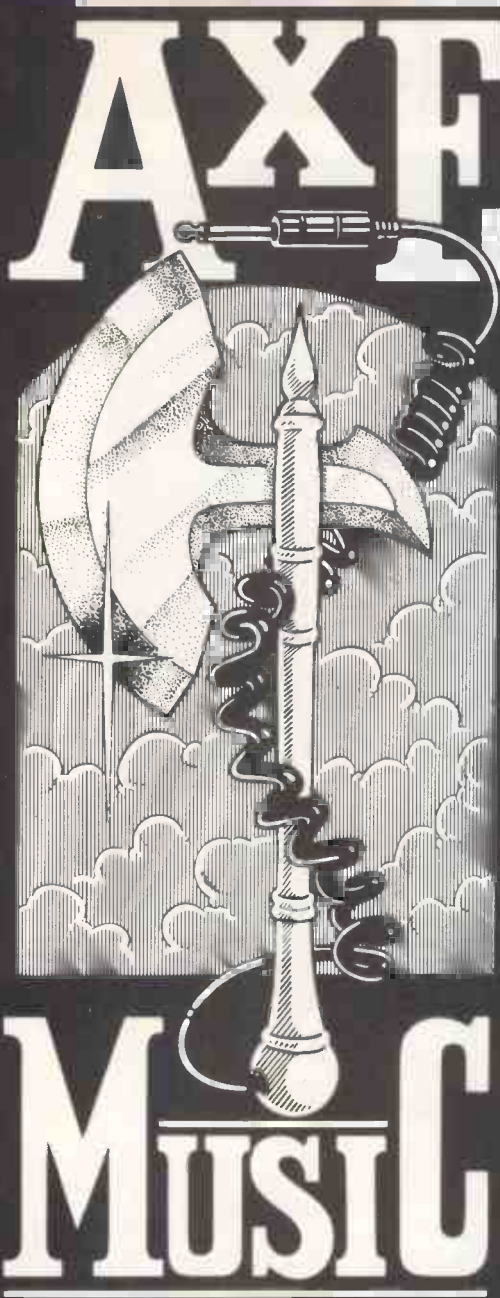

# Roland MAIN DEALER

- JUPITER 8 64 Memory PolySynth ..... ★
  - JUNO 6 6 Voice PolySynth ..... ★
  - JUNO 60 6 Voice PolySynth — programmable .... ★
  - SH 101 Latest development in MonoSynths ..... 275
  - SH 09 MonoSynth ..... 225
  - RS 09 Organ/Strings ..... 395
  - SH 2 MonoSynth ..... 395
  - SA 09 Organ/Piano ..... 355
  - EP 11 Electronic Piano. 5 octaves. Many features . . 345
  - EP 6060 Piano-Compo Dual voice ..... 525
  - HP 30 Piano Plus. 5 octave. .... ★
  - HP 60 Piano Plus. Touch sensitive ..... ★
  - HP 70 Piano 6 octave. Touch sensitive/chorus .... ★
  - CUBE, BOLT & SPIRIT AMPS IN STOCK ..... ★
- ★ PHONE FOR UP TO THE MINUTE PRICE

## BOSS

- BF2 Flanger ..... £62
- CE2 Chorus ..... £59
- CE3 Chorus (Stereo) .. £63
- CS2 Compressor ..... £46
- DS1 Distortion ..... £41
- SD1 Super Overdrive .. £41
- GE7 Graphic Equaliser. £57
- OD1 Overdrive ..... £43
- PH1R Phaser ..... £57
- DM2 Delay ..... £82

## AMDEK KITS

- DISTORTION ..... £27
- COMPRESSOR ..... £31
- PHASER ..... £35
- FLANGER ..... £54
- CHORUS ..... £46
- STEREO 6 CHANNEL MIXER . £77
- DELAY MACHINE ..... £109

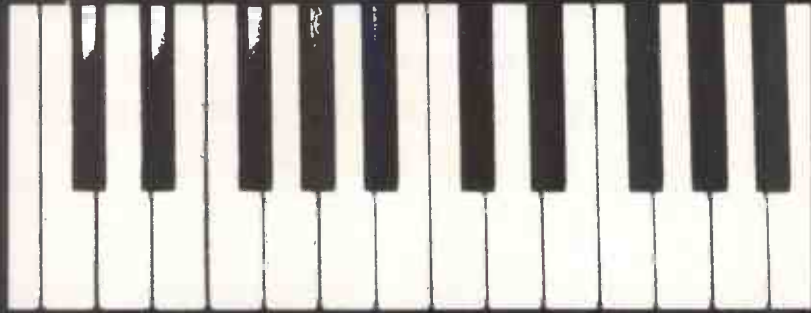

**96 HIGH STREET, COLCHESTER, ESSEX (0206) 65652**  
**41-43 ST. NICHOLAS STREET, IPSWICH, SUFFOLK (0473) 54996**



# Marshall

Main agents for Colchester/Ipswich.  
 Almost everything in stock. Phone for quote.

## TASCAM HOME RECORDING DEPARTMENT

- PORTA STUDIO 244 ..... £650
- MM20 MIXER ..... £189
- DBX 2B ..... £250
- 22/4 4Track — 7" Reels ..... £862
- 32/2B Master Recorder ..... £587

## TOKAI

Superb Replica  
 Guitars.  
 Whole Range In  
 Stock —  
 Phone for Best  
 Prices.



### ORDER FORM

Name \_\_\_\_\_  
 Address \_\_\_\_\_  
 Phone \_\_\_\_\_  
 Please send me: \_\_\_\_\_  
 I enclose cheque/P.O. for £ \_\_\_\_\_  
 Please debit by B'card, Access, American Express A/t No. \_\_\_\_\_  
 \_\_\_\_\_ Signed \_\_\_\_\_

# KEITH EMERSON



## From potted history, to reminiscences of The Nice and ELP, and Emerson the composer . . .

“I started playing when I was eight years old. My father played by ear and I was very influenced by his likes and dislikes in music. In fact, he got me started by playing duets with him. I adapted quite readily to the piano and every Saturday I would have piano lessons from a visiting teacher — she was 80 years old! The extent of my piano tuition went up to about the age of 13, I think. I used to do the occasional Worthing Music Festival that my music teacher put me in for, but my heart was not really into classics then. The first piano player that I really got to like was Russ Conway, actually (laughs). I did theory and practical exams up to grade 7 and then my teacher suggested I went up to London to finish off my studies. But I wasn't too keen and ended up playing things like 'Side-saddle' to my friends at school instead! Soon after that I took a liking to jazz piano. I also played piano for my aunt's dancing school and that introduced me to a lot of different styles.

The first jazz piano music I got was Andre Previn's version of 'My Fair Lady'. I went wild over that album! I didn't have the music, just the record, but if I played it enough I could pick up the notes on the piano — I did a lot of Oscar Peterson lines that way. I did gradually develop both types of playing, reading as well as picking things up by ear. Dave Brubeck music was something I enjoyed playing. Later, I joined a local swing band run by Worthing Council. It was a 20-piece unit and we used to do Count Basie and Duke Ellington arrangements. Some of the musicians in the band also did gigs with me in Brighton. I then formed a breakaway trio with the drummer and the bass player — we were

called the Keith Emerson Trio.

We played real sleazy bars in Brighton. They all demanded the latest pop music which I improvised around. I'd buy the occasional sheet music and do an arrangement of it. Other musicians used to sit in on our sessions and on one occasion a drummer called Brian Walkley who played with a rhythm and blues band called the 'T-Bones' came along. While I was with the trio I also worked at a bank. I used to play piano all the time on these gigs and had to put up with whatever instrument I got! I got so tired of playing bad pianos everywhere that I saved frantically for an organ — I'd heard this Jimmy Smith record 'Walk On The Wild Side' and I thought "Wow, that's just great!"

### My first Hammond

Organs were generally very expensive, although I did come across a Bird organ with built-in speakers at each side of the keyboard (it looked like it was made from a Cornflakes packet!). So I started saving for this instrument because it did seem quite reasonable and went off to the Portsmouth Organ Centre to buy it. I went with my father and when we got there we were actually shown another organ, a Hammond, and after trying it we both agreed it was a much better buy. My father chipped in the rest of the money needed to buy it — so that was how I got my Hammond L100. The Hammond wasn't as portable as the Bird, being an original tonewheel type, but it did work once you switched it on, unlike the 'M' model that required its generator to warm up beforehand. (Later on, Hammond brought out the C's, the B's and maybe an A. There wasn't much difference in the actual cir-

cuitry, I think it was actually the kind of cabinet it came in — I do remember the chorusing was different.)

I got a Bedford van to do the gigs and used to play Bingo halls, 'Tico Tico' and all that sort of rubbish (laughs). The amplification was a problem too — the amp/speaker system inside the L100 was just not enough. My father got hold of an old amplifier and we fitted this into the back of the instrument. The sound still wasn't very clean and at the time I didn't even know about Leslie rotating speakers. I then formed a band called 'John Brown's Bodies'. We used to play at the Starlight Rooms in Brighton — and that's where we come back to Brian Walkley and the T-Bones because the T-Bones came down to the club to hear me play. They invited me to join them. Their singer was Gary Farr who was the son of Tommy Farr, the boxer. Of course, I didn't do any singing myself. I've since tried singing but I sound awful except when I'm very drunk!

### First gigs

We played one of the Windsor Jazz Festivals and had a residency at the Marquee Club in London. Actually rhythm and blues was on the decline and was changing to something else, which I didn't really like at the time because I was a purist at heart. The T-Bones tried to be very true to their style, like T-Bone Walker and Howling Wolf stuff — all based on 12-bar rhythm and blues. But it was a bit more adventurous, kind of louder and a bit more electronic. They were unlike the Yardbirds who produced a commercialised form of R&B.

As the demand for R&B got less our manager prompted us to change our presen-



tation and do something a bit different. The Who were just coming in at that time (the early 60's) and there were efforts to make us something like that, but it didn't work. Things were falling apart, so I went on to another purist blues band, the VIP's. We toured Germany and France but it was a bit of a fiasco. We didn't make much money and I slept in the van to save what I could. The group actually thought I was quite conservative because they would take drugs frequently and their girlfriends were hookers from Hamburg. They thought I was very boring because I didn't join in.

I remember one occasion when we carried on playing a concert while a fight took place in the hall. That was the first time I got into doing a lot of nonsense with the organ — making crashing and exploding noises, and leaping and jumping around everywhere! The rest of the group said that was great and I'd have to do it again, so when I got back to England I tried it at our next gig, and everybody looked at me in utter amazement! However, it formulated a kind of stage act which ended up with me playing the instrument back to front.

Of course, up to that time the organ, or any keyboard instrument for that matter, was not a front line instrument — they used it as a sort of filling-out instrument — it was still the guitar player who got most of the limelight, while the organ player was there as a sort of gimmicky thing. I used to sit down and play before all this happened then my organ stool got lost and I had to stand up! There were pedals on the instrument but I didn't use them. I can play a bit on the pedals now, but I'm no Fred Astaire, and I did try the Jimmy Smith approach with left hand and pedals together. Pedal notes could be a problem with a bass player as well, and I would keep my left hand playing fairly light.

## The Nice

Some time later the roadie who used to look after the VIP's told me that P. P. Arnold (an English singer who had made a single on the Immediate label called 'The First Cut Is The Deepest') needed a backing band, so I went to England and formed the band which was called The Nice. The idea actually was that we would go on first and play a half-hour set on our own and then P.P. Arnold would come on and do her set. But sometimes she wouldn't turn up at the gig at all. We were so different — she was going on stage doing all that sort of soul stuff, while we were doing the rock music.

At the next Windsor Jazz Festival we did a spot in our own marquee which we packed out and then, when we went on to the main stage to back P.P. Arnold, everybody was shouting for us. A record company sussed us out and gave us a contract and we made our first record called 'The Thoughts of Emerlist Davjack'.

In the band was Lee Jackson who had previously played bass for the T-Bones. There was also David O'List on guitar and Brian Davidson on drums. David and Lee did the singing. Lee did the raunchier, gutsy vocals, while David would handle the more sensitive vocal lines. We were pushed into a studio by Andrew Holden who insisted on us doing all new material. So we produced a 7-minute single, 'America', played at the Albert Hall and got ourselves banned!

We did the concert as a protest — that sort of thing was very much in vogue at the time, with bands doing 'It's Good News Week' and this was the first 'instrumental' protest with visuals to go with the music. It was after the second Kennedy was shot and the concert was in aid of American Independence. We were the only rock band in the show and we showed our protest by burning a painting of the American flag. This got us a lot of press and our next gig at Norfolk the



following day brought us an audience that was queuing for miles — when we got to the town we thought someone else must be playing with us!

That was the start of it all, really. We were then given a residency at the Marquee as The Nice and we went from strength to strength. We went to America and played at a club in New York and the Whisky-A-Go-Go in L.A. When we got back to England, David O'List left the band and we continued as a 3-piece.

I was getting lots and lots of different effects out of the Hammond which weren't what the instrument was designed for, such as 'playing' the reverb spring by plucking it while notes were held down. I'd stick knives between keys to hold on notes and roll the organ around the stage to induce feedback. The motor for driving the tonewheels could be slowed down or speeded up for sliding pitch changes.

Looking back on the records I made with Nice, they were all good for me, although I don't get them out and listen to them regularly these days. But I'm quite proud of 'The Five Bridges Suite' which was commissioned by the Newcastle Arts Council. That was my first mixed media project of working with an orchestra, trying to merge orchestra and group together. We were one of the first to do that and we had lots of problems trying to balance it up. We were one of the first Western bands, I remember, to get into Japan. Along with Pink Floyd and, of course, The Beatles.

## From The Nice to ELP

The Nice were quite a revolutionary band for their day; there weren't many bands then who used keyboards at all, let alone as much as we did. The organ sound was an aggressive one — it proved a keyboard player could make as big an impact as a lead guitarist on stage, if he had the guts and determination.

I think a lot of people were surprised at how successful The Nice were. We weren't a 'heavy' band in the traditional sense but weren't exactly conventional pop either. There were limits as to how far that line-up could have gone though, musically.

We disbanded The Nice in 1968, mainly because the music I was writing was getting more adventurous. Lee was unable to handle the singing stuff I wanted, so I was looking around for a bass player that sang. When I was in San Francisco we were on the same bill as King Crimson and that's how I met Greg Lake. We decided to get a band together when we got back to England and eventually found a drummer, who was Carl

Palmer, of course, and that was the start of ELP in 1970.

The first ELP album, 'Emerson, Lake and Palmer' (1971), was totally unlike anything that was being played on the radio stations at the time. We were in a completely different category from the heavy bands like Led Zeppelin and Cream. In fact, I don't think we would have made it if there hadn't been that high level of aggression, because that was what attracted people initially. There were two arrangements of classical pieces on that album, and at that time rock people weren't supposed to be into that at all.

We also had a hit off that album, 'Lucky Man' which Greg wrote. (He wrote all the more commercial tunes.) But it was a good song in its own right and, more important, it got us recognised.

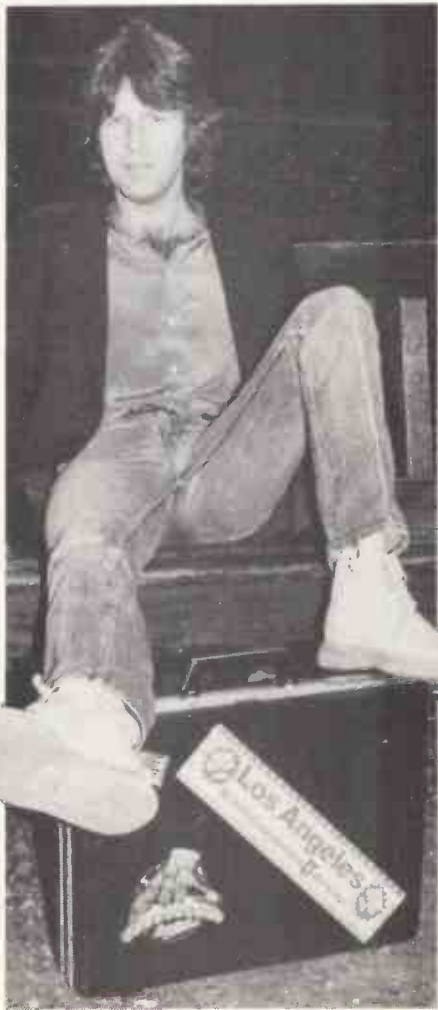

*Some recording systems  
stand on the sideboard,*



*some stand in the street;*





# only one stands on its own two feet.



It doesn't take a genius to see that there's a yawning gap in the choice of portable recording systems. On the one hand, we have the justly popular cassette-based recording units, which are fine – as far as they go.

On the other, the only serious alternative is a full blown, open reel, multitrack system, which can only be called portable when it's installed in the back of a ten ton truck.

Now though, there's a third option; the Clarion. We believe that for the first time we've combined the best features of cassette technology with the flexibility of real multitrack recording and mixing, to give working musicians a truly complete, self contained, portable recording system.

Quite simply, the Clarion consists of two units. First, there's the XD5 four track recording unit, which allows you to record four channels either singly or simultaneously, with full multitrack LED monitoring and play back facilities. It features double speed recording for optimum sound quality, with stereo panning. Dolby NR and logic electronic operation.

Then, with the XA5 Master Cassette/Mixer Amplifier, the Clarion really gets into top gear. With the XA5, you can mix down from your original recording, using the kind of facilities you only expect in a pro. studio; there's a seven band graphic EQ on both channels, pitch control, echo unit and drum machine, all backed up with 30 watt stereo amplification, optional remote control and speakers. When we say completely self contained, we mean it.

Singly, they're remarkable pieces of equipment. Together, they give portable recording a long-awaited innovation.

See the Clarion System at your local music store or write to us for a full colour brochure and poster. Considering it only has two feet, it's miles ahead of the competition.

I'd like to see if the Clarion really stands up. Please send me your brochure and the name of my nearest stockist. Write to Rose Morris Co. Ltd., 32 Gordon House Road, London NW5.

NAME \_\_\_\_\_

ADDRESS \_\_\_\_\_

POSTCODE \_\_\_\_\_

 **Clarion** **Rose-Morris**

## KEITH EMERSON

'Emerson, Lake and Palmer' isn't perfect, because at that stage we weren't really playing together as a unit. We were just a trio of individuals. 'Tarkus', ELP's second album, showed that we *could* play together — it's more musically mature, I think. Also, the first side of that album has got some screaming solo organ and synthesiser lines on it, and that showed that a keyboard player could do more than just lay backing chords under guitar solos.

By this time, of course, we were becoming more and more well-known so that our next release, 'Pictures at an Exhibition', which was just a selection of live recordings made before 'Tarkus', had to be rush-released because of popular demand. It was our first LP to go gold, I think. As well as Mussorgsky's title-track there was an arrangement of Aaron Copland's 'Hoedown' which proved very popular, plus another of Greg's ballads, 'From the Beginning' which was a hit single.

After these successes there was a bit of a break before our next album, 'Brain Salad Surgery' came out. The first LPs had come out within the space of about a year, and we felt we needed a bit of time to consider things and not let everything go to our heads.

I think it was worth the wait because a lot of people think 'Brain Salad Surgery' is just about the best thing we ever did. It had another Lake single on it ('Still You Turn Me On') but we certainly didn't feel we were getting stuck in a rut. I think that 'Karn Evil 9' [a 30-minute epic featuring some incredible keyboard-playing] proves that. Again, the most important thing was the way we were playing together as a band. The triple live album, 'Welcome Back My Friends To the Show That Never Ends — Ladies and Gentlemen, Emerson, Lake and Palmer', we put out in 1974 shows that too — it has a very 'together' feel about it.

We had another break after that — it wasn't until 1976 that 'Works Vol 1' was finally completed. We were trying something different — each member of the band doing one LP side and the three of us doing the fourth together — and looking back on it that might have been a retrograde step, though musically I still stand by it. From my own point of view, the piano concerto that made up my contribution was quite a milestone.

We tried to take 'Works Vol. 1' out on tour with a full orchestra, but everything went

wrong, and I think the whole affair was a big factor in the eventual break-up of the group: we had an awful lot of disagreements.

'Works Vol. 2' was a much less ambitious affair and it was really a bit of a let-down after Volume 1, because it's really just a collection of old singles that hadn't been available on album before. We were really just trying to recoup some of the losses we incurred on the tour with the orchestra.

We recorded 'Love Beach', our last studio album, in Nassau in 1978. Carl and Greg hated being in Nassau and just wanted to get out as quickly as possible, leaving me to more or less finish the album off single-handed. The LP has had a lot of criticism because it's so MOR, though I think some of it still stands up fairly well. On the other hand, there's no way it could be called classic ELP, and I don't think 'In Concert' (a live album released after the band had already broken up) does the group much justice either, to be honest.

### Instruments

Looking back, the Hammond was the prime instrument for me. It was still the L100. This is from the Nice period around 1966/67. I did use a fuzz box but the act was really based firmly on the L100. I also played a little bit of acoustic piano occasionally. There was a big mistake that Hammond had and they always tried to cover it up. It was with the contacts — if you had a lot of presence on your amplifier you'd get this click clicky sound. They tried to cover this up by using a Leslie, but when I used my instrument with a combination of Leslie and amplifier it would bring up this very percussive attacking sound. The Leslie speaker on its own lost a lot of top and gave a more mellow sound. Another thing that made me aim in that direction, that particular sound, was that I'd got hold of a record by Brother Jack McDuff playing 'Rock Candy' — his organ sound was so growling, so angry! That's what I tried to imitate within the Nice.

So it was a straight Hammond that I used with a Leslie and a Marshall amp at the same time.

[The Leslie speaker was designed originally for Hammond organs and its vented enclosure houses a rotating drum that throws out the sound in a circle at two basic speeds - slow 'Chorale' church effect and fast 'tremolo' Theatre organ effect.]

My L100 had no gimmicks at all, it was just straight drawbars, but not the full range possible with nine of them. I found a good way of getting a technique out of the organ by 'playing' the drawbars. I also used to play

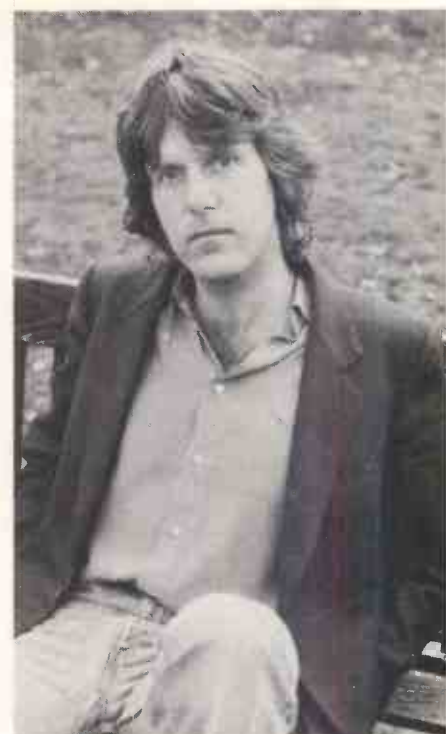

around with the tonewheel idea because by holding a chord or something, if you switched off the generator, you'd get a howling sound. (I mean like an air raid siren.) I was doing my 'jumping around' act on the L100 as I said and consequently had to get the organ serviced a lot. One day the chap who was doing the repair work for us saw me on TV and realised why the instrument was coming in with broken keys all the time. The guy actually refused to carry on servicing it because he said I didn't treat the instrument right. Soon after we got hold of Bill Haugh to do the work. One of the things he managed to do straight away was boost up the output of the Leslie.

### The First Live Moog

I brought in another instrument — the Moog — in late 1967-68. I was doing a concert at the Royal Festival Hall. We'd had the record 'Five Bridges Suite' out for some time, which used an orchestra and we decided to do one more concert with the London Philharmonic Orchestra. Joseph Eger was conducting it and we did selections from 2001 Space Odyssey, using the Ligeti and Strauss themes in our own style. I was trying to get a lot more effects out of the organ and I went into a record shop and I came across Walter Carlos' 'Switched on Bach' LP. That's when I heard the Brandenburg concerto, which we'd already been doing, played on a Moog synthesiser. I couldn't wait to see one of these instruments and found that Mike Vickers, who used to be with Manfred Mann, had one of the first Moog modular systems in his flat in London.

I went round to see it and asked him if I could use it for one of my performances with the orchestra. He told me that it wasn't really meant to be moved around, that it was really for studio rather than live performance. Anyway, he was willing to have a go, so what happened was that he hid behind the instrument while I played it live, jumping up occasionally to make the necessary patch changes. It amazed everybody because of all the new sounds that were coming out. They said "What the hell is that?"

I can't remember the name of the actual Moog system. I first used, but it had no sequencer on it, although there were some 4 oscillators, envelope generators and a lot of other stuff. I tried changing the patches but the whole thing looked to me like a telephone





The image shows a handwritten musical score for the opening of the film 'Inferno'. The score is written on multiple staves. At the top, there are tempo markings: '1 = 132' and 'M. 1'. There are also handwritten notes: '2' 511', '3 desks 1st', '2 desks 2nd', and '2 desks 3rd'. The score includes parts for Piano (Piano), Violins (Vlns.), and Moog synthesizer. The piano part has a '6/8' time signature and a '1' marking. The Moog part has a '6/8' time signature and a '1' marking. The strings part has a '5' marking. There are various performance markings such as 'p', 'mp', and 'TACT'. The score is heavily annotated with handwritten notes and markings, including a large scribble over the piano part.

switchboard. I finally sorted it out but it took a long time.

So I became the first person to use a synthesiser on stage and obviously wanted to get hold of a Moog instrument for myself. I wrote to Bob Moog asking for all the specs. He told me there was no 'live' model, but he had produced a new version which had a preset box, which might make live performance easier. All this stuff arrived over from America and I had it in my flat and didn't even know how to start to get the thing working! (There was no instruction manual.) In desperation I called up Mike Vickers who had it at his place for three days and finally got it going.

The preset cards gave me a fair variety of sounds to work with. You couldn't alter the oscillators except with the jacks. There were very few things that were actually able to be preset. Presetting was mainly for the 3 oscillators that I first had, so that you could get 5ths or any other interval you wanted. Also the filter. Any changes like from sine to square you still had to do by changing the jack around. It was quite small really, just with 3 oscillators, a filter bank, a set of envelope generators, a set of attenuators and that was about it really. The first problem was getting it to the hall and keeping it in tune. There was absolutely no way of tuning it except by ear. Consequently you had to do this all evening.

Later, I designed a system where you could switch off the audio out and put in a frequency counter, so that I'd be playing the organ with my right hand, I'd have the audio switch out, I'd play an A, and if I got a read-up of 440, I'd know I'd be in tune. But it was all a very risky business. Most of the time I had a

limited patching arrangement where I just needed to make a few alterations. The preset box did help a lot. This instrument that Bob Moog sent me was not generally available — it was just that he was very interested to see how I got on with it. I did meet Bob when I went to America and he stood there in the wings and was absolutely blown away — he couldn't believe the way the instrument was being used. He was very keen from then on to work closely together and often came up with suggestions for improving this or that function.

The Moog system was expanded considerably and I had a sequencer and another row of oscillators — it got so big, I couldn't even reach up to it and tune the damn thing any longer! I think Bob now has the full system that I used sitting in his factory as a piece of history — I haven't seen it for the last three years. If I looked at it now I'd probably be back to square one again in using it.

I used to use the sequencer basically just for the gimmick value it offered on 'Brain Salad Surgery'. I'd written this music about computerisation with very heavy lyrics, and the idea was that the instrument sort of took over in the end — it worked well on stage. The sequencer would be programmed to go through this change of notes and speed up until it blew up. It was very good visually — dry ice and all that.

Talking about the move from Moog to Korg, it was really to do with Bob leaving the organisation. I felt I'd lost that contact which had been so important between Bob and myself. I thought that Norlin music tended to ignore the professional musician and catered more for the general keyboard buying public who wanted cheap gimmicky

instruments. But the MiniMoog has been one of the most successful mass produced instruments.

## The move to Korg

So my relationship with Moog dwindled off when Bob left and while working on an album in Nassau in the Bahamas, my engineers (who often showed me new gear) brought in a piece of Korg equipment, the PS 3100 polyphonic synth. It seemed to offer the programming facilities that I wanted, but when I recorded with it, it turned out to be very thin in quality. Anyway, they gave it to me so I had it stuck on the side and I tinkled around with it, but if I wanted a big fat sound, I'd still go back to the Moog stuff.

Soon after that Korg seemed to pull everything together and I really liked their portable organ, the CX-3, which contained the 'key-click' which that I sort of had exaggerated with the early Hammond organ. It also had chorusing and the right percussion overtones.

Then I really started getting into their instruments to the extent that in May last year, I went over to Korg in Japan to give some specs for a special model they're building for me which is going to be quite impressive. It's both digital and analogue combined — in broad terms it's kind of like a Fairlight where you'll be able to sample sounds and then couple it with an analogue synthesiser. I have used the Fairlight for the 'Tramway' soundtrack on 'Night Hawks'.

Since working with Korg instruments I haven't really been in the live situation. I've done some TV shows, but most of my time has been with records and film music for which I used Korg instruments. Korg stuff is

Vlas

Glissando (Lato)

TACET 10x

mp

far more reliable from a tuning aspect than those early Moogs I used. I've got the 3300 and the 3100 polyphonics. I also use the Sigma, Lambda, and the Vocoder — I get an amazing harmonica sound that's very bluesy on this one. I just use the built-in keyboard and my voice. In fact with this new instrument that Korg are building for me now, I wanted the vocoder built into it. They looked at me in amazement and said "Are you serious?". I think they sort of lost interest in the vocoder, and maybe they're not all that proud of it, but I think it's unique as a soloing instrument. I've got the Mono/Poly, the Poly 6, the 3200, and the BX-3 organ. I've just received the digital delay and they've given me a sequencer as well but I haven't tried these out yet. I think the sequencer's an old analogue one that they've stopped producing.

There's so much happening now it's very difficult for me to keep track of the new developments — from analogue to digital. Recently I was in Japan and used the GX-1 Yamaha instrument, but I really find that I don't need to use much else besides what I've got. I do have a battle between acoustics and electronics — if I go electronic I use the Korg stuff, but I still love acoustic instruments. At home I've got a nine foot concert grand Steinway piano, and, you know, I've still got that something in the back of my mind that acoustic instruments are more reliable. I mean, as good as all the new electronic instruments are, I just don't feel altogether safe with them.

## Composing

I wrote quite a lot of the music for The Nice and ELP. At the beginning I'd write the odd bit down and scrawl it on a manuscript — and

then lose it! There was one piece, it was the fugue that was used on 'The Endless Enigma'. I wrote that out in proper form and always kept that by me. I learnt to write out music from my weekly half-hour lessons with my first music teacher — it's something I still really hate doing, it's a chore. You really have to sit down and work at it, but I've got quicker at it now I'm doing movie scores.

I did some of the scoring for the orchestra too — for 'The Five Bridges'. I admit that I went to an arranger in the end and showed him the parts I'd written out, and he pointed out things like, "Your trumpet player's going to be a little out of breath here". With the Piano Concerto, I worked with a guy called John Mayer. I would go to him with the piano transcriptions and we'd work out what I wanted, with the score all in concert pitch until it was transposed for the instruments. I did refer to Walter Piston's book on orchestration occasionally! I was totally bowled over when I heard the score played by the orchestra — it was a revelation to hear it all played at the same time!

I couldn't multitrack then because I didn't have the facility I have now in my barn studio. Composing for me these days is a matter of building up the parts, and it's really like doing a painting — I just add the colouration. There was a time when I didn't bother to write much down, and Warner Brothers suggested that I continue doing it, but I couldn't face the thought of going back over all those ELP albums, so they got a guy called John Kurtan to help. He would send me his transcriptions for me to do the corrections, which still meant I'd have to sit down with the record and go through it. What he heard was not what I played, but it was a good enough guide to trigger off my memory so that I could insert the right notes for him.

Nevertheless, I haven't really stopped to analyse how I write my music! I think we've had 3 books published altogether, there was Anthology, Tarkus and a collection of pieces just called ELP [see musical quote in this article]. When you get hold of these books, they have exactly what I play on the keyboards. When there was a question of overdubbing lines, I'd write that line in, but generally I'd look at the books being for one keyboard player so that he could entertain himself and play it at home. Quite a lot of the bass lines had to be written in as well, particularly in places like the Fugue where the bass was taking one of the fugue lines.

## Influences

I listen to classical music a lot — I'd be more prone to going home and listening to a classical LP than a rock LP, or even to the extent now of putting on a jazz LP. I love Shostakovich's way of orchestration.

When we were touring and playing we tended to have spots in the pieces where we improvised. We'd stick to a general format but there'd always be times where we'd be changing things or we'd have a unique evening where you'd throw your fate to the wind and go completely overboard and do something totally different. If it worked I'd develop it the next night and so on. The other guys usually found a way of following me around the chords. Sometimes it threw them but it kept them on their toes!

I used to like the Brubeck improvisations where he'd chop around with the time changes — we'd do a lot of this, playing 3's against 4's and so on. But I think when I compose I don't stick to a time signature. I



# LISTEN TO THE NEW SOUND OF MUSIC FREE FOR TWO WEEKS

Try one of these superb New Casiotone or Yamaha Keyboards Free for two weeks from Micro Musical the mail order specialists in electronic keyboards. If for any reason you're not delighted with the new sound of music simply return the keyboard in good condition and we'll refund your money in full. No questions asked. All our prices are very competitive and fully inclusive

of VAT, packing and same day despatch, subject to availability. Every keyboard carries our extended manufacturers guarantee for an incredible 18 months. That's how confident we are in the excellent quality and reliability of the latest generation of Casiotone and Yamaha instruments. So send off your order today (no stamp needed). Limited stock only.

## CASIOTONE CT-7000



The revolutionary new digital stereophonic synthesizer

with built-in 4 track recording facilities.  
· New sound locating system lets you traverse sounds through different locations · Chord and bass can be located independently while sound circulates · Multi-Track memory · 20 instrumental sounds · 12 rhythms  
· Vibrato, delayed vibrato, sustain and fill-in RRP £575

Micro Musical Price

**£525**

## CASIOTONE CT-405

768 Accompaniment Variations, 8 note polyphonic keyboard.

· Casio Chord auto-accompaniment · 20 preset sounds · 12 auto-rhythms with fill-in rhythmic interludes · Two modulation effects for a wide variety of sounds · Vibrato, delayed vibrato, sustain and reverb effects · Transposing function. RRP £325

Micro Musical Price

**£275**

## CASIOTONE CT-1000P



1000 Sound Combinations & Variable Arpeggio Patterns.

· 8 note polyphonic · Digital display of frequency and pitch · Keyboard split function gives duo sound effect · 3 vibratos and sustain effects

RRP £375

Micro Musical Price

**£325**

## CASIOTONE CT-501



It Reads The Score, Then Shows You By Lights How To Play It.

· 8 note polyphonic keyboard · 2-way memory · 3 playback modes · Casio Chord auto-accompaniment · 20 preset sounds · 10 auto-rhythms · Sustain, vibrato and delayed vibrato effects

RRP £375

Micro Musical Price

**£325**

## CASIOTONE MT-41

22 Preset Sounds, 6 Built-In Auto-Rhythms, Synchronised Bass Patterns, Or Manual Bass Accompaniment.

· 8 note polyphonic · Vibrato and sustain effects.

RRP £99

Micro Musical Price

**£79**

## CASIOTONE PT-20

Automatic Chord harmonics harmonise the melody with the right chords. Easy memory system with big 508-step capacity.

· 7 preset sounds · 17 Auto-rhythms · All in a palm-fit package.

RRP £59.95

Micro Musical Price

**£49-95**

## NEW CASIO AS110

### AMPLIFIER

Designed for Casio portable keyboard range. Includes input mixing, Bass and Treble, headphone output and modulation speed controls.

RRP £145

Micro Musical Price

**£125**

## \* YAMAHA CS01 SYNTHESIZER

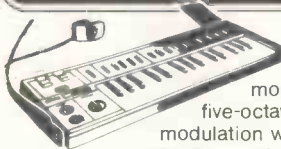

A unique high performance fully programmable monophonic synthesizer with full five-octave capability, pitch and modulation wheels, and a wide range of voice parameters.

\* FREE Breath Controller usually £19

Micro Musical Price

**£155**

## \* YAMAHA PC100

The Teach-Yourself Space Age Keyboard.

· Yamaha Playcard system and melody lamps · Auto Bass Chord, Arpeggio · Transposer Pitch Control · 10 orchestra voices · 10 rhythms · Sustain · Complete with case and 12 Playcards.

RRP £345

Micro Musical Price

\* FREE Handy Sound HS500 25 note polyphonic keyboard · 5 musical games · 5 instrument sounds RRP £69

**£279**

Micro Musical

FREEPOST,  
37 WOOD LANE,  
SHILTON, COVENTRY,  
CV7 9BR.

Interest Free Credit (zero %APR) on all H.P. or Credit Card transactions—ask for details. Free Securicor 24 hour delivery of CT models, or same day despatch by post for smaller items.

0203 616760  
for details of all  
Casiotone and  
Yamaha prices—  
it'll be music to  
your ears!

SEND  
OFF  
YOUR  
ORDER  
TODAY  
NO  
STAMP  
NEEDED

TO: MICRO MUSICAL LTD., FREEPOST, 37 WOOD LANE, SHILTON, COVENTRY CV7 9BR. EMM5

Please send me . . . qty Keyboard Model No. . . . . Value . . . . .  
I enclose cheque/postal order to the value of £ . . . . . or debit my

Access account No.

I understand that if I am not delighted I may return the Keyboard(s) to you within 2 weeks in good condition and my money will be refunded in full.

NAME

ADDRESS

POSTCODE

24 HOUR TELEPHONE ORDERING SERVICE: 0203 616760



just develop an idea. I feel I want to create something and I go to a keyboard and allow that feeling to represent itself through what I play. I've never really sat down and studied pentatonic scales and things like that, and I've never tried using quarter tones with some of the Korgs even though I could. Really, I write at the purely instinctive level — I know what I want to hear and I just keep working at it until I achieve it. Sometimes it doesn't work out. I think that if I'd been more schooled in the art of orchestration (which I certainly wasn't), and the art of counterpoint and harmony, it would have made things easier for me, because you can always fall back on a formula you know. With ELP, I had a lot of ideas that just fell into place but when I sit back and listen to some of the stuff now, I think, Jesus Christ that is the most schizophrenic material I've ever heard in my life! It sounds like a very impatient person trying to get everything done in one go. I think now in my old age I'm getting a little bit more mature and developing my themes a little more fully. I feel I'm taking an original idea to its ultimate objective. Some of the early music, such as on Tarkus and Brain Salad Surgery, I still like very much.

I did some work with Oscar Peterson — we did a TV show for BBC — which was a beautiful experience, because he'd always been a great influence to me and finally to do a show with him was awe inspiring. I remember I was very nervous about meeting him. He was playing at Ronnie Scotts and I'd heard through my management he wanted to meet me. Actually I wasn't keen on meeting him at all, I just thought it would be an embarrassing situation. So I ordered a bottle of champagne and sent it to his dressing room with a note on it saying

"you've always been a great influence, thanks a lot". I did finally meet him in his dressing room and it was a tremendous experience, completely unlike I thought it would be.

Other people who've influenced me in jazz are Winton Kelly, Red Garland, Thelonius Monk (particularly his compositions), ragtime pianists like Meade 'Lux' Lewis and Fats Waller, and Floyd Cramer on the rock and roll theme.

I'm still practising and I'm still changing my technique — I think you do have to change with the way you grow. I don't need to play the piano to keep the strength in my fingers, I think it's totally opposite now. When you're young you do have a lot of strength and a lot of attack, but that doesn't work out in technique after a while, it's now totally the opposite way of playing. I prefer to use keyboards that are weighted — I like to feel that bit of resistance. I really can't stand these little feathery light delicate touches.

## Performing

Live performance has always been the thing for me — well, it used to be and it's still at the back of my mind at the moment. I'm currently toying with the idea of getting another band together and I know the direction I'd like to put it into. But until I start getting a few more recordings done I can't really augment too much on that.

The challenges that I had before were always growing with ELP. It was one thing after another leading up to touring with that orchestra. I've always found it important to project to the audience, which is what really helped the keyboard become a front line

instrument for us. Now, of course, the keyboard is selling more than the guitar, whereas when I came in, the whole image was centred round the guitar. The guitarist moved around while I sat at my piece of furniture! All that moving around while I played is still part of me and if I get a band together I'm not going to rule that out. I think Pete Townshend still smashes his guitar up!

I always used Hammond Leslies with ELP. I finally got up to using the Pro 900 but there was something different about it. I never really liked it as much as the early ones I had. Bill Haugh took out the amplifier of the Leslie and boosted that up so it really shook. A lot of that early organ sound I remember was based on distortion and the right sort of

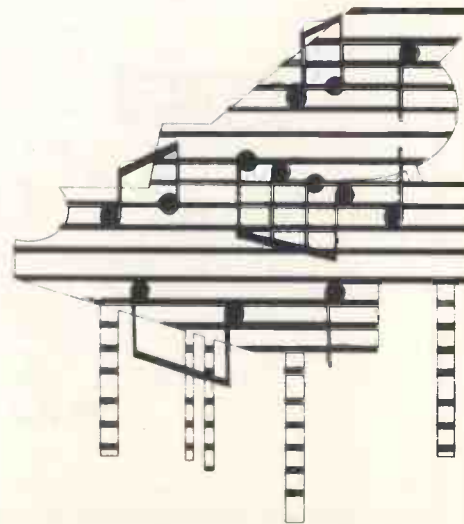



# ANOTHER STEP FORWARD INTO THE PAST.

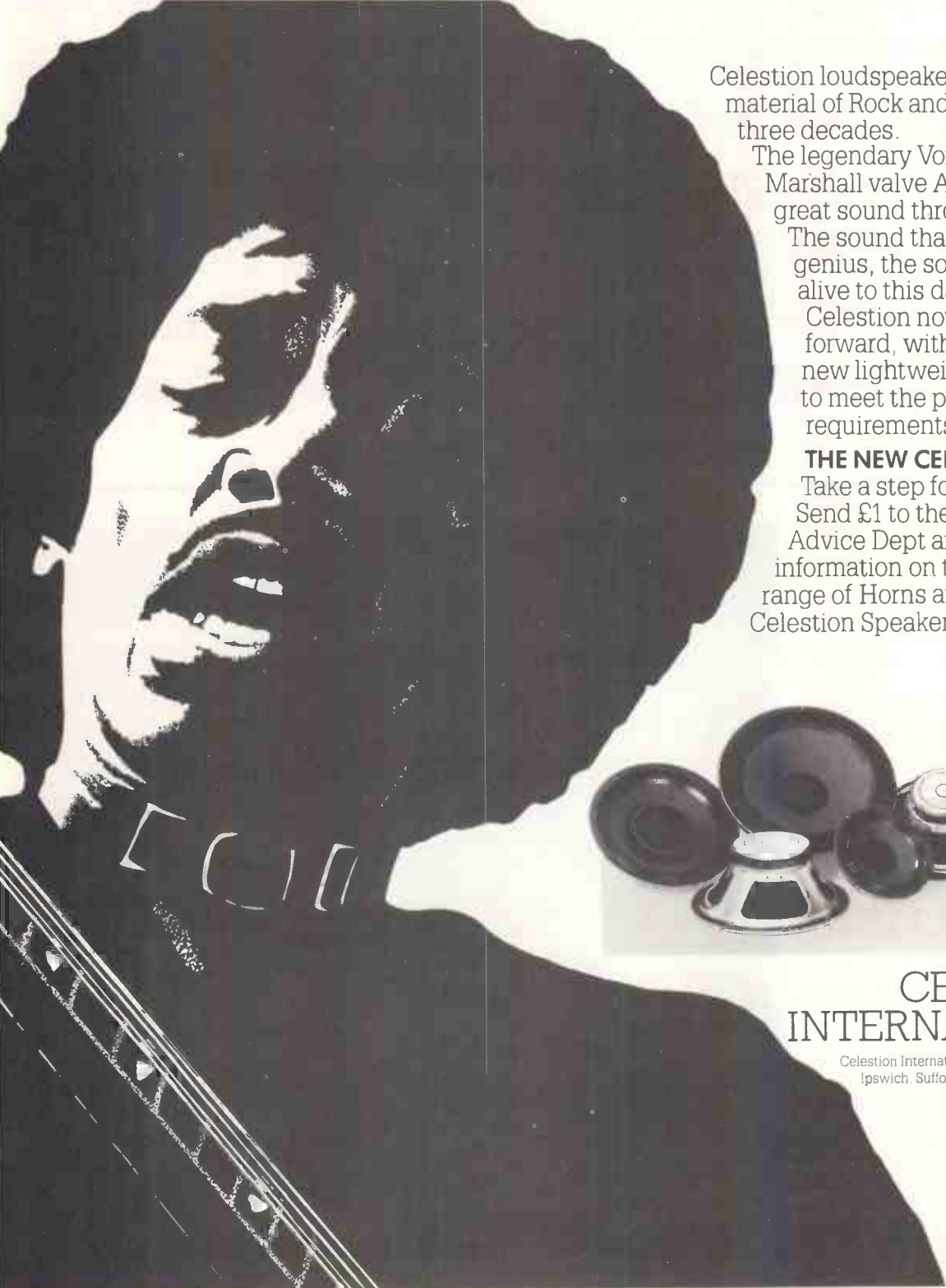

Celestion loudspeakers have been the raw material of Rock and Roll for over three decades.

The legendary Vox AC 30s and Marshall valve Amps produced their great sound through Celestions.

The sound that inspired musicians of genius, the sound that remains alive to this day.

Celestion now take a major step forward, with the introduction of a new lightweight power voice coil to meet the power handling requirements of the eighties.

#### **THE NEW CELESTION G SERIES**

Take a step forward.

Send £1 to the Celestion Technical Advice Dept and we'll send you information on the New G Series, our range of Horns and accessories plus the Celestion Speaker Cabinet Handbook.



**CELESTION  
INTERNATIONAL** 

Celestion International Ltd, Ditton Works, Foxhall Road,  
Ipswich, Suffolk IP3 8JP Tel: 0473 73131

# Keith Emerson



distortion you got. Of course, the Hammonds were all valve instruments and I jumped straight from those to the Yamaha GX-1. Altogether I had the Hammond L100, then I had a C-3 and an A-100 with The Nice.

When playing with the group, I would always leave the bass line alone and I've always disliked one-handed keyboard players! The thing was that when you went to play the organ it would be very boggy if you did too much heavy stuff in the left hand. So obviously the counterpoint style of layering musical lines was quite useful. Occasionally I'd use the left hand for ostinato figures [repeated patterns], but always it complemented what the bass player was doing. My solos with the band were always pretty rigidly laid out within the framework of the composition, but as I said, we would often take liberties and experiment. I never use pedals to set synth volume levels — the guy on the mixing desk would always do that, and we would have a pretty intense sound check beforehand. The guy on the mixing board was also in the studio when we were mixing so he knew exactly what line had to come up.

As far as PA was concerned, we did own a PA at one time but then we got into hiring the large rigs we needed — we did have a reputation for playing very loud! Our ELP engineer, John Robson, created a powerful PA for us in 1970 using cinema-type speaker cabinets with 10-foot folded horns and twin 15-inch loudspeakers for the bass, plus four Vitavox and two JBL horns for the upper frequencies, all driven by Crown amps. We tried quadraphonic at one point with speakers at the back of the hall but it didn't prove successful as a lot of halls didn't like it because of fire regulations. Later on we did our performances in stereo. Our engineer





# MUSICAL DISCOUNT WAREHOUSE

# HOBS MUSIC

# SPRING SALE

Super Low Prices on the Following ...

(please phone for quote where prices not listed)

## SEQUENTIAL CIRCUITS

PRO-ONE mono synth with sequencer  
PROPHET V  
POLY SEQUENCER  
MODEL 600 (in stock, but not in sale)

**CASIO** VL1, VL5, VL10, } EXTRA  
MT31, MT60, MT70, CT403, } LOW  
CT101, CT1000P } PRICES  
PT20, MT45, MT65 } IN STOCK  
CT202, CT602 } REDUCED!!!



## ROLAND

SH 101 MONO SYNTH with sequencer  
MGS1 STRAP HANDLE for above  
TR606 DRUMMATIC, TB 303 BASSLINE  
CR 5000/CR 8000 COMPURHYTHM  
TR 808 DRUM MACHINE  
501 SPACE ECHO with chorus

## GUITARS

FENDER STRATS, new, less trem, less case  
FENDER TELE'S, new, less case, from  
GIBSON LES PAUL'S with case, from  
GIBSON ES 335 dot, new, with case  
GIBSON ES 345 stereo, new, with case  
GIBSON ES 175, new, with case  
FENDER Precision Basses, less case, from  
FENDER Jazz Basses, less case, from  
FENDER Precision Special, new, with case

£250  
£225  
£395  
£575  
£599  
£699  
£225  
£299  
£395

## TEAC/TASCAM

M244 PORTA STUDIO — one left at old price,  
34 reel/reel 4-track — PRE PRICE RISE  
M30 MIXER — PRE PRICE RISE  
MODEL 2A MIXER — PRE PRICE RISE  
M35 MIXER — PRE PRICE RISE  
32/2B reel/reel mastering machine PRE PRICE RISE  
DX2B dbx for above — PRE PRICE RISE  
124 AV 2-track simul/sync cassette £139.00

## VARIOUS — Second-hand to clear

PROPHET V — latest model, perfect condition £1795  
GODWIN 749 string synth £250  
MOOG SATELLITE mono synth £99.50  
MOOG ROGUE mono synth £135  
MINI MOOG £395  
YAMAHA electric grand piano £2500  
WURLITZER electric piano £425  
CRUMAR electric piano £95  
ROLAND CR 5000 COMPURHYTHM £195  
BOSS reverb, stereo £75  
GIBSON L6S £175  
22-inch ride cymbal £75  
THE KIT £149  
LOADS OF AMPS and NASTY DRUM KITS from £49!

**ACCESSIT MULTI-TRACK** recording outboard  
FX in stock at discount prices — also GREAT BRITISH SPRING  
reverb now in stock!

FULL RANGE OF GUITARS IN STOCK!  
Access - Barclaycard - Mail Order  
Closed Wednesdays  
FREE SECURICOR DELIVERY

MARY STREET  
LANCASTER LA1 1UW  
0524 60740

**STOP PRESS!**  
GATEWAY STUDIOS 3-DAY COURSES —  
£60 per head + VAT planned for  
June 6, 7 and 8 in the  
Studios of Hobbs Music  
Please contact: Bruce Hobbs on  
**0524 60740**  
(Price does not include accommodation)

# HOBS MUSIC

A handwritten musical score for the piece 'Three Fates'. The score is arranged in a grand staff format with the following parts from top to bottom: Flute (Fl), Clarinet (Cl), Violin (Vn), Piano (Pno), Organ (Org), Trumpet (Tr), Violoncello (Vcl), and Contrabass (Cb). The organ part is the most prominent, featuring complex chords and melodic lines. Above the organ staff, there are five measures of music with time signatures 5/8, 4/8, 5/8, and 4/8. The piano part has measures numbered 25 through 29. The organ part has measures numbered 25 through 29. The score is written in black ink on white paper.

would muck around with the synthesiser quite a bit and throw it from side to side - I think that's what led a lot of people to think that I wasn't playing what I was playing. They thought it was taped because it was coming out of the other side, but we never used tapes.

On the other hand, there were some pieces that we recorded that could never be played live - for example, the Festival Hall organ piece. I'd have probably done the first movement of 'The Three Fates' piece I'm referring to because that was just solo piano. The last movement is 3 or 4 pianos playing away and it wasn't really intended as a live performance piece. These days I like to play piano, the GX-1 and my Korg stuff. The GX-1 cost me £30,000 when I bought it and I never got any free servicing from Yamaha either! I even had to hire a GX-1 when I was in Japan instead of them lending me one.

## Home Studio

I've got a ½-inch 8-track tape recorder with a Soundcraft 16-4-2 channel mixing desk, there's a couple of Pro Tannoy speakers, and a Great British Spring reverb unit. I don't have any outboard stuff really or computer instruments.

It's very much easier for me to work out compositions now. I just go in to the barn I use as a studio and start laying the tracks down. I generally work on my own, but if I need a drummer I just call one up and I've got an adjoining room for drums which gives a very tight sound. On some occasions I've taken the 8-track recording I've done up to London and bounced it onto a 24-track (I mainly use Advision), and then I carry on laying tracks up there. I've also used Air and

Lansdowne studios.

As far as composing is concerned, I think I'm still as eclectic as ever. I've been writing instrumental and vocal pieces but I haven't really hit on the right sort of group yet. I'm still looking for the right players to play with permanently. At the moment I'm just calling on a drummer and a bass player from time to time. There's a distinct possibility that I might use another keyboard player with me - I think that would be a nice touch. It would also help with the overdubs in the studio because I always like to do live what is on the album.

## Film music

I would like to become more established as a composer and I would still like to score a really good movie. I've already done several films. I won an award for the one I did in Italy called 'Inferno'. And I did 'Night Hawks' with Sylvester Stallone. There's also a Japanese film I've just had released as well, and there's another movie in the pipeline.

I don't find being tied to the structure of the film too limiting - I enjoy writing film music as the medium helps me to be much more concise in my writing. It's not like recording an album where I'd need a very heavy producer to keep me in check.

I haven't ruled out going back on the road again. I think that it is important that I do, but at the moment I don't find it so much of a challenge as doing the movie scores - I haven't broken that yet. The thing is getting the right film. If the film's a success or it stands up then the music has a better chance. Vangelis beat me to it (laughs) with 'Chariots of Fire'. In fact, I did have that film script and turned it down!

I don't think I shall ever do solo performances as I like the live performance touring situation, where you're working night after night with the same group of guys and partying afterwards - that's all part of it. I've been approached to do solo performances with orchestras, but that's not really the direction I want to go in.

Incidentally, one of the things that interested me with the Fairlight was the 'scaling', which enabled me to get some really interesting clusters of notes for cymbals that's great for film music - it helped a lot on 'Night Hawks'. But it's still too expensive for me to buy! I'm now multi-tracking stuff in the studio and I use a Linn

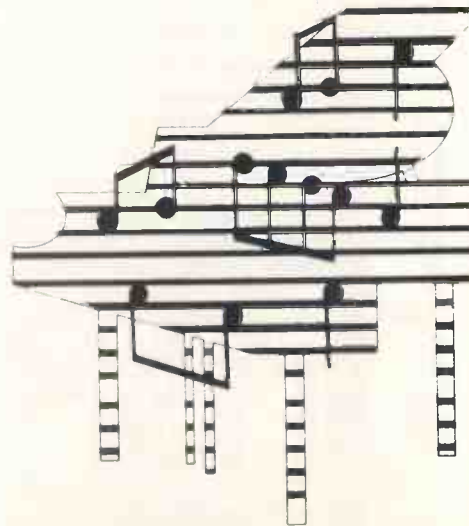



TITLE RETURN TO ROSE

Fl.  
Ob.  
Ba.  
Hn.  
Tpt.  
Tbn.  
Timp.  
Piano  
Cl.  
Cb.

Drum — the first model they brought out. I used electronic drums on 'Night Hawks' and on 'I'm A Man' (the old Stevie Winwood song). Yes, I really like the Linn — it doesn't argue!

I use a lot of trial and error when I'm building up something. I'm not really a big effects man, although I use a Harmonizer in the studio to get a honky-tonk piano when they won't let you de-tune the piano.

As much as I admire the music coming out on the radio now, it's the end product of an industry — that industry consists of a producer and a lot of technological effects, all of which I find quite good. But I don't find the harmonies, I don't find the tunes, there's no real melody there. The recording industry at the moment is in a big turmoil, there's lots of people being hired and fired all the time — they're very, very unrestful.

The record companies that I deal with have a certain concept of how Keith Emerson should be sounding these days. Their last

picture of me was with ELP and obviously I've moved on — I've broadened out on how I was writing with ELP. Nevertheless, whatever I presented them with in terms of music was not their preconceived image of what I should be doing. It's a big problem and something I'm battling against at the moment. I've even toyed with the idea of changing my name and releasing a single — that's a distinct possibility! Definitely, if I get back on the road it won't be announced. You won't get a big fanfare — I'll sneak into the back door.

It's now 3 or 4 years since I've been on the road although I've done the odd TV show. I'm not at all worried about the time gap since my last tour as long as I find the right band to take on the road. But I haven't found that right formula yet. In the meantime, I've had the 'Honky' album released that's available on import.

### Looking Ahead

I'm hoping to catch sight of this new Korg instrument they're making for me soon. It's going to be programmable with 16 oscillators and they're going to design the speakers to handle it all. There'll be a lot of outboard stuff that's all remembered by computer, as well as sound sampling, and the computer control will allow me to bring up a sound at the push of a button. I've also asked for a ribbon controller. Mr. Kato, the Korg President, is a very intelligent person and he's got wild ideas about building a circular keyboard! I certainly prefer to have a good length keyboard and I don't like the small gauge ones at all.

In order for me to survive in the rock world I'd have to make certain concessions and I don't know if I'd be prepared to make

those concessions. For example, I'd really have to simplify the ideas that I use. I mean it's literally drawing out a beautiful complete idea and making a riff out of it and then adding a vocal over the top — I think that's all it's down to these days. I think most modern music gets by with hook lines — you've just got that one, two-note motif, that if you hit on the right formula you're made.

The same thing is evident in soundtrack for films. If you come up with the simplest idea then you succeed — you've only got to hear that 'Jaws' theme. With the opening 2 notes that was made. I'm afraid that's all it's coming down to. This is something I'm battling with because what I write is very complex, so what I have to do in order to survive is simplify it all, and if you listen to my music with ELP and The Nice my music has never been simple. So while I'm learning to do that I don't want to adulterate a gift that I have, and I think it is a gift.

I'm not doing any live performances at the moment because I'm just too guarded. When that day comes and the audience ask me to play 'America', I shall enjoy doing it. I'm currently reorganising my management structure and I'm working on a lot of music. But from the record companies' point of view they would like something new. (Of course, film music is quite different because I shall write whatever is needed to fit the particular film.) I'm certainly not going to wait for the record companies to give their approval. Once I find the right combination, musicians who I enjoy playing with, and we've put a repertoire together, we'll go out and play a little club somewhere — whatever the record companies think and, for that matter, anybody else!"



The Emerson, Lake & Palmer music album (with sample page reproduced here) costs £3.95 and is distributed in the U.K. by Music Sales Ltd., 78, Newman Street, London W1P 3LA. A full catalogue of Music Sales titles can be obtained by sending a S.A.E. to this address.

The Emerson, Lake & Palmer music album is, as Keith Emerson says, a transcription of selected pieces for the keyboard player. Vocal lines and words are included and guitar chords appear for the relevant sections.

The 56-page album pieces are Trilogy, The Endless Enigma (Parts I & II), Take A Pebble, The Sheriff, Jeremy Bender, and Benny The Bouncer.



The music will certainly challenge your reading skills, although the opportunity to put Emerson's notes under your fingers is an exciting one. A lot of the idiosyncracies of his playing are written down and there's a wealth of interesting rhythmic passages in different time signatures (such as the 5/4 section in Trilogy). The page of music reproduced here is from The Endless Enigma (Part I) and will give you a sample of Emerson's fluid melodic lines and jazz harmonic structures.

This album is the first in a series of music books we'll be examining in the coming months and is likely to be a treasured collection that marks an era of rock for any keyboardist.

© 1973, 1977 Manticore Music Ltd. All rights reserved.

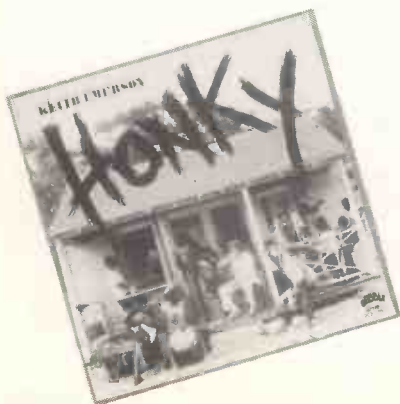





**Emerson Lake and Palmer  
Pictures at an Exhibition**  
Precision Video VAMPU 2575  
45 minutes — mono

Produced by Lindsey Clennell and directed by Nicholas Ferguson, the original film of Pictures at an Exhibition successfully did the rounds of UK cinemas, and occasionally surfaces for late-night showings even now. This videotape is a shortened version, reduced to the first half of the set played at the London Lyceum in 1971, but still captures much of the atmosphere and excitement of an early ELP show.

The theme, as in Mussorgsky's composition of the same name, is a tour around a picture gallery, with each musical 'picture' separated by a recurring 'promenade'. Greg Lake has put lyrics to the promenade theme, and the content of the pictures are equally divided between Emerson's and Mussorgsky's compositions.

While Greg Lake flits from electric guitar and bass to vocals and acoustic guitar, and Carl Palmer thrashes around a large drum kit complete with orchestral gong, chimes and tubular bells, Emerson displays all the showmanship that made the band famous from the keyboard set-up. Apart from the modular Moog system (no Minimoog available at the time), there are two Hammond organs facing each other, and also a clavinet which isn't seen in use in this section of the concert.

Cartoon animation and psychedelic gra-

phics add to the impact of Emerson's synthesiser runs, drones and abstract noises. The infamous posturing with the Moog ribbon controller is still there, and the intelligent application of a rock format to the keyboard classics turns the film into a virtual Hammond users' manual!

**Dario Argento  
Inferno**  
20th Century Fox 1140-50  
104 minutes — mono

Keith Emerson's powerful orchestral score is a major factor in the impact of this unusual Italian horror film. Director Dario Argento has a long history of imaginative commissioning of film music, another example being Goblin's atmospheric score for his film 'Suspiria'.

'Inferno' is a sort of spaghetti Exorcist, with very carefully dubbed dialogue and a high-quality soundtrack which captures all the subtle sounds of an eerie old house in New York. According to the plot there are three such houses, the others being in Italy and Germany; each one is home to one of the 'Three Mothers' — Whispers, Tears and Darkness — who secretly control the affairs of mankind.

When a series of murders begins in New York, a young music student makes it his responsibility to find out whether the supernatural associations have any real significance. During his search, rapid intercutting, unusual camera angles and the orchestral climaxes of the score itself create various moods of suspense, sudden terror or anti-climax. A recurring piano theme is invariably the prelude to a gory murder, and manifestations of the supernatural are usually accompanied by Latin choir pieces resembling Carl Orff's 'Carmina Burana'.

Godfrey Salmon's orchestrations complement Emerson's keyboards perfectly, and a wide selection of imitative sounds, from screaming guitars to string and brass sections are on display. The main title music and some other pieces are often obscured by dialogue, but for Emerson fans there's a soundtrack LP available as well.

and percussion by Frank Scully.

The orchestra used is the Orchestre de L'Opera de Paris, and other famous names taking part include Tristan Fry (of Sky) on orchestral percussion. Overall it's quite a heavily orchestral album, although in a more dramatic style than, for instance, the 'Piano Concerto No. 1' on 'Works'.

**Keith Emerson  
Honky**  
Bubble Records BLU 19608

Keith Emerson's latest solo offering shows his range of tastes and styles to be as varied and interesting as ever. Recorded at Elite Studios and Compass Point in the Bahamas, it displays a certain Caribbean influence, largely contributed by Kendal Stubbs on bass and Neil Symonette on drums; however, classical, jazz and rock styles are also represented, together with a certain element of humour which hasn't been seen since the days of ELP's 'Benny the Bouncer' or 'Are You Ready, Eddie?'

The opening 'Hello Sailor' includes George Malcolm's 'Bach Before the Mast' and comprises a set of variations on the traditional 'Sailor's Hornpipe'. Beginning with a slow bass guitar version of the theme, it works through piano solo and heavier rock versions of the same melody before return-

**KEITH EMERSON**

**Discography**

**NICE**

1967 Autumn '67 Spring '68	Charisma	CS1
1967 Thoughts Of Emerlist		
Davjack	Charly	300021
1968 Ars Longa Vita Brevis	Charly	300019
1969 Nice	Charly	300014
1970 Five Bridges Suite	Charisma	CAS1014
1971 Elegy	Charisma	CAS1030
1974 Best Of Nice	Electrola	04890674
1975 Vintage Tears	Sire	3710
1976 Armoeni Redivivi	Immediate	IML1003
1976 Nice With Keith Emerson	Phonogram	6641119

**ELP**

1970 Emerson Lake & Palmer	Manticore	K43503
1971 Tarkus	Manticore	K43504
1971 Pictures At An Exhibition	Manticore	K33501
1972 Trilogy	Manticore	K43505
1973 Brain Salad Surgery	Manticore	K53501
1974 Welcome Back My Friends...	Manticore	K63500
1977 Works Volume 1	Manticore	K80009
1977 Works Volume 2	Atlantic	K50422
1978 Love Beach	Atlantic	K50552
1979 In Concert	Atlantic	K50757
1980 Best Of ELP	Atlantic	K50652

**FILM MUSIC**

1980 Inferno	Cinevox	CIA 5022
1981 Night Hawks	MCA (Backstreet)	BSR 5196

**SOLO ALBUM**

1981 Honky	Bubble	BLU 19608
------------	--------	-----------

**Further information**

Besides the two video cassettes reviewed here, you'll find 'Night Hawks' also available. The 'Night Hawks' LP is available in the UK from MCA Records, 1, Great Pulteney Street, London W1R 3FW (tel. 01-439 9951). The 'Honky' LP is sold by Bubble Records, Cinevox, Rome (Telex 616241). Keith Emerson's Piano Concerto is not for sale, but can be hired by contacting Arnold Broido, Theodore Presser Co., Bryn Mawr, Pennsylvania 19010, USA. In this issue we are also offering the 'Honky' LP as the crossword prize.

Both video cassettes are available from Adrians Video, 36, High Street, Wickford, Essex. (Tel. 03744 3318). 'Inferno' costs £49.95 and 'ELP-Pictures At An Exhibition' costs £44.95. Add £1.45 for recorded delivery and packing. A full list of music videos will be sent on receipt of a S.A.E.

**Keith Emerson  
Nighthawks**  
MCA Records BSR 5196

Bruce Malmuth's powerful thriller features a strong cast, including Sylvester Stallone, Lindsay Wagner, Persis Khambatta and Nigel Davenport. Emerson has come up with an equally powerful soundtrack, which opens forcefully with the brassy chords of the Nighthawks Main Title.

Other tracks such as 'Mean Stalkin' open with subtly atmospheric background sounds, followed by more up-tempo passages with grand piano, disco/funk drums and vocals and rapid synthesiser leads. 'I'm a Man' features Keith's vocals over a Latin percussion backing with organ-like chords producing fanfares similar to ELP's earlier work.

'The Chopper' continues in this vein, with a gliding lead reminiscent of parts of 'Tarkus' contrasting with a string section of deep bass synthesisers. 'Tramway' sounds as if it's recorded by a string quartet with orchestral percussion, but in fact relies entirely on the breathtaking cello, brass and percussive memories of the Fairlight CMI.

Remaining tracks such as 'The Flight of a Hawk' give examples of Godfrey Salmon's orchestral arrangements, which on the whole complement the keyboard pieces well. Recording is divided between Compass Point and Advision, with bass contributed by Kendall Stubbs, drums by Neil Symonette  
E&MM MAY 1983

ing to solo piano for a heavily-ornamental Bachian finale.

'Salt Cay' is a light, Caribbean-flavoured instrumental with multiple synthesiser lead lines, while 'Green Ice' is a more dramatic piece along the lines of American TV music — all jazzy piano and synthesised brass sections.

Side two opens with a wacky introduction and 'Big Horn Breakdown', a country music influenced ragtime piece. It's followed by Meade 'Lux' Lewis' 'Yancey Special', which could have been a worthy follow-up to the same composers' 'Honky-Tonk Train Blues' on 'Works Vol 2' but tends to be a little diluted by the reggae backing. 'Rum-a-Ting' is another light instrumental concentrating on Minimoog leads and Kendal Stubbs' treated bass, while the closer 'Jesus Loves Me' overlays a revivalist prayer meeting with a fluid gospellish piece largely on Hammond C3. A highly varied album then, and well worth searching for.

**E&MM**

# MUSIC MAKER EQUIPMENT SCENE



Hitachi introduce their bid for the Compact Disc market with the DA 1000 Computer Controlled CD player.

The DA 1000 uses a new Unitorque motor to give a claimed wow and flutter too small to be significant, together with distortion no greater than 0.03% at any frequency. It's a 16-bit quantisation design with a sampling frequency of 44.1 kHz, and a variety of Play and Memory Modes. FF or FB run through the disc playing short samples until released at about 30 second intervals; Memory Stop marks any point on the disc for instant location using FF or FB; Repeat allows a disc to play contin-

uously while Random Memory Programming recalls a series of tracks in any order.

Time and programme information is displayed when desired, and a location indicator shows which portion of the disc is playing. The DA 1000 operates using a self-correcting 3-laser system and a unique D-A convertor claimed to produce superior sound quality with minimum distortion. Recommended retail price including VAT is £555.

Further details from Hitachi UK Sales, Hitachi House, Station Road, Hayes, Middlesex, UB3 4DR. Tel. 01 848 9797.

Sennheiser demonstrated their range of microphones, including radio transmitter models, at the Frankfurt Music Fair. Seen on the Sennheiser bandstand is European representa-

tive Michael Kessler.

Further details Hayden Labs, Hayden House, Chiltern Hill, Chalfont St. Peter, Gerrards Cross, Bucks SL9 9UG. Tel. 0753 888447.



Technics expand their range of multiple noise reduction cassette decks with the RS-M235 X. Offering Dolby B, Dolby C and dbx noise reduction, it reaches a claimed s/n of 92dB and dynamic range of 100 dB, together with low wow and flutter figures from a two-motor drive system. Automatic

tape formulation sensing and a built-in timer facility are two more capabilities of the deck, which retails at £176.95.

Further details from National Panasonic, 300-318, Bath Road, Slough, Berks. Tel. Slough 34522.



Multivox have introduced a new bass pedal synthesiser, the MX450. It features a full octave of keys and a powerful two-oscillator sound. Foot-switch controls include Sub-Oscillator, VCF Sweep, Percussion, Slow Attack, Sustain and VCA Hold. VC and Trigger inputs and outputs allow the

MX450 to be interfaced with other synthesisers, sequencers and modular units such as the SQ-01 Digital Sequencer/Synthesiser.

Further details from Multivox, 370 Motor Parkway, Hauppauge, New York 11788. Tel. 516 231 7700, USA.



Seck's Producer is a versatile broadcast standard mixer featuring four input channels each with cue facilities for suitably equipped record or tape decks, and with an overall stereo balance control, Auxiliary microphone input, headphone monitoring and all the other facilities necessary for radio, TV, cable or disco work. On show at the Frankfurt Music Fair, it's distributed by Turnkey who will be happy to supply further details.

Turnkey, Brent View Road, London NW9 7EL. Tel. 01 202 4366.

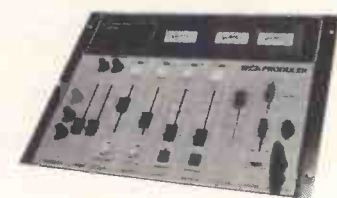

TOA Electronics announce a new series of radio microphones incorporating diversity receivers. This design involves two aerials and an automatic control to ensure that the strongest signal is always used. Designs available include a hand-held



model and a tie-clip unit linked to a small belt transmitter. Both models include windscreens and battery strength indicators.

Further details from TOA Electronics, PO Box 82, Castle Street, Ongar, Essex. Tel. 0277 364333.





## Constructor Series Speakers

IT'S  
SO  
EASY

Have fun, save money, building a Kef design with a Wilmslow Audio CS Total kit.

No electronic or woodworking knowledge necessary and the end result is a proven top-quality design that you'll be proud of.

Each kit contains all cabinet components, accurately machined for easy assembly, speaker drive units, crossovers, wadding, grille fabric, terminals, nuts, bolts, etc.

The cabinets can be painted or stained or finished with iron-on veneer or self adhesive woodgrain vinyl.

Easy foolproof assembly instructions supplied. Set of constructor leaflets sent free on receipt of large S.A.E.

Prices: CS1 (As 101)	£110 pr. inc. VAT, plus carr./ins. £ 5.50
CS1A (simplified LS3/5A)	£103 pr. inc. VAT, plus carr./ins. £ 5.50
CS3 (as 103.2)	£129 pr. inc. VAT, plus carr./ins. £10.00
CS5 (as Carlton II)	£192 pr. inc. VAT, plus carr./ins. £15.00
CS7 (as Cantata)	£250 pr. inc. VAT, plus carr./ins. £18.00



0625 529599

35/39 Church Street, Wilmslow, Cheshire SK9 1AS

Catalogue — £1.50 post free



Lightning service on telephoned credit card orders!

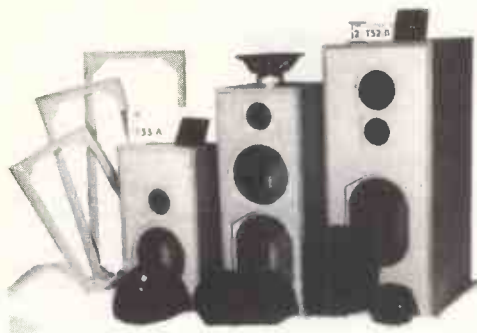

# BRITAIN'S No. 1 MAIL-ORDER SERVICE

Our unique 7 day money back guarantee gives you complete confidence in ordering the latest technology through the post.



High Part Exchange allowance on your old equipment. Tel. for quote.

### CSQ-600

With its integrated micro-computer, the CSQ-600 can store a maximum of 800 steps and rhythms. Sequences are directly loaded from the keyboard, and both scales (CV) or rhythms (GATE) can be added separately. To protect the memory, a battery backup function is provided. Four different memories allow continuous or random loading and playback and the CSQ-600 can be used with the Computer rhythm CR-78. Several CSQ-600s can be used together for an even greater range.

### CSQ-100

The CSQ-100 Digital Sequencer with its micro-processor element stores up to 168 notes. Synthesizer — played sequences can be loaded directly, and pitch can be loaded either separately at a constant time value or with variable time values added afterwards.

● Maximum Storage Capacity: 168 notes (or 84 notes per channel) ● Dimensions: 345(H) x 95(H) x 305(D)mm (13.7" x 3.7" x 12.0") ● Weight: 3.9kg (8.6lbs) ● Accessories: 1.5m Dual Patch Cord (x2).



rrp  
£599  
ABC  
price  
**£295**  
add £5 p&p

rrp £399  
ABC  
PRICE  
**£175**  
add £5 p&p  
Order now by  
phone. HURRY!



ROLAND SH 101	£ 249	ROLAND CR 8000	£ 325	ROLAND EP11	£ 299
ROLAND JUNO 6	625	ROLAND TR 808	550	ROLAND HP60	425
ROLAND JP4	699	ROLAND TR 606	199	ROLAND HP70	525
ROLAND JUNO 60	999	ROLAND TB 303	199	ROLAND Guitar	
ROLAND JUPITER 6	1999	ROLAND MC 202	325	Synth complete	695
ROLAND JUPITER 8	3250				
ROLAND JX3P new	899				
AMPS		ROLAND CUBE 60C	275	ROLAND PA80	325
ROLAND CUBE 40CH	175	ROLAND JC50	250	ROLAND PA150	475
ROLAND CUBE 60CH	210	ROLAND BOLT 30	175	ROLAND SST 120	350
ROLAND CUBE 40K	179	ROLAND BOLT 60	325	ROLAND 12 into 2 Mixer	895
ROLAND CUBE 60K	239	ROLAND BOLT 100	495		
ROLAND CUBE 60B	219	ROLAND SPIRIT 30	139		
ROLAND CUBE 100	295	ROLAND JC120	475		
ROLAND CUBE 40C	225				

**CASIO.**  
Amazing new models in stock now. Send for details.



CASIO CT7000	£ 495	CASIO 405	£ 275	CASIO MT11	£ 49
CASIO MT45	99	CASIO 1000P	325	CASIO PT30	69
CASIO MT70	199	CASIO 701	445	CASIO MT41	79
CASIO 501	325				

CARRIAGE FREE ON ALL CASIO'S



## YAMAHA

## KORG

UP TO 50% DISCOUNT  
WHILST STOCKS LAST

Sk30	£ 1195
SK50D	1595
CS70M	1795

KORG EP51	£ 999
KORG SP80	899
KORG POLY 61	999
KORG POLY 6	950
KORG TRIDENT II	1950
KORG KPR77	449

● INSTANT CREDIT



Phone in your credit card number for instant despatch

14-16 HIGH ST. ADDLESTONE SURREY  
Tel 0932 40139/54877

also at  
56 SURBITON RD. KINGSTON SURREY  
01-546 9877  
19 WEST ST. DORKING SURREY  
0306 886999

# The alphaSyntauri



## A VERY SPECIAL SYNTHESIZER Only for the serious among you

Standard features allow you to:

- Draw unique waveforms
- Create unique stereo envelopes
- Up to 8-way keyboard splits
- Fully programmable velocity sensing keyboard
- Layer up to 8 voices
- 8 voice polyphony
- 16 fully programmable digital oscillators
- 16 track digital recording
- Print out hard copy musical scores
- Software based
- Modular in construction

THE SYSTEM CAN GROW AS YOU DO  
IT CANT BE OUTDATED

Directly imported by Computer Music Studios  
62, Blenheim Cresc., London W11 1N2  
01-229 2597 01-969 5822



# ABC MUSIC

# Fostex X-15 Multitracker

The name Fostex is quickly becoming synonymous with quality home multitrack equipment. The very latest addition to the Fostex range of home recording equipment, the X-15 Multitracker, looks set to continue this trend. It is a portable, battery/mains operated four track cassette recorder and mixer — with the emphasis definitely on 'portable': for the complete unit measures only 3"(H) x 11½"(W) x 9"(D) and weighs in at under 6½lbs including the battery pack!

The unit is compactly constructed from tough black plastic. The X-15 differs from the model 250 Multitracker in several ways. Firstly, the tape speed — which is the standard 1½-ips; no double speed facility being provided. The slower tape speed should normally result in a lower signal to noise ratio, but the inclusion of built in Dolby B type noise reduction circuitry helps to maintain a healthy S/N of 60dB which is still slightly better than most open reel budget multitrack tape recorders! Crosstalk is quoted as 40dB, with a signal frequency response that extends up to 12.5kHz. The second difference is that you can only record on a maximum of two tracks at a time, which may appear somewhat limiting but is not in practice, as this machine is meant to be used for multitracking by one person and most musicians would rarely need to record more than two instruments simultaneously anyway.

## Portability

The recorder is designed primarily for portability. With this in mind, a rectangular case is provided that houses ten (1.5V) SP2 type batteries. This case attaches to the rear panel by two large slot head screws that can easily be turned using the edge of a coin for quick removal and change of batteries. The recorder requires a voltage of between 11 and 15 volts. When the batteries are too low to enable a good recording to be made, the green power LED on the top of the main panel will either dim, flash or go out completely. A DC In socket on the rear panel allows an AC adaptor to be connected for mains power and is accessible once the battery pack is removed. Incidentally, Fostex say that a rechargeable battery pack should be available very soon that will allow the recorder to be plugged into the mains and used while the batteries are charging.

## Connections

Now to the control layout of the recorder itself. The power switch is located on the rear of the battery case and a green LED on the main panel lights to say that power is on. The left side panel contains eight recessed phono sockets that provide connections for the Tape Output (-10dBV) from each track, the main Left and Right outputs (-20dBV) and channel A and B Line Inputs (-20dBV). Mic Inputs (-50dBV) are provided on the front panel for channels A and B. These are standard ¼" jacks and will



accept most high impedance input signals. To the right of these are two small black thumbwheels and a ¼" jack stereo headphone socket (8-40 ohms) for monitoring your recordings. These thumbwheels are flush mounted with the front panel, but are cut away at the bottom to allow you to turn them. The first wheel controls the headphone level and does not affect your recording level.

The second thumbwheel is a Pitch control that gives you plus or minus 15% of the normal tape speed, effectively allowing you to change the pitch of a note, up or down by three semitones (a major 3rd). A centre click-stop sets normal pitch operation. This pitch control is a very useful device, which allows you to tune sounds on the tape to the pitch of your instrument, or to create effects. Two sockets for Remote Punch In and Punch Out complete the front panel controls, and these accept the Fostex Model 9060 Remote foot control which operates on an 'airline pump' principle, rather like a camera flash selector. You squeeze the pump and air pressure switches a contact!

## Main Panel

The top panel contains the cassette section and the four channel monitor mixer. The cassette cover lid is situated on the centre right of this panel. Lifting it gives easy access to the standard cassette tape transport mechanism and the Erase and combined 4 track Record/Playback heads. The latter is the same one that is fitted to the model 250 Multitrack cassette recorder. Demagnetisation and regular cleaning of tape heads is particularly easy to achieve on this machine. Above the cassette LED is a 3 digit mechanical tape counter with a reset to zero pushbutton. Directly below the cassette lid are the cas-

sette motion functions.

The left hand side of the main panel is concerned with signal mixing and routing. Across the top are two rows of four small, rotary controls numbered 1 to 4, situated in a recessed compartment. The top row are the Gain controls with zero at the 12 o'clock position, and below these are the Pan controls for stereo positioning of tracks during mixdown or monitoring. Two Input Selector switches and two main faders (A and B) are located below this compartment. These three position switches determine which input signal is routed to the channel fader, and are labelled Mic, Line and Remix. The main fader controls either the record level of the input coming from the Mic/Line Selector or on Remix controls the level of off-tape signals during the stereo mixdown. Between the faders are two vertical green LED meters. These are the peak reading type of meter calibrated from -20 to +6 VU, with red LEDs above 0VU.

## Impressions

The X-15 Multitracker has only just been launched and is not available until May. The machine will sell at around £299 (inc VAT), a price that should enable anyone to multitrack their music — let's hope that every school music room gets one too! The unit comes with a strong, woven shoulder strap that fixes neatly to the case using two metal clasps, and makes the machine truly portable.

We will be testing the X-15 during the next few weeks and we'll publish a full practical appraisal shortly.

**E&MM**

The Fostex X-15 is distributed in the UK by Turnkey, Brent View Road, London NW9. Tel: 01-202 4366.

sette motion functions.

From right to left these are: Pause, Stop, Fwd, Rewind, Play and Record. The large Record button has an accompanying red LED to indicate the record status. While in the Play mode, depressing either Rewind or Fwd lets you hear what's on tape, giving an audio cueing facility for quicker selection of the start of your music. Pushing the Record button automatically depresses the Play button as well which cuts down the number of things you have to control

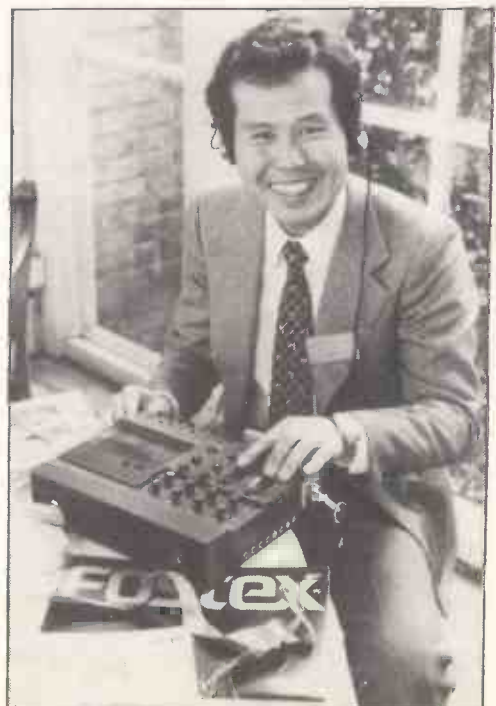

Mickey Matsumoto (Fostex R&D Manager) and X-15



# MUSIC MAKER EQUIPMENT SCENE

## Electronics & Computing



### New Instrument Cases

BOSS Industrial Mouldings Ltd have now increased their range of Instrument Cases by adding another size model to their BIM 3000 Series. Being of all metal construction and available in 2 sizes of 250 x 167.5 x 68.5 mm high and 250 x 187.5 x 78.5 mm high they incorporate a rigid matt black stove enamelled 18swg chassis to which red, grey or orange

stove enamelled 14swg top and bottom covers are independently attached.

The chassis design includes integral brackets etc, for supporting components, PCBs and other assemblies.

For further details contact: BOSS Industrial Mouldings Ltd, James Carter Road, Mildenhall, Suffolk IP28 7DE. Tel. Mildenhall (0638) 716101.

### Autorangeing Capacitance Meter

GSC has developed a handheld autorangeing capacitance meter, the Model 3002, which features a degree of precision, range and flexibility normally associated with benchtop instruments.

The new meter, which incorporates a 3½-digit liquid-crystal display and measures only 193 x 95 x 44mm, provides direct readings of capacitance from 1pF to 19,990uF. Eight automatically selected ranges remove the need for manual switching, and a dual-threshold measuring technique ensures an accuracy within 0.2% (± one count) from 1pF to 199uF and 1.0% (± one count) between 200uF and 19.99mF.

The dual-threshold measurement technique used in the Model 3002 eliminates reading errors caused by dielectric absorption, and the use of DC charging characteristics to determine true capacitance means that the instrument can be used for measurements on cables, switches and other components as well as on capacitors. For capacitor measurements, input connectors are provided for round or flat-leaded devices.

The Model 3002 operates from six AA nickel-cadmium or alkaline batteries, and the maximum current consumption of 75mA ensures a long battery life. An optional AC adaptor/charger can also be used.



For further details contact: Global Specialities Corporation, Shire Hill Industrial Estate, Saffron Walden, Essex, CB11 3AQ. Tel. (0799) 21682.



### Encased Transformers

To satisfy demand for a low VA, encased toroid transformer, ILP have just released a 15VA model, fully encased in an ABS plastic shell. The unit is mounted using an M4 bush in the base.

Throughout the year they will continue to bring out larger models up to around 120VA.

For further details contact: ILP Electronics Ltd., Graham Bell House, Roper Close, Canterbury, Kent, CT2 7EP. Tel. (0227) 54778.

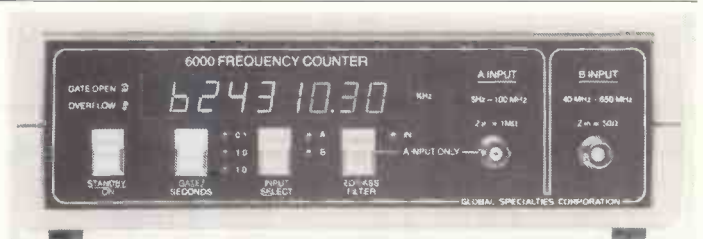

### Low-cost Frequency Counter

A new low-cost frequency counter offering high performance, ease of operation and measurement flexibility from 5Hz to 650MHz has been introduced by GSC.

The new Model 6000 incorporates an easy-to-read 8-digit LED display and simple pushbutton controls with LED indicators for selecting the input, gate time and low-pass filter.

Two front-panel BNC inputs are provided: one covering the range 5Hz to 100MHz with a 1M input impedance and the other for signals between 40MHz and 650MHz with a 50R impedance. Gate times of 0.1, 1.0 and 10 seconds are available, and a switchable low-pass filter provides

3dB/octave rolloff at 60kHz for audio and ultrasonic measurements.

The standard Model 6000 incorporates a 3.579545MHz, temperature-compensated crystal oscillator with an accuracy of ±1 part in 10<sup>6</sup>. An alternative high-stability version, the Model 6500, features a crystal-oven oscillator with an accuracy of ±0.1 part in 10<sup>6</sup>.

The instrument is compact (76 x 254 x 178mm) and lightweight (1.6kg), and features a flip-up leg for benchtop use.

For further details contact: Global Specialities Corporation, Shire Hill Industrial Estate, Saffron Walden, Essex CB11 3AQ. Tel. (0799) 21682.

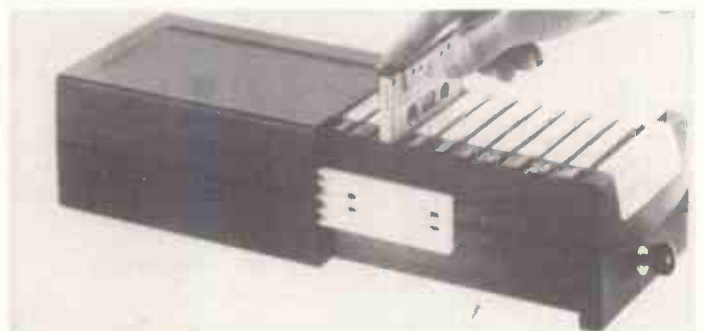

### Data Cassette Storage

Artur Fischer (UK) Ltd. are launching a new Fischer CBOX product in the UK.

The new Fischer CBox Drawer Unit has been specially designed for the owners of personal computers who are looking for safe and easily acces-

sible storage facilities for their data cassettes that contain long term information, important programs - or games.

For further details contact: Artur Fischer (UK) Ltd., 25, Newtown Road, Marlow/Bucks, SL7 1JY. Tel. Marlow (06284) 72882.

# PRO-ENTS Speaker Systems



Our largest full-range  
Cabinet — RK 400  
**£575.00 (inc. VAT)**  
Many smaller, more portable  
units available!

## FULL RANGE! With PRO-ENTS FULL-RANGE MEANS PRECISELY THAT!

- PA cabinets for PA Systems
- BASS cabinets for BASS PLAYERS
- ★ NOW — KEYBOARD CABINETS for KEYBOARD PLAYERS
- ★ NOW — CRYSTAL CLEAR DEFINITION
- ★ AT LAST — Cabinets *designed* to give accurate reproduction over the *whole* frequency range demanded by today's high-technology instruments.
- ★ NOW — you can realise the full potential of your expensive investment in latest generation keyboards.

## CLEARLY SUPERIOR!

Trade & Retail Enquiries to:  
Unit A1, Forelle Centre, Ebblake Ind. Estate,  
Verwood, Dorset Tel: 0202 825702

### POWER DIMMER MODULES

A range of electronic modular dimmers designed to suit your custom channel and facility requirement

- Considerable saving over commercial equipment
- All the commercial facilities and more
- Preset/remote/master
- Easily installed and wired

SPC — Simple but effective 1000W controller .....	£15.70
SPU — Used in conjunction with RS units for .....	£11.90 (1K)
Remote desks in 1000 and 2000W versions .....	£23.90 (2K)
MC — Master dimmer for SPC/RS units .....	£7.90
RS — Remote controller for SPU/SPC Units .....	£9.40
SUP/REF — Supply/signals for up to 50 modules .....	£20.00

Discounts on above only (order £100 to £199 25% £200 to £299 30% £300 + 35%)

#### EFFECTS ACCESSORIES

MXSL — Four channel sound to light .....	£33.20
MXLS — Four channel sequencer .....	£21.40
MXLC-S — Four channel sound chaser .....	£24.00
MXECF — Dip/dipless electronic crossfade .....	£28.70

#### MODULE 3 CHANNEL SOUND/LIGHT CHASER £35.70

LB31000SLC



A high performance sound to light providing bass, mid and treble separation, employing active filters. Automatic switching to chase in the absence of a music signal 1000W/chan

#### 3 CHANNEL SOUND/LIGHT LB31000SL



£22.70

All the advantages of the SLC without chase. Controls: bass/mid/treble/master sensitivity

#### MODULE STEREO DISCO MIXER/PREAMP

LBP3

M — Magnetic Main supply £7.20  
C — Ceramic PFL supply £1.00



£36.70

Magnetic or ceramic deck versions — please state All the requirements of a stereo disco preamp on the one board, left and right deck mixers/tones controls/misc. mixer/tones/mic. auto fade over decks/and P.F.L. The unit can be used with virtually any power amp.

#### AND THERE'S MORE

- \* 4 Chan s/l auto chase
- \* 4 Chan multi sound chaser
- \* 4 Chan sequencer
- \* 4 Chan sound chaser
- \* Fascia panels

ACTIVE CROSSOVERS £17.90  
(3-Way 300Hz/3KHz) supply £7.20

Don't hesitate to write or phone for immediate information. All prices include VAT. Please include 75p post except power dimmers (£2.75). Cheques/PO/C.O.D./Access all welcome. Mon to Fri 9 a.m.-4.30 p.m. — Please note our new address as follows:  
L & B ELECTRONIC, 34 OAKWOOD AVENUE, MITCHAM, SURREY. TEL: 01-640 6053.

# A1 MUSIC

88 OXFORD ST., MANCHESTER 1

Four floors packed with gear

AGENTS FOR: Roland : PAISTE : OHM : KORG  
CARLSBRO : H/H : PREMIER : TEAC : JBL  
FENDER : BOSS : CASIO : TOKIA : AMDEK : *Yamaha*  
YAMAHA : PEAVEY — and many more

## MELOS ECHO CHAMBERS

**TAPE ECHO**  
Gives a clear distortion-free sound. Tape lasts for 6 to 12 months. 2 Inputs for Microphone, Guitar or Keyboard.

**DIGITAL ECHO**  
No moving parts, has 2 separate Channels and 4 Inputs for Microphone, Guitar or Keyboard.



ONLY £59

LIMITED OFFER  
WHILE STOCKS LAST



ONLY £79

LIMITED OFFER  
WHILE STOCKS LAST

ALL Prices include VAT and Postage

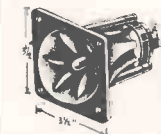

Buy 1 for £4.95  
Buy 2 for £9.50  
Buy 4 for £18.00

100 Watt PIEZO TWEETER



Buy 1 for £8.95  
Buy 2 for £17.50  
Buy 4 for £34.00

100 Watt PIEZO HORN

Add Treble to your Treble with these Horns suitable for Guitar, P.A. Systems, Keyboards & Disco

## FAST MAIL ORDER SERVICE

CARD No.

ALL SALES CARRY THE A1  
WORKSHOP WARRANTY



Tel: 061-236 0340



# ENTER THE TIME DOMAIN

Add Another Dimension to Your Sound !!!!!!!!!

*"Wee represent and imitate all Articulate Sounds and Letters and the Voices and Notes of Beasts and Birds. We have certaine Helps, which sett to the Eare doe further the Hearing greatly. Wee have also diverse Strange and Artificiall Echo's, Reflecting the Voice many times, and as it were Tossing it; And some that give back the Voice Lower than it came, some Shriller, and some Deeper; Yea some rendring the Voice, Differing in the Letters or Articulate Sound."*

It's tempting to believe that, in writing 'New Atlantis', seventeenth century polymath Francis Bacon had some vision of the musical technology available to the composers of the twentieth century. Yet his speculations on Sound Houses and other diverse instruments stem more clearly from an unconscious appreciation of the importance of echo and reverberation to the composition of satisfying music.

The long tradition of sacred music has always made use of the 'celestial' effect of reverberation produced by large spaces enclosed in stone walls, and European classical composers simulated the natural echoes of mountains and stone corridors in their pieces. Vivaldi's 'Four Seasons' is just one example of a piece containing an 'echo' passage, where the leading melody is repeated by other instruments after a few notes' delay. The organ compositions of J. S. Bach and many others used echo effects produced by repetition from upper to lower keyboard.

## Recording

Early recordings on disc, cylinder or wire usually employed a single-point recording device (such as the acoustic horn of the first Edison machines) which was naturally prone to reception of reverb from the recording studio. As sound damping, recording techniques and direct injection of sounds from pickups improved, however, the naturally reverberant sound of live music was lost. It became clear that it would have to be re-introduced artificially, and the rapidly developing science of tape recording represented an ideal medium for the production of repeat echoes.

## Tape Echoes

Early electronic echoes, then, were tape-based. The WEM Copicat for instance relied on a 15" loop of ¼" tape, a single erase and record head, and three replay heads situated at about 1" intervals inside the tape logs. Combinations of playback heads and different tape speeds could give many echo effects, from single or multiple repeats to a fast reverb-like sound, with the inevitable colouration produced by progressive distortion during re-recording. The Copicat, the HH tape echoes, Binson and Carlsbro models and the Echoplex became highly popular, the latter particularly for its ability to give very long delays and a sound-on-sound effect. Vivaldi's string pieces could now be reproduced by a single musician playing solos over his own backing played a few seconds earlier; guitarists Steve Hillage, Brian May and many others have created amazing passages using this method.

Studio quality tape units such as Roland's Space Echo became standard issue for PA work, and the tape echo still has a place in many studios and bands. In this supplement we've reviewed a recent model, the Evans SE-810 echo unit.

## Analogue Echoes

Tape echoes suffer from the inevitable electro-mechanical problems associated with motors, springs, moving tape loops or discs and pads or wheels under tension. Although they are accurately described as analogue systems — since the input information is copied in its original form for processing — an electronic analogue system was actively sought in the 60's and 70's to avoid these electro-mechanical problems. With

the introduction of BBD chips the answer seemed clear.

The Bucket Brigade Delay or BBD chip contains a series of tiny capacitors, which charge up when an input signal appears, and discharge their signal to the next capacitor in line until an output appears. Since this charging process takes a finite amount of time, a delay is imposed on the signal. This can be mixed with the input to create a single echo, or returned to the start of the bucket brigade to create repeat echo. Chips usually contain multiples of 1024 buckets, and are economical when used for short delays in the order of 100mS. BBD devices are capable of giving a few additional features, such as Doppler or Leslie effects. We've looked at another Evans unit, the MX-99, based on the BBD system, and also at two JHS Echotec models.

## Digital Echo

The problems of BBD designs included cost, if a large number of chips had to be used to gain long delays, quality, which tended to suffer from the BBD's limited frequency response, and versatility, which wasn't sufficient for the increasing number of studio tricks which had come to be expected in the 70's. The only foreseeable solution was to completely digitise a musical signal and produce effects by manipulation of this information. Although this was done with computers such as Peter Zinovieff's at EMS some time ago, it wasn't until the mid-70's that digital controllers became inexpensive enough to fit into standard studio equipment.

Once it was possible to replace the power-consuming BBD shift registers with efficient RAM storage, an enormous number of effects became easily accessible. Manipulations within the time domain (to create reverb and echo) were now joined by pitch and phase alteration (phasing and vibrato) and various forms of modulated short delay and filtering (chorus and flanging).

Flanging, originally produced by replaying two identical tapes and varying the speed of one by pressing down on the flange of the tape spool, could now be produced with a delay of 1-10mS, varied slightly in duration in a regular fashion and remixed with the original. Digital echoes examined with a built-in modulation section to produce such variation include the Ibanez DM 1000 and MXR II units.

**Automatic Double Tracking** or ADT uses a 10-45mS delay to give an almost inaudibly fast repeat of all the music input. The effect produced is that of two instruments playing together. Most of the units examined this month, including the Cutec

CD-242, DeltaLab Effectron ADM-64 and Roland SDE-2000 will produce ADT.

**Chorus** is similar to ADT, with slight rate variation of a delay around 50mS. Again, any of the units reviewed which has a modulation section or provision for external modulation can produce this sound-thickening effect. Similar remarks apply to Vibrato, the variation without feedback of a delay around 25mS.

**Echo** itself depends largely upon the maximum delay obtainable on any given unit. Delay costs money, and there is still a trade-off in operation between maximum delay time and frequency response. The MXR II unit reviewed here will give over 3 seconds delay, but with a maximum frequency response of only 4kHz. The Korg SDD-3000, on the other hand, can provide around 1 second of delay with 17kHz response.

**Programmability.** Microprocessor-based delay units can also be equipped with memories to store different echo programmes, making it possible to reproduce a desired studio effect at any time. Examples include the Korg unit mentioned above, and the Ursa Major mentioned below.

**Reverberation.** As recording quality improves, the demands for a clean reverb sound become more stringent. Spring lines are generally not sufficient, although the Evans SE-810 reviewed here can produce some impressive spring reverb effects. Echo plates in an acoustically isolated chamber are efficient, but bulky and expensive to purchase and install. The solution is a digital unit dedicated to reverb — a very fast series of pseudo-random, overlapping echoes — and we've looked at several devices intended for just this purpose. The Fostex 3050 is an inexpensive, popular, basic reverb unit; the Yamaha R1000 is the prototype for a slightly more up-market unit with various modes or reverb times selectable on the front panel; and the Ursa Major 8X32 could be described as the guv'nor of digital reverbs, an expensive but enormously versatile, state-of-the-art programmable unit.

## The Time Domain

Between these 13 units we have covered almost every design, function, cost and facility available on the market. From £70 starters' units to the top professional models, and looking ahead to items not yet available but sure to make their mark on the commercial scene, we've examined them all. We hope you enjoy your journey through the Time Domain.

E&MM





# URSA Major 8X32

The Ursa Major 8X32 is quite unlike the other units in this supplement because it is one of the few computer-based digital delay systems that produces reverberation. Since a natural space such as a large room, studio or concert hall each have their own complex pattern of reflected sound waves, the 8X32 has four basic reverberation programs that simulate these different environments, with fast and slow mechanical plate effects, a medium size concert hall, and a large echoing space having a phenomenal decay time of 20 seconds!

The control panel is suitably sophisticated for a unit of this price and, as well as giving visual signal monitoring, allows 64 user settings to be stored with comprehensive modification of the basic characteristics of any selected program.

Reverberation is simulated by three independent processing stages - first, the direct sound has 'Early Reflections' that give body to the sound and define the space size; second 'Initial Reverberation' forms the more distinct cluster of immediate reflections, and finally a dense indistinguishable mass of reverberation over a variable decay time is created. Each of these stages usually overlap as in a real acoustic space.

## Early Reflections

Three delay taps create the Early Reflections and each delay program has a preset delay value for them which can be increased up to 98mS by using the +/- buttons below the long red LED display on the left side of the panel. The display shows the increase you set immediately above the buttons. Similarly, the level of Early Reflections can be set from 1 to a maximum 8 steps. The echoes are much cleaner here and only give slight colouration to the waveform.

## Initial Reverberation

Initial reverberation is made from a cluster of 10 delays and this too has +/- buttons for increasing the preset delay up to 98mS, with volume level adjustment from 1 to 8, both shown on the display above. The left and right reflections are quite different and are complex waveform transformations that change for each of the four basic program settings.

## Final Reverberation

The decay time for the dense final reverberation can be set in increasing increments that vary for each program: Plate I .0-5 secs, Plate II .0-7 secs, Hall .0-8 secs, and Space .0-20 secs.

An interesting bonus hidden in the 8X32 is that with zero decay time, the Early Reflections and Initial Reverberation controls can produce short delays for fattening vocals by doubling. You can also detect a stereo balance that is a left to right 'slap'. Longer delay times show complex waveforms with highlighting of harmonics for each program.

There are also two other 4-button sections on the panel with LED indicators for controlling low and high frequency decay. LF decay can be set to slope off at 20, 50, 100 and 200Hz while HF decay can filter off at 1k, 2k, 5k and 8kHz. These are not provided as you might think to tidy up the sound with noise or rumble and so on, but are made to act only on the final reverberation - keeping the Early Reflections and Initial Reverb at full bandwidth and thus retaining the clarity. These controls are most useful for adjusting the character for the reverberation to the particular instruments in use. For example, cymbals can be cut out of the final reverberation by setting HF decay at 5, 2 or 1 and bass drum booming is removed by setting LF decay to 100 or 200.

At the centre of the front panel is an LED display that shows both input (by a vertical row) and reverberation (by a sloping row), calibrated from -36, 30, 24, 18, 12 and 6dB to 0dB 'overflow'. Like any digital system input, a maximum input is desirable without reaching the overflow point, although the unit's tolerance to strong peaks is very good.

Two other controls provide Input Mute on or off for straight through signal, and Reverb Clear for emptying the memory of decaying sounds instantly. The latter actually resets to 0.2 decay time and also takes part in saving program settings.

## Program Storage

Up to 64 'registers' can be stored in the non-volatile memory which is more than enough for most purposes. This is done by dialling 2 digits with buttons numbers 0-9 as shown in the right-hand display. Once a stored program is recalled, you can modify the panel controls as you wish and load the new program into another register. The moment a control is changed, edit mode is indicated by two dots either side of the program number. A-B comparison of original and edited programs is easily done and a safety locking feature stops other people corrupting your programs at a performance.

## Reverb Types

1. **Plate.** This simulates the reverberation produced by a plate device with a small, fast diffusing surface and its sound is bright and effective for percussion or adding body to a vocal or group sound.
2. **Plate II** is like a larger plate whose smooth reverberation diffuses more slowly and has a more stable ring to it.
3. **Hall.** This is very good indeed for true concert hall effect - solo instruments take on their correct acoustic image without any harshness but more 'rippling' reflections are present during long decays. The

sound is rich and complex, with high frequencies decaying more rapidly than low or middle frequencies.

4. **Space.** This unit would be quite good enough with a maximum Hall decay of 10secs, but to have this final program extending the decay to 20secs has to be heard to be believed. It's an unnatural effect that's more like drifting into space to infinity and can be very impressive with electronic music.

## Extras

A remote unit is available that duplicates the panel controls and program updates are likely to be issued from time to time. The CPU board will be updated for automated mixdown or remote computer control (RS232 interface) via a rear 15 pin connector. Left/right inputs and outputs are via XLR-3 sockets. Both are active differential types with inputs summed together before processing and outputs balanced. The unit is 19" rack mounting, measuring 3½" high and 15½" deep.

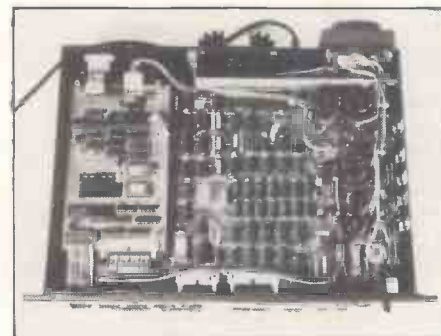

Top layer of circuitry (with second layer mounted underneath).

## Impressive

This word has to be used for the 8X32, although I'm tempted to say that for its price tag of just under £4,000, it deserves to be. The front panel display presses in unusually on its foam backing for no apparent reason, although general construction is up to professional standard. Its dynamic range is 80dB, which is quite acceptable for a delay machine, although some criticism is made by others about its limited bandwidth - only 8kHz, from its sampling rate of 20kHz. I personally found this no problem at all. In practice, the 8X32 has to be highly-rated and its high cost must be due to the large number of IC components and its original and authentic software-derived programs.

**E&MM**

The Ursa Major 8X32 is distributed in the UK by Feldon Audio, 126 Great Portland St., London W1. Tel.: 01-580 4314. Feldon Audio also hire out the 8X32 for £75 a day. Ask them for their hire leaflet, mentioning E&MM please.



### Suitcase Packages

Get started the minute you get home.

Buy either the Fostex or Tascam all in one studio, and not only do you get a massive discount, but also all you need to get started ☆ AKG D80 Microphone ☆ DH61s Headphones ☆ Pack of 4, 2 meter phono leads ☆ 10, Maxell C60 Cassettes ☆  
**Tascam 244 . . . . . £599**  
**Fostex 250 . . . . . £589**



Come to our demonstration room and compare the differences between the two systems, side by side before you decide which machine to spend your money on.

### Patchbay Choices

There are now three low cost systems to choose from.

Tascam's PB64 has 64 phonos front and back for £53. The Fostex bay is also phono, but normalised. Which means pairs of sockets are shorted together unless a plug is inserted £39.25

Modpatch is similar but jack type £63.95



### Quad Winners

These power amplifiers are our best sellers for studios.

They are extremely reliable, cool running, and offer clean watts for all monitoring applications. Also suitable as slaves for PA and presentation systems.

Quad 303 . . . . . £113  
 Quad 405 . . . . . £195

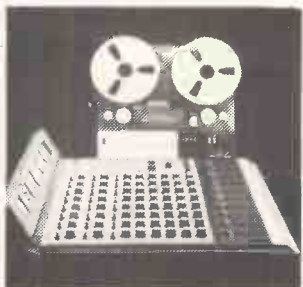

### The Great Multitrack War, that only You Win

There's a fight going on for leadership in the multitrack stakes.

Each company wants your business, so we can offer deals on the top selling items in the market. Compare our prices on the basic eight track packages;

★ **Fostex Quarter Inch Eight**  
 350 Mixer . . . . . £424.34  
 3060 meter bridge . . . . . £74.66  
 A2 two track . . . . . £468.51  
 A8 Recorder . . . . . £1095



### Ampex Tape on Sale

Mastering tapes from the major supplier are now at very reduced prices. You have the choice of either the Grand Master 456 (for professional machines with high bias setting) or the 406 variety that's more suitable for Revox and TEAC. GM1800 is recommended for the FOSTEX range of recorders.

	406	456
1/4" NAB	£9.20	£11.77
1/2" NAB	£17.55	£22.79
1" NAB	£29.32	£36.92
2" NAB	£61.31	£75.97

1/4", 7" spool, GM1800 . £6.99  
 We can offer bulk discounts if you buy ten or more tapes at one time, or over a period. Call or write for full details.

**Second Hand Deals** . . . . . only available until sold, first come first served basis ☆ Standard speed Revox B77 £450 ☆ Revox B710 cassette deck £599 ☆ Dynacord DRS 78 Digital Reverb £850 ☆ Fostex A8 Eight track recorder £850 ☆ Soundcraft Series 1S twelve into two, as new condition £1500 ☆ TWO only TEAC 3440, used, each £550 ☆ Taken in part exchange, original M144 Portastudio, one in at the moment, but usually available, £390 . . . . . All prices plus VAT.



### Mikes by Mail

The pick of the AKG range at direct prices.

D80 . . . . . £25.00  
 D190E . . . . . £49.00  
 D12 . . . . . £132.00  
 D310 . . . . . £54.00  
 D320 . . . . . £84.00  
 D330 . . . . . £118.00  
 D202, twin capsule . . . £123.50  
 D222, slim version . . . £104.50  
 C451E capacitor body . . £85.00  
 CK1, cardioid caps . . . £56.00  
 C414EB, condenser . . . £360.00



We have instant credit schemes available. Call us for full details now.

### EXR Excitement.

A powerful effect so different that you may not believe your ears.

Aural excitement was first used on hit records in the late 70's. It's a patented process, that's used in line with live or recorded material. Sounds become clearer, more transparent. Bass sounds tighten up, treble sparkles. The EXR now offers this possibility to every sound engineer. We urge you to hear it for yourself. All models units are available on 14 day sale or return.



SP1, basic . . . . . £369  
 EX3, studio . . . . . £679  
 EX4, mastering . . . . . £1199

### NEW Fostex Processors

Unique new products provide greatest flexibility in getting a tight, clean sound.



**3070 Compressor** Stereo linked unit includes a noise gate to prevent pumping, and has full control of attack, release, ratio and limiting depth . . . . . £228.00



**3030 Graphic** Ten band stereo with overload indication, at a special price . . . . . £162.95



**3050 DDL** Up to 350mS delay and a wide range of flanging, phasing, echo and chorus effects. Very quiet and smooth . . . . £239.95

### Monitor Madness

Studio proven monitoring at budget prices.

The basic 6 inch cube Auratones are used most major studios, followed closely by the Visonik Davids. You get more bass from Tannoy Stratfords going up in quality and price with the LRM and SRM.



You can come in and compare in our demo rooms.

Auratone, Teak . . . . . £55.00  
 Auratone, Vinyl . . . . . £75.00  
 Visonik David 6000 . . . . £99.00  
 Tannoy Stratford . . . . . £110.00  
 Tannoy SRM 10B . . . . . £498.00  
 Tannoy LRM . . . . . £550.00  
**All speakers priced per pair.**



### We are now OPEN on Saturday am's.



### Deltalab 1024 DDL

Probably the most versatile effects unit you can buy today. It provides a stunning range of effects. Three flange settings,

positive and negative feedback, infinite repeat. It maintains a full 16kHz bandwidth and 90dB dynamic range, at all delay settings. A truly professional unit.

**ADM 1024 . . . . . £630**

### THE NEWEST . . . . .

The amazing new Fostex X-15 Tracker, the studio in the palm of your hand, is coming soon for only £299 inclusive . . . . and from MXR, a one second, full bandwidth delay for £449 plus. . . . that works out less than half than 30p a millisecond. . . . .

All prices shown are exclusive of VAT and postage. Please add 15% plus our postage charges which are as follows;

up to £9 . . . . . £1.00  
 over £40 . . . . . £2.00  
 over £40 to £300 . . . . £3.00  
 Please check directly for bigger items.



# ECHO UNIT



## KORG SDD-3000

This digital delay rack-mounting unit from Korg came as something of a surprise — not that echo units are unfamiliar products for a synthesiser manufacturer, but that this instrument's high quality and variety of features should attract a large number of studio musicians who don't normally go to Korg for processing machines.

The SDD-3000 has an exceedingly high bandwidth of 17kHz for maximum delay time of 1.023 seconds. All the usual effects like flanging, doubling, chorus, vibrato, Doppler effect, slapback and echo can be obtained at the push of a button from 9 user-programmable memories, with full editing available.

Modulation is extended to three waveforms, including an unusual 'random' effect, and envelope follow, as well as external control. Footswitch control of several functions makes the SDD-3000 very flexible as a rack-mounted processor on stage. Input and output options make it easy to match up to both semi-pro and most professional recording studio situations (provided unbalanced signals are acceptable).

### Layout

The general layout and construction is very good indeed, with tidy interlinking wiring and well spaced-out component boards, due to the large depth. The unit measures 381(D) x 46(H) x 482(W)mm and weighs 6kg.

The front panel is in dark blue with yellow/white legending showing each section of the instrument clearly. Pushbuttons have a 'precise feel' action, some with built-in miniature red LEDs to show 'effect on'. A front power switch has been used without introducing hum and optional front in/out jack sockets usefully override rear connections.

### Panel Controls

**Input section.** Front and rear panel standard jack inputs can be tailored for maximum input without distortion by a 3-way attenuator switch for -30, -10 and +4dB. A level control makes the final adjustments in conjunction with the 'Headroom' LED meter calibrated in 5dB steps from -20 to 0dB (green LEDs), with a peak red LED for +3dB signals.

**Regeneration section.** Apart from the standard echo Feedback control, an Invert button gives an out-of-phase Feedback signal, effective for changing pitch of flange and chorus effects. There are also two filter switches for low frequency cut-off (Flat, 125, 250 and 500Hz) and high frequency cut-off (Flat, 8k, 4k and 2kHz) of the delayed signal only.

A Hold button is another good feature on the unit, providing infinite repeat of a fixed 1.023 seconds prior to selection. Delay time and

feedback are held at maximum but filter, invert and modulation controls can be changed to create 'sound-sampling' of very high quality. During 'Hold', further signals at the input are sent straight through, allowing you to play over the top of a musical segment — the optional footswitch (Korg PS-1 or any single pole type switch) can be connected to the rear 'Hold' socket (without disconnecting front panel Hold) and is an effective control in performance. Exciting sounds are created by briefly using Hold at the start of a single chord bar and continuing to play with it.

**Modulation section.** Time domain variations are created successfully by good modulation controls and Korg have given us plenty to choose from. Two standard waveforms, triangle and square, plus a Random wave output are switch-selected. Frequency is variable from 0.1 to 15Hz (with LED indication) and intensity can be over a range of 2.1 (a change from 100% to 50% of the displayed delay time). Triangle will produce vibrato style modulation, Square gives trills up to a very good span of an octave, Random is the kind of S/H effect used on oscillators, although its action is smoothed as it's intended to be used for more realistic doubling as well as special effects. In practice, the intensity has to be kept low to avoid sudden pitch leaps, but with a 'voice vibrato' (around 8Hz) frequency rate, it does produce a gentle variation of pitch against the original signal that is quite natural. For dramatic effects it's a lot of fun to use.

More sensible, is the provision of an Envelope Follower which causes the delay time to vary with the input amplitude envelope. As volume increases, the delay time becomes shorter. Most pro-units have this feature and it is a desirable modulation at any part of the delay range, for responding to the input — longer delays appear as a sound gradually fading or chorus effects become more animated from a voice input and so on.

Delay time can also be modulated externally and both the Korg MS-01 and MS-04 are useful for this (0 to +5V range). Unfortunately, all internal modulation is disabled when a summing situation would have been much better. However, the MS-04 will create some very responsive performance pitchbend and glissando quite unlike your usual instrument pitchchange effects.

**Effect and Output sections.** The final parts in the signal chain define the balance between the direct and the delayed signal using the Effect control. The Output section gives several types of mono and pseudo-stereo signals. A front panel standard jack

output can be switch-attenuated (-20, -10, +4dB), while the three rear outputs are all +4dB to match most studio and PA equipment. All outputs are unbalanced and can drive 600 ohms to full rated level (+21dBm max). An invert button will change the phase of the front and also the rear panel +MIX/MONO outputs (in-phase mix of direct and delayed signals). A Bypass switch will turn off delayed effect completely and is footswitch operated if you prefer. Two other outputs are provided for Direct signal and for out-of-phase-MIX of direct and delayed signals (set by Level Balance).

The stereo imaging can therefore be set for optimum effect using a mixer with 2 outputs from the SDD-3000 set to full left and right pan settings, and usually with level balance set for more of the delayed signal. Using +MIX/MONO and -MIX outputs in this way gives the best live sound, but it is unsuitable for most recording due to phase cancellation of the signal. For best recording results you use Direct and -MIX/MONO outputs.

### Programmer

Nine separate effects programs can be stored, recalled and edited at any time. All controls on the front panel (apart from In/Out settings) are remembered — making programming very versatile. A 5-digit numeric display (red for Program number and yellow for delay time in mS) is used to indicate the current Program number, 1-9 for stored programs, and 0 for manual setting of controls. Write and Program buttons store or select programs easily. Programs can be edited (once any control is changed during recall of a stored program, a decimal point appears by the Program No.) and copied into a new location using UP and DOWN buttons. These buttons also set the Delay Time from 0 to 1023mS. Counting speed is conveniently increased the longer a button is held.

Korg's dual footswitch (PS-1) is handy for Program selection one step at a time using rear UP and DOWN sockets.

### High Quality

Obviously a lot of development time has been put into making this instrument very worthy of itself. Priced at £1025 (including VAT) it is a high quality processing tool that has a very clean signal output — most of the time it's hard to distinguish direct and delayed in terms of signal degradation and the filter section is used for specific effects only. The modulation range is wide enough for achieving good pitch changes in the time domain and Korg have stuck to a modest (by today's standards) second or so of delay to keep a very wide bandwidth, with low distortion (0.03% quoted), and 94dB effect dynamic range without noticeable 'breathing' effects through the use of 13-bit converters. Incidentally, the user manual is very useful as it describes fully the processing treatments available.

E&MM

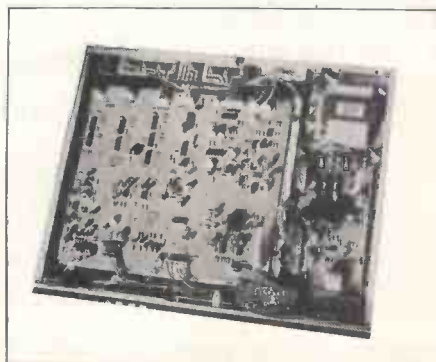

The SDD-3000's neat internal layout.

Further details from: Rose Morris/Korg, 32 Gordon House Road, Kentish Town, London NW5. Tel: 01-267 5151.



# CLIMBING THE CHARTS WITH THE HOTTEST NAME IN MUSIC

Now Playing at concerts, discos and on records and tapes everywhere.

Chances are that the last concert you went to used *Altec* speakers for sound reinforcement.

You may have danced to them in discos, played your guitar through them, listened to them in cinemas or heard them in your own home, (if you are lucky enough to have a pair of *Altec* hi fi speakers).

What you may not realise is that the last record or tape you bought probably used *Altec* equipment somewhere along the line for recording, mixing, playback, monitoring or amplification.



**3000 Series**  
low distortion woofers.



**ER Series**  
extended range guitar speakers.



**8000 Series**  
optimally tuned enclosures.

PLUS: Electronics, new Mantarays, Studio Monitors and many more.

If you'd like to hear more about any of these or any of our old favourites just fill in the coupon below.



**Rank Strand Sound**

P.O. Box 51, Gt. West Rd., Brentford, Mx. TW8 9HR Tel: 01-568 9222 Telex: 27976

Please send full details of the Altec Lansing Professional Speaker Range.

Name .....

Address .....



18A SOHO SQ. LONDON W1V 5FB 01-434 1365 All prices are for cash and include VAT



**THE ROGUE.** This machine must be heard before buying any mono synth. It has twin independent oscillators for an unbelievably fat sound, sync sweep, noise, auto trigger, sample and hold and an audio input for guitars, casios etc. RRP £335 SSHP £189 Heavy duty aluminium flight case for Rogue £55

**SOURCE:** The ultimate mono — 16 memories, real time sequencer. RRP £899 SSHP £649 Liberation: Portable RRP £1200 SSHP £775

**MEMORYMOOG IN STOCK NOW - P.O.A.**

**THE Kit**



**MATTEL SYNSONICS KIT**  
£99.95 (incl. p&p)

**YAMAHA CS01**  
£139 with breath control £156

**JEN SX1000**  
LFO, pulse width modulation, glide noise generator 37 note real full size keyboard. £145.00

**PROPHET 600**  
6 Voice Poly 2 Voice/Note Poly Sequencer P.O.A.

**PROPHET PRO-ONE**  
£375

**DRUMULATOR** by EMU SYSTEMS COMING SOON P.O.A.



**SH 101 JUNO-6 TR 808 DRUMATIX JUNO-60**  
**JUPITER-8 501 ECHO CUBE 60K CUBE-CH BASSLINE**

501 Echo 201 Echo Cube 60K Cube 20 Cube 40 Cube 60 Cube 40K Cube 60B CR-5000 CR-8000 MC4 & 8  
Piano + 30, 60, 70 EP 6060 Bolt 60 GR-300 GR-505 EP-11 RS 09 JC 50 JC 120 CSQ 100

The Rack Dimension SDE 2000 AV-Synth Vocoder + others on application  
**AMDEK** All Kits in stock + CMU-800 ADA-200 DXY-100 Compumusic All Pedals, Switches, Cases, Interfaces, Accessories + anything Roland on application.  
**NOW WITH THE FULL SERVICE BACK UP OF ROLAND U.K.**



CE3 Stereo Chorus CE2 Chorus BF2 Flanger SD1 Overdrive OD1 Overdrive Rocker Vol

Rocker Wah DS1 Distortion CS2 compressor DM2 Delay SG1 Slow Gear TW1 Touch Wah VB2 vibrato OC2 Octaver DM-100 Delay

DR-55 Dr Rhythm NF1 Noise Gate PH1R Phaser KM60 Mixer GE-7 Equalizer RX-100 Reverb FA-1 Amplifier  
**NEW** TU-12 DIGITAL CHR. TUNER

**LONDON'S NEW AUTHORISED MAIN DEALER**

**INTERNATIONAL MUSIC SHOW**

See you there

**ALEXANDRA PALACE**

**BANK HOLIDAY WEEKEND APRIL 29 - MAY 3**

Ring for advance tickets and details of clinics and seminars.

**ROZZ PEDALS FROM JAPAN**

These are brand name high spec Japanese effects. We are able to sell at these prices because our supplies are direct from the factory!

- R-1 DISTORTION £29
- R-2 COMPRESSOR £30
- R-3 OVERDRIVE £29
- R-4 PHASER £35
- R-5 FLANGER £42
- R-6 CHORUS £41
- R-8 ANALOG £65
- R-9 PARAMETRIC £31

All pedals are fully guaranteed. Prices incl. p&p. Make cheques or PO's payable to Soho Soundhouse.



**Godwin String Concert**

The Ultimate String Machine. As used by GENESIS, SUPERTRAMP etc. Cellos, Violas and Violins — chorus and vibrato. Fully variable envelope — in its own flight case. **LAST FEW REMAIN AT £299.00**

**Chroma/Apple**

Complete system set up and running. Eight Track real time sequencing, Parameter display, etc., etc.

**LONDON'S NEW POLY 61 in stock KPR 77 in stock**



POLY 6 Polysynth  
EPS 1 Piano String  
MONO POLY 4 VCO  
LP10 Touch Piano  
+ MUCH MUCH MORE

INSTANT NO DEPOSIT HP - ACCESS - BARCLAYCARD - AM EX By Phone or Otherwise - SECURICOR or MAIL DELIVERY BY RETURN

# ECHO UNIT

## Ibanez DM 1000

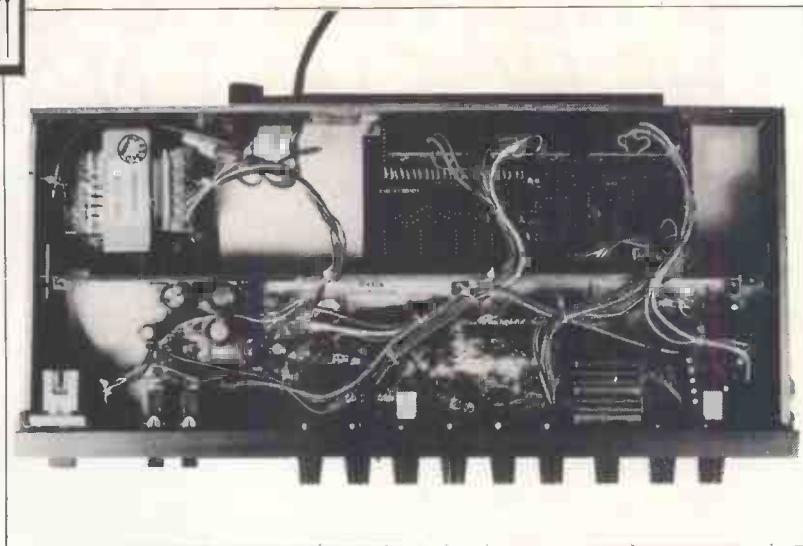

The smart and compact DM 1000 measures one unit high and is 19" rack mountable as well as free standing. It has a pleasant metallic grey finished front panel containing nine control knobs which have a smooth positive action to them.

### Layout

An Input jack socket with Input level control are standard front panel features. Simply pulling this control switches the signal level from Line to Mic, and input gain can then be monitored via the peak reading, horizontal LED display labelled 'Headroom', to achieve a clean, undistorted input. A cut-off boost type Tone control to the right modifies the delay signal, and appears to operate on upper mid frequencies. A useful centre indent is provided when no equalisation is required.

### Delay

This section has two controls which permit the selection of delay time. The first one being an 8-position rotary switch, which offers preset delay times in milliseconds ranging from 3.5mS to 450mS, each value basically double that of the previous one. The presets that Ibanez have chosen do give a good choice of delay effects that can be obtained quickly with the minimum of knob-twiddling, which is especially good when using the unit in a concert situation.

Variable delay times, however, can be obtained by turning the Delay Time control, which halves the preset delay time when turned fully anticlockwise (x0.5) and doubles it when fully clockwise (x2). Since this control is uncalibrated, it does make it difficult to set a specific time delay accurately, if need be. Thus by use of both preset and variable Delay Time controls, the Ibanez will give the user a maximum delay of

900mS, with a full frequency response up to 8kHz at all delay settings, enabling reverb, slapback (bathroom) echo and a myriad of repeat echo effects to be performed.

### Modulation

A low frequency oscillator is built in to the unit giving time modulation effects such as flanging and chorus, which are easy to obtain by referring to the sample settings indicated on the top of the case, and adjusting the Width and Speed controls. Delays greater than 100mS give crazy pitch changes which are not too useful for strictly musical applications but good fun anyway!

A Feedback control varies the amount of signal being recycled into the memory, gradually increasing the number of echo repeats when long delays are chosen, and enhancing reverb depth on shorter delays over 30mS. With very long delays and full feedback, the delayed signal will happily repeat for many seconds without noticeable degradation of the sound quality. When not playing, oscillator sweep noise can be heard, but only when modulation Width and Feedback are advanced past their number 7 settings. A bonus facility is the phase Invert of the feedback signal, which is selected by pulling the Feedback knob. The change in sound is very subtle making things sound 'thinner', and seems best employed on very short delay settings. On the right of the front panel is a latching pushbutton labelled 'Hold' and status indicator light. If a long delay is selected, pushing the switch immediately after a phrase is played causes the sound to be 'frozen' in the memory and repeated continually — just like an old-fashioned tape loop but without the build up in noise. What is more, by adjusting the

Delay Time control, the frozen sound may be changed, either up or down in pitch by a maximum of two octaves depending on the original setting of the Delay Time control, giving some exciting effects.

The DM 1000 offers separate level controls for Dry and Delay outputs, instead of the more common balance type mix control, so that an exact mix can be made between the two. Two jacks for Mix and Invert — Mix outputs, a Bypass/Effect pushbutton with LED and a power switch with LED complete the comprehensive front panel features.

On the rear panel, footswitch control is offered for Hold and Bypass/Effect functions, meaning the gigging musician can amaze his audience by switching to Hold and leaving the stage with the music repeating by itself! The duplication of front panel input and output connections on the rear and the inclusion of a third Dry only output, increase the versatility of this unit. The musician, of course, has the option of connecting the DM 1000 to further effects units, whilst still having a combined mix feed available for an amplifier or mixing desk.

### Conclusion

The inclusion of a compressor/expander in the delay signal chain and the use of pre- and de-emphasis circuitry makes for quiet operation. The DM 1000, with its 1.75mS to 900mS delay range and 8kHz bandwidth, is a versatile device capable of handling PA and recording work and certainly worth checking out for yourselves.

**E&MM**

The DM 1000 is distributed by Summerfields, Saltmeadow Road, Gateshead, Newcastle-upon-Tyne, Tel. 0632 770431, at a recommended retail price of £365 including VAT.





# ECHO UNIT

## Evans SE-810 and MX-99

The Evans Super Echo differs from the other models examined this month in that it is a tape-based unit intended largely for live use in conjunction with a mixer send and PA system. The Evans SE-810 Creative Sound Super Echo, to use its full title, is clearly styled after the enormously popular Roland Space Echo and Chorus Echo, or the Korg Stage Echo, and although it does not have the full specification of these models it is considerably cheaper. While Roland's recent price rises have increased the cost of the RE-201 Space Echo to £550, the Evans comes in at a fraction over £330.

### Tape Mechanism

Echoes are produced by the tried and trusted Copicat method of one Record/Erase head and four replay heads. The tape comes in a loop about 15 feet long, of a standard 1/4" format for good reproduction, and is moved at a variable speed by a rubber pinchwheel. Changing a tape is reasonably easy, with only a couple of pressure pads to slacken off and four finger-screws to remove from the protective perspex panel.

Variations in the echo sound are obtained by switching in different combinations of the playback heads, altering the tape speed and controlling the degree of feedback to the record head and thus the number of repeats. Since the physical layout of the tape playback mechanism — the fixed gap between record and playback heads for instance — proves a limit to the versatility of the system, other arrangements are generally made for producing reverberation.

### Reverb and Construction

Within the SE-810 there is a spring line unit to produce reverb. This consists of a metal-encased pair of standard 6" springs, which can be switched in using various combinations as described below. Disassembly of the echo to inspect the spring

lines is far from easy, but once accomplished it becomes clear that the design is simple but reliable. The circuitry in the record section is entirely discrete, and the bulk and solidity of the unit comes from a design using overlapping metal panels, heavy wooden construction and large numbers of screws of different shapes and sizes. There's something old-fashioned about this type of design, but if it leads to reliability it's entirely justified.

### Echo Selection

A rotary switch connects the playback heads in the combinations 1+2+3, 2+3, 1+3, 1+2, 3, 2 or 1 alone. A pot balances dry and echo levels, while a further two pots select number of echo repeats (from one to feedback) and delay time (by adjusting the running speed of the tape loop).

The Reverb can be faded up to any level desired, and Treble and Bass equalisation are available on its output, although these are by no means vital since the line isn't particularly noisy. Two footswitch sockets are available for Echo and Reverb, and there are three outputs; PA out (echo only -20dB) Head Phone (mix out) and a variable Output for -14dB, -26dB or -30dB.

The remaining controls on the right hand panel are white pushbuttons which determine the order of connection of the echo facilities. The buttons cannot be used in combination; the first one gives Echo (tape echo only), the second gives Echo Reverb (a reverberated sound passed to the tape echo), the third gives Cathedral (a tape echo sound passed to the reverb) and the fourth Reverb (spring line only). Using a combination of these controls gives a huge number of possible effects, as detailed below.

### Input Section

The versatile input stage has three channels and a VU meter with peak LED to indicate possible overload distortion. Each



channel is intended to be Universal and has its own rotary fader, matched with a Mic/Line selector switch. Each channel also has an Effect On/Off switch, which means that the Evans alone can act as a mini-mixer, with echo being added to each instrument or not as desired.

### In Use

All the controls and connections on the SE-810 are on the front panel, so there are no problems with accessibility even if the unit is used in a rack-mounting format (for which it's not obviously intended). The input section is highly versatile, and the VU meter helps to avoid distortion.

The maximum echo length is about a second. When repeat is near maximum this extends into a very deep and sustained repeat echo, with a gradual degradation of tone which is the inevitable trademark of tape designs. Fading up a little reverb puts the input signal whether from guitar or keyboard far into the distance subjectively, while full use of Cathedral gives a very impressive sense of space. Considering the fairly ordinary springs used, this is quite praiseworthy.

As previously mentioned, the unit has a distinctive tape echo quality which can't be duplicated by a digital unit: neither can it produce the very clear effects, flanging and chorus at which digital echoes excel. Use of a unit such as the SE-810 would be very much a matter of choice, but its particular specification should appeal to the taste of many guitarists, rock musicians and synthesists of the mid-70's school.

The Evans SE-810 Super Echo is available price £333.72 from Blue Suede Music, 19 Thornfield, Ashton Road, Lancaster LA1 5AG. Tel. Lancaster 65138.

### Evans MX-99 Mini Echo

The MX-99 is a budget BBD analogue design suitable as a first echo unit or as an effect for vocals on stage. It has four main controls: Input Volume, with a Peak indicating LED; Balance between Echo and Dry; Repeat, or number of echoes; and Delay Time, or echo speed. In addition there are two inputs, for Mic at -46dB and Instrument at -26dB; an On/Off footswitch socket; and a Mix Output at -20dB. The Power switch is a small toggle at the bottom right of the front panel, and there's also a Peak Level LED to indicate feedback in the echo circuit.

The Delay time is variable between about 20-200mS and the frequency response is up to 3 or 4 kHz. This is sufficient for vocals, but clearly not of studio recording quality. Signal to noise ratio is around 60dB, again not unacceptable for many applications but not quite up to recording standards. Construction is fairly simple, on a single inexpensive PCB which mounts all the components other than the mains transformer.

The MX-99 gives every indication of being reliable and hard-wearing, and within the limitations of sound quality described can give satisfyingly deep echoes, a hard metallic reverb on fast settings or a single slapback echo up to around a third of a second. Possibly its potential could be exhausted fairly quickly, but as an introduction to the use of echo and at the price quoted it could still be a useful purchase. **E&MM**

The Evans MX-99 Mini Echo is available price £77.11 from Blue Suede Music, 19 Thornfield, Ashton Road, Lancaster LA1 5AG. Tel. Lancaster 65138.



# ECHO UNIT



## Fostex 3050

The 3050 model digital delay line is currently part of the ever-expanding and very popular range of Fostex home recording equipment and as such offers the home or budget recordist digital quality effects at a very reasonable price. The full complement of delay effects; flanging, echo, chorus, vibrato and reverberation can all be achieved simply and efficiently using the 3050.

The unit is designed for operation at -10dBV line levels, making it fully compatible with most budget-priced tape recorders and mixers, and can be patched via echo send/return sockets or inserted into a separate channel of a mixing desk for individual treatment of a sound source if so desired.

The 17" x 1¾" grey coloured front panel has a logical layout and all control function labels are easy to read, being situated above each control knob rather than below, which is sometimes the case. Power is applied via a slimline pushbutton to the far right and a corresponding LED indicates the power status. Connection of an audio signal input is via the rear panel phono socket labelled Input, an adaptor being required if a standard jack is to be connected. The front panel Input control knob has three level indicators labelled Present, Norm and Limit which give a fast and accurate means of obtaining the best undistorted input signals. A good signal-to-noise ratio can be maintained when this input level control is set high enough so that the red Limit LED glows occasionally on peak signals.

### Delay Range

The Delay Time section contains two controls which together enable any delay time to be set between 0.13 mS and 270 mS. The first control selects delay range from 0.27 mS to 137 mS in ten fixed steps and the second control permits the user to vary this selected value from ½ to 2 times if required. The longest delay possible is thus approximately 270 mS, which is enough to give a distinct echo. A Feedback control adjusts the amount of delayed signal that is to be recirculated into the delay circuit to increase the number of echo repeats. On near full Feedback setting (8 or 9) the delayed sound will repeat happily for many seconds; a

facility that can be used to great effect to produce sound 'textures', as new and echoed phrases overlap one another in a continuously moving sound field. However, maximum feedback can cause a rapid build up in signal level as the feedback loop gain exceeds unity and care should therefore be taken when setting this control to prevent any overload. Used with taste, this feedback effect can produce a very interesting sound.

The combination of compressor-expander style noise reduction circuitry and the 10 kHz bandwidth at all delay time settings, means that noise is hardly a problem with the Fostex, and the resulting delayed signal does not lose too much bite remaining, in the main, clear and crisp.

### Voltage Controllable

The provision of a low frequency oscillator (LFO) permits the delay time to be internally modulated to produce both flanging and chorus effects when used in conjunction with the front panel Depth and Speed controls. The modulation Speed ranges between 0.1 Hz and 30 Hz, giving a usefully long, ten second sweep for slow flanging effects which sound good when applied to sustained string synthesiser chords, for example. A modulation limit indicator to the left of the Depth control lights up to tell you that the delay time being swept by the LFO, has exceeded its available range - namely ½ to 2 times the delay time set by the fixed range selector switch. This acts as both a warning and safety device when using the rear panel Cont In socket which allows the delay time to be externally controlled by a 10V peak to peak voltage. No matter how large the voltage being applied is, the delay time will not exceed its fixed range limits, thus removing any overdrive problems that would otherwise have caused severe problems. The delay time can either be set externally by a DC voltage or by routing an LFO from a synthesiser to modulate the time delay for example.

The Output Mix section completes the front panel description and contains separate output level controls for the Dry (unprocessed) and Delayed signals allowing subtle blends of each to be achieved. Finally a Phase switch to the right of the output

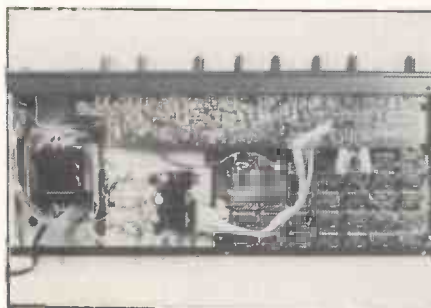

Fostex internal view.

section inverts the phase of the delayed signal being applied to the feedback and output mixing circuitry. It is most effective when a flanging effect is selected enhancing the cancellation effect.

### Twin Outputs

On the rear panel the Fostex delay unit provides the user with Input and Foldback sockets, effectively giving two inputs, and Output and Aux Out sockets, all of which are the standard phono type. The latter two sockets give identical output signals derived from the relative mix of Dry and Delay signals on the front panel. Twin outputs are very handy in a budget recording system as one can be routed to the echo return of a mixer and the other directly to another effects unit for further signal processing for example. Unfortunately, no footswitch connection is provided, probably due to the fact that the Fostex is geared more towards recording applications than to live performance; nevertheless, a footswitch option would have increased the versatility of this unit even more.

As already mentioned, an external voltage can be applied to the Cont In socket for delay time control, which is a very useful feature and one that begs to be exploited by any synthesiser owner. A one volt increase of this external voltage will increase the delay time by 1.15 times its preset value. A 5 volt increase therefore doubles the delay time. Controlling the time delay with an external control voltage derived from an envelope generator gives some extremely unusual delay effects, depending of course on the type of envelope you use. A long attack for example causes the delay time to be gradually increased whilst a long decay has the reverse effect. The scope for special delay treatments that this unit offers is limited more by your own imagination and spirit of adventure than by the inherent limitations of the unit itself!

### Conclusion

A comprehensive Owners' Manual accompanies the unit giving some very useful operational tips and a fine selection of example applications. All in all, the Fostex gives a good, wide selection of quality delay effects. The reverberation has that characteristic metallic sound to it that you associate with single tap digital delay lines. Fostex have no doubt looked carefully at the home recordists' needs for a good, reliable delay unit that can produce an extensive range of effects but won't cost the earth. The model 3050 digital delay line certainly fulfills those needs and offers the bonus of voltage control of delay time as well.

**E&MM**

The Fostex 3050 is available from Turnkey, Brent View Road, London, NW9 7EL. Tel. 01-202 4366. Recommended Retail Price is £262.20 including VAT.



# Star sounds \*\*

# Star quality \*\*

# Star features \*\*

**SUPERB  
KITS  
FOR THE  
MODERN  
MUSICIAN**

**Free  
SECURICOR  
DELIVERY**  
on all orders over  
**£100 (UK mainland  
only) Add just £2.50  
on lower price  
orders**



90 Stereo Mixer — this is a really satellite new mixer that enables the constructor DJ to produce a professional performance every time. There are two stereo inputs for magnetic cartridges, a stereo auxiliary input and mike input. Other 'plus' features are auto-tuning for fast or slow slider controls, multi-mixing, ducking, interrupt, input modulation, in short everything... the whole works — AND — under £100 complete! Complete kit **£97.50 + VAT**

TRANSCENDENT 2000 — Although only a 3 octave keyboard the '2000' features the same design ingenuity, careful engineering and quality components of its larger brethren. The kit is well within the scope of the first time builder — buy it, build it — play it! You will know you have made the right choice.

Complete kit **£165.00 + VAT**



**SALES  
COUNTER**  
Collect your order  
from the factory.  
Open 9-12/1-4.30  
Mon-Thurs. Easy  
parking, no  
waiting

Digital Delay Line — With its ability to give delay times from 1.6 mSecs to up to 1.6 secs. Many powerful effects including phasing, flanging, A.D.T., chorus, echo &



vibrato are obtained. The basic kit is extended in 400 mS steps up to 1.6 secs. Simply by adding more parts to the PCB. Compare with units costing over £1,000!

Complete kit (400 mS delay) **£130 + VAT**  
Parts for extra 400 mS delay **£9.50 + VAT**

A versatile modular mixer, featured as a constructional article in Practical Electronics can be built up to a maximum of 24 inputs, 4 outputs and an auxiliary channel. Each input channel has Mic and Line inputs, variable gain, bass and treble controls and a parametric middle frequency equalizer. There are send and return jacks, auxiliary, pan and master controls and output and group switching. The output channels have PPM displays for record and studio outputs. The auxiliary channel also has a PPM display and there is a headphone monitor jack and a built-in talk-back microphone. The mixer modules plug into base units each of which takes up to 6 channels. To eliminate hum, the power supply is in a separate cabinet.

### KIT PRICES

4 input channel	<b>£19.90</b>	Base unit and wooden front	<b>£27.50</b>
8 input channel	<b>£18.50</b>	Pair of mahogany end cheeks	<b>£12.50</b>
Auxiliary channel	<b>£22.50</b>	Power Supply and cabinet	<b>£19.50</b>
Front Panel	<b>£3.00</b>		

**All prices are VAT exclusive**

TRANSCENDENT POLYSYNTH — A four octave poly-synthesiser with outstanding design characteristics, versatility and performance to match.  
Complete kit **£230.00** plus VAT (single voice)  
Two voices (up to three more) **£35.60** plus VAT



**Free Soldering  
Practise Kit on  
request with your  
first kit — useful  
tips, well  
illustrated.**

MPA 200 — is a low price, high power 100W amplifier, its smart styling, professional appearance and performance, make it one of our most popular designs. With adaptable inputs the mixer accepts a variety of sources yet straightforward construction makes it ideal for

the first time builder. Complete kit **£49.90 + VAT**.  
Chromatèque 5000 — a 5 channel lighting system powerful enough for professional discos yet controllable for home-effects. Sound to light, strobe to music level, random or sequential effects — each channel can handle up to 500W yet minimal wiring is needed with our unique single board design. Complete kit **£49.50 + VAT**

ETI VOCODER — 14 channels, each with independent level control, for maximum versatility and intelligibility. Two input amplifiers — for speech/excitation — each with level control and tone control. The Vocoder is a powerful yet flexible machine that is interesting to build and thanks to our easy to follow construction manual, is within the capability of most enthusiasts. Complete kit **£175.00 + VAT**

SP2 200 twice the power with two of the reliable, durable and economic amps from the MPA 200; fed by separate power supplies from a common toroidal transformer. Superb finish and quality components throughout — up to (even over) the standard of high prices factory-built units! Complete kit **£64.90 + VAT**



**Incredible  
price for  
Polysynth  
£230.00  
Extra voice  
£35.00**

# POWERTRAIN

**WORLD  
LEADERS  
IN  
ELECTRONIC  
KIT DESIGN  
AND SUPPLY**

**PORTWAY INDUSTRIAL ESTATE**

**ANDOVER, HANTS SA10 3WW**

**ORDER BY PHONE (0264) 64455**



Simply request your chosen kit and quote your Access or Barclaycard Number.



# ECHO UNIT



## Cutec CD-424

The past year or so has seen a dramatic reduction in the price of digital delay units, bringing studio quality effects within the reach of the average musician. The Cutec CD-424 at £336 + VAT continues this welcome trend. The 14-bit digital delay line is of Japanese origin offering a maximum delay of 1024 milliseconds, a 15kHz bandwidth and the bonus of a Sub Delay.

### Appearance

The unit is compact, being only 1¾" (1U) high in the standard 19" rack-mounting format with a black satin finished front panel and a colourful array of knobs. The front panel controls are clearly marked and easy to understand. On the far left is an input level control, and to the right are two equalisation controls giving a very useful low and high frequency cut or boost to the signal being fed into the memory. The adjacent vertical, red LED bargraph provides a helpful display of the input level and is very useful for prevention of input signal overload.

A section containing the delay controls follows, the first knob of which is marked Delay and acts as a level control, with an accompanying LED bargraph for visual monitoring of delay level. This knob functions more as a 'mix' control between the dry and delayed sounds. The minimum setting gives 'dry' signal only, whilst maximum gives an equal balance of both signals.

Three latching pushbuttons each with their own red LED status indicator are next. These are clearly labelled Main Delay, Sub Delay, and Feedback and route the input signal to the main or sub sections of the Cutec's digital memory, enabling two separate delay times to operate simultaneously, if selected. A Feedback control recirculates the delayed signals back into the memory, producing 'repeats' ranging from a single repeat echo on longer delay times to self-oscillation effects when very short delays are selected, and the control knob is turned fully clockwise.

A digital readout is provided of the Main Delay time in milliseconds. This display is well positioned on the front panel, making it clearly visible from most angles and in most lighting conditions. Selection of Main Delay time is achieved by depressing the appropriate 'Up' or 'Down' pushbutton to the right of the display, and observing the readout

until the required value is reached. Depressing the latching 'Fast' button alongside these permits quicker delay selection, typically taking 17 seconds to step from 0 to 1024 milliseconds. It should be noted that whilst changing the Main Delay settings, the delayed signal is immediately removed from the output, which is standard procedure to clear the memory.

A further three pushbuttons on the extreme right of the front panel select the output level (-40, -20 or 0dB) and there is a mains on/off switch.

Moving on to the back panel, there is a standard Input jack socket which is unbalanced with switchable attenuation for mic or instrument signals. Two unbalanced output sockets are provided, one for the 'Delay Only' signal and the other for the dry/delay 'Mix'. Two further jack sockets permit the connection of external foot-switches to control 'Feedback' and 'Delay' on/off. The latter, however, only operate if the corresponding front panel buttons have already been selected.

### Sub Delay

Finally, and somewhat unusually, controls are mounted on the back for Sub Delay Level and Sub Delay Time. The logic in siting these valuable functions on the back panel escapes me, for once mounted in a 19" rack, they are virtually inaccessible. A less limiting compromise perhaps, would have been to mount the Sub Delay controls on the front panel in place of the equalisation controls, which tend to be left in one overall position anyway.

The Sub Delay Time control is a four position rotary switch giving two preset delay times on each position. The Sub Delay times available, in milliseconds, are: 50 (124), 101 (252), 203 (508), 306 (764). The Sub Delay is not independent of the Main Delay for when the latter is set on 399ms or less, the shorter Sub Delay times apply, the user being able, therefore, to select one of four possible Sub Delays. However, when the Main Delay is set at 400ms or more, the Sub Delay switches over automatically to the longer delay settings. It is possible though, to

have the Sub Delay set on a short delay, whilst the Main Delay is long (or vice versa). The delay permutations are almost endless, and coupled with individual level control of Main and Sub Delays, some very interesting delay treatments can be performed.

### Performance

The Cutec was used on various sound sources (synthesiser, drum machine, vocals, guitars) both in a live performance and 24 track studio environment. It performed well, was quiet and consistent in operation with no little idiosyncrasies. Being of a 14-bit design, the absence of noise is only to be expected, but still very welcome. The 15kHz bandwidth means that the delayed signal is 'bright' and 'full' sounding. On the longest delay times the bandwidth reduces to 6kHz which is still ample for most applications.

The wide variety of delay effects that can be obtained from this unit range from 'hard reverberation', through 'flutter echo' to long repeating echoes, which are especially useful for generating sequencer-like phrases.

The Sub Delay is most effective when used in conjunction with a short delay on the Main Delay to produce a fairly realistic concert hall reverberation, which is wonderful on lead-line synthesiser, or drum machine. By setting the Sub Delay at 101ms for example, and the Main Delay around 150ms, a convincing automatic 'triple' tracking effect can be obtained — excellent for vocals or wild guitar solos.

Although no modulation oscillator is provided, good 'cardboard tube' sounds and a quasi-flange effect can be achieved by matching a short Main Delay time to a short Sub Delay time and adding a touch of feedback to produce the characteristic comb-filter effect.

### Strictly Delay

The Cutec CD-424 digital delay is well constructed and provides a wide variation of delay effects with no distortion or noise. Unlike the Roland or Fostex delay units, the Cutec cannot produce flanging, chorus or phasing effects, it is strictly a digital delay unit, but as such, must still represent a good investment for any studio or musician. The only criticism of the unit must be the siting of the Sub Delay controls on the back panel.

Considering its good value for money and the bonus appeal of its Sub Delay, the Cutec is destined to find a home with a variety of users.

E&MM

Further details from: MTR-Cutec, Ford House, 58 Cross Road, Bushey, Herts WD14DQ. Tel: (0923) 34050.





# EFFECTRON UNIT

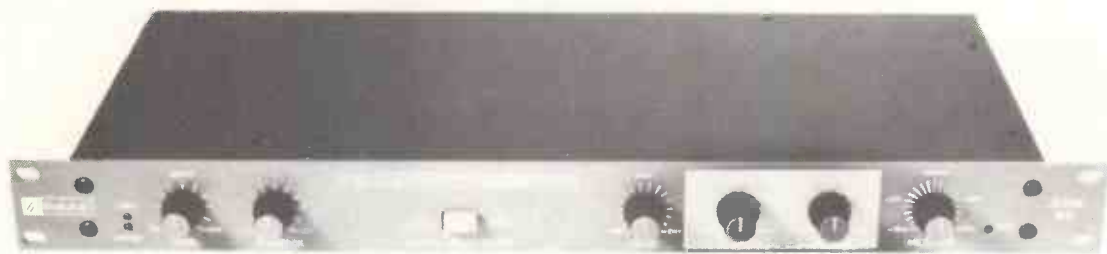

## DeltaLab Effectron ADM 64

Three new studio quality digital effects from DeltaLab Research Inc. have recently been introduced as the 'Effectron' range. The review instrument was the ADM 64, which is the lowest price unit at around £337 (plus VAT) and offers a flange ratio that is claimed to be twice that of any other digital unit available. Although we haven't fully checked that out, the ADM 64 does provide a full three octaves of flanging (8:1 flange ratio) which is in excess of anything else we've reviewed to date.

The other two Effectrons, the ADM 256 and ADM 1024, are single channel multi-effects processors for flanging, doubling, chorusing, echo and infinite repeat. All the units notably have a full audio bandwidth of 16K and wide 85-90dB dynamic range at all delay settings.

The Effectrons are all housed in the same smart 'shades of blue' 19" rack case measuring 1 3/4" high and 7" deep. Construction is of the usual high standard from this respected company who have become well known through products like their DL-2A Acoustic-computer and DL-4 Time Line.

The PSU has a toroidal transformer to reduce hum and the digital memory consists of 16K dynamic RAM, with CMOS digital ICs, bipolar/MOS analogue devices and an all-steel chassis all contributing to the quality. The same basic PCB board is used for each of the three Effectrons.

DeltaLab use their own patented *Adaptive Delta Modulation* for digital encoding. Pre-emphasis is applied to the input prior to this A to D conversion, which converts the audio signal by analysing both the value and the slew rate of the signal.

Rear panel connections are standard jack sockets. There's one for external voltage control modulation of the internal VCO. All kinds of interesting effects can be created using this input with a synth or voltage pedal. A 2-octave sweep requires a range of 0 to +5 volts while the full 3-octaves needs -6.2 to +6.2 volts. Most synths will handle the former range and the Korg MS-04 pedal is particularly exciting to use, making sweeping 'real glissandos' as well as S/H effects that are stunning on percussion.

E&MM MAY 1983

Also included is a by-pass socket which is in fact a switch with stereo tip-to-ring contact for direct signal, plus input and output sockets.

### Flanger/Doubler

The ADM 64 provides effects based round two delay ranges, selected by a central push switch on the front panel for Flange or Double. Six rotary controls allow wide variations to be made in both modes, especially with the provision of an envelope follower in addition to the more usual periodic modulation.

#### Controls

Although there are only a few controls, they all need careful selection during processing to get the most out of the unit.

The input signal can be between 100mV and 2V and a green 'Active' LED remains on if a suitable level signal is present, while a red 'Limit' LED indicates 0dB onset of clipping and/or slew limiting. Plenty of headroom is available in practice.

Once the delay range is selected by the Flange/Double switch, a delay control adjusts times from minimum to maximum at centre and then to envelope follower mode in clockwise half of the control. Flange range is 1-4ms and Double range is 16-64ms. In the envelope follower mode, the delay automatically follows the amplitude envelope of the input signal.

Feedback control is unusual in that it provides negative as well as positive feedback from 0 to almost 100%.

The Modulator section is an LFO that modulates the internal clock from one cycle every 10 seconds to 10Hz using the Speed control. The size of the flange or doubling delay sweep is set by the Width control, with maximum clockwise position giving the full 3-octave sweep. Other settings allow the Delay control to set the sweep 'centre' delay time and there is useful interaction with this and any external control CV in all but the minimum positions of Delay and Width, so some 'playing' with the controls is necessary to get the desired result.

Output level is dependent on the input signal level, and simply has a Delay Mix control for adjusting direct output (at centre) with amounts of in or out-of-phase processed signal.

### Effects

#### 1. Straight Delay

Three main types of effect can be produced. First, 'doubling' which delays a voice or instrument by 16 to 64ms. When this delayed signal is mixed with the original it produces a more 'full-bodied' sound. The Envelope Follower can add transient detuning for more natural effects on vocals.

The straight delay can also be used for sending to a separate reverb device to give a feel of early reflections (known as pre-reverb delay). A third effect is called Haas-Effect Image Shifting which can be used to stabilize images in a stereo field, since the ear does not relocate an echo in a different spatial position from the original sound if the delay is less than 40ms.

#### 2. Short Delay Feedback

Comb Filtering lets you dramatically alter the overtone structure and tonal quality of any steady sound.

Flanging is a result of modulating the short delay with or without feedback that makes the comb filter effect. The familiar 'metallic' sweeping and shifting of harmonics is heard from different notes.

Using in or out-of-phase feedback will give different colouration to the signal, and with maximum feedback, a tuned resonance or ringing of 'peaky' sounds at a definite pitch will result (that's different with feedback polarity changed). It's particularly good with percussion.

#### 3. Time base modulation

Manual pitch shifting is easily done by turning the Delay knob. Automatic control is done with the Modulator to give smooth sweeps of pitch similar to vibrato. The Envelope Follower also modulates the clock for effective pitch 'time domain' changes from percussive envelopes like piano, guitar and drums.

### Studio quality

This is an extremely efficient Flanger/Doubler unit that should find its way into many budget studios for creating specific effects.

On minimum delay setting the treated signal was very clean, but with some slight 'edge' ringing on a raw synth square wave input at maximum delay, which is hardly likely to affect most music inputs. The LFO modulator set at minimum still has a slight effect unless Delay is set to minimum. The review machine's LFO had a rather sharp triangular wave that was fine except for the full 3-octave sweep. Anything above the lowest Speed settings produced an unpleasant 'squelch'. At reduced sweeps below maximum there was no problem.

Above all, the ADM's clarity from the wide bandwidth, plus the wide modulation range makes it very acceptable for its reasonable cost.

E&MM

*The Effectron range is distributed in the UK by Scenic Sounds Equipment Limited, 97-99 Dean Street, London W1V 5RA. Tel. 01-734 2812.*

# ECHO UNIT



## Roland SDE-2000

The SDE-2000 is a typical studio-quality DDL unit in a standard 19" rack-mounting format. It has a built-in modulation section capable of controlling the delay time, and can produce a wide variety of echo, reverb, flanging, phasing and chorus effects.

Input and output sockets are located on the back of the unit, although there is a power switch on the right hand side of the front panel. Other front panel controls are described in order from left to right below.

### Input Stage

The input to the unit can be routed directly to the output using the Bypass switch. Input impedance is nominally 56 k ohms, and a four-stage LED display shows input levels of -20dB, 0dB, +3dB and +6dB.

### Feedback and Output

The degree of feedback, and thus the number of echoes or degree of reverberation

obtained, is continuously variable using the Level control. However, there is also a Single control with an associated LED indicator which effectively disconnects the internal feedback circuit. The Delay Output has a Level control for echo volume and gives +4dBm into a 600ohm load or -20dBm into a 10k ohm load. The Delay Output section also has a Phase Invert switch with LED, which changes the quality of flanging and other effects by reversing the phase of the DDL's output.

### Delay Section

The Delay section features a three-figure LED display to give the delay time. This can be from 0 to 320 mS, or by pressing the Delay x2 button, from 0 to 640 mS in 1 mS steps. Delay time is altered, not by a rotary or stepped control, but by a pair of momentary buttons marked Up and Down. An additional LED indicator shows whether the delay is On or Off.

### Modulation

A push-push button chooses between Triangle and Sine Wave modulation. Modulation speed is stated as 0.1 Hz to 10 Hz, and Depth is variable from 1 to 10.

It's also possible to produce modulation or fix the delay time using an external control voltage into a rear socket. The operating

voltage is 0 to +10V, but the unit can withstand levels of plus or minus 20V. Impedance is 90k ohms.

## Design and Specifications

The SDE-2000 design is based on an 8049C single-chip 8-bit processor and the 416 Dynamic RAM chip. Frequency Response is quoted as 10Hz-16kHz at 320 mS delay between +0.5 and -3dB, and 10Hz to 7.2kHz at 640 mS delay between the same levels. Signal to Noise is kept to 90dB using compression and expansion circuitry, and THD at 1kHz should be 0.08% on the delayed sound and should not exceed 0.2%. Power consumption is 30W and, as previously mentioned, the unit fits into a standard 19" rack at a height of 1 unit.

The modulation options on the SDE-2000 make it a versatile unit and specifications indicate that it should display sound quality to match. 640 mS will produce a very respectable repeat echo in addition to the wide range of other delay effects available, so the SDE-2000 should be suitable as the central processing device of any semi-professional or even professional studio.

The SDE-2000 is available via Roland dealers at a recommended retail price of around £600 incl. VAT.

## Yamaha R-1000 Digital Reverb

Reviewed at this year's Frankfurt Music Show, the R-1000 is a new studio-quality reverb featuring a built-in equaliser. It comes in a standard one unit 19" rack-mounting format and has front panel power and bypass switching.

Four reverberation types or modes can be selected, representing decay times of 1.55, 1.62, 2.3 and 2.4 seconds.

In the interests of economy, there's no readout of reverberation time other than an LED above each switch.

The equaliser is a three-band design which can be switched in or out at any time, using a footswitch if desired. It acts parametrically using dual-concentric pots, within the ranges Low (up to 700 Hz) Mid (up to 5 k Hz) and High (up to 20 kHz). Each band can be boosted on a scale of 0-15.

An Input Level control and associated LED display indicates -13 to +10 dB, the

control being calibrated from 0 to 10, as is the Output Level control. The final front panel feature is the Direct/Reverb mix.

The R-1000 is not expected to be available until late 1983 or early 1984, and the figures given here are those for the prototype and should be regarded simply as an advance preview to help ascertain the degree of interest in the unit, which Yamaha feels has been very encouraging. No retail price has been fixed as yet.

Kemble-Yamaha, Mount Avenue, Bletchley, Milton Keynes, Bucks MK1 1JE. Tel. 0908 71771.

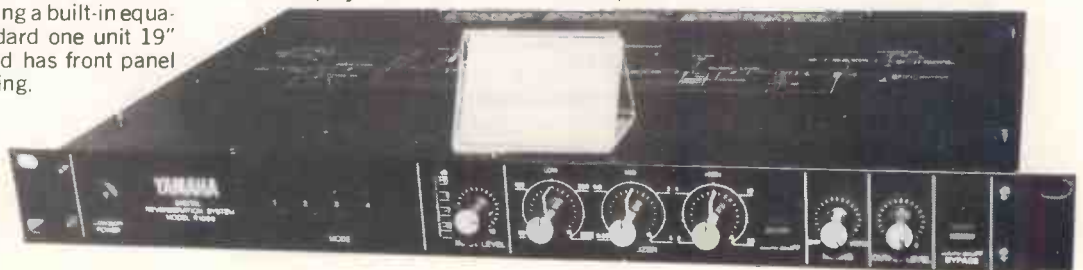





## MXR Delay System II

Over the past years MXR products have earned themselves an enviable reputation for reliability and versatility both in the studio and on stage. Walk into almost any professional recording studio, inspect their equipment racks and you're bound to see at least one MXR device; their distinctive blue front panels being instantly recognisable. However, the introduction of a new range of products heralds a new image slightly less distinctive than the previous one but still recognisable from the blue and white MXR logo.

The Delay System II is part of this range and supercedes the previous digital delay unit. It is available in either half or full memory configurations giving maximum delay times of 1600mS or 3200mS respectively. The unit under review had the full memory specification and came with the optional road case. The standard model is 2U 19" rack mounting with a black plastic coated front panel that houses all controls. Logical function grouping and clear, white labelling make for convenient operation. A large, red digital readout is provided for delay time in milliseconds and is well sited directly above the Fine delay time control for clear visibility, even in bright lighting conditions.

Switching on the power illuminates the Delay Time display and the unit remains switched out of its delay mode for almost four seconds whilst the digital memory is

cleared. The input Level control to the right of the panel and its associated LEDs are used to match the input signal level to the operational level of the delay unit, and a limiter is incorporated to prevent harmful input overload conditions from occurring. These LEDs are clearly marked -12dB and Limit and the former should remain lit for optimum signal to noise ratio. This proved a simple enough task in practice.

### Delay Set

A 32 position click-stop rotary switch is provided on the right of the display for delay range selection. This knob is fairly large and easy to turn from a short to a long delay quickly, without having to step through each position. Clockwise rotation increases the delay time and the digital readout gives a visual indication of your selected delay time and helps when duplicating a previous delay value. This is beneficial on repeat session work for example, when you may need to drop-in on an overdub whilst matching the previously recorded delay. The 32 delay ranges span the full 3200mS delay time available and proved to be well chosen in terms of their effect.

Three centrally positioned LEDs labelled 16kHz, 8kHz and 4kHz give an indication of the delay bandwidth in use; the bandwidth changeover points occurring automatically at 800mS and 1600mS delay times. In order to permit accurate setting of a delay value, the Fine delay set control may be used to reduce the value set by the main selector switch up to a value 20% less, when turned anticlockwise. Observing the display readout whilst tuning the delay time simplifies this task.

Once a delay has been set up, the Regen control next to the Level knob can be used to adjust the amount of delayed signal that is returned to the input for further processing. Short delays with regeneration give basic

metallic reverberation treatments whilst longer times give multiple echo. Smooth clockwise movement of the Regen control increases regeneration from Off to Full. According to MXR the unit has been adjusted to prevent self-oscillation at maximum setting. This is not the case, however, when very short delays are chosen and full regeneration employed, as runaway feedback results.

### Modulation

Time delay alone produces reverb or echo effects only, but the inclusion of a triangle wave LFO for automatic modulation of the time delay allows flanging, vibrato and chorus effects to be produced. The vibrato was particularly appealing, gently enhancing a rather mundane vocal performance. The chorus sound achieved by this unit is one of the better ones being extremely rich. Naturally, you need to experiment to find the effect that pleases you in particular.

Manual rotation of the Fine control gives a random modulation effect which may find a use on more esoteric music, or as a special treatment. The amount of modulation is determined by the Width control which is labelled 0% to 100% with oscillator sweep frequency being controlled by Speed. The sweep frequency ranges from 0.1 Hz to 20 Hz allowing slow flanging, variable vibrato rates and Leslie speaker effects. The latter was particularly realistic, with Speed on full and Width at 50%. It proved difficult to achieve the characteristic 'skying' effect on electric guitar, until the Invert Delay button was pushed. This has the effect of interchanging the peaks and notches in the comb filter, making the flanging sound even deeper and richer.

When modulation is selected, especially on slow settings, the Delay Time readout gradually changes with the sweep. This is a fascinating feature which helps clarify the actual operation of the LFO and Width control, as you can see the effect of increasing the Width control by observing the changing display.

Selection of delays greater than about 400mS enables the Repeat Hold function to be initiated by depressing a small push-button on the front panel or activating a footswitch connected to a rear panel jack socket. An LED lights up on the front to indicate the status whichever method is used. The Repeat Hold button causes a portion of the input signal, equal in duration to the selected delay time, to be stored in memory and continually cycled. With the maximum delay of 3200mS available from this unit, the Repeat Hold becomes a very attractive feature indeed, and excellent for producing tape loop effects with no annoying

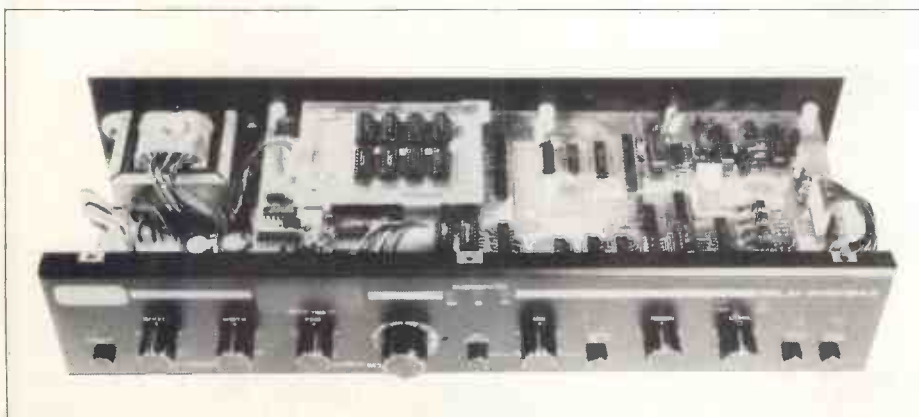

Internal construction.  
E&MM MAY 1983

noise build-up or consequent degradation of signal. The Hold is enabled by playing a phrase and then pushing the button in. A new phrase can then be 'overdubbed', so to speak, by disabling the Hold button, playing a new phrase and then reselecting Hold. With care, a short, multi-layered piece can be constructed and repeated indefinitely.

The final front panel controls deal with the balance between dry and delayed signals. Advancing the Mix control clockwise decreases the dry signal level as the delayed signal increases. The 12 o'clock position gives an equal balance of both signals. A Dry Defeat button shorts out the dry signal, effectively turning the Mix control into an output level control for the delayed signal. Finally, a Delay Bypass button with LED, cuts out the delay circuitry completely, the input signal passing through the system with unity gain. Footswitch control is also provided on the rear panel for this function.

## Balanced/Unbalanced

The rear panel offers two sets of audio input and output connections, both 1/4" jack and XLR, but only the XLR input is balanced which is strange on a unit of this calibre, designed for professional studio use. A white Level button permits the jacks to be switched from instrument level to line level, the latter being most appropriate for connection to mixing desks, having a maximum output level of +16dBm. A handy feature is the inclusion of an XLR pin diagram above each XLR connector - saves you the trouble of looking up pin numbers on the specification sheet! Additional connections are provided for linking an external signal processor using the Aux In and Out sockets.

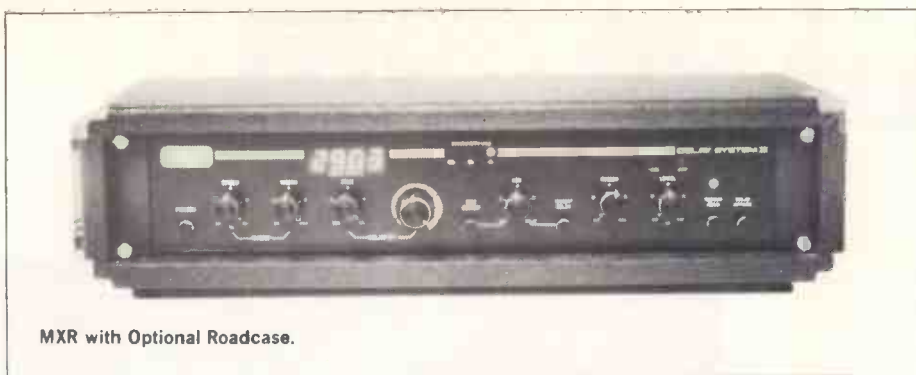

MXR with Optional Roadcase.

The sturdy construction of the Delay System II could not be faulted. The chunky controls are extremely easy to turn with a positive feel to them. They were well laid out ergonomically with clear labels. Internal construction is up to MXR's usual high standards having socketed ICs for easy maintenance. A ground shield is provided for the double-sided PCBs which contain components of the highest quality and all circuitry suggests that the unit should give very reliable performance. The optional road case is a recommended investment if you intend using the device in live performance or transporting it a lot.

## Flexible

The Delay System II is a very flexible unit capable of producing the full range of time delay effects. The 16kHz bandwidth right up to 800mS means that the discrete echo effects remain clear, crisp and bright. MXR

describe the unit as 'surgically clean' and it certainly leaves you with this impression. Some digital delays suffer from a 'halo' effect caused by the background quantisation noise, but this was not apparent on the MXR device. Longer delay times and wider bandwidth for the delayed signal requires additional circuitry, and this is reflected in the price. All in all, this is an impressive unit, befitting of the MXR name.

**E&MM**

*Recommended Retail Price is £1,199 inc VAT. Optional road case is £35 inc VAT. For further details contact Atlantex Ltd., 1, Wallace Way, Hitchin, Herts. SG4 0SE. Tel. 0462 31511.*

## THE NEW B.E.L. BC3 NOISE REDUCTION SYSTEM — WE'VE SLIMMED DOWN EVERYTHING BUT THE QUALITY

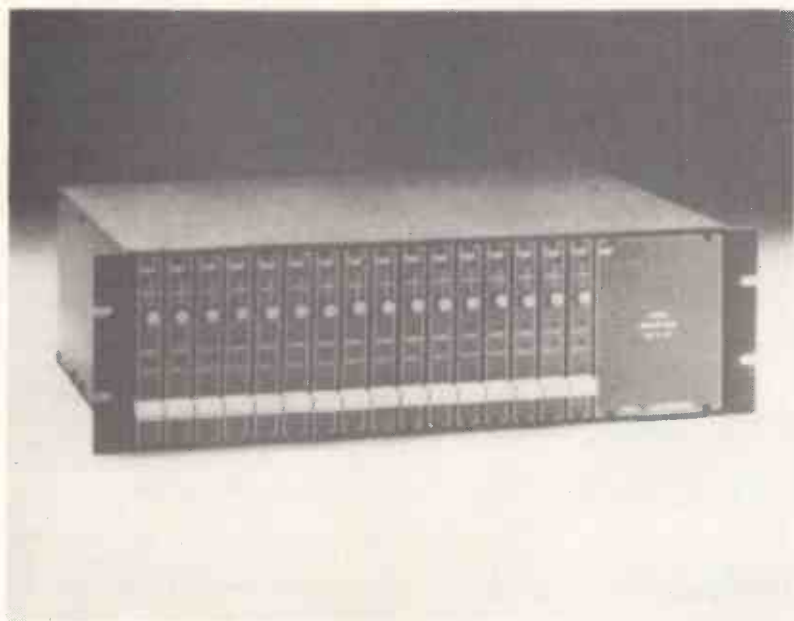

The only thing you'll find the B.E.L. BC3 Noise Reduction System doesn't cover is rackspace.

The new slimline BC3 comes in 8, 16 and 24 track versions with simultaneous en-code and decode. No switching is required.

The B.E.L. BC3 is available at the slimmer price of £1056\* for the 16-track system.

So save money and space, find out more about the new B.E.L. BC3 Noise Reduction System for your local dealer or contact us on Luton 450066.

*\*All prices are subject to VAT.*

**bel**

**B.E.L. MARKETING, 29 Guildford Street, Luton, Beds.**



# ECHO UNIT

## Echotec ET-100

Analogue echo units have been available for many years now, and although they have been kept out of the limelight by the newer digital delay lines, they still represent an effective means of producing echo related sounds.

### Bucket Brigade

The ET-100 is one such device offering a basic range of reverberation and short echo effects. It employs the common 'bucket brigade' principle to produce delay, whereby a signal input is clocked through a series of capacitive cells in a finite period of time. A single bucket brigade device can only produce a short time delay, the maximum delay being determined by the number of aforementioned cells and the rate at which they are clocked. With such devices there is always a trade-off between maximum delay time and signal bandwidth. The Echotec has opted for a long delay time (400mS approx.) at the expense of bandwidth which cuts off around 3kHz.

The unit measures 25 cm (W) x 6 cm (H) x 15 cm (D), is of lightweight aluminium construction and finished in black. Although increasing portability, this lack of weight does mean that the unit can be dragged off an amplifier top easily if accidentally caught. The interior of the unit is sparse with a small, base mounted PCB carrying the MN3005 bucket brigade device (BBD) and several other integrated circuits.

All controls and connections are housed on the front panel which features separate



Mic volume and Instrument volume controls with two pairs of jack sockets below each knob, suitable for -40dB (Mic) and -20dB (Inst) input signals. Up to four inputs can be accommodated which are summed with the delayed signal and fed to a common output socket (-20dB) on the right of the panel. An Echo Volume controls the mix between the direct and delayed signals, giving direct only at one extreme and an equal balance of both, at the other. If this control is left on direct signal only, then the Echotec could feasibly be used as a simple 4 into 1 sub-mixer, which is a useful bonus.

The combination of Delay and Repeat controls determine the type of delay effect. Very fast echoes can be achieved when Delay is in its central position, producing an early Rock 'n' Roll feel on vocals and a Hank Marvin impersonation with electric guitar. Advancing the Delay setting produces longer delay and by adding some signal regeneration with the Repeat control, multiple echo can be obtained which helps to give depth and a rich 'texture' to synthesizers. The reverberation produced by the Echotec is very metallic and 'ringy', and is not particularly suited to vocals but is pleasant on guitar. If a drum machine is fed into the unit, this reverberation will boost the level of the hi-hat slightly and generally increase the metallic nature of their sound. Care should always be taken, by the way, to limit the amount of accent on the bass drum or snare

when putting a drum machine through any effects unit, as input overload can easily occur. The peak reading input LED on the Echotec should help to prevent this and input volume should be reduced until this LED glows only on the very loudest passages of music.

### Limited Range

The range of the Repeat control is slightly limited giving roughly five seconds of repeats on maximum setting and long delay. The unit has very little inherent noise producing a clean delay sound but the use of BBD technology does mean that the delay signal frequency response is much lower than other echo units. Boosting the treble content of the delayed signal with the Tone control does improve things slightly though.

### Standards

The fact that the Echotec is aimed at the home recordist and music maker, whose standards are generally assumed to be below those of the professional, would have meant that limited bandwidth and poor delay range would not have mattered so much in the past. However, standards have changed for the better and the home musician looking for a good, budget-priced echo unit that will give a good range of sounds and reliable operation, has a greater choice of such devices available today.

Whether it is false economy in the long-term to purchase a unit like the Echotec in preference to a slightly more expensive digital delay perhaps, is a matter for the individual. The newcomer to music may outgrow this device fairly quickly, but having said that, as an introduction to the wonderful world of delay, the Echotec is ideal.

JHS also produce the Mini-Echotec MX99 unit, a baby version of the ET-100. It offers a standard complement of front panel controls: Input volume, Direct/Delay Balance, Repeat level (for multiple echo) and variable Delay time. Both Mic and Instrument inputs can be accommodated.

As with the ET-100, a useful footswitch socket is provided (but no footswitch!) which enables the delay effect to be bypassed giving a direct signal only. Various types of delay effects can be achieved but the delay time range limits this unit to reverberation effects which are useful for adding depth and colour to most sounds.

**E&MM**

The Echotec units are distributed by John Hornby Skewes & Co Ltd, Salem House, Garforth, Leeds LS25 1PX. Tel: 0532 865381. RRP of the ET - 100 is £108 and MX-99 is £75, both include VAT.

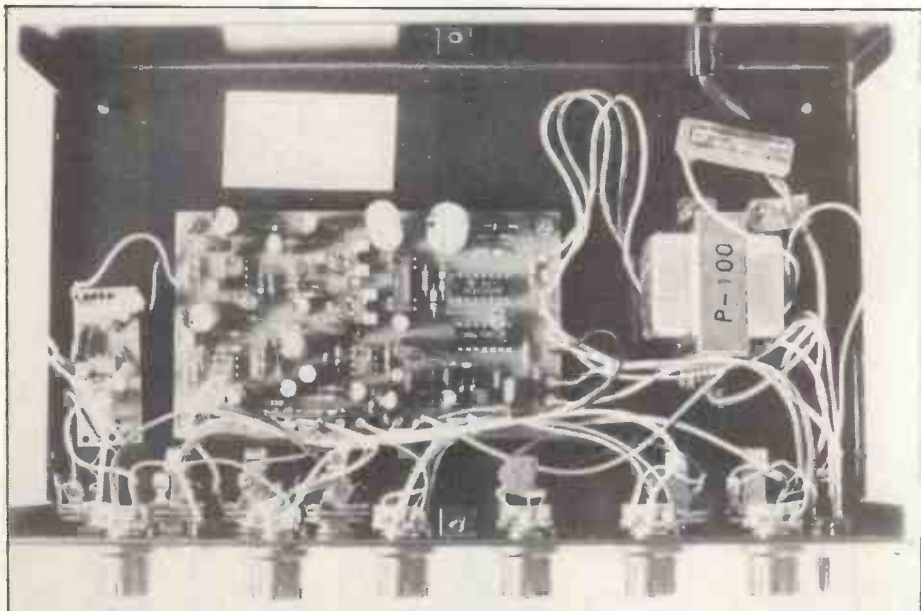

Interior of ET-100.

# PACKAGE STUDIO DEALS FINISH HERE.



☎ 06632 4244

# AUDIO SERVICES

STUDIO HOUSE HIGH LANE VILLAGE NR STOCKPORT SK6 2AA



# HOME RECORDING STUDIOS

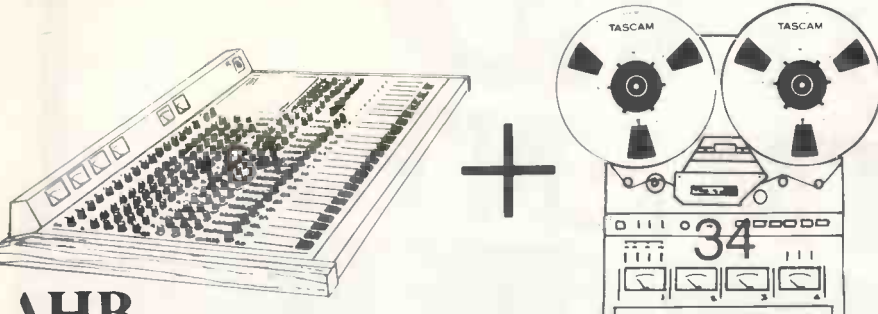

AHB SYSTEM 8 + TASCAM 34 = £



06632 4244

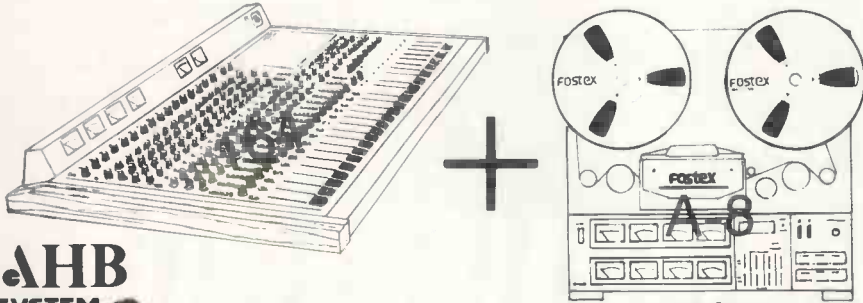

AHB SYSTEM 8 + FOSTEX A-8 = £



06632 4244

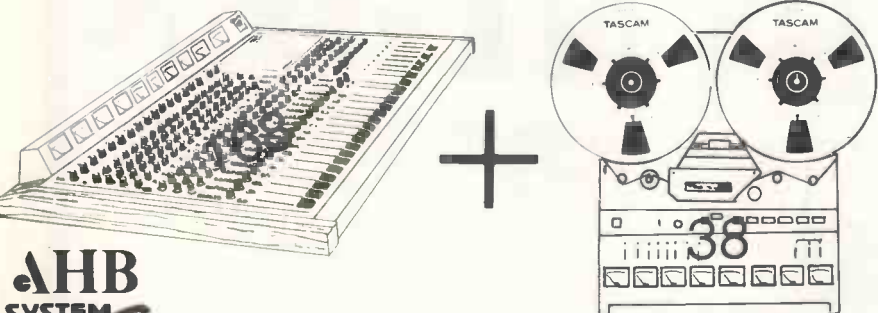

AHB SYSTEM 8 + TASCAM 38 = £



06632 4244

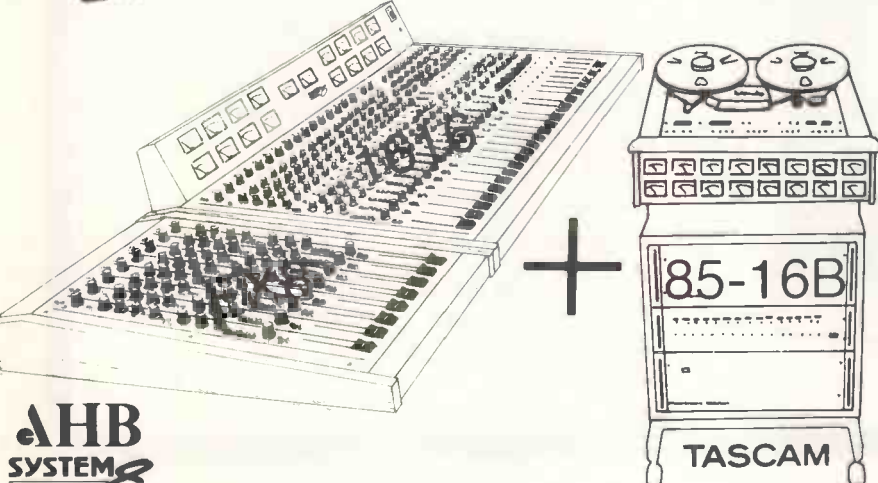

AHB SYSTEM 8 + TASCAM 85-16B = £



06632 4244

SPECS AND BROCHURES SENT ON REQUEST

# AUDIO SERVICES

STUDIO HOUSE, HIGH LANE VILLAGE, NR STOCKPORT SK6 8AA

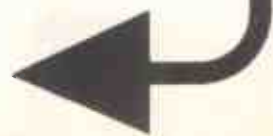

# SOUND INVESTMENT...



# ELKA SYNTHEX



Elka's exciting entry into the synthesizer market has brought rave reviews from the music press over the past few months. Small wonder when you stop to consider the outstanding features and infinite sound combinations that the Elka Synthex offers. Amongst its outstanding features is the fact that it's a fully programmable 8 voice polyphonic keyboard with five octaves; a built-in sequencer with four monophonic lines plus outputs for recording, footswitches, cassette interface, sequencer and other external hook-ups. All this and much, much more in a synthesizer costing just £3,199.00\* — including its own flight case.

*Check it out now at your nearest Elka dealer. We think you'll agree it's a sound investment!*



**ELKA-ORLA (U.K.) LTD**

3/5 Fourth Avenue, Bluebridge Industrial Estate  
Halstead, Essex CO9 2SY, England  
Telephone: 0787 475325 Telex: 987713





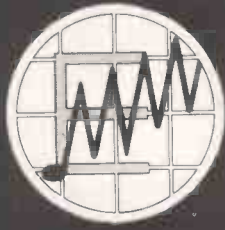

Electronics &  
**MUSIC Maker**

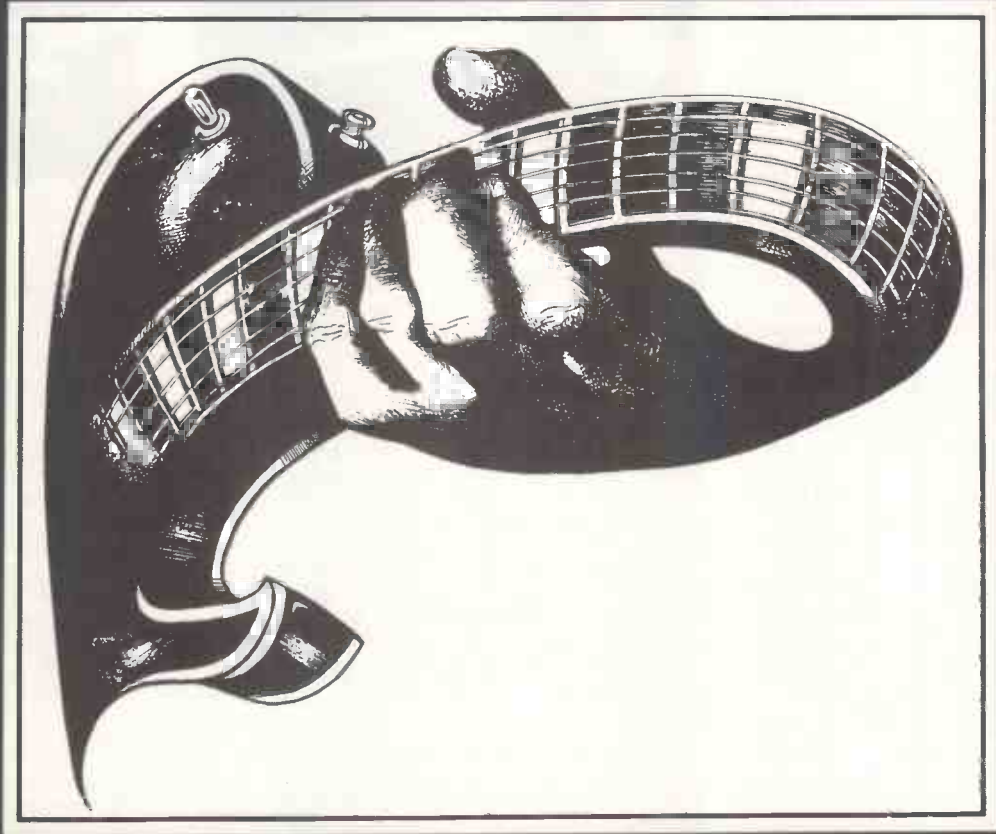

**A**n extensive listing of model numbers, colours and retail prices from the exciting range of guitars both old and new available in the UK today.

## Guitar Buyers Guide

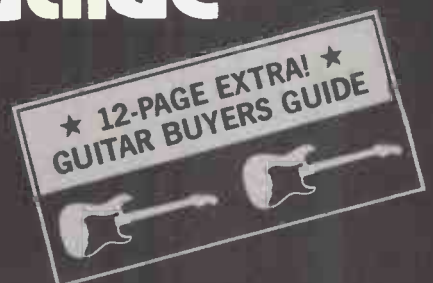

The Japanese have difficulty in producing a successful guitar themselves. Most of them are designed outside Japan, such as Washburn, Ibanez and Aria for instance. Of course they've been producing straight copies for many years, and Tokai is a good example. If you give them an outline they can reproduce a guitar very well, and technically they're hard to beat because of their application.

When the Japanese first began to make copies they'd take a stock model like a Fender Stratocaster or Telecaster, or a Gibson Les Paul, and they copied them but didn't get the fine details right - and the things that make a guitar desirable are the subtleties more than the overall idea. Partly it's a matter of cost - on the early ones the fittings and machine heads were a bit grim - but the more they produced, the more they came to appreciate the subtleties. Then the Japanese started to go into it a lot more, and Tokai in particular have gone really over the top even down to the same paints and dyes. The other models like Columbus, which are still going strong, are called Fender copies or Whatever, but they're built to a budget and if you held them up next to an original they wouldn't look the same at all.

### Factory Guitars

The great disadvantage of any guitar knocked out on a mass production level is that the setting up often isn't accurate. Luckily most shops, and even many of the wholesalers now, have a repairman - Aria, and Summerfields who distribute Ibanez, are good examples - and so all the truss rod adjustments, string tensions and so on are done before they're sold. Even then there's personal taste involved, everybody's got their own ideas, for instance some people want a very low action with very light gauge strings which is the worst combination in the world! Fortunately the use of extra-light strings is fading into the distance now, people are going for much heavier gauges and that gives you a lot of tone back. They're learning, for instance, that if you have an 8 thou. first on a strat you can't hear it!

On the recent less expensive models, the general setup and technical construction of the Japanese guitars has been better than on the American ones, because they've had to become better to gain a share of the market. Now the Americans are trying to equal their

technical standard, whereas over the last few years their standards have dropped because they've attempted to compete just in terms of quantity.

### Semi-Acoustics

Some of the nicest semis I've seen recently - and they seem to be coming back into fashion now - come from the Kasuga factory which I visited when I was consulting on the Japanese-built range of Eccleshal guitars. They're straight 335, 345 copies, and they've done a beautiful job of them, but you never see them in England probably because they work out a bit too expensive. Tokai also do incredibly good semi-acoustic copies, but again you don't tend to see them over here.

### Costs

Copies aren't that much cheaper than originals any more. A Fender Squier could be around £260 now, which is the price of an American Fender a year ago. The American side put prices up to get more back at their

# GUITAR BUYERS' GUIDE

As an introduction to this month's Guitar Buyers' Guide, we spoke to Chris Eccleshall, a highly respected designer and builder of quality acoustic and electric guitars and mandolins, who gave us some of his thoughts on the present state of a market increasingly dominated by the recent excellent imports from Japan.



end, and marketed the cheaper models to fill the gap. When you see the way that they make guitars, you realise it's a supermarket syndrome. The more you make, the cheaper an individual unit becomes, but it does take a particular type of national character to be able to mass-produce these things. America and English people get very bored doing the same thing all day ever day, but the Japanese as individuals seem to be able to handle it. That obviously has a great effect on the quality control and general standards of the guitars that are coming out, and that in turn helps to decide the level of costs. Kasuga are just one of the many factories that turn out guitars in vast quantities; people go along and say "Make me so many hundred of this or that" and they make them up to order. When you're there you can see guitars for Aria and some for Washburn, some for Ibanez and even the cheaper Yamahas, which really surprised me because I thought Yamaha kept everything in-house. The really cheap ones are made in Taiwan now, the lower and mid ones by Kasuga, and the up-market ones by Yamaha itself.

### Duplication

It's absolutely astounding how complicated some of the companies are over there in terms of the different brand names. Various factories will do different jobs for lots of different companies, and this has been fairly evident for quite a few years. That's why you could go to the British Music Trade Fair, see an SG copy with a certain name on it for example, and then go to the next stand and see exactly the same guitar with a different name on it, then another stand with exactly the same guitar on it. Antoria and Ibanez were a good example - the two ranges were absolutely identical, they were both produced by Hoshino, but they were marketed by different wholesalers so they just put different names on them!

*In a future issue we'll be sharing more of Chris Eccleshall's thoughts on the guitar market, looking at the new Japanese editions of his designs, and discussing his workshop and constructional methods.*

E&MM



Chris Eccleshall in his Ealing workshop

Thanks go to all companies and individuals who provided information for this guide, which, while we hope it is accurate, makes no claim to be comprehensive. Further information will be welcomed.



who put the bop in the bopshuwopshuwop?



Tokai Guitars and Basses. Exclusive Distributor: Blue Suede Music Ltd, 19 Thornfield, Ashton Road, Lancaster, England LA1 5AG. Ansafone (0524) 36227

Tokai did.



Westone Raider I

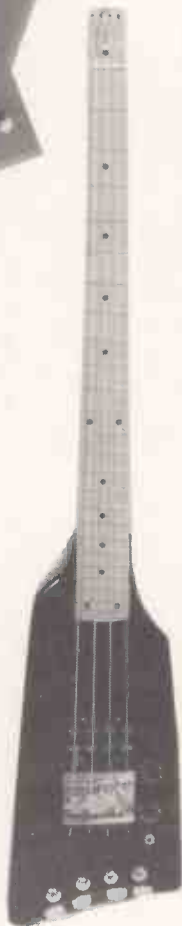

Hondo H890 B



Moon Custom Bass

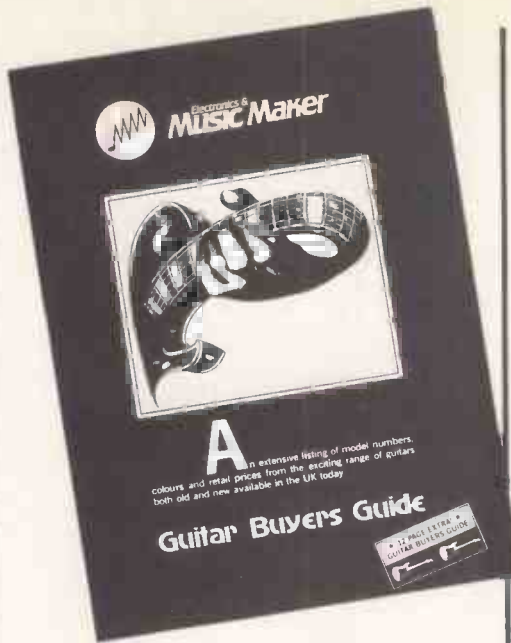

**Aria**

**Electrics**

*Pro II Series*

U60T	Tremolo	229.24
XX50V	Tremolo	259.00
ZZ50V		259.00

*Pro II Cardinal Series*

Price changes forthcoming on all models

- CS 400
- CS 350
- CS 250

*CS circuit*

*PE-R Series*

- PE-R80-AB
- PE-R80-JB
- PE-R60-JB
- PE-R60-AB

**Acoustic Electrics**

*TA Series*

- TA-70
- TA-60
- TA-100 AB

*Elecord Series*

- AE-100
- AE-90
- FE-70T
- FE-60
- FE-50

**Basses**

*Pro II Cardinal Series*

- CSB-450
- CSB-380
- CSB-300

*SB-R Series*

- SB-R 80-PR
- SB-R 80-0
- SB-R60-0
- SB-R60-PR
- SB-R60-PY

Gigsville, Phoenix Way, Heston, Middlesex. Tel. 01-897 3792/1225.

**Alembic**

**Basses**

Professional models 995-2,000  
Soundwave, 66, Victoria Road, Romford, Essex.  
Tel. 0708 25919.

**Ashley Pangbourn**

**Basses**

Super Custom	1,486.00
Warlord Custom	1,087.00
Warlord Standard	807.00
Warlord Stage	550.00
Warrior	1 pickup 372.00
Warrior	2 pickups 420.00
For Parametric EQ add	100.00
	Livewire

**BC Rich**

**Electrics**

Mockingbird	850.00
Bitch	10-string 1,300.00
Eagle	850.00
Wave	850.00
Warlock	850.00
The Bitch	1,000.00

**Basses**

Warlock	850.00
Mockingbird	850.00
Eagle	850.00
Bitch	1,000.00
Wave	850.00
Bitch	8-string 1,300.00
Southern Star	700.00
Soundwave or Livewire	

**Daion**

**Electrics**

Headhunter	Honey Sunburst	299.00
Power X	Natural Ash	250.00
Power XX	Natural Ash	355.00
Fretless	To Special Order	

**Basses**

Power X B-1	Natural Ash	257.50
Power X B-2	Twin pu	275.00
Power XXB	Natural Ash	355.00
Fretless	To Special Order	

Peavey UK, Unit 8, New Road Ridgewood, Uckfield, Sussex TN22 5SX. Tel. 0825 5566.

**Eccleshall**

**Electrics**

**Acoustics**

**Electric Acoustics**

Custom built to order

Japanese Range forthcoming

Chris Eccleshall, 17C Station Parade, Ealing Common, London W5. Tel. 01-992 4741.

**Fender**

**Electrics**

**Basses**

CBS Fender, Fender House, Centenary Estate, Jeffrey's Road, Brimsdown, Enfield, Middlesex. Tel. 01-805 8555.

**Encore**

**Electrics**

ENC 2	w. pickup	159.00
ENC 12E		
ENC 12E	12-string w. p'up	169.00
ENC 6C	Classic	169.00

**Basses**

ENC 4B	Electric Acoustic Bass	199.00
--------	------------------------	--------

John Hornby Skewes & Co Ltd., Salem House, Garforth, Leeds LS25 1PX. Tel. 0532 865381.

**Gibson**

**Electrics**

Les Paul Deluxe	Gold/Wine Red	775.00
Les Paul Pro DL	Ebony/Gold/Tobacco Sun'bst/Cherry Sunburst	850.00

Les Paul Custom	Vintage Cherry Sunburst/Antique Sunburst/Ivory/Wine Red	875.00
	Ebony	850.00

W. Nickel finish	Ebony/Silverburst/Wine Red	850.00
------------------	----------------------------	--------

W. Gold finish 1 hand	Vintage Cherry Sunburst/Ebony/Antique Sunburst	975.00
-----------------------	--	--------

W. Gold finish 3 pu	Ebony	900.00
---------------------	-------	--------

Les Paul Standard	Antique Sunburst/Vintage Sunburst/Ebony/Wine Red	800.00
-------------------	--	--------

Les Paul XR-2	Honey Sunburst/Vintage Cherry Sunburst/Antique Natural	700.00
---------------	--	--------

Victory MV-2	Candy Apple Red/Antique Fireburst	700.00
--------------	-----------------------------------	--------

Victory MV-X	Candy Apple Red/Twilight Blue/Vintage Cherry Sunburst	775.00
--------------	---	--------

L5S	Antique Sunburst/Vintage Cherry Antique Natural	1,400.00
-----	---	----------

SG Standard	Wine Red/Walnut/Ivory	650.00
-------------	-----------------------	--------

Left Handed	Wine Red/Walnut/Ivory	700.00
-------------	-----------------------	--------

SG Deluxe Explorer	Walnut	600.00
--------------------	--------	--------

	Antique Sunburst/Vintage Cherry Sunburst/Antique Natural	875.00
--	--	--------



# Amplify the U.K. with **acoustic**

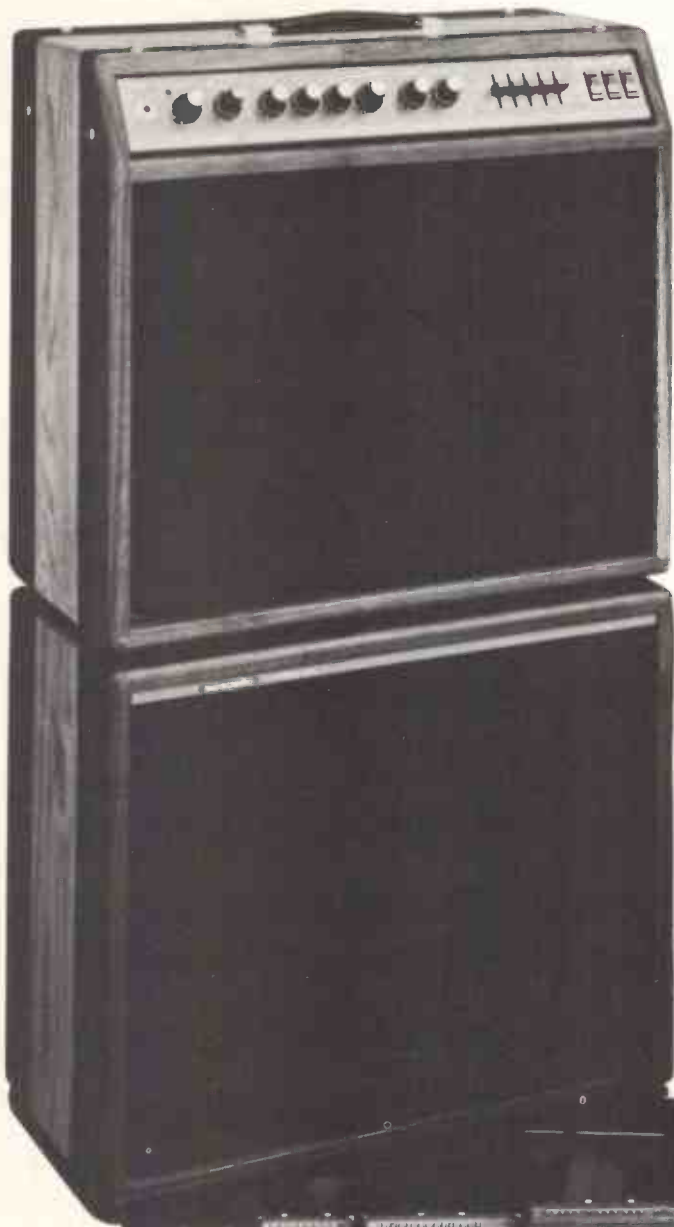

Acoustic is the standard of excellence when it comes to professional sound amplification. We pride ourselves in being sensitive to the artistic needs of the people in our industry. And that means developing and engineering the most technologically advanced products possible.

*See your Acoustic Dealer Today*



**We know you'll  
like what you hear.**



## **AUDIO-MUSIC MARKETING, Ltd.**

13, Cladswell Lane  
Cook Hill, Nr. Alcester  
Warickshire, England

(052789) 3766    **Telex: 334451 AUDMUS G**

### **AUTHORIZED ACOUSTIC DEALERS ENGLAND, U.K.**

**MORE MUSIC** Church Walk, Colchester, Essex, (0206) 47151  
**FRANK HESSY MUSIC, LTD.** 62 Stanley Street, Liverpool, (051) 236-1418  
**TIM GENTLE MUSIC** 1420 London Road, Leigh-On-Sea, Essex, (0702) 72926  
**CHASE MUSICIANS** 58 Oldham Street, Manchester, (061) 236-6797  
**MODERN MUSIC** 30 Castle Hill, Dudley, (0384) 55293  
**MUSIC GROUND** 245 Station Road, Dunscroft, Doncaster, (0302) 84 12 74  
**ROCK CITY MUSIC** 10 Mosley Street, Newcastle-Upon-Tyne, (0632) 32 41 75

**CAMBRIDGE ROCK** 8 Burreleigh Street, Cambridge, (0223) 31 60 91  
**CHASE MUSICIANS** 22 Chalton Street, London, (01) 387-7449  
**REW** 114 Charing Cross Road, London, (01) 836-2372  
**SOUND CONTROL** Elgin Street, Dunfermline, Scotland, (0383) 73 33 53  
**GUITARZAN** 23-27 Middlesborough Rd., Middlesborough, Cleveland, (0642) 46 75 10  
**SOUND CENTRE** 9, St. John's Square, Cardiff, Wales, (0222) 34018  
**CHASE MUSICIANS** 10 Priory Queensway, Birmingham, (021) 236-6255

© 1982 ACOUSTIC DESIGN JB WEST & ASSOC.

Kramer Headless Voyager Bass



Ibanez DT 500 CS



Hondo H 767 WH



The V	Antique Sunburst/Vintage Cherry Sunburst/	
	Antique Natural	750.00
Firebird II	Antique Sunburst/Vintage Cherry Sunburst/	
	Antique Natural	950.00
335S Deluxe	Cherry Red/ Tobacco Sunburst/	
	Silverbust	700.00
The Paul Deluxe	Walnut	600.00
GGC 700	White/Ebony	575.00
EDS 1275	Twin Neck Ivory/ Walnut/Vintage Cherry Sunburst	1,200.00
Sonex 180 Deluxe	Silver/Candy Apple Red/	
	Antique Firstburst	399.00
Left Hand	Same colours	425.00
Sonex 180 Custom	Ebony/White	499.00
Sonex Artist	Candy Apple Red/Silver	750.00
ES Artist	Antique Fireburst/	
	Antique Sunburst/Ebony	1,200.00
ES 347 TD	Antique Sunburst/Ebony/	
	Antique Natural	1,100.00
Nickel Parts	Vintage Cherry Sunburst/Ebony	1,000.00
BB King Standard	Cherry/Ebony	1,200.00
BB King Custom	Cherry/Ebony	1,200.00

**Acoustic Electrics**

Chet Atkins CE	2 models	950.00
ES 335 Dot	Cherry/Antique Natural/Ebony	850.00
Left Handed	Vintage Sunburst/ Ebony/Antique Natural	950.00
ES 335 Dot	Coil Tap; Cherry/ Ebony/Antique Natural	875.00
Byrdland	Natural/Antique Sunburst	2,200.00
L5 CES	Natural/Antique Sunburst	2,000.00
Super 400 CES	Natural/Antique Sunburst	2,400.00
Kalamazoo	Award Model; Natural/Antique Sunburst	5,250.00
Super V CES	Antique Sunburst/	
	Natural	2,400.00
Super V BJB	Same colours	2,300.00
Johnny Smith	JSD; Natural/ Antique Sunburst	2,400.00
Single Pickup	JS; same colours	2,400.00
ES 175D	Antique Sunburst/	
	Natural	1,100.00
Howard Roberts	Fusion; Ebony/ Antique Fireburst/ Antique Sunburst	1,100.00

**Basses**

Victory Standard	Silverbust/Candy Apple Red/ Fretless Candy Apple Red/ Fretless Silverburst/Ebony	750.00
Victory Artist	Antique Fireburst/ Candy Apple Red/ Fretless as above	900.00
Flying V	Blue/Ebony/ Silverburst/Ivory	775.00
Rosetti, 138-140, Old Street, London EC1V 9BL. Tel. 01-253 7294.		

**Hondo**

<b>Electrics</b>		
H1010B	Black	119.00
H1030N	Natural	144.70
HP1082CS	Twin w. case	399.00
H737B	Black	109.00
HL737B	Left hand	115.00
H780MR	Z-shape, red	132.00

H781CK	Z-shape, check	132.00
H767B	Y-shape, black	129.00
H760B	Black	109.00
H760BL	Blue	109.00
H732MR	Metallic red	99.00
H734CH	Cherry	89.00
H775GMB	Star-shape, blue	145.00
H781FL	Z-shape, flame	132.00
H781SWBW	Z-shape spiderweb	132.00
H767WH	Y-shape, white	129.00
H760B	Black	109.00
H757N	TC shape	115.00
M1B	w. case, black	199.00
M1MR	Metallic red w. case	199.00
EG1736	LP type, black	82.00

**Electric Acoustics**

H935 WA	Walnut	135.00
H937BS	Semi hollow	142.00
H935CH	Cherry	135.00
H937WA	Walnut	142.00

**Basses**

H830S	Sunburst	125.00
HL830S	Sunburst left-hand	125.00
H880MR	Z-shape red	132.00
H860B	Y-shape black	129.00
H830B	Black	129.00

John Hornby Skewes & Co. Ltd, Salem House Garforth, Leeds LS25 1PX. Tel. 0532 865381.

**Ibanez**

<b>Artist Range</b>		
AR50 BK		286.79
AR100AV		348.76
AR100CS		348.76
AR100FR		348.76
AR100PW		348.76
AR105AV		348.76
AR100AVL		367.70
AR112AV	12-string	392.92
AR300AV		435.95
AR300CS		435.95
AR305AV		435.95
AR500AV		567.29
AR500CS		567.29
AR1200AV	Twin Neck	857.17
AR5000AV	Limited Edn.	1,027.33

**Musician Range**

MC150DS		340.42
MC150FR		340.42
MC150PW		340.42
MC350NT		438.11
MC550WN		629.27

**Personality Series**

GB10BS		695.46
GB10NT		695.46
GB20BS		747.96
JP20BS		544.13
LR10AV		579.85

**Destroyer Range**

DT400CS		429.67
DT50FR		285.76

**Iceman Range**

IC400CS		429.67
IC50RB		285.76

**Rock 'n' Roll Range**

RR400CS		429.67
RR50FR		285.76
RR50BK		285.76
RR50WH		285.76

**Blazer Range**

BL100TV		180.76
BL170TV		180.76
BL300NT		193.32
BL350NT		219.57
BL350TV		219.57
BL400BY		228.00
BL450BY		259.51
BL450CR		259.51
BL450SB		259.51
BL470BY		259.51
BL470SB		259.51
BL500FR		254.26
BL550FR		285.76
BL550RB		285.76
BL560FR		292.04

**Studio Range**

ST60BG		208.04
ST80BR		233.26
ST90BR		282.54
ST1200BS	Twin neck	477.95



**Eat Your Heart Out  
AMERICA**



*Gordon  
Smith*  
guitars are  
**ENGLISH**



\*Models with 1, 2 or 3 humbucking or single coil Gordon Smith Pickups, all with push-pull coil splitting controls. 25 YEAR GUARANTEE

**KEITH HAND MUSICAL SUPPLIES**

For trade enquiries or brochures please write or telephone: 219 Walmersley Road, Bury Lancs BL9 5DF. Telephone: 061-764 1792/3.

**DEALER LIST**

- Allens Music - 22 Broad Row, Gt. Yarmouth.
- Alpha Music - 10-18 Bridge End, Leeds.
- Bolton Guitar Studios - 79 Mornington Rd, G. Bowman Ltd - The Viaduct, Carlisle.
- Bristol Guitar Workshop - 157-159 St. Michaels Hill, Bristol.
- Carlsbro Sound Centre - 22-32 Humberside Rd, Leicester.
- CC Music - 421-423 Gt Western Rd, Glasgow.
- Duck, Son & Pinker - Bath, Gloucester & Bristol.
- Guitarzan - 23-27 Middlesborough Rd, Southbank, Middlesborough.
- Macari's - 122 Charing Cross Rd, London WC2.
- Music Ground - Station Road, Dunscroft.
- Music Stop - 106 School St, Wolverhampton.
- Roadshow - 46 Henderson St, Bridge of Allen, Stirling.
- Scheerers - 2 Merrion Centre, Leeds.
- Gordon Simpson - 6 Stafford St, Edinburgh.
- White Sound - 181 Hylton Rd, Sunderland.
- Rock City - 10 Mosley St, Newcastle-on-Tyne.
- Curly Music - 58 Stanley St, Liverpool.

**PRO-STIX**

PRO - Because they're professional  
Stix - Because they're different!

All prime hickory.  
Full range of British model sizes  
with or without nylon tips.

PRO-STIX

REGAL PRO-STIX

**REGAL PRO-STIX**

Full range of American model sizes  
with or without nylon tips.

**PRODUCT LIST**

- GORDON SMITH GUITARS
- PILGRIM GUITARS
- FYLDE GUITARS
- AKG MIKES
- CANARY MIXERS
- LITTLEROCK AMPS
- WHITE AMPS
- SWITCHCARFT & BINDER CONNECTORS.
- SUPERSOFT CABLES IN 10 COLOURS.
- GAFFA TAPE
- VINCI STRINGS
- FENDER STRINGS
- PRO-STIX
- REGAL
- PRO-STIX

Please send me further info on  
Name .....  
Address .....



Ibanez RS315MS



Ibanez AS200V

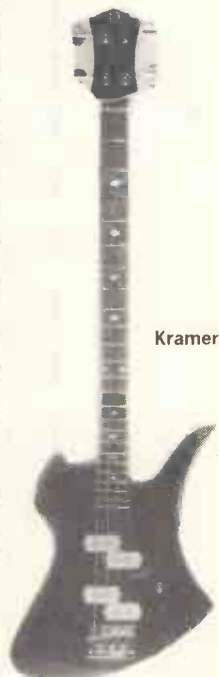

Kramer Voyager

**New Items**

RS100BS	168.00
RS100NT	168.00
RS1000CS	340.42
RS125BS	186.06
RS125NT	195.39
RS1400PC	378.20
RS1500BS	390.76
RS205BS	226.88
RS205WH	226.88
RS315CSD	244.80
RS315MS	244.80
RS405FR	264.77
RS405MB	264.77
RS405PW	264.77
RS505BS	307.80
RS505CS	307.80

**Acoustic Electrics**

AE300	175.40
AE400	194.35
AE405TV	194.35

**Basses**

*Musician Range*

MC824DS	408.67
MC924DS	487.42
MC924PW	487.42
MC924DSL	506.35
MC940DS	503.16

*Roadster Range*

RS721TB	265.79
RS721TR	265.79
RS824BB	283.70
RS824BK	283.70
RS924BS	333.00
RS924BSL	351.95
RS924TR	333.00
RS924BSL	351.95
RS924TR	333.00
RS940BS	348.76

*Blazer Range*

BL700NT	204.84
BL700TV	204.84
BL800BR	236.34
BL800BS	236.34
BL800BY	236.34

*Destroyer Range*

DT700	333.00
-------	--------

Summerfields, Saltmeadows Road, Gateshead, Tyne & Wear NE8 3AJ. Tel. 0632 770431.

**Kay**

**Electrics**

E-100	47.95
ET-200	33.10
K-32	69.00
KL-2	68.00
KL-1	68.00
K-45	Gun shape 109.95
K-30B	89.50
KDM-2K	125.00
LP	'Synth' 130.00
K-60	83.00
K-80	Flying V 199.00

**Acoustic Electrics**

EL Folk	w. speaker 96.00
---------	------------------

**Basses**

EB-100	59.95
KB-24	89.50
K-20B	79.95
K-60B	148.00

British Music Strings Ltd, Bedwas House Industrial Estate, Bedwas, Newport, Gwent, NP1 8XQ. Tel. 0222 883904.

**Kramer**

**Electrics**

SMG1	608.00
SMG2	597.00
SMG3	416.00
SMG10	482.00
Flying V	386.40
Duke	329.00
Voyager Imperial	547.00
Voyager Special	416.00
Pacer Imperial	416.00
Pacer Special	516.00
Pacer Custom	416.00
Pacer Standard	388.00

**Basses**

SMB1	608.00
SMB2	547.00

SMB3	482.00
SMB4	416.00
SMB8	639.00
V Bass	386.00
Duke	329.00
Pioneer Imperial	516.00
Pioneer Special	416.00
Livewire	

**Moon**

**Electrics & Basses**

Custom from 350.00

James M. Moon, Clauchlands, Lamash, Isle of Arran. Tel. Lamash 461, B. Moon, Glasgow. Tel. 041 423 5991.

**Peavey**

**Electrics**

T-15	Satin w. case	178.25
T-15EC	Electric Case	232.85
T-30	Natural	228.85
T-30EC	Electric Case	283.50
T-60NM	Natural	344.95
T-60NR	Rosewood f6	376.75
T-60WM	White	344.95
T-60WR	Rosewood fb	376.75
T-60SM	Sunburst	344.95
T-60SR	Rosewood f6	376.75
T-25	Sunburst	299.95
T-26	3 pu	327.75
T-27	Bridge humbucker	342.50

**Basses**

T-20	w. case	275.00
T-20FL	Fretless	305.00
T-40NM	Natural	344.95
T-40NR	Rosewood f6	376.75
T-40WM	White	344.95
T-40WR	Rosewood f6	376.75
T-40SM	Sunburst	344.95
T-40SR	Rosewood f6	376.75
T-45	Single pu	385.00

Peavey UK, Unit 8, New Road, Ridgewood, Uckfield, Sussex TN22 5SX. Tel. 0825 5566.

**Rickenbacker**

**Electrics & Basses**

420	All POA
430	
450	
450/12	12 string
460	
480	Bass
481	Bass
483	3 p-u
620	Stereo
620/12	12 string
4080	Bass/6 string
4080/12	Bass/12 string
310	¾ size
320	¾ size
330	
330/12	12 string
340	3 p-u
340/12	12 string
360	Stereo
360/12	12 string
362/12	6/12 string
370	3 p-u
370/12	12 string
3,000	Short scale
3,001	Long scale
4,000	
4,001S	2 p-u
4,001	Stereo
4,002	
4,003	Stereo
4,003S	Roundwound
4,005	Hollow body

**Strata**

**Basses**

Model 1	995
Fretless	995
Soundwave	

**Steinberger**

**Bass**

Soundwave	1300
-----------	------

**Trace-Elliott**

**Basses:** all models, Soundwave



# Fender



We were going to print a list of stars who use Fender but it would fill this magazine. You can't say Fender without name-dropping, so forgive us for not mentioning in this ad some of the legends famous for playing Fender who make Fender famous — you know who they are, and you may even be one of them. We are continually striving to produce quality, innovative products for you — the musician — so watch this space, because just as yesterday's Fenders are the classics of today — today's Fenders will be tomorrow's classics

**CBS Fender** Fender House, Jeffreys Road,  
Enfield, Middlesex EN3 7HE

# SUPER KITS!

Sets include PCBs, Electronic Parts, Instructions. Most also incl. Knobs, Skts, Wire, Solder, Box. Batteries not incl. but most will run from 9V to 15V DC supplies. Also see below.

AUTOWAH: Guitar-triggered wah-wah	SET 58	£14.01
BASS BOOST: Increases volume of lower octaves	SET 138-B	£8.87
CHORUS GENERATOR: Makes a solo voice or instrument sound like more	SET 162	£31.59
COMPRESSOR: Limits & levels maximum signal strength	SET 133-LS	£12.37
FREQUENCY DOUBLER: Raises guitar frequency by 1 octave	SET 98	£11.75
FLANGER: Fascinating delayed-feed-back effects plus phasing	SET 153	£22.49
FUZZ: Smooth distortion whilst keeping natural attack & decay	SET 91	£11.68
GUITAR EFFECTS: Multiple variation of level & filter modulation	SET 42	£15.42
GUITAR OVERDRIVE: Fuzz plus variable filter quality	SET 56	£21.17
GUITAR SUSTAIN: Extends effective note duration	SET 75	£11.77
HARMONOLA: 3-Oct organ with variable voicing, attack, sustain, vibrato	SET 124-T	£162.15
4-Octave version:	SET 124-F	£184.71
HUM CUT: Tunable filter for reducing low frequency noise	SET 141	£11.43
MAD-ROJ: Variable sirens, inc. police, galaxy, machine-guns etc.	SET 146	£9.99
METRONOME: With audible & visual beat & down-beat marking	SET 143	£13.52
MICROPHONE PRE-AMP: with switchable bass & treble response	SET 144	£8.92
MINISYNTH (PE) MK2: 3-oct very versatile music synthesiser	SET 38	£181.56
MIXERS: Several — details in catalogue (see below)		
NOISE LIMITER: reduces tape & system hiss	SET 145	£9.99
PHASER: with automatic & manual rate & depth controls	SET 164	£21.20
REVERB: Analogue unit with variable delay & depth controls	SET 122-LS	£20.39
RHYTHM GENERATOR: 15 switchable rhythms controlling 10 instruments	SET 103-F	£61.71
RING MODULATOR: for intermodulating 2 separate sine frequencies	SET 87	£13.62
SEQUENCERS: 128-note keyboard controlled (kbd incl)	SET 76	£120.45
16-note (up to 64-bit pattern) panel controlled	SET 86	£64.63
STORM EFFECTS: Automatic & manual wind, rain & surf generator	SET 154	£16.72
SYNTHESISER INTERFACE: allows instrument to trigger synth functions	SET 81	£9.49
TREMELO: Deep tremelo with depth & rate controls	SET 136	£10.71
TREBLE BOOST: Increases volume of upper octaves	SET 138-T	£8.46
tone CONTROL: bass & treb. cut, gain & range (6 controls)	SET 139	£13.62
VIBRATO: variable rate & depth plus additional phasing	SET 137	£23.99
VOICE-OP-FADER: for reduction of music level during talk-over	SET 30	£9.85
WAH-WAH: with auto-trigger, manual & oscillator control	SET 140	£17.31
WOBBLE-WAH: Oscillator controlled wah-wah for fascinating effects	SET 161	£13.40
KIMBER-ALLEN KEYBOARDS (surely the best?)	3-Oct £32.43, 4-Oct £40.68, 5-Oct £48.52	
KEYBOARD CONTACTS GJ (SPCO):	3-Oct £20.29, 4-Oct £26.50, 5-Oct £32.71	
KEYBOARD CONTACTS GB (DPST):	3-Oct £23.27, 4-Oct £30.45, 5-Oct £37.62	

## PHONOSONICS

Phonosonics Mail Order, Dept MM35, 22 High Street, Sidcup,  
Kent, DA14 6EH. 01-302 6184

Please use full address, payment CWO, CHQ, PO, ACCESS, BARCLAY, or pre-arranged collection. Prices incl. UK p&p & 15% VAT. (Add 50p ins. to credit card orders). Despatch usually 10 days on most items. Details of parts in above kits are stated in our comprehensive catalogue. Send s.a.e. (9 x 4 or bigger) for catalogue (if you live overseas please send £1.00 or equiv.) More kits are in catalogue.

IF YOU PLAY  
SYNTHS — GUITAR —  
ORGAN — BASS

# ALLIGATOR

MAKES THE RIGHT SOUNDS —  
FOR ALL OF 'EM!  
120W COMBO £269 inc. VAT



DESIGNED AND MADE IN ENGLAND

**SPECIFICATION:** Powerful, tough, and easy to handle. 120W R.M.S. Those frequencies which are vital for fine Keyboard, Bass and Guitar sounds are accurately produced by this compact Combo. For even more volume connect another K.G.B. 120 cabinet, amp output will automatically increase to 160W R.M.S. KGB 120W Cabinet £115 inc. VAT.

Variable sustain/boost control with facility for remote operation via foot switch socket. ACTIVE treble, bass controls. ACTIVE 4 band E.Q. for precise tonal selection to suit Keyboards, Bass and Guitar. Master volume control. L.E.D. Mains on/off indicator. Standby switch. Effects send/return sockets. D.I. output. Fully short circuit protected, separate speaker protection fuse. Tough A.B.S. corners. Size: 21" x 26" x 10". Weight: 50 lbs.

**THE BRITISH MUSIC PRESS ALL AGREE THAT WE HAVE PRODUCED AN AMP WHICH GIVES THE RIGHT SOUNDS FOR ALL INSTRUMENTS — FROM JUST ONE COMBO. HERE ARE A FEW QUOTES TO EXERCISE THE EYEBALLS.**

Sound — just one word will do. Superb. One of the best E.Q. sections of any amp currently on the market. Tried it with a variety of guitars, a Juno 6 synth and I can't remember the last time I was so impressed by the tonal versatility of one amplifier. **SOUNDS**

A universal amp suitable for guitar, bass, keyboards, synths, or anything else that makes music, this is their goal and they have gone about it in a very comprehensive way. Really does the job and it ain't half loud. **INTERNATIONAL MUSICIAN**

Mammoth spread of tone, standard of construction is excellent. Provides the heavy rock thump that combos don't always manage. The sound is surprising, far more projection and strength in the lower frequencies than the size of the cab would lead you to believe. **MELODY MAKER**

No matter what signal you present to it, Bass, Guitar, Percussion Machine, or Synthesiser, they all sound clear and true. All of the Alligator range represents excellent value for money. **ELECTRONICS AND MUSIC MAKER**

Delivers a searing lead sound. Its ability to handle bass guitar is little short of staggering. Wholeheartedly recommend them to any player quite regardless of what instrument he or she played. **MUSIC UK**

*SEEMS WE HAVE MADE A REALLY GOOD AMP AND IT'S GOOD VALUE BECAUSE OUR GEAR IS SUPPLIED DIRECT TO MUSICIANS*

**5**

YEAR  
GUARANTEE

HOW TO GET YOUR HANDS ON AN

## ALLIGATOR

Send Cheque/P.O./Bank Giro payable to:  
"MUSICIANS DIRECT SUPPLY CO"  
plus £12 per item for delivery by Securicor  
(Please print name & address clearly on order)



MUSICIANS DIRECT SUPPLY CO., DEPT E&MM5  
176B FIELD END ROAD, EASTCOTE, MIDDLESEX.  
01-866 7414 VISITS BY APPOINTMENT.  
FREE BROCHURE ON REQUEST.

If you are in anyway not happy with anything ordered from us, just return it within 7 days of receipt and your payment will be refunded in full.  
PETE TULETT, Managing Director



Hondo H781 FL

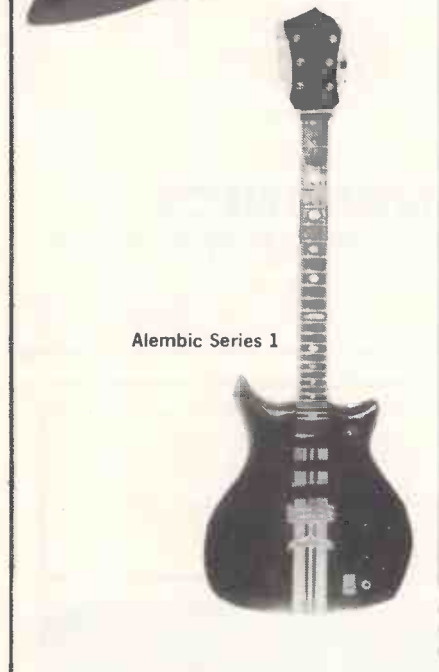

Alembic Series 1



Ibanez MC924PW

**Tokai**

**Electrics & Bases**

TST-100	'54 vintage	466.92
TST-85N	'54 vintage	398.92
TST-80	'54 vintage	375.81
TST-65N	'54 vintage	320.33
TST-60	'54 vintage	296.56
TST-55N	'54 vintage	272.79
TST-50	'54 vintage	249.02
TST-100	'64 oldie	466.92
TST-85N	'64 oldie	398.58
TST-80	'64 oldie	375.81
TST-65N	'64 oldie	320.33
TST-60	'64 oldie	296.56
TST-55N	'64 oldie	272.79
TST-50	'64 oldie	249.02
TTE-85N	Breezy Sound	398.58
TTE-80	Breezy Sound	375.81
TTE-70	Breezy Sound	330.23
TTE-55N	Breezy Sound	272.79
TTE-50	Breezy sound	249.02
TPB-85N	Hard Puncher	398.58
TPB-80	Hard Puncher	375.81
TPB-65N	Hard Puncher	320.33
TPB-60	Hard Puncher	296.56
TJB-120	Jazz Sound	558.05
TJB-85N	Jazz Sound	398.58
TJB-80	Jazz Sound	375.81
TJB-65N	Jazz Sound	320.33
TJB-60	Jazz Sound	285.27
TJB-45	Jazz Sound	225.25
TJB-120FL	Fretless	558.05
TJB-90FL	Jazz Sound	421.37
TJB-85FL	Jazz Sound	398.58
TLS-200V	Vintage	931.67
TLS-150V	Vintage	703.85
TLS-120V	Vintage	567.16
TLS-100S	Vintage	530.71
TLS-100	'58 standard	
	w. case	530.71
TLS-80		439.58
TLS-60		296.58
TLS-50		249.02
TLC-110	Love Rock	
	w. case	576.29
TLC-100		530.71
TLC-60		296.56
TLC-60M		296.56
TES-150R	Rock w.case	763.09
TES-100R	w. case	535.27
TES-150J	Jazz w. case	763.09
375.81		
TES-100J	w. case	535.27

Blue Suede Music, 19 Thornfield, Ashton Road, Lancaster LA1 5AG. Tel. 36227.

**Violette-Citron**

<b>Electrics</b>	
Standard	781.00
Baritone	621.00
Limited Edn.	1,031.00

**Basses**

Standard	781.00
8-string	890.00
Limited Edn.	1,165.00

Livewire, 21A Penylan Road, Roath, Cardiff. Tel. 0222 496619.

**Vigier**

<b>Electrics</b>	
Arpege	800
Fretless 6-string	850

**Basses**

Arpege	800	850
Arpege metal fretless		

Soundwave, or direct from Capelle Music, 333A, London Road, Hadleigh, Essex. Tel. 0702 559383.

**Wal**

**Professional Bases**

Pro 1	299
Custom	650 approx.

Soundwave, or direct from Electric Wood Ltd., Sandown Works, Chairborough Road, High Wycombe, Bucks HP12 3HH. Tel. 0494 442925/6.

**Westone**

<b>Electrics</b>		
Concord II		
80-0	off white	139.95

132-Z	Apple Red	139.95
Concord III		
81-R	Purple Red	169.95
82-U	Pearl White	169.95
Thunder I		
111-M	Light Oak Matt	129.95
103-N	Ash Black Gloss	144.95
104-Q	Sunset Red Gloss	144.95
Thunder I Active		
112-P	Light Oak Matt	149.95
105-T	Ash Black Gloss	164.50
106-W	Sunset Red Gloss	164.50
Thunder II		
164-U	Midnight Blue	184.95
165-X	Pearl White	184.95
Thunder II Active		
166-A	Midnight Blue	199.00
167-O	Pearl White	199.00
Prestige 150		
161-L	Charcoal Black	215.00
Prestige 250		
162-0	Sunrise Sunburst	269.95
163-R	Antique Cremona	269.95
Rainbow I		
*1127-J	Antique Walnut	219.95
Rainbow II		
168-G	Burgundy Red	269.95
169-J	Brown Sunburst	269.95
Raider I		
33-Y	Fire Red/Onyx	169.95
34-B	Black/Silver Sparkle	169.95
Raider II		
35-E	Yellow/Blue Sparkle	199.95
Paduak I		122.95
II		129.50

**Basses**

Concord I		
137-0	Matt Black	119.95
Concord II		
107-2	Purple Red	179.95
Thunder I		
121-R	Light Oak Matt	139.95
84-A	Ash Black Gloss	149.95
85-D	Sunset Red Gloss	149.95
Thunder I Active		
122-U	Light Oak Matt	159.95
86-G	Ash Black Gloss	169.95
87-J	Sunset Red Gloss	169.95
Thunder II		
124-A	Ash Black	299.00
123-X	Walnut	299.00
Thunder II Fretless		
138-R	Walnut	299.00
139-U	Ash Black	299.00
Raider I		
36-H	Fire Red/Onyx	179.95
37-K	Black/Silver Sparkle	179.95
Raider II		
38-N	Yellow/Blue Sparkle	199.95

FCN, Morley Road, Tonbridge, Kent. Tel. 0732 366421.

**Yamaha**

<b>Electrics</b>		
SG 3000	w. case	799.00
SG 3000S	w. case	799.00
SG 2000S	w. case	649.00
SG 1000S		379.00
SG 400		299.00
SG 300		259.00
SG 200		199.00
SC 400		209.00
SC 600		299.00
SC 300T		199.00
SC 400T		259.00
SF 1200		379.00
SF 600		299.00
SF 400		229.00

**Electric Acoustics**

SA 2000	w. case	599.00
SA 2000S	w. case	569.00
SA 1200S	w. case	499.00
SA 800	w. case	429.00
AE 2000	w. case	799.00
AE 1200	w. case	699.00

**Basses**

BB 3000	w. case	699.00
BB 2000	w. case	599.00
BB 1200S		429.00
BB 1000S		299.00
BB 400S		229.00
BB 300		189.00
BB 2000F	w. case	669.00
BB 400SF		249.00

Yamaha, Mount Avenue, Bletchley, Milton Keynes, MK1 1JE. Tel. 0908 71771.



# 'FINGER PICKIN' GOOD'

"MY career as an ace guitarist is well established, and recently my talent has been searching for new areas of self expression. Well, what better way than to write for musicians, and what better gear to write about than Gibson guitars.

"Today you get a bonus. Not only an action packed feature on the afore-said Gibsons, but red hot information on Epiphone, a guitar name of considerable standing round the world. If you can't find a guitar to play from these two names, give up real music and play the drums.

"The thing I like about Gibsons is that they have evolved, from people who have been building guitars for years, rather than 'designed' by engineering graduates. This is not to belittle a little college education, my own academic career still brings tears to my mother's eyes, but the point is that you have to *know* guitars to make guitars.

"The Les Paul series is the ultimate proof. Les wanted a guitar that would eliminate feedback and resonance problem, and it was natural for him to tie up with Gibson, who had done so much pioneering work in pick-ups and hollow bodied electrics. Les wanted a solid bodied instrument — he was looking for a 20 second sustain! — and of his earliest prototype he said 'You could go out and eat and come back and the note would still be sounding'.

"The Les Paul range is very varied now. This is how they line up:—

"Les Paul Deluxe Solid mahogany body

with carved maple top. Single cutaway, Tune-O-Matic bridge, two Gibson Humbucking pickups with individual tone and volume controls plus three position switch for pickup selection.

"Three piece solid maple neck, glued to the body like all Les Pauls, for increased sustain. Rosewood fingerboard with deluxe inlays and 22 frets.

"Les Paul Pro Deluxe Similar spec. to the above, but fitted with cream single coil pickups and ebony fingerboard.

"Les Paul Custom Body, top and cutaway style as Deluxe. Tune-O-Matic bridge. Two gold plated Humbucking pickups with individual tone and volume controls. Three position toggle switch to select either or both pickups. Maple neck with ebony finger board, and pearl block inlays. The Custom has beautiful finish details, like the black finger board with white edging and the gold plated machine heads.

"Les Paul Standard Same top quality body construction and cutaway style, plus the Tune-O-Matic bridge, pickups, controls and pick up selection as the Custom! Maple neck and beautiful rosewood fingerboard. Top quality chrome plated machine heads.

"Les Paul XR2 Laminated mahogany body with maple veneer top. Tune-O-Matic bridge again, two high output Humbuckers with coil top. Rosewood fingerboard.

"As I've said before, I play a Gibson MV2. I chose it for the balance and comfort, the fitted neck for the added sustain that I like and the coil tap switch to select, single coil or double coil sounds from the high output humbucking pickups.

"The MV2 is available in a different format, as the MV-X, with three pickups and five position pickup selection.

"Don't get the idea that Gibson only make guitars (and, of course, excellent guitar accessories). They make an ace bass or two — too! Today's bass player looks for an instrument that allows very fast clean playing. Guys are playing melodic bass lines like some guitar players now and the axe has to meet their style demands. It must be accurate — it must be good. The Victory Standard not only looks good, it is beautifully balanced and that is one thing that bass players look for first.

"If you take your hand off the bridge, you don't get machine heads in the left ear, or a thump in the ankle!

"The Victory bass has an oversized truss rod, reinforced by two steel strips, for rock solid neck. And the bridge is a knockout, with very fine adjustment features built in. It's a series VIII B potted humbucker with extended frequency response at high and low volumes.

"And don't try the Victory Artist bass unless you are serious! Two pickups and a package of on-board electronics make this an incredibly versatile instrument. The electronics work in three modes — passive, like the Standard, active/notched, which allows 18 dB boost or cut of bass and tremble with built-in 13 dB notch at 1 kHz, and active/flat mode, without notching.

EPIPHONE CASINO I



"This is the one!

"The Epiphone name is back on the scene, now. Epiphone always had a good reputation and they are now owned by Gibson, so that's no bad thing. They are built by specialist manufacturers to Gibson's very demanding specification, and it's possible to play Epiphone for a remarkably low price this way.

"There are five jumbo acoustics and four rather beautiful semi-acoustic electrics in the current range, and every last one of them looks great and handles perfectly. They go like this:—

"Epiphone Emperor A classic Epiphone, particularly loved by jazz musicians. Mother of pearl block inlays to the next and intricate inlays to the head. Superb fast action, and good machine heads. This incredible guitar will set you back only £475, and that includes the case!

"Epiphone Riviera Semi solid body gives bags of sustain and volume. Humbucking style pickups and double cutaway body. Not bad for £299 with case!

"Epiphone Sheraton A beautiful Riviera with multiple beading to neck and body. Lovely inlays too. Well worth the £350, to include the case.

"The jumbos start from as low as £89.95 for a highly playable range using mahogany, maple, rosewood cappings, and nice machine heads. Even the most expensive one in the range, the FR25, is only £139.95 and that's for a guitar with rosewood back, sides and neck, and superb inlays and bindings. They all play beautifully, of course.

"Your local stockist will be happy to show you these delightful instruments and don't forget that the Gibson & Epiphone distributors, Rossetti Limited, are always pleased to hear from you, at their London address, 138-140 Old Street, London EC1."

Dave Lacey

GIBSON MVII



# Rickenbacker® Recollections of Perfection

*The Professionals  
Choice*

Rickenbacker  
basses and guitars  
The Affordable Luxury

For your **FREE** Rickenbacker 24 page colour brochure and list of local stockists  
please complete the coupon and send to Golico Ltd, Studio House,  
High Lane Village, Nr Stockport, SK6 8AA

NAME \_\_\_\_\_  
ADDRESS \_\_\_\_\_  
POSTCODE \_\_\_\_\_

Distributed by  
**GOLICO**  
**Rickenbacker**  
TEL: 06632 3968.

available only from  
leading music shops  
throughout the United  
Kingdom and Eire.

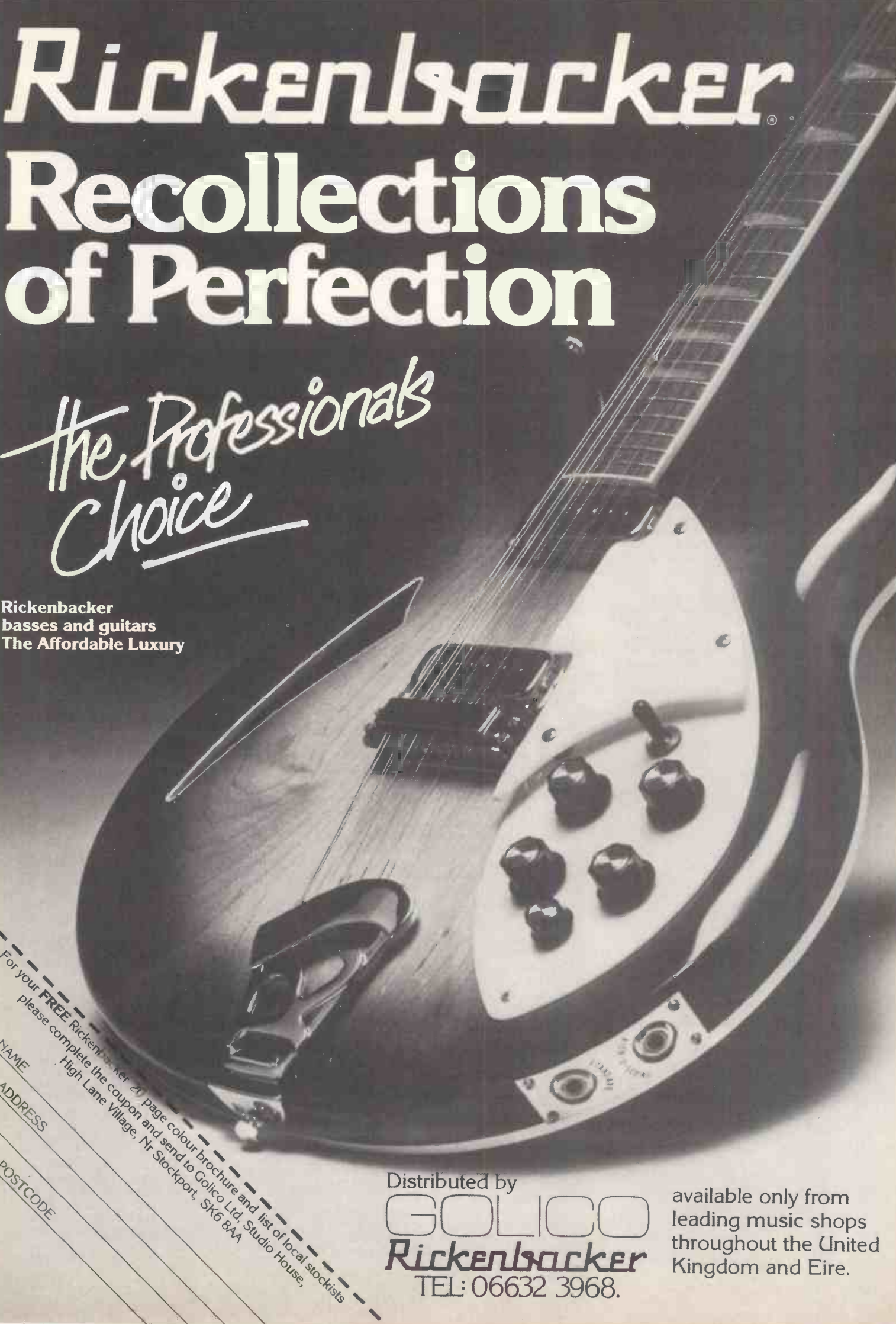



# biggles music

PROFESSIONAL SERVICES TO THE ENTERTAINMENT INDUSTRY



DIG/SEQ  
CSQ-100



FULL RANGE IN STOCK. PHONE FOR SPECIAL PRICES.



JUPITER 8 — JUNO 6 — SH-101 — CSQ 600 — JX3P



HOME RECORDING SPECIALISTS



SPECIAL PRICES P.O.A.



+ TRACE  
ELLIOT  
THE ULTIMATE  
BASS AMP

PRO 5 — PRO-ONE — PRO 600 — PRO 10 — DIG/SEQ



COME IN  
AND HAVE  
A GO AT  
THE AMAZING  
SIMMONS  
DRUMS AND  
SEQUENCER!



SDSV-SDS 6

PRICE £P.O.A.



STEINBERGER +  
STATUS BASSES  
IN STOCK

NO DEP. H.P. ACCESS, BARCLAYCARD, P.X. SERVICE, REPAIR, HIRE 200W-20K.

85 WEST ST, OLD MARKET  
BRISTOL, TEL: 0272 552147  
585319

182 KINGS RD,  
TEL: READING  
0734 584945

214, EXETER ST,  
TEL: PLYMOUTH  
0752 29858

A1 MUSIC  
MANCHESTER 061  
2360340

ARGENTS  
LONDON 01-240 0084  
WORCESTER  
0905 611774

ABC MUSIC  
WEYBRIDGE  
0932 54877

ALLANS MUSIC  
GT. YARMOUTH  
0493 58449

ALLEGRO MUSIC  
COLCHESTER  
0206 79886

ANDERTONS MUSIC  
CENTRE  
GUILDFORD  
0483 38212  
READING 0734 415800

BOOTLEG MUSIC  
EPSOM  
78 24528

G. BOWMEN LTD.  
CARLISLE 9228 28144

CARLSBORO SOUND  
CENTRE  
MANSFIELD  
0628 651633



## MAIN DEALERS

SHEFFIELD  
0742 640000  
NOTTINGHAM  
0602 700407  
LEICESTER 0533 24183

DOUGIES MUSIC  
NORTHWICH  
0606 6040

DUCKSON & PINKER  
BATH 65975

FREEWAY MUSIC  
BRISTOL  
0272 60734

FRET MUSIC  
SOUTHAMPTON  
0703 774433

FUTURE MUSIC  
CHELMSFORD  
0245 352490

JAMES GRANT MUSIC  
EDINBURGH  
031-228 1704

GIGSOUNDS  
LONDON 01-769 5681

FRANK HESSEY  
LIVERPOOL  
051-236 1418

HOBBS MUSIC  
LEICESTER  
0524 60740

HONKY TONK MUSIC  
HADLEIGH  
0702 553647

JONES &  
CROSSLAND  
BIRMINGHAM  
021-643 0655

JSG  
BINGLEY  
W. YORKSHIRE  
0724-568843

McCORMACKS  
GLASGOW  
041-332 6644

EDDIE MOORES MUSIC  
BOUNEMOUTH  
0202 35135

ROSE MORRIS  
LONDON WC2  
01 4372211

MUSIC GROUND  
DONCASTER  
0302 843037

PETER NOBLE  
CARDIFF  
0222 753911

ONE WAY MUSIC  
WOLVERHAMPTON  
0902 23060

ROCK CITY MUSIC  
NEWCASTLE  
0632 324175

THE ROCK SHOP  
LONDON NW1  
01 267 5381

SESSION MUSIC  
BELFAST 023 238502  
DUBLIN 606 777  
LONDONDERRY 46796

SOHO SOUNDHOUSE  
LONDON 01-434 1365

SOUTHERN MUSIC  
BRIGHTON  
0273 733387

# Technical Projects DI Boxes



The musician faced with a vast variety of microphones, mixer sockets, cables and instrument outputs often needs to be able to match and stabilise levels before he can use any of them. When working on stage with large numbers of microphones - for instance those on a large drum kit, plus vocal mics, plus backline mics - it becomes a problem to achieve a reasonable PA mix if line level outputs from keyboards also need to be taken into account. In the studio it's often necessary to adjust levels, input impedances, or to split signals, before the mixing desk and associated effects can be used to their full. Unfortunately with this sort of wiring complexity problems with Earth loops and line interference often occur.

Technical Projects aim to solve these problems with a range of four handy black boxes. Three of these are 'balancing boxes', designed to balance long cable runs, break earth loops and provide safety insulation, the fourth being an Active DI box. Three of the range are examined here: the GP (General Purpose); Hi Z (High Impedance) and the Active DI.

Construction of each of the boxes is similar, with the exception of the fact that the DI has a battery compartment, being the only active design of the three. Each model measures  $4\frac{1}{2} \times 3\frac{1}{2} \times 2$ " and weighs about one pound. The casings are extremely tough, formed from extruded aluminium, with alumin-

ium front and back panels. XLR sockets are in chromed metal and  $\frac{1}{4}$ " jack sockets in black plastic. Two rubber strips along the base of each unit should help keep the boxes in place on stage.

## DI 100

The unit has 2 inputs; instrument and amplifier, which are both standard  $\frac{1}{4}$ " jack sockets. Power is connected to the internal amplifier when a jack is inserted into either socket. If the mixer to be connected is phantom powered the internal regulator will take a feed from this, otherwise a PP3 battery should be inserted in the battery compartment. Input signals are fed to a unity gain buffer which has an input impedance of 10M. If the amplifier input is used the signal is attenuated by 45dB. The output of the buffer is passed through a 'padding' attenuator, which can be switched in to provide a further 20dB cut, before being connected to the isolating transformer. The secondary of the transformer, coupled in a balanced configuration, is connected to an XLR socket for connection to the mixer desk.

A second output, via another  $\frac{1}{4}$ " jack socket, is provided for connection to another amplifier, speaker or second mixer desk. This can be connected to a second primary on the transformer to

give a buffered, isolated version of the input or can be switched in parallel with the input, i.e. direct.

The circuitry also contains a special ground compensation circuit which makes 'ground lift' switches obsolete.

## Lo Z and Hi Z

These boxes are designed to be used as sending and receiving ends of a balanced line system. Two channels are provided in each which can be used separately, or as a stereo set up.

Lo Z can be used for equipment outputs at the sending end as it takes low impedance inputs such as balanced mics or unbalanced instruments and provides a transformer coupled balanced output.

Hi-Z can be used for equipment inputs at the receiving end as it accepts a balanced line input and provides a transformer coupled output which can be used to drive high impedance inputs such as mixer line or microphone inputs.

Standard XLR connectors are used on each channel and a 'ground lift' switch is provided to break the path between the ground lines, thus isolating each side.

## GP Box

The GP box is optimised for low impedance operation but can be used in most situations where isolation is required for safety, or to break hum loops. Again, XLR connectors are used for each channel and a 'ground lift' switch provided.

Internally, these units are very well constructed with all of the components mounted on resist-coated PCBs. When the front and rear panels are screwed on the case is, as the manufacturers claim, virtually indestructible.

Technical Projects have provided the musician with professional, compact, high quality products which should cure most of the problems associated with equipment connection.

**E&MM**

For further details contact Nikki Antoniou, Theatre Projects, Sound Sales, 10 Long Acre, London, WC2E 9LN. Please mention E&MM when doing so.



# LOCOBOX *Effects*

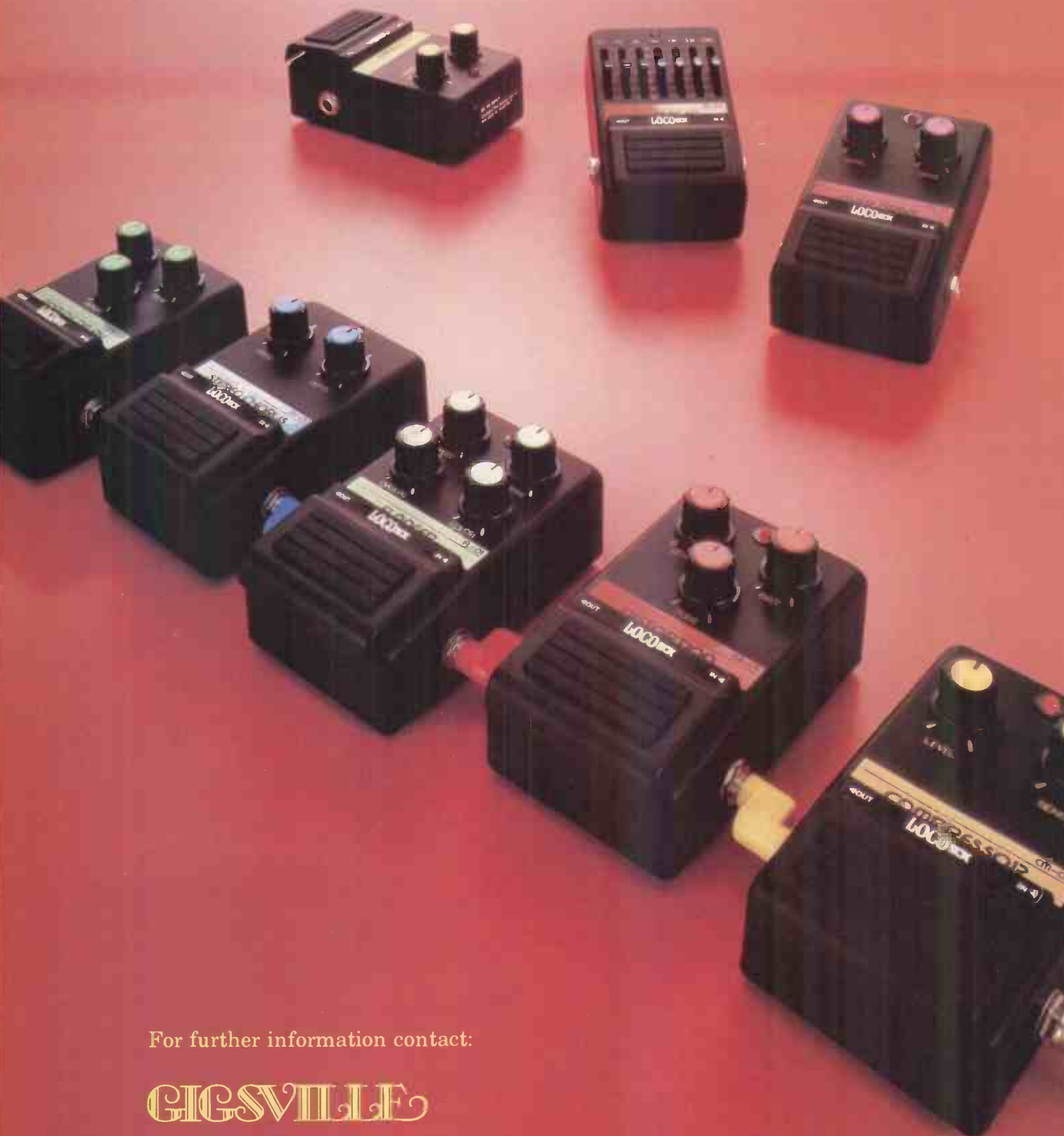

For further information contact:

**GIGSVILLE**

Phoenix Way, Heston, Middlesex. Telephone: 01-897 3792

# A Sound Success



## The Emulator.

When the Emulator was introduced a year ago it was immediately hailed as the 'soundcopier.' This sound copying machine enabled the musician to play any sound over its four octave keyboard. Either sampling the sound required or selecting it from the Emulator's enormous library of sounds on floppy disc.

The addition of extensive sequencer facilities caught the imagination of the industry. Such a versatile and user friendly machine is

ideal for commercial effects, jingles, and video work requiring ease and speed.

E-mu Systems now add to the Emulator's impressive range of options the analog interface making the Emulator interfaceable with any synthesiser or voltage controlled device.

Take a listen to the latest sounds behind the hits, sounds creating the ads, sounds fattening TV and film themes. The Emulator. Take a listen to what's become the latest sound success.

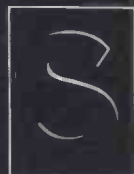

**Syco Systems Ltd**

20 Conduit Place, London W2 Tel 01-724 2451 for appointment. Telex 22278 Syco G



# Concert Review

## 10 CC

London Hammersmith Odeon  
16th March 1983

Rock superstars 10 CC have been quiet of late, with their last album 'Ten Out Of Ten' creating relatively little impression, but their musical qualities have not diminished and they can still turn in a spectacular live performance.

Founder members Eric Stewart and Graham Gouldman form the nucleus of the band, and they are now joined by Paul Burgess (drums), Rick Fenn (guitar and vocals), Vic Emerson (keyboards) and Stuart Tosh (drums, percussion and vocals). Against an impressive New York urban background, the band worked through most of their greatest hits, with a smattering of new material which was sadly much less familiar. The set opened with a pacey medley, and continued for the first half-hour or so to cover well-known tracks such as 'Rubber Bullets', 'Good Morning Judge' and 'Wall Street Shuffle'. 'Silly Love', another single from the 'Sheet Music' album, and 'Life Is A Minestrone' from 'The Original Soundtrack' also got a powerful, up-tempo rendition, with Stuart Tosh's drum sound being particularly noticeable. Apart from a bass drum with a kick like a mule, the tom sound was incredibly clear and precise, with all credit going to sound engineer Martin Lawrence.

Graham Gouldman alternated between a crisp rhythm guitar, Fender Electric piano and a genuine acoustic grand (not a frequent sight in these impoverished times), helping to set the pace and tone for clap-along songs such as 'The Things We Do For Love', heavier numbers such as 'Art For Art's Sake', or the poignancy of 'I'm Mandy, Fly Me'.

Since the latter track involves a heavy use of Mellotrons and special effects in its original form, it was interesting to see a live interpretation of the piece. Vic Emerson's keyboard set-up consisted only of a Yamaha Electric Grand and a CBS Rhodes Chroma with its associated foot-pedals and controllers, yet he managed to provide a wide array of rich, symphonic sounds including some very accurate instrumental imitations. The steel drums of 'Dreadlock Holiday' were one excellent example, and the Chroma also showed itself to be capable of good string sounds and convincing human voices. As a soloing instrument it has yet to prove itself on the evidence of Vic Emerson's one very brief lead break, however.

10 CC covered many musical styles during the evening, from the calypso of 'From Rochdale to Ocha Rios' to the more experimental feel of their seven-minute single '24 Hours'. Despite a predominantly middle-aged audience they generated a large degree of enthusiasm without excessive volume, and although there were a couple of duff notes in 'I'm Not In Love' (which they could reasonably be expected to have learned by now) the technical quality of the playing was very high indeed. Similar comments apply to the sound mix, which proved an unexpected bonus in an evening characterised by melody and harmony.

E&MM MAY 1983



10 CC's Gouldman & Stewart on stage.

## LGT

London Hammersmith Odeon  
16th March 1983

In support of 10 CC, Locomotiv GT make their UK debut with a set based on their EMI album 'Too Long'. To learn that they are Hungary's top rock band is to know everything there is to know about them; their music is slick, up-tempo, MOR and inescapably derived from the Western light rock tradition. Centre of attraction is band leader and keyboardist Gabor Presser (featured in April's E&MM), although the frontman is vocalist Tamas Somlo, who shared the introductions and links with Gabor. Completing the line-up are Janos Solti (percussion), Janos Karacsony (guitar) and a two-man brass section.

Most of the songs tend to be lengthy, with various solos, novelty sections and gimmicks thrown in to keep the audience happy. Tamas Somlo contributed a screaming jazz violin solo, together with the beginning of a sax solo taken over by the brass section for a fluid and expressive climax. The jazz/blues backing became a little predictable at times, however, and 50's-style rock and roll contrasted sharply with the band's Hungarian origins. At some points the influence of gypsy music — the accelerandi and fluid rhythms — were put to stimulating use, but the overall approach was not serious enough to be consistently interesting.

Gabor Presser's keyboards suffered from being a little low in the mix, but his jazzy Yamaha Grand piano runs managed to cut through and maintain a sense of continuity. His Jupiter 8 didn't fare so well, and any ambitious sounds attempted on it were largely lost, either through inaccurate mixing or through unfamiliarity with the instrument.

Although LGT created a reasonably enthusiastic response among a less than youthful audience, the overall impression was that this was as much due to their wacky non-musical antics as to their well-intentioned musical efforts. Comparisons with The Barron Knights are inescapable, and the more serious approach of Gabor Presser's solo album 'Electromantic' is much to be preferred.

## Mainframe

London Rock Garden  
20th March 1983

If Mainframe don't become famous in the next twelve months, it won't be because they're not good enough, but probably because they're too good. They are one of the very few bands playing high-quality, technologically oriented, accessible pop music, and are ambitious enough to make it if they can retain the freshness they're now displaying.

The set played at the Rock Garden, and at an earlier date in the exclusive Embassy Club, was based on the band's forthcoming concept album 'Tenants of the Lattice-Work', and like the album was played with the help of a selection of synthesisers and computers. To describe the band as a duo would be to neglect the activities of their engineers Andrew Earle of Gothic Audio-Visual (video) and Colin Holgate (graphics) and of road crew Jez West and Simon, and manager Rod Munro, who between them have helped to create a very slick performance machine.

However, the front men are John Molloy (keyboards and vocals) and Murray Munro (keyboards, guitar and vocals), who together with a 4-track Teac for backing, a slide projector, a selection of video machines and TV

monitors and the odd Apple 2 manage to throw together an entertaining and varied show with as much visual as musical appeal. John's set-up consists of a Juno 60, Moog Prodigy and Moog Liberation, which when slung around the neck provides a degree of mobility and expression almost unequalled by any other instrument. Murray uses a Yamaha SK20 keyboard together with guitar and a boom-mounted mic — which could do with being replaced by a headset mic to emphasise the band's image as a compact, high-technology unit.

The opening backing tape carried drum sounds and sequences which largely define the duo's sound, an up-tempo form of electro-pop. All the percussion sounds are played by hand on the Liberation and carefully multitracked before mixdown, resulting in a fluid and forceful backing which can't be identified as the usual Linn or TR808. Over this the Juno 60 typically lays string/harpsichord sounds, while Murray Munro's guitar picks up catchy hook lines with an unusually rich intonation. For slower sections he produces a gently attacking note, curling a finger around the volume pot to fade in each phrase, and a subtle use of echo on guitar and vocals helps to thicken the sound.

Some of the rapid sequences used to open tracks are reminiscent of Depeche Mode, but Mainframe have more power and more variation. Additionally their graphic display is unequalled. Live computer animation synchronised by a sound-to-light system and displayed on colour monitors includes moving cubes, starscapes, digitised photographs and spiro-graph-like abstracts. A projector screen at the rear of the stage shows pictures of the band's past shows, landscapes and other images, while a videotape intercut with the computer graphics helps to explain the concept of 'Tenants'. The Tron-like scenario involves a businessman named Oscar who finds himself reduced to a computer program in a digital limbo; the attraction of the band is that a single concept links together all their activities and ideas, yet they avoid the danger of becoming blandly mechanical as a result.

As the set went on the graphics became increasingly impressive, with a skeletal 'Mainframe' logo panning across the screens and John Molloy's Prodigy and Liberation solos become increasingly impassioned. The present single 'Radio (Will Bring Me Home)' proved a highlight, and with distribution by PRT and a degree of airplay it may well lead to greater things. Available from MC2 Records at 24 Missden Drive, Hemel Hempstead — also the managerial address for the band — it's unusual in that the third track is a coded message for Apple 2 owners, just the first of a



LGT in concert.

number of computer-related releases the band have in store.

With forceful management and the all-important quality of catchy accessibility, Mainframe could have a bright future. But, even if they don't catch the wider public imagination, every aspiring electro-musician should take any available opportunity to see live a band who are utilising every aspect of modern musical and audiovisual technology to the full.

**Mainframe at the Rock Garden.**

**Ian Boddy**  
**Triangle Arts, Birmingham**  
**19th February, 1983**

Ian's inaugural concert at the new music workshop in Aston University was mentioned in the review of his cassette album 'Options' in April's E&MM. With a compact set-up of electronic equipment he played two pieces of what he calls 'electro-pop', but is more closely allied to Tangerine Dream's or Jean-Michel Jarre's

more progressive style.

Central to the keyboard line-up was a Korg Polysix, which with a degree of digital echo provided string, swept filter and abstract sounds with equal ease. Percussion was provided by a Roland Drumatix programmed with lengthy chains of simple, driving rhythms, and linked to a Roland Bassline which produced a fluid sequencer pattern for the lengthy up-tempo sections. A Roland CSQ sequencer provided additional back-

ing patterns, and a 100M modular system improved some of the percussion sounds and carried out various other functions. Lastly, a VCS3 synth provided abstract sounds, with colour-coded sets of pins left in position on its patchboard for quick selection.

The emphasis in the longer piece was on rapid sequences, random changes of filter tone, powerful sweeping chords and only an occasional lead-line. Short themes re-



**Ian Boddy.**

occurred at various points, and the piece followed the classic pattern of slow abstract start, lengthy sequencer run, and gentle chordal finish. Ian then gave a talk on the equipment used, and was persuaded into playing another shorter piece based on a work in progress at Newcastle's Spectro Arts Workshop.

The whole event was highly enjoyable, and demonstrated the fact that Ian's live style is rapidly de-

veloping and producing even more energy than his popular but rather delicate recorded work. More live performances are planned for later in the year, and there's talk of an LP before long. Ian's style fills a definite gap between the abstraction of Jarre or Schulze and the descriptiveness of electronic film music, and as such will find an increasing number of devotees in the future.

**Mark Jenkins**

**E&MM**



**TUBBY DRUM**

**6 MIKES NO STANDS**  
**EXCELLENT SEPARATION**  
**SIMPLE TO USE**  
**COMPETITIVE PRICE**

For further details write to

**MUSIMEX**  
**33 CHURCH CRESCENT**  
**LONDON N20 0JR**

**COVENTRY**  
**MUSIC CENTRE**

**3-5 Whitefriars Street, Coventry**

**Your main area Roland dealer**

*Usual stock includes:—*

**Keyboards**

Juno 60, Juno 6, SH101, RS09, HP30, EP11, HP70, EP6060, VK09

**Amplification**

Bolt 30, 60. Spirit 10, 30, 50, 15B, 30B, 50B

**Roland effects**

CR8000, TR808, TR606, TB303, RE501

**Boss effects**

CE2 Chorus, CE3 Stereo Chorus, BF2 Flanger, DS2 Distortion, SD1 Super Overdrive, DM2 Delay, DR5 Doctor Rhythm, OC2 Octava, VB Vibrato, OD1 Overdrive.

**ALSO AREA AGENTS FOR MARSHALL, CARLSBORO, LANEY, YAMAHA, KORG, WESTONE, PEAVEY, STUDIOMASTER ETC.**

For some great prices contact us on Coventry  
**(STD 0203) 58571**

*Access — Barclaycard — finance arranged — Mail Order*

**Parking in street — closed all day Thursday**



# Studio sound ...on the road

If you're looking at your P.A. system, it could pay to check out the heart of the rig – the mixing console itself. You need a board that will let you be as creative as the music on stage, that'll survive in the back of the truck, and that won't break the bank.

## The 400B Live

So check out the Soundcraft Series 400B. Designed for the touring band and creative musician, the 400B is compact, transportable, yet still performs like our studio consoles.

That's because its modular construction contains some of the advanced features that have made Soundcraft consoles the first choice for more and more studios and touring sound companies. So you can take absolute control of 16, 24, or 32 inputs, and create the sound your music deserves.

## Recording with the 400B

But you get more than an ideal front-of-house mixer with the 400B. With 8 track

monitoring and 4 auxiliary buses, you get a desk that will handle your 8 track recording requirements within the same competitive price.

## The 400B Monitor



And if that sounds impressive, the 400B also comes configured in a Monitor format for the band which needs independent stage monitor mixing. The 400B Monitor gives you the facilities

to create 8 separate mixes plus a stereo mix for side-fills, front-of-house or stereo recording. Available in 16/8+2 and 24/8+2 sizes, all 8 outputs can be mixed into the stereo output via level and pan controls.

The Soundcraft 400B and 400B Monitor. They'll help you make the most of your performance. Just send for our brochure, and we'll show you how to do justice to your music wherever you go.

## Soundcraft

Soundcraft Electronics Limited,  
5-8 Great Sutton Street, London, EC1V 0BX,  
England. Tel: 01-251 3631. Telex: 21198.

Soundcraft USA, 20610 Manhattan Place,  
Suite 120 Torrance, Ca. 90501.  
Tel: (213) 328 2595. Telex 182499.





# MicroComposing with Roland

## The MC-202 MicroComposer



Roland's introduction of their first MicroComposer, the MC-8, in 1977 was undoubtedly ahead of its time and, like most new ideas, its great potential was little understood or accepted by musicians and studio engineers. As the Compu-Age grew rapidly around the MC-8, the awareness of the possibilities that micro computers offered for practical music-making (rather than just with mainframe machines), brought increased acceptance of this dedicated computer music instrument.

The concept of the MicroComposer has not changed since it still is a digital sequencer controlled by a microprocessor. The emphasis of the MC-8 was on programming by calculator keyboard up to 8 separate sequences that provided the necessary control voltages for external analogue synthesisers. The MC-8 cost around £4,000 in the UK and its editing facilities made it a powerful composing tool — allowing less articulate players to perform 'note perfect' music, provided they were willing to learn musical notation and the simple programming language.

The MC-4, introduced some 3 years later, was less expensive at around £2,000 for the basic unit and allowed real time, as well as 'step' keyboard input via an external synth. Although only 4 separate voice lines are available, the second CV can play different notes for each of the 4 sequences or add filter/amplifier control. Many editing features are also available to easily programme complete pieces of music that can be stored digitally or via mono cassette.

With home computers, home recording and, particularly for us, home music-making becoming almost a new way of life for many — without a lowering of musical quality — the electro-musician has become as much a composer as a player. The size of instruments has reduced significantly through micro-technology, with even the keyboard affected. Already a tremendous price drop has been seen with Roland's Amdek Compu-Music machine, the CMU-800 at around £400, for musicians already owning home micros such as the Sharp or Apple II. This system is a purely 'keypad' inputting device that makes the complete 'band' from numbers, and was reviewed in the February '83 issue of E&MM.

### Compose anywhere

Roland's MC-202 MicroComposer represents yet another step forward in a compact portable design that lets you create music anywhere. Its price is only £365 (inc VAT) — that's low considering it contains a full monophonic synthesiser with built-in moving rubber pad 2½-octave keyboard, and two independent digital sequencers. Sequencers are entered either in real time or by notes as 'steps' which are later edited to correct length, rests, etc. Any external 1V/oct, 5-15V trig synth can be hooked up to record or playback with the built-in synth or play the other channel on its own.

There are numerous editing possibilities and external in/out sync to drum machines, plus saving of sequences on standard mono cassette recorder — and a sync 'clicktrack' as well for tape control on playback. Plug in your stereo headphones and wherever you are you can compose your music!

Unlike other portable keyboards that offer melody recording and playback, the editing via the liquid crystal display and the direct communication with analogue and synth-controlled machines puts the MC-202 into a special category of its own for the more serious musician. Because the external tape sync will set the correct tempo throughout a played-back sequence, it's possible to use the built-in synth to create a multitrack recording just with something like the new portable Fostex Multitracker added to it.

### Layout

The MC-202 is lightweight and small, measuring only 13½"(W) x 8"(D) x 2"(inc knob max H). It is constructed in grey plastic with white labelling. Across the very top of the front case are all the rear connection markings from left to right: 9V DC input socket (Boss AC adaptor PSA 100) — when not in use, 6 x 1½V (size C) batteries are loaded into the rear of the case (Roland even have their brand name on batteries now!); Sync In/Out (5-pin Din sockets) enabling Roland instruments such as the TR606, CR8000 and TR808 drum machines to control the sequence start and hold sync'd tempo (or vice versa) — the CSQ-600 (to MC only), MC-4, and the TB-303 (from MC only) also; the calibrate screw driver-adjusting preset for tailoring the overall pitch when using other synths; 2x3.5mm sockets for separate mono cassette recorder 'Memory Save/Load' and 'Sync In/Out'; 6x3.5mm sockets for connecting an Ext 1V/Out synth (CV & Gate In), Built-in Synth CV/Gate Out, Ext Synth CV/Gate Out; a stereo headphone (8-30 ohms)

socket and finally a standard jack line output for the built-in synth.

The top section of controls are for the synthesiser with small variable or switch sliders. All 5 rotary controls are placed across the centre with the Power On/Off pushswitch, for Tune (adjusting overall pitch +/- 1 semitone), Portamento, Tempo, Accent and Volume. At the centre of the instrument is the focal point of the system — the LCD display.

The lower part of the case has momentary rubber pads that make switching contact with conductive rubber. The MC-202 scores here over its larger versions, because the keyboard-style layout makes it easy for the musician to enter the correct pitch without resorting to looking up numbers directly — even so, as a key is played it will be given a code in the display, from 1F to 6C, representing the note's octave and letter name. Larger blue pads select the operating modes and edit functions, while these and the keyboard buttons with the shift key are each allocated a second assignment. Over 60 separate functions are therefore definable in this lower part that communicates directly with the micro system.

The internal circuitry is on one main PCB with a separate keyboard contact PCB and rear connection strips. Construction is very neat and compact, with only a few wiring connections. The synth oscillator is based on the Curtis 3340 chip that seems to get in most instruments these days. CMOS circuitry is used throughout with low noise op-amps (TLO62 and TLO22) for signals. The display/driver is a non-standard type specifically for the MC-202 and the biggest space-taker is obviously the row of 6 batteries.

### Operating Modes

There are basically two ways you can play back and three ways you can record with the MC-202.

Playback can either be directly from the mini keyboard which directly controls the built-in mono synth, or it can be a replay of one or both of your programmed sequences. If it is the latter, the keyboard does not also function, but it is possible to use an external synth (1V/Oct) to send its CV and GATE outs to drive the built-in synth. What is more likely, is that you'll hook this in to be able to record in real time.

So the recording of melodic sequences is done either in real time using the built-in synth keyboard (or ext synth keyboard) or by a 3-stage process where you first enter the note pitches from the keyboard (as slow or fast as you like) in 'step' fashion, then enter the correct step time, and finally the gate time. Various editing functions help you to correctly enter the desired sequence. The third way enters pitch in step as before, but then enters the correct rhythm by simply setting 'Tap' mode and playing the right time lengths (as your entered pitch notes follow automatically) using two 'Tap' buttons.

*Continued on page 72*

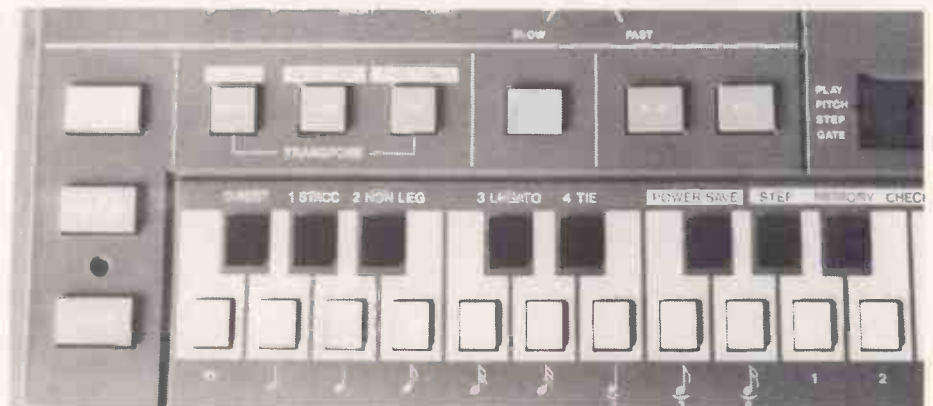

Left hand keyboard and blue function buttons.





**Dynamix 3000 Series 16:8:2 – 32:16:2**



## Professional Modular Range

The Dynamix 3000 Series range of mixers offer quality, features, and flexibility at a hitherto unheard of price.

The Dynamix 3000 Series mixing system caters for the needs of the professional user with a limited budget. Four mainframe sizes are available to allow the knowledgeable user to expand both the input and output sections of his mixer.

The systems features are as follows:—  
Transformer balanced mic and line inputs, mic line changeover, 48v phantom power, 20dB pad, phase reverse, four band equalisation with two parametrics, insert points on all inputs and outputs with send and return level controls, four auxiliary mixes, full routing, auto PFL, tape monitoring, 25 segment LED displays VU/PPI switchable on all outputs, two auxiliary returns, talkback with comprehensive routing, stereo headphones, stereo monitoring, Penny and Giles faders, and external power supply.



Marketing and Head Office  
Zeldavale Ltd  
353 Upper Street, London N1  
Telephone 01-359 5135 Telex 23271

PLEASE SEND ME FURTHER DETAILS ON THE  
DYNAMIX RANGE

NAME .....

ADDRESS .....

.....

.....

E&MM5

# MC-202 MicroComposer

Continued from page 70

Two sequences can be recorded, called Channel 1 and Channel 2, with 2729 notes (ie. complete events) available to be shared out between both. In real time mode, whilst a second sequence is recorded, the first sequence can be heard as well, provided you've got an external synth connected. A second synth can also be connected to duplicate the built-in synth if you wish.

Once programming is completed (and before switching off, as there is no battery back-up!), sequences in the internal memory can be saved on mono cassette for later recall. Since composing is likely to take some time, a 'Power Save' function conveniently turns off all operation and simply retains the internal memory intact until you're ready to continue. As mentioned, a tape 'Sync' track can also be saved.

## LCD Display

During all microcomposing recording and playback, the special LCD display is the focal information centre of the system, relaying to the user all function commands given, and enabling every note in a sequence to be 'analysed' as a numerical output of pitch, step and gate times. Measures can be accessed to be copied or deleted and have notes changed, inserted or deleted. Once a sequence is completed, it can be made to 'cycle' (loop) from beginning to end repeatedly at the tempo you've set. Each note can be given an accent (with the level set for all accented notes by the Accent control), and portamento between two notes can be specified (at the rate set by the Portamento control).

The oblong display has seven horizontal segments which appear as numbers, dashes, or small blocks. There is also a small dot at the bottom right that serves to indicate the tempo by turning on and off at the rate set. At other times it will simply stay on or disappear altogether to verify function operation.

The first segment (from left to right) contains small blocks to indicate the particular mode you have selected — either PLAY (by pressing the Play button) for playback in the ways described, or PITCH, STEP, or GATE which are EDIT modes required to record in real time, tap or step methods described. The latter three also enable editing to take place. Selection of one of the Edit modes is in 'cyclic' fashion, so pressing the Edit button will step through each mode, looping back to the first and so on.

The 2nd segment indicates the channel selected by the Channel button. Changing from one channel to the other can be at any time between recording or playback, and the built-in synth only responds to the channel number in the display.

The 3rd segment has three appropriately shaped dashes that show the pitch range of the keyboard: down 1 octave, normal pitch, or up 1 octave. This gives the MicroComposer an extended keyboard range of 4½ octaves (F to C, coded 1F-6C). In Step mode, this segment changes to show the type of note played code (rest, staccato, etc).



Right hand keyboard and blue function buttons.

The 4th, 5th and 6th segments show the alphanumerical data for the particular function at the time. Sharp or flat notes also have an upper or lower dash indication, with selection of sharp or flat key coding able to be preset at any time for a corresponding change in the code output. If special commands are given, the screen data will change accordingly and revert back to the current mode (Play, Pitch, Step or Gate) afterwards.

The final segment contains 4 small independent blocks that indicate the CYCLE (loop) function is on (by pressing Shift then Cycle); BATTERY — if the voltage has dropped significantly below 9 volts, this will come on; PORTA shows the current note has Portamento on it; ACC shows the current note has an Accent.

## MicroComposer Functions

Just to make sure I don't miss any of the specific functions on the MC-202, I'll deal with these in list form, with basic descriptions of each as necessary. This may seem a little over the top — in fact, some might say it's not a review but a copy of the manual. I can assure you this is not the case, as no manual was available — the comments are therefore based purely on the practical results achieved.

All processing is done via the blue buttons and/or the actual keyboard button. Since both these sets of buttons nearly all have a dual function, made by pressing the SHIFT button directly before and during the pressing of a chosen command, the second function is clearly marked in white above the button required. The ENTER button, like standard micro systems, makes the selected data entry complete, and most correct functions' entries are indicated not only in the display, but also by a high-pitched short 'beep' (Sinclair's 'Spectrum' may have been an influence here, and in the rubber buttons). The beep can be turned on or off as you wish (by pressing Shift with Bar) as it is generated internally and is not output on headphones or line output. Whilst in EDIT mode, the current measure (ie. bar number) is displayed by pressing the SHIFT key alone, so you always know where you are in a sequence.

### Recording By Step

On Power switch-on, the MC-202 enters Edit/Record PITCH mode, Channel 1, Measure 1. The built-in synth is set up to produce a sound, and the

TRANPOSE buttons are used to set the keyboard octave range for NORMAL, UP or DOWN. Now your sequence melody (ie. the 'pitch' data) can be entered from the keyboard. The code for each note will be shown on the display as you play. A new MEASURE is inserted by pressing the BAR button at the right point in the sequence.

### First Playback

With rotary volume level set appropriately for headphone or external monitoring (via the line Output socket), pressing PLAY then START will begin playback. During this time, the LED above the Start button will remain on. The Tempo can be adjusted at any time, and pressing the CONT/STOP button will halt the sequence and enable you to continue from that point later. Pressing Start will always begin the sequence at Measure 1, Step 1.

Playback at this time will be in regular equal steps according to the clock Tempo set. If you want to see the tempo, simply press TEMPO (between operations) and a readout on the display from slow to fast is given in steps of 2 (from 36 to 300).

### Changing the STEP time

Both STEP and GATE have 'default' modes (Step=24, Gate=24), as do many other functions, otherwise a lot of setting-up would be necessary before recording.

Changing the Step time (the time between notes) is easier than on the MC-4, simply by the addition of selectable note values with the first 9 white notes of the keyboard. So correct note lengths can be conveniently entered as you see them on the music! Alternatively, a number can be entered by using the remaining white notes numbered 0-9. Either type of entry is completed by pressing the ENTER button.

Code Values are allocated as follows: Semi-breve 192, minim 96, crotchet 48, quaver 24, semiquaver 12, demisemiquaver 6, crotchet (1 of a triplet) 32, quaver triplet 16, semiquaver triplet 8. Maximum entry is 239.

A lot of extra information is entered in Step mode:

1. Note lengths are entered as described.
2. The first 5 black notes can be used to enter an appropriate Gate time (the actual time the note remains on — or in 'sustain' on the built-in synth): 0=Rest, 1=Staccato (Step time ÷4), 2=Non Legato (Step ÷2), 3=Legato (¾ Step), 4=Tie (Gate=Step). In real time it defaults to code 2.
3. Portamento can be added to a note using the PORTA button.
4. Accent can be added to a note using the ACC button.
5. Programming of Step data is completed by pressing ENTER.

### Changing the GATE time

If you've used the best option of entering a certain type of note by the direct 'keyed' note value, you'll not need to use GATE mode. However, for special settings or tidying up of real time input, this mode allows numerical entry of GATE time, using the keys numbered 0-9, followed by the ENTER button. The maximum number is 239, but depends on the type of note entered ie. rest, staccato, tie etc.

### Recording Real Time Sequences

Preparation for real time recording is done in Pitch mode by pressing Shift with the Real Time button. Then a numbered key 1-9 is pressed for the number of beats in a bar followed by the Start button (with Shift still held). The internal piezo unit immediately provides high-pitched sounds on 3 notes with main beat, remaining beats and half-beat pulses on a clear 'metronome' for 2 bars. Then the Start LED comes on for the bar counting to begin as you record by playing the keyboard notes.

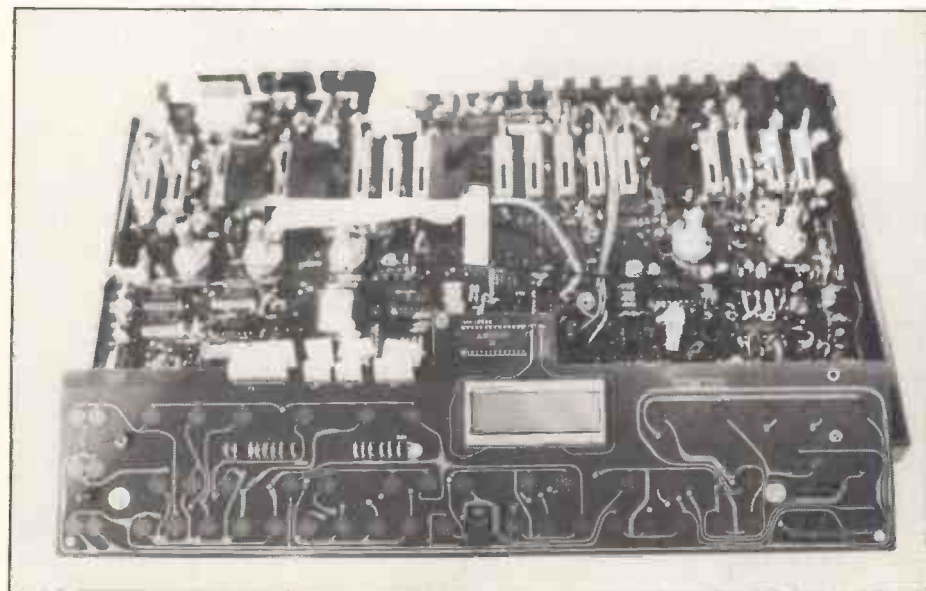

Internal circuitry, with keyboard/display PCB at front.





# BOOTLEG MUSIC

5-7, SOUTH STREET, EPSOM, SURREY.

TEL: EPSOM 24528

OPEN MON-SAT 10am-5.30pm. THURSDAY 7.00pm

## THIS MONTH'S AMAZING BACK DOOR DEALS!!

### KEYBOARDS

SH101, new portable model with arpeggio, sequencer, optional handgrip  
 SH09, 1 1/2 Osc. Demo model £199.00  
 EP11, piano with rhythm and chord coupler, Demo model £289.00  
 VK09, Drawbar organ, Demo model £365.00  
 SA09, Saturn organ/piano, Demo model £299.00  
 RS09, organ/string machine, Demo model £299.00  
 JUNO 6, the incredibly versatile polyphonic JUNO 60, new programmable version of JUNO 6  
 JUPITER 8, the 'Guy'  
 SEQUENCERS AND KEYBOARD ACCESSORIES ALWAYS IN STOCK



**Roland**

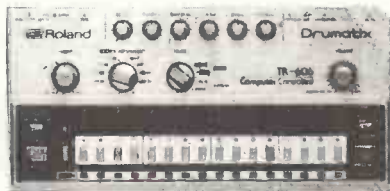

### RHYTHM UNITS

DR55, Dr Rhythm  
 TR606, Drumatix compurhythm  
 TB303, Bassline autobass sequencer  
 CR5000, Compurhythm  
 CR8000, Compurhythm with handclaps  
 ALL OTHER ROLAND AMPLIFIERS, GUITAR SYNTHESIZERS, ECHO UNITS IN STOCK. PHONE FOR LATEST BOOTLEG PRICES

### CRAZY CORNER

**AMPLIFIERS**  
 ROLAND BOLT 30 £315.00 £169.00  
 SPIRIT 30 175.00 119.00  
 SPIRIT 50 235.00 153.00  
 GA 120 R & P ex. hire 625.00 295.00  
 PEAVEY DEUCE 499.00 285.00  
 VOX A.C. 30 s/h 195.00  
 A.C. 30 Super twin immac. 295.00  
 YAMAHA JX 40 199.00 159.00  
 GA 100 112 399.00 269.00

**KEYBOARDS**  
 CRUMMAR TRILOGY 1300.00 Offers?  
 STRATUS 900.00 Offers?  
 Yamaha, Rhodes, Moog, Casio & Roland all at crazy prices!

**GUITARS**  
 VOX Standard 24 159.00 119.00  
 CUSTOM 25 295.00 229.00  
 CUSTOM 24 295.00 229.00  
 STANDARD BASS 139.00 129.00  
 VANTAGE VA 600 155.00 77.50  
 VA 690 169.00 85.00  
 VA 650 175.00 99.00  
 VA 800 Phantom 298.00 159.00  
 MACCAFERRIS ORIGINAL, NEW 299.00  
 MUSICMAN STINGRAY BASS 499.00  
 WASHBURN EAGLE 549.00 279.00  
 HAWK 399.00 249.00  
 B.20 Bass 395.00 229.00  
 B.20 8 string Bass 459.00 249.00  
 Complete range of Woodstocks, Tanglewoods and Montereys at crazy prices!

### BOSS

BF2 Flanger 83.00 54.00  
 CE2 Chorus 79.00 52.00  
 CE3 Stereo chorus 85.00 69.00  
 PH 1 R Phaser 77.00 49.00  
 DM2 Delay 110.00 76.00  
 OC2 Octaver 62.00 42.00  
 VB2 Vibrato 69.00 35.00  
 DR55 Dr Rhythm 110.00 69.00



FREE POST!

### AMDEK kits by BOSS & Roland

Distortion Kit 38.00 29.95  
 Compressor 44.00 34.95  
 Phaser 50.00 39.95  
 Tuning Amp 44.00 31.95  
 Electronic metronome 44.00 31.95  
 Flanger 77.00 59.95  
 Stereo Chorus 65.00 52.95  
 Stereo 6 channel mixer 110.00 69.95  
 10 band graphix equalizer 85.00 59.95  
 Delay machine 155.00 112.95  
 Percussion synthesizer 65.00 49.95  
 Programmable Rhythm 110.00 78.95



FREE POST!

### LOCO by Aria

SPECIAL INTRODUCTORY OFFER... LIMITED PERIOD

FL 01 Flanger £56.42 £44.95  
 AD 01 Delay 82.38 64.95  
 CH 01 Stereo Chorus 45.62 36.95  
 PH 01 Phaser 37.96 29.95  
 CM 01 Compressor 32.74 25.95  
 GE 06 Graphic 42.06 32.95  
 DS 01 Distortion 32.76 25.95  
 AD 240 Mains Adaptor 6.80 5.95



FREE POST!



NEW FENDER AMPS NOW IN STOCK...

HARVARD REVERB II 20  
 YALE REVERB 50  
 STUDIO LEAD 50

STAGE LEAD 100 1 x 12" and 2 x 12" all in stock

Plus the old CHAMPS, PRINCETOWN, TWIN REVERBS, BASS 70 & BASS 135



SURREY'S LARGEST STOCKISTS OF



COMPLETE RANGE IN STOCK AT BOOTLEG PRICES

### TASCAM TEAC Production Products

**TEAC**  
 V9 Cassette deck £135.00  
 MO9 4 into 2 mixer 135.00  
 244 Portastudio 599.00  
 32-2B Track Master 599.00  
 DX2B DBX for 32-2B 249.00  
 2A 6 into 4 mixer 179.00  
 34 The latest 4 track 875.00  
 Guide to 4 track recording 4.50



MR10 Rhythm BOX

WITH PADS

£89.00 £79.95

CS01 217.00 175.00

CS15D 669.00 389.00

SK30 2069.00 1095.00

CS70M 3859.00 1695.00



### SURREY'S NEW



CENTRE ROGUE, OPUS, SOURCE, TAURUS AND MEMORY MOOG IN STOCK



### SURREY'S LEADING STOCKIST OF

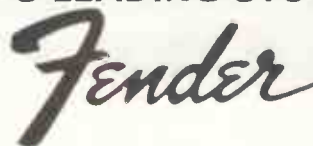

INSTANT CREDIT

ACCESS

BARCLAYCARD

All Prices correct at time of going to Press.

## MC-202 MicroComposer

Continued from page 72

All Pitch, Step and Gate data is recorded and can be examined with the 3 Edit modes as described earlier. A rest will contain the previous note Pitch (or default 3C) and Gate 0 (plus correct Step Value).

### Add a 'TAP' Rhythm

An alternative to entering codes for Step and Gate, or for correcting a real time rhythm (without changing Pitch) is to use two 'Tap' buttons. Pressing Shift with the Tap function button (in Pitch mode) starts the metronome again. A time signature can be redefined, by entering a new number from 1-9 before pressing Start.

Stopping both Real Time and Tap recording will always occur at the end of the current bar (with an extra beep added on the first pulse of the next available bar).

### Special editing functions

**Cycle (+ Shift).** Allows continuous looping of sequences on playback but is not operative in EDIT modes and is not stored with sequence on cassette. Cycling with Tape Sync will work as long as the sync pulse is still running.

**Delete (Step or Measure + Shift),** followed by Enter in Pitch mode. Deletes displayed note (next to be sounded) or current measure, and a 'd' appears instead of Channel number.

**Insert (+ Shift),** followed by keyboard notes and/or Bar lines required, then Enter. Inserts notes in step fashion prior to the current note 'I' is shown.

**Copy (+ Shift).** In Pitch mode this will copy bars onto the end of the current sequence (all information, including Accent and Portamento for each note). The 'start' measure is located, followed by Shift and Copy. Then the Enter button is pressed for each next bar to be copied 'C' is displayed.

**#/b (+ Shift)** gives either sharp or flat note code simulation. eg. 3F<sup>♯</sup> or 3G<sub>-</sub> = F# at 3rd octave up.

**Accent (+ Shift) in Step mode.** Opens up the VCA or both VCA and VCF to give a volume accent with or without a brighter tone on the current note (shown as A or FA on display).

**Memory Check (+ Shift).** Indicates number of note events left out of maximum 2729.

**Step (+ Shift).** Indicates in Play mode the total Step count for the Measure.

Using Back or Forward Step buttons in any of the Edit modes, you can step through your sequence note by note. As you step back, any bar lines will sound a double beep. Then the pitch of a note can be re-entered to correct it, and Gate or Step values can be changed. Two further buttons also step backward or forward measure by measure. The display always indicates the current measure until these buttons are released.

You can also jump to a measure by pressing Shift, keying in the bar number and pressing Enter. If you go to a non-existent bar, the last bar will be recalled.

You can add to your sequence bit by bit by starting at the right measure (ie. current measure = entry point). You can't insert in real time, but you can as mentioned correct a passage by starting it at the incorrect measure — although you'll lose all original data from that point on. If you reach the end of the memory you're also likely to corrupt previous data input. Error entries are indicated by 4 beeps!

Incidentally, if one sequence is longer than the

other, both sequences will cycle over the longer sequence. As the length of a sequence increases, the function commands will become slow to respond. And you can't hear one channel while you record another in Step mode, only in Real Time.

## Tape Memory and Sync

Both sequences can be stored in one tape dump onto standard mono cassette recorder, using the SAVE (+ Shift) function in play mode. A start tone (mid D) is generated on the tape output and when the Enter button is pressed, becomes a higher D. 'S' is shown on the display, the Tempo dot stops flashing and the current displayed data will disappear until saving is complete.

Loading the stored sequence with the LOAD (+ Shift) function is done in a similar way. (Display shows 'L'.) Verifying the tape transfer is done with VERIFY (+ Shift), displayed as 'U'.

After all three tape operations, the MC-202 will beep and return to current status. Save time varies with the amount of data stored (up to 2¼ minutes for full memory). Errors give 3 beeps and the display returns to Channel 1, Measure 1.

One very useful feature is the addition of TAPE SYNC. Once you've saved your sequence, you can put a Sync track onto a multitrack or even your mono cassette machine that will remember all your tempo changes and precise start and stop. Laying down the Sync track on tape is simply done by starting your tape machine to record and then operating MC-202 playback.

Running a sequence from Tape Sync is also easy and is done by pressing Shift + Tape Sync buttons, starting the tape recorder to play back, then pressing Start during the opening tone. The red start LED comes on until the tape sequence timing data ends, or you press Stop. By holding back pressing the Start button, you can jump into a Sync track signal.

## Synthesiser

This is a standard monophonic (low note priority, multiple trigger) analogue synthesiser with controls divided into 6 labelled sections as follows. The Source Mixer provides 2 mixable basic waveforms: pulse and sawtooth (falling ramp). A sub-oscillator can also be mixed that can either be switched to one or 2 octaves down from the basic pitch as a squarewave or as a 2-octave down pulsewave. Each of the sub-oscillator types are pulsewidth modulated by the VCO Modulation slider over approximately 50%.

The VCO section sets the pitch of the 2 basic waveforms, switchable to 16', 8', 4', 2'. With the sub-oscillator 2 octaves down, this gives a deep 64'. Pulsewidth is variable by setting the Pulsewidth slider manually, by switching to LFO triangle modulation (but with no delay), or to modulation from the envelope shape set by the ADSR controls. The latter control will reduce the pulsewidth to zero (no sound) on maximum peak (with Sustain up full).

The pitch can also be modulated by the LFO with or without delay up to one second. The rate is variable between 1 cycle over 9 seconds to some 20Hz and the red LED gives visual rate indication.

The VCF section has standard analogue control for a low pass filter with 24dB slope. Cut-off frequency will tailor a sawtooth/square mixture into a near sine shape. Resonance will put the filter into oscillation at maximum settings. As the battery voltage drops, modulation interference is noticeable here, as is a slight pitch change on release of

lower keys in particular. Also a result of this, the overtone changes during the filter sweeps are not as smooth as with full power operating. Other VCF controls are for amount of Envelope control, LFO Modulation depth, and Keyboard follow effect.

The envelope sets the amount of filter cut-off change from the Attack, Decay, Sustain and Release sliders. Maximum Attack is 1.7 seconds, Decay is 9 seconds, and Release is 11 seconds. The VCA can be switched to be controlled either by the envelope ADSR settings or by an organ-type on/off gate.

Portamento only operates with the MicroComposer, although the tune control adjusts pitch +/- 1 semitone and the volume control adjusts the final output of the synthesiser at all times.

## Summary

The MC-202 has to be regarded as a desirable package because it offers the whole microcomposing process in one very neat portable instrument at significantly low cost. Obviously, the keyboard format is a compromise that will not deter the budding Tangerine Dream electro-musician, although it is not too easy to execute tricky passages in real time. The bonus of a built-in synth far outweighs this problem anyway, and as the Roland people will no doubt point out, it's really meant to let you edit precisely with something we all know — the keyboard, rather than strings of unfriendly number codes alone.

At first the advantage of a second sequencer without a built-in synth seems to defeat the object of the complete package concept, but it is very useful when using multitrack techniques with the Tape Sync facility for playing back two parts. I would have liked Tape Sync in record as well as playback, but preliminary trials show it's still possible to use the MC-202 with a multitrack machine to layer tracks. (Lay your Sync track, Chan 1, then use Tape Sync to add Chan 2. Delete MC Chan 2 and make a new Chan, using Tape Sync to add this new Chan 3. Carry on!)

Also, the cassette input for Load and Save requires a high level drive, like most micro systems. That means most cheap cassette machines work fine, but a simple driver interface had to be added to the Fostex Multitracker, for example, to give sufficient input gain. (Write to E&MM if you want the one-chip circuit costing a few pence.)

There's about 8 hours constant usage on batteries, although in the review model a 1½V drop made the synth completely unstable, even though no battery 'low' sign was observed. Driving an external synth can also be a problem with reduced battery voltage, so Roland's 9V adaptor is recommended. (Roland also sell a nice light pair of headphones, type RH-10.)

For the number of microcomposing functions available, it's a remarkable little machine, especially for its keyboard-orientated operation which should attract many more 'players' to the micromusic world. Synthesiser quality is quite exceptional for an analogue instrument — the lack of a second oscillator is partly compensated for by the sub-oscillator and parameters are good enough for the MC-202's main purpose — sequencing.

Composing is very easy (much more so than using the Spectrum micro in terms of function access!) and the dedicated LCD (angled towards the player) has no drawbacks whatsoever. One important function missing is repeating parts of the sequence without using more memory — the Copy function will repeat passages, but still uses up more notes. Processing time does get rather slow as you use up memory, with a wait of several seconds between function operation. A 'memory full' indication and operation halt should have been included in the software. It's also very easy to switch off without thinking about saving your sequence on tape, so beware! Since two Sync outputs are provided, it's easy to link Micro-composers together — maybe Jean-Michel Jarre will swop his rack of EMS Synths for MC-202's!

Some people say that stand-alone sequencers will soon be outdated by synthesisers with software able to do all the sequencing you'll need, but Roland's MC-202 is sure to inspire the imagination of many people making music at home because it is a computer with a synthesiser — so now you've no excuse for not joining the Compu-Age!

E&MM

For further details contact Roland (UK) Ltd, Great West Trading Estate, 983 Great West Road, Brentford, Middlesex TW8 9DN. Tel: 01-568 4578.

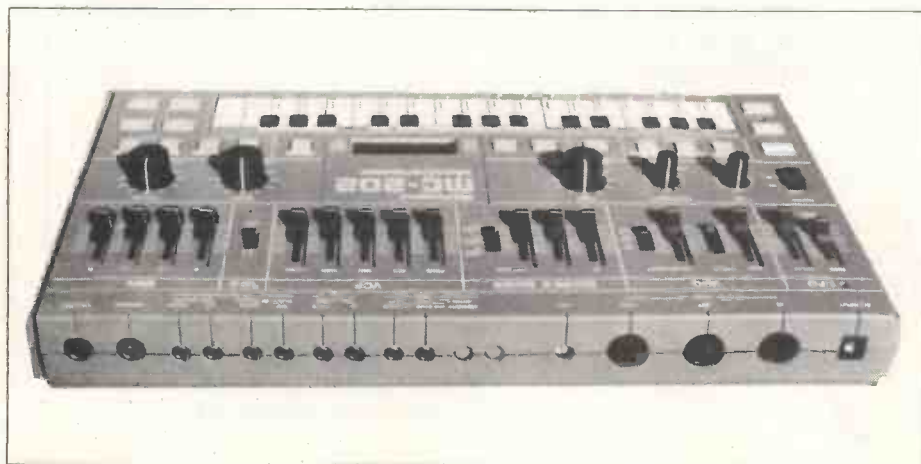

Rear view of the MC-202.



# ELECTRO-MUSIC CROSSWORD COMPETITION

No. 8

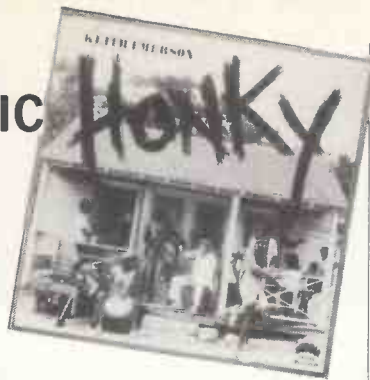

This month a chance to win Keith Emerson's solo album 'Honky'. The album, kindly donated by Manticore, will be awarded to the sender of the first correct crossword drawn on May 31st.

Send your completed crossword or a single neat photocopy, including your name and address, to:

**E&MM Crossword**  
282 London Road Westcliff-on-Sea Essex SS0 7JG

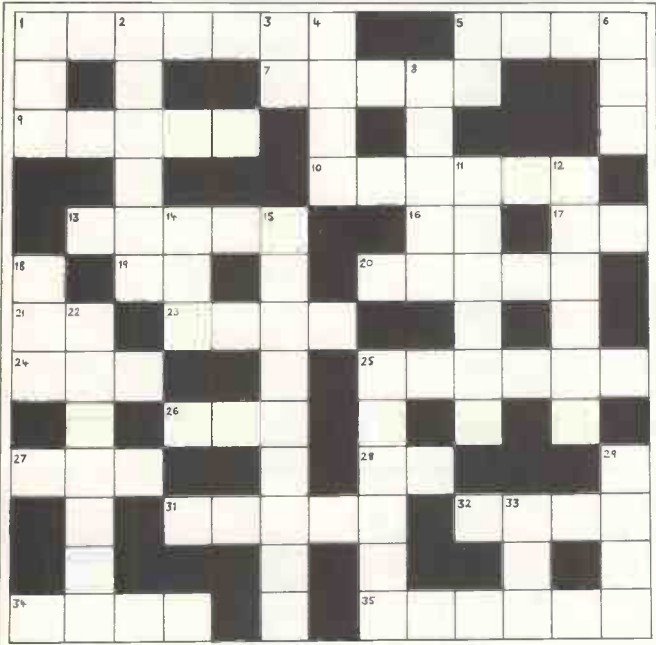

## Across

- Parts of a guitar reacting to string movement (7)
- Trigger signal for synths (4)
- Tempting microcomputer (5)
- Patrick is a Moody keyboardist (5)
- Daniel Miller's pseudonym for 'Warm Leatherette/T.V.O.D.' (6)
- Range of effects kits from Roland (5)
- Yamashta, Schulze, Shrieve LP (2)
- Long single or short album? (1,1)
- Envelope controls (1,1)
- (See 31 Across)
- Tim Souster's band, or a noise measurement (1,1)
- Jon played for Deep Purple (4)
- Czukay, Leibzeit, Schmidt and Karoli are capable (3)
- Main melodies of a piece (6)
- Popular wood for guitars (3)
- Octave's feline synth (3)
- Equalisation (abbr.) (2)
- 31 & 20. Si, si, he played for Return to Forever (5,5)
- Distinct repeat as opposed to reverb (4)
- First name in home multitrack (4)
- Three times, the highest frequencies (6)

## Down

- Variation of square wave width (1,1,1)
- Rhodes' analogue/digital polysynth (6)

- A band can't be heard without it (1,1)
- Steeleye adjusts the range (4)
- Does it produce reverse envelopes? (1,1)
- Famous British record company (1,1,1)
- Slow piece sounds like a drink (5)
- Well-known make of effects pedal (6)
- Found at the start of tapes (6)
- Electronic echo effect (1,1,1)
- Stockhausen's Christian name (9)
- Digital to analogue conversion (1,1,1)
- Relative sound levels (6)
- New British drum machine (3,3)
- Balance of frequencies (4)
- Speaker container (abbr.) (3)

All answers can be found in back issues of E&MM.

## March's Answers

Across: 1, Arpeggiator. 6, Fine. 7, ARP. 9, Bow. 12, Ear. 13, OB. 15, (see 5 down). 17, PET. 19, ES. 22, Fender. 23, Ball. 25, Oscillator. 27, VU. 28, King. 29, PPM. 30, Alf. 31, Transistor.  
Down: 1, Axte. 2, Pearl. 3, Go. 4, (see 21 down). 5, and 15 across, Richard Pinhas. 8, Pop. 10, Op. 11, Wind. 14, BEF. 16, Spectrum. 18, Temp. 20, (see 21 down). 21, and 4 Down, and 20 Down, A Flock of Seagulls. 24, Alto. 26, Congo. 29, Pot.

March's winner: Peter Masheder, Darlington.

## AUDIO SERVICES

BEST PRICES — BEST AFTER SALES SERVICE — PROMPT DELIVERY — PART EXCHANGE WELCOME

### Tape Machines (multitrack)

Teac 80/8 S/H with brand new DX8 ..... £1500  
Otari MX 50/50 8T s/h mint £1800  
Tascam 38 new ..... P.O.A.  
Fostex A8 new ..... P.O.A.  
Tascam 34 new ..... P.O.A.  
Teac 3340S s/h from ..... £395  
Teac 3440 s/h from ..... £495

### Tape Machines (stereo)

Studer B67 Mk II VU in console, new ..... P.O.A.  
Teac 35-2B in console, new ..... £900  
Teac 35-2 in console, new ..... £795  
Teac 32-2B NAB/IEC switchable, new ..... £510  
Otari MX50/50 ..... £795

### Mixers

Syncon A 28/24/4, new ..... £8,300  
Syncon A 20/16/4, new ..... £6,850  
Syncon B, all formats, new ..... P.O.A.  
Trident V.F.M. 16/4/2, one only, ex-demo ..... £850

### Soundcraft Series 2 16/B/2

re-built ..... P.O.A.  
Allen & Heath 8/4/2, S/H ..... £395

### Noise Reduction

Immediate cash paid for modern Dolby's!  
Dolby 360 S/H with brand new CAT 22 ..... £395

Tascam DX4D 4-chan simultaneous, new ..... £175

### Cassette Machines

Teac C1 Mk II with RX8, new ..... £500  
Tascam 122, new ..... £375

### Monitors

J.B.L. full range in stock ..... new  
Tannoy full range in stock ..... new

### Power Amps

Turner A500VU, new ..... £495

### Reverberation

Master Room 'C' Series reverb, S/H ..... £895  
EMT 140TS only 4 months old £2650  
Klark Teknik DN 50 ..... £395  
Loads of 'Great British Springs' ..... £List

### Equalisation

Gold Line Spec. Analyser ..... £250  
Survival Projects Auto Pan ..... £395  
Klark Teknik DN22 stereo, new £425  
Orban 622B 2 chan, Parametric, new ..... £490

### Compressor Limiters Expanders and Gates

UREI LA4 pairs (or split) new (ea) £270  
Audio & Design Transdynamic Processor with Mk III express limiters ..... P.O.A.  
Audio & Design Easy-Rider new £325  
MXR 136 Dual Limiter, new ..... £275  
Time Processors  
Aphex aural exciter, new ..... £650  
Delta-Labs Effectron 1024 new £495  
Drawmer Multitracker, new ..... £395  
Roland Space Echo 201, new ..... £335  
MXR pitch-shift Doubler, new ..... £350

### PORTASTUDIOS — TASCAM & FOSTEX

#### Radio Microphone Adaptors

EDC Micromic ..... Brilliant plug on transmitter unit for use with your favourite mic. Hire or buy, please call us 06632 2442. Transmitter & Receiver ..... £450

#### DE-Essers

Orban 516EC 3 chan unit, new £295  
Orban 526 mono unit, new ..... £195

#### Electronic X-overs

Klark Teknik Statik SA30 Electronic 2/3 way stereo with Sub filter, new £195

#### Headphone Amplifiers

Tascam MH40 4 chan, independent, stereo, rackmount (new product), per 4 chans ..... £105  
Sennheiser Infra-red 4-way headphone system ..... £395

#### Microphones

Neumann full range ..... P.O.A.  
Shure full range (quantity discounts!) ..... P.O.A.  
Electro-Voice DS35 ..... £79 (quantity discounts)  
Boom Mic Stands (Beyer type) ..... £22  
AKG full range 'Best Prices' ..... P.O.A.  
Sennheiser full range ..... P.O.A.

Beyer Headphones DT100 new £30  
Service Department: Fully equipped with latest technology testing and analysis equipment, all test tapes, spares etc. Main Service Agents for: Tascam, Fostex, Allen & Heath, Brenell, Revox.  
Trade Counter: Ampex and TDK tapes, XLR's, multicore & leads, microphones, NAB adaptors, leader & splicing empty spools, edit blocks, jackfield & patchcords, Auratones, loads of cans. Musiflex, studio & stage boxes, workshop manuals, literally everything 'cash & carry' or mail order.  
P.S. We still sell more '244 Portastudios' than anyone else in the country. £690 + freebies! The above price for '244 Portastudios' includes VAT and free 48hr Securicor Delivery.

Please allow for VAT and delivery to all other prices. Credit cards welcome.

ALAN CHEETHAM AUDIO SERVICES

Phone: (06632) 4244 (9.30am-8pm Mon.-Sat.) (Sun. by appointment)  
Address: Studio House, High Lane Village, nr Stockport SK6 8AA



10 Baddow Road,  
Chelmsford, Essex.  
Tel: (0245) 352490.

# FUTURE

## Roland

COMPLETE RANGE ON DEMONSTRATION —  
WE ARE THE SPECIALISTS!  
LARGEST STOCKS! LOWEST PRICES!

### NEW ROLAND GOODIES!!!

**NEW!**



**JP6** Budget version of the famous JP8. All the important features for only £2,000.

**NEW!**



**JX-3P**  
Fantastic new budget priced programmable preset polysynth with built-in poly phonic sequencer.



#### JUNO 6 & JUNO 60

These incredibly successful digital polysynths are in stock at all times and our price includes FREE case!

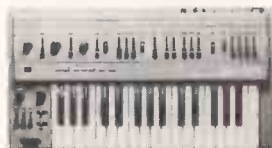

#### SH101

Roland's outstanding value for money monophonic synth now with free case and MGS1 handgrip — £275.

Roland Guitar Synths, New Cube Chorus amps, PA, Spirit, Bolt and JC amp range, Drumatix, Bassline, TR808 — in fact everything in stock! Call for low low prices on all Roland and Boss gear.

Roland G20Z  
Guitar Synth  
for £299.00  
with FREE  
GR100  
module!



CSQ100  
Sequencer £195  
CSQ600 £295

**NEW!**

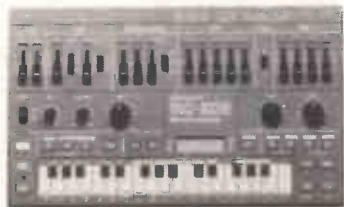

**MC-202**  
Price breakthrough!  
Roland's new revolutionary duophonic sequencer — available soon.

2,600 notes and advanced features for a ridiculously low £365. Order now for early delivery — limited supply.

★ SPECIAL OFFER ★



ONE OF THE WORLD'S  
BIGGEST SELLING RANGES

BLAZERS FROM £150.00

THE NEW ROADSTAR RANGE  
FROM £135.00

AM50 — The small scale semi-acoustic — another first from IBANEZ — only £240.00

## VIGIER

THE FRENCH HAVE DONE IT!

*The world's first fully programmable memory guitar!*

- ★ Traditional craftsmanship
- ★ New Technology
- ★ Active EQ
- ★ Parametrics

**PHONE FOR PRICES**

We are the exclusive dealers for this amazing new product —

## Westone

We now have the complete range of these value-for-money guitars in stock **PHONE FOR PRICES**



## SIMMONS

Only agents in Essex and Hants!

SDS5 Kits always in stock — many colours

NEW! Simmons Sequencer



## Drumulator

Only agents in Essex and Hants! We are proud to announce ourselves as exclusive Essex and Hampshire agents for the fantastic DRUMULATOR.

*The digital drum machine we've all been waiting for!*

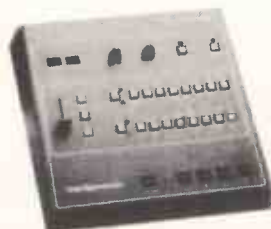

### Analogue Drum Units

#### KLONE-KIT

The amazing value Klone-Kit now in stock. Complete kit and all electronics only £299. Great sound too, come and try!!

#### NEW & SECONDHAND DRUM BARGAINS

Premier Royale new £299  
Premier Resonator s/h £299  
Gretsch 5-piece s/h £499  
Hoshino 4-piece new £219  
Maxwin 5-piece new from £339

**ROLAND:**  
TR808, CR8000,  
CR5000, TR606,  
CR78, DR55

**YAMAHA:**  
MR10 — £79.00

Claptrap still only £115.00

The Kit — still only £199.00

FAST MAIL ORDER

NO DEPOSIT HP

INSTANT CREDIT



# MUSIC

104-106 Elm Grove,  
Southsea, Portsmouth.  
Tel: (0705) 820595.

85 St Mary's Street,  
Southampton, Sussex.  
Tel: (0703) 26798.

## Fostex

The personal Multitrack  
now at reduced prices

### MULTITRACK RECORDERS

- A8 — 8 Track
  - A4 — 4 Track
  - A2 — 2 Track
  - 250 4 Track Cassette —
- call for special package deals

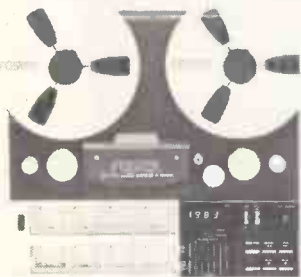

### EFFECTS!

- 3180 Reverb
- 3070 Compressor
- Personal Monitor
- Professional Mikes
- 350 Mixer
- 3030 Dolby C
- 3050 Digital Delay

### COMING SOON!

The biggest  
breakthrough yet  
in personal  
multitrack!

WHAT IS THE  
FOSTEX ORANGE?

## SEQUENTIAL CIRCUITS

NEW — IN STOCK — NOW!

### T600

99 memories, built in  
sequencer, midi buss  
output, 2 oscillators —  
£1,625.00.



### PRO-1

Dual oscillator mono  
synth, 40 note sequencer  
— only £375.00



## moog

AVAILABLE NOW FROM FUTURE MUSIC —  
The incredible MemoryMoog from the people who  
started it all!!

**MemoryMoog**  
Computer controlled  
programmable poly



### The Source

Microprocessor controlled  
mono built-in digital  
sequencer



## Rhodes

### CHROMA

The analogue/digital  
hybrid with everything  
16 note programmable  
with a vast memory  
capacity. Built in  
sequencer,  
programmable touch  
sensitivity Apple  
interface  
now available!



## Fender

### GUITARS

- |               |           |              |      |
|---------------|-----------|--------------|------|
| Vintage Tele  | £545      | Squier Tele  | £199 |
| Vintage Strat | £570      | Squier Strat | £215 |
| USA Tele from | £285      | Squier       |      |
| USA Strats    |           | Precision    | £225 |
|               | from £385 | Squier Jazz  | £235 |
| Bullets from  | £135      |              |      |
| Precision     |           |              |      |
| Basses        | £299      |              |      |
| Jazz Basses   | £325      |              |      |



**NEW COLOURS  
FOR USA STRATS  
— PHONE FOR  
DETAILS!**

★ SPECIAL OFFER ★ — Musicmaster guitars £125!

## soundhouse

### NEW AMPS

- |                |              |
|----------------|--------------|
| Concert Series | Stage lead   |
| Londoner       | Studio lead  |
|                | Super Champ  |
|                | Princeton II |

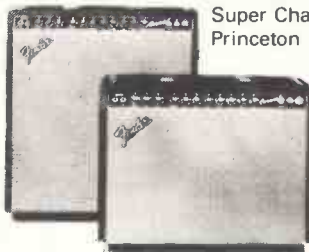

### SECONDHAND AMPS & GUITARS & SALE ITEMS

- |                               |      |
|-------------------------------|------|
| New Yamaha SC400 w/case       | £199 |
| New Aria RS700                | £225 |
| Shop soiled Aria LC440        | £175 |
| S/H Fender/Schecter Strat     | £199 |
| S/H Gretsch Country Club      | £495 |
| S/H Les Paul & Strat Copies   | £55  |
| Shop soiled Kramer XL5        | £275 |
| Shop soiled Kramer DMZ5000    | £225 |
| New Washburn Ravens, few left | £99  |
| S/H Vox AC30                  | £99  |
| S/H Vox AC50 Top              | £75  |
| S/H HH 100W Combo             | £175 |
| S/H Carlsbro Marlin 150W      | £175 |
| S/H Ampeg 60W Top + 4x12 Cab  | £225 |
| S/H Hiwatt 100W Top           | £125 |
| S/H Laney 100W Slave          | £95  |
| Shop soiled Kustom 100W com   | £175 |
| Shop soiled Kustom 1x15 Cab   | £150 |
| Shop soiled Kustom 4x12 Cab   | £155 |

### NEW & SECONDHAND KEYBOARD BARGAINS

- |                       |      |
|-----------------------|------|
| Roland Juno 60 S/H    | £795 |
| Roland SH09 S/H       | £175 |
| Roland SH2 + case S/H | £295 |
| Roland RS09 new       | £275 |
| Moog Prodigy S/H      | £185 |
| Yamaha CS40M new      | £895 |
| Yamaha CE20 new       | £695 |
| Yamaha CP10 new       | £275 |
| Yamaha CS5 new        | £165 |
| Yamaha CS01 new       | £175 |
| Yamaha PS2 new        | £95  |
| Yamaha PS3 new        | £99  |
| Yamaha PS10 new       | £175 |
| Yamaha PS20 new       | £225 |
| Casio 301 new         | £195 |
| Casio 403 new         | £265 |
| Casio 1000P new       | £295 |
| Hohner Clavinet S/H   | £195 |
| Hohner Pianet S/H     | £149 |
| Wurlitzer Piano S/H   | £375 |
| Jen SX1000 S/H        | £115 |
| Eurotec Piano S/H     | £149 |
| Elka X55 Organ S/H    | £195 |

## CASIO

### CASIO MAIL ORDER SPECIAL

Order any of these Casio  
Mini-Keyboards POST FREE!  
PT20 £49.95 PT30 £69 MT45 £99  
MT65 £149 MT70 £199

FILL IN THE COUPON TO ORDER  
YOUR CASIO TODAY!!  
**COMING SOON —  
CASIO MT7000**



Built-in multi-track recording and cassette  
dump facility — ideal for composing and  
arranging — 20 preset sounds — 12 rhythms,  
chord and bass accompaniment — stereo!

**ONLY £525.00**

### ORDER FORM

Name .....

Address .....

Telephone number: .....

Please send me the following goods:

I enclose a cheque/Postal Order for £.....  
Or please debit my Access/Visa Account

No: .....

Signature: .....

NO DEPOSIT H.P. AVAILABLE!

H.P. Quotation Required  Tick for F.M. Catalogue

Please send me details on the following goods: (I  
enclose a large s.a.e.)

BARCLAYCARD AMERICAN EXPRESS ACCESS

# Carlsbro Cobra 90 Keyboard Combo



Carlsbro's Cobra series is aimed for use in small venues and for home studio use: Aside from a power (and price!) tradeoff, they're essentially identical to corresponding models in the well known *Marlin* range. The 3 channel combo we're concerned with here features a high impedance input on one channel for Fender Rhodes and the like, FX routing switches, and integral reverb to which the channels are routed by push buttons. There's also a control labelled 'Attack' and a socket for headphones. In the absence of the latter, sound comes from a 15" driver in a vented enclosure, together with a horn tweeter. Alternatively, auxiliary amplification can be hooked up to the line output socket - or you can simply connect up extra speakers, 2 sockets being provided.

The first problem encountered was 'BI-FET' hiss when the master gain control was wound up. This might not matter much when the combo is used in its own right, but as an item of backline gear hooked up to a PA, this HF noise could prove quite a nuisance, although, in some cases, it'd probably be swamped by hiss from keyboards!

## Testing

The Combo was tested with a Transcendent 2000 as it seemed a likely partnership. Overall, the sound was full, but perhaps a little brittle and lacking in warmth, certainly in comparison to a valve instrument amp, though the application of a little reverb helped matters considerably. Bass response was smooth and well extended. But at the same time, the 15" driver's cone didn't 'flap' on very low notes, which is a common problem with Theile alignments. This suggests considerable care has been taken to optimise the driver's loading - it's certainly not an easy task. So, full marks on the bottom end performance.

Now, although the top - in terms of handling audible harmonics - was reasonably sweet, problems arose when the synth's attack setting was wound up. The Combo began to sound uncomfortable and there was a distinct nastiness in the high mid-range to the extent of hurting the ears at high sound levels.

Moving on to other instruments, the combo handled a drum synth competently. Electret and high impedance moving-coil mics also made a good partnership with any of the 3 inputs. Putting all three instruments together (Keys, vocals and the drum synth), the combo proved itself up to handling a one man band without the intermodulation distortion (giving rise to ear wrenching nastiness) that characterises some combos in this mode.

As channels 2 and 3 have a pair of inputs, the combo can potentially handle 5 instruments, assuming the extra two can make use of the existing EQ and gain settings. We tested the mixing of the two inputs on each channel and couldn't detect any tonal colouration arising from the mixing of two sources.

In all cases, it was easy to get a 'good' sound because, with the unit's response (with the tone controls at their central

position) being basically flat, the EQ was nearly wholly available for creative purposes rather than being used up in a struggle to achieve an acceptable sound from the speaker.

The reverb uses a standard 350mm springline; sonic differences in comparison to other gear arises principally from the mounting of the spring and the drive circuitry. As implied earlier, a small amount of reverb greatly improved the combo's keyboard sound, and moreover, the reverb depth control showed pronounced changes in FX over most of its range - unlike some! One worry here is the absence of any foam rubber to restrain the spring from bouncing around excessively. Moving the amp around with the reverb turned fully on and the volume turned up is definitely not recommended for people who jump out of their skins easily!

## Construction

Moving onto the mechanics in general, the design of the knobs is particularly well thought out. It's possible to spot your control settings from twenty feet. Also, the pots feel good, although they're set a little close together. The speaker grille aesthetics are good but how long it'll stand up to abuse on the road without tears appearing is open to debate. A rather more annoying feature is that whilst both drivers are front loaded, the

grille and associated frame aren't readily removable - without, it seems, breaking apart glued-up seams. Another niggle is the On/Off switch. This has an easily broken plastic toggle. The panel recess is unlikely to give adequate protection in transit, whilst experience suggests a metal toggle, adding a few pennies to the cost would survive unscathed. Perhaps these points will be corrected in production versions?

## Circuitry

The physical design and assembly of the unit, in common with other items from Carlsbro, is exemplary. To begin with, the electronics is tightly packaged. The PCBs have screened legends. Moreover, the two assemblies that make up the amp (built around the front and rear panels) are exceedingly easy to gain access to without the need to dismember enormous cable looms. Instead, the two sections are coupled together with a length of standard 4 core cable, as used by BT and in domestic security loops, both ends being pluggable. The remainder of the wiring (there isn't much) consists of very short, point-to-point links. This is elegant design work, and in view of the fact that wholesale wiring looms are prime scapegoats for mechanical failures, RF burnout and finicky performance, the minimal use of wire deserves praise. Again, the pots (which are PCB mounted) deserve

### Specification

Input Sensitivity

Tone Controls

Front Panel Effects Loop

Rear Panel Effects Loop

Output Power

CH1 26mV 1M

CH2 & 3 46mV 47K

Treble +12dB, -16dB at 10kHz

Bass +10dB, -12dB at 100Hz

Presence +10dB at 8kHz

-10dBV send and return

-6dBV send and return

90 watts into 4 ohms at 1kHz for 240V AC

supply. 5% THD





special mention in that they're supported by brackets. This eases the strain from the electrical connections whenever the combo is banged around, so avoiding the hairline fracture and consequent hassle with pots going intermittent that plagues other equipment. In fact, with the bracket supports, the rear of the PCB is held so rigidly you could almost drive a vehicle over it without breaking anything!

Turning to the power amp assembly on the rear panel, the power rails pass via PCB mounted fuses. In theory, these should blow only if something calamitous happens to the amp, thus the fact that they're hidden away isn't any real cause for concern; if they do blow, then the amp will almost certainly need repair - it'd be no use just replacing the fuses. However, fuses do have a habit of developing metal fatigue and breaking spontaneously - or even falling out - and if this occurs, DC can appear across the 15" driver. Result? Dead speaker for no justifiable reason. This potential problem could be easily avoided by fitting anti-surge fuses (which will still protect the transformer from overload, but are much less prone to metal fatigue) and tiewrapping these in place.

Finally, the combo's electrical performance was checked out in view of the minor shortcomings noted earlier. With the master gain wound fully up, noise was 59dB below maximum output between 1Hz and 3MHz-3dB points. In view of the unit's very audible dislike of signals with a large transient content (i.e. with fast attack) the frequency response was inspected. With the tone controls set flat, it was 5dB up at 20kHz, 0dB at 30kHz and only 6dB down at 65kHz. The Attack control provides a bell curve response, adding about 5dB centred on 10kHz at its maximum setting. However; with a channel treble control turned to maximum boost, the response rose another 8dB at 20kHz, 11dB at 30kHz (!) and didn't fall back to 0dB until 150kHz... With a frequency response like this, it's clear that the amp will be easily grossly overloaded by ultrasonic energy. In view of the power amp design being an RCA bipolar derivative, and thus not exactly excelling at frequencies above 20kHz, it's no wonder that lots of transient energy from the test synth caused problems! Fortunately, this problem is nothing that can't be put right with some judiciously applied HF filtering to tame the treble

control's boost above 20kHz, and ruthlessly attenuate ultrasonic energy. Returning to the noise, this fell to a more respectable -76dB below maximum output when the measurement bandwidth was reduced from 3mHz to 10kHz, so this problem appears to relate directly to the mixer's over-extended response and the characteristic very 'toppy' noise of Bi-Fet op-amps. A 10kHz low pass filter on the line output should ensure that the noise is reasonably well cleaned up for DI feeds.

### Conclusions

Overall, once a few easily corrected shortcomings have been sorted out, this amp is strongly recommended for those who don't need enormous amounts of power. The standard of construction and the aesthetics are both first class and should be a lesson to other UK manufacturers!

Ben Duncan

E&MM

For further details contact: Carlsbro Sales Ltd., Cross Drive, Lowmoor Road Industrial Tel. (0623) 753902. Please mention E&MM when doing so.

## SEQUENTIAL CIRCUITS INC UK DEALER LIST

A 1 MUSIC, Manchester	061-236 0340
ROD ARGENT'S KEYBOARDS, London	01-240 0084
ROD ARGENT'S KEYBOARDS, Worcester	0905 611774
BIGGLES MUSIC LTD., Bristol	0272 555319
BIGGLES MUSIC LTD., Plymouth	0752 29858
BIGGLES MUSIC LTD., Reading	0734 584945
PETER BONNER MUSICAL, Eastbourne	0323 639335
PETER BONNER MUSICAL, Hastings	0424 421885
CARLSBORO SOUND CENTRE, Mansfield	0623 651633
CARLSBORO SOUND CENTRE, Hyson Green, Notts.	0602 704820
CARLSBORO SOUND CENTRE, Sheffield	0742 663862
CARLSBORO SOUND CENTRE, Leicester	0533 24183
DOUGIE'S MUSIC SHOP, Northwich	0606 6040
FUTURE MUSIC, Chelmsford	0245 352490
HOBBS MUSIC, Lancaster	0524 60740
J.S.G. MUSIC, Bingley	0274 564389
THE LONDON ROCK SHOP, London	01-267 5381
LIVEWIRE, Cardiff	0222 496619
MCCORMACKS, Glasgow	044-332 6644
MUSIC GROUND, Doncaster	0302 843037
ONE WAY MUSIC, Wolverhampton	0902 23060
ROCK CITY, Newcastle	0632 324175
ROCKBOTTOM, Croydon	01-680 1042
SOUTHERN MUSIC, Brighton	0273 733387
SESSION MUSIC, Belfast	0232 38502
SESSION MUSIC, Londonderry	0504 46796
SESSION MUSIC, Dublin	01-606777
GORDON SIMPSON LTD., Edinburgh	031-6305/7
TELECOMMS, Portsmouth	0705 660036

## CARLSBRO AT ALLAN GORDON'S

### COBRA 90 KEYBOARD COMBO



- ★ 90 Watts ★ 3-Channel
- ★ 15" Driver + HF Horn
- ★ Reverb ★ Full EQ ★ F/X loops
- ★ Line out ★ 'Phone socket
- ★ Chi Hi-Input (for elec pianos etc)
- ★ Master outputs

PHONE 01-520 3706/8642  
FOR DETAILS OF OUR VERY SPECIAL  
CARLSBRO PRICES

Always a full range of Carlsbro Products in stock  
and on permanent demo. All at amazingly  
special prices. Phone for details

MAIL ORDER

ACCESS

BARCLAYCARD

**Allan  
Gordon**

ALLAN GORDONS  
32 MARKHOUSE RD  
WALTHAMSTOWE  
LONDON, E17

# Talking

# SHOP

## Honky-Tonk Music



After eight years of trading in Essex, Honky-Tonk seems to have established itself as the sort of competent all-round music store which supports the huge 'silent majority' of amateur and semi-professional musicians in the UK. Founder Pete Brewer entered the business after abandoning his ambitions as a professional drummer, and started to cater for the semi-pro market by stocking large amounts of second-hand equipment.

Ludwig drums were one early line which, like many other imports, have become more expensive recently. Tama, Pearl and other Japanese makes are now heavily stocked instead, along with a large amount of Roland equipment of all kinds. Honky-Tonk were one of the first Roland dealers, starting with the preset synthesisers and rhythm boxes around 1975 and expanding the range while other local music shops were contracting and closing down. Fender guitars and amps were heavily featured in the early days, but now there's a much wider choice in both areas.

Recently Honky-Tonk have gone into manufacturing with the electronic Kloner Kit, now halfway through an initial production run of 120. Modifications are constantly being made - such as the use of two or three pickups in each pad to give more even response - and a radically different follow-up is planned. The basic model has been very successful however, with mail orders coming from as far afield as Norway.

As a drummer, Pete Brewer appreciates the necessity for a good range of spares, and so over 1,000 heads are kept in stock, together with stands, accessories, and an increasing number of the Latin American percussion instruments which seem to be coming into fashion. Drums are kept in a separate department upstairs and any kit can be set up for demonstration as required.

Larger PA equipment isn't stocked in great quantities at present, since the trend seems to be for a band to own a small PA for rehearsal and hire a larger setup for performance. Carlsbro, HH, Traynor and Bose are represented in the PA room, together with the original British designs of McGregor. Their MOSFET amps, spotted by Honky-

Tonk at Frankfurt, include a model specially intended for duos or soloists using tape or electronic accompaniment. There's also a 100W wedge monitor with 5-band EQ for a very reasonable £256.

Downstairs the shop is divided into keyboard, home recording, guitar and amp sections. The semi-professional market goes mainly for the Juno 6 and 60, SH-101 and the very inexpensive Jen SX 1000, an excellent beginner's synth at £159. However, professional keyboards such as the Memorymoog and Korg Trident 2 are in stock, together with secondhand goodies such as Yamaha CS60, Clavinets and so on. New products are well represented; the Korg



The Kloner Kit.

Poly 61 is gaining a good degree of acceptance nowadays, and the Yamaha CE20 is there for fans of the FM synthesis sound. Casios, Korg pianos and a wide variety of string synths are also available.

The home recording section occasionally looks bare because even the demo models have had to be sold! The huge demand for TEAC Portastudios, Cutec mixers and rack-mounting effects, TC Electronic signal processors and even more for exotic items like the Roland Dimension D keeps the staff on their toes. Luckily the compact nature of rack-mounting equipment keeps the shop reasonably tidy and business-like.

Guitars stocked include about 30 Tokai models, Hondo, a wide selection of less expensive copies and a good cross-section of professional instruments. Some tasty Gibsons are to be seen on the secondhand rack, and Aria's new models are likely to be seen in the near future. Westone guitars and basses are still selling in very large numbers, and all the models including the eye-catching Paduak are represented.

A wide range of effects pedals both new and secondhand, and a good choice of accessories are on sale. Occasional special offers, such as one on the Roland GR100 guitar synthesiser and its associated guitar controller, help to keep sales patterns varied and imaginative. One hope is that the move towards a more dynamic and visual style of drumming - with the Simmons kit, transparent polyester designs and the Kloner - will rub off on keyboard players, who will take to the guitar-like possibilities of the SH-101 and CS-01.

Honky-Tonk don't deal in quantity with acoustic guitars or brass instruments because they recognise a lack of expertise in that area. Determined to be good at what they do however, they employ their own technical staff and are able to give guarantees on secondhand equipment. Engineer Dick Straker was one of the first employees to be taken on when the shop opened, a good sign of the degree of technical backup provided.

Honky-Tonk is all about giving an all-round service, and with equal attention to guitars, acoustic and electronic percussion, amplification and keyboards, this is what they've succeeded in doing. They are a happy example of a venture which has succeeded by avoiding over-specialisation.

Honky-Tonk Music, 300-302, London Road, Hadleigh, Essex. Tel. 0702 533647.



Phil Straker & Pete Brewer.



Guitars and Amplification.

E&MM



**STRETCH YOUR MIND and your IMAGINATION! . . . but not your WALLET!!!**

— Largest Selection of Musical Equipment in ESSEX —

GUITARS & BASSES	
GIBSON Les Paul Custom T.S.B.	£495
GIBSON Les Paul I/hand 20th ANN	£375
GIBSON SG STD with Bigsby s/h	£299
GIBSON SG STD walnut s/h	£299
GIBSON Melody Maker - 1960 original	£225
YAMAHA SG. 400 cherry	£249
YAMAHA SG. 300 cherry	£215
YAMAHA SG. 175 natural s/h	£225
YAMAHA SF. 400 red	£199
YAMAHA SC. 400 wine	£189
YAMAHA SC. 600 walnut/natural	£275
TOKAI Les Paul 58 inc. case	£289
JOHN BIRCH Custom SG. black s/h	£295
GUILD SG. black s/h	£159
SHERGOLD 12-string Masquerader s/h	£125
YAMAHA SQ 2000 C.S.B. s/h	£325
SHERGOLD Masquerader, white s/h	£125
KAWAI fixed neck, natural s/h	£125
IBANEZ artist deluxe s/h	£185
IBANEZ Artist AR100, Natural	£199
IBANEZ Blazer BL450 dark blue	£199
IBANEZ Blazer BL500 dark blue	£185
IBANEZ Blazer BL300 natural	£149
WASHBURN Falcon, coil taps	£225
WASHBURN Raven, white	£115
HAGSTROM Scandi, natural s/h	£95
HAGSTROM Swede. Wine	£175
PEAVEY T60, Natural s/h	£145
DAN ARMSTRONG, Twin slid, pick-ups	£175
EPIPHONE 1958 Coronet - twin P.A.F.	£195
GORDON SMITH SG. Fixed neck s/h	£139
VOX Custom deluxe, walnut	£225
KRAMER DMZ 3000, alum. neck s/h	£145
KRAMER DMZ 2000 alum. neck s/h	£149
KRAMER 450 Model alum. neck s/h	£159
VANTAGE Mystic walnut	£169
FENDER Fixed neck model	£195
FENDER Stratocaster, U.S.A.	£295
FENDER Stratocaster + Trem. USA	£345
FENDER Tele. antique finish s/h	£235
FENDER Lead One inc. case	£119
FENDER Bullet inc. case	£119
OVERWATER Model 030 fixed neck	£225
OVERWATER Custom, natural finish	£325
WESTONE Concorde 1 red	£99
WESTONE Thunder 1/hand	£110
WESTONE Padout, natural stain	£110
HAYMAN White Cloud, 3 pick-ups s/h	£95
HAYMAN Modular white s/h	£99
GIANNINI Custom SG. dark wood	£195
HONDO II New Explorer style	£125
WESTBURY Standard, left-handed	£95
KAY Guitar synthesizer	£99
CRAFTSMAN Flying V cherry s/h	£99
CRAFTSMAN Flying V inc case	£160
CRAFTSMAN Explorer inc case	£150
GIBSON 335-Pro, tobacco s/h	£495
IBANEZ AS 50 tobacco	£249
IBANEZ AM 50 tobacco	£239
IBANEZ AS 50 tobacco s/h	£189
VANTAGE VSG 435, tobacco	£175
FRESHER 335 walnut	£125
FRESHER 335 walnut l/hand	£125
HONDO 335 walnut	£89
HONDO II 175 copy	£119
RICKENBACKER 340 black s/h	£345

* SPECIAL OFFER *	
ROLAND GR202 guitar with case plus ROLAND GR100 control box, inc. cables. List Price £644.	OFFER PRICE (inc. free delivery in UK) £299

ELECTRIC BASSES	
FENDER Tele Bass s/h	£175
GIBSON EB 3L long scale s/h	£149
GIBSON EBO, 1959	£145
GIBSON EBO, cherry s/h	£99
GUILD B301 wine s/h	£195
ARIA SB600 black s/h	£195
BURNS Bison, white, immac. s/h	£225
WASHBURN SB40 bass, blue or wine	£195
YAMAHA BB400, walnut	£199
YAMAHA BB1200, cherry, case	£295
FENDER Jazz 1967, black	£295
FENDER Precision, black s/h	£185
FENDER Precision fretless s/h	£249
FENDER Precision white M/N s/h	£239
FENDER Precision, new, black	£295
FENDER Musicmaster, white s/h	£89
IBANEZ Blazer 800' white	£185
IBANEZ Blazer 800' red	£179
IBANEZ MC 924 Active, ivory	£355
YAMATO Jazz l/hand white or black	£110
HAYMAN 4040 black, M/N s/h	£125
AXEMAN Ricky, fixed neck s/h	£99
VANTAGE VP 795, 2-pick-up, natural	£175
HOHNER Pro-Bass fixed neck	£145
WESTONE Thunder One Active	£129
JAY-ROCK Custom, green	£125
VANTAGE Witch Bass, natural	£115
HONDO II Pro-Bass walnut	£99

**TOKAI GUITARS**  
JAPAN'S FINEST 'REBORN-OLD' guitars  
OVER 40 VINTAGE INSTRUMENTS in stock.  
Most models & colours, including: TE., ST., PB  
and JAZZ. BASSES also Les Paul and 335's.  
Phone for our low, low VINTAGE PRICES.

HOME RECORDING	
<b>CUTEC - Home recording.</b> New in UK, amazing value!	
MR402 4-track cassette recorder	P.O.A.
MX1200 12/2 Stereo Mixer	P.O.A.
MX 800 8/2 Stereo Mixer	P.O.A.
CD 424 DIGITAL DELAY UNIT	P.O.A.
SA 2000 Spectrum Analyser	P.O.A.
GS 2200 Stereo graphic & analyser	P.O.A.
PA 902 90+90 stereo amp	P.O.A.

YAMAHA - Home Recording	
Early delivery expected of all new MT-44	
Multitrack Cassette	P.O.A.
MM-30 Multitrack mixer	P.O.A.

**RHYTHM UNITS**

KORG KPR-77, programmable rhythm unit	48 memories, claps, flams, tape interface	£399
KORG KR55B, 48 pre-set rhythm with pre-set	'intros' and drum fills	£299
KORG KR33, 48 pre-set rhythm swing beat	control, trigger output	£169
ROLAND TR808 rhythm composer, 16 voices,	768 programmable measures, intros	£545
ROLAND CR800, Compurhythm 24 basin	rhythm, 8-programmable rhythms, LED	tempo meter
ROLAND CR5000, 24 pre-set rhythms with	variable arrange section plus 'fill-ins'	£235
ROLAND TR606 Drumatix, 32 rhythm patterns	with total of 8 voices	£195
ROLAND TB303 Bassline programmable bass	unit with total of 64 pattern memories	£199
ROLAND DR55 Doctor Rhythm, 16 rhythm	pattern bass, snare, rim shots & hi-hat &	accent
SOUND MASTER SR-88 memory rhythm 16'	pattern with 'fill-ins'	£69
SOUND MASTER ST305 Stix programmer,	16 pattern, 8 voices, variation & 'fill-ins'	£110
MOVEMENT Sequence memory rhythm,	16 patterns, 'fill-ins' & variations	£59
AMDEK from Roland, 16 rhythms, 5 voices,	drum fills, rhythm chaining	£75
THE KIT, Variable touch sensitive pads, 7	voices, built-in rhythm generator	£195
THE KIT, Bass drum & hi-hat control		£39
THE KIT, Clap module, external trigger		£79
THE KIT, Timpani module, external trigger		£79
THE KIT, Synth drum module, external trig		£79
NEW YAMAHA RHYTHM UNIT MR-10		£89

COMBOS	
ROLAND Spirit 10 Lead	£69
ROLAND Spirit 30 Lead Reverb	£129
ROLAND Spirit 50 Lead Reverb	£117
ROLAND Spirit 15 Bass	£85
ROLAND Spirit 30 Bass	£139
ROLAND Spirit 50 Bass	£185
ROLAND Bolt 30 Valve, Reverb	£235
ROLAND Bolt 60 Valve, Reverb	£315
ROLAND Cube 20 Lead, Reverb	£120
ROLAND Cube 40 Lead, Reverb	£165
ROLAND Cube 40 Reverb/Chorus	£185
ROLAND Cube 60 Lead, Reverb	£195
ROLAND Cube 60 Reverb/Chorus	£220
ROLAND Cube 100 Lead, Reverb	£289
ROLAND Cube 40 Keyboard	£175
ROLAND Cube 60 Keyboard	£235
ROLAND Cube 60 Bass	£215
ROLAND Jazz-Chorus, 50 Lead	£259
ROLAND Jazz-Chorus 120 Lead/k'brd	£495
MARSHALL 5050, 12 watt lead	£69
MARSHALL 5501, 12" Bass	£74
MARSHALL 5010, 30 watt lead	£119
MARSHALL 5503, 30 watt Bass	£125
MARSHALL 5210, 50 watt Lead	£199
MARSHALL 5506, 60 watt Bass	£189
MARSHALL 4010, 50 watt Valve Lead	£229
MARSHALL 4104, 50 watt Valve Lead	£269
MARSHALL 4210, 50 watt Valve Lead	£299
MARSHALL 5520, 160 watt Bass	£315
MARSHALL 5305, 50 watt Keyboard	P.O.A.
MARSHALL 5306, 60 watt Keyboard	P.O.A.
TRAYNOR TS.10 Lead, overdrive	£65
TRAYNOR TS.15 Lead, Overdrive	£89
TRAYNOR TS.20 Lead, Overdrive	£119
TRAYNOR TS.25 Lead, Reverb	£159
TRAYNOR TS.50 Lead Reverb	£175
TRAYNOR TS.25 Bass	£159
TRAYNOR TS.50 Bass	£209
CARLSBRO Wasp, 10 watt Lead	£65
CARLSBRO Scorpion 20" Reverb Lead	£89
CARLSBRO Scorpion 20" Bass	£75
CARLSBRO Cobra 90 Lead	£215
CARLSBRO Cobra 90 Bass	£225
CARLSBRO Cobra 90 Keyboard	£269
CARLSBRO Cobra 60 Bass	£175
YAMAHA K550 Keyboard	£299
YAMAHA JX50 Lead/Reverb	£145
YAMAHA JX50 Bass, 1x15	£225
YAMAHA G100 Lead, Reverb	£325
YAMAHA G100 Lead, Reverb S/h	£195
YAMAHA G50 Lead Reverb S/h	£149
PRO-AMP 100 Lead	£299
McGREGOR Bassman 200, Graphic	£345
FENDER 75 Lead 1 x 15	£399
FENDER Twin Reverb J.B.L. S/h	£445
FENDER Twin Reverb S/h	£299

**KEYBOARDS & SYNTH.**

ROLAND	
JX-3P, new model, 32 pre-set POLY with	POLY SEQUENCER
PG-200 programmer for JX-3P allows pre-	sets to be reprogrammed
JUPITER 8, Polyphonic synthesizer 64	memories, split-keyboard
JUPITER 6, Amazing new model,	48 memories
JUNO-60 Polyphonic synthesizer,	56 memories, Stereo Chorus
JUNO 6, Polyphonic synthesiser, arpeggiator,	stereo chorus etc.
SH-101 Monophonic synth, sub oscillator,	100 step sequencer, amazing
MC200 amazing NEW microcomposer with	SH101 type synth section

**CONTEMPORARY KEYBOARD CENTRE**

EP 11 piano, 5-octave, auto-rhythm, bass arpeggiator, built-in amplifier. P.O.A.  
HP 30 piano, 5-octave, transpose, arpeggiator, built-in amplifier. P.O.A.  
HP 60 piano, 5-octave, touch sensitive, 4-voice twin-built-in speakers. P.O.A.  
WH 70 piano, 6-octave, touch sensitive, 4-voice built-in chorus, stereo effects. P.O.A.

**KORG**

POLY-SIXTY ONE, new model with 64 memories and many features. £995  
POLYSIX Polyphonic, 32 memories, chord memory, arpeggiator. £995  
MONO/POLY 4 oscillator synthesiser, polyphonic or monophonic capabilities. £575  
LAMBDA strings, organ, choir, brass, piano, clavichord, stereo chorus. £865  
DELTA Polyphonic, fully variable strings with stereo outputs. £595  
SIGMA Twin-oscillator monophonic synth, 20 pre-sets, touch sensitive. £445  
80 Electric piano, 76 notes, 6 voice chorus, key response built-in amp. £595  
80-S Electric piano, string section, stereo vibrato & chorus, built-in amp. £775  
NEW EPS-1 Symphonic 76 note piano, 6-voice equaliser, strings, stereo chorus. £925  
BPX-3 Bass Pedals & Controller. £250

**MOOG**

TAURUS 11 Synthesizer bass pedals, twin oscillators, 2-octave pedals. £499  
OPUS-3 Polyphonic synth, strings, organ, brass, variable synth. section. £525  
SOURCE Mono synth, with 16 memories two-channel sequencer, twin oscillators. £699  
ROGUE Monophonic synth, twin oscillators noise generator, pitch bend. L.F.O. £245  
MemoryMoog now in stock. P.O.A.

**CASIO**

MT-11 32 notes, 8-note polyphonic, 8 voices, sustain, vibrato and only. £49  
MT-41 39 notes, 8 note polyphonic 22 voices, 6 rhythms, Auto accompaniment £79  
MT-45 49 notes, 8 voices, 8 rhythms, drum fills, 16 bass patterns, arpeggio. £99  
MT-65 49 notes, 20 voices, 12 rhythms, 48 bass and chord patterns, reverb etc. £149  
PT-30 31 notes monophonic, 8 voices, 12 rhythms, 6 arpeggio patterns, 508 step memory, automatic harmonisation. £69  
VL-1 6 voices, auto rhythm, memory. £35  
CT-10 miniature version of above. £25  
CT101, 49 notes, 25 pre-set sounds, 8 note, poly, vibrato, sustain. £195  
CT202 as above but 49 pre-set sounds. £275  
CT405, 20 voices, 12 rhythms, 48-bass, chord or arpeggio patterns, reverb. £275  
CT1000F Polyphonic 5 octave, 1000 sounds 10 memories, arpeggio, split keyboard. £325  
CT-7000 amazing new model with "multitrack" memory facilities. £575

**YAMAHA**

CS-01 Monophonic Synthesiser. £159  
CS-60 Polyphonic synthesiser, immac. £995  
SK-20 6 x poly, 14 mono pre-sets. £899  
CE.15 Polyphonic strings, organ, chorus. £675  
CP-11 piano, auto-accompaniment. £385  
CP-25 piano, 81 keys, touch sensitive. £375  
CP-30 piano 73 keys, touch sensitive. £979  
DX-7 New Digital Polysynth with 32 memories. Delivery June. £1,299  
DX-9 New digital Polysynth with 20 memories. Delivery June. £899

**KAWAI**

SX210 New! 61 key 8 voice Polyphonic with 38 memories. July delivery. £999  
EP608 New! Acoustic/Electric upright stage piano in trolley. April delivery. £1,495

**OTHERS**

HOHNER Globetrotter Pianos. £165  
HOHNER Clavinet D6 S/h. £145  
MOOG Opus III S/h. £425  
HOHNER String Orchestra S/h. £225  
JEN SX1000 S/h. £125  
WASP Synthesizer S/h. £95

**KLONE-KIT 'Electronic Percussion System' £299**

Price includes delivery in U.K. But not Stands or Cymbals.



**AT LAST AN AFFORDABLE ELECTRONIC DRUM-KIT**

- Touch sensitive pads for volume, pitch-bend and 'rim-shots'.
- Fully variable tuning for 'Bongo to Timpani' percussion sounds.
- Damping/Decay controls allow 'dead' studio sounds, natural acoustic sounds or exaggerated 'pitch-bend' sounds for today's electronic music.
- Snare Drum has separate Snare (White Noise) control.
- Separate Bass Drum output \* Master volume control \* MAINS POWERED

**INSTANT CREDIT also NO DEPOSIT H.P. ACCESS/BARCLAYCARD PART EXCHANGE and MAIL ORDER SERVICE AVAILABLE**

**SOUTHEND (0702) 553647**



# M&A K-1/B Drum Kit

Innovation in the field of electronic percussion continues with the K-1B and the slightly cheaper K-1, which has a small mounted bass pad as opposed to the larger free-standing unit on the K-1B. M&A have established a solid reputation in the past for their middle-range studio mixers and their first excursion into the field of instruments is consciously aimed at the Simmons market.

Luckily, as well as being considerably cheaper than the Simmons Kit (still indubitably the leader in its field) the K-1 has a visual appeal all of its own. The distinctive rounded-off triangular pads are painted red (on the underside of their transparent polycarbonate playing surfaces) with a black wood-and-metal finish, and the whole kit has the advantage of being compact and relatively lightweight. The electronics can be mounted on a single microphone stand, while the pads themselves come in two sets of three which all mount on a standard Premier dual tom stand.

The snare pad mounts horizontally onto the upright itself, and a special footpedal is provided for the hi-hat. In the K-1B kit there's also a larger free-standing bass drum pad, for which a conventional bass pedal is needed. Connection from the snare, the bass drum and the two sets of pads is by a locking XLR-type plug to a similar socket on the electronics panel.

The electronics section includes direct outputs for each of the sounds, together with stereo outputs with individual Treble and Bass equalisation and panpots on each sound. Each sound also has an individual Volume control, but the control layout for each particular sound is otherwise quite different.

The Bass Drum section has Tune, Resonance, Attack and Sensitivity controls. Because the polycarbonate playing surface is extremely rigid its associated foam-mounted piezo pickup responds very quickly; this response can be reduced or increased as desired. A click tends to be transmitted directly from the piezo to the audio output, and while this can be quite interesting in some applications it can be reduced, and the general initial impact of the sounds diminished by using the Attack and Sensitivity controls.

Tuning is over a relatively narrow range, keeping the Bass sound to fairly low frequencies, while the Resonance control give useful variations of tone without giving any over-the-top effects. Similar comments apply to the Toms, which don't produce high-pitched 'disco drum' effects. The Toms have an Attack control similar to that on the Bass Drum, and also a Resolve Time control which could more simply have been labelled Decay. As the Tom sounds decay they bend slightly to simulate the change in skin tension of an acoustic drum.

The Snare drum can be tuned but has a Balance control - between pitch and white noise - rather than a Resonance control. After 18 months of development with a Resonance control included, market research found that drummers spend much of their time trying to avoid resonance on an



amplified snare sound!

Snare and Hi-Hat also have a Quality control consisting of a high pass filter for tone modification. Each of the two cymbals has Quality, Attack, Decay and Sensitivity controls, and the electronics console is completed by a power switch and indicator and a fuse holder.

The Hi-Hat pedal contains a piezo itself, and so in addition to cutting the sound's decay to a short 'closed' effect, it can trigger the Hi-hat sound with just a foot movement. All the sounds are also sent to a Monitor output suitable for headphones, which can be used to adjust and tune the kit without sound going to the amplifier or PA.

## Construction

The metal casing of the electronics module is neat, reasonably lightweight, and designed to be suitable for rack mounting. Circuitry is based on a clever utilisation of quad op-amps, with white noise zener-generated. PCB construction is reasonably neat, with a power supply installed in one corner of the module; the transformer is mounted on the single large PCB which also includes the circuitry for the summing mixer.



K-1 Electronics Module.

The controls are in the form of large carbon presets, which unfortunately are of an open design and so may be prone to noise. Additionally the presets are not fitted with a knob (a reasonable enough economy measure) and this makes them a little difficult to adjust quickly and accurately by hand. On the other hand, the intention of the kit's design is to set up an ideal sound at the start of a set and to avoid modifying it as far as possible, so this needn't be a drawback.

## Performance

The K-1 is very comfortable to play, with a good balance of fast attack and response on the foam-mounted pads, and a compact layout with everything close to hand on both kit and control console. Response is fast enough to play fours and eights even on the Hi-Hat, although the design of the tensioned polycarbonate strip on the Hi-Hat pedal is such that a sharp blow could break it.

The Bass, Tom and Snare sounds are powerful enough although consisting only of simple oscillator frequencies, with a mix of white noise on the Snare. The Cymbals and Hi-Hat consist of white noise only, and so can't be very closely imitative. Although the drum sounds can simulate an acoustic kit reasonably well, the quality of the cymbal sounds is such that the K-1's overall feel is inevitably that of an electronic unit, and so the styles of music for which it would normally be used are relatively limited.

Reasonable amplification allows the K-1, with its Treble and Bass equalisation, to produce very striking and impressive drum sounds. The kit is being developed constantly, recent additions including stabilising pins on the Bass drum pad and new piezo pickups which are totally enclosed and screw directly to the inside of the pad. The advantages of being able to break down the kit in about five minutes and pack it into a single flightcase are incalculable, and once set up the K-1 is visually striking and a great asset to any electronically-based band's sound.

E&MM

RRP of the K-1 kit is £598 and of the K-1B kit £658 including VAT. Contact Seabright Supplies, 93, Main Road, Broomfield, Chelmsford, Essex. Tel. 0245 441312.



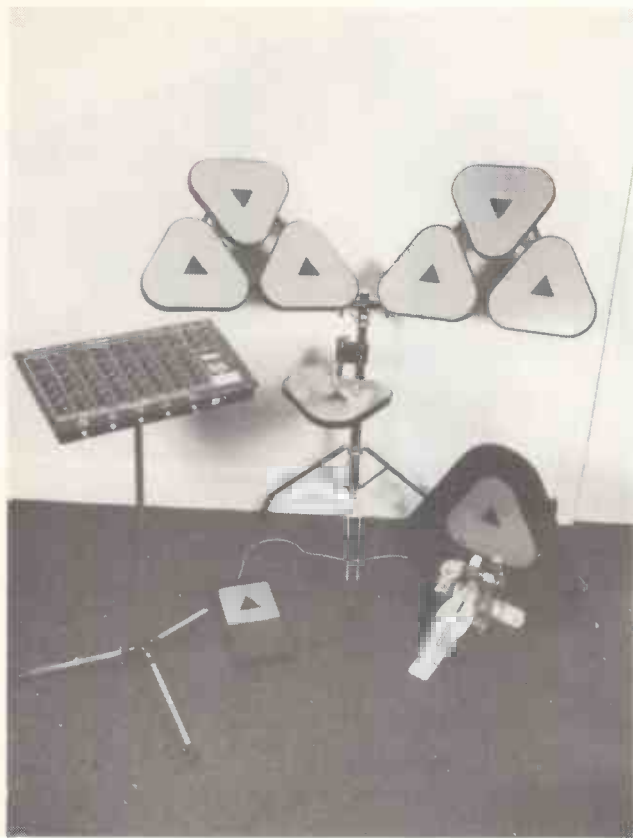

# M&A

## ELECTRONIC PERCUSSION SYNTHESIZER

Kit comprises:—

- ★ Bass Drum
- ★ Snare Drum
- ★ 3 Tom Toms
- ★ Hi-Hat
- ★ 2 Cymbals
- ★ Electronics Module
- ★ Stands by



Premier Percussion

Sole Distributor:

**SEABRIGHT SUPPLIES**  
 93 MAIN ROAD, BROOMFIELD  
 CHELMSFORD, ESSEX

ASK YOUR LOCAL DEALER OR CONTACT (0245) 441312/441119



### KORG KEY CENTRE

FULL RANGE IN STOCK!

KORG KEY CENTRE — FULL RANGE IN STOCK  
 POLY 61 IN STOCK — P.O.A. POLY 6 IN STOCK — P.O.A.  
 EPS 1 PIANO IN STOCK — P.O.A. MONO POLY IN STOCK — P.O.A.



ROGUE — £199.00  
 SOURCE — P.O.A.  
 TAURUS PEDAL CONTROLLER,  
 TAURUS II PEDALS — £495.00  
 MEMORY MOOG and SECONDHAND MINI MOOG

### SEQUENTIAL CIRCUITS INC



PRO ONE'S — £350.00  
 PRO 600 IN STOCK  
 PRO 5 — £2,150.00

### YAMAHA

FULL RANGE INCLUDING CS01 IN STOCK — P.O.A.  
 DX7/DX9 — ARRIVING SOON!  
 CS70M — SPECIAL PRICE WE DO NOT PRINT —  
 PLEASE TELEPHONE!  
 ARRIVING ANY DAY — THE AMAZING PF10 & 15 PIANO'S!

### Drumulator BY EMU IN STOCK

AKG MICS — SHURE MICS — WESTONE GUITARS —  
 FENDER SQUIERS — GIBSON GUITARS — TOKAI GUITARS  
 FANTASTIC CLASSICAL and ACOUSTIC RANGE —  
 WE SPECIALISE IN LEFT HAND GUITARS

### Roland



JUPITER 8,  
 JUNO 60 — P.O.A.  
 JUNO 6 — P.O.A., SH 101's  
 TR 606 — £183.00, TB 303 — £188.00  
 CR 8000's, etc.

**PLUS MANY MORE!**  
 BOSS PEDALS — BOLT & SPIRIT AMPS

### CASIO®

FULL RANGE!

7000	M7 45
1000P	M7 65
405	M7 11
403	AND
202	MANY
101	MORE



### ONE WAY MUSIC

100 SCHOOL STREET  
 WOLVERHAMPTON. 0902 23060

# MicroMIDI

by Kenneth McAlpine

- ★ Serial MIDI link
- ★ Opto-coupled input
- ★ Crystal controlled data transfer
- ★ 3 Parallel I/O ports
- ★ Single board construction

At last synthesiser manufacturers have come together and agreed on a specification which allows the latest processor-controlled equipment of different origins to be connected together. This system known as the MIDI (Musical Instrument Digital Interface), is implemented by transferring digital information, in serial format, between instruments.

Being digital it is a fairly simple matter to connect a microcomputer into the system and generate or process data relevant to particular instruments.

A detailed introduction to the MIDI is given elsewhere in this issue, so this article will mainly deal with the practical aspects of a computer interface.

To allow other circuitry to be connected into the system a parallel interface with 3 Input/Output ports has also been included.

The interface can be connected directly to any Z80 processor system and selected using IN and OUT instructions. However, the micro buss connections have been configured in a format suitable for direct connection to the Sinclair Spectrum.

Other processor systems such as those using the 6502 could be connected by decoding the address lines and treating the registers as memory locations.

MIDI connections are made to the board using the specified 5 pin DIN sockets.

## Serial Data

The MIDI is operated at 31.25 kBaud, each data 'word' containing 10 bits; one start bit, 8 data bits (D<sub>0</sub> to D<sub>7</sub>) and one stop bit as shown in Figure 1. Each 'word' therefore takes 320uS to be transmitted. This high transfer rate is necessary to prevent noticeable delays between equipment.

In the MicroMIDI the serial conversion is handled by an ACIA (Asynchronous Communications Interface Adaptor) which essentially contains two registers, one for 'transmit' and one for 'receive'. The device is configured to produce a serial 'word' in the required format whenever the transmit register is loaded with data. Conversely, when serial data is detected on the receive input, it is converted and loaded into the receive register. The transfer rate is set by an external clock.

## Circuitry

A complete circuit diagram of the interface is shown in Figure 2. IC2 is the ACIA, which is enabled via IC3 and IC1f. Transmitted data is buffered by IC1d & e and connected to the MIDI OUT socket. Incoming data is connected via an opto-isolator, IC6, which prevents ground loops corrupting the data and protects IC2 from potentially destructive signals. The external 2MHz

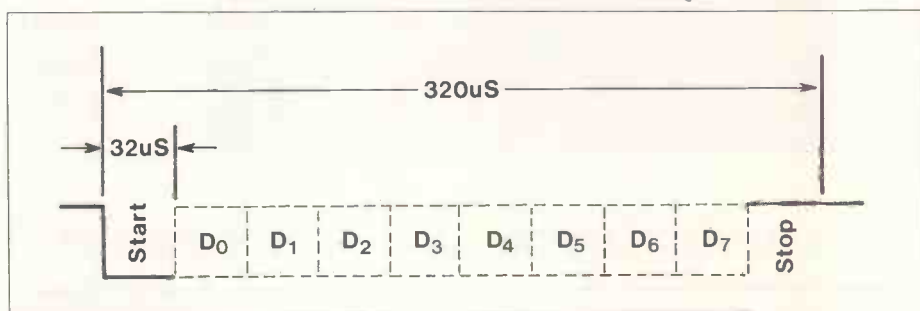

Figure 1. MIDI Serial word format.

clock is based around IC1 a & b and is squared up by IC1c. This is divided down inside IC2 by either 16 or 64. Dividing by 64 gives the required transfer rate of 31.25KHz.

IC5 is enabled via IC4 and provides the 3 parallel I/O ports. Bit 8 of Port C has a 'user definable' switch connected which could be used as a break switch in machine code

programs or to produce some other specific operation.

Decoupling is provided around the circuit by C2, 3 and 4.

## Construction

Assembly should present no great problems as all the parts are mounted on the



MicroMIDI connected to the Sinclair Spectrum.





# MicroMIDI

Buffer Address				
Data Bus Line No.	Transmit Register (Write Only)	Receive Register (Read Only)	Control Register (Write Only)	Status Register (Read Only)
0	Data Bit 0	Data Bit 0	Counter Divide Select 1 (CR0)	Receive Data Register Full (RDRF)
1	Data Bit 1	Data Bit 1	Counter Divide Select 2 (CR1)	Transmit Data Register Empty (TDRE)
2	Data Bit 2	Data Bit 2	Word Select 1 (CR2)	Data Carrier Detect (DCD)
3	Data Bit 3	Data Bit 3	Word Select 2 (CR3)	Clear to Send (CTS)
4	Data Bit 4	Data Bit 4	Word Select 3 (CR4)	Framing Error (FE)
5	Data Bit 5	Data Bit 5	Transmit Control 1 (CR5)	Receiver Overrun (OVRN)
6	Data Bit 6	Data Bit 6	Transmit Control 2 (CR6)	Parity Error (PE)
7	Data Bit 7	Data Bit 7	Receive Interrupt Enable (CR7)	Interrupt Request (IR)

\*Leading bit = LSB = Bit 0

CR6	CR5	Function
0	0	RTS = low, Transmitting Interrupt Disabled
0	1	RTS = low, Transmitting Interrupt Enabled
1	0	RTS = high, Transmitting Interrupt Disabled
1	1	RTS = low, Transmits a Break level on the Transmit Data Output Transmitted Interrupt Disabled

CR4	CR3	CR2	Function
0	0	0	7 Bits + Even Parity + 2 Stop Bits
0	0	1	7 Bits + Odd Parity + 2 Stop Bits
0	1	0	7 Bits + Even Parity + 1 Stop Bit
0	1	1	7 Bits + Odd Parity + 1 Stop Bit
1	0	0	8 Bits + 2 Stop Bits
1	0	1	8 Bits + 1 Stop Bit
1	1	0	8 Bits + Even Parity + 1 Stop Bit
1	1	1	8 Bits + Odd Parity + 1 Stop Bit

  

CR1	CR0	Function
0	0	÷ 1
0	1	÷ 16
1	0	÷ 64
1	1	Master Reset

Table 1. Definition of ACIA register contents.

Control Word		Ports			
Dec	Hex	A	B	C(Upper)	C(lower)
128	80	OUT	OUT	OUT	OUT
129	81	OUT	OUT	OUT	IN
130	82	OUT	IN	OUT	OUT
131	83	OUT	IN	OUT	IN
136	88	OUT	OUT	IN	OUT
137	89	OUT	OUT	IN	IN
138	8A	OUT	IN	IN	OUT
139	8B	OUT	IN	IN	IN
144	90	IN	OUT	OUT	OUT
145	91	IN	OUT	OUT	IN
146	92	IN	IN	OUT	OUT
147	93	IN	IN	OUT	IN
152	98	IN	OUT	IN	OUT
153	99	IN	OUT	IN	IN
154	9A	IN	IN	IN	OUT
155	9B	IN	IN	IN	IN

Table 2. Definition of PIO Port control, Mode 0.

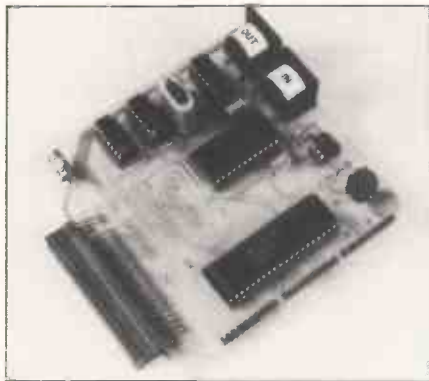

The completed MicroMIDI board.

### 16 bytes of program data

BYTE	MS BIT	A6	A5	A4	A3	A2	A1	LS BIT
0	B0	A6	A5	A4	A3	A2	A1	A0
1	D0	C3	C2	C1	C0	B3	B2	B1
2	E1	E0	D6	D5	D4	D3	D2	D1
3	F4	F3	F2	F1	F0	E4	E3	E2
4	H0	G5	G4	G3	G2	G1	G0	F5
5	11	10	H6	H5	H4	H3	H2	H1
6	J3	J2	J1	J0	I5	I4	I3	I2
7	K4	K3	K2	K1	K0	J6	J5	J4
8	M2	M1	M0	L3	L2	L1	L0	K5
9	O2	O1	O0	N3	N2	N1	N0	M3
A	Q2	Q1	Q0	P3	P2	P1	P0	O3
B	S2	S1	S0	R3	R2	R1	R0	Q3
C	U2	U1	U0	T3	T2	T1	T0	S3
D	V6	V5	V4	V3	V2	V1	V0	U3
E	Z7	Z6	Z5	Z4	Z3	Z2	Z1	Z0
F	ZF	ZE	ZD	ZC	ZB	ZA	Z9	Z8

### POT BITS

- A=OSC A PULSE WIDTH (7)
- B=PMOD FIL ENV AMT (4)
- C=LFO FREQ (4)
- D=PMOD OSC B AMT (7)
- E=LFO AMT (5)
- F=OSC B FREQ (6)
- G=OSC A FREQ (6)
- H=OSC B FINE (7)
- I=MIXER (6)
- J=FILTER CUTOFF (7)
- K=RESONANCE (6)
- L=FIL ENV AMT (4)
- M=FIL REL (4)
- N=FIL SUS (4)
- O=FIL DEC (4)
- P=FIL ATK (4)
- Q=AMP REL (4)
- R=AMP SUS (4)
- S=AMP DEC (4)
- T=AMP ATK (4)
- U=GLIDE (4)
- V=OSC B PULSE WIDTH (7)

### SWITCH BITS

- Z0=OSC A PULSE
- Z1=OSC B PULSE
- Z2=FIL KBD FULL (only 1 on)
- Z3=FIL KBD 1/2
- Z4=LFO SHAPE (1=TRI)
- Z5=LFO FREQ AB
- Z6=LFO PW AB
- Z7=LFO FIL
- Z8=OSC A SAW
- Z9=OSC A TRI
- ZA=OSC A SYNC
- ZB=OSC B SAW
- ZC=OSC B TRI
- ZD=PMOD FREQ A
- ZE=PMOD FIL
- ZF=UNISON

Table 3. Prophet 600 program dump.

After the computer has been switched on the ACIA must be reset. To do this the two LSBs of the control registers should be set. The clock divide is then selected ( $\div 64$ ) and the word length specified by loading the register with OUT 159,86 (56 Hex). A complete definition of the register contents are given in Table 1.

The status register can be read, by printing IN 223. It should contain the value 2 which shows that the Transmit register is empty. Loading the transmit register with any number eg OUT 191, 85 and then reading the Status register should now produce the value 3. This means that data has been transmitted and the receive register is now full. When the receive register is read, IN 255, it should contain the transmitted number 85.

Parallel ports can be tested by setting up the control register for the required configuration as shown in Table 2. (Note that Port C can be split into two 4 bit sections which can either be In or Outs). Data can then be read from, or written to, Ports A, B and C using IN and OUT instructions.

## Applications

A simple program which illustrates the possibilities of the MIDI is shown in Figure 4a. Firstly, the ACIA is reset and configured (lines 10 and 20). A program number is requested (line 30) which is variable 'n'. The number 192 (C0Hex) is then output to the transmit register which is the code for a program change (see MIDI Data Format), and then the program number, n, is output which will change the program of the instrument connected. Line 60 makes the program jump back to line 30 for another selection. This illustrates how easily voice changes could be incorporated into a sequencer program or a string of voice changes could be stored and stepped with a footpedal.

A second example which demonstrates the exciting possibilities of the MIDI is shown in Figure 4b. This is a machine code routine which waits for a program dump from the Prophet 600 and then converts the incoming data from 32 four bit nibbles into 16 bytes of program data as shown in Table 3. This data could be displayed, edited or printed as required.

The routine checks for 240 (System Exclusive Status), then 1 (SCI's ID number) then 2 (Prophet 600 program dump) before loading the program number and program data. When an end of block code, 247, is detected the control returns to the basic monitor. The program number is written into location 32500 followed by 16 bytes of data.

Analogue synthesisers may be added to the system by connecting ADC and DAC converters to the I/O ports as described in the MicroMusic articles November '82 and January '83.

Synchronising the system from an external clock is also possible using Port C and sending the required System Real Time codes when the relevant edge is detected.



Spectrum, MicroMIDI and Prophet 600 test set-up.

```

10 OUT 159,86
20 OUT 159,86
30 INPUT "Program Number? ";n
40 OUT 191,192
50 OUT 191,n
60 GO TO 30
    
```

Figure 4a. Sample program allowing synthesiser program changes.

```

7000 ORG 32400
7E90 DBDF TEST IN A, (223)
7E92 CB47 BIT 0,A
7E94 28FA JR Z,TEST
7E96 DBFF IN A,(255)
7E98 C9 RET
7E9C 21F47E START LD HL,32500
7E9E CD907E CALL TEST
7E9F FEBF CP 240
7EA1 20F6 JR NZ,START
7EA3 CD907E CALL TEST
7EA5 FE01 CP 1
7EA7 20EF JR NZ,START
7EA9 CD907E CALL TEST
7EAB FE02 CP 0
7EAD 20E8 JR NZ,START
7EAF CD907E CALL TEST
7EB1 CD907E LD (HL),A
7EB4 77 INC HL
7EB6 20 CALL LOOP CALL TEST
7EB8 FEB7 CP 247
7EBA C9 RET I
7EBC 4F LD C,A
7EBD CD907E CALL TEST
7EC0 C827 SLA A
7EC2 C827 SLA A
7EC4 C827 SLA A
7EC6 C827 SLA A
7EC8 81 ADD A,C
7ECC 77 LD (HL),A
7ECA 23 INC HL
7ECB 18E9 JR LOOP
    
```

```

10 OUT 159,86
20 OUT 159,86
30 CLEAR 32399
40 FOR a=32400 TO 32460
50 READ n: POKE a,n
60 NEXT a
70 DATA 219,293,203,71,40,250,
819,255,201,33,244,126,205,144,1,
206,254,240,32,246,205,144,126,205,
4,1,32,239,205,144,126,254,2,32,
332,205,144,126,119
90 DATA 35,205,114,126,254,247
100,200,79,205,144,126,203,30,203,0
3,203,39,203,39,129,119,35,24,23
60 PRINT USR 32409
    
```

Figure 4b. Machine code routine which reads a Prophet 600 program dump into memory.

Now that SCI, Roland, Korg, Yamaha and Moog have all agreed to adopt the MIDI we shall no doubt see some interesting software appearing for home computers. Now is the time to join the MIDI revolution.

E&MM

## MICROMIDI PARTS LIST

Resistors — all 1/4W, 5% carbon film

R1,2	680R
R3	470R
R4,5	100R
R6	1k

Capacitors

C1	1nF polycarbonate
C2	47uF 25V PCB electrolytic
C3,4	100nF polycarbonate

Semiconductors

D1	1N4148
IC1	74LS04
IC2	MC6850P
IC3	74LS11
IC4	74LS27
IC5	INS8255
IC6	TIL 111

Miscellaneous

SK1	2 x 23 or 28 way connector
SK2,3	5 pin PCB mounting socket
SK4,5,6	10 way Minicon latch plug
X1	2MHz crystal
SW1	Click switch, push to make
	40 pin DIL socket
	24 pin DIL socket
	14 pin DIL socket
	8 pin DIL socket

The PCB for the MicroMIDI is available from E&MM, 282 London Road, Westcliff-on-Sea, Essex SS0 7JG at £4.25 inc. VAT and P&P. Please order as: MicroMIDI PCB.





## Construction and Operation

The tuner is based on a quartz crystal oscillator running at 3.579545 MHz. Internally it's very neatly constructed, all of the components being mounted on one double sided PCB. The three miniature push-buttons are raised above this on their own miniature PCB.

The digital processing is done inside a large 72-pin flat pack LSI chip, which uses the crystal as a reference. Many of the other components, such as the meter and LED display, appear to be custom-designed for Roland.

## In Use

The tuner is used in conjunction with acoustic instruments via the built-in condenser microphone. Although this should ideally be held near the soundboard or strings of an instrument, it in fact works at quite a distance provided that there is not too much background noise.

For electric or electronic instruments there are a pair of jack sockets for input and output on one end of the tuner. Passing the sound through the tuner causes no distortion or loss of volume, so the unit can be left on or off as desired while playing.

The Tuner is reasonably fast to use, highly accurate and, what is more important, highly visible. It's pocket-sized, operates from a PP3 battery, and is well constructed. The TU12 is not cheap, but if you need a reliable tuner — and most working musicians do — it will give good value for money.

**E&MM**

*The Boss TU-12 Digital Processing Chromatic Tuner is distributed by Roland UK, Great West Trading Estate, 983 Great West Road, Brentford, Middlesex TW8 9DN. Tel. 01-568 4578, and has a recommended retail price including VAT of £49.00.*

# Boss TU-12 Tuner

Roland have now applied microprocessor technology to the humble tuning aid, the result being a versatile and accurate device ideally suited for stage conditions.

In addition to an 8-LED note display, the TU-12 features a moving coil tuning needle matched with another pair of LEDs indicating sharp or flat signals.

## Pitch Selection

The LED display has several functions, the first of these being overall pitch selection. After the unit is switched on, the 'Pitch' button should be held down and the adjacent 'Down' and 'Up' buttons used. These allow selection of A=440, 441, 442, 443, 444 or 445 Hz. Once the Pitch button is released the figure selected becomes the reference standard for the unit.

## Chromatic Scale

The power switch has three positions, Off, Guitar, and Chromatic. In the Chromatic scale mode, all the segments of the LED

display are in use. These are C, D, E, F, G, A, B, and a Sharp indicator. The LEDs show the nearest note while the meter gives a more accurate reading from A=440 plus or minus 50 cents.

## Guitar Scale

With the power switch in the 'Guitar' position, the first four LEDs represent E, A, D, G (for Bass guitars) and the fifth and sixth B and E (for 6-string guitars). In the Guitar mode, the 'Up' and 'Down' buttons are used to step the display along these positions until the string to be tuned is reached.

## Meter

The meter on the left of the unit covers a range of plus or minus 50 cents, or 10 Hz. An arrow-shaped LED to the left of the meter indicates that the sound being input is slightly flatter than the note indicated on the LED display: another LED to the right indicates that it is slightly sharper. When both LEDs are illuminated the sound is in tune, with further visual confirmation being given by the meter.

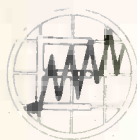

**Electronics & Music Maker**

**Make sure of your copy every month!**



Have E&MM reserved or delivered by your local newsagent.

Please deliver/reserve a copy of Electronics and Music Maker for me each month.

Name .....

Address .....

# Southern Music

THE SUSSEX KEYBOARD CENTRE FOR

**SEQUENTIAL CIRCUITS inc** **moog**  
**Roland CASIO** **YAMAHA**

**RHODES, KORG ★ SIMMONS DRUMS ★**

OVER 50 KEYBOARDS ALWAYS IN STOCK

Just a few of our keyboards:

Pro-one .....	£339	Roland SH101 in stock	£249
Prophet 5, one left .....	£2200	Polysix .....	£945
Poly Sequence .....	£775	Poly 61 .....	POA
Moog Rogue .....	£199	Yamaha CS70 .....	£1799
Moog Opus .....	£535	Yamaha SK30 .....	£1099
Moog Source .....	£645	S/H Yamaha CS15D .....	£399
Memory Moog, last one	£2500		
Roland Juno 6 .....	POA	<b>Prophet 600 now in stock</b>	
Roland Juno 60 .....	POA	<b>Phone for Special Prices</b>	

**AMPLIFICATION — MARSHALL MAIN DEALER, CARLSBORO, PEAVEY, SESSION AMPS V-AMP HH ROLAND FENDER, OHM & PRO-AMP MASSIVE SELECTION OF EFFECT PEDALS AND RHYTHM BOXES INC. THE KIT AND CLEF BAND BOX**

Over 100 new and used Guitars in stock —

**GIBSON — FENDER — ARIA — WESTONE — IBANEZ — SQUIER — TOKAI — and many more. Phone for prices!**  
 E.G.: S/H Mesa Boogie 1x12 + Graphic £595 — Rickenbacker 360 Semi Stereo, black, inc. case £480 — Les Paul Custom, Wine, inc. Case £395

Largest stockist of new and used group gear in Sussex — and don't forget our Disco Department!

You owe it to yourselves to give us a try before you buy!  
 Instant credit up to £1,000. Mail order. P/ ex.  
 Access, Barclaycard. We buy for cash.

**40/41 CASTLE STREET  
 WESTERN ROAD, BTN. 733387**



# AUDIO VISUAL STUDIO

10 Baddow Road,  
 Chelmsford, Essex.  
 Tel: 356218



Recently opened behind the Future Music Store we proudly introduce our new 24 track audio-visual studio. Built to the highest standards we have strived to produce a comfortable environment in which to experiment with state of the art audio-visual technology. The separate control room is equipped with the latest Soundcraft 24 track audio recorder and desk with the addition of 16 channel computer mix down. Master machines are by Studer, with cassette copying by Nakamichi decks. Monitoring is by JBL 4343 and we have a host of 19" rack equipment for you to try from Lexicon Digital Reverb, Roland and Eventide digital delays to vocoders, flangers, and phasers etc. For video monitoring we have 8 Barco Monitors (2 are multistandard) 3 JVC monitors and a brand new Sony VO-U-Matic electronic edit system, with a lock to our audio machines. Cameras are Ikegami, Sony and Hitachi, genlocked together through vision mixers with special effects generators. The downstairs studio is a comfortable 30' X 15' size with a large separate drumbooth giving variable dry or live acoustic environments. Microphones are by Neumann, AKG, Electrovoice Sennheiser and Shure and we are now using the revolutionary Crown SPL reflecting mikes when required. We also offer excellent in studio auxiliary equipment completely free of charge. These include a Yamaha CP80 piano, Roland JPB, Prophet 5 synths, Roland Jaz chorus, built amps and various guitars and drums/percussion as required. For electro-music sessions we are pleased to offer Linn drums, Roland TR808, MC4 with system 100M and the fantastic CMI computer system. Audio recording rates start at £20 per hour (block bookings more than 4 hours) or regular rates £30 per hour (+10% after 12 pm). Our resident studio manager Mo Whitlam will be pleased to take bookings or offer advice, call Chelmsford 356218 now. Opening offer £150 for 10 hours recording! (plus tape and VAT). Never has such advance facilities been available at such a bargain price! Book now while special opening offers are still available!

## CAN YOU AFFORD TO IGNORE THE VIDEO REVOLUTION?

More than ever, Management, Record Companies, Agencies and Club Owners, need to evaluate your visual potential as well as your musical ability. With only an audio demo, you could easily get passed over. This is where we can help you.

One of the advantages of modern video is that sound and vision can be concentrated on separately, and independently. Either build a good stereo audio master first, and dub on a milled video sequence (the most popular method). Or record the audio and visual tracks together, in the studio or at a live gig. The latter method, although far quicker and cheaper, leaves no room for editing mistakes, and limits final editing. By treating the two media separately you are free to enjoy the spectacular effects that are available from modern audio-visual studio techniques. We have the latest Sony VO 5850 P. U-Matic editing equipment, making possible frame by frame resolution, perfect still frame, varispeed forward/reverse, and of course stereo sound capability.

For normal work we use three genlocked cameras (Professional Sony DX 1800) through a vision mixer capable of all standard effects, such as superimpose, wipes, and chroma-key. Plus a Chromascope special effects generator, for those starting colour enhancement and graphics. Why not call now, and view a special Future Music promotional video and see for yourself. Or write for a copy (enclosing £15 returnable deposit, and stating Beta, V.H.S. or U-Matic Low Band).

**SPECIAL OPENING OFFER — VIDEO RECORDING £150 Per Day + Tape + VAT. All In!**



# Gigsounds

85/88 MITCHAM LANE, STREATHAM, LONDON SW16

Tel: 769 5681 — Access & Visa welcome — Instant Credit

**THE KEYBOARD CENTRE: TEL. 01-769 6496/5681**

UP TO £1000 INSTANT CREDIT AVAILABLE

(subject to status)

ACCESS & VISA

WELCOME

MAIL ORDER — ANY ITEM



**Roland**

We are a ROLAND Main Dealer and carry huge stocks, at the best prices, telephone for a quote before you buy.

**ROLAND PACKAGE DEAL:**  
 SH101 MONO SYNTH + SEQUENCER  
 DRUMATIX RHYTHM BOX  
 JUNO 6 POLYSYNTH  
 SUPERDEAL PRICE £1,065



If you want a MOOG product we've got it!  
**MOOG SUPERDEAL —**  
 ROGUE 2 VCO MONOSYNTH £199

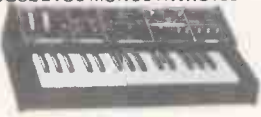

**Yamaha PF**

FM Sound Price Breakthrough

**YAMAHA**

Now in stock the exciting new range of YAMAHA digital FM synths at an affordable price.

CE25 DIGITAL POLY ..... £999  
 CE20 DIGITAL POLY ..... £849  
 PF15 DIGITAL PIANO, new ..... £949  
 GS2 DIGITAL SYNTH, ex-demo, one only ..... £2,850

**YAMAHA SUPERDEAL**  
 SK10 POLY + CS5 MONO SYNTHS  
 SUPERDEAL PRICE £499

**CASIO**

CT7000 now in stock

featuring digital

multi-track recorder

MT 41 ..... £899

MT 45 ..... £99

MT 65 ..... £149

MT 70 ..... £199

PT 30 ..... £69

PT 20 ..... £49

CT 405 ..... £275

CT 501 ..... £325

CT 1000P ..... £325

# Drumulator

WE ARE THE LONDON AGENTS FOR THE AMAZING 'DRUMULATOR' — £985. A DIGITAL DRUM MACHINE WITH ALL THE FACILITIES OF UNITS COSTING 3 TIMES ITS PRICE.



# TASCAM

TEAC Production Products



WE ARE SOUTH LONDON'S MAIN TASCAM AGENT AND HAVE IN STOCK A COMPLETE RANGE OF HOME RECORDING EQUIPMENT. We can also offer expert advice on recording and setting up your own studio because we have our own 16 track studio situated in the basement of the shop.

TASCAM 34 4 track ..... £875  
 TASCAM 38 8 track ..... £TEL  
 TASCAM 22-4.4 track ..... £799  
 TASCAM 22-2.2 track ..... £395  
 TASCAM 244 Portastudio ..... £TEL

**KORG**



WE ARE A KORG KEY CENTRE AND HAVE IN STOCK ALL THE GREAT NEW SYNTHS.

KORG MONOPOLY now only £550

KORG POLY 61 in stock £995

KORG KPR77 rhythm box £419

KORG PACKAGE SUPERDEAL

MONOPOLY 4 VCO POLYSYNTH +

KRP77 £949 (RRP £1,199)



**SUPERDEAL: SAVE £1's**  
 DR RHYTHM DRUM BOX,  
 CASIO MT 41 POLY KEYBOARD  
 MOOG ROGUE SYNTH £365

**GIGSOUNDS MAY SUPERDEAL**  
 DRUMULATOR  
 KORG POLY 61 or ROLAND JUNO 60  
 HARD CASE for SYNTH  
 TOKAI SPRINGY SOUND GUITAR  
 1 day 16 track studio session  
 SUPERDEAL PRICE £2,300.

**STUDIO SUPERDEAL**  
 244 PORTASTUDIO, BOSS DM2 DELAY,  
 ATM 41 MICROPHONE, ACCESSIT  
 NOISEGATE  
 OR EQUALIZER UNIT £829.

**86/88 MITCHAM LANE, LONDON SW16  
 LONDON'S BIGGEST SYNTHESIZER STORE!**

# MOVEMENT

Sole London Agents for Movement Drum Computers. Tel. to arrange a demonstration. £2,300.





# AMERICA

The new Ripley guitar has enough pickups, selector switches and balance knobs for six guitars and as the sound is spread or divided between two or more amplifiers it's easy to tell why. Each string has its own pair of humbucking pickups on the neck and bridge. A separate pickup selector switch for each string turns on either one of the pickups, or both of them. Each string also has its own balance knob so that, treating the strings as six separate entities, a stereo mix can be created on the guitar. Further, a master pickup selector switch shifts between the front six and the back six pickups.

"You can set up a mix just like a studio engineer; only the things you are mixing are the six strings," explained Steve Ripley, who has been a recording engineer for five years and a guitarist who toured with Leon Russell and Bob Dylan.

Using both his on-the-road performing experience and his in-the-studio technical experience, he spent four years developing the guitar which was first introduced to dealers at the National Association of Music Merchants show early this year. "My first prototype had a different amp for each string," he said. "Then I realized you could get the same sound panning with two amps. It's a much bigger sound than on a standard guitar yet it can be as subtle as you want it to be. You can spread the sound just a little bit, or it can be spread with some strings only coming out of the left and some only out of the right so as you play it sounds like two guys playing. You can even bounce back and forth."

Ripley went through eight different prototypes before, with the help of Bill Bartolini who wired the pickups, he developed a model that met his demands. "I'm taking orders now but it'll be summer before I'm ready to start shipping guitars," he said. "The first 10 are to be used as demonstrators." Three of those demonstrators already are in the hands of musicians — J. J. Cale, Santana and the guitarist with the orchestra on television's Tonight Show. "The reception it got at the NAMM show was really great," Ripley said. "Everybody loved it." However, the price is certain to keep it out of the hands of everyone except professional guitarists — \$2,000.

"But all the synthesizer prices start at \$2,000," Ripley points out. And because of the sound possibilities he prefers to compare his guitar with synthesizers rather than with other guitars.

"It is a high priced guitar," he admits. "But it's not meant to be a trick guitar. It's a great guitar. The neck is great; the wood is great; the finishes are great. And it has a real stereo pleasing sound. It's more pleasing from having the spread. When you put part on the left and part on the right, it fattens up the sound. I just love this guitar," Ripley said. "It's a guitar that came from my heart."

Along more traditional lines, with just two pickups, comes the new Model HH-555 Daion handcrafted electric guitar. It features two high-output Power Pulse pickups with a coil-tap switch for each pickup, through-the-body stringing, a side-lock brass bridge, a E&M MAY 1983



Roland SH-101 synthesiser.

'negative' bottom for a stronger shell cavity and improved overall balance and a specially designed centre block. That block is made with three piles — one dense layer of maple sandwiched between two thick, softer layers of solid spruce — and features 10 'sound grooves' which are routed at either end to add resonance. The Daion HH-555 is available in five finishes: gold, brown, burgundy, honey sunburst and tobacco sunburst.

## Peavey Guitars

A new electric bass and three new electric guitars have been introduced by Peavey. The Peavey Foundation Bass, a full 34-inch scale maple body bass, features a neck with an ultra-thin width, eight-inch fingerboard radius and specially contoured back. Each single coil pickup is curved to the radius of the fingerboard and when both pickups are combined a hum rejection circuit acts to cancel unwanted hum and noise. Each pickup also has its own independent volume control. And because all controls are rear mounted there is no need for a pickguard, creating a cleaner appearance.

The distinctively shaped Peavey Mystic and Razer electric guitars feature bi-laminated maple necks, two high output dual coil pickups with dual/single coil circuitry, a master volume control, tone controls for each pickup and a fully adjustable bridge saddle for improved string compensation and intonation. Both guitars are also available with Peavey's Octave Plus Tremolo system for creating pitch altering effects from as little as a quarter step to a full octave below the normal tuning of the guitar plus return to pitch.

The new Peavey Horizon guitar has the same features but has a more traditional sleek contoured body with the upper and

lower cutaways being carved deeper into the maple body for full access to the 23 fret neck. Like the Foundation, Mystic and Razer, all controls are rear mounted through the body, eliminating the need for a pickguard.

## Accessories

A guitar pickup that attaches above the strings has been introduced by Strad-O-Mike. The pickup straddles the strings, resting on cloth pads. This, according to the manufacturer, eliminates the vibration feedback associated with conventional in-the-hole pickups and also eliminates the need to retune the guitar when the pickup is installed or removed.

A new wireless guitar system has been introduced by Telex Communications. Only 70mm x 102mm x 25mm in size and 153 grams in weight, it has a 400 meter operating range from its flexible wire antenna and 9-volt battery power. Controls on the Telex WT-100 include an on/off switch, battery test switch and a screwdriver adjustable audio level control.

Telex also offers a wireless handheld transmitter microphone for music performers. The WHM-400, which has a 300 metre operating range, is an integral cardioid dynamic microphone with a vocal tailored response and features a screwdriver adjustable audio level control.

Pearl continues to expand its catalog of effects pedals, the latest being a 'heavy metal' pedal, the Distortion DS-06, which has been added to its Sound Spruce Series. The DS-06 is designed to create both 'heavy metal' effects and normal distortion sounds by means of four controls — Spectrum Mode, Spectrum Level, Out Level and Distortion. The Spectrum controls create the unique 'heavy metal' effects by adding



higher partials to the fundamental distortion tones. The Spectrum Mode selects the overtones, with a clockwise turn of the control producing higher partials. The Spectrum Level determines the volume of the overtones. The Out Level controls the effect's output level and Distortion controls normal distortion sounds, with a clockwise turn of the knob increasing the level of distortion. The suggested retail price of the DS-06 is \$127.

Sessum, which has been custom designing pedal boards, is now making some of its efforts available to the general public. One of these is its small Travel Board, TB-1100, which was designed for Tommy Tedesco. It includes a tuner/effects switch and holds up to six effects and a medium sized pedal. Yet the board easily slips under a plane seat.

The CB-1200 Club Board holds two medium sized pedals as well as 10 or more effects and features a tuner/effects switch and a preset switch. The SB-1400 Studio Board accommodates the large number of effects required for studio performance. In addition to the tuner/effects and preset switches, the SB-1400 includes a remote feature for outboard effects.

## Synthesiser

A compact, battery powered monophonic synthesizer, the SH-101, that gives a keyboardist the same freedom as a guitarist has been introduced by Roland. Synthesiser functions of the SH-101 include a dual waveform VCO, a sub-oscillator, LFO modulation, noise generator, VCF with key follow and a VCA switchable to either gate position or an envelope position which engages the ADSR. Portamento can be either normal-on, or an auto setting which adds portamento when the keyboard is played legato.

In addition to the normal synthesiser functions, the SH-101 contains an arpeggiator with three directions of arpeggio controlled either by the internal LFO or an external clock pulse and also contains a 100-step sequencer which can either be controlled internally or synced to such other Roland products as the TR-606 Drumatix for even greater applications. Other features include key transpose, a built-in headphone amp, CV and gate inputs and outputs and



Shure PE5 dynamic microphone.

overall tuning control. The list price of the SH-101 is \$495.

## Shure Mics

Shure Brothers has expanded its PE (Professional Entertainer) Series of dynamic microphones with the introduction of the PE5, a light weight and economically priced microphone designed for younger musicians who are purchasing their first microphone. Its cardioid pickup pattern and frequency response is tailored for both instrumental and vocal pickup, providing, according to Shure Brothers, a vibrant and penetrating sound that is both clear and distinct.

The PE5 comes with an attached 4.6 meter cable, an on-off switch, a professional

accessory swivel adaptor, an internal rubber shock mount and a pop-filter grille assembly. Its construction of Armo-Dur, a shock-resistant material, provides additional ruggedness and durability.

The Shure PE5 is available in two versions: PE5 H-C (high impedance with a phone plug at the cable's equipment end) and PE5 L-CN (low impedance with a professional 3-pin connector at the cable's equipment end).

Shure also has introduced a new eight input microphone mixer, the M268, which has been designed for optimum effectiveness as a submixer for rock, jazz and country music groups. Thus it allows musicians to inexpensively expand the capabilities of their mixing boards.

"The M268 is also an ideal mixer for electronic keyboard players, since it provides a high-impedance output for the onstage amplifier, plus a low-impedance output to feed the main board," explained Michael Pettersen, Shure's Assistant Marketing Manager for Circuitry Products.

The M268 has a high-impedance and a low-impedance jack on each of its four main input channels and also has an auxiliary input channel for tape recorders or other high-level accessories. Other features include individual feedback-type gain controls for all five input channels, a master volume control, simplex (phantom) power for condenser microphones, a mix-bus for simple mixer interconnection and an automatic muting circuit that prevents speaker damage during turn-on and turn-off.

**E&MM**

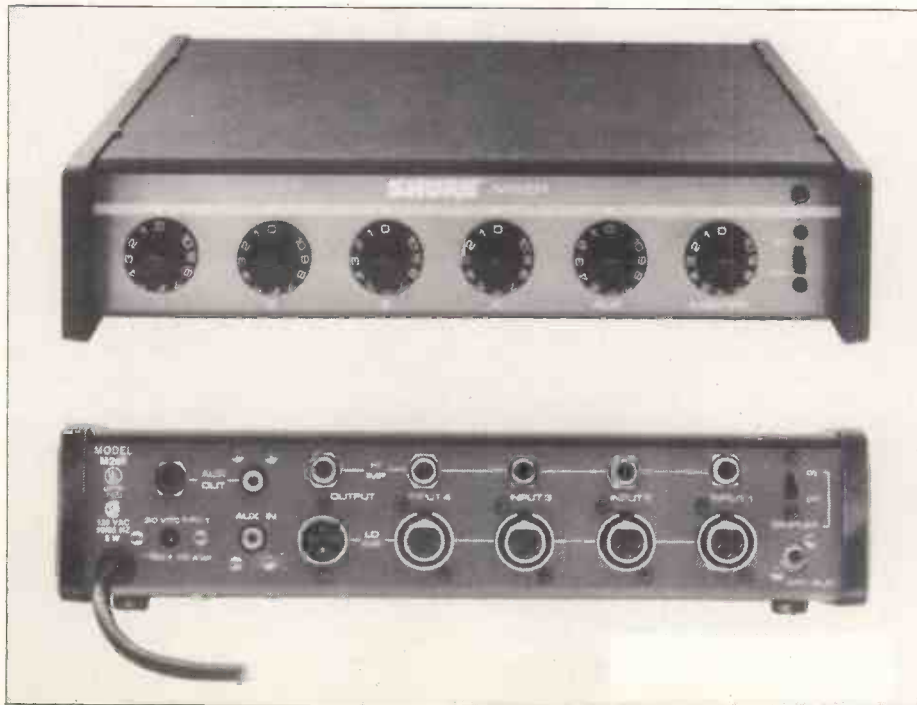
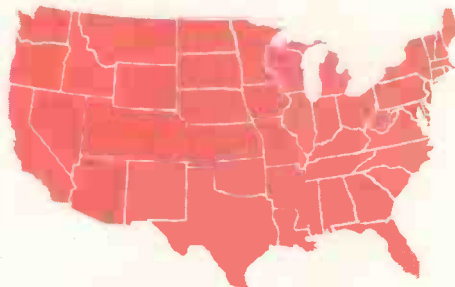

Shure M268 microphone mixer.

### Manufacturers and companies mentioned

Daion Guitars, MCI Inc., P.O. Box 8053, Waco, TX 76710.

Pearl Electronics U.K., Unit 8, New Road, Ridge-wood, Uckfield, Sussex TN22 5SX.

Peavey Electronics Corp., 711 A Street, Meridian, MS 39301.

Ripley Guitars Inc., 616 South Sunset Cyn Drive, Burbank, CA.

Roland UK, Brodr Jorgensen Ltd., Great West Trading Estate, 983 Great West Road, Brentford, Middx.

Sessum, P.O. Box 16361, Irvine, CA 92713.  
Shure Electronics, Eccleston Road, Maidstone ME15 6AU.

Strad-O-Mike, P.O. Box 921, Yuba City, CA 95991.

Telex Communications Inc., 9600 Aldrich Avenue South, Minneapolis, MN 55420; La Bonaparte, Office 711, Centre Affaires Paris-Nord, 93153 Le Blanc-Mesnil, France.



# PIANO 73

The fabulous new Electric PIANO 73 from Jen sets new standards in contemporary keyboard design and brings modern electronic technology to a full piano keyboard layout.

Features include:—

- ★ Chrome Stand
- ★ 6-Octave Keyboard
- ★ 4 Realistic Voices:
  - Piano Bright — Piano Mellow —
  - Clavichord — Spinet



**£299**

- ★ Vibrato with variable depth
- ★ Built-in Phaser with variable speed
- ★ Powerful 20W Amplifier
- ★ Headphone Output
- ★ Sustain Pedal

# SYNTHETONE SX-1000

Reviewed in the September 1982 issue of E&MM



**£196**

THE SYNTHETONE SX-100 is the result of an extensive research programme aimed at producing a light, compact and simple to operate synthesiser with the latest LSI technology at an amazingly low price.

It has all the main features of the most sophisticated professional synthesisers and its controls are logically arranged and colour-coded for easy identification and playing simplicity.

The digital technology used provide the SYNTHETONE SX-1000 with a dependable accuracy, high tune stability and reliability under the most demanding circumstances.

It also means the combination of new standards of performance with minimum and easy servicing.

### Specification:

37-note **KEYBOARD** C to C.

**TUNE:** Master tuning for setting pitch to other instruments. Adjustable + ½ tone.

**OCTAVE SELECTOR:** For setting range of the keyboard at 32', 16', 8' or 4'.

**WAVEFORM SELECTOR:** For choosing the sound waveform among Sawtooth, Square and Pulse Width adjustable from 5% to 50%.

**PWM (Pulse Width Modulation):** It gives you automatic modulation on the pulse width and creates chorus, phasing and many other fabulous effects.

**GLIDE:** For automatic glissando between any two keys depressed. Adjustable speed.

Other **VCO (Voltage Controlled Oscillator)** include Output Level and Vibrato Intensity.

**LFO (Low Frequency Oscillator)** used to control VCO,

**VCF and PWM,** creates tremolo, vibrato, trill and repeated effects. Adjustable rate.

**NOISE GENERATOR** with white/pink switch and level control. It enables you to obtain wind, thunder, surf and other exciting effects.

**VCF (Voltage Controlled Filter)** changes the timbre of the sound by adding, subtracting or enhancing harmonics. Rotary controls adjust Frequency, Resonance, LFO Intensity and Envelope Level. The **ADSR (Attack, Decay, Sustain and Release)** controls will enable you to obtain the exact effect you are seeking. **VCA (Voltage Controlled Amplifier)** with **ADSR (Attack, Sustain, Decay and Release)** controls will allow you to shape the volume of the note for percussive or any other effect which you require. Additional rotary control (Output Volume) adjusts the overall volume.

Jen Products are available from all good music shops and stores

*British Music Strings Ltd*

Pontywindy Industrial Estate, Caerphilly, Wales CF8 3HU.

Telephone: Caerphilly (0222) 883904 all lines.

# INTRODUCING THE MIDI

In less than two decades the music synthesiser has developed from its monophonic origins into a fully integrated microprocessor controlled instrument. During this time manufacturers have all had their own ideas of how control voltage and/or trigger signals should be implemented. This has made it almost impossible to interface directly between different machines, without some form of conversion circuitry to cope with incompatible signal levels or polarities.

The fabrication of integrated circuits dedicated to electronic music production by Solid State Music (SSM) and Curtis Electro-Music (CEM) has helped this situation. Control voltages of 1V/Octave and positive going triggers between 5 and 15V have become the standard for any manufacturer using these devices. However, this does not help in the case of the current microprocessor controlled polyphonic machines. The complex algorithms used prohibit direct connection and each manufacturer again tends to produce dedicated interfaces which connect to his own specific controllers.

The problems of compatibility along with the advent of the home computer, providing its musically creative possibilities, has forced instrument manufacturers to finally make their products comply to an industry standard specification and thereby protect their equipment from obsolescence.

The Musical Instrument Digital Interface (MIDI) is such a specification, which has been developed by leading manufacturers in the last few years. It does not dictate instrument design but merely specifies a language which carries meaningful information between instruments.

What does this all mean to the musician? The purpose of the specification is to allow synthesisers, other electronic keyboards, sequencers, drum machines and home computers to be linked in one programmable system. Useful lifetime of equipment is therefore also multiplied. Some of the exciting possibilities are as follows:

Synthesisers can be configured 'in parallel' with instruments played simultaneously or remotely.

Entire compositions, consisting of monophonic and polyphonic sequences and rhythm can be played at a touch.

Computer terminals can be used for composing, sequence creation and editing.

Graphic quality printers can produce the 'hardcopy' manuscript of an improvisation or composition.

Video synthesis can be integrated with music synthesis.

Musical education such as reading music, scale recognition, and ear training can be automated.

## History

### SCI Digital Interface

Sequential Circuits Inc first became interested in microcomputer interfacing in conjunction with the design of the Prophet-10 polyphonic and its internal polyphonic sequencer. The Prophet and its sequencer each were based on Z-80 microcomputers. To record, as notes were played, every few milliseconds (at a rate set by the sequen-

cer clock), the Prophet would send its complete keyboard 'status' to the sequencer. The sequencer had to figure out which notes were going on and off, and record these events in reference to the clock count. On playback, the sequencer computer also sent the complete keyboard status every clock pulse, with events as counted out by the clock. The Prophet would play these notes just as if they came from its own keyboard. Later, this sequencer was made available as an accessory for the Prophet-5. The Prophet-5 Remote Keyboard was also developed which used this interface. SCI published the data protocol upon which this interface was based, in the hopes that the programming public would be encouraged to develop their own interfaces for the Prophet-5.

This did not occur, apparently because in being conceived for a specific application, the interface was very fast but too clumsy for general-purpose use. It was criticised as requiring too much programming 'overhead,' in the constant transmission of meaningless keyboard information. As a result of this experience, SCI resolved to pursue a more streamlined interface that would be easier for programmers to work with.

### Universal Synthesiser Interface

In the meantime, occasional discussions between the presidents of Sequential Circuits, Oberheim Electronics and Roland (Dave Smith, Tom Oberheim and Ikutaro Kakehashi) also revealed a shared interest in the interface problem and development of an interface widely acceptable to the industry.

Smith then outlined a specification for a 'Universal Synthesiser Interface' (USI). It was developed with the assistance of SCI's Chet Wood and presented at the Autumn, 1981 convention of the Audio Engineering Society (AES).

The USI differed markedly from the

earlier SCI Digital interface in that rather than being polled at the sequencer clock rate, information was only sent when an event actually occurred - for example, a note going on or off. The USI was proposed to be serial, operating at 19.2 kBaud, with TTL levels, and connected through phone jacks.

After incorporating changes in response to comments from AES, Smith sent a questionnaire to all manufacturers and industry consultants he could find, asking for their suggestions and any special requirements. There was a strong response to this initiative; some saying, for example, that it would not be possible to do it serially, that a parallel interface was necessary. Others thought the proposed serial speed too fast for operation with home computers. Many other issues were raised.

All respondents were invited to a conference in coincidence with the January, 1982, Western National Association of Music Merchants (NAMM) convention in Anaheim. This meeting was attended by representatives from SCI, Roland, Oberheim, CBS/Rhodes, Yamaha, E-mu, Unicord (Korg), Music Technology Inc., Kawai, Octave Plateau, Passport Designs and Syntauri. Other manufacturers seemed to be maintaining a 'wait-and-see' policy.

At this meeting the chief changes which occurred to the USI were to add optoisolation to prevent audio ground loops, and to increase the speed to 31.25 kBaud.

### Japanese Interface Proposal

Following the USI discussion at Anaheim, an alternative specification was presented by some of the Japanese companies which had grown out of their own research. Whereas the USI was basically content to specify note on/off codes, this new proposal went on to define many more complex operations. It also offered a different data structure, with status and data bytes being flagged by bit 7 (1=status, 0=data). This greatly simplified the protocol by eliminating all the checks which were other-

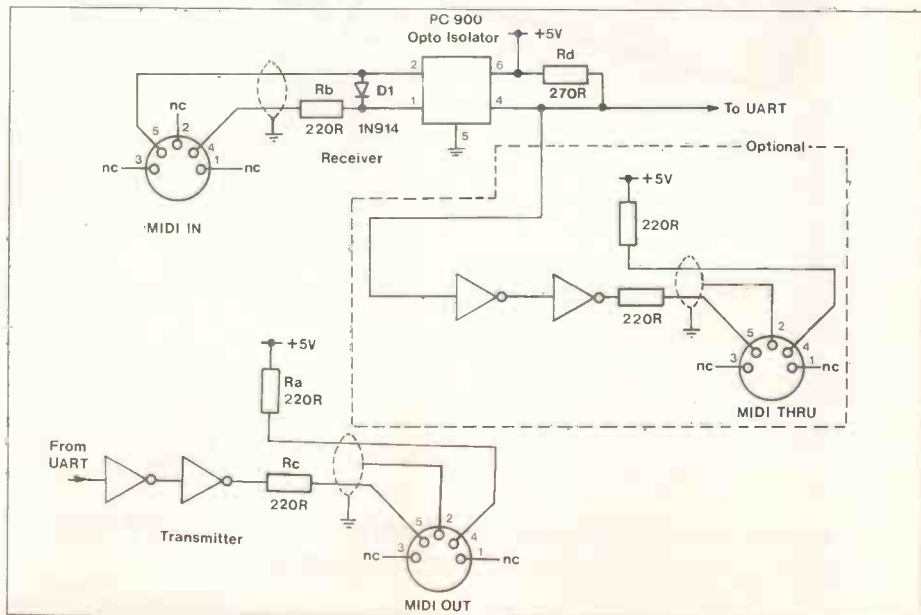

Figure 1. MIDI Hardware Schematic.



wise needed to distinguish the data category. With the most significant bit now defined as a 'flag', data is thereby limited to 7 bits, but this is sufficient for most synth data, and when not, can simply be sent as multiple 4-bit nibbles.

## MIDI

After the Anaheim meeting, Smith and Wood integrated the USI and Japanese proposals, forming the first MIDI specification. This was sent to all of the meeting participants but, curiously, provoked no further comment from this continent. The final document was therefore arrived at after several exchanges between SCl and Roland, which is serving as liaison with Yamaha, Korg and Kawai.

## Hardware

To simplify cabling between instruments, the interface is serial. It operates at 31.25 kBaud (thousand-bits-per-second), asynchronous. This is considered a high speed for serial operation - in comparison to the typical RS-232 maximum of 19.2 kBaud - but was chosen to prevent objectionable delays between equipment. The 31.25 kHz clock can also be easily obtained from hardware, for example, by dividing 1 Mhz by 32. One serial data byte consists of a start bit, 8 data bits (D0 to D7), and a stop bit - for a total of 10 bits transferred in 320 microseconds (us).

Physically, MIDI appears as two or three jacks on the instrument. See Figure 1, the hardware schematic. The connectors are DIN 5-pin (180 degree) female panel mount receptacles. DIN connectors were agreed to by US manufacturers because it was felt that DIN connectors are now widely available here. However, the specification does provide that a manufacturer can use XLR connectors, if the firm makes available all necessary conversion cables.

The two required jacks are MIDI OUT and MIDI IN. The transmitter data typically originates in the instrument's UART. The interface circuit is a 5-mA current loop, designed especially to prevent the formation of audio ground loops which often develop in complex systems. The output is normally meant to drive only one input. If transmit data is low (0), current flows from Vcc (+5V) through Ra, over pin 4 of both connectors, through the opto-isolator, returns over pin 5, then through Rc. The opto-isolator output is normally pulled high by Rd. However, when current flows through the internal LED, the isolator output switch turns on, grounding Vo, thus sending a low to the receiver UART. When data is high, the LED does not light. The receiver UART therefore sees a high. D1 protects the opto-isolator from reverse-polarity currents which may result from transmitter anomalies.

Interconnecting cables should not exceed fifty feet (15 meters), and must have a corresponding 5-pin DIN male plug. The cable should be shielded twisted pair, with the shield connected to pin 2 at both ends. Notice that while the MIDI OUT jack is grounded to the instrument chassis, MIDI IN is not. This allows the cables to provide their shielding services without creating ground loops.

The optional third jack, MIDI THRU, provides a direct copy of data coming in MIDI IN. It is included when the manufacturer intends the instrument to operate in a 'chain' or 'loop' network, as opposed to a 'star' network.

## Modes and Channels

The first thing to realise about MIDI is that the total control features available still depend on the design of each specific piece of equipment. MIDI does not magically transcend equipment limitations or differences. Rather it merely enables them to

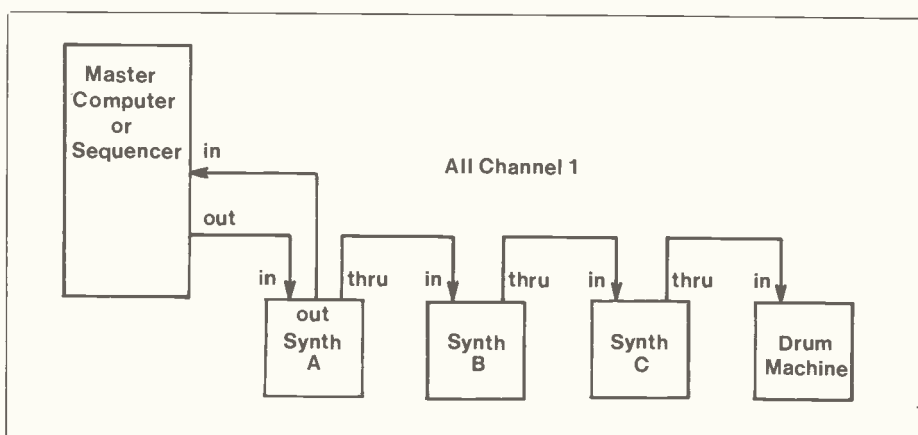

Figure 2. Omni-mode chain network.

'communicate' at their 'least common' level. For example, specific programmed sounds can't be transferred directly between different models of synthesisers because of inherent differences, but keyboard information and program selections can be communicated.

One of MIDI's design goals was to be simple enough so that you could connect any polyphonic synthesiser to any other, or to a sequencer, and at the very least the notes would be correctly played or stored. This would be possible with virtually no other action on the part of the user. Above this minimum, each instrument may or may not include further facilities for complex control options.

Each type of equipment has different minimum requirements. For synthesisers, minimal usefulness seems to include remote control and program switching. While polyphonic sequencers send and receive keyboard data, they may or may not be interested in program changes. Monophonic sequencers can only deal with individual lines, so keyboard data must somehow be different for them. Drum units don't usually care about specific keyboard notes, but may need to synchronise to their timing, or to the sequencer, and perhaps react to program changes as well.

While most of these requirements and useful control options can be foreseen, the number of possible interconnections cannot. Therefore, while the specification says that each transmitter will drive one and only one receiver, provision has been made so that any specific instrument or synthesiser voice on the MIDI bus can be addressed, regardless of the interconnection scheme. This is accomplished by assigning up to 16 channels under increasingly powerful (and complex) modes.

Each unit connected to the MIDI bus has separate transmit and receive ports. There are three modes of operation for transmitters and receivers: Omni, Poly and Mono.

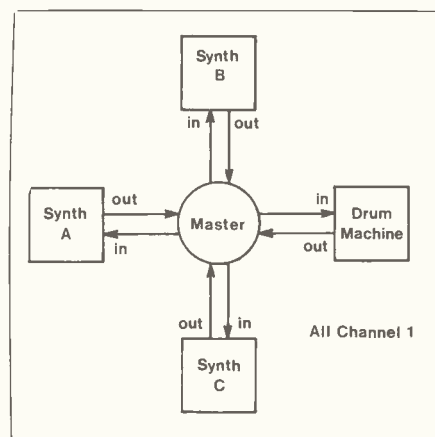

Figure 3. Omni-mode star network.

Omni mode is the most general level of operation, interfacing all units. Poly mode allows each unit (synth, sequencer, or drum box) to be addressed separately. Mono mode is the most specialised, allowing individual addressing of (for example) each synthesiser voice.

Normally, transmitters will periodically send out a Mode Select command for the most powerful mode to which they can be configured. However, the actual data transmitted will be in the mode to which a second transmitter may have switched the receiver. For example, Synth A by default transmits in Omni mode to Synth B. Synth B, being capable of Poly mode operation, periodically transmits Poly Mode Select codes to Synth C. But the data sent from Synth B to C will be in Omni format (because Synth B's receiver is constantly getting Omni Mode Select commands from Synth A). Synth C may or may not respond to the Poly Mode Select commands from Synth B, because if a receiver is capable of operating in the requested mode, it switches to that mode. Otherwise, it ignores the Mode Select command. (Note, the Mode Select commands double as 'All Notes Off' commands, therefore can only be

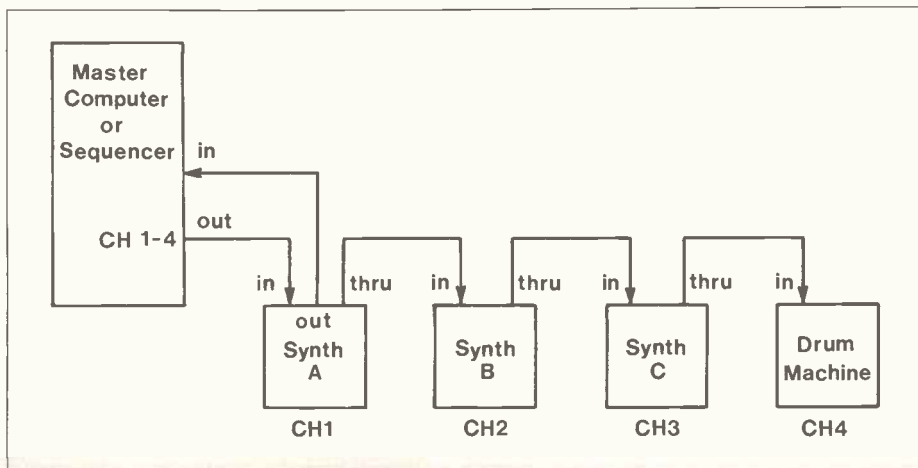

Figure 4. Poly-mode chain network.

sent while all notes are off, or when it is desired to turn all notes off).

### Omni Mode

At power up or reset, all instruments default to Omni mode. See Figures 2 and 3. Regardless of the system configuration, Omni transmitters always send polyphonic data on Channel 1. Omni receivers respond to Note On/Off Events sent over any channel (1-16). These notes are handled according to the internal assignment scheme of the synthesiser. So this configuration allows any number of polyphonic synthesisers to play in parallel, as soon as they are interconnected.

A receiver's mode can only be changed by a Mode Select command transmitted in the channel(s) to which it is currently assigned. If the receiver is not capable of operating in the requested mode, it ignores the Mode Select command. No unit may switch its own modes. Even though a re-

ceiver in Omni mode receives in all channels, it will respond to Mode Select commands in only one channel: the one to which it is assigned.

Receivers and transmitters without channel selection capability are always assigned by default to Channel 1.

### Poly Mode

Poly mode allows individual addressing of each unit. In other words, the master controller can send separate parts to each synth, whereas in Omni mode they all played the same part.

As shown in Figure 4, the master controller in the chained network sends all commands, which are encoded with their destination channel number, over one line. This requires each unit include an address selector switch to define its channel of operation.

The channel definitions having been

made, the master controller must issue the command to the receiver on that channel to switch to Poly mode. Thereafter, the receiver listens for keyboard data encoded with its channel number. Any number of notes can be sent, to which, again, the polyphonic synth will respond according to its own priorities.

Poly mode will be useful for sequencing multi-part arrangements of standard synths, for example, which can't be done in Omni mode.

### Mono Mode

When a synthesiser has Mono capability, and it receives a Mono Mode Select command, it configures itself to receive on the channel it is assigned to and above, up to the number of voices it has. For example, the Prophet-T8 in Mono mode will transmit and receive on Channels 1-8. (Future synthesisers could contain more elaborate channel selection capability).

Channeling each voice provides fast transfer of individual pressure (also called 'after touch') data for each key. It also makes true legato possible, because the note value (=voice pitch) can be changed without having to first turn the note off (as in Poly mode).

## Data Format

There are five categories of MIDI data: Channel, System Common, System Real Time, System Exclusive and System Reset.

Each data category encompasses a number of 'status bytes' which define specific commands under that category, and which precede data bytes which specify the exact operation. Status bytes are distinguished from data bytes according to whether the most significant (MS) bit is set (1=status) or reset (0=data). The status bytes under each category are defined below. Note that any data sets (eg. Note On event data) which are sent successively under the same status, can be sent without a status byte until a different status byte is needed.

Channel information performs most of the routine work. Commands are addressed to specific channels by a 4-bit number which is encoded into the status byte. The associated data bytes can identify keys going down (on) and up (off), their on or off velocities, and pressure or 'after-touch' (on keyboards so equipped).

System Common, Real Time, and Reset information is intended for all channels in a system. System Common information identifies song selections and measure numbers for all units. Real Time information is used for synchronizing everything (perhaps to a master sequencer). Therefore, Channel and System Common information is interruptible by System Real Time information.

System Exclusive information allows the exchange of data which can be formatted as the manufacturer wishes. Only devices which recognise the manufacturer's format will attend the exchange.

Reset simply initialises all equipment to power-on condition.

The five categories are ordered in Table 1 according to their utility.

## Conclusions

The MIDI is one of the most important and powerful developments in electro-music technology. Not only does it allow machines to communicate with each other, but allows the instrument to become a peripheral for a computer system, unleashing the tremendous power that such a set-up can offer.

E&MM

Our thanks to Sequential Circuits Inc., for allowing us to reproduce text from their MIDI specification.

# MIDI DATA FORMAT

### Channel

The most significant four bits of each Channel status byte define the command, while the least significant four bits identify the effective channel.

#### 9xH NOTE ON EVENT

3 bytes: 1001 nnnn + Okkk kkkk + Ovvv vvvv

#### nnnn

Channel code, 0-15. Corresponds to channel numbers 1-16.

#### kkk kkkk

Key number, 0-127.  
For all keyboards, middle C=60. All C key numbers are multiples of 12.  
The standard five-octave synth keyboard ranges 36-96.  
The 88-note piano keyboard ranges 21-108.

#### vv vvvv

Key On velocity, 0-127.  
With no velocity sensors, default to 64.  
With velocity, 1=ppp (softest), 127=fff (loudest).  
Key On velocity=0, turns note off.

#### 8xH NOTE OFF EVENT

3 bytes: 1000 nnnn + Okkk kkkk + Ovvv vvvv

#### vv vvvv

Key Off (release) velocity.  
Implemented on Prophet-T8.

#### AxH POLYPHONIC KEY PRESSURE

3 bytes: 1010 nnnn + Okkk kkkk + Ovvv vvvv

#### vv vvvv

Pressure/After-touch value, 0-127.  
Used in Omni mode. (Compare code DxH, Mono mode)

#### 8xH CONTROL CHANGE

3 bytes: 1011 nnnn + Cccc cccc + Ovvv vvvv

#### ccc cccc

Control address, 0-127.  
Except for the Pitch Bender (0), the controllers are not specifically defined. A manufacturer can assign the logical controllers to physical ones as necessary. The controller allocation table must be provided in the user's operation manual. Continuous controllers (including the Pitch Bender) are divided into Most and Least Significant Bytes. If only 7 bits of resolution are needed for a specific controller, only the MSB is sent. It is not necessary to send the LSB. If more resolution is needed, then both are sent; first the MSB, then the LSB. If only the LSB has changed in value, the LSB may be sent without re-sending the MSB.

0	Pitch Bender MSB
1	Controller 1 MSB
2	Controller 2 MSB
3	Controller 3 MSB
4-31	Continuous controllers 4-31 MSB
32	Pitch Bender LSB
33	Controller 1 LSB
34	Controller 2 LSB
35	Controller 3 LSB
36-63	Continuous controllers 4-31 LSB
64-95	Switches (on/off)
96-123	Undefined
124	Local/Remote Keyboard Control (toggle)
125	Omni Mode Select/All notes off
126	Mono Mode Select/All notes off
127	Poly Mode Select/All notes off
if c=125, 126, or 127, v (see below) must be 0	

#### vv vvvv

Control value, 0-127.  
For mode selections (c=125, 126, or 127), vv vvvv must be 0.  
Pitch benders should range from 0-127, with 64 being centre (no pitch bend).  
Other controllers will range from 0=minimum to 127=maximum. Switches are defined 0=off, 127=on.

#### CxH PROGRAM CHANGE

2 bytes: 1100 nnnn + Oppp pppp

#### ppp pppp

Program number, 0-127

#### DxH CHANNEL PRESSURE

2 bytes: 1101 nnnn + Ovvv vvvv

#### vv vvvv

Channel pressure/after-touch amount, 0-127.  
For Mono mode: channel (rather than key) is identified.

#### ExH UNDEFINED

(SCI uses this status for Pitch Wheel change in the Prophet-600)

### System Exclusive

A format has been defined for System Exclusive information, consisting of a two-byte preamble, the data itself, and a one-byte end code. The purpose of this format is to provide for the transmission of data which may be useful to any two

instruments from one manufacturer but uninterpretable to other MIDI-bussed devices. For example, SCI uses this protocol for loading and dumping program data. System Exclusive information can only be interrupted by a System Reset command.

Format: F0H + 0iiii iiiii + data + F7H

#### F0H

Status byte, Must be followed by manufacturer's ID#

#### 0iiii iiiii

Manufacturers ID#.

iiiiiii can be 0-127

Current ID numbers are:

Sequential Circuits	01H
Kawai	40H
Roland	41H
Korg	42H
Yamaha	43H

Receivers which do not recognise the ID# ignore the ensuing system exclusive data.

#### data

Any number of bytes.  
MSB must be reset. (Otherwise will signal a new status byte). Data can range 0-127.  
Data is intended for all channels.

#### F7H

An END OF BLOCK code which terminates System Exclusive status. SYSTEM RESET will also terminate System Exclusive status.

In no case should other data or status codes be interleaved with System Exclusive data, regardless of whether or not the ID code is recognised.

### System Real Time

The System Real Time codes control the entire system in real time. They are used for synchronising sequencers and rhythm units.

To maintain timing precision, these codes can be sent between any System Common or Channel data sets which consist of two or more bytes. However, the codes may not be interleaved with System Exclusive data.  
System Real Time statuses are intended for all channels and recognised by all units using the interface. If the functions specified are not implemented, they are simply ignored.

#### F8H TIMING-CLOCK-IN-PLAY

This clock is sent while the transmitter is in Play mode. The system is synchronised with this clock which is sent at a rate of 24 clocks/quarter note.

#### F9H MEASURE-END

The MEASURE-END is transmitted instead of the TIMING-CLOCK-IN-PLAY at the end of each measure.

#### FAH START-FROM-1st-MEASURE

This code is immediately sent when the PLAY button on the master (eg. sequencer or rhythm unit) is hit. The first TIMING-CLOCK-IN-PLAY must follow within 5 ms after this code.

#### FBH CONTINUE START

This is sent when the CONTINUE button (on the master) is hit. A sequence will restart from the point where the sequence stopped on the last TIMING-CLOCK-IN-PLAY. The next TIMING-CLOCK-IN-PLAY must be sent within 5 ms after this code.

#### FBH TIMING-CLOCK-IN-STOP

This code is placed in Stop mode to synchronise a Phase-Locked Loop (PLL) which is used (during Stop) for interpolating the timing clock.

### System Common

System Common information is intended for all channels in a system.

#### F1H Undefined

#### F2H MEASURE INFORMATION

3 bytes: F2H + 0mmmm mmmmm (MS) + 0mmmm mmmmm (LS)  
The two data bytes code the 14-bit measure number.

#### F3H SONG SELECT

2 bytes: F3H + 0sss ssss  
The data byte codes the 7-bit song number.

#### F4H Undefined

#### F5H Undefined

#### F6H TUNE REQUEST

Initialises synthesiser tune routines.

### System Reset

There is one system reset code. It initialises the entire system to the condition of just having power switched on.

#### F7H SYSTEM RESET

System Reset should be used sparingly, preferably under manual command only. In particular, it should not be sent automatically on power up. This could cause two units connected together to endlessly reset each other.

Table 1. Data Format.



THE 1983 LONDON

# INTERNATIONAL MUSIC SHOW

Alexandra Palace April 29-May 3

## Everything for the music lover Under one Roof . . .

- 200 STANDS ● 100 BANDS ● DEMONSTRATIONS ●
- CLINICS ● SEMINARS ● COMPETITIONS



Join in the fun with Peter Powell and the Radio One Roadshow  
broadcasting live on Bank Holiday Monday  
Capital Radio Cruiser at IMS Saturday and Sunday

### PLUS

- GIANT FUN FAIR ● EVENING BARBEQUES ● CHILDREN'S PLAYGROUND
- FIREWORKS ● HOT PUNCH ● OUTDOOR BANDSTAND

*You can even take a boat out at this years IMS!*

**THE LARGEST MUSIC SHOW IN ENGLAND**

## TICKETS — TIMES — ENQUIRIES

I REQUIRE FURTHER INFORMATION ABOUT:

- EXHIBITING (STANDS AND STALLS AVAILABLE)
- OUTDOOR SPACE AVAILABLE
- ADVERTISING IN SHOW BROCHURE

DEMONSTRATIONS, SEMINARS & CLINICS

- ACQUIRING A TICKET FRANCHISE
- ORGANISING PERSONAL APPEARANCES
- ORGANISING OUTDOOR EVENTS

PLEASE INDICATE TICKETS WANTED

DATES:		OPEN	CLOSE	PRICE	
A P R I L	FRI 29	19:00	22:30	£1.50	x.....
	SAT 30	10:30	22:30	£2.00	x.....
M A Y	SUN 1	10:30	22:30	£2.00	x.....
	MON 2	10:30	21:00	£2.00	x.....
	TUE 3	10:30	13:00	£2.00	x.....
<b>TICKET VALID EVERY DAY</b>				<b>£5.00</b>	x.....

MY NAME IS .....

ADDRESS/COMPANY .....

TEL ..... TELEX .....

PLEASE ENCLOSE STAMPED ADDRESSED ENVELOPE

I AM ENCLOSING A CHEQUE FOR £.....

# THE ELECTRONIC

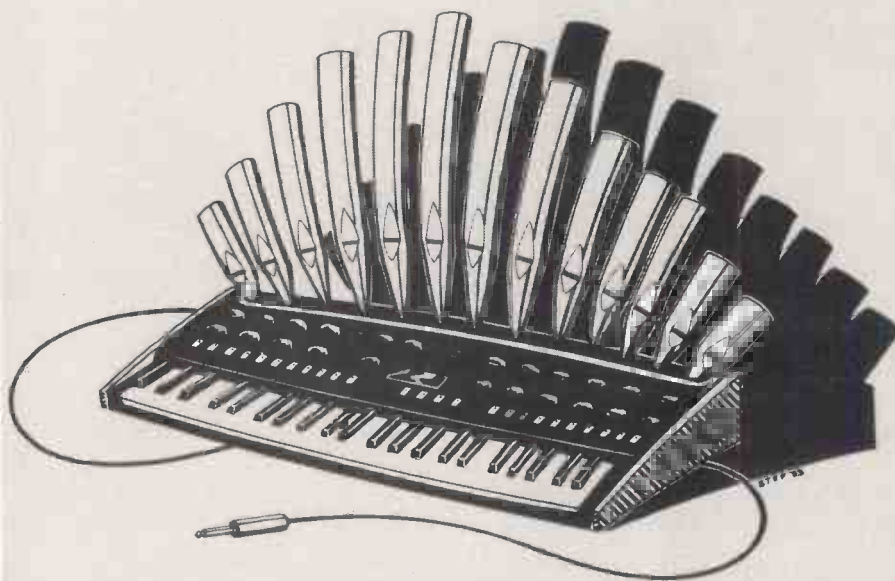

# KEYBOARD

## Part 2

by Alan Douglas

**An historical and technical survey of the development of the electronic keyboard from its origins to the present day. This informative series will be of interest to anyone who has played an electronic keyboard instrument, whether an organ, electric piano or synthesiser, and its practical examples give the electro-music engineer a valuable insight into early music technology.**

We have seen that by 1934, all the valid methods of organ tone production had been exploited, although not all were equally successful. One of the first photoelectric systems, using pre-recorded tracks on photographic emulsions, showed great promise; the German Welte company developed an excellent organ using large coated glass discs, about 3ft in diameter. This allowed them to rotate slowly. Alas, deterioration of the emulsion due to age, dirt and the light from the exciter lamps resulted in a short life, and the advent of the Second World War stopped development. But interest was revived, and Kimball tried the same idea but with modern technology, using tracks etched out on metallic-sputtered glass discs. However, mechanical problems dogged the design and it was abandoned. The Baldwin company also had a photoelectric system out on field trials, but this too came to nothing. So since the early experiments of Eremeeff in 1932 and Toulouse & Midgeley in the mid-thirties, no one has succeeded in bringing the system onto the market. We might note that Mercadier tried a crude form of photoelectric generator in 1890.

The Hammond, Compton and Wurlitzer electro-mechanical generators had so far held sway because they were so much more reliable than other methods. But research under the pressure of war had enormously improved components like resistors and capacitors, and metallurgical advances improved laminations and iron cores in general. The C. G. Conn company introduced a

full-scale 2 manual organ in 1947, with 164 independent oscillators each giving two independent waveforms; the company never departed from this very successful system, as not since the organs of Coupleux & Givélet had such full and rich choruses been produced. However, there is no doubt that the tone forming circuits could have been improved, and it is rather surprising that the Americans did not use any of the tone research pioneered by Frederick Trautwein or Meyer-Epler, or even Oskar Vierling.

Shortly after this the Baldwin company

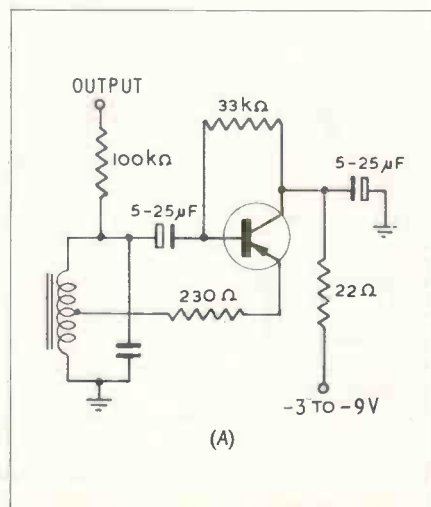

Figure 1. Typical Hartley oscillator for sine waves.

introduced an ingenious *blocking oscillator divider* system. I was invited by the company to examine this instrument in their Cincinnati factory and found they had developed tone shaping circuits almost to perfection. To this day, I believe these circuits, if used with the same waveforms, are unsurpassed. A larger organ soon appeared and the company moved on to other models. Baldwin were the first to devise modulation of selected organ frequencies, 1, 2 or 3 Hz, to produce a random chorus effect. They also pioneered some very effective reverberation systems.

## Home Organs

Wurlitzer were refining their earlier electrostatic reed organs and indeed as pipe organ builders their workmanship was unsurpassed. We should note here that all the instruments so far mentioned were intended for classical or church use. Wurlitzer, however, as pioneers of the cinema organ, realised there was a market for small entertainment organs for the home. They took a step towards this by making all the reeds vibrate continuously, and keying the polarising voltage. This provided a rapid attack, more suitable for popular music. They also fitted a pickup at the tip of the reeds, thus obtaining twice the frequency compared with the pickup above the tongues. All the same, tonal variations were limited to those which vibrating reeds could supply.

But with saturation in church sales approaching, the home market became very tempting. Several smaller companies like Lowrey, Estey, Thomas, Minshall etc. entered the field, having found that a cheaper organ could be made by using *frequency dividers* supplied from just twelve oscillators. With plenty of vibrato and care in playing, quite acceptable results were obtained. The Wurlitzer company were the first to supply a complete rhythm generator unit, and it is interesting to compare the size of the "side man" with that of present day units.

All the foregoing used valves. The first organ to be transistorised was the Gulbransen. The first models used independent oscillators, but soon turned to blocking oscillators; which in turn gave way to 2:1 frequency dividers. It was inevitable that all other makers should turn to transistors but since they were only suitable for small currents, valves continued to be used in power amplifiers; it is only a short time since Philips abandoned these. However, many people in other walks of life still prefer valve where rough treatment can be expected!

A feature which is almost universal in entertainment organs is the rotating *Leslie loudspeaker*. Donald Leslie originally patented his many variants on this method in 1945, but for some reason it did not become popular until 1950, when it was re-issued. We might note that the John Compton organ company had obtained a British patent for the same device in 1934 and 1936. Pity it was not taken up.

## Organ Kits

As the cost of components especially transistors continued to fall, a market opened up for the home constructor. Several kits came on the market, persisting to this day. If you know what you are doing, this is a very economical way to acquire an organ and leaves one free to design any kind of console to suit one's surroundings. It also encourages experiments with tone circuits for some people will want more, some less and some quite different kinds of sounds.

The market for classical or concert organs now begins to show an upturn. This is largely because the cost of new pipe organs is prohibitive. The principal examples now available are made by Allen, Ahlborn, Rogers



# World's End! Why go any further?

There's no need to travel to the ends of the earth — Ambiance's studios are ideally placed to give you everything you need — 24 hours a day. Not just the best equipment and expertise but all in a purpose-built, air conditioned complex with live room, rest room, TV, kitchen, shower and direct access to studios from car park.



## Equipment

**Mixing Desks**  
STUDIO 1 ALLEN-HEATH SYNCON B 32 — 24 — 2  
STUDIO 2 SOUNDRAFT 1624 16 — 16 — 2

**Tape machines**  
SOUNDRAFT — 24 TRACK WITH FULL REMOTE  
SOUNDRAFT — 16 TRACK WITH SEARCH CYCLE ETC

**Outboard equipment**  
AMS DIGITAL DELAY & HARMONISER  
AMS DIGITAL DELAY & HARMONISER  
EVENTIDE H 949 DELAY & HARMONISER  
BEL STEREO FLANGER  
BEL DELAYING FLANGER  
AMS TAPE PHASE SIMULATOR  
DEX 2020 COMPUTER GRAPHIC EQUALISER  
DBA 165 OVER/EASY COMPRESSOR  
LIMITERS  
REBIS NOISE GATES  
REBIS COMPRESSORS  
REBIS DE ESSER  
MASTER ROOM STEREO REVERB

**Monitoring**  
ROSE 1600 POWER AMP  
QUAD 465 POWER AMP  
QUAD 303 — STUDIO FOLDBACK — STEREO MONITOR DT 1005  
TANNOY LITTLE REDS — STUDIO 1 & 2  
AURATONES & DAVDS — STUDIO 1 & 2

**Microphones**  
AKG — NEUMANN — SHOEPS — SHURE — BEYER

**Masterson**  
STUDER BDM — REVDA PH 99

**Drum machines**  
LINN DRUM COMPUTER  
ROLAND TR 808  
ROLAND CS 78

**Guitars**  
OVATION GLEN CAMPBELL 12 STRING  
OVATION ARTIST  
OVATION VAPER  
KRAMER & PANGBORN BASSES

**Synthesisers**  
ROLAND MC 4 MICRO COMPOSER  
ROLAND GUITAR SYNTHESISER  
ROLAND CSG 600 SEQUENCER  
ROLAND SW 99  
MINI MOOG  
YAMAHA CS 60  
JUPITER 4  
YAMAHA CS 40M  
RSF BLACK BOX  
FAIRLIGHT CMI AVAILABLE WITH OR WITHOUT OPERATOR RATES ON REQUEST

**Percussion**  
FULL GRETSCH DRUM KIT  
LARGE RANGE OF LATIN PERCUSSION  
CHALLENGER ACOUSTIC PIANO

**Amplifiers**  
ROLAND JC 160  
ROLAND CUBE 40  
TRACE ELLIOTT

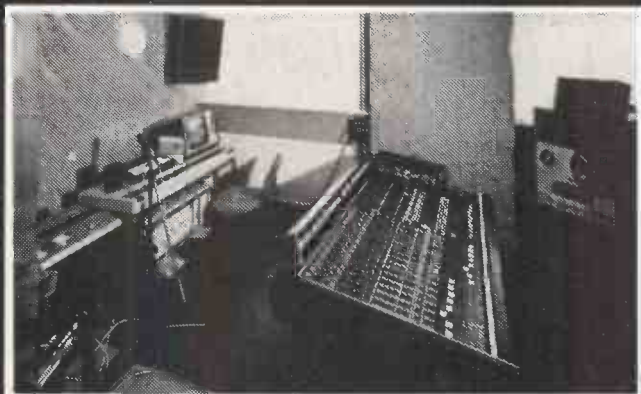

## Our prices

STUDIO 1 £25.00 per hour  
STUDIO 2 £15.00 per hour  
FAIRLIGHT £40.00 per hour  
PROGRAMME FACILITY £10.00 per hour (with operator)



Ambiance Recording Studios  
1/5 GORDON ROAD, WORLD'S END  
BURGESS HILL, SUSSEX  
TEL: (0444 96) 45163/43872. TELEX: 957002

# SPEAKERS > SPEAKERS > SF EAKERS > SPEAKERS > SPEA

DISCO, P.A. etc.	
Celestion G12-50 TC or CE	£19.50
Celestion G12-80 TC	£23.75
Celestion G15-100 TC	£38.50
Fane Classic 10-100	£17.90
Fane Classic 12-100	£23.75
Goodmans 8HPA	£ 8.50
Goodmans 12HPA	£23.50
Goodmans 12HPD	£26.50
McKenzie C12-100TC	£25.95
McKenzie C12-125TC	£39.95
RCF L12-31 (8 ohms only)	£39.50

LEAD GUITAR ETC.	
Celestion G12-80CE	£24.50
Celestion G12-125CE	£42.00
Celestion P/cell 12/150	£66.00
Fane Classic 12-150	£37.25
Fane Classic 15-200	£48.50
Fane Studio 12L	£51.00
Goodmans 12HPG	£25.95
McKenzie C12-100GP	£25.95
McKenzie C12-125GP Studio	£39.95
McKenzie C12-200 Studio	£54.25

BASS GUITAR, ORGAN ETC.	
Celestion G15-100CE	£37.95
Celestion G18-200	£64.75
Celestion G18-250	£81.75
Celestion Powercell 15-250	£88.00
Fane Classic 15-150	£42.25
Fane Classic 18-200	£52.95
Fane Classic 18-250	£56.15
Goodmans 15HP (8 ohms only)	£64.95
Goodmans 18HP (8 ohms only)	£64.50
McKenzie C12-100 Bass	£25.95
McKenzie Studio 15-200	£63.25

TREBLE UNITS, CROSSOVERS ETC.	
Celestion HF50	£18.90
Celestion HF50X	£26.50
Celestion RTT50	£20.95
Celestion RTT50X	£28.25
Fane HF250 bullet (8 ohms only)	£29.95
Fane HPX4 Crossover (for HF250)	£ 5.75
Motorola KSN1005A	£ 4.50
Motorola KSN1025A	£ 8.75
RCF TW105 bullet (8 ohms only)	£22.50

When ordering, please specify 8 or 16 ohms where applicable.  
All prices include VAT at 15%  
Carriage/insurance: 10" £2.50 each (2 or more £1.75 each)  
12" £3 each (2 or more £2.25 each) 15" £5 each (2 or more £4 each)  
18" £6.50 each (2 or more £5.50 each)  
Treble units £1.50 each (2 or more 95p each)

## Cabinets

Excellent quality, rugged construction.  
Fully assembled with corners, handles,  
feet, jack sockets etc. less drive units.



Type	For:	Price each	Carriage/insurance
112H	12" & piezo	£17.95	£4.00
D112H reflex	12L & HF250	£29.95	£4.50
212H	2 x 12" & piezo	£25.75	£5.00
412	4 x 12"	£41.95	£6.00
R15 reflex	15"	£36.95	£5.00
R215 reflex	2 x 15"	£48.95	£5.50
118	18"	£41.95	£6.00
WMH wedge	12" & piezo	£23.95	£3.50
DFB12	12" Horn/reflex	£51.75	£6.00
DFB15	15" Horn/reflex	£64.50	£8.00

Lighting service on telephoned credit card orders!  
Catalogue of drive units, crossovers, cabs, mics etc. £1.50 post free.



**WILMSLOW  
AUDIO**  
The firm for Speakers

35-39 Church St., Wilmslow, Cheshire SK9 1AS  
Tel: 0625-529599

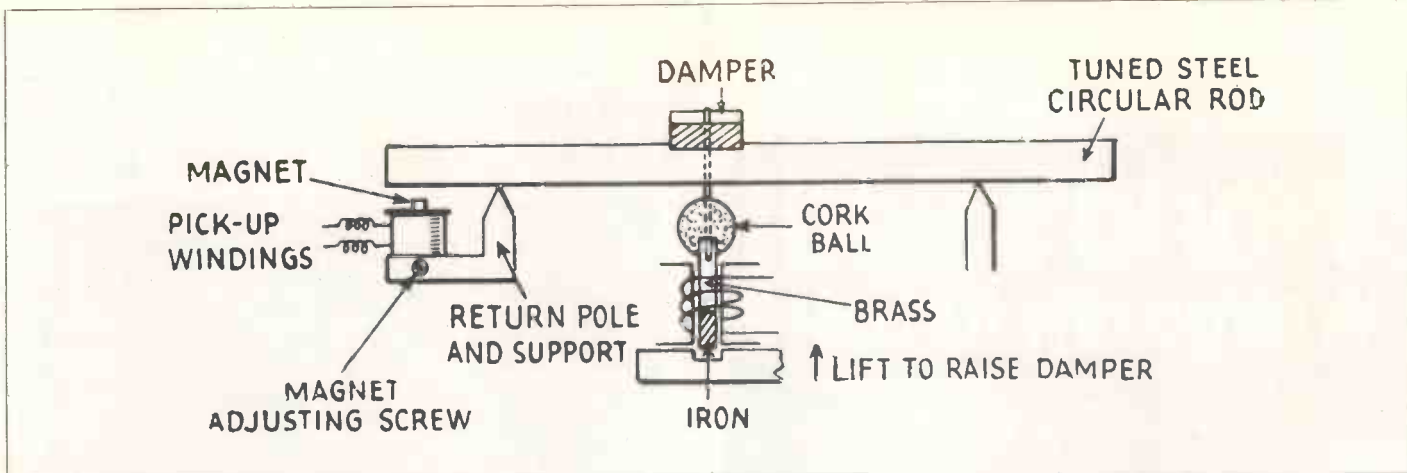

Electro-mechanical pickup for chime or Carillon sound.

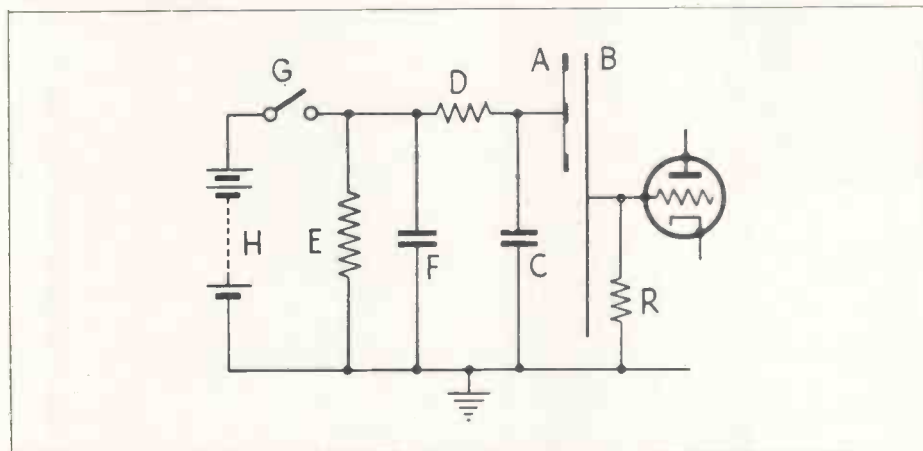

Figure 2. Compton polarising circuit. A, Stator. B, Rotating Disc. C,D,F, Click Suppression. E, Regulating resistor. G, Playing key. H, DC Supply. R, Grid Bias resistor.

and Copeman Hart. The Allen is digital, more of that later. The others either use independent oscillators for each note throughout, or occasionally introduce a frequency divider rank if it is appropriate. Because of the versatility and low cost of present-day integrated circuits or micro-chips, there is a tendency to over-elaborate some of the circuits, for what purpose is not clear, since the principal function of any organ is to make music and nothing else. Although the original company is now defunct, we should not overlook the Miller organs. These originated as English versions of the Constant-Martin, but Miller soon branched out on his own and there are many examples of these separate oscillator valve organs still in use; some very large ones, as at the Sprowston church in Norwich and Khartoum cathedral. Miller always used separate ranks for flute, diapason, reed and string, keying the HT line through relays. The system was kept at a constant temperature, hence the organs held their tune.

The last attempt of the Hammond company to re-enter the concert field was the grand 100, an enlarged version of the tone wheel organs; this was not successful and was succeeded by the Concorde, their first solid state generator instrument. By this time, the electro-mechanical organs were obsolete, although The Parie in France and the Harmoniphon in Spain continued to be made for several years more.

Bracketed with the above must be the original Allen organs. Alone amongst U.S. manufacturers, Allen built to any specification. All organs had separate oscillators for every note, interesting because the inductances were toroidal. Toneforming units on trolleys were used in the larger organs, easily interchangeable. The writer visited their first large instrument at Catsaqua in 1949, and found it astonishingly lifelike. Smaller entertainment organs appeared later, notably the "Carousel",

which in common with the Rogers, used mechanically-struck metal bars for the celesta or glockenspiel. However, about this time the advances in integrated circuits opened the way for mass production of divider generators, and the market was rapidly saturated with instruments from Japan and Italy; strange to say, the countries once in the forefront, France and Germany, made no real contributions to these developments.

When the ingenious patents of Ralph Deutsch appeared, Allen decided to go digital and use his methods. Although it was not now possible to have an independent tuned source for every note (since these are derived from dividers), more than one complete generator is used in the larger organs.

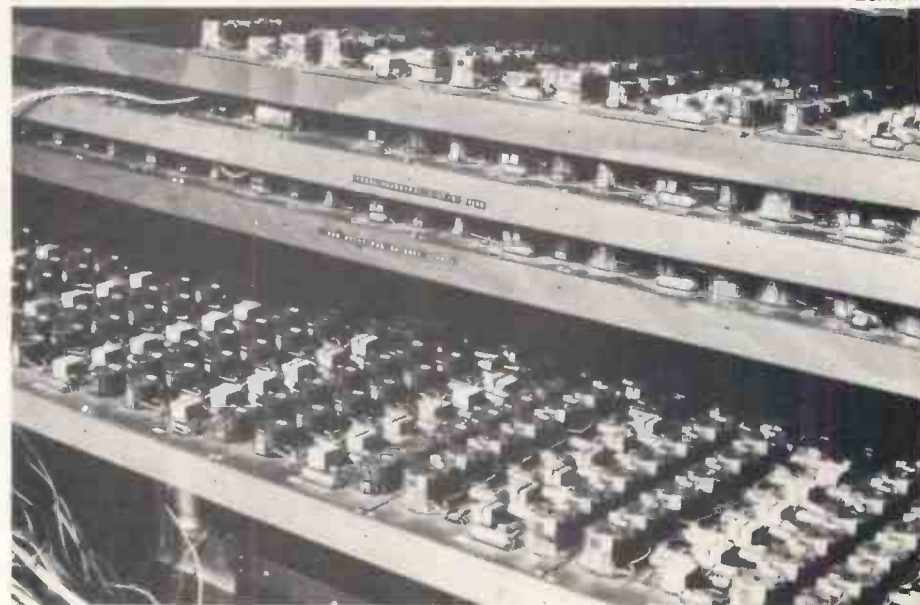

Generator ranks of a modern classical electronic organ.

## Digital

Philips were the originators of the digital system in 1969/70, their complete generator measuring only 4½" x 4" x ½" - an extraordinary achievement. Deutsch enlarged upon the method, bringing in tone forming, attack and decay circuits, and other features, all digital. The interesting features of the current organs are that analysed components of selected organ tones are stored in a diode memory circuit, which is repeatedly scanned by a read-out system when a key is depressed and the appropriate stop gate is opened. The prime movers are oscillators which feed very accurate multivibrators which in their turn feed 2:1 dividers. The multis are kept in accurate tune by frequency comparators which hold the division ratios at 185 and 196, because  $196/185 = 2^{1/12}$  which is the interval of a semitone on the equally tempered scale; the error is extremely small, approximately  $4 \times 10^6$ . The selected analysis points on any waveshape could be as many as 48, giving excellent fidelity; but of course this would apply to all notes on the keyboard; so that the differences in voicing which occur in a real rank of pipes, over its compass, will not be reproduced. As in any digital device, it must be exact and precise. Shift registers provide attack and decay and though these are step functions they occur so rapidly that the ear hears them as a continuity. The inevitable high frequencies produced as the steps switch are removed by filters. Digital to analogue converters feed the audio outlets and this instrument well illustrates the many virtues of integrated circuits.

E&MM





# A brilliant idea on paper.

**The Yamaha Portasound MP1. The world's first portable keyboard with a built-in music score printer.**

One of the most revolutionary developments in the history of electronic keyboards, the MP1 uses the very latest in computer technology plus an integral microprinter to produce instant music scores, saving you from constantly interrupting your playing to write by hand. Complete with key signature, staff, time signature and rhythm, MP1 scores are neat, clean and note-perfect, every time.

Independent melody and chord sequence memories allow you two-channel recording capability for simple scores and spur-of-the-moment

composing, whilst full orchestral scores can be produced with the ease of using an electric typewriter.

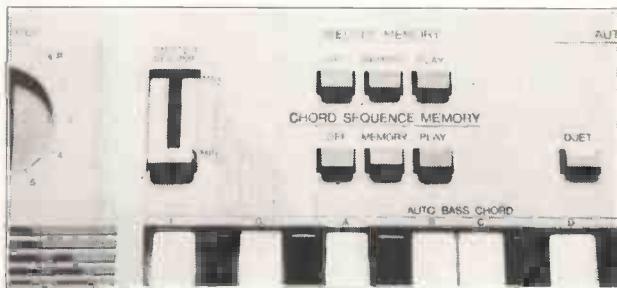

A 44-note keyboard with ten instrumental voices and rhythms, the MP1 takes the headache out of writing music, saving time and effort whether composing, transcribing, arranging or teaching. See the MP1 for yourself. If it's brilliant on paper, in practice it's an absolute marvel!



Please send me further information on the MP1.

Name .....

Address .....

Price includes power adaptor.

Yamaha Special Products, Mount Avenue, Bletchley, Milton Keynes, Bucks. Tel: (0908) 71771.

*Leading the world to play.*

E&MM 5.83



# YAMAHA

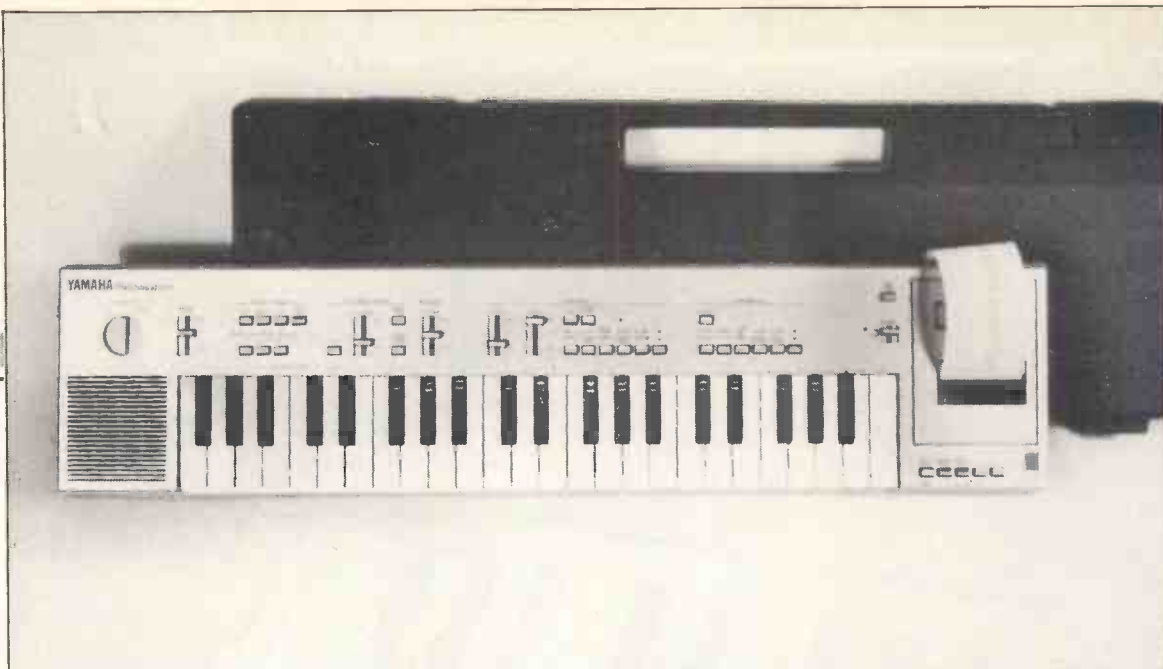

# Yamaha Portasound MP-1

The MP-1 breaks new ground by providing a simple-to-use music printer which can transcribe melody notes and chord symbols from memory or live playing. Very few other machines are capable of doing this until the alpha Syntauri or Synclavier class is reached, and so for those who wish to learn music notation, copyright their compositions or keep a written record of musical ideas, this instrument could be ideal.

## Performance

In most respects the MP-1 is identical to the PC-100, which was reviewed in E&MM November 1982. It doesn't offer the Play-card facility which is the PC-100's own gimmick, but voicing and accompaniment sections are similar with ten 8-note polyphonic sounds, ten rhythms, Automatic Arpeggios, Automatic Bass Chords with One Finger Chord facility, Transposition over an octave, Synchro Start of rhythms and a 4-Bar variation on percussion and bass.

The rhythm voices are quite reasonable, with a metallic touch to the cymbal and snare and a fairly powerful bass drum. Variations and bass lines are well composed, particularly on the 16 Beat and Swing patterns which together with Disco, Jazz Rock, Rhumba and so on add up to a good selection of backing patterns.

Some of the polyphonic voices, such as the Hammond-like keyclick Organ and the delay-vibrato Trumpet, are quite attractive although obviously not in the same league as Yamaha's FM voicings as on the CE and DX instruments. The miniature 3½ octave keyboard, similar to that on the CS01, is fairly firm and pleasant to play. One feature not found on the PC-100 is the Duet button, which adds a harmony note to the melody line based on the left-hand chord being played at the time.

## Printer

The MP-1's printer, installed at the right-hand end of the instrument, is a micro-graphic roll-type device using miniature ball-point pens and 2¼" wide paper in rolls of 8 yards or so. The pens use water-based ink lasting for about 480 bars of music, after which it is quite simple to install another one of the pens provided. Changing paper rolls is also quite straightforward. The printer gives 100

extremely clear representations of the stave, of notes, time signatures and chord names, and is clearly superior to any similar thermographic or carbon-based printer design.

## Using the Printer

The simplest mode in which the printer can be used is Play & Print. A rhythm is selected and the Play & Print button depressed. A melody with single-finger chords is played, the printer starting as soon as the first key is touched. When the melody is finished the Play & Print button is released, and the printer will continue until it has finished transcribing the whole tune.

The information given on the paper roll by this method is as follows; the name of the rhythm used; the bar number in multiples of four starting at Bar 1; a Treble clef; a time signature; a Chord Name below the stave every four bars or wherever there is a new chord; the notes themselves, with appropriate ties, flats and dots to indicate increased length; a key signature when the starting key is not C.

## Memory

The chord and melody sections have memories which can be programmed and replayed separately or together. Each has a Play, Off and Memory button, the Melody section also having a Sensitivity button which switches off the MP-1's built-in tendency to round off melodies to the nearest beat and so allows more complex patterns of rests and ornamentation to be printed. Any tune programmed using the Play & Print mode automatically goes into the memories; any tune put into the memories 'live' or one step at a time can be printed as desired. Mistakes made in entering one step at a time can be deleted if desired, and the lengths of chords entered in this way can be defined as what Yamaha call Whole Notes, Dotted Half Notes, Half Notes or Quarter Notes by referring to the labelling over the top 5 white keys. The fifth of these keys produces ¾ time, while the highest black key cancels a chord entered in error.

Turning off the power or entering a new melody always clears the memory. Before

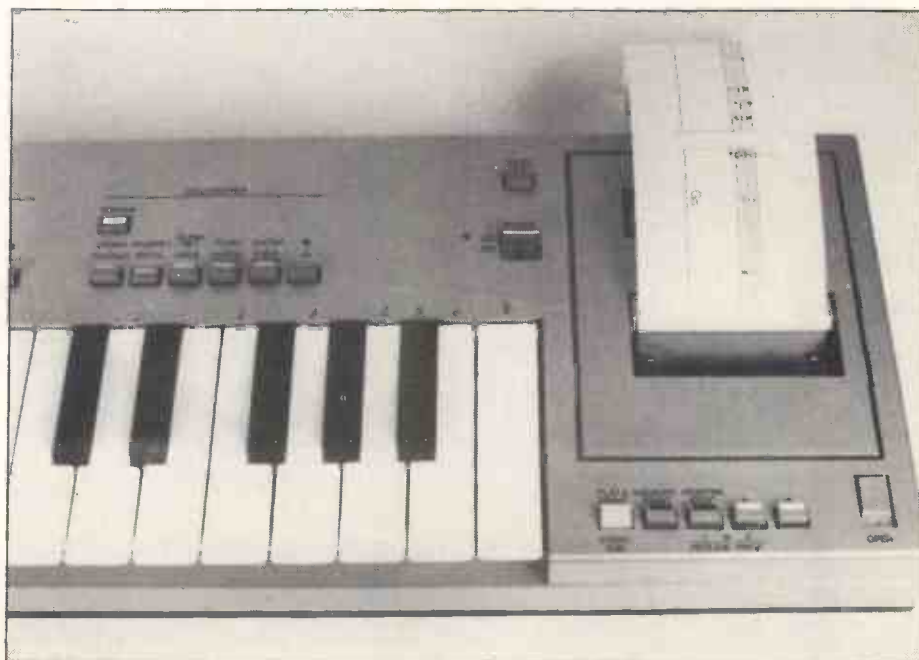

Voice selection and Printer controls.



# Not just INDESTRUCTIBLE black boxes . . . but boxes which . . .

1. balance long cable runs to prevent interference and noise
2. break earth loops between unbalanced pieces of audio equipment to stop earth loop hum
3. provide safety mains isolation between pieces of equipment



## So why 4 black boxes?

- GP Low cost box for General Purpose application
- HI-z For use at equipment inputs or receive end of lines
- LO-z For use at equipment outputs or send end of lines

## The DI Box is different . . .

Active Direct Injection Box; Phantom or Battery powered, can be used as an instrument splitter.

For further information contact:

# THEATRE PROJECTS

SOUND SALES

10 Long Acre, London WC2E 9LN

Telephone: 01-240 5411 Telex: 27522 Tee Pee G

Stockists:

Music Labs  
72-74 Eversholt Street NW1  
Tel: 01-388 5392

London Rock Shop  
26 Chalk Farm Road NW1  
Tel: 01-267 5381

Mail to Nikki Antoniou Theatre Projects, Sound Sales,  
10 Long Acre, London WC2E 9LN for full details of black boxes

Name

Address

Phone

music printing from the memory or from live playing begins, a key signature can be defined to avoid excessive use of sharps and flats on the printed paper. Two buttons beneath the printer make this possible; if, for instance, the 'flat' button is pushed three times, the music will be printed in E flat major with the appropriate key signature.

## Conclusions

The MP-1 is designed for a highly specialised function and performs it excellently. Quite rapid ornamentation can be performed and printed accurately, although obviously it is possible to confuse the machine by playing too fast or in a particularly sloppy manner. The printed music is highly legible and neat, although the paper strip format isn't practical for reading back and the rolls would have to be cut up and card-mounted or photocopied. Once this is done the plastic case provided can act as a music stand as well as a means of protection for the instrument.

As usual the keyboard is light and portable, with a number of power options, built-in speaker, headphone, foot volume and output sockets. It gives every indication of being highly reliable and will no doubt prove

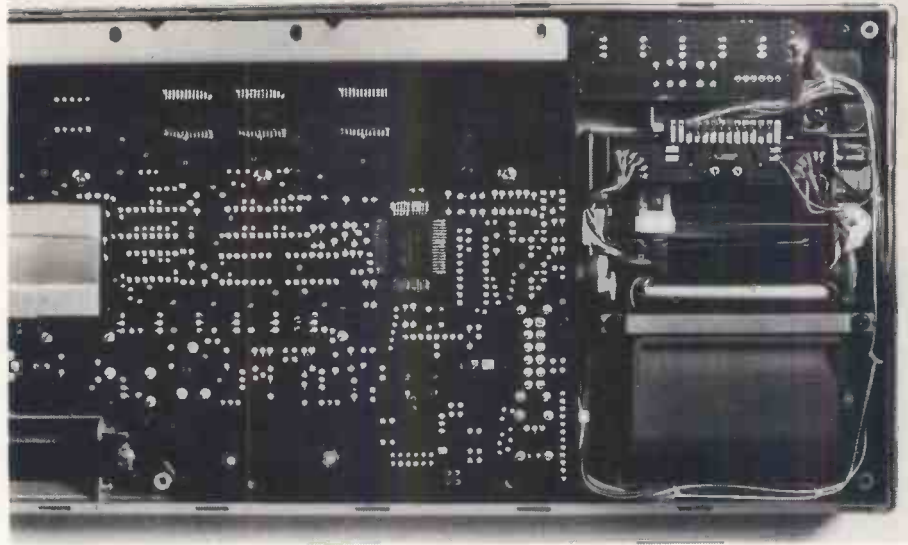

MP-1 Printer and PCB.

a godsend for the many musicians who still work with conventional musical notation.

**E&MM**

The Yamaha MP-1 is available from Yamaha UK, Mount Avenue, Bletchley, Milton Keynes, Bucks MK1 1JE. Tel. 0908 71771 at a recommended retail price of £480.00 including VAT.

## VIDEO MUSIC

### Video Rock Attack Spectrum 790 533 2 60 minutes (Mono)

Polygram's promo film collection features 14 bands and a good mixture of big hits and fine songs that didn't quite make it. Of particular interest to electro-musicians would be tracks from Soft Cell, King Crimson, Tears for Fears and Trio.

The opener is Roxy Music's 'More Than This', concentrating largely on Bryan Ferry's charismatic presence but with a good use of 'giant screen' effects, slow motion and odd camera angles. Duncan McKay's reeds are prominent on this smooth mid-tempo song.

Soft Cell's 'Say Hello Wave Goodbye' is set in a sleazy nightclub background, and again concentrates much more on the personalities of the performers than on the musical side.

Level 42's 'Are You Hearing What I Hear?' is much better in this sense, and much wider use of video technology is made. Between each track the picture is digitised into small squares, which are then increased in coarseness and faded into a digitised version of the next opening shot. To this technique the Level 42 track adds SqueezeZoom effects, crushing and expanding pictures in various directions, split screen and box effects. The music is more interesting, too, with Mark King's vocals dominating together with his incredibly expressive active bass sounds. Backing on a combination of Minimoog, Prophet 5 and banjo is fast, staccato and unerringly precise.

Junior's 'Mama Used To Say' makes use of cartoon-like graphics and synthesised disco-funk bass, and is followed by Steve Miller's 'Abracadabra'. This must be one of the most spectacular videos of recent times, with the accent on magic, animation and optical trickery. A lot of the effects are of the Magic Circle kind, and it's interesting to note how many of them are based simply on reversed film. However, there's an enormous array of video and film techniques in use, including picture key and reversal, selective digitisation of the picture, multiple superimposition, time lapse and chroma-key. The music is straightforward enough, although with some interesting reversed sounds which match the film well; poor Shakatak don't have much chance of competing with a relatively straightforward studio video of 'Nightbirds'.

King Crimson's 'Heartbeat' is an unusual but not uncommercial song, featuring Robert Fripp's glassy and often reversed guitar, and a good selection of video tricks applied to a party setting. More selective digitisation, removal and squeezing of dif-

ferent figures from the picture and so on. Dexy's 'Come On Eileen' and its accompanying pseudo-nostalgic film is best described as a gross piece of narcissistic self-indulgence, while Junior's second appearance singing 'Too Late' doesn't add too much visually or musically to his first.

Duo Tears for Fears turn in an atmospheric film set in the countryside to accompany their equally atmospheric 'Mad World', full of synthesiser sweeps and gently echoed vocals. In contrast there's Trio with Da Da Da, which probably did more for sales of the Casio VL-tone than anything else; the video's set in a bar and has a tendency towards very black humour.

Finally, there's Golden Earring with a fantasy gangster film to accompany their straight-ahead rock song 'Twilight Zone'. Since the film's full of sex and violence it was probably never shown on British TV; clearly one of the advantages of these video compilations is that they can include material which may not be suitable for the average Top of the Pops audience.

Overall a very wide-ranging tape, perhaps a little too wide-ranging as these things tend to be. One highlight is definitely Raymond le Gue's computer animation, and it's interesting to note that the whole tape is a product of Video Hilversum, although it's credited as being Made in England. That probably explains the inclusion of Golden Earring, who are obviously still popular in Holland although they've failed to repeat the success of 'Radar Love' in the UK.

### Imagination In Concert

Red Bus VRBPV 2592  
72 Minutes (Mono)

Imagination seem to have cap-

tured a corner of the market with their sophisticated disco/soul music. Mike Mansfield's direction manages to encapsulate their very energetic stage act with breathtaking accuracy, so that all the singers and backing musicians - a keyboardist doubling as musical director, two drummers, keyboards/bass, three backing vocalists and a guitarist - are given a fair share of the airtime.

The backbone of the band is Errol Kennedy's powerhouse drumming technique, and the combination of Simmons and conventional drums gives plenty of variation in this area. Keyboards include the inevitable Prophet 5, which combines with the bass of Ashley Ingram to give a fluid rhythmic backing.

The frontman is Lee John, whose voice remains powerful and expressive no matter how much energy he puts into his choreographed stage movements. Most of the video consists of the 1982 London Dominion Theatre show, one of seven sold out nights which followed the group's six hit singles and two gold albums within eighteen months. The audience reaction can be imagined, and the atmosphere is authentically captured through tight camera work and imaginative editing.

Featured hits include 'Body Talk', 'Just An Illusion', 'In the Heat of the Night' and 'Changes'. Sound quality is very high, although the tape is not stereo, and apart from the overall appeal to fans of sophisticated, electronically oriented dance music, the bass playing stands out in terms of both technique and sheer driving power. Rounded off with a couple of promotional films and some audience reactions, this represents a good value-for-money tape at 72 minutes running time.

**E&MM**



# WISHER (DERBY) LIMITED

## MIDLANDS' LARGEST COMPLETE MUSIC STORE



POLY 61 —	MS 10	£231
NOW ON DEMO	MS 20	£295
POLY 6	£1000 CX 3	£628
MONO/POLY	£556 KPR 77 —	
DELTA	£519 NOW ON DEMO	

Sk 20	£762	CS 01	£145
Sk 15	£524	CS 15	£345
Sk 10	£295	CS 20m	£755
CP 20	£629	CS 40m s/h	£695
CP 25	£895	MR 10	£85



ROLAND SH 101  
p.o.a.

CASIO 1000 P  
£325.00

CARLSBRO COBRA  
KEYBOARD 90 watt  
COMBO

3 channel F/X send-return  
1x15" + Horn, Reverb available  
also as amp & cab  
£217.00

ROLAND DRUMATIX  
£195.00

CASIO 202  
£275.00

**Rickenbacker**

NEW DELIVERY — Just  
arrived, call now for low prices.

THE KIT  
+ all accessories from  
£45.00

THE KIT Mk II  
arriving shortly!  
Call now for details

MAIL ORDER, TELEPHONE FOR DETAILS

**77-79 OSMASTON ROAD, DERBY**  
**(0332) 48156**

ACCESS - BARCLAYCARD : CLOSED WEDNESDAY  
INSTANT CREDIT 35.2% THROUGH AVCO/HFC

# ROCKMAN

Tom by Scholz



The  
**ROCKMAN**  
has built in  
chorus, echo, compression,  
distortion, EQ for guitar or  
keyboards, line out for  
recording, amp or mixer,  
tape input, etc. A  
fully produced studio  
sound that fits in  
your hand. rrp £230.00  
inc. vat.

You won't  
believe  
your ears...

The \$10,000 Guitar  
sound now available  
at Carlsbro Sound  
Centres—

Tel. Mansfield  
**651633**

Nottingham  
**581888**

Leicester  
**24183**

Sheffield  
**640000**

Distributed by **DIXIES MUSIC**,  
2 Stocks Walk, Almondbury,  
Huddersfield.  
(0484) 512601/25920.



**Finally someone is  
prepared to do  
for the synthesizer—  
what Rhodes did  
for the piano**

At Rhodes we've always felt there's a big difference between a keyboard that responds like a machine and one that plays like a musical instrument.

At last there's a synthesizer that comes up to our standards that you can understand. **CHROMA**. The first in a new family of advanced musical instruments.

The Chroma is a hybrid of digital and analogue technology that combines the best of both worlds. This 16-channel programmable polyphonic synthesizer has an acoustic-style keyboard response. So, instead of pushing buttons that look like keys, you can finally feel what you're playing.

Chroma has 50 pre-set voices, plus a further 100 voice programmes on cassette are included with every keyboard. Besides a cassette interface the Chroma's computer interface also makes Chroma the first intelligent music terminal. The compatibility factor we're most proud of

though, is the one all Rhodes instruments have — with people. The way we look at it, advanced electronics don't mean a thing unless you've got that human touch that makes music what it is — feeling.

**CBS Fender** Fender House, Jeffreys Road, Enfield, Middlesex EN3 7JF.



**Rhodes Chroma**  
Limited only by your imagination

Get your fingers on a  
Chroma at

Ballymena  
Nichol Brothers  
13 15 Church Street Ballymena,  
Northern Ireland  
Tel 0266 49616

Bath  
Duck, Son, & Pinker  
Pulteney Bridge, Bath  
Tel 0225 65586

Bournemouth  
Eddie Moores  
879 Christchurch Road  
Bournemouth, Dorset  
Tel 0202 35135

Doncaster  
Music Group  
245 Station Road, Dunsicroft,  
Doncaster Tel 0302 843037

Eastbourne  
Peter Bonner  
124 Grove Road, Eastbourne,  
Sussex Tel 0323 639335

Epsom  
Bonfield  
5 7 South Street, Epsom, Surrey  
Tel 01 782 4528

Essex  
Future Music  
10 Baddow Road, Chelmsford  
Essex Tel 0245 352490

Hastings  
Peter Bonner  
29 41 Sedlescombe Road North,  
St Leonards, Hastings, Sussex  
Tel 0424 42 1895

Leicester  
Carlsbro Sound Centres  
22 32 Humberstone Road,  
Leicester, Leicestershire  
Tel 0533 24183

London  
Chase Musicians  
22 Chilton Street, Off Euston  
Road, London NW1  
Tel 01 387 7626

Portsmouth  
Future Music  
104 106 Elm Grove  
Southsea, Portsmouth, Hants  
Tel 0705 820595

Rad Argen Keyboards Ltd  
Denmark Street, London WC2  
Tel 01 240 0084

Scotland  
Sound Control  
Elgin Street, Dunfermline  
Tel 0383 733353

Soho Sound House  
18A Soho Square, London W1  
Tel 01 434 1365

Manchester  
A 3 Music Centre  
88 Oxford Street, Manchester 1  
Lancashire Tel 021 236 0340

Chase Musicians  
58 Oldham Street, Manchester  
M4 1LE Tel 061 228 2865

Mansfield  
Carlsbro Sound Centres  
182 184 Chesterfield Road  
North Mansfield, Notts  
Tel 0623 651633

Sheffield  
Carlsbro Sound Centres  
720 City Road, Sheffield, Yorks  
Tel 0742 640000

Tyne & Wear  
Rock City Music  
10 Muesley Street, Newcastle-  
upon-Tyne, Tyne & Wear  
Tel 0632 324175

Worcester  
Rad Argen Keyboards Ltd  
15 The Butts, Worcester  
Worcestershire Tel 0305 51174

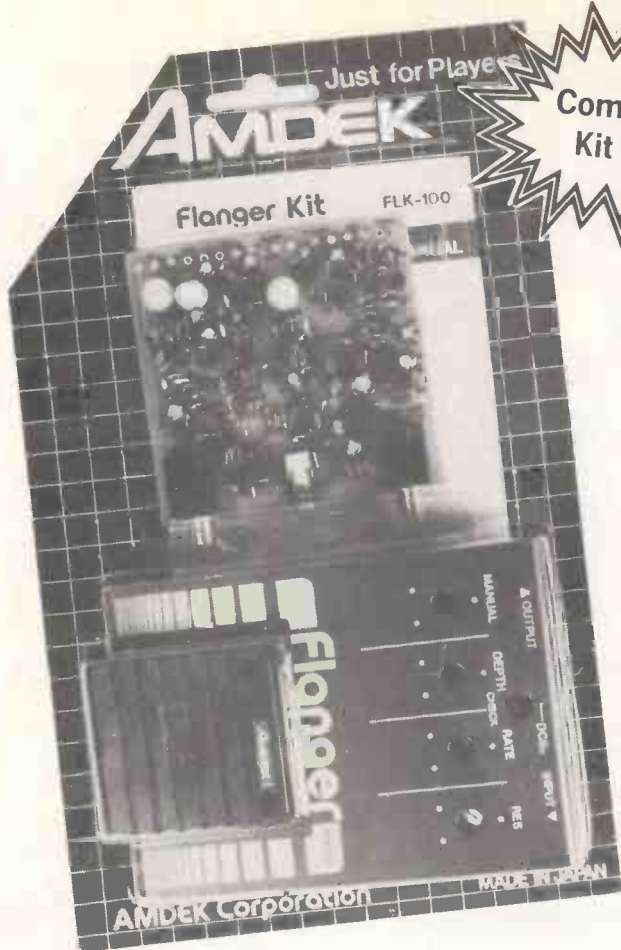

**Complete  
Kit £52**

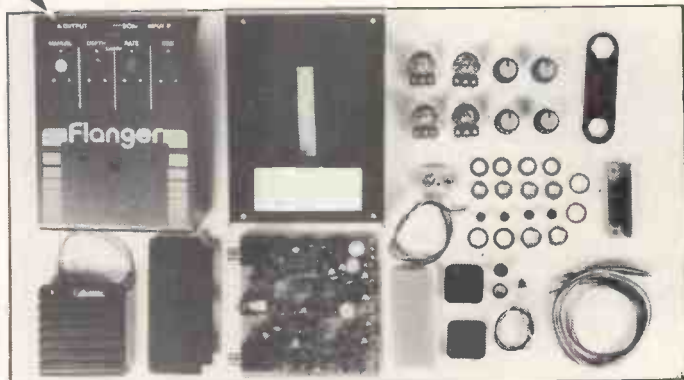

Complete set of parts ready to be checked off.

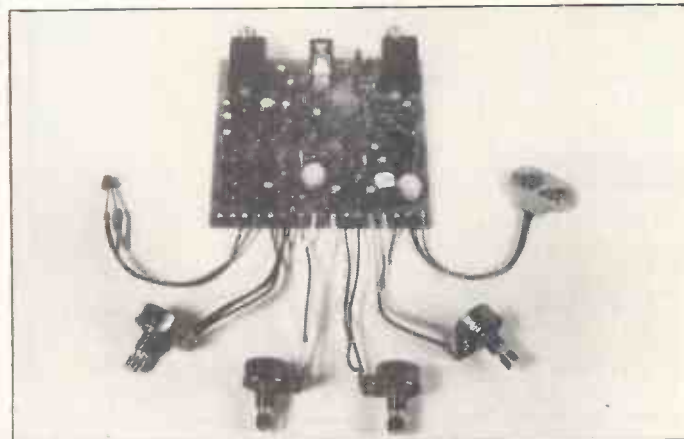

Pots, LED and battery snap fitted to the PCB (Steps 2-9).

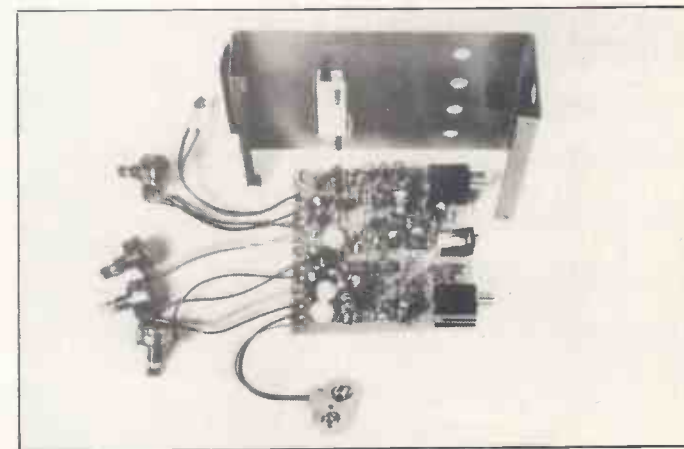

Footswitch fitted to PCB and connected to PCB (Steps 10-12).

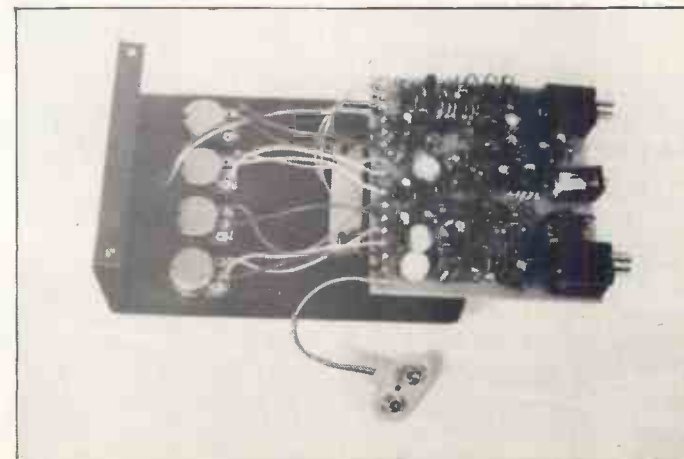

LED and Pots fitted into the case (Steps 13-14).

# AMDEK

## Flanger Kit

The Amdek Flanger is a useful, high quality effect which can be assembled and modified with the minimum of technical difficulty.

- ★ Automatic and Manual Flanging
- ★ Rate and Depth modulation controls
- ★ Variable Resonance control
- ★ LED effect on and battery check
- ★ Pre-assembled circuit board
- ★ Complete kit with detailed instructions

Flanging is undoubtedly a very popular effect with the modern musician producing a distinctive and easily recognisable range of sounds - from a metallic type of phasing to rich chorus effects. It is ideal for treating electric guitars, synthesisers and even vocals. Less expensive drum machines can also be given a welcome boost, enhancing the metallic nature of synthetic cymbal sounds for example.

Amdek's FLK 100 kit can produce a wide range of effects using the four controls: Manual frequency; Modulation Depth and Rate and Resonance or feedback.

### The Kit

The Flanger kit is available in bubble-pack form, complete with all parts, a spanner for tightening nuts and detailed instruction sheet. The extra tools required are a 15 to 30W

fine tipped soldering iron, wire cutters and strippers, small pliers and a cross-head screwdriver. A 9 volt PP3 battery is needed to power the unit unless you use an external DC 9V power pack.

Parts identification is easily done from the component drawings in the instructions and, once you've laid them out on the work surface, they can be checked off one by one.

Step by step assembly commences with the preparation of 11 lengths of connecting wire for attaching to the four pots - simplified by the provision of a scale and specified lengths for each wire. Useful tips on soldering are also given. In steps 5 to 7 the battery connector, LED and footswitch leads are cut to specified lengths. Then all the necessary soldering to the factory-built PCB (which includes 2 ready-mounted IN/OUT sockets is done (steps 8-9) and the



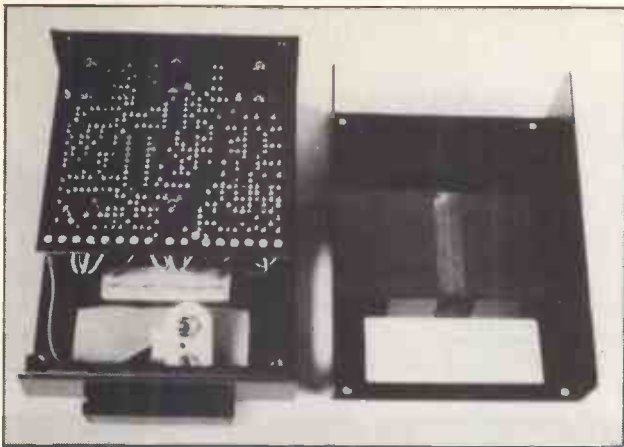

PCB fitted into case and insulation added (Steps 15-17).



The completed Flanger (Steps 18-21).

footswitch and LED holder are mounted in the metal case (steps 10 and 11). Soldering the lead wires of the footswitch to the PCB completes the soldering work (step 12).

Now the main components are inserted in the case following steps 13 to 15. The small hexagonal spanner provides easy fastening of the pots and sockets. Care must be taken when inserting the PCB and a plastic insulation sheet provided sticks to the base plate to avoid shorting out the circuit board against the case. A sponge insert holds the battery in

Circuit diagram of The Flanger.

place. The base plate screws neatly into place and the rubber battery cover gives simple and effective access without the use of screws (steps 16 to 20). The construction is completed by the addition of two stick-on feet and the four control knobs.

## Circuitry

Flanging is produced by adding two signals, one slightly delayed in time with respect to the other, delays normally ranging from 1 to

10ms. The phase cancellations resulting produce a comb filter in the audio spectrum.

Originally this effect was created by recording the signal on two tape decks and slowing one down on playback, by applying friction to the flange of the tape spool - hence the name. Obviously this could not be done in real time and was therefore an effect which could only be produced in the studio.

Analogue delay chains or BBDs (Bucket Brigade Devices) have made it possible to produce this popular effect in real time.

The circuit diagram is shown in Figure 1. Signals from the input are buffered by Q2 then passed through a pre-emphasis circuit, compressor and low pass filter before entering the BBD, IC4, which has 1024 capacitive cells. These are clocked using

IC5, a dual phase clock. The clock frequency is varied by the voltage on the Manual pot and the modulation waveform on the Depth pot. Triangle wave modulation is produced by the LFO based around IC3.

A second low pass filter is connected to the output of the BBD to remove any clocking noise. FET switching, Q1, is used to connect the effect.

Original and effect signals are summed at the final de-emphasis op-amp before being connected to the output socket and a bistable flip-flop controls the FET switching from the footswitch.

## Operation

The Flanger kit was assembled without any problems and worked first time. If you do have problems, however, you can contact the Roland 'Hot Line' at the UK factory, tel. 01-847 1671.

Flanging effects are wide and varied using the four controls to experiment with sounds that are best suited to your playing style.

## Modifications

Amdek do not recommend modifications to their circuit 'unless you have powerful tools at your disposal!' However, one modification we made, which does not alter the circuitry, is to connect an external control voltage.

The internal LFO can be disconnected using a switched jack socket and a voltage ranging from 0 to 9V can be used. To fit the socket, drill a hole to suit and connect the centre wiper of the Depth control to the switched side and tag 10 on the PCB to the live side. If no jack is connected, the circuit operates as before. When a jack is connected signals such as those from an external VCO, ADSR, Sequencer, Random Sample and Hold or even Breath Control could be used.

E&M

**Output Jack** — for connection to the input of an amp or other effector.

**LED** — indicates the effect's ON/OFF condition. Also functions as a battery checker.

**MANUAL** — for adjustment of the delay time. Turning clockwise lengthens the time of delay.

**DEPTH** — Depending on the delay time set by MANUAL, the sweep width can be further adjusted by this DEPTH control. Turning clockwise widens the sweep and vice versa. When turned fully clockwise, MANUAL control does not have any effect.

Panel description.

**External Power Input Jack** to external power: used when an optional power pack (DC 9V).

**Input Jack** for connection to a guitar or other instrument. Input jack also functions as a power ON/OFF switch. When not playing, pull out the jack.

**RES** for adjustment of the amount of feedback.

Turning clockwise strengthens the characteristics flanging sound.

**RATE** for adjustment of the sweep speed. Turning clockwise makes the sweep cycle faster.

**Foot Switch** for changeover of the effect.

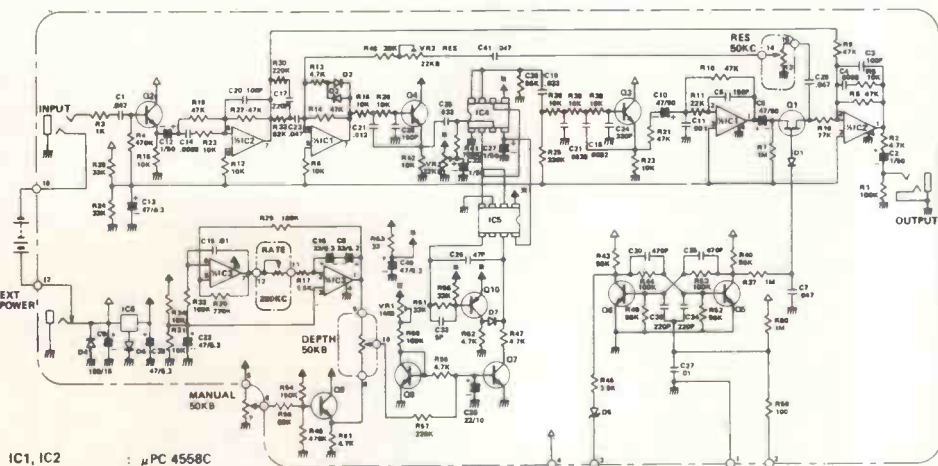
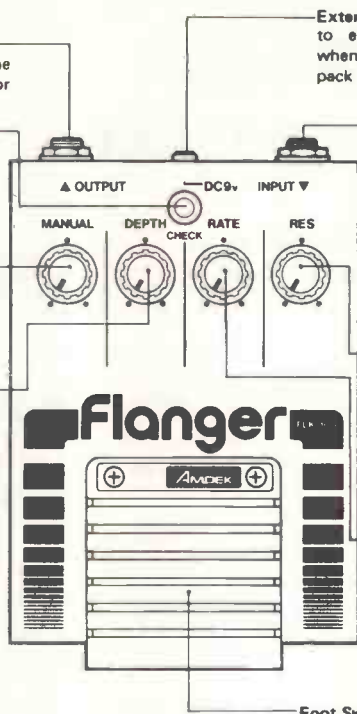

- IC1, IC2 :  $\mu$ PC 4558C
- IC3 : TL022CP
- IC4 : MN3207
- IC5 : MN3102
- IC6 :  $\mu$ PC78L05
- Q1 : 2SK30A TM Y
- Q2 - Q4 : 2SC732 TM GR
- Q5 - Q9 : 2SC945 P
- Q10 : 2SA733P
- D1 - D3, D6, D7 : DS442
- D4 : 10E2
- D5 : RD5.1EB3

E&M's special offer price for the Amdek Flanger Kit is £52 inc. VAT and P&P. Please order as: Amdek FLK-100 kit.

# Home Studio Active Speaker

by Jeff Macaulay



- ★ 30W Output
- ★ Independent Power Amplifiers
- ★ Built-in Power Supply

This speaker system was designed specifically to match with the woofer described in the March '81 issue of E&MM. However, its performance is of monitoring standard and is perfectly adequate when used alone, although the inevitable consequence of its small size is the lack of deep bass response. As they stand the low frequency cut off of the system is about 70Hz.

Matched with the woofer a full scale active stereo system is formed which responds from 30Hz-20kHz within the -3db points.

## Active Circuits

To explain why the active approach has been taken it is necessary to return to the basics of speaker design.

It is, unfortunately, impossible for a single drive unit to give a satisfactory performance across the audioband. To produce good bass a heavy, large cone is required that can respond to large movements. For good treble a small moving mass is needed that can respond rapidly. These two requirements are obviously contradictory.

The usual solution is to use two or more speakers which will handle the range, with a passive network to feed the frequencies to the appropriate drive units.

Unfortunately, speakers are far from simple resistive loads. They contain considerable amounts of inductance, for example, as well as generating currents which will feedback into the network producing response anomalies.

For these reasons a typical crossover network is very complex, wastes amplifier power and can only be used with the speakers for which it has been specifically designed. For economic reasons the optimum integration of the drive units is very rarely achieved in practice.

Active speakers, in actual fact, date from 1958! The original designs used filters designed around valve cathode followers. Unfortunately, they didn't catch on because of the then high price of Hi-Fi amplifiers. However, a lot of water has flowed under the bridge since and in relative terms the cost of the electronics now makes a system more viable. This in turn has led to the resurgence of active systems, although their average price is at present in the £1,000 region.

Briefly, an active system uses a filter built around a transistor or op-amp stage. Using only standard C's and R's the crossover becomes very cheap to build. However, the problem comes after the filters because each drive unit now requires its own power amp.

With this system the advantages over the passive types are amazing. Most of the small response irregularities of the drive units are smoothed out because of the better damping applied to the voice coils. Efficiency is increased by several dB allowing smaller power amps to be used for the same SPL. The speaker's impedance has no effect on the active crossover so that a textbook perfect crossover response is obtained every time. Lastly, it is easy to adjust the relative balance between woofer and tweeter to cater for different acoustics.

## Cabinet Design

The sound of a speaker system depends on several factors, all inter-relating with one another. Firstly, the type of cabinet employed and its construction. In this system the simple closed box, or infinite baffle (IB) has been chosen. This has two major consequences for the performance, both at the low end. First when a drive unit is placed into a sealed box the resonant frequency rises. In this case to about 75 Hz. Signals above this frequency to the cutoff at the high end are reproduced flat. Below the resonant frequency the response rolls off at 12dB/octave. This rolloff is exactly complementary to the rolloff imposed on the woofer and is within the adjustment range available. This means that the woofer and speakers are easily integrated.

The IB type of enclosure has an inherently good transient response, a necessity for the proper reproduction of music. One of the most serious problems associated with speaker cabinets is colouration. This is because the cabinet usually consists of parallel walls and standing waves are set up when the sound reproduced has a wavelength identical with one or other of the internal dimensions. The cure is twofold: standing waves can be reduced by inserting suitable acoustic absorbants into the cabinet and wall vibrations can be damped by adding extra mass and bracing for rigidity.

In this design BAF wadding is used for internal damping whilst the walls are stiffened and damped with ceramic tiles. In fact the perfect cabinet material would probably be ceramic as it is completely dead and heavy - try flexing a tile! The use of ceramic tiles for damping is at least as effective as using bitumous felt panels but without the problems associated with fixing this material in place.

Experience with large numbers of speaker systems has shown that the stability and depth of the stereo image created by a pair of speakers depends, in large part, on the width of the front baffle.

All else being equal a narrow speaker width allows greater dispersion of the sound than a wide one. For this reason the speakers are only 9" wide. Another important thing is to ensure that sufficient depth behind the drive units is available. The reason for this is that the sound radiating from the rear of the speaker cone impinges directly on the rear panel. Some of this is reflected back to hit the speaker cone. This being flexible will try to move in sympathy. The resulting sound when re-radiated in this way tends to obscure fine detail. The cure is to attenuate this energy as much as possible. This requires a long signal path and plenty of damping material.

To maintain an even response the drive units must both be very linear in response and accurately crossed over. The drive units chosen for this design are the Dalesford D110/30 for the woofer/midrange unit and the Audax HD13D34H dome tweeter for the high end.

Crossover order is the next factor to be determined. A 6db/octave response would be too low to avoid problems with the fundamental resonance of the tweeter and the inevitable response irregularities at the extreme high end of the woofer's response.

Third and fourth order filters are rather complex to design and furthermore have a

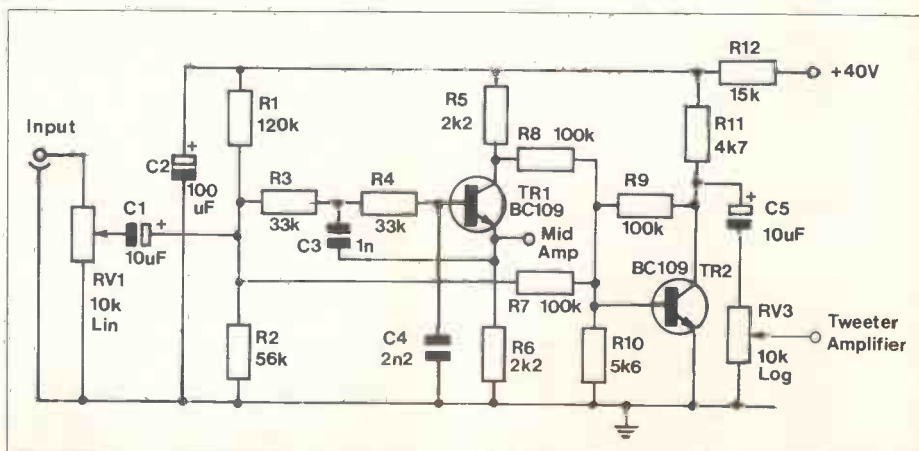

Figure 1. Circuit diagram of the Active Filter.



worse phase response than the lower order types. This leaves the second order which are both straightforward to design and implement and are good at handling transients.

The only suitable filter slope having been determined the remaining problem is to ensure that the 'Q' is set at 0.707. This will ensure the optimum rolloff rate combined with minimal phase ripples in the pass bands.

## Circuitry

The circuit of the active filter is shown in Figure 1. Input signals are fed into the active filter by means of the attenuator RV1. Because the amplifiers are internal the units can be driven either from the output of a preamplifier, or from the speaker outputs of an existing amplifier.

If the latter option is used a hidden advantage is that the input impedance of the speakers is such that the output stages of the driving amps will operate in class A, removing most of the distortion usually generated.

The active filter is a standard 'Sallen and Key' type built around TR1. The response is that of an optimally damped Butterworth with a 'Q' of 0.7. R3, R4, C3 and C4 form the feedback loop for a low pass response with a -3dB point at 3kHz.

The treble component of the signal is separated from the full range input by subtracting the inverted low pass response at TR1's collector from the input with a virtual earth mixer, TR2.

In order to prevent any possible instability and hum modulating the outputs, a hefty decoupling network consisting of R12 and C2 is employed.

As with most speaker systems the sensitivity of the tweeter is greater than that of the woofer so some means of equalising the

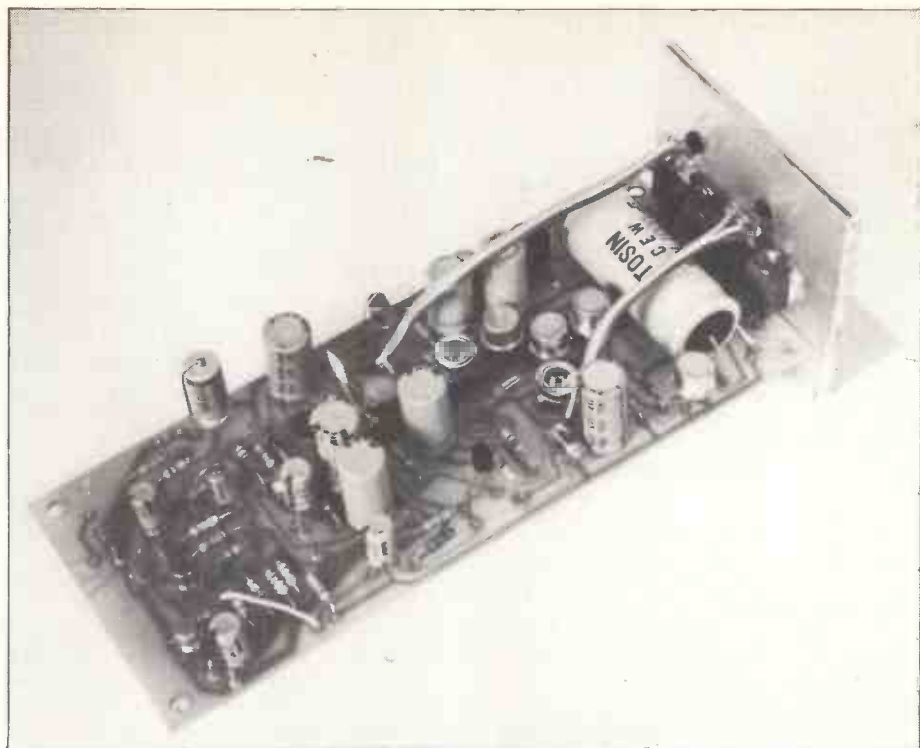

Completed PCB with angled heatsink.

amplitude response is needed. Here this is achieved by attenuating the treble component with RV3 which is brought out for the use of the listener.

Only one amplifier is shown in Figure 2 although two are required in each cabinet. The other amplifier is identical to the one shown except for the output capacitor C12. This component is 100uF for the tweeter and 1000uF for the woofer/midrange. The size

differential occurs because the output capacitor and drive unit form a first order highpass filter whose cutoff depends on their relative impedances.

Bias for TR3 is provided by the resistive divider formed by R13, 14 and 15. The base is decoupled from line variations by the capacitor C7.

Output signals from TR3 are taken from the collector across R16 which also provides bias for the pre-driver TR4. TR5 and RV2 form a Vbe multiplier for setting the bias for the output stage. The collector load of TR4 is bootstrapped by C11. This provides the constant current drive required by the output stage if crossover distortion is to be avoided. C9 and C10 put a pole in the high frequency response to achieve stability.

The output stage consists of a pure complementary pair of discrete Darlington's. The power transistors have a fairly high ft which helps to produce a low distortion level at high frequencies.

Overall DC feedback is obtained by R18 whilst the AC gain is defined by the ratio of this component to R17 to which it is coupled by C8.

An advantage of the active approach over the passive is that, since no attenuation is used in front of the tweeter, several dB more headroom is available at high frequencies.

The power supply is very conventional consisting of a full wave rectifier followed by a large decoupling capacitor. By connecting the two secondaries in parallel a 'stiff' supply is obtained which means in practice that the amplifier can cope with awkward signals with ease.

A dual connector is taken out to the back panel from across the D110/30 to facilitate connection to the E&MM woofer. If this is not contemplated, these are not required.

## Cabinet Construction

The mechanical work involved in making the cabinets has deliberately been kept as simple as possible. Apart from making life easier for constructors I must also admit to an ulterior motive here. I don't count woodwork as my strongest subject so the reader can safely assume that if the writer can build it, so can he (or she)!

Butt joints are used throughout, again for simplicity. When using chipboards it must

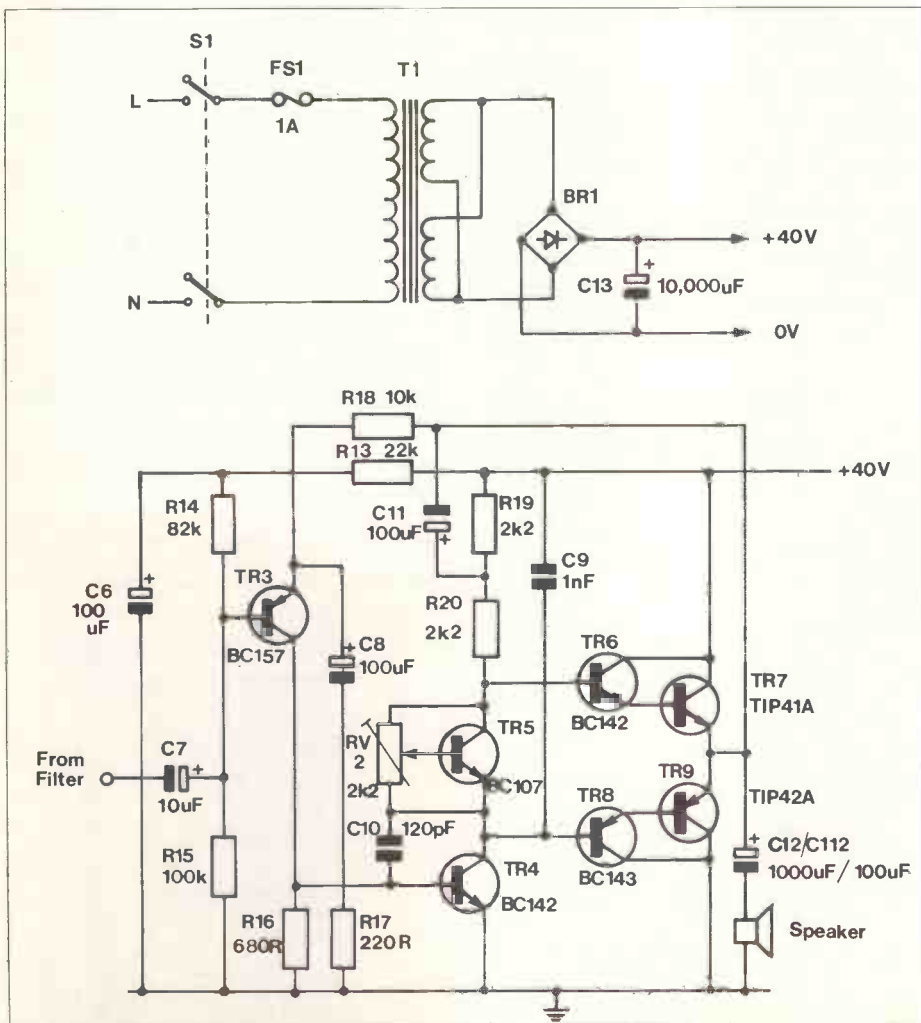

Figure 2. Circuit diagram of the Power Amplifier.

be remembered that the glue holds everything together and so this must be carefully chosen.

For this job, as with the bass unit thixofix adhesive is specified. For those who have not used this before a brief description is in order. Thixofix is a contact adhesive marketed by Dunlop and a small tin, easily adequate for a pair of speakers, can be obtained from your local hardware store. It will stick a wide variety of materials apart from wood and is really intended for gluing worktops. It adheres well to melamine teak chipboard and works better here than the more usually encountered PVA wood adhesives.

The real advantage, however, is that it is possible to slide the boards around to position them correctly. If pressure is then applied to the joint the materials will stick hard.

Teak melamine board is the ideal material to use for the speakers for a variety of reasons: it is somewhat denser than the real veneer type; it is cheaper and lastly it requires no finishing.

The physical construction of the speakers can be divided into two parts the electronic and mechanical. Lets start with the mechanics.

Take the cutting list along to your local neighbourhood wood merchant, insisting that the pieces are cut to size accurately - this is worth the price of a pint of beer extra in saved work and temper!

All the pieces can be cut from a pair of 6' by 9" boards with a few inches spare. The battens are hardwood which has the advantage over softwood that it's dimensions tend not to vary from piece to piece. It is also straight edged and doesn't warp.

Having got the wood home mark the worst face with it's corresponding letter as per the cutting list. Take the front panel and mark out the cutouts for the drive units. Note here that the woofer cutout is not recessed as per the instructions supplied for it. For these speakers it is not necessary and saves a lot of work. Don't drill the fixing holes at this stage but position the units and mark the hole positions through the mounting holes themselves. The woofer is then fixed into place as per enclosed instructions. Remember to use the foam gasket supplied under the drive unit for a good seal.

The tweeter is fixed in place with four 1/2" long No 6 self tap screws. The best way to use these is to take an 1/8" twist drill and wrap a

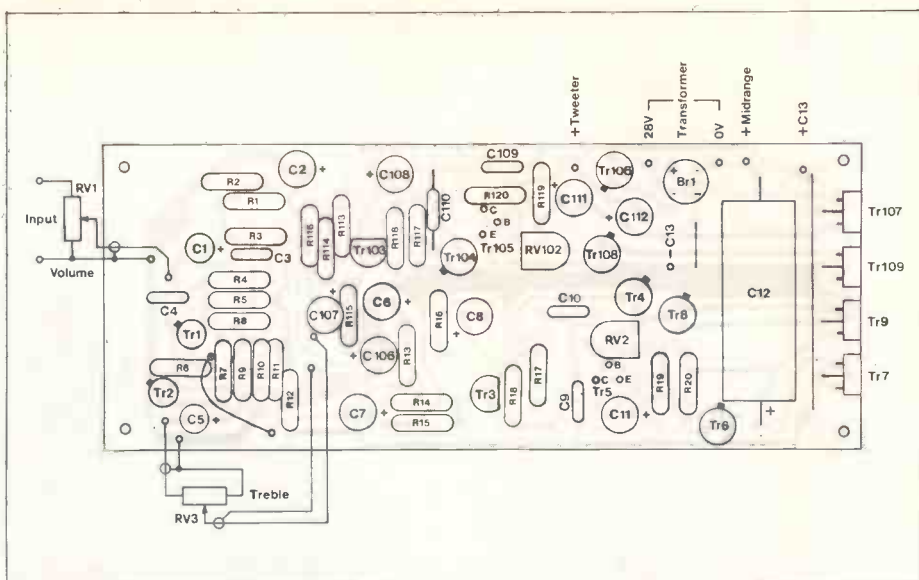

Figure 3. PCB component overlay.

piece of masking tape 1/2" from the end around the shank. This can then be used as a guide to prevent you drilling right through the panels. The tweeter is then simply screwed against the front baffle with four of these screws.

Now the cabinets themselves can be tackled as follows:

- 1) Mark out the sides, top and bottom to accept the battens.
- 2) Glue these into position.
- 3) Apply adhesive to the butting pieces and the edges of the front baffle.
- 4) Bring these together to form the cabinet. Don't do anything to the back panel at this stage.

## Electronic Construction

The electronic side of the construction must be done now before the equipment can be finally assembled.

First, the PCB which is straightforward. Insert and solder the components using the overlay shown in Figure 3. Make certain that all the semiconductors and electrolytics are correctly orientated. Having completed and checked the board it can be fixed into position on the back panel by means of 1/2" self tapping screws. Then screw the transformer, C13 and heatsink into position.

The heatsink assembly should be fitted

as shown in Figure 5. Transistors are mounted on to a piece of angled aluminium, which passed through a hole cut in the back panel and is screwed onto the larger flat heatsink.

Lastly, interconnections can be made as shown in Figure 3 and the internal photos.

Having reached this stage it is necessary to set the quiescent current of the output stages. The presets have to be adjusted for zero quiescent current. Connect a multimeter, switched to its lowest resistance range, between the base of TR5 and it's collector. Adjust the preset until a short circuit is read. Repeat this for the other amp. At this stage it is a good idea to cover the mains terminals on T1 and the mains input socket to avoid the possibility of accidental shock. Then remove the earthing link from the board and insert the multimeter in it's place switched to give a clear indication of 50mA quiescent current.

Apply power and the meter should indicate around 10mA. Slowly turn one of the presets until the indication shows 25mA. Now adjust the other preset until 40mA is read. Switch off, remove the meter and reinsert the link.

Switch on again and measure the output voltages at the emitters of the power transistors. They should be about 20V, a couple of volts either way is of no consequence.

Switch off once more and connect the speakers up temporarily with some hookup wire. After switching on again a finger placed on the input should result in a loud buzz from the speakers.

If all is well at this stage switch off, detach the speakers and turn your attention back to finishing the cabinets.

The next task here is to fit the ceramic tiles into the cabinets. You will find that the tiles are a good fit into the spaces between the battens where they should be glued into

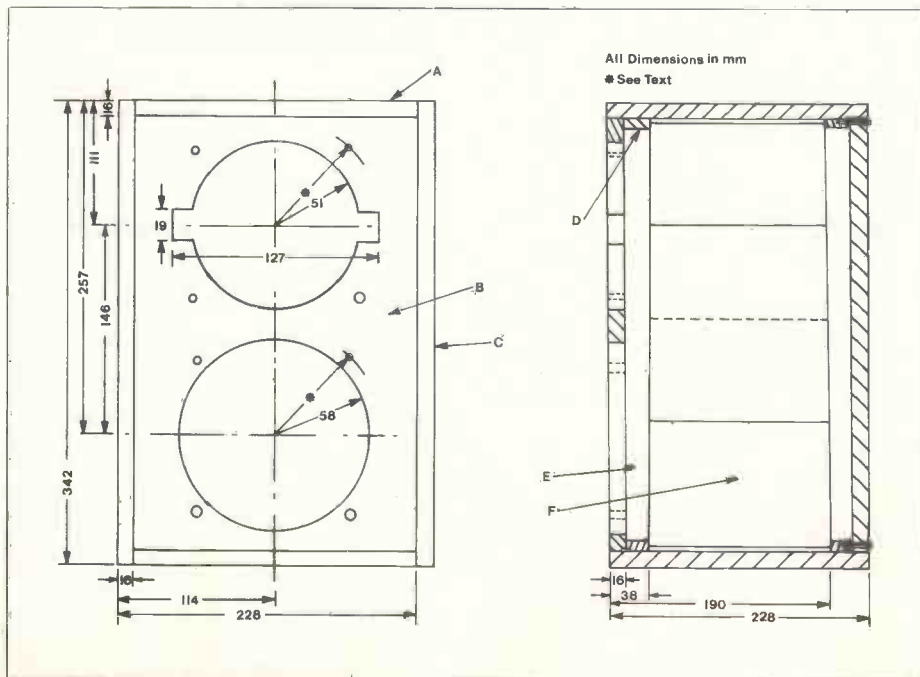
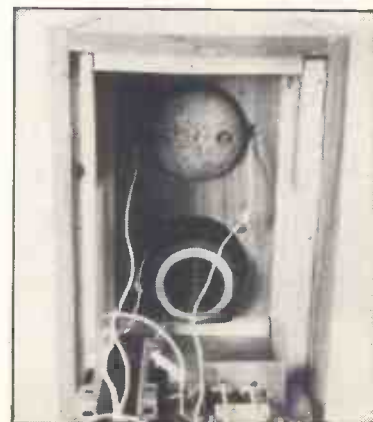

Figure 4. Cabinet construction details.



Internal cabinet construction.



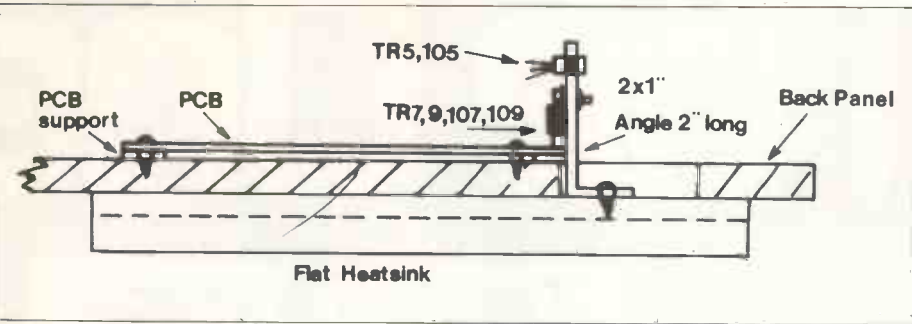
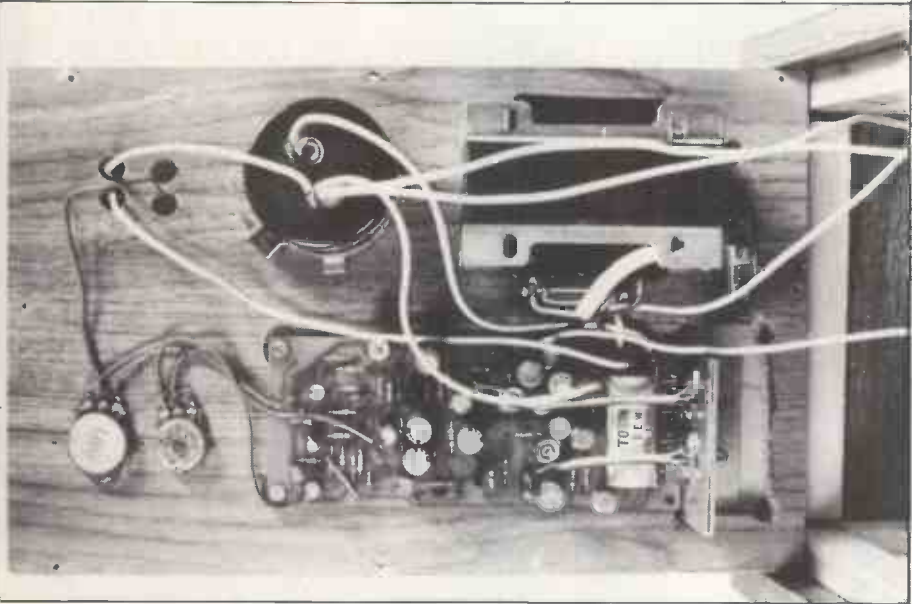

Figure 5. Heatsink layout.



Completed back panel construction.

place with thixofiz.  
 Having done this solder a couple of feet of 5A mains cable to the drive units and roll up a couple of feet of BAF wadding and insert this into the cabinet(s).  
 Remembering to observe phasing, connect the speakers to the amplifier outputs. Apply a signal to the input and switch on. At this stage sweet sounds should issue forth. Try the effect of the balance control and check that the tonal balance alters between too much and not enough treble.  
 Once satisfied, screw the back panel into place with 1½" No. 6 woodscrews around the periphery into the support battens on the sides. The job is now completed and all that remains is to set the balance up to suit your room/taste.

This is best done with a source of voice signals. I suggest that a decent FM broadcast, say Radio 4 is ideal for this purpose. You should find that, with your tone controls in the flat position, voices will sound very natural without chesty boom or overemphasised sibilants. Of course adjusting the balance control on the rear panel will alter what you hear, but speech is ideal for getting it right.

With music the sound should be clear and detailed with adequate bass especially taking into account the size of the cabinet! If you are going to use the woofer with these use the spare terminals on the back connected to the D110/30. Setting up follows the same procedure as detailed in the March '81 issue.

As with all speakers room positioning is vital. Ideally they should be kept away from corners and placed at least a foot away from the rear wall if the stereo image is to possess depth as well as width.

In conclusion I would like to say that I have yet to hear a speaker system that I would care to swap for these regardless of price.

E&MM

**ACTIVE SPEAKER PARTS LIST (For 1 Enclosure)**

Resistors — all ¼W, 5% carbon film		TR5,105	BC107	2 off
R1	120k	TR7,107	TIP41A	2 off
R2	56k	TR8,108	BC143	2 off
R3,4	33k	TR9,109	TIP42A	2 off
R5,6,19,119,20,120	2k2	BR1	W01	
R7,8,9	100k			
R10	5k6	Miscellaneous		
R11	4k7	T1	28-0-28V 1½A Transformer	
R12	15k	PL1	Mains Plug SA 2403	
R13,113	22k	SK1	Mains Socket SA 2404	
R14,114	82k	FS1	1A 20mm Fuse	
R15,115	47k		Fuseholder	
R16,116	680R		Capacitor mounting clip for C13	
R17,117	220R		TO66 Mounting kit	4 off
R18,118	10k		Veropins	
RV1	10k Lin potentiometer		Speaker connectors	2 off
RV2,102	2k2 Horizontal pre-set		3M 6A Twin mains cable	
RV3	10k Log potentiometer		1M Screened cable	
			2.6°C per watt Heatsink	
			2" x 1" Angled aluminium, 2" long	
Capacitors		Drive Units		
C1,5,7,107	10uF 35V PCB Electrolytic	4 off	Bass/Midrange	Dalesford D110/30 6½"
C2,6,106,8	100uF 25V PCB Electrolytic	7 off	Soft Dome Tweeter	Audax HD13D34H
C3	1nF Polycarbonate		Cabinet	
C4	2n2 Polycarbonate		Veneered Melamine Chipboard ¾"	
C9,109	1uF Mylar	2 off	A	7¾" x 9" 2 off
C10,110	120pF Silvered Mica	2 off	B	7¾" x 12¼" 2 off
C12	1000uF 63V Axial Electrolytic		C	13½" x 9" 2 off
C112	100uF 63V PCB Electrolytic		Hardwood battens	
C13	10,000uF 63V Can Electrolytic		D	7¾" x 7⅞" x ¾" 4 off
Semiconductors			E	11½" x 7⅞" x ¾" 4 off
TR1,2	BC109C	2 off	F	6" square ceramic tiles 8 off
TR3,103	BC557	2 off		Thixofiz adhesive
TR4,104,6,106	BC142	4 off		

The PCB for the Active Speaker is available from E&MM, 282 London Road, Westcliff-on-Sea, Essex SS0 7JG at £3.75 inc. VAT and P&P. Please order as: Active Speaker PCB.

# ITA. The One

## BUDGET PACKAGES

### Tascam 4 track systems



A variety of small systems for the cost conscious, from the M244 Portastudio, complete on its own; or the latest Tascam 34 4 channel reel-to-reel now available in a package with the new PEP 800 8 x 4 mixer. This mixer has the comprehensive facilities of larger mixers costing twice the price. Total Package Price **only £985.**

### Fostex



The world's smallest 8 track. Available also as a complete system, with the 350 Mixer. **NEW LOW PRICES.**

### The New Sensation from Fostex - X-15 Tracker

A portable battery or mains operated 4 channel cassette recorder with built-in mixer.

The musical note book you can use anywhere.

Dolby noise reduction, treble and bass EQ, punch-in/out, and lots more for **only £260.**



### Tascam 8 track systems



38 — the sensational new half inch 8 track has shattered price barriers. Yet performance is better than ever, with digital counter, lower noise electronics, and pitch control.

### Special Offer



Only from ITA — the new Tascam 38, 8 track with Itam dB30

noise reduction. 8 channels of simultaneous NR giving 30dB improvement in sig/noise ratio.

**£1666 Complete**

### ITAM/TRIDENT 16 track system



This brand new package brings 16 track recording to those with an 8 track budget! The Itam 1610 is a one inch 16 track and features 3 speeds [inc. 30 ips] full function remote with varispeed, optional noise reduction. The Trident VFM is a fully modular 20 x 8 x 16

console with 20 inputs and full 16 track monitoring. Special Offer [subject to stocks]:

**£6350 Complete**

**ITA, 1-7 Harewood Avenue, Marylebone Road,**



# Source.

What do you need?  
A budget 4 track recorder? A 24 track system? The hire of a 2 track for a day, or just a reel of tape? Come to ITA — the Central London source for every requirement!

## STUDIO SYSTEMS **OTARI/ITAM** 8 track system



The ultimate compact 8 track studio. Otari's advanced MkIII-8 recorder, with microprocessor controlled transport, built-in oscillator, and full function remote. The MkIII-8 can be interfaced to video synchronizers for "audio sweetening" work. The entirely new Itam 12-4-8 is a professional multitrack mixer. All 8 tracks can be continuously monitored while recording and the 8 tape returns are additionally normalised to the line inputs on 8 of the 12 input channels. Autolocator Now Available

### SPECIAL OFFERS

## **D & R signal processing**

Any 4 of the following modules, complete with power supply and cabinet:

parametric EQ, noise gate, compressor/limiter, stereo limiter, compressor, stereo disc amp, high-low pass filter.

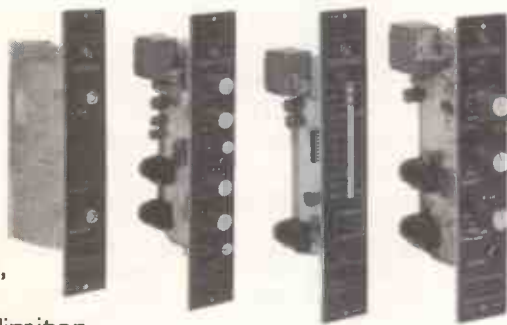

**Only £295**

Alternatively, buy any 4 D & R modules at our normal professional price, and get a 19 inch rack FREE!

## MULTITRACK MIXERS **ITAM Sigma**



SIGMA — the new multitrack console that outclasses the competition — in price, features and performance. Facilities include: Full modular construction, full 16 track monitoring, 8 busses + stereo buss + 4 aux busses, programmable muting, autosolo, LED bargraph metering with switchable VU/PPM characteristics, PFL on groups and cue sends, comprehensive line-up oscillator, dedicated FX returns, 4-band EQ mid-bands sweepable, hi and lo pass filters, flexible talk-back system, electronically balanced mic. inputs with switchable phantom power, phase reverse and pad.

**16-8-16: £3,960**

**With Audiofad faders: £4,360**

**Stand: £155**

### SECOND HAND EQUIPMENT

The following equipment has been taken in part exchange, and has been overhauled in our workshops.

MCI JH114 24 track	<b>£12,500</b>
STUDER A80 MkII 16 Tr	<b>£9,500</b>
Brenell Mini 8	<b>£1,500</b>
TEAC 4 track/RX9	<b>£495</b>
Otari MX5050B	<b>£700</b>
Revox A77	<b>£340</b>
Otari C2 cassette duplicator	<b>£1,200</b>

[Please phone for latest details]

**London NW1. Tel: 01-724 2497. Telex: 21879**

# CLASSIFIED

New rates for 1983: Lineage 34p per word (min. 12 words); Box No. 80p extra. Semi-Display: £1.00 extra. Display: £10.00 per single cm. column.

All lineage advertisements must be pre-paid. Closing date: 5th of month preceding publication. Advertisements are accepted subject to the terms and conditions printed on the advertisement rate card (available on request). Telephone: 01-527 3376 "Classified". E&MM, 282 London Rd, Westcliff-on-Sea, Essex SS0 7JG.

## Loudspeaker Cabinet Fittings

From Adam Hall Supplies:  
Coverings & frets • flight case parts  
• Celestion power speakers •  
Rean jacks & fittings • P&N stands  
Send 30p PO/cheque for Illustrated catalogue

**ADAM HALL  
SUPPLIES LTD**  
Unit M,  
Carlton Court,  
Grainger Road,  
Southend-on-Sea  
Essex

**Celestion**  
Cabinet Handbook  
Available NOW  
Extra **£1**

## City Music

for  
**Roland**  
**BOSS AMDEK**  
Unbeatable Prices?

**MAIN LINE**  
TORQUAY: 65 Market Street (25488)  
TRURO: 16 Pydar Street (71359)  
JERSEY: Wests Centre (78901)  
**CONTEMPORARY KEYBOARDS**  
N. HARROW: Pinner Road (01-863 1841)  
UXBRIDGE: Chequers Square (30127)  
EXETER: Queen Street (51846)  
NEWTON ABBOT: Queen Street (65275)

Special offer to E&MM readers. Central London, one inch 8-track Juno 60, TR808, and much more. £7.00 per hour inclusive. Tel: 01-286 0642.

**CLASSIFIED TELEPHONE:  
GRAHAM  
BUTTERWORTH  
ON 01-527 3376**

## DRUM DROPS

'The Ultimate Drum Track Albums'  
American produced real drum  
sound backing tracks  
Volumes 1-5 available NOW!  
**£5.99 per LP inc P&P**  
Please send S.A.E. for track details etc.  
**MUSTANG RECORDS & TAPES**  
P.O. Box 139 High Wycombe  
Bucks HP13 5LH

## HOBBS MUSIC

Gateway Studio's 3 day  
courses — £60 per head +  
VAT, planned for June  
6th, 7th & 8th in the  
studios of HOBBS MUSIC  
(Lancaster).  
Please contact:  
**BRUCE HOBBS on**  
Lancaster (0524) 60740.  
(Price does not include  
accommodation.)

# WANTED

## Electro-Musician/ Home Recordist

to demo and sell HI-TECH  
products in established retail outlet  
(London area).

*Good rewards for competent person.*

Write in confidence to:—

**FREEDMANS**  
627-631 HIGH ROAD  
LEYTONSTONE  
LONDON E11 4PA

**7 DAYS A WEEK** **FOR HIRE** **24 HR SERVICE**

A northern based hire company offering a national service, specialising in the home recording market. Small example of products include:-

**8 Track Package - £150 per week**  
(8 track, 8,4,2 mixer, 2 track)

**Linn Drum - The best available £45 per day**

Keyboard Department Now Open

**Jupiter 8 - £45 per day**  
**Prophet Pro-one - £15 per day**  
**Roland CSQ 600 sequencer - £15 per day**

From Portastudios to 8 tracks plus all recording accessories from a mike stand to a compressor.

Phone **STUDIO SUPPLY SERVICE - 061-928 5037**

## GATEWAY MULTI-TRACK COURSES

Gateway Studios, in co-operation with BANDIVE and the FOSTEX CORPORATION have put together a series of courses on professional studio techniques for the home recordist, musician or producer involved in recording at any level.

These 3-day courses are organised fortnightly.

Call **DAVE WARD** on  
**01-223 8901**

Gateway courses should NOT be confused with any others currently available

## London College ilea of Furniture

### COURSES IN ELECTRONICS FOR THE MUSIC INDUSTRY

#### T.E.C. DIPLOMA IN MUSICAL INSTRUMENT STUDIES

(2 years full time specialising in Electronics)

#### T.E.C. HIGHER DIPLOMA IN MUSICAL INSTRUMENT TECHNOLOGY

(2 years full time specialising in Electronics)

The Electronics option of these T.E.C. courses allow the student to specialise in music industry applications.

Suitable students would be interested in both music and electronics and wish to combine them. Higher Diploma applicants would normally have an A level or its equivalent in an appropriate subject.

Applications forms and further details are obtainable from the Senior Administrative Office at the College.

Department of Musical Instrument Technology  
London College of Furniture  
41-71 Commercial Road  
London E1 1LA 01-247 1953



# ULTIMATELY

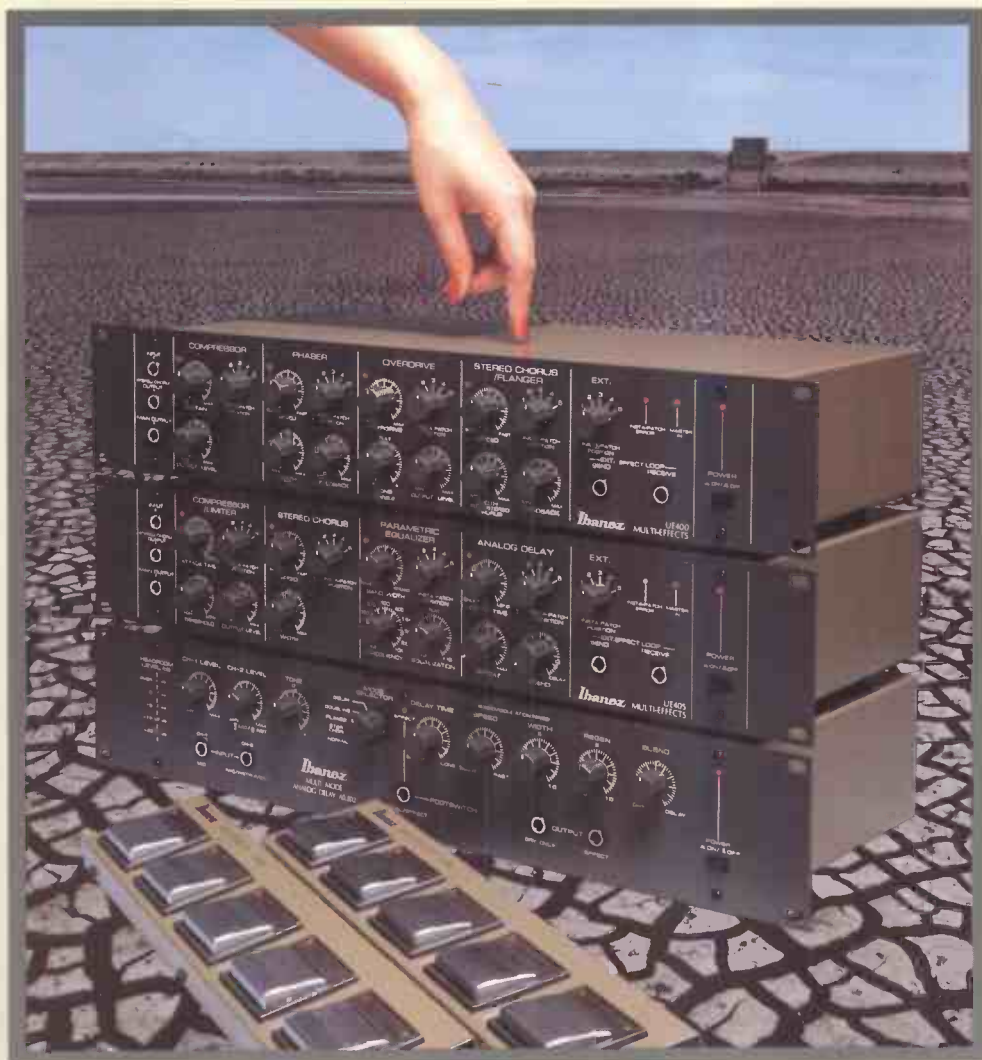

Today's musician-artist or technologist, must distill a complex array of devices into a system that is organized and easy to use. Ultimately, he wants to forget about technology and concentrate on his music.

Ibanez rack systems liberate musicians from technical concerns by providing the ultimate in sophisticated effects system design. The AD202,

Analog Delay and the UE400 and 405 rack systems offer the professional quality, reliability and simplicity that have made them the choice of professionals and amateurs world wide. Ultimately... Ibanez.

Tomorrow's Innovations  
**Ibanez**

Send 30 pence for latest Ibanez Effects Catalogue to: Summerfields (EMM), Saltmeadows Road, Gateshead NE8 3AJ

**NEW**

**Creative Kits  
for Creative Musicians...**

# AMDEK

## Flanger Kit (FLK-100)

Four controls for manual, depth, rate and resonance to provide thicker and powerful effect sounds. Uses special BBD element to assure high stability.





- Assembly process: 21
- Control: Manual, Depth, Rate, Resonance
- Function: Effect changeover switch, Effect indicator
- Terminals: Input, Output, External power source
- Delay time: 1ms — 13ms
- LFO speed: 100ms — 16s
- Residual noise: -95dB (IHF-A)
- Input impedance: 470k $\Omega$
- Output load impedance: Over 10k $\Omega$
- Power source: 006P battery or external power source
- Consumption current: 15mA (DC 9V)
- Dimensions: 95(W) x 64(H) x 143(D)mm (3.74" x 2.52" x 5.63")
- Weight: 520g (1.15 lbs.)
- Modifiable points: 0

Consumers:  
Questions, Problems  
Suppliers?  
Retailers:  
Supplies & Re-orders?

**USE THE  
AMDEK HOTLINE!**

# AMDEK

Roland (UK) Ltd., Great West Trading Estate  
983 Great West Road, Brentford, Middx. TW8 9DN

from the manufacturers of:  Roland /  BOSS

**AMDEK  
HOTLINE!  
01-847 167\***