

Founded 1925

Incorporated
by Royal Charter 1961*To promote the advancement
of radio, electronics and kindred
subjects by the exchange of
information in these branches
of engineering*

The Radio and Electronic Engineer

The Journal of the Institution of Electronic and Radio Engineers

Communications with Off-shore Installations

INEVITABLY, and with good reason, energy is a topic of concern to us all. We have to find ways to extend our use of available forms of energy and to find new sources for the future. Thus we are heavily dependent upon oil: oil which has had a great and serious effect upon our balance of payments over many years and which, with its rapidly increasing cost, is now a root cause of inflation; oil which has led us into profligate uses for fuel and plastics and which now, as it becomes scarce, detracts from our civilization and threatens aspects of our way of life.

But in the United Kingdom we have some time to learn to adapt. Oil and gas have been found in the North Sea and prospecting continues in even less hospitable waters in other parts of the continental shelf. Working in such difficult environments requires complex and sophisticated technology with high reliability and the skills of many kinds of engineering are important for the provision and maintenance of platforms and for the operations of drilling, fuel extraction and transfer to the shore.

Electronics is ubiquitous for instrumentation, control and data handling and there can be no doubt that the development of electronic techniques has been vital in such an industry. However, when working in deep water away from the shores of the UK the more traditional skills of the radio and electronic engineer also have an important part to play.

In the early days of North Sea exploration it was possible to treat communication with the new drilling platforms as an extension of the maritime radio service. The information to be communicated was modest in quantity and the reliability available from m.f. and h.f. radio systems was adequate. However, the rapid growth in exploration placed a great strain on the available services. Once oil was found there was an increased demand for channels carrying transmissions at high data rate and with high reliability. This need was met by the use of tropospheric scatter radio systems and there are now proposals to use satellites. The radio engineering has not been straightforward. Data transmissions at medium and high frequencies have to cope with problems of multi-mode propagation via the ionosphere and with interference. There was little known about the performance of tropospheric scatter systems in climates like the North Sea and the systems designers had difficult decisions to make in planning of stations which would give adequate performance without being over-engineered.

Another facet is the problem of communicating to the supply vessels and aircraft which provide physical links with the rigs. With conveniently sited coast stations, communications across the North Sea are likely to be within the capabilities of conventional techniques. But as ranges increase, as may well be the case in the Western Approaches, difficulties are likely also to increase, particularly when we consider the low radiation efficiencies which are achieved from some helicopter antennae.

Communications are very important, but so are techniques for precise position fixing and for safe navigation. Requirements vary from the modest accuracy needed for en-route navigation to accurate determination of the location of well-heads. In deep waters some new designs for rigs rely, not on a physical connection between the rig and the sea bed, but on a dynamic system in which the floating rig is accurately maintained in position over the well.

The engineers' response to some of these problems, for which a successful solution is so important to our way of life, is indicated in the group of papers in this issue of *The Radio and Electronic Engineer*. These papers describe the growth of radio communications for the North Sea and some of the means by which performance is maintained. It is intended that further papers over the next few months will discuss other aspects of the use of radio in the off-shore and gas industries.

L. W. BARCLAY

The Adorian and Brennan Premiums

In the June issue of the Journal it was announced that the name of the Premium which is awarded annually for the outstanding paper on communications or broadcasting engineering is to be changed to the Paul Adorian Premium with immediate effect. At the same time, the terms of award of the Hugh Brennan Premium are being broadened to provide recognition of the outstanding paper presented at a meeting of a Local Section and subsequently published in the Institution's Journal. To the older generation of members of the Institution the names of both these Premiums will recall well-known personalities: the present generation of engineers from whom the recipients of future awards of these Premiums will come may like to know a little more about the two members who can be regarded as representative of the first and second generations of members of the Institution.

Paul Adorian and Hugh Brennan are senior Fellows of the IERE whose contributions to the profession and to the Institution (of which their combined periods of membership total just 80 years) are thus commemorated. Interesting coincidences are that both these engineers devoted many years to wired broadcasting: now of course retired from full-time professional work, both are currently actively engaged in studies concerned with energy sources and their utilization.

Paul Adorian joined Rediffusion in 1932, retiring in 1970 following five years as its Managing Director. Born in Hungary in 1905, he received his technical education in England, at the Polytechnic, Regent Street and at Imperial College, and he was for a short while an engineer with Standard Telephones & Cables before joining Rediffusion. Here he was involved in the development of radio and television wire broadcasting and in 1941 he was appointed Technical Director. In 1956 he became a founder Director of Associated-Rediffusion Ltd and was Managing Director of that company and of its successor, Rediffusion Television Ltd. It was during his tenure of office that the company produced the first programmes for schools shown on television. As an adviser to the Ministry of Aircraft Production during the war Mr Adorian served on two special assignments with the British Air Commission in Washington. He invented a flight trainer that was later adopted by the Allies, and concerned himself with various flying and antisubmarine projects and with the production of radar equipment. After the war he was instrumental in setting up Redifon Flight Simulators.

Since 1970, Mr Adorian has been with Resource Sciences Corporation of Tulsa, Oklahoma, as Technical Advisor and as Director, and he is now a Director of the British subsidiary company, Williams Brothers Engineering; the Corporation is concerned with the broad field of energy engineering, embracing extraction, processing and transport of fuels as well as energy utilization.

Paul Adorian is a Fellow of the City and Guilds Institute, a Freeman of the City of London, a Member of the Worshipful Company of Horners, and a Governor of the British Film Institute. He was elected a Fellow of the IERE in 1943, and served on the Council from 1945, being elected President for 1951–52. He has contributed several papers to the Journal and at conferences on subjects of wired broadcasting, communications and flight simulation.



Paul Adorian



Hugh Brennan

A man of many parts, Paul Adorian was actively interested in rocket propulsion in his student days, and wrote a book on 'Rockets' in 1929. He has been an active glider pilot, and holds one of the first 150 glider pilot licences. His most recent hobbies include industrial archaeology—he collaborated in the excavation of a pre-Roman bracelet factory in Dorset and he restored an ancient water mill on his land in Sussex. For many years he was among Wimbledon's leading umpires and he adjudicated there regularly from 1928.

Hugh Brennan was born in 1900 and received his general education in Newcastle upon Tyne, and at Armstrong College (now King's College) of the University of Durham. After graduating with a B.Sc. degree in 1921, he joined the North Eastern Electricity Company by whom he was employed for eight years.

In 1930 he started his own business as a Consulting Radio and Electrical Engineer. Initially in this capacity, he negotiated a substantial contract with his former employers to restore to working order a wide variety of non-standard electronic equipment, put out of commission by the conversions from d.c. to a.c. and 40 to 50 Hz that the power company were undertaking on a very large scale at that time. Concurrently he was responsible for the installation of sound cinematograph equipment, and the organization of specialized public address work.

During the late 1930s Mr Brennan became involved in wired broadcasting and set up experimental wired television systems in various parts of North East England before regular broadcasting from local television transmitters was established. Between 1940 and 1960 he directed the complete construction of seven wired systems, three of which were the first in Northumberland to provide high quality v.h.f. transmissions for four radio programmes transmitted at audio frequency.

Elected a Member of the Institution in 1938, Mr Brennan was transferred to Fellow in 1944. He was joint author with Mr T. A. Cross (Fellow) of a paper on Public Address Systems, published in the Journal in 1943. Mr Brennan was the first Chairman of the North Eastern Section on its formation in 1943 and subsequently served the Committee in other capacities. He was a Member of the General Council during 1945 and 1946 and was again elected Chairman of the North Eastern Section in 1956, remaining so till 1958. (It was at this time he endowed the Premium which bears his name.) Arising out of his earlier activities in the electrical supply industry, he is a Fellow of the Institution of Nuclear Engineers and a Member of the Institution of Electrical Engineers.

Now in his eightieth year and semi-retired, Hugh Brennan is still occupied with business interests and he is writing a book on the subject of Natural Energy.

Institution Premiums for 1979

The Council of the Institution announces that authors of the following papers are to receive Premiums for outstanding contributions published in the Journal during 1979.

MAIN PREMIUMS

LORD MOUNTBATTEN PREMIUM *Value £100*
For the outstanding paper on the engineering aspects of electronics or radio

'Superscreened cables'
E. P. Fowler (*Atomic Energy Establishment*)
(Published in the January 1979 issue of the Journal)

CLERK MAXWELL PREMIUM *Value £100*
For the outstanding paper on the science of electronics or radio

'Physical measurements in the 100-1000 GHz range'
M. J. Bangham, Dr J. R. Birch, Dr T. G. Blaney, Dr A. E. Costley, Dr J. E. Harries, Dr R. G. Jones and Dr N. W. B. Stone (*National Physical Laboratory*)
(July/August)

MARCONI PREMIUM *Value £75*
Engineering of an electronic system, circuit or device

'Digital transmission of video and audio signals over an optical-fibre system'
N. H. C. Gilchrist (*British Broadcasting Corporation*)
(December)

HEINRICH HERTZ PREMIUM *Value £75*
Physical or mathematical aspects of electronics or radio

'Real-time spectrum analysis using hardware Fourier chirp-Z transformations'
Dr R. Benjamin (*Government Communications Headquarters*)
(February)

SPECIALIZED TECHNICAL PREMIUMS

CHARLES BABBAGE PREMIUM *Value £50*
Design or electronic engineering application of computers

'Microprocessor implementation of tactical modems for data transmission over v.h.f. sources'
Dr B. H. Davies and T. R. Davies (*Royal Signals and Radar Establishment*)
(April)

LORD BRABAZON PREMIUM *Value £50*
Aerospace, maritime or military systems

'The detection of ice at sea by radar'
P. D. L. Williams (*Decca Radar*)
(June)

A. F. BULGIN PREMIUM *Value £50*
Electronic components or circuits

'Schottky diode receivers for operation in the 100-1000 GHz range'
Dr B. J. Clifton (*Massachusetts Institute of Technology*)
(July/August)

PAUL ADORIAN PREMIUM *Value £50*
Communications or broadcasting engineering
'Atmospheric propagation in the frequency range 100-1000 GHz'
Dr R. J. Emery and A. M. Zavody (*Appleton Laboratory*)
(July/August)

P. PERRING THOMS PREMIUM *Value £50*
Radio or television receiver theory or practice
'Television measurements through psychophysics to subjective picture quality'
J. Allnatt (*Post Office Research Centre*)
(December)

SIR CHARLES WHEATSTONE PREMIUM *Value £50*
Electronic instrumentation or measurement
'Visual range monitors'
M. E. Judge (*Marconi Radar Systems*)
(November)

GENERAL PREMIUMS

ERIC ZEPLER PREMIUM *Value £50*
Education of electronic and radio engineers
'The relevance of science to engineering'
Professor D. Lewin (*Brunel University*)
(March)

RESTRICTED PREMIUMS

SIR JAGDISH CHANDRA BOSE PREMIUM *Value £50*
Outstanding paper by an Indian scientist or engineer on any subject
'An amplitude-controlled adaptive delta sigma modulator'
Dr C. V. Chakravarthy (*Indian Institute of Technology, Kharagpur*)
(January)

Papers of sufficiently high standard were not published within the terms of the following Premiums and they are withheld:

Dr Norman Partridge Premium (Value £50)—Audio frequency engineering

Lord Rutherford Premium (Value £50)—Electronics associated with nuclear physics or nuclear engineering

J. Langham Thompson Premium (Value £50)—Theory or practice of systems or control engineering

Dr V. K. Zworykin Premium (Value £50)—Medical or biological electronics

Arthur Gay Premium (Value £50)—Production techniques in the electronics industry

Admiral Sir Henry Jackson Premium (Value £50)—History of radio or electronics

Leslie McMichael Premium (Value £50)—Management techniques associated with electronic engineering

Hugh Brennan Premium (Value £50)—Outstanding paper first read before any Local Section of the Institution and subsequently published in the Journal

Members' Appointments

CORPORATE MEMBERS

J. G. Alder (Member 1964, Graduate 1961) an Executive Director of Standard Telephones & Cables (SA) for the past two years, has taken up an appointment on the board of Grinaker Electronics (formerly Racal SA) as Works Director and Deputy Managing Director.

D. A. Brown (Fellow 1965) has been appointed General Manager of Crow of Reading. Following some thirty years service in the Royal Electrical and Mechanical Engineers where his appointments included Head of REME Radar Branch, RRE Malvern and Commandant of the REME Apprentice College, Arborfield, Col. Brown retired from the Army in 1977.

M. M. Brown (Member 1970, Graduate 1966) who has been in the United States since the past three years, initially as a Senior Engineer with the Industrial Controls Division of Emerson Electric, Santa Ana, California, is now working as an independent consultant in the application of power electronics at Kingston, New Hampshire.

E. D. W. Dove (Member 1967, Graduate 1965) has taken up an appointment as Senior Instrumentation Officer with the Ministry of Defence Proof & Experimental Establishments, Eskmeals, Cumbria.

E. W. Horrigan, B.Sc., P.Eng. (Fellow 1970, Member 1964) who is a Senior Partner of E. W. Horrigan and Associates, consultant engineers of Willowdale, Ontario, has been elected President of the Canadian Association of Broadcast Consultants.

J. Mavor, B.Sc., Ph.D. (Member 1966) has been appointed to the Lothian Chair of Microelectronics in the Department of Electrical Engineering at the University of Edinburgh. Dr Mavor who went to Edinburgh in 1971 following several years in the semiconductor industry, was appointed a Reader in electronic engineering last year. He has specialized in c.c.d. technology and applications and was co-author of a paper in a recent special issue of the Journal on this subject. He has been Chairman of the conferences held on c.c.d.s at Edinburgh and he is currently Joint Honorary Editor of the *IEE Journal on Solid-state Devices*.

D. C. Neighbour (Member 1973, Graduate 1966) who was a Senior Engineer with Decca Survey is now with Marconi Avionics as a Senior Field Support Engineer.

H. Nixon (Member 1963) has left the Radio Corporation of America, Riviera Beach, Florida, where he has been since 1966, and is now President of Coaxial Systems Associates Inc., Tequesta, Florida.

J. R. Parks, Ph.D. (Member 1970, Graduate 1957) has been seconded by the Department of Industry to Quest Automation Research, Ferndown, Dorset as Technical Manager. For the past five years he has been at the Headquarters of the D of I in the Control Systems and Electronics Division where his responsibilities were initially with the



Advanced Instrumentation Project and subsequently with the Microprocessor Applications Project. In his new appointment he will be continuing some of the pattern recognition work which he was engaged in at the National Physical Laboratory where he was for many years. Dr Parks served as a member of the Papers Committee from 1975 to 1978 as well as on conference organizing committees; in 1977 he was Guest Editor for the special issue of the Journal on Intelligent Machines.

S. K. Randev, B.Sc., M.Sc. (Member 1972, Student 1964) has been transferred to the Trombay V Expansion Project of Rashtrya Chemicals and Fertilizers, Bombay. Mr Randev was previously Assistant Chief Engineer of the Fertilizer Corporation of India in Andhra Pradesh.

Major S. Rycroft, M.B.E., REME (Member 1971) who was formerly with International Military Services in Tehran, has returned to the United Kingdom to take up an appointment as Assistant Director of Studies in the Management Wing at the REME Officers' School, Arborfield.

I. J. Shelley (Member 1959, Associate 1946, Student 1943) has retired from the BBC after four years of service. Since 1970 he has been Head of the Monitoring and Control Section in the Designs Department and for seven years previously he was Head of the Signal Processing Section. Projects with which he has been concerned include cable film, which was used before the days of satellites to carry television pictures across the Atlantic by means of slow-scan methods, and more recently on transmitter automation. He has represented the BBC on international organizations, having joined the CCIR Study Group on satellite transmission of television signals and for some years he has been Chairman of the EBU Satellite Working

Party. His papers to the Institution have included 'Automatic measurement of insertion test signals' which appeared in March 1971.

P. J. Stones (Member 1971) retired from the Army in September 1978 with the rank of Lieutenant Colonel after 30 years service in the Royal Artillery. Following a period of study at the London Business School, leading to the award of a Fellowship with Distinction, Col. Stones is now Commercial Director of the Blackpool Pleasure Beach Company.

Major R. O. O. Taiwo, B.Eng. (Member 1978) has been appointed Staff Officer in charge of Ballistics at the Headquarters Directorate of the Electrical and Mechanical Engineers Corps of the Nigerian Army in Lagos. He recently completed a two-year postgraduate course at the University of Wales Institute of Science and Technology.

J. C. Taylor (Member 1973, Graduate 1973), who is a Senior Project Leader with Ferranti Instrumentation, has recently been appointed to the Editorial Board of the Institute of Physics *Journal of Physics E (Scientific Instruments)*.

R. E. Taylor (Member 1973, Graduate 1972) is now with Systematics, Piscataway, New Jersey, where he is principally concerned with the development of devices utilizing the Weigand effect. He was previously with the company's UK subsidiary.

G. Turton (Member 1972, Graduate 1967) who has been Branch Manager at Leeds for the Digital Equipment Company, has been promoted to Sales Group Manager, Midlands.

Wong Chor Shoon (Member 1980, Student 1971) has been appointed Repair and Maintenance Test Manager on a two-year expatriate assignment to Texas Instruments (Philippines). He has been with Texas Instruments Malaysia since 1973, working in the plant at Kuala Lumpur.

M. J. Young (Member 1973, Graduate 1971) has taken up an appointment as Principal Engineer with Plessey Radar in the Isle of Wight. He was for a number of years a Senior Scientific Assistant at the SHAPE Technical Centre in The Hague.

NON-CORPORATE MEMBERS

P. J. Goillau, Ph.D. (Graduate 1974) is now a Higher Scientific Officer with the Royal Signals and Radar Establishment, Great Malvern. Dr Goillau was previously with GEC-Elliott (now Fisher Controls UK) as a Systems Engineer.

P. J. Watts, B.A., M.Ed. (Associate Member 1973, Associate 1969) formerly a Research Officer at the Science & Technology Education Centre, University of Bath, has taken up an appointment as Lecturer responsible for electronics courses in the Department of Engineering Technology at Oswestry College, Shropshire.

BSI Promotes Q & R

During 1979 the important subject of quality and reliability received excellent attention from BSI: the wide-ranging work carried out under the direction of its Quality, Management and Statistics Committee coalesced into several new standards, some of which have already been described in the Journal. The new standards, listed below, herald the transformation of practice in quality and reliability from a combination of subjective values and extempore adjustments into a body of disciplined and properly integrated requirements.

This transformation will have to take place if the high variability in quality, which is now so common, is to be brought under control. It has been suggested that quality and reliability are critical factors which are absent from most costing and economic evaluation systems and this is due, no doubt, to the fact that they demand technical rather than just financial competence.

Remarkable successes have been achieved wherever a more integrated approach has been applied. The rapid evolution of Japanese industry, for example, from an era in which it was known chiefly for the supply of inexpensive curiosities to its present leading position, is largely due to systematic quality control procedures. Japan now produces highly reliable and sophisticated technical products, it is a leader in quality control and has proved that striving for quality results in savings rather than increases in overall costs, i.e. increases in market share and profits for the supplier and lower whole-life-cycle costs for the consumer.

Undoubtedly British industry can do the same. The fact that BSI's guides and drafts are now being rewritten as

specifications is possible because of the enthusiastic application of integrated quality control philosophy. Britain is still a leader in the development of practical specifications, and it is hoped that this new work will provide industry with a set of new tools to be wielded with vigour in the 1980s.

Recent Quality and Reliability Standards:

BS 3138 Glossary of terms used in work study and organization and methods. (£10.40)

BS 4778 Glossary of terms used in quality assurance (including reliability and maintainability terms). (£14.50)

BS 5497 Precision of test methods. Part 1 Determination of repeatability and reproducibility. (£14.50)

BS 5701 Quality control charts. (£10.40)

BS 5703 Data analysis and quality control using cusum techniques. (In 3 parts, £14.50 each)

BS 5750 Quality systems. Part 1 Design manufacture and installation. Part 2 Manufacture and Installation. Part 3 Final inspection and test (£3.60 each part)

BS 5781 Calibration system requirements. (£3.60)

BS 5760 Reliability of systems equipment and components. Part 1 Reliability programme management. (£10.40)

The published standards listed above may be obtained from BSI Sales Department, 101 Pentonville Road, London N1 9ND. Prices given are less 50% to BSI Subscribing Members.

Hazards from Non-Ionizing Radiation

Much of the Health and Safety Executive's report on Nuclear Establishments for 1977-78*, published earlier this year, deals with the work of the Nuclear Installations Inspectorate on power stations and associated fuel manufacturing and processing plants. Several sections are, however, concerned with establishments outside the nuclear industry using non-ionizing radiations.

Discussing visual display units, the report agrees that although emissions of any electromagnetic radiation appears to be minimal and in any case is reduced by the transparent viewing screen, there has been widespread national and international interest in the claim that some operators have suffered discomfort induced by using the equipment. In order to ensure that they are not in fact subject to any significant levels of electromagnetic radiation a survey has been arranged to measure all radiation in the X-ray, ultraviolet, infra-red, microwave and radio frequency regions of the electromagnetic spectrum. Results to date suggest that there is no significant exposure. As there are many types of v.d.u.s in use, the survey will take some time to complete. It is being carried out by the National Radiological Protection Board at the request of HSE.

Lasers provide a parallel beam of light and therefore the power density does not fall off as with divergent light sources. Concern therefore arises where the public are not excluded from beam paths which moreover may be reflected from surfaces so giving rise to additional risk of exposure. Due to the

focusing effect of the eye, beam power densities are very significantly increased in transmission across the eye onto the retina and care must be taken to ensure that, where the beam can enter the eye, the power densities are low enough to avoid permanent injury. Over the years industrial and research uses of lasers have increased steadily in number. A newer application of lasers has been in the field of entertainment where they have been deployed to provide visual effects at 'pop' shows, at stage performances and on studio sets. Additionally the use of lasers to provide advertising and other decorative effects in place of conventional lighting is well advanced. The proposed British Standard on the Protection of Persons against the Hazards from Lasers will include a reference to the entertainment context but to provide more specific advice HSE proposed issuing some Notes for Guidance.

There has been considerable public interest in the question of the exposure standards for persons exposed to microwave radiation. One of the most widespread uses of microwaves, apart from radar, is in the microwave oven which is gaining increasing sales in the UK. The emission standard for these ovens, which operate at a frequency of 2,450 MHz is covered by both international (IEC 335.25) and national (BS 5175: 1976) standards which allow microwave leakage up to a maximum of 5 mW/cm² at 5 cm from any accessible surface. At this level there would be no possibility of any person approaching the maximum exposure which is currently set at 10 mW/cm². Late in 1978 a survey was mounted to examine all the new microwave ovens manufactured in or imported into the UK, and the findings will be compared with BS 5175. The work is being carried out by NRPB at the request of HSE and involves about a dozen visits to makers or agents. Additionally a small number of ovens which had been in use for a number of years have been examined.

Health and Safety: Nuclear Establishments 1977-78, HM Stationery Office, 1979. Price £1.25 plus postage.

New and Revised British Standards

Copies of British Standards may be obtained from BSI Sales Department, 101 Pentonville Road, London N1 9ND. Non-members should send remittances with orders. Subscribing members will be invoiced and receive 50% discount. A minimum invoice charge of £2.50 applies to both.

MORE TERMS IN POWER, TELECOMMUNICATIONS AND ELECTRONICS GLOSSARY

A new group of terms concerned with power, telecommunications and electronics is dealt with under BS 4727 *Glossary of electrotechnical, power, telecommunication, electronics, lighting and colour terms*. This is Part 1 Group 02 *Electrical and magnetic devices terminology* (£6.20).

BS 4727 is divided into four main parts, each subdivided into groups related to a particular brand of electrical engineering. The new group is published under Part 1 *Terms common to power, telecommunications and electronics*. Part 2 deals with terms particular to power engineering, Part 3 with telecommunications and electronics, Part 4 with lighting and colour. As far as practicable all terms and definitions established in current usage and falling within the scope of the glossary have been included.

Part 1 Group 02 brings the total of groups published to 29. Like other issues it includes a substantial foreword, explaining the policy behind the choice of terms and their arrangement in the document, as well as an overall guide to the glossary. An alphabetical index is provided. The group is divided into four sections; general; connections of electrical circuits; behaviour and use of electrical devices; and performance and testing. It is identical with the English text of the International Electrotechnical Vocabulary, Chapter 151.

PERFORMANCE OF PULSE GENERATORS

Just issued by the British Standards Institution, BS 5813 *Guide for the expression of the performance of pulse generators* (IEC 624) (£14.50) is of particular interest to manufacturers producing pulse generators and accessories, to laboratories and to other users.

The new standard establishes definitions, terminology for describing the functional performance, a listing of performance characteristics on which a statement of the performance may be based, the criteria for evaluating the performance, and the tests necessary to verify the performance. It specifically excludes generators with continuous or pulse sinusoidal outputs, television pattern generators, complex function generators, and generators for insulating resistance testing. A guide to pulse techniques and apparatus was published recently as BS 5698.

ANALOGUE SIGNALS FOR PROCESS CONTROL SYSTEMS

A new part of BS 5873 *Analogue signals for process control systems* has just been published by the British Standards Institution. This is Part 2 *Specification for direct voltage signals* (£3.60). Identical with IEC 381-2, the standard specifies signals used in industrial process measurement control system to transmit information between elements of systems. It does not apply signals used entirely within an element.

COLOUR GUIDE—RESISTORS AND CAPACITORS

Advice on selecting suitable colours for certain electronics components is provided in a new British Standard published by BSI. This is BS 5890 *Guide for the choice of colours to be used for the marking of capacitors and resistors* (£1.60).

BS 5890 specifies the colours to be used for the coding and identification of capacitors and resistors intended for installation in electronic equipment. The colours are defined by the chromaticity co-ordinates and luminance factor for illuminant C in the Colorimetric system. The new standard is technically identical with the corresponding IEC Publication 425 issued by the International Electrotechnical Commission.

RECHARGEABLE SINGLE CELLS

The new British Standard BS 5932 *Sealed nickel-cadmium cylindrical rechargeable single cells* (£2.60) is related to IEC Recommendations 285-1, 285-1A and 285-2. It specifies performance requirements and type tests, closely following the proposals so far established for the revision of IEC Publication 285.

The cells specified can be used over a wide range of industrial, and consumer applications, wherever compact and lightweight power is needed. Four of the cell designations are physically interchangeable with four of the round batteries specified in BS 397.

TERMINAL JUNCTION MODULES

BSI has published a new aerospace standard for certain types of cable junction modules commonly installed in aircraft and guided weapons. This is BS G 225 *Performance of environment-resistant terminal junction modules with removable crimp-type contacts* (£10.40).

BS G 225 gives the general requirements covering the design, performance and testing

of such components together with their mounting frames, but does not specify dimensions. The standard is intended as a basis for detail specifications, including control drawings, individually prepared for each range of modules and frames. A typical example of a detail specification is included in an appendix to the standard.

CISPR EXTRACTS ON INTERFERENCE

The British Standards Institution has just issued a revision of PD 6485 *Limits of radio interference and leakage currents according to CISPR and national regulations* (£14.50). The new edition is identical with the fourth edition of CISPR Publication 9 (1978). It consists of extracts from other CISPR publications together with information on national requirements for limits of radio interference and of leakage currents of suppression capacitors. The information is arranged in tabular form and is of general interest to anyone concerned with radio interference—particularly exporters or importers of equipment which may be a source of interference.

ELECTRONICS COMPONENTS—BUYER'S GUIDE

BS 9000 and its European counterpart, CECC, are the recognized systems for the specification and quality assessment of electronics components of assessed quality. They incorporate stringent rules covering inspection and continued surveillance of manufacture, testing and distribution, and also deal with operating methods. To be approved under this scheme distributors must meet strict requirements and ensure that the items they supply are stored under prescribed conditions and are easily traceable back to the manufacturer responsible.

A free publication now available direct from BSI's Quality Assurance Division entitled *A buyer's guide to BS 9000 and CECC distributors* enables the designer to pin-point his nearest supplier of attested components. The guide is in two parts. Part 1 lists, by county, all the approved distributors together with their addresses, telephone and telex numbers, and also indicates whether they are approved to handle components complying with the European system. Part 2 provides detailed information from certain distributors on component ranges stocked and the source of manufacture.

Copies of the guide may be obtained from Mr C Weaver, BSI Quality Assurance Division, Maylands Avenue, Hemel Hempstead, Herts HP2 4SQ. Tel: 0442 3111. Telex: 82424.

Ship-shore communications for the off-shore oil industry

J. L. HYATT,
C.Eng., M.I.E.E., M.I.E.R.E.*

SUMMARY

The paper describes the provision that has been made at United Kingdom Coast Stations to meet the major requirement for ship/shore communications created by off-shore oil exploration and related activities. The constraints imposed by spectrum shortage and congestion are discussed and an indication given of the magnitude of traffic handled and the performance achieved. The use of developing techniques for future use is also discussed.

* Maritime Radio Services Division (ISB), British Telecommunications, Landsec House, New Fetter Lane, London EC4A 1A.

1 Introduction

The commencement of oil exploration in the North Sea in 1964 created a requirement for ship/shore communications not hitherto experienced in the maritime radio services. The likelihood of a number of oil rigs operating simultaneously, together with their support vessels, in a single area—each probably requiring immediate and reliable communications with the mainland—made would-be demands for service completely beyond the capacity of the normal provision at coast stations for merchant shipping. At the same time the classification of oil rigs as seagoing vessels placed considerable constraints upon the number of additional radio frequency channels that could be made available from the very limited amount of frequency spectrum allocated by the ITU to the maritime mobile services.

Against this background this paper reviews the provision that has been made at British coast stations to meet these developing requirements of oil rigs since the initial demand in 1964 and refers also to the performance that has been achieved.

With the subsequent exploitation of successful drillings other classes of user such as pipelaying barges appeared on the scene. The extra provision that had to be made to meet these requirements is also described.

2 Basic Requirements

The extent of the UK off-shore areas is shown in Fig. 1. Communications may be required up to distances of 200 miles from the shore—somewhat greater, 250 miles, from the nearest existing coast station.

It has been the government's practice to open up the off-shore areas for exploration in a phased manner. Thus the initial area was in the southern part of the North Sea followed in the late sixties by the area around the Shetlands. This piecemeal development confined and to some extent eased the problem of providing communications. Nevertheless experience has shown that although exploration activity in a particular area might pass its peak, demand for communications has tended to remain at a significant level. Where drilling has been successful and the oil is to be exploited a new demand builds up from vessels concerned with pipelaying and the construction of production platforms. In these areas the overall communications requirement may be well in excess of the original demands with exploration and construction work going on side by side.

2.1 Communications for Oil Rigs

In considering the communications requirements for oil rigs it is necessary to take into account three distinct types of use.

- (a) Exploration business use—A rig can be likened to an outstationed factory requiring regular and possibly lengthy contact with its controlling office.

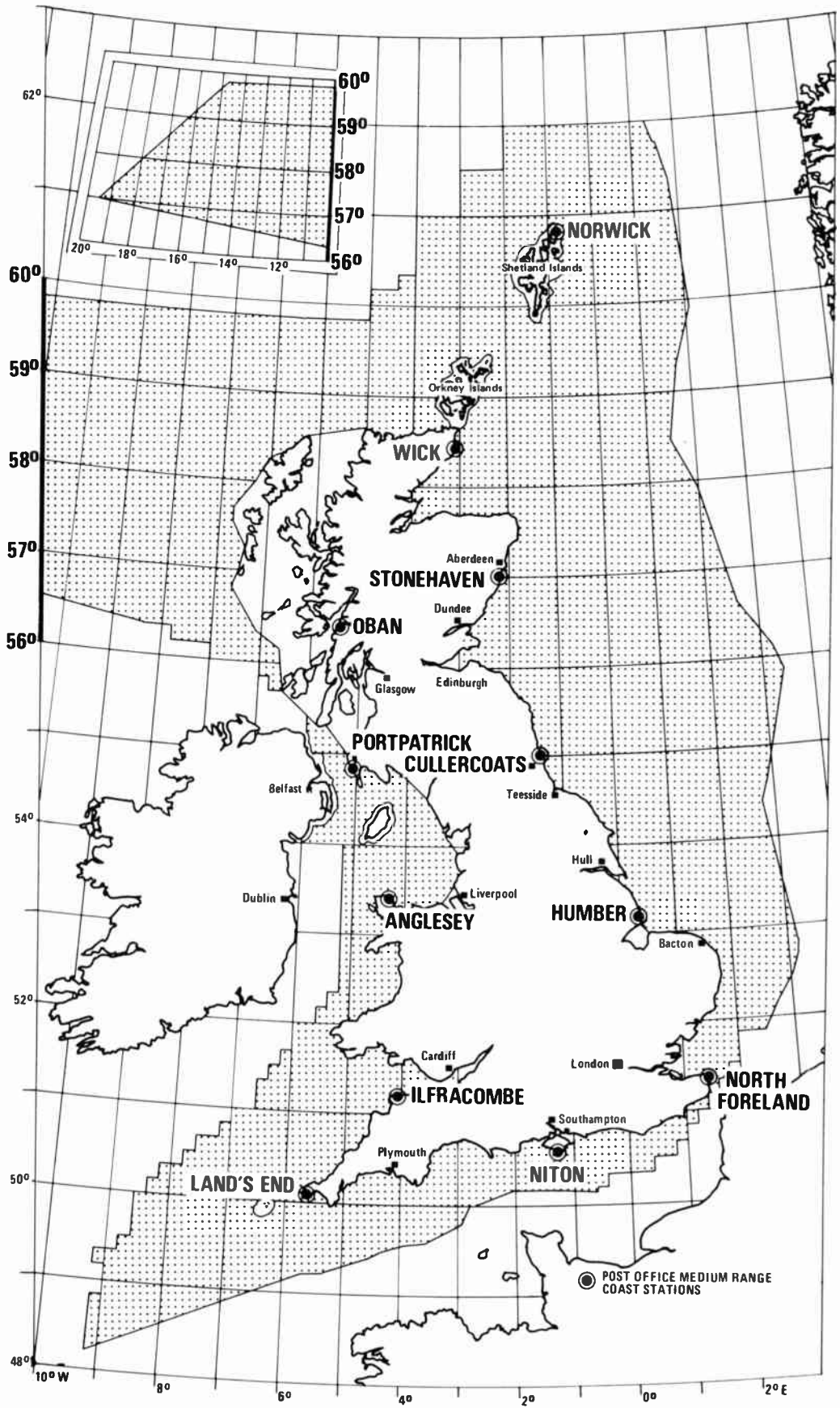

Fig. 1. United Kingdom off-shore areas available for oil exploration and location of coast stations.

In view of the critical nature of oil drilling, immediacy of access to base is essential. Oil companies also tend to require high circuit confidentiality.

- (b) Ship's business use—Rigs also have the usual ship's business requirements including those mandatory for Distress and Safety as set out in the Safety Convention.
- (c) Social use—Rig personnel normally spend two weeks at a time aboard and like to keep in touch with their families. Many come from overseas and are in the habit of making lengthy telephone calls to their homes.

Ship's business and social requirements are similar to the normal run of ship-shore communications and can be met by the normal type of provision at coast stations suitably expanded to meet the extra demand. These stations are already fully equipped to deal with Distress and Safety situations.

However, the first requirement—exploration business—poses special problems of circuit loading and immediacy of access that cannot in general be met by the normal public service arrangements. These latter are based upon a communications pattern in which the average ship makes about one call per day and because of spectrum limitations has to await its turn during busy periods for a free channel (although most calls are connected within minutes). Also, with the exception of Distress and Safety messages and certain service traffic categories, no priority arrangements are operated in the public correspondence services. For instance special classes of commercial user such as oil rigs cannot be permitted to 'jump the queue' for what would be basically commercial/industrial reasons.

To meet the rig requirements satisfactorily, therefore, it was necessary to make a special provision of dedicated channels providing continuous connection between rigs and their controlling offices.

2.2 Communications for 'Pipelaying' and Construction Vessels

The second major category of special user consists of pipelaying and construction vessels. As explained above, their participation is a second-phase activity consequent upon the discovery of oil. Whilst their basic communications needs are similar to those of rigs—immediacy of access etc—the manner in which their work is organized enables a construction company to handle a number of its vessels in an area over one channel. This lessens the problem of finding an adequate number of radio channels but requires the provision of facilities at the controlling office to identify and call individual ships.

2.3 Communications for Support Vessels

Each of the special users referred to requires the support of a large number of supply and auxiliary vessels of

various descriptions which also need communications facilities with the mainland. Fortunately, although of greater intensity these needs are generally similar to those of the general run of shipping and can be met by the normal coast station provision on an expanded scale as necessary.

2.4 Integration of Systems

It might be argued that since the two special classes of user referred to in Sections 2.1 and 2.2 appear to have needs that are basically similar there would be merit in the provision of common schemes open to both, possibly reducing costs and improving flexibility. There is little doubt that with the present knowledge of the operational requirements and the experience that has been gained such a course of action would be given serious consideration in the planning of any future 'starting from scratch' provision. However, at the time of the initial provision and for some years afterwards the only requirement was from oil rigs and the early systems are tailored to meet their needs. When construction vessels and pipelayers eventually appeared some 4 years later it was not operationally practicable to integrate them into the oil rig schemes.

3 Considerations in the Design and Operation of Oil Rig Systems

Although the initial considerations and basic planning were in the context of rig communications much of what is contained in this Section is equally applicable to the construction vessel schemes.

3.1 Choice of Frequency Band

At the start of the North Sea activity in 1964 two frequency options appeared feasible within the constraints of the frequency spectrum allocated to the maritime mobile services:

1. The use of v.h.f. (156–174 MHz) over-the-horizon techniques to achieve the required range of 250 miles. In this way the provision of exclusive radio-telephone channels to each rig seemed possible assuming that the overall number of rigs in any one area was not excessive.† However, at the time little practical experience was available about the working of such a system in a mobile environment under the conditions that would exist, especially at the extreme ranges required. Extensive field trials would have been essential before it could have been accepted as a proven method.
2. The use of frequencies in the m.f. bands (2–4 MHz) utilizing ground wave propagation. The 2 MHz band was the normal one for medium range maritime communications and the vast amount of

† The greatest number of rigs requiring communications in one area has been 44. Whether v.h.f. channels could have been found for each of these is open to doubt.

operating experience available showed that consistently good reliability over the required distances could be expected during daylight. Some deterioration at night from fading and distant interference from transmissions on the same channels due to sky-wave propagation had to be accepted. Nevertheless it was considered that an adequate performance could be expected for most of the time provided the frequencies chosen were reasonably clear of co-channel emissions from distant stations. The major drawback of this system was the lack of available frequency spectrum which effectively eliminated any possibility of providing each rig with a dedicated telephony channel. Individual provision was only possible on the basis of narrowband teleprinter channels.

Nevertheless bearing in mind the uncertainties of the v.h.f. solution, and the very limited time that was available to meet the 1964 requirement, the choice of the m.f. system, despite its shortcomings, was inevitable. Provision therefore went ahead. To achieve the maximum frequency spectrum economy, an independent sideband system ‡ was adopted with the lower sideband carrying one telephone channel shared between the rigs using the system and the upper sideband carrying a multi-channel system having a capacity of up to 15 teleprinter channels.

3.2 General Arrangements

The particular radio frequency registrations available in 1964 to British Telecom were limited to peak transmitter output powers of 1kW and 500 W for the coast and ship stations respectively. At the shore end therefore, assuming an equal division of power between the two sidebands, 250W of power was available for the radiotelephone circuit. This was considered adequate under daytime conditions to maintain good commercial quality circuits up to ranges of 250 miles. At night although the range for the same quality of circuit was reduced to about 150 miles, a lower grade circuit, but nevertheless one acceptable for business calls was still achievable for most of the time over the full distance provided that no serious co-channel interference from distant stations was present.

In the case of the multi-channel radioteleprinter system the available sideband power had to be shared by up to 15 circuits so that only 20W per channel could be expected. As this was less by some 15 dB than that required to maintain a reliable start-stop type radioteleprinter circuit over the specified distances synchronous signalling and error correcting techniques had to be employed over the radio path. In the event the 'Autospec'¹ forward error correcting system was adopted which converted the standard 5-unit teleprinter

‡ At the time (1964) double-sideband systems with a bandwidth of 6kHz were the norm for radiotelephony in the Maritime Service.

code to a 10-element error correcting code at a signalling rate of 68.5 bauds.

Although ship transmitter powers were only half those of the coast station no particular problem was seen for communicating in the ship-to-shore direction as the superior receiving antenna performance at a coast station compared with that of a ship's antenna more than compensated for the reduction.

The basic system arrangement at coast and ship stations for the i.s.b. system is shown in Fig. 2. It has already been described in detail.¹ In the shore-to-ship direction the arrangements are straight-forward. The individual teleprinter signals from subscribers are converted to the error correction code in the Autospec terminal and are assembled in correct channel order in the frequency division multiplex (f.d.m.x.) equipment to modulate the transmitter. This latter has similar characteristics to that developed (1964) for the use in British Telecom's h.f. fixed service. Channels are spaced at 170Hz intervals in the audio frequency band 340 to 2890 Hz. Frequency shift keying is used for each channel with a shift of ± 42.5 Hz about the nominal centre frequency. (This shift is half that specified in the Radio Regulations for frequency shift telegraph emissions in the Maritime Service.) For the receipt of the teleprinter signal rigs are equipped with a single channel receive unit of the f.d.m.x. equipment described above.

In the rig-to-shore direction (teleprinter) each vessel transmits a signal having similar characteristics to a single channel frequency shift emission operating around the centre frequency of its assigned channel and compatible with the f.d.m.x. receive terminal at the coast station. When the system is in operation the coast station receiver receives the aggregate of the separate emissions from all the rigs operating in the scheme assembled in proper frequency order.

3.3 Special Performance Requirements

For satisfactory operation these arrangements require a system standard of performance that is rather higher than that normally required in the maritime services.

- (i) Each emission must not only keep within its assigned radio frequency channel but must also meet the frequency base band accuracy requirements of the f.d.m.x. system.
- (ii) The received levels of the emissions from the rigs must be approximately equal to each other at the coast station receiver input.

As suppressed carrier operation was essential, at least in the ship to shore direction, automatic frequency control could not be used. All frequency conscious equipment had therefore to have and maintain high absolute frequency accuracy. This was particularly so in the case of the radioteleprinter system. For multi-channel systems with 170 Hz channel spacing the maximum acceptable end-to-end system frequency error

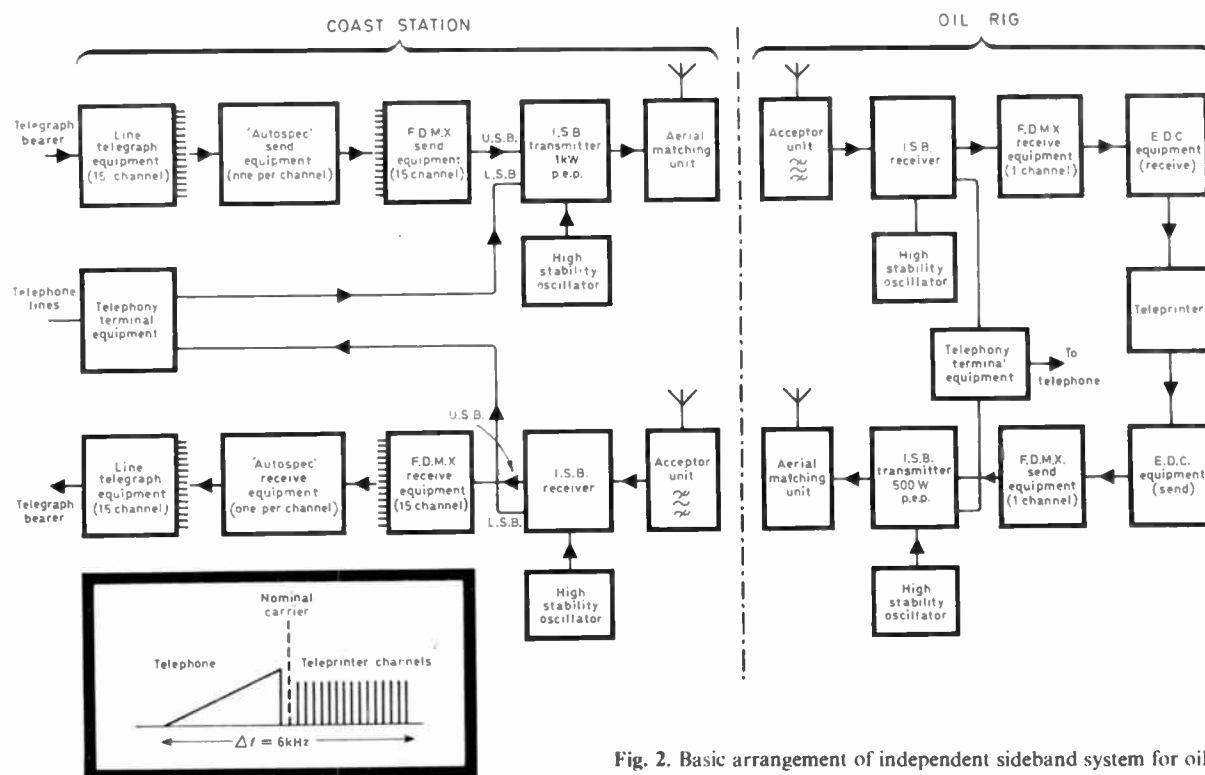

Fig. 2. Basic arrangement of independent sideband system for oil rigs.

was about 12Hz. As this included the errors due to the f.d.m.x. terminal equipments the overall tolerance permitted to the radio equipments was somewhat less. Bearing in mind the much harsher conditions of temperature, humidity and vibration that the rigs were likely to meet most of permissible radio system tolerance was allocated to the rig equipments. Thus for both coast station receivers and transmitters an absolute frequency accuracy (long and short term) of ± 0.5 Hz was specified. The corresponding figures for the rig equipments were ± 5 Hz (receiver) and ± 9 Hz (transmitter). To ensure the maintenance of these limits coast stations have been provided with frequency measuring equipment of the requisite standard. Design specifications covering all significant characteristics of both coast station² and oil rig³ equipments have been issued by British Telecom to ensure that complete compatibility is achieved and can be maintained. Manufacturers of equipment for installation on rigs must seek British Telecom Approval before it can be brought into use in the scheme.

The automatic gain control voltage in the receiver is derived from the aggregate signal received from all rigs in the scheme. The reception of approximately equal signals from rigs is therefore essential if the general gain is not to be depressed by an excessively strong signal from one vessel. Coast stations monitor the relative signal levels by means of spectrum analysers. When a rig first goes on station its transmitter power is adjusted to give the correct received level at the coast station. There is normally no difficulty in achieving a satisfactory

common level. Since rigs are only concerned with the transmission of one teleprinter channel, more than adequate transmitter power is normally available from their transmitters to provide adjustment of their signal level over the required range.

Use of the radiotelephone channel of a particular system is limited to the rigs operating in that system but is otherwise operated in the normal way for a shared maritime circuit. Rigs proposing to make a call first check that the channel is clear. Where rigs require simultaneous use of teleprinter and telephone circuits it is usually necessary for them to fit separate transmitters/receivers.

3.4 Operating Arrangements

The oil rig services are operated on a leased basis. The oil company rents an exclusive teleprinter radio channel and the line connection needed between the coast station and the required mainland office. The composite through circuit is permanently connected and apart from a general oversight of performance there is normally no operational involvement by coast station staff. The rental agreement for the teleprinter circuit also covers the shared access to the system's radiotelephone channel. This is continuously monitored by the coast station. Telephone calls from rigs are connected into the public network at the coast station in the normal way and are charged at the appropriate rate for a public maritime telephone call.

Those rigs requiring telephone-only access are

accepted into the scheme at a reduced rental but teleprinter-only access is not normally granted since the r.t. circuit is an essential feature for teleprinter circuit line-up purposes. Rigs also have access to the normal correspondence services and are obliged to participate in the Distress and Safety services in accordance with the Safety Convention. Standard maritime equipment is fitted additionally for these purposes.

4 Consideration of System for Pipelaying and Construction Vessels

The increasing exploitation of successful drilling from the late 1960s onwards created a new demand from vessels concerned with the laying of pipelines between the oil fields and the mainland and with the construction of production platforms. It was quickly recognized that the construction companies involved in this work, like the exploration companies before them, had an essential need to pass large amounts of traffic probably requiring continuous access to a communications channel. Similar provision to that made for rigs appeared to be required. However, the methods of working and organization were rather different from those of the oil rig companies in that the companies involved operated on a fleet basis, rather than on a single vessel basis. It was therefore possible to allocate radio channels on a per-company rather than on a per-unit basis. In view of the large number of vessels likely to have been involved in these operations and the lack of suitable radio channels this was extremely fortunate. Nevertheless the problems of finding even a few channels that were reliably free from co-channel interference during the hours of darkness had by this time become acute, with little chance of an early solution.

The decision had been taken at the 1967 World Maritime Administrative Conference to make the use of single-sideband operation mandatory in the maritime

services, thus freeing an appreciable amount of much-needed spectrum. However, the very long periods that had been allowed for the amortization of ships' double-sideband equipment (final date 1st January 1982) effectively prevented the full potential benefits of the better spectrum utilization from being realized. In the event therefore it was only possible to provide exclusive radioteleprinter channels and no dedicated radiotelephone channels could be made available even on a shared basis. A multi-channel radio system having the same basic characteristics as for the oil rig systems was adopted for the teleprinter facility but to improve spectrum utilization a public service channel having the appropriate radio characteristics was 'slotted' into the centre of the occupied band. To conform with the somewhat looser frequency tolerances and the higher frequency shift (± 85 Hz) permitted in the public service, a 500 Hz wide slot in the centre of the band was necessary. Nevertheless it was still possible also to accommodate up to 10 of the narrower band leased channels within the assigned bandwidth. The general arrangement is shown in Fig. 3. A different error correcting system was also introduced.

Subsequent to the introduction of the oil rig service in 1965 CCIR had made recommendations (Rec 476) on the error correction system to be used in the public maritime services. The new system differed from 'Autospec' in that it was an ARQ system using a 7-unit error correcting code with a forward error correcting facility alternatively available for the reception of broadcast transmissions, e.g. navigational warnings. The system also incorporated facilities for the transmission and reception of a selective call code to initiate a contact. In view of the likely future standardization on this system in the maritime services it was decided, in consultation with the construction companies, to adopt it for the new leased channels and, of course, for the

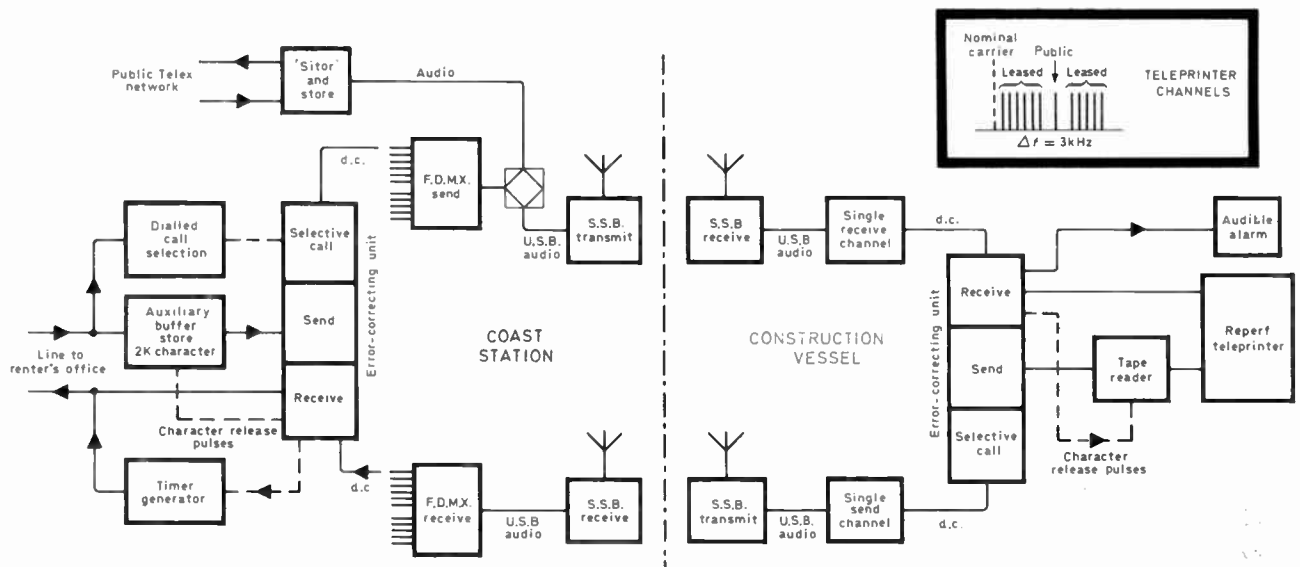

Fig. 3. Basic arrangement of single sideband system for construction vessels.

public correspondence channel. The exclusive channels are available on a rented basis similar to the arrangements described for oil rigs. The public channel is, however, available to all ships equipped to work in the maritime radioteleprinter service. No rental is payable for the use of this channel, calls being charged on a time basis in the normal way. In practice vessels equipped for the exclusive system also make use of the public channel. No difficulty is experienced in changing from one system to another, provided the vessels are able to adjust to the frequency shift and the carrier frequency appropriate for the particular channel they wish to use.

As for the Oil Rig system, the PO issued a specification covering the equipment to be used in this service.⁴

5 Public Correspondence Provision

As already indicated in addition to the special provision of dedicated circuits it was necessary to increase the public radiotelephone circuit capacity at several coast stations for general use by all vessels concerned in the offshore oil areas. An indication of this expansion is given by Table 1. It will be noticed that both medium frequency and v.h.f. circuits have been provided. Whilst the range of v.h.f. is somewhat limited (40–50 miles), its simplicity of operation, good circuit quality, interference-free performance, its cheapness and last but not least the availability of radio channels make it very

Table 1.

Development of medium short range services at coast stations serving the off-shore oil industry 1965/1978

1965	2 leased r.t. channels Cullercoats (until 1973) 12-channel* r.t.t. + 1 r.t. leased system at Humber for oil rigs 12-channel* r.t.t. system at Stonehaven *The 12-channel allocation was shared between the 2 stations
1966	P.C. v.h.f. Cullercoats
1967	Stonehaven oil rig system upgraded to 12-channel r.t.t. + 1 r.t. P.C. v.h.f. Stonehaven
1970	Stonehaven oil rig system upgraded to 15 r.t.t. channels
1972	P.C. v.h.f. r.t. Bacton (Humber †)
1973	12-channel r.t.t. + 1 r.t. leased system for oil rigs Norwick
1974	P.C. m.f. r.t. Cullercoats, Stonehaven, Norwick P.C. v.h.f. r.t. Orkney (Wick†), Shetland (Wick†) Leased 10-channel r.t.t. + 1 P.C. r.t.t. system for construction vessels etc at Stonehaven. 2nd 14-channel r.t.t. + 1 r.t. leased system for oil rigs at Norwick.
1975	Leased 3 r.t.t. channels added to 12-channel oil rig system at Humber for construction vessels. Leased 10-channel r.t.t. + 1 P.C. r.t.t. system for construction vessels etc. at Wick. P.C. v.h.f. r.t. Severn (Ilfracombe†) and Celtic (Ilfracombe†).
1976	P.C. v.h.f. r.t. Shetlands, 2nd channel. Leased 12 r.t.t. channel + 1 r.t. for oil rigs Ilfracombe.
1977	P.C. v.h.f. r.t. Cromarty (Wick†).
1978	P.C. v.h.f. r.t. Forth (Stonehaven†), Collafirth (Wick†), Humber 2nd channel Leased 6-channel r.t.t. system for oil rigs, Norwick.
1979	P.C. v.h.f. r.t. Whitby (Cullercoats†).

† Controlling Station. P.C. = Public Correspondence.

attractive It is widely used for inshore traffic and helps to reserve the m.f. circuits for the longer distance requirements.

Most of the medium frequency provision has been made at existing coast stations. However, to cover the offshore areas in the north it was necessary to establish a completely new station at Norwick on Unst, the most northerly of the Shetland Isles. This station is unattended and remotely controlled from Wick.

The v.h.f. expansion that has been made is in line with British Telecom's policy of extending general v.h.f. coverage around the United Kingdom coast by 1980.

6 Modifications and Developments

Although additional rig schemes have been introduced as new exploration areas have been opened up (see Table 1), it has been neither necessary nor desirable to make major changes to the original basic arrangements. Since rigs tend to move from area to area, continued standardization as far as possible was necessary. Nevertheless a number of detailed changes have had to be made either to improve performance or to meet changes made to the International Regulations.

With the introduction of mandatory single sideband emissions (from coast stations) in 1971, it was necessary to change from the independent sideband mode of operation to twin-channel single-sideband operation with telephony on one channel and multi-channel teleprinter on the other. These two emissions may or may not occupy a contiguous part of the frequency spectrum. The same overall bandwidth is occupied as in the i.s.b. case but at coast stations two transmitters and two receivers are required.† In some ways the change has eased the problem of finding interference free 'slots' in the frequency spectrum for new services, since even though twice as many are now required they are each only half the bandwidth.

With the adoption of the CCIR radioteleprinter error correcting system for 'pipelayer' and public correspondence teleprinter services the possible conversion of the oil rig services to this system was considered. However, as the Autospec system continued to give good performance especially once modifications had been made to improve protection against bursts of errors, the consensus wish of the users was for no change. Nevertheless it is recognized that there would be benefits in having only one system and further consideration is being given to it. A gradual conversion on a rig-by-rig basis seems possible since trials have shown that the two systems can work on adjacent channels in the same f.d.m.x. system with no ill effects.

† Many rigs were already equipped with two sets of equipment.

7 Traffic Demand

An indication of the magnitude of the traffic generated by the off-shore oil industry is given in Fig. 4. This compares the growth of radiotelephone traffic in the last 10 years at the three coast stations† that have handled most of the oil traffic during this period with the overall traffic handled by the eight remaining coast stations around the UK coast including those serving the busiest areas such as the English Channel. The fact that a small but significant amount of this other traffic has itself been generated by the oil industry in the less actively exploited areas only serves to emphasize just how great the demand from the oil industry has been.

In 1979 oil exploration and related activities accounted for 48% of the whole of the UK's short/medium range traffic. It is not possible to give corresponding figures for radioteleprinter traffic because most of it is passed over the leased links between shore offices and rigs/vessels and no records are available. However the returns for the public teleprinter service through Wick/Norwick (only two channels) show that 4000 minutes of traffic have been handled in a peak week. Practically all of this would have been generated by the oil industry in addition to any that was passed over the leased circuits.

8 Comment on Performance

Bearing in mind the unavoidable constraints imposed by the shortage of radio-channels available the overall performance of the systems is considered to have met the requirements during daylight hours. Teething troubles, some chronic, plagued the operation of individual circuits in the introductory stages of the first system at Humber. Some of these were due to shortcomings of certain rig equipments and were eventually overcome. Others (radiotelephony) were due to attempts at coast stations to operate relatively sophisticated terminal equipment in a maritime service environment where poor signal/noise ratios were endemic. Once operating experience had been gained, however, and the nature of the problems appreciated they were quickly overcome.

The major shortcoming to which there seems to be no real solution has been the incidence of night-time co-channel interference from distant stations (up to 2000 miles or so away). Where, as sometimes happens, the interfering station is a radio-teleprinter one operating in the fixed service, interference can be severe and continuous, effectively 'knocking out' communications for long periods at a time. Redress through the administrative channels has not always been successful and in chronic cases it has been necessary to abandon a frequency completely and introduce another. But this is not a solution that can be undertaken lightly. Crystal changes may be required at both mobile and fixed stations and all new frequency applications have to be

† And their remotely controlled v.h.f. stations.

processed and cleared with the regulatory authorities in the normal way—always assuming of course that a satisfactory alternative frequency can be found. Detailed searches in the Frequency Registration records followed by extended monitoring of likely 'slots' over a period of some weeks are essential before any change can even be considered.

Inevitably the uncertain pattern of interference places a limit on the performance and reliability that can be offered to the customer.

9 Future Developments—Tropospheric Scatter and Satellite Systems

With the passage of time new techniques have become available offering potentially more reliable methods of communication free from the problems of congestion and interference.

Over-the-horizon tropospheric scatter systems have been introduced in the North Sea for oil production platforms⁵ to meet the requirements for a large number of highly reliable circuits for data, telemetry and remote control purposes. At first glance such a system would seem to provide all the answers to the rig problems. However, it is an elaborate and costly system that is essentially for fixed service use and it is doubtful whether it could be directly employed by rigs without seriously restricting their mobility. Nevertheless it would appear to be operationally feasible in appropriate areas to have tropo stations serving a number of rigs via v.h.f. or u.h.f. links. Whether a tropo system specially established for rig use would be financially viable seems doubtful in view of the very high costs involved. But the use of existing

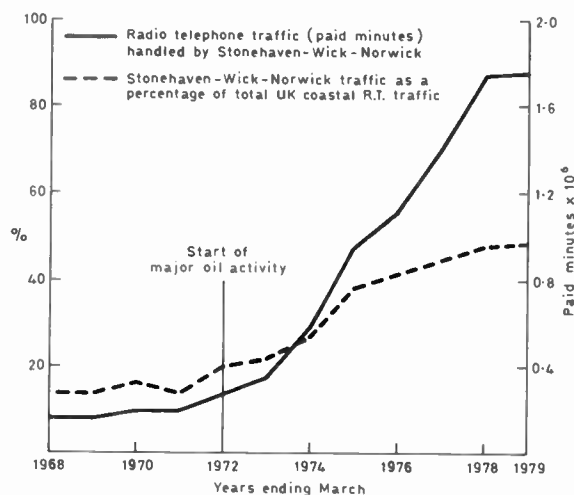

Fig. 4. Radiotelephone traffic handled by Stonehaven, Wick, Norwick in paid minutes as a percentage of total United Kingdom medium-range maritime traffic.

tropo terminals on production platforms would seem to offer attractions for suitably located rigs that cannot be ignored in the future.

The introduction of the Inmarsat Satellite system in 1982 should make a number of highly reliable channels

available in a fully mobile context and would seem to offer the real long term solution to meeting rig and construction vessel requirements. The large number of channels that will presumably be available could well provide an immediacy of access that would avoid the need for dedicated circuits and for non-standard installations aboard the rigs. It therefore seems likely that there will be a gradual changeover to the satellite service once it is introduced. Nevertheless much of the existing medium-frequency equipment fitted will probably continue in use until renewal date. It has always been recognized, of course, that all the schemes provided for the exploration industry are inherently of a temporary nature and amortization of equipment has always been foreshortened accordingly.

10 Conclusion

This paper describes the steps that have been taken by British Telecommunications during the last 15 or so years to meet the communications requirements of the off-shore oil exploration and construction industries.

The congested condition of the maritime frequency bands has made spectrum economy a major constraint in system design and performance and whilst the facilities provided have given a generally good service that has been very intensively used, the effects of interference from distant stations operating on the same channel have limited the ultimate performance achievable.

The advent of a maritime satellite service should enable high standards of performance and reliability to be achieved possibly without the need for exclusive channel assignments and it seems likely that this service

will meet an increasing part of the demands of the oil industry in the years to come.

11 Acknowledgments

Much of the information contained in this paper has been extracted from official files and is published by the permission of the Post Office. The author would also like to acknowledge the very useful advice he has received in discussions with his colleagues in the Maritime Radio Service and the Radio Engineering Service Divisions of British Telecommunications.

12 References and Bibliography

- 1 Bronsdon, E. G., 'Communications for the North Sea oil exploration project', *P.O. Elect. Engrs J.* 58, pt. 3, pp. 160-3, October 1965.
- 2 Specification ET4120 'For the Supply Installation and Performance of Equipment for Radiocommunication with Maritime Oil Rigs', 1973. British Telecommunications.†
- 3 Specification ET4118, 'For the Requirements and Performance of Radiotelephone and Radioteleprinter Installations on Maritime Oil Rigs', 1973. British Telecommunications.†
- 4 Specification ET4036, 'For Ship's Radioteleprinter Installation for use with the Leased Simplex Error Correcting Direct Printing Service', 1973. British Telecommunications.†
- 5 Hill, S. J., 'British Post Office transhorizon radio links serving off-shore oil/gas production platforms', *The Radio and Electronic Engineer*, 50, No. 8, pp. 397-406. August 1980.

†Obtainable from Radio Engineering Service Division RES1.1.4, British Telecommunications, 207 Old Street, London EC1V 9PS.

*Manuscript first received by the Institution on 3rd October 1979 and in final form on 13th February 1980.
(Paper No. 1948/Comm. 200)*

The Author



Jim Hyatt has spent the whole of his career in the Post Office (recently re-named British Telecommunications) where he joined the then Engineer-in-Chief's Office as a Youth-in-Training in 1939. He is at present Head of the Maritime Radio Services Division. During his career he has been concerned, *inter alia*, with the operation of HF transmitting stations, and the development and provision of the PO's radiophone and mobile radio systems. For some years he was attached to the

Radio Interference Laboratories carrying out studies into the suppression of interference from power lines, radio transmitters and other high powered industrial equipments. Mr Hyatt transferred to the Maritime Radio Services Division in 1966 where he has been mainly concerned with System Planning and Development. This work has involved him in the CCIR and other international organizations and conferences. He is also a member of the IEE Ships' Regulations Committee.

Interference aspects of off-shore terrestrial microwave networks

T. ARTHANAYAKE,
B.Sc.(Eng.), C.Eng., M.I.E.E.*

SUMMARY

In an off-shore environment, as a general rule, communications need to be established directly between terminals with no provision for intervening repeaters. In planning terrestrial microwave communication networks, this imposes a requirement to use trans-horizon links to a greater extent than in land-based communications.

The attendant problems of interference and practical methods for reducing such interference in terms of frequency planning, equipment design, and network power control are discussed.

1 Introduction

The increase in the last decade in the number of production platforms to serve the oil and gas industries will continue into the foreseeable future. This has caused a corresponding expansion in the communication networks required to handle their varying and sometimes urgent demand for traffic. The networks provide communication facilities between platforms as well as from platforms to the shore where they patch to national and international circuits. The communications needs of the offshore continuous process industries are noted for the large variety of traffic required such as speech, telex, facsimile, and data, in relation to the traffic loading which is small in comparison with main line trunks.

A typical off-shore communications network consists of platforms and shore stations being linked by low capacity, line-of-sight and trans-horizon microwave links. As the traffic requirements increase the network is expanded by increasing channel capacities and providing additional microwave links. One of the most concentrated of such networks exists in the United Kingdom/Norwegian sectors of the North Sea. The system originated with private links, the first being British Petroleum's trans-horizon link from Brimmond Hill to the Forties Field established in the early 1970s, followed by Phillips Petroleum's links via Ekofisk to Emden. The system was expanded considerably with the British Post Office links with their network control centre at Mormond Hill. High network reliability is ensured by having duplicated equipment; together with path redundancy which is obtained by providing facilities for baseband switching via alternate paths within a triangulated section of the network (e.g. links AC, CE, EA in Fig. 1).

The choice of terrestrial microwave in the offshore environment may be traced to a number of reasons.

- (a) Communications were required over a limited geographic area.
- (b) The traffic estimates were within the limits specified by the CCIR for low-capacity systems providing fixed radio relay services, i.e. less than 300 speech channels, but exceeded that usually available over h.f. or v.h.f. radio links.
- (c) There was no economic or technical justification for adopting satellite or submerged repeater systems.
- (d) The off-shore platforms were rigid and not of the tethered buoyancy type currently being proposed.

In mid-1980 the number of production platforms in the North Sea alone was in excess of 40 and with advances in off-shore technology enabling exploration in deeper waters, the scenario is likely to be repeated in other areas. The consequent establishment or extension of off-shore terrestrial microwave networks may require the use of trans-horizon links to a greater extent than in

* Marconi Communication Systems Ltd., Lawford Lane, Writtle, Chelmsford, Essex CM1 3RW.

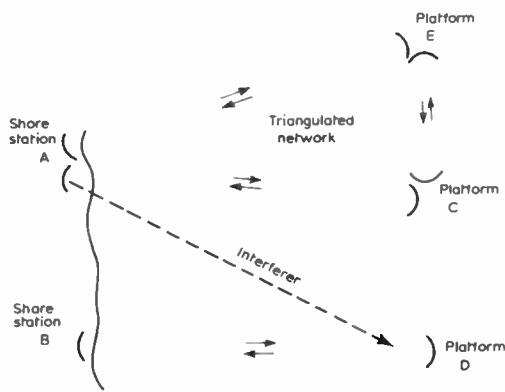

Fig. 1. Segment of off-shore network.

land-based communications and, as with all radio systems, extra precautions will be introduced to avoid interference between circuits.

The North Sea trans-horizon systems initially installed operated in the 2.4-2.7 GHz band. Quadruple diversity was employed to provide four diverse propagation paths whose fading characteristics were virtually uncorrelated, thereby improving the link availability in the presence of rapid fading. Only one carrier frequency was used in each direction. To satisfy the increasing demand for circuits, additional frequencies in part of the 1.7-2.3 GHz band were made available in the UK sector. As the demand for the use of the available spectrum continues to grow, a number of approaches may be considered with regard to increasing the utilization of the spectrum without any significant increase in mutual interference. Some of these approaches are described in the following Sections.

2 Interference Reduction by Frequency Planning

In the off-shore network segment of Fig. 1, A and B are shore stations and C, D and E are platforms. AC and BD are trans-horizon links and CE may either be line-of-sight or trans-horizon. The A to C transmission at frequency f_1 may provide an unwanted component at the receiver at D. In order to estimate and to set limits on the interference from the A to C transmission incident on the receiver at D, the following symbols are defined.

- q = % of time path availability associated with long-term fading for each path in the network. The design path loss is exceeded for only $(100-q)\%$ of the long-term fading period.
- r = maximum % of the long-term period during which the interference is permitted to degrade the wanted signal by a specified amount.
- L_i = net loss of the interfering path which is exceeded for $(100-i)\%$ of the long-term period:
= path loss—net antenna gain between the interfering transmitter and the receiver interfered with as determined from the radiation patterns.
- L_q = net loss of the wanted path at the receiver which is not exceeded for $q\%$ of the long-term period:

- = path loss—net antenna gain between the transmitter and receiver of the wanted path.
- P_i = transmitted power level of interferer in its emission band $f_1 \pm df_1$ (dBm).
- P_w = transmitted power level of wanted signal in its emission band $f_2 \pm df_2$ (dBm).
- F = receiver noise figure (dB).
- B = receiver noise bandwidth (kHz).
- A_R = r.f. selectivity of receiver front-end to interfering signal spectrum in the band $f_1 \pm df_1$ relative to wanted signal spectrum $f_2 \pm df_2$ (dB).
- A_1 = i.f. selectivity of receiver to interfering signal spectrum relative to wanted signal spectrum (dB).
- D = protection offered by the demodulator against the interfering signal spectrum outside the baseband relative to the wanted signal spectrum (dB).
- N = receiver basic noise = $10 \log kTB + F$ (dBm) where $10 \log kT = -143.9$ dBm/kHz, at temperature $T = 293$ K.
- R = minimum carrier-to-noise ratio at receiver input for acceptable communications.
- R_i = minimum acceptable carrier-to-interference ratio at the receiver input for a given type of interference and a given type of demodulator. Once a specification has been established for the maximum acceptable deterioration of the wanted signal by an interferer, this parameter may be derived from Reference 1.

In practical systems, q is greater than 99%, r is less than 0.1% and the specified long-term period is the worst month for interference which usually differs from the worst month for propagation. r is such that an overall path availability $(q-r)\%$ due to propagation and interference is acceptable. To provide a guaranteed immunity from interference assuming that the worst propagation and worst interference periods are uncorrelated, the total interference from all sources should not exceed the receiver noise level for more than $r\%$ of the specified long-term period as follows:

$$\sum (P_i - L_i - A_R - A_1 - D) \leq N. \quad (1)$$

If there are sufficient unused gaps in the frequency band then f_1, f_2 may be separated to increase $A_R + A_1 + D$ until the condition (1) above is satisfied for the total interference. In an established network where the frequency band is heavily utilized, the freedom in choice of frequencies needed to satisfy condition (1) may not exist for new links. In such cases, a total interference greater than N but preferably below $(R+N)$ may be tolerated provided that the wanted signal level exceeds the total interference by a minimum of R_i dB for more than $(100-r)\%$ of the specified long-term period. This condition is expressed as follows:

$$(P_w - L_q) - \sum (P_i - L_i - A_R - A_1 - D) \geq R_i. \quad (2)$$

If the wanted and interfering paths are uncorrelated which is most likely, due to the wide disparity between q ($>99\%$) and i ($\leq 0.1\%$), the availability of the wanted path will be between $q\%$ and $(q - \sum i)\%$. If $r \geq \sum i$, no further analysis is required.

The effect of the interference on the availability is estimated more accurately by a convolution of the signal distributions of the wanted and interfering paths. Sources of data to derive the cross-correlation coefficient between the wanted and interfering overseas paths are considered in Reference 2. However, more experimental data on the dependence of the cross-correlation coefficient on frequency, climate, physical separation between paths and time of year are required before any general recommendations are likely to emerge.

Another aspect of frequency planning is the reduction in the total number of frequencies required in order to achieve a specified quality of service. Quadruple space diversity requires only one frequency in each direction but it is usually not adopted due to the high cost of providing four antennas per site. With quadruple space-frequency diversity the number of antennas is halved but the number of frequencies required is doubled. In quadruple space-frequency diversity the separation between the two frequencies is usually inadequate to provide sufficient de-correlation for frequency diversity. However, quadruple diversity performance is usually achieved in such an arrangement by creating four de-correlated space paths in the following manner.

Transmitters 1 and 2 transmit frequencies f_1 and f_2 respectively. Receiver 1 at the opposite end receives both f_1 and f_2 and isolates the two receive space paths by appropriately tuned r.f. filters. Similarly receiver 2 at the opposite end also receives both f_1 and f_2 and isolates the third and fourth receive space paths.

If transmission at frequencies f_1 and f_2 in the above case is replaced by transmission at different polarizations at a common frequency and each of the two receivers at the other end are designed to separate signals of different polarizations instead of signals at different frequencies, then four receive space paths would be separated as before but with the advantage that only one frequency is employed in each direction of transmission. Hence the use of space-polarization instead of space-frequency halves the number of frequencies required to implement quadruple diversity trans-horizon links.

3 Interference Reduction by Equipment Design

Modifications or designs of equipment which provide a greater immunity to interference than existing designs is an evolving process which permits the adoption of new frequency plans with closer inter-channel spacings than previously thought possible. For a new network a frequency plan that demands a high immunity to interference in the equipment may form part of the

specification. The same objective may be achieved for an existing network provided the resulting equipment modification using replacement modules with better interference rejection characteristics does not keep any link out of service for an unacceptably long period.

The following equipment modules or characteristics have a significant effect on the interference characteristics.

3.1 R.F. Preselector Filter

This filter is the major contributor to the r.f. selectivity A_R defined in Section 2. R.f. filter selectivity can be improved to have a significant effect on the suppression of interference signals at or near the receive local oscillator image frequency. However, for frequency plans that are used in concentrated off-shore microwave networks, the radio channels are too closely spaced for the current generation of r.f. preselector filters to provide a measurable adjacent channel suppression relative to the wanted carrier. Although adjacent channel suppression r.f. filters have been laboratory tested for such applications they are unlikely to be cost-effective at the present time.

3.2 Intercept Levels of Receiver Front-end

In instances where the magnitude of the interference levels in an existing network are sufficiently high to cause intermodulation distortion at the receiver front end, the distortion is reduced by fitting replacement front-end units or changing the operating conditions such that the high-level interferers are in a more linear region of the front-end transfer characteristic. The units affected are usually low-noise amplifiers and mixers. Semiconductor characteristics, drive levels and local oscillator power can be varied in order to increase the third and higher intercept levels of the receiver front-end units, which will improve the immunity to interference. In certain instances immunity to interference will only be achieved with a simultaneous degradation in the receiver noise figure.

3.3 I.F. and Baseband Filters

In f.d.m./f.m. systems the first i.f. filter is the main contributor to adjacent channel suppression with some contribution from the demodulator selectivity.

In t.d.m. systems, both the i.f. covering filter and the base-band channel-shaping filter contribute to adjacent channel suppression with a significantly greater contribution from the latter as far as contemporary low-capacity equipments are concerned.

In f.d.m./f.m. systems the adjacent channel suppression is improved by increasing the transmission selectivity of the i.f. filter and equalizing for any consequent degradation in the filter group delay response.

An example of the development of narrower i.f. filtering in order to suppress interference and thereby achieve closer inter-channel spacing for 72-channel f.d.m./f.m. operation is shown in Fig. 2. The amplitude responses of the original non-delay equalized filter and the replacement filter with two sections of group delay equalization but having the same modular size and interface characteristics, are compared. The latter filter permits the operation of a frequency plan with 3 MHz adjacent channel separation with carrier to adjacent channel interference ratio of -10 dB using a conventional f.m. demodulator.

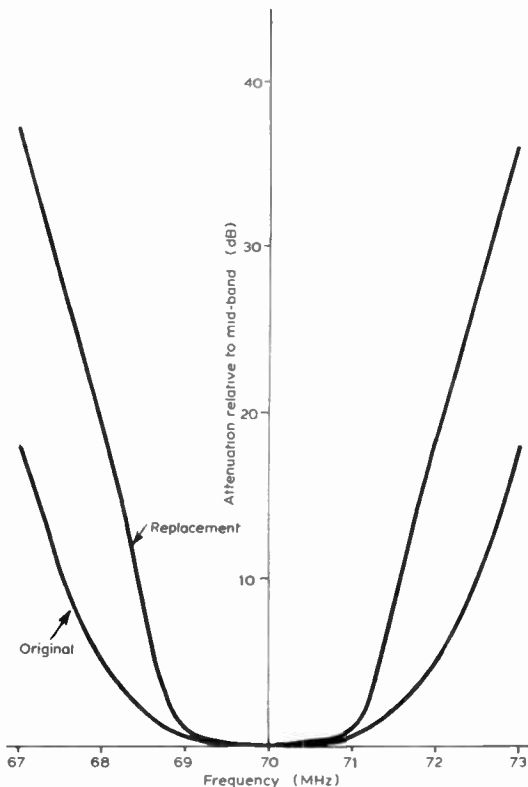

Fig. 2. I.f. filter transmission characteristics.

In digital equipments further improvement in the adjacent channel suppression can be achieved by reducing the roll-off factor of the baseband channel shaping filter but at the risk of increasing the intersymbol interference and consequently worsening the error rate floor. Some marginal advantage in interference improvement may be gained by attempting to transfer the receiver channel shaping characteristic to the i.f. filter. The resulting adjacent channel suppression at i.f. may reduce the intermodulation that is likely to occur in the i.f. amplifiers between the i.f. filtering and the demodulator. However, at the present time, the practical difficulties of implementing narrow band, delay equalized channel shaping filters at i.f. for low-capacity systems more than outweighs any interference suppression advantage that may be gained.

3.4 Spread Spectrum

This approach is effectively an abandonment of frequency plans and a utilization of the whole of the available spectrum by each transmitter. The coded transmission is extracted from the pseudo-noise signal by the receiver receptive to the code. Such systems may be overlaid on existing frequency plans, provided that the resulting interference due to the increase in the general noise level in the network is acceptable.

3.5 Modulation Techniques

In digital communications the spectral occupancy, which is defined as the bit rate divided by the inter-channel spacing, may be improved by the use of partial response (or correlative level coding) signalling methods. In conventional digital communications the receiver assumes that at the sampling instant the current bit or symbol is uncorrelated to other bits or symbols in the stream. In partial response systems, the receiver assumes a known correlation between successive bits or symbols. Since the sampling is performed in the presence of a predictable interference, the receiver either needs to be considerably more complex or has a poorer signal/noise ratio performance for a given error rate, in comparison with a conventional receiver. Since channel shaping is performed primarily at baseband in low capacity systems, the spectral occupancy of such systems may be increased through the use of partial response signalling by replacing only the modem.

4 Interference Reduction by Network Power Control

In line-of-sight or trans-horizon microwave links there exist variations in both long-term and short-term signal levels throughout the year and these propagation effects have been summarized in standard documents.^{3,4} In addition, unusual propagation phenomena, such as ducting, would increase signal level sufficiently to cause intermodulation distortion in the receiver front end. In a network with many trans-horizon links, as is found in off-shore environments, and where the wanted and interfering path signals are uncorrelated, it is probable that a high level interferer would either capture the receiver or reduce the wanted signal-to-noise ratio below its specified minimum. The wanted signal-to-noise ratio could also deteriorate due to high levels of the wanted signal causing receiver front-end intermodulation, especially during duct propagation.

The solutions for such interference and overloading conditions require a network approach where automatic level control is applied for each link in one of the following modes.

4.1 Transmit Level Control (T.L.C.)

The transmitter output power level is varied by a control signal fed back from the far end receiver via the return channel supervisory. The objective is to ensure that the

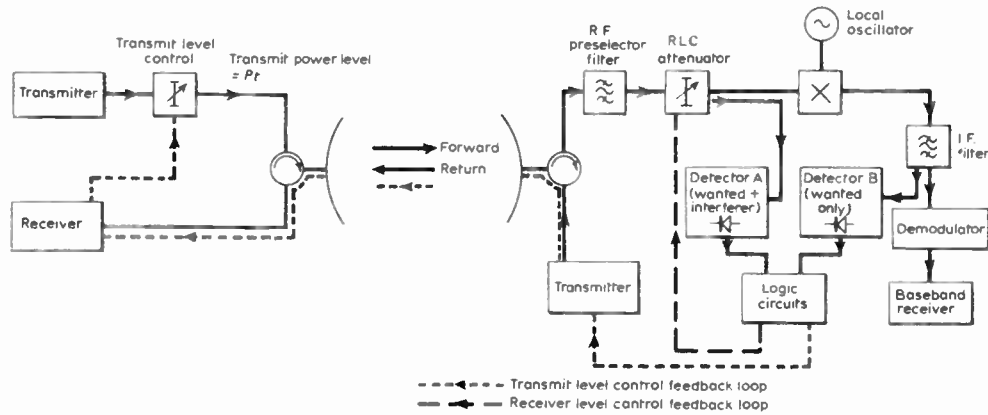

Fig. 3. Combined operation of transmit level control and receiver level control.

transmitter has an output level sufficient but not greatly in excess of that required for satisfactory communications. The feedback control loop varies the transmit output power such that the receiver input level is maintained within a window in the receiver signal/noise ratio vs. input power level characteristic. The upper and lower limits of the window should be sufficiently far apart to stabilize the loop and prevent hunting.

By limiting the output power to what is required instead of what is available, especially during the conditions of anomalous propagation more frequent in oversea paths, the transmitter is less likely to act as an interferer to other receivers in the network.

A transmit level control arrangement is already in operation in the North Sea network and is described in Reference 5.

4.2 Receiver Level Control (R.L.C.)

If the interfering power at the receiver front-end is greater than the wanted signal level and is sufficiently high to drive the receiver into a saturated state that would cause unacceptable distortion, the incoming power is then attenuated to bring the combined wanted and interferer power level nearer to the linear region of the receiver front-end input/output power characteristic. The feedback occurs within the receiver, and the variable attenuator for the receive power control as well as the detector which measures the combined wanted and interference power level are located after the pre-selector filter but before the active circuits in the front-end of the receiver. (See Fig. 3.)

During operation, the feedback loop to the variable attenuator maintains the combined input level of the wanted signal and the interferer to the receiver active circuits within a window of the receiver S/N vs. wanted signal input level characteristic. The levels of the upper and lower limits of the window and the attenuation range are determined by the maximum level of interference expected and the maximum degradation in S/N ratio that can be tolerated at that level of interference. As the wanted input level is increased in the

presence of the maximum expected interference level, typically the S/N ratio will increase, reach a maximum, and then begin to decrease since the front-end active circuits are operating in the non-linear region where significant intermodulation product levels are generated. The upper and lower limits of the window would be specified to lie on either side of and at a pre-determined level below the peak of this characteristic. Invariably, the upper limit of the r.l.c. window occurs at a higher wanted input level than the upper limit of the t.l.c. window of Section 4.1.

The r.l.c. feedback loop is inhibited regardless of the strength of the interferer when the wanted signal, which is attenuated along with the interference, is too low and is approaching the receiver threshold.

4.3 Combined Operation of Transmit and Receive Level Control

In a high-density network the operation of t.l.c. and r.l.c. are combined as follows:

- (a) The transmit powers are reduced when possible to minimize their roles as potential interferers.
- (b) The receiver input levels are attenuated as necessary to minimize non-linear operation within the front-end active circuits.

The net result is either to improve the availability of the network due to the reduction in interference, or to enable the operation of a frequency plan with closer inter-channel spacings but having the same degree of availability as before.

In the implementation of such dynamic level control systems care should be taken to avoid network instabilities since more than one feedback loop is involved over each link.

A simplified approach is to apply one feedback control loop at a time depending on an established order of priority and permitting the link to settle prior to re-assessing its status. In general, anomalous propagation conditions which lead to increased interference are phenomena with relatively slow time-constants lasting several hours. Therefore a fast feedback response time

can be dispensed with without effectively reducing the protection offered. A functional block diagram of a combined t.l.c. and r.l.c. arrangement is shown in Fig. 3.

Detector A measures the combined level of the wanted signal and interference and functions as the r.l.c. detector.

Detector B measures the level of the wanted signal only and functions as the t.l.c. detector.

If the normalized level at detector A exceeds the normalized level at detector B then interference is present on the assumption that the adjacent channel interference is suppressed sufficiently by the i.f. filter so as not to be detected by the high-level detector at B. If the normalized levels are equal then only the wanted signal is present.

The logic sequences which govern the combined operation of t.l.c. and r.l.c. depend on the following inputs:

- (1) level at detector A is within or outside r.l.c. window
- (2) level at detector B is within or outside t.l.c. window
- (3) level at $A >$ level at B , or $=$ level at B .

Each cycle of logic operations will lead to one of the following actions:

- (a) increase or reduce transmitter output power via t.l.c. feedback loop
- (b) increase or reduce received output power via r.l.c. feedback loop
- (c) no action.

The logic circuitry for both t.l.c. and r.l.c. operation is included within the receiver.

Due to the many variables which apply both to the network as well as to the equipment such as the propagation model from which the worst possible carrier to interference ratios are deduced, the user specified limits for link availability and acceptable performance, the latitudes and operating levels of the t.l.c. and r.l.c.

windows, the implementation of the logic sequence may differ from one network to another.

An example of such a logic sequence using the inputs described above is shown in Table 1. In this implementation the receiver is not aware of the settings of the controls for the transmitter output power P_t in the t.l.c. loop and of the attenuation inserted in the r.l.c. loop. Therefore when instructions are necessary to vary P_t , or the r.l.c. attenuation, the control signals are transmitted via the feedback loops with a time limit set for the predicted change to take place in the receiver before other actions are taken. Also, if either P_t or the r.l.c. attenuator reach their range extremities, instructions may continue to be issued by the logic circuitry to go beyond these extremities but they are ignored. The number of logic options for 'other input conditions' referred to in Table 1 are limited. For example, since the normalized upper limit of A is greater than that of B , if A is above r.l.c. window, B must also be above the t.l.c. window when only the wanted signal is present. Hence certain conditions such as A above window, B below window, and $A = B$, cannot exist simultaneously in a properly designed system.

A laboratory prototype of the combined system shown in Fig. 3 has been constructed with the path losses simulated by attenuators and couplers and is currently being tested for f.d.m./f.m. performance.

5 Conclusions

Despite the inherent interference hazards of combining communication links with widely divergent transmitter powers and receiver threshold levels within the same network, as is likely in an off-shore environment, the efficient utilization of the radio spectrum can still be achieved. Detailed attention to frequency planning, equipment modifications to improve receiver selectivity, modulation techniques which utilize the spectrum more

Table 1.
Combined operation of transmit and receive level control-logic sequences

Normalized level at Detector A	Normalized level at Detector B	Relative normalized levels of A and B	Action
Above r.l.c. window	Above or within t.l.c. window	$A > B$	Interference is too high. Increase r.l.c. attenuation until A is within r.l.c. window.
Above r.l.c. window	Below t.l.c. window	$A > B$	Interference is too high but wanted signal is too low. Increase transmitter power P_t until B is within t.l.c. window.
Within r.l.c. window	Below t.l.c. window	$A > B$ or $A = B$	Interference is minor, but wanted signal is too low. Increase transmitter power P_t until B is within t.l.c. window.
Below r.l.c. window	Below t.l.c. window	$A > B$ or $A = B$	Negligible interference but wanted signal is too low. Reduce r.l.c. attenuation until A is within r.l.c. window. If this is not achieved within a specified time interval, increase transmitter power P_t until B is within t.l.c. window.
Above r.l.c. window	Above t.l.c. window	$A = B$	Negligible interference but wanted level is too high. Reduce transmitter power P_t until B is within t.l.c. window. If this is not achieved within a specified time interval, increase r.l.c. attenuation until A is within the r.l.c. window.
All other input conditions			No action.

efficiently, and the use of automatic network power control are some of the approaches available for system implementation. The particular method adopted depends invariably on the circumstances relating to a particular network but even when a completely new off-shore network is being established the system planning options may be restricted due to interference with land based networks. With the continuing demand for spectrum space in all frequency bands and the need to establish commonly accepted criteria for mutual interference between networks, the subject of interference reduction will assume increasing importance in the years ahead.

6 Acknowledgments

The author thanks his colleagues in Marconi Communication Systems Ltd. and in particular, B. S. Skingley, J. K. Johnson, J. Jason, and A. Sills for many helpful discussions and contributions.

Acknowledgments are also due to the British Post Office and the petroleum companies who have, over the years, supported and contributed to many studies of interference in North Sea communication networks, and to the Director of Engineering of Marconi Communication Systems Ltd. for permission to publish this paper.

7 References

- 1 CCIR XIVth Plenary Assembly, Kyoto 1978, Report 388-3.
- 2 'Propagation data for use in the planning of frequency channel assignments for trans-horizon radio relay systems operating in the North Sea area in the 2.5 GHz band', RTD Technical Memorandum P40, Directorate of Radio Technology, Home Office.
- 3 CCIR XIVth Plenary Assembly, Kyoto 1978, Vol. 5, Report 238-2.
- 4 NBS Technical Note 101 Revised, Vols. I and II, AD 687820 and AD 687821, National Bureau of Standards, Washington DC, 1967.
- 5 Johnson, J. K., 'Automatic power control of transmitters', *Electronic Engineering*, 50, no. 616, pp. 69-71, 73-4, 77, December 1978.

*Manuscript first received by the Institution on 22nd August 1979 and in final form on 6th December 1979
(Paper No. 1949/Comm 201)*

Book Review

The Einstein Myth and the Ives Papers—A Counter-Revolution in Physics

Edited by DEAN TURNER and RICHARD HAZELTT Devin-Adair, New York, 1979. 19.5 × 28.5 cm. 424 pages. \$22.50

CONTENTS: The Einstein Myth: A presentation of evidence for the reality of absolute space and time. The Ives papers. Ives on the demise of the photon. Papers and notes by others. Euclid or Einstein: A proof of the parallel theory and a critique of metageometry.

At first Einstein's special theory of relativity (STR), as it has come to be known, was greeted with scepticism, but after some years it began to attract increasing attention until in the nineteen thirties it was regarded as firmly established. There have always been physicists who did not accept the theory, however, and since the nineteen fifties it has come increasingly under attack.

The work under review is another attack on the STR. The core of the book consists of thirty papers, spanning the years 1937 to 1953, by the famous optician H. E. Ives, who was one of the physicists who never accepted the STR. They are preceded by a 110-page

introductory attack on the STR by Turner, and followed by several bits and pieces by other opponents of the STR, the whole being interrupted by scattered editorial comment.

Ives rejected the STR because of its illogicalities. Nevertheless, he upheld the Lorentz transformations, deriving them in the eighteenth of his papers in this book, dated 1945; the other twenty nine papers are devoted to the interpretation of various optical experiments or theoretical aspects of space and time from his own viewpoint. The discussions are interesting and will give good exercise to the critical faculties of students, but cannot be regarded as a significant contribution to the development of physics.

It is fashionable to regard the STR as having dispensed with the aether and to have established the Lorentz transformations as being fundamental properties of space and time. Ives rejected this view, and reintroduced the aether; on this basis he again derived the Lorentz transformations. However, contrary to popular belief and to the statements in all the standard texts, the STR did not dispose of the aether; the aether is implicit in the theory, but is very carefully not made explicit. The

essence of the STR is the Lorentz transformations, which also form the core of Ives's theory. Thus Ives has merely presented the STR in a different manner from that which is usual. The serious objections that may be made to the STR as such (not to a particular presentation of it) therefore apply equally to Ives's theory.

Moreover, the theory as presented here is incomplete. A serious contender for consideration must explain all the known facts, but in the present work only optics, geometry, and kinematics are fully treated. On the subject of electrodynamics Ives is silent, and the editors do not comment on the omission of such an important branch of physics.

Although this book has little to add to modern physics, it has an interest in that it will make the reader think critically about—and perhaps come to understand better—the STR. Specialists in relativity theory should study it, and historians of science will find it a convenient source of material. But as an attack on the STR its main effect is to give some indication of the extent of the unease which exists among scientists.

R. A. WALDRON

British Post Office trans-horizon radio links serving off-shore oil/gas production platforms

S. J. HILL, C.Eng., M.I.E.E.*

SUMMARY

This paper provides an outline description of the Post Office trans-horizon radio link services to off-shore oil/gas production platforms and takes a brief look into the future. It also compares the result of using different methods of predicting the statistical behaviour of the radio path transmission loss, and offers a possible method to give an estimate of the cumulative distribution of scatter loss for trans-horizon radio links operating in the North Sea.

* *British Telecommunications, North Sea Task Force, International and Maritime Services, 207 Old Street, London EC1V 9PS*

1 Introduction

Early in 1965 when oil exploration in the North Sea got underway the Post Office met the new demands on its services by expanding the number of communication channels in the 2–4 MHz band available from coast radio stations. The augmented service to the rigs provides five speech channels, which can be used on a shared basis, and includes some 90 dedicated teleprinter channels which can be equipped with error correcting devices and routed to specific inland business addresses.¹ This rig service for the exploration activity is still in operation today, but more stringent requirements for permanent communication networks for off-shore production platforms arise because of the more sophisticated nature of the business carried out and the need to provide off-shore all the usual communication facilities available to inland business organizations.

Submarine cables were considered but rejected for reasons of high cost and their vulnerability, particularly in the vicinity of the off-shore platforms. A suitable satellite would not be available at the time required so trans-horizon radio with multichannel capacity was chosen for the communication medium.

Post Office involvement came about when it became clear that there would be a requirement for connection to the Post Office switched telephone network. Furthermore, System economy in frequency spectrum usage in order to serve something like 50 or more oil/gas production platforms expected in the UK part of the northern North Sea by the mid-1980s required a single operating authority.

Trans-horizon radio was a new venture for the Post Office because this method of radio communication, although by no means new, had not previously been used on a commercial basis in this country.

Consultations with oil companies who were planning to develop off-shore oil and gas fields indicated that a radio propagation worst-month target reliability of 99.98% of the time was required for the off-shore communication services for the oil/gas production platforms.

2 Basic Configuration and System Design of PO Trans-horizon Radio Links

Because of the imperative requirement to conserve the available frequency spectrum the Post Office trans-horizon links are planned on a common carrier mode of operation. This means that the off-shore trans-horizon radio terminals must also act as relay stations to forward communication services via line-of-sight radio links to other platforms operating in nearby oil/gas fields. Table 1 lists the target transmission standards, which are based on CCIR Recommendations.²

In early discussions with the oil companies it became clear that if security of communication was to be maintained as far as possible then a triangulated system

Table 1

Post Office target transmission standard for North Sea trans-horizon radio links

The transmission standard requirements (i) to (iv) for a Post Office trans-horizon radio link are specified in terms of noise power in the worst telephone channel at a zero level point relative to 1mW and based on an acceptable relaxation of CCIR REC 397-3.

The standard is assumed independent of route length up to 250km. It is also assumed that in practice the number of trans-horizon links in tandem will not exceed 3. Requirements (i) and (ii) are weighted 5ms mean values. It is assumed that the diversity combiner time constants are such that a 5ms and one minute mean value would be substantially the same.

- (i) 10,000 pWp of noise power not to be exceeded for more than 20% of the worst month.
- (ii) 100,000 pWp of noise power not to be exceeded for more than 0.2% of the worst month.
- (iii) 2×10^6 pW of noise power not to be exceeded for more than 0.02% of the worst month.
- (iv) Hourly mean data element error rate not to exceed 1 in 10^5 for more than 0.02% of the worst month for a transmission speed of 2400 bauds.

(see Fig. 1) would be necessary. This arrangement makes efficient use of the frequency spectrum and also ensures that dependent platforms which rely on the trans-horizon host platforms to relay their communication services can have an alternative route to land whenever one off-shore trans-horizon radio terminal is out of commission or its high-power trans-horizon radio

† All high-power radio frequency energy must be switched off to provide a safeguard against possible pre-detonation of the explosive charges, used for hole perforation, during the operation when they are being lowered into the oil well. When in position the charges are exploded to perforate the well thereby enabling a greater oil flow rate to be obtained.

transmitters are switched off for safety reasons during oil/gas drilling operations†. Thus it can circumvent the loss of traffic which would otherwise occur whenever a terminal trans-horizon radio platform resorts to radio silence.

A triangulated trans-horizon radio system arrangement requires only one pair of radio-frequency allocations for the two trans-horizon links and one pair (but in a different frequency band) for the bridging microwave line-of-sight radio link between the two platforms used as trans-horizon radio terminals. This means that in any system only one of the two off-shore trans-horizon radio terminal platforms can transmit to shore at any time.

The trans-horizon radio links operate in either the 2.5 GHz or 2 GHz bands and are configured on a quadruple diversity basis using space and polarization to achieve four independent radio signal paths. Solid-state technology is used throughout the equipment apart from the two output power amplifiers where 1kW klystrons are employed. The output from each power amplifier is connected via coaxial cable or elliptical waveguide to the feed or launch unit associated with one of the two space diversity aerials. With this arrangement each aerial radiates energy in one polarization only but accepts both vertical and horizontal polarizations of the incoming radio signal. Uncooled parametric amplifiers are used at the receiver input in order to improve the receiver noise factor and increase system sensitivity. Pre-detection combining yields a further 5 dB carrier-to-noise improvement. The use of these two techniques together result in a receiver threshold of -131 dBW. In later

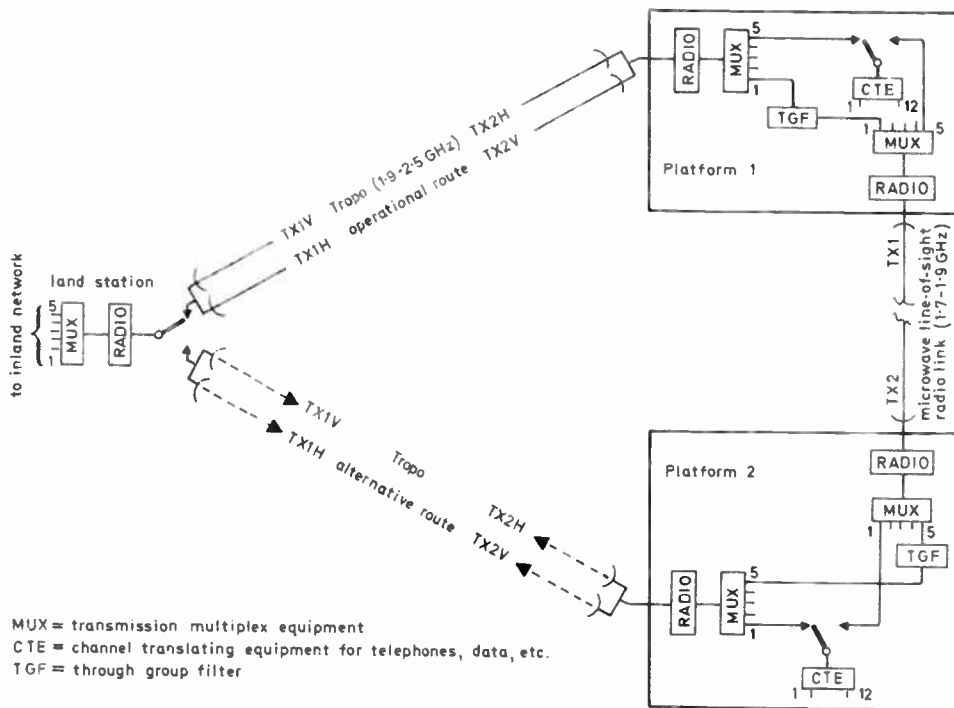
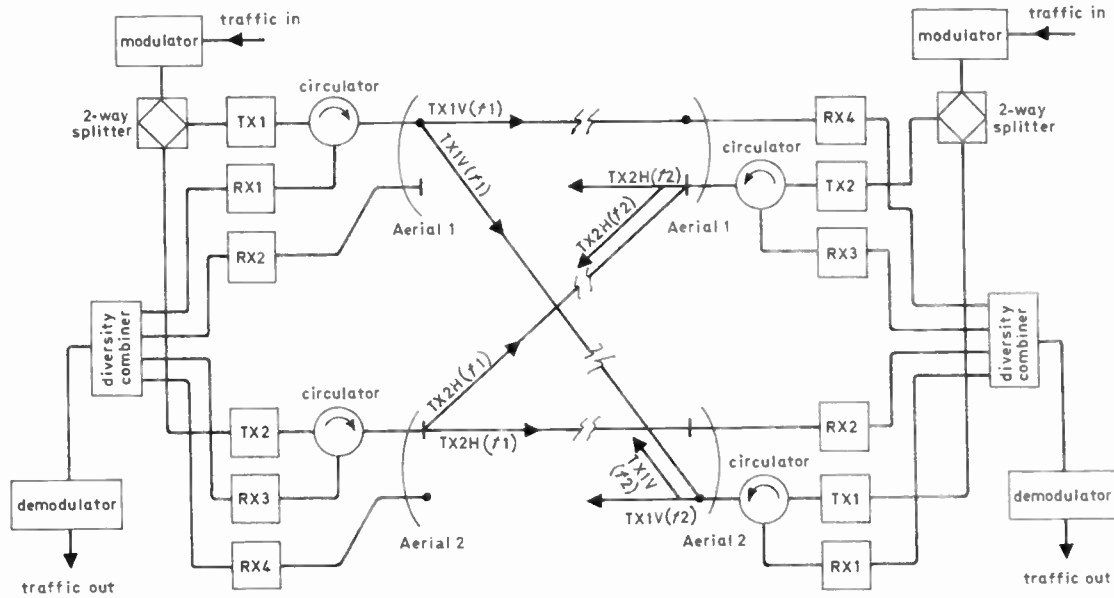

Fig. 1. Trans-horizon radio alternative route



NB; each aerial transmits either vertical or horizontal polarization, but receives both polarizations

Fig. 2. Space/polarization quadruple diversity

systems the use of threshold extension demodulators improves the limit of reception to -136 dBW per diversity radio path.

In general the shore terminal is constructed with a pair of either 18m or 12m diameter double off-set paraboloid type of billboard aerials faing each of the trans-horizon off-shore terminals. The r.f. transmit/receive signal paths are switched on an automatic/manual control arrangement between the two pairs of billboard aerials depending on which of the two off-shore trans-horizon radio terminal platforms is operational. Figure 2

illustrates the quadruple diversity arrangement and Fig. 3 shows a block schematic of a typical trans-horizon transmitter/receiver. Radio equipment reliability is enhanced by the adoption of redundant path techniques.

Provision of a no-break power supply and a large capacity battery ensures that in the event of a failure of the public mains supply the radio stations can continue to be fully operational for up to one hour. This is more than adequate to allow for the auto-start or manual-start diesel-driven alternators to be brought into use until such time as the public mains supply is restored.

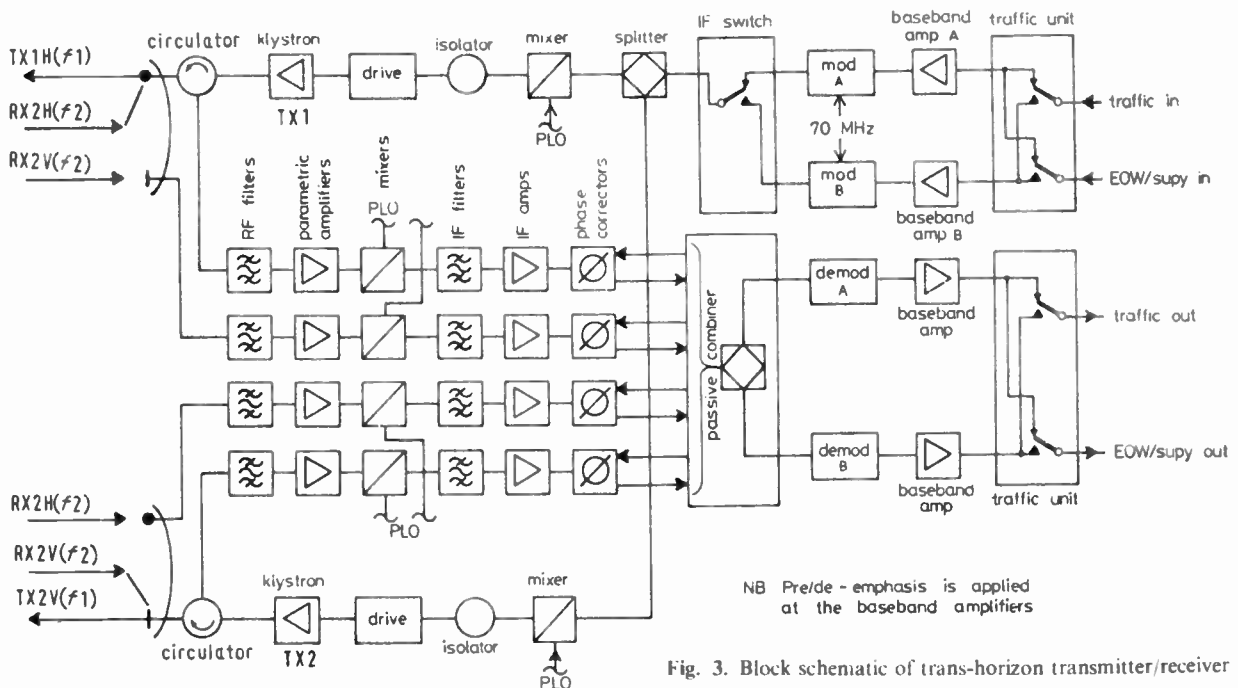

Fig. 3. Block schematic of trans-horizon transmitter/receiver

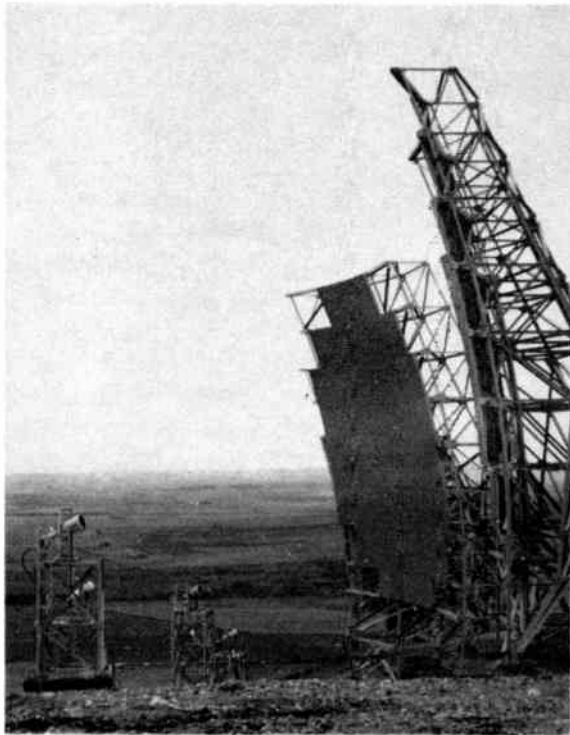

Fig. 4. Land terminal aerial

Because of the physical constraints imposed on the off-shore platform design it is usual for the off-shore trans-horizon aerials to be one-half of the diameter of those used at the land terminal and of the more conventional centre-fed type.

Figures 4 and 5 show typical aerials used at shore and off-shore terminals. The feed associated with the shore billboard aerial is of the corrugated type, and is designed to produce a circular symmetric field at the reflector surface.

The bridging microwave line-of-sight radio links between the two off-shore trans-horizon terminals operate in the 1.7 to 1.9 GHz band and are engineered on a dual space-diversity basis using 2.4m diameter aerials, and a hot-standby transmitter. The method used both on trans-horizon and line-of-sight radio links to convey intelligence is frequency division multiplex/frequency modulation (f.d.m./f.m.).

The nominal 4 kHz voice channels are first assembled in the standard f.d.m. format before being applied to a frequency modulator centred on 70 MHz; the f.m. signal is then translated to a specified frequency in the appropriate trans-horizon or line-of-sight band, amplified and then transmitted. The trans-horizon and line-of-sight microwave radio systems are generally engineered for either 72 or 132-circuit capacity but some line-of-sight radio links may have a capacity of up to 300 circuits.

The sub-based band part of the f.d.m. spectrum between 300 Hz and 12 kHz is allocated to a selective call

engineering order wire, control and supervisory facilities. Figure 6 shows the baseband and sub-baseband format.

3 Propagation Considerations

To the systems engineer, the most difficult and perhaps the most elusive feature of trans-horizon radio link planning is the prediction of the statistical pattern of the received signal. Any prediction of overall transmission loss is further complicated by the aerial-to-medium coupling loss which is a feature of trans-horizon radio propagation and arises because of the absence of phase coherence over the aperture plane of the receive aerial. When a high degree of reliability is called for then the scatter propagation loss not exceeded for more than 0.01% of the worst month is usually taken into account for system design calculations. At the same time it may be necessary to consider also the likelihood of interference and again a target noise figure not to be exceeded for more than 0.01% of a month may be imposed on system design. These two considerations together provide a target transmission performance standard of not more than 2×10^6 pW of noise in the top telephone channel for more than 0.02% of the month of worst propagation.

Beyond the horizon the diffraction loss over a smooth earth at first increases rapidly and is a function of frequency, distance, ground electrical constants and aerial heights. At even greater distances beyond the horizon the rate of attenuation/distance decreases and propagation of radio signals due to a scattering process from atmospheric refractive inhomogeneities (or atmospheric blobs) becomes effective. These scattered signals, although small (approximately 1 to 10 pW) and varying in amplitude from instant to instant, may be combined in dual or quadruple diversity arrangements to provide a high quality circuit.

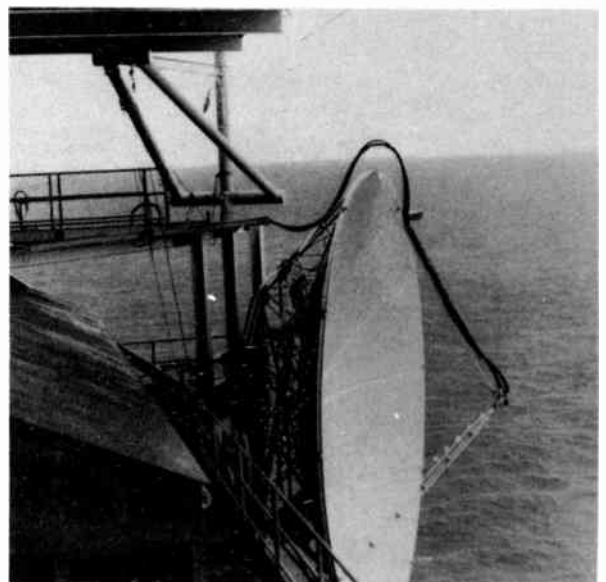

Fig. 5. Off-shore terminal

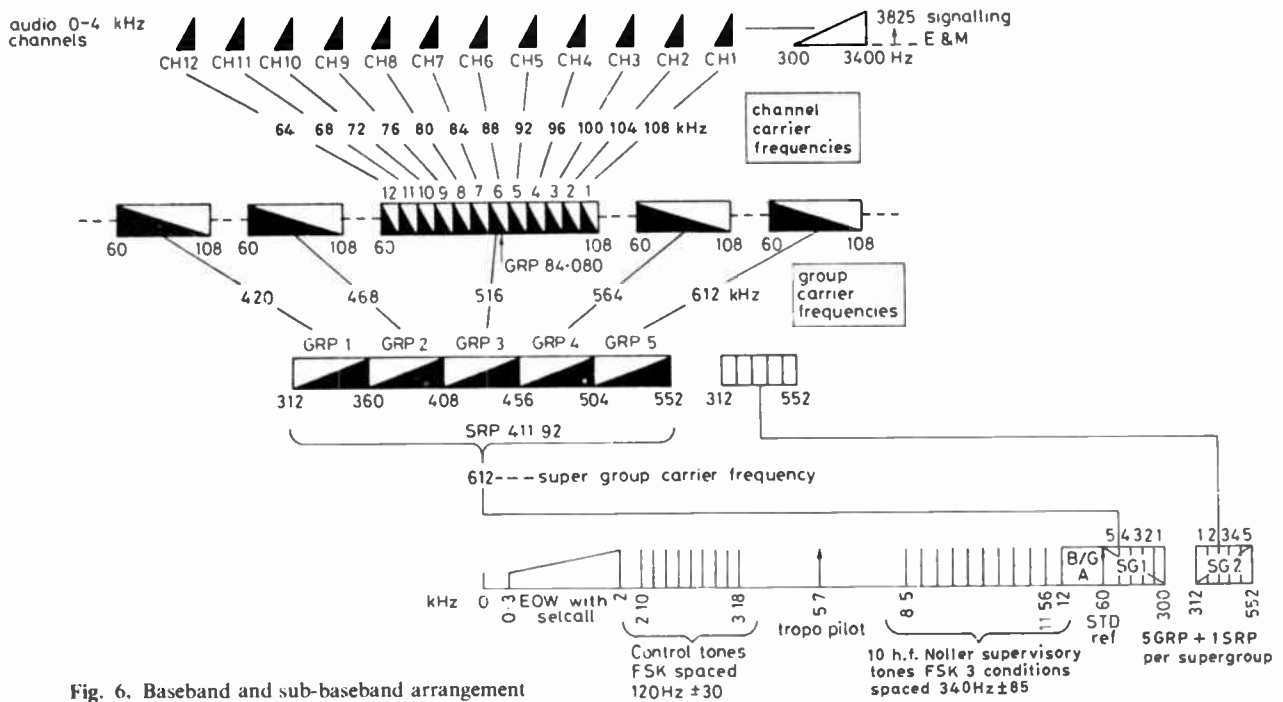

Fig. 6. Baseband and sub-baseband arrangement

The propagation characteristic of a tropospheric scatter radio path exhibits both slow and rapid variation of the received signal level. The slow variations in general follow a log-normal type of distribution about the long-term hourly median value while the rapid variations in amplitude follow a Rayleigh type of distribution. Figure 7 shows a typical tropospheric scatter signal received over a 265km path. In general the rapid variations cover a 40 to 60 dB range but when signal enhancement resulting from duct propagation conditions is included the received signal level may extend over a total range of 100 dB or more.

At the time (1973) when the Post Office was first involved with the planning of trans-horizon radio links to off-shore oil/gas production platforms a joint study with the Home Office (then Ministry of Posts and Telecommunications) was undertaken in an attempt to predict the statistical propagation fading pattern that might be experienced over the North Sea Area.

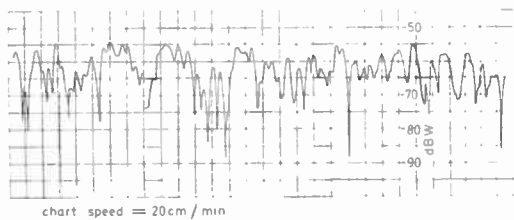

Fig. 7. Typical tropospheric scatter received signal (single path)

Although other organizations were at that time using the American National Bureau of Standards (NBS) 101 method for predicting trans-horizon radio link propagation performance³, it was decided to use data,

mainly at u.h.f., collected by the BBC and the PO for radio paths which were more closely related to the North Sea area where oil/gas production platforms were expected to operate. The joint Home Office/Post Office study produced propagation curves which gave the scatter loss (relative to the free space loss) based on a 10 log f (MHz) function, not to be exceeded for various percentages of time during the worst month. The study also produced signal enhancement propagation curves for estimating interference to other services operating in the same radio band frequencies. Signal enhancement is a phenomenon of a reversal and change of lapse rate of the atmospheric refractivity which occurs during anti-cyclonic weather conditions and gives rise to the creation of a surface or an elevated duct. Radio signals can get trapped in such an atmospheric duct and in so doing may be propagated over vast distances and produce interference in distant radio receivers. Signal enhancement usually occurs during the summer months when high atmospheric pressure areas predominate accompanied by temperature inversions. Periods of greatest signal variability may occur also during these months.

Figure 8 provides a ready comparison between the American NBS 101 and the HO/PO methods of predicting the propagation performance, on an overall transmission loss basis, for a 265km trans-horizon radio link with parameters as listed in Table 2. Included in this figure are the worst month measured values based on some 1200 hourly mean readings for two of the four diversity paths, and converted to transmission loss on the assumption that the full plane wave gain of the aerials is realized. Aerial-to-medium coupling loss has

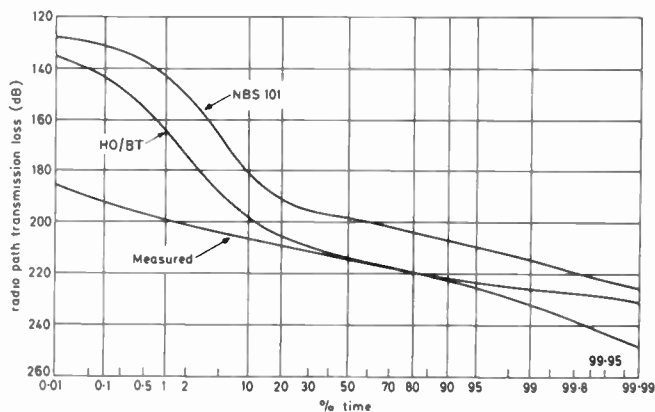

Fig. 8. Worst month transmission loss at 2 GHz for a 265 km trans-horizon radio path with a scatter angle of 15.3 mrad

not been included in the two prediction methods compared in Fig. 8 because of the wide discrepancy that results from its inclusion. For example, the HO/PO prediction method uses a curve published in CCIR Report 238-3⁴ and gives an estimated coupling loss of 15 dB, whereas the NBS 101 method gives an estimated loss of 4 dB. Clearly because there is a lack of phase coherence of the received signal over the aperture plane of the receive aerial, a loss of plane wave gain will result. The author is of the opinion that the NBS 101 method of estimating the aerial-to-medium coupling loss for aerials of up to 18m diameter although more complicated and tedious, is more accurate than the straight application of the curve given in Report 238. It is suggested that the CCIR curve of aerial-to-medium coupling loss should perhaps be modified to indicate a less severe loss of gain. Figure 9 shows a possible modification to the graph (which relates to aerial-to-medium coupling loss in CCIR Report 238) for North Sea paths. A further divergence between the HO/PO method and the NBS101/CCIR method occurs with the formula proposed for the calculation of the standard error of prediction (or 84% confidence limit). For the radio path (Table 2), the NBS 101 method gives a standard error of prediction at the 99.99% of the worst-month criterion of 9.7 dB while the HO/PO method gives a value of 6.1 dB. The corresponding prediction errors for the long-term median values are 3.6 dB and 1.7 dB respectively. It is of interest to note that the measured hourly mean received signal value over four diversity radio paths for a whole year gave a standard deviation of 3.7 dB and 4.5 dB at the 50% and 99.99% of the time criteria. A more appropriate formula for the 84% confidence limit might be $\sigma = (13 + 0.05Y^2)^{1/2}$ where Y is the difference in dB between the 50% and Y% of the time on the log-normal distribution curve.

Because the two mechanisms which determine the received signal level under ducting and under tropospheric scatter propagation conditions are so very different and, as might be expected, produce quite different distributions and standard deviations, it is

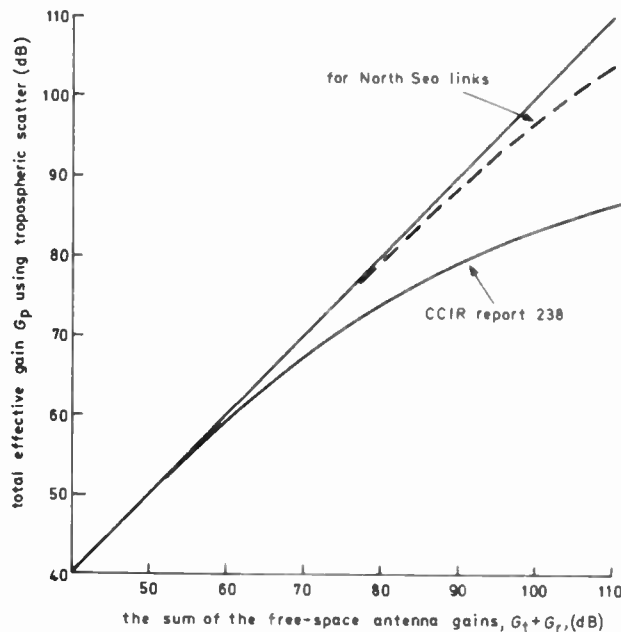

Fig. 9. Aerial-to-medium coupling loss

suggested that the received signal level values actually measured during the worst month between the 50% and 99.99% of the time should be used to determine the standard deviation of the log-normal curve for the fading half of the distribution. A similar treatment for the lower half of the distribution curve but based on the month of greatest variability where signal enhancement predominates suggest that propagation predictions should be based on a higher standard deviation of some 11 dB compared with a standard deviation of about 6 dB for the upper half of the distribution where the scatter mode of propagation predominates.

Figure 10 is a suggested cumulative distribution curve of transmission loss for trans-horizon links operating in the North Sea area. It must however be pointed out that the measurements were made over a symmetrical path with high aerials at each end of the link. While a good deal more work needs to be done especially with investigating the aerial-to-medium coupling loss at low received signal levels, the evidence so far indicates that the HO/PO propagation curves used to predict the

Table 2
Parameters of 265 km trans-horizon radio link

transmitter output power	1 kW (= 30 dBW)
transmitter/receiver feeder loss etc	5 dB
transmit aerial gain at 2 GHz (18m dia)	49 dB
receive aerial gain at 2 GHz (18m dia)	49 dB
great circle distance	265 km
scatter angle	15.3 mrad
transmitter aerial height	239 m (a.m.s.l.)
receiver aerial height	246 m (a.m.s.l.)
transmit launch angle	-7.4 mrad
receive launch angle	-7.5 mrad
receive signal level to give f.m. threshold (10 dB)	-131 dBW

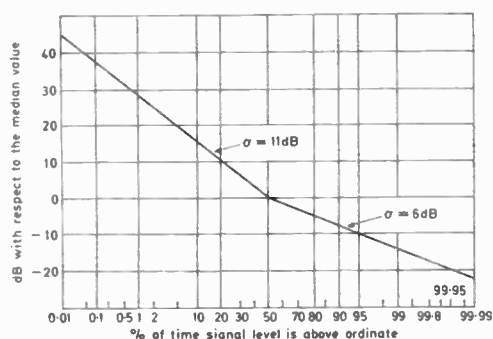

Fig. 10. Suggested cumulative distribution for North Sea trans-horizon links

performance of trans-horizon radio links operating in the North Sea area are in general some 10-12 dB pessimistic. The CCIR curve in Report 238 for aerial-to-medium coupling loss also overestimates the amount of plane wave gain degradation for the size of aerials used on North Sea radio links. A possible method of predicting the transmission performance of a trans-horizon radio link operating in the North Sea area is given in Appendix 1.

Finally Figure 11 illustrates the transmission performance achievements of the 265km PO trans-horizon radio link (details of which are given in Table 2) and demonstrates that the targets set are surpassed and even exceed those for an equivalent length line-of-sight link based on the transmission performance criteria set out in CCIR Recommendation 395.⁵ It is worth noting that the noise level recorded on two tandem-connected trans-horizon radio links totalling 430km in length was -65 dBm0p.

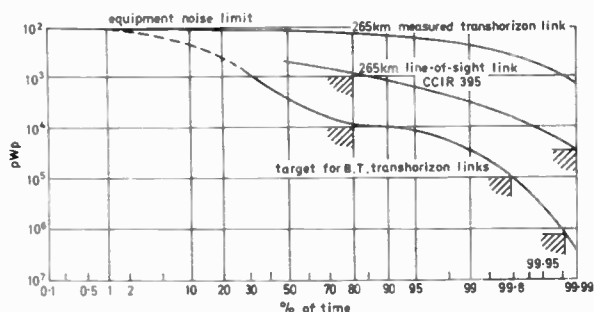

Fig. 11. Comparison of target and measured transmission performance (worst month) for a 265-km trans-horizon radio link. (See Table 2)

Because the transmission performance of the trans-horizon radio links is a good deal better than expected, it is a relatively simple exercise to extend the capacity from 72 to 132 channels. Theoretical and practical tests carried out on site have established that provided the loss/frequency and group delay/frequency of the i.f. filters are symmetrical then a 132-channel system can be contained within the 3 MHz r.f bandwidth allocated for a 72-channel system and the need to take up more spectrum and to incur substantial equipment costs is thus avoided.

4 Resumé of PO Trans-horizon Radio Services

There are now five PO trans-horizon radio links in operation four of which connect with off-shore terminals. These terminals serve 11 oil/gas fields in the UK sector of the North Sea either directly or via line-of-sight microwave radio links and include some 18 oil/gas production platforms. In the next two years the number of PO trans-horizon radio links will increase to 7 and the number of platforms served will be in excess of 24. Figure 12 illustrates the off-shore scene, and includes existing and planned platforms.

Figure 13 serves as an example to illustrate how the complexity of the off-shore networks is growing and may expand over the next five years. PO specifications covering the performance requirements for operation of line-of-sight radio links in the 1.5 GHz and 1.7 GHz bands have been issued in order to ensure that satisfactory connections to the UK national and international communication highways can be obtained from off-shore platforms. The off-shore line-of-sight microwave links together with the trans-horizon radio link to shore and the inland radio links are either equal to or in addition to the local line network to the customer's land-based office and therefore the need to set a high transmission standard is apparent. The transmission objective for the off-shore network is to limit the overall circuit weighted noise to -58 dBm0p (or 1585 pWp).

Each off-shore customer rents one or more groups of 12 circuits and in order to preserve a measure of intelligence security, channel access facilities are provided only on the platform where the circuits terminate. At all other company's platforms through-group filters and group switches are provided. Channel access is normally provided at the PO shore stations to facilitate test and patch arrangements between off-shore and the inland connections. Out-of-band signalling (3825Hz) with tone-off idle condition is used throughout the network and use is made of this spare out-of-band facility on telegraph bearer channels to provide system guard arrangements on circuits between off-shore and on-shore installations.

A more recent in-band signalling system (AC15A) which includes a busy-hold facility is now available for use over radio circuits. Data at 2400 bit/s is already in use over the trans-horizon and line-of-sight radio links and before long it is hoped that speeds of 9600 bit/s will be in use.

5 Future Prospects for PO Services

Exploratory drillings have been made West of the Shetlands, in the South Western approaches and in the English Channel. No decision has yet been made to develop any of the oil/gas fields in these areas but there is little doubt that economic pressures and world shortages of hydrocarbons will force the pace of exploration and development of off-shore fields.

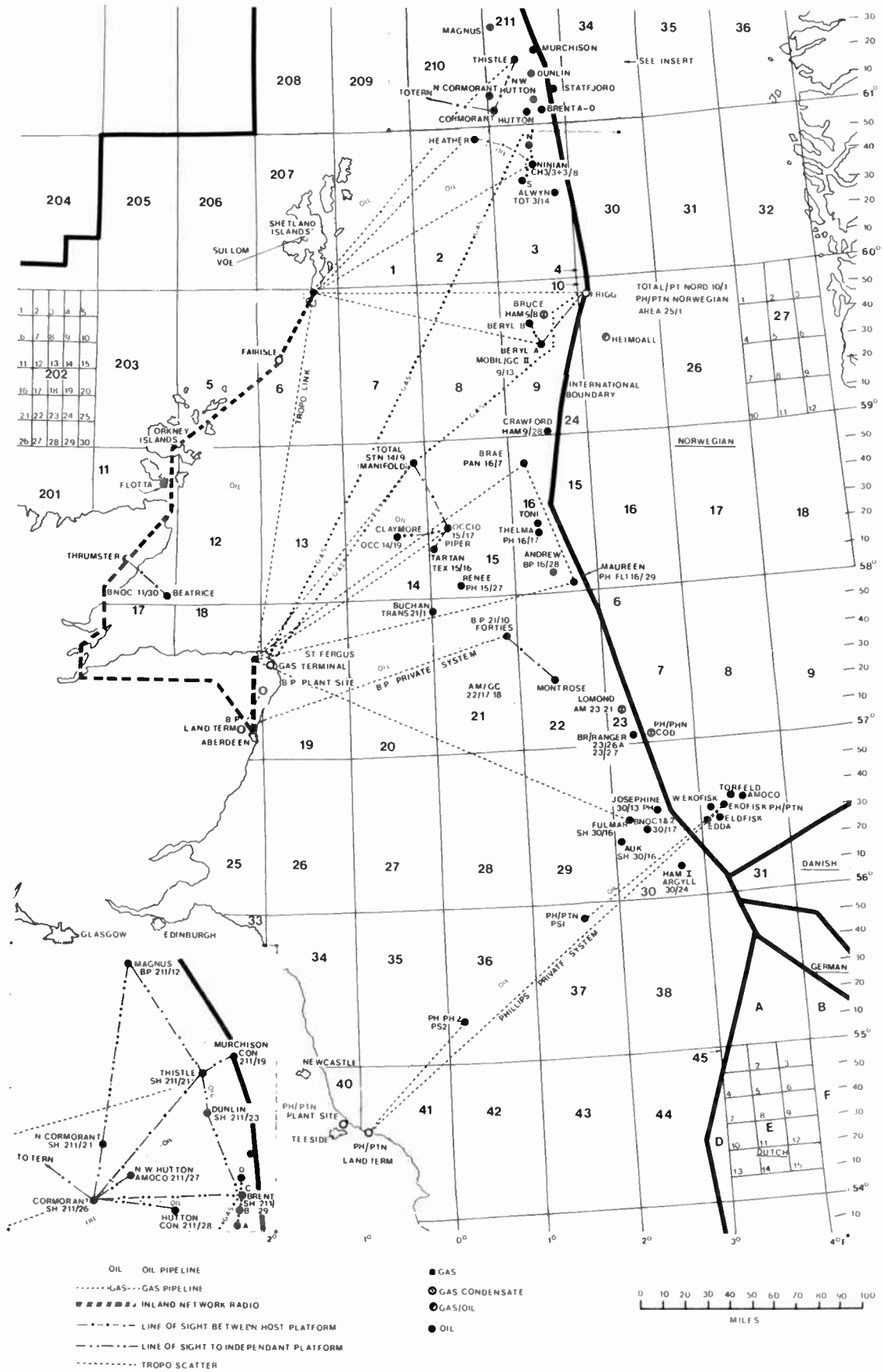

Fig. 12. Planned communications for oil/gas production platforms

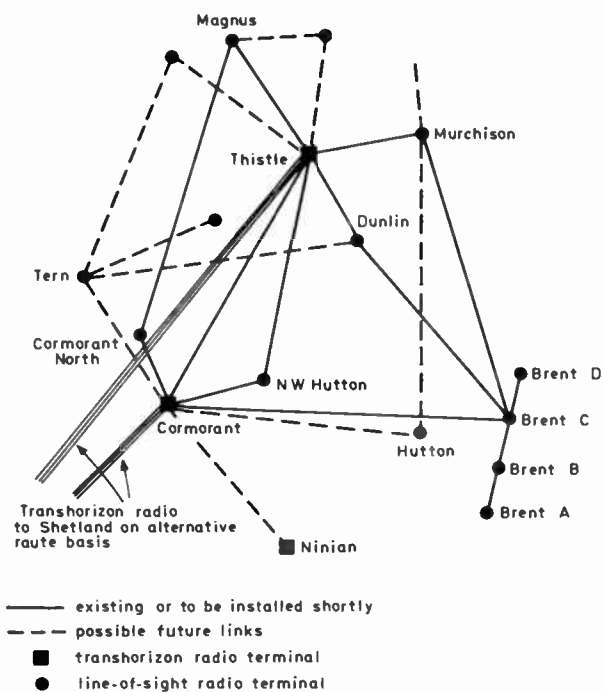

Fig. 13. Thistle/Cormorant microwave network

By the mid 1980s a European satellite is expected to be available and this may be used to provide services to oil/gas production platforms that are beyond trans-horizon and line-of-sight radio range or cannot be accommodated by these radio methods because of their location. The tethered type of platform that seems to be gaining favour for the small to medium-size fields or for fields where the water depth is excessive may also best be served from a communications satellite.

If in addition other off-shore mineral sources are discovered and the necessity to expand the number of trans-horizon radio links in use arises then undoubtedly transmit and receive level control will have to be employed in order to make frequency sharing practicable.

6 Acknowledgment

Acknowledgement is made to the Director Post Office International Services for permission to publish this paper.

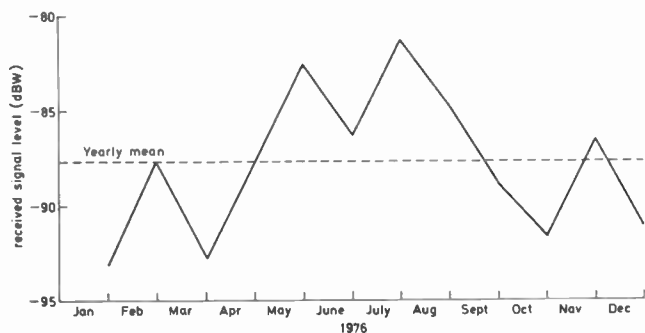

Fig. 14. Variation of monthly mean received signal level (dBW)

7 References

- 1 Hyatt, J. L., 'Ship-shore communications for the off-shore oil industry,' *The Radio and Electronic Engineer*, 50, no. 8, pp. 381-9, August 1980.
- 2 CCIR, Vol. IX, XIVth Plenary Assembly, Kyoto, 1978, Recommendation No 397-3.
- 3 Rice, P. L., et al., 'Transmission Loss Predictions for Tropospheric Communication Circuits.' Vols 1 and 2. NBS Technical Note 101. Distributed by National Technical Information Service, US Department of Commerce.
- 4 CCIR, Vol. V, XIVth Plenary Assembly, Kyoto, 1978, Report No 238-3.
- 5 CCIR, Vol. IX, XIVth Plenary Assembly, Kyoto, 1978, Recommendation No 395-2.
- 6 Yeh, L. P., 'Simple methods for designing troposcatter circuits,' *IRE Trans on Communication Systems*, C5 8, no. 3, pp. 195-8 September 1960.

8 Appendix 1: A proposed performance prediction method for North Sea trans-horizon radio links

An analysis of the recording charts associated with the four diversity radio paths for a 265km trans-horizon link (see Table 2 for radio-path details) and taken over a period of one year, included some 25 000 mean hourly received signal level assessments. These results indicate that while the standard deviation for the long term log-normal type of distribution is correct at about 6 dB the level of the measured received signal was about 10-15 dB higher than the predicted value based on the Home Office/Post Office propagation curves. Figure 14 shows the variation of the monthly mean and Figure 15 shows the variation of the monthly standard deviation, taken over the same period of one year.

Figure 15 also shows that the smaller variation of signal level experienced during winter months can be seen contrasted with those during the summer months when a much higher standard deviation was measured. The mean of the monthly mean values of received signal level recorded was -87.8 dBW, with a standard deviation of 3.7 dB and the mean of the monthly standard deviations for the log normal long-term fading was 6.16 dB with a standard deviation of 1.03 dB.

Based on the analysis of these charts and the known performance of other trans-horizon radio links operating in the North Sea area a prediction method has

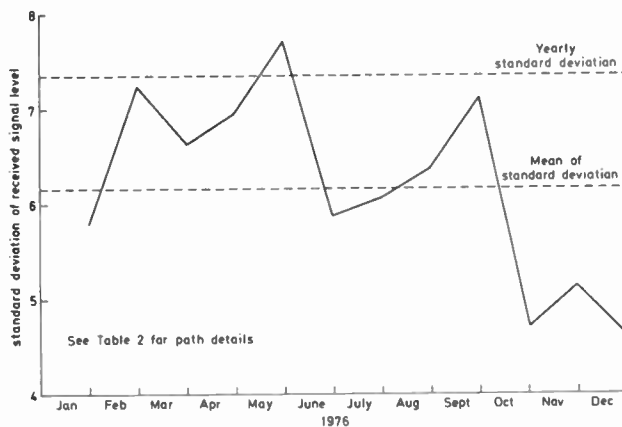

Fig. 15. Monthly standard deviation of received signal levels

evolved that appears to give a good approximation to the actual performance.

A good starting point is the fundamental equation which determines the 'free space' radio path attenuation between two isotropic aerials. This attenuation is given by the ratio

$$\frac{\text{power transmitted}}{\text{power received}} = \frac{(4\pi d)^2}{(\lambda)^2}$$

where d and λ are in the same units.

This ratio may be converted to decibels and expressed more conveniently as

$$\text{attenuation (dB)} = 32.45 + 20 \log_{10} d + 20 \log_{10} f$$

where d is in kilometres and f is in megahertz.

Based on experimental evidence, Yeh's formula⁶ gives the scatter loss for a yearly mean surface refractive index, N_s for air, of 310 as:

$$L_s = 21 + 0.57\theta + 10 \log_{10} f$$

where θ is the scatter angle in milli-radians and f is the frequency in megahertz.

To adjust for other values of N_s , the median scatter loss $L_s(50)$ above the free space loss is given by

$$L_s(50) = 21 + 0.57\theta + 10 \log f - 0.2(N_s - 310) \text{ dB}$$

Using the parameters listed in Table 2, the free-space path loss is given by

$$32.45 + 20 \log 265 + 20 \log 2000 = 147 \text{ dB.}$$

The scatter loss, $L_s(50)$, for a value, $N_s = 320$ (estimated to be appropriate for North Sea links) and $\theta = 15.3$ mrad is given by

$$21 + 0.57 \times 15.3 + 10 \log_{10} 2000 - 0.2(320 - 310) = 60.7 \text{ dB}$$

If the measured yearly mean value of received signal level of -87.8 dBW (see Fig. 14) is now equated to the effective power transmitted and system losses:

$$P_t - L_t(50) + G - L_f = -87.8 \text{ dBW}$$

$$\begin{aligned} \text{where } P_t &= \text{transmitter power} && = +30 \text{ dBW} \\ L_f &= \text{transmitter/receiver feeder loss} && \\ &+ \text{circulator losses etc} && = 5 \text{ dB} \\ G &= \text{combined plane wave gain of transmit} && \\ &\text{and receive aerials} && = 98 \text{ dB} \\ L_t(50) &= \text{the median scatter loss + free space loss} \end{aligned}$$

Then $L_t(50)$ is given by
 $30 - 5 + 98 + 87.8 = 210.8 \text{ dB}$

This represents the maximum path loss because no allowance has been made for aerial-to-medium coupling loss. Subtracting the free space path loss of 147 dB from the total path loss gives 63.8 dB for the scatter loss contribution. This is only some 3.1 dB more than the loss estimated from the application of Yeh's formula and falls well within the 84% confidence figure of 6.1 dB for the mean of the monthly standard deviations (see Fig. 15).

Clearly aerial-to-medium coupling loss needs to be included in the estimation of path loss and when the NBS derived value of 4 dB for the path example is included then the measured scatter loss becomes $63.8 - 4 = 59.8$ which is within 1dB of the estimated value using Yeh's formula.

A suggested method of predicting the propagation performance of a trans-horizon radio link operating in the North Sea area is therefore:

- (1) Calculate the great circle distance.
- (2) .., the free space path loss
- (3) .., L_s , the median scatter loss from Yeh's formula
- (4) Estimate the small percentage of time path loss variations from Fig. 10.
- (5) Include additional loss to give 84% confidence limits derived from $\sigma = (13 + 0.05 Y^2)^{1/2}$ where Y is the percentage difference in dB between the 50% and Y % points in the cumulative distribution curve (Fig. 10).
- (6) Include aerial-to-medium coupling loss estimate from Fig. 9.

Manuscript first received by the Institution on 22nd February 1980 and in final form on 19th May 1980 (Paper No. 1950/Comm 202)

The feasibility of using spread-spectrum communication systems for the land mobile service on a non-interference basis with other users

R. F. ORMONDROYD, B.Eng., Ph.D.*

and

M. S. SHIPTON, B.Sc.*

Based on a paper presented at the IERE Conference on Land Mobile Radio held at Lancaster in September 1979

SUMMARY

This paper examines the conditions which would allow land mobile radio systems using spread-spectrum techniques to share certain r.f. channel allocations on a mutual non-interference basis with the existing users of these channels, namely the television broadcasters.

An experimental spread-spectrum communication system has been developed and this has been used to examine the feasibility of bandsharing from the point of view of establishing protection for the television signal from the spread-spectrum interference for imperceptible visual interference on the screen, whilst still allowing adequate reception of the spread-spectrum signal under conditions of high television interference.

The results indicate that the spread-spectrum signal must be at least 42 dB below the peak television carrier level at the television carrier frequency for picture quality to be unaffected, and under these conditions an output signal with at least 25 dB signal-to-noise ratio can be obtained from the spread-spectrum receiver.

1 Introduction

There are numerous broadband transmission techniques which fall into the category of 'spread-spectrum'.^{1,2} Within the context of interference-limited multi-access communication systems the choice falls into two main systems, direct-sequence encoding, and frequency-hopping encoding. Several hybrid forms, and time hopping and frequency chirp also exist and these share the attributes of both main systems. In multi-access systems all users share a common centre-frequency and transmission bandwidth. The baseband information of each user is spread out to the much broader transmission bandwidth; however, for it to be of any use in these multi-access systems the spreading process must provide the encoding necessary to define the wanted user from all other spread-spectrum users, or other sources of interference which may exist in the band. Separation and decoding of the wanted channel in the receiver depends upon the original spreading technique adopted.

In the direct-sequence systems, illustrated in Fig. 1(a), the energy in the baseband signal or the modulated r.f. carrier is spread in bandwidth by multiplication by a broadband spreading function. Typically the baseband data will be spread by a factor of at least 10^3 or 10^4 . If the spreading process occurs at baseband, the spread signal is then translated to the r.f. transmission frequency. This may be achieved by one of the following techniques: (a) conventional bi-phase shift keying, (b) four-phase shift keying which handles the data twice as fast as bi-phase modulation for the same bandwidth and power, or (c) continuous phase-shift modulation, which minimizes the power in the sidelobes of the broadband spectrum.³ The source of the baseband information may be digital or digitally-encoded speech, or analogue amplitude or frequency modulated information. The spreading function allocated to each user is one of a set of functions which are mutually orthogonal or quasi-orthogonal. For simplicity binary maximal length sequences and Gold codes⁴⁻⁶ are often used in direct sequence systems clocked at a very high rate, relative to the baseband data rate, to give the desired spreading ratio. The encoding may then be accomplished by allocating a unique code to each user, or by allowing each user to share the same maximal length sequence, but ensuring that they are all time-shifted relative to each other by one bit or more.

Figure 1(b) illustrates a typical direct-sequence spread-spectrum receiver. Because all users are co-channel, the wanted signal will probably be buried in high levels of other user interference. After translation back to baseband or a suitable intermediate frequency, the received signal is multiplied by a replica of the encoding sequence of the wanted channel. If the replica sequence is perfectly synchronized with the received wanted code, then the code will be removed from this signal by coherent demodulation and the energy in the

* School of Electrical Engineering, University of Bath, Claverton Down, Bath, Avon BA2 7AY.

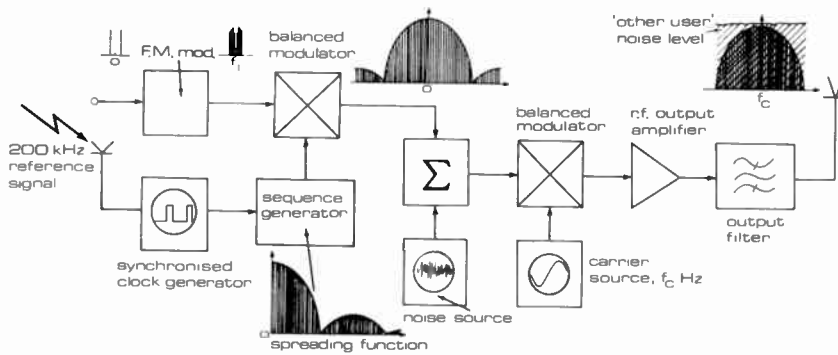

Fig. 1. (a) Direct-sequence, spread-spectrum transmitter.

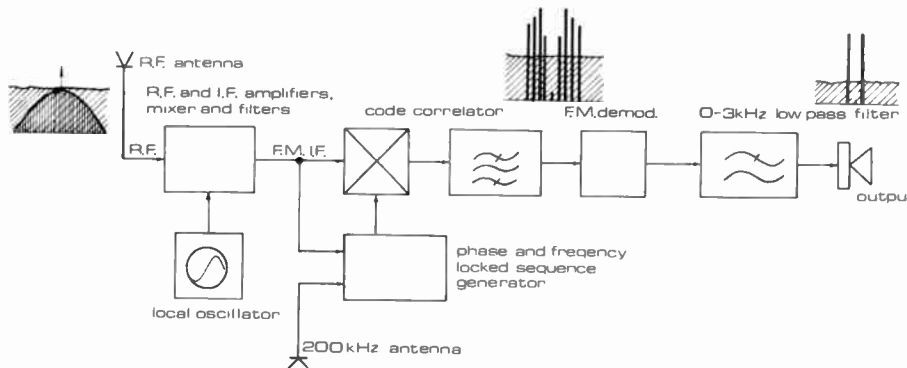

Fig. 1. (b) Direct-sequence, spread-spectrum receiver.

signal will be despread back to the original relatively narrowband signal at baseband (or the i.f.). However, since all other users are encoded with different sequences, these will not be coherently demodulated but will be further randomized by the multiplication process, where they exist as background interference. If the desired signal is digital, this may be extracted from the background interference by either filtering or using an integrate-and-dump technique, whilst for analogue signals filtering must be used. The noisy despread signal may then be demodulated via a conventional analogue or digital demodulator.

If narrowband or c.w. interference is received, the energy in this signal will be spread by the receiver sequence in a manner analogous to signal spreading in the transmitter. In an idealized spread-spectrum system in which the energy of a c.w. signal is uniformly spread over the transmission bandwidth, B_s , and if the energies of the wanted and unwanted signals at the input to the receiver are equal, then the signal-to-noise improvement at the output of the narrowband filter, prior to demodulation, will be given by the ratio of the bandwidths, $G_p = B_s/B_d$, where B_d is the post-correlation filter bandwidth and G_p is the processing gain of the system.

However, this is a fairly arbitrary definition, confined to white noise or c.w. interference sources and relies on

continuous and uniform spreading. The overall processing gain must also include the processing gain associated with the final demodulation process. For example, if the information source prior to spreading is frequency modulated analogue information, a more suitable definition of overall processing gain when the f.m. demodulator is operating above its threshold signal-to-noise ratio would be:

$$G_p \approx \frac{\text{(transmission bandwidth)}}{\text{(post correlation bandwidth)}} \times \left(\frac{3}{2}\right) \beta^2$$

where β is the deviation ratio of the baseband information and $(3/2)\beta^2$ is the processing gain of an f.m. demodulator.

Again, this definition assumes uniform spreading. The processing gain determines the ability of a system to process a wanted signal from those of other users, or interference. In a multi-user spread-spectrum system it is unlikely that the users will have white-noise characteristics. For direct-sequence spread-spectrum systems the signal power spectrum has components at frequencies which are integer multiples of $1/M\Delta$, i.e.:

$$G_s(f) = \frac{1}{M\Delta} G(f) \sum_{v=-\infty}^{\infty} \delta(f - v/M\Delta)$$

where M is the length of the sequence,

A is the digit width,
 $\delta(f-f_0)$ is the Dirac delta function defined by the operator equation

$$\int_{-\infty}^{\infty} H(f)\delta(f-f_0) df = H(f_0)$$

and $G(f)$ represents the 'envelope' of the signal spectrum. For a maximum length sequence $G(f)$ takes the form:

$$G(f) = A \left[\frac{\sin(\pi Af)}{\pi Af} \right]^2, \text{ for } f \neq 0,$$

$$G(f) = \frac{A}{M}, \text{ for } f = 0.$$

Since typically 90% of the transmitter power is contained in the main lobe of this spectrum, it is normal to filter out the sidelobes prior to transmission and transmit only the main lobe to prevent excessive spectrum usage. The measure of discrimination between users (i.e. the processing gain) is now given in terms of the correlation between the wanted user's received code and the locally generated replica code (which thus requires perfect code synchronization for maximum output after despreading) and the cross-correlation of the wanted code with the codes of all other users. Since the members of the code set used have imperfect (i.e. non-zero) cross-correlation properties, the signals of all other users appear as correlation noise over the wanted signal.

For a non-coherent demodulation system in which all interferers are considered to be transmitting a code-spread carrier which is not further modulated by data, then, if k users simultaneously use the spread-spectrum channel, each having the same spreading bandwidth but a different code, and if the peak power spectral density of each received user is P_i , then the signal-to-noise ratio (SNR) at the input to the receiver is:

$$SNR_{input} = \frac{\sum_{f=-1/A}^{1/A} P_t \left[\frac{\sin(\pi Af)}{\pi Af} \right]^2 \frac{1}{M} \sum_{v=-M}^M \delta(f-v/M A)}{\sum_{i=2}^k \sum_{f=-1/A}^{1/A} P_i \left[\frac{\sin(\pi Af)}{\pi Af} \right]^2 \frac{1}{M} \sum_{v=-M}^M \delta(f-v/M A)} + \frac{1}{M^2}$$

where P_t is the wanted user and P_i is the i th interferer and where the summation in f is taken in steps of $1/M A$, except for $f = 0$.

The output SNR is given by:

$$SNR_{output} = \frac{\int_{-\infty}^{\infty} H(f)R_{y1}(f) df}{\int_{-\infty}^{\infty} H(f)R_{yi}(f) df}$$

where $H(f)$ is the transfer function of the post-correlation filter or integrate and dump system.

$R_{yi}(f)$ is the Fourier transform of the correlation function between the receiver replica code and the i th signal.

$$R_{y1}(f) = \sum_{i=2}^k R_{yi}(f)$$

where $R_{yi}(f)$ is the Fourier transform of the correlation between the replica code and all the interferers, $r_{yi}(\tau)$.

The processing gain is then:

$$G_p = \frac{SNR_{output}}{SNR_{input}}$$

for an ideal system in which the noise figure of the receiver is zero.

The worst case output signal-to-noise ratio occurs when all the code delays, τ_i , of the i users with the receiver code are such that the area under the Fourier transform of the composite cross-correlation function, within the post-correlation filter bandwidth, is a maximum. This then maximizes the correlation noise at the receiver.

This is a much more reliable definition of processing gain for multi-user systems. However, all practical receivers introduce additional noise and another important parameter in a practical system is the jamming margin. This essentially gives information about the maximum level of noise that a typical system can operate with before circuit losses and non-linearities cause a reduction in the processing gain. Since this is determined by the dynamic range and noise figure of the receiver 'front end' and despreading mixer this is often a more important design consideration than the processing gain in a multi-access system. Another consequence of finite dynamic range and poor processing gain in a multi-user spread-spectrum system is the 'near-far' problem. This is effectively the swamping of the wanted channel by a very strong signal which blocks the weaker signals. To date, the only satisfactory suggestion⁷ for overcoming this problem is to use a cellular area coverage scheme in which base stations in the centre of each cell monitor the received signal of each transmission and then control the power of each transmitter so that the received powers of all incoming signals to the base station are equal. However, it is quite clear that it is not possible to have power control between mobiles, and thus the capability of the system reduces to one of mobile-to-base/base-to-mobile only, or mobile-to-mobile communication via the base station and subsequent retransmission. Practical means for implementing this power control have not previously been considered by other researchers, but they generally assume it to be a trivial matter! However, it is doubtful that power control may be regarded as a trivial matter.

Frequency-hopping spread-spectrum systems, which are a variant of the well-known m.f.s.k. systems, are much less prone to the near-far problem. Figures 2(a) and (b) illustrate a typical frequency-hopping transmitter

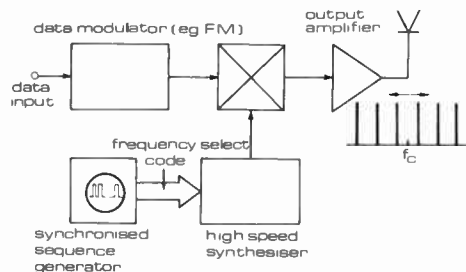
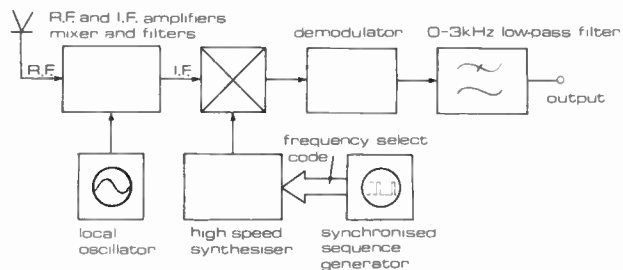

Fig. 2. (a) Typical frequency hopping transmitter.



(b) Typical frequency hopping receiver.

and receiver. Generally speaking, for multi-access use each user has a wide-range frequency synthesizer. The frequency generated at any instant from this synthesizer is determined by a digital code word. This can be generated as $2^n - 1$ different n -tuple words from the n parallel outputs of a maximal length sequence generator, for example. An identical synthesizer and code generator at the receiver are phase and frequency synchronized to the wanted channel. Thus the incoming signal, which has been suitably modulated by data (e.g. f.m.) can be mixed back to baseband or i.f. with a replica signal and the data recovered via a conventional demodulator and low-pass filter. As with direct-sequence systems, other channels may be coded via different sequences or via delaying and starting time of the common code by more than one bit for each user. This type of system is effective against c.w. (or jamming) interference, since if the system rapidly hops randomly between any of 1000 discrete frequencies, say, then the interference will only be effective for about $\frac{1}{1000}$ th of the time.

2 The Role of Spread-spectrum Systems in the Land Mobile Service

By comparison with conventional narrowband communication systems very little has been published on spread-spectrum communication systems, and even less has been published on the developments towards their practical implementation. However, several authors⁷⁻¹⁰ have illustrated the importance of spread-spectrum communications in the service of land mobile radio, and some^{7,8,11} have ventured to point out that such systems may actually be more efficient in spectrum utilization than conventional f.m. mobile radio systems.

These favourable comparisons were made on the basis that the design of land mobile radio systems is dominated by the need to re-use radio channels in adjacent areas to ensure maximum spectrum efficiency. The re-use distance between transmitters is limited primarily by co-channel interference under normal as well as anomalous propagation conditions, although adjacent channel interference may be a limiting factor when the e.r.p. of the transmitter is high and the out-of-band signal is also high.¹² Consequently, the assumption that narrowband systems are noise-limited rather than interference-limited does not hold when many

simultaneous transmissions are required in a given area on a limited number of frequency allocations. Cellular mobile radio area coverage schemes have been proposed^{13,14} which offer a greatly improved number of simultaneous users. These schemes, using arrays of small area cells, each with its own low-power transmitter base station, are ideally suited to the spread-spectrum philosophy, primarily because the 'near-far' problem associated with spread-spectrum systems effectively limits the maximum range of the transmitter. In the cellular schemes proposed each cell is allocated a set of frequencies which is different from the set of frequencies allocated to adjacent cells. Cells sufficiently far apart use the same set of frequencies. Conversations between mobiles in other cells are made between the base stations covering their respective cells, the base stations being interconnected via some other link, e.g. conventional telephone lines.

Cooper and Nettleton^{7,10} have pointed out that the adoption of frequency-hopping spread-spectrum modulation would result in considerably improved spectrum efficiency for such cellular schemes. This is primarily because spread-spectrum systems, which are to some extent interference-tolerant, do not suffer from co-channel interference from transmissions in other cells, and have a frequency diversity capability to minimize the effects of fading in urban environments. Furthermore, the 'graceful degradation' of the performance of the system as the number of simultaneous users exceeds the design value means that there is no hard limit on the numbers of active users that can be handled simultaneously by the system. Two other important factors are that since the spread-spectrum systems are co-channel users, they do not require channel changing facilities as the user moves from one cell to another, and they offer some measure of user security by virtue of their digital encoding. Despite this, however, because of the complexity of implementation such systems have largely remained theoretical exercises. In general, for normal area coverage schemes, spread-spectrum systems are not usually considered to be efficient from the standpoint of spectrum utilization.¹⁵

However, in the context of mobile radio there is a great advantage in adopting a spread-spectrum communication system, and this can actually yield spectrum

economies. These schemes utilize the interference rejection properties of direct-sequence spread-spectrum systems which enables them to be used on a non-interference basis with existing users sharing the same channel allocations. Because of the additional technological complexity, a band-sharing system such as this is only worthwhile if it yields relatively large amounts of bandwidth. It is apparent that one of the largest users of r.f. spectrum is the television broadcast channel, covering some 400 MHz of bandwidth in the v.h.f. and u.h.f. bands. For this reason it has been proposed^{16, 17, 18} that spread-spectrum transmissions could occupy the 'fallow' channels existing between the three main channels of the television broadcast transmissions in any geographical region, as illustrated in Fig. 3, since these bands contain very weak signals from distant television transmitters which are not used as part of the local broadcasting service and which are unlikely to cause interference to users of the spread-spectrum system.

Before such a system can be considered, assurances must be given that the spread-spectrum systems will not cause interference to local television broadcasts. This could happen when a mobile radio was transmitting in a geographic region distant from his base station where the normally fallow band of the user's base station centre frequency is actually occupied with a television signal in this particular region, or equally likely, co-channel interference occurs because of anomalous propagation conditions.

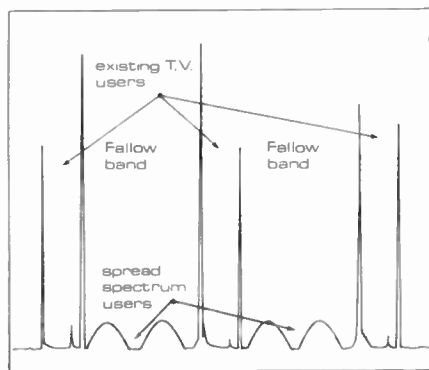

Fig. 3. Typical spectrum in the Bath area, with anticipated spread-spectrum users.

The purpose of this paper is to present evidence to show that such systems are perfectly feasible from the point of view of mutual non-interference operation of spread-spectrum systems with the television transmission and vice versa. From these results estimates of the protection margins required of the spread-spectrum systems to ensure perfect television reception will be given.

In the description of the system above the importance of perfect code synchronization was stressed. Because of the poor signal/noise ratio at the receiver input this is difficult to achieve and the acquisition time relatively long. In the mobile environment code synchronization is

further complicated by signal fading. As a consequence reception is significantly impaired as synchronization is constantly lost.

3 The Experimental System

Although systems have been proposed elsewhere^{19, 20} in which data is transmitted over the same bandwidth as the television broadcast by interweaving the data spectrum with the line spectrum of the video signal, such systems require accurate line and frame synchronization of the data encoder with the television transmission to prevent the data channel significantly interfering with the video channel. The interweaving of the data spectrum with the television spectrum is complicated by the 'ultra-fine-detail' line spectrum of the video signal, caused by the need to achieve frame synchronization, which is spaced at 12.5 Hz. To achieve a satisfactory data bit error rate under conditions of high television interference the data rate is much less than the frame rate. This would give a processing gain of the order 60 dB.

However, these systems are primarily 'add-on' systems giving extra capacity to the television broadcast system for subtitles or additional facsimile data transmissions, etc., and could not be easily extended to bandsharing for mobile radio use.

In the system proposed no such complex synchronization with the line and frame scan is necessary, although it is still vital to synchronize the receiver code to the received wanted code, and this makes the system much more viable for mobile radio use.

The spread-spectrum system on which the measurements described in this paper were taken was based on a direct-sequence system, using either a 255-bit maximal length sequence or a similar length Gold code. This bi-phase modulates a u.h.f. carrier which itself is frequency modulated by the 0.3 kHz baseband information with a deviation ratio of approximately 4, to give a total transmission bandwidth of 6.375 MHz.

An r.f. strip-line bandpass filter allows through only the main lobe of the $\left[\frac{\sin(\pi Af)}{\pi Af} \right]^2$ power spectrum

envelope to prevent excessive spectrum pollution. The television signal for quantitative measurements is derived from a u.h.f. PAL signal generator, and mutual coupling of this with the spread-spectrum transmission is achieved using wideband hybrid couplers. This ensures that the system is accurately simulated in the laboratory without actual broadband transmission. Alternatively, the subjective tests of the effect of spread-spectrum interference on an actual broadcast may be performed by coupling the spread-spectrum transmitter to the television antenna via a hybrid coupler, which ensures that the leakage power of the spread-spectrum signal re-transmitted via the television antenna is at least 45 dB below that entering the television receiver. Figure 4 illustrates the transmitter system used.

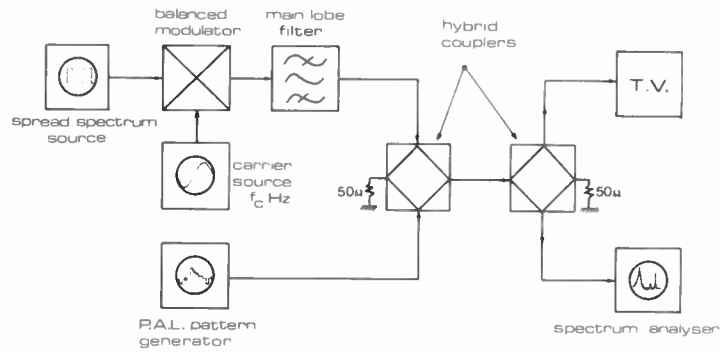

Fig. 4. System used for subjective interference tests.

The receiver, illustrated in Fig. 1(b), features r.f. and i.f. filtering to allow through either 100% or 60% of the transmitted main lobe power spectrum. The choice of 60% maximizes the improvement in the received s.n.r. with respect to very broadband noise by 1.8 dB¹ but causes additional distortion to the received coded signal, which reduces the correlation between the received coded signal and the replica code by 0.9 dB. Although this distortion may be removed when f.m. or digital data modulation methods are used by hard limiting the incoming signal, this too can cause a worsening of the s.n.r. at the output of the limiter by typically 1 dB for broadband Gaussian noise when the s.n.r. at the input to the limiter is 0 dB or worse.^{21,22} As a consequence the anticipated improvement of 1.8 dB because of 60% band limiting is not achieved in practice. In a practical system the theoretical 0.1 dB degradation in signal/noise performance by hard limiting is more than compensated by the use of binary logic circuits, thereby avoiding the deficiencies in the performance of analogue circuitry. However, some filtering is necessary to remove the large interfering signal powers containing in the television video carrier and sound channel and this contributes much to the system's processing gain. The synchronized replica code recovers the wanted signal from the television interference, or other users. This is the

frequency modulation signal at an i.f. of 30 kHz. After post-correlation filtering to remove the wideband interference, the f.m. signal is demodulated using a conventional phase-lock-loop demodulator.

Three techniques have been examined to synchronize the transmitter and receiver codes. All three use a delay lock loop within the receiver to achieve phase lock between the sequences.

In the basic system the frequency lock of the codes is achieved by locking both the transmitter and the receiver sequences to a universally available off-air frequency standard. In our case this is the 200 kHz Droitwich transmission. The delay-lock-loop then tracks the phase shifts due to the motion of the mobiles by controlling a voltage controlled delay with the filtered error signal, as shown in Fig. 5. This basic system and the three techniques associated with it will be discussed in a future paper.

Figure 6 shows the performance of the system in terms of the input and output signal-to-noise ratios for additive Gaussian broadband noise. The bandwidth of the input to the system was taken as 6.375 MHz, the bandwidth of the r.f. strip line receiver filter, whilst the bandwidth of the audio output channel was 3 kHz. These bandwidths were used in evaluating the total input and output noise powers. The degradation of the processing gain at low

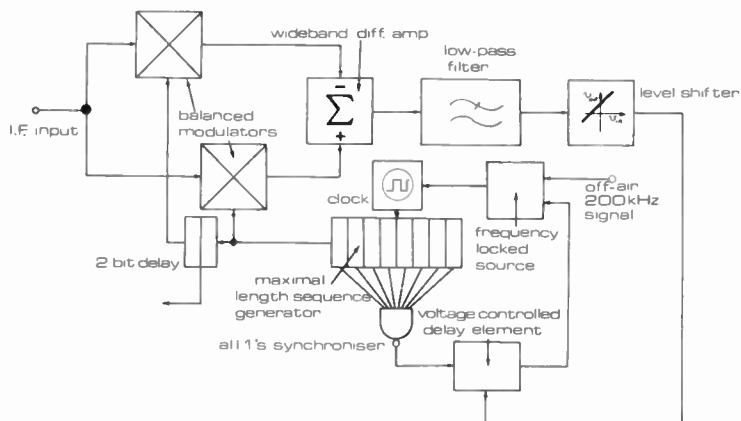

Fig. 5. The delay-lock loop circuit.

s.n.r. (less than 0 dB) due to the f.m. threshold is seen as the limiting factor in the f.m. spread-spectrum system. From this figure the process gain at 0 dB input s.n.r. is 30.5 dB. However, it should be pointed out that the input noise is measured at the receiver antenna and includes the noise figure of the u.h.f. amplifiers which contribute 8 dB to the input noise power for a power gain of 48 dB, consequently the process gain quoted is not representative of the spread/despread process, but of the entire system. In comparison with the noise figure of the r.f. amplifiers, the noise contribution from the mixers and despread multiplier contributed a negligible degradation to the overall process gain. Examination of the s.n.r. at the output of the post-correlation filter indicated that there was a negligible loss of processing gain over a 60 dB dynamic range.

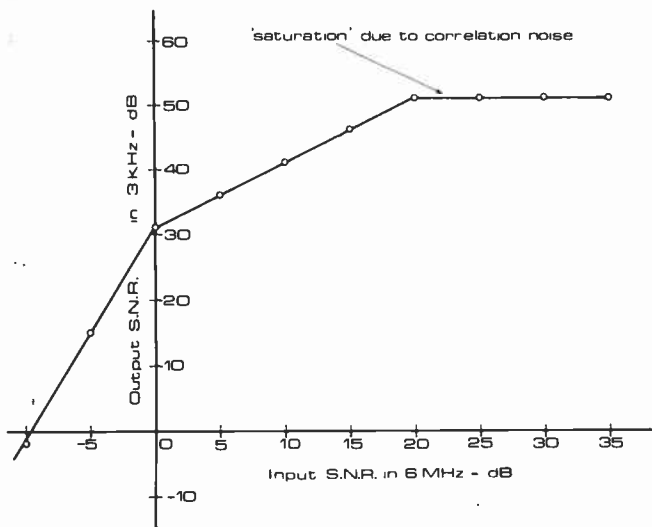

Fig. 6. Performance of system with Gaussian noise.

Gaussian white noise is not representative of the noise found for co-channel and multi-user operation, and to test the feasibility of the system under these conditions the noise source was replaced by several different maximal-length binary sequences each of 255 bits. Each of these, suitably frequency modulated with test data, was added in equal power to the wanted channel prior to transmission. The codes each ran at the same rate as the wanted channel. On the assumption that an output signal/interference ratio of 25 dB would be considered adequate, it was found that the maximum number of simultaneous users which could be tolerated by the system was only three. Reference to Fig. 6 reinforces this result. The reason for this very low figure can be accounted for by the poor cross-correlation performance of the codes used, which each had a measure of discrimination of 4. This has a two-fold effect. First, because the cross-correlation performance does not reject all the interference of the other channels significant noise levels are presented at the input of the f.m. demodulator, and secondly, since phase synchronization

of this system is maintained via a delay lock loop the poor cross-correlation with unwanted channels causes false locking and optimum correlation with the wanted channel cannot be maintained.

For the system described here the loss of process gain due to the receiver noise figure has in fact set the limit on the number of users possible, and choice of a better code would not result in an improvement in the number of users. It is clear from this result that in order to double the number of simultaneous users it would be necessary to significantly improve the noise figure of the r.f. amplifiers by a further 4 or 5 dB, before any improvements due to improved cross-correlation performance of the codes would result in an increase in the number of users. Whilst this is perfectly feasible, the system is unlikely to be cost effective for private mobile use.

At first sight these figures for the numbers of users are very low, however, it is interesting to note that Matthews *et al.*¹¹ have predicted theoretically that only just over 1 user/MHz may be expected for a narrowband f.m. spread spectrum system similar to the one we have described for an output SNR of 30 dB for a 3 kHz output bandwidth. For their model they assume a circular cellular array in which each base station can control the power of each user within the cell so that the received power levels may be equalized. It should also be pointed out that they assumed an ideal, lossless system in which the interference is purely random. This optimizes the cross-correlation performance and therefore maximizes the number of users for a given system.

However, to put the situation into perspective, Cooper and Nettleton⁷ point out that, because of the need to re-use frequencies, a conventional f.m. system used in a cellular array system may have as few as 0.1 users/MHz km² for a 1 km radius cell, and for normal mobile radio schemes a typical number of users may be approximately 1 user/MHz. As a consequence, this demonstrates that for a cellular scheme with power control, the spread-spectrum system can compete favourably with the f.m. system on a user density basis, and therefore this facet of the argument may be ignored when deciding which should be used. The special attributes of spread-spectrum systems described earlier may be an important factor in the ultimate choice.

4 Performance of the Spread-spectrum System over a Television Channel

It is anticipated that a multi-user spread-spectrum system would be operated within the 16 MHz wide fallow bands between television channels. This would appear to offer no advantage in terms of spectrum utilization over the use of conventional narrowband modulation schemes, also placed in the fallowbands. However, it is possible for a user to wander into a geographical region where that region's television

transmission is co-channel with his, thus causing perceptible interference, or it is equally possible that television interference may occur because of anomalous propagation conditions. Since any interference to the existing television user is totally unacceptable, the use of a spread-spectrum system, because of the improved protection ratio that it offers to the television, begins to look attractive. The adoption of such a system should result in a significant reduction in the interference range of the mobile transmitter. Conversely, this would significantly reduce the minimum distance which must exist between the television transmitter and the base station serving the mobile radio system.

Although it is obvious that the system should be two-fold compatible, in that the television should not cause unacceptable interference to the demodulated spread-spectrum signal, it is unlikely that both interference criteria will have to be met simultaneously, since the mobile and television areas do not overlap.

Before any estimates of the reduction of the interference range of the mobile transmitter relative to a narrowband system can be made, it is necessary to examine the effect of spread-spectrum signal interference on the television transmission. From this the protection ratio may be established and compared with the corresponding protection of a narrowband system.

As a basis for comparison, co-channel c.w. sinusoidal interference, and broadband Gaussian noise were used to obtain bounds on the protection margin of the television. Narrowband f.m., wideband f.m. and single-sideband modulation were used as direct comparisons for possible competitors of the spread-spectrum systems. In the latter cases, 0.3–3 kHz filtered Gaussian noise was used to represent the modulating speech source. Although it is appreciated that the statistics of the Gaussian noise and speech differ, it is felt that this should not have a

significant impact on the results. The c.w. interference was used to represent amplitude modulation, whilst the Gaussian noise represented the effect of a great many spread-spectrum users. The protection margin of the television for all types of interference was determined on the basis that subjectively there was *no* observable interference on the displayed signal. The results of these tests are summarized in Figs. 7 and 8.

In these figures the protection margin is defined as the ratio of the *total* television signal power received relative to the maximum total interference power allowed before any degradation is observed, and this is plotted as a function of the frequency offset of the centre frequency of the interference from the video carrier frequency. Although alternative definitions of protection ratio for television have been made,²³ in the context of this work the definition given above is the most suitable since we are considering mutual interference effects. Reasons for this choice of definition are discussed more fully in Ref. 18.

As might be expected, the results for the sinusoidal interference show that maximum protection must be given at the video carrier, colour sub-carrier and f.m. sound channel. If these interference bounds are exceeded, the c.w. interference causes the familiar moiré patterning. Figure 9 illustrates this phenomenon with the c.w. interference superimposed across the colour sub-carrier, as the r.f. spectrum associated with Fig. 9 shows. The pitch and degree of patterning are dependent upon the relative amplitude of the interference and its frequency offset from the television video carrier.

In contrast, broadband Gaussian noise superimposed over the television signal causes a 'snow' effect on the display when its protection margin is exceeded. Subjectively this type of interference is less disturbing to the viewer than moiré patterning. Because of the

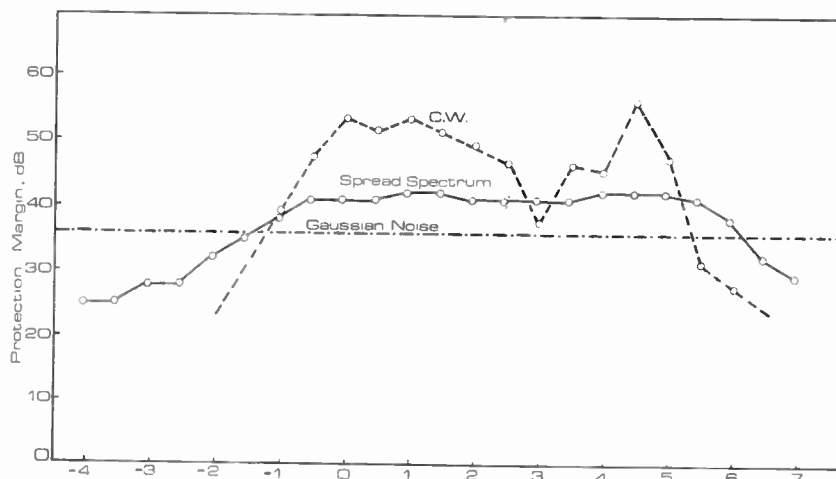

Fig. 7. Protection margin for non-visible interference to a colour television with (a) c.w., (b) spread spectrum and (c) Gaussian noise interference.

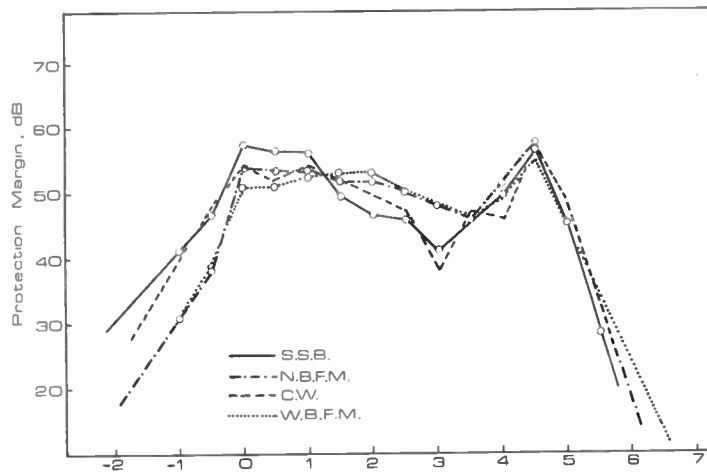

Fig. 8. Protection margin for non-visible interference to a colour television with C.W., S.S.B., W.B.F.M. and N.B.F.M. interference.

broadband nature of the interference, the total interference power averaged over the television bandwidth is 17.5 dB above the peak value for c.w. interference, before the interference is perceptible. The interference caused by the spread spectrum signals when above its protection margin, defined by Fig. 7, causes a more regularly patterned snow effect, shown in Fig. 10. This type of interference is also subjectively much better tolerated by the viewer than c.w. interference. From Fig. 10 it is also seen that the optimum protection margin occurs when the spread-spectrum system is centred in frequency directly over the television channel, due to the increased protection at the video carrier due to the sidelobe filtering of the spread-spectrum signal, but, as might be expected, does not fall as rapidly as the curve for the c.w. interference case because of the broadband

nature of the interference. It is also interesting to note that in terms of the total interference power the improvement in protection margin over that for c.w. interference is a minimum when the interference is approximately midband. The reason for this is that, for the clock rate employed, a significant number of frequency components in the spread-spectrum signal interfere with the colour subcarrier. This does not happen for c.w. or narrowband interference until the interference frequency corresponds within a narrowband of frequencies, to the colour subcarrier.

Figure 11 shows the variation in protection margin as a function of code length for spread-spectrum interference centred (a) directly over the video carrier, and (b) centred between the video carrier and f.m. sound channel, with the first null of the spread-spectrum signal

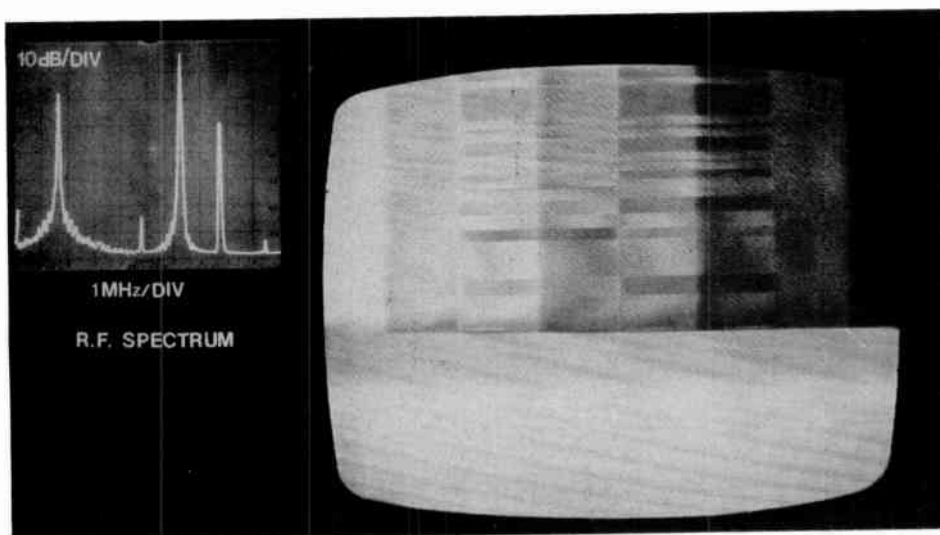

Fig. 9. Video output with sinusoidal interference directly on the colour sub-carrier.

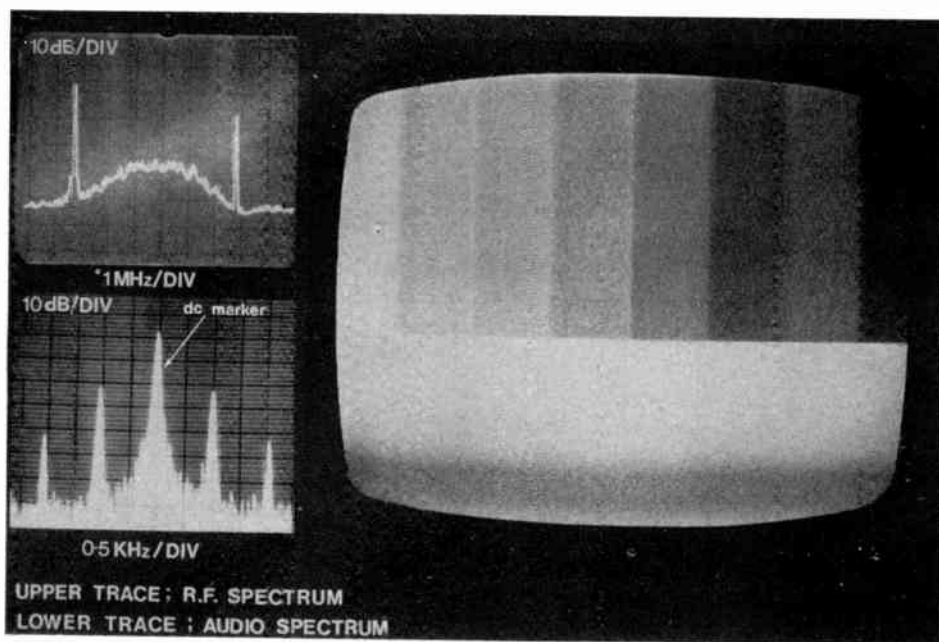

Fig. 10. Video output with spread-spectrum interference.

centred over the video carrier. For both measurements the spreading bandwidth was 6.375 MHz, as before. The results may be considered as sections taken through the protection margin measurements shown in Fig. 7. Both curves follow the same basic trend with increasing code length. This is not surprising, since they both represent the effect of spread-spectrum interference on (a) the video carrier, and (b) the colour sub-carrier, and the consequence of such interference might be expected to produce similar results for both carriers.

However, the results are interesting because they illustrate the changes in the threshold of perception of visual interference as the code length is increased. For code lengths of 63 bits or less the interference is primarily of the moiré type because of the relatively few number of

interfering frequency components within the television receiver bandwidth. For curve (a) this is manifest as primarily monochrome moiré, whilst for curve (b) the patterning is coloured. The distinct edges to this sort of patterning give rise to an easily discernible interference, irrespective of its colour, on the standard colour-bar test pattern obtained from the PAL generator.

As the code length, and hence the number of interfering frequency components, is allowed to increase the patterning becomes increasingly complex with much more diffuse edges. As a consequence the threshold of perception to the visual interference falls considerably. This is manifest by a reduction in the protection margin required by the television from the spread-spectrum interferer. It is instructive to note, however, that the

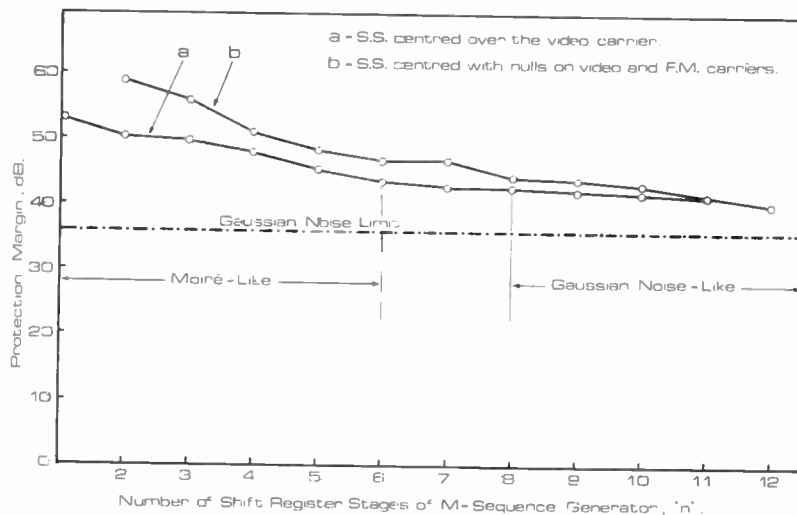

Fig. 11. Variation of protection margin as a function of M-sequence length. $2^n - 1$ bits.

threshold of perception to interference on the colour information channel on a colour television is higher for these short sequence lengths than for interference to the video carrier, illustrating the importance of the colour information.

For code lengths of 255 or greater the interference observed for test (a) and (b) is virtually identical to the 'snow' observed for Gaussian broadband interference. Again the perception of interference on the colour sub-carrier is higher than for the video carrier, but the difference becomes vanishingly small as the code length increases. Although it is clear from this figure that for sufficiently long codes (typically longer than 64 000 bits) the Gaussian noise limit is reached for both curves (a) and (b), there is only a limited improvement in protection margin by increasing code length much beyond 255 bits. This can be contrasted with the significant change in protection margin as the code length is shortened below 63 bits.

It should also be pointed out that the results are dependent upon the code clock frequency used.

For the choice of code lengths and bit rate stated the optimum improvement in protection margin relative to c.w. by adopting a spread-spectrum modulation scheme is 13 dB. Figure 8 shows the protection margins obtained for broadband and narrowband f.m., and also s.s.b. modulation. It is clear from a comparison with the c.w. protection margin results that there is very little difference in protection between these modulation schemes and c.w. interference. However, s.s.b. and

d.s.b.d.c. modulation schemes have the advantage that when unmodulated, unlike a.m. or f.m., they cause no interference and as competitors to spread-spectrum modulation are to be preferred.

Figure 12 illustrates the ability of the spread-spectrum system to reject television interference. This Figure shows the input r.f. spectrum to the spread-spectrum receiver and the resulting demodulated audio output for a spread-spectrum interference level just below the television protection range. The corresponding television display, also shown in this figure, is interference-free and the output from the spread-spectrum receiver shows an s.i.r. of 25 dB. It should be emphasized that under these conditions the delay lock loop synchronizer in the receiver maintains phase synchronization of the received signal and replica sequence.

The main point to note in the results is that, for the spread-spectrum system outlined, the protection margin afforded is 13 dB better than can be obtained for c.w. interference under worst case conditions, i.e. when the centre frequency is directly over the video carrier and colour sub-carrier, and marginally worse when centred directly between the carrier and f.m. sound channel. Limiting the spread-spectrum bandwidth to approximately 4 MHz to avoid interfering with the sub-carrier would remove this interference, but would also reduce the process gain of the system by approximately 1.8 dB. On the credit side, however, this would enable four spread-spectrum frequency allocations to be made within each fallow band.

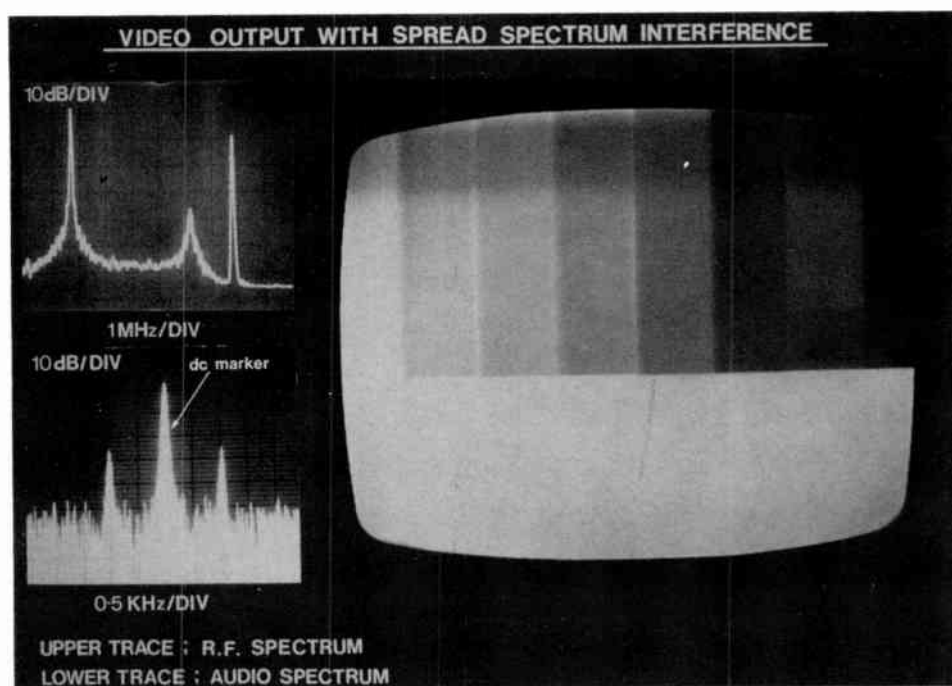

Fig. 12. Video output with spread-spectrum interference.

5 Conclusions

The results presented in this paper clearly illustrate the feasibility of using spread-spectrum systems on a non-interference basis within the television transmission bands. It is clear from the results that there is a 13 dB improvement in protection margin relative to c.w. interference when the interference is directly over a particular television video carrier. In a practical implementation this represents a reduction in adjacent channel interference. However, for pure co-channel interference there is little to be gained by way of improved protection. This is due primarily to the susceptibility of the television to interference at or near the colour sub-carrier frequency.

Under these latter conditions reception of the spread-spectrum signal is still possible, by virtue of the processing gain of the spread-spectrum receiver. However, for the system described, the protection margin is insufficient to give the spread-spectrum system any significant range, particularly when signal fading is taken into account. For this reason it is not envisaged that the system will be operated co-channel with the television.

Adoption of a spread-spectrum system for small-area cellular schemes in the television fallow bands, utilizing the improved protection margin against primarily adjacent channel interferers should open up a large amount of frequency spectrum for mobile radio use. Nevertheless, many practical problems still remain, and spread-spectrum systems cannot yet be regarded as the universal panacea to all private mobile radio problems!

6 References

- Dixon, R. C., 'Spread Spectrum Systems' (Wiley-Interscience, New York, 1976).
- Dixon, R. C. (Ed.), 'Spread Spectrum Techniques' (IEEE Press, New York, 1976).
- White, W. E. and Reddy, C. P., 'Continuous phase shift modulation saves power in spread-spectrum data comm', *Electron Design*, 25, December 6th, pp. 92-6, 1979.
- Golomb, S. W., 'Shift Register Sequences' (Holden-Day, San Francisco, 1967).
- Gold, R., 'Optimal binary sequences for spread spectrum multiplexing', *IEEE Trans. on Information Theory*, IT-13, pp. 619-21, 1967.
- Pursley, M. B., 'Evaluating performance of codes for spread-spectrum multiple-access communications', Proc. 12th Ann Allerton Conference on OCT and System Theory, Monticello, Illinois, pp. 765-74, 1974.
- Cooper, G. R. and Nettleton, R. W., 'A spread-spectrum technique for high capacity mobile communications', Proc. 27th Annual Vehicular Technology Conference, Orlando, Florida, pp. 98-103, 1977.
- Eckert, R. P. and Kelly, P. M., 'Implementing spread-spectrum technology in the land mobile radio service', *IEEE Trans. on Communications*, COM-25, no. 8, pp. 867-9, 1977.
- Miller, L. S. and Thompson, W., 'Use of pseudo-noise concepts in mobile communications', 'Signal Processing Methods for Radio Telephony', IEE Conf. Publication 64, pp. 150-9, 1970.
- Cooper, G. R. and Nettleton, R. W., 'Special efficiency of spread spectrum land mobile communication systems', Proc. IntelCOM '79 Exposition, Dallas, Texas, pp. 267-70, 1979.
- Matthews, P. A., Bajwa, A. S. and Drury, D., 'Spread spectrum signalling in land mobile radio systems', 'Land Mobile Radio', IERE Conference Proceedings no. 44, pp. 319-24, 1979.
- Gosling, W., 'A simple mathematical model of co-channel and adjacent channel interference in land mobile radio', *The Radio and Electronic Engineer*, 48, no. 12, pp. 619-22, December 1978.
- Young, W. R., 'Advanced mobile 'phone service: introduction, background, and objectives', *Bell Syst. Tech. J.*, 58, no. 1, pp. 1-14, 1979.
- MacDonald, V. H., 'The cellular concept', *ibid.*, pp. 15-41.
- Berry, L. A. and Haakinson, E. J., 'Spectrum Efficiency for Multiple Independent Spread-Spectrum Land Mobile Radio Systems', NTIA Report 78-11, No. PB291539, 1978.
- Ormondroyd, R. F., 'Spread spectrum communication in the land mobile service', Proc. COM '78 Conference, Birmingham, pp. 156-62, 1978.
- Kochevar, H. J., 'Spread spectrum multiple access communications experiment through a satellite', *IEEE Trans. on Communications*, COM-25, no. 8, pp. 853-6, 1977.
- Juroshek, J. R., 'A Preliminary Estimate of the Effects of Spread Spectrum Interference on TV', NTIA Report No. 78-6, 1978.
- Szepanski, W., 'Compatibility problems in add-on data transmission for tv channels', Conference Proceedings on 2nd Symposium and Technical Exhibition on Electromagnetic Compatibility, Montreux, pp. 263-8, 1977.
- King, P. T., 'A novel television add-on data communication system', *J. Soc. Mot. Pict. Telev. Engrs*, 83, pp. 10-13, January 1974.
- Sevy, J. L., 'The effect of multiple cw and fm signals passed through a hard limiter or twt', *IEEE Trans. on Communications Technology*, COM-14, no. 5, pp. 568-78, 1966.
- Anderson, D. R. and Wintz, P.A., 'Analysis of a spread-spectrum multiple access system with a hard limiter', *IEEE Trans. on Communication Technology*, COM-17, no. 2, pp. 285-90, 1969.
- Green, R., Ali Zaid, M. A. M. and Gardiner, J. G., 'Signal/noise performance evaluation for colour-television picture sources', *Proc. Instn Elect. Engrs*, 125, no. 11, pp. 1195-8, 1978.

Manuscript first received by the Institution in June 1979 and in final form on 13th March 1980.

(Paper No. 1952/Comm 213)

Modelling the digital magnetic recording behaviour of shielded magneto-resistive replay heads with displaced elements

BARRY K. MIDDLETON,

B.Sc., Ph.D., M.Inst.P., C.Eng., M.I.E.E.*

SUMMARY

This paper is concerned with shielded magneto-resistive replay head structures in which the sensitive magneto-resistive elements are displaced to be either nearer to one shield than the other or deep into the gap between the shields. These structures are analysed experimentally using a resistive paper analogue and theoretically using standard potential theory. It is found that 'sideways' displacement of the element has the effect of causing asymmetry in replayed pulse shapes, the amount of asymmetry decreasing with increasing head-to-medium separation. Shifting of the elements back into the gap is shown to result in significant reductions in signal amplitude but only minor increases in pulse width. Theory and experiment show reasonable agreement.

* Department of Electrical and Electronic Engineering, Manchester Polytechnic, John Dalton Faculty of Technology, Chester Street, Manchester M1 5GD.

1 Introduction

Shielded magneto-resistive replay heads have been under study for some time in view of their potential applications in high-density digital magnetic recording. Much work has been published describing experiments carried out on actual recording heads and on theoretical analyses of their performance. In the latter case, Cole *et al.*¹ gave details of rigorous micromagnetic computations of the output pulses replayed from digital recording media by heads with shields of infinite dimensions. These results have been augmented by the more recent computations of Kelley and Ketcham² who were concerned with heads having finite shields. Both sets of results were obtained using complex numerical computations to give numerical data outputs. In contrast Potter³ suggested the use of potential theory whereby analytical methods could be used for predicting replay performance. However, the use of potential theory, in the way suggested by Potter,³ required the questionable assumption^{1,3} that the surfaces of the heads were equipotentials but, nevertheless, led to predictions in good agreement with precise numerical computations.¹ Therefore the use of potential theory is somewhat justified by experience.

Potter's³ use of potential theory was to describe the behaviour of a head with magneto-resistive element placed symmetrically between the shields. Davies and Middleton⁴ developed this line of work to analyse the same structure and one with a magneto-resistive element recessed into the gap between the shields. The application of potential theory led to the use by Middleton *et al.*⁵ of a 'resistive paper' analogue for predicting the performance of a number of magneto-resistive head structures. The latter work gave confirmation of the earlier mentioned theory^{3,4} and qualitative agreement with the work of Kelley and Ketcham² concerning heads with finite shields. There remains much work to be done on the type of head structures likely to be produced in laboratory and production situations where magneto-resistive elements are displaced either from the symmetry position of midway between the shields or back into the gap between the shields. These structures are shown diagrammatically in Fig. 1(a) and 1(b).

In this work the original potential theory^{3,4} is developed in such a way as to apply to the new situations, shown in Fig. 1, and the predictions are compared with the results obtained from measurements on a resistive paper analogue. In all cases recording tapes are assumed to be thin, to have unit relative permeability, and to contain only components of magnetization parallel to their planes: normal components have been assumed to be excluded by the high demagnetizing factor in that direction. The heads have all been assumed to have shields of infinite extent although, in principle, shields of finite length, i.e. those

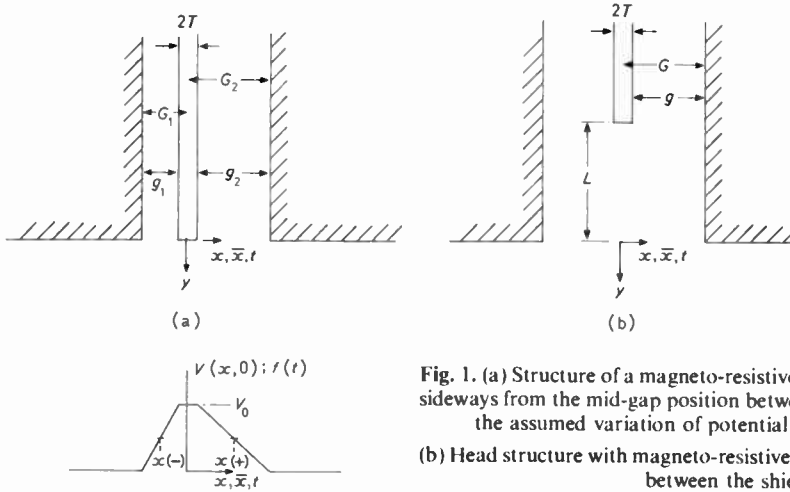

Fig. 1. (a) Structure of a magneto-resistive head with element displaced sideways from the mid-gap position between the shields. Also shown is the assumed variation of potential along the $y = 0$ plane. (b) Head structure with magneto-resistive element recessed into the gap between the shields.

with outer edges not too distant from their magneto-resistive elements, could also be treated at the expense of additional complexity.

2 Theory

It has been shown that if the potential variation along the $y = 0$ plane (see Fig. 1) is given by $f(t)$ then the potential $V(x, y)$ at a point (x, y) is given by^{4,5,6}

$$V(x, y) = \frac{y}{\pi} \int_{-x}^{+x} \frac{f(t)}{y^2 + (t-x)^2} dt. \tag{1}$$

If a step magnetization transition from $-M_r$ to $+M_r$ in a thin recording medium of thickness c passes at a separation $y = d$ from the head then the output voltage provided by the head is^{4,5}

$$e(\bar{x}) = K2M_r c V(\bar{x}, d) \tag{2}$$

where K is a suitable constant of proportionality. Further, if the medium contains a transition of arctangent form, with transition width parameter a , the output voltage would be^{4,5}

$$e(\bar{x}) = K2M_r c V(\bar{x}, d+a). \tag{3}$$

With reference to equations (3) and (1) it is apparent that output voltages are a reflection of the potential variations below the head. These voltages can be determined either by measurements of $V(x, y)$ on a head or its analogue, and interpreting y as $(d+a)$, or by computing or assuming a suitable form for $f(t)$ and evaluating equation (1). Both of these processes will be carried out in this work.

2.1 Asymmetric Head

Consider the geometry shown in Fig. 1(a) where, using equations (1) and (3), the output voltage can be defined

by the formula^{4,5}

$$e(\bar{x}) = K \frac{2M_r c}{\pi} \int_{-\infty}^{+\infty} \frac{f(t)(d+a)}{(d+a)^2 + (t-\bar{x})^2} dt. \tag{4}$$

Supposing that the potential distribution along the plane $y = 0$ has the linearized variation shown in Fig. 1(a), then equation (4) can be used to show that the output voltage is, after some manipulation, given by

$$e(\bar{x}) = K \frac{2M_r c V_0}{\pi} \left[\int_{-g_1/2}^{g_1/2} \arctan \left(\frac{-t + T + \frac{1}{2}g_1 + \bar{x}}{d+a} \right) \frac{1}{g_1} dt + \int_{-g_2/2}^{g_2/2} \arctan \left(\frac{t + T + \frac{1}{2}g_2 - \bar{x}}{d+a} \right) \frac{1}{g_2} dt \right]. \tag{5}$$

When the integrals in equation (5) are evaluated the result is

$$e(\bar{x}) = K \frac{2M_r c V_0}{\pi} \left[\left(\frac{d+a}{g_1} \right) \left\{ f \left(\frac{g_1 + T + \bar{x}}{d+a} \right) - f \left(\frac{T + \bar{x}}{d+a} \right) \right\} + \left(\frac{d+a}{g_2} \right) \left\{ f \left(\frac{g_2 + T - \bar{x}}{d+a} \right) - f \left(\frac{T - \bar{x}}{d+a} \right) \right\} \right] \tag{6a}$$

where

$$f(X) = X \arctan X - \frac{1}{2} \ln (1 + X^2). \tag{6b}$$

Pulse amplitudes and pulse widths can only be determined numerically from equation (6) because of its complexity. The reason for this is that the pulses display significant asymmetry and that determination of the value of \bar{x} at which the peak occurs is not a simple analytical matter. Nevertheless the peak pulse amplitude differs little from the amplitude of the pulse at $\bar{x} = 0$ and so equation (6) with $\bar{x} = 0$ can be used as a reasonable approximation.

However, as a means of simplification, equation (5) can be treated in a similar manner to the way in which

the case of the symmetrical head was treated by Davies and Middleton.⁴ The result is then

$$e(\bar{x}) \simeq K \frac{2M_r c V_0}{\pi} \left\{ \arctan \left(\frac{T + \frac{1}{2}g_1 + \bar{x}}{d+a} \right) + \arctan \left(\frac{T + \frac{1}{2}g_2 - \bar{x}}{d+a} \right) \right\}. \quad (7)$$

This pulse has a peak occurring at

$$\bar{x} = \frac{g_2}{4} - \frac{g_1}{4} \quad (8)$$

and corresponding pulse amplitude of

$$e \left(\frac{g_2}{4} - \frac{g_1}{4} \right) = K \frac{4M_r c V_0}{\pi} \arctan \left(\frac{T + \frac{1}{4}g_1 + \frac{1}{4}g_2}{d+a} \right). \quad (9)$$

On the way to determining pulse width it is easy, using equations (9) and (7), to show that the values of \bar{x} at which the voltage falls to 50% of its peak amplitude are given by

$$\bar{x}(\pm) = \left(\frac{g_2}{4} - \frac{g_1}{4} \right) \pm \frac{1}{2} \left[\left(\frac{g_2}{2} - \frac{g_1}{2} \right)^2 + 4(d+a)^2 + 4 \left(T + \frac{g_1}{2} \right) \left(T + \frac{g_2}{2} \right) \right]^{\frac{1}{2}}. \quad (10)$$

Consequently pulse width at 50% of peak amplitude is given by

$$P_{50} \simeq \bar{x}(+) - \bar{x}(-) = \left[\left(\frac{g_2}{2} - \frac{g_1}{2} \right)^2 + 4(d+a)^2 + 4 \left(T + \frac{g_1}{2} \right) \left(T + \frac{g_2}{2} \right) \right]^{\frac{1}{2}}. \quad (11)$$

Equation (10) is also useful in that it gives information about pulse asymmetry. A measure of the latter, used later in this paper, is $-\bar{x}(-)/\bar{x}(+)$.

These various formulae derived here will be used for comparison with experimental results at a later stage of this work. But before then it is noted that all the above formulae reduce to those expected for the corresponding symmetrical head^{3,4} upon setting $g_1 = g_2$.

2.2. Symmetric Head with Recessed Element

In this geometry shown in Fig. 1 (b) the magneto-resistive element is displaced a distance L into the gap between the shields. The solution of Laplace's equation for the potential $U(x, y)$ in the region $-G \leq x \leq +G$, $-L \leq y \leq 0$ is⁴

$$U(x, y) = \sum_{n=1}^{\infty} [A_n \exp(-k_n y) + B_n \exp(k_n y)] \cos k_n x \quad (12a)$$

where

$$k_n = (2n-1) \frac{\pi}{2G}. \quad (12b)$$

Making the reasonable assumption that the $n = 1$ term makes a dominating contribution to the form of equation (12a) and that the amplitude of the same term decreases as y increases, then $U(x, y)$ will be given approximately by

$$U(x, y) \simeq A_1 \exp(-\pi y/2G) \cos \pi x/2G. \quad (13)$$

To satisfy the condition $U(0, -L) = V_0$ it must be that

$$A_1 \simeq V_0 \exp(-\pi L/2G)$$

and so

$$U(x, y) \simeq V_0 \exp(-\pi(L+y)/2G) \cos(\pi x/2G). \quad (14)$$

Therefore for the purposes of determining output voltages using equation (4) it can be deduced from equation (14) that

$$f(t) \simeq V_0 e^{-\pi L/2G} \cos(\pi t/2G) \quad (15)$$

and consequently using equation (4) it can be seen that

$$e(\bar{x}) \simeq K \frac{2M_r c}{\pi} V_0 \exp(-\pi L/2G) \times \int_{-G}^G \cos \left(\frac{\pi t}{2G} \right) \frac{(d+a)}{(d+a)^2 + (t-\bar{x})^2} dt. \quad (16)$$

The above equation has been used for the numerical computation of output voltage waveforms which will be discussed later. However, an approximation to the pulse width at 50% of peak voltage amplitude has been suggested to be⁴

$$P_{50} = 2 \left[(d+a)^2 + \left(\frac{2g}{3} + \frac{2T}{3} \right)^2 \right]^{\frac{1}{2}}. \quad (17)$$

This will also be used later.

3 Experimental Results

Experimental results were obtained from an analogue⁵ prepared by applying conducting paint to resistive paper to form the shield and element structures shown in

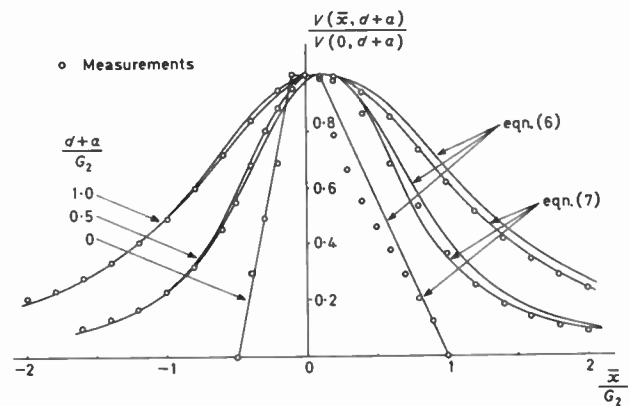

Fig. 2. Measurements on an asymmetric head structure of pulse shapes for various reduced head-to-tape separations. These are compared with the theoretical predictions obtained using equations (6) and (7).

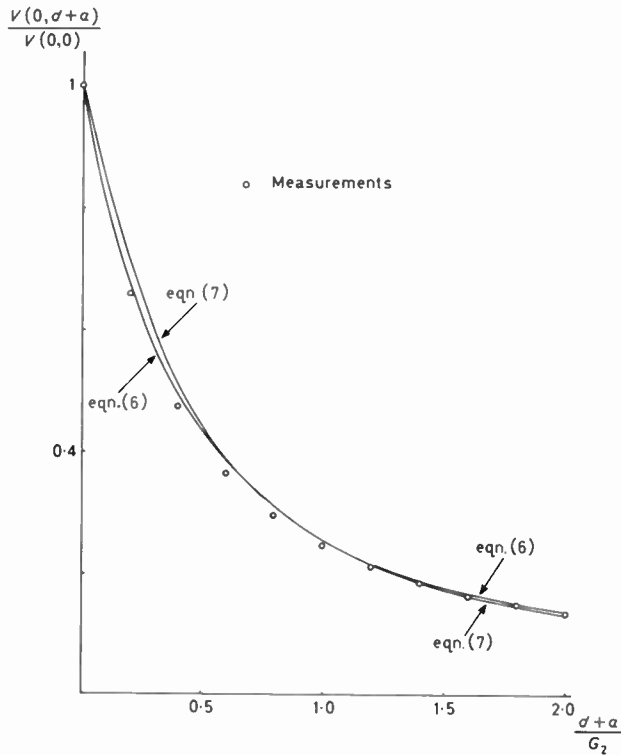

Fig. 3. Measurements on an asymmetric head structure of reduced pulse amplitude as a function of reduced head-to-medium separation. The theoretical curves are derived using equations (6) and (7).

Fig. 1. The shields were maintained at earth potential and the magneto-resistive elements at 10 volts. A digital voltmeter was used for taking readings of potential at various points in the (x, y) plane, and, as indicated by

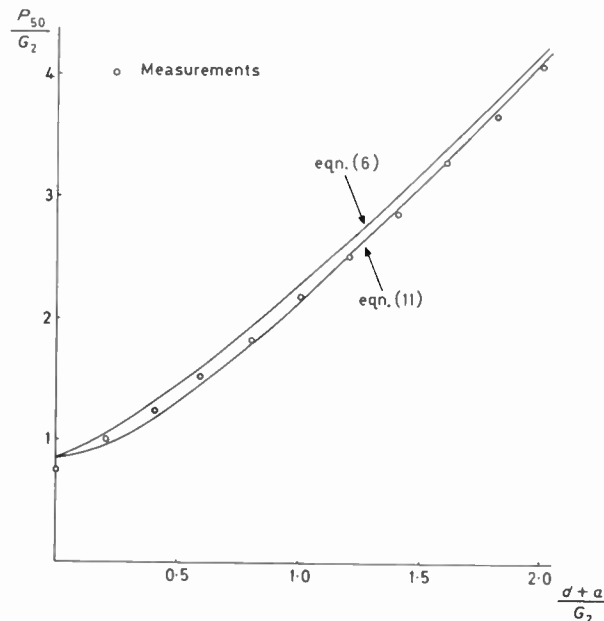

Fig. 4. Measurements of reduced pulse width as a function of reduced separation for an asymmetric head structure. Theoretical curves were obtained using equations (6) and (11).

equations (2) and (3) the resultant information can be directly interpreted in terms of output voltages.

3.1 Asymmetric Head

In the analogue it was arranged that $G_1 = 2.5$ cm, $G_2 = 5$ cm, $2T = 1$ cm and all other dimensions were much larger than those quoted. Variations of potential as a function of \bar{x}/G_2 , for different values of reduced separation $(d+a)/G_2$, are plotted in Fig. 2. For each separation the potentials are normalized with respect to pulse amplitude. These results are compared with the predictions of equations (6) and (7), whereupon it can be seen that reasonable agreement between theory and experiment has been obtained. The cause of any measure of disagreement between theory and experiment can be related to the divergence between assumed linear variation of potential along the $y = 0$ plane and the actual variation.

Close inspection of Fig. 2 shows definite pulse asymmetry with the pulses displaced to the right of $\bar{x} = 0$, although the pulse amplitudes are almost insignificantly higher than the outputs at $\bar{x} = 0$. The voltage magnitude at $\bar{x} = 0$ is plotted as a function of reduced separation $(d+a)/G_2$ in Fig. 3. The results, normalized so that $V(0, 0) = 1$, are compared with the predictions of equations (6) and (7): again reasonable correlation is observed.

Figure 4 shows measurements of reduced pulse width as a function of reduced separation. The theoretical pulse widths have been obtained numerically from equation (6) and also from the simple but approximate equation (11). The convenience and accuracy of the latter formula is clearly demonstrated.

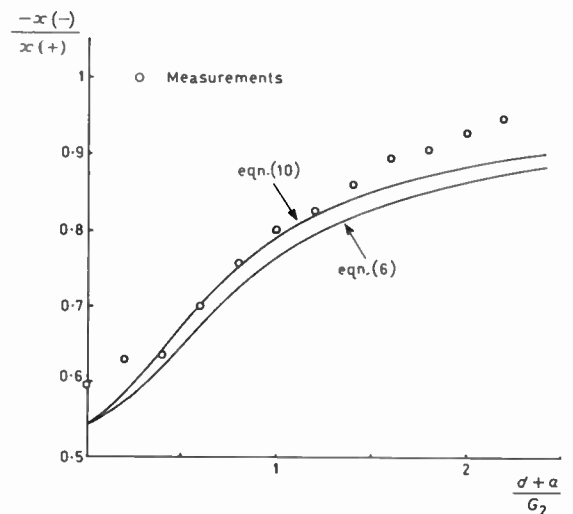

Fig. 5. Pulse asymmetry in the asymmetric head structure, defined in the text as $-x(-)/x(+)$ as a function of reduced separation. The points represent experimental results while the lines are theoretical results derived using equations (6) and (10).

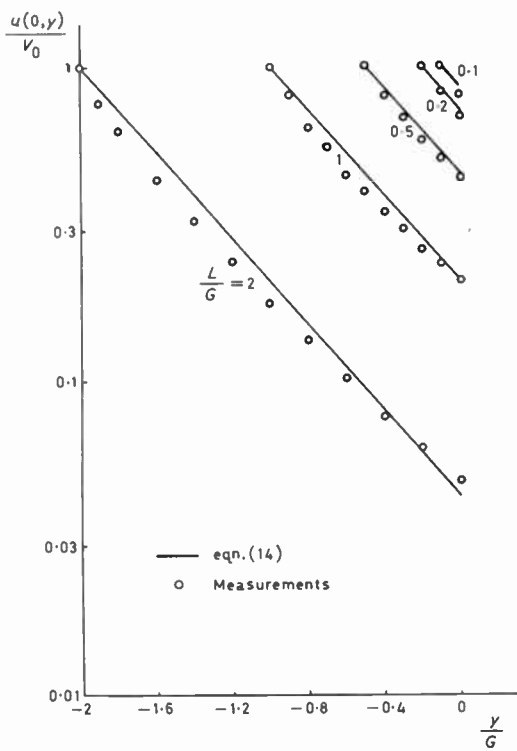

Fig. 6. Variation of reduced potential in the region of recessed magneto-resistive elements. Results have been obtained for a number of displacements L of the magneto-resistive element and the lines represent the predictions of equation (14).

As a measure of the asymmetry of the pulses, $-x(-)/x(+)$, defined earlier, is plotted in Fig. 5, as a function of reduced separation. The results are compared with predictions obtained numerically from equation (6) and the simpler approximation of equation (10). Both curves diverge from experimental results at $(d+a) = 0$, where the initial assumption of the form of $f(t)$ is at fault. Nevertheless broad agreement between theory and experiment is obtained and the value of the approximate formulation demonstrated.

3.2 Recessed Head

One consequence of recessing the element by a distance L , as shown in Fig. 1(b), is to reduce the potential in the region $-L < y < 0$. It was suggested that the potential in this region might be approximated by equation (14). Consequently, graphs have been plotted of $U(0, y)$ as a function of y/G in Fig. 6. The straight lines represent the predictions of equation (14) and the measure of their agreement with the observations gives some backing to the approximations made in the analysis. The important consequence of this is that voltage amplitude at $y = 0$ should be exponentially related to the distance L . Figure 7 shows the corresponding experimental results and the prediction of equation (15); there is obviously good agreement between theory and experiment.

For a recessed element with $L/G = 2$ the pulse shapes

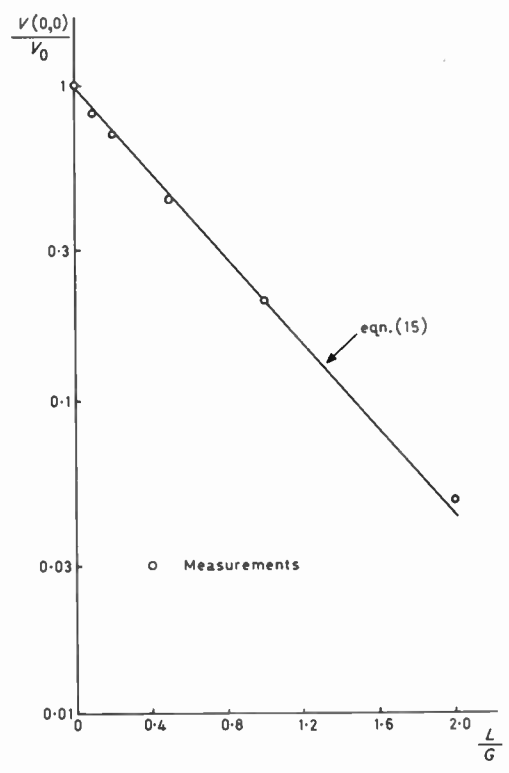

Fig. 7. The variation of potential at the point $(0, 0)$ as a function of reduced values of L , the distance by which the element is recessed. The full line is the prediction of equation (15).

at different reduced separations are plotted in Fig. 8; all curves are normalized to the amplitudes at $x = 0$. The prediction of equation (15) that the potential along the

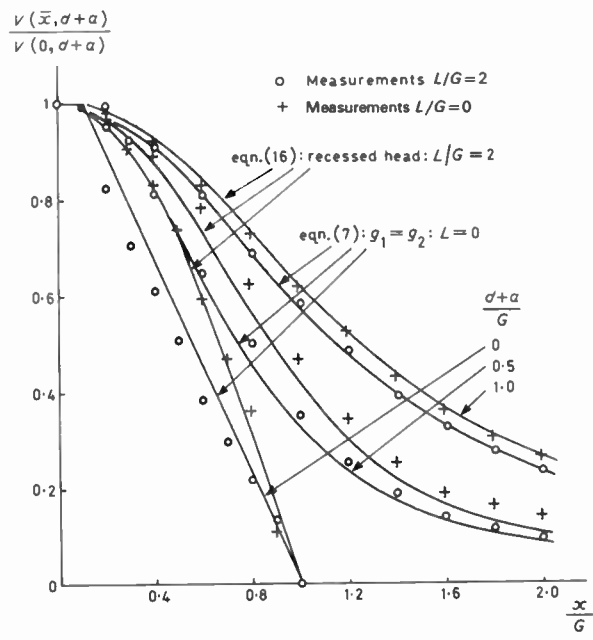

Fig. 8. Pulse shapes obtained for a head with element recessed by an amount $L/G = 2$. Graphs are plotted for various reduced head to tape separations. The theoretical curves are derived from equation (16), for a recessed element, and for comparison from equation (7) for a non-recessed element.

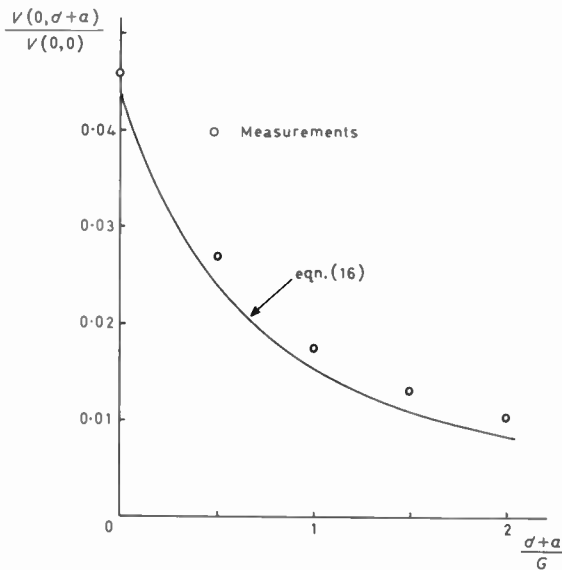

Fig. 9. Reduced pulse amplitude plotted as a function of reduced separation for a head with element recessed by $L/G = 2$. The theoretical curve is derived from equation (16).

$y = 0$ plane follows a cosine function is upheld. Using this variation in equation (16) the pulse shapes at other values of separation have been computed and are plotted, also in Fig. 8. These results are shown in comparison with those obtained for a 'flush' head, i.e. one in which $L = 0$. The theory for the latter being taken from equation (7) with $g_1 = g_2$.

Pulse amplitude, as a function of reduced separation, is plotted in Fig. 9, along with the predicted variation produced by numerical integration using equation (16). Except for a slight shift in the theoretical curve, due to the exponential part of equation (16), there is good

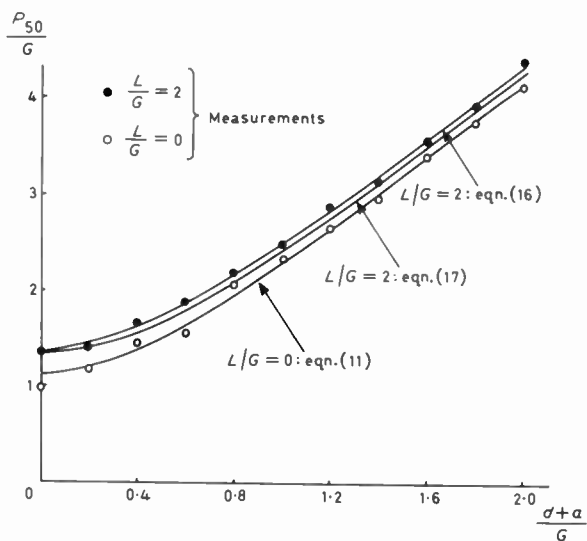

Fig. 10. Measured and theoretical pulse widths obtained for heads with $L/G = 0$ and $L/G = 2$. Wider pulses are obtained for the recessed element head. Equation (11) is used for predicting pulse width for the flush head while equations (16) and (17) are used for the recessed head.

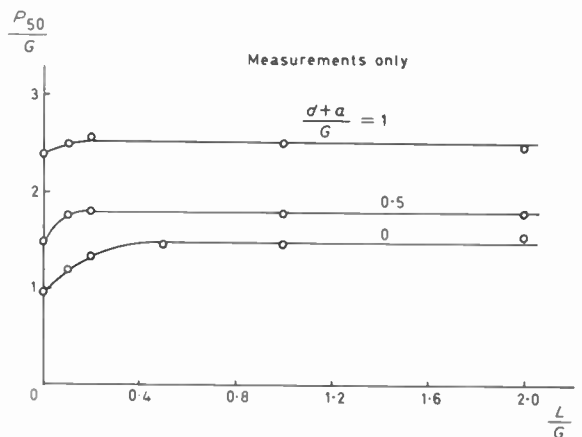

Fig. 11. Reduced pulse width as a function of distance by which the element is recessed.

general agreement between theory and experiment. Theoretical and experiential pulse widths, for heads with $L/G = 0$ and $L/G = 2$, are plotted in Fig. 10 as a function of reduced separation. Clearly recessing the magneto-resistive element widens pulses. The equations used for the theoretical curves are (11) for the flush head, and (16), with numerical computation, and the approximation (17) for the recessed head. The usefulness of equation (17) is clearly demonstrated. Finally, pulse width is plotted as a function of L/G in Fig. 11. This shows that the slight increase of pulse width caused by the recessing of the elements comes about for small displacements of the magneto-resistive element and that large displacements cause little further widening of pulses.

4 Conclusions

The performance of magneto-resistive replay heads having displaced elements has been modelled using an electrical analogue technique and theoretically. In general, the two methods have produced results which agree closely and which could be used, with appropriate modification, for the investigation of other head structures. With the theoretical results the advantages of using certain simplified formulae have been demonstrated.

In particular, it has been shown that asymmetrical heads cause asymmetry in replayed pulses but that this asymmetry decreases with increasing head-to-medium separation. It has also been shown that displacing the magneto-resistive element deep into the gap of the heads causes a significant loss pulse amplitude but only a slight increase of pulse width.

In working systems it could be envisaged that pulse asymmetry may have a significant role where differentiating and cross-over detection circuits are used to detect pulse peaks while wear on heads might cause recessing of elements.

5 Acknowledgment

Thanks are due to A. V. Davies for helpful discussions during the course of this work.

6 References

- 1 Cole, R. W., Potter, R. I., Lin, C. C., Deckert, K. L. and Valstyn, E. P., 'Numerical analysis of the shielded magneto-resistive head', *IBM J. Res. Dev.*, **18**, pp. 551-5, November 1974.
- 2 Kelley, G. V. and Ketcham, R. A., 'An analysis of the effect of shield length on the performance of magneto-resistive heads', *IEEE Trans. Magnetics*, **MAG-14**, no. 5, pp. 515-7, September 1978.
- 3 Potter, R. I., 'Digital magnetic recording theory', *IEEE Trans.*, **MAG-10**, no. 3, pp. 502-8, September 1974.

- 4 Davies, A. V. and Middleton, B. K., 'The resolution of vertical magneto-resistive readout heads', *IEEE Trans.*, **MAG-11**, no. 6, pp. 1689-91, November 1975.
- 5 Middleton, B. K., Davies, A. V. and Sansom, D. J., 'The modelling of magneto-resistive replay head performance', Conference on Video and Data Recording, IERE Conf. Proc. No. 43, pp. 353-63, July 1979.
(Note that in conclusion (a) and in the text of this paper it was stated inadvertently that recessed elements caused a narrowing of pulses, whereas it had, in fact, been shown that a widening had been both observed and predicted.)
- 6 Karlqvist, O., 'Calculation of the magnetic field in the ferromagnetic layer of a magnetic drum', *Trans. Roy. Inst., Stockholm*, **86**, pp. 3-27, 1954.

Manuscript first received by the Institution on 28th November 1979 and in final form on 21st February 1980. (Paper No. 1951/CC 331)

BOOK REVIEW

Frequency Engineering in Mobile Radio Bands

WILLIAM M. PANNELL (*Consultant, Pye Telecommunications*). Granta Technical Editions, Cambridge, 1979. 24 × 18 cm. 353 pages. £25.00.

CONTENTS: The frequency planning tree. Basic rules of land mobile radio frequency planning. The use of the radio channel. Single-frequency versus two-frequency channel allocations. The problems of mixing single and two-frequency operation in single and multiple-user systems. Types of system normally encountered. Preferred frequency bands. Sharing of mobile radio bands with other services. The effect of antenna height and transmitter power. Block allocations within the permitted frequency spectrum. Separation of private and public service blocks. Sub-dividing blocks into individual channels. Large user requirements. Spectrum economy by range restriction.

Channel occupancy. The use of tone squelch in shared systems. Operation of mobile radio systems over radio links. Frequency planning of radio link systems. Acceptable system degradation limits. Equipment specifications. Records. Monitoring of the spectrum. Operators' instruction book.

Published to coincide with the WARC 79 report and inevitable revision of frequency bands currently used in the mobile radio service, this book seeks to guide those responsible for frequency planning. The reader is given a good insight into the problems and techniques of frequency allocation from the global situation to individual assignments. Attention is drawn to methods for maximizing spectrum usage in increasingly crowded bands, with particular reference to multiple user sites, intermodulation products, and splitband working.

Produced in association with Pye Telecommunications, the book comprises mainly appendices drawn largely from in-house technical notes; not surprisingly the overall result is somewhat disjointed with diagrams and calculations at times inadequately explained.

This book is a reflection of past practices, and present current UK methods and equipment specifications as models for the future. It fails to look forward and discuss seriously the implications on frequency allocations of current developments, for example v.h.f. s.s.b. systems or the widespread use of data transmission; either could be as important a factor in spectrum economy as is minimizing intermodulation products. Instead, a future with a.m. and 12.5 kHz or narrower channel spacing appears to be recommended.

J. A. SHORT

Standard Frequency Transmissions

Communication from the National Physical Laboratory

Relative Phase Readings in Microseconds NPL—Station
(Readings at 1500 UTC)

MAY 1980	MSF 60 kHz	GBR 16 kHz	Droitwich 200 kHz	MAY 1980	MSF 60 kHz	GBR 16 kHz	Droitwich 200 kHz
1	1.4	19.8	18.3	17	1.5	20.2	17.6
2	1.5	20.7	18.3	18	1.5	20.0	17.5
3	1.4	21.1	18.2	19	1.5	20.7	17.4
4	1.5	20.2	18.2	20	1.6	22.2	17.3
5	1.5	20.2	18.1	21	1.7	21.2	17.2
6	1.7	20.7	18.1	22	1.8	20.5	17.1
7	1.7	20.7	18.1	23	1.9	21.1	17.1
8	1.7	20.6	18.1	24	1.8	21.0	17.0
9	1.7	20.2	18.1	25	1.8	21.0	17.0
10	1.5	20.6	18.1	26	1.8	21.5	16.9
11	1.4	20.1	18.1	27	1.8		16.9
12	1.3	20.0	18.0	28	1.8	20.9	16.8
13	1.5	20.2	17.9	29	1.8	20.9	16.8
14	1.6	20.4	17.8	30	1.8	20.7	16.8
15	1.6	20.7	17.7	31	1.8	20.4	16.8
16	1.5	20.2	17.7				

Notes: (a) Relative to UTC scale ($UTC_{NPL} - \text{Station}$) = +10 at 1500 UTC, 1st January 1977.
(b) The convention followed is that a decrease in phase reading represents an increase in frequency.
(c) 1 μ s represents a frequency change of 1 part in 10^{11} per day.

Contributors to this issue*

Stan Hill joined Post Office Telecommunications as Youth-in-Training and gained experience on telephone and telegraph exchange maintenance and construction. He served two years in the Royal Corps of Signals and returned to Post Office Telecommunications to work on microwave radio link planning, studies in electrical interference to cable networks from electrified railways and high voltage power lines. This was followed by a three-year sojourn with the Ministry of Posts and Telecommunications and in 1974 he joined the Post Office North Sea Task Force.



Barry Middleton received a B.Sc. degree in physics from Sheffield University in 1962 and a Ph.D. from Salford University in 1970. Between 1962 and 1966 he worked for International Computers and Tabulators at Stevenage on magnetic recording and computer storage devices and in 1966 he joined the Department of Pure and Applied Physics of Salford University to study hard and soft magnetic materials for various computer storage applications. Since receiving his appointment as a Senior Lecturer at Manchester Polytechnic in 1972, Dr Middleton has been carrying out research on magnetic recording mechanisms and the properties of bubble domains.



Richard Ormondroyd received the B.Eng. degree in electronic and electrical engineering from the University of Sheffield in 1971 and in 1975 he was awarded a doctorate from the same University for research studies into the a.c. and d.c. electrical properties of amorphous chalcogenide threshold switches. In 1975 he was appointed as a Lecturer in the School of Electrical Engineering, University of Bath. Currently his main research interests are the application of spread-spectrum techniques to land mobile radio and band-sharing for improved spectrum usage.



Michael Shipton received the B.Sc. degree in electrical and electronic engineering from the University of Bath in 1977. After graduating he remained at the University and is currently working for his Ph.D. degree on spread-spectrum communications. He is supported by the Science Research Council.



Tilak Arthanayake graduated from the University of Ceylon in Sri Lanka in 1960. He joined the microwave development laboratories of Standard Telephones and Cables in the United Kingdom in 1961 and subsequently moved to Standard Telecommunication Laboratories. In February 1977 he joined Marconi Communication Systems where he is attached to the Space System Studies Group. His experience and contributions include microwave communication systems development and interference studies.



Contributors to the July issue

David Cree graduated in electrical engineering in 1965 as an external student of London University, having completed a student apprenticeship with AEI (Rugby). He subsequently worked in the fields of medical and industrial electronics, joining the Research and Development Division of British Railways Board in 1970. Mr Cree has worked on train control and communications and he is now a Senior Principal Scientific Officer leading a radio communications team at the Railway Technical Centre, Derby.



Alan Whittaker commenced a Post Office Student Apprenticeship in 1968 and went on to receive a B.Eng. degree in Electronic Engineering from the University of Sheffield in 1972. He was subsequently employed in the Post Office Maritime Satellite Systems Group, where he worked on analogue and digital speech processing and modulation methods. In 1974 Mr Whittaker joined the Research and Development Division of British Railways Board and has been involved with all aspects of mobile radio systems. He is now a Senior Scientific Officer working on microprocessor applications in mobile radio.

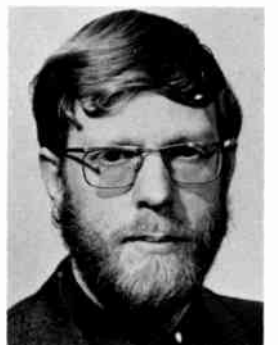

* See also page 389.