

Founded 1925

Incorporated
by Royal Charter 1961

*To promote the advancement
of radio, electronics and kindred
subjects by the exchange of
information in these branches
of engineering*

Volume 50 No. 1/2

January/February 1980

The Radio and Electronic Engineer

The Journal of the Institution of Electronic and Radio Engineers

Electronics—A Profession in its Golden Age

The Presidential Address of

PROFESSOR WILLIAM GOSLING

B.Sc., A.R.C.S., C.Eng., F.I.E.E., F.I.E.R.E.

Delivered after the Annual General Meeting of the Institution in London on 25th October 1979

You have done me the incomparable honour of electing me to the Presidency of our Institution at a very special time in its history. It is special for two reasons. One is more immediate: you could call it a tactical matter. The other has implications in the much longer term, the strategy of the thing.

At the tactical level, the Institution is now preparing itself to respond to the report of the Committee of Inquiry into the Engineering Profession, under Sir Monty Finniston. During the period of the Committee's deliberations, many rumours have inevitably circulated about the nature and likely outcome of its work, and doubtless most of them have been wide of the mark. We are fortunate that a group of people of great distinction could be found, willing to devote so much energy and dedication to their task, the importance of which could hardly be overstated.

For some time, indeed for a generation and more, the feeling had been growing that something was wrong in British engineering. It was not that great feats of engineering were not still being performed, or that great volumes of less spectacular but vital engineering at a more routine level were not being carried forward by competent and reasonably well qualified engineers. Yet still, all was not well, and disquiet grew.

The poor return, in industrial growth, for a substantial national investment in university level education attracted attention. It seemed that the immediate post-war belief in greatly augmented expenditure on higher education in science and engineering as automatically

leading to industrial prosperity was altogether naïve. Throughout the post-expansion period in the Universities and Polytechnics there were empty science and engineering places. The young people of the late 'fifties through to the early 'seventies exhibited a continuing and seemingly stable tendency to read anything but engineering for their degrees. This was the era of great growth in the social sciences, unchecked because of the almost universally held post-Robbins conviction that young people must be allowed to read for their degrees whatever they in their wisdom chose, and that the national need was too difficult to measure for there to be any way in which it could be reflected in a policy for undergraduate recruitment. So there were empty places in the Engineering Schools and entry standards sagged ever lower.

At the same time even those engineers who did graduate often chose either to emigrate or to seek posts in Government service or education, rather than go into industry. What few industry got—and perhaps they were not always the pick of the output—all too often gave their employers little cause for satisfaction. Stringent criticisms of engineering curricula, and of the poor quality of engineering graduates, compared with their French and German counterparts, became commonplace, and were heard in very high places. Conscious of the cost of the university and polytechnic system as a whole—and even today we are sometimes told that we have the most expensive system in the world—few were aware that comparing the cost of a newly-qualified

British B.Sc. with a German Diplom Ingenieur or his equivalent elsewhere, the UK system was investing far less resources into producing its engineers than other developed countries. No doubt the British academic did his best in the three years available to him, against the five or more in many other countries, but he could not work miracles. Indeed, since the universities and polytechnics insisted on paying exactly the same salary to engineering lecturers (who could, if they were good, earn more in industry or government service) as they paid to the lecturer in philosophy or sociology, whose profession made him largely unemployable outside Academe, it was not even clear that the engineering teachers were the best of their kind. This was a part of the price of opting for our traditional broad universities, with the scientists on tap (as the comfortable saying then was) but not on top, in contrast to the great technical universities of continental Europe.

The trouble was dimly perceived by many, clearly by some. Successive Governments founded first the Colleges of Advanced Technology, later the Polytechnics. In both cases it was not long before the Faculty of Arts moved in and the game was lost. Vested interests, a misconceived notion of fair play, the Robbins principle, and an irresistible urge to save pennies where they could be shaken out, combined to ensure that we did not achieve the great technological institutions that we needed. The CATs did at least start out in the right direction but did not get the resources and the support needed to make them an elite. Strongly entrenched in the British establishment was the conviction that such was the rightful role only of Cambridge and Oxford, the latter with fourteen professors of history and one of engineering. 'We don't mind which University a man comes from,' said a senior civil servant in a memorable phrase, 'they are both quite good'.

The logic that modern technological societies create wealth by industry, and that industry prospers only if certain conditions are met, could have been accepted. The notion that one of those conditions is a supply of appropriately trained and educated engineers and technicians would perhaps also have been conceded to be true. However, that to meet this condition would be costly in money and would involve the creation of new and prestigious institutions was accepted neither by the Left, who rejected the implication of elitism, nor by the Right, who feared an erosion of traditional values and attitudes. In the end the CATs ran for cover into University status and the proponents of the Polytechnics were reduced to selling their ideas on the grounds that they could do all that the Universities did, but cheaper. A couplet by Ezra Pound comes to mind:

Leucis, who intended a Grand Passion,
Ends with a willingness-to-oblige.

It was a situation in which nobody could win, and nobody did. At the same time the ordinary engineer in practice came to realize that his professional status in no

way compared with that of colleagues in continental countries, of whose lives he became more aware as we moved towards EEC membership. Suddenly the status of the engineer became a matter of concern, at least to engineers. Alarming—and to be frank, not always very accurate—comparisons were drawn between the public standing of lawyers and doctors, and the position of our own profession. The hard fact that by continental educational standards there scarcely were any engineers of the upper echelon in Britain was brushed aside, and it was widely concluded that the reason for the low status of engineering was its disunity.

The diagnosis was seductive, because it seemed to admit of easy, fairly cheap and painless solution. Engineers looked at the powerful British Medical Association and decided that here was the key to medical prestige and influence—could not the Engineering Institutions become somewhat the same? The argument seemed convincing but was flawed at many points.

First, engineering is, in fact, more diverse than medicine, because doctors, however varied their specialisms, have one object for their attention, the human being. By contrast, an electronic engineer and, say, a municipal engineer have almost nothing in common but the name. The science that they deploy will be entirely different, as will their employment situation, the criteria of success and failure applied to them, even the means by which they communicate their professional decisions to those who will carry them out. The point is too obvious and too well known to be further laboured. We speak, habitually, of the engineering profession, but we must always remember that it is a profession inescapably characterized by plurality and diversity: it can never therefore be monolithic.

Secondly, the BMA is, in some respects, much more of a trade union than the Royal Charter of the Engineering Institutions would ever allow them to be. Like all trade unions, it therefore has the real power that flows from ability, in the extreme, to call for a withdrawal of labour or other sanctions. For this a monolithic structure is of great advantage. By contrast, the Engineering Institutions have literally no power of compulsion at all over society at large (although they may have influence), so that for them the impulse to joint action is far weaker. There have been those willing to argue that the Institutions should become trade unions, but this ignores the fact that not one but several trade unions exist already to serve the needs of professional engineers, who nevertheless, except in certain particular areas of employment, have traditionally shown little inclination to join them.

Even so, the feeling that some greater unity would be in the profession's interest carried the day and resulted in the setting up of the Confederation (later the Council) of Engineering Institutions. From the beginning, and despite the efforts of its staff and officers, who served it in a dedicated fashion and on the basis of the highest

possible motivations, the CEI has repeatedly been criticized from many quarters and has not succeeded in satisfying the high hopes which brought it into being. In particular it has not been able to speak as the authentic voice of the profession, finding it difficult to react unitedly and speedily to almost any national situation, and it has been forever rent with internal dissension. Such collective policies as it has managed to evolve have often looked like grey compromises rather than brilliant initiatives, frequently reached too late and at the cost of yet more internal ill feeling. The culmination of it all was the notice of intention to withdraw given by the Institution of Electrical Engineers, which seemed to suggest that CEI might be about to fall apart.

On the principle that if a plant is not growing well it is best to dig it up and examine its roots, a revision of CEI was put in hand, which in the end resulted in the addition of a certain number of directly elected Council members. When the elections were held the number of Chartered Engineers prepared to cast their votes was quite derisory. Clearly if this reform was intended to make CEI more representative of engineers at large it had signally failed. However, by the time the elections were held, events had already moved on: as a result of the general disquiet about the state of UK engineering the Finiston inquiry was already in being.

All the great institutions of society are rightly subjected, from time to time, to a process of outside review. Habitual patterns do indeed become ill-suited to changing times, and for a variety of reasons reconstruction from within does not always prove to be possible. Clearly for engineering this is our present position, and we are fortunate that we now have the impulse from without that we so clearly need. We will not necessarily agree with every detail of the outcome of the inquiry—to be mortal is to be fallible, and it may be that some of the Committee's conclusions and recommendations seem better founded than others. However, as a profession we would be foolish indeed if we did not approach the Committee's report in the most sympathetic and open-minded spirit. It will help us to do so if we are fairly clear-eyed about the realities of our situation.

For sure, nothing that could conceivably have come out of this inquiry will overnight change the whole status and remuneration of engineers. Maybe if engineers could be organized into a tight and monolithic union, and if they exploited their power ruthlessly and without regard for others, a change of that magnitude could be achieved. So far, however, engineers have for the most part not shown that willingness to unionize themselves, nor yet to their credit the extreme degree of ruthlessness and militancy. We may be sure that what they have not been prepared to organize themselves for and force from society, they will not be given unasked, from some kind of altruistic recognition of merit. We do not live in that kind of world.

However, equally, those who exercise power in our land need not hope that they can create an engineering profession adequate to the needs of our society at trifling cost and without substantial remaking of the customary fabric of British life. To be effective we need—and urgently—an elite corps of engineers, particularly electronic engineers, who will be as able, perhaps abler, than any others in the world. To induce the most talented people to seek such a life, society will need to use the only inducements which have ever been known to work, namely honour, prestige and wealth. They will also need a good 'second division' of supporting engineers, of technician engineers and technicians. At each level of employment the appropriate rewards—tangible and intangible—to secure the quality and numbers to meet our social needs must be forthcoming. Such things are not achieved cheaply, but only by the diversion of resources in the appropriate direction. Since the wealth of society cannot immediately increase, even with the most favourable industrial policies, we are faced with a stark logic. If we need better engineers, more able to facilitate the creation of wealth by industry, we must make that career more attractive to the ablest of our children. To do that the rewards must be markedly improved. But if the very best engineers grow richer, everybody else, including all the other engineers, the trade union members and the arts graduates, must for a time see their prosperity grow less rapidly than would otherwise have been the case. This is a high hurdle for us all to get over, particularly in a society largely run by a collusion of arts graduates and trade unions, which has developed a marked predilection for living on its seed corn.

There are a lot of convenient ways of dodging this hard question. Should you be on the left wing of politics, then for you egalitarianism constitutes a primary consideration. The emergence of highly rewarded elite groups is considered socially undesirable in itself. If we are to have outstanding engineers they must be motivated, in this view, by altruism. If that will not work—and all the historical evidence screams that it will not—then the true egalitarian will argue, even if with some reluctance, that a poor but equal society is better than a wealthy unequal one. It is as if the sufferings of the poor in nineteenth-century capitalism, which were indeed an accusation against humanity, have been so traumatic in their psychological consequences and have so scarred the liberal imagination that the possibility that some degree of social inequality is unavoidable for effective social function cannot be entertained.

One of the more engaging fantasies that Karl Marx allowed himself was that specialization of labour—expertise—would one day fade away. It has not proved so. The day has not dawned, and will never dawn, when one can drive a locomotive today, be a brain surgeon tomorrow, and an electronic engineer the day after. Work, in our society, is becoming more differentiated,

not less so, and expertise more intense. Because we are not, over our lifetimes, consistently driven by pure altruism, it follows that for the more taxing, difficult and important specialisms sufficient additional rewards must be given to elicit the number and quality of recruits that are needed. The alternative is a progressive national impoverishment and ultimately the egalitarianism of the poor-house.

On the political right, the excuse for inaction is that if society needs these things the workings of the market economy will provide them. The first point to be made is that in an economy such as ours where the State takes more than half of the total wealth generated and spends it in accordance with political decisions, the market economy probably no longer exists. However, secondly, and much more importantly, we are talking about the human stock of our society and that is slow to change. If you fail to reward engineers, relative to the levels which would produce a stable supply acceptable in quality and number, or if you educate and train them inadequately relative to the technology of the society in which they will operate, you may have thirty years before your folly becomes manifest.

Equally, if you should learn the error of your ways, it could be decades before the contrary policy generates enough additional wealth to become self-sustaining through market forces. The time-scales are too long for entrepreneurs, perhaps—and this is our great danger—for politicians. Control engineers will be familiar with the likely consequences of naïve efforts to regulate a system of this kind: attempts to ‘sharpen up’ market forces, for example by monetarist policies, will only raise the loop gain and make instability more certain. We are therefore in no position to adopt a ‘hands off’ tactic.

In England our national policy towards engineering was manifestly wrong by the second half of the nineteenth century, as Playfair pointed out at the time. Overconfident of our dominance in industrial matters, which a generation earlier had been absolute, we did not develop the educational or social institutions to bring on a class of highly respected professional engineers comparable to that which developed in Germany and other European countries. For a generation thereafter we went on having our triumphs, but it was an Indian summer, and now we feel the frost.

Perhaps no disaster which can befall a people is sadder than to be the centre of an empire based on trade. The greatest such empire that the world has ever seen—the Arab empire which extended from France to Indonesia—on its collapse reduced the Arab people to a pitiable state from which only in our own time are they beginning to recover. Similarly, the British Empire was a disaster for us, if a lesser one by virtue of its shorter duration. The ruling people of an empire learn to live not by making things which sell in the free market, but by the arts of diplomacy and government, by talk. If they make things at all, they are likely to be goods which only those

will buy who must. And if it all depends on trade, woe betide, for the terms and technology of trade are as changeable as the face of the sea.

This curse was laid on us. It gave us, for a time, great wealth, but it left us, in the end, with all too many obsolescent industries, grown fat and slow on captive markets, no proper scientifically-based system of engineering education, and the deeply-held conviction that law, politics and government service were the proper professions for the ablest. To the English ruling class it was a natural transition from being the squirearchy of a rural England to performing the same function on a world scale for the Empire. It confirmed them in the belief that the proper education of a gentleman was one that fitted him for such a role. Today we are left with a situation in which we encourage, treat as prestigious, and most highly reward talents and skills that cannot earn our living and bid fair to be our curse. Chesterton described the consequences:

They have given us into the hand of new unhappy Lords,
Lords without anger and honour, who dare not carry their
swords.

They fight by shuffling papers; they have bright dead alien
eyes;

They look at our labour and laughter as a tired man looks at
flies.

From this morass the blind operation of market forces will not save us. Our situation is bad, some would say critical, and perhaps we are like the man who has sunk already so far into the swamp that he knows that there is no hope for him, gives up his struggles and composes himself for his end. Perhaps, but I do not think so.

Seen in the perspective of our situation, to demand the means of salvation from the Finiston Committee is to ask more, far more, than they could reasonably be expected to give. Nevertheless, the deliberations of that Committee have been an indication that we battle on, not yet having surrendered to our fear. It is a sign of hope, and one among others, for there is energy yet in our country and we are stirring. As always, the young are showing us the way, with the swing to hard science and engineering in University and Polytechnic recruitment which is becoming ever more manifest. This is the best of news for the future, and we must not fail to provide these admirable young people with the educational opportunities which they are now seeking.

Indeed, I suspect that the whole emotional climate of our country may be about to change. The establishment of the Fellowship of Engineering demonstrates a willingness—at last—to give acclaim to distinguished engineers. It recognizes that they are not the same as scientists (even if some rare spirits combine the talents), that their criteria of excellence are different, and that they should be independently rewarded. CEI, despite its chequered story to date, may yet find itself, even if, perhaps, in a form changed beyond recognition. History may record its birth as marking the faltering emergence

of a collective recognition that engineering is an important, perhaps indeed the most important, instrument of social change and welfare. We know not the springs and wells of social motivation from whence customary attitudes derive, or what the means by which they are changed, but change they do. Great nations have their times of optimism, when all seems possible for them. Equally they have their times of despair. No social mood is permanent, neither the best nor the worst. We have had our bad times, but I believe that in England the first beginnings are perceptible of that lifting of hope which has for so long seemed to be denied us. In saying so I am, of course, moving away from the tactical factors which make this epoch special for us, towards the strategic.

In the longer sweep of time, thinking on the scale of human generations rather than years or decades, the suspicion hardens that the present is very special indeed, a time unique in the whole history of our race, formative, crucial, and so definitive in its impact on the human story that the future is unlikely to hold anything quite to compare with it. We are living in an era when a change is overtaking technology more bizarre than anything our forefathers could have dreamed of, a change which, had it been described to them, they would have ridiculed as impossible, even absurd. This is the unforeseen moment in history when the machines began to think.

Our colleagues in the other Institutions created the first Industrial Revolution of the nineteenth century. The Civil Engineers built the roads, railways and canals which were to be the infrastructure of the new industrial society. The Mechanical Engineers, supported by the Metallurgists, made the new productive machines which filled the factories, the locomotives which vivified the railways, and later the new ships, road vehicles and aircraft on which the modern world depends. All the other engineering disciplines also made their contribution. Last in time, the Electrical Engineers added to all the rest a universal and instantaneous power source of the greatest flexibility and the most revolutionary impact. We can still sense, across the years, the excitement of it: a sudden access of technological virtuosity which in a couple of generations converted a traditional, largely agricultural, society into the modern developed world with its unprecedented wealth, transformed life-style, and capacity to satisfy the needs and wants of its members beyond, far beyond, anything previously known. The new developed societies were better able to safeguard their people against natural disaster and had an access of military power, consequent upon their technological advances, which made them totally invulnerable, except to each other. It has recently become fashionable to see most clearly the follies and failings of this age, looking back to an imagined pre-industrial society in a blissful equilibrium with the natural world. No image of the past can be more false, for not since the human race left the gathering of fruits

from the trees to become the most successful predator that history has ever seen, has any such mystical simplicity existed. Agriculture was itself one of our great technological achievements, the second, after the evolution of the weapons that made us such bloody and successful hunters and fighters.

The engineers are those most centrally concerned with what is archetypically human, for Man is distinguished from the apes first, best and above all by being the technological animal. Unequipped with fang or claw, it is with weapons of our own devising that we became natural history's bloodiest and most effective predator. The evolution of weapons for hunting and war was our first technology: it remains our obsession to this day. Our second was agriculture, achieved hundreds of generations later. There is nothing at all natural about it. From the spade to the plough, the breeding of draught and stock animals, the evolution of crop plants: it is all a most fascinating technology, the wedding of skills part mechanical and part biological, which we in this country have now carried as far as any people in the world. Every other technology that we have evolved—windmills, water power, steam, the internal combustion engine, flight, chemical technology, the computer—all have been harnessed, according to their utility, to this, our second great technological preoccupation, and before long you will see robots working in our fields. Romantics who dream the impossible dream of returning to a simple peasant rural economy—a dream which the Khmer Rouge of Cambodia have recently acted out as an incredibly bloody nightmare—may believe that they are escaping from technology: actually they are only returning to a more primitive form of it. There is no escape, for we cannot escape what we are. Technology is the obsession of our species.

In point of truth, the Industrial Revolution has enabled more people to survive, more to be adequately fed, clothed, housed, has prolonged lives and more widely distributed education, culture and the arts both high and low, than a thousand years of subsistence agriculture was ever able to do. A price has been paid, to be sure, and for some a heavy one, but had we known precisely the gain and loss in advance of the game beginning, no question but that we would have picked up our hand and played. Yet, although this profound transformation which our grandfathers and their fathers wrought should be seen as a great advance, a great liberation, a precious blessing, yet still it was flawed.

The machines of the nineteenth and early twentieth century were relatively simple. They greatly enhanced human ability to apply mechanical power, not only in sheer brute force terms, but also in delicacy and speed of operation. However, they were mindless, and incapable of any but the simplest patterns of action except under human supervision. They could not, other than in the most primitive ways, sense and react to the universe around them. Thus the machines of this era could

substitute for human muscle and fibre, but not for brain. As a consequence there was born an unnatural partnership between man and machine, a symbiosis, which was to be the hallmark of that era of industrial development. The age of the machine minder had begun.

Worse, because the fluency of that phase of engineering was far below present levels, the machines could not be adapted very well to those who operated them; instead, the workers of the day were the unfortunates who were obliged to adapt to the machines. The early telegraph operators learnt the codes which suited the primitive transmission technology of the day, the train driver manipulated hard-to-manage controls on an uncomfortable swaying footplate, the factory operative endlessly repeated routine movements and made over and over again trivial decisions needed in the production process, all because the machines could not then be made any better. That was technology as it was, and it produced a whole culture in which men and women seemed to be slaves to machines rather than the reverse. This was technology in its primitive childhood, but now technology is coming to childhood's end.

What has happened in our day is so incredible that even we who are directly concerned find it hard to come to terms with the reality. Electronics began with the technology of vacuum valves, large, fragile and power hungry. Who could then have foretold that within half a century, after having given birth to a revolution of intercontinental communications, to radio and television broadcasting, instrumentation and control of breathtaking sophistication, and last, most incredible of all the first computers, the valves would themselves be so quickly overtaken by a new technology, more potent yet? For in solid-state electronic devices, and the microelectronics revolution to which they have given birth, we now have the capacity, for the first time in human history, to create artefacts of more than biological complexity, and from materials that are literally as common as dirt. So armed we can equip our machines to perceive, calculate, make logical decisions, and act upon their conclusions. They have senses and memory.

If we sometimes hesitate to ascribe to them the power of thought, it is because we recognize that these electronic brains, which we have created, certainly do not think at all as we do. Their virtues are coincident with our weaknesses, and we are strong where they fumble. They think faster than us, do not forget as we forget, and tolerate the endless repetition which would bore us beyond bearing. Yet they cannot create, originate, invent as we can, do not know pleasure, cannot fall in love, or philosophize on their mortality. They are motiveless.

We have not created an intelligence to rival ours, but another brand of intelligence altogether, as different as metal and crystal is from flesh and blood. Yet the intelligence that we have created is exactly right for our

machines. If we can build a robot around a microcomputer mind, we do not need, as in the past we needed, to make human beings behave in our industrial processes as if they were themselves robots.

The first Industrial Revolution liberated people from physical labour, but enslaved them to machines because the machines were mindless. Once endowed with the power to think, however differently they may do it from us, machines need no longer feed parasitically on human intelligence but can be independent of us, and we of them except for services they do us. This is the gift of the second Industrial Revolution, which we, the Electronic and Radio Engineers are creating. Used well, no greater gift could there be than the liberation it grants us from the age-old chain of work as the necessity of survival.

There is interminable discussion at the present time about technology-produced unemployment. I have no wish to make light of the social problems facing us as we enter the new age of the thinking machines. It is always likely to be painful to live in an epoch of transition, even if it can also be at the same time exciting and enjoyable. However that may be, the difficulties of making a transformation to the future ought not to blind us to the fact that the technology now coming is potentially the most liberating in all human history. When people were needed to tend and control the machines, and were thus a key element in systems of economic production, the temptation to exploit them was almost irresistible, simply by virtue of the wealth that exploitation could bring. Equally, economic, political and military power came to those who could dominate people. We are bringing that to an end, for when our technological revolution has run to its close manufacturing industry and agriculture will be robot based, and if—which God forbid—we fight wars, it will be robot armies which fight them. All the ground rules of politics and economics will have changed.

Thus what we are doing in electronics will remake the world. Political and social institutions, the arts, everyday life, all will be changed. The future and the past will be strangers to each other. What we have put our hands to will set the new patterns and styles for the world of the future. Just as the great civil and mechanical engineers of the nineteenth century were the catalyst by which the whole of their society was made over anew, so also are we in the twentieth. It is a unique privilege to be an electronic engineer at this time, and in a hundred years our professional descendants, the electronic engineers of that day, will look back at us with unendurable envy. We are here, now, when the instruments by which the future will be built are in the process of assembly, and we, uniquely, understand how it is to be done. In this situation, the role of our Institution is clear. The interest of our whole world and our posterity demands that it must be true to the terms of its Charter: committed single-mindedly to forwarding the science and practice of the electronic and radio engineering profession.

The central role that electronics plays in the development of the world to come demands that our country must not fail to take the opportunities that this new era of technology offers us. The duty this lays on our profession and our industry is awesome. Considerations of the scale on which a modern electronics industry operates, of the size of markets required to make it viable, makes us think in terms of a European theatre of operation. It was for this reason that your Institution was one of the founder members of EUREL (the Convention of National Societies of Electrical Engineers of Western Europe), but, no less, we also wish to cultivate the best relationship that can be achieved with IEEE, which speaks for electronic engineers over most of the American continent.

So far as the UK is concerned, we must face the reality that representation of our profession is divided between your Institution and the Electronics Division of the Institution of Electrical Engineers. Those who have the privilege, as I have, of membership of both societies will be aware of their very different character.

The Electricals began, in 1871, as a light-current oriented group, the Society of Telegraph Engineers. Within a few years, however, they had taken their present title, and increasingly the centre of gravity of interest among their members moved towards power engineering. It was right and natural, in the last quarter of the nineteenth century, that it should do so since it was the great heavy-current pioneers, men like Hopkinson, Crompton, and Sebastian de Ferranti who were doing the exciting things and making the running in applications of electricity at that time. As a consequence, interest by the Electricals in the newly emerging science of radio and electronics was, by the turn of the century, rather small. To them, at that time, it did not look like an important, or even a legitimate, part of their professional concern. The attitude of educators, who then regarded the study of heavy electrical engineering as adequately covered by a final year specialism in an otherwise mechanical engineering degree, cannot have helped.

As a consequence, and for almost the first half of the twentieth century, the Institution of Electrical Engineers remained dominated by the heavy-current interest. The inevitable result was that in 1925 steps were taken which led to the foundation of the Institution of Electronic and Radio Engineers. It was an old story, for something like it had often happened before in the past history of the Engineering Institutions.

Probably the emergence of our Institution, and perhaps the relatively poor showing of electrical engineers compared with the physicists (many of whom were IERE members) in the exciting electronics developments of World War II, served to alert the Electricals to the error they had fallen into. Their Divisional structure was the solution that they found, and their Electronics Division rapidly became a numerous and influential association of electronic

engineers. By virtue of its publishing and other business enterprises, the Institution of Electrical Engineers is a financially powerful body, dependent for only a small fraction of its income on member subscriptions. This has enabled it to mount an impressive programme of publishing in the field of electronic engineering, surpassed in volume only by the remarkable IEEE Transactions, but in quality by none. All electronic engineers, particularly in Europe but also the World around, owe an inestimable debt to the IEE for this great effort. We offer them every good wish for the reorganization and extension of their publishing programme now in hand.

By contrast, the fortunes of the IERE depend entirely on financial and other support by its members. It cannot be as ambitious as the IEE in what it undertakes, on the other hand, its freedom of action is perhaps greater. The IEE retains a very proper and correct concern with heavy current, represented by its Power Division, and this in turn links it back, through generation, utilization and traction, to the Institution of Mechanical Engineers (with whom it actually explored the possibility of merger a few years ago) and hence to the main body of the 'old' engineering. The IERE has no such links, it exists for the radio and electronic engineering profession alone, and whilst it maintains good collegial relationships with the fellow members of CEI, its natural affinity to the Institution of Mechanical Engineers is really little more than to, say, the Institute of Physics or the British Computer Society.

Although there might seem to be logic in the merger of your Institution with the Electronics Division of the Electricals, and talks to that end have occasionally been held in the past, the fact that the two continue as independent entities probably reflects the fact that they are at present indeed sharply distinct, serving different ends, which still need to be separately served. Perhaps we will do best to go forward as allies, collaborators, but not to force unduly the pace on any kind of organic union, which after all gave rise to enormous difficulties when attempted in America. There have been times in the past when the two Institutions have regrettably been on less than good terms, the older seeing the younger as an upstart and the younger fearing the intentions towards it of the older. It is high time that antipathies of that kind were laid to rest: we should all concentrate on doing the best that we can for the profession that we serve, willing to support each other generously where we can, and developing such links and practical co-operative measures as seem likely to be effective. The effluxion of time alone will determine whether the separate identities of our Institutions are a transient phenomenon or something deeper.

Any perceptive electronic engineer must, indeed, confess that a great question mark hangs over our future. Can electronic engineering remain but one component (or perhaps one-and-a-half) of the CEI spectrum? As

things are developing, our industry and our profession will, by the end of the century, begin to challenge in importance and perhaps even in size, all the others in engineering put together. Shall we remain in unity with them, or shall we diverge? Will engineering split into the old and the new? After all, for the old the scientific basis is Newtonian mechanics but for ours it is Quantum Mechanics. We also have new science of our own, in network theory, control theory, and information science which has no Newtonian roots, and is far from our colleagues' comprehension. The point is not a trivial one: aspects of electronic engineering have an intellectual basis so different from the common currency of the old engineering as to be quite alien to it. What we deal with is neither visible nor tangible. There is a pervasive quality of abstractness and remoteness from ordinary experience which is significant, and also levels of complexity can be extreme. The division between the old and the new engineering is not easy to verbalize, but it is nonetheless real and profound. Only time will tell whether engineering is one great profession or, as I suspect, two.

Certainly it is still true that the electronic engineer must understand the elements of mechanical and

production engineering in order to be properly educated and able to discharge his function. He will learn it for use, as he may learn economics or a foreign language. It will certainly not be presented as we might once have taught him, believing it to be the root and intellectual origin on which his own subject is built, for that it is not.

This is our age, then, and our special time has come round. The shadow of the electronic engineer is long across the world, the future in his hand. A golden age of excitement and challenge is our gift and our responsibility. In that long unrolling of the story of human kind, which has revealed as true so many wild improbabilities and has proceeded by means of so many unlikely twists and turns, it is uniquely our chapter which is now to present itself to millions of astonished eyes. The thinking machines are from us, our creation, and with them the universe that we presently know will be reconstructed and made over altogether new. This a great and deeply significant time in the history of the human race, a great quantum jump into a new technical virtuosity which complements and completes the earlier industrial and social revolution. Above all, it is a great time, the very greatest time, in which to be an electronic engineer.

A vote of thanks to Professor Gosling was proposed by Professor W. A. Gambling, F.Eng. (Past President):

'It is astonishing to recall that some five or so years ago it was being said that Electronics was coming of age and that the mantle of a young dynamic subject producing spectacular progress was about to fall elsewhere, perhaps on biomedical engineering. There would be steady, or rather sedate, development but few revolutionary changes. How wrong that prediction was is now clear and any possible doubt has been dispelled by the excellent address of our new President. It is not difficult to see directions in which Electronics is likely to develop. Thus at present we can store information at a greater density than ever before but are far from the ultimate goal of locating one bit in a volume of molecular size. With optical fibres we have transmission lines of unprecedented bandwidths and almost zero attenuation but are only beginning to learn how to use them. Display and pattern recognition techniques are in their infancy . . . but one could go on indefinitely. Massive technological changes will continue to take place and we must not be complacent but strive to predict, accept and apply them faster than our competitors overseas.

'Professor Gosling has also drawn our particular attention to the equally vital professional front on which, as he has said, there are certain discussions afoot, the results of which we

await with no little interest and some apprehension, because of the considerable effect the consequential recommendations are likely to have on the future. His challenging and penetrating discourse has shown that professional electronic and radio engineers must meet the dual challenges of their technology and their profession. Nevertheless, however well the Finiston Committee arrives at its recommendations, however assiduously CEI, the Institutions and individual engineers accept and enact them, the industrial health of this country is, above all, a political and a social problem. In other words, the health of the profession is a necessary but not a sufficient condition for our national prosperity. We must therefore ensure that our voice is effectively heard in the political arena too.

'Professor Gosling was recently described in the technical press as one of the most dynamic professors of electrical engineering in the country and his stimulating analysis this evening has done nothing to dissuade us from that view. We are fortunate indeed to have him at the helm during the coming year when we have such stirring technological and professional waters to negotiate.

'On behalf of all our members and guests may I thank you, President, for an excellent and wide-ranging address. May we also wish you every success in what is going to be a very exciting and important period of office.'

Members' Appointments

NEW YEAR HONOURS

The Council has sent its congratulations to the following members whose names appear in Her Majesty's New Year Honours List:

KNIGHT BACHELOR

Robert James Clayton, C.B.E., M.A., F.Eng. (Fellow 1977) Sir Robert is Technical Director of the General Electric Company; he has been a member of the Institution's Council for the past year and he was President of the Institution of Electrical Engineers in 1975-76. A note on his career was published in the September 1977 issue of the Journal.

MOST HONOURABLE ORDER OF THE BATH

To be Companion of the Order (C.B.)

Ralph Benjamin, D.Sc. (Fellow 1955) Dr Benjamin has been Chief Scientist at the Government Communications Headquarters since 1971 and was previously Director of Underwater Weapons Research and Development at the Ministry of Defence.

MOST EXCELLENT ORDER OF THE BRITISH EMPIRE

To be an Ordinary Commander of the Military Division (C.B.E.)

Colonel Peter Attwood Dally (Graduate 1962), late of the Royal Corps of Signals, has been a Project Manager in the Directorate of Military Communication Projects, MOD(PE) since 1977.

CORPORATE MEMBERS

With the reorganization of the Engineering and Operations Departments in London of the BBC Television Service, **C. R. Longman** (Fellow 1968, Member 1965, Graduate 1954) whose post was previously known as Chief Engineer, Television, is now Controller, Engineering and Operations, Television; in this capacity he is responsible for three operating groups. Also involved in this reorganization are **D. R. Kinally** (Member 1962, Graduate 1949) who is now Assistant Controller, Engineering Television Developments, and **D. W. Thorogood** (Member 1967) who becomes General Manager, Outside Broadcasts, Engineering and Operations, Television.

E. G. Avery (Member 1968, Graduate 1963) has now left his appointment as Training

Manager (Civil Aviation) with International Aeradio at Jeddah, Saudi Arabia, and has taken up the post of Manager, Technical Services for the company at Abu Dhabi International Airport.

S. J. Butt (Member 1973, Graduate 1964) who was with Dynamic Electronics as Chief Engineer, has now joined Herbert Sigma where he is Engineering Manager.

C. P. C. Heightman (Member 1971, Associate 1969) who is with the Plessey Company, has been appointed Programme Progress Officer, Project *Piarmigan*. He was previously a Design Assurance Review Engineer with the project.

M. D. K. Kendall-Carpenter, O.B.E. (Member 1973, Associate 1969) has been appointed Vice Principal of Cable and Wireless's Porthcurno Engineering College in addition to his present duties as Head of Line Communications Training at the College.

P. D. G. Marlow-Mann (Member 1973, Graduate 1968) has been appointed Head of Group, International Standards and Networks in the Prestel International Division of the Post Office where he will be concerned particularly with the design and implementation of networks for international access and the Post Office's viewdata service and with technical representation for viewdata standards. Mr Marlow-Mann joined the Post Office as a Youth in Training and has recently



been concerned with packet switched services for data communication. He is at present Honorary Secretary of the East Anglian Section.

C. S. Metcalfe (Member 1973) has been appointed Managing Director of Technology for Communications International having previously been a Sales Director. Before joining TCI, Mr Metcalfe was with Marconi Communication Systems as Manager, Broadcasting and Television Sales.

K. Mondal, B.Sc., M.Tech., Ph.D. (Member 1979, Graduate 1973) has been appointed to a Chair in the Department of Electrical Engineering at Lehigh University, Bethlehem, Pennsylvania. Since 1977 Professor Mondal has been at the University of Santa Barbara, initially as a Research Assistant and latterly as a Lecturer in the Department of Electrical and Computer Engineering teaching electronic circuits. His special research interests have been in digital signal processing including microprocessor-based implementation of digital filters.

T. P. Reid (Member 1961) has taken up a new appointment with T. I. Fords as Technical Manager. He was previously with GEC Medical Equipment as Chief Engineer (Ultrasound).

B. R. Syms, M.Sc., (Member 1972, Graduate 1964) is now Senior Head Teacher of Electronics in the School of Electrical Engineering at the North Sydney Technical College, New South Wales.

A. Woodward (Member 1973, Graduate 1968) has retired from the Royal Navy after 24 years service and taken up an appointment as Lecturer in Management Studies at Norwich City College of Further and Higher Education. His final appointment before retirement as Lieutenant Commander was Officer in Command, RN Data Squadron at the Maintenance Data Centre at RAF Swanton Morley.

NON-CORPORATE MEMBERS

Sqn Ldr G. S. Clark, RAF (Associate 1970) has taken up the appointment of Officer Commanding Supply and Movements Squadron at RAF St Mawgan, Cornwall. He was formerly at HQ Strike Command, High Wycombe, as Supply Range Manager for motor transport, marine craft and transportable generator-sets.

S. A. Idowu, B.Sc., M.Sc. (Graduate 1979) has returned to Nigeria to resume duties with the Ministry of Communications, Department of Posts and Telecommunications as a Transmission Planning Engineer after completing an M.Sc. degree in telecommunications at the University of Essex. He had previously obtained a CNA degree following studies at the Polytechnic of North London.

T. Jeyaveerasingam, B.Sc. (Graduate 1972) who has been with Southall College of Technology as a Technical Officer and part-time lecturer since 1973, left the College in September 1978 to take up an appointment as Senior Lecturer in the Department of Electrical and Electronics engineering at Sokoto Polytechnic, Nigeria. Since January 1979 he has been acting Head of the Department.

Members are invited to notify the Institution of changes in their appointments for inclusion under the above heading. Details may be sent in using the 'Members' Records' form which is printed occasionally at the back of the Journal, or in a letter.

1979 MacRobert Award for Software System Inventor

THE MacRobert Award, this country's premier engineering award, has been made to a consultant engineer, Mr Sam Fedida, and Post Office Telecommunications for the invention and development of the viewdata software system—Prestel.

H.R.H. The Duke of Edinburgh, Founder President of the Council of Engineering Institutions, made the presentation of the MacRobert Medal and £25,000 to Mr Fedida for the invention of the viewdata concept and the MacRobert Gold Medal to Mr Peter Benton, Managing Director of Post Office Telecommunications, at Buckingham Palace on December 5th.

The MacRobert Award, made annually by the Council of Engineering Institutions on behalf of the MacRobert Trustees, is presented in recognition of an outstanding contribution to innovation in engineering and physical technologies, or in the application of physical sciences, which has enhanced or will enhance the prestige and prosperity of the United Kingdom.

Mr. Fedida invented the concept of viewdata whilst working at the Post Office Research Centre in the early 'seventies. It combines a modified television set, a telephone line and a computer: a push button control panel calls up a 'page' of the information required by a subscriber on to a television screen using a telephone line link routed into a computer data bank. The simplicity of operating the system provides the potential for the mass marketing of information on a wide range of general and technical subjects.

The Post Office launched Prestel this year as the first public viewdata service in the world. There are currently 1,750 Prestel sets linked to the system and some quarter of a million 'pages' of information in the storage bank provided by 800 British and international organizations. The service, now centred in London, will be extended to other centres next year. Prestel is a joint project in which the Post Office has co-operated with the country's television and electronics industries and information providers.

The MacRobert Award Evaluation Committee requires the project which they choose for the Award not only to have achieved domestic marketing success, but likewise to have made a contribution to the country's prestige and prosperity overseas. The Post Office meets this requirement having sold Prestel technology to communications authorities in West Germany, The Netherlands, Switzerland, Hong Kong and the U.S.A.

In his citation, Mr J. C. Duckworth, M.A., F.Eng., Chairman of the Evaluation Committee said:

'The concept of innovation has normally been associated with the development of a novel engineering product or production process, i.e. with the development of hardware, and in the past the MacRobert Award has reflected this concept. The rapid development of electronic devices, and particularly of microelectronics, over the last couple of decades, has placed an increasing emphasis on the way in which complex electronic hardware items, such as computers, are designed and accessed to make the most efficient use of their enormous processing power. The software aspects of the design of complex electronic systems are now often at least as challenging, and as costly, as those of the hardware.

'One particular field which has been revolutionized by the development of electronics is that of the storage and rapid, on-line retrieval of information of all kinds. The greatest demand for information has been in the field of science and technology to match the explosive growth of knowledge in these fields. To meet this need, data bases have been developed in specific areas, such as abstracts of papers in physics, aeronautical

engineering, or aspects of medicine, which can be interrogated by experts in their own field. The swift advance of science and technology has generated information on such a scale that it can only be fully utilized by the application of advanced electronic technology.

'Communication with the specialized data bases which are now available, and which add up to "big business" in their own right, requires a degree of skill, knowledge and training on the part of the operator. But every one of us, in our everyday lives, seeks information on a vast variety of subjects ranging from the time of a train, or the name of a suitable hotel or restaurant in a strange town, to a stock exchange share price or the cost of a mortgage. Such information can be stored, but to make it readily accessible to an unskilled enquirer constituted a new and formidable problem. It is the first elegant solution of this problem which provides the basis for this year's MacRobert Award.

'Users of specialized information services are prepared to pay for the relatively costly terminal equipment involved. It is unlikely that the public at large would be willing or able to pay for the necessary display equipment, but fortunately most of us already have the most expensive component of the system in our homes, in the form of a television set. Moreover most of us already have a telephone connection to a central network. If these two components, which are already in place, can be utilized, the main costs of a nationwide information system have already been met. It is then only necessary to provide the computerized data banks to feed into the telephone network to complete the hardware aspects of a national, and indeed an international, system.

'The development of the Prestel software system has been the first practical solution to the problem of providing access, to both specialized and generally available information systems, by a totally untrained operator, or any member of the public. The demand for specialized systems has already been proven and exceeds the manufacturing industry's present ability to meet it. The quantity production of equipment to meet the specialized demand will bring down costs to a level which is likely to be attractive to the general public. The confidence of the market in this production is borne out by two facts. Firstly, a number of overseas operators have bought licences for the Prestel software for trials in their own territories, both for



Mr Sam Fedida, B.Sc., M.Sc., C.Eng., F.I.E.E., M.B.C.S., A.C.G.I., who was born in Alexandria, Egypt in 1918, was educated in England and gained a B.Sc.(Hons) at Imperial College, London. He served in the RAF as a radar officer, and after the War joined the Marconi Company, becoming a Development Manager in 1960 and Assistant Director of Research in 1965.

He joined the Post Office Research Department as Manager of Computer Applications in 1970 and soon after invented the viewdata system, demonstrating its feasibility in 1974. A year later he gave its first public demonstration. In 1973, Mr Fedida obtained an M.Sc. in computer sciences at Birkbeck College, London.

specialized and for public services. Secondly, a number of providers of information have paid considerable sums to incorporate their data in the central Post Office computer data banks, in anticipation of a public demand for the service—known as Prestel—in the future.

The demand for the public service is by no means yet proven, nor can one yet predict the ways in which it may develop—for example, by ordering and billing for retail items direct from the home. But the MacRobert Award Committee has been immensely impressed by the novelty, ingenuity and simplicity of operation of the Prestel system, which has opened up for the first time the possibility of a totally new public service which could influence all our lives. The benefits to UK industry and commerce have already been encouraging, both in overseas earnings and in the provision of specialized services,

and whatever the future developments may be there is no doubt that Prestel will have opened up a new field. This concept of linking television set, telephone line, and computer was invented by Sam Fedida, and developed by him with the assistance of his colleagues at the Post Office Research Centre in 1974.

This is only the second occasion in the eleven years since the foundation of the MacRobert Awards on which an individual has been identified as sole innovator in the citation for the Award and the first time, in 1972, it was also for an electronic system: Mr G. N. Hounsfield was honoured for his invention of the X-ray technique—now known as the EMI-Scanner—which employs computer techniques to give detailed pictures of the brain or body. An electronic instrument, the Malvern Correlator, was the subject of the 1977 Award.

Plans for IBA's Fourth Channel

THE Independent Broadcasting Authority aims to have 30 main high-power transmitting stations for the new Fourth Channel colour television network completed and ready for a simultaneous launch in all ITV regions (except Channel Islands) by November 1982.

From the outset the Fourth Channel will be available to over 80% of the population of the United Kingdom—more than 40 million potential viewers. An additional 18 high-power main stations will then join the network as they are completed at the rate of one a month during 1983–1984. The extension of the Fourth Channel to the several hundred relay stations in England, Scotland and Northern Ireland will follow progressively from the end of 1982.

Priority is being given to Wales in two ways. All six main high-power stations serving Wales are included among the first 30 stations on which the Fourth Channel will be launched and, additionally, it is planned to equip some 80 local relay stations in Wales before November 1982. The population coverage in Wales, from the start, should thus be in excess of 90%. The new network will enable Independent Television to meet demands for more Welsh language programmes.

Contracts totalling more than £16M have been awarded to Marconi Communication Systems, Chelmsford, and Pye TVT, Cambridge, for the supply and installation of the 48 sets of high-power transmitters, beginning in Spring 1981.

Two main types of transmitter systems are to be supplied by both Marconi and Pye. Twenty-one high power stations will use two 15 kW u.h.f. transmitters in parallel, and the 26 low power stations the same 15 kW transmitter but with a 4 kW transmitter as a passive reserve.

The transmitter drive incorporates a number of features aimed at making it stable, reliable and easy to maintain. The use of a surface acoustic wave filter as a pass-band shaping device contributes towards the stability and reliability of the equipment, and quick-release printed boards with the minimum number of connectors, coupled with access to boards in the working condition without the use of extenders, greatly simplify the task of maintenance personnel.

The 15 kW transmitter uses separate amplifiers for the sound and vision signals and the outputs are combined for

connection to the aerial system through a combining filter which is built into the transmitter enclosure. The 4 kW equipment uses a single klystron amplifier for a combined vision and sound signal.

The new transmitters will be the first major television network to be based on the latest generation of high-efficiency klystron amplifiers. Except at Crystal Palace, all transmitters will use 15 kW and 25 kW members of a single family of klystrons developed by Mullard, and which represent a new concept in design in that they cover the entire u.h.f. television band (470–860 MHz). Normally three klystrons are required, each one covering a section of the band. Apart from simplifying transmitter design and hence building layouts, the use of a single klystron eases spares problems. The new amplifiers, which typically have a conversion efficiency of about 45%, compared with about 25–30% of the earlier power klystrons, will not only reduce operating costs and conserve energy but will also make possible significant reduction in the size of the transmitting installations, including the cooling and power systems. They also feature rapid warm-up when brought into service as a reserve unit; under such conditions they become fully operational in seconds rather than in minutes.

A novel microprocessor-based programmable transmitter control system will, in conjunction with control units to be supplied by the IBA, provide automatic operation of the transmitters, together with external status indications and remote and supervisory functions at the IBA's new Regional Operations Centres around which the network will be built.

The transmitters to be installed by Pye TVT at the Crystal Palace Station are, like the other transmitters, of the latest modular design employing intermediate frequency modulation and incorporating microprocessor control systems for unattended operation and remote control and monitoring. There are to be however two 40 kW transmitters to be operated in parallel producing 80 kW into the aerial system. These are of the type Pye TVT is currently supplying to Sweden and the USA. They are completely solid-state except for the vision and sound final amplifiers which will, in this case, be fitted with EMI-Varian klystrons.

Applicants for Election and Transfer

THE MEMBERSHIP COMMITTEE at meetings on 27th November and 12th December 1979 recommended to the Council the election and transfer of the following candidates. In accordance with Bye-law 23, the Council has directed that the names of the following candidates shall be published under the grade of membership to which election or transfer is proposed by the Council. Any communication from Corporate Members concerning the proposed elections must be addressed by letter to the Secretary within twenty-eight days after publication of these details.

November Meeting (Membership Approval List No. 266)

GREAT BRITAIN AND IRELAND

CORPORATE MEMBERS

Direct Election to Member

ASHWORTH, Michael John. *Plymouth, Devon.*
GREEN, Alan John. *Cheadle, Cheshire.*
KING, Christopher Ronald. *Castle Donington, Derby.*
LOCKLEY, Paul. *London.*
MONDS, Fabian Charles. *Belfast.*
READ, Geoffrey Paul. *Warrington, Cheshire.*

NON-CORPORATE MEMBERS

Transfer from Student to Graduate

LAU, Peng Seng. *Bradford, W. Yorkshire.*
SMITH, Richard Douglas L. *Tewkesbury, Gloucestershire.*

Direct Election to Graduate

ACKERMAN, Keith Michael. *London.*
ANDERSON, Iain. *St. Helens, Lancashire.*
KU, Kwok Kuen. *Chelmsford, Essex.*
LI, Peter Chi Wo. *Basildon, Essex.*

Direct Election to Student

AL-SATEEH, Abdul S.A. *London.*
BARKFR, Richard John. *Slough, Berkshire.*
COLEGATE, Andrew Edward. *Bromley, Kent.*
CROSLAND, Roy. *Hull, Humberside.*
DAVERN, Timothy John. *Kilmallock, Co. Limerick, Ireland.*
EASEY, David Hamilton. *Bath, Avon.*
HOWES, Michael Charles. *Worcester Park, Surrey.*
HUTCHINGS, Mark John. *Bath, Avon.*
ISSAKHANIAN, Edmond. *London.*
KINLOCKE, Mark Wesley. *London.*
NAGLE, Victor Anthony F. *Limerick, Ireland.*
RAVINDREN, Duraisamy. *Cardiff.*
SITHIRAPATHY, Pasupathy. *Southall, Middlesex.*
TRANter, John. *Bath, Avon.*
WEDGE, Christopher Stanley. *Bath, Avon.*
WHITE, Alan Christopher. *Limerick, Ireland.*
YONG, Yi Henn. *Salford.*

NON-CORPORATE MEMBERS

Transfer from Student to Graduate

CHAN, Kwok Wah Johnny. *Kwai Chung, Hong Kong.*
LEE, Chi Wah Johnson. *Kowloon, Hong Kong.*
OH, Ai Leng. *Johore, Bahru, Malaysia.*
TEO, Koon Hoo. *Singapore.*
WONG, Sang. *Causeway Bay, Hong Kong.*

Direct Election to Graduate

LIM, Sam Lee. *Bandar Seri Begawan, Brunei.*
RICHARDS, Geoffrey John. *Hamilton, Bermuda.*
WONG, Siu Leung. *North Point, Hong Kong.*
YEUNG, Ka-Sing Sammy. *Hamilton, Ontario, Canada.*

Direct Election to Student

CHAN, Yok Ming. *Kowloon, Hong Kong.*
LAI, Shung Yin. *Hong Kong.*
LEE, King Chiu. *Kowloon, Hong Kong.*
LIM, Chee Kwee. *Singapore.*
WONG, Woon Keung. *Kowloon, Hong Kong.*

OVERSEAS

CORPORATE MEMBERS

Transfer from Member to Fellow

HALL, l'Fan G. *Pickering, Ontario, Canada.*

December Meeting (Membership Approval List No. 267)

GREAT BRITAIN AND IRELAND

CORPORATE MEMBERS

Transfer from Member to Fellow

FRENCH, Richard Charles. *Horsham, Sussex.*

Transfer from Graduate to Member

BISHOP, Kenneth Ward. *Fareham, Hants.*
CARTER, John. *Salisbury, Wiltshire.*
CHAN, Koon Wah. *Ashby-de-la-Zouch, Leicestershire.*
HAKHVERDIAN, Armik. *London.*
HARRIS, Richard William. *Sandy, Bedfordshire.*
LANCASTER, Horace Anthony. *London.*
MACKINTOSH, Robert Hugh. *Tewkesbury, Gloucestershire.*
PLUMB, Barry Sidney. *Sheffield.*
WILSON, David Russell. *London.*
WRIGHT, Alfred. *Southport, Lancashire.*

Direct Election to Member

LARKMAN, David Ian. *Brough, N. Humberside.*
LEA, David Alan. *Cardiff.*
LISLE, Michael Edgar T. *Reading, Berkshire.*

NON-CORPORATE MEMBERS

Direct Election to Graduate

LEE, Kwok Chiu. *Dundee, Scotland.*

Transfer from Associate to Associate Member

THOMAS, Gordon Reginald. *Heathfield, Sussex.*

Transfer from Student to Associate Member

WHITE, Malcolm John. *Sandown, Isle of Wight.*

Direct Election to Associate Member

ACHUNCHE, John Fundoh. *London.*
BURR, Christopher Edward. *Cophorne, W. Sussex.*
LANSDOWNE, Ralston M.G.G. *Morden, Surrey.*

Direct Election to Associate

BREIK, Hamdi A. K. *London.*

Direct Election to Student

BURTON, Ian. *Purley, Surrey.*
BYLO, Nicholas. *York.*
CHU, Hou Hon. *Bournemouth, Dorset.*
DAVIES, Andrew Kenneth. *Guildford, Surrey.*
HARRY, David Michael. *Southampton.*
MITCHELL, Geoffrey. *Slough, Berkshire.*
MONAHAN, Patrick. *Limerick, Ireland.*
PATEL, Harnish P. *London.*
PROUT, Michael John. *Wells, Somerset.*
QUINLAN, Philip Eugene. *Limerick, Ireland.*
RYCROFT, Christopher M.D. *Plymouth, Devon.*
WIGMORE, Peter Donald. *West Ewell, Surrey.*
WILLIAMS, Christopher. *Farnham, Surrey.*
WILLIAMS, David Paul. *Bath, Avon.*

OVERSEAS

CORPORATE MEMBERS

Transfer from Graduate to Member

BOND, Norman. *West Pymble, New South Wales, Australia.*

Transfer from Student to Member

LAI, Lin Shing. *Kowloon, Hong Kong.*
WONG, Chor Shoon. *Damansara, Kuala Lumpur, Malaysia.*

NON-CORPORATE MEMBERS

Transfer from Student to Graduate

MA, Wai Chung. *Kowloon, Hong Kong.*

Direct Election to Graduate

KYRIAZIS, Neoklis. *Limassol, Cyprus.*

Transfer from Associate to Associate Member

DICKINSON, Clifford Ivor. *Riyadh, Saudi Arabia.*

Direct Election to Associate Member

AKARANDUT, Louis Dickson. *Warri, Nigeria.*
HARMAN, Keith Ashley. *Sana'a, Y.A.R.*
KOMOLAFE, Michael O. *Yaba, Nigeria.*
KWOK, Shun Keung. *Kowloon, Hong Kong.*
TANMALANO, Kaharianto T. K. H. *Singapore.*

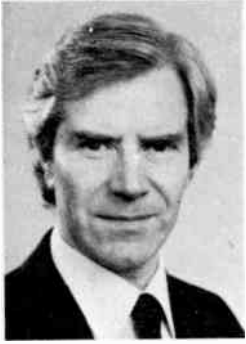

Management in a Competitive Environment

The Experience of Tandbergs Radiofabrikk A/S

RON McLELLAN, M.A., D.M.S., C.Eng., M.I.E.E., A.M.B.I.M.

When the late Vebjorn Tandberg founded his company in 1933 to manufacture loudspeakers for wireless sets, he could hardly have expected that he would lead it through forty years of harmonious growth or that it would crash so spectacularly, and with so much acrimony and confusion. This paper describes the technical and financial background and suggests reasons for the course of events.

Vebjorn Tandberg was born in the northern Norwegian town of Bødø in 1904 and graduated in electrical engineering from the Norwegian Institute of Technology in 1930. When the Norwegian state broadcasting system started transmission in 1934, his newly formed company supplied loudspeakers to the developing radio industry. By 1937 the company, along with several other Norwegian companies, was producing receivers.

The business was seasonal and the tradition in the industry was to hire and fire the work force as the demand for labour fluctuated. Perhaps the first of several 'social acts' that the founder was to offer his employees during his career was 'all the year round' employment. He achieved this partially by extending the season for his company's products by concentrating on portable radios which were bought during the otherwise slack summer months, and also by stockpiling off-season output for delivery when the season started. At a time when a 48-hour working week was common he introduced a 42-hour working week for all his employees, who were not subject to 'hourly or staff' differentiation, all having the same conditions of employment.

In 1939, confronted by the prospect of war in Europe, he transferred all the shares of the company to the Tandberg Foundation. The statutes of this non-profit foundation specified that its income 'should be used to develop the Norwegian electrotechnical industry for the benefit of society by supporting research and other activities'.

During the German occupation it was not possible to supply radio receivers to his customers, nevertheless Tandberg continued to produce and store sets for delivery when peace returned. The demand for radio receivers in 1945 was at a high level and continued so for ten years, with thirty manufacturers operating in Norway, of whom Tandberg and Radionette were the largest.

After 1955 the growth in demand for radios in Norway was past its peak and imports from the EFTA countries appeared on Tandberg's home market. Many Norwegian companies left

the industry, whilst others turned to the manufacture of professional communication equipment.

Fortunately, by this time Tandberg had introduced a new product that was to prove important for the company's future business—the tape recorder. An open reel tape recorder had been developed by the company in the late 1940s with sales confined to their home market.

In the early 1950s the recorder was introduced into neighbouring Scandinavian markets where the distribution and the servicing of the product was not too difficult—the company had entered the export market. Then in 1955 an American entrepreneur started to sell the tape recorder in the United States. It was well received and after detail improvements to meet the American users' needs, it became an outstanding success. The unit was followed in 1957 by a four-track stereo machine.

In the early 1960s Tandberg formed marketing companies in Denmark, Sweden and Finland and obtained the bulk of the recorder business in these markets.

Television transmissions had started in Norway in 1958, leading to colour transmission in 1960, and Tandberg became involved in television receiver production.

In 1962 the company's tape-recording expertise was the basis of their language laboratory products and the company soon became the largest producer of language laboratories in the world. Tape-recorders also became the company's springboard into the data products business.

In 1970 the company's hi-fi receivers, designed for the difficult Norwegian reception conditions and their reliability thus proved in the home market, were marketed with great success in the United States.

The company was now supplying more than half its output to export markets, with sales to the other Scandinavian countries being approximately equal in total to the Norwegian sales.

Radionette, the other major surviving Norwegian radio company from the early days, whose sales had mainly been to the Scandinavian countries, was in trouble in 1972 and was taken over by Tandberg with the Norwegian Government's encouragement.

Tandbergs' Recent Environment

The combination of the post-war demand for consumer products and a rapidly developing electronics technology provided the opportunity for new initiatives from the hi-fi and television industry. This fertile situation encouraged new entrants to join the pioneers of the pre-war radio era and some of the newcomers are now major companies in the industry.

The high value-to-weight ratio of hi-fi and television products has been used by many of the new entrants into the

Ron McLellan teaches Business Policy at the Anglian Regional Management Centre and is tutor of the Centre's Advanced Management Programme M.Sc. course. He is a Chartered Engineer and obtained an M.A. in management studies from the Administrative Staff College, Henley, and Brunel University. His engineering training was with Standard Telephones and Cables and after working on the design and development of radio communication systems he moved to the Corporation of Trinity House to design marine navigational aids. His management experience included periods with the components group of S.T.C. and Elliott Automation. Mr McLellan's research with British and Scandinavian engineering companies has resulted in several business policy case studies and he is currently involved in a comparative study of business policy in Britain and Scandinavia.

industry as a base for an active export trade. This has resulted in the internationalization of the industry with a major part of many countries' demand for these products being satisfied by imports. Japan has emerged as a major source of such products in post war years, although other South East Asian countries are now becoming an important source of low cost products.

The emergence of Japanese electronics companies as a dominant force in the world's hi-fi and television markets has had a profound effect upon companies throughout the world. There seems little doubt that although a large share of any particular country's market for hi-fi and television may be held by the indigenous producers, Japanese companies are major suppliers of these products to most countries.

Compared with the early years of Tandbergs' history the industry is now more mature and customers are much more selective in their purchases. In the early days the possession of a radio receiver may have been more important than the quality of its performance or the aesthetics of its design. Today most potential customers are able to own a hi-fi system or a colour television and are able to choose from the many offered on the world's markets. As a result, purchasers of hi-fi and colour television are much more discerning and collectively represent an ever-widening range of tastes and needs. Manufacturers have therefore to recognize these differences in potential customers' needs when formulating their business policy.

The world hi-fi and television industry has been subject to large and rapid changes in both technology and markets. These changes have resulted in a degree of uncertainty and unpredictability which strain the organizational structures of many of the companies in the industry. In addition in the previously high growth area of colour television, there have been signs of overcapacity, chiefly due to a slackening in demand and an increased output capability resulting from advances in technology.

Most companies in the hi-fi and television industries have had to provide a stream of new products for the market, which may be more the result of technological changes in components than evidence of the conventional product life-cycle concept. This has resulted in the demand for many products declining before the investment in the product has been recouped.

The design, cost, performance and hence appeal to the customer are all very dependent upon the characteristics of the electronic components. Equipment designed a few years previously may use components which are by current standards unreliable, expensive, low performance, large, or even unfashionable.

By 1975 hi-fi and colour television accounted for over 80% of Tandbergs' income although the company was a relatively small supplier of these products in the world markets. For example, Tandbergs' output of colour receivers at between 1000 and 3000 per week was only 20% of the output of leading UK manufacturers. The company probably had a much larger share of the language laboratory market, but this accounted for only 5% of its total business. The data products represented an even smaller share of the company's income.

The company's Japanese competitors obtained four to eight times the sales turnover obtained from hi-fi and television. There were also several European and American companies trading internationally who were larger than Tandberg.

In 1975 the company's export sales to Scandinavia, the UK and US were about NK 40M each, with Austria, France, Germany and the Netherlands sharing sales to 'other markets' of NK 90M.† The company chose, or was forced, to spread its net wide for its catch.

† It is convenient to assume 10 Norwegian Kroner (NK 10) to the pound sterling (£).

In its home market, with 25% of sales, it was effectively the only indigenous supplier, competition being mainly from imports, whereas in the export markets it was only one of a large number of potential suppliers.

Operating Details

Organization

The Tandberg group was organized as shown in Fig. 1, with twelve sales and service companies covering the group's main markets, and manufacturing units at six sites, one in Scotland.

Products

Tandbergs' products were characterized for the customer by a combination of external appearance and technical performance. The importance of these varied throughout the product range, technical performance predominating for data products and language laboratories, external appearance becoming more important for Tandbergs' hi-fi and colour television range.

The company's consumer products tended to be seen as reliable, higher than average quality items. Their rugged design and reliability to cope with the difficult Norwegian conditions was promoted as a selling point. Sales for each group of products for years 1972 to 1975 are shown in Table 1.

Table 1
Sales breakdown for 1972-75

	Million Kroner							
	1972		1973		1974		1975	
Radio	67	19%	105	22%	118	21%	158	25%
Television	144	41%	206	43%	250	43%	246	39%
Tape recorders	81	23%	96	20%	96	17%	108	17%
Loudspeakers							38	6%
Educational							32	5%
Data	59	17%	72	15%	111	19%	6	1%
Others							44	7%
	351		479		575		632	

Source: Company records.

Markets

Eighty-six per cent of the group's sales in 1975 were to six countries, 75% to the Nordic countries. Table 2 lists four years' sales by country; 30 countries were represented in the 'others'.

Table 2
Distribution of sales 1972-75

	Million Kroner							
	1972		1973		1974		1975	
Norway	140.5	40%	182.0	38%	233.1	40%	253.0	40%
Sweden	62.8	18%	75.6	16%	118.7	21%	126.8	20%
Denmark	30.1	9%	49.5	11%	53.8	9%	69.4	11%
Great Britain	—	—	82.5	17%	64.8	11%	37.9	6%
USA	23.3	7%	29.1	6%	27.8	5%	31.6	5%
Finland	11.9	3%	15.9	3%	20.3	4%	25.3	4%
Others	82.4	23%	44.4	9%	57.3	10%	88.4	14%
	351.0		479.0		575.0		632.0	

Source: Company records.

Penetration of colour television in the homes of Tandbergs' Scandinavian markets was considered to be approaching 50% in 1975, and sales of colour television to Scandinavia were generally expected to become a declining proportion of the group's total sales, although retaining the company's share of the Norwegian market was considered important for the company's business.

The sales income from the group's export markets was below budget by approximately NK 64M in 1976. This included a substantial loss of sales income from the United Kingdom due to the decline in the £ sterling rates against the Kroner.

During most of 1976 the sales of colour television sets were limited by productive capacity, partly as a result of a strike at the Radionette factory. Sales of most of the other products were limited by market potential and price competition.

However, language laboratory sales were developing in the Middle Eastern and North African countries and sales organizations were being established to serve them.

Distribution

The seasonal nature of the consumer electronics business was a major problem for the company in general and the distribution system in particular. It is estimated that half of the market's annual retail sales in Europe and North America occurs in the last quarter of the year. Tandbergs chose to establish its own sales companies in its export markets, although the initial entry to these markets may have been, as in the UK, through an agency agreement with an established distributor. To retain control of the distribution of its products 90% of Tandbergs' sales were distributed through its group companies to retailers, although it did not operate a franchised dealer network, but used a multiplicity of trade outlets.

If it is desired to have steady factory production throughout the year despite a seasonal demand pattern it is necessary to

store the output, by dispersing the products throughout the distribution chain for example. The ownership of this stored output may have crucial effect upon the capital employed in a company's operation.

Personnel

Since the early history of the company its advanced and unusual personnel policies attracted attention: the abolition of the distinction between white and blue collar workers; the limitation of the size of factories to no more than 700 people; only one entrance to factories for all employees; internal promotions wherever possible for all jobs; a fetish for company physical recreation activities; training of new employees in how to work as a group; a non-contributory inflation adjusted pension scheme providing 70% of salary after 35 years of service; and a company union outside the Norwegian trade union movement.

During the recession of 1974/1975 which required a 15% reduction in the company's work force, these personnel policies were under stress.

The Directors' Report for 1975 stated:

'In accordance with its policy, the Group has avoided dismissing any personnel in 1975, but suspended all recruitment of new personnel during the year. Natural attrition reduced the personnel in the company's Norwegian divisions by 435, of whom 315 were from production divisions and 120 from other divisions.

'In the course of the year, 87 persons were transferred from other divisions to production. In addition, 124 transfers were made between other divisions in order to attain maximum utilization of labour resources.

'On a Group basis the number of employees declined by 245 persons. This figure included also those who are

*† These companies were combined in January 1977

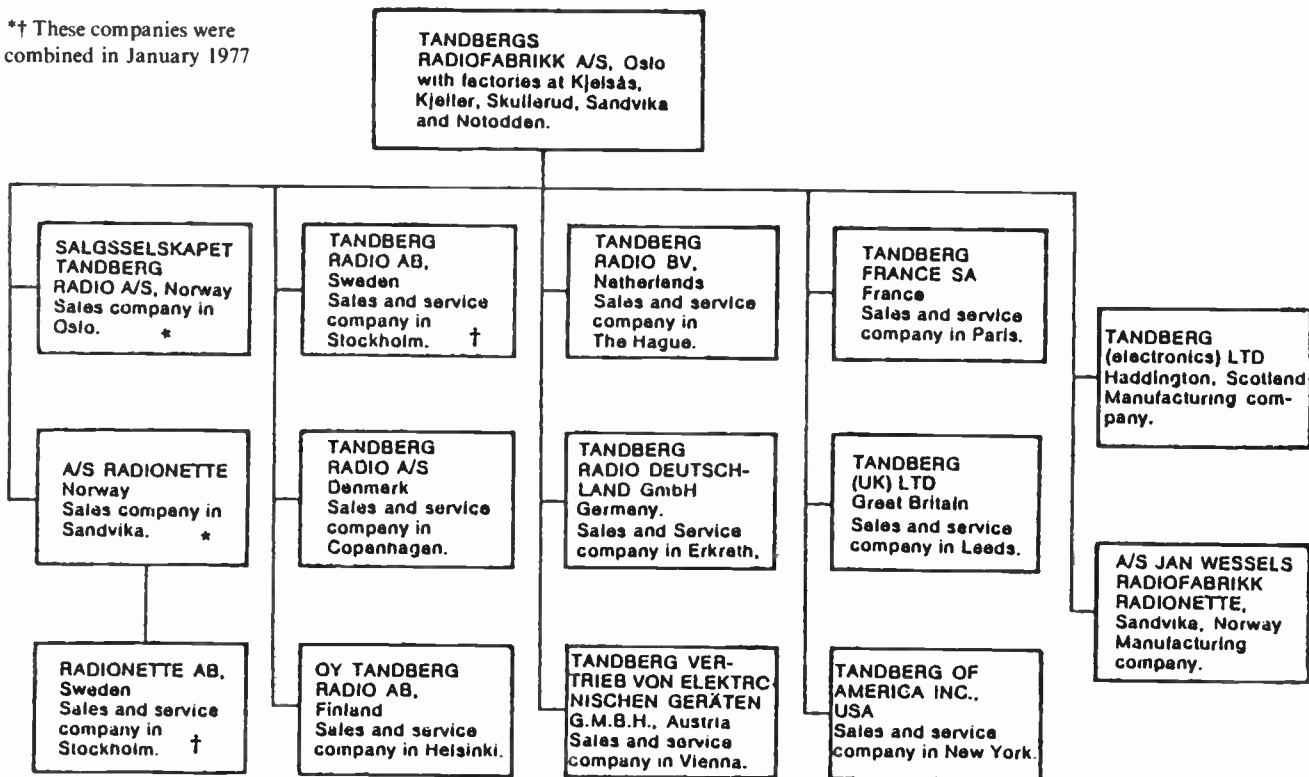

Fig. 1. Organization of the Tandbergs Group

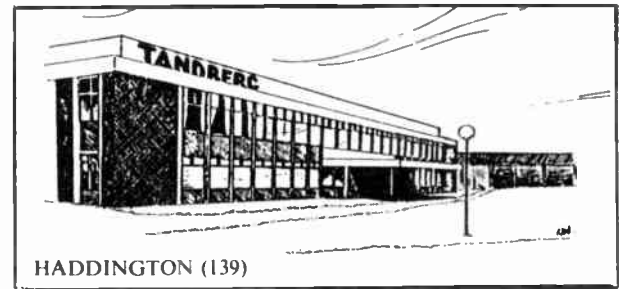
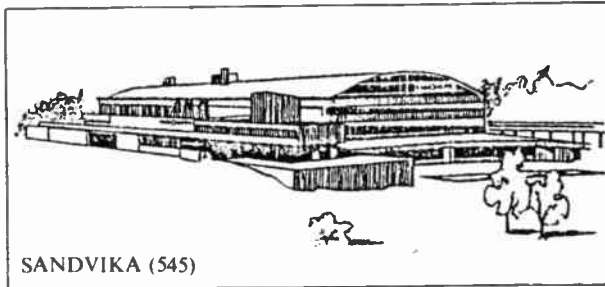
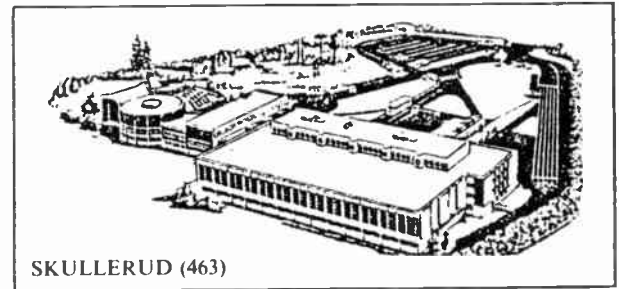
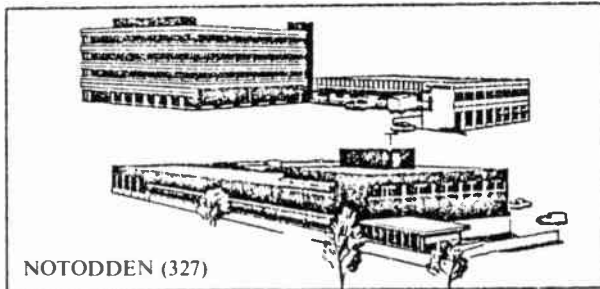
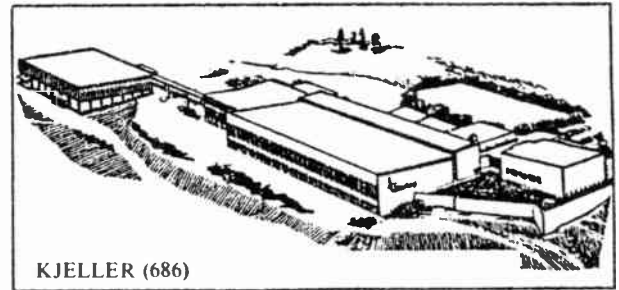
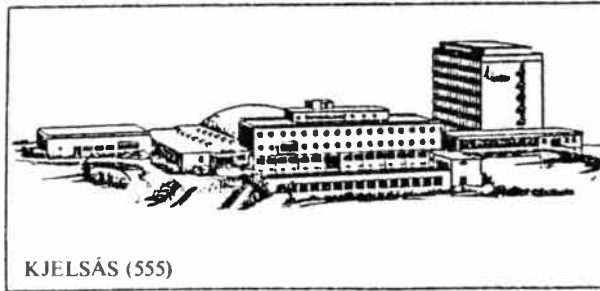

Fig. 2. Tandbergs' six plants and their work forces at the end of 1976.
Source: Annual Report.

employed in our new subsidiaries in Britain and France. The increased flexibility that has resulted from the company's 'slimming' process is considered to have improved its ability to compete.

'Nevertheless, the Tandberg Group had at the end of 1976 160 more production employees in Norway than at the beginning of the year. The number of staff fell by 50 during the year. It must be admitted that the cause of the fall in profitability, in addition to price pressure on the products and increased costs, is that the Group has too large a labour force.' (Annual Report 1976).

Production

Vebjorn Tandberg believed that good working conditions were necessary for the manufacture of good products and preferred small factories of 700 employees or less located in pleasant surroundings. (See Fig. 2.)

The company had for several years experimented with different working arrangements for the assembly of its products. Its methods ranged from traditional paced assembly lines to autonomous work groups with the emphasis on individual responsibility for the employee. However the company could not obtain comparative data on the effectiveness of the methods.

The basic production objective was to overcome the effect of

the rise in material and labour costs. The company did not believe it would be possible to compensate fully for the increase in both of these by either economies of scale through increased volume or increased prices in the market place. Although some UK retailers considered the company's colour television receivers were under priced, it was relying on its investment in mechanized assembly and testing equipment and in product simplification programmes to 'substantially reduce variable costs'. This placed further stress upon the company's personnel policies. Relative labour costs in Norway and selected countries are illustrated in Fig. 3.

Several component insertion machines were installed but technical difficulties delayed their effective implementation and the expected saving of labour did not materialize.

During 1976 twelve new consumer products were introduced but technical difficulties in production restricted their availability and delayed the recovery of their development cost. The point had been reached where the company considered that the production capacity of its factories was not being effectively used and was excessive for its present level of business.

In 1975 the company's long term plan for the production of colour television sets for the European market had started at Haddington, Scotland, and their initial experience was considered encouraging. Purchase and enlargement of the hitherto leased premises was being considered.

The Annual Report for 1976 stated:

'The intention is to take advantage of the lower cost level in the UK and by this to maintain the competitive ability of the Group's colour TV lines. The project has developed according to plan. In 1975 the factory in Scotland produced 19 000 TV sets (21% of the total production) and in 1977 it will produce approximately 25 000 sets (from a total budgeted production of 81 000). It is the view of the board that the production facilities in the UK are of importance to the Group's continuing competitive ability.'

The Scottish company's performance is shown in Table 3.

Production of the company's colour television receivers in Norway was expected to decline, but it was envisaged that increased production at the factory in Scotland would maintain the group's total output.

Diversification

For several years the company had been successfully pursuing diversification related to its prime business of radio, television and tape recorders. The reel to reel tape recorders diversification of the 1950s accounted for NK 96M (17%) of total operating income in 1974. Language laboratories were also well established with a total of 1300 installations in 52 countries, representing 6% of the group's turnover in 1975.

Additional educational products were being developed but the major diversification of the company's later years was the development of data products. The entry into data products satisfied the company's wish to 'contribute to the development of a co-ordinated and diversified Norwegian computer industry'. (Annual Report 1975). However, this move probably constituted the company's most crucial diversification in its history. It involved the company in both new technology and new markets, taking them out of consumer electronics into the data processing market. Both consumer electronics and data products share rapid change as a major characteristic: the significant difference is that change is largely cosmetic in the former, whereas technological advancement sets the pace of change for the latter. In addition 'the development of data products is also relatively long and the life span of the products is relatively short'. (Annual Report 1976.)

Furthermore the company was not in a position to finance this diversification. It was also spreading engineering, manufacturing and distribution effort rather thinly. And Tandberg was a late starter in the field with a large backlog to catch up. The labour costs of this development were NK 4.2M, 3.3M and 2.3M in 1974, 1975 and 1976 respectively. These amounts were capitalized and were being depreciated at 33 1/3%. This assumed a degree of certainty for the outcome of the development work that was later seen to be unjustified. Data products only contributed 1% to the group's sales in 1975.

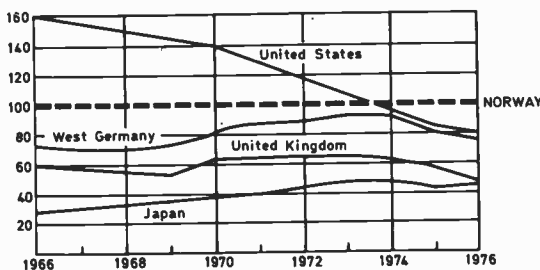

Fig. 3. Relative labour costs of major industrial countries compared with Norway. Source: O.E.C.D.

January/February 1980

The company was also actively developing its sub-contractor role as a supplier of occasional surplus production capacity to the Norwegian electronics industry. The Annual Report of 1976 comments: 'In terms of both corporate and social economics it is important that this equipment be fully utilized, and that the Norwegian industry as a whole benefits from it.' Unfortunately this was a period of overcapacity for many electronics companies.

Tandbergs also considered that its technological development and production expertise could be in demand in Eastern Europe on a licence basis and although this may have provided a modest income it can hardly be seen as a significant solution to their problems.

In every direction, the company's outlook was expansionist, the horizons wide. But the resources were being strained and too thinly spread and the rate of change of their environment was faster than that of their diversification procedures.

Financial

The Tandberg Group was a private limited company with approximately 10 000 shareholders. About 1% of the 465 000 shares were held by the Tandbergs' Foundation. The Foundation's shares were entitled to 50% of the total votes in a general meeting. Until 1973 Tandbergs had experienced a rapid growth in demand for its products and they built up their physical facilities—machinery and buildings—accordingly. Total assets during this period increased by more than NK 200M. Most of the capital required for this expansion was borrowed with only an estimated NK 75M being financed through retained earnings and new share capital. After 1973 the growth in demand slackened but the company continued to commission new facilities. Whether this was from myopia or a belief in the company's perpetuity is unknown.

Table 3
Performance of Tandbergs (Electronics) Ltd

	Turnover	Exports	Net Profit (Loss) before tax
1976	£5.0M	n.a.	£364k
1977	£4.5M	£1.9M	£24k

The company's environment was changing and the 1974 Annual Report contained the following comments:

'Costs have risen steeply. Wages and component prices, especially from Norwegian suppliers, have increased faster than normal in recent years. The capital expenses have been extraordinary, due to the building and equipment of the new factories at Skullerud and Notodden.

'Customer credits are becoming an increasingly important competitive factor in our industry. Together with the increased volume this has led to a demand for additional working capital in the Group. To cover its capital requirement the Group has raised loans at home and abroad, some of them of a long term nature. The increase in credits from suppliers has also contributed to the financing. The larger volume of loans and the higher interest rates have led to a substantial increase in the interest charges this year.'

The Directors' Report for the following year observed:

'Tandbergs Radiofabrikk A/S had a difficult year in 1975. The general downturn in the economies of Europe and USA has prevented us from increasing our prices to counteract the domestic cost increase. The

approximately 10% sales increase which the Group achieved in 1975 is largely a volume increase.

The company's result has moreover been strongly affected by the inflationary cost development that has taken place in Norway. As this industry is labour intensive and since so many of the components are bought in Norway, this cost increase is the company's most serious problem. The Norwegian economy is now so inflationary that we face the possibility that our competitors may price us out of some of the international markets.'

Unfortunately the situation continued to deteriorate and trading during 1976 resulted in a loss of NK 34M, forcing the company to seek additional capital to remain solvent.

It was becoming clear that the policies for coping with the company's present environment and management processes were not proving to be as successful as those used during its early years. Perhaps for the first time the point had been reached where the company's management team was being really tested.

Tandbergs Radiofabrikk's Final Years

Table 4 shows the variation of salaries, wages and social costs, component costs, and total operating costs in relation to total operating income for the past four years. The figures have been adjusted to remove the effect of inflation. Since the company supplied the trade and was not dealing directly with consumers, the variation in the wholesale price index has been used as a deflator. The results indicate that the cost of parts and components has remained relatively static when inflation is allowed for. However, salaries, wages and social expenses, and other operating costs have increased.

Table 4

Operating costs and income

	Million Kroner				
	1973	1974	1975	1976	1977
Total operating income	489	576	633	669	700*
Wholesale price index	100	111	117	127	137
Deflated	489	519	541	527	510*
Salaries, wages and social expenses	131	162	193	216	
Deflated	131	146	164	170	
Other operating expenses	70	75	100	119	
Deflated	70	67	85	94	
Parts and components	247	299	302	326	
Deflated	247	269	258	257	
Total operating expenditure	457	550	619	683	766*
Deflated	457	495	529	538	

* Forecast

Source: Calculated from information extracted from Annual Accounts.

A more sensitive indicator of these trends may be to relate costs to total operating income. Table 5 shows these costs as a percentage of income and confirms that parts and components are a fairly static proportion of total operating income, whereas salaries, wages and social costs and 'other' operating costs are absorbing an increasing proportion of the income. In addition 'other' operating expenses are seen to be increasing more rapidly than salaries, wages and social costs. 'Other' operating costs are defined in the company's accounts as comprising 'property, product development, service, administration, sales and advertising expenditure'. Other

operating costs would include some of the purchased inputs omitted from the added value calculations referred to below, but would not include any of Tandberg's salary or wage costs. (But the company was investing in mechanization to reduce its wage costs. Was this the programmed response to shrinking profit margins?)

Findings based on the information developed in Table 4 and Table 5 could indicate that the company was progressively subcontracting less of its manufacture and using its own labour and facilities to produce a larger proportion of its products. This could well be the case since the company's facilities were underused and it was actively seeking subcontract work from other companies.

Table 5

Operating costs as a percentage of total operating income

	1973	1974	1975	1976
Parts and components	50	52	48	49
Salaries, wages and social costs	27	28	30	32
Other operating expenses	14	13	16	18

Source: Extracted from Annual Accounts.

Whatever the reason for these trends, it is clear that, unless drastic changes occurred, total operating expenditure was unlikely to be within the forecast total operating income for 1977.

An alternative method of assessing a company's operation is to consider the trend of its net output, or added value, and relate this to aspects of the organization's performance. Added value may be derived by deducting the value of purchased inputs from the total output they are used to generate and adjusting for changes in the stock of parts, work in progress, and stocks of finished goods. It is necessary in Tandbergs' case to assume that the cost of parts and components consumed is approximately equal to the bill for all the purchased inputs, since the expenditure on the other inputs—heat, light, power, maintenance and repairs—is not available. Their exclusion will inflate the calculated added value but may not reduce its suitability as a comparative measure.

The calculated added value for the four years is shown in Table 6, from which it can be seen that after allowing for inflation the added value generated by the company's operation declined. During this period total operating expenditure was rising steeply: more quickly than the trend in added value.

The internal effectiveness of the firm was declining, as shown by the trend of added value for each Kroner of salaries, wages, and social costs, which can be seen to be falling.

It was also clear from the accounts that the company had financial problems other than those of manufacturing efficiency. Table 7 includes the detailed figures.

The net working capital—current assets less current liabilities—had fallen by 72% during the past four years. The current ratio—

$$\frac{\text{current assets}}{\text{current liabilities}} = \frac{(\text{stocks and work in progress, debtors, marketable securities, cash})}{(\text{creditors, bank overdraft, taxation, provisions, dividends due})}$$

i.e. the company's ability to convert its current assets into cash

Table 6
Operating added value trends

	Million Kroner			
	1973	1974	1975	1976
Total sales	489	576	633	669
Parts and components	247	299	302	326
	242	277	331	343
Adjustment for change in s.w.i.p. level	+75	+78	-38	+10
Added value	317	355	293	353
Deflated	317	320	250	278
Total operating expenditure				
Deflated	457	495	529	538
Salaries, wages and social expense	131	162	193	216
Added value per Kroner of salaries, wages and social costs	2.4	2.2	1.5	1.6

Source: Calculated from information extracted from Annual Accounts.

to meet its current liabilities—was falling. And the company's ability to meet its financial obligations day by day as measured by the quick ratio—the current ratio calculation but excluding the value of stocks and work in progress—was also falling dangerously low.

Table 7 also reveals that drastic changes had occurred in the company's source of funds. Short-term loans and creditors had taken the place of long-term liabilities and shareholders' equity as the main sources of funds.

The loss of a major part of the shareholders' equity during the 1976 operations reduced it to an insignificant portion of the company's total liabilities.

In contrast, the use of the funds remained relatively stable.

By early 1977 the company was facing a crisis which was seen as a threat not only to the Tandbergs enterprise but also to a significant part of the Norwegian electronics industry. Tandbergs' survival was considered sufficiently important for management to embark upon a reorganization of the company within a restructured Norwegian electronics industry.

Industrifondet, the government body responsible for encouraging and providing financial support for Norwegian industry, agreed at the end of March 1977 to support Tandbergs. It granted the company a loan of NK 20M and guaranteed additional borrowings of NK 10M.

Industrifondet's loan was on condition that Tandbergs could obtain additional facilities from its bank and postpone all instalments and repayments of matured loans. It also required the company to submit a plan for the Group's future development, and stipulated that Tandbergs' Radiofabrikk's Foundation renounce the special voting rights of their shares.

The company's creditors were sympathetic towards their difficulties and agreed to continue to co-operate. As a result Tandbergs Radiofabrikk A/S survived this crisis and was able to concentrate on the work of long-term planning and reorganization of the company.

The sales target for 1977 was reduced by over NK 100M to approximately NK 700M which, according to the Board's view, was a realistic assessment under prevailing conditions.

After meetings and consultations with the employees' unions, the Board and the corporate assembly decided to reduce the labour force in the course of the first half year by approximately 500 people. This was achieved by natural wastage, suspending recruitment, and approximately 200 redundancies. In addition, a four-day week was introduced from 15th April 1977, together with lay-offs in May and June for a substantial number of employees. This reduction in the labour force was in line with the reduced sales budget and—although somewhat delayed—in line with the investments in automatic production machinery that had already been made.

It has been seen from Table 5 that the trend of operating expenditure in 1976 was rising and would result in a total operating cost during 1977 of NK 766M. The company expected to achieve a total operating income for 1977 of NK 700M which would therefore result in an operating loss of NK 66M. In addition, finance costs, provisions, and extraordinary items were averaging NK 20M, which would result in a net loss of NK 86M.

Even if the company achieved its forecast operating income, it would be necessary to reduce the operating expenditure by an estimated NK 86M to break even. The company's decision to reduce the labour force would cut personnel costs to about NK 145M, a saving of NK 100M. But possible redundancy payments and disruption costs would still have to be set against these economies.

It was assumed that the reduced labour force would be capable of producing the required output and that mechanical assembly, which would probably take the place of some of the human labour, would not incur its own costs.

Table 7
Financial operating information

	Million Kroner			
	1973	1974	1975	1976
Bank overdraft	27	30	5	26
Shareholders' equity	55	56	52	19
Long term liabilities	145	199	189	129
Trade creditors	79	113	88	124
Short term loans	36	70	113	143
Net working capital	141	167	138	47
Fixed assets	89	115	111	109
Stock and w.i.p.	108	186	148	158
Trade debtors	161	208	203	205
Shareholders' equity as % of total assets	13	9.8	9.5	3.5
Current ratio	1.8	1.6	1.5	1.1
Quick ratio	1.2	0.9	0.9	0.7
Total assets	432	572	545	549

Source: Calculated from information extracted from Annual Accounts.

Thus the very delicate balance between income and expenditure resulted in the company's profitability being acutely sensitive to small changes in performance over which it may have had very little control. Nevertheless, if the planned operating income of NK 700M were achieved, the 1977 operations could result in a profit of NK 14M.

The company then attempted to reorganize its financial structure and designed the following plan (March 1977):

Industrifondet to become a shareholder by converting NK 10M of their loans into new share capital.

A/S Kongsberg Vapenfabrikk and A/S Elektrisk Bureau subscribe for NK 10M of new share capital each.

The Board to approach the company's main insurance company, and A/S Raufoss Ammunisjonsfabrikker with a proposal to come in as new shareholders, each subscribing for NK 5M.

Finally, the Board to approach Tandbergs Radiofabrikk A/S's suppliers, proposing that they underline their relationship between Tandbergs Radiofabrikk A/S and themselves by coming in as shareholders for NK 10M altogether.

However, the new Board that had been formed as part of the reorganization found it difficult to stem the company's loss making. Several possible reasons have been advanced to explain their ineffectiveness: depression of the consumer electronics market in Scandinavia; world wide overcapacity in the hi-fi and colour television industry, resulting in severe price competition; impossibility of reaching the 1977 sales targets; cost of employee severance pay reducing the anticipated savings in salary and wage costs to insignificant levels. In addition, political pressure to retain full employment was especially strong in Norway and the Board found it difficult to reach compromises that were acceptable to the community.

However the Ministry of Industry publicly declared its faith in Tandbergs Radiofabrikk's ability to survive and during the summer of 1977 an additional loan of NK 20M was provided by the government and a revised plan for 1977 was produced by the management.

A leading Norwegian consultancy company was commissioned to undertake an analysis of the company's future prospects. This was completed in November 1977 and anticipated a return to profitability by 1980 if the company concentrated on high quality, high price audio products, educational aids (language laboratories), the continued development of data peripherals, and a rationalization of its operations. The report anticipated a reduction in the number employed by the company in Norway, the sale of facilities no longer required, and the location of all colour television production at Haddington.

In April 1978 the company's Annual Accounts for 1977 were published. The key figures from the accounts are shown in Table 8.

The reduced level of sales during 1977 had been accompanied by an increase in the value of finished stock and work in progress of NK 18M. This implies that the output of the factories during 1977 had declined by NK 110M, and yet the total of the salaries, wages, social expenses and other operating expenses had only fallen by NK 10M.

Allowing for inflation the total income for 1977 was only 73% of that achieved four years earlier for approximately the

same total operating expenditure. The net output produced by the company was also the lowest of any of the previous four years. The effect of the company's lower net output and increasing salary bill reduced the added value for each Kroner of salary, wages, and social cost for 1977 to 1.4 compared with 2.4 for 1973. Clearly the new Board of Tandbergs Radiofabrikk A/S had not succeeded in halting the decline.

Perhaps the only happy sight in the 1977 Annual Report and Accounts was the growth in sales, although from a small base, of the teaching aids and data peripherals sections of Tandbergs' business, as shown in Table 9.

Table 9
Sales 1976-77

	Million Kroner		Change after allowing for inflation
	1977	1976	
Consumer products	460	613	-32%
Language laboratories	48	37	+16%
Data peripherals	33	19	+58%
	541	699	

By the spring of 1978 the company had reacted to its 1977 performance and formed another new board of directors. The government's response was to write off NK 75M of its loans to the company, to subscribe NK 120M of new share capital, and to guarantee NK 50M of new loans.

The new board of directors and management were to be given a free hand to choose the areas of operation of the company and all activities in Norway and abroad would be valued on 'managerial grounds.'

However, the new board and management were to have very little time to prove themselves. By early December they realized that the estimated deficit of NK 100M for the 1978 operation would force the company into bankruptcy. The Norwegian government offered additional help of NK 50M but this was not enough to change the majority of the board members decision and on 13th December 1978, Tandbergs Radiofabrikk A/S was declared bankrupt.

The Industrifondet and the consultants then proceeded to assess whether any sections of the company could prove viable and so save some of the technological and human resources accumulated during the past four decades.

Their first initiative was to propose the formation of a company to continue production of those products which they considered viable in the long term. The new company would require NK 200M capital, provide employment for 700 people, and achieve an annual turnover in the region of NK 200M. On the 19th January 1979, the Norwegian government made a total of NK 120M available to the new company, Tandberg Industrier. The chairman of the new company was the consultant who had helped to prepare the new company's plan and who had previously been associated with Tandbergs Radiofabrikk's efforts to survive. The company would produce and market language laboratories, tape recorders, and advanced audio equipment. A separate company called Tandberg Data would be formed by Siemens of Germany and the Norwegian government to continue production of Tandbergs Data products. Colour television production would cease, causing the closure of factories at Notodden, Kjeller, and Haddington.

However, the government also agreed to grant NK 0.2M to an employees' company, Tandberg Produkter, for the preparation of a report on the commercial viability of continuing to produce the company's simpler stereo equipment

Table 8

Consolidated profit and loss account at 31st December 1977

	Million Kroner	
	1977	1976
Net sales	541	669
Parts and components	277	325
Salaries, wages and social costs	210	216
Other operating expenses	135	141
	622	683
Operating Profit/Loss	-81	-14
Net Financial Expenses and extraordinary items	44	22
Net Profit/Loss	-125	-34

and colour television sets, but nothing more has been heard of this venture.

Meanwhile, the factories, offices and production equipment of the bankrupt company, including the Haddington facility, were offered for sale.

In Norway and other parts of the world Tandbergs subcontractors, dealers, and customers were in turmoil. The Norwegian Consumer Council started to investigate the servicing and guarantee problems. Norwegian dealers were able to apply for assistance in reorganizing businesses which had been dependent upon the Tandbergs company's products. The Scottish Economic Planning Department were trying to find a company willing to develop a new business in Haddington and so preserve employment in East Lothian. They were able to offer substantial financial assistance to any new enterprise.

The Norwegian management and the Scottish workforce had developed at Haddington a business manufacturing colour television sets which had been profitable during its four years of operation. British interests considered taking over the company but on 16th March 1979, this successful Norwegian and Scottish enterprise was terminated, and it was announced in *The East Lothian Courier* that Mitsubishi had bought the Tandberg television factory. This is the Japanese company's first European factory and if successful in producing television sets could be expected to be its European base for the production of electronic and other consumer products.

Meanwhile, Tandberg Industrier were re-establishing themselves as a supplier of hi-fi tape recorders and language laboratories and were expecting to achieve their 1979 sales target of NK 110M. They were negotiating to buy the factory and equipment that they had leased from the receiver.

The Board was also seeking investors to take up the major part of the company's NK 30M share capital because the Norwegian government did not wish Tandberg to be state-owned indefinitely. In fact, the Ministry of Industry caused Tandberg Industrier's first crisis by telling them in early April 1979 that they must find these partners by the end of the month.

The Tandberg saga therefore continues, but there is little doubt that by now most of the technological and human investment, the heritage of four decades of the original company's activity, has been dissipated. Could it have been avoided?

Conclusion

Although Tandbergs Radiofabrikk A/S was a pioneer in its industry and outlived many of its early contemporaries, it was small compared with its recent competitors. Why had Tandbergs failed to grow at the same rate as the newcomers to its industry?

The company was effectively Norway's only manufacturer of hi-fi and domestic television. It had 25% of its home market sales whereas in its export markets, on which it depended for almost half its sales income, it required only a minute market share.

Although the company was operating from a high cost base compared with its competitors, price was becoming less important, since aesthetic and psychological factors and a range of product styles compatible with a variety of decor and life styles were becoming increasingly important in customers' purchase decisions. As basic needs are satisfied, consumers look for products through which they can differentiate themselves from their neighbours—imports selected from international suppliers are often the solution, price being a subordinate consideration.

The hi-fi and television industry is dominated by advances in

electronic component technology. The value of the components within consumer electronic products is becoming an increasingly large proportion of the finished product with important implications for the equipment assembler.

These major advances in technology are available to all equipment companies via their bought-in electronic components and so new entrants to the industry may be able to nullify the technological achievements of longer established companies quite quickly. In Tandbergs case there were signs of overcapacity due to a slackening in demand and an increase in output capability resulting from such advances in technology.

In the final years Tandbergs were expected to satisfy an increasing number of stakeholders which complicated the management of the business. For example, the new sources of capital upon which Tandberg relied could not be expected to have as cohesive a view of the performance of their company as the shareholders of old.

The environment of the consumer electronics industry will continue to change, and it is to be expected that while entrepreneurs will conceive new ways of operating successfully within this environment, existing companies may fail.

Tandbergs were operating in this environment with a limited amount of information on the changes that were occurring. The company had the options of trying to obtain more information, or to reduce the information needs of the task they were performing.

In their survival situation, Tandbergs attempted to diversify into data products. This created a gap in their knowledge base which was beyond them. The task depended upon the availability to Tandbergs of more information than they possessed or were able to obtain. The diversification into data products also required a larger cash flow than could be generated by the other sectors of the business.

It is also probable that after forty years of operation Tandbergs had resources committed to activities which were no longer justified.

It was possible that some of the company's activities could have been performed equally well by another organization without prejudicing the sovereignty of Tandbergs' business. A company needs to resist pressures to create pockets of inertia based upon humdrum operations which are best performed by less sophisticated organizations. For example, it is possible to argue that a subsidiary in a foreign market is essential for a successful operation in that market. At a particular period in the company's history in the market, this may be so; at others the subsidiary may be an inessential piece of resource whose main effect is to reduce the flexibility of the company's operation.

If arrangements can be made to sub-contract, to form joint activities or to amalgamate, then a scarce resource could perhaps be released for the more essential activities which only the company itself can perform and upon which its viability really depends. A slimming operation within organizations, as with human beings, is likely to result in a more mobile animal, better fitted to survive in a dynamic environment.

It would be foolish to suggest that any company which experiences a crisis of the magnitude of Tandbergs had adequate managerial resources. However, if it had been able to unlock the entrepreneurial talent which probably existed within the company it might have been able to operate the more complex business demanded of the continuously evolving environment of the 1980s and satisfy the diverse expectations of its wide range of stakeholders.

Manuscript first received by the Institution on 16th January 1979 and in revised form on 6th August 1979. (Paper No. 1910/MT 3)

Measurement of the immunity of television receivers to r.f. interference

R. J. HARRY, Dip.E.E., C.Eng., M.I.E.E.*

and

R. J. HASLER, M.I.E.E.E.†

Based on a paper presented at the IERE Conference on Television Measurements held in London on 21st to 23rd May 1979.

SUMMARY

This paper reviews current developments in the measurement of the immunity of receivers for sound radio and television broadcast reception from high-level ambient radio-frequency fields.

The need for the control of immunity is justified by quoting examples of field strengths generated by authorized transmitters in which sound radio and domestic television installations are required to operate satisfactorily.

The main attributes of standard methods of measurement, which may be adopted internationally are listed. The principal methods which are at present being considered are described and compared.

It is shown that each has its limitations, but that by careful selection it is possible to conduct immunity measurements simply and with confidence over the frequency range 10 kHz to 1 GHz.

* Formerly with the Directorate of Radio Technology, Home Office; now with the Police Scientific Development Branch, Home Office, Woodcock Hill, Sandridge, St. Albans, Hertfordshire.

† Formerly with the Directorate of Radio Technology, Home Office; now with Applied Radiation Laboratories, Brixworth, Northampton.

1 Introduction

Any piece of electronic equipment may malfunction if subjected to a strong enough external electromagnetic field. Broadcast sound radio and television receivers, for instance, may be required to work in near proximity to land mobile radio or amateur transmitters. The level of field strengths generated by these types of transmitter for various distances from the aerial are shown in Table 1. It can be seen that receivers may be required to work in the presence of unwanted fields in excess of 2 V/m or 126 dB(μ V/m). In the United Kingdom today there are, excluding the military and civil authorities, over 230 000 licensed mobiles and some 25 000 amateurs. Further, equipments which fortuitously produce interference are becoming more numerous. These equipments include industrial, scientific and medical apparatus as well as domestic appliances.

Thus, in the future, broadcast receivers will be required to operate satisfactorily in an increasingly hostile electromagnetic environment, a condition which implies a corresponding increase in receiver immunity standard.

Immunity is the ability of an equipment to reject unwanted signals, but it is impractical to control the level of immunity without a standard method of measurement. Despite this there is no internationally standardized method of measuring the immunity of an equipment, and little limitation on the maximum field strengths in which a receiver must operate.

Complaints from the public of interference to television and radio reception or to audio equipment are becoming more frequent. It is inconvenient and costly to modify equipment after it has been sold.

This paper reviews the present situation in that the concepts of internal and external immunity are considered in Section 2; the existing methods of measurement are described in Section 3, and the merits of these methods are compared in Section 4.

2 The Concept of Immunity

There is no internationally agreed measurement method for immunity. Moreover, until recently there has been little recognition of the differences between internal immunity and external immunity, or the fundamentally different mechanisms operating.

2.1 Internal Immunity

The internal immunity of a receiver is its ability to reject unwanted signals which are present at the aerial input terminals.

The internal immunity characteristics are governed by the receiver's selectivity and linearity. At its worst the effect of poor internal immunity when a receiver is within a high electromagnetic field is overload resulting in loss of picture or sound.

Less severe effects can be produced because of poor selectivity resulting in co-channel interference, and poor

Table 1

Levels of man-made electromagnetic radiation

Radio transmitters in the United Kingdom—operating frequency ranges and maximum radiated powers

Service	Approximate operating frequency (MHz)	Maximum permitted power	Approximate maximum power in current use	Estimated field strength dB ($\mu\text{V}/\text{m}$) at distance of:						
				10 m	100 m	1000 m				
Amateur transmitters:										
Medium frequency	1.8–2.0	10 W d.c. input	27 W p.e.r.p.	148	111	91				
High frequency	3.5–30.0	150 W d.c. input	1.620 kW p.e.r.p.	154	129	109				
Very high frequency	70–70.7	50 W d.c. input	1.35 kW p.e.r.p.	148	128	108				
Very high frequency	144–146	150 W d.c. input	4.05 kW p.e.r.p.	153	133	113				
Ultra high frequency	432–440	150 W d.c. input	16.2 kW p.e.r.p.	159	139	119				
Communication and broadcast transmitters:										
Very low frequency (telegraphy)	0.014–0.020	Not specified	75 kW p.e.r.p.	—	—	147				
Low frequency (long wave)	0.16–0.225	Not specified	400 kW e.r.p.	—	—	133				
Medium frequency (medium wave)	0.525–1.605	Not specified	300 kW e.r.p.	—	152	132				
High frequency (short wave)	3.0–27.5	Not specified	7200 kW e.r.p.	—	165	145				
Very high frequency (Band I tv)	41–68	Not specified	200 kW e.r.p.	—	150	130				
Very high frequency (Band II radio)	88–97.6	Not specified	120 kW e.r.p.	—	148	128				
Very high frequency (Band III tv)	174–216	Not specified	475 kW e.r.p.	—	154	134				
Ultra high frequency (Band IV, V tv)	470–854	Not specified	1000 kW e.r.p.	—	157	137				
Industrial r.f. heaters:	9–36	Not specified	2 kW	126 ± 30	82 ± 30	38 ± 30				
Land mobile base station transmitters:										
Very high frequency	71–88 105–108 138–141 165–173	25 W e.r.p.	25 W e.r.p.	131	111	91				
Ultra high frequency	450–470									
Radar transmitters:	600						500 MW (p.e.r.p.)	—	184	164

e.r.p. = effective radiated power.

p.e.r.p. = peak effective radiated power.

p.e.p. = peak effective power.

linearity giving rise to intermodulation products. Both deficiencies may produce patterning on the screen.

2.2 External Immunity

When a receiver is operating in a high electromagnetic field, currents are induced in the aerial feeder braid, mains lead, internal wiring and chassis. This will couple into the receiver signal path and may cause significant interference.¹ The external immunity of a receiver is its ability to prevent significant coupling into the signal channel by these spurious paths.

There are two classes of external immunity, the non-tuned frequency immunity and the tuned frequency immunity. The tuned frequency immunity is a measure of a receiver's ability to reject signals at the frequency to which the receiver is tuned which arrive by paths other than the aerial. The non-tuned frequency immunity is a measure of a receiver's ability to reject signals at frequencies other than the tuned frequency, which arrive by paths other than the aerial. In practice, values of tuned frequency immunity are lower than those for non-tuned frequency immunity.

Investigation of the coupling mode has shown that at

v.h.f. the predominant coupling mode is due to currents induced in the braid of the aerial feeder.

At u.h.f. where the television chassis and internal wiring dimensions approach an appreciable fraction of a wavelength direct pick-up by the chassis and wiring predominates. The effects on reception are similar to those produced by poor internal immunity, that is loss or impairment of picture or sound.

3 Methods of Measurement

For the measurement of immunity of domestic broadcast receivers for standards purposes a number of basic attributes for an 'ideal' method can be identified:

1. The measuring method should be inexpensive.
2. The method should model as closely as possible the situation likely to be encountered in use.
3. The measurement should be repeatable.
4. The method should be capable of working over a sufficient frequency range to cover the frequencies where high r.f. fields may be encountered in normal use and where the receiver may be vulnerable to interference.

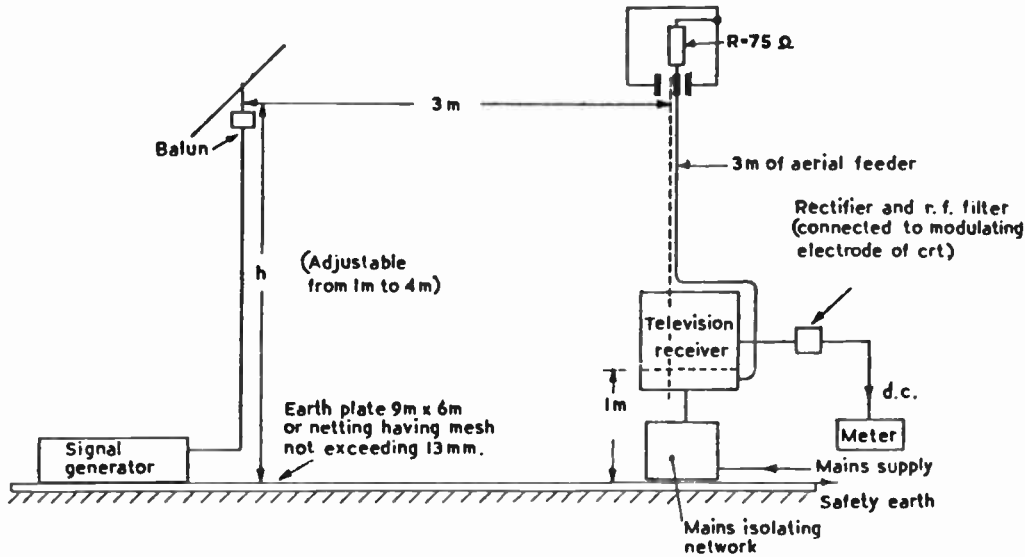

Fig. 1. Measurement of tuned frequency immunity (BS 905 : 1969).

At the present time the International Electrotechnical Commission (IEC) and the International Special Committee on Radio Interference (CISPR) are actively considering the problems. Several alternative methods of measurement are currently either in use or under investigation in various laboratories throughout the world. Those at present receiving most attention are described below.

3.1 Tuned Frequency Method (BS 905 : 1969)

The assessment of tuned frequency immunity is an example of a method which measures not only the receiver but the receiving installation. It is the standard method used in the UK and is described in British Standard 905 : 1969.² Fig. 1 shows the measuring arrangement.

The test signal is an amplitude-modulated carrier produced by a signal generator. The signal generator output is connected to a suitable half-wave dipole placed on a standard IEC 3m test site.³ The television receiver is arranged in a standard manner and a simple rectifier (envelope detector) is attached to modulating electrode of the cathode ray tube to detect the amplitude modulation of the test signal.

The detected signal level is displayed on a suitable moving coil meter. The signal generator is then connected to the aerial socket of the receiver and the signal generator adjusted for the same reading on the meter. The two signal generator output readings are then used to calculate the immunity of the television receiver. A variation of this method has been recently introduced in Japan where it is used for evaluating the immunity of television receivers to radiated interference at frequencies close to the vision intermediate frequency.⁴

3.2 Uniform Field Method

The principal improvement to the method over the existing (tuned frequency) technique is that the radiating dipole is positioned three-quarters of a wavelength above the test site ground plane. The receiver under test is positioned to lie within one of the three principal lobes of the aerial pattern, an arrangement which produces a more uniform field in the vicinity of the receiver under test.⁵ Also incorporated is an optical sensor which requires no physical connection to the test receiver.⁶ The sensor replaces the rectifier and meter, eliminating the risk of the detector affecting the measured value of immunity, which is particularly important in the non-tuned frequency case. Figure 2(a) illustrates the test configuration and Fig. 2(b) shows the field pattern.

3.3 TEM Cell

The object of the TEM cell is to generate a guided wave which has the characteristics of a far-field electromagnetic wave. The cell is designed to contain the wave and the equipment under test.

The simplest form of the cell consists of two parallel plates arranged as a terminated transmission line driven by a r.f. source (Fig. 3). The equipment to be tested is placed between the two plates. More sophisticated versions are designed in the form of a rectangular coaxial transmission line of sufficient size to permit the insertion of the equipment under test.⁷

For an immunity measurement the receiver is placed in the cell and a modulated signal generator connected to the aerial input and tuned to the wanted vision frequency. The output level on the screen can be measured using the remote sensor. The input signal is then removed and the unwanted field adjusted in level to

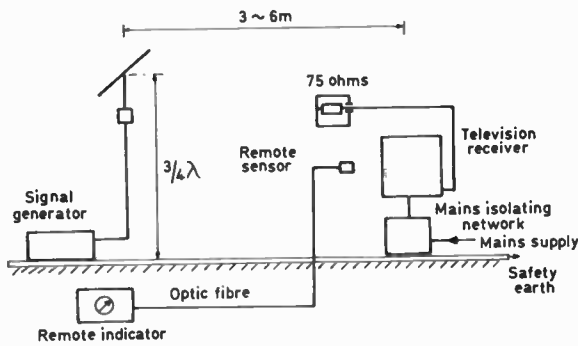

(a) Test configuration for the uniform field method.

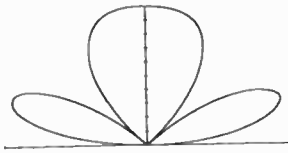

(b) Field pattern for a horizontal half-wave dipole positioned $\frac{3}{4}\lambda$ above a perfect ground plane.

Fig. 2.

produce the same output on the remote sensor indicator. Once the cell has been calibrated the value of external immunity can be calculated from the output levels of the signal generator. The cell is particularly adaptable to swept frequency measurements.

3.4 Other Techniques

When an electromagnetic field induces a longitudinal current in the outer conductor of the aerial feeder there are two effects on the value of immunity of the receiver. Firstly, a transverse voltage is produced at the aerial terminals at the end of the cable, and secondly a path is provided for r.f. currents to be conducted into the chassis of the receiver, hence coupling into the receiver circuits.

Immunity tests on television receivers, carried out at the Home Office Directorate of Radio Technology Interference Laboratory indicate that a reasonable guide to immunity values can be obtained from braid injection measurements for frequencies below 100 MHz. This is because at low frequencies pick-up by the aerial feeder is the dominant coupling mechanism. Encouraging results have been obtained in investigations using a CISPR ferrite clamp,⁸ or a triaxial injection jig,⁹ similar to that used for the measurement of transfer impedance.

Alternative measuring techniques are continually being developed along various lines. Examples of measurement methods have varied from measurements using underground mines and tunnels⁷ to antennas hooded with r.f. absorbing materials in a screened

room.¹⁰ Even the r.f. anechoic chamber is not a satisfactory solution for frequencies below 30 MHz due to the difficulties in achieving adequate absorption and the high cost of construction.^{11,12}

The variety of methods in current use illustrate the problem of finding a single solution for all frequencies at a reasonable cost.

4 Comparison of Methods

4.1 Equipment and Complexity

Table 2 lists the essential equipment for four measuring techniques previously described.

Both the tuned frequency and uniform field methods require the use of a measuring site free of unwanted reflected surfaces. Hence the site is usually situated out of doors and subject to weather conditions. The TEM cell and injection techniques do not require an outdoor site, although for testing large items of equipment a significant laboratory area is needed. In the cell method the height of the equipment to be tested should not be greater than half the separation distance between the cell plates if an unacceptable distortion of the field is to be avoided. This means that for large receivers large cells are necessary, and the highest operating frequency is reduced. The TEM cell and injection techniques can both be set up on a laboratory bench. These laboratory methods have the advantage of a short setting up time and a freedom from weather conditions.

In all the methods the proprietary equipment required is inexpensive and readily available. However, all techniques require some special equipment. The rectifier unit used in the tuned frequency measurement is very simple and can be constructed quite cheaply. The remote sensor and indicator unit are comparatively more complex, but again they use readily available components (Fig. 4), and can be used with any of the methods described. The TEM method requires the cell itself while for the injection method the injection jig is required.

The expertise required to carry out the measurements are within the competence of the average technician and no special skills are required. The radiation methods may present more difficulty when first used because of the need to check the suitability of the test site. However, once this is established the measurement method is straightforward.

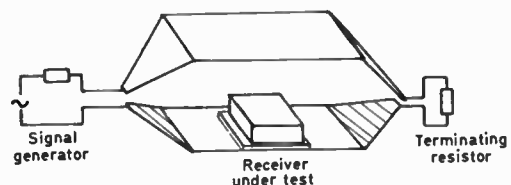

Fig. 3. Simplified diagram of parallel plate TEM cell.

Table 2

BS 905	Remote sensor	TEM cell	Injection techniques
Outdoor measuring site 6 × 9 m	Outdoor measuring site 6 × 9 m	—	—
Modulated signal generator	Modulated signal generator	Modulated signal generator	Modulated signal generator
Aerial and supports	Aerial and supports	—	—
Rectifier unit	Remote sensor	Remote sensor	Remote sensor or rectifier unit
—	—	TEM cell	—
—	—	—	Braid injection jig

4.2 Representation of Reality

The tuned frequency and uniform field methods can be seen to present a closer approximation to a typical receiving installation since both the aerial feeder and receiver are subjected to the unwanted field. Also the immunity is found from two like quantities (wanted and unwanted signals are both expressed as incident fields).

The TEM cell can accommodate a coiled aerial feeder but the size of the cell prohibits laying out the feeder in such a way as to represent a typical installation.

The injection technique avoids this problem by modelling on the bench the actual immunity mechanism. It does not account for direct chassis pick-up and the correlation between braid current and incident field needs to be established.

4.3 Repeatability

The tuned frequency method has been in use for some years and has been found to give satisfactory results, although a degree of uncertainty is introduced by the lack of precision in defining the height of the transmitting dipole above the reflecting ground. This results in an uncertainty in the value and uniformity of the field in the vicinity of the receiver under test. The use of the rectifier unit connected to the receiver can also provide an alternative path of entry for induced r.f. currents, although this has been found to have little effect where tuned frequency immunity values do not exceed 30 dB. Inaccuracy and poor repeatability can occur at other unwanted signal frequencies as high values of external immunity require high levels of field strength. Measured values of at least 50 dB can be expected for immunity at other than the tuned frequency.

In the uniform field method a more uniform field is generated and the remote sensor itself overcomes the potential errors of the rectifier unit. Both these factors contribute to an improvement in the accuracy of the measurement.

With the TEM cell a difference in the positioning of the receiver within the cell may result in a distorted field, as may the presence of nearby metallic objects in the parallel plate form of the cell. At higher frequencies, modes other than the TEM can be sustained within the

cell. These factors have a consequent effect on the measured value of immunity.¹³⁻¹⁵

The injection techniques by their simplicity and mode of operation offer a high degree of repeatability where the method is applicable.

4.4 Frequency Range

The tuned frequency method can be used at any tuned frequency in the range 40 to 1000 MHz. The use of the method at frequencies other than the tuned frequency could lead to inaccuracy as mentioned before due to the effect of the rectifier unit possibly becoming significant at frequencies where high values of immunity may be expected.

The uniform field method can be used without difficulty from about 40 to 1000 MHz and has been used in the laboratory at higher frequencies.

In both these methods the highest frequency of operation is limited by the practical problems associated with physically small aerials while use below about 40 MHz is restricted by the size of the measuring site required and the problems of erecting a large adjustable aerial.

The TEM cell method can be used at frequencies down to 10 kHz but the highest operating frequency is restricted to about 200 MHz by the physical dimensions of the cell. Resonances and multimode effects act to distort the uniformity of the generated field within the cell, particularly where the plate spacings are in the order of one wave length. Radio-frequency absorber loaded cells have been used to extend the frequency up to about 500 MHz.¹⁶

The injection techniques are limited to frequencies below about 100 MHz. Apart from practical difficulties in applying the technique at u.h.f., it is known that chassis pick-up becomes increasingly significant with increasing frequency and thus the method is no longer useful.

5 Conclusions

It has been shown that no one method possesses all the attributes of an 'ideal' method.

None of the methods described is expensive in terms of

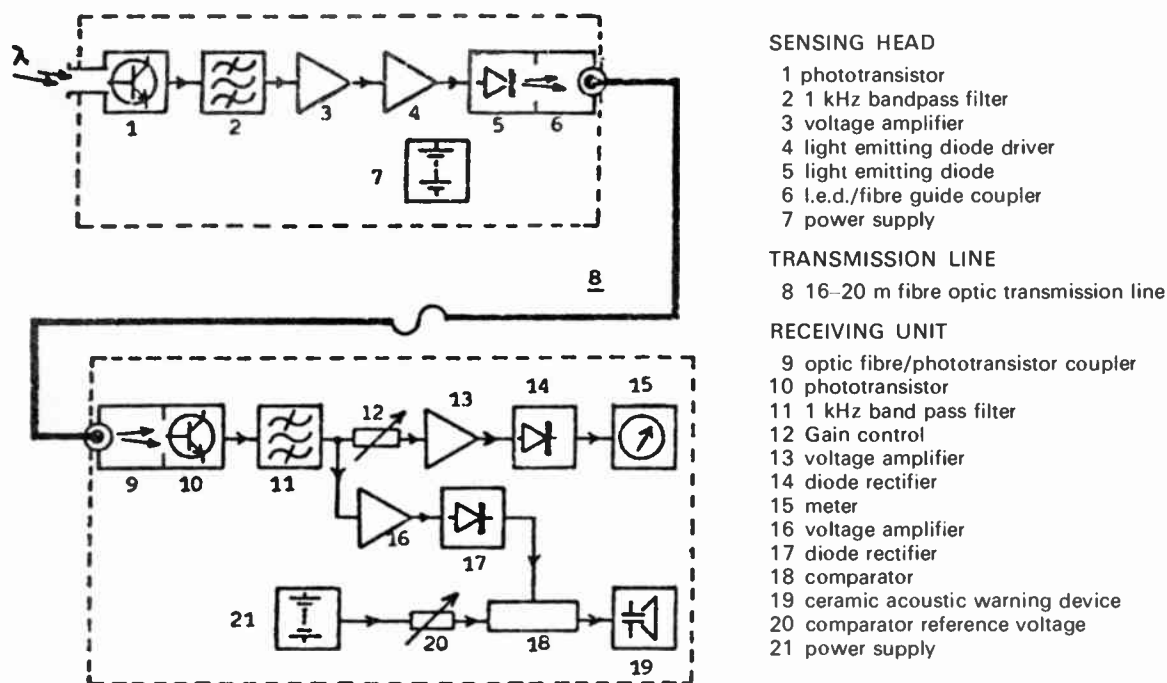

Fig. 4. Block diagram of prototype remote sensor.

equipment cost, measurement time or technician training. However, the provision of an outdoor test site would appear to be significant, most laboratories already involved in television interference measurement being equipped with a suitable site and the test gear needed for carrying out local oscillator radiation measurements.

The advantages of the uniform field method, which may be regarded as an extension of the tuned frequency method, are a good representation of an actual installation and wide frequency range, 40 MHz and above. Its most serious disadvantage is the need to radiate r.f. energy and thus itself be a potential source of interference.

The advantage of the TEM cell are that there is very little spurious radiation and that it can be used for frequencies down to 10 kHz. It also provides screening from ambient signals. However, it does not fully account for the representation of the installation and the maximum useable frequency is limited to about 200 MHz. Further, it is the only method which, because of the inaccessibility of the receiver when in the cell, does not lend itself readily to being a design aid.

The braid injection techniques are quick and simple but are limited to frequencies below 100 MHz.

Most of the techniques that have been described are still being developed with the intention of them being accepted as an international standard. Such a standard will enable television receiver manufacturers to market their products with confidence that they will operate satisfactorily in today's high ambient electromagnetic environment.

At present it would seem that no one method can be developed to adequately cover the entire frequency range 10 kHz to 1 GHz. It is possible that the TEM cell may be adopted for the range 10 kHz–200 MHz and the uniform field method for the range 40–1000 MHz with the braid injection method as a design aid below 100 MHz.

6 Acknowledgment

This paper is presented by kind permission of the Home Office Director of Radio Technology.

7 References

- 1 de Jong, A., 'Measurements of the immunity characteristics of electronic communication equipment', Proc. Intl. Symp. on Measurements in Telecommunications, URSI, Lannion, France, October 1977, pp. 560–2.
- 2 British Standard BS 905:1969, 'Specification for radio interference limits and measurements for television and v.h.f. sound receivers'.
- 3 IEC Publication 106, 2nd Edition, 1974, 'Recommended methods of measurement of radiated and conducted interference from receivers for amplitude-modulation, frequency-modulation and television broadcast transmissions'.
- 4 EIAJ Standard CP 208. 'Measurement of immunity of television receivers from radiated interference'. Engineering Department, Electronic Industries Association of Japan, 1973.
- 5 Hasler, R. J., 'The measurement of external immunity of domestic television receivers some problems and their solution'. 2nd Symp. on EMC, Montreux, June 1977, 77CHI224–5EMC.
- 6 Harry, R. J., 'A remote sensor for immunity measurement'. Conference on Electromagnetic Compatibility, Guildford, April 1978. IERE Conference Proceedings No. 39.

- 7 Crawford, M. L., 'Techniques for measurement of electromagnetic radiation and susceptibility of electronic equipment'. Proc. 1st EMC Symp., Montreux, May 1975, pp. 38-44.
- 8 Meyer de Stadelhofen, J., 'A new device for radio interference measurements at v.h.f.: the absorbing clamp'. IEEE EMC Symp. Record IEEE 69C3-EMC 1969, pp. 189-93.
- 9 Fowler, E. P., 'Superscreened cables', *The Radio and Electronic Engineer*, 49, no. 1, pp. 38-44, January 1979.
- 10 Toler, J. C. and Woody, J. A., 'An analysis of errors in radiated EMC measurements'. Proc. 2nd EMC Symp., Montreux, June 1977.
- 11 Emerson, W. H., 'Electromagnetic wave absorbers and anechoic chambers through the years', *IEEE Trans. on Antennas and Propagation*, AP-21, no. 4, pp. 484-90, 1973.
- 12 Voyner, Z. E. and Draper, D., 'Design and evaluation of the r.f. anechoic chamber at Hawker Siddeley Dynamics'. Workshop on antenna testing techniques ESA/ESTeC, Noordwijk, Holland, June 1977.
- 13 Groenveld, P. and de Jong, A., 'A simple r.f. immunity test set up', 2nd Symp. on EMC, Montreux, June 1977, 77CH1224-5EMC.
- 14 Meyer, G., 'Broadband measuring lines for the generation of homogeneous EM fields'. Proc. Int. Symp. on Measurements in Telecommunications, URSI, Lannion, France, 1977, pp. 552-559.
- 15 Babij, T. M. and Trzaska, H., 'TEM cell—an EMC testing tool'. Proc. 4th Wroclaw EMC Symp., Wroclaw, Poland, September 1978.
- 16 Crawford, M. L., *et al.*, 'Expanding the bandwidth of TEM cells for EMC measurements', *IEEE Trans. on Electromagnetic Compatibility*, EMC-20, no. 3, pp. 368-75, August 1978.

Manuscript received by the Institution on 10th March 1979
(Paper No. 1911/M112)

The Authors



Robert Harry studied at the Welsh College of Advanced Technology, Cardiff, and worked for some years in the Engineering Department of the Post Office. In 1972 he joined the Radio Interference Branch of the Home Office Directorate of Radio Technology where he has been involved with radio interference measurement and suppression techniques. He has served on several radio interference sub-committees of the

British Standards Institution and has also been a member of the International Electrotechnical Commission Working Group concerned with the measurement of the immunity of audio and receiving equipment to interference.

R. J. Hasler formed the consultant engineering company, Applied Radiation Laboratories, last year and deals with electromagnetic problems of all types including aeriels and electromagnetic compatibility. He was previously for 3 years with the Directorate of Radio Technology at the Home Office.

Data compression techniques and applications

G. BENELLI, Ph.D.*

Professor V. CAPPELLINI, D.Sc.*

and

F. LOTTI, Ph.D.†

SUMMARY

Several data compression methods are reviewed for signal and image digital processing and transmission, including both established and more recent techniques. Methods of prediction-interpolation, differential pulse code modulation, delta modulation and transformations are examined in some detail. The processing of two-dimensional data is also considered.

Results of the application of these techniques to space telemetry and biomedical digital signal processing and telemetry systems are presented.

Some of the considerations and comparison criteria presented, even though not completely general because extracted from experimental results, can be useful in selecting and defining the more pertinent data compression system for the different practical applications.

* *Istituto di Elettronica, Facoltà di Ingegneria, Firenze, Italy.*

† *Istituto di Ricerca sulle Onde Elettromagnetiche, C.N.R., Firenze, Italy.*

1 Introduction

In recent years a problem of increasing importance has been recognized in the large amount of data to be handled in different areas and to be transmitted from one place to another. Indeed in space and ground telemetry systems, in communications, in biomedical signal processing and transmission, an increasing amount of data obtained through analogue-to-digital conversion of signals or images is to be processed and transmitted.

A new research and application area was therefore opened in the 1960s called data compression which can be defined as meaning any operation or transformation to reduce the amount of transmitted data. An inverse transformation, data decompression, is usually applied to the recovery of the original data.

Many methods and algorithms have been studied, defined and applied to perform data compression operations. As a general classification they can be divided in two main groups: reversible methods, which permit, at least in principle, the recovery through decompression of all the original information; irreversible methods, which do not permit the recovery of all original data and which introduce some information loss or distortion.

Another important aspect of data compression applied to data transmission (telemetry, communications etc.) is concerned with the method of data reduction which is used. Two solutions are in general followed to take the best advantage for transmission by the data reduction: (i) decreasing the transmission power, (ii) decreasing the communication bandwidth, usually termed bandwidth compression.

In this paper we review the most important methods and techniques of data compression, pointing out their actual impact in digital signal processing, data transmission and telemetry systems. (Speech data compression, e.g. vocoding systems, will not be covered directly, apart from some techniques of interest for data transmission and telemetry.) Theoretical aspects will first be recalled, limited however to the concepts strictly necessary to establish a general synthesis and classification of the different practical techniques and approaches which follow.

A brief description is also given of the application of data compression to two-dimensional data or image processing. Some typical applications are finally presented in areas of especial practical importance.

2 Information Theory and Data Compression

Figure 1 illustrates the mode of operation of a data compression system in a digital communication link, where the source output is assumed to be a digital signal.

The transmission of the numerical data is accomplished by means of pulse code modulation (p.c.m.) requiring in general a very large bandwidth. In fact the number of pulses per second to be transmitted is

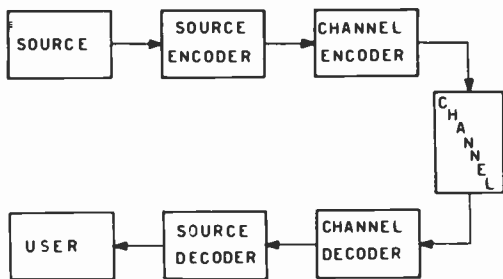

Fig. 1. A digital communication system with source and channel encoding.

a function both of the number of samples and of the number of bits necessary to represent each sample (word).

To reduce this large number of pulses per second (and consequently the bandwidth) it is necessary, as already pointed out, to introduce data transformation represented by data or bandwidth compression. Such a transformation can be considered as one which operates on the data given by an information source, reducing the amount of non-useful or redundant data and hence the bandwidth needed to transmit the required data through the available communication link.

The third block in Fig. 1 in the transmission chain represents the encoding of the compressed data in such a way to reintroduce suitable redundancy to protect the encoded signal against the degradation introduced by the channel (error control coding, error detection and correction). This kind of encoding is known as channel encoding and is to be distinguished from the source encoding which is effected by the second block in Fig. 1, namely the transformations applied to the source symbols to obtain data compression.

Channel encoding is indeed useful after source encoding because the compressed data are in general more sensitive to the communication channel noise than the non-compressed ones, due to the fact that at the receiver the signal is reconstructed using a lower number of samples. An error in the compressed data will generally introduce a considerable amount of distortion. For this reason it is necessary to protect the compressed data by using channel encoding (error control coding).

Data compression can also be a very useful tool in local processing systems which do not involve any data transmission but where it is necessary to process or to store a great number of data or to set up information retrieval systems.

2.1 Entropy

The theoretical basis of data compression depends on Shannon's first theorem on the noiseless coding of information.^{1, 2, 3} Given a zero memory source S emitting the symbols s_1, s_2, \dots, s_q with the corre-

sponding (independent) probabilities p_1, p_2, \dots, p_q , we can define the entropy of the source under the above conditions:

$$H(S) = \sum_{i=1}^q p_i \log_2 \frac{1}{p_i} \quad (1)$$

where the log is taken to the base 2 because measurement is in bits.

Several properties of the $H(S)$ function are described in Refs. 4 and 5. To underline one of these we may introduce the concept of wordlength of the source codeword.

Each of the symbols s_1, s_2, \dots, s_q can be mapped into a fixed sequence of k symbols taken from a finite alphabet $X = \{x_1, x_2, \dots, x_k\}$. This corresponds to encoding each symbol s_i into a codeword X_i belonging to the set $\{X_1, \dots, X_q\}$ and having length l_i . We can now define the average length \bar{L} of this transformation (code):

$$\bar{L} = \sum_{i=1}^q p_i l_i \quad (2)$$

Such a code is said to be compact for that source if its average length is less than or equal to that of any uniquely decodable code.† Searching for compact codes means that \bar{L} must be made as small as possible.

Thus from eqns. (1) and (2), the following important property of $H(S)$ can be proved:

$$H_r(S) \leq \bar{L} \quad (3)$$

where $H_r(S)$ is given by (1) but with logarithm to the base r .

According to eqn. (3) the entropy of the source is a lower bound for the code average length, and the ratio

$$\eta = \frac{H_r(S)}{\bar{L}}$$

is defined as the efficiency of the source code, while $(1 - \eta)$ is the redundancy.

A data compression method can be therefore considered as a transformation of the source data with an average length \bar{L} as near as possible to $H_r(S)$.

One important method of developing compact codes is due to Huffman:⁴ the length l_i of each word X_i is inversely related to the value of p_i .

In this way the more probable and therefore the more frequent words will be encoded in shorter sequences compared to the less probable ones. The $H(S)$ obtained from (1) can be used to evaluate an upper bound for the mean compression ratio:

$$C_r = \frac{\bar{L}_S}{\bar{L}} \quad (4)$$

\bar{L}_S and \bar{L} being the source and encoded mean wordlengths respectively. \bar{L}_S is a constant value due to

† By definition in that case each codeword X_i corresponds to only one symbol s_i .

the specific source, therefore the maximum value for C_r is obtained for \bar{L} minimum. From (3) and (4) we have:

$$\max C_r = \frac{\bar{L}_S}{H_r(S)} \quad (5)$$

It is important to remember that equations (3), (4) and (5) depend on the hypothesis of perfect reversibility of the compressed signal, which is expanded to give back the original signal with zero errors.

A higher value for C_r than that expressed by (5) can only be obtained by introducing a certain amount of distortion in the reconstructed signal. In the latter case the process is said to be irreversible and the number of errors introduced depends upon several parameters (such as tolerances, threshold values, apertures, etc.) which are specific to the particular data compression method.

When however perfect retrieval of the original data is necessary, only those algorithms can be applied which, under suitable conditions, maintain the entropy and give a zero error reconstruction: they are usually classified as reversible.

The main interest of these considerations lies with the fact that in most practical applications perfect reproduction of the source signal is not required or, in other words, a certain number of errors can be accepted in order to increase the compression ratio. If this is the case it can be convenient to reconstruct the signal at the user end with sufficient fidelity, thus allowing the use of the reversible algorithms to give a higher efficiency.

Among the reversible methods most frequently found in the literature are:

- adaptive sampling
- Fourier analysis and multiple filtering, covering the complete spectrum
- Karhunen-Loeve expansion
- predictors (adaptive and non-adaptive)
- interpolators (adaptive and non-adaptive)
- encoding

and among the irreversible algorithms:

- power spectrum
- parameter extraction
- thresholding

2.2 Channel Capacity

A communication system like that of Fig. 1 is characterized by two main quantities: the channel capacity C and the rate-distortion D . To quantify mathematically the concepts of capacity and distortion, we first briefly recall some general results of information theory.

The entropy (eqn. (1)) can be considered as the average information associated with the emission of a source symbol. Let the output alphabet reproducing the source be $\{B\}$ with r symbols then $\{B\} = (b_1, b_2, \dots, b_r)$

and $p(b_i)$ is the probability of the symbol b_i . Mutual information can be defined as a function of the source symbols $(s_i) \subseteq S$ and of the received symbols $(b_i) \subseteq B$, as:

$$I(S, B) = \sum_{S, B} p(s_i, b_j) \log \frac{p(s_i/b_j)}{p(s_i)p(b_j)} \quad (6)$$

and it represents the average information obtained from the emission of a symbol s_i when b_j is known.

$I(S, B)$ is a non-negative \cup convex function of the probabilities $p(s_i)$ and it always admits a maximum. This maximum, taken over all the possible choices of the source probability distribution $p(s_i)$ is called the channel capacity C :

$$C = \max_{p(s_i)} I(S, B) \quad (7)$$

In fact, if $H(S) < C$, it is always possible to find a channel coding method for transmission on a noisy channel, such that the error probability at the receiver is lower than an arbitrary small quantity. However this could imply the use of a prohibitively long code, which is not of practical usefulness.⁶

2.3 Rate-distortion Function

To introduce the rate-distortion function it is first necessary to measure the distortion.

Let a vector \mathbf{x} with n components of the source alphabet $\mathbf{x} = (x_1, x_2, \dots, x_n)$, $x_i \in S$, be encoded in a vector $\mathbf{y} = (y_1, y_2, \dots, y_n)$ with $y_i \in B$. We denote with $\rho_n(\mathbf{x}, \mathbf{y})$, called the word distortion measure, the distortion obtained by representing \mathbf{x} with the vector \mathbf{y} .

The criteria to define mathematically $\rho_n(\mathbf{x}, \mathbf{y})$ depend on the signal and on its user. An often-used measure of distortion, specially suitable for memoryless systems, is the single-letter fidelity criterion, where $\rho_n(\mathbf{x}, \mathbf{y})$ is the arithmetic mean of the single distortions introduced by representing x_i with y_i , i.e.:^{2, 7}

$$\rho_n(\mathbf{x}, \mathbf{y}) = \frac{1}{n} \sum_{i=1}^n \rho(x_i, y_i) \quad (8)$$

For channels with memory more complex definitions are needed to measure distortion and in general these are very difficult to deal with.

In many cases the single letter fidelity measure is utilized as a first approximation for systems with memory. From eqn. (8) the overall average distortion d will depend on the conditional probabilities $p(y_i/x_i)$ and it is given by:

$$d = \sum_{S, B} p(x_i)p(y_i/x_i)\rho(x_i, y_i) \quad (9)$$

When d turns out to be less than a prefixed quantity D , the conditional probability $p(y_i/x_i)$ is called D -admissible.

Now we can define the rate-distortion function $R(D)$ as the minimum of the average mutual information:^{2, 7}

$$R(D) = \min_{\substack{p(y_i/x_i) \\ D\text{-admissible}}} \sum_{A, B} p(x_i)p(y_i/x_i) \log \frac{p(y_i/x_i)}{p(y_i)} \quad (10)$$

where the minimum is taken over all the possible conditional probabilities that are *D*-admissible.

In eqn. (10) *R(D)* is expressed in bits per source letter using logarithm to the base 2.

3 Data Compression Methods

As pointed out in the previous Section, most of the algorithms studied can return the reconstructed signal with a limited amount of distortion with respect to the original signal. This non-reversible data compression is still very useful in practical applications.

The highest compression ratios are indeed obtained only by tolerating a certain degree of distortion.

In the following the operational principles of several types of algorithms are described without regard to their reversibility.^{8, 9, 10}

3.1 Data Compression Algorithms with Prediction or Interpolation

Algorithms using prediction or interpolation are very important in data compression: many studies and applications have been developed with them.⁸⁻²¹

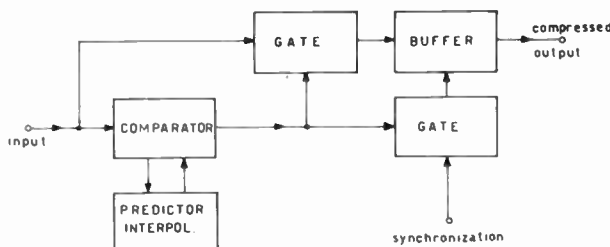

Fig. 2. A typical data compression system with prediction or interpolation.

In the prediction methods *a priori* knowledge of some previous samples is used, while in the interpolation methods *a priori* knowledge both of previous and future samples is utilized. In both types of operations the most widely applied methods consist in comparing the predicted or interpolated sample with the actual sample. If the difference is less than a pre-set error tolerance the actual sample is not transmitted. Otherwise the actual sample is transmitted.

In Fig. 2 the block diagram of a typical data compression system with prediction or interpolation is shown. The non-redundant samples (i.e. the samples for which the prediction or the interpolation fails) are fed into a buffer to be reorganized at constant time intervals with the time position identification necessary for the

reconstruction of the data from the compressed samples. The important role of the buffer is therefore to store the incoming aperiodic samples, so that they can be sent out at a uniform rate. In this way, while at the input of the buffer we have bit compression, at its output we have also bandwidth compression.

In the following we will use the symbols *C_b* and *C_a* to indicate the average compression ratios respectively with and without including the bits added for the time identification (synchronization).

3.1.1 Data compression algorithms using prediction

These algorithms are based on polynomial predictors: a finite difference technique by means of which an *n*th order polynomial can be passed through (*N*+1) data points. Predicted data are obtained by extrapolation of the polynomial, one unit at a time. A polynomial

$$y(t) = a_0 + a_1t + a_2t^2 + \dots + a_nt^n \quad (11)$$

may be fitted to the data points by means of the difference equation:^{9, 10, 11}

$$y_{pn} = y_{n-1} + \Delta y_{n-1} + \Delta^2 y_{n-1} + \dots + \Delta^N y_{n-1} \quad (12)$$

where:

y_{pn} = predicted sample at time instant *t_n*

y_{n-1} = sample value at the sampling instant prior to *t_n*

$\Delta y_{n-1} = y_{n-1} - y_{n-2}$

.....

$\Delta^N y_{n-1} = \Delta^{N-1} y_{n-1} - \Delta^{N-1} y_{n-2}$

The value of *N* corresponds to the order of the prediction algorithm: with *N* = 0 we obtain the zero-order predictor and with *N* = 1 the first-order predictor.

(a) Zero-order predictor (z.o.p.)

Several types of procedure can be followed applying this algorithm. In the z.o.p. with fixed aperture the dynamic range of the data is divided into a set of fixed tolerance bands with a width of 2δ. Let *y_{n-1}* be the last transmitted sample: *y_n* is not transmitted when it lies in the same tolerance band. The most interesting z.o.p. algorithm is the one with floating aperture (Fig. 3),

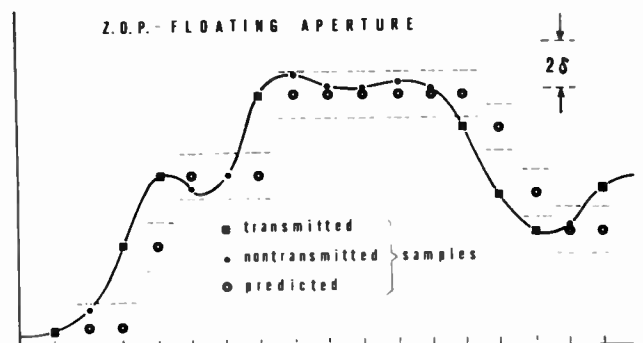

Fig. 3. Principle of zero-order predictor.

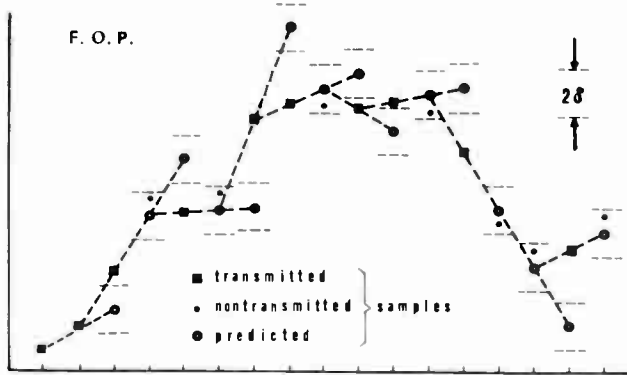

Fig. 4. Principle of first-order predictor floating aperture.

where a tolerance band $\pm \delta$ is placed about the last transmitted sample. If the following sample lies in this band, it is not transmitted. In this case the next samples are compared again with the value of the last transmitted sample $\pm \delta$ and so on. Another method is the z.o.p. with offset aperture,⁹ in which the predicted sample is $y_{pn} = y_{n-1} \pm \epsilon$, where ϵ is a prefixed quantity. If the last transmitted sample is out of tolerance in the positive direction, the sign $+$ is used and vice versa.

(b) First-order predictor (f.o.p.)

In the f.o.p. algorithm (Fig. 4) with floating aperture the first two data points are transmitted and a line is drawn through them, placing an aperture $\pm \delta$ about the obtained line.¹³ If the actual sample y_n is within this aperture, it will not be transmitted and the line will be extrapolated for a following time interval and so on.

3.1.2. Data compression algorithms using interpolation

These algorithms differ from the corresponding ones with prediction due to the fact that with interpolation both past and future data points are used to decide whether or not the actual sample is redundant.^{9, 10, 15}

The more interesting algorithms, based on low-order interpolation, are the following.

(a) Zero-order interpolator (z.o.i.)

Let us suppose that y_n is the generic sample from which the procedure starts. Considering Fig. 5, a tolerance band of width $2K$ is placed about each y_n . An analogous tolerance band is placed about the following sample y_{n+1} . We can have two situations:

- (i) the two tolerance bands have a part in common (intersection band);
- (ii) the two tolerance bands have no part in common.

In the first situation each horizontal line (parallel to t axis) included in the common part (intersection band) is distant less than K from the points y_n and y_{n+1} and hence its two points corresponding to the time instants t_n and t_{n+1} can represent the samples y_n and y_{n+1} with an error

less than or equal to K . In the second situation such a horizontal line does not exist and the sample y_n is transmitted. Going back to the first situation, let us consider the subsequent sample y_{n+2} and the corresponding tolerance band placed about it; if this tolerance band has a part in common with the intersection band corresponding to y_n and y_{n+1} , each horizontal line included in the common part can still represent, with its points corresponding to the time instants t_n, t_{n+1}, t_{n+2} , the samples y_n, y_{n+1}, y_{n+2} with an error not greater than K . We do not transmit these samples and the procedure can be extended to subsequent data points until they are in the above described conditions as y_n and y_{n+1} (Fig. 5). When the band placed about the current sample does not cover the intersection band of the previous ones, the current sample becomes the first point in a new processing step and the mean value of the updated intersection band will be transmitted to approximate the previous (redundant) samples.

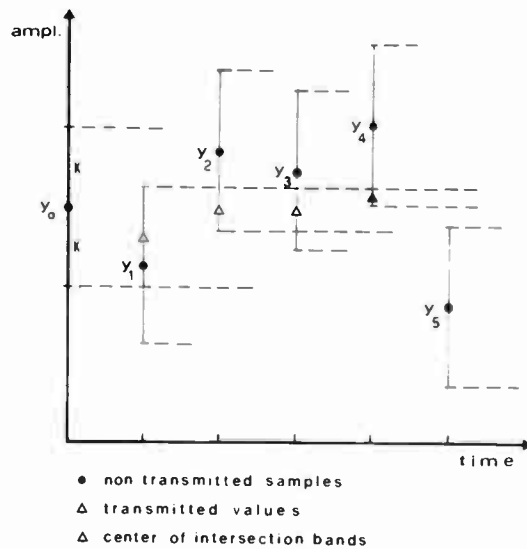

Fig. 5. Principle of zero-order interpolator (z.o.i.).

(b) First-order interpolator (f.o.i.) with two degrees of freedom (f.o.i.d.s.)

Let the process start from the generic sample y_n and consider the next one y_{n+1} , as shown in Fig. 6. Let us set up the points $y_{n+1} \pm K$ and connect them with the data point y_n . Going then to y_{n+2} , connect the points $y_{n+2} \pm K$ with y_n . The two angles thus obtained have the vertex in common and can have a non-zero intersection angle. If the above intersection angle is non-zero, each line passing through y_n and completely contained in the intersection angle can represent, with its points corresponding to the time instants t_{n+1} and t_{n+2} , the samples y_{n+1} and y_{n+2} with an error not greater than K . Those samples are therefore not transmitted, until the intersection angle is non-zero. When it does not occur,

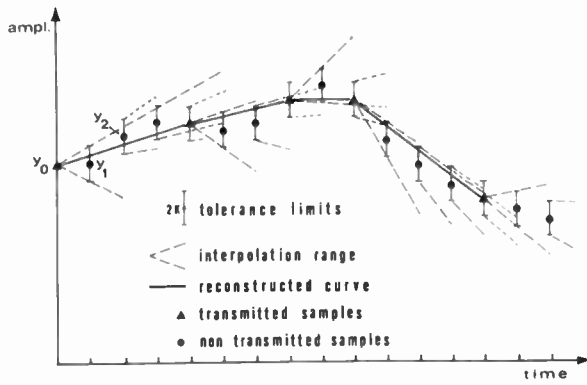

Fig. 6. Principle of first-order interpolator (f.o.i.), joint line segment.

for example, at the sample y_r ($r = 5$ in Fig. 6) we can follow two processing ways: (i) the process starts again, transmitting y_{r-1} and taking it as the new initial point (joined line segment method); (ii) the process starts again taking the next actual data sample y_r as the new initial point and transmitting it (disjoined line segment method).†

In general prediction or interpolation algorithms with a degree higher than 1 are rarely used. In fact, in many cases these algorithms, which require a more complex equipment, do not perform so well as zero and first-order algorithms. Limited experiments with second-order predictors, as reported by Lockheed Missile & Space Co. in Reference 12, have shown that this algorithm is even more sensitive to noise perturbations than the first-order predictors.

3.1.3 Adaptive methods

In some cases, when the prediction or interpolation algorithms are not very efficient, due for example to the high activity of the input signal, it can be convenient to use some prediction algorithms, which adapt themselves to the signal time evolution.

Such algorithms can be subdivided into linear and non-linear ones depending on the method used for the adaptive prediction.^{18, 20}

In the adaptive linear prediction (a.l.p.), the predicted sample $y_p(t_n)$ is evaluated by a linear weighting of M previous samples:

$$y_p(t_n) = \sum_{j=1}^M \beta_j y(t_{n-j}) \tag{13}$$

where β_j are suitable weighting coefficients.^{9, 18} If the prediction error falls within a given threshold value γ , the actual sample is not transmitted. If the process is a stationary Gaussian time series with zero mean, the coefficients β_j can be determined so to minimize the mean square prediction error given by:

† It was found (in Agena experiments¹²) that the joined method can lead to oscillating situations.

$$\sigma^2\{M, N\} = \frac{1}{N} \left\{ \sum_{k=1}^M y(t_{n-k}) - \sum_{j=1}^M \beta_j(M, N)y(t_{n-k-j}) \right\}^2 \tag{14}$$

M being the number of the preceding samples which are stored for the prediction, and N the number of samples which the predictor uses to learn the signal time evolution. The method turns out to be advantageous as long as the statistical characteristics of the signal, estimated during the N -point learning time, are maintained. Some problems arise when the signal changes significantly when a long succession of uncorrected predictions can occur.

An example of how to overcome these difficulties is given by the following technique.⁹ A counter is used to measure the number of consecutive predictions affected by error; when this number exceeds a prefixed value T , a new set of M coefficients is again computed and the algorithm goes back T samples. Of course, once the algorithm has gone back, if again more than T predictions fail in such way as to require for the same time period a further coefficient computing, the latter is inhibited to avoid closed loops. It is convenient to select N to be not too large in order to permit the predictor to adapt itself to the statistical evolution of the data, neither too small in order to have an acceptable value for σ in eqn. (14).

In some cases it is convenient to use a non-linear adaptive prediction.^{18, 20, 21} In this case the mean square prediction error to be minimized can be set in the form:

$$\sigma^2\{M, N\} = \frac{1}{N} \left\{ \sum_{k=M+1}^{M+N} y(t_n) - \sum_{j=1}^M \beta_j(M, N)y(t_{k-j}) \right\}^2 \tag{15}$$

where

$$x(t_k) = \begin{cases} y(t_k) & \text{if } \left| y(t_k) - \sum_{j=1}^M \beta_j(M, N)y(t_{k-j}) \right| > \gamma \\ \sum_{j=1}^M \beta_j(M, N)y(t_{k-j}) & \text{if } \left| y(t_k) - \sum_{j=1}^M \beta_j(M, N)y(t_{k-j}) \right| \leq \gamma \end{cases} \tag{16}$$

3.2 Differential Pulse Code Modulation

In this Section we describe the differential pulse code modulation technique (d.p.c.m.) which has many applications and has received great attention for its efficiency and flexibility shown in many cases.²²⁻³² The general block diagram of a d.p.c.m. is shown in Fig. 7.

In the d.p.c.m. technique a predicted sample \hat{y}_n is evaluated through a linear weighting of the M past samples y_n :¹⁹

$$\hat{y}_n = \sum_{i=1}^M a_i y_{n-i} \tag{17}$$

The predicted samples can be obtained using any of the prediction algorithms like z.o.p., f.o.p., a.l.p., etc. The difference e_n between the actual sample and the predicted one is quantized with quantization intervals of amplitude Δ and encoded for transmission in a codeword L_w bit long. If the correlation of the input signal is high and provided that the weighting coefficients are correctly chosen, d.p.c.m. generally offers a higher efficiency with respect to p.c.m. In general, with an equal number of bits, the signal-to-quantization noise ratio (s.n.r.) is higher than for the p.c.m., or with an equal s.n.r., the d.p.c.m. requires a lower number of bits.

The gain G in the s.n.r. of d.p.c.m. with respect to p.c.m. can be expressed by:²⁸

$$G = \frac{E[y_n^2]}{E[e_n^2]} = \frac{E[y_n^2]}{E[(y_n - \hat{y}_n)^2]} \quad (18)$$

where $E[y_n^2]$ is the variance of y_n .

In general the variance of the difference $y_n - \hat{y}_n$ is lower than that of the signal y_n and we have an effective improvement of the s.n.r. using d.p.c.m. To maximize G , it is necessary to choose suitable coefficients a_i of the predictor to minimize the variance of the difference $e_n = y_n - \hat{y}_n$.

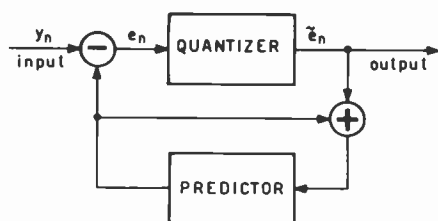

Fig. 7. Block diagram of differential pulse code modulation system.

Many workers consider the optimization of the system in Fig. 7 by minimizing the denominator of (18). McDonald²³ computed a relation for the quantization noise in a d.p.c.m. system, using a sampling frequency $f_s = 2B$ (B = signal bandwidth), for $L_w > 3$ and considering a noiseless channel. Noll³¹ has presented some experimental results on the gain G as a function of the predictor coefficients for a speech signal. In this case the basic d.p.c.m. does offer a good performance with respect to p.c.m. Nevertheless, when non-stationary signals are processed, and the predictor fails, there may be large peak errors in the reconstructed data.

To avoid the above errors and to improve the efficiency, many adaptive d.p.c.m. techniques (a.d.p.c.m.) were studied.²⁹⁻³⁴ In the adaptive d.p.c.m. technique the step amplitude Δ of the quantization interval is changed, following the signal evolution. The Δ value becomes small when the signal is quiescent and vice versa. In this way an increase of the accuracy is obtained in the reconstructed samples during the quiescent intervals of the signal.

Xydeas²⁹ and Jayant³⁰ studied the Δ variations to

obtain for the speech signal the maximization of the s.n.r. with respect to p.c.m. with adaptive quantization. However, also with a.d.p.c.m. the improvement obtained may become apparent only when large variations of the signal follow quiescent periods. In this case Δ can assume a very low value and before having time to become comparable with the difference signal, large errors can arise.

The work of Jayant uses only adaptive quantization, while Noll³¹ considers also adaptive prediction.

For the basic and adaptive d.p.c.m. the compression ratio is given by:

$$C_b = L_p/L_w \quad (19)$$

where L_p is the p.c.m. word length. Another way to modify this algorithm, to permit in general higher efficiency with respect to the basic d.p.c.m., is the use of variable word length d.p.c.m. (v.w.l. d.p.c.m.).⁹ In this algorithm it is first necessary to know the amplitude distribution of the differences $y_p(t_n)$ and $y(t_n)$ for each t_n and then Huffman encoding is applied.⁴ The mean compression ratio is:

$$C_b = L_p/\bar{L}_H \quad (20)$$

where L_p is the p.c.m. word length and \bar{L}_H is the mean word length given by eqn. (2).

This method always permits exact reconstruction of the signal and the best compression ratio.^{9, 35} Nevertheless, in general the implementation of the v.w.l. d.p.c.m. can be complex and the necessary knowledge of the statistical distribution of the signal can be a difficult condition to meet. An estimate of the probability distribution of the input signal values can be substituted for the exact one: an errorless reconstruction is still obtained, but with lower compression ratios.⁹

The third interesting modification of d.p.c.m. is asynchronous d.p.c.m.^{34, 35} With this algorithm the length of the prediction interval (M) is determined by the signs and values of the past m differences between the predicted and the actual values. If the past m differences turn out to have the same sign and maximum value, then the prediction frequency is increased by a factor x . If the past m differences have alternating signs ($- + - \dots$) then the prediction frequency is decreased by a factor x .

The compression ratio for asynchronous d.p.c.m. is:

$$C_b = N_m L_p / N_t L_w \quad (21)$$

where N_m and N_t are respectively the number of input and transmitted samples.

3.3 Delta Modulation

The delta modulation (d.m.) technique can be considered as a d.p.c.m. with a 1-digit code.^{36, 40} In delta modulation the changes in the signal amplitude between consecutive sampling instants are transmitted in place of the absolute signal amplitude. These changes are sent in the form of binary pulses whose sign (+ or -)

Fig. 8. Block diagram of delta modulation system.

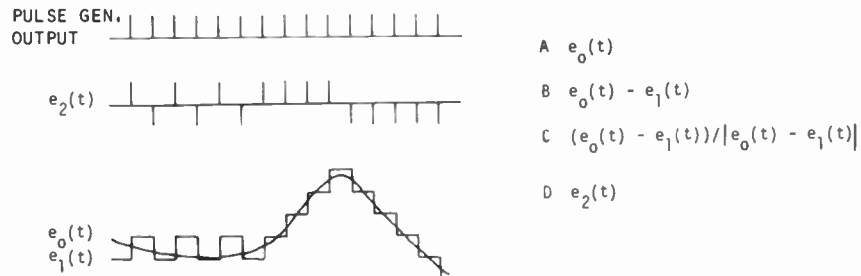
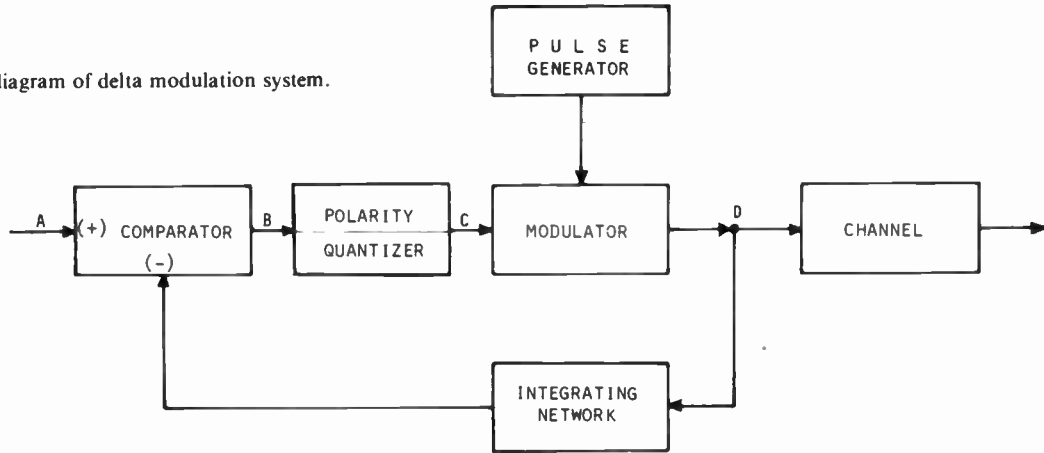

depends on the sign of the change in amplitude (Fig. 8). In classical delta modulation a single binary pulse is transmitted at each sampling period instead of a complete codeword, as in p.c.m. The output pulse sequence is in this case synchronous with the input word stream, yielding a constant compression ratio. Different types of d.m., encoding asynchronous pulse sequences, are described later. An increase (often also considerable) in the error of the reconstructed data is however to be seen in two effects:

- (a) the approximation of the signal to a step function (granular or quantization noise);
- (b) delta modulation cannot follow with accuracy quick variations of the signal, i.e. the variations for which the gradient of the sampled data exceeds the limit value

$$G = \Delta r \tag{22}$$

where Δ is the change in amplitude that a transmitted pulse represents and r is the rate of the pulse transmission (slope-overload distortion).

The effect on the reconstructed data of these two classes of error has been studied in many works.³⁷⁻⁴³ O'Neal³⁹ computes the s.n.r. in d.m. versus the Δ value, and $F = f_0/2B$, where f_0 is the d.m. sampling frequency and B is the bandwidth of the signal. These results were obtained for Gaussian signals with uniform power spectrum. De Jager³⁶ has presented some results for sinusoidal signals. For both classes of signals the s.n.r. in d.m. presents a maximum, whose value depends on F .

The Δ for which s.n.r. is maximum is the optimum value for the signal for a fixed F . De Jaeger found that the maximum increases approximately as the cube of the sampling frequency.

The simple implementation of delta modulation has encouraged many studies to increase the efficiency of this algorithm.

A first method is based on change of the step amplitude, according to the signal variations. This technique can be subdivided into two classes: instantaneous companding or high information delta modulation (h.i.d.m.) and syllabic companding d.m.

In h.i.d.m. the step amplitude is increased when a given number N of consecutive pulses have the same binary value and it is decreased in the contrary case.^{44, 48}

The more simple method is to use two consecutive binary pulses to vary the Δ step amplitude.

Figure 9 represents the behaviour of a particular example of h.i.d.m. applied to a step signal. In this case the criterion followed to implement the algorithm was based on the sign sequence of the previous three pulses. In practice only two bits were necessary to store the corresponding sign variations, according to the following scheme:

pulse sign sequence	past difference bits	next step amplitude	next pulse sign
+++ or ---	0 0	$\times 2$	unchanged
++- or --+	0 1	: 2	changed
+-+ or -+-	1 1	: 2	changed
+-- or -++	1 0	constant	unchanged

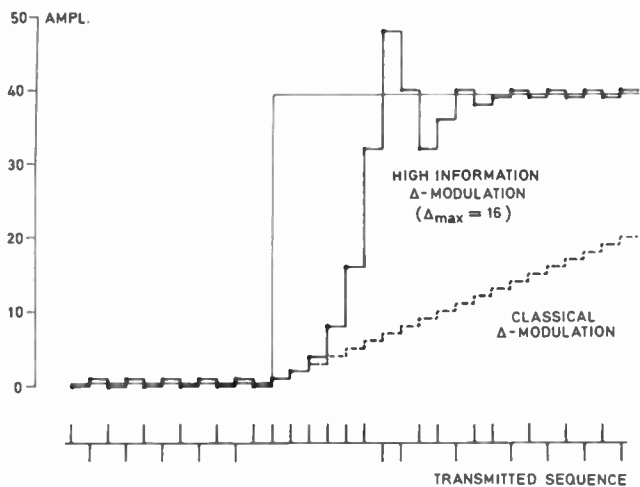

Fig. 9. Typical behaviour of high information delta modulation applied to a step function.

If Δ is the ratio between the Δ values at the instant n and at $n-1$, Jayant⁴⁵ has shown that for many signals the optimum ratio $\Delta_{r(opt)}$ is

$$1 < \Delta_{r(opt)} < 2 \quad (23)$$

In particular, for speech signals, $\Delta_{r(opt)}$ turns out to be equal to 1.5. To avoid large peak errors during high activity periods of the signal, a maximum value (Δ_{max}) is fixed for the step amplitude.

In syllabic companding d.m. the step amplitude Δ varies slowly and it is dependent on the envelope of the input signal.^{49, 50} This technique is useful for speech signals, while the h.i.d.m. technique is more convenient for signals with rapid variations, such as telemetry and television.

Another interesting modification of the classical d.m. algorithm is basic asynchronous d.m.⁹ In this method the sampling rate is increased during the periods of high data activity and it is decreased when the data show

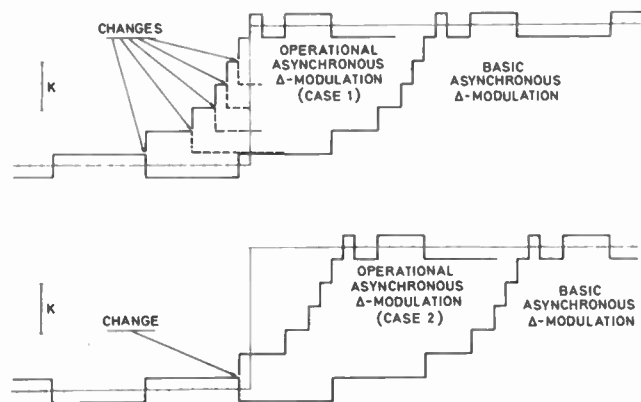

Fig. 10. Typical behaviour of basic asynchronous d.m. and operational asynchronous d.m. applied to a step function.

lower activity (Fig. 10). This method gives good efficiency in processing with many types of signals. Also with asynchronous d.m. large peak errors can result when a quick variation of the signal occurs and the algorithm is applied to low sampling frequencies. In these cases, indeed, a given number of samples is required before reaching the maximum sampling frequency, which is necessary to resolve the discontinuity. To avoid these errors, a modification of basic asynchronous d.m. was proposed by Pryke *et al.*,⁹ namely operational asynchronous delta modulation. In this procedure whenever the difference between the input and reconstructed samples exceeds a preset tolerance value, the algorithm goes back m samples and inverts the Δ value, adjusting the sampling period appropriately. In Fig. 10 the behaviour of operational d.m. is shown for comparison together with basic asynchronous d.m. in two typical cases encountered while processing a step function. The sign changes of the Δ value are shown for the case $m = 2$. The algorithm requires suitable inhibition commands to avoid closed loops.

In general for many signals this method offers high efficiency compared to the other d.m. algorithms.

Many other modifications of the classical d.m. can be found in the literature. We briefly recall the $\Delta-\Sigma$ modulation^{51, 52} and multistage d.m.⁵³ which can be useful in some cases.

3.4 Some Other Compression Algorithms

Another method of obtaining data compression consists in preprocessing the input digital signal by means of a linear orthogonal transformation (Fig. 11) and suitably encoding the transformed output to reduce the amount of information to be transmitted. The user, after an inverse transformation, will recover the original signal with a certain degree of error.

Some well-known transformations, most of them already applied in the practice, are: Fourier, Walsh, Hadamard, Haar, Karhunen-Loeve.^{54, 55, 56} For some of them special computer algorithms have been developed to make their program execution times shorter (fast algorithms), and the results of these are particularly useful in digital processing.

The encoding techniques applied to the transformed signal (spectrum) depend on the particular application, since each class of signals has peculiarities in its spectrum. In principle each of the above mentioned algorithms (predictors, interpolators, etc.) could be employed to compress the transformed signal. In practice only certain techniques can give useful results.

As an example we can think of a signal made up of a few sinewaves which could show a low efficiency when compressed by a predictor. The Fourier spectrum of this signal will show only few lines corresponding to the main input components, the rest of the spectrum being very

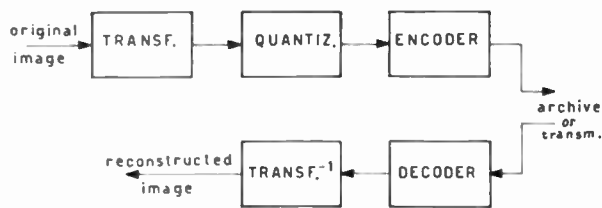

Fig. 11. Use of a linear orthogonal transformation to obtain data compression.

near to zero. Such a spectrum could be so highly compressed to justify the complicated processing of the whole algorithm.

For these reasons many *ad hoc* techniques have been studied for encoding the transformed signal such as threshold annihilation, variable word-length encoding (v.w.l.) and local means.

In threshold annihilation methods a selection is made of the sample in the transformed domain by eliminating those components which are below a given threshold value. The v.w.l. method, referred to previously (Sect. 3.2), consists of codewords of different length according to a prefixed law, which assigns a smaller number of bits to the most frequent messages. In the local means method the average value of a suitable number of components is encoded in place of the transformed samples.

The Haar, Walsh and Hadamard transforms find their largest application in the field of image processing for two-dimensional data compression (Sect. 6).

Some other interesting techniques, which can be useful in some cases, are bit-plane encoding (run-end and run-length encoding),^{57, 58} the logarithmic counters, and the use of the spline functions.⁵⁹ In the latter method compression is obtained by representing the compressed signal by means of linear segments. The line segments are chosen by minimizing the r.m.s. error between the estimated signal and the original one, taking into account the noise variance through statistical methods. An advantage of this method is that together with data compression a reduction of noise components is also accomplished.

Finally, we recall some interesting data compression methods using digital filtering and decimation. They are in general based on the extraction of a given frequency band through digital filtering and subsequent decimation of samples toward the minimum value required to represent the considered limited bandwidth. Two methods are of particular interest: the former uses a single low-pass digital filter and a frequency shift of the sampled signal spectrum to perform, in many steps, a band-pass analysis with a reduction of the sample number by a factor 2 at each step;⁶⁰ the latter method (complex demodulation, or complex envelope detection) consists of an algorithm which uses a digital Hilbert filter to extract the complex envelope of a limited bandwidth signal by using in-phase and quadrature components

and approaching the theoretically minimum number of sampling data.⁶¹

3.5 The Buffer

As already observed (Sect. 3.1 and Fig. 2), the design of the buffer will avoid two unfavourable working conditions: (a) underflow, which corresponds to a state where the buffer is too empty (caused by the selection of a too high value of the output data rate); (b) the overflow, which corresponds to a state where the buffer is too full (output data rate too low).⁶²⁻⁶⁴

A simple way to avoid these error conditions is to control the amplitude tolerance, increasing it when the buffer becomes too full and diminishing it in the contrary case.

Another approach is to insert an adaptive pre-compression low-pass digital filter: the cut-off frequency is diminished when the buffer is in overflow state and it is increased for the underflow state.

The schematic structure of an adaptive data compressor using the above controls for a single data channel is shown in Fig. 12. Here a decision circuit can control, through a buffer fullness sensor, both the amplitude tolerance of the bit compressor and the cut-off frequency of the digital filter, depending on the actual state of the buffer.

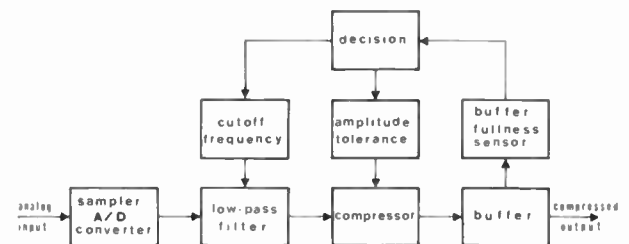
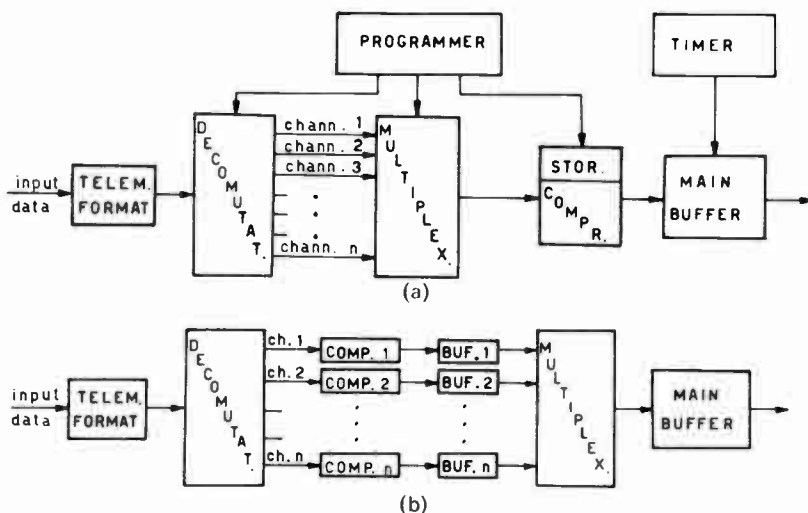

Fig. 12. Scheme of an adaptive data compression system, using two types of buffer control.

In a communication system using data compression on many channels, design of the buffer can represent a crucial point. Figures 13(a) and (b) illustrate, as an example, two different approaches that can be followed in the particular case of a space telemetry data communication link from a receiving ground station to the operation centre. In Fig. 13(a) a programmer unit sends commands to the multiplexer to keep a suitable number of samples, from each channel having different sampling rates, to be sent to a compressor unit for the application of the selected algorithm. The number of samples collected by the multiplexer will be such that the corresponding time intervals of the incoming data will be the same for each channel. The output of the compressor is sent to the main buffer in an asynchronous way, while a timer unit will provide the synchronous pulses for the output.

Fig. 13. Two possible schemes to implement a multichannel data compression and buffering system for ground communication links.



Different algorithms can also be used with this scheme: the programmer and compressor units can be designed to select the algorithm for each channel, together with the number of samples. The compression unit must also be designed with care, in order to store the status of compression each time the multiplexer switches off a channel to enter the other one. A suitable memory (a few words per channel) will be used to store the current situation (status word) of each channel after the interrupts occurred.

However, in this case, the scheme of Fig. 13(b) can be more advantageous when separate compression units are considered, operating on the decommutated signals, which process in the same time interval different numbers of samples, according to the sampling rates. The status words are stored in the compressors themselves.

Small-size buffers are necessary to hold the compressed data waiting for collection by the multiplex unit, which sends the compressed data to the main buffer asynchronously.

3.6 Timing

In some compression methods time synchronization is always maintained by the intrinsic strategy of the algorithm. For example, in the d.m. technique the bit output stream contains all the necessary elements to reconstruct the compressed signal.

For other algorithms like predictors and interpolators, it is necessary to insert into the output signal (i.e. after each transmitted sample) a suitable identification word to give the exact time position of each received sample. The most commonly used methods are:

- (a) time information represents the number of the non-transmitted samples;
- (b) time information identifies the temporal position of the transmitted samples.

Obviously the final compression ratio (C_b) includes the bits necessary to transmit the time information.

In general, method (b) requires a higher number of bits than method (a). Nevertheless in real transmissions on noisy channels method (b) is less sensitive to channel errors.

Higher efficiency can be obtained in some cases, using a variable word-length for the time identification words, with suitable encoding for synchronization.

4 Application of Data Compression to Signal Processing: Experimental Results and Comparisons

Among the most important application areas of data compression we can consider the following:

- space telemetry and communication systems;
- data transmission;
- biomedical signal-image processing and telemetry;
- Earth resource evaluation (processing of images from aircraft and satellites) (see Sect. 6).

As regards space telemetry systems the data compression is required on-board the satellite to transmit many scientific experiment data to ground through a limited bandwidth channel.^{9, 34, 65}

An example of the processing of a space telemetry signal (received from *ESRO 1A* satellites) using the z.o.p. with fixed aperture is shown in Fig. 14. At the bottom of the Figure is shown the original signal. Over this diagram a certain number of reconstruction curves is presented corresponding to the different tolerance values used. In Fig. 15 are shown, for the same signal, the corresponding compression ratio C_a (time insertion has not been taken into account), the r.m.s. and the peak errors as a function of the normalized aperture (tolerance). In References 9 and 10 analogous figures are shown, as those here described, concerning predictors, interpolators, d.p.c.m. and delta modulation.

Many techniques developed for similar applications to

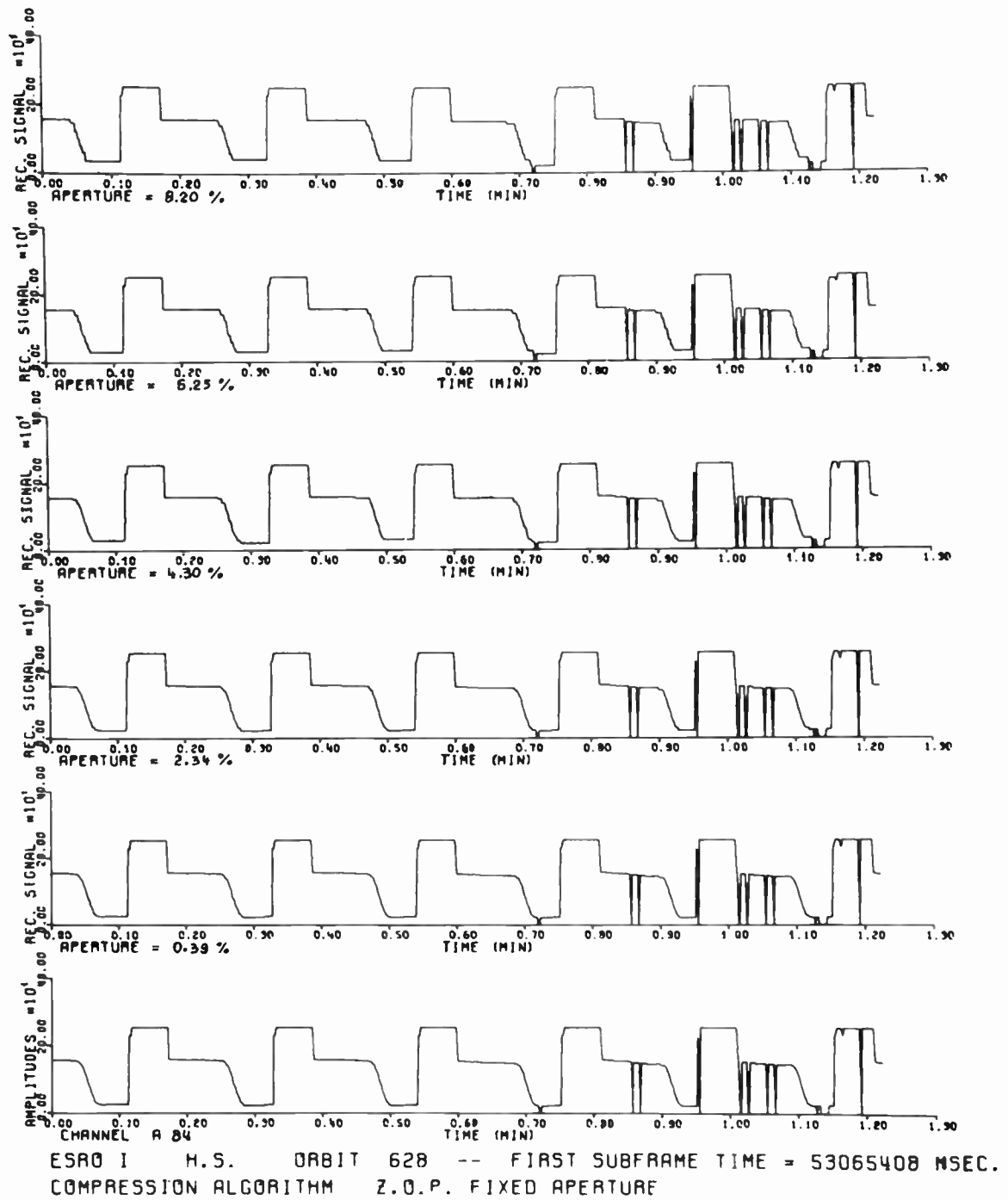

Fig. 14. Example of application of z.o.p. (fixed aperture) to ESRO IA satellite telemetry signals.

those listed above can be easily extended to ground data transmission and ground telemetry links. In particular data exchange between computer centres is of increasing importance and a number of practical applications are in operation, using simple data compression algorithms.

Data compression of biomedical signals is interesting both for telemetering the biomedical data (e.c.g., e.e.g., etc.) taken at single clinical points (e.g. at the bedside) to a unique control and computer centre, and for storing near the patient or in the control centre the biomedical

data of patients.

An example of application of the zero order predictor with floating aperture to e.c.g. signals is shown in Fig. 16.^{59, 66}

In Fig. 17 the method of the spline functions (see also Sect. 3.4) is shown applied to e.c.g.⁵⁹ In the example reported in the Figure a compression ratio of $C_a = 2.78$ was obtained (time identification bits were not included), with an r.m.s. error of 0.55% and a peak error of 1.75%. A smoothing effect with a good signal quality is evident.

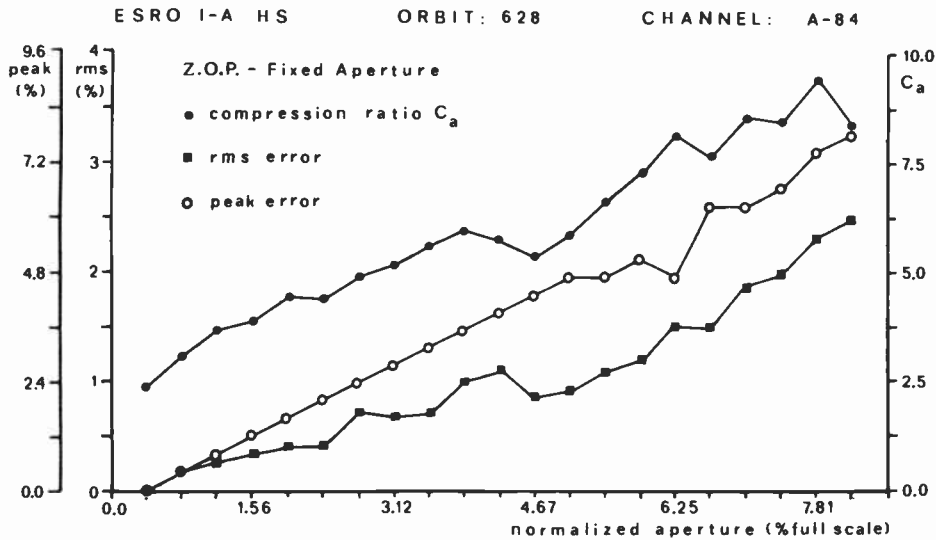

Fig. 15. Efficiency curves for the signal of Fig. 14.

Figure 18 shows the method of complex demodulation, as described in Section 3.4, applied to an e.g. signal.⁶¹

In recent years remote sensing by using satellites and aircraft has become practical for land use, Earth resources and energy investigations. A very large amount of data is obtained by satellite images and aircraft photographs. Data compression seems to be an important solution to handling and reducing these data (see Sect. 6).

A crucial point for practical application of data compression methods is the selection of the best algorithm for the data involved.

The efficiency of any data compression system indeed depends on the characteristics of the signals but in general it is impossible to decide theoretically the most suitable compression method. Usually comparisons are made experimentally for each class of signals. To compare the performances of the compression algorithms mathematically the parameters most often used are: (i) the compression bit ratio C_a , defined as the ratio between the bit number necessary to transmit the non-compressed data and the bit number necessary to transmit the compressed data, including the time information; (ii) the root mean square error (r.m.s.); (iii) the peak error, expressed as percentage of the signal dynamics. Subjective testing is also widely used in practice, but it suffers from the limitation that comparisons are difficult.

In the following the general characteristics of the most interesting compression algorithms are presented and some typical results are shown and compared, using the above mathematical criteria, based on the study of compression techniques to be applied to different ESA satellite telemetry data sets.

Through time and frequency analysis it was possible to

classify these data into the following six classes having different behaviour (Fig. 19).

- (a) data with constant or nearly constant value (e.g. data corresponding to the monitoring of switch positions);
- (b) periodic data, including data constituted by a few sinewave components (e.g. physical data with nearly constant values obtained through an interrogation or scanning method);
- (c) slowly varying data (e.g. temperature or battery conditions);
- (d) data resulting from the combination of periodic and slowly-varying components (e.g. data with a periodic component caused by the spinning movement of the satellite);
- (e) random data;
- (f) data with strong isolated active periods at regular or irregular time intervals (physical data with bursts or spikes).

Tables 1, 2 and 3 present synthetic comparisons of the efficiency of the most interesting algorithms. The six columns correspond to the six classes of signals (a), . . . (f), as mentioned above and each row to a specific algorithm.

The maximum and minimum values of the compression ratio C_a (see Sect. 3.1) are reported, considering only those data sets giving reconstruction errors below the limits reported in the last row (expressed as percentage of the maximum signal dynamics).

Table 1 shows a comparison of the results obtained for the prediction or interpolation algorithms. For data with simple time behaviour, the most simple algorithms such as zero and first-order predictors (z.o.p., f.o.p.) and zero and first-order interpolators (z.o.i., f.o.i.) give very good

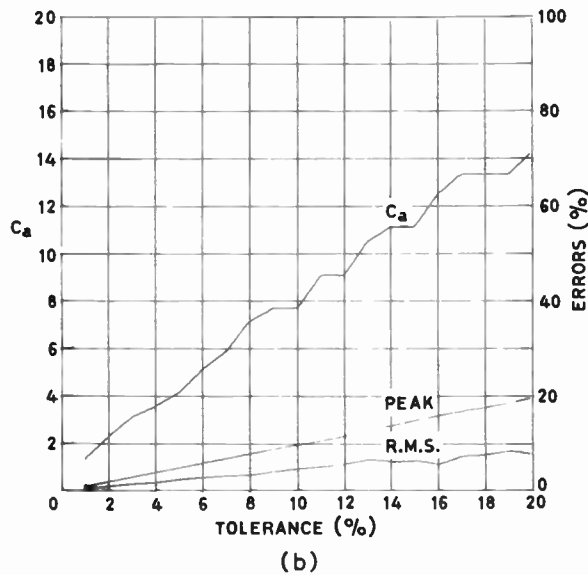
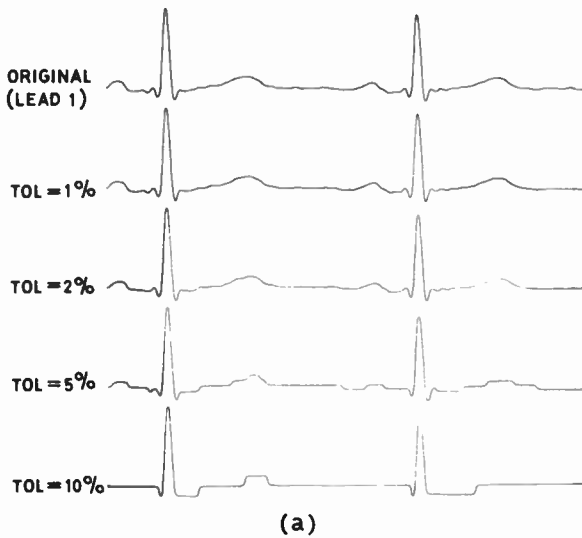

Fig. 16. Application of z.o.p. with floating aperture to e.c.g. signal, (a) original and reconstructed waveforms for different values of the tolerance, (b) compression ratio (C_a) and per cent errors.

results. In many cases a high compression ratio (> 10) with low r.m.s. and peak errors ($< \text{few } \%$) can be obtained. In general the z.o.i. offers the best efficiency, followed by the f.o.i. (disjoint) and by the z.o.p. with floating aperture. The adaptive linear prediction (a.l.p.) algorithm shows a lower efficiency than the interpolators.

In Table 2 the results of the application of some d.p.c.m. algorithms are shown using the same sets of input signals. CR_1 denotes (as in Table 1) the theoretical lower bound of the compression ratio. In adaptive d.p.c.m. the following criteria were adopted for the variations of the quantization interval amplitude Δ :

- (a) The Δ value is doubled after a full-scale value

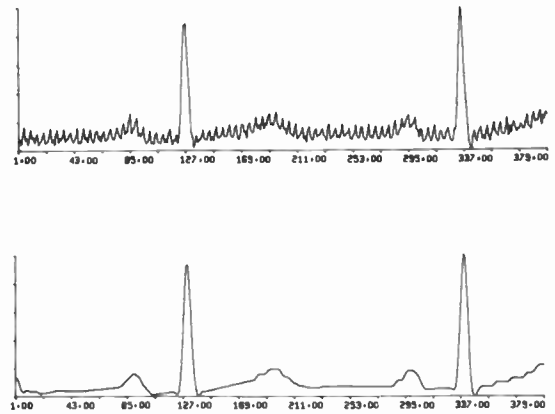

Fig. 17. Example of compression by application of spline functions to e.c.g. signal. (a) original, (b) reconstructed. $C_a = 2.78$, r.m.s. error = 0.55%, peak error = 1.73%.

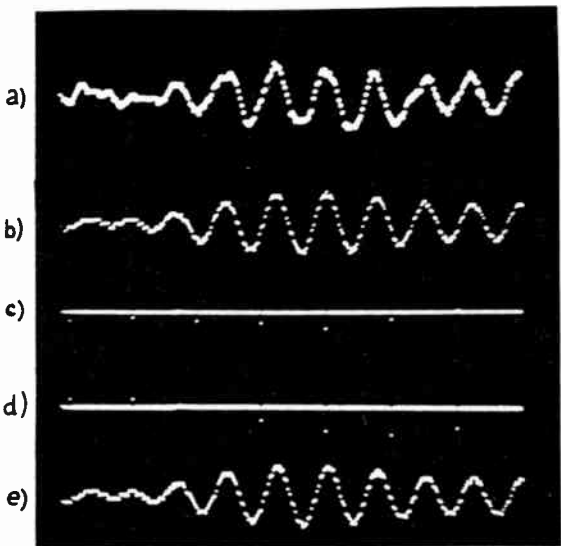

Fig. 18. Results of complex demodulation method applied to e.e.g. signal as reported in Ref. 61. (a) original, sampled at 96 Hz; (b) 6 to 14 Hz band (digitally filtered); (c) in-phase samples; (d) quadrature samples; (e) reconstructed signal (6-14 Hz).

(maximum absolute amplitude of the transmitted word), which indicates an increasing activity of the signal.

- (b) The Δ value is halved after two consecutive null values are transmitted or a reversal of sign occurs in two consecutive words, whose absolute value is equal to 1 (quiescent signal).
- (c) The actual value of Δ ranges between two extreme values Δ_{\min} and Δ_{\max} , where Δ_{\max} is equal to that for the basic d.p.c.m. and

$$\Delta_{\min} = \frac{D_{\max}}{2^n} \quad (24)$$

where D_{\max} is the dynamic range of the d.p.c.m. maximum difference and n is the integer which satisfies

the relation:

$$\frac{D_{max}}{2^{n-1}} > q \geq \frac{D_{max}}{2^n} \quad (25)$$

and q is the d.p.c.m. quantization interval.

In a manner analogous to those for the asynchronous d.p.c.m. the criteria for the sampling period assignment were the following:

- (a) The maximum sampling frequency (F_{max}) is set equal to that of p.c.m.
- (b) The frequency is decreased by a factor 2 ($x = 2$) after two consecutive samples whose amplitude (absolute value) is equal to 1 and opposite in sign.
- (c) The frequency is increased by a factor 2 after a full scale (negative or positive) is transmitted.

Three different tests are shown, using three different ranges for the frequency ratio between the p.c.m. and d.p.c.m. sampling frequency. Setting

Test 1: $f_{min} = 1, f_{max} = 4, f = 1,2,4$

Test 2: $f_{min} = 1, f_{max} = 8, f = 1,2,4,8$

Test 3: $f_{min} = 1, f_{max} = 16, f = 1,2,4,8,16$

$$(f_{min} \leq f < f_{max}).$$

From Table 2 it is clear that asynchronous d.p.c.m., followed by f.o.p., offers the best compression ratio (up to 25), as happens in general with all the asynchronous techniques. The only limitation is that, without special controls, the algorithm does not respond to spikes,

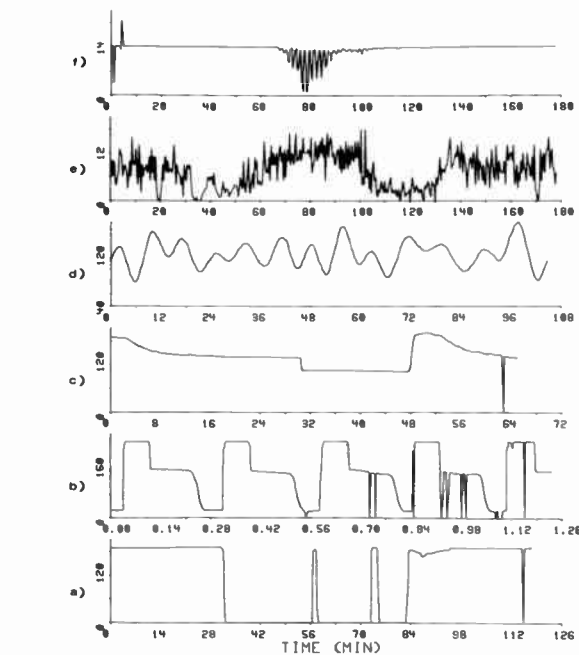

Fig. 19. Example of typical classes of space telemetry signals.

especially after a quiescent period, which increases the sampling period.

In basic and adaptive d.p.c.m. techniques the best results are obtained for the low dynamic channels. In the adaptive d.p.c.m. large peak errors (more than 50%)

Table 1

Results of prediction and interpolation algorithms applied to six typical space telemetry data channels

C_a = compression ratio (minimum and maximum values)
 A_p = absolute apertures (minimum and maximum values)
 CR_1 = theoretical lower bound of the compression ratio.

Channel	A 25 (a)	A 84 (b)	A 82 (c)	A 74 (d)	D 20 (e)	A 31 (f)
Algorithm	$CR_1 = 18.9$	$CR_1 = 6.8$	$CR_1 = 18.7$	$CR_1 = 5.2$	$CR_1 = 2.5$	$CR_1 = 4.2$
Z.O.P. fixed	C_a 8.3-34.3 A_p 1-14	C_a 2.4-6.6 A_p 1-14	C_a 6.8-40.9 A_p 1-10	C_a 3.6-9.5 A_p 2-5	—	C_a 2.2-7.0 A_p 2-15
Z.O.P. floating	C_a 14.8-39.2 A_p 1-13	C_a 3.9-9.0 A_p 1-12	C_a 15.0-59.1 A_p 1-9	C_a 4.0-9.7 A_p 1-3	C_a 2.8 A_p 3	C_a 4.1-9.3 A_p 1-10
Z.O.P. offset	C_a 12.0-37.0 A_p 1-12	C_a 3.4-9.0 A_p 1-12	C_a 15.2-59.1 A_p 1-10	C_a 5.7-11.1 A_p 1-3	C_a 2.6 A_p 3	C_a 2.4-8.9 A_p 1-9
F.O.P. floating	C_a 5.8-17.7 A_p 1-13	C_a 2.9-5.1 A_p 1-13	C_a 2.4-10.3 A_p 1-8	C_a 2.5-3.7 A_p 1-3	—	C_a 2.7-6.1 A_p 1-12
Z.O.I.	C_a 18.8-42.1 A_p 1-11	C_a 4.5-10.2 A_p 1-10	C_a 20.1-76.0 A_p 1-8	C_a 6.1-16.4 A_p 1-3	C_a 3.1-5.1 A_p 2-3	C_a 4.9-13.6 A_p 1-11
F.O.I. disjoint	C_a 13.4-21.9 A_p 1-13	C_a 3.7-7.5 A_p 1-12	C_a 19.0-59.1 A_p 1-11	C_a 7.1-15.4 A_p 1-4	C_a 4.1 A_p 4	C_a 3.3-8.1 A_p 1-12
A.L.P.	C_a 9.8-22.0 A_p 1-13	C_a 2.1-3.2 A_p 1-12	C_a 12.4-44.3 A_p 1-9	C_a 2.0-13.0 A_p 1-4	C_a 2.1-2.9 A_p 2-3	C_a 2.1-7.6 A_p 1-12
Maximum r.m.s. error	2%	2%	2%	1%	1%	2%
peak	5%	5%	5%	1.5%	1.5%	5%

Table 2

Results of d.p.c.m. applied to the same data as in Table 1

C_a = compression ratio; L_w = word length; CR_1 = theoretical lower bound of compression ratio. An asterisk indicates that peak error can assume values up to 50% of the p.c.m. full scale. (°) = zero errors.

Algorithm		Channel	A 25 (a)		A 84 (b)		A 82 (c)		A 74 (d)		D 20 (e)		A 31 (f)	
			$CR_1 = 18.9$		$CR_1 = 6.8$		$CR_1 = 18.7$		$CR_1 = 5.2$		$CR_1 = 2.5$		$CR_1 = 4.2$	
Basic z.o.p.	C_a		1.60	1.14	1.33	1.14	1.60	1.14	4.00	2.66	2.00	1.60	1.60	1.14
	L_w		5	7	6	7	5	7	2	3	4	5	5	7
Basic f.o.p.	C_a		1.60	1.14	1.60	1.14	1.60	1.14	4.00	2.67	2.67	1.33	2.00	1.14
	L_w		5	7	5	7	5	7	2	3	3	6	4	7
Basic a.l.p.	C_a		1.60	1.14	—	—	1.60	1.14	4.00	2.66	2.00	1.60	1.60	1.14
	L_w		5	7	—	—	5	7	2	3	4	5	5	7
Adaptive z.o.p.	C_a		—	—	—	—	1.33	1.14	4.00	2.66	2.66	1.60	1.33	1.14
	L_w		—	—	—	—	6	7	2	3	3	5	6	7
Adaptive f.o.p.	C_a		—	—	—	—	1.33	1.14	4.00	2.66	2.66	1.33	2.66	1.14
	L_w		—	—	—	—	6	7	2	3	3	6	3	7
Adaptive a.l.p.	C_a		—	—	—	—	1.33	1.14	4.00	2.66	2.00	1.60	2.00	1.14
	L_w		—	—	—	—	6	7	2	3	4	5	4	7
V.w.l. (°) z.o.p.	\bar{C}_a		5.84	2.96	6.20	4.42	2.00	2.35						
V.w.l. (°) f.o.p.	\bar{C}_a		5.44	2.73	5.26	4.51	1.69	1.91						
V.w.l. (°) channel	\bar{C}_a		3.29	1.70	2.18	1.75	1.96	2.34						
Asynchronous f.o.p. Test 1	C_a		—	—	—	7.11	5.01	7.68	3.31	—				
	L_w		—	—	—	2	3	4	6	—				
Asynchronous f.o.p. Test 2	C_a		—	—	—	8.09	5.23	14.23	4.25	—				
	L_w		—	—	—	2	3	4	6	—				
Asynchronous f.o.p. Test 3	C_a		—	—	—	8.66	5.23	24.80	4.90	—				
	L_w		—	—	—	2	3	4	6	—				
Maximum error	r.m.s.		2%	2%	2%	1%	1%	1%	2%					
	peak		5%	5%	5%	1.5%	1.5%	1.5%	5%					

appear when processing channels of classes (a) and (b) (Fig. 19), mainly due to the sharp amplitude variations on their waveforms.

The v.w.l. d.p.c.m. shows good results for many channels, also for highly dynamic channels and permits exact reconstruction of the signal. However, v.w.l. d.p.c.m. techniques present in general a higher implementation complexity.

In Table 3 the results are shown which have been obtained from the application of various delta modulation techniques to the six classes of signals already mentioned. In this case the C_a value is also the final compression ratio of the transmission chain, any time insertion being unnecessary.

The results presented for basic asynchronous d.m. are

obtained using the following criteria for the frequency sampling variations:

- (a) The sampling frequency f_r is varied between two extreme limits:

$$\text{MIN} \leq f_r \leq \text{MAX} \tag{26}$$

- (b) f_r is doubled, if possible, after a change in the sign of the transmitted pulses.
- (c) f_r is halved, if possible, after the pulse signs have remained unchanged.

An important problem is the choice of the frequency variations and of the minimum and maximum sampling frequency.

Three tests were performed with $\text{MIN} = 1$ and

Table 3

Results of delta modulation applied to the same data as in Table 1

FR = interpolation rate.
 Δ = step amplitude.
 C_a = compression ratio.
 CR₁ = theoretical lower bound of compression ratio.

Channel \ Algorithm	A 25 (a) CR ₁ = 18.9	A 84 (b) CR ₁ = 6.8	A 82 (c) CR ₁ = 18.7	A 74 (d) CR ₁ = 5.2	D 20 (e) CR ₁ = 2.5	A 31 (f) CR ₁ = 4.2
	FR Δ C _a	FR Δ C _a	FR Δ C _a	FR Δ C _a	FR Δ C _a	FR Δ C _a
Classical	8 8 1	8 16 1	8 8 1	8 8 1	8 8 1	8 8 1
	8 16 1	16 8 0.5	8 16 1	16 4 0.5	16 4 0.5	8 16 1
	16 4 0.5	16 16 0.5	16 16 1	16 4 0.5	16 8 0.5	16 16 1
	16 8 0.5		16 8 0.5			16 16 0.5
H.I.D.M.			4 8 2			4 8 2
			4 16 2			4 16 2
	8 4 1	8 4 1	4 32 2			8 4 1
	8 4 1	8 8 1	8 4 1			8 8 1
	8 16 1	8 16 1	8 8 1	8 4 1	8 4 1	8 8 1
	16 2 0.5	16 2 0.5	8 16 1	16 2 0.5	8 16 1	8 16 1
	16 4 0.5	16 4 0.5	8 32 1	16 4 0.5	16 2 0.5	16 2 0.5
	16 8 0.5	16 8 0.5	16 2 0.5			16 4 0.5
	16 16 0.5	16 16 0.5	16 4 0.5			16 8 0.5
			16 8 0.5			16 16 0.5
		16 32 0.5				
Basic asynchronous Test 1	16 16 2.0 16 8 1.9	16 16 1.8	8 32 4.0 16 4 2.0	16 4 2.0	—	8 32 3.8 16 4 1.6
Basic asynchronous Test 2	—	—	8 32 7.8 16 4 3.8	16 4 3.8	—	8 32 7.0 16 4 2.8
Basic asynchronous Test 3	—	—	8 16 15.3	16 4 7.3	—	8 8 14.3 16 4 3.9
Operational asynchronous Test 1	8 16 3.7 16 8 1.9	8 16 3.4 16 8 1.7	8 32 4.0 16 4 2.0	16 4 1.9	16 4 1.8	8 16 3.5 16 4 1.6
Operational asynchronous Test 2	16 16 3.6 16 8 3.4	16 16 3.3 16 8 2.9	8 16 7.8 16 4 3.8	16 4 3.8	16 4 3.4	8 16 5.9 16 4 2.5
Operational asynchronous Test 3	16 16 6.7	—	8 8 14.7 16 4 7.3	16 4 7.3	—	8 8 7.5 16 4 3.5
Maximum r.m.s. error peak	2% 50%	2% 50%	2% 50%	2% 3%	2% 3%	2% 50%

MAX = 4,8,16 respectively.

Also for the operational asynchronous d.m. the sampling frequency varies between two extreme values (MIN and MAX), as for the basic asynchronous case and three tests were performed with MIN = 1 and MAX = 4,8,16.

In Table 3 FR is the ratio d.m.-to-p.c.m. sampling frequency. The results show the good performance of operational asynchronous d.m. in many cases, also for the signals of the type (e), where the other techniques are

in general not efficient. Also basic asynchronous d.m. shows a good performance in the case of test 1 (typically C_a = 4), while for tests 2 and 3, a very low number of cases gives errors within the prefixed limits.

Also the h.i.d.m. technique offers good performance in some cases.

An overall evaluation of these and other algorithms, with an indication of implementation complexity, is shown in Table 4.

Although related to the analysis of typical space

Table 4
Summary of the algorithm performances

Algorithm	Types of signals giving the best results	Efficiency	Hardware complexity	Software complexity	Buffer requirements (words)
Power spectrum (f.f.t.) followed by z.o.p./fl.	periodic signals with few sine wave components	good	high	medium	2^N ($N = 6, \dots$)
Power spectrum (f.f.t.) followed by thresholding	narrow band and high S/N ratio signals	good	high	medium	2^N ($N = 6, \dots$)
Zero order predictor floating aperture	quiescent, nearly constant value, slowly varying data	very good	low	low	1
Adaptive linear predictor (r.m.s.)	any type; random or burst data give bad results	good	high	medium	4-60
Adaptive non-linear† predictors (r.m.s.)	any type; random or burst data give bad results	good	high	medium	4-60
Zero order interpolator	quiescent, nearly constant value, slowly varying data	very good	high	low	1
First-order interpolator	any type; random or burst data can give bad results	very good	high	low	2
Huffmann encoding	quiescent, nearly constant value, slowly varying data	almost good	high	medium	2^N ($N = 10, \dots$)
Differential p.c.m.	slowly varying data for classical d.p.c.m.; any type for adaptive methods	almost good	low	medium	2
Delta modulation	quiescent, nearly constant value, slowly varying data	good	low	medium	1-6
Run length encoding	quiescent, nearly constant value, slowly varying data	very good	low	low	1
Bit plane encoding	quiescent, nearly constant value, slowly varying data	good	low	low	2^N ($N = 10, \dots$)
Hadamard transformation	any type	almost good	low	low	2^N ($N = 2, \dots$)
Hadamard transformation followed by z.o.p./fl.	any type	very good	low	low	2^N ($N = 2, \dots$)

† Experienced only on few *ESRO 1A-LS* channels (A76, A59, A57, A01)

telemetry signals, the above considerations and results can be extended to different source signals which behave like the six considered classes of input data.

Other theoretical and experimental comparisons exist in the literature, in particular for the speech signals. We recall the work of Jayant⁴⁶ who reported signal-to-noise ratio versus bit rate for: (i) adaptive d.p.c.m. using a f.o.p.-like predictor; (ii) h.i.d.m. using two-bit memory; (iii) log-p.c.m. The h.i.d.m. presents a higher efficiency than the log-p.c.m. at low bit rates, while the log-p.c.m. behaves better at high bit rates.

5 Effect of Channel Errors on Compressed Data and Coding Techniques

In general the compressed data are more sensitive to channel noise than normal data.⁸ Also the different compression techniques are influenced differently by the errors. It is often very difficult to compute the effects of the errors in the compressed data. A preliminary theoretical study on this problem was made by Lynch⁶⁷ and Massey.⁶⁸

In the algorithms using prediction or interpolation, an

error in the samples introduces t_i errors, where t_i is the time information following the non-predicted samples. Also an error in the time information produces a translation of the reconstructed sequence. It is clear, from this, that it is in general useful, and sometimes necessary, to use channel encoding in the transmission of compressed data on a noisy channel to obtain at the receiver an acceptable distortion.

Most of the papers available in the literature dealing with the data compression problem disregard the channel characteristics, assuming noiseless transmission. As an example to show the importance of the channel noise on the efficiency of a communication system with data compression, we briefly present some results obtained by a computer simulation of a channel with memory.⁶⁹ The channel noise simulation was obtained through the Gilbert model, which describes very well the behaviour of some channels with memory, for example telephone lines.⁷⁰

To characterize the behaviour of the compression system, we present the results relative to four structures: the uncompressed-uncoded (UU), compressed-uncoded

(CU), uncompressed-coded (UC) and compressed-coded (CC) systems. In the coded systems a Samoylenko binoid code⁷¹ for burst-error correction was utilized. These codes afford a simple and fast software implementation, together with a good performance also using a general-purpose computer.† In the simulation we have used a binoid code of the type (90, 80) able to correct bursts with length $b \leq 5$ in the $GF(31)$, which corresponds, in binary transmission, to a code of the type (450, 400) for bursts up to 21 binary digits.

Different test signals were used: taking for instance as transmitted signal an electrocardiogram and using a z.o.p. algorithm with floating aperture, we obtained, for a tolerance $2\delta = 1\%$, a r.m.s. error $EM = 1\%$ (both 2δ and EM expressed as a percentage of the full scale). In general the first time information method of Section 3.6 gave a higher compression ratio, but it was more sensitive to channel errors than the second one.

In fact the time information sequence t_i is strictly increasing and many channel errors can be detected, i.e. the errors for which the sequence t_i is not increasing. In this case it is also possible to correct approximately some errors in the sequence t_i . In fact if an error changes t_i to a value t'_i , such that $t'_i > t_{i+2}$ or $t'_i < t_{i-2}$, but $t_{i+1} < t_{i+2}$ and $t_{i-1} > t_{i-2}$, then the received t'_i value has a high probability of error and it can be substituted for a mean between t_{i-1} and t_{i+1} . This method offers in general good performances in transmission over channels without memory. Nevertheless, in the case of burst errors, this method is not very good. In fact several consecutive t_i are often corrupted by the bursts and therefore the necessary conditions to correct the value of that wrong are not verified and many new errors can be introduced during the previous correction of erroneous t_i . In Ref. 72 a strategy is described, called COSYDAI (compression with synchronization control and data interpolation), which enables very high noise immunity to be obtained on burst-type channels, also without channel encoding. The flow-diagram of this system is shown in Fig. 20.

In the COSYDAI strategy the second mentioned time information method is utilized and the data compression is made so that a fixed number of samples greater than N_{MAX} cannot be eliminated consecutively. At the receiver, using the method shown in Fig. 20, when some consecutive time information numbers are detected in error, they are replaced with new time information numbers equidistant between themselves and having values included between the last exact value which

† In a Galois field $GF(q)$ with q prime number, the binoid codes which are able to correct a burst with length b have a maximum wordlength $n = (q - 1)b$ and a redundancy $m = 2b$. Therefore the binoid codes are one of the few known classes of codes which satisfy the Reiger bound on the redundancy.⁷¹ If $2^{n_0-1} \leq q < 2^{n_0}$ each element of $GF(q)$ can be represented by a binary n_0 -tuple. In this case the binoid code can be used in binary transmission. Correcting a burst of length b in $GF(q)$ will correspond to the correction of all bursts with length $(b - 1)n_0 + 1$ in the binary transmission.

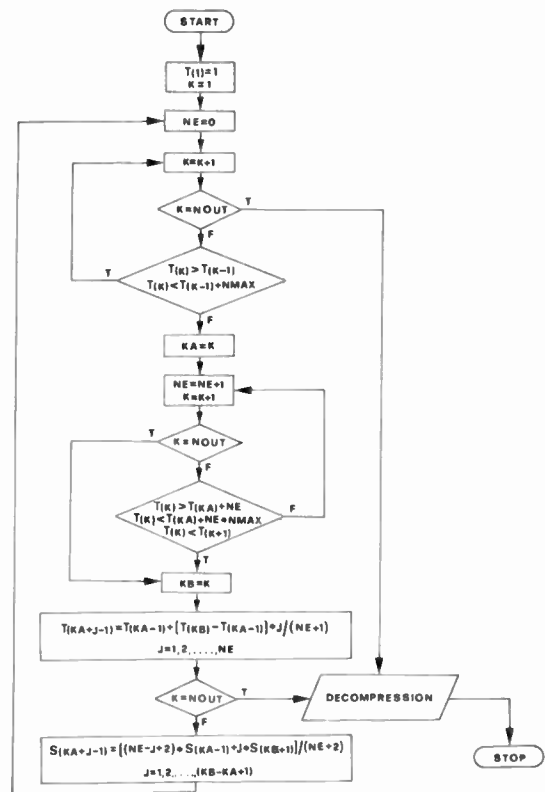

Fig. 20. Flow-chart of a computer program for COSYDAI system. The time information vector T , and the compressed samples vector S have $NOUT$ components. $NMAX$ is the maximum number of compressed samples between two consecutive transmitted samples.

precedes them and the first value found again to be exact after the incorrect ones. Obviously due to the nature of the burst errors, if some consecutive t_i are detected in error, also the samples between these t_i are altered by the noise. In the COSYDAI system these samples are modified by a weighted mean of the values of the exact samples which precede the first and the last wrong t_i .

In Figs 21 and 22 the EM values obtained for many communication systems versus the channel error probability P_e are shown.⁷² In these Figures we have denoted with the index 1 the system using the first time synchronization method, with the index 2 the system using the second method (with the correction procedure outlined above) and with the index 3 the COSYDAI system. In Table 5 the compression ratio C_b for the different systems is shown.

In the systems CU and CC the EM value includes the distortion introduced by the compression error and channel noise. To show the different influence of these two error types, Figs 21 and 22 also show the r.m.s. error due only to the channel noise (obtained through the comparison between the data reconstructed at the receiver from the compressed vector with and without channel errors). The results for EM , counting only the distortion introduced by the channel, are denoted without the asterisk.

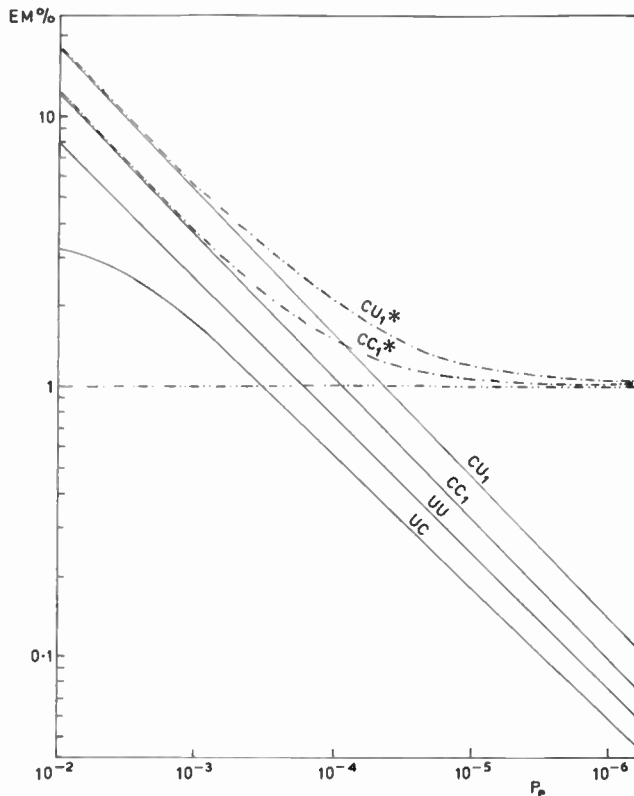

Fig. 21. R.m.s. error versus channel error probability for various system configurations, including data compression and error control coding.

The curves marked by an asterisk, on the contrary, represent the total distortion, due both to data compression and channel errors. In the cases CU and CC the total r.m.s. error cannot go below the EM value given by the compression operation (in the Figure equal to 1%).

From the previous Figures it is clear that the second method for time information (CU₂) presents a very low improvement with respect to the case CU₁, but the compression is reduced to 2.6 (Table 5). In the case CC₂ (particularly for low P_e) a net improvement is obtained in comparison with CC₁, but the compression ratio is reduced to 2.2. The COSYDAI system (CU₃) presents, on the contrary, a great reduction in the r.m.s. error: in fact the value of EM obtained is lower than for UU and UC.

The encoded COSYDAI system (CC₃) has also an efficiency similar to CU₃. In fact when an uncorrectable burst happens, the code can correct some errors in the t_i sequence and some information necessary for the identification of the error position is lost. Then a higher

Table 5

Compression ratio values for some simulated data communication systems

System	UU	UC	CU ₁	CU ₂	CU ₃	CC ₁	CC ₂	CC ₃
C _b	1	0.89	3.07	2.6	2.6	2.73	2.16	2.16

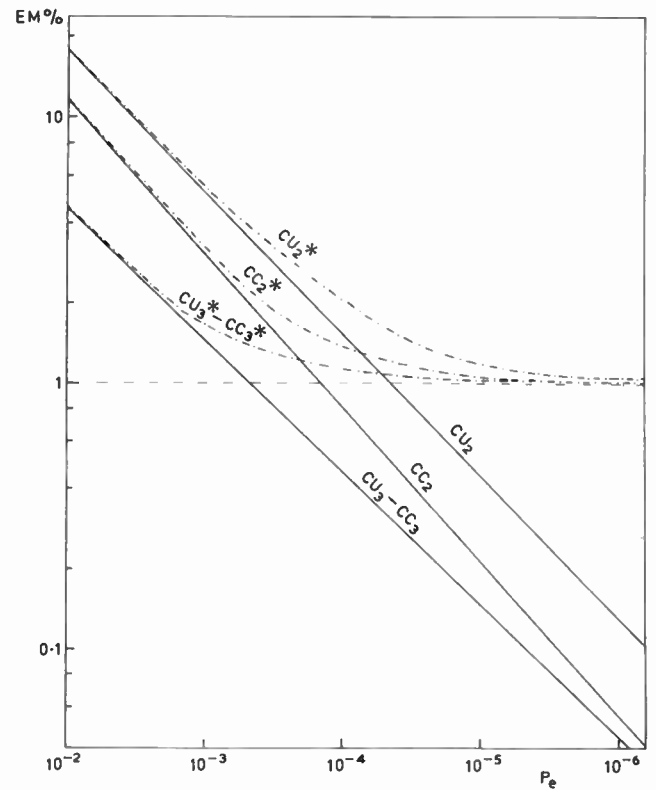

Fig. 22. R.m.s. error versus channel error probability for various system configurations, including data compression and error control coding.

EM error can result than with case CU₃. In Fig. 23 examples of the reconstructed electrocardiographic analogue waveforms for some of the transformations considered above are shown for a particular channel error pattern.

The influence of the channel errors in the compressed images are also presented, for particular cases, in References 73 and 74. From Reference 75 it is possible to deduce that the d.p.c.m. technique offers, from this viewpoint, some advantages with respect to the normal p.c.m.

6 Data Compression for Image Processing

All the data compression methods examined for one-dimensional signals can be extended to the processing of images if these are scanned line by line and are considered as a one-dimensional signal.

Several algorithms previously described for one-dimensional signals can give advantageous results when extended to two dimensions. Important methods of this type are the prediction-interpolation methods. Further we recall the use of two-dimensional digital filters and the use of transformations.

6.1 Use of Digital Filters

The use of two-dimensional digital filters for image processing is as interesting as the one-dimensional case for two main reasons:

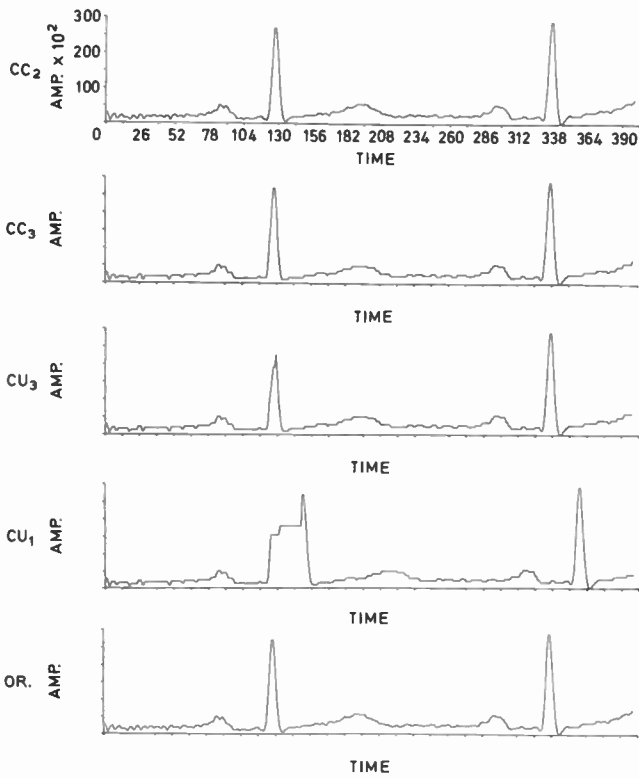

Fig. 23. Examples of reconstructed e.c.g. analogue waveforms. CU = compressed uncoded, CC = compressed coded. The indices are related to the different reconstruction methods and timing.

(i) The two-dimensional digital filtering (low-pass, band-pass) represents by itself a sort of data compression, because a limited part of the space frequency spectrum is extracted, requiring a lower number of data to be represented;

(ii) Two-dimensional low-pass digital filtering is in general useful pre-processing before the application of particular data compression algorithms, because the smoothed data can be more efficiently compressed by specific compression algorithms.

6.2 Use of Transformations

Some orthogonal transformations such as Fourier, Hadamard, Walsh, Haar, Slant, Karhunen–Loeve, etc., can be applied to the signal stream. Then the transformed data are processed using algorithms such as thresholding, variable length coding of groups of transformed data and prediction-interpolation. It is often possible to obtain some data reduction when the compressed spectrum is sent in place of the signal.

As is well known, fast algorithms (fast Fourier transform, FFT), are available for discrete Fourier transform (DFT), also for application to the two-dimensional domain, and they are currently used in image processing.⁷⁶

Fast computer algorithms have also been developed for other orthogonal transformations such as the fast Walsh transform (FWT), fast Hadamard transform (FHT), etc.

It is known that the Walsh transform of two-dimensional data, having 2^n rows and 2^n columns, is given by:

$$T = WSW \quad (27)$$

where S is the matrix of the data (samples of the image) of order $N = 2^n$ and W is the Walsh matrix of the same order. The inverse Walsh transform of T results:

$$S = \frac{1}{N^2} WTW \quad (28)$$

with the inverse Walsh transform given by:

$$W^{-1} = \frac{1}{N} W \quad (29)$$

The two-dimensional data domain S_{ij} and the transform domain T_{uv} are connected by the relation:

$$\sum_{i=0}^{N-1} \sum_{j=0}^{N-1} |S_{ij}|^2 = \frac{1}{N^2} \sum_{u=0}^{N-1} \sum_{v=0}^{N-1} |T_{uv}|^2 \quad (30)$$

By using a fast algorithm, the number of operations required to obtain the FWT of two-dimensional data turns out to be $2N^2 \log_2 N$ instead of $2N^3$.

This FWT was applied to obtain data compression of images by encoding the transform values. Because of the large amplitude variations of the transformed image data in comparison with the original image data, variable word-length-coding can be used to obtain good compression ratio values.

The main characteristic of these methods is the transformed image processing. Some criteria suggested in References 77 and 78 indicated that a method of minimizing the number of bits needed for encoding is to divide the transformed data into several equal squares and to employ for each of them a minimum word-length (a bit number sufficient to represent the maximum absolute amplitude value in the square plus 1 bit for the sign). In the actual storing or transmission of the processed image an additional fixed-length word is to be inserted before the square amplitude data, in order to specify the number of bits used to represent the square coefficients.

If $N = 2^n$, with n an integer, is the number of rows and columns of the sampled image and L is the number of luminosity levels, the maximum value which the transform will assume (assumed by the coefficient representing the addition of all the image samples) could be N^2L . If q is the quantization value for the transform coefficients, the number of bits required to specify the word-length used in a square will be:

$$n_b = \log_2 \left\{ \log_2 \left(\frac{N^2L}{q} + 1 \right) \right\} \quad (31)$$

where the logarithms are rounded to the upper integer.

A modification of the above method consists in applying the same procedure of variable word-length

encoding of the coefficients in a limited number of transformed image sub-areas; the criterion followed in Reference 76 is that of not maintaining any value for those sub-areas, where the sum of the absolute values of the coefficients is below a given threshold.

As regards the data compression of Earth resource images, interest is increasing in the analysis of aerial photographs and images from satellites. Indeed in both cases a considerable amount of data results, also from examination of limited Earth regions.

Examples of data compression of LANDSAT-1 images are shown in Fig. 24.

7 Implementation of Data Compression Methods

Any digital signal processing operation, in particular data compression, can be implemented following three main solutions:

- (a) use of standard computers or minicomputers (software definition);
- (b) use of special type or special-purpose digital processors;
- (c) use of microprocessors.

Solutions (b) and (c) refer to the so-called hardware definition.

The software and hardware approaches are strictly connected and a good knowledge of both techniques is required to design and build satisfactory digital signal processors.

7.1 Use of Standard Computers or Minicomputers

A digital signal processing operation can be generally implemented by using a standard computer or a minicomputer, through a suitable software package (set of programming instructions), defining completely the processing operations.

A typical step of the software implementation is the algorithm flow-chart. Figures 25(a) and (b) show as an example the compressor and decompressor flow-charts for the z.o.p. (floating aperture) algorithm. The great advantage of using standard computers for digital signal processing and in particular for data compression lies in their flexibility and computational power. The computer has great advantages when adaptive systems have to be employed requiring long learning storages or a complex

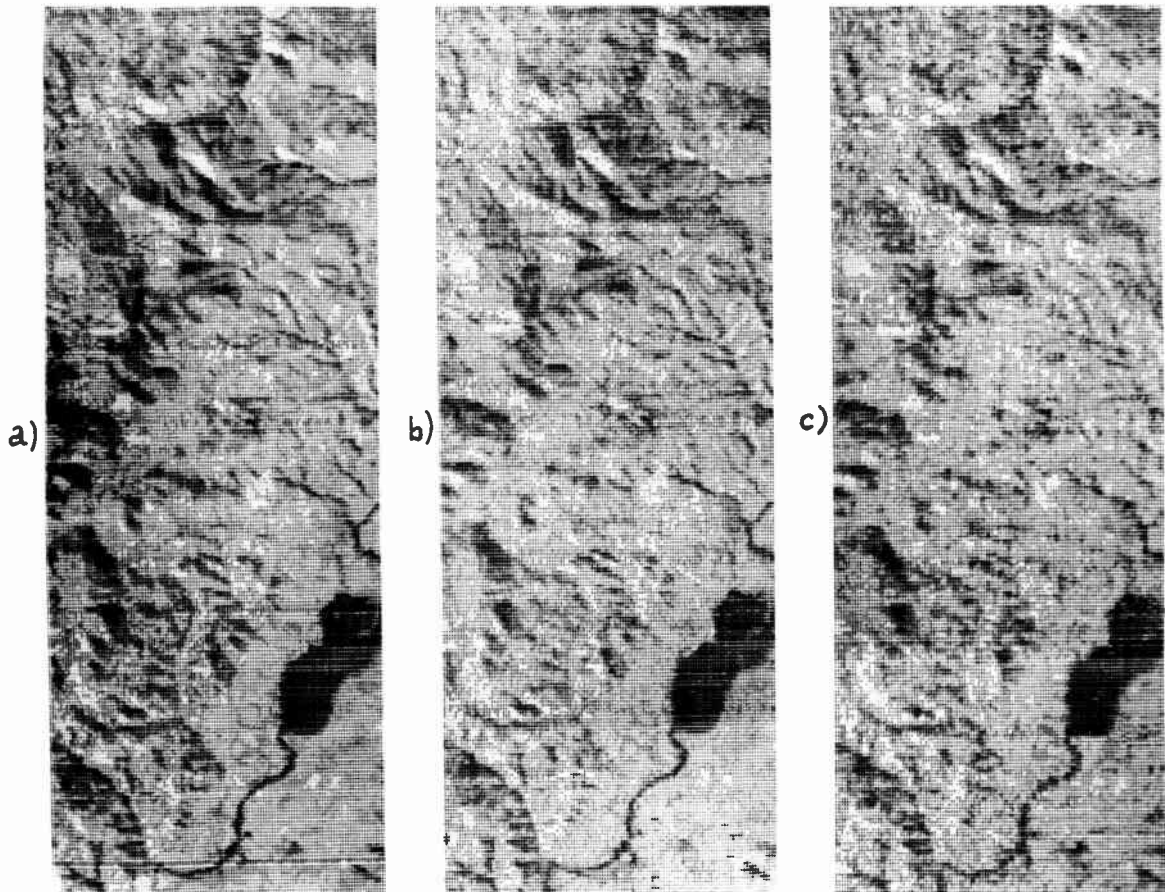

Fig. 24. Example of data compression of LANDSAT-1 images by using FWT and variable word length encoding of square subareas with thresholding. Original picture (5 bit/sample) is displayed in (a) using only 10 grey level scale; (b) reconstructed with a mean word/length L_m of 2.33 bit/sample; (c) the same with $L_m = 1.3$ bit/sample.

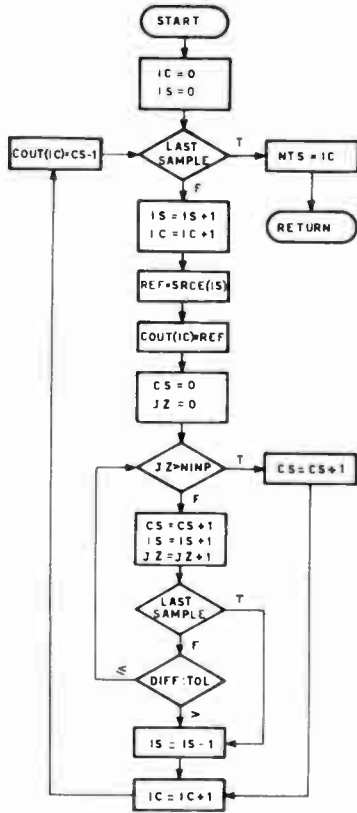
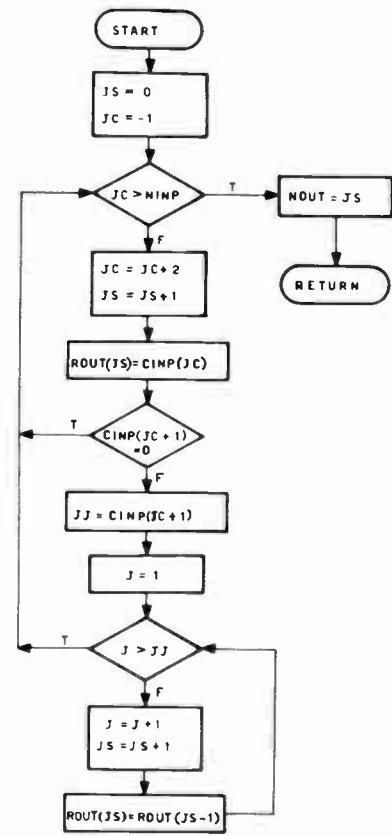

Fig. 25 (a). Zero order predictor—floating aperture.

Flowchart of a typical compression routine 'C' providing the compressed output with the time insertion as described in Sect. 3.6. Calling statement: CALL C (SRCE, NINP, TOL, COUT, NTS). The input vector SRCE has NINP components and index IS, and the compressed output vector COUT has NTS components and index IC. TOL is the absolute value of the tolerance band and DIFF = |REF - SRCE(JS)|.



(b) Flow-chart of a typical decompression routine 'D'. Calling statement: CALL D(CIMP, NINP, ROUT, NOUT). The compressed input vector CIMP (having NINP components and index JC) gives the reconstructed output in the vector ROUT of NOUT components and index JS.

evaluation of the weighting coefficients. Also for mathematical transformations the fast algorithms give considerable time advantages, as has been pointed out earlier.

However other kinds of problems and limitations can occur when using standard computers for data compression. Apart from the size and cost of this solution, problems can arise due to the limited speed of the computing systems. Indeed, when continuous signals or sampled data have to be processed in real time and the data compression is done on line, fixed limits of bandwidth are encountered generally due to the lower speed of the software approach compared with the hardware one.

These problems were partially solved recently by the last computer generation and in particular by some types of minicomputers, which are characterized by a smaller size and a higher processing speed.

Another aspect of using digital computer for data compression is that different computers and processors can be interconnected for better efficiency in a network to which the data are sent after suitable formatting.

7.2 Use of Special Type or Special-purpose Digital Processors

A special type or special-purpose digital processor has a structure designed to solve in the best way a particular or some specific problems of data processing. Due to this more specific approach, this solution appears to be complementary to the preceding one using standard computers.

Here we have limited flexibility of processing and very complex operations are not generally performed. However lower size and cost can be obtained for fast processing.

The specific configuration of the processor depends on the operation to be implemented and on the hardware components used. According to the form in which elementary operations are performed inside the processor, we have two different types:

- (a) serial processors, in which the elementary operations are performed serially in successive time intervals;
- (b) parallel processors in which the elementary

operations are performed in parallel, in the same time interval.

It is clear that serial processors are more economic than parallel processors, but the latter assure faster processing. An example of serial processors performing short time spectral estimation (see Sect. 3.5) is shown in Fig. 25.

An important aspect of the digital processor development lies, as already pointed out, in the high speed of processing which can be obtained. By extending the concept of parallel processing considered above, array processors have been developed and are currently designed and built, especially for two-dimensional signal or image processing.

The development of special type digital signal processors is strongly linked, even more than standard computers, with progress in technology and electronic components. Indeed the impressive progress of semiconductor technology in recent years allows an ever larger integration and also a continuous increase of processing speed.

Moreover, new classes of special components have been recently developed which are very useful for signal and image processing. Three important examples of this line are: electro-optical components,⁷⁸ surface-acoustic-wave devices⁷⁹ and charge-coupled devices.⁸⁰

8 Conclusions

Data compression methods and techniques have already become a practical tool for solving, at least in part, the problem of processing and transmitting large amount of data through a band-limited communication channel or to store data in limited size memories and archival systems.

Starting from aerospace applications, more recently the impact of data compression has extended into many important areas, such as ground data communications and telemetry remote sensing systems, computer systems, biomedical signal processing, etc.

The comparison and selection criteria reported here, even though not quite general since they are extracted from experimental results, can nevertheless be useful considering the intrinsic difficulty of the problem in selecting and defining the more pertinent data compression system for the different practical applications.

9 References

- Shannon, C. E. and Weather, W., 'The Mathematical Theory of Communication' (University of Illinois Press, 1949).
- Shannon, C. E., 'Coding theorems for a discrete source with a fidelity criterion', *IRE Nat. Conv. Rec.*, 7, pt. 4, pp. 142-163, 1959.
- Ash, R. B., 'Information Theory' (John Wiley, New York, 1967).
- Abramson, N., 'Information Theory and Coding' (McGraw-Hill, New York, 1963).
- Jelinek, F., 'Probabilistic Information Theory' (McGraw-Hill, New York, 1968).
- Gallager, R. T., 'Information Theory and Reliable Communication' (John Wiley, New York, 1968).
- Berger, T., 'Rate Distortion Theory—A Mathematical Basis for Data Compression' (Prentice-Hall, Englewood Cliffs, N.J., 1971).
- Special issue on Redundancy Reduction, *Proceedings of IEEE*, 55, no. 3, March 1967.
- Cappellini, V., Lotti, F., Ori, C., Pasquini, G. and Pieralli, F., 'A Study on Data Compression Techniques', Final Report for the ESTEC/Contract 902/70 (ESRO: CR-93, April, 1974).
- Cappellini, V., Lotti, F., Pasquini, G. and Pieralli, F., 'Study on Data Compression and Queuing Statistics', Final Report for the ESOC Contract 220/70 AR., Univ. of Florence, September 1973.
- Medlin, J. E., 'Sampled-data prediction of telemetry bandwidth compression', *IEEE Trans on Space Electronics and Telemetry*, SET-11, no. 1, p. 29, March 1965.
- Final Report, 'PCM Telemetry Data Compression Study, Phase I', NASA Contract no. NAS 5-9729, October 1965.
- Weber, D. R., 'A synopsis on data compression', *Proceedings of the 1965 National Telemetry Conference (NTC)*, pp. 9-16, A65-24192, 1965.
- Hochman, D. and Weber, D. R., 'Adaptive telemetry-data-compression', in 'Aerospace Telemetry', vol. II, pp. 167-201, H. L. Stiltz, (Ed.) (Prentice Hall, Englewood Cliffs, N.J., 1966).
- Kortman, C. M., 'Redundancy reduction: a practical method of data compression', *Proc. IEEE*, 55, no. 3, pp. 253-63, March 1967.
- Andrews, C. A. and Schwartz, G. R., 'Analysis and simulation of data compression techniques', *Proceedings of National Telemetry Conference (NTC)* p. 57-64, 1967.
- Andrews, C. A., Davies, J. M. and Schwartz, G. R., 'Adaptive data compression', *Proc. IEEE*, 55, no. 3, pp. 267-77, March 1967.
- Davison, L. D., 'Theory of adaptive data compression', 'Advances in Communication', vol. 2 (Academic Press, New York, 1966).
- Jayant, N. S., 'Waveform Quantization and Coding', (IEEE Press, New York, 1976).
- Davison, L. D., 'An approximate theory of prediction for data comparison', *The Radio and Electronic Engineer*, 43, no. 10, pp. 274-8, April 1967.
- Davison, L. D., 'The theoretical analysis of data compression systems', *Proc. IEEE*, 56, no. 2, pp. 176-86, February 1968.
- Turner, L. F., 'Data compression techniques as a means of reducing the storage requirements for satellite data: a quantitative comparison', *The Radio and Electronic Engineer*, 43, no. 10, pp. 599-608, October 1973.
- MacDonald, R. A., 'Signal-to-noise and idle channel performance of dpcm systems, particular application to voice signals', *Bell Syst. Tech. J.*, 45, no. 9, pp. 1123-51, September 1966.
- Neal, J. B. and Stroh, R. W., 'Differential pcm for speech and data signals', *IEEE Transactions on Communication Technology*, COM-20, no. 5, pp. 900-12, October 1972.
- O'Neal, J. B., 'A bound on signal-to-quantizing noise ratios for digital encoding systems', *Proc. IEEE*, 55, no. 3, pp. 287-92, March 1967.
- Max, J., 'Quantizing for minimum distortion', *IRE Trans on Information Theory*, IT-6, no. 1, pp. 7-12, March 1960.
- O'Neal, J. B., 'Predictive quantizing systems (differential pulse code modulation) for the transmission of television signals', *Bell Syst. Tech. J.*, 45, no. 5, pp. 689-722, May-June 1966.
- Donaldson, R. W. and Chan, D., 'Analysis and subjective evaluation of differential pulse-code modulation in voice communication systems', *IEEE Trans on Communication Technology*, COM-17, no. 1, pp. 10-19, February 1969.
- Xydeas, C. S. and Steele, R., 'Dynamic ratio quantizer', *Proc. Instn Elect. Engrs*, 125, no. 1, pp. 25-29, January 1978.
- Jayant, N. S., 'Digital coding of speech waveforms: pcm, dpcm and dm quantizers', *Proc. IEEE*, 62, no. 5, pp. 611-32, May 1974.
- Noll, P., 'Non-adaptive and adaptive dpcm of speech signals', (Overdruk wit Polytechnics Tijdschr. Editor Elektrotechnics, Netherlands, no. 19, 1972).
- Cummiskey, P., Jayant, N. S. and Flanagan, J. C., 'Adaptive

- quantization in differential pcm coding of speech', *Bell Syst. Tech. J.*, **52**, no. 7, pp. 1105-18, September 1973.
- 33 Jayant, N. S., 'Adaptive quantization with a one-word memory', *Bell Syst. Tech. J.*, **52**, no. 7, pp. 1119-44, September 1973.
 - 34 Cappellini, V., Lotti, F., Ori, C., Pasquini, G. and Pieralli, F., 'Application of some data compression methods to ESRO satellite telemetry data', *Alta Frequenza* (English Issue), **43**, no. 9, pp. 673-681, September 1974.
 - 35 Goyal, S. K. and O'Neal, J. B., 'Entropy coded differential pulse-code modulation systems for television', *IEEE Trans on Communications*, COM-23, no. 6, pp. 660-6, June 1975.
 - 36 De Jager, F., 'Delta modulation, a method of pcm transmission using the 1-unit code', *Philips Res. Rep.*, **7**, pp. 442-66, December 1952.
 - 37 Schouten, J. F., De Jager, F. and Greefkes, J. A., 'Delta modulation, a new modulation system for telecommunication', *Philips Tech. Rev.*, **13**, no. 9, pp. 237-45, March 1952.
 - 38 Goodman, D. J., 'Delta modulation granular quantization noise', *Bell Syst. Tech. J.*, **48**, no. 5, pp. 1197-1218, May-June 1969.
 - 39 O'Neal, J. B., 'Delta modulation quantizing noise: analytical and computer simulation results for Gaussian and television input signals', *Bell Syst. Tech. J.*, **45**, no. 1, pp. 117-42, January 1966.
 - 40 Steele, R., 'Delta Modulation Systems' (Pentech Press, London, 1975).
 - 41 Jayant, N. S. and Rovenberg, A. F., 'The preference of slope-overload to granularity in the delta modulation of speech', *Bell Syst. Tech. J.*, **53**, no. 10, pp. 3117-25, December 1974.
 - 42 Cummiskey, P., 'Single-integration, adaptive delta modulation', *Bell Syst. Tech. J.*, **54**, no. 8, pp. 1463-74, October 1975.
 - 43 Slepian, D., 'On delta modulation', *Bell Syst. Tech. J.*, **51**, no. 10, pp. 2101-37, December 1972.
 - 44 Winkler, M. R., 'High information delta modulation', *IEEE Int. Conv. Rec.*, **11**, pt. 8, pp. 260-5, March 1963.
 - 45 Jayant, N. S., 'Adaptive delta modulation with one-bit memory', *Bell Syst. Tech. J.*, **49**, no. 3, pp. 321-42, March 1970.
 - 46 Jayant, N. S., 'Delta modulation of pitch, formant and amplitude signals for the synthesis of voiced speech', *IEEE Trans. on Audio and Electroacoustics*, AU-21, no. 3, pp. 135-40, June 1973.
 - 47 Scindler, H. R., 'Linear, non-linear and adaptive delta modulation', *IEEE Trans on Communication Technology*, COM-22, no. 11, pp. 1807-23, November 1974.
 - 48 Zetterberg, L. S. and Uddenfeldt, J., 'Adaptive delta modulation with delayed decision', *IEEE Trans on Communication Technology*, COM-22, no. 9, pp. 1195-8, September 1974.
 - 49 Tomarowa, A. and Komeko, H., 'Companded delta modulator for telephone transmission', *IEEE Trans on Communication Technology*, COM-16, no. 1, pp. 149-57, February 1968.
 - 50 Broolin, S. J. and Brown, J. M., 'Companded delta modulation for telephony', *IEEE Trans on Communication Technology*, COM-16, no. 1, pp. 157-62, February 1968.
 - 51 Panter, P. F., 'Modulation, Noise and Spectral Analysis' (McGraw-Hill, New York, 1967).
 - 52 Cartmale, A. A. and Steele, R., 'Calculating the performance of syllabically companded delta-sigma modulators', *Proc. Instn Elect. Engrs*, **117**, no. 10, pp. 1915-21, October 1970.
 - 53 Chatterjee, P. K. and Rama Rao, V., 'Digital-computer-simulation results of multistage delta-modulation systems', *Proc. Instn Elect. Engrs*, **120**, no. 11, pp. 1379-82, November 1973.
 - 54 Harmouth, H. F., 'Transmission of Information by Orthogonal Functions' (Springer Verlag, Berlin, 1972).
 - 55 Beauchamp, K. G., 'Walsh Functions and their Applications' (Academic Press, London-New York, 1975).
 - 56 Pratt, W. K., Kane, J. and Andrews, H. C., 'Hadamard transform image coding', *Proc. IEEE*, **57**, no. 1, pp. 58-68, January 1969.
 - 57 Huang, T. S., 'Run-length coding and its extensions', *Proc. Symp. Picture Bandwidth Compression*, Mass. Inst. Tech., Cambridge, April 1969.
 - 58 Meyr, H., Rosdolsky, H. G. and Huang, T. S., 'Optimum run-length codes' *IEEE Trans on Communications*, COM-22, no. 6, pp. 826-35, June 1974.
 - 59 Cappellini, V., Del Re, E., Evangelisti, A. and Pastorelli, M., 'Application of digital filtering and data compression to ecg processing', *Digest of Papers of 6th Canadian Medical and Biological Engineering Conference*, Montreal, pp. 32-33, August 1976.
 - 60 Cappellini, V. and Emiliani, P. L., 'A special-purpose on-line processor for band-pass analysis', *IEEE Trans on Audio and Electroacoustics*, AU-18, no. 2, pp. 188-94, 1970.
 - 61 Cair, G. D., Cappellini, V. and Del Re, E., 'A digital band-pass analysis approach for biomedical signal processing and telemetry', *EUROCON 77*, European Conference on Electrotechnics, Venice, May 1977.
 - 62 Medlin, J. E., 'The prevention of transmission buffer overflow in telemetry data compressors', *IEEE Trans on Communication Technology*, COM-16, no. 1, pp. 94-107, February 1968.
 - 63 Medlin, J. E., 'Buffer length requirements for a telemetry data compressor', *Proceedings of the National Telemetry Conference* (NTC), vol. 1, 1961.
 - 64 Schwartz, G. R., 'Buffer design of data compression systems', *IEEE Trans on Communication Technology*, COM-16, no. 4, pp. 606-15, August 1968.
 - 65 Cappellini, V., 'Compression and coding systems for data transmission from the ground stations to the control center', *Proceedings of ESRO-Summer School*, 1970.
 - 66 Cappellini, V., *et al.*, 'Application of Some Data Compression Methods to ECG Processing', Consiglio Nazionale delle Ricerche, I.R.O.E., Internal Report, CM-R. 182-10.50, February 1975.
 - 67 Lynch, T. J., 'Performance measures for compressed and coded space telemetry systems', *IEEE Trans on Aerospace and Electronics Systems*, AES-3, no. 5, pp. 784-95, September 1967.
 - 68 Massey, J. L., 'Joint source and channel coding', NATO Advanced Study Institute on Communication Systems and Random Process Theory, Darlington, August 1977.
 - 69 Benelli, G., Bianciardi, C., Cappellini, V. and Del Re, E., 'High efficiency digital communications using data compression and error correcting codes', *EUROCON 77*, European Conference on Electrotechnics, Venice, May 1977.
 - 70 Gilbert, E. N., 'Capacity of a burst-noisy channel', *Bell Syst. Tech. J.*, **39**, no. 9, pp. 1253-65, September 1960.
 - 71 Samoylenko, S. I., 'Binoid error correcting codes', *IEEE Trans on Information Theory*, IT-19, no. 1, pp. 95-101, January 1973.
 - 72 Barducci, M., Benelli, G., Cappellini, V., Del Re, E., 'Digital simulation of integrated communication systems using data compression and error correcting codes', *International Symposium on Simulation '77*, Zürich, June 1977.
 - 73 Raga, G. L., 'Wideband video data transmission', *IEEE Trans on Communication Technology*, COM-15, no. 1, pp. 124-9, February 1967.
 - 74 Andrews, H., 'Computer Techniques in Image Processing' (Academic Press, New York, 1970).
 - 75 Haralick, R. M., Shanmugam, K. S., Young, J. D. and Goel, D. K., 'A comparative study of data compression techniques for digital image transmission', *1972 IEEE SMC International Conference*, Washington, October 1972.
 - 76 Cappellini, V., Lotti, F. and Stricchi, C., 'Some image-compression methods using the Fast-Walsh-Transform', *Proc. of 1975 Midwest Symposium on Circuits and Systems*, Montreal, August 1975.
 - 77 Pratt, K. W., 'Two-dimensional unitary transform', *NATO Advanced Study Institute on Digital Image Processing and Analysis*, Bonas, France, June 1976.
 - 78 Papers on 'Electro-Optical Imaging', *Optical Engineering*, **16**, no. 3, May-June 1977.
 - 79 Special Issue on 'Surface Acoustic Wave Device and Applications', *Proc. IEEE*, **64**, no. 5, May 1976.
 - 80 Proceedings of the IEE/IEEE Conference on 'The Impact of New Technologies on Signal Processing', Aviemore, Scotland, September 1976.

Manuscript first received by the Institution on 9th February 1978 and in revised form on 8th May 1979
(Paper No. 1912/Comm. 191)

Microstrip filter analysis using a microstrip waveguide model

G. KOMPA, Dr.-Ing.*

and

R. MEHRAN, Dr.-Ing.†

SUMMARY

The microstrip waveguide model has been successfully applied to a host of elementary discontinuity problems generally encountered in microstrip circuits. However, until now the efficiency of the model has never been proved for more complex distributed microstrip structures such as multiple element filters, where both the amplitude and the phase of the computed scattering coefficients for the elementary discontinuity elements can be checked.

In this paper it is shown the waveguide model may be used to design microstrip filters, taking into account the frequency dependent parasitic effects of any junction and discontinuity involved. The frequency dependent properties of the junctions and discontinuities considered can also be calculated by the quasi-static technique; as has been shown in many studies, the latter theory is restricted to lower frequencies. The quasi-static approach and the wave calculation obtained also suffer from the effect that radiation effects in the discontinuities have not been taken into account.

1 Introduction

Microwave filters in microstrip are an important constituent of nearly any complex microwave system. They can be found, for example, in microwave transistor or negative-resistance amplifiers, as impedance-matching networks or in bias circuits. They are used in diplexers or multiplexers for separating or summing frequency channels, or they may suppress the spurious harmonics generated in Gunn oscillators.

Microstrip filters generally include a number of discontinuities and junctions with parasitic capacitive and inductive effects, both frequency dependent. Two different methods are used to calculate the frequency-dependent properties of the microstrip junctions and discontinuities:

- (a) the quasi-static technique, and
- (b) the field-matching technique using a microstrip waveguide model.

The quasi-static approach, which is applied in References 1–3, for example, does not consider the higher-order modes, and therefore this method is restricted to the low-frequency-region, far away from the first cutoff-frequency. The microstrip waveguide model, published in Ref. 4 has been successfully applied to calculate the frequency dependent scattering coefficients of elementary filter components such as T-junctions, stubs, steps, crossings, and shunt capacitances, as illustrated in Fig. 1.^{5–8}

Knowing the scattering coefficients of the microstrip filter elements mentioned above, one may analyse more complex microstrip circuits, such as multiple element filters. Figure 2 shows some filter configurations under consideration. The 50 Ω input and output transmission lines match the measuring set-up of the network analyser.

Figure 2(a) shows a microstrip low-pass filter; the equivalent circuit is sketched in Fig. 3. As can be seen the small microstrip line sections l_v ($v = 1, 3, 5$) correspond to the series inductances L_v ($v = 1, 3, 5$). The microstrip stubs produce peaks of high attenuation at the resonant frequencies f_{01} , and f_{02} respectively.

The fourth filter element in Fig. 3 is approximately realized by two paralleled transmission lines of the same geometry in order to circumvent stubs with too large widths of transmission line, involving increased parasitic junction effects. The filter configuration in Fig. 2(b) shows a similar response. In this case the L - and C -elements of the series-resonant shunt circuits (Fig. 3) are realized by short sections of microstrip lines much less than a quarter-wavelength long.

The filter configuration in Fig. 2(c) consists of a straight 50 Ω microstrip line, coupled with stubs of different lengths. At zero frequency all the input power is transmitted. The first peaks of attenuation appear at frequencies where the stub lengths are ideally a quarter-

* Endress & Hauser GmbH, Postfach 20, D-7867 Maulburg.

† Lehrstuhl für Allgemeine und Theoretische Elektrotechnik, Gesamthochschule, Postfach 919, D-4100 Duisburg 1.

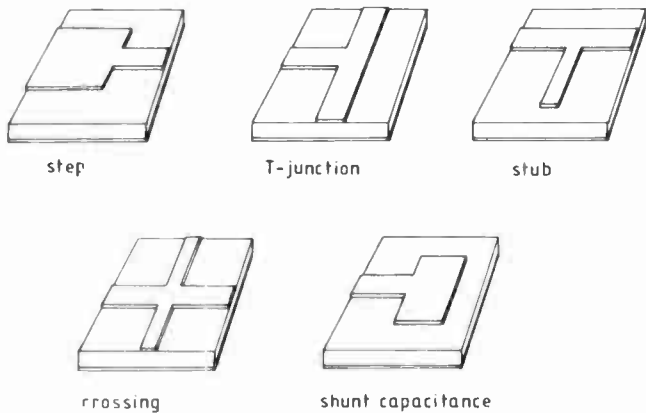

Fig. 1. Elementary microstrip filter components.

wavelength. Because the microstrip stubs have a periodic transmission characteristic, such a configuration can also act as a band-stop or band-pass filter for a given input frequency band.

2 Theoretical Basis for Calculating Microstrip Filter Elements

The filter configurations discussed in this paper have been derived from tables of prototype filters given in

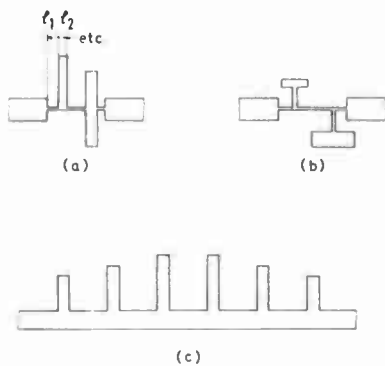

Fig. 2. Microstrip filter structures under consideration.

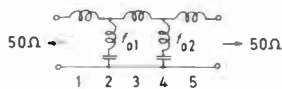

Fig. 3. Lumped-element equivalent circuit of filter configurations in Fig. 2(a) and 2(b).

well-known filter catalogues (e.g., that published by Saal⁹). Generally, it is no problem to find an LC-prototype filter network that corresponds to the desired power transfer function and attenuation. The main problem seems to be the conversion of the related lumped element LC-filter network into an adequate microstrip structure with distributed and dispersive transmission line parameters. As the extensive experimental and theoretical investigations show, an efficient

filter design must include further optimization techniques, e.g. the method of least squares. For the design of the filter structures considered here, microstrip dispersion and open-end effects were taken into account, and the reference plane locations in the junctions and discontinuities were calculated from the results given by Hammerstad.¹⁰ The evaluation shows that the measured and the computed filter response using the waveguide model are shifted to lower frequency values than those predicted by the response of the LC-prototype filter. Thus, microstrip dispersion and junction and discontinuity effects as well have to be taken into account

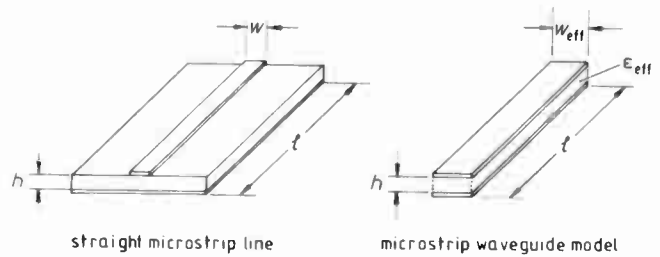

Fig. 4. Geometry of microstrip line and the equivalent waveguide model.

for more effective optimization procedures. This is particularly true for frequencies for which the excitation of higher order evanescent modes in the junctions cannot be neglected.

As is discussed in Ref. 4 the straight microstrip line can be approximately described by an equivalent microstrip waveguide as illustrated in Fig. 4. Formulas for the frequency-dependent effective width $w_{eff} = f(w, h, \epsilon_r, f)$ of the microstrip model, and the frequency-dependent effective dielectric constant $\epsilon_{eff} = f(w, h, \epsilon_r, f)$ can be found in the literature.⁴⁻⁷

The frequency-dependent wave impedance $Z_L(f)$ of the microstrip line is calculated to be

$$Z_L(f) = \frac{Z_0}{\sqrt{\epsilon_{eff}(f)}} \frac{h}{w_{eff}(f)} \tag{1}$$

with

$$Z_0 = \sqrt{\frac{\mu_0}{\epsilon_0}}$$

The phase constant β is then

$$\beta = \frac{2\pi f}{c_0} \sqrt{\epsilon_{eff}(f)} \tag{2}$$

Figure 5 shows the most important microstrip filter elements with their approximate waveguide models. In all cases the effective widths $w_{(v)eff}$ with $v = 1, 2$ are calculated as

$$w_{(v)eff}(f) = f(w_v, h, \epsilon_r, f), \quad v = 1, 2 \tag{3}$$

in relation to eqn. (1) in Ref. 11.

As can be seen from Fig. 5(a) the reference plane of the

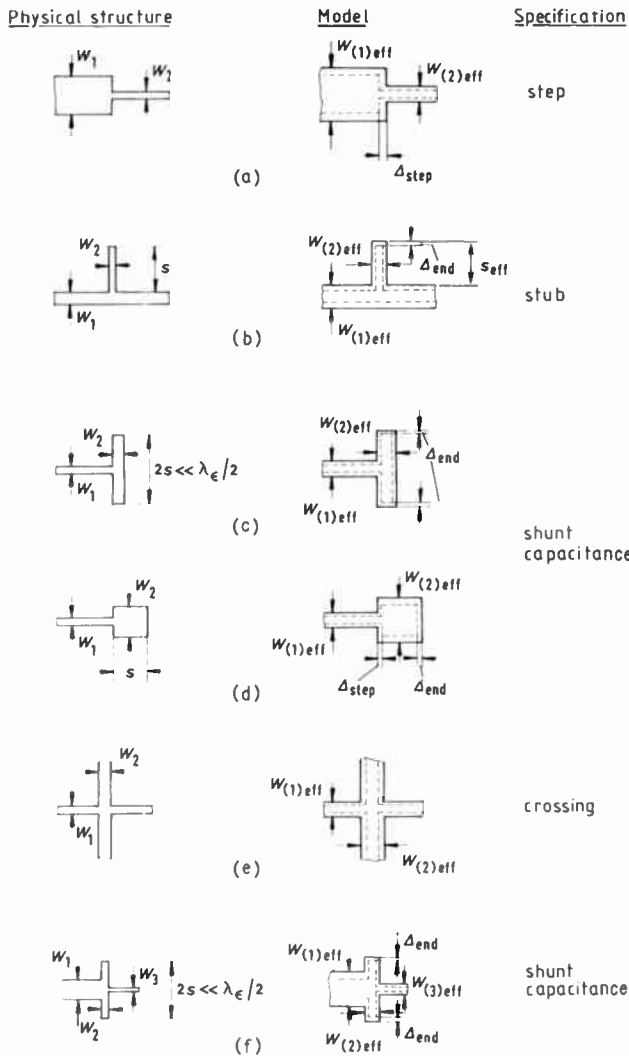

Fig. 5. Important microstrip filter elements with waveguide model approximation.

impedance step is shifted by a length of Δ_{step} caused by the fringing field of the discontinuity. The displacement is approximately evaluated under the assumption that the fringing field at the edges of the larger straight transmission line equals the fringing field of the step. Thus an equivalent fringing capacitance can be derived:

$$C_f = \frac{1}{2} \left(\frac{1}{Z_{L1} c_0} \sqrt{\epsilon_{(1)eff} - \epsilon_0 \epsilon_r} \frac{w_1}{h} \right) (w_1 - w_2). \quad (4)$$

This approach was successfully used in Ref. 11. The small capacitance C_f can be replaced by a short transmission line of width w_1 and length Δ_{step} where

$$\Delta_{step} = \frac{1}{2} \left(\frac{\epsilon_{(1)eff}}{\epsilon_r} w_{(1)eff} - w_1 \right). \quad (5)$$

As can be seen from eqn. (5) the capacitive effects of the step discontinuity are frequency dependent. When $f \rightarrow \infty$, it follows that $\epsilon_{(1)eff} \rightarrow \epsilon_r$ and $w_{(1)eff} \rightarrow w_1$, and thus Δ_{step} becomes zero for infinite frequency.

Figure 5(b) shows the physical structure of a stub and its equivalent model. The configuration has been resolved into a T-junction, as discussed in Ref. 5, with one port open-circuited at a distance s from the junction. The effective stub length is calculated as

$$s_{eff} = s + \frac{1}{2}(w_{(1)eff} - w_1) + \Delta_{end}. \quad (6)$$

The last term in eqn. (6) corresponds to the end-effects of an open-ended microstrip transmission line and is computed from the results given in Ref. 10.

Figures 5(c) and 5(d) show the modelled structure for a semi-lumped shunt capacitance. One must carefully distinguish between the two different realizations. Configuration (c) is regarded as a T-junction with open-ended transmission lines, the physical lengths extended by Δ_{end} on both sides, calculated from Ref. 10. If the metallic surface of the shunt capacitance is similar to a square, and $s > w_2$ (Fig. 5(d)), the configuration must be interpreted as an open-ended step and determined from results given in Ref. 7.

Figure 5(f) shows a shunt capacitance, usually inserted in the transmission line configuration of low-pass filters. Under the assumption that the width w_2 is much less than the width $2s$, the configuration shown is to be considered as a 4-port with two open-ended transmission lines and unequal input and output microstrips. Using the flowgraph method the scattering parameter of this filter element can be given as a function of the scattering parameters of the crossing and the lengths of the stubs.

3 Experimental Results

Figures 6 to 8 show the measured modulus of the transmission coefficient of a Chebyshev filter of 9th-order compared with theory based on the results given in Section 2. In all three cases the filter structures have been derived from the same LC-prototype filter C09 05 71 given in Ref. 9 with a pass-frequency equal to 3.0 GHz, and a stop-frequency equal to 3.2 GHz. The LC-filter response has been sketched as a dash-dotted line in the diagrams. As can be seen, the computed and the measured transition from the pass- to the stop-band are shifted to lower frequencies as was predicted by the LC-prototype filter. The slope to cut-off depends strongly on the topology of the filter configuration realized.

The filter in Fig. 6 shows a poor transition from the pass-band to the stop-band region. Much better behaviour in the upper part of the pass-band region is observed in Fig. 7, where the second filter element with very low wave impedance (Fig. 6) has been replaced by two paralleled stubs with double impedance value.

Figure 8 shows the low-pass filter with series-resonant shunt circuits realized by semi-lumped inductances and capacitances. It can be seen that this filter realization generates the very sharp cut-off predicted by the response of the LC-prototype filter.

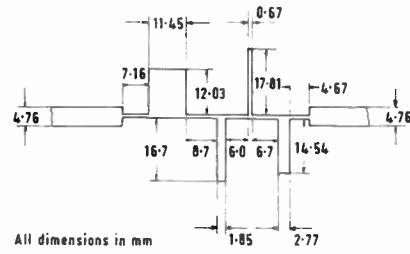
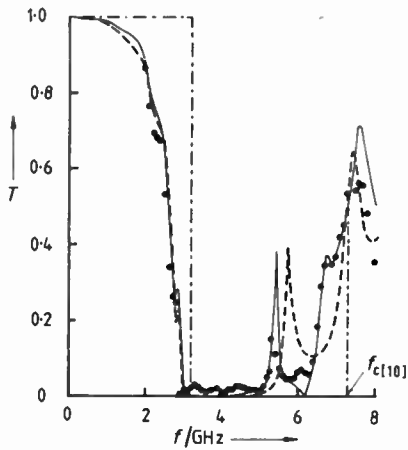

Fig. 6. Measured and computed modulus of the transmission coefficient of a low-pass filter on Polyguide substrate ($\epsilon_r = 2.32$; $h = 1.56$ mm).

- · - · - LC prototype filter response
 - - - theory with any junction and discontinuity effect neglected
 - - - this theory
 ● ● ● experiment

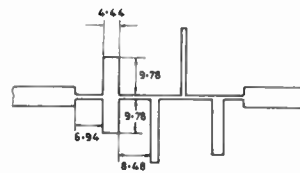
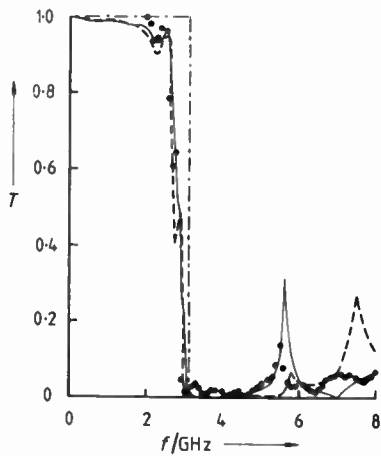

Fig. 7. Same filter structure as in Fig. 6, with one filter element replaced by two paralleled stubs.

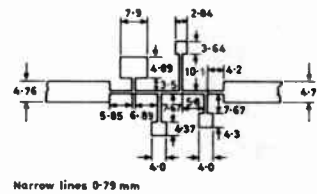
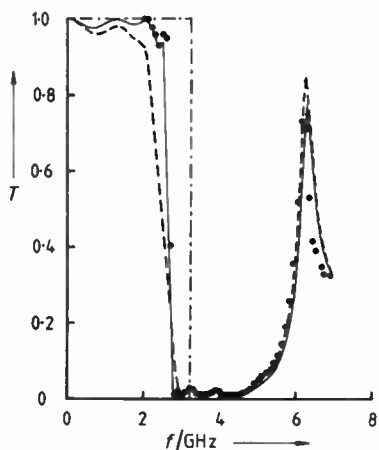

Fig. 8. Microstrip filter with semi-lumped inductances and capacitances.

The examples discussed show that—though much work remains to be done in deriving transmission line prototype filters from the LC-filter network for further computer-optimization—the agreement between measurement and theory using the waveguide model is very good. When junction and discontinuity effects are not included in the theoretical model of the filter, the LC-prototype response differs markedly from the measured.

techniques, showing accuracy and fast numerical computation, and circumventing time-consuming 'cut-and-try' techniques.

5 References

1 Silvester, P. and Benedek, P., 'Microstrip discontinuity capacitances for right-angle bends, T junctions, and crossings', *IEEE Trans. on Microwave Theory and Techniques* MTT-21, pp. 341-6, 1973.

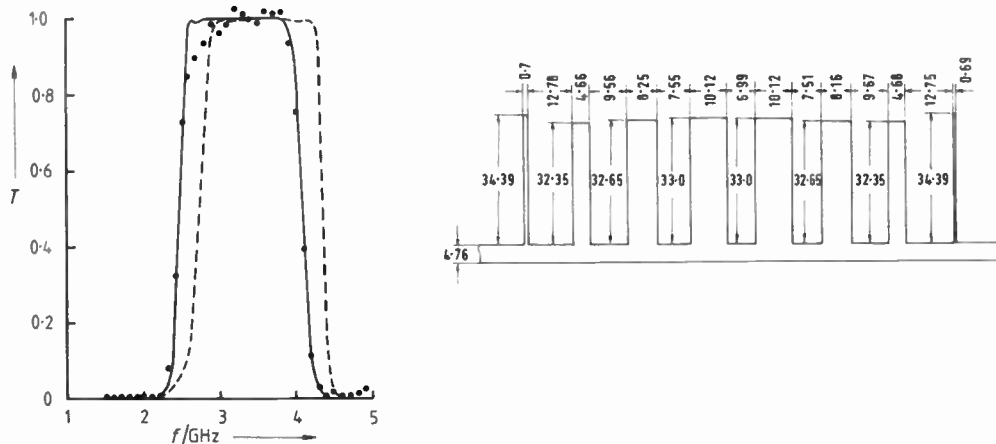

Fig. 9. Measured and computed modulus of the transmission coefficient of a band-pass filter on Polyguide substrate ($\epsilon_r = 2.32$; $h = 1.56$ mm).

Figure 9 represents an example for a bandpass filter consisting of stubs with different lengths and widths. The transitions to both sides of the pass-band are met exactly by theory, whereas the computation with ideal junctions show a shifting of the filter response to higher frequencies.

4 Conclusions

The microstrip waveguide has been successfully used for calculations on a variety of microstrip junctions and discontinuities which are part of more complex microwave structures such as microstrip filters. It has been shown in this paper how the waveguide model can be used to give an approximate description for several important filter elements.

Some examples of filter structures have been derived from well-known LC-filter catalogues, showing that the measured and computed response of the distributed filter configurations agree well. This leads to the conclusion that the waveguide model may be considered to be an efficient tool in practical filter design and optimization

2 Easter, B., 'The equivalent circuit of some microstrip discontinuities', *IEEE Trans.*, MTT-23, pp. 655-60, 1975.
 3 Thomson, A. F. and Gopinath, A., 'Calculation of microstrip discontinuity inductances', *IEEE Trans.*, MTT-23, pp. 648-55, 1975.
 4 Kompa, G. and Mehran, R., 'A planar waveguide model for calculating microstrip components', *Electronics Letters*, 11, pp. 459-60, 1975.
 5 Mehran, R., 'Die frequenzabhängigen Übertragungseigenschaften von Streifenleitungs-Wellenwiderstandssprüngen', *Filtern und Technical University of Aachen, Germany*, 1974.
 6 Mehran, R., 'The frequency-dependent scattering matrix of microstrip right-angle bends, T-junctions and crossings', *Arch. Elek. Übertragung*, 29, pp. 454-60, 1975.
 7 Kompa, G., 'Die frequenzabhängigen Übertragungseigenschaften von Streifenleitungs-Wellenwiderstandssprüngen, Filtern und Stichleitungen in Mikrostrip-Technik', Thesis, Technical University of Aachen, Germany, 1975.
 8 Kompa, G., 'Design of stepped microstrip components', *The Radio and Electronic Engineer*, 48, no. 1/2, pp. 53-63, 1978.
 9 Saal, R., 'Der Entwurf von Filtern mit Hilfe des Kataloges normierter Tiefpässe', (Telefunken, Backnang, Germany, 1961).
 10 Hammerstad, E. O., 'Equations for microstrip circuit design', *Proceedings, 5th Microwave Conference*, pp. 268-72, 1975.
 11 Storck, H., 'Streifenleitungen auf Halbleitermaterialien', Thesis, Technical University of Aachen, Germany, 1971.

Manuscript first received by the Institution on 3rd July 1978 and in final revised form on 16th May 1979 (Paper No. 1913/CC313)

Use of the transmission-line modelling (t.l.m.) method to solve non-linear lumped networks

PETER B. JOHNS,
M.Sc., Ph.D., C.Eng., M.I.E.E.*

and

MARK O'BRIEN, B.Sc.†

SUMMARY

The transmission-line modelling (t.l.m.) method presents a new approach to the solution of lumped networks by providing discrete models for components. Errors become due to the modelling process only and not due to the approximate solution of an approximate calculus model. The correspondence between stub models and existing implicit methods is shown and the concept of numerical parasitic components as a means of assessing errors is introduced. The paper then describes the entirely new explicit routines resulting from transmission-line modelling and explains their use in non-linear circuits. Finally, examples of mixed implicit and explicit working are given for the solution of non-linear transistor circuits.

* Department of Electrical and Electronic Engineering, University of Nottingham, University Park, Nottingham NG7 2RD.

† Department of Theoretical Mechanics, University of Nottingham.

1 Introduction

The state equation approach is the most generally accepted method these days for the solution of lumped networks in the time domain. However, although there has been considerable development in the automatic production of state equations, even Chua and Lin say (Sect. 17.1, Ref. 1) that 'formulating state equations for a non-linear dynamic network is a formidable task'.

Associated discrete circuit models^{1,2} provide an attractive alternative to state equation formulation. Inductors, capacitors, and non-linear elements are replaced by discrete models and the problem reduces to multiple d.c. analysis of a resistive network. One disadvantage of the associated discrete circuit model method is that it corresponds to the use of an implicit integration scheme for the state equations. This means that values of voltage and current at one time-step cannot be expressed in terms of values at previous time steps only, and for non-linear networks a complete d.c. solution of the network is required at each iteration. A second disadvantage is that hybrid techniques for separating non-linear and linear parts of a network cannot be used, and finally, a third disadvantage is that it is difficult to implement automatic control of order and step size.

The transmission-line modelling (t.l.m.) method presents an entirely new approach to the problem by again providing time-discrete replacements for inductors, capacitors and non-linear elements. Well-known implicit methods can be realized as transmission-line models but the important new feature of the t.l.m. method is that it can result in procedures which are explicit. This means that values of voltage and current at one time-step can be expressed in terms of values at previous steps only thus avoiding the need to solve simultaneous equations at each iteration. Explicit transmission-line models do not in general correspond to known explicit routines and in particular they have the important property of being unconditionally stable. This is extremely useful in the solution of stiff networks where instability in explicit methods always causes problems. The explicit nature of the t.l.m. routine means that non-linear elements can be completely and individually separated from the linear parts of the network. Thus a network containing N non-linear elements can be solved in terms of N separate and unconnected single non-linear equations rather than N connected non-linear equations as in the hybrid formulation of the state equations. Transmission-line modelling of inductors, capacitors and non-linearities also provides considerable knowledge about the errors introduced by the discretizing process. This means that the step size necessary for a certain accuracy of representation of the circuit can be assessed before calculation begins. This in turn may mean that either it is not necessary to use step sizes small enough for convergence to the calculus equations or that

compensation for errors due to large step sizes may be undertaken.

The use of the t.l.m. method in the solution of simple linear networks has already been demonstrated³ and sensitivity analysis has also been included.⁴ This paper extends the t.l.m. formulation to general networks with mixed implicit and explicit working. The correspondence between stub models and existing implicit methods is shown and the concept of numerical parasitic components as a means of assessing errors is introduced. The paper then demonstrates the use of link transmission-lines for connecting non-linear elements to a network and again an error analysis is given. Finally, the t.l.m. method is used to solve some simple examples.

2 Solution of the Transmission-line Model

Let the scattering zone S in Fig. 1(a) represent the whole or part of the network under consideration. Suppose that the inductors, capacitors and non-linear elements are connected externally on pairs of nodes termed ports. Within S this leaves linear resistors, independent voltage and current sources and all types of linear controlled sources. Where S represents only part of the network it is assumed there is a connection to other scattering zones through additional ports in S. The

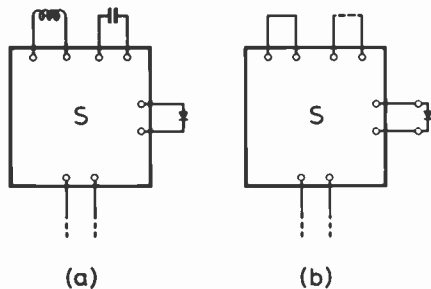

Fig. 1. Transmission-line scattering zones.

transmission-line model is shown in Fig. 1(b). The inductors and capacitors are modelled by stub transmission-lines and each non-linear element is connected individually to S by a link transmission-line. Link transmission-lines also connect S to other scattering zones and these links may include a model of an inductor or capacitor if convenient.³

The t.l.m. procedure operates by transmitting numbers or pulses along the transmission-lines. During the delay *T* caused by the lines the numbers or pulses remain constant in amplitude and this is the mechanism by which the model is time-discrete.

Suppose that the sources within S are emitting pulses corresponding to a sampling process with period *T*. At time *t* = 0 the sources will inject pulses out of the ports of S. These pulses will travel along the transmission-lines, be reflected or partially reflected at the distant

termination and travel back towards S. At time *t* = *T* the pulses will be incident upon S and will scatter into all of the ports of S. These reflected pulses together with a new injection from the sources are launched again into the transmission-lines and the process repeats. To achieve synchronism, all of the delays in the transmission-lines must be equal to *T*.

For a general scattering zone S, the relationship between the incident and reflected pulses is found from the following procedure. Form the transmission-line model. Remove the transmission-line from each port in S and replace it by a Thèvenin equivalent circuit consisting of a resistor equal to the characteristic resistance (*Z*₀) of the transmission-line and a voltage generator equal to twice the value of the incident pulse on the transmission-line. Solve S and find the branch voltages. The reflected pulse is the incident pulse subtracted from the branch voltage.

Let the incident and reflected pulses at time *t* = *kT* be defined by the vectors.

$${}_kV^i = \begin{pmatrix} {}_kV_1^i \\ {}_kV_2^i \\ \vdots \\ {}_kV_b^i \end{pmatrix} \quad {}_kV^r = \begin{pmatrix} {}_kV_1^r \\ {}_kV_2^r \\ \vdots \\ {}_kV_b^r \end{pmatrix}$$

Pulses are only incident upon and reflected into branches which are also ports and so the values of incident and reflected pulses are taken to be zero on branches which are not ports. Thus, for *p* ports, *kV*_{*n*}^{*i*} = 0 and *kV*_{*n*}^{*r*} = 0 for *n* > *p*.

Let

$$J = \begin{pmatrix} J_1 \\ J_2 \\ \vdots \\ J_b \end{pmatrix} \quad \text{and} \quad E = \begin{pmatrix} E_1 \\ E_2 \\ \vdots \\ E_b \end{pmatrix}$$

be the independent current generators across branches and voltage generators in branches respectively (see Ref. 1, Sect. 4-2). Also let

$$Y_b = \begin{pmatrix} Y_{11} & Y_{12} & \dots & Y_{1b} \\ Y_{21} & Y_{22} & \dots & Y_{2b} \\ \vdots & \vdots & \dots & \vdots \\ Y_{b1} & Y_{b2} & \dots & Y_{bb} \end{pmatrix} \quad (1)$$

be the branch-admittance matrix. For the first *p* branches this matrix contains diagonal entries corresponding to the characteristic resistances of the removed transmission-lines. The remaining branches (*p* + 1 to *b*) cause entries corresponding to the linear resistors and linear controlled sources of the network.

The equivalent nodal source vector *J*_{*n*} is now given by¹

$${}_kJ_n = A(J - Y_b E - 2Y_b {}_kV^i) \quad (2)$$

where *A* is the reduced incidence matrix.

The nodal voltages ${}_k v_n$ in the network are then obtained from the node-admittance matrix Y_n through the equation

$${}_k v_n = Y_n^{-1} {}_k J_n \quad (3)$$

The vector ${}_k v_n$ is the solution of the network expressed in nodal voltages at the k th iteration. The reflected pulses are calculated from the fact that the sum of the incident and reflected voltage pulses at a node must equal the nodal voltage. Thus,

$${}_k V^r = A^T {}_k v_n - {}_k V^i \quad (4)$$

where A^T is the transposed reduced incidence matrix.

The reflected pulses now travel along the transmission-lines and are reflected back to the same ports or are transmitted to neighbouring scattering zones.

Thus

$${}_{k+1} V^i = C {}_k V^r \quad (5)$$

where the connection matrix C is a sparse matrix containing only entries of unity which describes how the transmission-lines are connected.

The t.l.m. procedure repeats equations (2), (3), (4) and (5), advancing time by one step at each iteration. Since the non-linearities in S have been extracted, the matrix inversion required in equation (3) is only performed once at the beginning of the problem.

3 Stub Models and Implicit Methods

The use of companion models or associated discrete circuit models is well known,^{1,2} the technique being to replace each inductor and capacitor in a network by its discrete model. The exact solution of the resulting network is precisely the same as the solution obtained by setting up the state equations for the network and solving with a preselected numerical integration routine.

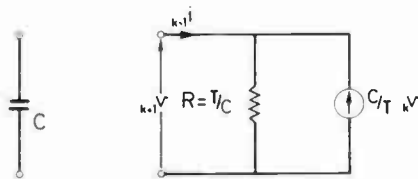

Fig. 2. A capacitor and its associated discrete circuit model.

The discrete models presently used for inductors and capacitors are one-ports and the corresponding numerical routines are implicit. In this Section it is shown that these discrete circuits can also be thought of as stub transmission-line models and the advantages of such representations are explained.

Figure 2 shows a capacitor and the associated discrete circuit model corresponding to the backward Euler implicit numerical integration scheme (see Ref. 1, Sect. 1-9-1, for example).

From the model it can be seen that

$${}_{k+1} i = \frac{C}{T} {}_{k+1} v - \frac{C}{T} {}_k v \quad (6)$$

Consider now the transmission-line model shown in Fig. 3. Because of the resistor R , the reflected voltage is not the difference between the voltage at the port (V) and

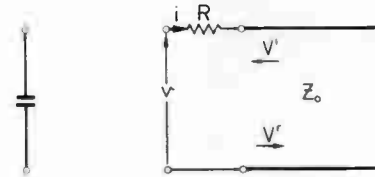

Fig. 3. A capacitor and a transmission-line model.

the incident voltage as in equation (4). More generally, the reflected voltage consists of the proportion of v injected into the transmission-line via R added to the reflected portion of the incident pulse due to R when v is set to zero.

Thus

$${}_k V^r = \frac{Z_0}{R + Z_0} {}_k v + \frac{R - Z_0}{R + Z_0} {}_k V^i \quad (7)$$

If $R = Z_0$ then

$${}_k V^r = \frac{{}_k v}{2} \quad (8)$$

The total current i at the port is the difference between the incident and reflected current and so for the $(k + 1)$ th iteration,

$${}_{k+1} i = \frac{{}_{k+1} V^r}{Z_0} - \frac{{}_{k+1} V^i}{Z_0} \quad (9)$$

If the transmission-line stub is open circuit

$${}_{k+1} V^i = {}_k V^r$$

Hence

$${}_{k+1} i = \frac{{}_{k+1} V^r}{Z_0} - \frac{{}_k V^r}{Z_0} \quad (10)$$

Substituting from equation (8)

$${}_{k+1} i = \frac{1}{2Z_0} {}_{k+1} v - \frac{1}{2Z_0} {}_k v \quad (11)$$

Equation (11) is the same as equation (6) provided

$$Z_0 = \frac{T}{2C} \quad (12)$$

and provided the length of the transmission-line is such that the total propagation time of a pulse down the line to the open circuit and back again is T .

Thus, if all the capacitors in a lumped RC network are replaced by the resistor plus stub transmission-line model of Fig. 3, then the exact solution of the resulting transmission-line model is precisely the same as setting

up the state-space equations for the network and integrating by the backward Euler method.

One of the advantages in time discretizing using transmission-line modelling is that the effect of the time-discretizing process may be observed easily in electrical terms. For example, the admittance of the discrete model may be compared with the admittance of the original lumped component. Thus, for the backward Euler capacitor model shown in transmission-line form in Fig. 3, the admittance of the model at the port terminals is obtained from steady-state transmission-line theory:

$$Y = \frac{\left(\frac{2C}{T} j \tan \frac{\omega T}{2}\right) \frac{2C}{T}}{\left(\frac{2C}{T} j \tan \frac{\omega T}{2}\right) + \frac{2C}{T}} \quad (13)$$

This expression may be expanded to give

$$Y = j \frac{2C}{T} \left(\frac{\omega T}{2} + \frac{1}{3} \left(\frac{\omega T}{2} \right)^3 + \dots \right) \times \left(1 - j \frac{\omega T}{2} - \left(\frac{\omega T}{2} \right)^2 \dots \right) = j\omega C + \frac{\omega^2 C T}{2} \dots \quad (14)$$

This is compared with

$$Y = j\omega C$$

which is the admittance of the original capacitor. Thus the error in modelling the capacitor is of order T which is all that can be expected from the backward Euler method. The error is also proportional to ω^2 , thus transients with high-frequency components are modelled less accurately than those with only low frequencies in them.

Another advantage of using the t.l.m. method is that certain stability properties can be deduced by inspection of the circuit. The effect of the associated discrete circuit on the overall numerical stability is not obvious since the circuit of Fig. 2 contains an active generator. Compare this with the transmission-line model of Fig. 3 where there is only an ideal loss-free transmission-line and an ideal resistor. There are no active components and so there is no way in which this model can introduce instability into the rest of the network. In fact the argument can be taken further in this example since the presence of the resistor will obviously tend to dampen any oscillations that happen to be in the rest of the network. Thus, by inspection, it can be seen that this model, and hence the backward Euler routine, is not only unconditionally stable but also can give a stable output for circuits which would otherwise be unstable. This is a well-known result for the backward Euler method as shown in Reference 1, Section 13-1-3.

Intuitively, the electrical properties of the transmission-line model in Fig. 3 lead to the proposition

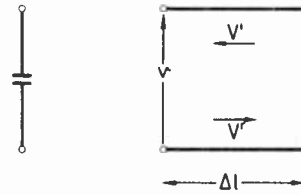

Fig. 4. A capacitor and an improved transmission-line model.

of omitting the resistor to produce a better model for the capacitor. The result is the simple open-circuit stub model for the capacitor shown in Fig. 4. If the length of the stub is Δl and the inductance and capacitance per unit length are L_d and C_d respectively, then to model a lumped capacitor of value C ,

$$C = C_d \Delta l \quad \text{and} \quad T = \sqrt{L_d C_d} \Delta l.$$

The characteristic resistance Z_0 is given by

$$Z_0 = \sqrt{\frac{L_d}{C_d}}$$

Thus

$$Z_0 = \frac{T}{2C} \quad (15)$$

as for the backward Euler model.

Also for this model

$$\begin{aligned} k^i &= \frac{1}{Z_0} ({}_k V^r - {}_k V^i) \\ {}_k v &= {}_k V^r + {}_k V^i \\ {}_{k+1} V^i &= {}_k V^r. \end{aligned}$$

These equations combine to give

$${}_{k+1} i = \frac{1}{Z_0} {}_{k+1} v - \frac{2}{Z_0} {}_k V^r.$$

Thus

$${}_{k+1} i = \frac{1}{Z_0} {}_{k+1} v - \left(\frac{1}{Z_0} {}_k v + {}_k i \right). \quad (16)$$

Substitution for Z_0 from equation (15) gives the equation for the associated discrete circuit model for a capacitor when the state equations are solved using the trapezoidal algorithm (Ref. 1, Sect. 1-9-1). Thus the solution of an RC network by the t.l.m. method using the stub transmission-line model of Fig. 4 is the same as solving by the trapezoidal algorithm. This property of

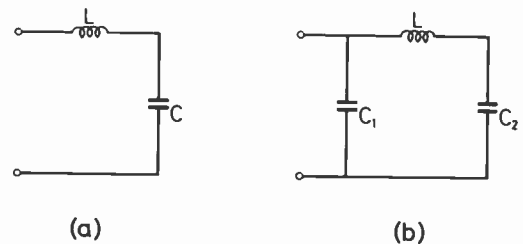

Fig. 5. Parasitic errors introduced by the trapezoidal algorithm.

the t.l.m. method has been demonstrated before for the particular RC networks associated with the modelling of the diffusion equation.⁵

The admittance of this transmission-line model is given by steady-state transmission-line theory as

$$Y = \frac{2C}{T} j \tan \frac{\omega T}{2} \quad (17)$$

$$= j \frac{2C}{T} \left(\frac{\omega T}{2} + \frac{1}{3} \left(\frac{\omega T}{2} \right)^3 + \dots \right)$$

$$= j\omega C + j \frac{\omega^3 C T^2}{12} + \dots \quad (18)$$

Thus the method models the admittance of the capacitor with error of order T^2 , again a result that would be expected from the second-order trapezoidal algorithm. The method is unconditionally stable but this time there are no damping effects.

There is another advantage to the t.l.m. method which again arises from its simple electrical properties. When a lumped network is solved in the time domain using any numerical method there is an error in the result due to the process of time discretization. This error can be seen immediately in terms of transmission-lines upon forming the transmission-line model. Since subsequent solution of the model is exact, the errors lie in forming the model not in solving it. However, when dealing with lumped networks it may be more useful to describe the modelling error in terms of parasitic lumped components rather than the exact error description given by the transmission lines.

Looking at the model of Fig. 4, it can be seen that the error is due to the distributed inductance in the transmission line. Hence to a first approximation the lumped form of the parasitic error can be regarded as an inductor in series with the original lumped capacitor. The capacitor with its parasitic numerical error is shown in Fig. 5(a) and the admittance of this circuit is

$$Y = \frac{j\omega C}{1 - \omega^2 LC} \quad (19)$$

$$= j\omega C + j\omega^3 LC^2 + \dots$$

If the value of the series inductor L in Fig. 5(a) is taken to be

$$L = \frac{T^2}{12C} \quad (20)$$

then the admittance corresponds to the transmission-line stub of equation (18) with error of order T^5 . In modelling a lumped capacitor, therefore, the error introduced by the trapezoidal algorithm may be regarded approximately as a series inductor of value $T^2/12C$, the approximation having an error of order T^5 . If the capacitor is split as in Fig. 5(b), a different value for the inductance is obtained, as in the abbreviated results

of reference 4. If there happens to be a real inductor in series with the capacitor in the original lumped circuit, then the error can be compensated for by including it in the original series inductor.^{3,4}

It is of some philosophical importance to note that it is impossible to build a capacitor in real life without including some series inductance: the plates of the capacitor must have a finite size and the capacitor must have leads. The parasitic components introduced by transmission-line modelling are very similar to parasitic components in practice. In fact it can be argued that a real capacitor can look more like a transmission line than a device that sets its current proportional to the derivative of its voltage. If T is too large the numerical errors become larger than real life, if T is too small the 'errors' become smaller than real life. Using the t.l.m. method, the engineer can not only estimate the numerical errors in terms of parasitic components before the calculation starts but may also be able to go some way to choosing the value of T to give the best fit to the practical parasitic components.

The analysis in this Section has been concerned with the modelling of capacitors. A similar analysis may be performed for inductors using short circuit transmission-line stubs. The results obtained are the dual of those for the capacitor.

4 Link Models and Explicit Methods

Stub transmission-line modelling leads to implicit methods because the stubs are one-port devices. A pulse on the stub which is incident upon its port at the k th iteration scatters simultaneously into all of the other stubs and the scattering process involves the entire network contained within S . To realize a discrete model corresponding to an explicit numerical method it is necessary to be able to express the potential at one node at the k th iteration exclusively in terms of the potentials at other nodes at the $(k-1)$ th, or previous, iterations. In terms of transmission-line modelling, this means that the network consists of many scattering zones S each containing only one node. These zones are connected by link transmission lines which provide the delay time T needed to isolate their scattering processes in time from the rest of the network.

Conceptually, link transmission lines are as obvious as stub transmission lines yet link transmission lines seem to give rise to an entirely new class of numerical algorithm. In the special case of the RC networks associated with the diffusion equation it has been possible to give the transmission-line model corresponding to the state equations integrated by the explicit forward Euler method.⁵ In this application it appears that the t.l.m. algorithm is a general one which includes the forward Euler method as a particular case. The generality comes from dealing with incident and reflected quantities in the t.l.m. routine, while only

dealing with nodal voltages in the forward Euler method places severe restrictions on the link transmission-line model. For example, the restriction requires transmission lines with negative characteristic resistance if the step size T is made too large. The model then contains active components and the instability typified by the Euler method occurs. Without the restrictions it is possible to realize a single-step explicit method for the network which is also unconditionally stable, and this is quite unique.

The link t.l.m. method has also been applied to simple linear, but stiff filter networks³ and again an explicit but unconditionally stable method emerges.

In the analysis of general networks the advantages of an explicit method can be exploited without necessarily making the model wholly explicit. In other words it is possible to mix link modelling and stub modelling. One of the main uses of link modelling in general networks is to separate the non-linearities from the rest of the network and again the resulting method seems to be new and to have very definite advantages.

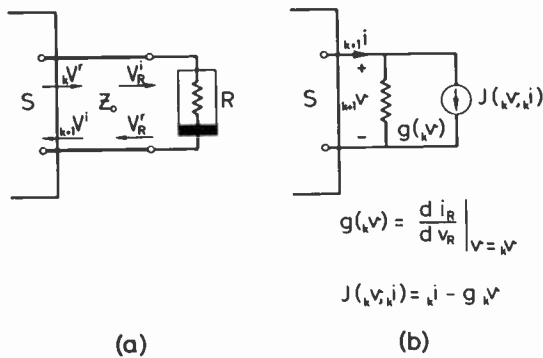

Fig. 6. A non-linear resistor, its transmission-line model and its Newton-Raphson model.

Figure 6(a) shows a non-linear resistor R connected by a link transmission line to the scattering zone S . If S launches a pulse ${}_k V^i$ into this branch at the k th iteration then this becomes an incident pulse V_R^i on the non-linear resistor at the following half-time interval. A reflection V_R^r is produced at the non-linear resistor and this becomes the next incident pulse ${}_{k+1} V^i$ on S . Let the non-linear resistor be described by

$$i_R = f(v_R). \tag{21}$$

Since

$$i_R = \frac{1}{Z_0} (V_R^i - V_R^r)$$

and

$$v_R = V_R^i + V_R^r$$

then the reflected pulse from the non-linear resistor is obtained from the equation

$$V_R^i - V_R^r = Z_0 f(V_R^i + V_R^r). \tag{22}$$

Equation (22) is a single non-linear equation which is independent of the rest of the network and can be solved

by a simple stepping procedure for example.

Alternatively the non-linearity could be described by

$$v_R = f(i_R). \tag{23}$$

In this case

$$V_R^i + V_R^r = f\left(\frac{V_R^i - V_R^r}{Z_0}\right). \tag{24}$$

Figure 6(b) shows the Newton-Raphson associated discrete circuit for the non-linear resistor R for comparison with the transmission-line model. It can be seen that the branch resistor across the terminals of S in the Newton-Raphson case changes every iteration. This means that the inverse matrix Y_n^{-1} in equation (3) must be calculated every iteration. In the t.l.m. case the resistance presented by the transmission line is Z_0 at every iteration and hence Y_n^{-1} is only calculated once at the beginning of the problem. The Newton-Raphson algorithm also requires the derivative of the non-linearity whereas this is not necessary in the t.l.m. case. Using nodal analysis strictly, only voltage-controlled non-linearities can be used with Newton-Raphson; with t.l.m., voltage and current-controlled non-linearities can be used. Although the convergence of the Newton-Raphson algorithm can be guaranteed if an initial guess is made close enough to the final solution, the convergence properties are not obvious from the associated discrete circuit model. For t.l.m., the absence of active components means that in electrical terms the convergence properties are much more obvious. Certainly, if the original practical lumped circuit is not on the verge of instability, then the transmission-line model will not be unstable. Finally, a major advantage of t.l.m. is that the numerical errors can be expressed in simple electrical terms.

Consider a d.c. problem in which the final value of a non-linear resistor R turns out to be R_f . The choice of Z_0 is arbitrary but suppose the choice happened to be $Z_0 = R_f$. The resistance presented to S is $Z_0 = R_f$, the non-linear resistor is matched to the transmission line, the reflected pulse from the resistor is zero, and the final solution is obtained in one iteration. Obviously Z_0 cannot be chosen to be equal to R_f without prior knowledge of the solution and hence reflections do occur on the transmission line. It is the transient caused by the interchange of reflections between R and S that constitutes the modelling error introduced by the link transmission line. If Z_0 can be chosen to be a value approximately equal to the values taken by R or the values of the resistance looking into S then the time of

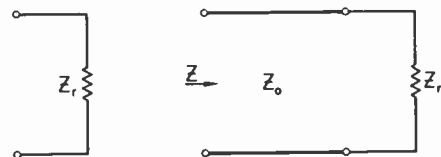

Fig. 7. Link connection of a resistor.

error transient will be reduced. To a first order of approximation the link transmission line may be regarded as a series inductor or shunt capacitor. If such a component happens to be in the original circuit then the link transmission line may be modelled to model it; if there is no such component then the inductance or capacitance can be regarded as a numerical parasitic component. For analysis purposes, suppose that the non-linear resistor presents a linear impedance Z_r . The impedance looking into the link transmission-line model as shown in Fig. 7 is given by

$$Z = \frac{Z_r + jZ_0 \tan\left(\frac{\omega T}{2}\right)}{1 + j\frac{Z_r}{Z_0} \tan\left(\frac{\omega T}{2}\right)} \quad (25)$$

$$= Z_r + jZ_0\left(\frac{\omega T}{2}\right) - j\frac{Z_r^2}{Z_0^2}\left(\frac{\omega T}{2}\right) - \frac{Z_r^3}{Z_0^3}\left(\frac{\omega T}{2}\right)^2 + Z_r\left(\frac{\omega T}{2}\right)^2 + \dots \quad (26)$$

Thus the model is always correct for $\omega = 0$, of course, and correct to order T for transients unless $Z_0 = Z_r$, when the model is exact.

Figure 8 shows the resistor Z_r with a series inductor L which would be real if the original circuit conveniently contained such an inductor but otherwise it would be regarded as a numerical parasitic. The impedance looking into this circuit is

$$Z = Z_r + j\omega L$$

$$Z_0 = \frac{2L}{T}$$

From equation (25) the model is now correct to order T^2 . The circuit of Fig. 9 is correct to order T^3 and on.

Again it is of considerable importance to note that the parasitic components introduced by the t.l.m. method are very similar to the parasitic components encountered in practice. This is not very surprising since at least some

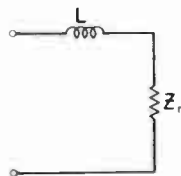

Fig. 8. Parasitic error of link.

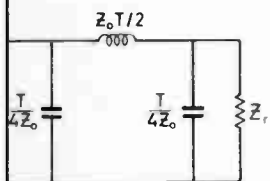

Fig. 9. Higher-order parasitic errors of link.

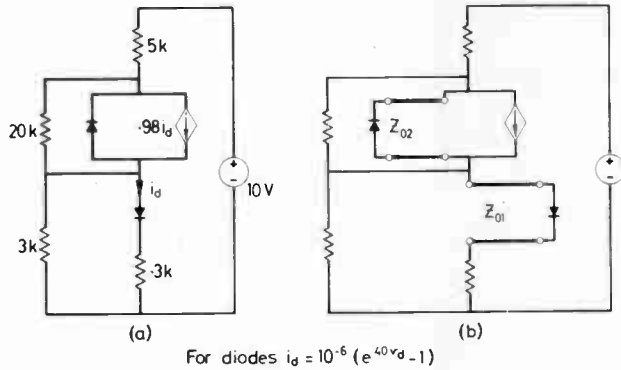

Fig. 10. Single transistor stage and transmission-line model.

of the parasitics come from the fact that the device must be connected to the circuit with leads which themselves are a link transmission line. Yet again it should be emphasized that the physical circuit has been modelled by the transmission-line circuit and the transmission-line circuit has been solved exactly. Any errors are in the modelling procedure and not in the mathematics which solve the model. All of the errors in the numerical procedure are defined exactly by the transmission-line model. The parasitic lumped components in Figs 8 and 9 represent a lumped approximation of these errors and are used only because it may be preferable to indicate the errors in lumped form.

5 Examples

Examples of the use of t.l.m. for the transient solution of linear networks can be found in References 3 and 4. This paper therefore concentrates on non-linear examples and in the first instance convergence to d.c. answers will be considered.

The transistor stage shown in Fig. 10(a) is solved by Calahan in Reference 2 by the Newton-Raphson

Table 1. Convergence to d.c. Results for circuit of Fig. 10

Iteration number	Newton Raphson	Z_0 in $k\Omega$				
		1	0.5	2.0	0.1	10.0
1	5.038	5.913	5.078	6.712	3.796	7.817
2	4.943	4.922	4.804	5.555	4.694	7.309
3	4.881	4.862	4.871	5.121	4.921	6.893
4	4.860	4.858	4.855	4.957	4.830	6.550
5	4.858		4.859	4.896	4.870	6.265
6			4.858	4.872	4.853	6.029
7				4.863	4.860	5.833
8				4.860	4.857	5.670
9				4.859	4.858	5.534
10				4.858		5.421
11						5.327
12						5.249
13						5.184
14						5.129
<hr/>						
20						4.949
30						4.873
40						4.860
50						4.858

method. The transmission-line model is shown in Fig. 10 (b) and the results for the collector voltage (V_c) for various values of transmission-line characteristic impedance Z_0 are shown in Table 1. For both the t.l.m. method and the Newton-Raphson method, the initial guess for the voltage across the diode is taken to be zero. Details of the matrices and operations on them for this particular example are shown in the Appendix.

The results in Table 1 show that the number of iterations required for convergence depends upon the choice of Z_0 for the link transmission line and, in this example, it was not difficult to make a guess for Z_0 which gives quicker convergence than the Newton-Raphson method. If the value of Z_0 chosen happens to equal the resistance of the diode at the solution point (0.40974 k Ω in this example), then the solution would have been realized in just one iteration. Convergence in one iteration also depends upon the initial value chosen for the first reflected pulse from the diode and this is also taken to be zero. For any other value of Z_0 , convergence in one iteration can be achieved provided the correct value of initial reflected voltage is used. Since the correct combination of Z_0 and initial reflected pulse cannot be known without solving the problem, it will, in general, be necessary to iterate and converge to the d.c. solution.

Convergence in one iteration can also be achieved if the characteristic impedance Z_0 is chosen to be the value of the resistance looking into the scattering zone S. Table 1 indicates that this value of Z_0 lies somewhere between 1 k Ω and 2 k Ω . In general, however, problems contain more than one non-linearity and the matched condition looking into S then depends upon the values of the incident voltages.

Figure 11(a) shows the same circuit as Fig. 10 with a slightly more refined model for the transistor. Since the collector diode is reverse biased, the d.c. result is the same as for the previous case. A transmission-line model is shown in Fig. 11(b).

Table 2 shows results obtained for V_c for various values of Z_{02} with Z_{01} fixed at 0.40974 k Ω . Here it can be seen that convergence is slow. The value of V_c at the first iteration for $Z_{02} = 100\,000$ k Ω shows that Z_{02} must

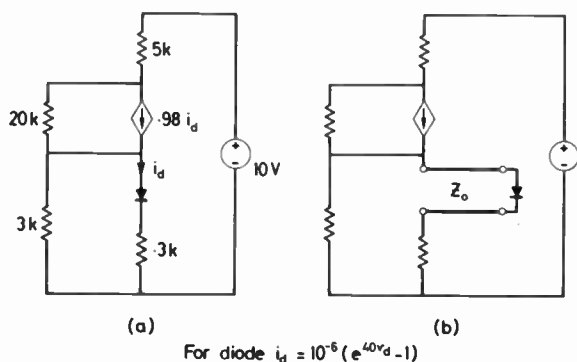

Fig. 11. Single transistor stage and transmission-line model.

Table 2.

Convergence to d.c. Result for circuit of Fig. 11

Iteration number	Z_{02} in k Ω		
	1	1000	100 000
1	1.3368	4.8146	4.8575
2	1.5122	4.8851	4.8580
3	2.1356	4.8364	4.8577
4	2.3797	4.8780	4.8580
5	2.7773	4.8392	4.8577
6	3.0060	4.8767	4.8580
7	3.2778	4.8398	4.8587
8	3.4694	4.8763	4.8580
9	3.6621	4.8402	4.8587
10	3.8135	4.8759	4.8580

have been quite close to the matched condition, in fact, to three decimal places it has converged in one iteration. The transients, however, are obviously not being dissipated quickly. This is because the collector diode effectively terminates its transmission line in a constant current generator of value 10^{-6} mA. Thus an impulse incident on the diode is returned with the same magnitude and a constant value of $10^{-6} \times 10^5 = 0.1$ subtracted from it. The internal resistance of the scattering zone at the terminals of the collector transmission line is small compared to 100 000 k Ω and so there is little of this returned pulse dissipated there. The oscillations about the true answer are therefore due to oscillation of energy in the transmission line which is unable to escape quickly. There are straightforward ways of overcoming this problem, but the simplest way here is to choose a more suitable transmission-line model for the circuit of Fig. 11(a). This is shown in Fig. 12 and the obvious choice for Z_{02} is 20 k Ω . Results for the collector voltage are given in Table 3.

Thus, the use of a little care in the choice of transmission-line model can make quite a large difference in the rate of convergence to its d.c. solution.

As a more general example of d.c. analysis, the circuit of Fig. 13 is used and this is similar to circuit 5 in Reference 6. The output voltage is shown in Table 4 and the value of $Z_{01} = 200 \Omega$ and $Z_{02} = 900 \Omega$ are chosen for

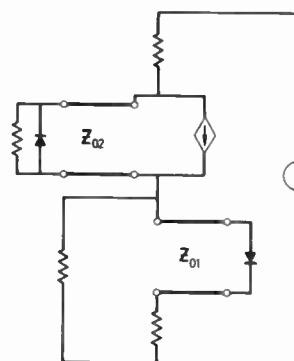

Fig. 12. Alternative transmission-line model for transistor in Fig. 11.

Table 3.

Convergence to d.c. Result for circuit of Fig. 11 using transistor model of Fig. 12

Iteration number	Z_{02} in $k\Omega$		
	19	20	21
1	4.746	4.858	4.965
2	4.818		4.897
3	4.870		4.845
4	4.854		4.862
5	4.859		4.856
6	4.857		4.858
7	4.858		

Table 4.

Application of power supply to circuit of Fig. 13

Iteration number	V_s	
	0 V	5 V
5	2.000	1.729
10	3.087	0.853
15	5.045	0.078
20	6.839	0.078
25	8.459	0.077
30	9.863	0.083
35	10.292	0.084
40	10.139	0.084
45	10.027	
50	10.004	
55	10.001	
60	10.001	

a reason to be explained later. The transistor model used is shown in Fig. 14.

A transient non-linear example is provided by a circuit similar to that used by Calahan² and shown in Fig. 15(a). In the transmission-line model of Fig. 15(b), the capacitor is replaced by an open circuit stub and the results for time steps of 0.1 ms, 0.02 ms and 0.01 ms are shown in Fig. 16. The diode transmission line has a characteristic impedance (Z_d) of 1 k Ω in all cases and the characteristic impedance (Z_c) of the capacitor stub is given by equation (12).

The results in Fig. 16 show that there are, in effect, two

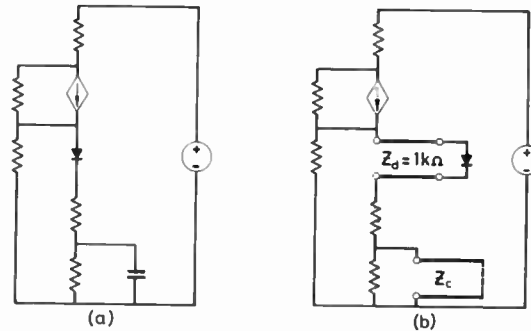

Fig. 15. Single transistor stage and transmission-line model.

transients involved and that these overlap less as the time step is reduced. The first transient is due to the diode link transmission line connecting the diode to the circuit and the second is due to the capacitor charging up. The overlap is due to the fact that the diode iteration is taking place at the same time as the capacitor iteration. There are no iterations within iterations used. It can be seen that convergence to a result for $T = 0$ is taking place and that this is reasonably achieved by the 0.01 ms curve. The

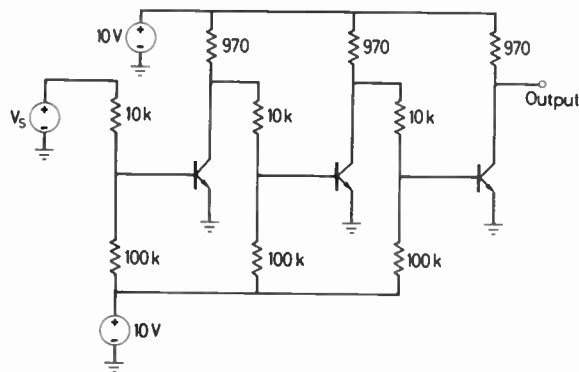

Fig. 13. Three-stage inverter.

Table 5.

Transient analysis of circuit in Fig. 13 for V_s switched from 0 V to 5 V

Time μs	Output V
0.36	10.001
0.72	9.999
1.08	9.987
1.44	9.873
1.80	9.551
2.16	8.021
2.52	4.801
2.88	0.490
3.24	0.099
3.60	0.060
3.96	0.089
4.32	0.084

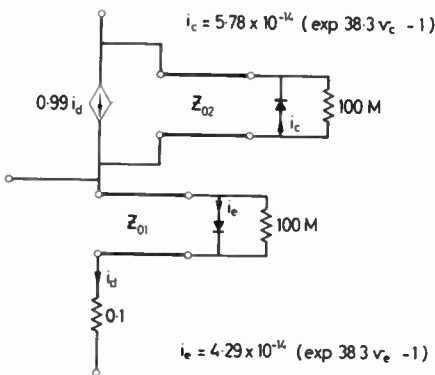

Fig. 14. Model for transistor in Fig. 13.

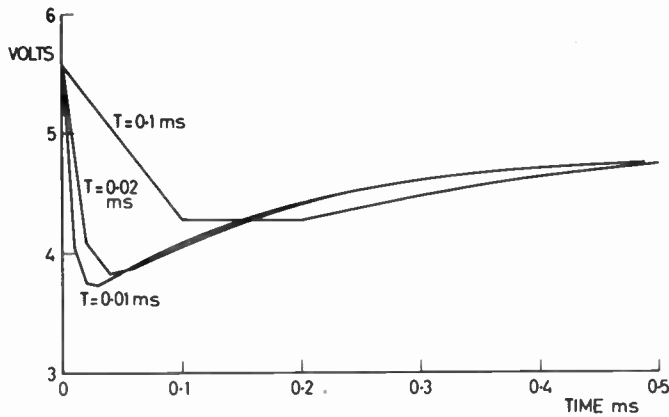

Fig. 16. Transient results for circuit of Fig. 15.

accuracy compared with the true physical result (which is different from the $T = 0$ non-parasitic result) can be estimated from the lumped circuit of Fig. 17 where the parasitics for $T = 0.01$ ms have been included. For example, the numerical parasitics around the diode could be compared with manufacturer's data for the actual diode parasitics.

A second example of a transient analysis is given by the time response of the circuit of Fig. 13. A transient model for the transistors is shown in Fig. 18. In the results of Table 4 the characteristic impedances of the diode link transmission lines are deliberately chosen to be small in order to emphasize the shunt capacitors shown in Fig. 18. The ratio of Z_{01} to Z_{02} is the same as C_2 to C_1 and the values correspond to a time step of $0.072 \mu\text{s}$. Thus Table 4 not only shows convergence to a d.c. solution, for application of the power supply, but also shows the transient involved in getting to the d.c. solution. The transient obtained by switching V_s after the power supply has been established is shown in Table 5.

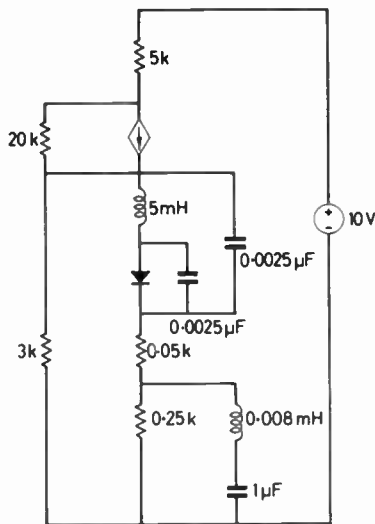

Fig. 17. Numerical parasitics for circuit of Fig. 15.

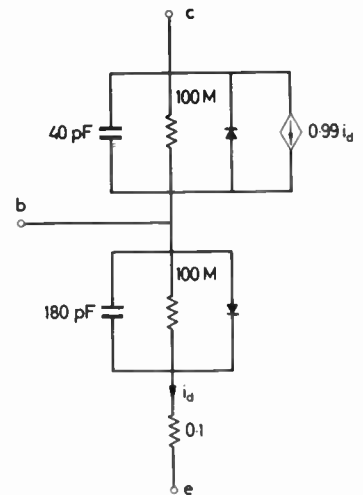

Fig. 18. Transmission-line model for transistors in Fig. 13.

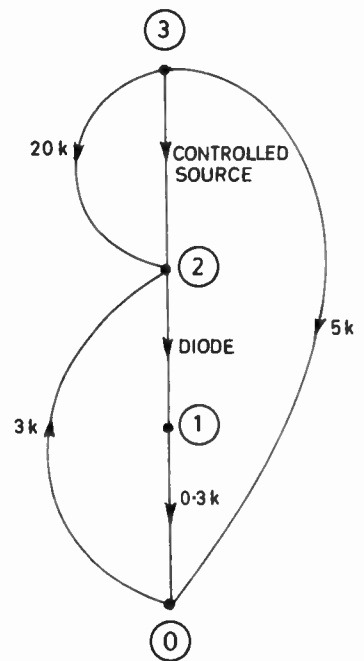

Fig. 19. Directed graph for the circuit of Fig. 10(a).

6 Conclusions

This paper describes a new way of viewing the numerical solution of lumped networks. The technique requires the engineer to produce a theoretical time-discrete model of the lumped network using networks of transmission lines. The computer merely mimics the model and produces an exact solution of it. Very often the time-discrete transmission-line model represents the physical lumped circuit better than the time-continuous calculus model and so convergence to an infinitely small time step may not be needed.

7 Acknowledgment

This work was supported in part by the UK Science Research Council under contract GR/A42608.

8 References

- 1 Chua, L. and Lin, P., 'Computer-Aided Analysis of Electronic Circuits' (Prentice-Hall, Englewood Cliffs, N.J., 1975).
- 2 Calahan, D. A., 'Computer-Aided Network Design' (McGraw-Hill, New York, 1972).
- 3 Johns, P. B., 'Numerical modelling by the TLM method', in 'Large Engineering Systems', A. Wexler (Ed.) (Pergamon Press, Oxford, 1977).
- 4 Bandler, J. W., Johns, P. B. and Rizk, M. R. M., 'Transmission-line modelling and sensitivity evaluation for lumped network simulation and design in the time domain', *J. Franklin Inst.*, 304, no. 1, pp. 15-23, 1977.
- 5 Johns, P. B., 'A simple explicit and unconditionally stable numerical routine for the solution of the diffusion equation', *Int. J. Num. Meth. in Engng*, 11, pp. 1307-28, 1977.
- 6 Bowers, J. C., Zobrist, G. W., Lors, C., Rodby, T. and O'Reilly, J. E., 'A Survey of Computer-Aided Design and Analysis Programs', Electrical and Electronic Systems Department, University of South Florida, April 1976.

9 Appendix

This appendix shows the matrices and operations required to solve the network shown in Fig. 10(a). The exact details of how to construct these matrices may be found in Reference 1.

The reduced incidence matrix A is found from the directed graph of the circuit which is shown in Fig. 19.

			controlled		resistors			
	nodes	branches	diode	sources	20 k	5 k	3 k	0.3 k
A =	1	2	3	$\begin{pmatrix} -1 & 0 & 0 \\ +1 & -1 & -1 \\ 0 & 1 & +1 \end{pmatrix}$	0	0	0	+1

The branch admittance matrix is

$$Y_b = \begin{pmatrix} \frac{1}{Z_0} & 0 & 0 & 0 & 0 & 0 \\ 0 & 0 & 0 & 0 & 0 & \frac{0.98}{300} \\ 0 & 0 & \frac{1}{20000} & 0 & 0 & 0 \\ 0 & 0 & 0 & \frac{1}{5000} & 0 & 0 \\ 0 & 0 & 0 & 0 & \frac{1}{3000} & 0 \\ 0 & 0 & 0 & 0 & 0 & \frac{1}{300} \end{pmatrix}$$

The nodal admittance matrix is found using

$$Y_n = AY_bA^T.$$

Alternatively Y_n can be constructed directly as shown in Reference 1, Section 4-6. Using either method we obtain

$$Y_n = \begin{pmatrix} \frac{1}{Z_0} + \frac{1}{300} & -\frac{1}{Z_0} & 0 \\ -\frac{1}{Z_0} - \frac{0.98}{300} & \frac{1}{20000} + \frac{1}{3000} + \frac{1}{Z_0} & -\frac{1}{20000} \\ \frac{0.98}{300} & -\frac{1}{20000} & \frac{1}{20000} + \frac{1}{5000} \end{pmatrix}$$

There are no independent current sources and only one independent voltage source, thus

$$J = \begin{pmatrix} 0 \\ 0 \\ 0 \\ 0 \\ 0 \\ 0 \end{pmatrix} \quad E = \begin{pmatrix} 0 \\ 0 \\ 0 \\ 10 \\ 0 \\ 0 \end{pmatrix}$$

There is only one port so

$${}_kV^i = \begin{pmatrix} {}_kV^i \\ 0 \\ 0 \\ 0 \\ 0 \\ 0 \end{pmatrix} \quad {}_kV^r = \begin{pmatrix} {}_kV^r \\ 0 \\ 0 \\ 0 \\ 0 \\ 0 \end{pmatrix}$$

We now construct ${}_kJ_n$ using

$${}_kJ_n = A[J - Y_bE - 2Y_b{}_kV^i]$$

i.e.

$${}_kJ_n = \begin{pmatrix} -\frac{2{}_kV^i}{Z_0} \\ \frac{2{}_kV^i}{Z_0} \\ 10 \\ \frac{1}{5000} \end{pmatrix}$$

Again it should be noted that ${}_kJ_n$ can be constructed automatically as shown in Reference 1, Section 4-6. The nodal voltages ${}_kV_n$ are computed by inverting Y_n

$${}_kV_n = Y_n^{-1} {}_kJ_n.$$

We now find ${}_kV^r$ by using

$${}_kV^r = A^T {}_kV_n - {}_kV^i$$

which can be written in this example as

$${}_kV^r = ({}_kV_2 - {}_kV_1) - {}_kV^i$$

$({}_kV_2 - {}_kV_1)$ is merely the potential drop across the diode at the k th iteration.

At the start of the computation

$${}_0V^i = 0.$$

Thus

$${}_0V^r = {}_0V_2 - {}_0V_1.$$

As there is only one port we need only solve the single equation for ${}_{k+1}V^i$ for the scheme to proceed.

$${}_{k+1}V^i - {}_kV^r = Z_0 \times 10^{-9} [\exp [40({}_{k+1}V^i + {}_kV^r)] - 1].$$

Choosing the value of 1 kΩ for Z_0

$$Y_n^{-1} = \begin{pmatrix} 587.45 & 427.76 & 85.55 \\ 1545.63 & 1853.61 & 370.72 \\ -7366.93 & -5218.64 & 2956.27 \end{pmatrix}.$$

Hence

$${}_0v = \begin{pmatrix} 0.171 \\ 0.741 \\ 5.913 \end{pmatrix}.$$

Thus

$${}_0V^r = 0.5703$$

and we find ${}_1V^i$ by a simple stepping method, thus

$${}_1V^i = -0.2306.$$

Using this we find ${}_1J_n$

$${}_1J_n = \begin{pmatrix} +0.00046 \\ -0.00046 \\ 0.002 \end{pmatrix}$$

and hence

$${}_1v = \begin{pmatrix} 0.245 \\ 0.599 \\ 4.922 \end{pmatrix}.$$

Manuscript first received by the Institution on 27th March 1979 and in final form on 23rd July 1979. (Paper No. 1914/CC314)

The Authors



Mark O'Brien received his B.Sc. degree in mathematics-with-engineering from the Department of Theoretical Mechanics, University of Nottingham in 1977. He is currently working on his Ph.D. thesis on transmission line modelling in the Departments of Theoretical Mechanics and Electrical and Electronic Engineering.



Peter Johns was awarded the B.Sc.(Eng.) degree in electrical engineering and the M.Sc. degree in physics from London University in 1964 and 1966 respectively; he obtained a Ph.D. degree from Nottingham University in 1973. From 1964 to 1967 he was with the British Post Office Research Department where he worked on modulation and interference problems associated with communication-satellite systems. In

1967 he was appointed lecturer in the Department of Electrical and Electronic Engineering at the University of Nottingham and became Reader in this Department in 1978. His research interest is now in the area of modelling and numerical analysis with emphasis on electromagnetic waves, diffusion and lumped networks. Dr Johns spent a year doing research at the University of Manitoba, Canada, from 1975 to 1976.

Standard Frequency Transmissions

(Communication from the National Physical Laboratory)

Relative Phase Readings in microseconds
NPL—Station
(Readings at 1500 UT)

NOVEMBER 1979	MSF 60 kHz	GBR 16 kHz	Droitwich 200 kHz
1	-2.9	7.8	48.7
2	-2.9	9.8	48.4
3	-3.2	9.6	48.2
4	-3.0	9.7	47.9
5	-3.0	9.5	47.9
6	-3.0	8.2	47.9
7	-3.1	9.7	47.5
8	-3.0	7.9	47.5
9	-3.0	7.7	47.3
10	-3.1	8.7	47.1
11	-3.2	7.8	46.9
12	-3.3	8.5	46.7
13	-3.1	8.0	46.5
14	-3.3	7.4	46.4
15	-3.3	8.2	46.3
16	-3.1	9.9	46.3
17	-3.3	9.5	46.1
18	-3.2	9.5	45.9
19	-3.2	9.0	45.7
20	-3.0	8.0	45.4
21	-3.0	8.7	45.2
22	-3.0	9.2	44.9
23	-3.0	7.2	44.6
24	-3.0	8.2	44.3
25	-3.1	9.2	44.0
26	-2.9	8.2	43.7
27	-3.1	8.7	43.5
28	-3.1	9.2	43.3
29	-2.7	9.2	43.2
30	-2.7	7.2	42.9

Notes: (a) Relative to UTC scale (UTC_{NPL}-Station) = + 10 at 1500 UT, 1st January 1977.

(b) The convention followed is that a decrease in phase reading represents an increase in frequency.

(c) Phase differences may be converted to frequency differences by using the fact that 1 > s represents a frequency change of 1 part in 10¹¹ per day.

A new technique for the generation of television test signals in all bands

WENDL, Phys.*

Based on a paper presented at the IERE Conference on Vision Measurements in London on 21st to 23rd May 1979.

SUMMARY

This paper deals with a new technique for the generation of test signals for television testing. A signal generator covers continuously through all the television bands is described. The operating principle is based on the generation of sound- and vision-modulated test signals at a standard intermediate frequency followed by sideband frequency conversion to the range 25 to 1000 MHz. The method is justified in a description of the technique of up-conversion to a high intermediate frequency with subsequent broadband down-conversion. This is followed by a presentation of the specification necessary for the local conversion oscillator, together with its operating principle and electrical characteristics. The method of frequency stabilization, indication and tuning is described in greater depth. In conclusion, the characteristics of the overall system are discussed, including a description of the modulator section, and the range of applications indicated.

Rohde & Schwarz GmbH & Co KG, Muhldorfstrasse 15, D-80 München 80, FDR.

Radio and Electronic Engineer, Vol. 50, No. 1/2, pp. 71-78, January/February 1980

1 Introduction

All efforts to produce a continuously tunable generator of r.f. television test signals capable of meeting the relevant television transmission specifications have so far given unsatisfactory results. It has been necessary to accept certain channel-dependent errors in the amplitude and group-delay characteristics, in the linearity and in the modulation depth. Vestigial-sideband filtering was often not available either. The combination of vision and sound signals at radio frequency was often the cause of matching errors and unwanted coupling in the output stages, both of which add uncertainty to the measurement results. This unsatisfactory state of affairs was sufficient reason for Rohde & Schwarz to begin research into new technologies, with the aim of developing a better method of generating precise r.f. test signals in any television channel. Developments in fixed-frequency systems and rapid advances in the field of broadband amplifiers, mixers and oscillators led to a generation technique which can be readily realized with available components and circuits.

2 Principle of Operation

The most important features of the new technique are:

- (1) Processing of the vision and sound test signals at fixed standard intermediate frequencies. This is the method being used in modern television transmitters. Rohde & Schwarz adopted this principle as early as 1954 for fixed-channel test systems and has proved its worth both in centralized generation systems for television-receiver manufacturing plants¹ and in the development laboratory. Systems for special test functions are additionally equipped with a sideband generator which can be tuned or swept over a range of ± 8 MHz relative to the vision i.f. Such a generator can be used in conjunction with the unmodulated vision and sound carriers for three-signal measurements of static non-linearity and intermodulation.
- (2) Linear conversion of the combined vision and sound signals to any channel frequency in the range 25 to 1000 MHz using broadband mixers and oscillators. The oscillator frequency is stabilized in a phase-locked loop configuration and a simple means of setting the carrier frequency, with a precise counter display, is provided.

2.1 Frequency Conversion

Each time the frequency of an r.f. signal is changed by mixing, unwanted byproducts are produced, such as the second sideband or the mixing frequency itself. Only adequate filtering or compensation circuitry can suppress such signals sufficiently. Figure 1 illustrates various possible methods of frequency conversion.

0033-7722/80/010071 + 08 \$1.50/0

© 1980 Institution of Electronic and Radio Engineers

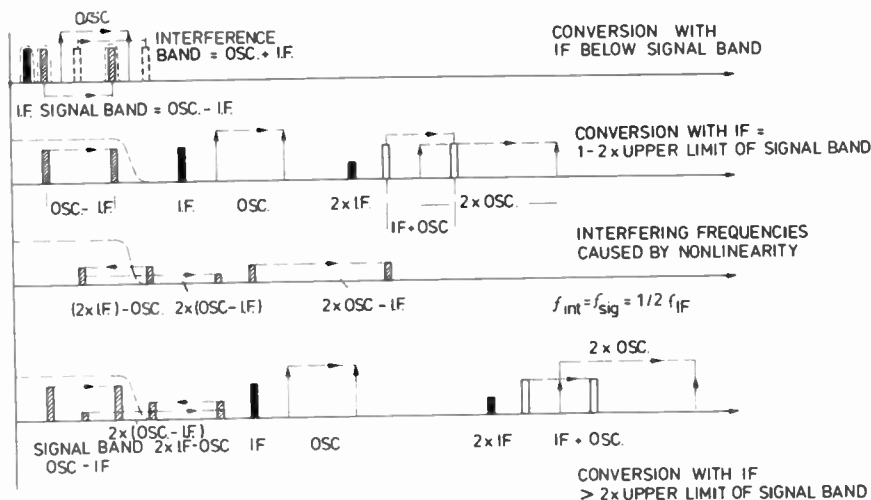

Fig. 1. Frequency schemes for i.f.-r.f. conversion

Line 1 shows what happens when a low intermediate frequency is up-converted to a higher radio frequency. It is immediately clear that only a bandpass filter which can be tuned to track with the oscillator will be able to suppress the oscillator frequency and the upper sideband. The high demands placed on such a filter in respect of tracking characteristics, mechanical and electrical design and the excessive amount of adjustment time needed at the testing stage make it clear that the practical realization of such a filter with close tolerances is a very doubtful proposition.

An easier approach is to use a second conversion in which the second i.f. lies above the final television signal band. When this is done, it is only necessary to have fixed i.f. filters for selecting the up-converted i.f. and a lowpass filter for the down-converted television signal in order to achieve suppression of the unwanted mixture products (line 2 of Fig. 1).

Other unwanted signals result from the nonlinear distortion of the mixers and amplifiers, the most critical of these being the term $2 \times \text{i.f.} - \text{oscillator frequency}$. This product term frequency decreases with increasing signal frequency. At a frequency of $\text{i.f.}/2$, the unwanted product falls in the useful signal band at a level of between 15 and 20 dB above the noise, assuming that mixers and amplifiers are so fully driven as to give the possibility of a useful signal-to-noise ratio of over 60 dB referred to the black-white transition. This is shown separately in line 3 of the Figure.

Line 4 shows how even this unwanted product can be made ineffective. The second i.f. is chosen higher than twice the highest useful signal frequency, with the result that this product no longer falls in the useful signal band and can be further suppressed by a lowpass filter. Unwanted mixture and distortion products of higher order still falling in the useful signal band can be kept so low as to be below the noise level in the output signal by the use of high-level mixers and extremely linear amplifiers.

Figure 2 shows how such a mixing scheme is applied in an instrument. For technical reasons, a further i.f. of 250 MHz has been added to make it easier to achieve high selectivity specification for the final i.f. of 2250 MHz. The mixing signals for the first two stages of conversion are both derived by multiplication of a crystal oscillator. In the first case the multiplication factor is 3 and the crystal frequency 70.36 MHz, in the second case a crystal frequency of 100 MHz is multiplied by 20. The mixing signal for the final down-conversion from 2250 MHz to the output frequency range of 20 to 1000 MHz is obtained from a continuously tunable oscillator with a working range of 2275 to 3250 MHz. The 25-to-1000-MHz output signal is then passed through a multi-section lowpass filter with a block attenuation of over 40 dB at the oscillator and upper sideband frequencies to the broadband output amplifier.

2.2 Conversion Oscillator

The oscillator required for down-conversion from the final i.f. of 2250 MHz must meet the following specification:

- (1) Tuning range of 2275 to 3250 MHz with output power higher than 20 mW in order to be able to drive the high-level mixer fully.
- (2) High spectral purity and low phase noise to provide a p.p.m. signal-to-noise ratio of 60 dB to be achieved. (Referred to 3 GHz, this means a frequency constancy of better than 1 part in 10^8 over an interval of 25 ms, or a modulation frequency of 40 Hz.)
- (3) Constancy of better than 10 kHz over a measuring time, equal to 3 parts in 10^6 of oscillator frequency.

A free-running oscillator tunable over such a wide range cannot fulfill these conditions unless special circuitry is added to clean up and stabilize the oscillator.

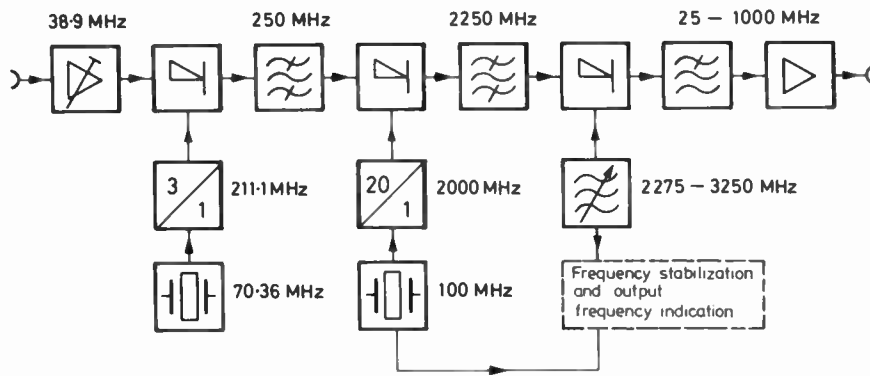

Fig. 2. Frequency conversion.

frequency. In the instrument here described, a phase-locked loop arrangement was used which, despite the limited bandwidth of the control loop, gives very good results as long as the oscillator meets a number of further conditions.

Extensive experiments have shown that an oscillator tuner with varactor diodes only gives useful results when the varactors are so loosely coupled that the tuned circuit can be operated at a very high Q . This is not possible when a wide tuning range is required, and all the more so when the basic operating frequency is high. The reason for this is that demodulation in a Nyquist-slope demodulator converts any phase noise on the converted vision carrier into unwanted amplitude modulation. As a result, the signal-to-noise ratio is degraded up to the highest video frequencies. Analysis has shown that the noise spectrum falls off towards higher frequencies.

The search for a better type of oscillator showed that the YIG oscillator was best suited for this application. The YIG oscillator works on the following principle.

A small, highly polished sphere of monocrystalline yttrium-iron garnet (YIG) is positioned in a static magnetic field and excited into oscillation in the microwave region. The resonance frequency is directly

proportional to the density of the surrounding magnetic field and, due to the low losses, the YIG sphere of less than 1 mm diameter represents a high- Q microwave resonator with Q factor of 4000 or more. Thus the most important requirement for an oscillator with a very narrow noise spectrum and low phase noise is met. The magnetic field is produced in the air gap of an electromagnet, the current of the magnet winding determining the field strength and thus the frequency of the oscillations. An auxiliary coil on the electromagnet allows separate modification of the magnetic field. In general applications this coil is used for frequency modulation with bandwidths up to 100 kHz, in this specific case it is used for frequency control of the oscillator.

The YIG oscillator used here is manufactured by Sivers Lab and has a tuning range of 2 to 4 GHz with a tuning sensitivity of 20 MHz/mA for current flowing in the f.m. winding. The use of a very linear voltage/current conversion circuit has made it possible to produce a tuning characteristic with a linearity error of less than 0.2%. The output power is more than 25 mW and the harmonics suppression greater than 16 dB. Spurious f.m. at low frequencies is about 5 kHz peak-to-peak.

Fig. 3. Stabilization and indication of output frequency.

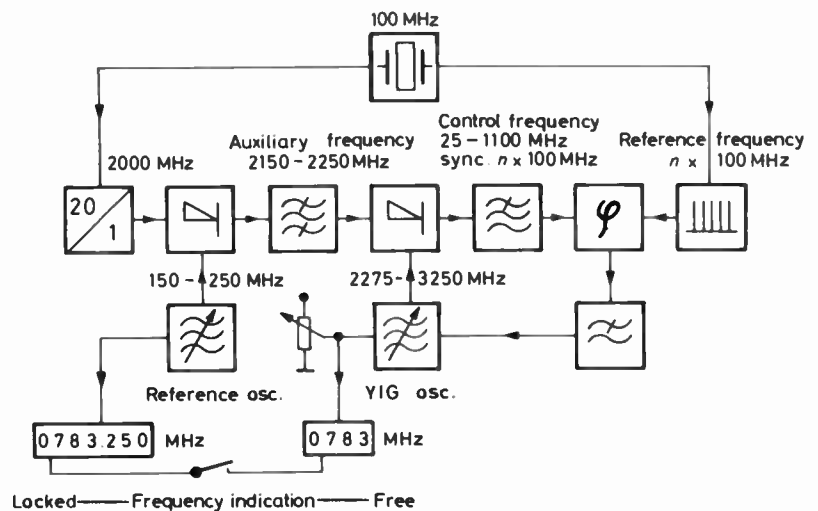

2.3 Frequency Stabilization

Two main requirements formed the basis for the development of the stabilization circuit.

- (1) The intrinsic signal-to-noise ratio of the YIG oscillator must be improved sufficiently to ensure an unweighted signal-to-noise ratio of over 66 dB for the sound carrier, referred to 40 kHz deviation, and a video signal-to-noise ratio of over 60 dB (r.m.s.), referred to the black/white transition.
- (2) Stabilization should be effective not only at channel frequencies but at all frequencies within the tuning range. The setting accuracy should be around 10 kHz, a value small enough to ensure that changes in the receiver characteristic caused by inaccuracies in the position of the carrier on the Nyquist slope remain below 1%.

As already mentioned, the first requirement can only be met with a phase-locked loop. The zero-crossings of an auxiliary frequency derived from the oscillator frequency are compared with those of a highly stable, crystal-controlled reference in a phase discriminator. The resulting difference is used to generate a voltage for controlling the frequency of the oscillator.

The second requirement, stabilization at all frequencies, demands a comparison frequency which is tunable over the entire output-signal range but still has very low spurious f.m. Figure 3 shows the principle used.

The reference oscillator is free-running and can be tuned over the range 150 to 250 MHz by means of a rotary capacitor. The oscillator output has a signal-to-noise ratio of better than 70 dB referred to a useful f.m. deviation of ± 40 kHz. The output frequency is converted to the range 2150 to 2250 MHz by means of the same 2 GHz signal used for up-conversion to the final i.f.

Two bandpass filters eliminate unwanted mixture products. The resulting auxiliary frequency is down-converted to the range 25 to 1100 MHz by mixing with the YIG-oscillator frequency and taken to the phase discriminator via a lowpass filter. For a given YIG frequency, the control frequency thus produced can be set by tuning the reference oscillator so that a multiple of 100 MHz is always applied to the phase discriminator. The required control voltage is generated by comparing this signal with the 100-MHz crystal-controlled spectrum at the other input of the phase comparator. This voltage is used to vary the frequency of the YIG oscillator until the control frequency coincides exactly with one of the 100-MHz spectral lines. In this condition, the YIG oscillator is phase synchronized. To assist during the synchronizing phase of the YIG oscillator, a Wien-bridge oscillator is connected in parallel with the control amplifier. This varies the frequency of the YIG oscillator by ± 5 MHz, approximately, at a rate of 10 Hz as long as it is not synchronized. The relationship between the vision carrier output frequency F_O , the auxiliary frequency F_A , the control frequency F_C and the YIG-oscillator frequency F_Y can be shown as follows: Assuming

$$F_O = F_Y - IF; \quad F_C = F_Y - F_A = n \times 100 \text{ (MHz)}$$

when synchronized,

with $n = 1 \dots 11$ (integer) it follows that

$$F_O = F_C + F_A - IF;$$

where

$$F_A = 2150 + \Delta F \quad \text{and} \quad \Delta F = 0 \dots 100 \text{ MHz,}$$

giving

$$F_O = (n - 1) + \Delta F \text{ (MHz)}. \tag{1}$$



Fig. 4. Television test transmitter SBUF.

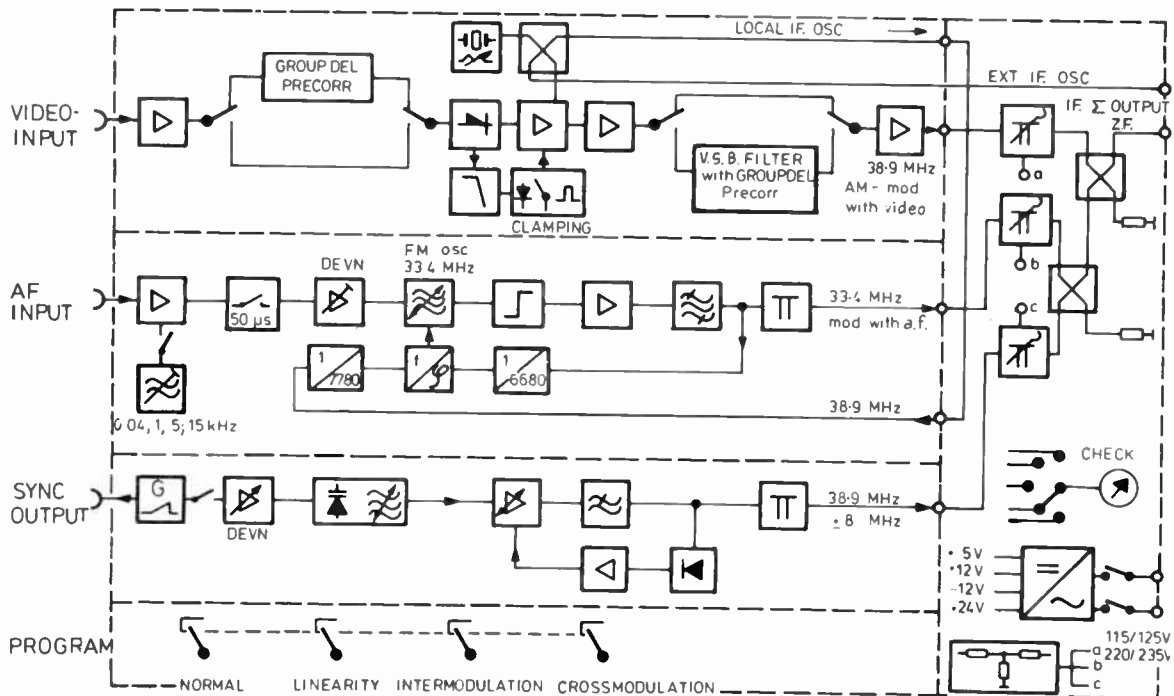

Fig. 5. Outline of modulator section of the SBUF.

Since, apart from the reference oscillator, only crystal-controlled frequencies are used in the control loop for forming the control frequency, the extent to which the YIG-oscillator frequency and hence the output frequency can be cleaned up with respect to unwanted f.m. within the bandwidth of the control loop depends mainly on the performance of the reference oscillator. Outside the bandwidth of the control loop, the Q -factor of the YIG oscillator itself determines the unwanted f.m. In order to achieve very low unwanted f.m. from the reference oscillator, a very high Q resonant circuit with rotary-capacitor tuning was used. The long-term stability is further improved by a regulation circuit, in which a regulating voltage is derived from the 1-kHz decade of a frequency counter using a digital-to-analogue converter and varies the reference-oscillator frequency until the 1-kHz digit is zero.

2.4 Frequency Indication and Tuning

The relationship expressed by (1) offers the possibility of indicating the output frequency exactly using a counter without having to measure it directly. Such a direct measurement would in any case only be feasible using complex correction or sampling circuits since the possible combinations of vision, sound and sideband signals make reliable measurement of the vision carrier frequency almost impossible. On the other hand it is an easy matter to measure the frequency of the reference oscillator, which is exactly the term ΔF (MHz) in equation (1) after subtraction of its starting value of 150 MHz from the result in the counter.

The first term in equation (1) is identical with the 100-

MHz digit of the output frequency and can be derived from an auxiliary digital display of the YIG-oscillator tuning voltage. When calibrated for the frequency range 0 to 1000 MHz, this 100-MHz digit plus the ΔF indication gives a complete and accurate display of the chosen output frequency, as soon as the YIG oscillator has synchronized to the control frequency. Inaccuracies of the auxiliary indication of up to ± 10 MHz can be easily corrected by a logic comparator when the value is transferred to the main display.

The process described here also makes for very easy tuning to the output frequency. Using the reference-oscillator tuning, the desired vision-carrier frequency is entered, omitting the 100-MHz digit (counter indication between 0 and 99.990 MHz). Then the YIG oscillator is set roughly to obtain the required output frequency (25 to 1000 MHz) on the auxiliary display. This is sufficient to cause the YIG oscillator to synchronize. The 100-MHz digit of the auxiliary display is set in front of the counter indication to produce a complete readout of the output frequency which is accurate to 1 kHz.

3 Results and Applications

The technique for the generation of television test signals in any channel in the range 25 to 1000 MHz described above was successfully realized in a practical form. Figure 4 shows the complete test transmitter SBUF.

3.1 Characteristics of Transposer Section

Thanks to the use of 8-diode high-level mixers developed in-house for up- and down-conversion at

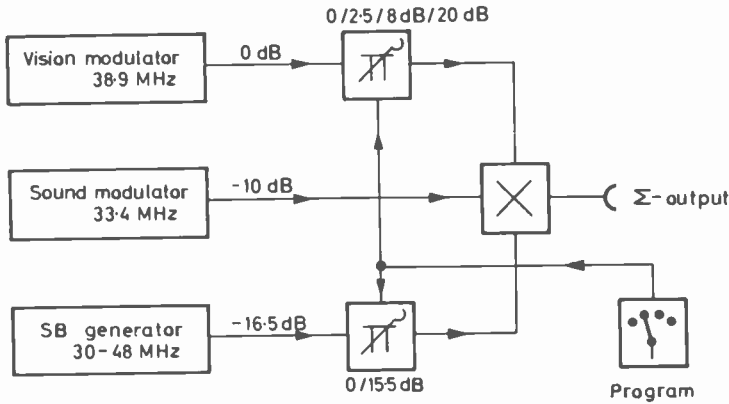

Fig. 6. Modulator of SBUF.

frequencies up to 3 GHz, the adoption of thin-film technology for amplifiers, filters and couplers working in the microwave range and the use of circulators for the isolation of unwanted signals and comparison signals within the frequency control loop, it was possible to achieve the following specification for the transposer section of the new television test transmitter:

- (1) Channel-dependent amplitude changes are typically $< \pm 3\%$ and variations of the group delay < 10 ns within the channel width.
- (2) Variations of the output level are $< \pm 1$ dB over the entire range; the automatic levelling functions independently of the signal combination.
- (3) The nominal output level can be varied continuously from 100 to 200 mV into 50 Ω , further attenuation is possible by means of a switched divider with steps of 1 dB down to a minimum level of 30 μ V.
- (4) At an output level of 100 mV, the nonlinearity (k_2) is $< 1\%$ and the intermodulation suppression (k_3) > 70 dB as measured by the three-source method.
- (5) The signal-to-noise ratio referred to a black/white transition and measured with a Nyquist-slope test

demodulator is > 56 dB (r.m.s.) (unweighted) for frequencies between 0.1 and 5 MHz, rising to > 60 dB at an output level of 200 mV.

- (6) Hum suppression is > 56 dB peak-to-peak.
- (7) Weighted and unweighted signal-to-noise ratio of the sound signal is ≥ 66 dB peak-to-peak referred to a deviation of 40 kHz with both pre-emphasis and de-emphasis switched on.
- (8) All crystal oscillators are thermally stabilized, guaranteeing an accuracy of better than ± 2 kHz in the output frequency; crystal ageing is $\leq 2 \times 10^{-8}$ /day.

3.2 Characteristics of Modulator Section

The performance of the transposer shown above can, of course, only be fully utilized if the modulator section generates i.f. signals of corresponding quality. This has been achieved in the vision and sound modulators developed for this new instrument. The addition of a programming unit has greatly improved the efficiency of test-signal selection compared with previous test-signal sources.

Figure 5 shows the principle of operation of the modulator section. Vision, sound and sideband signals

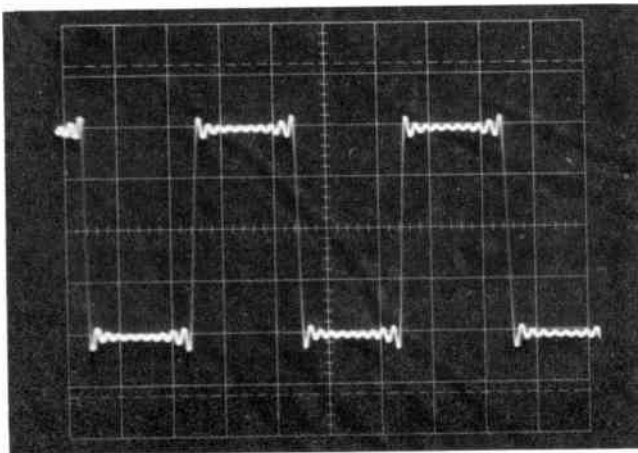

Fig. 7. 250-kHz squarewave: SPF + SBUF (without v.s.b. filter) + AMF2 (broadband i.f.).

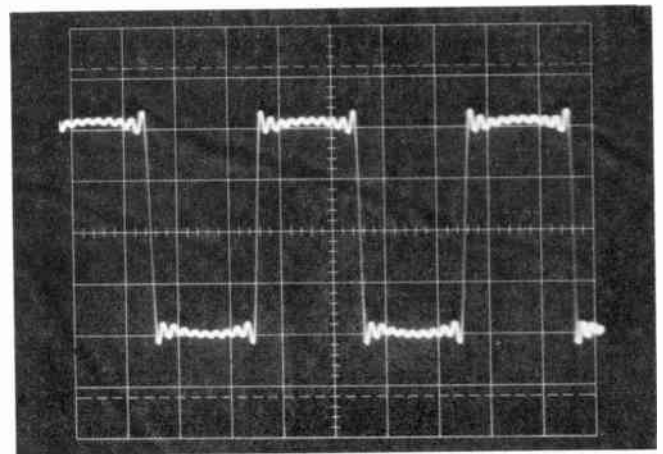

Fig. 8. 250-kHz squarewave: SPF + SBUF (with v.s.b. filter) + AMF2 (broadband i.f.).

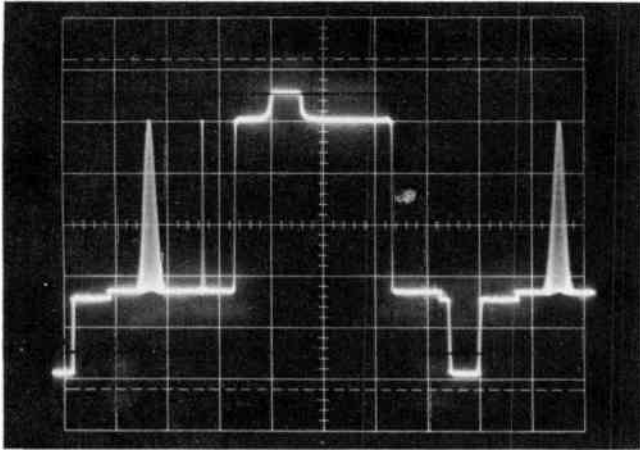

Fig. 9. 2T'20T SPF+SBUF (without v.s.b. filter)+AMF2 (i.f.).

are connected to a combining network via switchable attenuators. The combining network feeds two identical outputs, one on the front and one on the rear panel, with 200 mV vision i.f. (measured at sync peak). The isolation between the two outputs is better than 20 dB. According to the program chosen with the selector buttons, the relative levels of the vision, sound and sideband components are adjusted for specific testing functions on transposers, receivers or demodulators. Five different programs are provided.

(1) Vision and sound carriers are modulated with the externally fed-in video and internally generated audio signals. Level ratio of vision to sound $V/S = 0/-10$ dB. This program is used for the measurement of all dynamic transmission parameters such as the transient response, linearity, differential gain, differential phase, amplitude/frequency and group delay/frequency

responses, signal-to-noise ratio, control characteristics and levelling.

- (2) Vision and sound carriers are unmodulated. Level ratio $V/S = 0/-10$ dB. This program is used for measuring the out-of-channel intermodulation products of the vision and sound carriers ($V \pm n(V-S)$) and harmonics.
- (3) Vision, sound and sideband signals are unmodulated. Level ratio $V/S/SB = -8/-10/-16.5$ dB. Program used for measuring intermodulation products of vision, sound and sideband signals falling within the selected channel ($V \pm S \pm SB$).
- (4) Vision, sound and sideband signals are unmodulated. Level ratio $V/S/SB = -2.5$ or $-8/-10/-32$ dB. Program used for measuring line-time non-linearity in the picture range between blacker-than-black and grey. Vision-carrier amplitude switches at intervals of approximately 1 second.
- (5) Vision, sound and sideband signals are unmodulated. Level ratio $V/S/SB = -2.5$ or $-20/-10/-32$ dB. Program used for measuring line-time non-linearity in the picture range between blacker-than-black and white. Vision carrier amplitude switches at intervals of approximately 1 second.

In addition to the selection of preprogrammed signals provision is also made for fine adjustment of the level ratios. Each component produced by the vision, sound and sideband generators can be varied individually by more than ± 3 dB or switched off altogether. Since the signals are processed at i.f. and broadband-converted to the required r.f. channel, the usual problems of interconnecting three separately tunable signal generators with attenuators and decoupling networks

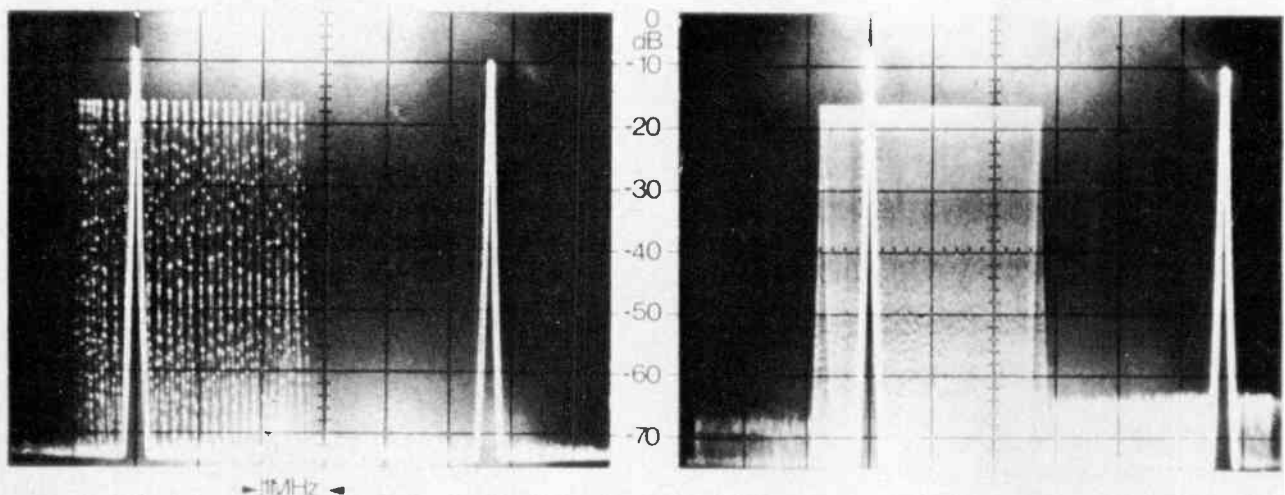

Fig. 10. Sideband measurement -0.75 to $+2.5$ MHz.

Left: with SBUF (cross. mod.) + analyser.

Right: with SBUF + UT011 + analyser.

involved in three-source measurements on transposers or receivers are all eliminated. Of course the tuning of the three generators to the vision, sound and sideband frequencies, and the adjustment of the relative levels also are superfluous.² It is clear that this new instrument has a drastic rationalizing effect and greatly reduces the risk of making wrong settings.

Among the special features of the vision modulator are the bridgeable vestigial sideband filter in which group-delay errors caused by the selectivity filters are compensated by active i.f. all-pass filters, and a switched video group-delay equalizer for compensation of receiver errors which is matched to the particular television standard. Sampled, peak and mean value clamping modes are provided. All the remaining electrical parameters are fully compatible with the requirements of modern commercial measurements (e.g. differential gain $\leq 2\%$, differential amplitude $\leq 2^\circ$).

Special features of the sound modulator are an exact centre-frequency control circuit, a built-in sine-wave generator with the selectable frequencies 40 Hz, 1, 5 and 15 kHz to provide the most important a.f. test signals, and full stereo compatibility. With its typical distortion of 0.3% and a deviation range of 75 kHz, the internal audio generator allows measurements such as amplitude/frequency response, distortion and signal-to-noise ratio to be made without an external a.f. source.

The sideband generator can be tuned continuously through the range 30 to 48 MHz either manually (static) or in an automatic sweep of 1 or 10 s (dynamic) with a maximum sweep width of ± 8 MHz. This facility can be used for adjusting and checking the amplitude/frequency response of the test object.

Figure 6 is the block diagram of the modulator. Figures 7 to 11 show oscillograms for measurements on various test items.

3.3 Applications

The system described represents a continuously tunable television test-signal generator offering r.f. test signals of a variety and quality not previously available. This clearly makes it suitable for a wide range of applications in the laboratory, test department and service workshop. Combining the signal generator with suitable test demodulators and analysers will build a system capable of rapid, simple and rational evaluation of the electrical performance of television receivers, amplifiers, transposers and subassemblies of such equipment. The wide frequency range of 25 to 1000 MHz not only covers all common television broadcast channels but also includes the bands used for cable television, amateur radio, police services and traffic monitoring. The quality of the generated signals with amplitude and frequency modulation will generally be good enough for testing non-television equipment, measurements such as signal-to-noise ratio, distortion

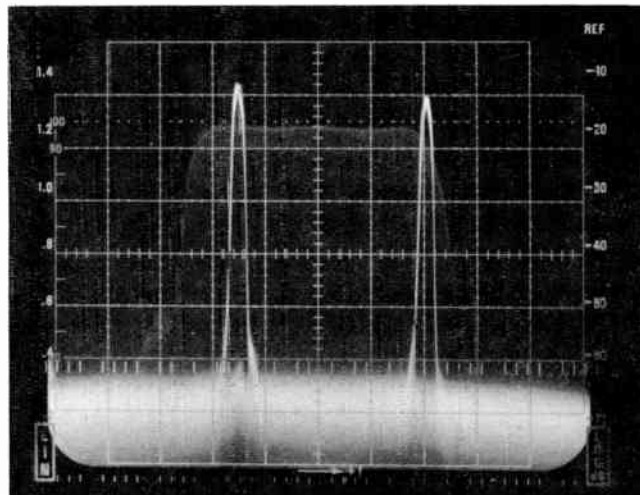

Fig. 11. Passband characteristic of UT011, measured with SBUF (cross mod.) + analyser (log. indication).

and crosstalk in stereo receivers being good examples. Although developed specially for television testing, this is undoubtedly a measuring instrument which will find a wide range of applications.

4. References

- 1 Strössenreuther, W., 'Messgeräte für die hochfrequente Übertragung von Schwarz-Weiss- und Farbsignalen', *Rundfunktechnische Mitt.*, 8, no. 4, pp. 212-9, 1964.
- 2 Wendl, A., 'Fernsehmeßanlage für die Fabrikation von Fernseh-Empfängern', *Rohde & Schwarz-Mitt.*, no. 17, pp. 101-13, 1963.
- 3 Wendl, A., 'Neue Verteilernetzwerke erweitern und verbessern Meßanlagen für die Fernsehgeräte-Industrie', *Radio Mentor Electronic*, 42, no. 11, pp. 434-7, 1976.
- 4 Wendl, A., 'TV test transmitter SBUF continuously tunable from 25 through 1000 MHz', *News from Rohde & Schwarz*, 18, no. 81, pp. 6-9, 1979.
- 5 Burkhart, D., 'Intermodulation and crossmodulation measurements with power signal generator SMLU', *News from Rohde & Schwarz*, 13, no. 62, pp. 5-7, 1973.
- 6 Mangold, H. and Neumann, H., 'Eine Fernseh-Sendeanlage für Bild und Ton mit kleiner Leistung', *Rohde & Schwarz-Mitt.*, no. 6, pp. 398-401, 1955.

*Manuscript received by the Institution on 5th February 1979
(Paper No. 1915/Comm. 190)*

The Author:



Adolf Wendl is head of the group responsible for the development of test generators for television and broadcasting applications at Rohde & Schwarz, Munich. He has been with the company since 1954, having previously studied mathematics and physics at the Universities of Regensburg and Munich. From 1954 until 1969 he worked as a development engineer concerned with television transposers, receivers and test systems.

D.c.-parameter characterization of the Early effect in bipolar junction transistors

B. L. HART, B.Sc., C.Eng., M.I.E.R.E.*

SUMMARY

The effects of base width modulation ('Early effect') on the d.c. and low-frequency incremental output characteristics of a bipolar junction transistor are reviewed critically, using only a basic consideration of the physical electronics of device operation. Attention is focused on the dependence on collector-base voltage of the majority carrier charge in the base of a device having an arbitrary base doping distribution. The conditions under which a single voltage parameter ('Early voltage') can be used to describe the output characteristics, independent of base-emitter drive conditions, are examined and some implications of the results to the circuit engineer outlined.

* School of Electrical and Electronic Engineering, North East London Polytechnic, Longbridge Road, Dagenham, Essex RM8 2AS.

List of Principal Symbols and Abbreviations

A_E	base-emitter junction area
$C_{jc}(V)$	incremental collector-base junction capacitance
$C_{je}(V)$	incremental base-emitter depletion capacitance
$d = (\bar{D}_n/\bar{D}_p)(n_{iB}^2/n_{iE}^2)$	
D_n	uniform-base electron diffusion coefficient
\bar{D}_n, \bar{D}_p	mean diffusion coefficients, for electrons in base and holes in emitter, with non-uniform doping
$G_B(W) = \int_0^W N_a(x) dx$	= base 'Gummel number'
G_E	effective Gummel number for emitter current: subscripts B, C, E, refer to base, collector, emitter, respectively
I	
$I_{B(V)}$	base region bulk recombination component of I_B
I_{En}	electron component of emitter junction current
I_{Ep}	hole, back-injection component, of I_B
I_{rg}	surface and depletion-layer recombination component of I_B
K	Boltzmann's constant
$m = \beta_V(W)/\beta_Y(W)$	
n	exponent in formula for C_{jc}
n_{iB}, n_{iE}	intrinsic carrier concentrations in base, emitter
$n_p(x)$	base electron concentration
n_{p0}	equilibrium electron concentration in base
$N_a(x)$	base acceptor concentration
N_B	uniform-base acceptor concentration
$N_d(x')$	emitter donor concentration
q	magnitude of electronic charge
Q_{jE}	base-emitter depletion layer charge
Q_{mB}	magnitude of minority carrier charge in base
Q_{MB}	magnitude of base majority carrier charge
$r_{O(I)}$	collector incremental output resistance, I_B constant
$r_{O(V)}$	collector incremental output resistance, V_{BE} constant
T	absolute temperature
V_A	the Early voltage
$(V_A)_I$	an Early voltage, for case I_B constant
$(V_A)_V$	an Early voltage, for case V_{BE} constant
V_{BE}, V_{CB}, V_{CE}	direct base-emitter, collector-base, collector-emitter, voltages
$V_T = kT/q$	'thermal voltage'
W	width of quasi-neutral base region
x, x', x''	longitudinal position co-ordinates of one-dimensional b.j.t. model
$\beta = I_C/I_B$	(subscript 0 refers to $V_{CB} = 0$)
$\beta_V(W) = I_C/I_{B(V)}$	
$\beta_Y(W) = I_C/I_{Ep}$	

γ	emitter injection efficiency
η	field factor
τ_B	minority carrier lifetime in base
τ_t	base transit time
ψ	contact potential of collector-base junction

1 Introduction

J. M. Early, in a classic paper¹ was the first to account for the finite output conductance of a bipolar junction transistor (b.j.t.) in terms of the modulation of the base width by a variation in collector voltage (the 'Early effect'). The advent of the transistor curve-tracer facilitated the rapid examination of device characteristics and it became clear that the common-emitter (c.e.) output characteristics of a b.j.t.—operating in the forward-active mode with base current drive—not only had a finite positive slope but also, when extrapolated, appeared to radiate from a common point on the negative V_{CE} axis. However, it was Gummel and Poon² who first published this observation, and who coined the term 'Early voltage' for a parameter describing the output characteristics of a b.j.t. In recent years there has been a revival of interest³⁻¹⁰ in the Early effect because of the importance of realistic device models in computer-aided circuit design and, especially, in the design of precision analogue integrated circuits.

With modern transistors the Early effect is often attributed solely to variation of emitter injection efficiency with collector voltage, on the grounds that the base is so thin that bulk recombination effects can be neglected. However, this is not necessarily true, even for b.j.t.s with base widths less than one micron. Furthermore, in two recent papers,^{11,12} the existence of an Early voltage is attributed solely to bulk recombination in the base region. There is apparently a need for some clarification of the physical reasons for the existence of an Early voltage and the importance of this parameter in circuit engineering.

This paper is primarily of a review and 'integrating' nature and its objectives are threefold: (a) to clarify and quantify the effects of basewidth modulation for a device with a non-uniformly doped base, by focusing attention on base majority carrier charge and its variation with collector voltage; (b) to establish the conditions under which a single d.c. parameter can be employed to describe the d.c. and l.f. incremental output characteristics, irrespective of the incremental resistance in the base drive circuit; (c) to achieve (a), (b) not by referring to a particular device model but, rather, by a basic consideration of the physical electronics of device operation.

2 Device Structure and Assumptions

An npn transistor is chosen for discussion and analysis because of its predominance in modern bipolar circuits.

However, the treatment—with appropriate sign and material polarity changes—is equally applicable to a pnp transistor.

Figure 1 shows, schematically, a cross-section of a planar device. The quasi-neutral base region is bounded by the planes $x = 0, x = W$. The base-emitter depletion layer is confined to the region between $x = 0$ and $x' = 0$: similarly, the collector-base depletion layer exists in the region between $x = W, x'' = 0$.

Only those current components relevant to future discussion are shown, the arrowheads indicating the direction of conventional current flow. I_{En} is the component of the emitter current, I_E , that is associated with electron transport across the base (giving a collector current I_C) and the base region bulk recombination component, $I_{B(V)}$; I_{Ep} is the hole component of I_E that results from back-injection into the emitter region; I_{rg} takes into account all surface leakage and base-emitter depletion layer generation-recombination effects.

The following assumptions are made concerning device structure and operating conditions:

- (i) All acceptor and donor atoms are fully ionized.
- (ii) $W \ll$ mean free path of charge carriers in the base, so the usual drift-diffusion equations apply.
- (iii) One-dimensional current flow.
- (iv) Operation in the forward active mode ($V_{BE} > 0, V_{CB} > 0$) at values of V_{CB} for which the collector multiplication factor can be taken as unity.
- (v) 'Small' recombination in the base region, so that $I_{En} \gg I_{B(V)}$: an implication of this is that we can regard $I_{B(V)}$ as a small perturbation current so that the minority and majority carrier distributions in the base are essentially those corresponding to $I_{B(V)} = 0$.
- (vi) Operation under low-level injection conditions in the base, at current levels high enough to ensure that $I_{B(V)} \gg I_{rg}$ but low enough for thermal feedback effects⁹ and such phenomena as the Kirk effect¹³—base width widening at 'high' collector currents—to be disregarded.

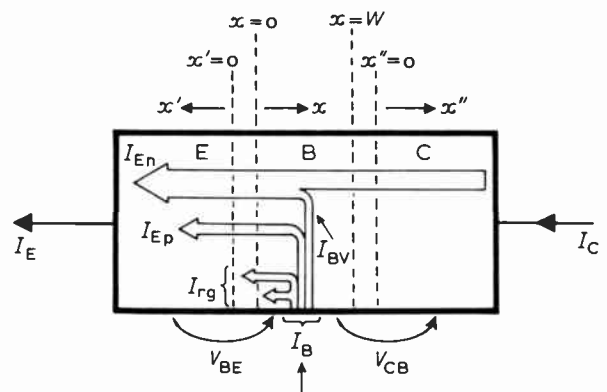

Fig. 1. Basic b.j.t. structure with relevant current components.

Most of these assumptions are implied in simplified descriptions of device operation in the linear region but they are explicitly set out here because their applicability to practical devices is discussed later (Sect. 7).

The assumptions are not, in reality, unduly restrictive—particularly in respect of many commonly-met low power monolithic circuit configurations such as the long-tailed pair, the ‘current-mirror’, and a wide variety of ‘translinear’ circuits.

3 Analysis

In most introductory treatments (see, e.g., Ref. 14) of the Early effect the assumptions of Section 2 are augmented by the assumption that the base is uniformly doped. Consequently, minority carrier flow across the base is principally diffusive. As recombination is considered small, the collector current and the minority carrier charge in transit are well-represented (for the calculation of I_C, I_B) by the slope and area, respectively, of the sensibly-linear minority carrier profile. Major merits of this approach are that the effect of changes of collector voltage—and, hence, changes in base width—on collector current and base charge are easily represented pictorially and are amenable to simple algebraic analysis. Though the assumption of uniform base doping might well have been justifiable for early b.j.t.s (e.g. alloy-junction types), it is not—as a result of the manufacturing technique now widely employed—acceptable with the majority of modern devices. To obtain quantitative information relating easily measurable d.c. and small signal l.f. output parameters to device structure and doping levels, for the case of arbitrary base doping, it is beneficial to turn our attention from minority carriers to *majority* carriers and consider the manner in which the base majority carrier charge is affected by collector-base voltage. The starting point is the classic work of Moll and Ross.¹⁵ For a b.j.t. in which the base doping profile is arbitrary (but continuous), and in which base region recombination can be neglected,

$$I_{En} = qn_{iB}^2 A_E \bar{D}_n \{ \exp(V_{BE}/V_T) \} / G_B(W) \quad (1)$$

$$I_{Ep} = qn_{iE}^2 A_E \bar{D}_p \{ \exp(V_{BE}/V_T) \} / G_E \quad (2)$$

In (1): $G_B(W)$ —the ‘Gummel number’ for the base—is the integrated base doping density per unit area of the emitter (which has an area A_E), thus

$$G_B(W) = \int_0^W N_a(x) dx$$

\bar{D}_n indicates a mean value for the diffusion coefficient over the base region (this is justifiable as D_n is a relatively slowly-varying function of doping level): the second subscript of n_i takes into account possible high level doping effects.¹⁶

In (2), G_E is an effective Gummel number for the

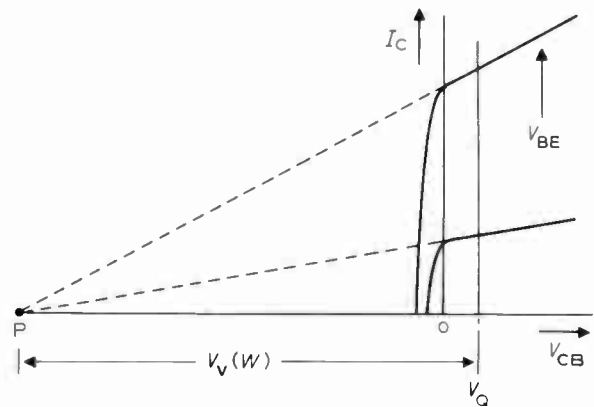

Fig. 2. The common point of intersection, P, defines an ‘Early voltage’ for base-emitter voltage drive, on the I_C, V_{CB} characteristics.

emitter region that takes care of possible heavy doping levels.¹⁷ The remaining symbols in (1), (2), and others henceforth not explicitly defined have their conventional meanings. (See list of symbols.)

$G_B(W)$ is obviously related to the design and processing of the b.j.t., via $N_a(x)$, and its operating conditions, via V_{CB} (which affects W). Now, each acceptor atom from Group III of the Periodic Table contributes a hole if all the atoms are ionized, as assumed. Thus if Q_{MB} is the base majority carrier charge,

$$Q_{MB} = qA_E G_B(W) \quad (3)$$

and

$$I_{En} = q^2 n_{iB}^2 A_E^2 \bar{D}_n \{ \exp(V_{BE}/V_T) \} / Q_{MB} \quad (4)$$

When a collector current flows, with V_{CB} fixed, Q_{MB} is sensibly constant under low-level injection conditions. It is the variation of $G_B(W)$, and hence Q_{MB} , with V_{CB} that causes finite incremental output conductance. To proceed further and find the effects of V_{CB} change on I_C with V_{BE} fixed, and with I_B fixed, we must derive functional relationships involving Q_{MB} or $G_B(W)$.

Consider, first, the condition $I_{B(V)} = 0$. For this case the c.e. direct current gain is limited only by the emitter injection efficiency, γ , and is designated, here, β_γ .

From (1) and (2),

$$\beta_\gamma = G_E d / G_B(W) \quad (5)$$

in which

$$d = (n_{iB}^2 / n_{iE}^2) (\bar{D}_n / \bar{D}_p)$$

Consider, next, the case $I_C \gg I_{B(V)} > 0$. By virtue of assumption (v) of Section 2, we calculate the minority carrier charge in transit, assuming $I_{B(V)} = 0$, and then divide by the minority carrier lifetime τ_B (a bulk parameter independent of W and, for the assumed case of low-level injection, independent of collector current level) to find the base bulk recombination current, $I_{B(V)}$.

Thus

$$I_{B(V)} = I_C \tau_B / \tau_B = I_C / \beta_V(W) \quad (6)$$

Using the expression for minority carrier transit time, τ_i , derived in Reference 15 it follows that,

$$\beta_V(W) = \bar{D}_n \tau_B \left/ \left[\int_0^W \{1/N_a(x)\} \left\{ \int_x^W N_a(x) dx \right\} dx \right] \right. \quad (7)$$

Thus, for $I_C \gg I_{B(V)}$,

$$I_C(W) = (I_{En} - I_{B(V)}) \approx I_{En} [1 - \{1/\beta_V(W)\}] \quad (8)$$

or

$$I_C(W) = \lambda \{ \exp(V_{BE}/V_T) \} f(W), \quad (9)$$

where λ is a device parameter-grouping independent of W , and,

$$f(W) = [1 - \{1/\beta_V(W)\}] / G_B(W). \quad (10)$$

The relationship between I_C and I_B is,

$$I_C = \beta(W) I_B \quad (11)$$

where

$$\frac{1}{\beta(W)} \stackrel{\text{def}}{=} \left[\frac{I_{B(V)}}{I_C} + \frac{I_{EP}}{I_C} \right] \approx \left[\left\{ \frac{1}{\beta_V(W)} \right\} + \left\{ \frac{1}{\beta_V(W)} \right\} \right]. \quad (12)$$

Equations (9) and (12) are now used to characterize the d.c. and i.f. incremental output characteristics for the two most frequently encountered conditions of base drive, namely base-emitter voltage drive and base current drive.

3.1 Base-emitter Voltage Drive

Let $(1/r_{O(V)}) = (\partial I_C / \partial V_{CB})_{\text{at constant } V_{BE}}$.

Then, from (9), by logarithmic differentiation,

$$\begin{aligned} (1/I_C r_{O(V)}) &= [d\{\log f(W)\} / dW] [dW / dV_{CB}] \\ &= \{1/V_V(W)\}. \end{aligned} \quad (13)$$

As $V_V(W)$ is only dependent on V_{CB} (and not I_C), $I_C r_{O(V)}$ is independent of I_C (but see Appendix). Thus the tangents to the I_C, V_{CB} characteristics (with V_{BE} the parametric variable), at a particular value, V_Q , of V_{CB} have a common point of intersection, P , on the V_{CB} axis, as shown in Fig. 2. P is at $V_{CB} \approx -V_V(W)$ for the usual case $V_V(W) \gg V_Q$. $V_V(W)$ is dependent on V_Q so the negative V_{CB} axis is the locus of P as V_Q varies. (It is clear, from (13), that $1/V_V(W)$ only remains fixed as V_{CB} varies if $f(W) \propto \exp(V_{CB})$.) The quantity $\{dV_V(W)/dW\}$ is obviously dependent on the particular doping distributions used for the base and collector regions. $V_V(W)$ may, in fact, vary appreciably⁷ with W , and hence V_{CB} . However, over a limited but nevertheless practically useful range of several volts about a specified V_Q , $V_V(W)$ may be assumed sensibly constant: over a larger range an averaged value of $V_V(W)$ must be taken in modelling and for circuit calculations. Taking $V_V(W)$ as constant we write $V_V(W) = (V_A)_V$, the subscript A having come to be associated with an 'Early voltage' and the subscript V referring to base-emitter voltage drive.

The assumed constancy of $V_V(W)$ means we can write, for $V_{CE} = V_Q$,

$$(I_C)_Q = (I_C)_Q + \{(\partial I_C / \partial V_{CB})_{V_{BE}}\} \Delta V_{CB} \quad (14)$$

where

$$\Delta V_{CB} = (V_Q' - V_Q).$$

A rearranged form of (14) is,

$$(I_C)_Q = (I_C)_Q [1 + \{\Delta V_{CB} / (V_A)_V\}]. \quad (15)$$

Sometimes it is convenient to take Q as referring to $V_{CB} = 0$. Then (15) becomes

$$I_C(V_{CB}) = I_C(0) [1 + \{\Delta V_{CB} / (V_A)_V\}]. \quad (16)$$

Often we are interested in the characterization of the Early effect with respect to the I_C, V_{CE} characteristics. As $V_{BE} \ll (V_A)_V$ and $\Delta V_{BE} \ll V_{BE}$, (9) tells us that V_{BE} changes only by some 60 mV per decade change in I_C , we conclude that the tangents to the I_C, V_{CE} characteristics also have a common point of intersection, at $V_{CE} \approx -(V_A)_V$, as shown in Fig. 3. Accordingly, (16) is modified by writing V_{CE} for V_{CB} . $(V_A)_V$ can, of course, be estimated from curve-tracer measurements (Sect. 6). Further insight into its physical nature is obtained by examining $f(W)$ for practical transistors. $\beta_V(W)$ appears as a correction term in (10): thus, if $\beta_V(W)$ were to change from 100 to 200 (an unrealistically large fractional increase) as V_{CB} varied by, say, 10 volts this would mean a change of only 0.5% in the bracketed term. In other words, $f(W)$ is virtually independent of base region recombination if it is small. There is thus no appreciable error in writing,

$$f(W) \approx 1/G_B(W). \quad (17)$$

Using (17) in (13) it follows that

$$\begin{aligned} \{1/(V_A)_V\} &= -\{1/G_B(W)\} \{dG_B(W)/dW\} \times \\ &\quad \times \{dW/dV_{CB}\}. \end{aligned} \quad (18)$$

This can be written as

$$\{1/(V_A)_V\} = -(1/Q_{MB})(dQ_{MB}/dV_{CB}). \quad (19)$$

To see what precise meaning can be attached to the quantity (dQ_{MB}/dV_{CB}) we consider the simplest case of a b.j.t. having a uniform base distribution $N_a(x) = N_B$. For a finite I_C the minority carrier profile for a particular collector voltage, V_{CB} , is $e_m c_m$ (see Fig. 4). Base charge

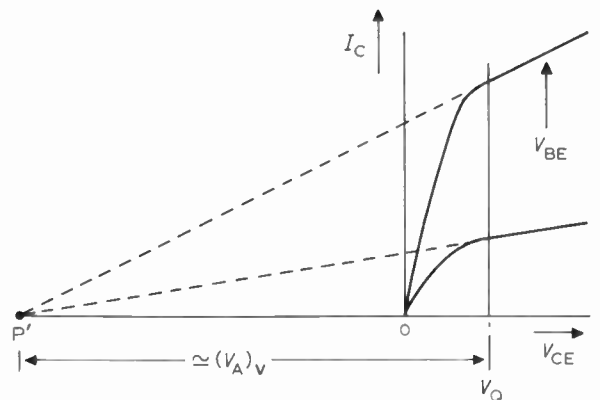

Fig. 3. P' is the associated Early voltage on the I_C, V_{CE} characteristics.

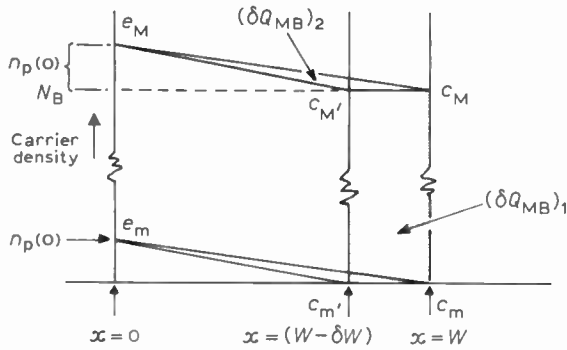

Fig. 4. Showing changes in minority carrier profile (from $e_m c_m$ to $e_m c_m'$), majority carrier profile (from $e_m c_m$ to $e_m c_m'$) and associated charge changes for a decrease in W .

neutrality dictates that the majority carrier profile $e_m c_m$ must run approximately parallel to this. If a change δV_{CB} , in V_{CB} , causes a decrease, δW , in W then,

$$(\delta Q_{MB}) = (\delta Q_{MB})_1 + (\delta Q_{MB})_2. \quad (20a)$$

However, $n_p(0) \ll N_B$ because of the low-level injection assumption, so

$$(\delta Q_{MB}) \approx (\delta Q_{MB})_1. \quad (20b)$$

But,

$$-\{d(Q_{MB})_1/dV_{CB}\} = C_{jc}(V),$$

the collector depletion capacitance: the negative sign occurs because $C_{jc}(V)$ is a positive quantity and an increase in V_{CB} causes a decrease in Q_{MB} .

Hence, (19) becomes,

$$\{1/(V_A)_V\} = \{C_{jc}(V)/Q_{MB}(V)\}. \quad (21)$$

The reasoning leading to (21) is also true for an arbitrary-doped base device if $N_a(x) \gg n_p(x)$, i.e. we operate at an I_C well below that at which the Kirk effect¹³ manifests itself. Two observations follow from (21). First, $(V_A)_V$ could be independent of V_{CB} only if the fractional changes in $C_{jc}(V)$ and $Q_{MB}(V)$ with V_{CB} were equal. Now C_{jc} can be written,

$$C_{jc}(V_{CB}) = C_{jc}(0)/\sqrt[n]{1 + (V_{CB}/\psi)}$$

where $\psi =$ built-in junction potential (~ 0.6 V) and, usually, $3 > n > 2$. Thus it is easily shown, using (21), that

$$\{1/(V_A)_V\} \{d(V_A)_V/dV_{CB}\} = + \{1/(V_A)_V\} + \{1/n(V_{CB} + \psi)\}. \quad (22)$$

For $(V_A)_V \approx 100$ V, a typical figure for a low power npn i.c. transistor, and $n = 2$, $V_{CB} = 5$ V, this implies a percentage change in V_{CB} of some 9% per volt change in V_{CB} in the vicinity of $V_{CB} = 5$ V.

The second deduction from (21) is that the dependence of $(V_A)_V$ on temperature, T , is slight. This is because Q_{MB} is fixed by the doping pattern and is essentially constant over the normal, useful, range of device operation, and C_{jc} is only weakly temperature dependent (via the change

in ψ of some -2 mV/deg C).

Before considering the case of current drive we derive an alternative form for (17) that is useful in future discussion.

Using (5) in (17) we obtain,

$$f(W) = \beta_V(W)/G_E d. \quad (23)$$

It is shown in the Appendix that G_E is sensibly independent of V_{CB} so, substituting from (23) into (13), we find,

$$\{1/(V_A)_V\} = [d\{\log \beta_V(W)\}/dW][dW/dV_{CB}]. \quad (24)$$

3.2 Base Current Drive

Let

$$(1/r_{O(I)}) = (\partial I_C / \partial V_{CB})_{\text{at constant } I_B}$$

Then, from (12), by logarithmic differentiation,

$$(1/I_C r_{O(I)}) = [d\{\log \beta(W)\}/dW][dW/dV_{CB}] = \{1/V_I(W)\}. \quad (25)$$

By reasoning analogous to that of Section 3.1 the tangents to the $I_C, V_{CE}(V_{CB})$ characteristics at a particular value, V_Q , of $V_{CE}(V_{CB})$ have a common point of intersection, P'' , on the $V_{CE}(V_{CB})$ axis as shown in Fig. 5.

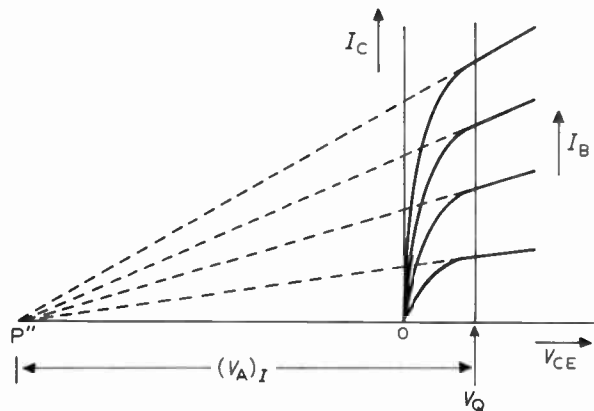

Fig. 5. P'' defines an Early voltage for base current drive.

Parameter $V_I(W)$ is sensibly constant over a useful practical range of several volts about V_Q and is denoted, here, $(V_A)_I$. The assumed constancy of $(V_A)_I$ means we can write:³

$$I_C = \beta_0 I_B [1 + \{V_{CE}/(V_A)_I\}] \quad (26)$$

where

$$\beta_0 = \beta(W) \text{ at } V_{CB} = 0 \text{ V.}$$

$(V_A)_I$ does not, normally, have as simple a physical interpretation as $(V_A)_V$ because $(V_A)_V$ depends on $\beta_V(W)$ whereas $(V_A)_I$ depends on both $\beta_V(W)$ and $\beta_V(W)$. With some b.j.t. structures, particularly monolithic lateral pnp devices having relatively wide bases, uniformly doped in the direction of carrier transport, it might well happen¹²

that $(V_A)_I$ is mainly attributable to $\beta_V(W)$. When there is the possibility that $\beta_V(W)$ and $\beta_Y(W)$ may be comparable we can establish a useful relationship for $(V_A)_I$ by substituting from (12) into (25), differentiating, and putting $\beta_V(W) = m\beta_Y(W)$.

This gives,

$$\left\{1/(V_A)_I\right\} = \left[\left\{ \frac{m}{(1+m)} \right\} \frac{d}{dW} \left\{ \log \beta_Y(W) \right\} \frac{dW}{dV_{CB}} \right] + \left[\frac{1}{(1+m)} \frac{d}{dW} \left\{ \log \beta_V(W) \right\} \frac{dW}{dV_{CB}} \right]. \quad (27)$$

Some physical insight into the relationship between $(V_A)_V$ and $(V_A)_I$ may be obtained by considering the b.j.t. with uniform concentration $N_a(x) = N_B$. As in the case of voltage drive there is, under low-level injection conditions, a change $\delta Q_{MB} \approx qA_E N_B \delta W$ in majority carrier charge (when the base width decreases by δW) and the corresponding change in I_C . However, there is also a further change in I_C owing to an increase in V_{BE} . This comes about because a decrease in W means a smaller $I_{B(V)}$: as I_B is constant it follows that I_{EP} must increase and from (2) this means an increase in V_{BE} . We conclude that, at a given I_C , $r_{O(V)} > r_{O(I)}$ and hence $(V_A)_V > (V_A)_I$.

4 Conditions for a Unique Early Voltage

The conditions under which a single d.c. parameter ('the Early voltage') can be employed to describe the d.c. and i.f. incremental output characteristics independent of the incremental resistance in the base drive circuit are obviously of interest to the device designer and circuit engineer. It is clear from the discussion of Section 3.2 that, in the general case, $(V_A)_I \neq (V_A)_V$.

$(V_A)_V$ is sensibly independent of β_V in devices having $\beta(W) > 100$, say, because this implies $\beta_V > 100$ and, hence, $(V_A)_V$ is governed by $G_B(W)$. By comparison, $(V_A)_I$ is dependent on the nature of $\beta(W)$ and base region recombination cannot be ignored simply because $\beta(W)$ is 'large'. Thus, with $\beta(W) = 500$ we could have the condition $\beta_V(W) = \beta_Y(W) = 1000$ corresponding to $m = 1$. This means comparability in magnitude of the two terms on the right-hand side of (27) if the fractional changes in $\beta_V(W)$, $\beta_Y(W)$ with V_{CB} are of similar magnitude.

For the theoretical case $m = \infty$ and the possible practical condition $m \gg 1$ we can write $(V_A)_I = (V_A)_V = V_A$, say, where V_A is now a unique voltage parameter that we can designate 'the Early voltage'. For a given W , τ_i is less¹⁵ with a conventionally graded-base device (i.e. doping concentration greatest at emitter end of base) than with a uniform-base device for which $\tau_i = W^2/2D_n$.

Hence, from (5) and (7), a safe criterion for $(V_A)_I \approx (V_A)_V$ that incorporates structural and doping

parameters is

$$\tau_B \gg (W^2/2\bar{D}_P)(n_{iB}^2/n_{iE}^2)(G_E/G_B). \quad (28)$$

Equation (28) is, principally, of interest to those involved in device design and parameter characterization.

A circuit designer would have to make measurements at the device terminals to check the validity of the popular assumption $(V_A)_I = (V_A)_V$ for modern devices.

Nevertheless, (24) and (27) yield simple relationships for $\{(V_A)_V/(V_A)_I\}$, for arbitrary m , in two special cases now briefly considered.

4.1 Uniform Base Device

Substituting $N_a(x) = N_B$ in (5) gives

$$\beta_Y(W) = G_E d/N_B W. \quad (29)$$

From (7),

$$\beta_V(W) = 2D_n \tau_B / W^2. \quad (30)$$

Using (29) in (24),

$$\{1/(V_A)_V\} = -(1/W)(dW/dV_{CB}). \quad (31)$$

Similarly, using (29) and (30) in (27) gives

$$\{1/(V_A)_I\} = -(1/W)(dW/dV_{CB})[(m+2)/(m+1)]. \quad (32)$$

Hence, from (31), (32)

$$\{(V_A)_V/(V_A)_I\} = (m+2)/(m+1). \quad (33)$$

Table 1. $\{(V_A)_V/(V_A)_I\}$ for a uniform base transistor

m	$\ll 1$	≈ 1	$\gg 1$
$(V_A)_V/(V_A)_I$	2	1.5	1

Table 1 gives some spot values of $(V_A)_V/(V_A)_I$ based on (33). The case $m \ll 1$ is in accord with the well-known observation that for homogeneous base b.j.t. that has $\beta(W)$ effectively limited by base region bulk-recombination the incremental output resistance, at a given I_C , is twice as great with base-emitter voltage drive as it is with base-current drive.

4.2 Exponentially Doped Base

The doping profile of a modern npn planar transistor is basically Gaussian. However, it can, in the interests of analytical simplicity, be closely approximated¹⁸ by a suitably chosen exponential of the form

$$N_a(x) = N_0 \exp(-\eta x/W) \quad (34)$$

where η is the 'field factor' and N_0 is a constant.

Then it is easily shown, from (5), (7), that

$$\beta_Y(W) = G_E d\eta / [N_0 W \{1 - \exp(-\eta)\}] \quad (35)$$

and

$$\beta_V(W) = \bar{D}_n \tau_B \eta^2 / [W^2 \{\eta - 1 + \exp(-\eta)\}]. \quad (36)$$

Thus, as in Section 4.1, $\beta_v(W) \propto (1/W)$ and $\beta_v(W) \propto (1/W^2)$. Hence, (33) and Table 1 are also valid for a base with a simple exponential doping profile. As far as this author is aware this theoretical result has not so far appeared in the literature though supporting experimental evidence for its validity does exist.¹⁹

5 Some Circuit Implications of an Early Voltage

So far, an Early voltage has been considered as a way of characterizing the output characteristics of a b.j.t. In this Section we examine briefly, the relevance of $(V_A)_v$ and $(V_A)_i$ to two illustrative circuit configurations, one using base-emitter voltage drive, the other using emitter-current drive.

5.1 Base-emitter Voltage Drive

The description can be misleading. Voltage drive implies, ideally, zero incremental source resistance. However, the circuit of Fig. 6 would be unsuitable for most applications because n_{iB}^2 is sensitively dependent on temperature. Clearly, we normally apply a measure of temperature compensation. One example of how this can

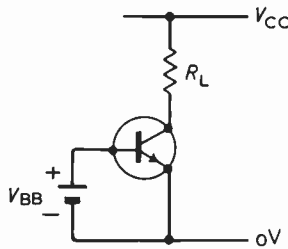

Fig. 6. Unsuitable scheme for practical circuit with base-emitter voltage drive.

be achieved, with d.c. coupling, is the structure of Fig. 7 that incorporates a monolithic b.j.t. pair Q1, Q2 and an emitter follower transistor Q3. This circuit, a member of the 'current-mirror' family, is selected because it is useful for parameter evaluation.

We will not discuss the operation in detail: all we need note is that Q1 is forced, via the collector-base feedback loop that includes Q3, to pass a collector current sensibly equal to I_1 and that V_{BE} adjusts itself accordingly. As Q2 is fabricated alongside Q1 on the same chip and has the same emitter area, then $I_0 = I_1$ at $V_0 = V_{BE}$. This assumes identical processing for Q1 and Q2: minor processing variations can be taken into account, analytically, by a temperature-independent 'effective-emitter area ratio'.

When T changes the associated changes in n_{iB} , \bar{D}_n of Q1 are matched by identical changes in the respective parameters of Q2, so I_0 is sensibly independent of T provided I_1 is fixed. The incremental source resistance, r_s , seen looking back from the base of Q2 is, approximately, $V_T/\beta_3 I_1$. $\beta_3 (\gg 1)$ is the c.e. direct current gain of Q3 at a collector current, I_{C3} , sensibly equal to $(I_{B1} + I_{B2})$. If the

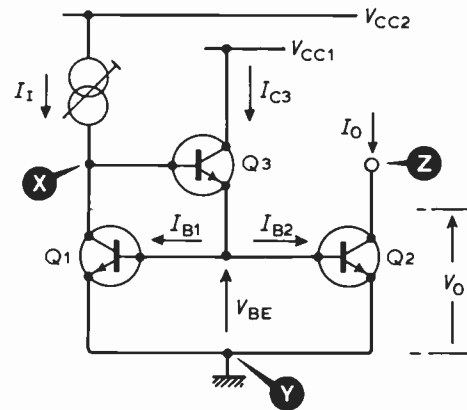

Fig. 7. A practical scheme for base-emitter voltage drive.

incremental resistance seen looking into the base-emitter circuit of Q2 is r_i , then it is well-known that $r_i > \beta_2(V_T/I_0)$, in which $\beta_2 (\gg 1)$ is the c.e. direct current gain of Q2. As $I_0 = I_1$ it follows that $(r_i/r_s) > \beta_2 \beta_3 \gg 1$ and, hence, Q2 is effectively voltage-driven. Some typical figures make this clear. Assume $\beta_2 = \beta_3 = 50$ and take $V_T = 25$ mV, $I_1 = 0.1$ mA, then $r_s = 5 \Omega$ and $r_i > 12.5$ k Ω .

The output characteristic of Q2 is, from (16),

$$I_0 = I_1 [1 + \{(V_0 - V_{BE}) / (V_A)_v\}]. \quad (37)$$

Equation (37) makes clear a point easily overlooked. Even if Q1, Q2 were perfectly matched there would still be a 1% difference between I_0 and I_1 if the collector voltage differential of Q1, Q2 was one volt and $(V_A)_v = 100$ V.

In the case of the long-tailed pair a collector voltage differential can be referred to one of the inputs as an equivalent input offset voltage by use of the parameter $(V_A)_v$.

5.2 Emitter Current Drive

β -uncertainty, alone, rules out the use of constant base current drive in the design of professional analogue transistor circuits. This does not mean, though, that (26) is useless in circuit analysis and design because the relationship is valid irrespective of the specific details of the circuit configuration.

Consider Fig. 8: this represents a common-base stage frequently employed as a buffer/impedance transformer. It can easily be shown from the use of the relationship $I_E = (I_C + I_B)$, the use of (26), and the assumption $\{V_0 / (V_A)_v\} \ll 1$, that

$$I_0 = I_C = [\beta_0 I_E / (1 + \beta_0)] \times [1 + \{V_0 / (1 + \beta_0) (V_A)_i\}]. \quad (38)$$

It follows from (38) that the l.f. incremental output resistance in the c-b connection exceeds that of the c.e. connection by a factor $(1 + \beta_0)$ —a well-known result.

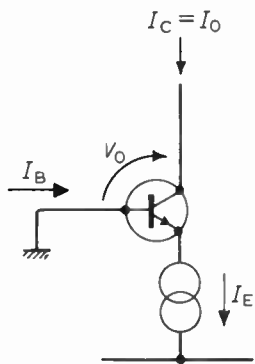

Fig. 8. A common-base stage.

6 Parameter Determination

Experimental evidence for the existence of an Early voltage has been reported by a number of workers,^{6,7,9,11,12} and will not be repeated here. Jaeger and Broderon⁶ have shown that $(r_{O(V)}/r_{O(I)}) \approx 2$ for a Ge alloy junction device at low current levels. Gegg *et al.*¹⁹ have found that $(r_{O(V)}/r_{O(I)}) \approx (1.5-2)$ for some ion-implanted b.j.t.s. with base-region recombination-limited β : this supports the reasoning of Section 4.2.

This Section is basically concerned with outlining some experimental techniques for establishing the existence of, and measuring, $(V_A)_V$ and simple methods for checking the validity of the assumption $(V_A)_I \approx (V_A)_V$. The measurement of $(V_A)_I$ is not discussed because the techniques involved are similar to those for $(V_A)_V$.

6.1 $(V_A)_V$ Measurements

The existence of $(V_A)_V$ can, in principle, be verified by use of the familiar curve-tracer. Unfortunately, the exponential dependence of I_C on V_{BE} means the appearance of few base voltage steps (on most curve-tracers) if appreciable heating is to be avoided, and it is not always easy to establish the existence of $(V_A)_V$ this way.

One technique for 'linearizing' the spacing of the base-emitter voltage steps for a curve-tracer display of the I_C, V_{CE} characteristics with base-emitter voltage drive is to use the circuit of Fig. 7 and to treat the terminals X, Y, Z as the base, emitter, collector, respectively, of a composite transistor driven by 'base' current steps (I_1 and collector voltage sweep (V_0). Each step of I_1 corresponds to a step in V_{BE} . If (I_0/I_1) is independent of I_0 , as is implied by the definition of $(V_A)_V$ —see (37)—then it should be possible to superimpose sets of characteristics by making the deflection sensitivity of the curve-tracer I_0 -display inversely proportional to the magnitude of the steps in I_1 . The photograph in Fig. 9 is a double exposure of two sets of output characteristics for the circuit of Fig. 7 using two transistors (Q1, Q2) of a monolithic array (CA3046, RCA Ltd).

Q3 (monoMAT-01 AH, Precision Monolithics) was selected for its well-specified low current gain ($\beta > 400$ at $I_C = 10 \mu A$).

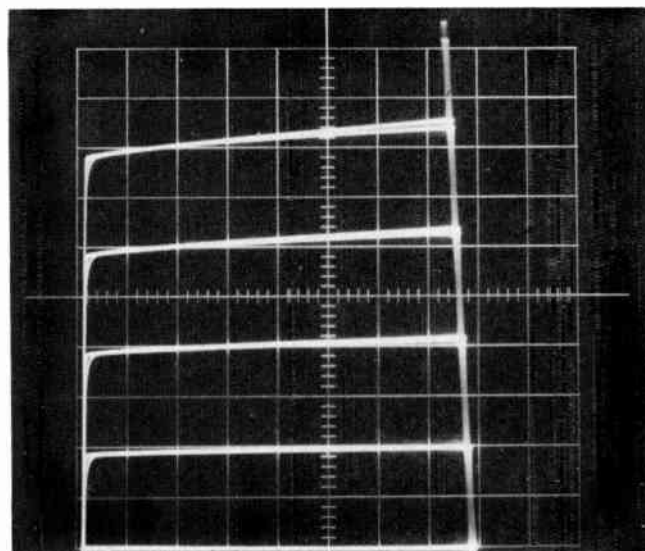

Fig. 9. Output characteristics of circuit of Fig. 7.

(Q1 + Q2) = part CA3046 (RCA Ltd.)
 Q3 = monoMAT 01 AH (Precision Monolithics Ltd.)
 $V_{CC1} = 5 V$
 Horizontal scale 2 V/div. For vertical scale see text.

For the first exposure $I_0 = 0.01 \text{ mA/div.}$ and $I_1 = 0.02 \text{ mA/step}$: for the second exposure $I_0 = 0.05 \text{ mA/div.}$ and $I_1 = 0.1 \text{ mA/step}$.

The two sets of characteristics are essentially coincident for $I_0 \leq 0.3 \text{ mA}$: the small departure from coincidence at $I_0 \approx 0.4 \text{ mA}$ is attributed to self-heating.⁹

To establish the existence, and value, of $(V_A)_V$ with greater precision it is necessary to determine $r_{O(V)}$ for specific values of I_C, V_{CB} and compute the product $(I_C r_{O(V)}) = (V_A)_V$. A circuit such as that of Fig. 10, in which A1, A2 are f.e.t. op. amps is suitable. I_1 and $V_R (\leq 0)$ are set to desired levels and 'back-off' current I_R adjusted to give $V_X = 0$. An increase, δV_R , in the magnitude of V_R causes an increase δI_0 , in I_0 and hence $V_X = R_X \delta I_0$.

Hence,

$$(V_A)_V = (I_C r_{O(V)}) = I_R R_X (\delta V_R / V_X).$$

A number of experimental refinements are possible.

6.2 Measurements to Check Whether $(V_A)_I + (V_A)_V$

For a simple visual check on the validity of the assumption $(V_A)_I = (V_A)_V$ for planar devices, in which I_{EP} is thought to be the dominant component of I_B , the circuit of Fig. 7 is again used with a curve-tracer: the method is best illustrated by reference to an example. Figure 11 shows a doubly-exposed film of two nearly-coincident traces for the case of voltage drive and current drive for a b.j.t. in the CA 3046 array. To obtain the first

trace showing the I_C, V_{CE} characteristics of Q2 with V_{BE} constant, at a value appropriate to a chosen collector current level, I_1 was an externally adjusted d.c. bias source. For the second trace showing I_C vs V_{CE} with I_B constant, Q1, Q3 were removed from the circuit and the bias source connected directly to the base of Q2. It was then adjusted for the same I_C as in the first trace at $V_{CE} \approx 0.7$ V (corresponding to the edge of saturation). Figure 11 indicates a difference between $(V_A)_I$ and $(V_A)_V$. More refined measurement techniques involving 'backing-off' procedures can be employed to determine small differences between $(V_A)_I$ and $(V_A)_V$.

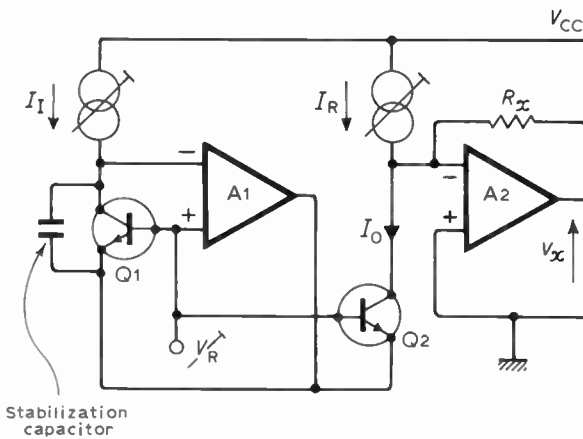

Fig. 10. Precision technique for finding $(V_A)_V$.

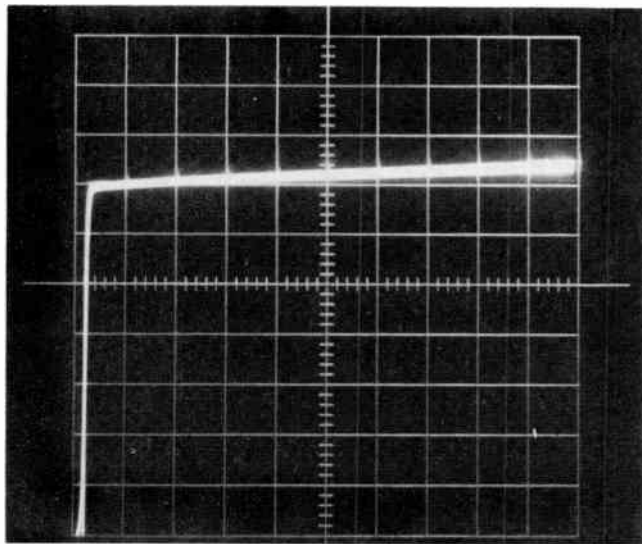

Fig. 11. Output characteristics of a monolithic b.j.t. (part CA3046) for base-emitter voltage drive and base current drive. Horizontal scale 1 V/div. Vertical scale 0.05 mA/div.

7 Validity of Analytical Assumptions

In this Section we consider, briefly, in the same number order, the validity of the assumptions made in Section 2.

(i) Theoretical and experimental evidence exists (see, e.g., Ref. 20) to support the assumption of full ionization of dopant atoms over a temperature range that includes the military equipment range (-55°C to $+125^{\circ}\text{C}$).

(ii) For 'usual' basewidths (say, $W > 0.3 \mu\text{m}$) the drift-diffusion equations can be assumed valid because charge carriers experience many collisions in the active base region. Rohr and Lindholm²¹ have questioned the applicability of the equations for very narrow bases and proposed a hypothetical 'collisionless b.j.t.'. Such a device would have a metallurgical base width less than $0.1 \mu\text{m}$ and, despite basewidth changes, would exhibit zero l.f. output conductance.²² However, no experimental evidence has yet been produced to support this hypothesis.

It should be realized that a device with such a small basewidth would have a very low Q_{MB} . This would mean an unacceptably low (e.g. 1 V) collector-emitter punch-through voltage for most applications since the collector voltage required fully to deplete the base is dependent on Q_{MB} .²³ Furthermore, the associated high extrinsic base resistance would give high $r_{bb'}$ noise.

(iii) One-dimensional current flow is a valid assumption²⁴ for devices, operated at low injection levels and having lateral dimensions large compared with dimensions perpendicular to the planar surface. Then, the dominant components of current flow vertically in a cylinder the cross-sectional area of which is that part of the emitter area parallel to the crystal surface. ('Fringing' effects at the emitter periphery are ignored. An analogy is the neglect of field fringe effects at the edges of a parallel plate capacitor having large area plates close together. Hence, in (21), Q_{MB} and C_{jc} refer to the active base region, between aa' and bb' of Fig. 12: if C_{cb} = total collector-base capacitance then $C_{jc} \approx C_{cb}(A_E/A_C)$ where A_C = total collector-base junction area.)

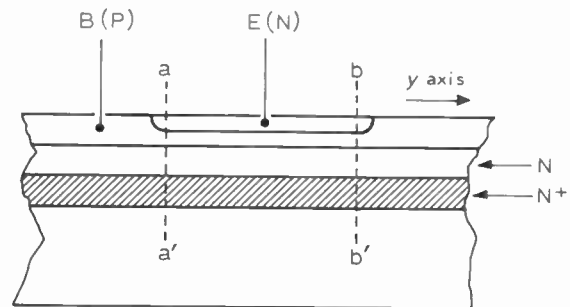

Fig. 12. Cross-section of b.j.t.

The experimental evidence in support of the assumption, in the case of monolithic devices, is the success with which circuit currents can be 'scaled', in configurations such as the current-mirror, by choice of emitter-area ratios. The assumption of one-dimensional current flow does not necessarily cease to be valid with small area devices provided these are made using shallower diffusions.

- (iv) The collector multiplication factor, M , can be written²⁵

$$M = 1/[1 - (V_{CB}/BV)^r]$$

where BV is the breakdown voltage of the junction and $6 > r > 3$. For $BV = 50$ V, $V_{CB} = 5$ V and $r = 3$, we obtain $M \approx 1.001$ ($BV \approx 65$ V) on measured samples of CA3046).

Actually the effect of M slightly greater than unity is to linearize the I_C, V_{CE} characteristic with V_{BE} constant, and thus help maintain the constancy of $(V_A)_V$ with V_{CE} .

- (v) Figure 13 shows asymptotic approximations to the curves $\log_e I_C$ vs V_{BE} and $\log_e I_B$ vs V_{BE} , for constant V_{CB} . There are three operating regions of interest. The assumptions of the analysis imply operation in Region II ($I_{CH} > I_C > I_{CL}$) for which $\beta \neq f(I_C)$. I_{CH} denotes the onset of high-level injection effects (base conductivity-modulation, emitter current crowding, the Kirk effect¹³). In Region III the theory presented ceases to be valid.

In Region I ($I_C < I_{CL}$), I_{TB} —the (normally) small current that is always present, but has so far

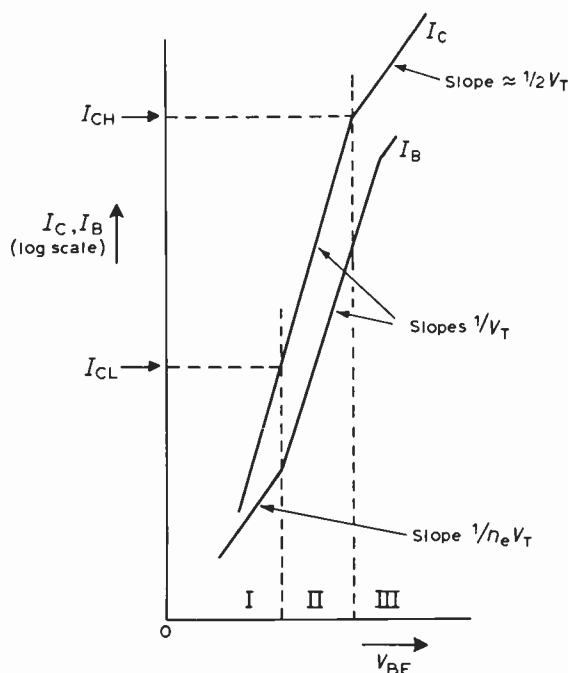

Fig. 13. Asymptotic approximations to plots of $\log I_C, \log I_B$ vs V_{BE} , with V_{CB} const., and possible operating regions.

been ignored—dominates I_B . Now I_{TB} , as defined in this paper, originates from: lateral current flow due to emitter-sidewall injection; base-emitter depletion layer generation-recombination effects; surface states at the crystal-oxide interface. Only the first of these components has an $\exp(V_{BE}/V_T)$ dependence. Consequently, $I_B \propto \exp(V_{BE}/n_e V_T)$, $\beta = f(I_C)$, and $(V_A)_I$ has no meaning. However, provided $I_C \gg I_{CBO}$, $(V_A)_V$ has the same magnitude as in Region II. This is because I_{TB} does not enter into its definition: the only part of I_B which could influence $(V_A)_V$ is $I_{B(V)}$ and the effect, then, is only very small. (See discussion in Sect 3.1.)

I_{CL} and I_{CH} both depend on device design and process technology and, though reproducible, are not accurately predictable.

Typically, Region II spans a current range exceeding two decades. Recently, Hansell and Fonstad²⁶ have used device optimization procedures and special clean processing techniques to produce devices having $I_{CL} \sim 1$ nA, $I_{CH} \sim 1$ mA and $\beta(\max)$ in the range 100 to 400.

Ion-implanted devices have also been produced²⁷ having a sensibly constant β for an I_C range of some four decades above $I_{CL} \sim 1$ μ A.

8 Conclusions

For d.c. and l.f. operation the Early effect in a b.j.t. working, under certain specified conditions, in the forward-active mode can be described by an 'Early voltage'. This parameter, which is of particular use in the second-order analysis of low power precision analogue circuits, owes its existence to the fact that the base width (and base majority carrier charge) is dependent on collector-base voltage but is sensibly independent of collector current.

If bulk recombination in the base region is negligible the relationship between base current and base-emitter voltage is independent of collector base voltage. In this case it is possible to characterize base-width modulation effects by a single parameter 'the Early voltage', that is independent of base-emitter drive conditions.

9 Acknowledgments

Thanks are due to Dr R. W. J. Barker (Sheffield University) for stimulating discussions and Ir G. C. M. Meijer (Delft University of Technology, The Netherlands) for a helpful conversation.

10 References

- 1 Early, J. M., 'Effects of space-charge layer widening in junction transistors', *Proc. IRE*, 40, pp. 1401-6, November 1952.
- 2 Gummel, H. K. and Poon, H. C., 'An integral charge control model of bipolar transistors', *Bell Syst. Tech. J.*, 49, pp. 827-52, May-June 1970.

- 3 Lindholm, F. A. and Hamilton, D. J., 'Incorporation of the Early effect in the Ebers-Moll model', *Proc. IEEE*, 59, no. 9, pp. 1377-8, September 1971.
- 4 Logan, J., 'Modeling the "Early effect" in bipolar transistors using an empirical but effective parameter', *Proc. IEEE*, 60, no. 3, p. 335, March 1972.
- Lindholm, F. A. *et al.*, Remarks on Logan, *Proc. IEEE*, 60, no. 3, pp. 335-6, March 1972.
- 5 A. Van Der Ziel, 'A sufficient condition for an Early voltage', *Solid State Electronics*, 17, pp. 108-10, 1974.
- 6 Jaeger, R. C. and Broderson, A. J. 'Modeling the Early effect—a second look', IBM Research Report RC5760, January 1976.
- 7 Hart, B. L. and Barker, R. W. J., 'Early-intercept voltage: a parameter of voltage-driven b.j.t.s'. *Electronics Letters*, 12, pp. 174-5, April 1976.
- 8 Hart, B. L. and Barker, R. W. J., 'D.c. matching errors in the Wilson current source', *Electronics Letters*, 12, pp. 389-90, July 1976.
- 9 Meijer, G., 'The current dependency of the output conductance of voltage-driven bipolar transistors', *IEEE J. Solid State Circuits*, SC-12, no. 4, pp. 428-9, August 1977.
- 10 Hart, B. L., 'Incremental output resistance of a Wilson current mirror', *Proc. IEEE*, 66, no. 5, pp. 597-8, May 1978.
- 11 Malone, F. D., 'The Early voltage of a bipolar transistor', *IEEE Trans. on Electron Devices*, ED-24, no. 2, pp. 167-8, February 1977.
- 12 Malhi, S. D. S. and Salama, C. A. T., 'The Early voltage of a lateral pnp transistor', *Solid State Electronics*, 21, pp. 1187-90, 1978.
- 13 Bowler, D. L. and Lindholm, F. A., 'High current regimes in transistor collector regions', *IEEE Trans. on Electron Devices*, ED-20, no. 3, pp. 257-63, March 1973.
- 14 Sparkes, J. J. 'Junction Transistors' (Pergamon Press, Oxford, 1966).
- 15 Moll, J. L. and Ross, I. M., 'The dependence of transistor parameters on the distribution of base layer resistivity', *Proc. IRE*, 44, pp. 71-78, January 1956.
- 16 Slotboom, J. W., 'The pn-product in silicon', *Solid State Electronics*, 20, pp. 279-83, 1977.
- 17 de Graaf, H. C., Slotboom, J. W. and Schmitz, A., 'The emitter efficiency of bipolar transistors', *Solid State Electronics*, 20, pp. 515-21, 1977.
- 18 Lynn, D. K., Meyer, C. S. and Hamilton, D. J., 'Analysis and Design of Integrated Circuits', chap. 4, p. 61 (McGraw-Hill, New York, 1967).
- 19 Gegg, W. M., Saltich, J. L., Roop, R. M. and George, W. L., 'Ion-implanted super-gain transistors', *IEEE J. Solid State Circuits*, SC-11, no. 4, pp. 485-90, August 1976.
- 20 Grove, A. S., 'Physics and Technology of Semiconductor Devices', chap. 4, pp. 104-6 (John Wiley, New York, 1967).
- 21 Rohr, P. and Lindholm, F. A., 'Questionability of drift-diffusion transport in the analysis of small semiconductor devices', *Solid State Electronics*, 17, no. 7, pp. 729-34, 1974.
- 22 Rohr, P. and Lindholm, F. A., 'Modifications of equivalent circuits for narrow-base transistors', *IEEE J. Solid State Circuits*, SC-10, no. 1, pp. 65-72, February 1975.
- 23 Grove, A. S., *op. cit.*, chap. 7, p. 231.
- 24 Lynn, D. K. *et al.*, *op. cit.*, chap. 4, p. 62.
- 25 Grove, A. S., *op. cit.*, chap. 6, p. 194.
- 26 Hansell, G. L. and Fonstad, G., 'A bipolar npn transistor with reduced low current beta falloff', *IEEE Trans. on Electron Devices*, ED-24, no. 9, pp. 1200-1, September 1977.
- 27 Payne, R. S. *et al.*, 'Fully ion-implanted bipolar transistors', *IEEE Trans. on Electron Devices*, ED-21, no. 4, pp. 273-8, April 1974.
- 28 Hamilton, D. J. and Howard, W. G., 'Basic Integrated Circuit Engineering', chap. 4, pp. 142-3 (McGraw-Hill, New York, 1975).
- 29 Camenzind, H. R., 'Electronic Integrated Systems Design', chap. 5, pp. 96-7 (Van Nostrand Reinhold, New York, 1972).
- 30 Poon, H. C. and Gummel, H. K., 'Modelling of emitter capacitance', *Proc. IEEE*, 57, pp. 2181-2, December 1969.

11 Appendix

We consider here the validity of two assumptions, made in the course of the analysis, that may seem obvious at an intuitive level but nevertheless require quantitative investigation. These assumptions are: Q_{MB} is independent of I_C at fixed V_{CB} (this is equivalent to assuming W independent of I_C at fixed V_{CB}); G_E is sensibly independent of V_{CE} . Both of these are established if it can be shown that the change, ΔQ_{jE} in the base-emitter depletion layer charge accompanying a change in I_C or V_{CB} , is small compared with Q_{MB} .

From data given in Ref. 28 for a typical monolithic commercial b.j.t. we can deduce that in the base region ($0.51 \mu\text{m} > x > 0$) the doping density, in atoms cm^{-3} , is

$$N_a(x) = [1.01 \times 10^{17} \exp \{-(x/1.08)^2\}] - [0.708 \times 10^{17} \exp \{-(x/0.833)^2\}] - [1.1 \times 10^{15}]. \quad (39)$$

But,

$$(Q_{MB}/A_E) = q \int_0^{0.51} N_a(x) dx. \quad (40)$$

Hence, integrating (40),

$$(Q_{MB}/A_E) = 1.47 \text{ pC/mm}^{-2}. \quad (41)$$

Making the usual assumption of an abrupt base-emitter junction, $C_{je}(0)$ can be found²⁹ from,

$$C_{je}(0) = 2.9 \times 10^{-12} \sqrt{N_a(0)/\phi} \text{ pF} \cdot \mu\text{m}^{-2} \quad (42)$$

where $\phi \approx 0.6 \text{ V}$ and, from (39),

$$N_a(0) = 3.82 \times 10^{16} \text{ cm}^{-3}.$$

This gives $C_{je}(0) \approx 0.15 \text{ pF} \cdot \text{mm}^{-2}$. Allowing³⁰ a factor of 2 for operation at $V_{BE} > 0$ gives,

$$(C_{je}/A_E) \approx 0.3 \text{ pF} \cdot \text{mm}^{-2}. \quad (43)$$

A three-decade change in I_C , at fixed V_{CB} , implies $\Delta V_{BE} \approx 180 \text{ mV}$, and hence $(\Delta Q_{jE}/Q_{MB}) < 0.04$. This is the justification for assuming Q_{MB} independent of I_C (or W independent of I_C) at fixed V_{CB} . Note, however, that the small variation in Q_{MB} , due to ΔQ_{jE} , at fixed V_{CB} causes² small deviations in the ideal exponential relationship between I_C and V_{BE} .

With I_B constant the change in I_C with V_{CE} would certainly be less than a factor of 10, in any useful device, over a practical operating range. This implies, $\Delta V_{BE} < 60 \text{ mV}$, and $(\Delta Q_{jE}/Q_{MB}) < 0.02$: as $Q_E (= qA_E G_E) > Q_{MB}$ (normally $Q_E \gg Q_{MB}$), the fractional change in Q_E , and hence G_E , with V_{CE} (or V_{CB}) can safely be ignored.

Manuscript first received by the Institution on 10th January 1979 and in revised form on 19th June 1979.
(Paper No. 1916/CC315)

Contributors to this issue*



Brian Hart (Member 1961, Graduate 1955) received the B.Sc. degree in physics from Queen Mary College, London, in 1951. Following two years National Service in the Royal Corps of Signals he studied at Edinburgh University, where he obtained the Postgraduate Diploma in electronics and radio in 1954. After a period as a graduate trainee with the Marconi Company he worked as a research engineer in the

radio display group of the Marconi Research Laboratories, Great Baddow, on the design and development of interscan marker systems, alpha-numeric displays and logic elements. From 1961 to 1964 he was a sales engineer for Transitron Electronic Ltd. He joined the staff of the electrical engineering department of West Ham College of Technology (now incorporated in North East London Polytechnic) in 1964 and is currently a Senior Lecturer in charge of the Postgraduate Electronics Laboratory. In 1977 Mr. Hart was appointed to an honorary lectureship in the Department of Electronic and Electrical Engineering at the University of Sheffield. His research interests include device modelling, waveform circuit techniques, and ultrahigh-impedance wideband amplifiers and has contributed several papers in these areas of the Institution's Journal.



Reza Mehran received the Dipl. Ing. and Dr. Ing. degrees from the Technical University of Aachen, West Germany, in 1969 and 1974 respectively. Since 1974 he has been working on microstrip circuit problems as a Research and Teaching Assistant at the Department of Electrical Engineering, University of Duisburg, Germany.



Günter Kompa graduated from the Technical University of Aachen with the Dipl. Ing. in 1970 and for the next five years he was Research Assistant at the Institute of High Frequency Technique at the Technical University. As a result of his research work he was awarded the Dr. Ing. degree in 1975. In 1976 Dr Kompa joined the Research Division of Endress & Hauser, Maulburg, West Germany, where he is

working on specialized short-range radar systems. His current research activities in the areas of subnanosecond techniques

and the generation of short powerful laser impulses with GaAs diodes have led to an optical impulse radar with extremely high accuracy. In 1978 Dr Kompa contributed a paper to the special m.i.c. issue of *The Radio and Electronic Engineer* entitled 'Design of stepped microstrip components' which gained him the Heinrich Hertz Premium.



Giuliano Benelli obtained his degree in physics from the University of Florence in 1973. He then worked for a year on a research project on error detecting and correcting codes for the European Space Research Organization and during 1974 he lectured on channel coding in the information theory course of Scuola di Perfezionamento in Physics at the University of Florence. At present he has a research fellowship at the

Engineering Faculty of the University where he continues to work on channel coding and data compression.



Franco Lotti graduated in physics from the University of Florence in 1967. Since that time he has worked on information theory and its applications to signal processing and in 1970 he joined the National Research Council at the Istituto di Ricerca sulle Onde Elettromagnetiche in Florence. Here he has been involved in data compression and digital filtering for three contracts with the European Space Agency. His main

interests are now source and channel coding, digital filtering and image processing with biomedical applications.



Vito Cappellini received the degree in electronic engineering from the Politecnico di Torino in 1961 and then spent a year with the FIAT Company, Turin, and the Solvay Company, Leghorn, working on data processing and automatic control systems. In 1963 he started research work at Istituto di Ricerca sulle Onde Elettromagnetiche of C.N.R. in Florence, where he was mainly concerned up to 1975 with ionospheric studies

by means of satellites, data processing, digital telemetry and communications. In 1975 he obtained the full professor degree in electrical communications at Florence University, becoming in 1977 Director of the Istituto di Elettronica. He has published himself or as co-author more than 60 papers in the fields of data processing, digital telemetry and communications and particularly in digital filtering, data compression and error-correcting codes with applications in several areas such as communications, biomedicine and remote sensing. He is also co-author of a book on 'Digital Filters and Their Applications'.

* See also pages 28, 70 and 78