

Founded 1925

Incorporated  
by Royal Charter 1961

*To promote the advancement  
of radio, electronics and kindred  
subjects by the exchange of  
information in these branches  
of engineering*

Volume 49 No. 3

March 1979

# The Radio and Electronic Engineer

The Journal of the Institution of Electronic and Radio Engineers

## NEWS AND COMMENTARY

### CEI Officers' Oral Evidence to the Finniston Committee

The Chairman of the Council of Engineering Institutions, Sir John Atwell, C.B.E., F.Eng., supported by other Officers and Officials, gave oral evidence to the Government's Committee of Inquiry into the Engineering Profession on 18th January.

The opening statement to the Committee of Inquiry was made by Sir John who said:

'All the Institutions which are members of CEI have had the opportunity to give evidence and it is no secret that there are important differences of opinion between them. The Officers of CEI in their written evidence and in preparing for this session have not attempted to represent a consensus. I know you will understand and respect our position.

'Before we put ourselves at your disposal to answer questions, I should like to make a few points that we think are important:

'We do not believe the defects in the performance of British industry can be fairly attributed to the quality of British engineers or the organization of the profession. Engineers are however generally under-valued and under-rewarded.

'Were it possible to start again from scratch it is probable that the engineering profession would be organized differently. However, the present arrangements work much better than some would have you believe, and the benefits of radical change would not begin to justify the cost and disruption involved. We know of no evidence that methods adopted by other countries with quite different traditions would meet our needs better.

'We think the greatest strength of the British system for producing engineers is our insistence on practical training and experience. Raising academic thresholds in itself is not sufficient. We agree that the arrangements for conducting

and monitoring practical training and experience need to be strengthened, and that public finance will be necessary. We are convinced that the Institutions have an extremely important role in all this and that membership of an appropriate institution is very beneficial to an engineer.

'We are satisfied that the Registration of engineers at all levels is in the public interest. We regard the ERB, despite its limitations, as an effective and economical organization which has steadily improved its performance and which has a great deal of expertise. Any new registration body set up to replace it would have much the same problems and would have to rely on the work of much the same people, but would have to pay them for their work. It would be much more expensive to run and more remote from the profession it serves. (The ERB costs about £100,000 p.a.)

'Given time, there is no reason why the ERB should not gain full recognition on a voluntary basis. However, rapid progress depends on Government recognition. I have no doubt that, given the resources, the ERB is capable of adapting to meet any reasonable demands on it that Government recognition may imply.

'We are completely unconvinced by the arguments for general licensing of all engineers. It is unworkable and unnecessary.

'Finally, a word about academic standards for Chartered Engineers. There are, unfortunately, wide variations in the standards of degrees awarded in this Country. We therefore regard the CEI exam as the yardstick for assessing whether or not a particular degree is acceptable.'

This CEI Officers' statement has already met with unofficial approval from our own Institution as being much more in tune with IERE views than were previous pronouncements by CEI and some other Institutions.

### The Journal 50 . . . . 25 . . . . 10 years Ago

We recently had to look up issues of the Institution's Journal published in the twenties and were interested to see a report of a discussion meeting which took place just over fifty years ago on 'Selectivity and the Regional Scheme'. Opened by Mr G. Leslie Morrow, a former BBC Development Engineer, it ranged widely over the problems of the new medium-wave network, notably the interference between these transmitters and from foreign stations: problems which are not too remote from those which have brought the BBC an enormous post bag of complaints since the changes of home broadcasting wavelengths last November! In 1928/29 one solution was a more selective receiver but compromises with

sensitivity and distortion worried some speakers.

Taking a jump of 25 years to the March 1954 Journal showed us one of the first 'feature issues'—and a very different theme from 1929. Four papers, from a symposium on 'Vibration Methods of Testing', dealt with generators, stroboscopes, strain gauges and other transducers, and the associated electronic equipment.

A further jump to March 1969 revealed papers on large scale integration, flashover in picture tubes, stored micro-program control using tunnel diodes, and RC active circuits.

## The Role of Risk Analysis in Engineering

On Monday, 26th March, at 3.00 p.m., Mr B. Hildrew, F.Eng., Managing Director of Lloyds Register of Shipping, will deliver a paper on the above subject to an Ordinary Meeting of the Fellowship of Engineering. The meeting will be held at the Institution of Mechanical Engineers, and it is open to all Chartered Engineers. A summary of Mr Hildrew's paper is as follows:

Following a discussion of the various problems associated with rapidly evolving technology, a review will be given of the various risk analysis methods covering function, approach, principles and techniques. Of particular importance is the need for supporting historical data, and theoretical and laboratory tests on the reliability of engineering components. The application of risk and reliability techniques to various engineering areas will be briefly discussed, together with the growing importance of the use of such techniques to future problems. In a rapidly evolving technological world with its increasing complexity, there is a real need to apply the discipline of risk analysis to an increasing extent. Moreover, the engineering profession must apply these techniques in association with its in-depth experience knowing that it must be responsible to the community for the safe performance of any engineering product.

Tickets for admission will not be issued, but all who wish to attend are asked to inform the secretary of the Fellowship of Engineering, 2 Little Smith Street, London SW1, (Tel: 01-799 3912) as accommodation will be limited.

## BUPA Group for IERE Members

We would like to remind members that the Institution operates a Group Scheme with BUPA, so as to help members who, in the event of illness, would like to have private treatment for themselves and their families. Group membership enables a member to obtain a rebate of 10% on the basic rate of subscription, plus immediate cover upon acceptance instead of the usual three months' waiting period.

Present members of the IERE Group are advised by BUPA to re-examine their level of cover before their annual renewal date in view of the impending increases in Hospital charges. At present, for a London Teaching Hospital the private accommodation charge is about £460 per week while a Provincial Teaching Hospital charge for accommodation is £343 per week, and a General Hospital charges £300 per week.

The Medical Centre in King's Cross, London provides facilities for complete health checks. Subscribers of the Group may avail themselves of a complete screening at this unique fully automated clinic for a specially reduced fee.

Further details for joining BUPA or any of the extra schemes may be obtained from Mr F. W. Tyler, Deputy Secretary, IERE, 99 Gower Street, London WC1E 6AZ. (Telephone 01-388 3071).

## Fellowship of Engineering

The Annual General Meeting of the Fellowship of Engineering was held at St. James's Palace on Friday, 9th February, under the Chairmanship of the Senior Fellow, H.R.H. The Duke of Edinburgh. Lord Hinton of Bankside, O.M., F.R.S., the President, reported upon the activities of the Fellowship during the past year and sixty new Fellows were elected. The new Fellows included Professor William Alexander Gambling, Head of the Department of Electronics at the University of Southampton and Immediate Past President of the Institution, and Professor David Evan Naunton Davies, Department of Electronic and Electrical Engineering, University College London, a Past Vice President of the IERE.

## CEI Officers for 1979

The Board of CEI, at its meeting on 25th January 1979, elected Dr. G. S. Hislop, C.B.E. (formerly of Westland Helicopters) as Chairman of the Council, and Dr. P. A. Allaway, C.B.E. (Chairman of EMI Electronics and a Past President of the IERE) as Vice Chairman. They took up office at the conclusion of the Annual General Meeting of CEI on 15th March.

## Research into Industrial Robots

The National Engineering Laboratory is embarking on an 18-month research programme into the development of industrial robots.

The programme, which is being financed by the Department of Industry's Mechanical Engineering and Machine Tools Requirements Board, is part of the programme of the Committee for Automated Small Batch Production. It will extend the NEL's present research into the use of robots in arc welding to the general development of techniques, standards and applications of robot devices.

The main activities will be in interface and performance standards with basic facilities for evaluation and calibration. Research will also be aimed at enhancing the abilities of robots. These are seen as common to the likely applications of industrial robots or to extend their use into small batch applications.

The specific areas of research are:

### Evaluation of Robot Characteristics and Performance Standards

The eventual aim is to provide standards and calibration support for industry in characteristics such as static and dynamic positioning, loading deflections and manoeuvrability.

### Development of Interface Standards

Standards will be important in those areas where industrial robots interface with humans and have mechanical, electrical or optical interfaces with the outside world. High-level-language standards will also be considered.

### Simulation

Facilities are being developed to simulate robot movements.

### Review of Applications

A comparison is being made of the present and potential UK market which would be available to robots with improved features. Particular attention is being paid to checking Japanese and German predictions that, with the provision of tactile sensors and facilities for inspecting and orienting parts, there will be a large increase in potential applications.

### Equipping Robots with Sensors

The project will review the research work done on sensors for complex applications—recognizing and selecting parts for a bin; recognizing and rejecting a faulty part; adjusting for variations in workpiece dimensions as in welding and making use of force or torque measurements to avoid damage or incorrect assembly. Particular attention will be paid to work which is relevant to the UK interest in the automation of batch production. Certain features such as visual inspection and recognition will be implemented and demonstrated, and the work currently being done on weld joint recognition will be extended to more general surface profile sensing.

The use of microprocessors and multi-processor configurations will be examined, but the cost of computer processing and communications will not be assessed.

# Forthcoming Institution Meetings

## London

Wednesday, 28th March

JOINT IERE MEASUREMENTS AND INSTRUMENTATION GROUP/IEE

### Colloquium on MEASUREMENTS AND HIGH VOLTAGE

Royal Institution, Albemarle Street, London W1, 10.00 a.m.\*

Tuesday, 10th April

AEROSPACE, MARITIME AND MILITARY SYSTEMS GROUP

### Colloquium on PORTABLE COMMUNICATION SYSTEMS

Royal Institution, Albemarle Street, London W1, 10.00 a.m.\*

Friday, 11th May

JOINT IEE/IERE MEDICAL AND BIOLOGICAL ELECTRONICS GROUP

### Colloquium on MINIATURE TRANSDUCERS FOR MULTI-PARAMETER CLINICAL DIAGNOSTICS

IEE, Savoy Place, London WC2, from where further information may be obtained.

Tuesday, 15th May

JOINT IERE/IEE MEDICAL AND BIOLOGICAL ELECTRONICS GROUP

### Colloquium on STORAGE DEVICES FOR MEDICAL AND BIOLOGICAL SIGNAL ANALYSIS AND RECORDING

Royal Institution, Albemarle Street, London W1, 10.00 a.m.\*

Tuesday, 5th June

COMMUNICATIONS GROUP IERE/RSGB

### Colloquium on MICROWAVE COMMUNICATIONS IN THE AMATEUR SERVICE

Royal Institution, Albemarle Street, London W1, 10.00 a.m.

Tuesday, 12th June

COMPONENTS AND CIRCUITS GROUP

### Colloquium on PERIPHERAL COMPONENTS FOR MICRO-PROCESSORS

Royal Institution, Albemarle Street, London W1, 10.00 a.m.\*

## Beds and Herts Section

Thursday, 29th March

### Optical fibre communications

By Professor W. A. Gambling (*University of Southampton*)

Hatfield Polytechnic, 7.45 p.m. (Tea 7.15 p.m.)

\* Advance registration necessary. Further details from Colloquium Registrar, IERE.

Thursday, 26th April

### ANNUAL GENERAL MEETING

followed by

#### Loudspeakers

By J. Akroyd (*Decca Radio and Television*)

Hatfield Polytechnic, 7 p.m. (Tea 6.45 p.m.)

## East Midland Section

Tuesday, 3rd April

### ANNUAL GENERAL MEETING

Room H.08, Leicester Polytechnic, 7.15 p.m.

## Kent Section

Thursday, 5th April

### ANNUAL GENERAL MEETING

followed by

#### The Dolby noise reduction system

By J. Iles (*Dolby Laboratories*)

Boxley Country Club, Boxley, Nr. Maidstone, 7.00 p.m.

## Merseyside Section

Wednesday, 4th April

### ANNUAL GENERAL MEETING

followed by

#### A Discussion on Membership of the IERE

Opened by the Secretary of the Institution  
Bradford Hotel, Tithebarn Street, Liverpool 2

(Please note change of venue)

## North Eastern Section

Tuesday, 10th April

### Quadraphonics and other multichannel sound systems

By Dr. K. Barker (*University of Sheffield*)

Newcastle-upon-Tyne Polytechnic, Ellison Building, Ellison Place, 6.00 p.m. (Tea 5.30 p.m.)

## Northern Ireland Section

Wednesday, 25th April

### Electronic development in the automotive field

By R. Bird (*Lucas Electrical*)

Castlereagh College of Further Education, 7.00 p.m.

## North Western Section

Wednesday, 28th March

JOINT MEETING WITH IEE

### Electronics for off-shore oil rigs

By J. Couser (*Ferranti Off-shore Systems*)

Lancashire County Cricket Club, Talbot Road, Old Trafford, 6.15 p.m. (Light refreshments available before the lecture.)

Thursday, 26th April

### Automobile electronics

By a lecturer from Rolls-Royce

Bolton Institute of Technology, Deane Road, Bolton, Lancs 6.15 p.m. (Light refreshments available before lecture.)

## Scottish Section

Wednesday, 4th April

PUBLIC LECTURE

### Human engineering

Prof. J. M. A. Lenihan (*Department of Clinical Physics, University of Glasgow*)

Boyd Orr Lecture Theatre, Glasgow University

Thursday, 5th April

PUBLIC LECTURE

### Human engineering

Prof. J. M. A. Lenihan

David Hume Building, Edinburgh

## Southern Section

Wednesday, 21st March

### ANNUAL GENERAL MEETING

followed by

#### Electronics in supertankers

By A. M. Bate (*London and Overseas Freighters*)

Boldrewood Lecture Theatre, Medical School, University of Southampton, 7.00 p.m. (AGM), 7.30 p.m. (Lecture)

Wednesday, 4th April

CEI MEETING

### Symposium on The Engineer and the Environment

Southampton University.

Further information from The Director, Southern Science and Technology Forum, Building 25, The University of Southampton Southampton SO9 5NH. (Tel: 558379)

Thursday, 26th April

### Microcomputers and their applications

By H. Kornstein (*Intel Corporation*)

Farnborough College of Technology, 7.00 p.m.

## South Midland Section

Tuesday, 24th April

### Some thoughts and experiments on audio topics

By P. J. Baxendall

followed by the

#### ANNUAL GENERAL MEETING

Carlton Hotel, Parabola Road, Cheltenham 7.00 p.m.

## South Wales Section

Thursday, 5th April

JOINT MEETING WITH IEE

### Viewdata

By K. E. Clarke (*Post Office Research Centre, Martlesham*)

University College of Swansea, 6.30 p.m. (Tea 5.30 p.m.)

Tuesday, 24th April

JOINT VISIT WITH INSTITUTE OF PHYSICS

**British Steel Corporation of Wales Research Laboratories, Port Talbot.**

Tour of Instrumentation Laboratories from 3.00 p.m. to 5.00 p.m. (Tea 5.00 p.m.)  
Lecture on Research Laboratory Function in British Steel Corporation, 6.00 p.m.

## South Western Section

Monday, 2nd April

ANNUAL GENERAL MEETING

Royal Hotel, Bristol, 7.00 p.m.

(Refreshments available after meeting.)

Tuesday, 3rd April

JOINT MEETING WITH IEE

**Brain activity and its relation to function**

By Dr. R. Cooper (*Burden Neurological Institute*)

The College, Regent Circus, Swindon, 6.15 p.m. (Tea 5.30 p.m.)

Wednesday, 25th April

JOINT MEETING WITH IEE

**Impact of LSI on logic circuit design**

By Professor D. W. Lewin (*Brunel University*)

The Canteen, Westinghouse Brake & Signal, Chippenham, 6.00 p.m. (Tea 5.30 p.m.)

Wednesday, 2nd May

JOINT MEETING WITH IEE

**Digital television studios—when?**

By J. Baldwin (*IBA*)

Chemistry Lecture Theatre No. 4, University of Bristol, 6.30 p.m. (Tea 6.00 p.m.)

## Thames Valley Section

Thursday, 3rd May

ANNUAL GENERAL MEETING

followed by

**Recent advances in frequency synthesis**

By K. Thrower (*Racal Advanced Developments Division*)

Caversham Bridge Hotel, Reading, 7.30 p.m.

## West Midland Section

Wednesday, 25th April

ANNUAL GENERAL MEETING

followed by **Quadraphonics**

By R. I. Collins and C. P. Daubney (*IBA*)

Wolverhampton Polytechnic, 7.00 p.m. (Tea 6.30 p.m.)

## Yorkshire Section

Tuesday, 27th March

**Prestel: The Post Office Viewdata Service**

By K. E. Clarke (*P.O. Research Centre Martlesham*)

University of Leeds, 6.30 p.m.

Tuesday, 24th April

**One-day Conference: MICROPROCESSING '79—The Micro in Society**

Royal Station Hotel, York.

# Applicants for Election and Transfer

THE MEMBERSHIP COMMITTEE at its meeting on 2nd February 1979 recommended to the Council the election and transfer of the following candidates. In accordance with Bye-law 23, the Council has directed that the names of the following candidates shall be published under the grade of membership to which election or transfer is proposed by the Council. Any communication from Corporate Members concerning the proposed elections must be addressed by letter to the Secretary within twenty-eight days after publication of these details.

February Meeting (Membership Approval List No. 255)

## GREAT BRITAIN AND IRELAND

### CORPORATE MEMBERS

#### Transfer from Member to Fellow

CURTIS, George Henry. *Cumbernauld, Glasgow.*  
HALSALL, James Richard. *Runcorn, Cheshire.*

#### Transfer from Graduate to Member

AHMAD, Rashid. *London.*  
BOULTON, Dion Craig. *Derby.*  
CRINSON, Leslie Holmes. *Newcastle-upon-Tyne.*  
DAVIS, Michael Jefferson. *South Shields, Tyne & Wear.*  
DEGUN, Joginder Singh. *Luton, Bedfordshire.*  
HARDMAN, James Colin. *Leyland, Lancashire.*  
ILLINGWORTH, Graham. *Hitchin, Hertfordshire.*  
LEE, Christopher John. *Warminster, Wiltshire.*  
STEVENSON, John Graham. *West Drayton, Middlesex.*  
VYAS, Dinker. *London.*

#### Transfer from Student to Member

ALDOUS, Jack Maurice. *Wokingham, Berkshire.*  
MURPHY, Robert Stephen. *Wincanton, Somerset.*

#### Direct Election to Member

COOK, James Ian. *Gateshead, Tyne & Wear.*

### NON-CORPORATE MEMBERS

#### Direct Election to Companion

MICHAELSON, Robert Bernard. *Great Malvern, Worcestershire.*

#### Transfer from Student to Graduate

FU, Hay Yau. *London.*

#### Direct Election to Graduate

MAYHEW, Trevor Paul. *Saxmundham, Suffolk.*  
SQUIRES, Peter John. *Erith, Kent.*  
WARREN, Simon John. *Belvedere, Kent.*

#### Direct Election to Associate Member

HUMPHRIES, Vincent George. *St. Austell, Cornwall.*  
ROBINSON, Dennis Robert. *St. Lawrence, Jersey, C.I.*  
SULLIVAN, Michael. *Dymchurch, Kent.*

#### Direct Election to Associate

NIXON, Anthony Michael. *Plymouth, Devon.*

#### Direct Election to Student

BRACEY William. *Eastbourne, Sussex.*  
FEREBEE Ian Charles. *Morden, Surrey.*  
SPENCELEY, Nicholas Michael. *Epsom Downs, Surrey.*

## OVERSEAS

### CORPORATE MEMBERS

#### Transfer from Member to Fellow

TEO, Chye Poh. *Singapore.*

#### Transfer from Graduate to Member

LAM, Kay Leung George. *Hong Kong.*  
OLANIYI, Joseph Abimbola. *Ibadan Nigeria.*  
SMITH, Reardon. *Singapore.*  
YOUNG, John Andrew. *Rio de Janeiro, Brazil.*

#### Transfer from Student to Member

SIEW, Ying Oak. *Singapore.*

#### Direct Election to Member

LEUNG, Tsun Ho Michael. *Hong Kong.*

### NON-CORPORATE MEMBERS

#### Transfer from Student to Graduate

CHAN, Pang Chiu. *Hong Kong.*

#### Direct Election to Graduate

LAM, Lai Yin. *Hong Kong.*

#### Transfer from Graduate to Associate Member

DUGGAL, Jaghohan Sarup. *Poona, India.*

#### Direct Election to Associate Member

ABDULHUSSAIN, Mansur. *Dubai, UAE.*  
IKEJIKU, Sylvester C. D. *Lagos, Nigeria.*  
SUTHERLAND, Nigel. *Wellington, New Zealand.*

#### Direct Election to Student

LAI, Kei Hok. *Hong Kong.*  
LAM, Kim Chuen Kenneth. *Hong Kong.*  
LEUNG, Wai Ming. *Hong Kong.*

# Members' Appointments

## CORPORATE MEMBERS

**C. S. den Brinker, M.Sc.** (Fellow 1973), Technical Manager of Redifon Telecommunications since November 1977, has been appointed to the Board of the company. Mr. den Brinker, who was first Chairman of the Institution's Beds. and Herts. Section, currently serves on the Council and on the Components and Circuits Group Committee.

**M. S. Hasan, M.Sc., B.Sc.** (Fellow 1978, Member 1973), who has been with the Water and Power Development Authority, Pakistan, since 1972, has been promoted to Chief Engineer, Telecommunications.

**J. W. Parsons** (Fellow 1977, Member 1971), Deputy Managing Director of ITR International Time since August last year, has been appointed Managing Director.

**K. C. Stuart** (Fellow 1975, Member 1967, Associate 1966), who joined Cable and Wireless as an apprentice in 1946, has been appointed General Manager of Eastern Telecommunications (Philippines). His previous appointment was as Administrative Manager for Cable and Wireless at Bahrain.

**D. P. Taylor** (Fellow 1972, Member 1964, Graduate 1955), formerly Managing Director of Hewlett-Packard from 1969 to 1978, has joined Sinclair Radionics Ltd. as a non-executive Director.

**M. C. Anderson** (Member 1973, Graduate 1969) has been appointed Materials Manager with Data General, Southall. From 1976 to 1978 he was Systems Manager with EMI Medical.

**T. M. Ball** (Member 1963, Graduate 1960), who has been with British Aerospace (formerly Hawker-Siddeley Aviation) for some years, has been appointed Chief Buyer (Avionics and Electronics) of the Kingston-Brough Division. Mr. Ball has represented the Institution on BSI technical committees and he is currently Vice-Chairman of the Kingston branch of the Institute of Purchasing and Supply.

**J. C. A. Chaimowicz, Dipl.Ing.E.S.E.** (Member 1977) is now Senior Development Engineer, Electro-optics, with Linotype-Paul, Cheltenham.

**D. E. A. Coles** (Member 1973), who joined the Chief Signal Engineer's Department of London Transport in 1977, is now graded Tech. 1 and concerned with train interference instrumentation.

**J. Dixon** (Member 1973, Graduate 1972) has taken up a post as Resident Tutor in Electronics with the British Gas School of

Engineering at Killingworth, Newcastle-upon-Tyne. For the past 11 years he has been with the Northern Regional Health Authority as an Electronics Manager.

**Flt Lt P. M. Eckert, B.Sc., RAF** (Member 1976, Graduate 1972) has been posted to RAF Leuchars as Officer Commanding Air Radio Servicing Flight. Since March 1976 he has been Officer Commanding Engineering Information Centre at the Maintenance Data Centre, RAF Swanton Morley.

**J. R. Flanders** (Member 1973, Graduate 1969), who has recently retired from the RAF after a 21 year engagement, latterly as Computer Projects Officer at RAF Swanton Morley, has been appointed Sales Engineer with the English Electric Valve Company, and is concerned with ground based radar microwave devices.

**Major G. W. Howard, R.Sigs** (Member 1972, Graduate 1967) has returned to the UK to take up a staff appointment at the Headquarters Intelligence Centre.

**M. D. K. Kendall-Carpenter, O.B.E.** (Member 1973, Associate 1969) is now Head of Line Telecommunications Training at the Cable and Wireless Telecommunications College, Porthcurno. Since returning to the UK in 1976 from the West Indies, he has been Head of Overseas Consultancy Services with Cable and Wireless.

**J. D. Lythgoe, B.Sc., M.Tech.** (Member 1969) was appointed Head of the Engineering Department at Watford College in September 1978. He was previously a Principal Lecturer in Electronics at Oxford Polytechnic.

**J. McGrath** (Member 1974, Graduate 1970), who has been with Radio Telefis Eireann since 1966, is now Senior Engineer in Charge, North Eastern Region.

**A. C. Powell** (Member 1969, Graduate 1963) has recently taken up a post with the Department of Transport in Bristol as an Electronics Engineer (P & TO 1). He was previously with the UK Atomic Energy Authority at Aldermaston.

**Major B. Reavill, REME** (Member 1965) has relinquished his post as Senior Quality Officer, Army Ground Radar Group with the Electrical Quality Assurance Directorate, Bromley, and is now Officer in Charge, 15 Maintenance Advisory Group (Electro Medical & Dental Equipment) of the Weapons Branch, REME.

**J. J. Sainsbury** (Member 1970, Graduate 1966) has joined Ultra Electronic Controls, Acton, as a Project Engineer. He was previously Section Leader of Control Engineering with the Shoe and Allied Trades Research Association, Kettering.

**Wg Cdr G. E. Trevains, RAF (Ret.)** (Member 1959) is now Guided Weapons Safety Officer with the Hatfield/Lostock Division of British Aerospace Dynamics Group at Hatfield. His final appointment before retiring from the RAF was with the Directorate of Engineering Policy (RAF), Ministry of Defence. While Assistant Air Attaché at the British Embassy in Paris, Wg Cdr Trevains was on the Committee of the Institution's French Section, and more recently he has served on the Aerospace, Maritime and Military Systems Group Committee.

## NON-CORPORATE MEMBERS

**D. A. Harding** (Graduate 1973) is now Area Engineering Manager, UK and Ireland for AccuRay (UK) of Rickmansworth.

**H.-K. Kwan, B.Sc., M.Phil.** (Graduate 1976) is now working in the Department of Electrical Engineering at Imperial College London on digital filter research for a Ph.D. degree; before leaving Hong Kong he was a Design Engineer with Tek-Devices.

**C. K. Li, B.Sc., M.Sc.** (Graduate 1976) is now with the Dynamics Section, London Transport Executive. For the previous two years he was Research Assistant in the Control Engineering Group of the Polytechnic of Central London.

**Col. M. H. Mackenzie-Orr, O.B.E., G.M.** (Graduate 1965) has been appointed Director, Army Quality Assurance with the Defence Quality Assurance organisation of the Government of Australia in Melbourne. He was previously Commanding Officer of the Australian Defence Explosive Ordnance Disposal School, Liverpool, New South Wales.

**Lt Cmdr D. K. Allen** (Associate Member 1976) is now Deputy Base Engineer Officer with the Royal Bahamas Defence Force. From 1973 to 1978 he was Marine Radio Electrical Officer with the Royal Bahamas Police; he had previously served with the Royal Navy for 23 years, latterly as a Chief Radio Electrical Artificer.

**P. J. Hulse** (Associate Member 1974) is now Workshop Manager (Electronic and Instrument) at 41 Command Workshop REME, Huntington, York. His previous appointment was as an Assistant Project Officer in the Telecommunications and Radar Branch REME, Malvern.

**Lt Cdr J. W. Smith, RN** (Associate Member 1974) has completed a 2-year tour of duty in HMS *Charybdis* as Weapons Engineer Officer and is now Staff Engineer Liaison Officer to Flag Officer Plymouth.

**S. D. Buckingham** (Associate 1961), formerly Telecommunications Advisor to the Oil Service Company of Iran, is now in practice as a telecommunications consultant in Mallorca.

# Letters to the Editor

From: Professor D. A. Bell, F.Inst.P., C.Eng., F.I.E.E.,  
F.I.E.R.E.

Mr. J. D. Sampson, M.A., C.Eng., F.I.Mech.E.,  
F.I.Mar.E.

## Academics or Entrepreneurs?

We can hardly expect budding radio and electronic engineers to be both of the above immediately on completion of a 3-year (or possibly 4-year) university course for an honours degree, especially as most such degree courses purport to cover electrical power engineering as well as electronic engineering. Yet our industry clearly needs both. The problem is enhanced by the fact that an appreciable number of members of our profession have initial training as physicists or mathematicians and they, too, are needed. So I endorse the President's plea for *flexible* syllabuses in his Presidential Address, published in *The Radio and Electronic Engineer* for January 1979. For many years I have sought to have some basic economic or business training included in the undergraduate curriculum, but I have always had a sneaking doubt at the back of my mind: should one put all students through this programme regardless of motivation? Britain has always been notorious for a belief in amateurism in management; but can this really be changed by adding a little more to the undergraduate curriculum of all engineers, or should one rely on the outstanding engineers following the same path as our President and acquiring whatever additional knowledge may be necessary as their careers progress?

87 East End,  
Walkington, Beverley, HU17 8RX

D. A. BELL

6th February 1979

## Representation for Professional Engineers

Lord Denning has been widely described as perhaps the greatest judge of recent times. On January 17th this year, as Master of the Rolls and Senior Judge of the Court of Appeal, he and his two colleagues, Lords Justice Lawton and Brandon, dismissed the Appeal of ACAS against the High Court Judgement of Mr. Justice May in the case of UKAPE v. ACAS. In his judgement, Lord Denning described Professional Engineers in these terms:

'Men of standing who had qualified by taking a university degree in engineering or attained equivalent status by experience. Traditionally they are regarded as the elite of their calling. They rank higher in the social scale than craftsmen, draughtsmen and technicians. Their outlook is different. Their values are different. Their loyalties are different. They have no political objectives. In particular these professional men would not normally regard it as appropriate to resort to strike action to redress their grievances. Yet they have come to see the value of collective bargaining.'

Lord Denning's judgement gave a clear ruling that, if the great majority of engineers in a particular group wished to be represented by their own Professional Association, then both the employer and ACAS, if it was asked to adjudicate on the matter, should grant recognition to that Association. He said the attitudes and threats of the incumbent Unions representing other employees should be discounted.

This case has been regarded as of National importance because it involves the interpretation of the basic terms of reference of ACAS, as well as the fundamental freedom of professional people to choose their own representative agent.

The Court of Appeal therefore gave to ACAS leave to appeal to the House of Lords and this they will certainly do. An unfortunate error in the *Daily Telegraph* article on the Judgement stated that the Lords' Appeal costs would have to be borne by ACAS but, in fact, no such order was made and, although UKAPE have been awarded costs in the Lower Courts, we must shoulder our own costs in the Lords, at least until the Law Lords decide otherwise.

UKAPE has been fighting at Allen's for this simple right since 1971. The faith and dedication of UKAPE members have been amply demonstrated by the £14,000 which they have voluntarily subscribed so far to help meet the legal costs. Over £1,000 has also come from non-member engineers including colleagues from as far away as Australia. UKAPE is fighting this battle on behalf of all professional employees and engineers in particular. Our slender resources are fully stretched and UKAPE is appealing for help from all engineers to fund the House of Lords Hearing. Contributions to 'UKAPE Action Fund', addressed to me at 32 High Street, Bookham, Surrey, will be gratefully received.

32 High Street,  
Bookham, Leatherhead,  
Surrey, KT23 4AG.

JOHN SAMPSON  
General Secretary,  
UKAPE

5th February 1979

## Standard Frequency Transmissions

(Communication from the National Physical Laboratory).

Relative Phase Readings in Microseconds  
NPL—Station  
(Readings at 1500 UTC)

January 1979	MSF 60 kHz	GBR 16 kHz	Droitwich 200 kHz
1	2.5	6.2	21.4
2	2.7	5.6	20.8
3	2.9	5.8	20.2
4	2.8	6.1	19.7
5	3.1	5.8	19.0
6	2.8	5.7	18.3
7	2.5	5.9	17.8
8	2.9	5.4	17.1
9	3.0	4.6	16.3
10	3.0	4.6	15.6
11	2.9	6.2	14.9
12	2.9	5.4	14.2
13	3.0	5.8	13.4
14	3.0	6.0	12.8
15	2.8	5.4	12.3
16	2.9	4.8	11.4
17	2.8	3.6	10.8
18	2.8	3.6	12.8
19	2.9	4.3	15.3
20	3.0	3.6	16.9
21	3.0	4.0	18.3
22	2.8	4.1	19.7
23	2.9	4.1	20.4
24	—	—	21.0
25	2.8	3.6	21.6
26	2.7	3.6	22.8
27	—	3.6	23.7
28	2.4	3.6	24.7
29	2.6	—	25.7
30	2.7	4.3	27.0
31	2.6	4.2	28.1

Notes: (a) Relative to UTC scale (UTC<sub>NPL-Station</sub>) = +10 at 1500 UTC, 1st January 1977.

(b) The convention followed is that a decrease in phase reading represents an increase in frequency.

(c) Phase differences may be converted to frequency differences by using the fact that 1 μs represents a frequency change of 1 part in 10<sup>11</sup> per day.

## News from Industry

### Specialized Oscilloscopes for 100 MHz Operation

As part of a new range, based on their general-purpose 100 MHz oscilloscope (PM 3262), Philips have introduced two further models—a storage oscilloscope and an instrument featuring multi-function timing facilities and event counting which employs microprocessor control.

Writing speeds up to 1000 div/ $\mu$ s are possible with the compact portable dual-trace 100 MHz storage oscilloscope (PM 3266). It uses a transfer charge cathode-ray tube system and provides these high writing speeds over the whole screen. Storage time at maximum speed varies from 15s to one hour, depending on intensity. Autoerase and variable persistence facilities are also provided.



Fig. 1. Philips new 100 MHz PM 3266 storage oscilloscope uses a transfer charge tube system to provide high writing speeds up to 1000 div/ $\mu$ s with display over the whole screen

Facilities shared with the basic PM 3262 include alternate display of main and delayed sweeps, a third trigger view channel, 5 mV sensitivity over the whole bandwidth, with 2 mV up to 35 MHz, and a trigger bandwidth up to 200 MHz.

The oscilloscope uses a specially-developed, high-speed image transfer storage tube with scan magnification in the vertical direction providing the high writing speeds over the screen. A writing speed of 1000 div/ $\mu$ s makes it possible to store single-shot signals up to the maximum vertical amplifier bandwidth.

Versatile timing measurement capability and facilities for delay by time or event are combined in the microprocessor-equipped 100 MHz oscilloscope, the Philips PM 3263. A two-trace instrument, it provides a dual-delay timebase, digital delay, direct frequency measurement and automatic TTL triggering. Sensitivity of the instrument is 5 mV over the full band width, with 2 mV up to 35 MHz. Timing measurements include time interval and frequency, and event counting is possible before the delayed or main timebase start.

A built-in I.e.d. display provides unambiguous readout of delay times, events and frequency. Other features include alternate display of main and delayed sweeps and a trigger view facility which can be used as a third display channel.

Time and frequency are displayed in engineering notation and operator errors are also indicated. If time measurements are being carried out when the main timebase is uncalibrated for example, the division indication will be given rather than time. Frequency measurements with too small a resolution will result in an UNCAL warning on the I.e.d. display. Trigger

source errors and mis-setting of trigger controls will also result in warnings.

Equipping a standard oscilloscope with a microprocessor provides multifunction timing facilities with simple operation and no instrument cabinet extensions are needed. Benefits of the Philips' system include storage of subsequent event and time settings, indication of faulty instructions and self-test of the I.e.d. display. Also built in is a service monitor and a set of service routines for the microprocessor to simplify service and maintenance.

These oscilloscopes, which are made by Philips' Scientific and Industrial Equipment Division at Eindhoven in The Netherlands, are marketed in the U.K. by Pye Unicam.

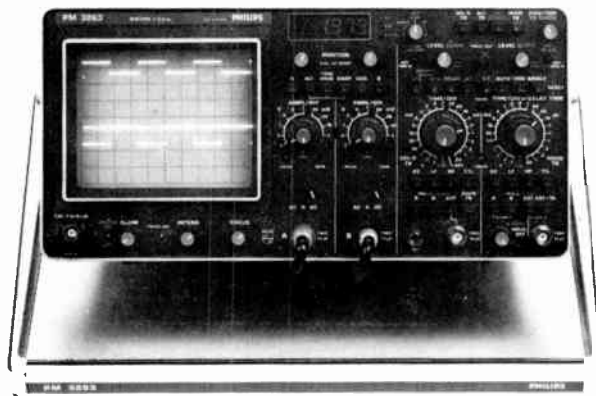

Fig. 2. Philips new PM 3263 100 MHz microprocessor-equipped oscilloscope combines versatile timing facilities with delay by time or events.

### New Programming Language for Microelectronics Circuits

What is claimed to be a major new technique for the design of microelectronic devices has been announced by the GEC Hirst Research Centre.

The gap between microcircuit technology and systematic design has become so large that *ad hoc* methods of designing large-scale integrated circuits had to be used. This has not prevented designers producing successful systems but the lack of a formal design procedure has meant that it is not easy to assess a design or communicate it to others until it has been worked out in considerable detail.

The problem has now been overcome by the development at the Hirst Research Centre of a system using a special language called HARTRAN (Hardware Translation) with the aid of which a designer can describe his ideas concisely at an early stage, check them by computer simulation, and provide a sound basis for the next phase of design in which the details of the circuit are worked out.

Unlike many previous attempts at such a descriptive language, HARTRAN is closely associated with the widely used scientific language, FORTRAN. Because of this it is possible to write programs in HARTRAN and convert them into FORTRAN programs that may be run on virtually any scientific computer. Another important feature of HARTRAN is that it uses only the standard typewriter set of characters. These two features will enable it to be widely used.

## Pye Celebrate 50th Anniversary

Fifty years ago, on 14th February 1929 was founded Pye Radio Limited, which has developed into one of the largest radio and television manufacturing companies in this country, now trading under the name of Pye Limited and part of the Philips concern. The company evolved from the wireless side of the original W. G. Pye & Co. founded in 1896 by William George Pye, who initially started business making instruments for schools and laboratories from a shed in the garden of the family home in Chesterton, Cambridge.

After the first world war the company diversified into making wireless receivers, and at the end of 1922 the beginning of broadcasting transformed, and greatly increased, the market for wireless receivers. Within months W. G. Pye & Co. were producing the 500 series of receivers which were followed by the highly successful 700 series, designed and introduced by Harold J. Pye, son of W. G. Pye, who had joined his father in the family business in 1923 after graduating from St. John's College, Cambridge. This 700 series was to lay the foundation of the Pye success story before the radio side of the business was eventually sold to Charles Orr Stanley in 1928, which resulted in the formation and registering of Pye Radio Limited as a public limited company on 12th February, 1929.

To celebrate this golden landmark in the history of the company, Pye Limited are publishing an illustrated booklet on the history of the company and its radio and television products based on those early years, with a foreword by Harold J. Pye. The Public Relations Department of Pye Limited, (137, Ditton Walk Cambridge), will be delighted to hear from anyone who worked for Pye Radio Ltd. in 1929, and from any persons who sold the original Pye wireless receivers.

## MK Electric's Diamond Jubilee

On 10th February 1919 Charles Arnold and Charles Belling founded the Heavy Current Electrical Accessory Company on the first floor of a factory at Park Road, Edmonton to manufacture plugs, sockets and switches. In 1923, the Company name was changed to MK Electric after the introduction of the Multi-Kontakt spring socket outlet—a revolutionary and highly effective new socket tube design.

Since then, MK Electric has grown to be the leading electrical wiring accessory manufacturer in the United Kingdom, claiming a share of more than 50% of the home market as well as being one of the largest companies in the world specializing in this field.

## Information for Schools on Industrial Sponsorship

The Schools Liaison Service, operated jointly by the Institutions of Electrical and Mechanical Engineers, is producing 'Training Opportunities', a comprehensive new publication providing a single source of information on all undergraduate training places in electrical and mechanical engineering. 'Training Opportunities', which will enable firms to direct publicity on their training places to potential engineers in the schools, includes specific details of training schemes for the forthcoming academic year. It will be issued free of charge to all careers offices and schools with sixth forms.

The new publication will be revised four times annually, enabling companies to delete their entries when they have filled their quota of training places.

Further information may be obtained from The Schools Liaison Service, Institution of Mechanical Engineers, P.O. Box 23, Northgate Avenue, Bury St Edmunds, Suffolk IP32 6BN.

## A Survey of the Electronics Industry

An industry in the midst of major change and developments is how a recent survey regards the companies in Britain's Electronics industry in a new presentation of an established financial publication. Interest in the industry continues to grow and the new survey completely updates Jordan's last study of the sector published just over a year ago. The new survey covers 500 companies whose turnovers range from £2 million to over £2,000 million.

In addition to financial tables on each company, the survey includes ancillary tables covering the top 20 companies, in the categories of Quoted Companies, Private Companies, Foreign-owned Companies, Largest Pre-tax Profits, Highest Profit Margins, Largest Exporters (both in value and as a proportion of sales), Highest Total Wagebill and Highest U.K. Wage.

GEC, as might be expected, is top in five of seven of these tables as the largest quoted company with a turnover of £2,342 million, the largest pretax profit with £325 million, the largest exporter—£665 million sales, and the highest wagebill totalling £522 million. A GEC subsidiary, Reliance Systems, has the highest profit margins with profits at 34% of turnover. As for the foreign-owned companies, Philips Electronics and Associated Industries tops the list—its turnover was £636 million.

Two lesser known companies head the lists of the highest exports as a proportion of sales and highest average wage. Magnavox Electronics, an American-owned subsidiary, had exports representing 98% of its sales and the average wage in CMG (Computer Management Group) was £7,618 during the year ended April 1978. Of the ten companies with an average yearly wage of £5000 or more, the first nine are computer software or hardware companies; the tenth is Cable and Wireless Ltd.

Within the main financial tables, three years' information is given for each company, together with codes that indicate ownership types (quoted, private, subsidiary, etc.) and main area of activity (consumer products, components, etc.) The alphabetical list of companies indicates the immediate and ultimate holding company and the name of the chairman or chief executive.

Among the companies which have produced particularly outstanding performances are two subsidiaries of Japanese companies, namely Sharp Electronics U.K. Limited who increased sales by 109%, and National Panasonic U.K. Limited who increased sales by 82% in the latest years reported. Another foreign-owned company, Digital Equipment Co. Limited, a subsidiary of Digital Equipment Corporation (U.S.A), recorded an increase in sales of 58%. Amongst British companies, Racal Electronics Limited showed a sales increase of 50%.

On the whole the electronics industry appears from its latest figures to be thriving. However, some of the large companies including E.M.I., Hoover, Decca and Plessey are not performing so well.

The average profit/sales ratios in the three main categories in the survey make interesting comparisons:

Public companies	11%
Foreign-owned companies	8.67%
Private companies	6.19%

There is one proviso to drawing too far-reaching conclusions from these and the other figures. Many of the companies in the survey—particularly the large public companies—have important interests outside electronics which are, of course, not shown separately in the company's consolidated accounts.

The survey is available, price £35.00, from the publishers, Jordan Surveys, Jordan House, Brunswick Place, London N1 6EE (Tel: 01 253 3030) or from leading business bookshops.





# The Relevance of Science to Engineering - A Reappraisal

DOUGLAS LEWIN, M.Sc., D.Sc., C.Eng., F.I.E.E., F.I.E.R.E.

This paper sets out to establish that engineering is a fundamental discipline in its own right based on deductive problem solving principles and the concepts of open-system theory. In so doing it has been shown that the engineering method is analogous to Popper's philosophy of science but in direct conflict with traditional empirical science.

## Introduction

Considerable discussion has taken place over the years on the status and education of engineers and their importance to the economic and social well-being of our society. In recognition of the problem the UK government recently set up a committee, the Finiston Committee, to consider ways and means of improving the quality of the engineer and their requirements for education and training. Throughout much of this debate an inherent fundamental assumption has been made that engineering is simply a branch of science, that is applied or engineering science. This attitude is reflected in many Universities where it is still held that the best training for an engineer is to be taught the fundamental principles of science, coupled with some management and social studies and, if possible, industrial training.

Though it is undoubtedly true that engineering is based on scientific facts and principles, as for example so is medicine, nevertheless engineering has entirely different goals to science—primarily that of producing artifacts for society—and very different ways of achieving them. The traditional Baconian philosophy of science, based as it is on inductive methods and arguing from the particular to the general, is not appropriate to engineering. It could be that to educate engineering students along these principles may well have a lasting and detrimental effect on their approach to engineering practice.

Engineering is rarely considered as a respectable discipline in its own right with a corresponding philosophy, indeed many academics would vehemently oppose this viewpoint. That this attitude persists is witnessed by the fact that engineering research in the Universities in the UK is still administered by the Science Research Council. Consequently engineers inevitably appear to be some form of 'impure' scientist, a viewpoint which is prevalent in schools where if you can't make the grade as a scientist you are relegated to engineering. It is no wonder that bright young people are reluctant to choose engineering as a career, it is tantamount to admitting you can't make the score as a scientist!

---

**Professor Douglas Lewin** (Fellow 1974, Member 1960) has been at Brunel University since January 1972, initially as Professor of Digital Processes, and since 1974 as Head of the Department of Electrical Engineering and Electronics. He was previously a Senior Lecturer in the Department of Electronics at the University of Southampton and from 1962 to 1967 he lectured in Computer Engineering at Brunel University. He has served as a member of the Southern Section Committee and has been a member of the Computer Group Committee since 1970 (Chairman from 1974 to 1977) and of the Papers Committee from 1971 to 1978; he has represented the Institution on the organizing committees for several joint conferences. In 1973 Professor Lewin was elected to the Council for a three-year term. He has contributed papers to the *Journal* and is author of several books and Editor of the journal *Digital Processes*.

Another deterrent to youngsters choosing engineering as a career is society's over-reaction to technology, which holds it to be the root of all evil. Writers such as Reich<sup>1</sup>, Mumford<sup>2</sup> etc., have advocated a return to a more natural (that is, less artificial) way of life and have criticized scientists and technologists alike for their 'abstract and scientific way of thinking' and claiming that they are 'remote from human experience and values'.

Whilst not wishing to enter into the anti-technology argument, it is evident that once again the engineer's way of thinking is closely aligned with that of the scientist. Unfortunately in many cases this is true but what is not realized is that engineering can, and should be, approached from a different viewpoint—that of designing man-machine systems. In this case the interaction of an artifact, or system, with the *total* environment (including the human aspects) becomes an integral part of the engineering process.

These ingrained attitudes, coupled with a lack of formal identity for the engineering process, have contributed much to our present problems, accounting for both the dearth of good engineering students and the social status of its current practitioners.

The objective of this paper is to show, drawing from general systems theory, that the engineering method is a fundamental discipline in its own right. Moreover it is also postulated that since engineering provides the basis for a general approach to problem solving, it should be included as a standard component in any educational curriculum. In pursuing these arguments the relevance to engineering of Popper's philosophy of science will be established; the paper concludes with examples of how the basic engineering principle can be taught to undergraduate students.

## The Concept of Systems Engineering

Traditionally science is concerned with endeavouring to understand and determine the laws of natural phenomena. This is achieved by the observation and gathering of data, to which an hypothesis is then fitted and an experiment set up to establish the validity of the hypothesis. Though the process is iterative, nevertheless the basic starting point is with the observation of the natural world. This method however has been challenged by Popper<sup>3</sup> who maintains that the hypothesis should come first, thereby eliminating the inductive process, followed by experiments designed to refute the original hypothesis—once again the process proceeding by iterative feedback. We shall return to this particular theory of scientific method later in the paper.

In contrast to science, engineering is primarily concerned with the artificial world, that is, with the design and manufacture of artifacts. Thus inherent in all engineering activity is the process of synthesis (or design), and it is this aspect which attests to the essential creative aspect of the subject.

Moreover, the engineer's chief concern is with the design of artifacts which can achieve certain desired objectives (the specification) and to establish the necessary properties required by the artifacts to allow them to function correctly to this end.

The emphasis on artifacts and the artificial world would seem to preclude any human involvement, and it is this literal interpretation of the engineering process which gives fuel to the anti-technology arguments. However, as we shall see, concentrating on the design of the hardware itself, excluding other considerations such as the environment and human participation, is very bad engineering.

As technology developed and the complexity of products increased it slowly became obvious that the traditional approach to engineering, that of the applied scientist proceeding from a bright idea to a final product—the inventor concept—was no longer possible or desirable. During the forties a process evolved in the US (almost out of necessity) to deal with the design of large engineering projects; this approach called *systems engineering* represented an abrupt change from accepted engineering practice.<sup>4,5</sup>

What is meant by systems in this context? The word systems has recently entered our language and is now used loosely by all and sundry to describe anything from social organizations to bathroom showers! In our discussion we shall adopt a fairly general definition of system—a set of interrelated elements forming a collective entity—where related implies that information and/or energy are exchanged or shared between the elements. Note that this implies that the characteristics of the system could well change with time. Even today controversy ranges over what systems engineering really entails, is it simply a new name for general engineering or does it just mean good engineering, does the concept apply only to large complex systems, is it principally concerned with project management etc.? Indeed the best way of starting a heated discussion among engineers is to introduce the subject of systems engineering! It is hoped that the approach adopted in this paper will draw together these conflicting opinions and in so doing present an acceptable consensus viewpoint of systems engineering.

The systems engineering approach is fundamentally one of problem solving, where the problem presented is the system (or artifact) to be designed and implemented. In so doing it is essential to take into consideration all possible alternative solutions and their interaction with other system parameters. The final solution then must inevitably be a *compromise* between technical, economic, human and environmental considerations. Note that there can be no *unique* solution to an engineering problem only a best solution with regard to the constraints imposed on the system design. An essential component of systems design is the consideration of the total interface between the man and the machine—that is the function and place of the user, operator, production personnel, maintenance staff etc.—thus man is considered as an integral part of the system (the *liveware*?). Coupled with this is the need to consider the effect of the final, implemented, system on the existing environment (note that every system is itself only an element of a larger system). This approach must inevitably involve the human sciences such as psychology, ergonomics, management etc., and provides substantial evidence why these subjects should be taught to undergraduate engineers. However these subjects must be treated as being essential to the engineering process and not relegated to ancillary topics of secondary importance to science-based engineering subjects.

Let us now consider the systems approach in more detail. The basic steps in evolving the solution to a design problem are as follows:

(a) *Problem specification.* It is impossible to satisfactorily solve any problem until it has been defined as fully as possible, including the basic objectives to be attained and the constraints imposed on its solution. In many cases the information required to specify the problem is not immediately available and would need to be acquired in some way (or perhaps estimated).

(b) *The synthesis stage.* This is the creative stage of the process and requires that a solution to the design problem be postulated. The first attempt is normally a fairly approximate solution produced simply to establish the economic and technical feasibility of a design.

(c) *Analysis of the solution.* Fundamental to the analysis stage is the concept of a *model* which can be used to represent the proposed system and its functional operation. (In the majority of cases it is not economically viable, or even desirable, to produce a prototype in the early stage.) The model can take various forms, a formal mathematical description, a physical analogue, a computer simulation or simply an intellectual argument. Having established a representative model of the system it is then analysed using mathematical based techniques, or exercised in the case of a physical model or simulation, to determine its general behaviour and in particular if it satisfies the original specifications.

(d) *Implementation.* Once the practicality of the system design has been established it is necessary to examine the detailed means of implementation in terms of available resources, including manpower and material, and the method of management etc.

There are a number of important points to be borne in mind when considering the design process outlined above:

(i) The systems approach leads naturally to a 'top-down' design, where initially the system objectives are derived independently from the means of achieving them. (The alternative approach, frequently used in practice, is called 'bottom-up' design and can lead to disastrous results.)

(ii) The design process is iterative and interactive feedback can take place at *all* stages, not just over the whole process; in this way the design may be optimized at any level to obtain the best solution.

(iii) Man-machine involvement must be considered throughout the entire design process. However, the allocation of tasks between man and machine primarily takes place during the specification and synthesis stage.

## Open and Closed Systems

The formulation of a model which is then subjected to experimental tests is a common feature of both the engineering and scientific methods. In the case of science the model (or hypothesis) represents the natural phenomena under investigation, whereas in engineering it corresponds to the system (artifact) being designed.

The scientific model normally corresponds to a *closed system* which is isolated from the real world (the environment) and has a restricted and well-defined input set. The output of the system is given by some explicit transformation or mapping of the input variables; thus the behaviour of the system can always be described explicitly in terms of its functional components. Moreover a closed system *must*, according to the second law of thermodynamics, eventually attain a time-independent equilibrium state with maximum entropy. Thus a closed system will increase in entropy over time toward greater disorder and randomness. The approach of isolating a small part of the real world and systematically investigating a few variables under controlled

conditions (called the reductionist method) is a fundamental aspect of science and a major source of its power.

The engineer however has to deal with the real world as it exists and the models he employs are more representative of an *open system*.<sup>6,7</sup> Open systems have the characteristic of interacting dynamically with the total environment and are responsive to changing external stimuli. Moreover the open system can adapt to its environment by changing the structure and processes of its internal components. An open system may, under certain conditions, attain a time independent state, called the *steady state*, when the system remains constant whilst continuously reacting with the environment. The open system does not run down however (that is obey the second law of thermodynamics) because it can import energy (or information) from the environment.

In practice the engineer's problem is really one of complexity. The closed system model of the scientist, with a bounded and well-defined set of input and state variables, leads generally to a deterministic solution. Where appropriate of course the engineer also uses this type of model, as for example in the design of a fully specified sub-system component. In the majority of cases however, and certainly at systems level, the engineer is faced with a highly complicated system consisting of a very large number of elements that interact in a complex manner. In such a system the whole is greater than the sum of its parts in the sense that given the properties of the components and their laws of interaction it is extremely difficult (practically impossible) to infer the properties of the whole. For example, in large digital systems though the basic logic gates are extremely simple, it is virtually impossible to precisely define the operation of the system (that is predict the response) for all input conditions. This is particularly true for systems with user interaction (and systems are never totally automatic) which have a virtually unbounded input set and the ability (by feedback action) to modify or reconfigure their own structure. Thus it is unrealistic to expect to obtain a unique deterministic solution to an engineering problem.

Unfortunately many scientists are conditioned by their training to the closed system model and in attempting to portray engineering problems in this way fail to take full account of the environmental constraints. The teaching of science subjects at schools (particularly Nuffield Physics) tends to instil this attitude of mind as well as emphasizing the classical scientific method.

### Popper versus Bacon

The traditional scientific method was first systematically described by Francis Bacon and consists initially of carrying out carefully controlled observations and measurements on the particular phenomenon of interest. These findings are then examined and an attempt made to formulate some law or general hypothesis which fits the known facts. Experiments, designed to verify the validity of the hypothesis, are then set up which if proved successful finally lead to the formulation of a new natural law. This method of deriving general statements from an accumulation of observations on particular happenings is known as *induction* and is considered to be the keystone of experimental science.

Whilst not wishing to enter into the philosophical arguments it must be said that Hume has cast considerable doubts on the inductive approach as used in science. Hume's main arguments stem from the fact that it is impossible to demonstrate the validity of the inductive procedures, since it does not logically follow that future events will obey laws based on past observations. Thus scientific laws cannot be proved



Sir Karl Popper, Ph.D., M.A., D.Lit., F.B.A., Professor of Logic and Scientific Method, University of London, at the London School of Economics 1945-1969.

theoretically to be true, nevertheless by extensive observations it can be shown that a high degree of probability exists that the laws are true in practice. It cannot be doubted that the inductive approach works in practice, witness the scientific achievements that have taken place, however it is also true that scientific theories are often displaced in the light of new knowledge.

Popper<sup>8</sup> has postulated a solution to the problems caused by the philosophical objections to induction and in so doing has rejected the orthodox view of scientific method and replaced it with another. The basic tenet of Popper's argument is that though it is logically impossible to verify the proof of a statement it is possible to produce proof of its falsification. For example, the statement 'wood always floats in water' can be falsified by the single observation of a wood that sinks, thus allowing the true statement 'not all wood floats in water' to be derived. Thus empirical generalizations though not verifiable are certainly falsifiable and scientific laws may be tested by setting up experiments designed to refute them. It is important not to abandon a theory too lightly (experimental errors quite often lead to refutation!) since it is essential to ensure that all theories are rigorously tested.

Popper's philosophy of scientific method however goes much further than this. he maintains that the starting point of the process is the postulation of a theory, thereby eliminating the inductive process used in the empirical sciences. This belief that scientific discovery should proceed from theory to observation (the reverse of the orthodox approach) has been met with incredulity on the part of many scientists—and controversy still rages! However it would seem obvious that before any measurements can be attempted a decision

must be made as to the objective of the work, thus presupposing some existing theory. The new method may be systematically described as follows:

- (a) *Formulation of problem*, for example, a rebuff or extension to an existing theory.
- (b) *Proposed solution*, i.e. a new theory.
- (c) *Deduction of testable propositions*, involves setting up a model.
- (d) *Experimental tests*, based on refuting the propositions.
- (e) *Evaluation of competing theories*.

Popper's approach then is concerned essentially with the postulation of a solution to a problem, which is then subjected to tests for falsification. It is however the problem itself which is the real starting point, and the reasons for it being a problem. Consequently the method focuses on the need to precisely formulate the problem prior to attempting to search for a solution.

It is also essential to appreciate the iterative nature of this process, where step (e) above leads naturally back to step (a), the original problem emanating from some inherent *a priori* consideration. Popper has formulated the process as a continuous development, parallel to the theory of evolution, where problem solving is the basic activity, thus:

$$P_1 \rightarrow TS \rightarrow EE \rightarrow P_2$$

where  $P_1$  is the initial problem, TS the proposed trial solution, EE the process of falsification applied to the trial solution and  $P_2$  the resulting solution which presents a new problem. Note that there can never be a definitive solution, only one which, with due regard to the constraints involved in the model, provides a currently plausible explanation.

## Back to Engineering

It should be obvious by now that there is a very close similarity between Popper's view of scientific method and the systems engineering approach outlined earlier. The important aspects which are common to both approaches are as follows:

- (a) The two methods are essentially concerned with problem solving in the broadest sense. The initial starting point in both cases is the specification of the problem to be solved followed by the postulation of a solution.
- (b) Both methods proceed by subjecting the postulated solution to analysis and test in the light of experience and existing theory. In the engineering sense this would correspond to the evaluation of a proposed design with respect to the original user specification. Though the principle of falsification is not necessarily strictly adhered to in engineering, the technique of deductive testing<sup>9</sup> is used extensively. For example, alternative design solutions are often evaluated by adding or tightening user requirements until only one design remains viable. Again, the principle appears in the breakdown testing of components, the use of random testing methods to discover design faults etc. That the ideas are endemic to engineering is illustrated by the well-known saying 'engineers make things and then attempt to break them'.
- (c) Neither method leads to a definitive solution to a problem and both proceed by an iterative feedback process.
- (d) Both methods depend on creative insight and intuition in postulating the solution to a problem.
- (e) Fundamental to both approaches is the concept that complex systems change in time due to the inherent feedback process—this interaction with the environment can of course be represented in both cases by the open systems model.

(f) The two methods are evolutionary in nature, with the engineering approach drawing on past experience, with due regard to physical and social constraints, to formulate a solution.

There are many other points of contact between the two methodologies which we shall not elucidate here, but it should be clear by now that Popper's scientific method and engineering are almost identical in concept and practice.

It would appear from the arguments above that in attempting to establish engineering as a discipline in its own right with a well-defined philosophy we have succeeded in proving that engineering is really science! However in doing so we have also shown that engineering is completely different in concept to the inductive empirical sciences, being based on an alternative deductive philosophy closely akin to Popper's logic of science.

The form of the model used to represent the proposed solution (or system) under test is also an important distinguishing factor. Invariably the engineer, working within a real environment, must resort to an open-systems model, whereas the scientist can generally use a closed-systems model to reduce the complexity of the problem to manageable proportions. Note that Popper's methods can be applied irrespective of the type of model employed.

It would not be untrue to say that Popper's philosophy of science is not as yet completely accepted by the scientific world. Whether or not the scientific community should accept Popper's thesis is not a point of issue in this paper, though if it was accepted the difference between science and engineering would disappear overnight, and engineering would become a science in its own right—the science of the artificial world.<sup>10</sup>

Unfortunately science departments still impart the orthodox view of experimental science based on inductivist arguments. While this attitude persists, to consider engineering as an applied science and educate our young engineers accordingly can only be viewed as irresponsible and to the long term detriment of the profession.

## Engineering as a General Education for Life

Everybody in their path through life is continuously faced with problems of a lesser or greater magnitude which must be solved in some way or other in order to survive. Thus living is first and foremost a process of problem solving, the very essence of which is the propounding of trial solutions and their consequent subjection to critical analysis. As we have seen it is these very aspects which are the prime concern of the deductive approach to engineering, and thus the engineering philosophy can also be considered as a general problem solving methodology and not just merely as a means of designing artifacts. For example, the essential prerequisite to solving any problem is to define exactly what the problem is (if only students would appreciate this fact!) and the engineering approach, with its essential first step of formulating a specification, truly emphasizes that point. Again the fact that there is no unique solution to an engineering problem, but just a 'best solution' chosen from a number of possible solutions depending on circumstances (which of course may well change!) is again a useful concept in solving real-world problems (but a strange one to students educated in conventional sciences). Another important consequence of an engineering-based education is that the animosity which has built up against technology may well be dissipated when it is appreciated that engineering is a creative, problem-solving activity, which takes due regard of the attendant social and human factors.

Many other disciplines could also benefit from the application of the systems engineering approach, notably the social sciences, politics, administration etc. Popper himself has applied his ideas to sociological problems,<sup>11</sup> and the ideas of general systems theory have been used extensively in management and the social sciences.<sup>12,13</sup>

Thus there would appear to be considerable advantages to be gained by including the fundamental principles of engineering philosophy as a basic subject in the curriculum of schools and universities. This course of action would be far more beneficial in the long term than our current, rather futile, attempts to teach technology in schools and making engineering degrees more relevant by the inclusion of social science and management subjects.

## Teaching Systems Engineering

Systems engineering, and its underlying problem-solving philosophy, cannot be taught effectively as a formal lecture course. Students must be exposed to the ideas throughout their undergraduate course and, of utmost importance, allowed to experience for themselves the problems of engineering design.

Thus the main objectives of an introductory course in systems engineering can be stated as follows:

- (a) To demonstrate to the student that engineering is a problem-solving philosophy with creative overtones.
- (b) To expose the student to realistic open-ended man-machine systems problems which require problem definition, model building, feasibility studies, optimization and the evaluation of alternative solutions.
- (c) To make the student aware of his need for fundamental knowledge in science, technology and management.

In order to achieve these objectives it is essential that the students become personally involved in the problem-solving activity. Consequently the mode of teaching should be primarily by project work, preceded by a short lecture course on the principles of systems engineering. The projects must of course be designed to be within the general understanding of first-year undergraduates, but they should also require a comprehensive literature search to be performed before attempting to specify the problem.

It is not necessary, or indeed feasible, that the students should obtain a detailed technical solution to the system problem. The main concern should be that they appreciate the difficulties and requirements of problem specification and acquire experience in the postulation and evaluation of trial solutions—the essential theory testing process. In undertaking the project students should be required to consider the man-machine system aspects as well as the economic and technical factors.

Typical of the projects which could be undertaken by students on such a course are:

- (i) Automatic recording and checking of votes in a general election.
- (ii) Automatic baggage handling in airport terminals.
- (iii) Supermarket system to eliminate cash-out queues.
- (iv) Robotic aids in the home.
- (v) Replacement of library facilities by a computer-based information retrieval system.
- (vi) Communication system to enable office workers to work from home.

Ideally the projects should be organized on a small group basis with the students working together as a team; in this

way the work can be shared and ideas exchanged verbally with their peers. In order to direct the work of the group regular programmed tutorials should be held with an academic staff member who acts as guide and consultant to the team. The major part of the project work however should be performed by the students in their own time, both individually and collectively, holding group meetings as and when required.

It would be naive to expect that a course of this nature can do little more than introduce students to the engineering philosophy. It can however lay the essential foundations which can be built on in subsequent years of the course. It is thus essential that the other component modules of the course be presented, whenever possible, from the systems engineering viewpoint, and that appropriate project work should be included in all years. This form of education places a tremendous responsibility on the part of the teaching staff, who must, as well as being academically competent in their subjects, practice their engineering professionally.

The scheme of studies described above has been based on the Engineering Systems course given at Brunel University to first-year Electrical Engineering students (a teaching syllabus is given in the Appendix). It is not suggested however that this approach is the only way of achieving the educational objectives and indeed the course would need modification in order to adapt it for students of a different discipline.

The major difficulties encountered by students attending the Brunel course have been in the acceptance and application of new concepts. For example, the constraints and assumptions inherent in model building, the idea that engineering problems do not have unique solutions, and the change from an inductive to deductive methodology.

## Conclusions

It has been demonstrated in this paper that engineering has a unique philosophy of its own based on the principle of deductive problem-solving, akin to Popper's logic of scientific discovery, and utilizing the concept of open-system models. Furthermore the method has been shown to be fundamentally different from the orthodox empirical sciences and that it could be a dangerous misnomer to classify engineering as applied science.

It is suggested that the education of engineering students along the lines proposed in this paper would ensure the highest professional standards and re-establish the engineer's rightful place in society.

## References

- 1 Reich, C. A., 'The Greening of America' (Random House New York, 1970).
- 2 Mumford, L., 'The Myth of the Machine: 1. Technics and Human Development' (Harcourt, Brace and World, New York, 1967).
- 3 Magee, B., 'Popper' (Fontana, London, 1973).
- 4 Affel, H. A., 'Systems engineering', *Intl. Science and Tech.*, 35, pp. 18–26, 1964.
- 5 Singleton, W. T., 'Man-machine Systems', (Penguin, Harmondsworth, Middlesex, 1974).
- 6 Bertalanffy, L. Von, 'The theory of open systems in physics and biology', *Science*, 111, pp. 23–29, 1950.
- 7 Bertalanffy, L. Von, 'General Systems Theory' (Brazillier, New York, 1968).
- 8 Popper, K. R., 'The Logic of Scientific Discovery', 3rd ed. (Hutchinson, London, 1972).

- 9 *Ibid.*, pp. 32–33.
- 10 Simon, H. A., 'The Sciences of the Artificial' (M.I.T. Press, Cambridge, Mass., 1969).
- 11 Popper, K. R., 'The Open Society and its Enemies', 5th ed (Routledge and Kegan Paul, London, 1966).
- 12 Emery, F. E., (Ed.), 'Systems Thinking' (Penguin, Harmondsworth, Middlesex, 1969).
- 13 Beishon, J. and Peters, G. (Ed.), 'Systems Behaviour', (Harper and Row, London, 1972).

### Appendix: Engineering Systems Teaching Syllabus

Objectives and principles of science and engineering; inductive and deductive methods. Introduction to systems thinking; definition of a system and the concept of complexity; open and closed systems; functional specification, models. Examples of sociological, biological and engineering systems.

Systems approach to problem solving—problem definition, synthesis, analysis, implementation. Design of man-

machine systems; task allocation, effect of environment—social, physical, economical.

Reliability and maintainability of systems.

Introduction to model building and simulation.

#### *Time allocated*

20 hour module, 5 hours lectures—15 hours tutorials.

#### *Assessment*

Set essays; written report and oral presentation on project.

#### *Book List*

1. 'The Sciences of the Artificial', H. A. Simon. M.I.T. Press 1969.
2. 'Man-Machine Systems', W. T. Singleton. Penguin, 1974.
3. 'Zen and the Art of Motor Cycle Maintenance', R. M. Pirsig. Corgi Books 1976.
4. 'How It Works: The Computer', David Carey. Ladybird Books 1971.

---

## EEC Meeting of Representatives of Professional Engineering Organizations

On October 3rd and 4th 1978, the CEI organized two half-day meetings in London of senior officers and officials from the principal professional engineering organizations in the nine member states of the EEC, together with representatives from each of the Corporation Members and Affiliates of the CEI. The first meeting was 'The Requirements of Industry in the EEC for Professional Engineers and Technicians', and the second 'The Control of Engineering Activities in the EEC'.

The meetings were well attended and a number of papers had been prepared by participants which provided the basis for the discussions at which the following points were made:

The importance to industry of a good blend and mix of engineers and technicians is essential for good engineering performance.

There was slower recognition of the use of the technician than the engineer in Member States and most, if not all, have a shortage of trained technicians.

The Rome Treaty gave an entitlement to all citizens of the nine Member States to be able to move and work freely. As engineers generally could do so in the EEC, there was as yet no cause for a Directive on the mutual recognition of qualifications of engineers. A possible consequence of entitlement to move and work freely was that if there were a shortage in any one Member State of engineers and technicians in any field of employment, replenishment could be sought from other countries without former restraints such as of nationality.

There is a Liaison Committee in the EEC for engineers at which the representatives from the principal organizations of professional engineers in the Member States are members. (In the case of the United Kingdom the CEI is the representative, and CEI also provides the Secretariat to the Committee.) Another Liaison Committee has been set up by the European Consulting Engineering Organizations, and both the Liaison

Committees co-ordinate those of their activities which are of mutual concern.

Too much dependence must not be put on forecasts of needs of industry due to the many variables such as demands arising from advances in technology.

Emphasis was given to the need to ensure that those entering a career in engineering received a sufficiently broadly-based education and training to enable them to adapt to the changes in employment.

The control of engineering works varied from country to country and the overall pattern relied on one or more of the following:

Legislation on specific hazards in identifiable areas of engineering activity from which the public can be at risk.

Legislation to protect those who are working in particularly hazardous conditions.

Regulations for specific activities such as buildings in urban areas, for health and safety practice in the working environment.

Licensing of persons specifically authorised to supervise and approve specific engineering operations.

Monitoring of professional performance through promulgated Codes of Conduct, reference being made to that agreed by the CEI Institutions through the Code of Conduct for the Chartered Engineer, who is required to safeguard at all times the public interest in respect to matters of health and safety.

Legal action in cases of negligence and incompetence through Courts of Law.

The need for engineers to maintain their reputation by a record of good engineers performance in respect to the works with which they are identified.

Copies of the papers may be obtained on request from the Secretary, CEI, 2 Little Smith Street, London SW1P 3DL.

# New and Revised British Standards

Copies of British Standards may be obtained from BSI Sales Department, 101 Pentonville Road, London N1 9ND.

## Electronic Measuring Apparatus

The first revision of BS 4308 **Documentation to be supplied with electronic measuring apparatus (£6.40)** has been published, this Standard being identical with IEC Publication 278. It is designed to achieve uniformity of content, layout and presentation of documentation supplied with apparatus in order to provide the user with adequate information on such aspects as the principle of operation, field of application, technical specification, use, maintenance and repair of equipment. Instructions for the latter are to be sufficiently detailed to allow all repairs to be carried out by a skilled technician, except where there is a stipulation for these to be performed by the manufacturer or his authorized representative. Drawings and component lists should therefore be included in the repair instructions. Definitions and general requirements of documentation are given in the Standard, which also specifies the required content of the instruction manual and the log book used to record the history of the apparatus and other important data. Requirements for the external form and layout of the documentation are also given.

## Domestic Radio and Television Aerials

The initial parts of an international series of specifications relating to linearly-polarized radio and television aerials for domestic use have been published under the general title, **BS 5240 Aerials for the reception of sound and television broadcasting in the frequency range 30 MHz to 1 GHz**. The first of the new publications is **Part 1 Electrical and mechanical characteristics (£3.20)**, which defines the relevant terminology and specifies the essential electrical and mechanical properties of such aerials. The companion document is **Part 2 Methods of measurement of electrical performance parameters (£4.20)**, which specifies the essential conditions and requirements for such parameters as reflection coefficient, gain, directivity pattern and protection. Also included is a description of a suitable measuring site and the measuring procedures to be used. Parts 1 and 2 are identical with the corresponding IEC documents (Publications 597-1 and 597-2, respectively).

## Auxiliary Passive Elements in Audio Equipment

A further part of the British Standard BS 5428 **Methods for specifying and measuring the characteristics of sound system equipment** is **part 4 Auxiliary passive elements (£8.80)**. BS 5428 gives the characteristics to be specified and the methods of measurement for various parts of sound system equipment. **Part 1 General**, **Part 3 Microphones** and **Part 11 Loudspeakers** have already been published. The auxiliary passive elements dealt with in **Part 4** include attenuators, transformers, filters, equalisers etc, applied as separate units to be combined with other separate sound system units in a complete sound system. It does not apply to components mounted in sound system units where they form non-interchangeable parts of such units. BS 5428 is substantially equivalent to IEC Publication 268, in fact this part of the British Standard is identical with IEC 268-6.

Other parts in advanced stages of preparation deal with amplifiers, automatic level control and artificial reverberation. Later issues under BS 5428 will cover mechanical design features, headphones, programme level meters, preferred interface values and listening tests.

## Standard Condenser Microphones

Techniques for measuring certain characteristics of one-inch (25.4 mm) condenser microphones are dealt with in three new Standards recently published by the British Standards Institution. Their common purpose is to ensure that exchanges between testing authorities are based on clearly expressible and reproducible results.

The first of these Standards is **BS 5677 Method (precision) for pressure calibration of one-inch standard condenser microphones by the reciprocity technique (£6.40)**, which describes procedures for measuring such characteristics with the highest obtainable accuracy. It is restricted to reciprocity pressure calibration by the coupler method, examples of cylindrical couplers also being given. A similar document relating to standard condenser microphones of smaller dimensions is under consideration. This Standard is identical with IEC Publication 327.

The second of the new issues is **BS 5678 Method (simplified) for pressure calibration of one-inch condenser microphones by the reciprocity technique (£4.80)**. This concerns a method of absolute pressure calibration of microphones used in laboratories for conventional measuring purposes not requiring the highest obtainable accuracy and where the frequency range is restricted to 50 Hz-10 kHz. The error introduced by application of this simplified method is estimated to be less than 0.3 dB. This Standard is identical with IEC Publication 402.

The final Standard in this group is **BS 5679 Method (precision) for free-field calibration of one-inch standard condenser microphones by the reciprocity technique (£6.40)**. These microphones are also intended for use as laboratory standards. This Standard is identical with IEC Publication 486.

## Dimensional Standardization of Electronic Components

Two new British Standards just published are concerned with dimensional aspects of electronic components. **BS 5692 Method of measurement of the dimensions of a cylindrical electronic component having two axial terminations (£2.20)** describes methods and gauges for determining body and termination lengths of cylindrical electronic components, together with body diameter and length of coating material measurements. It is equivalent to IEC 294. **BS 5693 Preferred diameters of wire terminations for capacitors and resistors (£1.00)** lists a series of preferred diameters of the finished wire termination of capacitors and resistors. It does not necessarily apply to the wire used to manufacture the terminations. The Standard is equivalent to IEC 301.

## Know your Certification Schemes

Details of the major international certification and approval schemes in use in over 90 countries are given in **International certification and approval schemes**, published by Technical Help to Exporters (THE), the export advisory service of the British Standards Institution. The publication contains general information about each scheme and details about how they are operated. Complementary information about the international organizations concerned in the schemes is also included, together with lists of participating countries and organizations. Schemes covered are: the CB scheme; CEE approval marks scheme; CENELEC protocol agreements; CENELEC HAR agreement; CECC harmonized system; IECQA system; CEN certification system; ECE harmonization and conformity certification scheme; EEC schemes under 'Article 100' Directives; and schemes coordinated by EFTA.

## Contributors to this issue



Keith Salmon became interested in electronics during National Service, which he completed as an instructor with REME at Arborfield. Later, in 1960, he obtained a B.Sc. in physics at Reading University and has since been with Philips (formerly Mullard) Research Laboratories. His areas of work have principally involved mixers, transistors and f.e.t. r.f amplifiers, and oscillators at frequencies up

to 12 GHz for receivers, which have included 12 GHz television. He is now in charge of projects on u.h.f. oscillators stabilized by surface acoustic wave delay-lines.



Gregers Mogensen was awarded the M.Sc. in electronics engineering from the Technical University of Denmark in 1971 where he worked as a Research Associate until 1977. He was mainly occupied with 19 GHz propagation experiment, working on equipment, data analysers, commissioning and compilation of results. In 1977 he obtained his Ph.D. degree—based on this propagation work. From June

1977 to December 1978 Dr Mogensen was with Marconi Communication Systems at Chelmsford, developing modems for high-speed digital satellite and troposcatter transmission.



Erik Lintz Christensen graduated *cum lauda* from the Technical University of Denmark, Lyngby, as 'civilingeniør' (M.Sc.E.E., Telecommunication) in January 1966. Between 1966 and 1968 he did compulsory military duty in the Royal Danish Navy, working with microwave circuits and antennas in the Navy Laboratories. Simultaneously he worked on measurements of antenna radiation patterns and

backscatter in the Laboratory of Electromagnetic Theory (now Electromagnetics Institute) at the Technical University.

For the next five years Mr Christensen was a Research Associate at Electromagnetics Institute with full responsibility for the development of radar systems for radio echo sounding of the Greenland inland ice, and the sweep system for amplitude and phase propagation measurements. In 1973 he was appointed Associate Professor and he teaches radio communication systems at Lyngby. His present interests are satellite propagation measurement and antenna near-field measurements.



Robert McLintock obtained an honours degree in electronic and electrical engineering from Manchester University in 1972. He then joined the Post Office Telecommunications Development Department as an Executive Engineer and worked initially on the development of 24 channel, and subsequently 30-channel, pulse code modulation transmission systems. He has recently been temporarily promoted to

Head of Group grade and his new duties include involvement in CCITT and CEPT matters as they relate to digital transmission systems. His work also includes studies into transmultiplexer equipment and high-speed digital line systems operating in the region of 500 Mbit/s.



Tony Pratt joined the Department of Electronic and Electrical Engineering, University of Technology, Loughborough, in 1967 as an Assistant Lecturer having completed 3 years of research following an undergraduate degree at Birmingham University; promotion to Lecturer followed in 1969. Since then Dr. Pratt's research interests have been mainly associated with detection and estimation theory and

with sector scanning sonar systems. He has visited both India and USA, being Visiting Professor at the Indian Institute of Technology, Delhi, in September 1977, and Visiting Associate Professor, Department of Engineering and Applied Science, Yale University, during the early months of 1978. Dr Pratt is a founder member and Treasurer of the Underwater Acoustics Group of the Institute of Acoustics.

Biographies of the other Contributors will be found on page 164.



# Experimental investigation of line-of-sight propagation at 13.5–15.0 GHz

E. LINTZ CHRISTENSEN, M.Sc.E.E.\*

and

GREGERS MOGENSEN, M.Sc.E.E., Ph.D.\*

## SUMMARY

A 13.5–15.0 GHz sweep measurement equipment designed to measure amplitude, differential phase, and differential gain of a propagation path is briefly described, and the qualities of the data are discussed.

Statistics of fading and intermodulation noise in the frequency band of 13.6 to 14.9 GHz from a 45 km l.o.s. propagation path in Denmark are presented. The statistics cover the period July 1974 to July 1975. Both monthly and diurnal variations of the fading are given as well as the distribution of the fading durations. Separate statistics are given for multipath propagation and for precipitation attenuation. Distributions of the 1 minute and the 1 hour mean values of total noise power for the whole period, and for the worst month are presented. The monthly variations of these values are also presented.

Based on the data it is concluded that this propagation path will satisfy the relevant part of the CCIR Recommendation 395-1, concerning the transmission quality in the worst month—provided the antennas are protected against wet snow and the system uses some type of diversity to cope with multipath propagation.

\* Electromagnetics Institute, Technical University of Denmark, DK 2800, Lyngby, Denmark

## 1 Introduction

The demand for increasing capacity in telecommunication networks will require radio circuits at frequencies above 10 GHz where precipitation attenuation becomes of importance. The effect of multipath propagation may however still have to be considered dependent on the characteristics of the climate and the propagation path. A propagation experiment has thus been set up in Denmark to investigate both multipath propagation and precipitation attenuation. The main emphasis is on the multipath propagation as the available information was not considered sufficient for planning of proposed high capacity analogue and digital radio circuits.

The measuring and data logging equipment as well as the computer programmes for the analysis of the data were developed at Electromagnetics Institute of the Technical University of Denmark. The Danish Post and Telegraphs is responsible for the rain-gauge network and for the operation of the experiment. The experiment is sponsored by Danish Post and Telegraphs.

The aim of this paper is mainly to describe the experimental system, that is the equipment, the data analysis and the types of statistics produced. The results obtained are represented by selected samples from the period July 1974–July 1975 only, as a comprehensive presentation of all results is too voluminous.

## 2 The Experimental Set-up

The experiment is installed on a 45 km line-of-sight overland path employing the towers of the existing microwave trunk system. The path runs from southwest of Copenhagen to the centre of the city as shown on Fig. 1. This path is known to exhibit pronounced multipath propagation as do most Danish line-of-sight paths. The terrain roughness of the path is 21 m as measured by the standard deviation of terrain elevation at 1 km intervals. The path profile is depicted in Fig. 2. Seven rapid response rain gauges of the drop-counting type are located in the vicinity of the path (see Fig. 1), with the sole purpose of obtaining statistical information of the precipitation in the area.

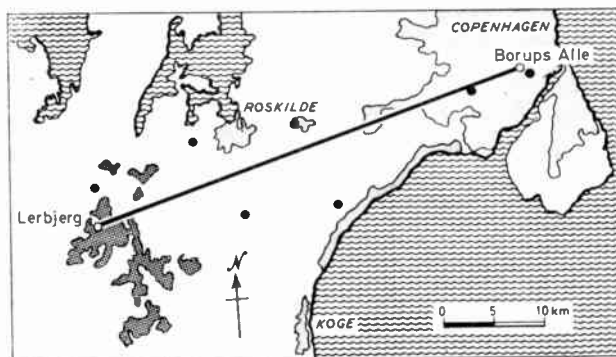

Fig. 1. Lerbjerg to Borups Alle test path. ● locations of rain gauges.

An overall block schematic of the experiment is shown on Fig. 3. The measuring equipment, i.e. the on-line part, consists of a transmitter, a receiver and a data logging equipment that records propagation data, rain-gauge data, time, system status etc. on magnetic tape. These tapes are subsequently analysed on a CDC 73 computer at the computer centre of Danish Post and Telegraphs. The main features of the experiment are described in the next section and the exact specifications are given in Table 1.

2.1. The Transmitter (Fig. 4)

The experiment uses the sweep technique to investigate multipath propagation, the transmitter frequency being swept sinusoidally between 13.5 and 15.0 GHz with a period of one second. The carrier is, in addition, narrow-band frequency-modulated with 10 MHz to enable measurements of the differential phase and differential gain of the propagation path. The 10 MHz modulation has been selected because 10 MHz is a reasonable approximation to the upper baseband channel in both 1800 and 2700 channel f.d.m. systems.

The oscillator is a YIG-tuned Gunn oscillator which fulfills the requirements for very linear broadband tuning and fast frequency modulation. Both the sweep frequency and the modulation frequency is derived from a highly stable 5 MHz crystal oscillator. The modulated carrier is amplified in a t.w.t. amplifier and then emitted via the front fed 1.2 m, (4 ft) paraboloid antenna. The output level is controlled by an a.l.c. circuit which uses a temperature-controlled diode detector and a pin-diode

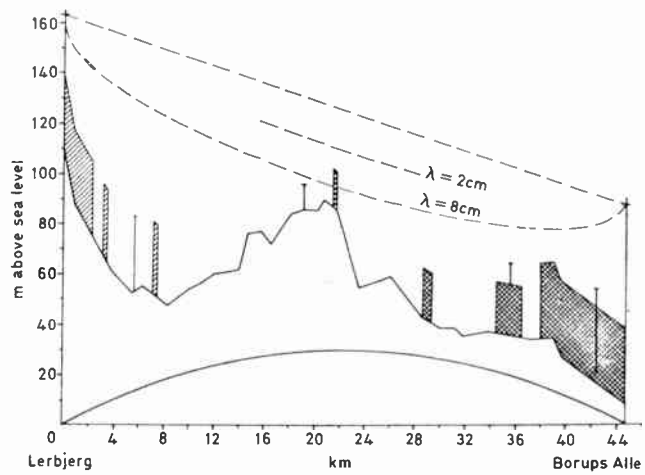

Fig. 2. Lerbjerg to Borups Alle path profile,  $K=4/3$ . First Fresnel zone indicated for frequencies 15 GHz ( $\lambda=2$  cm) and 3.75 GHz ( $\lambda=8$  cm).

attenuator. The low-pass filter at the output of the amplifier suppresses the 2nd and 3rd harmonics of the carrier which otherwise would affect the levelling. The frequency of the transmitter is controlled by an a.f.c. circuit which employs a wavemeter tuned to 13.6 GHz as reference. The a.f.c. ensures that 13.6 GHz always corresponds to a certain point of the sweep waveform.

The possibility of introducing the modulation by means of a phase modulator in the antenna feed was investigated thoroughly but the power level (7 W) and the bandwidth (1.5 GHz) are prohibitive for a design of a simple low loss modulator. Direct modulation of the

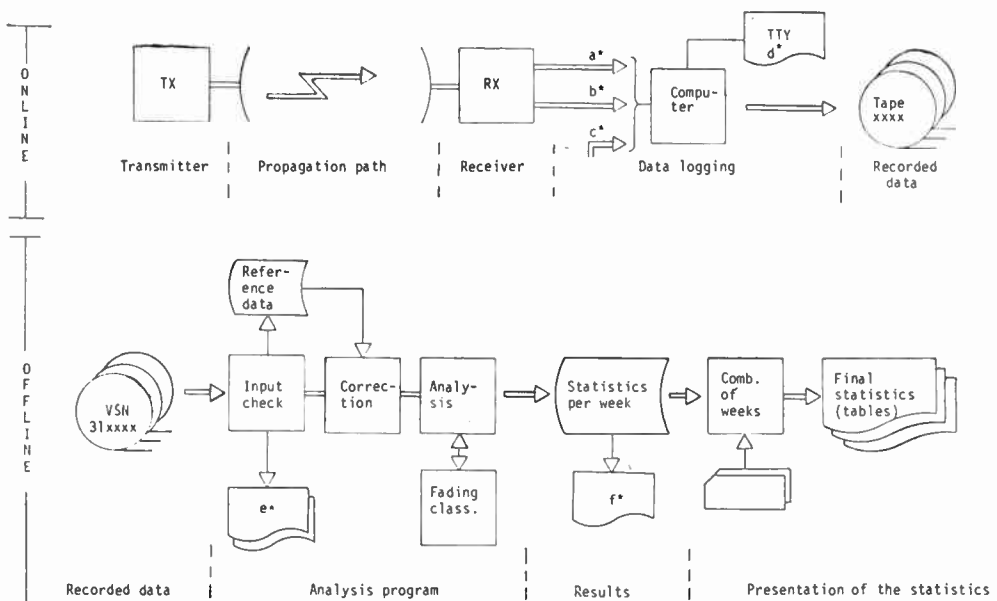

Fig. 3. Schematic diagram of the 13.5-15.0 GHz propagation experiment.

a\*=measured data, b\*=error flags, c\*=time and rain gauge data, d\*=status and error print-outs, e\*=errors and events concerning the on-line part, f\*=condensed statistics per week.

**Table 1**  
System performance

<b>Aerials:</b> 1.2m (4ft) uncovered front-feed parabolic reflectors Nominal gain: 42 dB V.s.w.r. maximum: 1.15	<b>Amplitude measured (13.5-15.0 GHz):</b> Range from nominal: +12 to -60 dB Short-term accuracy at nominal level: ±0.01 dB Absolute accuracy: ±0.5 dB
<b>Feeders:</b> Total loss in filters, isolators and waveguides: 3 dB	<b>Differential phase measured:(10 MHz)</b> Range: +180° to -180° Short term accuracy at nominal level: ±0.1° Equivalent 'delay': ±30 ps
<b>Transmitter:</b> Saturated power output: 10 W Operating power output: 6.5 W Frequency sweep: 13.5-15.0 GHz Frequency of modulation: 10.0 MHz Peak frequency deviation (m=0.1): 1.0 MHz	<b>Differential gain measured: (10 MHz)</b> Range: +14 dB to -6 dB Short term accuracy at nominal level: ±0.01 dB Equivalent 'linearity': ±0.1%  <b>Sample frequencies: (13.5 GHz+n×2.5 MHz)</b> Range: 57 ≤ n ≤ 572 Accuracy: ±50 kHz
<b>Receiver:</b> Nominal received level: -29 dBm A.g.c. dynamic range from nominal: +6 to -60 dB Usable dynamic range from nominal: +12 to -60 dB Noise figure: 10 dB Post-detection bandwidth (-1 dB): 1.0 kHz Frequency lock accuracy (drift and noise): ±50 kHz Acquisition time (+10 to -50 dB level): 25 ms	<b>Data storage on magnetic tape:</b> Bytes per record: 3850 Records per 2400 feet tape reel: 9125 Worst case tape consumption: 1 reel per 2h 32m Typical expected tape consumption: 1 reel per 3 days

carrier oscillator is satisfactory provided all elements in the signal path are carefully matched to avoid multiple reflections. The waveguide run between the amplifier and the antenna is furthermore kept to a minimum by mounting the transmitter directly behind the antenna. The frequency-dependent variations in differential phase still present are mainly caused by the t.w.t. and the feed system of the transmitter antenna.

### 2.2 The Receiver (Fig. 5)

The receiver front end is a crossfield waveguide mixer

that converts the incoming signal to the 140 MHz i.f. The mixer is located immediately behind the feed horn of the antenna. No image rejection is attempted as this is likely to cause substantial ripples of differential phase. The conversion loss and input impedance of the mixer are stabilized by levelling the l.o.-signal to keep a constant rectified current in the mixer diodes. The local oscillator circuit is identical to that of the carrier oscillator.

The 140 MHz main amplifier has a 66 dB a.g.c. range provided by a chain of six identical amplifiers where each

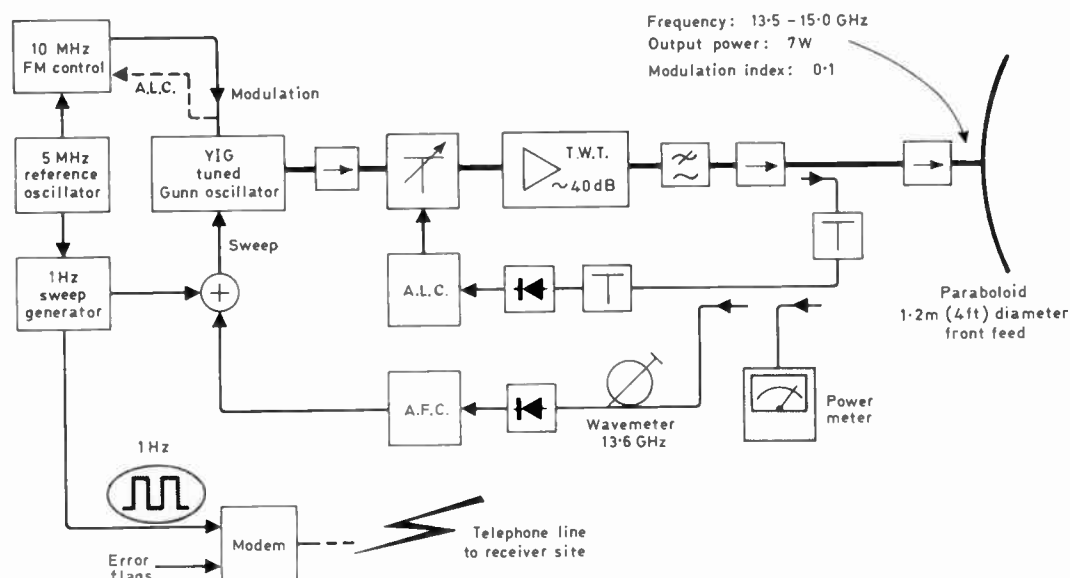

**Fig. 4.** Schematic diagram of the transmitter.

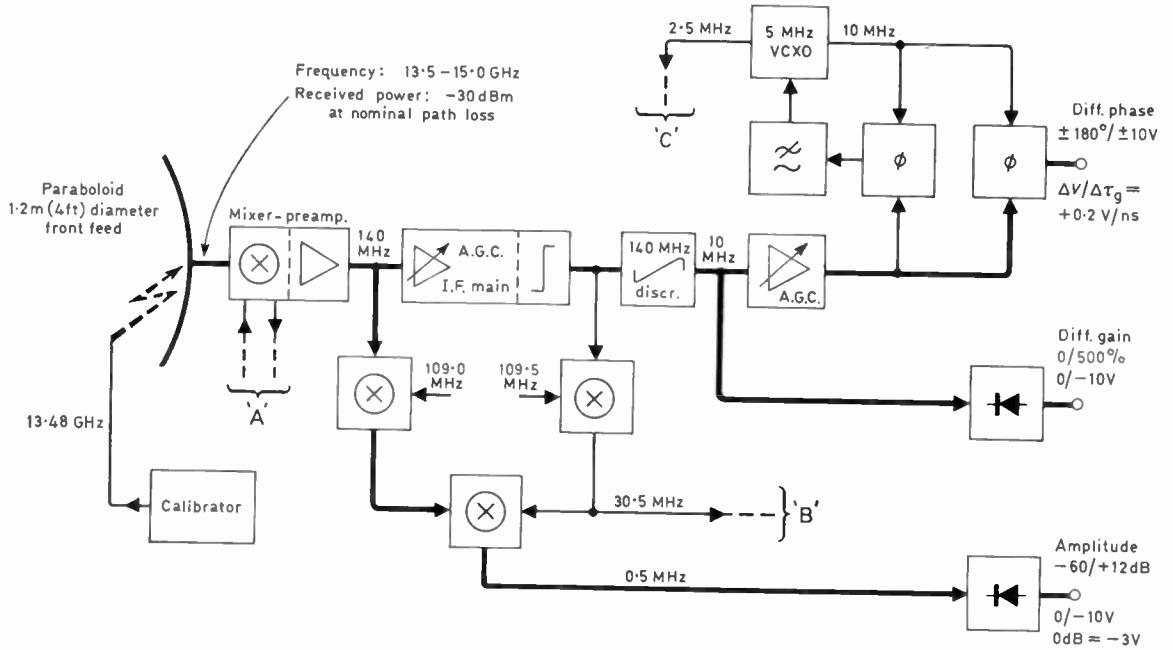

(a) Signal detection system.

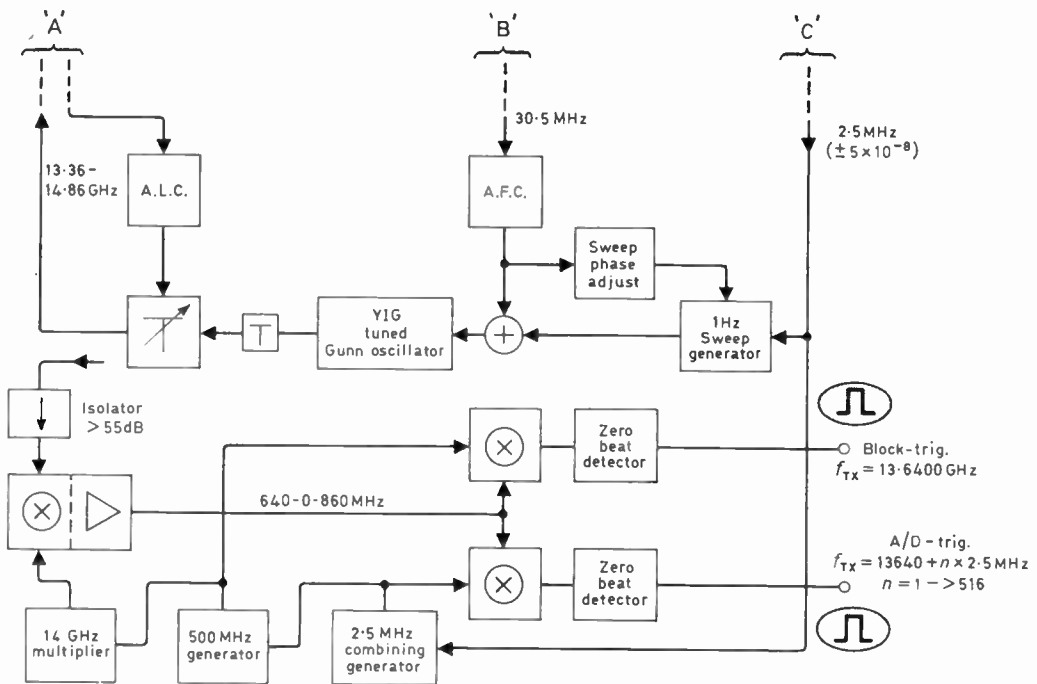

(b) Frequency tracking system.

Fig. 5. Schematic of the receiver.

has its own independent a.g.c. and 11 dB gain range. This distribution of the a.g.c. action gives a fast overall response time.

A part of the i.f.-signal is taken out after the i.f.-pre-amplifier and converted to 0.5 MHz for linear detection of the carrier level. The linear range is limited upwards by the maximum output available from the i.f.-pre-amplifier and downwards by transition to a square root law. This characteristic is introduced to limit the

quantization steps at deep fadings.

The output of the a.g.c. chain is fed to a discriminator that extracts the 10 MHz modulation. The level of the modulation, i.e. the differential gain, is measured by a 10 MHz amplitude detector. The phase of the modulation, i.e. the differential phase, is measured relative to a stable crystal oscillator identical to that of the transmitter. This oscillator is phase locked to the received signal but with such a large time-constant that the

locking does not influence the variations of different phase measured during a sweep.

The temperature drift of all three detectors is kept small by use of oven control of the detecting elements.

The receiver is locked to the frequency of the incoming signal. The frequency correction is automatically minimized by adaptive phasing of the receiver sweep. This ensures minimum outage time if the receiver loses lock during a deep selective fading.

The three measured parameters are sampled at 516 frequencies during the up-sweep. This measuring sequence lasts 330 ms out of the 1 second sweep period. Each of the 516 frequencies is a harmonic of 2.5 MHz and the frequency identification subsystem generates a sampling (a/d-trig) pulse when the transmitted frequency is a multiple of 2.5 MHz. The strict control of the sampling instants eases the requirement for tuning linearity and absolute frequency stability of the microwave oscillators. It enables furthermore a substantial reduction of deterministic errors by off-line correction of the measured data.

### 2.3 The Data-logging System (Fig. 6)

The collecting and recording of data are managed by a minicomputer. Here, data means propagation data, rain-gauge data, time and system status. The time is generated in a separate real time clock equipped with no-break power supply. This is one of the measures taken that enable the entire experiment to recover automatically from all temporary error conditions including power failure. Another of the computer's tasks is to monitor the condition of the measuring system and the rain-gauges via check bits in the data collected and via a number of hard-wired status indicators in receiver and transmitter. The data from the rain-gauges and the status information from the transmitter are collected via

permanently connected telephone lines.

The computer performs a screening of the propagation data such that data from a sweep are recorded subject only to a minimum deviation from the previously recorded data. This procedure extends the measuring period per tape from the minimum 2½ hours to between 12 hours and 14 days. All of the rain-gauge data are arranged in a buffer the contents of which are recorded with the first coming propagation data to be recorded. Every change in system status is recorded immediately together with the latest measured propagation data.

### 3 Data Evaluation

The choice of a sweep rate of one period per second was based on the information available in the literature. Only minor changes in the propagation conditions were expected within a second and virtually no change was expected to occur within the 330 ms it takes to sweep the band 13.6425 to 14.9300 GHz from which the data are recorded. However, the propagation measurements have revealed that this assumption is not always fulfilled during severe fades.<sup>1</sup> Even precipitation fades have been seen to vary several dB during the 330 ms. It would have been possible to design the system for 10 sweeps per second but this would reduce either the dynamic range or the system's ability to respond accurately to selective fading. The actual sweep rate is thus still considered a reasonable choice.

The frequency spacing of 2.5 MHz between the sampling of the propagation parameters and the 1290 MHz true sweep width has proved to be barely sufficient to get the full picture of the situation,<sup>1-3</sup> during severe multipath propagation. The shortcomings caused by the sweep rate, the frequency spacing and the sweep width are only of concern for the analysis of multipath

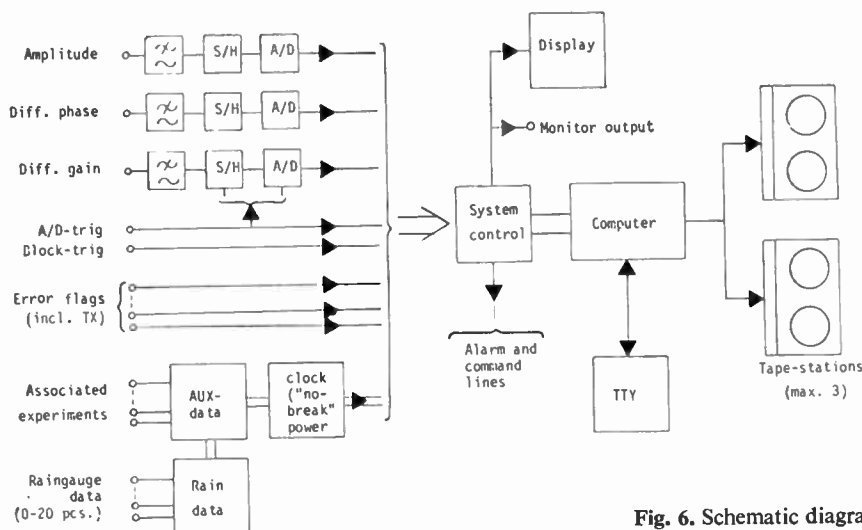

Fig. 6. Schematic diagram of the data logging equipment.

propagation with the intention of determining the actual multipath parameters.<sup>4</sup>

The large number of sampling frequencies was decided upon as a measure for facilitating multipath analysis but it is also used to improve the quality of the basic propagation statistics. This is possible because the distributions of fadings are nearly independent of frequency within the actual band except during extreme precipitation fading. Thus the distributions from many (or all) sample frequencies can be combined for a particular distribution. The uncertainty due to sparse sampling is more or less eliminated, but the uncertainty due to changing meteorological conditions from year to year remains.

The measurements of the three quantities amplitude, differential phase, and differential gain give the complete transfer function of the path. Multipath analysis without the phase information has been reported.<sup>5</sup> Even if the multipath parameters may be calculated at reasonable speed and accuracy from an amplitude sweep, the complete transfer function must be synthesized from the multipath parameters before phase dependent properties such as intermodulation-noise in f.d.m.-f.m. systems may be calculated. When the phase information has been obtained by measurement, the i.m.-noise and the other phase dependent quantities can be calculated directly without involving the multipath parameters.

The dynamic range of the system is from +12 dB to -60 dB relative to nominal, however, with some nonlinearity above +6 dB and in particular above +10 dB. A calibration is used to compensate for the nonlinearities, but the accuracy is reduced at high levels. It should be mentioned that +12 dB levels (or higher) have been recorded several times during the first year of operation. Slow variations of the transmitter level and the receiver sensitivity will change the reference level relative to the nominal level. The computer programs take care of this by using the long-term (several days) running average of the signal level in fading free periods as the signal reference level.

A slight compression of differential gain takes place when the signal level fades below -40 dB relative to nominal due to the onset of the f.m. threshold effects, but it is easy to compensate for this by computation. The f.m. threshold effect becomes pronounced when the signal level fades below -50 dB. In the latter case it is advantageous to reconstruct the differential phase and differential gain. This is done by the use of the shape of the amplitude-versus-frequency curve around the amplitude minimum and based on the assumption that the fading near the minimum may be described by a two-ray multipath model.

The sensitivity and accuracy at nominal level correspond to an equivalent noise level in a 2700 channel f.d.m.-f.m. system (worst channel) well below 10 pWop because the system was designed to cope with prediction of mean noise levels (with reference to CCIR) at very

short path length. Error sources such as phase and amplitude ripples from the system may be totally neglected at the present path.

The three measured quantities are all band-limited before the sampling by post-detection filters. These filters have 1 dB cut-off at 1.0 kHz and a transmission zero at 1.6 kHz. This means that the instantaneous measured values have been measured with an equivalent time constant of approximately 0.15 ms.

Finally it must be mentioned that the sample frequencies are determined with an accuracy of within  $\pm 50$  kHz which is sufficiently good for any of the data to be presented. The high accuracy is required to reduce to the specified level the amplitude and phase noise due to oscillator jitter coupled via transmission line reflections and filter imperfections.

#### 4 The Data Analysis

The off-line part of the experiment as shown on Fig. 3 performs analysis of the recorded data for the purpose of producing standard propagation statistics and detailed supervision (i.e. error analysis) of the running of the experiment. All the propagation data and the rain-gauge data undergo extensive checks to avoid the inclusion of erroneous data in the distributions. The checks are based on the system status data, the timing information data, data check bits and characteristics of the data such as extreme values, abnormal sequences, etc. Propagation data from periods of nearly ideal propagation are used for updating a long-term running average, i.e. the reference data. This average is then subtracted from the measurements to correct for system errors.

The accepted and corrected data are then the basis for the propagation statistics. The distributions produced include i.m.-noise power and total noise power. The noise powers refer to a telephone channel at 10 MHz baseband frequency in a 2700 channel f.d.m.-f.m. system. The thermal noise is set to 20 pWop for carrier levels equal to and above nominal and to increase proportional with the fading depth, i.e. a tenfold increase for each 10 dB fading. All the statistics are prepared for one week of measurements at a time and then stored in a permanent computer file. Statistics for each week can then later be retrieved independently and weeks can be combined at random to obtain statistics for months, seasons, years etc. The basic analysis is run on a routine basis at the computer centre whereas the retrieval and eventual combination of the weekly statistics can be performed via remote terminals.

The ease of access and the flexible choice of timebase are considered important in order to encourage the maximum use of the results of the experiments.

The following statistics are prepared.

##### 4.1 Fading and Noise Statistics

Distributions of (1) multipath fading, (2) precipitation fading, (3) i.m.-noise power (with pre-emphasis), and

(4) total noise power—with separate distributions of instantaneous values, 1 minute mean values and 1 hour mean values for each of the four parameters. The mean values of the fading are in fact the mean values of thermal noise which are reconverted to fading level. These 12 distributions (4 parameters  $\times$  3 mean times) are also produced for each hour in the day.

Distributions of the duration of events (fading and noise bursts) of the four parameters are made. Only events which are entirely contained in periods with valid data contribute to these statistics.

All distributions in this group are based on data from 125 frequencies spaced at 10 MHz intervals over the sweep band.

#### 4.2 Frequency Diversity Statistic

Frequency diversity based on simple jumps between frequencies is simulated with three different sets of criteria for jump. The channels are arranged in a  $n+1$  pattern, which means  $n$ -traffic channels with one stand-by channel. Ten different  $n+1$  patterns ( $4 \times |1+1|$ ,  $2+1$ ,  $\dots$ ,  $7+1$ ) are simulated for each set of criteria. Distributions of the instantaneous values of total noise power are generated for each of the  $n$ -traffic channels in the  $n+1$  pattern together with the average of the same distributions from the  $n+1$  frequencies. Also the number of jumps are counted for each traffic channel. Separate statistics are created from periods with multipath propagation and from periods with precipitation attenuation.

#### 4.3 Precipitation Statistics

Distributions of precipitation intensity with 0.5, 5 and 50 minute mean values are prepared for each rain-gauge connected to the data-logging equipment. A distribution of the duration of the events at the different intensity levels and a distribution of amount of precipitation versus precipitation intensity are also made.

The individual showers are classified into 26 groups (light rain, rain, dry and/or wet snow, with or without hail, etc.) based on additional information from the rain-gauges. However, the validity of this classification has not been fully tested yet.

Tables of the total amount of precipitation per rain-gauge per day are prepared for comparison with standard meteorological observations.

#### 4.4 Other Statistics

Distributions of fading rate from multipath propagation and from precipitation attenuation are created separately based on data from three frequencies with 425 MHz spacing. Distributions of differential phase and differential gain at all 516 frequencies are produced.

A distribution of the relative amplitude and delay in a synthetic two-ray propagation is made. Data are derived solely from the variations of the amplitude vs. frequency where each distinct dip is supposed to originate from a

two-way propagation. The multipath parameters are derived from the shape of the amplitude at and in the vicinity of the dip.

The sweep is divided into eight sections and distributions of instantaneous total noise power are prepared for each section for periods with multipath propagation and for periods with precipitation fading.

### 5. Classification of Fadings – Multipath vs. Precipitation

For the interpretation of the measured data it is important to be able to separate the influence of multipath propagation from that of the precipitation. Therefore, it was decided to include an automatic classification feature in the computer programs for the analysis.

The classification requires two steps—the proper demarcation of a fading period and the classification of data from the period. In this analysis only two classes are considered—namely multipath propagation and precipitation fading. Fading activity is assumed to be present if more than three cases of fading  $> 5$  dB or up-fading  $> 1$  dB have occurred within the last 45 minutes. Data from periods without noticeable fading deeper than 5 dB are classified as multipath.

The classification is based on the following data:

1. The two-dimensional distribution of the peak-peak amplitude and the corresponding value of maximum fade depth—one set per sweep.
2. The two-dimensional distribution of the slope of differential phase v. frequency compared with the corresponding value of maximum fade depth—one set per sweep.
3. Number of seconds with up-fading.
4. Number of seconds with precipitation on any of the rain gauges situated in the vicinity of the propagation path.

The data in 1 and 2 are taken as measures of the selectivity of the propagation. An example of peak-peak amplitude versus maximum received level is shown in Fig. 7(a). Every plotted point indicates that one or more sweep during that particular fading period has had such a combination of peak-peak amplitude versus minimum level. The number of sweeps is indicated by the letter, i.e. A = 1, B = 2, etc. Figure 7(c) shows the presentation of similar data but for a period with precipitation fading. The difference between the two propagation phenomena is fairly clear with this presentation. The degree of selectivity is quantified by the slope of the best fitting linear regression.

The correlation between the slope of the differential phase and the minimum received level is presented in Figs. 7(b) and 7(d) for multipath and precipitation respectively. These examples show that precipitation fading does not cause differential phase variations apart from those due to the thermal noise. The degree of

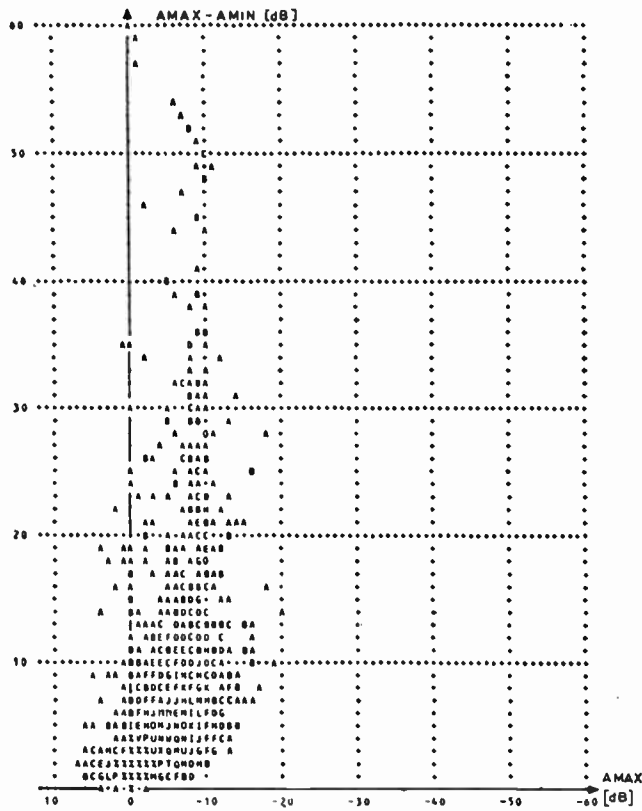

(a) Amplitude scattergram—multipath.

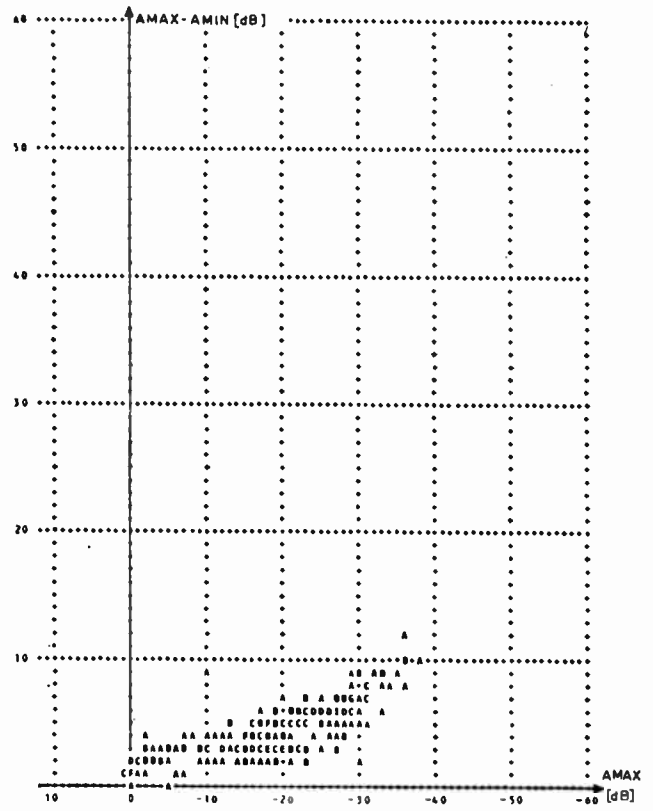

(c) Amplitude scattergram—precipitation.

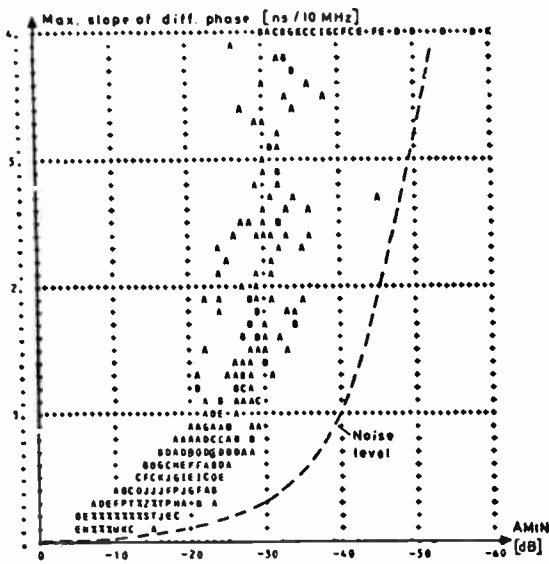

(b) Differential phase scattergram—multipath.

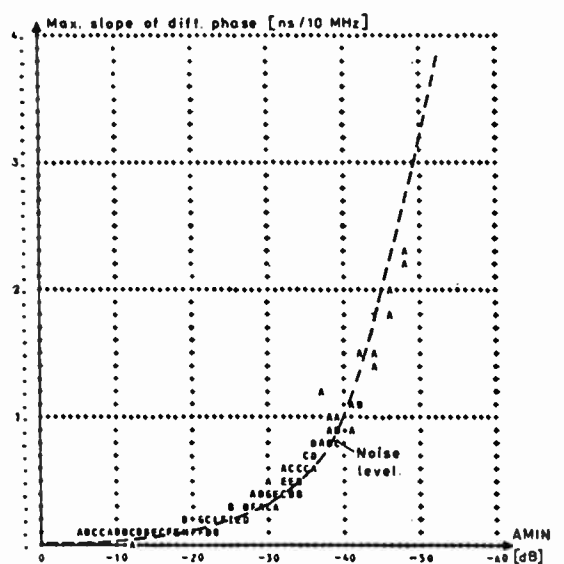

(d) Differential phase scattergram—precipitation.

Fig. 7.



**Table 2**

Classification of fading periods, July 1974-July 1975.

Fading type	I	II	III	IV
No. of cases:	90	24	37	94
Total duration (hours):	199.2	50.9	85.3	621.1
Average duration (hours):	2.2	2.1	2.3	6.7
% of classified time:	20.6	5.3	8.9	65.2

I: Definitely precipitation  
 II: Probably precipitation  
 III: Probable multipath  
 IV: Definitely multipath

selectivity is here quantified by the quadratic regression curve.

The four types of data used for the classification are continually updated during the fading period and at the end of the period used in a pattern recognition algorithm which finally yields the classification. Based on 50 representative test examples it is concluded that the classification is correct for more than 80% of all fading periods (> 5 dB fade) and it is nearly 100% correct for periods where deep fadings (> 20 dB) occur. The results of the classification for the period July 1974-July 1975 are given in Table 2.

Two examples of classification are reported in the literature. However, they cannot be directly compared with the results shown above since in Ref. 6 a large part of the fading periods are left unclassified and in Ref. 7 no information is given about the criteria for the classification at all.

**6. Calculation of the Intermodulation Noise**

Several methods for calculating i.m.-noise in a f.d.m.-f.m. system have been published—but only the most

**Table 3**

The overall accuracy of the determination of the intermodulation noise.

Fraction (%)	1	5	50	95	99
Deviation (dB)	+2.5	+0.5	-1	-3	-4

fundamental work<sup>8,9</sup> is suitable in the actual case. The reason is that the measured values of amplitude and differential phase both may show large non-linearities and these are in conflict with the basic assumptions for most of the published methods.

A new expression was derived from equations (22) and (23) of Ref. 8. The relative contribution from the individual parts in the new expression was investigated by means of a Monte Carlo simulation of the multipath propagation and afterwards all insignificant parts were removed. The shape and the magnitude of the calculated distortion spectra are in agreement with the spectra published in Ref. 10.

The accuracy of the reduced expression was tested on a computer model of the equipment including level dependent thermal noise and quantization errors. This test was also based on a Monte Carlo simulation of the multipath propagation. The accuracy was investigated by comparing the i.m.-noise based on the simulated measurements and calculated by the reduced expression with the i.m.-noise based on the known multipath data and calculated by the complete expression. The deviations of the simulated values from the 'true' values are shown in Table 3.

**7. Examples of Statistics**

A number of propagation statistics are presented in Figs. 8 to 15. The measuring period is July 1974-July 1975 (year 74/75) for all but Fig. 9.

Fig. 8. Fading and intermodulation noise. Year 1974/75.

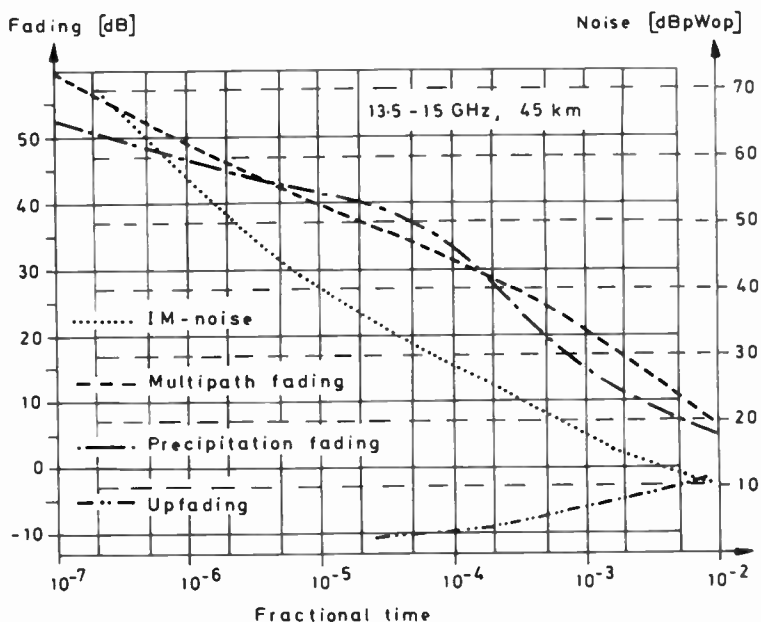

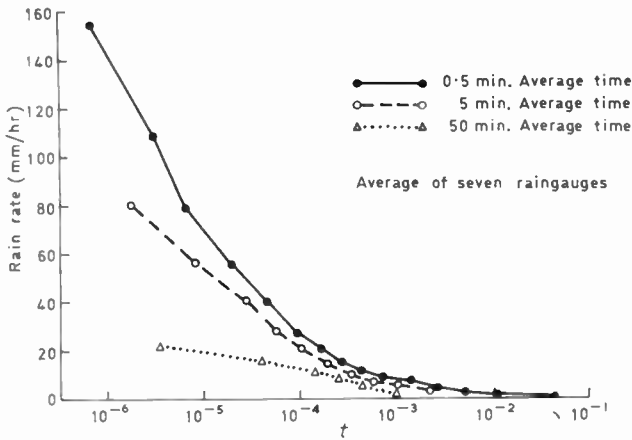

Fig. 9. Cumulative distribution of rain rate.

The distributions of fading and i.m.-noise are given in Fig. 8. The amount of multipath fading is fairly equal to the fading caused by precipitation. This characteristic holds for later periods of measurements also. The multipath propagation also causes significant increase in the received level (i.e. up-fading). Levels up to +12 dB relative to nominal have been measured and levels of +7 dB were present 0.1% of the time. The distribution of i.m.-noise shows that the thermal noise (i.e. fading) is the dominant factor. It must however be remembered

that the i.m.-noise is very dependent on the actual multipath delays occurring on a path such that the present may not be directly applicable for say an over-water path. An example of annual rain rate distributions for the area is given in Fig. 9. The distributions cover the period November 1974–October 1975 because all the rain gauges were not in operation before November 1974. The data are mainly included as they are very representative for the average conditions in Denmark.<sup>11</sup>

The variation of fading versus frequency is assessed by dividing the sweep into eight slots and producing separate statistics for each slot. The distributions are actually for total noise power but they can be interpreted as well as fading since the i.m.-noise is small compared to the thermal noise. Figures 10(a) and (b) show the frequency dependence for multipath and precipitation respectively by giving the fractional time for every full 5 dB. The probability of multipath fading is approximately proportional with frequency which is in agreement with the theory presented in Ref. 12. The frequency variation of the precipitation fading agrees with the published theories (e.g. Ref. 13) which predict that the attenuation in dB is proportional to the square of the frequency in the 10–20 GHz range.

The diurnal variation of fading is evaluated by producing an average distribution for each of the 24 hours of the day. The results for multipath and precipitation

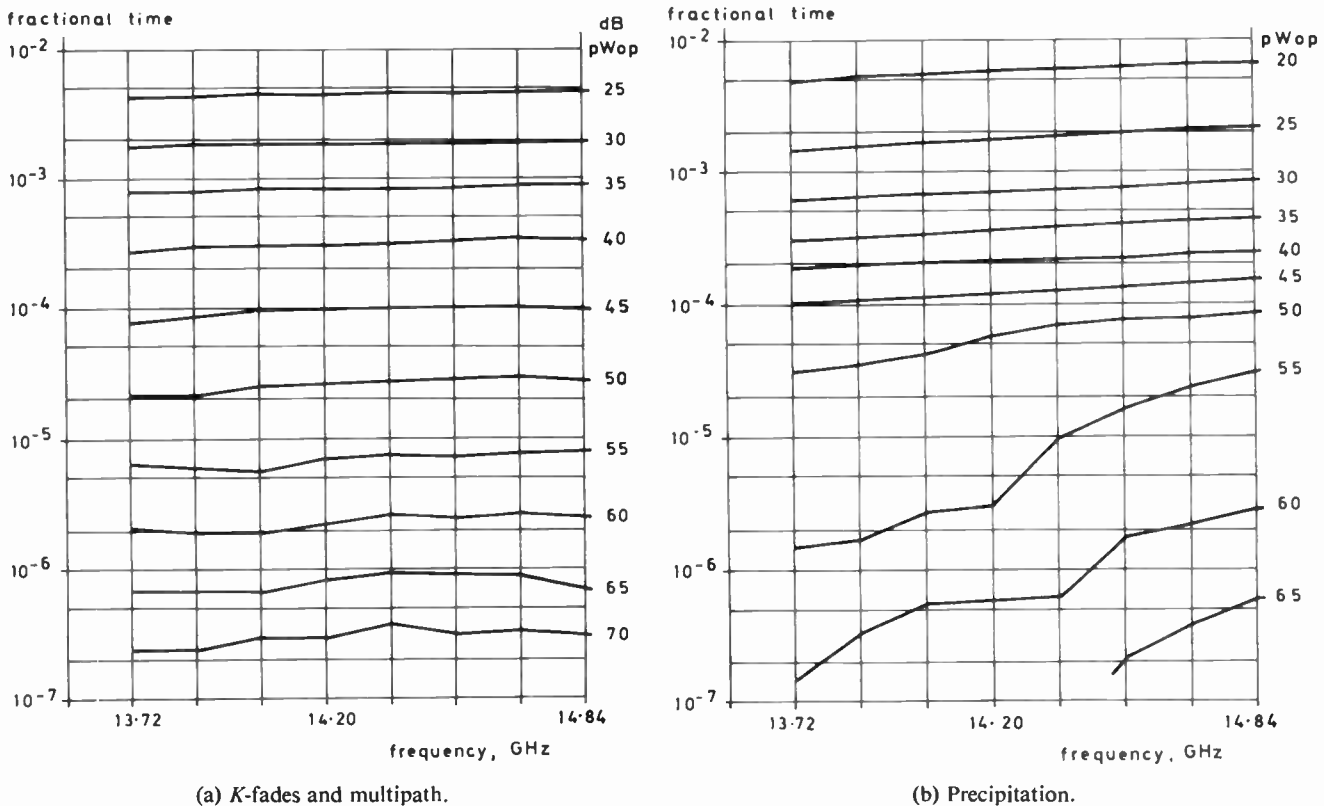
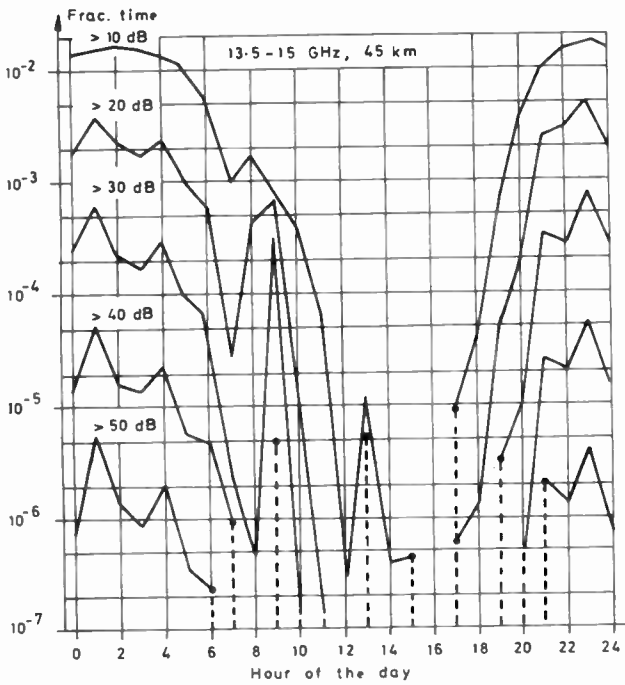
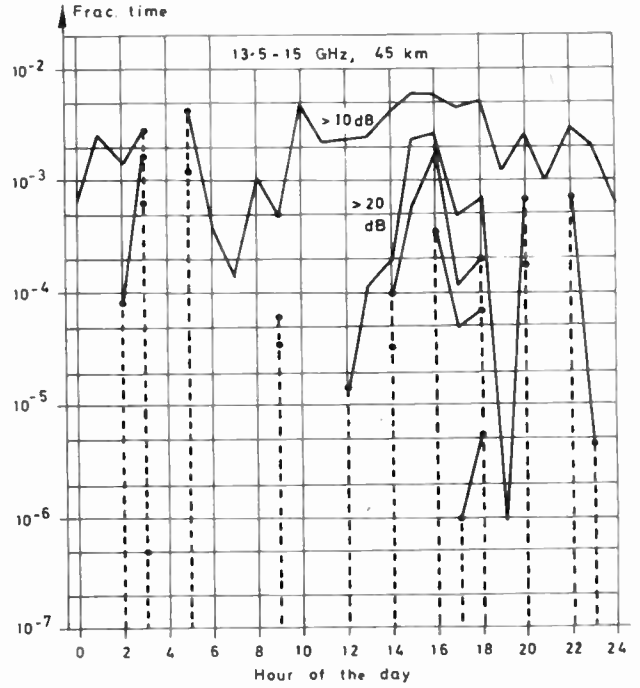

Fig. 10. Total instantaneous noise vs. frequency. Year 1974/75.



(a) Multipath fading.



(b) Precipitation fading.

[Fig. 11. Cumulative distribution of instantaneous values of diurnal variations Year 1974/75.

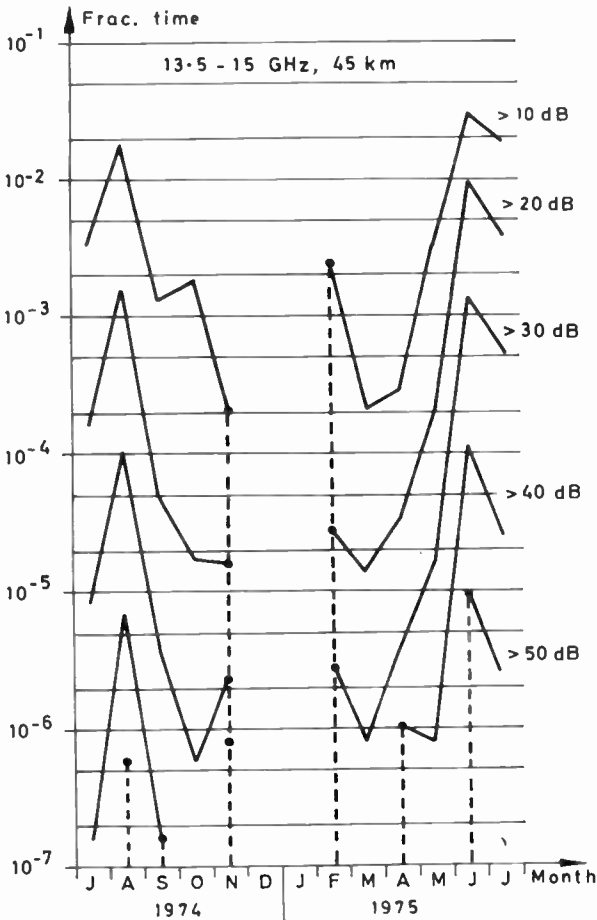

(a) Multipath fading.

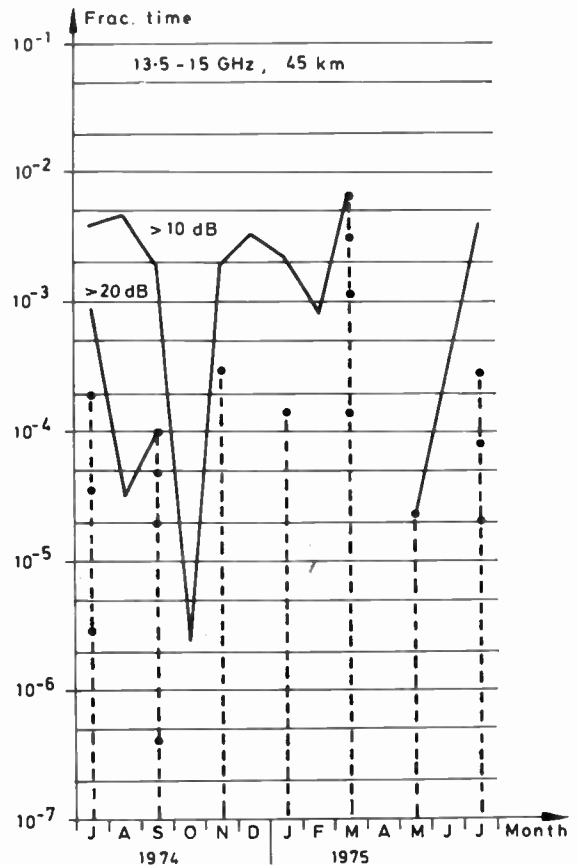

(b) Precipitation fading.

Fig. 12. Cumulative distributions of instantaneous values of monthly variations. (10 dB step).

are shown in Figs. 11(a) and (b) respectively. The graphs show the fractional time for every full 10 dB of fading. A level is represented with a dot and connected to the x-axis by a vertical dashed line if it is not present in both the preceding and the succeeding hours. The same presentation is used in Figs. 12 and 15. The multipath propagation is most frequent between sunset and sunrise as it was expected for an over-land path where multipath is likely to be caused mainly by atmospheric inversions. A part of the peak around 9 hours has been traced to an incident where the atmospheric conditions supporting multipath propagation around and after sunrise developed into showery weather. The intermediate period without fading was in this case not long enough for the classification procedure to be able to separate to two periods of fading.

The diurnal variation of precipitation fading exhibits increased probability in the afternoon. This is in agreement with the diurnal variation measured by long-term rain-gauge measurements.<sup>14</sup>

The monthly variation of fading is shown in Figs. 12(a) and (b). It is noteworthy, that appreciable multipath propagation occurred in February during a period with calm and frosty weather. The extreme precipitation attenuation in March is caused by a single occurrence of wet snow.

A rarely published parameter is the fading rate which indicates how fast the received level changes. The recorded values shown in Fig. 13 are entirely due to multipath propagation. The distribution is likely to underestimate the fading rate since it is determined by taking the amplitude variation over a period of one second.

The figure of main interest for the radio circuit designer is the total noise power in a telephone channel. Figure 14 shows distributions of noise power for

integration times of 1 second, 1 minute and 1 hour. The monthly distributions for 1 minute and 1 hour integration are given in Figs. 15(a) and 15(b) respectively.

### 8. Comparison with CCIR Rec. 395-1

This Recommendation specifies three quality criteria for circuits established over real links of length  $L$  ( $50 \text{ km} < L < 840 \text{ km}$ ).

1: Not to exceed more than  $3 \times L + 200$  pWop noise power in any hour.

It is commonly agreed that this criterion—which is inherited from the cable circuits—cannot be fulfilled in a radio link. Figure 15(b) confirms this point of view.

2: Not to exceed more than  $3 \times L + 200$  pWop one-minute mean power for more than 20% of any month.

In the actual circuit noise power loss of only  $2 \times L$  pWop = 100 pWop should be allowed for the propagation since a suitable amount of the noise power must be reserved for the radio equipment. According to Fig. 15(a), the level of 100 pWop = 20 dB pWop is not exceeded in more than 6% of any month.

3: Not to exceed more than 47500 pWop one-minute mean power for more than 0.011% of any month.

According to Fig. 11 this is not fulfilled in March and June–July (1975). In March the reason is the above-mentioned event with wet show. Based on the information given in Ref. 15 it is reasonable to claim that protection of the antennas will resolve most of the problem.

The fading activity in June and July is dominated by multipath propagation. The use of some kind of diversity may reduce the percentage of time with that noise level to at least one order of magnitude. In this case the performance criterion will be fulfilled.

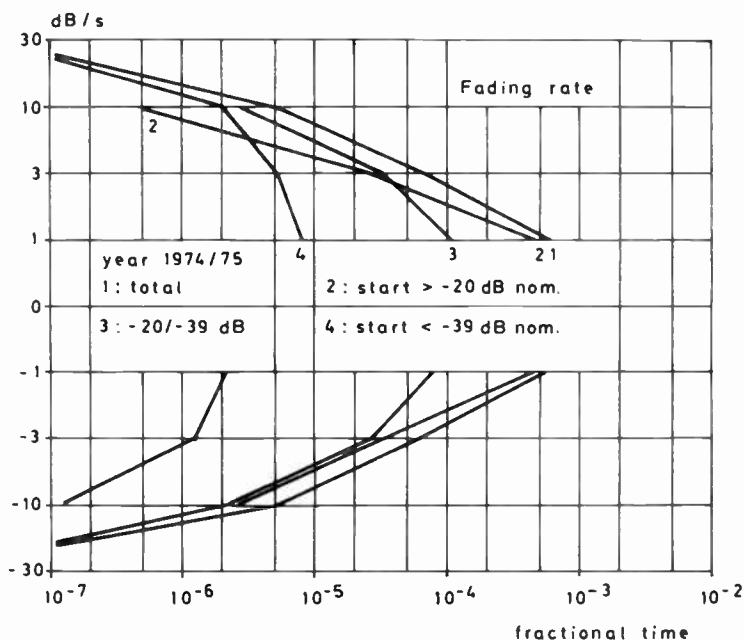

Fig. 13. Fading rate. Year 1974/75.

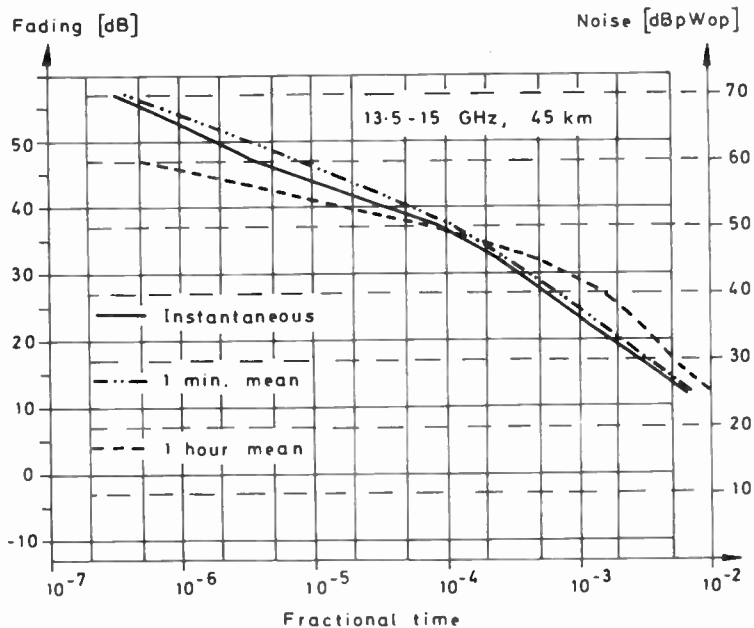
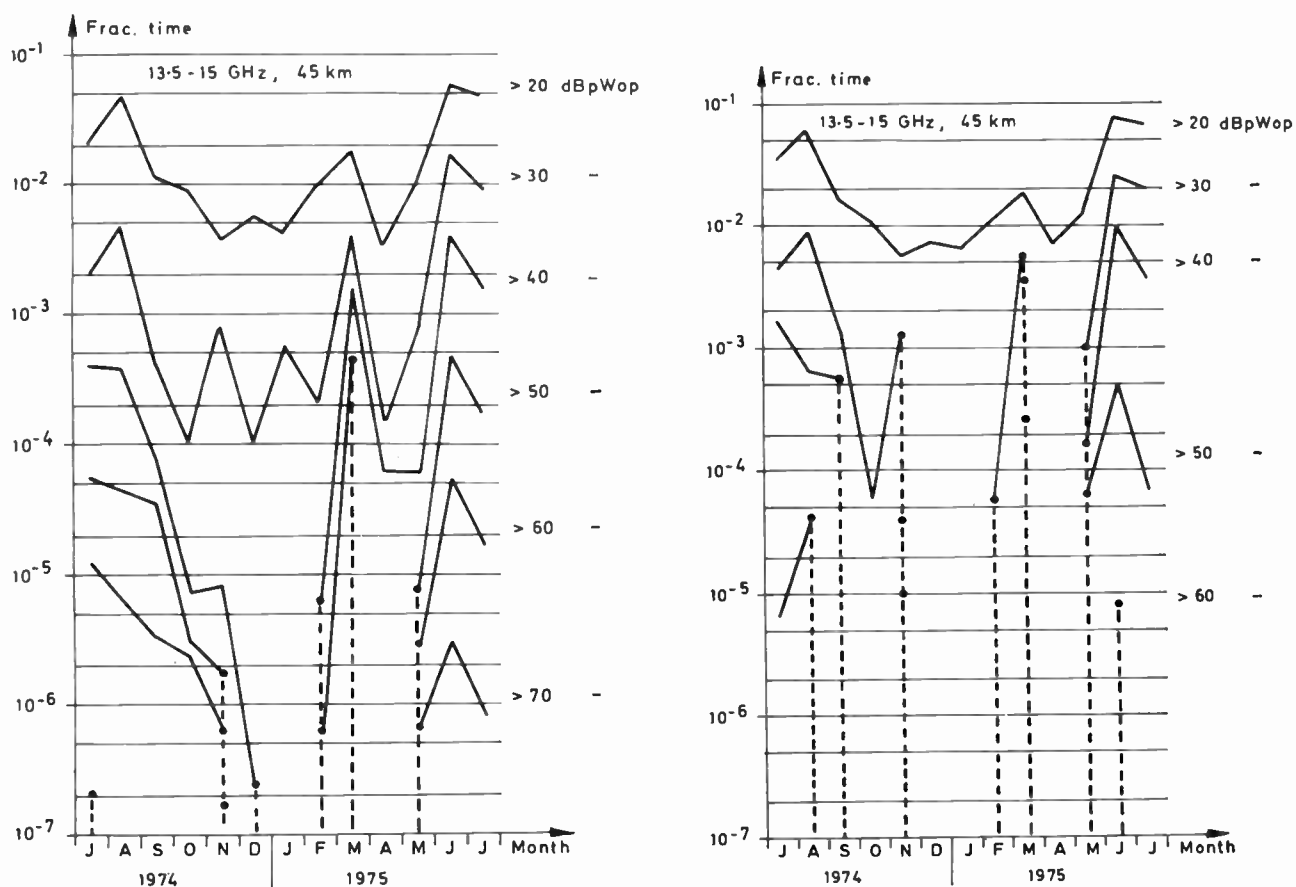

Fig. 14. Total noise (or fading). Year 1974/75.

9. Applications of the Measured Data

The examples of propagation data shown are mainly concerned with f.d.m.-f.m. radio systems. The statistics

prepared can, however, be applied in many different ways and two special investigations have hitherto been carried out. The first one<sup>16</sup> deals with the level dependence



(a) Cumulative distributions of 1 min. mean values (10 dB step). (b) Cumulative distributions of 1 hour mean values. (10 dB step)

Fig. 15. Monthly variation of total noise power.

of multipath fading, i.e. the probability of fading, the number of fades and the durations of fades. The number and the duration show a distinct difference from previously published results for 4, 6, and 11 GHz in that the level dependence is different and that the duration of the fades are much shorter at 14 GHz than estimated from the measurements at lower frequencies.

The second investigation concerns the possibility of predicting precipitation fading from point measurements of precipitation. The concurrent measurements of fading and precipitation in this experiment constitutes an ideal test case for estimation of the various prediction methods published. Nine prediction methods have been estimated by means of data from two summer periods.<sup>17</sup> The best prediction was given by taking the distribution of rain rate with 50 minutes integration time as an estimate of the path average rain rate from which the fading was calculated.

The measured propagation data can, however, supply more information than that extracted by the currently implemented analysis program. The reason is that the three parameters—amplitude, differential phase and differential gain—contain sufficient information to enable a complete description of propagation path in terms of its complex transfer function.<sup>18</sup> This description facilitates, for example, a more straightforward derivation of multipath parameters than has been possible with previous experiments. This course has been pursued successfully and the outcome is an automatic analysis that yields multipath delays with a resolution of better than 0.1 ns. Distortion in digital communication systems may be derived either from the complex transfer function directly or from the various multipath components.<sup>19</sup>

## 10. Conclusion

The measurement system which has been developed by the Electromagnetics Institute and the Danish Post and Telegraphs has collected a large amount of unique data. These data have already proved valuable. New knowledge has been obtained on subjects such as intermodulation distortion due to multipath propagation, instantaneous noise distributions, the influence of precipitation (including wet snow) on microwave propagation, methods for classification of fadings, diurnal and monthly variations of fadings, etc. One important conclusion is that the Danish climate appears to permit microwave links at 14 GHz with much longer path lengths than expected.

The measured complex transfer functions are stored on magnetic tape in a form which is easily accessed by a computer. This means that the influence of the propagation on communication systems with virtually any modulation scheme may be predicted without the need for new measurements.

## 11. References

- 1 Mogensen, G., 'Analysis of 13.5–15 GHz amplitude and phase propagation data', Symposium on 'Problems of Space and Terrestrial Microwave Propagation', (Austria, April 1975) ESA SP 113, pp. 257–63, May 1976.
- 2 Babler, G. M., 'A study of frequency fading for a microwave line-of-sight narrowband radio channel', *Bell Syst. Tech. J.*, **51**, no. 3, pp. 731–57, March 1972.
- 3 Subramanian M., *et al.*, 'Phase dispersion characteristics during fade in a microwave line-of-sight radio channel', *Bell Syst. Tech. J.*, **52**, no. 10, pp. 1877–1902, December 1973.
- 4 Sandberg, J., 'Multipath parameters from swept measurements', URSI Symposium on 'Propagation in Non-ionized Media', La Baule, France, 28th April–6th May, 1977.
- 5 Tattersall, R. L. O., Barnes, B. C. and Cartright, N. E., 'Multipath transmission test at 11, 20, and 37 GHz', Conference on 'Propagation of Radio Waves at Frequencies above 10 GHz', IEE Conference Publication no. 98, p. 65 and Authors' Supplementary Notes, p. 5, London, April 1973.
- 6 Turner, D., Easterbrook, B. J. and Golding, J. E., 'Experimental investigation into radio propagation at 11.0–11.5 Gc/s', *Proc. Instn Elect. Engrs*, **113**, no. 9, pp. 1477–89, September 1966.
- 7 Rooryck, M. and Battesti, J., 'Etude experimentale d'une liaison a 13 GHz sur 53 km', Symposium on 'Problems of Space and Terrestrial Microwave Propagation', Graz, Austria, 7th–9th April, 1975. ESA publ. SP 113, pp. 217–27.
- 8 Liou, M. L., 'Noise in an fm-system due to an imperfect linear transducer', *Bell Syst. Tech. J.*, **45**, pp. 1537–61, November 1966.
- 9 Cross, T. G., 'Intermodulation noise in fm systems due to transmission deviations and am/pm conversion', *Bell Syst. Tech. J.*, **45**, pp. 1749–73, December 1966.
- 10 Garrison, G. J., 'Intermodulation distortion in frequency-division-multiplex fm systems—a tutorial summary', *IEEE Trans. on Communication Technology*, COM-16, no. 2, pp. 289–303, April 1968.
- 11 Mogensen, G., 'Evaluation of rain data from pluviograph recordings', Electromagnetics Institute, Technical University of Denmark, Lyngby, R 97, September 1971.
- 12 Ruthroff, C. L., 'Multiple-path fading on line-of-sight microwave radio systems as a function of path length and frequency', *Bell Syst. Tech. J.*, **50**, no. 7, pp. 2375–98, September 1971.
- 13 de Bettencourt, J. T., 'Statistics of millimeter-wave rainfall attenuation', *J. Rech. Atmos. (France)*, **8**, no. 1–2, pp. 89–119 Jan–June 1974. (189 refs.).
- 14 Dansk Ingeniørforening, Spildevandskomiteen, skrift nr. 4: 'Nedbørens fordeling efter intensitet' (Teknisk forlag, København, 1953/69).
- 15 Tattersall, R. L. O., 'Snow fading on 1 March 1974 on microwave links in the Mendelsham propagation experiment', *Electronics Letters*, **11**, no. 24, pp. 603–5, 27th November 1975.
- 16 Stephansen, E. T. and Mogensen, G. E., 'Experimental investigation of some effects of multipath propagation on a line-of-sight path at 14 GHz', *IEEE Trans. on Communications* (to be published).
- 17 Mogensen, G. and Stephansen, E., 'An estimation of methods for prediction of rain induced attenuation on l.o.s. paths', International Conference on Antennas and Propagation, London, 28th–30th November 1978.
- 18 Mogensen, G., 'Improved data for propagation analysis', AGARD Conference on 'Telecommunications Aspects of Frequencies between 10 and 1000 GHz', Gausdal, Norway, 18th–21st September 1972. AGARD Conf. Proc. no. 107, ref. 11.
- 19 Sandberg, J., 'Multiparameters and multipath propagation related to psk communication', Electromagnetics Institute, Technical University, Lyngby, LD 34, June 1978.

*Manuscript first received by the Institution on 13th January 1978 and in revised form on 18th September 1978. (Paper No. 1867/Comm.176).*

# A 1.1 to 2.4 GHz transistor amplifier with low noise figure and good power match

S. K. SALMON, B.Sc.\*

*Based on a paper presented at the IERE Conference on Radio Receivers and Associated Systems held at Southampton from 11th to 14th July 1978.*

## SUMMARY

A potentially low cost amplifier module has been made using transistor chips with thin film, beam lead or chip components in a hybrid microwave integrated circuit.

The design of this amplifier demonstrates a technique which has been devised to obtain input power match with minimum noise figure. This uses feedback to achieve the power match whilst maintaining, at the transistor input terminals, the source impedance required for minimum noise figure. The amplifier uses transistor chips from low-noise 'slices' of the Mullard BFR90, which, without feedback, would give a mismatch (v.s.w.r.) of  $>3:1$ .

Over a bandwidth of 300 MHz, centred on 1.5 GHz, the coincident conditions have been achieved, resulting in an amplifier noise figure of 3.5 dB and input v.s.w.r.  $<1.25:1$  for 50 ohm source. The gain of the two-stage matched amplifier is between 16 and 12 dB from 1.1 to 2.4 GHz.

## 1 Introduction

It is anticipated that by the 1980–85 period the demand for more communications channels will bring an expansion of 'traffic' in the 1–2 GHz frequency band. Receivers in this band for systems such as microwave links and communications and navigation via satellite will often benefit from low-noise pre-amplifiers.

Cheap broadband amplifier modules exist for frequencies below 1 GHz but the lowest noise figures do not appear to be compatible with low cost. This paper describes work aimed at a basically low cost amplifier module with optimum noise figure and good input match over as broad a frequency band as possible centred on 1.5 GHz. The coincident conditions were achieved by the use of feedback.

The plastic encapsulation of many transistors limits the performance due to the internal lead configuration. Since microwave packages are expensive, any cheap and small amplifier module will, almost certainly, use transistor chips with thin film, beam lead or chip components in a hybrid microwave integrated circuit (m.i.c.). The amplifier, later described, is of this form. It has not, yet, been developed to production standards.

## 2 Specification and Design Compromises

### 2.1 Input Requirements

Minimum noise figure and good input power match to the source impedance are the usual requirements. The source impedance which results in minimum noise figure is not, in general, the same for minimum reflection, i.e. the power matched condition. For some systems power match is not necessary and a simple input circuit for minimum noise figure is possible. One method that has commonly been used to satisfy both requirements is to use two identical amplifiers in a balanced arrangement with 3 dB,  $90^\circ$  couplers at input and output.<sup>1,2</sup> Briefly, this arrangement consists of a 3 dB coupler to split the input into two equal amplitude signals which are separately amplified and then recombined in a similar coupler at the output. The advantage of this approach is that the input circuit to each amplifier needs then to be designed only for minimum noise figure over a bandwidth extending to at least 1 GHz (e.g. 1–2 GHz). The input reflections, if similar, will be absorbed in the load on the fourth port of the input coupler. The disadvantage is the need for two couplers and amplifiers. The alternative is to use feedback on the transistor to improve the input match whilst maintaining the minimum noise figure. A noise figure approaching the minimum together with an input v.s.w.r., relative to 50  $\Omega$ , of  $<1.25:1$  has been achieved over a band of approximately 300 MHz centred on 1.5 GHz. Optimum source impedance and low input v.s.w.r. were theoretically shown to be possible over a wider bandwidth by the use of both shunt and series negative feedback but with such a circuit the first-stage gain was so low (4 dB) that the overall amplifier noise figure would be high.

\*Philips Research Laboratories, Redhill, Surrey, RH1 5HA.

## 2.2 Gain–frequency Response and Output Match

It is important to distinguish between the needs for a flat gain response and lack of dispersion. If very simple broadband circuits are used then dispersion can be minimized. For most narrowband communication systems a pre-amplifier need not have a flat broadband gain response. Silicon bipolar transistors have an available gain which decreases at approximately 6 dB per octave. Various methods can be employed to compensate this fall in gain. One commonly used is to mismatch the interstage circuit at low frequencies so that the maximum gain will only be achieved at the highest frequency. One disadvantage of this approach for a two-stage amplifier is that all the compensation must be in the interstage circuit and therefore the contribution to the noise figure from the second stage will be far from optimum at low frequencies. A second disadvantage is that transistor feedback can have greater effect on the input v.s.w.r. when its load is mismatched. An alternative method is to provide frequency dependent attenuation in the output and interstage circuits, which are then ideally designed to have zero loss at the highest frequency and also provide output terminal match. In addition, the interstage circuit can provide optimum source impedance for minimum second-stage noise figure. Simple shunt circuits with these attenuation characteristics have been evolved in the designs of the L-band amplifier and i.f. amplifiers at u.h.f. for 12 GHz television receivers.

The L-band amplifier, later described, has two stages and it was not possible to provide other than a falling gain response without compromising the design for minimum noise figure and input and output power match. The gain was typically 16 dB from 1.1 to 1.5 GHz, then decreasing steadily to 12 dB at 2.4 GHz.

For a flatter gain response either:

- (a) Three stages would be required. For many systems the additional pre-amplification given by three stages would unacceptably reduce the dynamic range; or
- (b) A pair of two-stage amplifiers, designed only for minimum noise figure and a flat gain response, could be used in the balanced arrangement, which also gives a good output match. A balanced amplifier approach is not incompatible with a microstrip circuit since interdigitated Lange couplers<sup>3</sup> can be used.

## 3 Characterization of Transistor Chips

The Mullard BFR90 range of transistors has been in production for several years but is sufficiently close to the state of the art that it is representative of conventional silicon bipolar transistors with arsenic doped emitters. Chips, from slices of BFR90 transistors with low noise figure, were eutectically bonded to 50 Ω gold-plated microstrip lines on alumina substrates. A double emitter bond lead to adjacent earthing posts kept common lead inductance to 0.17 nH. For the microwave package of the BFR49 the minimum inductance of the double lead

Table 1

Frequency GHz	$Z_s$ , normalized to 50 Ω	Noise figure dB
1.3	0.68 + j0.28	
1.5	0.75 + j0.18	2.4 ± 0.2
1.7	0.74 + j0.11	
2.0	0.73 - j0.13	4.0 ± 0.4

is approximately 0.35 nH and for the normal BFR90 it is 2 nH. In the final amplifier configuration a single bond lead to a microstrip line was used when feedback was required to be generated in the common emitter circuit.

The source impedance for minimum noise figure was measured with an Ailtech noise figure indicator, type 75, with which the noise figure was continuously monitored. The optimum measured source impedances ( $Z_s$ ) for BFR90 chips, at  $I_c = 5$  mA and  $V_{ce} = 5$  V, are given in Table 1. The reference plane for the measurements was the end of the 50 Ω transmission line to the input base terminal.

It was estimated that a multistage amplifier could be made with a noise figure of 3.0 to 3.5 dB at 1.5 GHz.

The S-parameters were also measured for use in the amplifier design.

## 4 Amplifier Design

### 4.1 General Approach

The maximum available gain for the BFR90 chip was predicted to be approximately 19 dB at 1 GHz and 12 dB at 2 GHz. Realizable gain is nearer 10 dB in a broadband amplifier with an ideally flat gain characteristic and so two stages are required for a pre-amplifier module.

A simple input circuit was designed using Smith chart manipulation to provide the optimum source impedance for minimum noise figure. From a simple equivalent circuit of the transistor output admittance a load circuit was designed for the transistor chip. This single-stage amplifier was analysed and an input v.s.w.r. of between 3 and 4 : 1 was predicted. The input impedance of the transistor was too low for power match with the input circuit for optimum noise performance (Fig. 1). Series-derived feedback using an uncoupled emitter inductance of 1 nH was predicted to give the right order of increase (Fig. 2). The input circuit was re-optimized to provide the required source impedance to the emitter/base terminals. One of the effects of the feedback is that all parts of the circuit become interdependent and satisfactory design for a multistage cascaded amplifier can only be accomplished by optimization of the components of a complete amplifier.

The two-stage amplifier was designed by cascading the single matched stage with a basically similar one but with reduced feedback to give more gain. By cascading with a second stage which had a source impedance approaching optimum it was thus aimed to produce the minimum



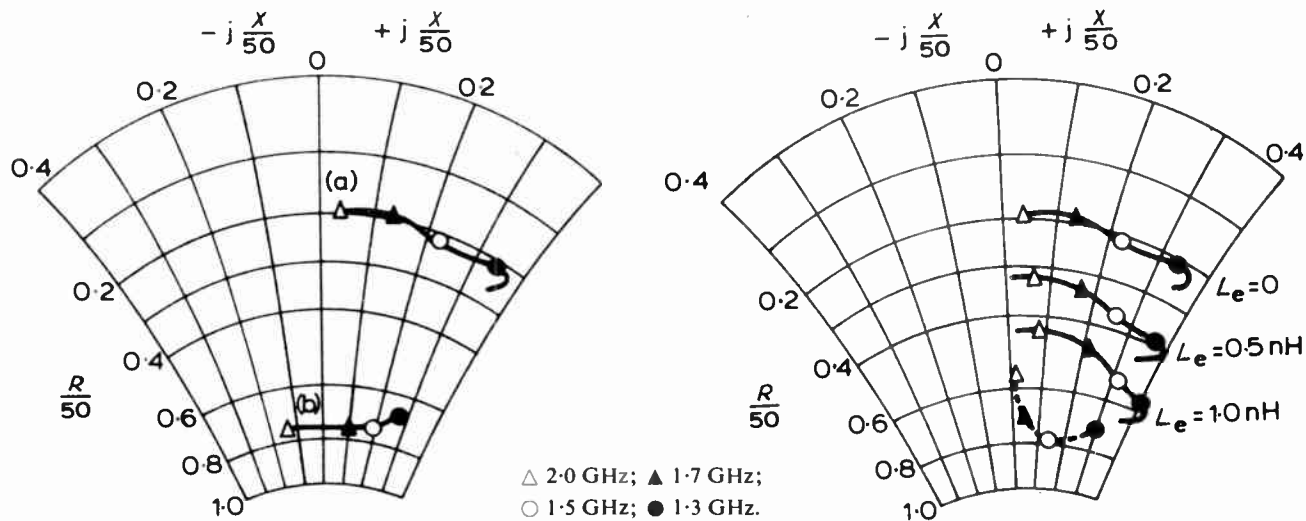

Fig. 1. Source impedances required for (a) power match; (b) for minimum noise figure.

overall noise figure. Final computer optimization adjusted the circuit to give input and output v.s.w.r.s of less than 1.8 : 1 and the gain to between 16 dB and 12 dB over the frequency range from 1.1 GHz to 2.4 GHz as shown in Figs. 4, 5 and 6.

It was not possible to provide the optimum source impedance over a bandwidth greater than approximately 300 MHz at 1.5 GHz. The gain of the first stage was reduced to approximately 7 dB. Shunt feedback from collector to base by a series RLC circuit was added for the analysis and an optimum source could then be provided over a bandwidth from 1.3 to 2.0 GHz but the stage gain was less than 4 dB. The effect of this lower gain would be an increased overall noise figure.

4.2 Circuit Details

The broadband load circuit was designed to match the approximate output impedance (110 Ω in parallel with 0.86 pF) to 50 Ω using a three-resonant-element Chebyshev circuit using formulae given by Levy.<sup>4</sup> The inductors were realized by short lengths of high impedance transmission lines and the shunt capacitors by low impedance shunt open circuit stubs. Beam lead capacitors were used in series.

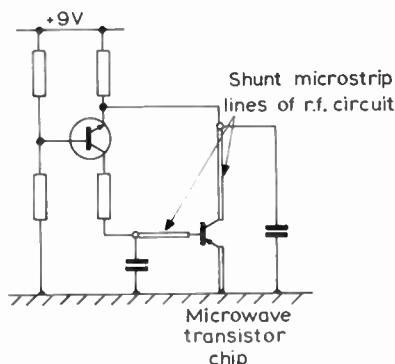

Fig. 3. Transistor bias circuit.

--- Impedance of source at transistor terminals 1 and 2 with  $L_e = 1$  nH.  
 —  $Z_{IN}^*$  Conjugate of the input impedance for various values of  $L_e$ .

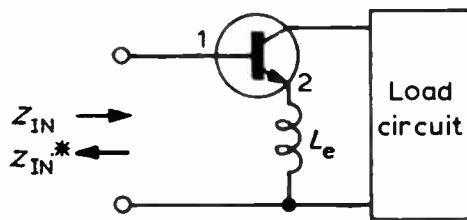

Fig. 2. Effect of emitter inductance.

The practical circuit included frequency dependent attenuation to flatten the gain response. This was effected by including shunt transmission lines which were terminated in a resistance to earth. This resistance was shunted by a 2.2 pF capacitor to reduce high-frequency loss. In the amplifier optimization, to minimize the loss at the upper frequencies, lines of a quarter wavelength at 2 GHz were tried. It was not possible to achieve a good match over an octave bandwidth with this length and the final optimization resulted in shorter lines.

The negative feedback in each emitter circuit was provided by using a single emitter bond lead (adding 0.2 nH) and a 70 Ω microstrip line to the earth at the edge of the 0.5 mm alumina substrate.

The d.c. operating current of each transistor was controlled by stabilizing the collector current with a simple feedback circuit to the base. (Fig. 3.)

5 Performance Summary

5.1 Gain (Fig. 4)

The gain was 16 dB from 1.1 to 1.5 GHz dropping to 12 dB at 2.1 GHz and remaining at 12 dB to 2.4 GHz. For the temperature range -40 to +86°C the change was approximately 1.5 dB.

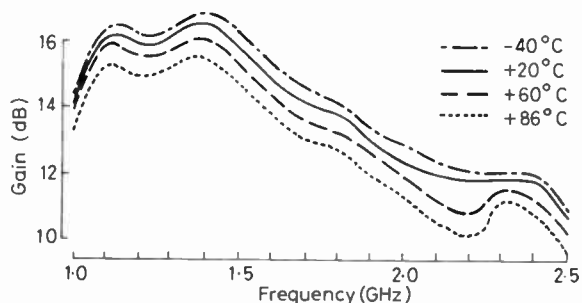

Fig. 4. Measured gain over the temperature range  $-40$  to  $+86^{\circ}\text{C}$ .

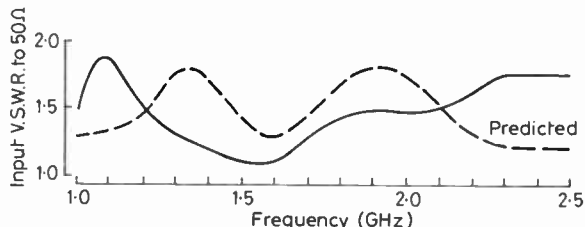

Fig. 5. Predicted and measured input v.s.w.r.

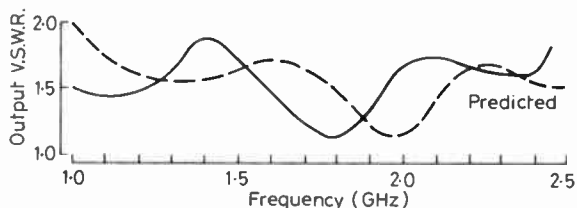

Fig. 6. Predicted and measured output v.s.w.r.

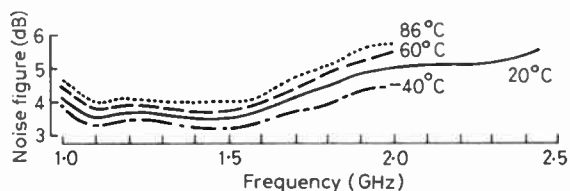

Fig. 7. Noise figure  $-40$  to  $+86^{\circ}\text{C}$ .

### 5.2 V.S.W.R. (Figs. 5 and 6)

The input and output v.s.w.r. were independent of temperature and were less than 2 : 1. From 1.2 to 2.0 GHz the input v.s.w.r. was less than 1.5 : 1.

### 5.3 Noise Figure (Fig. 7)

For the temperature range  $-40$  to  $+86^{\circ}\text{C}$  the noise figure changed approximately linearly between the following limits:

- at 1.5 GHz: 3.2 dB at  $-40^{\circ}\text{C}$  and 4.0 dB  $+86^{\circ}\text{C}$ .
- at 2.0 GHz: 4.5 dB at  $-40^{\circ}\text{C}$  and 5.8 dB  $+86^{\circ}\text{C}$ .

It was estimated that originally the first stage gain was 6 dB at 1.5 GHz and after the gain flattening was removed in the interstage circuit the gain was 7.3 dB. The effect of this was to reduce the noise figure from 3.8 to 3.5 dB.

When indium foil was placed over the 70  $\Omega$  emitter feedback line, reducing the feedback, the first stage gain increased to 9.0 dB and the noise figure increased to 3.8 dB representing a 0.5 dB worse first stage noise figure. The input v.s.w.r. was then 1.7 : 1. This experiment indicated that the negative feedback has produced the desired change in the transistor source impedance.

### 5.4 Power Output

The power output for 1 dB gain compression changed over the frequency range from 2.6 dBm at 1.3 GHz to 6.4 dBm at 2.0 GHz. This change was due to the attenuation of the gain flattening circuits.

### 5.5 Intermodulation

The output intercept point for second-order inter-

modulation products was +32 dBm and for third-order products was typically +20 dBm.

## 6 Conclusions

The amplifier that has been described demonstrates a relatively simple and potentially inexpensive technique for obtaining the minimum noise figure for an amplifier together with good input power match. The match, with respect to 50  $\Omega$ , was better than 1.25 : 1 over a band of 300 MHz centred on 1.5 GHz. The amplifier uses cheap transistor chips developed for u.h.f. applications and the noise figure, whilst slightly inferior to the state of the art, was 3.5 dB at 1.5 GHz. The alternative method for achieving power match and minimum amplifier noise figure from a particular transistor type is significantly more complex, using two amplifiers with 3 dB couplers in a balanced amplifier arrangement.

One possible application for which the amplifier is being considered is for point-to-point links at approximately 1.5 GHz in narrowband multiplex radio systems.

## 7 References

- 1 Kurokawa K., 'Design theory of balanced transistor amplifiers', *Bell Syst. Tech. J.*, 44, pp. 1675-98, October 1965.
- 2 Engelbrecht, R. S. and Kurokawa, K., 'A wide-band low noise L-band balanced transistor amplifier', *Proc. IEEE*, 53, no. 3, pp. 237-47 March 1965.
- 3 Paolino, D. D., 'Design more accurate interdigitated couplers', *Microwaves*, 15, no. 5, pp. 34-38, May 1976.
- 4 Levy, R., 'Explicit formulas for Chebychev impedance-matching networks, filters and interstages', *Proc. Instn Elect. Engrs*, 111, no. 6, pp. 1099-1106, June 1964.

Manuscript first received by the Institution on 16th February 1978 and in final form on 20th December 1978.  
(Paper No. 1868/CC 302)

# Time-slot access to digital transmission systems

R. W. McLINTOCK, B.Sc.\*

*Based on a paper at a Colloquium on Interworking between F.D.M. and P.C.M. held in London on 25th January 1978.*

## SUMMARY

The British Post Office is introducing digital transmission equipment into its telecommunications network. The opportunity arises to take advantage of plant to be installed for telephony purposes to act as bearer plant for non-speech services, e.g. digital data. The per-voice channel capacity of a digital system is known as a channel time-slot and this paper describes how access might be gained to this capacity for use by non-telephony services.

## 1 Network Structure

For economic reasons the British Post Office started to install 24-circuit pulse code modulation systems (p.c.m.) into its network in 1968. Already some 6000 such systems are in existence throughout the country, primarily in the junction part of the network.<sup>1</sup> Such a junction is typically 25 km long and connects a local exchange to its main network switching centre. The transmission rate of these systems is 1536 kbit/s. (Ref. 2.)

More recently a hierarchical family of digital transmission equipment is in the course of development which includes higher levels of digital multiplexing and associated digital line systems.<sup>3,4</sup> Just as with frequency division multiplex systems, these higher-order systems are assembled via a number of stages of multiplexing to allow flexibility and to permit the matching of equipment with the number of circuits required on specific routes. The basic building block of the hierarchy is the 30-circuit p.c.m. multiplex terminal which digitally encodes and time division multiplexes 30 telephone channels together to produce a 2048 kbit/s digital stream. At the distant terminal the complementary processes are executed.<sup>5,6</sup>

As well as its use in the junction network, 30-circuit systems will be used extensively in the main trunk network which is destined to become almost totally digital within the foreseeable future.<sup>7</sup> Figure 1 shows the digital hierarchy.

The map shown in Fig. 2 illustrates the extent of the coverage that will have been achieved by the early 1980s. Note that only 8 Mbit/s and above are illustrated so as not to clutter the illustration. By this time there will additionally be some 2000 2048 kbit/s systems in the network.

One of the advantages of digital transmission is that by relatively simple conversion processes any analogue signal can be converted into digital form. Once in this form it can share transmission plant with any other service treated in the same way without fear of mutual interference. Digital transmission could be considered as a universal transmission medium allowing a fully integrated services digital network to be developed.

Clearly the opportunity arises to utilize this capability for new services such as digital data (as opposed to Datel<sup>8</sup>) or as an alternative for providing existing services such as the transmission of high-quality music circuits for the broadcasting authorities. In the case of data, the use of digital transmission is likely to be much more efficient than the use of Datel modems. The information rate allocated for each telephony channel on digital transmission systems is 64 kbit/s which is a much larger capacity than can be attained using Datel modems over an analogue telephony channel which at best can only yield 9.6 kbit/s.

For the provision of music circuits one of the current practices is to use phantom circuits derived from the symmetric pair cables used for 24-channel f.d.m. carrier

\* PO Telecommunications Development Department, 2-12 Gresham Street, London EC2V 7AG.

systems. It has been decided to re-equip these cables with 8 Mbit/s digital transmission systems because the existing carrier equipment is nearing the end of its economic life. The phantom circuits will no longer be available for music circuits and other arrangements will have to be made. Consideration is being given to the digital conversion of these signals. It appears that the

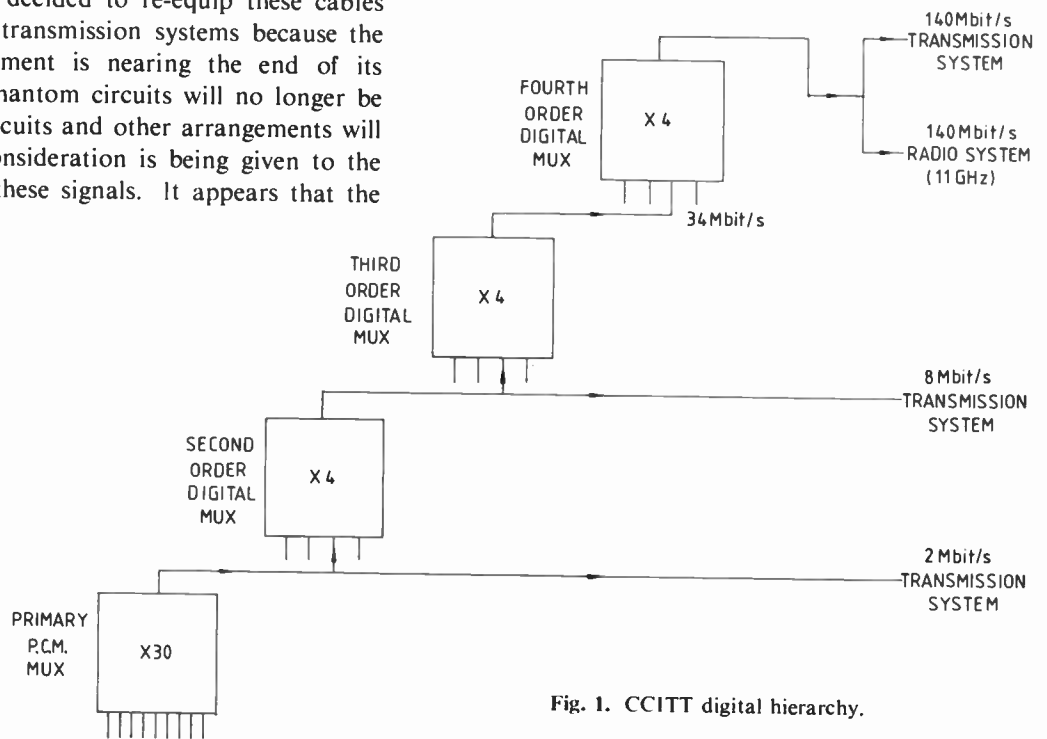

Fig. 1. CCITT digital hierarchy.

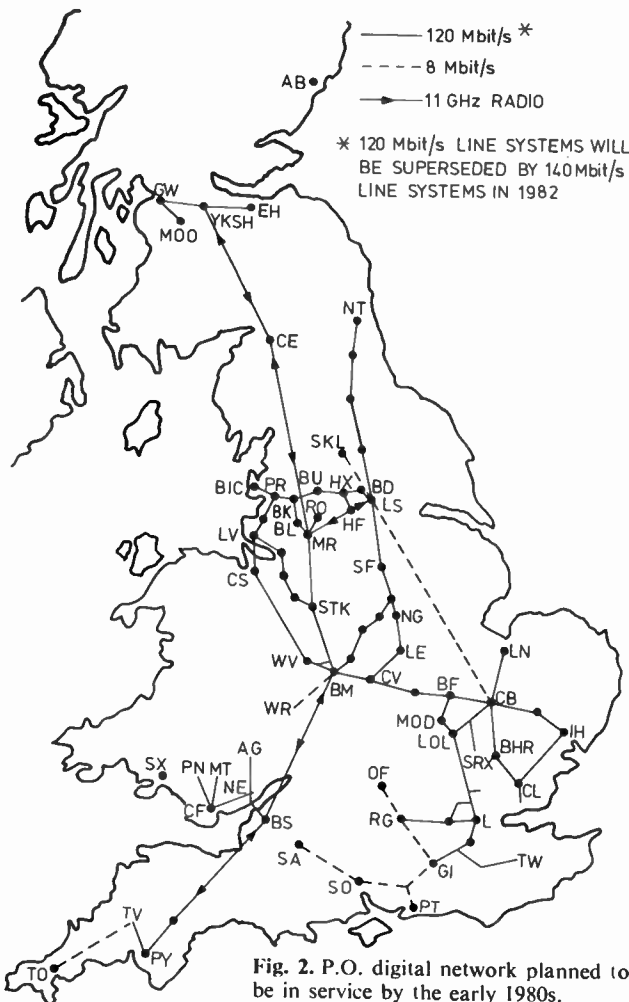

Fig. 2. P.O. digital network planned to be in service by the early 1980s.

digital capacity equivalent to 6 telephony channels (i.e. 384 kbit/s) will be required for each monophonic music circuit.

Other services which are particularly well suited to digital transmission are facsimile, viewdata and telex.

Some of the services mentioned are new and provision will inevitably start in a relatively small way. In the case of music, the requirements are likely to be small for the foreseeable future. In many instances the present minimum provisioning unit of a 2048 kbit/s digital path is rather large and it is here that time-slot access might be useful. By gaining access to a few time-slots of a primary 2048 kbit/s system, provided primarily to meet telephony requirements, a digital transmission capability for non-telephony services could be established on a route which could not justify a complete 2048 kbit/s path for this sole purpose. This use of time-slots for non-telephony services is considered advantageous since the 30-circuit block size is currently rather large on many routes even for telephony purposes.

## 2 Frame Structure at 2048 kbit/s

Figure 3 illustrates the frame structure of the 2048 kbit/s digital signal.<sup>5,9</sup> A frame, consisting of 32 time-slots numbered TS0-TS31, contains a digitally encoded sample from each of the 30 channels (TS1-15, TS17-31), together with frame alignment and signalling information. The frame repetition rate is 8 kHz and each time-slot contains 8 binary digits. TS0 contains a frame alignment signal which is a fixed pattern that enables the distant terminal to recover the identity of time-slots by reference

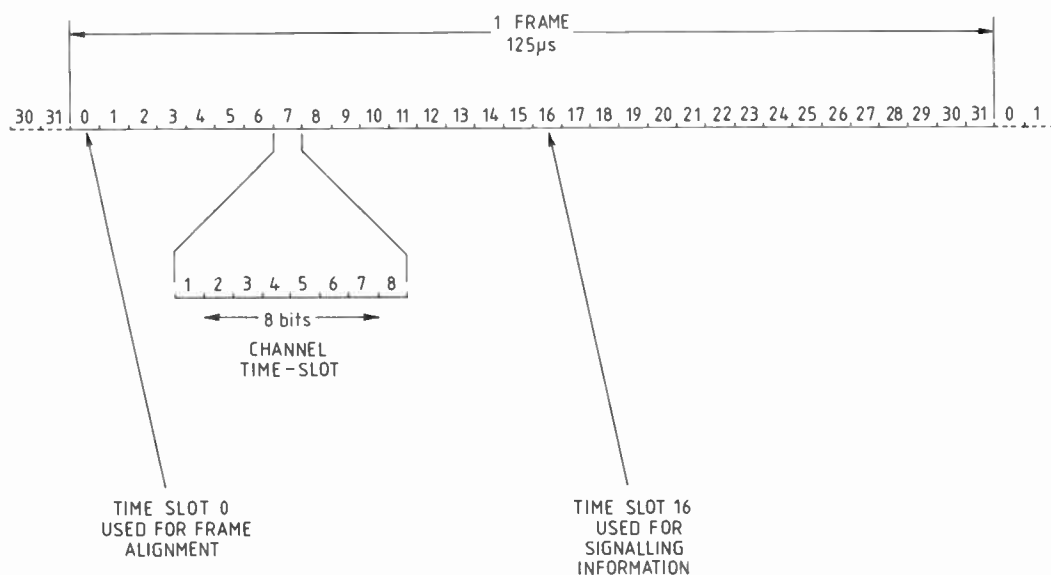

Fig. 3. Frame structure of 30-channel p.c.m.

to this known signal. TS16 contains signalling information for the 30 channels although, in any single frame, the 8 bits of TS16 only contain the signalling information for two channels. Signalling for other channels is conveyed by arranging for the information to be submultiplexed into TS16 over a period of 16 consecutive frames, known as a multiframe.

$$\begin{aligned} \text{gross digit rate} &= \frac{\text{frame repetition rate} \times \text{number of time-slots per frame} \times \text{number of bits per time-slot}}{\text{frame repetition rate}} \\ &= 8000 \times 32 \times 8 \text{ bit/s} \\ &= 2048 \text{ kbit/s} \end{aligned}$$

$$\begin{aligned} \text{per-channel rate} &= \frac{\text{frame repetition rate} \times \text{number of bits per time-slot}}{\text{frame repetition rate}} \\ &= 8000 \times 8 \text{ bit/s} \\ &= 64 \text{ kbit/s} \end{aligned}$$

### 3 Options for Achieving Time-slot Access

There are two basic ways in which time-slot access can be achieved, known as external and internal time-slot access.

External access is the technique whereby a separate equipment intercepts a 2048 kbit/s path from a primary p.c.m. multiplex and inserts or extracts information from a number of time-slots.

Alternatively the access can be incorporated into the standard 30-circuit p.c.m. multiplex terminal, in which case this is referred to as internal access.

#### 3.1 External Access

Figure 4 shows a block diagram of an external time-

slot access equipment and it is immediately apparent that there is considerable duplication of many of the functions already executed in the p.c.m. multiplex. For each direction of transmission the line coded signal (High Density Bipolar 3, HDB3) has to be decoded, a timing signal extracted, other timing signals generated and frame alignment established before information can be either inserted or extracted from particular time-slots. Subsequently the composite signal must be recoded into the HDB3 line code format. Power and alarm functions are also necessary. Further, since the equipment is in effect in tandem with the p.c.m. multiplex, the overall performance of the 2048 kbit/s path is dependent upon the reliability of the access equipment.

The advantages of external access are that it only has to be provided when access is required on a particular route. There is no question of it being a cost burden on 30-circuit p.c.m. multiplex equipment when access is not required. The equipment can be developed on a different timescale to p.c.m. multiplex equipment to meet the requirements of the services for which it is required. Access can be arranged to be at any point along the 2048 kbit/s path and does not need to be associated with the p.c.m. terminals.

The disadvantages are that duplication of many of the multiplex functions already executed in the p.c.m. multiplex leads to increased cost and reduced reliability of the telephony system.

#### 3.2 Internal Access

Industry are currently developing, for the PO, a second generation of 30-circuit p.c.m. multiplex equipment which will provide an internal time-slot access capability. By substitution of telephony channel cards with non-voice

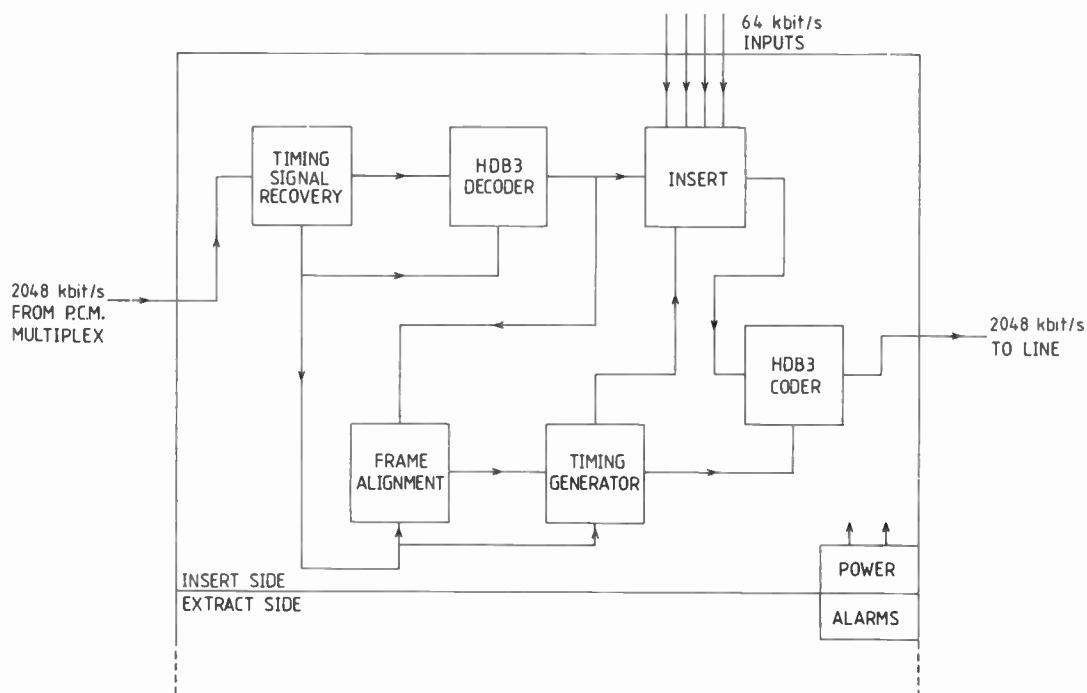

Fig. 4. External time slot access.

variants, access will be possible to a limited number of time-slots. Figure 5 shows schematically how the access will be achieved. The important point to be borne in mind is that access will be achieved in such a way that, when the multiplex is used solely for the telephony, its majority application, the increased cost, as a result of the in-built potential to provide time-slot access, will be minimal.

The advantages of internal access are that there is none of the duplication of circuitry as in the case for external access. The cost of providing an access capability should be lower and there should be no adverse effects on the reliability of the telephony circuits carried on the same system.

### 3.3 International Standardization of Time-slot Access Order

For both methods of access, the CCITT (International Telegraph and Telephone Consultative Committee) has recommended an order in which the time-slots should be accessed,<sup>10</sup> this being necessary to achieve interworking across international boundaries at some future date. The order is based upon distributing the non-speech terminals throughout the frame to minimize the possibility of adverse patterns in the non-speech services causing phase jitter problems on the succeeding line equipment.

### 4 Characteristics of 64 kbit/s Paths

The 64 kbit/s paths provided by both external and internal access will be presented at defined electrical interfaces. There is no restriction on the information content of the 64 kbit/s streams, that is the paths are bit sequence independent. Information can be applied to the

time-slot access equipment as 8-bit words, known as octets, which are recoverable at the distant terminal with the octet integrity preserved.

In the case of music circuits, by combining the capacity of 6 time-slots, a digital path of 384 kbit/s could be offered. This is likely to be compatible with encoders/decoders suitable for broadcast-quality music signals which might have a sampling rate of 32 kHz with a 10-bit amplitude representation. Additional information would be added for error protection, control and scaling information. The capacity of 12 time-slots could be offered for a stereo circuit.

### 5 Access to 24-circuit P.C.M.

Twenty-four circuit p.c.m. is the predecessor of 30-circuit p.c.m., and, as mentioned earlier, there has been considerable penetration of these systems into the network. However, it seems unlikely that access will ever be provided for a number of reasons.

(1) On 24-circuit p.c.m. the frame structure is different to 30 circuit. Although each time-slot consists of 8 bits, only 7 bits are used to represent the speech sample size. The other bit is shared between the frame alignment and signalling functions. Thus 64 kbit/s paths could not be achieved simply.

(2) The line code used on 24-circuit p.c.m., known as alternate mark inversion (a.m.i.), is such that long strings of consecutive zeros in the bit stream must be avoided. Otherwise the timing information required for the correct operation of intermediate regenerators would not be present. When conveying digitally-encoded telephony signals, the probability of this

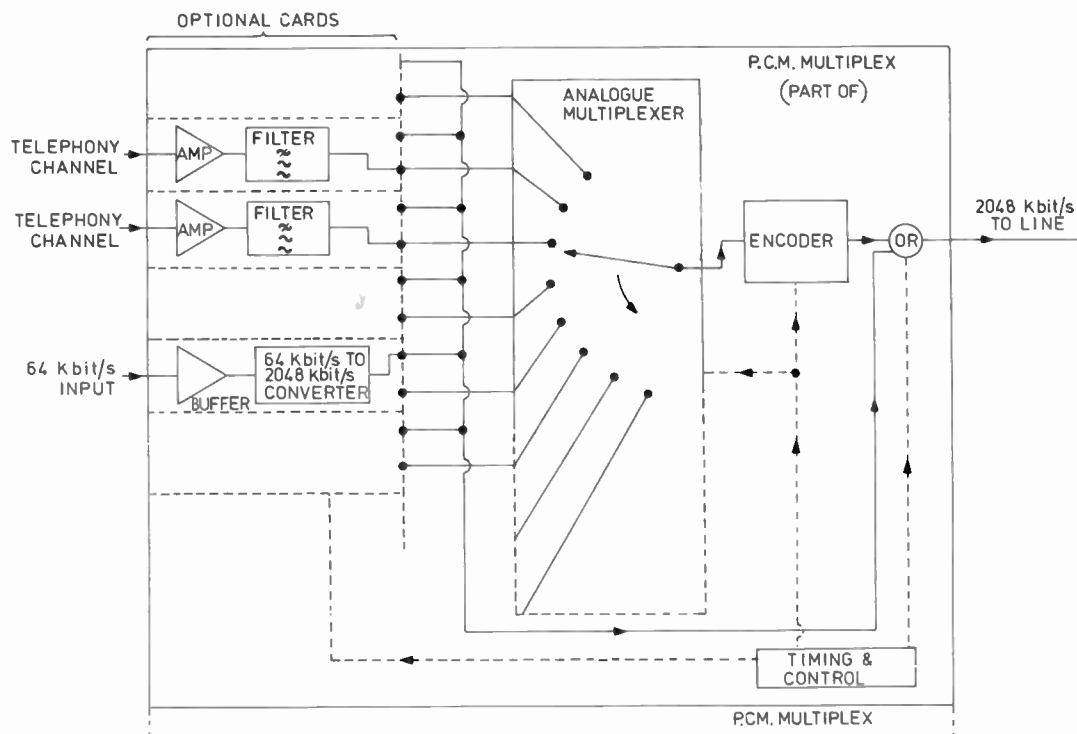

Fig. 5. Internal time slot access.

happening has been arranged, by prudent allocation of code words, to be sufficiently small to be insignificant. However, by introducing non-telephony services into time-slots this could adversely affect the situation.

(3) Twenty-four circuit systems do not fit into the hierarchy of higher-order digital systems.

(4) Digital switching equipment will not terminate 24-circuit p.c.m. systems directly.

## 6 Alternatives for Providing Digital Data Services

Time-slot access is obviously only part of the story in providing digital data services. For one thing the signals have to be conveyed between customers' premises and the time-slot access equipment which might be sited at the local exchange. Plans are in hand to make use of data modems operating at rates up to 64 kbit/s on existing cable pairs in the local distribution network. For customers requiring data rates less than the 64 kbit/s, available from the time-slot access equipment, two alternative solutions are being considered: either to reiterate the information, that is to send the information more than once to fill up the full 64 kbit/s, or to combine a number of these lower-speed data signals by a sub-multiplexing stage. Initially at least, the former is likely to be preferred.

It is likely that digital data services will be provided in the first instance using data modems in association with dedicated data multiplex equipment, that is multiplex equipment similar in format to the telephony multiplex

but which multiplexes thirty-one 64 kbit/s channels directly to 2048 kbit/s. Service will be offered initially between major centres such as London, Birmingham, Manchester where data routes are thick enough to justify the use of completely dedicated paths.

## 7 Conclusions

Time-slot access is likely to be used at a later stage as the service spreads away from the main centres to areas where the traffic routes, in terms of the number of data circuits, are much thinner. This approach should be commensurate with the introduction of the second-generation p.c.m. multiplex equipment, with its access capability, into the network.

The paper has described how time-slot access techniques are a useful tool for the network planner to realize telecommunication networks suitable for the integration of services.

Of the two alternatives, referred to as external and internal time-slot access, the former is unlikely to find widescale usage for the reasons given in Section 3. Internal access is a facility that is likely to be provided by the second-generation 30-circuit p.c.m. equipment and use will be made of this capability in the early 1980s as the systems penetrate into the network.

## 8 Acknowledgment

Acknowledgment is made to the Senior Director of Development of the Post Office for permission to make use of the information contained in this paper.

9 References

- 1 Boag, J. F., 'The end of the first pulse-code modulation era in the UK', *Post Office Elect. Engrs J.*, 71, p. 2, April 1978.
- 2 Bolton, L. J. and Bennett, G. H., 'Design features and application of the British Post Office 24-channel pulse code modulation system', *Post Office Elect. Engrs J.*, 61, p. 95, July 1968.
- 3 Schickner, M. J. and Zick, L. C., 'Development of a 120 Mbit/s digital line system—part 1 and 2', *Post Office Elect. Engrs J.*, 69, p. 154, October 1976 and p. 217, January 1977.
- 4 Brigham, E. R., Snaith, M. J. and Wilcox, D. M., 'Multiplexing for a digital main network', *Post Office Elect. Engrs J.*, 69, p. 93, July 1976.
- 5 Vogel, E. C. and McLintock, R. W., '30-channel pulse-code modulation system, part 1—multiplex equipment', *Post Office Elect. Engrs J.*, 71, p. 5, April 1978.

- 6 Whetter, J. and Richman, N. J., '30-channel pulse-code modulation system, part 2—2048 kbit/s digital line system', *Post Office Elect. Engrs J.*, 71, p. 82, July 1978.
- 7 Simpson W. G., 'Review of trunk transmission planning in the UK Post Office', *Proc. Instn Elect. Engrs*, 123, No. 5, p. 393, May 1976.
- 8 Spratt, C. J., 'A review of data transmission in the United Kingdom', *Post Office Elect. Engrs J.*, 69, p. 19, April 1976.
- 9 Bennett, G. H., 'Pulse code modulation and digital transmission', Marconi Instruments, St. Albans, 1977.
- 10 Annex 1 to Question 1 of CCITT Study Group XVIII, Study Period 1977–1980.

*Manuscript first received by the Institution on 13th September 1978 and in final form on 12th December 1978. (Paper No. 1869/Comm 177)*

Letters

From: J. L. Eaton, B.Sc., C.Eng., M.I.E.E.

B. W. Osborne, M.Sc., F.Inst.P., S.M.I.E.E.E.,  
C.Eng., F.I.E.R.E., M.I.E.E.

Television Signal-to-Noise Ratio Before and After Demodulation

B. W. Osborne's paper<sup>1</sup> has sparked off several letters in your journal and, reading them, I am surprised that the notorious 6dB is still causing trouble. Using the theory of synchronous detection it is easy to see how it arises and to appreciate that it has nothing to do with the frequency response of the receiver near to carrier.

The theory of synchronous detection can be carried out entirely in the frequency domain and only requires elementary trigonometrical operations. The full theory of the envelope detector is much more difficult but, providing that the noise level is small, its operation is somewhat analogous to synchronous detection and the results from the synchronous theory can be used for it without much error.

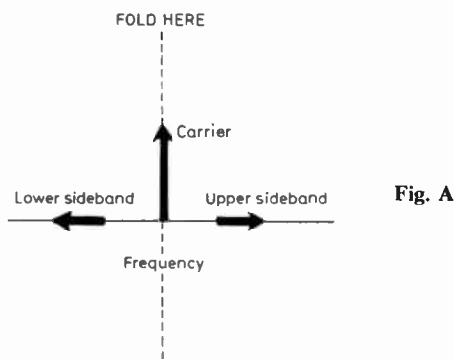

Fig. A

Figure A shows the spectrum of a carrier amplitude modulated to 100% by a single tone. The directions of the vectors representing the lower and upper sidebands indicate phase. After ideal synchronous demodulation the baseband

part of the spectrum is obtained by folding the spectra picture about the carrier vector and shifting the frequency scale so that the carrier is at zero (d.c.). When this is done the two sidebands fall exactly upon one another and add directly. As they were each originally half the carrier amplitude the resultant is now equal to the carrier amplitude.

This operation is valid for any set of lower and upper sidebands providing that they are properly phased and added as vectors after the fold. If there is added noise, represented as a continuum of randomly phased vectors, the addition after folding must be carried out in terms of power  $\Delta f$ . The relative noise power is clearly equal before and after detection. Hence the well-known fact that for 100% amplitude modulation by a single tone the carrier/noise ratio before detection and the signal/noise ratio after detection are equal. This is the reference case that is used in the calculation of signal/noise ratio in television amplitude-modulated systems. It is crucial to the argument to remember that all the adjustments that are made in the calculation are with respect to this reference.

After detection what is important is the relation between signal and noise; the carrier is no longer significant because it has been reduced to d.c. Before detection any convenient level of carrier may be used as a reference to scale the calculation in terms of received field strength for example. The frequency response of the receiver must be taken into account prior to detection as it will modify both signal and noise. The effect on the noise can be allowed for by calculating noise power in the receiver r.f. noise bandwidth. The effect on the signal will be to complete the removal of one set of sidebands from the original d.s.b. signal and therefore, to reduce their baseband relative amplitudes by 6dB. This is the 6dB which must be included in the calculation. The hypothetical frequency response of the receiver could be rectangular but is usually specified to slope symmetrically about the carrier so that any sidebands that are reduced on one side are topped up (after the fold) by the residue of sidebands from the other.

It must be remembered that the calculation is ideal and many factors may make practical measurements differ from the expected results by a decibel or so.

J. L. EATON

BBC Research Department,  
Kingswood Warren,  
Tadworth, Surrey.  
27th October 1978



I welcome Mr. Eaton's clear statement that 'for 100% amplitude modulation by a single tone the carrier/noise ratio before detection and the signal/noise ratio after detection are equal'. I have no argument with his first three paragraphs, though synchronous detection can itself introduce noise.

When comparing the d.s.b. with the v.s.b. receiver (his paras. 4 and 5) we have about 3dB more noise in the d.s.b. receiver after detection, as well as the 6dB more signal. The signal-to-noise ratio at the receiver input is a matter of arbitrary definition, both for d.s.b. and for v.s.b. The noise energy bandwidth at the input of the d.s.b. receiver must be specified.

I believe that the d.s.b./v.s.b. comparison is a red herring. It is often useful to try a new approach, and I am indebted to my colleague, Dr. A. E. Cutler, for the following discussion of signal-to-noise ratios in the v.s.b. receiver with envelope detector, starting from the basic physics.

A simple television signal suitable for signal-to-noise assessments consists of black and white vertical bars of equal width. The full r.f. signal consists of periods of carrier at various levels and in each 64μs line period we have 5μs at peak amplitude ( $A$ ) in the syncs., 9μs at 0.76 $A$  in the porches, and 25μs each at 0.76 $A$  and 0.20 $A$ . This gives a mean square voltage over the line period, as measured by a power meter, of

$$\overline{V_r^2} = \frac{A^2 (5 \times 1^2 + 34 \times 0.76^2 + 25 \times 0.2^2)}{64} = 0.2A^2.$$

Exactly the same result is obtained if the brightness is sinusoidally modulated between the same limits.

If a noise signal is present with r.m.s. voltage  $(\overline{V_n^2})^{1/2}$ , the r.f. signal-to-noise ratio is numerically

$$\left(\frac{S}{N}\right)_{\text{R.F.}} = \frac{\overline{V_r^2}}{\overline{V_n^2}} = \frac{0.2A^2}{\overline{V_n^2}}$$

measured over the bandwidth from -1.25 to +5 MHz from vision carrier.

The shaping characteristic of a v.s.b. receiver is designed to decrease from +1.25 to -1.25 MHz, being 6dB down at vision carrier. This causes the vision carrier and signals near it to be reduced to half amplitude and reduces the noise power. Calculation shows† that the noise power compared with that of a flat 6.25 MHz noise spectrum is reduced by 1.35dB (a power ratio of 0.73).

Since all the components of the specified test pattern fall near the carrier, the locus of peaks appears at the output of the rectifier. The d.s.b. signal

$$\frac{A}{2} f(t) \sin \omega t$$

rectifies to  $(A/2)f(t)$  in the envelope detector, and the step from black to white in  $f(t)$  is 0.56, so that the output step is  $(A/2) \times 0.56 = 0.28A$ .

We also need to know how the noise fares during detection. Now band-limited noise exhibits a periodic variation in which the periods are typical of those of sinusoidal signals in the same band, from which it follows that when the detector diode is periodically switched by the applied signal, because of the relative size of the carrier and noise components, the samples will be substantially regular in time and consist of the peak of the carrier and a sample of the noise. The rectified noise has, therefore, the same statistical distribution of levels as the input noise, i.e.  $(\overline{V_r^2})_{\text{out}} = (\overline{V_n^2})_{\text{in}}$ .

This leads to a signal-to-noise ratio as defined for video

$$\left(\frac{S}{N}\right)_{\text{video}} = \frac{(0.28A)^2}{0.73 \overline{V_n^2}}$$

Comparing the two definitions, we have

$$\left(\frac{S}{N}\right)_{\text{R.F.}} : \left(\frac{S}{N}\right)_{\text{video}} = \frac{0.2A^2}{\overline{V_n^2}} : \frac{0.73 \overline{V_n^2}}{(0.28A)^2} = 1.86:1$$

So we see that the definitions of signal-to-noise ratio for r.f. before and for video after an envelope detector lead automatically to a disparity of 1.86:1. A power ratio of 1.86:1 is equivalent to 2.7 dB.

In the above, the r.f. noise bandwidth is properly taken to be 6.25 MHz, and not the 5 MHz which I used in Section 2.1 of my paper.

Rediffusion Engineering Ltd. B. W. OSBORNE  
 Technical Services Division  
 187 Coombe Lane West,  
 Kingston-upon-Thames, Surrey KT2 7DJ  
 4th January 1979

## References

- 1 *The Radio and Electronic Engineer*, 47, No. 12, pp. 555-61 December 1977.
- 2 *The Radio and Electronic Engineer*, 48, No. 9, pp. 444-6, September 1978. (Letters).

† e.g. as quoted by Dr. Maurice on p. 444 of Ref. 2.

# The use of digital techniques to improve modulation-type sector-scanning sonar systems

A. R. PRATT, B.Sc., Ph.D, M.I.O.A.\*

## SUMMARY

The methods by which the local oscillator signals for use in a modulation-type sector-scanning sonar system may be produced are briefly reviewed. To achieve good performance in practice, it is often necessary to incorporate many adjustments in the system. An alternative system employing mainly digital techniques is considered, the analysis of which reveals the potential for improvements in performance. A sector-scanning sonar requiring few adjustments has been constructed using these techniques.

\* Department of Electronic and Electrical Engineering, University of Technology, Loughborough, Leicestershire LE11 3TU

## 1 Introduction

High-resolution sector-scanning sonar systems are becoming of increasing interest because of their potential for underwater exploration and surveying operations in connection with the oil industry. Historically, sector-scanning sonar systems have been operated almost exclusively by those closely associated with their design and construction. This situation is unlikely to continue with the expected widespread application in the civilian field since skilled personnel will not be available to make the detailed and complicated adjustments apparently necessary to such systems. Thus it is desirable to consider possible methods by which some or all of the more complicated adjustments might be eliminated. The purpose of this paper is to present one such solution.

## 2 Basic Scanning Requirements

First consider a  $(2n + 1)$  element linear array of point hydrophones connected through a series of phase-shifting circuits to an adder. The phase-shifters allow the main beam of this array to be steered. A scheme of this type is illustrated diagrammatically in Fig. 1 and is appropriate to narrow-band operation only. With the

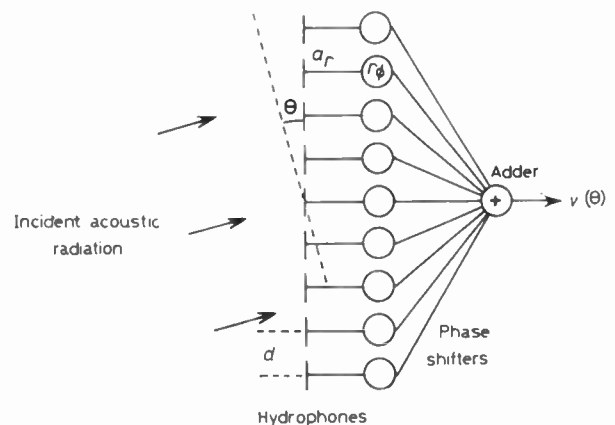

Fig. 1. Sector scanning array processing.

definition of terms given in Fig. 1, the angular sensitivity of this system is

$$v(\theta) = \sum_{r=-n}^n a_r \exp(j\{\omega_0 t - r\phi - 2\pi r d(\sin \theta)/\lambda\}) \quad (1)$$

where  $\omega_0$  is the angular frequency of the incident acoustic wavefront and  $a_r$  is the peak output voltage from hydrophone  $r$  due to an incident sinusoidal pressure signal. Frequently, the hydrophones are of equal sensitivity and thus the output voltage of each is the same:

$$a_r = a \quad \text{for all } r \quad (2)$$

By applying this restriction to equation (1), the required summation yields:

$$v(\theta) = a \frac{\sin ([2n+1] [\pi d(\sin \theta)/\lambda + \phi/2])}{\sin (\pi d(\sin \theta)/\lambda + \phi/2)} \exp(j\omega_0 t) \quad (3)$$

The maximum value of  $v(\theta)$  and the values of  $\theta (\theta_i)$  for which  $|v|$  attains this value are

$$|v(\theta_i)| = |v(\theta)|_{\max} = (2n+1)a. \quad i=0, \pm 1, \pm 2, \dots$$

and

$$\sin \theta_i = \left(2i - \frac{\phi}{\pi}\right) \frac{\lambda}{2d} \quad \text{for } |\sin \theta_i| \leq 1 \quad (4)$$

The values of  $\theta_i$  can thus be varied through control of  $\phi$ .

It is convenient to make  $\phi$  vary as a linear time function, i.e.

$$\phi = \omega_s t = 2\pi f_s t \quad (5)$$

so that the  $\theta_i$  vary cyclically with time:

$$\sin \theta_i = (i - f_s t) \lambda / d.$$

The values of  $i$  which can be used to satisfy this equation are determined by the requirement that  $|\sin \theta|$  must be less than unity, thus

$$f_s t - d/\lambda \leq i \leq f_s t + d/\lambda.$$

The convenience of making  $\phi$  a linear time function may be realized by considering the output of the phase shifter in the  $r$ th channel:

$$v_r = a_r \exp(j\{\omega_0 t - r\omega_s t - 2\pi r d(\sin \theta)/\lambda\}) \quad (6)$$

The various terms inside the parenthesis can be identified as the frequency of the acoustic radiation, the time-varying phase shift and the path length difference appropriate when the direction of the acoustic radiation is not normal to the array. The consequence of the time-varying phase shift is to cause a frequency change of  $r\omega_s$ . It is possible to realize a sector-scanning receiver by simply implementing the  $2n$ -phase coherent frequency changes (none is required for  $r=0$ ) using  $n$  local oscillators. For high-resolution systems, the number of hydrophones in the receiving array can be large (greater than 100) and thus the number of local oscillators can be inconveniently high. Techniques have been reported by which the number of local oscillators needed can be significantly reduced.<sup>1-3</sup> These involve performing the required modulation processes in stages.

### 3 Review of Modulation Methods

Consider the outputs from the elements  $+r$  and  $-r$  in Fig. 1. The signals from these hydrophones require changing in frequency by  $-r\omega_s$  to  $\omega_0 - r\omega_s$  and by  $+r\omega_s$  to  $\omega_0 + r\omega_s$  respectively. One simple way to do this would be to pass each signal through a double balanced modulator whose local oscillator inputs are supplied from a sine wave of frequency  $r\omega_s$ . Each modulator will

produce an unwanted sideband which would have to be rejected by filtering as illustrated in Fig. 2(a). The filter placed in each of the  $(2n+1)$  channels must have identical frequency, phase and delay characteristics. Each filter then requires a very steep transition between passband and stopband and it is, therefore, concluded that this method does not represent a practically realizable system.

A second method involves single-sideband techniques and is illustrated in Fig. 2(b). The unwanted sideband is cancelled in the adder. With the phase assignments shown in this Figure the lower sideband is ideally cancelled. If the input to the lower path suffers a phase reversal ( $+\pi$ ) in comparison with the upper path, then it is the upper sideband which is removed. These two systems can be combined by the use of sum and difference networks in the signal channels, to provide the modulation requirements for the hydrophone outputs  $+r$  and  $-r$  simultaneously, using only two modulators. This is illustrated in Fig. 2(c). The problem with these techniques is that it is rarely possible to reject the unwanted sideband by more than 40 dB in Fig. 2(b) and similarly difficult to null simultaneously both unwanted sidebands—see Fig. 2(c).

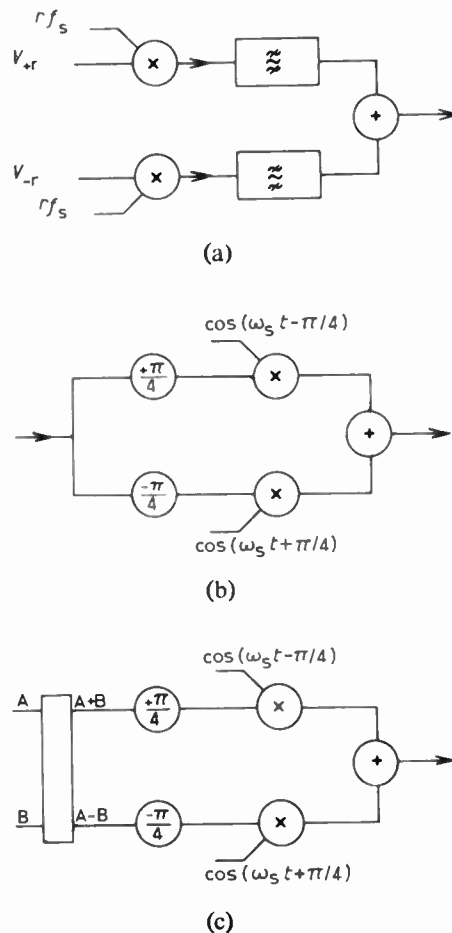

Fig. 2. Modulation methods.

A third method involves the generation of two frequencies, for example,  $\omega_1 + r\omega_s$ ,  $\omega_1 - r\omega_s$ , which are then used to cause an overall change in the average signal frequency by  $\omega_1$  radians per second.<sup>4</sup> The unwanted sidebands at the modulator outputs in a scheme like that in Fig. 2(a) can, by suitable choice of  $\omega_1$ , be easily rejected by simple filters. The problem in this case lies in the generation of the two local oscillator signals  $\omega_1 + r\omega_s$  and  $\omega_1 - r\omega_s$ . It is normal to use the techniques of Figs. 2(b) and 2(c)—the latter scheme requires the sum and difference network to be moved from input to output. Again, difficulties occur in the attempt to separately or simultaneously reject the unwanted sidebands. At low frequencies, it is possible to achieve 40 dB of rejection (requiring adjustments, etc., accurate to 1%) but at high frequencies it is rarely possible to better 20 dB of rejection in circuits employing the techniques of Fig. 2(c).

**4 Digital Generation of Local Oscillator Signals**

One method of avoiding the sensitive adjustments which are implicit in the above systems is, perhaps, to choose a direct method of carrier signal generation. In this context, it has been found most fruitful to consider the third method since it has the advantage of easy filtration of the modulator output signals. The filtering requirement is always present due to the generation of other spurious outputs. The signal generation requirement is thus to form sinusoidal waveforms with frequencies  $\omega_1 + r\omega_s$  and  $\omega_1 - r\omega_s$  in which  $r$  may take values from 0 to  $n$  inclusive.

One method by which these signals can be generated directly uses a read-only memory (r.o.m.) to store sample values of an integral number of cycles of a sine wave—successive samples in time being stored in successive address locations in the memory. The address inputs to this memory are driven from a counter and clock so that each memory location is successively accessed. The contents of the various address locations are sequentially fed to a digital-to-analogue converter to produce a sine-wave output. A block diagram of this scheme is illustrated in Fig. 3. It is assumed that the counter is an  $m$ -stage binary one, since most memories are organized with  $m$ -input binary coded addresses. We also assume that there are  $k$  data output lines available from the memory ( $k$  data bits in each address location) and that  $p$  cycles of a sine-wave have been stored in the  $2^m$  locations. The sine wave output from the digital to analogue converter has frequency  $f_p$ :

$$f_p = \frac{f_c}{2^m} p. \tag{7}$$

It is thus possible to generate a series of sinusoids whose frequencies are in arithmetic progression, starting with  $f_c/2^m$  ( $p=1$ ). These are suitable for use as the local oscillator sources in a sector scanning receiver because it is possible to lock the phases of the output sinusoids together by driving the address inputs of two or more

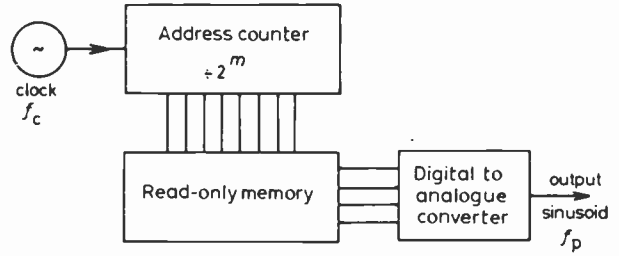

Fig. 3. Schematic for digital signal generator.

r.o.m.s either from the same binary counter or from delayed versions of the same counter output. If this technique is to be used, a restriction is clearly placed on  $\omega_1$  in that it must be a multiple of  $f_c/2^m$ . This does not seem to be a practical hindrance.

There are two types of errors involved in the representation of sinusoids by this means. The first of these is that normally associated with sampling—there are sidebands around each harmonic of the sampling frequency. The separation between a given harmonic and its nearest sideband is simply  $f_p$ . Thus, the sampled output contains the frequencies

$$qf_c \pm \frac{f_c p}{2^m},$$

where  $q$  is the number of the harmonic in question.

In practice, only the lowest frequency sideband would probably be used—that is with  $q=0$ . The other unwanted outputs would be removed by a filter following the digital to analogue converter. The filtering requirements would probably set an upper limit to  $p$  at approximately  $2^m/3$ . The second type of error is that associated with the amplitude quantization necessary with digital storage systems. These quantization errors will always be present in the digital representation of the sums of finitely many sine waves since the quantization theorem cannot be satisfied.<sup>5</sup>

**5 Analysis of Quantization Errors**

We assume that the quantizing errors are uniformly distributed and are uncorrelated from sample to sample. The later assumption is likely to be true only when the number of bits per sample ( $k$ ) is greater than 6 but the results will give some guide for smaller values of  $k$ . We also assume that the smallest output from the digital to analogue converter has unity magnitude so that the quantization error, being uniformly distributed in the interval  $(+\frac{1}{2}, -\frac{1}{2})$ , has an energy (in a 1 ohm resistor) of  $1/12$  of a unit. The total error energy  $E_{TOT}$  in the  $2^m$  samples is thus:

$$E_{TOT} = 2^{m-2}/3 \tag{8}$$

The pattern of quantization errors repeats at least as often as  $f_c/2^m$  times per second and thus the spectrum

of this error signal contains non-zero components at harmonics of  $f_c/2^m$ . The energy in all of these sidebands must equal  $E_{TOT}$  and thus by computing the number and relative magnitude of these sidebands we will be able to attribute an average energy level to each one. In considering the relative magnitude of the various sidebands, there are two relevant aspects. Firstly, since we have assumed that the quantization errors are independent from sample to sample, the spectrum of these errors will be white—i.e. uniform envelope to the energy in each harmonic of  $f_c$  which is present. The second aspect relates to the output of the digital to analogue converter between sample values. Normal engineering practice would ensure that the address input to the memory and therefore its output would not change in the interval under consideration. The output samples thus have a boxcar shape and hence the power spectrum of the quantization errors will be multiplied by the power spectrum of the boxcar. Hence the quantization errors have a power spectrum whose average,  $E(\omega)$ , is

$$E(\omega) = \frac{E \sin^2(\omega/2f_c)}{(\omega/2f_c)^2} \tag{9}$$

where  $E$  is a constant to be determined later.

We next calculate the number and frequencies of the quantization error sidebands. In order to do this, we must consider any symmetry which might be present in the quantization error pattern. The  $i$ th sample value of the sinusoid which is stored is:

$$s(i) = \left\{ 1 + \sin \left[ \frac{2\pi pi}{2^m} \right] \right\} 2^{k-1} - 2^{-1} \quad i=0, 1, 2, \dots, 2^m - 1$$

The process of rounding  $s(i)$  to the nearest integer  $\hat{s}(i)$  in the amplitude range  $(0, 2^k - 1)$  produces the quantization errors,  $\epsilon(i)$ .

$$\epsilon(i) = s(i) - \hat{s}(i)$$

Since quantization error generation is a memoryless process in the system under consideration, it is only necessary to search for symmetrical properties in  $s(i)$ . We will first consider odd symmetry by comparing  $s(2^m - i)$  with  $s(i)$ .

$$\begin{aligned} s(2^m - i) &= \left\{ 1 + \sin \left[ \frac{2\pi p(2^m - i)}{2^m} \right] \right\} 2^{k-1} - 2^{-1} \\ &= \left\{ 1 + \sin \left[ 2\pi p - \frac{2\pi pi}{2^m} \right] \right\} 2^{k-1} - 2^{-1} \\ &= s(-i) \\ &= \left\{ 1 - \sin \left[ \frac{2\pi pi}{2^m} \right] \right\} 2^{k-1} - 2^{-1} \end{aligned}$$

The portion of  $s(i)$  which varies with the sample number ( $i$ ) has opposite sign to that of  $s(-i)$  and hence the spectrum of  $s(i)$  contains only sine wave components. To show that the spectrum of the quantization errors,

$\epsilon(i)$ , only contains sine-wave components it is necessary to show that the quantization process has odd symmetry. Consider the values of  $\sin [2\pi pi/2^m]$  at which transitions in the value of  $\hat{s}(i)$  take place. These values form the following sequence:

$$(\dots -3, -2, -1, 0, +1, +2, +3, \dots) \times 2^{-k+1}$$

This clearly has odd symmetry and hence the spectrum of quantization errors contains only sine wave components.

We next consider the case when  $p$  is odd and search for half-wave symmetry to test for the presence of even harmonics of  $f_c/2^m$ . In the case when  $p$  is even, the sequence of samples in the memory repeats. Assume that  $p$  can be factorized into the product of an odd number,  $a$ , and a power of 2:

$$\text{i.e. } p = a2^b.$$

The sample values,  $s(i)$ , in this case are:

$$s(i) = \left\{ 1 + \sin \left[ \frac{2\pi ai}{2^{m-b}} \right] \right\} 2^{k-1} - 2^{-1}$$

From this equation we deduce that the repetition interval in  $i$  is  $2^{m-b}$  so that the spectrum of the quantization error in the case of composite  $p$  contains only odd harmonics of  $f_c 2^b/2^m$ .

The foregoing discussion has determined the number and frequencies of the unwanted signals due to quantization effects and we now distribute the total error energy,  $E_{TOT}$ , between them according to equation (9). Hence:

$$E_{TOT} = E \sum_{l=0}^{\infty} \frac{\sin^2 [\pi(2l+1)2^{b-m}]}{[\pi(2l+1)2^{b-m}]^2} \tag{10}$$

By the straightforward application of Fourier analysis techniques, it is possible to show that the summation in equation (10) is  $2^{m-b-2}$ . By substitution from equation (8)

$$E = \frac{2^{m-2}}{3} \frac{1}{2^{m-b-2}} = \frac{2^b}{3}$$

The average energy to be associated with each component in the power spectrum resulting from quantization errors is

$$E(\omega_l) = \frac{2^b \sin^2(\omega_l/2f_c)}{3 (\omega_l/2f_c)^2} \tag{11}$$

where

$$\omega_l = 2\pi f_c(2l+1)2^{b-m}$$

### 6 Signal-to-Noise Ratio of the Generated Signal

In the last Section, we found expressions for the average energy levels of the unwanted spectral components in the digital to analogue converter output. By determining the spurious signal energy in the required

output, we will be able to compare this method of generation on a signal-to-noise basis with those appropriate to other techniques. We assume that there are a large number of samples of the stored sine waves (i.e.  $2^m$  large), so that the energy stored in the alternating part of samples (neglecting the quantization errors) is

$$E_s = \sum_{i=0}^{2^m-1} [2^{k-1} \sin(2^{1-m}\pi pi)]^2 \quad (12)$$

$$= 2^{2k+m-3}$$

This energy is distributed amongst all the spectral components present in the sampled (but not quantized) waveform. The energy  $\hat{E}$  in a component at frequency  $f_c p/2^m$  is

$$\hat{E}(\omega_p) = 2^{2k+m-3} \frac{\sin^2(\omega_p/2f_c)}{(\omega_p/2f_c)^2} \quad (13)$$

where

$$\omega_p = 2\pi f_c p 2^{-m}.$$

If we assume that unwanted spectral components in the output signal due to quantization errors are close to the wanted spectral component, the  $\text{sinc}^2(x)$  term cancels, and the average ratio between wanted and unwanted components ( $SNR$ ) is found by dividing equations (13) by (11)

$$SNR = \hat{E}(\omega_p)/E(\omega_i)$$

$$= 3 \times 2^{2k+m-b-3} \quad (14)$$

The utility of equation (14) is that it enables average calculations about likely system performance to be made. For example if r.o.m.s with storage capacity of  $256 \times 8$  bits are used to hold the sine-wave samples and we assume the  $p$  is relatively prime to 256, the energy signal to noise ratio is  $3 \times 2^{21}$  or 68 dB. More typically r.o.m.s with a storage capacity of  $256 \times 5$  bits might be used and then calculations yield (with  $b=0$ ) a signal to noise ratio of 50 dB. In this latter case, the assumption of independence of the quantization errors from sample to sample is not strictly correct but the calculated signal to noise ratio should give a reasonable guide to actual system performance.

## 7 Practical Results and Discussion

A 45-element sector-scanning sonar receiver has been constructed using the signal generation technique described above. To reduce the number of phase-locked carrier signals, group modulation techniques were employed.<sup>3</sup> Altogether eleven frequencies were required at 360, 370, 380 kHz, 1.2, 1.23, 1.26, 2.56, 2.67, 2.76, 2.85, and 2.94 MHz. Appropriate samples were stored in  $256 \times 4$  bit r.o.m.s whose outputs were fed to 4-bit

digital to analogue converters constructed from weighted resistors.

The digital to analogue converter outputs were each fed to simple tuned circuits (with  $Q$ -values in the range 20–30) so generally only the nearest unwanted sidebands to the wanted spectral component had significant magnitude. At the higher frequencies, around 2.7 MHz, the unwanted spectral components at the tuned circuit output had levels better than  $-40$  dB compared with the wanted output and at the lower frequencies it proved possible to achieve ratios better than  $-60$  dB. Even with the crude representation (4 bits) of the wanted signal, it has been possible to reduce the level of the unwanted signals by about 20 dB in comparison with the other methods of generation outlined in the introduction. Two characteristics appear at high clock frequencies which the analysis has not revealed and which both have the same origins. The first of these is that most of the even (as well as some of the odd harmonics) of  $f_c/2^m$  appear in the output spectrum. Secondly, the levels of the unwanted spectrum components tend to be higher than the predicted average levels.

These effects can be attributed to transient non-linearity in the digital-to-analogue converter and to slight unevenness in the sample repetition time due to variations in the delay between a clock pulse and the associated change of signals on the data output lines from the r.o.m.

Potential for the application of more complicated signal processing techniques is made available by replacing the read-only memories by random-access memories which are programmable by mini- or micro-computer.

## 8 References

- 1 Voglis, G. M., 'A general treatment of modulation scanning as applied to acoustic linear arrays', (Parts 1 and 2), *Ultrasonics*, 9, No. 3, pp. 142–53, July 1971 and No. 4, pp. 215–23, October 1971.
- 2 Voglis, G. M., 'Design features of advanced scanning sonars based on modulation scanning', (Parts 1 and 2), *Ultrasonics*, 10, No. 1, pp. 16–25, January 1972 and No. 3, pp. 103–13, May 1972.
- 3 Holley, M. L., Mitson, R. B., and Pratt, A. R., 'Developments in sector scanning sonar'. Conference on Instrumentation in Oceanography, Bangor, September 1975. (IERE Conference Proceedings No. 32, pp. 139–53.)
- 4 Creasey, D. J., and Dunn, J. R., 'A high-resolution within-pulse sector-scanned sonar with electronically-variable focusing'. Conference on Instrumentation in Oceanography, Bangor, September 1975. (IERE Conference Proceedings No. 32, pp. 349–57.)
- 5 Widrow, B., 'Statistical analysis of amplitude-quantized sampled-data systems,' *Trans. Am. Inst. Elect. Engrs, Applications and Industry*, 79, pp. 555–68, January 1961.

*Manuscript first received by the Institution on 10th August 1978 and in final form on 30th November 1978.*  
(Paper No. 1870/AMMS 90)

# Pulse-forming networks using generalized Laguerre polynomials

B. D. RAKOVICH, Dipl. Eng., Ph.D.\*

D. KRSTICH, B.Sc., M.Sc.†

and

M. V. POPOVICH, B.Sc., M.Sc.\*

## SUMMARY

A new class of all-pole transfer functions for pulse-forming networks based on the use of generalized Laguerre polynomials is introduced. It is shown that the two variable parameters, which are available with the generalized Laguerre polynomials, can always be adjusted so as to obtain an impulse response with any prescribed attenuation of transient overshoots. These filters, which may be referred to as generalized Laguerre filters, are shown to include as special cases Bessel filters, Gaussian filters and a recently derived class of transitional filters utilizing modified Bessel polynomials. A comparison with the Schüssler filters, designed for impulse response with equal ripple transient ringing is also presented.

Tables are presented giving the pole locations of these filters for  $n=3-7$  and the transient overshoot attenuation of 20–60 dB in steps of 10 dB. Normalized element values for LC ladder realization with equal resistance terminations are also included.

\* Faculty of Electrical Engineering, University of Belgrade, Belgrade, POB 816, Yugoslavia.

† Department of Electronic Engineering, University of Nish, Nish, Yugoslavia.

## 1 Introduction

In the design of pulse forming networks used in data transmission and other communication systems involving pulses a perfect Gaussian filter is highly desirable since its impulse response is free from any transient ringing; this has the same shape as the magnitude characteristic. Unfortunately, it is known that the Gaussian magnitude characteristic associated with linear phase, or any other phase function, is not physically realizable, since for this type of amplitude response the Paley–Wiener criterion is violated.<sup>1</sup> Hence, in order to obtain a realizable filter function with negligible impulse response overshoot an  $n$ th-order Taylor approximation to the ideal Gaussian magnitude function  $\exp(-\omega^2)$  has been proposed leading to the well-known Gaussian filters.<sup>2</sup>

Alternative methods are based on linear phase approximation or, what amounts to the same, on the approximation of a constant group-delay characteristic by means of a realizable transfer function. Apart from the well-known Bessel filters, that provide a maximally flat type of delay approximation, and the filter functions with Chebyshev linear phase or Chebyshev group delay approximations, there are various other techniques using either analytical or empirical approaches to the linear phase approximation problem.<sup>3,4</sup> The idea underlying all these methods stems from the fact that in minimum-phase networks a linear phase is associated with the magnitude characteristic which is reasonably close to the ideal Gaussian response.

A least squares approximation technique using Laguerre functions has been extensively used in time domain synthesis, but it has not achieved much popularity in the frequency domain synthesis of pulse forming networks. More recently, a method has been proposed to approximate the perfect Gaussian magnitude response by a series of Laguerre polynomials using a least-mean-squares norm.<sup>5</sup> These filters compare favourably with the Bessel filters since they provide the same amount of stopband attenuation but their transient overshoots are less. This paper reports on the results obtained in an attempt to increase the potentiality of this method by expanding the ideal magnitude characteristic into a series of generalized Laguerre polynomials. In these polynomials one additional free parameter is available that can be used to adjust the attenuation of the impulse response overshoots to any prescribed value. Of course, the higher the attenuation of the impulse response overshoots, the smaller is the stopband rejection in the frequency domain so that with this parameter a useful trade-off between time and frequency domain specifications is made possible. Moreover, it will be shown that some of the aforementioned classes of filter functions including Bessel filters and a most recently introduced class of transitional Bessel filters are but special cases of the approximation procedure described. Thus, in a sense, all these filters belong to a common class that might be referred to as the generalized Laguerre filters.

**2 Approximations to the Ideal Gaussian Magnitude**

In the beginning, our procedure parallels that used by Jones<sup>5</sup> so that substituting  $x = \omega^2$  in the reciprocal of the perfect Gaussian magnitude squared function  $\exp(2\omega^2)$  and expanding  $\exp(2x)$  into a series of orthogonal polynomials we have

$$\exp(2x) \approx \sum_{r=0}^n c_r(\beta) L_r^{(\alpha)}(\beta x) \tag{1}$$

where  $c_r(\beta)$  are the Fourier coefficients and  $L_r^{(\alpha)}(\beta x)$  are the generalized Laguerre polynomials with the explicit representation<sup>6</sup>

$$L_n^{(\alpha)}(\beta x) = n! \sum_{\nu=0}^n \binom{n+\alpha}{n-\nu} \frac{(-\beta x)^\nu}{\nu!} \tag{2}$$

For  $\alpha > -1$  the polynomials  $L_n^{(\alpha)}(\beta x)$  are orthogonal in respect of the weight function  $w(x) = x^\alpha \exp(-\beta x)$  over the interval  $[0, \infty]$  in the sense that

$$\int_0^\infty \exp(-\beta x) x^\alpha L_n^{(\alpha)}(\beta x) L_m^{(\alpha)}(\beta x) dx = \frac{n! \Gamma(n+\alpha+1)}{\beta^{\alpha+1}} \delta_{nm} \tag{3}$$

where  $\delta_{nm}$  is the Kronecker delta function, i.e.  $\delta_{nm} = 0$  if  $m \neq n$  and  $\delta_{nm} = 1$  if  $m = n$ .

If the approximation criterion is stated in terms of a least-mean-squares norm the error integral to be minimized has the form

$$E = \int_0^\infty \exp(-\beta x) x^\alpha \left( \exp(2x) - \sum_{r=0}^n c_r(\beta) L_r^{(\alpha)}(\beta x) \right)^2 dx \tag{4}$$

The integral on the right side of (4) converges only if  $\alpha > -1$ ,  $\beta > 4$  and the  $c_r(\beta)$  ( $r=0, 1, 2, \dots$ ) are obtained by the well-known formula for the Fourier coefficients

$$c_r(\beta) = h_r^{-1} \int_0^\infty \exp(-\beta x) x^\alpha \exp(2x) L_r^{(\alpha)}(\beta x) dx \tag{5}$$

where, from (3),

$$h_r = \frac{r! \Gamma(r+\alpha+1)}{\beta^{\alpha+1}} \tag{6}$$

Substituting

$$\beta x = \frac{\beta}{\beta-2} y = ky$$

in (5), it reduces to

$$c_r(\beta) = \frac{k^{\alpha+1}}{r! \Gamma(r+\alpha+1)} \times \int_0^\infty \exp(-y) y^\alpha L_r^{(\alpha)}(ky) dy \tag{7}$$

Using the formula<sup>7</sup>

$$L_n^{(\alpha)}(ky) = \sum_{\nu=0}^n k^\nu (1-k)^{n-\nu} \binom{n}{\nu} \times \frac{\Gamma(n+\alpha+1)}{\Gamma(\nu+\alpha+1)} L_\nu^{(\alpha)}(y) \tag{8}$$

and the orthogonality relations for the generalized Laguerre polynomials (3), the last integral (7) can easily be evaluated

$$c_r(\beta) = \frac{k^{\alpha+1} (1-k)^r}{r!} \tag{9}$$

Substituting (9) in (1), we have

$$\exp(2x) \approx \sum_{r=0}^n c_r L_r^{(\alpha)}(\beta x) = k^{\alpha+1} \sum_{r=0}^n \frac{1}{r!} (1-k)^r L_r^{(\alpha)}(\beta x) \tag{10}$$

or, returning to the previous variables  $x = \omega^2$ ,  $k = \beta/(\beta-2)$ , the magnitude squared function of the  $n$ th order approximant is finally obtained in the form

$$A_n^2(\omega^2) = \frac{1}{\left(\frac{\beta}{\beta-2}\right)^{\alpha+1} \sum_{r=0}^n \frac{1}{r!} \left(\frac{2}{2-\beta}\right)^r L_r^{(\alpha)}(\beta \omega^2)} \tag{11}$$

Of course, the transfer function and the pole locations are then found by standard method, i.e. by putting  $\omega^2 = -s^2$  and factorizing out the roots in the left half of the  $s$ -plane.

The choice of the parameters  $\alpha$  and  $\beta$  is an important consideration. Unless these two parameters are constrained to  $\alpha > -1$ ,  $\beta > 4$ , the error integral does not converge and, hence, in a strict sense the magnitude function (11) does not represent a least-mean-squares approximant to a perfect Gaussian magnitude characteristic. On the other hand, the generalized Laguerre polynomials are defined for all real values of the parameters  $\alpha$  and  $\beta$  and, so is the summation formula (8). Also, from the physical point of view, the restrictions  $\alpha > -1$ ,  $\beta > 4$  are not essential so that it can be concluded that all real values of  $\alpha$  and  $\beta$  are permissible.

**3 Applications and Comparison with Other Systems**

The two variable parameters  $\alpha$  and  $\beta$  in the magnitude squared function (11) can be adjusted so that the resulting filters fulfils any prescribed specification with respect to the attenuation of the first two impulse response overshoots. No additional parameter is available in (11) to control other transient overshoots that may occur in the impulse response. However, the amplitudes of these overshoots, if any, are so much smaller than the first two that they are of no practical significance.

The problem of determining the unknown parameters can be solved by means of a digital computer and a simple search program. Suitable search programs are widely



available and the computation is not unduly time consuming because the ranges of variables  $\alpha$  and  $\beta$  (or preferably  $k = \beta/(\beta - 2)$ ) are limited for filter functions of any degree. Also, decreasing the attenuation of the transient overshoot increases  $k$  and decreases  $\alpha$  for all  $n$ . However, in order to facilitate the practical applications

of the filter functions described in Tables 1-5 pole locations are presented for filters of order  $n=3-7$  that provide equal attenuation of the first and the second impulse response overshoots in the range 20-60 dB in steps of 10 dB. In all cases the frequency is normalized so that  $\omega_{3\text{ dB}} = 1$ .

**Table 1**  
Pole locations and element values for overshoot attenuation of 20 dB

Order	Pole locations		Type	$C_1$	$L_2$	$C_3$	$L_4$	$C_5$	$L_6$	$C_7$
3	-0.4550463	+j0.0000000	M, O	1.2065	0.9037	3.4143				
	-0.3333378	±j1.0341586								
4	-0.6886977	±j0.3294359	M	2.6630	1.0250	1.1397	0.6078			
	-0.3216586	±j1.3081648	O	0.9333	2.7492	0.6995	1.0535			
5	-0.3999099	+j0.0000000	M	3.1830	0.8260	1.3563	0.4859	0.7829		
	-0.3038155	±j0.8998570	O	1.1186	0.3025	2.7699	1.0094	1.4336		
6	-0.5423754	±j0.2783404	M	2.8269	1.1184	1.0321	0.6598	0.7720	0.5981	
	-0.3008687	±j1.0425924	O	1.4494	0.2740	1.8367	1.3536	1.3448	0.7486	
7	-0.1696079	±j2.1375292								
	-0.8804910	+j0.0000000	M	2.3628	0.9583	0.6645	0.5210	0.7152	0.8035	0.3419
	-0.7691603	±j0.5815693	O	0.7630	0.5417	0.9514	0.2933	1.8792	1.4478	0.4908
	-0.4015322	±j1.4042416								
	-0.0631516	±j2.7262096								

**Table 2**  
Pole locations and element values for overshoot attenuation of 30 dB

Order	Pole locations		Type	$C_1$	$L_2$	$C_3$	$L_4$	$C_5$	$L_6$	$C_7$
3	-0.7050447	+j0.0000000	M, O	2.6267	0.9205	0.6402				
	-0.6188066	±j1.2040005								
4	-0.9111475	+j0.3989424	M	2.3582	1.0271	0.8493	0.3860			
	-0.5962257	±j1.4800545	O	0.7222	2.5940	0.6909	0.6135			
5	-0.5982826	+j0.0000000	M	2.6343	0.9248	0.9245	0.5689	0.4339		
	-0.5369825	±j0.9785287	O	0.7175	0.3496	2.5004	1.1442	0.7747		
6	-0.5061261	±j2.1378043								
	-0.7608953	±j0.3530044	M	2.3885	1.0387	0.8216	0.6383	0.5889	0.3272	
	-0.5536406	±j1.2390181	O	0.7906	0.2751	2.0210	1.2767	0.9874	0.4524	
	-0.4230225	±j2.4450620								
7	-0.9997708	+j0.0000000	M	2.2952	1.0236	0.7835	0.6121	0.5735	0.5468	0.2368
	-0.8954854	±j0.6346240	O	0.4323	0.4507	0.8110	0.4297	2.2193	1.3021	0.4264
	-0.5854010	±j1.4853468								
	-0.3482629	±j2.7685687								

**Table 3**  
Pole locations and element values for overshoot attenuation of 40 dB

Order	Pole locations		Type	$C_1$	$L_2$	$C_3$	$L_4$	$C_5$	$L_6$	$C_7$
3	-0.9057006	+j0.0000000	M, O	2.3770	0.9308	0.4586				
	-0.8477935	±j1.2073181								
4	-1.0771010	±j0.4236493	M	2.2938	1.0278	0.7359	0.2969			
	-0.8247224	±j1.4892418	O	0.6152	2.5706	0.7096	0.4591			
5	-0.7773552	+j0.0000000	M	2.3836	0.9713	0.8049	0.5728	0.3112		
	-0.7383759	±j0.9947756	O	0.5521	0.3991	2.3987	1.1451	0.5488		
6	-0.6896054	±j2.1380748								
	-0.9161722	±j0.3825218	M	2.2909	1.0207	0.7761	0.6337	0.5223	0.2397	
	-0.7596073	±j1.2810656	O	0.5023	0.8473	2.5683	0.6647	0.5186	0.3820	
	-0.6284109	±j2.4412288								
7	-1.1208003	+j0.0000000	M	2.2683	1.0191	0.7682	0.6324	0.5635	0.4572	0.1836
	-1.0312944	±j0.6679192	O	0.3725	1.1736	2.3366	0.4784	0.7622	0.4568	0.3123
	-0.7837735	±j1.5138803								
	-0.5677987	±j2.7077402								

**Table 4**  
Pole locations and element values for overshoot attenuation of 50 dB

Order	Pole locations		Type	$C_1$	$L_2$	$C_3$	$L_4$	$C_5$	$L_6$	$C_7$
3	-1.0783653	+j0.0000000	M, O	2.2850	0.9038	0.3679				
	-1.0387364	±j1.1671269								
4	-1.2274486	±j0.4367323	M	2.2652	1.0022	0.6558	0.2458			
	-1.0275089	±j1.4711316	O	0.5405	2.5450	0.7076	0.3760			
5	-0.9361160	+j0.0000000	M	2.2972	0.9930	0.7621	0.5510	0.2488		
	-0.9119698	±j0.9784262	O	0.4634	0.4469	2.4094	1.0971	0.4353		
6	-0.8476649	±j2.0722458								
	-1.0411986	±j0.3981138	M	2.2646	1.0153	0.7636	0.6219	0.4737	0.1960	
7	-0.9288403	±j1.2872078	O	0.4175	0.8276	2.2560	0.6881	0.5244	0.3176	
	-0.8016210	±j2.3787212								
7	-1.2250170	+j0.0000000	M	2.2591	1.0153	0.7639	0.6353	0.5419	0.4025	0.1537
	-1.1506488	±j0.6905212	O	0.3348	1.0791	2.4119	0.5239	0.7196	0.4501	0.2524
	-0.9554436	±j1.5250945								
	-0.7562769	±j2.6327313								

**Table 5**  
Pole locations and element values for overshoot attenuation of 60 dB

Order	Pole locations		Type	$C_1$	$L_2$	$C_3$	$L_4$	$C_5$	$L_6$	$C_7$
3	-1.2126798	+j0.0000000	M, O	2.2520	0.8678	0.3187				
	-1.1843885	±j1.1157864								
4	-1.3252101	±j0.4546813	M	2.2513	0.9749	0.6038	0.2184			
	-1.1863622	±j1.4537191	O	0.5002	2.5244	0.6930	0.3307			
5	-1.0800245	+j0.0000000	M	2.2692	1.0010	0.7396	0.5204	0.2112		
	-1.0640316	±j0.9506361	O	0.4075	0.4882	2.4451	1.0333	0.3673		
6	-0.9841982	±j1.9895975								
	-1.1084660	±j0.4165794	M	2.2556	1.0146	0.7568	0.6081	0.4416	0.1747	
7	-0.9321758	±j2.3315455	O	0.6146	2.5271	0.7083	0.7066	0.4745	0.2203	
	-1.0425833	±j1.3026804								
7	-1.3121403	+j0.0000000	M	2.2564	1.0141	0.7620	0.6295	0.5181	0.3650	0.1350
	-1.2526819	±j0.7081555	O	0.3078	1.0085	2.4603	0.5627	0.6862	0.4374	0.2172
	-1.1008027	±j1.5287361								
	-0.9167302	±j2.5617526								

As might be expected, the stopband rejection increases with an increase in the maximum tolerable values of impulse response overshoots. To illustrate this, in Figs. 1 and 2 the amplitude and impulse response characteristics of the fifth-order approximants with transient overshoots of 30 dB, 40 dB and 60 dB down are displayed. Included in Fig. 1 are also the passband delay responses of these filters which are reasonably flat in all cases.

For  $\alpha=0, \beta=7$ , the magnitude-squared function (11) reduces to that described by Jones.<sup>5</sup> These functions have subsequently been used by Weaver and Broughton<sup>8</sup> to achieve suitable shaping in pulse generation circuitry for television equipments. The superiority claimed for the Jones filters over the Gaussian filters of Dishal in respect of the stopband rejection has been confirmed since, for example, the Jones filter for  $n=5$  provides a stopband attenuation of 49 dB at the normalized frequency  $\omega=5$ , which is to be compared with 42.5 dB for the Gaussian filter of Dishal. On the other hand, the Gaussian filter yields a higher attenuation of transient overshoot of 68 dB in comparison with 56 dB for the fifth-order filter of Jones. At the same time, the fifth-order network of the present design for  $\alpha=1, k=1.23$  has transient overshoots 70 dB down and yet at the

normalized frequency  $\omega=5$  it provides about 5 dB more stopband rejection than the Gaussian filter.

In this connection the following remark seems to be in order. For  $\alpha=0$ , the generalized Laguerre polynomial (2) reduces to the Laguerre polynomial  $L_n(\beta x)$  dependent on one variable parameter  $\beta$ . This parameter does not play the role of a simple scaling factor which controls only the convergence rate of the error integral as suggested by Jones, and subsequently by Weaver and Broughton.<sup>8</sup> Since the weight function in the error integral (4) depends on  $\beta$ , so also does the final, stable solution obtained by minimization of the error integral. This is demonstrated in Fig. 3 in which the impulse response of the fifth-order filter of Jones ( $\alpha=0, \beta=7$ ) is shown together with the solutions obtained for two different values of  $\beta$  ( $\beta=5, \beta=15, \alpha=0$ ).

The Schüssler filters<sup>9,10</sup> are known to produce the narrowest pulse-width for a given frequency bandwidth and a prescribed maximum value of transient overshoot. The impulse response of these filters is characterized by  $(n-1)$  equal transient overshoots where  $n$  is the order of the network. The transfer functions of these filters have been determined by direct time-domain synthesis. First, an analogue computer is used to find an approximate

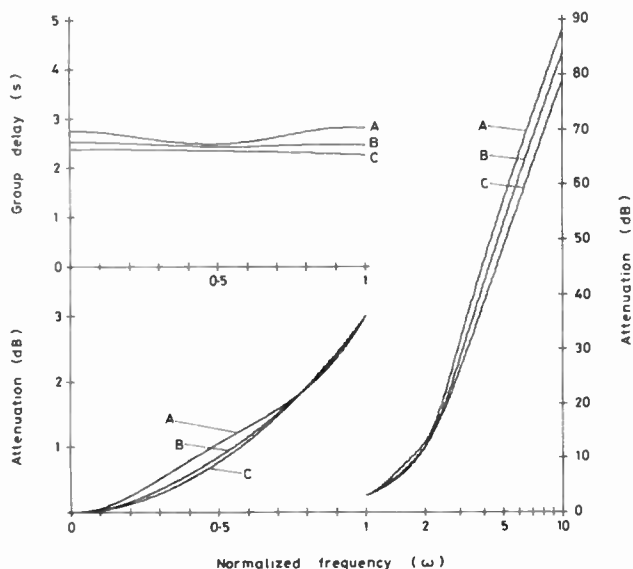

Fig. 1. Attenuation and group delay responses of the fifth-order filters for overshoot attenuation of 30 dB (A); 40 dB (B) and 60 dB (C).

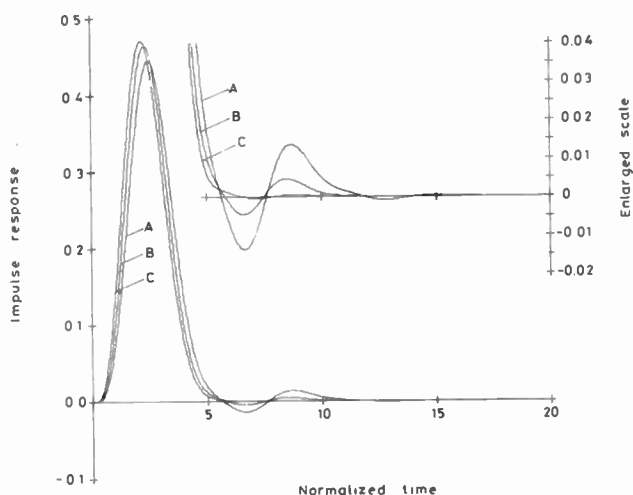

Fig. 2. Impulse responses of the fifth-order filters for overshoot attenuation of 30 dB (A); 40 dB (B) and 60 dB (C).

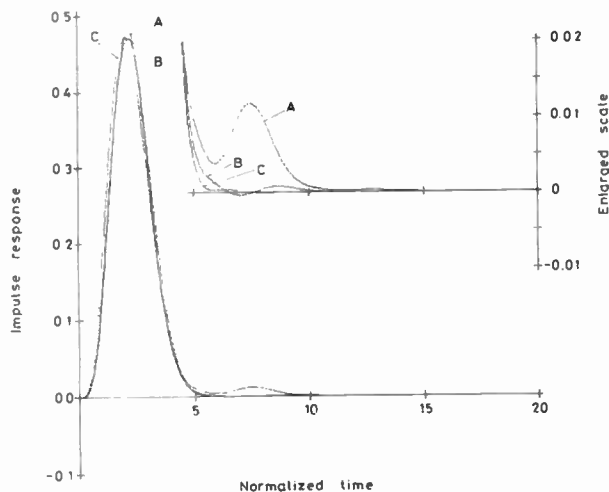

Fig. 3. Impulse responses of the fifth-order networks for  $\alpha=0$  and  $\beta=5$  (A);  $\beta=7$  (B) and  $\beta=15$  (C).

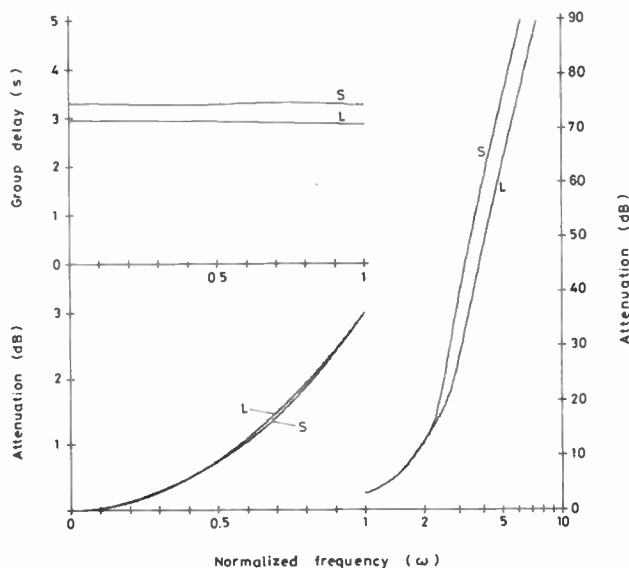

Fig. 4. Attenuation and group delay responses of the seventh-order filters with 40 dB overshoot attenuation: Schüssler filter (S); new design (L).

solution sufficiently close to the final result, and then the exact transfer function is found by means of a digital computer. Since there are  $(n-1)$  transient overshoots of equal magnitude in the impulse response of Schüssler filters, it is evident that for  $n=3$  the Schüssler filter and the present solution are identical. Also, for  $n=4$  and  $n=5$  the results obtained by both methods are quite similar. However, increasing the order of the network increases the differences between the two designs. This is illustrated in Figs. 4 and 5 in which the frequency domain characteristics and the impulse responses of the seventh-order filters are compared. Both are designed

for 1% transient overshoot (40 dB overshoots attenuation). The Schüssler filter and the new one have almost constant group delay responses in the passband and very similar magnitude characteristics up to the end of the first octave in the stopband, but the Schüssler filter provides more stopband selectivity. On the other hand, from the point of view of intersymbol interference in pulse communication systems the new design is superior because of the long tail in the impulse response of the Schüssler filter which has the first six overshoots of equal magnitude (Fig. 5).

The filter functions described can be realized as

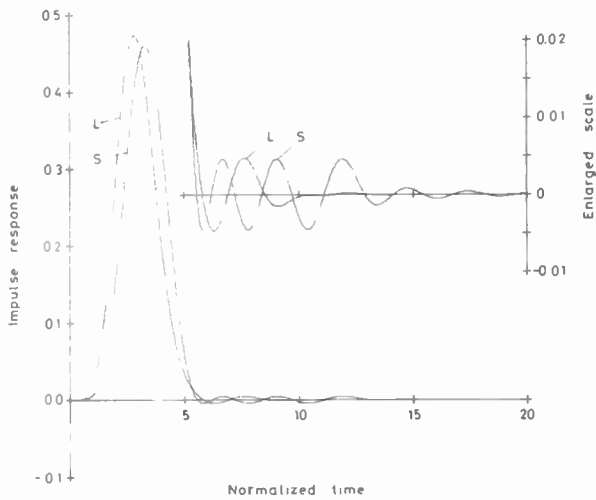

Fig. 5. Impulse responses of the seventh-order filters with 40 dB overshoot attenuation: Schüssler filter (S); new design (L).

passive LC networks or in active form using the data presented in Tables 1-5. To facilitate the work, these Tables also contain the normalized element values of lossless ladder networks with equal resistance terminations of 1 Ω (Fig. 6). Two sets of element values are given. In the first realization, referred to as maximized (M), all reflection zeros are confined to the left half of the complex frequency plane. As shown by Bode<sup>11</sup> this type of realization provides the highest gain-bandwidth product but the ratio of the terminating capacitances may be too high in case of higher-order networks. The second realization, which is termed optimum<sup>8</sup> (O), is preferable in some applications since it provides much smaller ratios of the terminating capacitances.

To illustrate the method a fifth-order LC filter was designed with the terminating resistances  $R_g = R_L = 150 \Omega$ , the cut-off frequency  $f_c = 500 \text{ kHz}$ , and the element values (tolerances 1.25%):  $C_1 = 5060 \text{ pF}$ ,  $L_2 = 46.39 \mu\text{H}$ ,  $C_3 = 1708 \text{ pF}$ ,  $L_4 = 27.36 \mu\text{H}$ ,  $C_5 = 660 \text{ pF}$ . The measured values of the  $Q$  factors of the inductors at  $f = 500 \text{ kHz}$  were  $Q = 210$  for  $L_2$  and  $Q = 160$  for  $L_4$ . In Fig. 7 the responses of the filter to an impulse (400 ns duration) and a step input waveforms are shown. The experimental results were in excellent agreement with theoretical prediction.

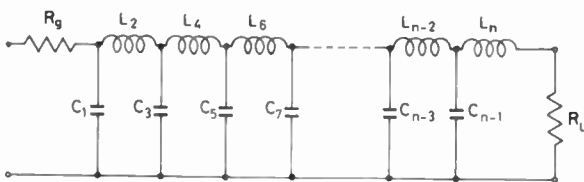
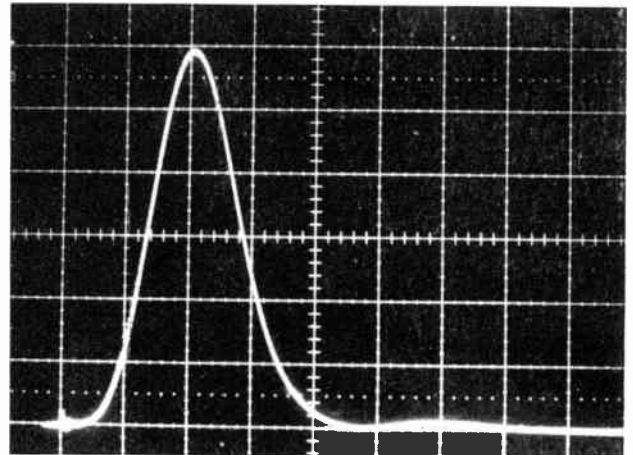
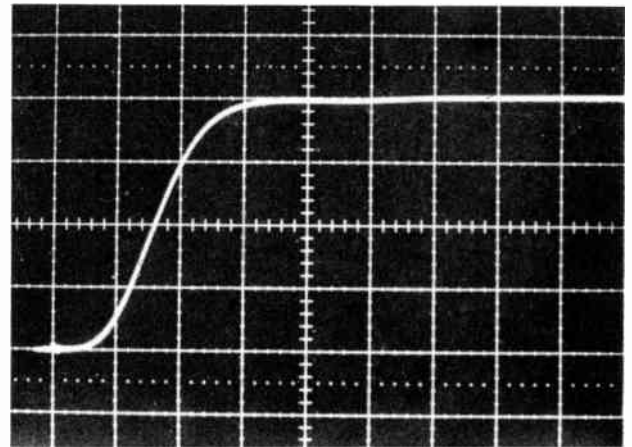

Fig. 6. Lossless ladder realization with resistance terminations



(a) Vertical scale 0.2 V/div, horizontal scale 500 ns/div;



(b) Vertical scale 0.5 V/div, horizontal scale 500 ns/div.

Fig. 7. Impulse and step responses of the fifth-order filter

#### 4 Some Remarks on Linear Phase Filters

The transfer function of Bessel filters approximating to the ideal group delay characteristic in a maximally flat sense has the form<sup>12</sup>

$$F_n(s) = \frac{y_n(0)}{y_n(s)} \tag{12}$$

where the polynomials  $y_n(s)$  are related to Bessel polynomials  $B_n(s)$  by

$$y_n(s) = s^n B_n\left(\frac{1}{s}\right) = \sum_{k=0}^n \frac{(2n-k)! s^k}{2^{n-k} k!(n-k)!} \tag{13}$$

Now, substituting  $\beta = 2$ ,  $\alpha = -2n - 1$  in (2) and employing the well-known combinatorial identity<sup>13</sup>

$$\binom{n+m-1}{m} = (-1)^m \binom{-n}{m} \tag{14}$$

we have

$$L_n^{(-2n-1)}(2s) = (-2)^n \sum_{r=0}^n \frac{(2n-r)! s^r}{2^{n-r} r!(n-r)!} \tag{15}$$

Comparing (13) and (15) we find

$$y_n(s) = \frac{1}{(-2)^n} L_n^{(-2n-1)}(2s) \quad (16)$$

Thus, the transfer function of the Bessel filters (12) can be written in the equivalent form

$$F_n(s) = \frac{L_n^{(-2n-1)}(0)}{L_n^{(-2n-1)}(2s)} \quad (17)$$

meaning that the maximally flat delay approximation is only a special case of filter functions using generalized Laguerre polynomials.

It is known<sup>14</sup> that generalized Laguerre polynomials for  $\alpha < -n$  have no real zero for  $n$  even and one real zero (which is negative) for  $n$  odd. Another useful property of these polynomials that has been verified by numerical computation up to degree  $n=15$  is that they have a strictly Hurwitz character for  $\alpha < \alpha_H$  where  $\alpha_H = -(0.021n^2 + 1.31n - 0.679)$ . Now, if in  $L_n^{(\alpha)}(2s)$  the parameter  $\alpha$  is adjusted in the range  $-2n-1 < \alpha < \alpha_H$  so that the resulting magnitude response has a zero attenuation at a frequency near the band-edge, a useful class of transitional Bessel filters is obtained. These filters most recently derived using a different technique combine a fair amount of stopband attenuation with excellent phase linearity over a large portion of the passband.<sup>15</sup>

If, on the other hand,  $\alpha < -2n-1$  is used in (17), the stopband attenuation decreases but the attenuation of the impulse response overshoots increases when compared with that for the Bessel filter ( $\alpha = -2n-1$ ). As an example, in Fig. 8 the frequency domain characteristics of the filters using generalized Laguerre polynomials for  $n=4$  ( $\alpha = -12.7$ );  $n=6$  ( $\alpha = -20.75$ ) and  $n=10$  ( $\alpha = -29.0$ ) are plotted together with the Gaussian filters of

Dishal for  $n=4$ ,  $n=7$ , and  $n=10$ . Since for all practical purposes the corresponding filters are identical, the Gaussian filters can also be considered to be a special case of the generalized Laguerre filters.

The discussion regarding the relative merits of various filters belonging to this class can now be concluded by stating that the Bessel filters provide least delay distortion in the passband and are optimum in those applications where the approximation of a constant group delay is of overriding importance. From the point of view of the attenuation of impulse response overshoots and the stopband rejection they are inferior to the Laguerre filters discussed in the preceding Section. For example, the fifth-order Bessel filter has the first two overshoots 34 dB and 49 dB down, respectively, and the stopband attenuation of 49.3 dB at the normalized frequency  $\omega=5$ . The fifth-order approximant from Table 4, having approximately the same stopband rejection,  $A=50.2$  dB at the normalized frequency  $\omega=5$ , yields transient overshoot attenuation of 50 dB. As for Gaussian filters of Dishal it follows from the discussion in the preceding Section that they are optimum in no respect.

### 5 Conclusion

A method has been presented for determining a class of all-pole transfer functions intended for pulse applications which provides a useful trade-off between frequency and time domain characteristics of the resulting filters. Results derived are more general than those previously obtained by using Laguerre polynomial series to approximate a perfect Gaussian magnitude response because of an additional parameter available with the generalized Laguerre polynomials. It has been shown that this additional parameter may be used to obtain filter characteristics with either more stopband rejection or less transient ringing in the time domain. The attenuation of impulse response overshoots can be adjusted to any prescribed value. In addition, these filter functions have been shown to include as special cases Bessel filters, Gaussian filters and a recently introduced class of transitional Bessel filters.

### 6 Acknowledgment

The authors wish to acknowledge the Research Fund of SR Serbia for financial support of work of which that described forms a part. They also wish to thank Dr. Lj. Milić for practical realization of the filter described in Section 3.

### 7 References

- 1 Daniels, R. W., 'Approximation Methods for Electronic Filter Design', pp. 256-9 (McGraw-Hill, New York, 1974).
- 2 Dishal, M., 'Gaussian-response filter design', *Electrical Communication*, 36, no. 1, pp. 3-26, March 1959.
- 3 Humphreys, D. S., 'The Analysis, Design, and Synthesis of Electrical Filters', pp. 413-45 (Prentice Hall, Englewood Cliffs, 1970).
- 4 Su, K. L., 'Time Domain Synthesis of Linear Networks' pp. 170-316 (Prentice Hall, Englewood Cliffs, 1971).

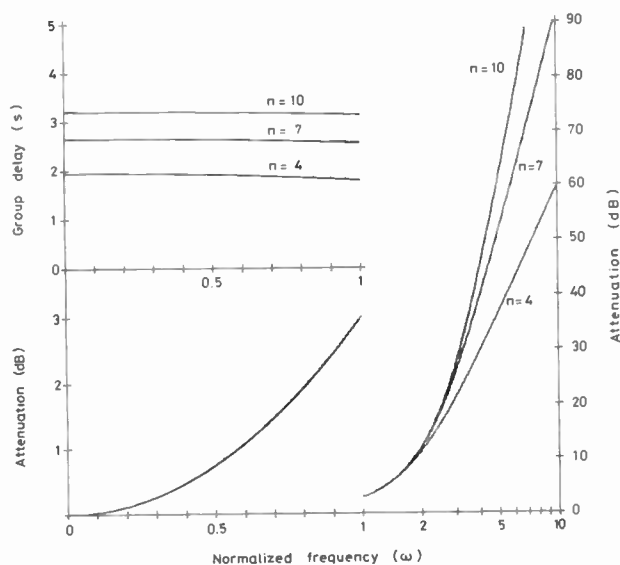

Fig. 8. Magnitude and group delay responses of the Gaussian filters of Dishal and the new filters for  $n=4$ ;  $n=7$  and  $n=10$ .

- 5 Jones, N. B., 'A Laguerre series approximation to the ideal Gaussian filter', *The Radio and Electronic Engineer*, 40, no. 3, pp. 151-5, September 1970.
- 6 Abramowitz, M. and Stegun, I. A., 'Handbook of Mathematical Functions', p. 775 (Dover Publications, New York, 1965).
- 7 Mitrinović, D. S., 'Introduction to Special Functions', 2nd ed., pp. 47-60 (Gradjevinska knjiga, Beograd, 1975). (In Serbian).
- 8 Weaver, L. E. and Broughton, D. C., 'Gaussian filters for pulse shaping', *The Radio and Electronic Engineer*, 41, no. 10, pp. 457-62, October 1971.
- 9 Jess, J. and Schüssler, H. W., 'A class of pulse forming networks', *IEEE Trans. on Circuit Theory*, CT-12, no. 2, pp. 296-9, June 1965.
- 10 Jess, J. and Schüssler, H. W., 'On the design of pulse forming networks', *IEEE Trans. on Circuit Theory*, CT-12, no. 3, pp. 393-400, September 1965.
- 11 Bode, H. W., 'Network Analysis and Feedback Amplifier Design' (Van Nostrand, New York, 1945).
- 12 Weinberg, L., 'Network Analysis and Synthesis', pp. 499-504 (McGraw Hill, New York, 1962).
- 13 Riordan, J., 'Combinatorial Identities', p. 1 (J. Wiley, New York, 1968).
- 14 Szegő, G., 'Orthogonal Polynomials', p. 147 (American Mathematical Society, Colloquium Publications, Vol. XXIII, New York, 1939).
- 15 Rakovich, B. D., Popovich, M. V. and Drakulich, B. S., 'Minimum phase transfer functions providing a compromise between phase and amplitude approximation', *IEEE Trans. on Circuits and Systems*, CAS-24, no. 12, pp. 718-24, December 1977.

*Manuscript first received by the Institution on 31st March 1978 and in final form on 5th October 1978  
(Paper No. 1871/CC303)*

## The Authors



Professor Branko Rakovich received his bachelor's and doctor's degrees from the University of Belgrade in 1948 and 1955 respectively. From 1948 to 1951 he served as a Research Assistant at the Institute for Telecommunications of the Serbian Academy of Science, Belgrade, and he then joined the Faculty of Electrical Engineering at the University of Belgrade as a Teaching Assistant until 1954 when he became an

Assistant Professor. From 1954 to 1955 he held a National Education and Research Council of Yugoslavia Fellowship at Marconi College, Chelmsford. In 1959 he was appointed an Associate Professor of Electronics and later a full Professor of Electrical Engineering; currently he is also the Head of the Department of Electronics. His research interests lie in the field of active and passive network synthesis, particularly in wide-band amplifier theory and design.



Dragisha Krstich obtained his B.Sc. degree in electronic engineering in 1965 from the Department of Electronic Engineering, University of Nish and his M.Sc. degree in electrical engineering in 1974 from the Faculty of Electrical Engineering, University of Belgrade. He is now Senior Teaching and Research Assistant at the Department of Electronic Engineering, University of Nish, and he has taught two courses in

linear and non-linear electronic circuitry. Mr Krstich has published several technical papers and he is now doing research in filter synthesis towards a Ph.D. degree.



Miodrag Popovich received the B.Sc. degrees in electrical engineering from the Faculty of Electrical Engineering, University of Belgrade, in 1972 and 1975, respectively. Since 1972 he has been a Teaching and Research Assistant on the Faculty of Electrical Engineers. He is currently finishing his research in filter theory towards the Ph.D. degree in electrical engineering. his research interests being ana-

logue and digital filter design and computer-aided circuit design.