

Founded 1925

Incorporated
by Royal Charter 1961

*To promote the advancement
of radio electronics and kindred
subjects by the exchange of
information in these branches
of engineering*

Volume 44 No. 4

April 1974

The Radio and Electronic Engineer

The Journal of the Institution of Electronic and Radio Engineers

Guglielmo Marconi, 1874-1937

GUGLIELMO MARCONI, the great pioneer of practical radio telecommunications, was born 100 years ago on 25th April 1874 in Bologna, Italy, of an Irish mother and an Italian father.

As a young man, still in his teens, he was inspired to think that electric waves were likely to offer an effective means of sending Morse signals over large distances through space. In coming to this view he was influenced particularly by the work of Clerk Maxwell showing that light had the character of an electric wave, of Heinrich Hertz demonstrating the reality of Maxwell's theory, of Oliver Lodge in



GEC—Marconi Electronics photograph

Marconi with equipment which he demonstrated soon after coming to England in 1896. This photograph shows his insistence on good earthing: wide copper straps link the apparatus to the metal wall of the screen cage.

perfecting the coherer and in designing new arrangements for generating short waves, and perhaps above all by his compatriot Augusto Righi who did so much in the nearby University of Bologna to develop the experimental techniques then available.

Although Marconi must have been at that time a comparative amateur in studies of electric waves and of devices for radiating and receiving them, he determined in 1894 to set up for himself equipment

with which to obtain first-hand information and experience of the possibilities. He proceeded to do this at the family home, the Villa Grifone near Pontecchio just outside Bologna and his enterprise developed surprisingly quickly into the epoch-making experiments with which his name is now indelibly associated.

Marconi, like many of our innovators of major technological developments, possessed in marked degree what may perhaps be described as an uninhibited imagination tempered by a good practical approach to the translation of ideas into tangible form. Although a novice in the early days of his efforts, he was quick to learn from experience and to adjust his concepts accordingly.

Marconi's experiments were marked by their first real success during the summer of 1895 and from that time onwards he made astonishing progress towards the spanning of greater distances and the achievement of much improved signals. By the following year, 1896, he was confidently transmitting messages over $1\frac{3}{4}$ miles, within another 12 months the range had risen to 8 miles and by 1899 he had established radio communication across the Channel between France and England, followed in 1901 by the celebrated link between Poldhu in Cornwall and St. John's in Newfoundland.

What was so remarkable about Marconi was his absolute conviction from the start that he would achieve his goal of sending telegraph messages over large distances through space, in spite of the widely accepted belief at the time that this would fail to materialize due to the curvature of the earth's surface. Quite early in his work Marconi had made some simple experiments at the Villa Grifone, receiving messages in a valley well below the line-of-sight from the transmitter and his results which showed quite good signals in shadow convinced him that radio waves do not necessarily always travel in straight lines. While he conceded that very tall aerials were required for transmission over long distances, he maintained nevertheless that the waves tend to hug the surface of the earth and thus to extend their influence quite significantly over the horizon.

While Marconi made every conceivable use of instruments and equipment developed by others he also added much of his own. His discovery of the much improved performance of aerials when grounded had very important consequences and his application, at a very early date, of continuous-wave operation with tuned circuits replacing the earlier heavily-damped spark-gap arrangements, was a notable advance. He was also one of the first to observe diurnal variations in radio transmission.

For the detection and translation of signals into observable form, Marconi had to rely first on coherers, representing as they did, one of the forerunners of semiconductor electronics. When the thermionic valves of Ambrose Fleming and Lee de Forest came along about 1907, a complete transformation of the scene took place making possible the enlargement of previous developments to create a worldwide communications network and services of almost inconceivable facilities. One wonders what Marconi would have thought of present-day miracles of communication over the vast distances of outer space. It is perhaps a sobering reflection that with all our accumulated knowledge and experience, we are apparently still no nearer to an understanding of what provides for the electric waves to travel through space in which there is no material medium, only the so-called all-pervading aether.

Side-by-side with his deep scientific interest Marconi had a well-developed sense of the commercial value of his work, probably more so than any of his contemporaries. He exhibited a surprisingly

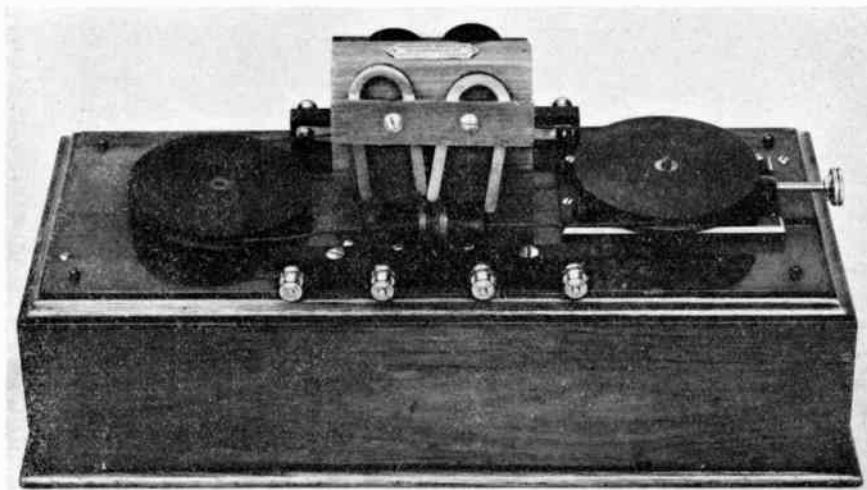

The magnetic detector developed by Marconi from an experimental detector invented by Rutherford in 1895. A high frequency field acting on a piece of magnetic material overcomes its magnetic hysteresis (cf. h.f. bias in modern tape recording). In Marconi's magnetic detector, an endless band of iron wires is moved by clockwork past permanent magnets at about 8 cm/s. At the point where the moving band experiences a strong field from the magnets it is surrounded by two small coils of wire; one coil carries the radio-frequency signal from the aerial, the other is connected to headphones. The bursts of r.f. signal received from a spark transmitter induce impulses of current through the headphones, giving an audible note. This device was in widespread use for nearly twenty years.

Science Museum photograph and description

The Radio and Electronic Engineer. Vol. 44, No. 4

good understanding of the enormous potentialities of radio telecommunications and he worked very hard towards the practical exploitation of his interests.

On this hundredth anniversary of Marconi's birth we salute him as a truly remarkable man, not least for his profound perception of the great possibilities of radio and for the invaluable work he did to advance knowledge of it but also as much for his acumen and ability in bringing these developments to fruition in the service of mankind.

H. M. BARLOW

Some Marconi Landmarks

25th April 1874	Born in Bologna.	December 1909	Shared Nobel Prize for Physics with Prof. K. F. Braun (Telefunken).
1894	First experiments.	1912	Formation of Amalgamated Wireless (Australasia) Ltd.
1896	Came to England.	1915	Appointed to Italian Army General Staff.
2nd June 1896	World's first patent for wireless telegraphy (Brit. Pat. No 12039).	1916	First started work on inter-ship communications using ultra-short waves (~2m).
June and September 1896	Trials on Salisbury Plain	April 1923	Started short-wave (97m) trials between Poldhu and S.Y. <i>Elettra</i> in the Atlantic. Ranges up to 2230 nautical miles recorded.
20th July 1897	Formation of 'The Wireless Telegraph and Signal Company Limited'.	May 1924	Speech transmission on 92m from Poldhu to Sydney, N.S.W.
23rd November 1897	First over-sea trials from Bournemouth to Isle of Wight and to ships 18½ miles distant.	October 1924	Short-wave transmissions with North and South America and Australia on 32m.
May 1898	Italian Navy adopted Marconi system. Demonstration to Lloyd's Committee off Rathlin Island.	1930	Created Marchese.
December 1898	Demonstration to Elder Brethren of Trinity House.	1931	Demonstrated duplex telephony over 22 mile link in Italy on 50 cm wavelength.
17th June 1899— 23rd September	Tests for Royal Navy in English Channel from stations at Dover and Wimereux (ranges up to 85 miles).	1933	Microwave propagation trials over sea.
15th November 1899	First ship's newspaper compiled on S.S. <i>St. Paul</i> .	1934	Demonstrated microwave direction finder by navigating <i>Elettra</i> 'blind'.
25th April 1900	Marconi International Marine Communication Co. Ltd. formed.	1935 and 1937	Experiments on radio reflexions from land vehicles and aircraft.
26th April 1900	Tuned coupled circuit patent (No. 7777).	20th July 1937	Died after heart attack.
4th July 1900	Admiralty contract for wireless apparatus.	Some Marconi Biographies	
23rd July 1900	Company renamed Marconi's Wireless Telegraph Co. Ltd.	Jolly, W. P., 'Marconi'. (Constable, London 1972)	
January 1901	Poldhu station commissioned.	Baker, W. J., 'A History of the Marconi Company'. (Methuen, London 1962)	
June 1901	Transmission received over 186 miles at Niton, Isle of Wight, and over 255m at Crookhaven, Co. Cork.	Marconi, Degna, 'My Father Marconi'. (Muller, London 1962)	
12th December 1901	Transatlantic transmission from Poldhu to St. John's.	Geddes, R., 'Guglielmo Marconi 1874-1937'. (H.M. Stationery Office, London 1974)	
1st April 1902	Marconi's Wireless Telegraph Company of America (later RCA) incorporated as public company.	Marconi Centenary Celebrations	
1902	Magnetic detectors patented.	'The Marconi Heritage', a colloquium held on 25th April at the IEE with the joint sponsorship of the IERE and the RSGB, consisted of five lectures on his life and contributions to radio. (Details of the lectures were given in the February Journal.)	
December 1902	Permanent station commenced operation at Glace Bay, Newfoundland.	On 26th April, a special exhibition called 'I'll put a girdle round about the Earth . . .', and bringing together original documents, personalia and commemorative material, as well as some representative early apparatus, was opened at the Science Museum, London, by Marchesa Maria Cristina Marconi. It will remain on view to the public for about six months.	
24th July 1903	Patent rights and use of high power station granted to British Admiralty.	A Science Museum Booklet by Keith Geddes (see above), has been published to coincide with the exhibition, and may be warmly recommended as an excellent short biography of Marconi. Critical where necessary, it is written with considerable authority and in its small compass sets out a fascinating account of the main technical contributions made by one of the great figures of radio.	
July 1904	High power (500 kW) station opened at Coltano, Italy.	F.W.S.	
1907	Synchronous disk discharger patented.		
1909	Balanced antenna circuit using Fleming diodes patented.		

Carbon composition, cracked carbon, metal film and metal oxide resistors

M. BARDSLEY, L.R.I.C.*

and

A. F. DYSON, C.Eng., F.I.E.E., M.I.E.R.E.*

*Based on a paper presented at an IERE Colloquium
on Fixed and Variable Resistors held in London on
30th January 1973*

SUMMARY

Typical manufacturing processes, nominal parameters and the major advantages and disadvantages of carbon composition, metal oxide, carbon film and low value nickel film resistors are discussed. The structure of these resistors is shown by photomicrographs, in some cases coupled with X-ray probe analysis.

* Erie Electronics Ltd., South Denes, Great Yarmouth, Norfolk.

1 Introduction

This paper is a state-of-the-art review of certain commercially available resistors for consumer, industrial, and professional applications. Previous authors have examined resistors as a whole¹, sometimes with emphasis on the materials aspects² and sometimes from the specific point of view of electrical conduction processes.³

2 Carbon Composition Resistors

It is now nearly ninety years since the first reported use of the carbon composition type of resistor and yet weekly output in the United Kingdom is still measured in tens of millions and, world-wide, still represents a large part of the total output. Many styles of carbon-composition resistor are available, ranging from ceramic encased, humidity-proof units to cheap lacquer-coated axial resistors and pluggable resistors specially designed for various styles of printed circuit board mounting. All these styles are produced from the same basic carbon composition rod, and as the common name 'solid carbon resistor' implies, the whole mass of this rod is the resistive element.

To appreciate the properties and the influence of the various materials used to produce a carbon composition rod, it is helpful to examine a typical sequence of manufacturing stages for a cold moulded carbon-composition resistor.

2.1 Manufacture of Carbon-composition Resistors

2.1.1 Mix preparation

The first requirement is to produce a suitable powder such that, after pressing and firing, a resistor rod is produced which is satisfactory in terms of physical strength, hardness, etc., and also has the necessary electrical properties. A description of the materials is given in Section 2.2.

2.1.2 Moulding

There are two major moulding processes and these may be described as follows:

- (i) Moulding of the powder is by conventional press and the resin, which is a major constituent of the powder, is fired at approximately 350°C through a conveyor oven. Because at a later stage the resistor rod must be terminated using an interference fit cap, the rod diameter must be accurate to within plus or minus one thousandth of an inch (± 0.025 mm) and this is not easily controlled in such a moulding process. Consequently, the rod is moulded hexagonal in section and, after firing, is then centreless ground to a cylindrical shape with the desired dimensional accuracy.
- (ii) This method uses similar resistive material to that used in the process described above. However, in the moulding stage the termination wires are also moulded in and, in some processes, an insulating sleeve (generally of a phenolic material to be compatible with the resistive mix resin), can also be moulded on to the resistive element. The resultant unit is only semi-cured in the moulding.

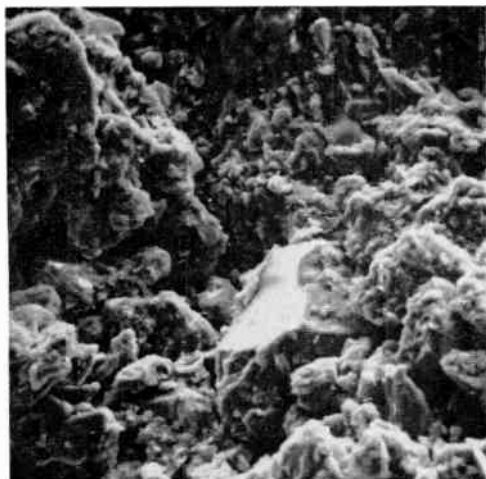

Fig. 1. Fracture plane through high value carbon composition resistor. (magnification $\times 500$).

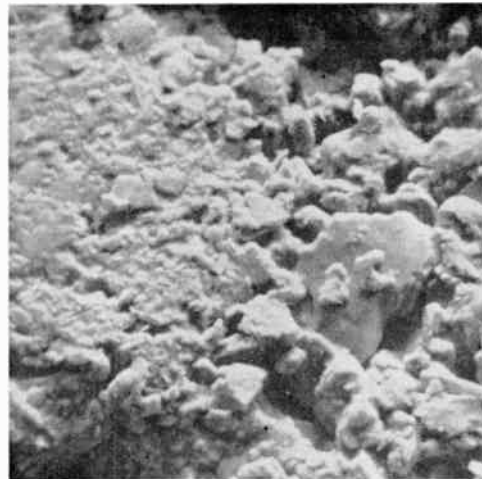

Fig. 2. Fracture plane through a low value carbon composition resistor. (magnification $\times 500$).

2.1.3 Intermediate contact

To ensure a good electrical contact between the resistor rod and the metal caps, the ends of the rod, before capping, are flame sprayed with pure copper. This technique is only applicable to process (i) above.

2.1.4 Impregnation

The cold mould process described produces a resistor which is, to some extent, porous and the absorption of atmospheric moisture into these pores would cause serious deterioration in the electrical properties of the resistor. To prevent this, the pores are effectively sealed using a conventional paraffin wax vacuum impregnation process.

2.1.5 Capping

Lead-out wires, traditionally of solder coated copper, are either riveted or welded to interference-fit non-corrodible metal caps pressed over the ends of the rod. This is only applicable to process (i) above.

2.1.6 Encapsulation

The final process is the encapsulation of the rod by one of several methods; ranging from the humidity-proof ceramic case to lacquer finishes present merely as a background colour enabling the colour coding or printing to be read. This is only applicable to process (i) above.

2.2 Carbon Mix Ingredients

The most important of these manufacturing stages is the mix preparation, as the composition and quality of the materials used dictate the final electrical properties of the resistor.

Typical ingredients are:

(i) phenolic resin, (ii) carbon, (iii) inert filler, (iv) accelerator, (v) flow agent and (vi) solvent.

Phenolic resin is a thermosetting resin and the accelerator is present to ensure the complete curing of the resin in a short baking time. Several grades of carbon are

used according to the required electrical properties of the resistor, graphite being used for low values. The inert filler is typically silica.

In order to produce moulded rods of consistent physical strength, the mix must have a constant resin/solids ratio; the solids being silica plus carbon. The variation in ohmic value of the rod is therefore brought about by varying the carbon/silica ratio whilst keeping the sum total constant. By this means good physical mouldings can be produced ranging from below $1\ \Omega$ up to hundreds of megohms. The ingredients are wet mixed using solvent and the flow agent to ensure a homogenous product. The solvent, being volatile, is then allowed to evaporate and the resulting dry cake is granulated by ball-milling to a suitable size for moulding.

2.3 Structure of Carbon-composition Resistors

Figures 1 and 2 show photomicrographs of fracture sections through carbon-composition resistors of high and low value at a magnification of 500 times. The lower value rod contains a much higher proportion of carbon, which has a smaller particle size than that of the silica filler, and the result is a closer-knit agglomerate. However, in both cases the porosity of the material can be seen and it is this porosity which is largely removed by the impregnation process.

2.4 Properties of Carbon-composition Resistors

The carbon-composition resistor is basically a general-purpose resistor and is not available in selection tolerances closer than $\pm 5\%$. Table 1 shows typical specification limits for the more important electrical parameters. These parameters require some explanation. The load change is the maximum permitted change in resistance, expressed as a percentage of the original resistor value, permissible after 1000 hours in an ambient temperature of 70°C with a direct voltage applied such that the rated wattage of the resistor is dissipated. Although the specification allows for positive and negative changes in resistance, in practice for a mid-range resistor ($10\ 000\ \Omega$) the typical load change will be -5% .

Table 1. Typical specification limits for the more important electrical parameters of carbon-composition, carbon-film and metal oxide resistors.

	Carbon-composition	Carbon-film	Metal oxide
Load change	±15%	±3%	±3%
T.C.R.	±1200 parts/10 ⁶ /degC	-800 parts/10 ⁶ /degC	±250 parts/10 ⁶ /degC
V.C.R.	-0.05%/V	nil	nil
Noise	$\left(2 + \log \frac{R}{1000}\right) \mu\text{V/V}$	0.5 μV/V	1.0 μV/V

The resistance of all resistors varies according to the temperature at which they are operating—this variation is usually expressed in terms of the temperature coefficient of resistance (t.c.r.) given by $(1/R) dr/dt$. Again, although positive or negative coefficients are allowed for in the specification, in practice a 10 000 Ω resistor will have a coefficient of -400 parts/10⁶.

It is an unfortunate property of carbon composition resistors that an increase in the applied voltage invariably causes a decrease in the resistor value. This is expressed as the percentage change in resistance per volt (d.c.) applied and is termed the voltage coefficient of resistance (v.c.r.). The effect is created by the varying contact resistance between adjacent carbon particles and the effect is more marked at low carbon concentrations (i.e. high values) where the contact resistances form a larger proportion of the total resistance. In fact the limit for values below 1 MΩ is -0.025% per applied volt. The coefficient is always negative.

Noise in a fixed resistor is of two types. Firstly the noise which is common to all types is the thermal (or Johnson) noise, and this is attributed to the thermal agitation of the electrons in the conducting path. It is independent, therefore, of the material from which the resistor is made. The other type of noise is dependent on the resistive material and is termed 'current noise.' This is generated by the passage of current through a non-homogeneous material and is attributed to the variation in contact resistance between the particles from which the resistor is made.

For a film resistor current noise is low but in carbon-composition types this noise is inversely proportional to carbon content and noise figures increase as resistance rises. The formula in Table 1 takes account of this and the Johnson noise. For example, the limit for a 1 MΩ resistor is $2+3 = 5 \mu\text{V/V}$, whereas that for a 10 MΩ resistor will be $2+4 = 6 \mu\text{V/V}$.

Although the parameters of carbon-composition resistors fix them firmly in the general-purpose class, they have certain advantages over the more sophisticated film type. In particular, their construction is such that they are able to withstand higher voltages than is usual for film resistors and because of the solid resistive element,

short term overloads and high pulse loadings can be tolerated without catastrophic failure. Further, as can be seen from the simple construction of these resistors, they exhibit very low inductance. The main attraction of this resistor, however, is its robustness and relatively low price and for this reason vast quantities are consumed by the radio and television industries.

3 Film Resistors: General Considerations

In a film resistor, the electrical current is carried by a relatively thin resistive film deposited on the surface of an alkali-free ceramic rod of accurate dimensions. Consequently the manufacture of all film resistors follows a common pattern, apart from the deposition of the film itself, and Fig. 3 shows a typical manufacturing sequence for any film resistor.

Following film deposition the rod is capped as in the case of the carbon composition resistor with an interference fit non-corrodible cap attached to a wire lead.

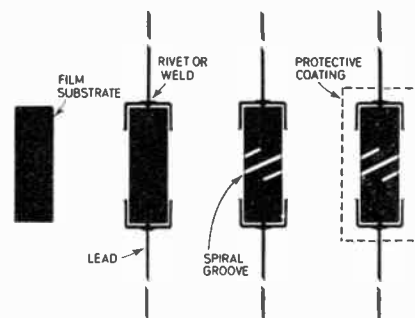

Fig. 3. Typical stages in the manufacture of any film resistor.

Unlike the carbon composition resistor, the capped film resistor is adjusted to final ohmic value by a process known as helixing or spiralling. As the name implies, a thin spiral track is cut through the film increasing the effective path length between the caps and thus the resistance value. Three techniques are in common use for the spiralling of film resistors. Abrasion of the film by a powder carried in a thin high-velocity air stream and cutting of the film by a thin, rapidly rotating grinding wheel are both traditional methods, and a more recent technique uses a laser beam to cut the necessary track, usually about 0.25 mm wide, through the resistive film. In all these methods the headstock, be it grinding wheel, nozzle or laser head, traverses the substrate as the resistor is rotated between chucks. The resistor ohmic value is constantly monitored as helixing continues until a preset value is reached at which point the operation is automatically stopped. By this method the final value of the resistor may be set to within ±0.1% of the required value.

The film resistor may then be sealed in a ceramic case or coated with a variety of cement or lacquer finishes; all of which should protect the thin resistive film from handling damage or moisture ingress and also give the resistor a pleasing appearance. The electrical characteristics of the various film resistors are dictated by the resistive film itself and these will be examined in closer detail in the next section.

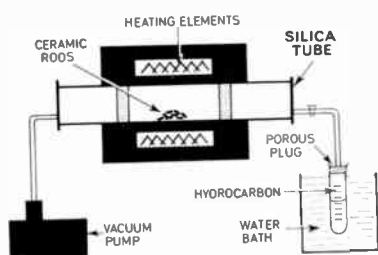

Fig. 4. Schematic diagram of carbon filming furnace.

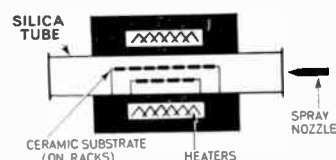

Fig. 7. Schematic diagram of metal oxide filming furnace.

4 Carbon Film Resistors

Pure carbon can be deposited onto a ceramic rod by the method known as pyrolysis, and Fig. 4 is a schematic diagram of a typical carbon filming furnace. Hydrocarbon vapour (e.g., benzene or heptane), from the liquid kept at a constant temperature by means of a water bath, is passed over ceramic substrates, which are heated to 900°C – 1000°C , by means of an inert carrier gas or as in this case drawn into the hot zone by vacuum. The hydrocarbon decomposes into its elements or 'cracks' (hence the name cracked carbon-film resistors) with the result that the carbon is deposited onto the substrates and the hydrogen is carried away by the vacuum pump. For a given rate of introduction of hydrocarbon, the filmed resistance value depends on the length of time in the furnace.

Film thicknesses produced are in the range 0.025 to $0.1\ \mu\text{m}$, corresponding roughly to $5000\ \Omega$ per square down to $1\ \Omega$ per square.

4.1 Photomicrographs of Carbon Film

Figures 5 and 6 show fracture surfaces through a carbon filmed rod at 500 and 2000 times respectively. The smooth continuous film is evident and at the higher magnification the penetration of the film into the surface pores of the ceramic is visible.

4.2 Properties of Carbon Film Resistors

Reference to Table 1 shows that the electrical properties of a carbon-film resistor are considerably better than for

carbon-composition. In particular the load change limit is a respectable $\pm 3\%$ and selection tolerances available are correspondingly tighter; $\pm 5\%$, $\pm 2\%$, and $\pm 1\%$ tolerance resistors are commercially available in the approximate value range $5\ \Omega$ – $2\ \text{M}\Omega$.

Temperature coefficient is relatively high for a carbon film resistor and is negative, increasing rapidly with increasing ohms per square. Voltage coefficient is negligible and noise is very low for a good carbon-film resistor.

The thin and relatively fragile film cannot tolerate high voltages as these will ultimately track across the spiral groove. This fragility also results in the inability of the film to withstand electrical overloads of any magnitude without rapidly going open circuit; indeed this fusing characteristic is considered an advantage by many carbon film resistor users.

These resistors can now be bulk produced at a price very similar to carbon composition and for general commercial use offer closer selection tolerances and far better stability.

5 Metal-oxide Resistors⁴

To produce this film, a fine spray of a solution of tin and (often) antimony chlorides is passed into a belt furnace similar to the schematic diagram in Fig. 7. Under the action of heat the chlorides are decomposed resulting in a semiconductor film consisting of a mixture of tin and antimony oxides on the surface of the substrates. The reaction takes place at 700°C – 800°C and is carried out under atmospheric conditions.

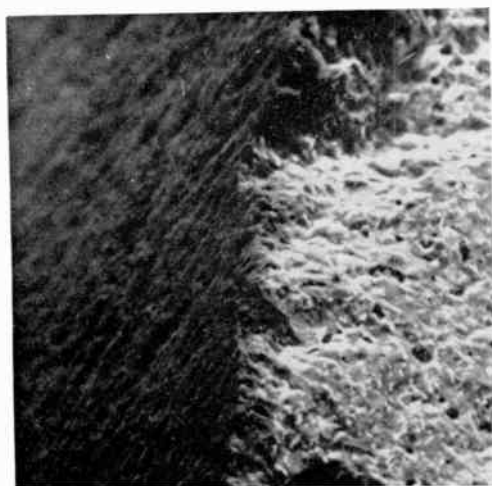

Fig. 5. Fracture plane through a carbon filmed ceramic rod. (magnification $\times 500$).

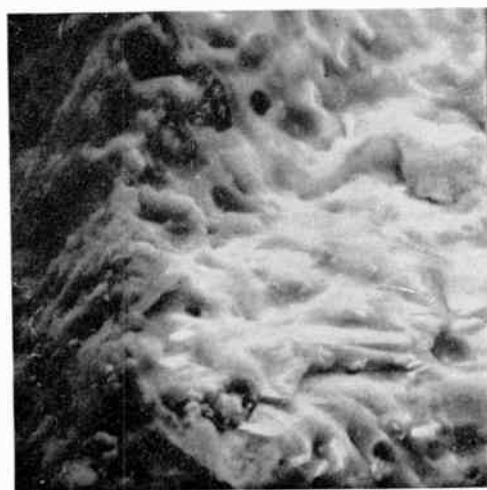

Fig. 6. Fracture surface through a carbon filmed ceramic rod. (magnification $\times 2000$).

The film formed is an oxygen-deficient semiconductor type, the antimony being present as a dopant in the tin oxide lattice. Films produced by this method are of thickness 0.2–0.8 μm , corresponding to 1200 Ω to 5 Ω per square.

5.1 Photomicrographs of Metal-oxide Film

Figures 8 and 9 at magnifications of 2000 and 10 000 times respectively show fracture surfaces through a metal-oxide resistor rod. In Fig. 9 especially the close following of the ceramic surface by the film can be clearly seen. Measurement shows this film to be 0.2 μm thick.

It has been mentioned that the film is antimony-doped tin oxide and by combining the electron microscope with X-ray probe analysis it is possible to photograph the antimony distribution as a dot picture. Figures 10 and 11 show the same area of metal oxide film at 2000 times magnification, Fig. 11 being a map of the antimony distribution. This area was especially chosen to cover the film defect in the lower portion which shows up in the X-ray picture as being deficient in antimony.

5.2 Properties of Metal-oxide Resistors

Reference to Table 1 will show the good performance of this type of film resistor. Load change and voltage coefficient are both low and noise, although not so low as in the best carbon film resistor, is perfectly satisfactory for the majority of applications. Temperature coefficient shows a marked improvement even on carbon film resistors and in fact ± 100 parts in 10^6 resistors are now common. There is a slight disadvantage in that the value range in selection tolerances $\pm 5\%$, $\pm 2\%$ and $\pm 1\%$, extends from 10 Ω only up to approximately 500 000 Ω due to the comparatively low ohms per square of the thinnest practical film. However, this film is robust and able to withstand temporary overload, making it generally considered to be the best all-round resistor for stability and reliability.

6 Nickel Film Resistors

In recent years demand has been steadily increasing for resistor values below 10 Ω and often below 1 Ω , particularly for emitter resistors in transistor output stages. This value region is too low for metal oxide films and carbon films do not extend into the region below 1 Ω where the carbon layer would be necessarily thick, probably not well adhered and certainly lengthy and thus costly to produce.

The manufacture of low value carbon-composition rods is also difficult as the high carbon content necessary leads to a fragile moulding liable to fracture during subsequent finishing operations. Consequently, more use is being made of electroless plated metal as a cheap low value resistive film.

6.1 Nickel Film Deposition

'Electroless' is a corruption of 'electrode-less', implying that no electricity is used in the plating process and this is by no means a new technique; much of the decorative trim on motor cars is now being moulded in plastic, which is electroplated only after initial electroless plating has

given an adherent conductive coating to the plastic. Technically, several metals, including copper, are capable of electroless deposition although nickel is by far the most commonly used to produce resistive elements. The method of film formation is purely chemical. By immersing ceramic substrates in various chemical solutions the ceramic becomes activated such that when finally immersed in a solution containing nickel sulphate and a reducing agent, nickel metal spontaneously plates onto the activated surface and is then autocatalytic such that plating proceeds and thickness builds up until the substrate is either removed from the solution or the solution becomes exhausted.

Film resistivities under standard conditions depend purely on plating time and range from 0.1 Ω per square to 100 Ω per square, although it is the low value region which is most useful. Films with a resistivity below 1 Ω per square are thick by comparison with other film resistors, measuring about 2 μm . This leads to very good thermal conductivity along the film and into the metal end caps and terminal leads, as a result, when electrically loaded, the surface temperature rise of these nickel films is low and comparatively large wattages can be dissipated by a small resistor.

So far it has been implied that the electroless film is pure nickel, but this is not strictly true. Were it the case, the temperature coefficient of resistance of the film would be +5000 parts/ 10^6 and this is prohibitively high. It has been found, however, that inclusion of phosphorus in the resistive film reduces the temperature coefficient to a satisfactory level and furthermore this phosphorus can be conveniently introduced by means of a side reaction in the plating bath.

6.2 Photomicrographs of Nickel Film

Figure 12 shows a typical area of nickel film at $\times 2000$ magnification. The plating is not completely smooth due to the filming method in which plating initiates from activated sites and spreads outwards to form a complete film. Figure 13 shows an X-ray probe analysis of the same area showing the even distribution of the element phosphorus.

6.3 Properties of Nickel Film Resistors

Load stability of these resistors is within $\pm 3\%$ and voltage coefficient and noise are negligible. Temperature coefficient is always positive in the range 0 to +600 parts/ 10^6 . The film is robust and unaffected by the cements and solvents used in resistor encapsulation, making it very valuable in this low value area of resistor production.

7 Metal Film Resistors

A further type of resistor which comes under the same category as the nickel film structures is that prepared by evaporation or sublimation of metal, usually a nickel-chromium alloy^{5,6} on to a rough ceramic rod. The properties of these types, which will not be considered here in any detail, are dependent both on the ceramic and the thickness of metal deposited. Thickness of metal is often only around 10 nm and very low temperature coefficients of resistance can be obtained for sheet

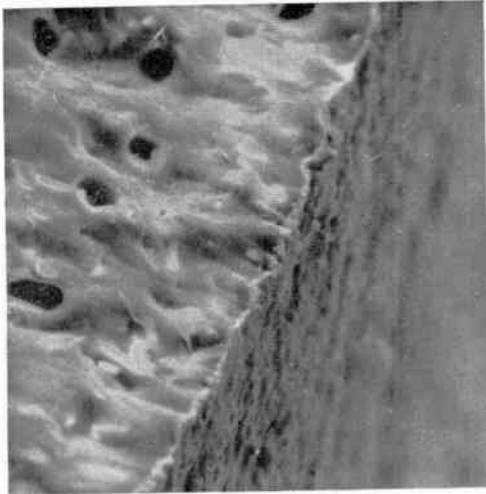

Fig. 8. Fracture plane through a metal oxide filmed ceramic rod. (magnification $\times 2000$).

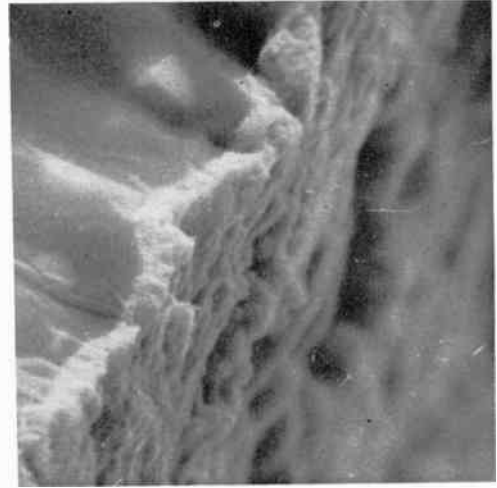

Fig. 9. Fracture plane through a metal oxide filmed ceramic rod. (magnification $\times 10\ 000$).

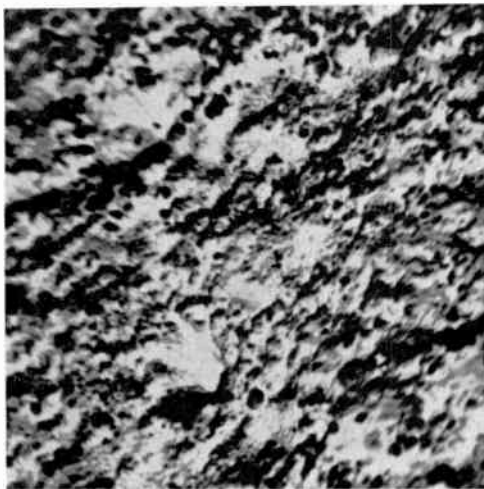

Fig. 10. Surface of a metal oxide film. (magnification $\times 2000$).

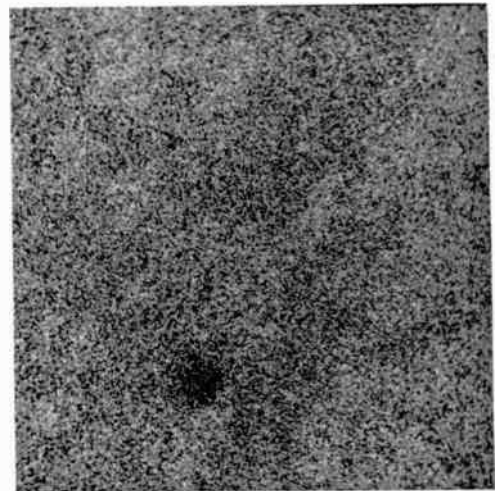

Fig. 11. Antimony distribution in the area of metal oxide film shown in Fig. 10. (magnification $\times 2000$).

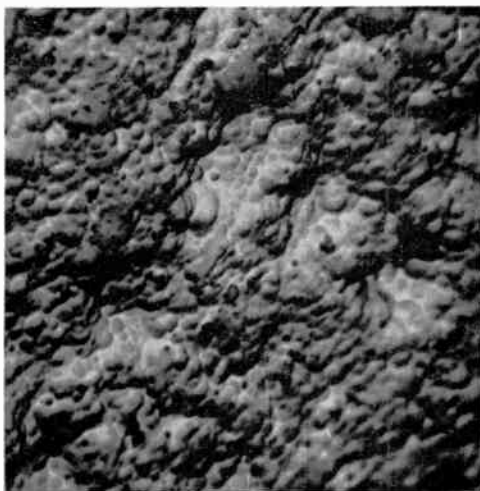

Fig. 12. Surface of an electroless nickel film. (magnification $\times 2000$).

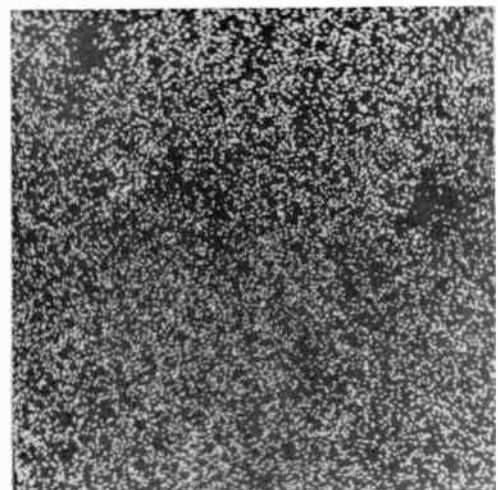

Fig. 13. Phosphorus distribution in the area of nickel film shown in Fig. 12. (magnification $\times 2000$).

resistance values of around 300 Ω per square. As with the other film types, these resistors may be spiralled to value before being encapsulated.

8 References

1. Roberts, B. C., 'Resistors' in 'Component Reliability', ed. Waller, W. F., pp. 29-35 (Macmillan, London, 1971).
2. Watkins, J., 'Modern Electronic Materials', (Butterworth, London, 1971).
3. Campbell, D. S. and Morley, A. R., 'Electrical conduction in thin metallic, dielectric and metallic-dielectric films', *Rep. Prog. Phys.*, **34**, pp. 283-368, 1971.
4. Dearden, J., 'The development of tin oxide film resistors', *Electronic Components*, **9**, No. 2, pp. 178-182, February 1968.
5. Watkins, J., as ref. 2, p. 40.
6. Campbell, D. S. and Hendry, B., 'The behaviour of Ni-Cr thin films', *Brit. J. Appl. Phys.*, **16**, pp. 1719-25, 1965.

Manuscript first received by the Institution on 8th October 1973 and in final form on 18th January 1974 (Paper No. 1576/CC192)

© The Institution of Electronic and Radio Engineers, 1974

The Authors



Mr. M. Bardsley gained his Licentiate of the Royal Institute of Chemistry through an RIC 'sandwich' course at Flintshire College of Technology, North Wales, and during this time he obtained industrial experience in surface coatings at the Paint Research Station and in heavy chemical with Courtaulds Ltd., and Lancashire Tar Distillers Ltd.

On leaving college Mr. Bardsley joined Erie Electronics Ltd. and spent four years in their Resistor Design Department working on the theoretical and practical design and manufacture of resistors. He is now working on all aspects of electronic component encapsulation for the same company.



Mr. A. F. Dyson (Member 1968, Graduate 1962) gained his Diploma in Electrical Engineering from Rugby College of Technology in conjunction with a 'sandwich' course at the British Thomson Houston Co. Ltd. He then moved to the BT-H Semiconductor Division at Lincoln and worked on the development of power semiconductors. In 1961 Mr. Dyson went to the USA and joined Erie Technological Products Inc.

He returned to the UK in 1963 and joined Erie Electronics Ltd. as assistant general manager, becoming engineering director of Erie's UK group in 1967. Following a recent company reorganization, he has been appointed Director of the Thick Film Division.

Mr. Dyson has contributed previous papers to the Institution on component manufacturing techniques and he is at present serving on the Components and Circuits Group Committee.

Realization of a double-ladder operational amplifier network by CA-association

N. MURTHY, M.Sc., Ph.D.*

V. K. AATRE, M.E., Ph.D.†

and

Professor V. RAMACHANDRAN,
M.E., Ph.D.‡

SUMMARY

The transfer function of a double-ladder network constrained by an infinite gain operational amplifier is realized by associating it with a C parameter (CA-association). A low-pass network can always be realized by such an association; whereas, in the realization of a transfer function with finite transmission zeros, there are some constraints.

* University of Zambia, Lusaka, Zambia; formerly at Nova Scotia Technical College.

† Nova Scotia Technical College, Halifax, Nova Scotia, Canada.

‡ Sir George Williams University, Montreal, Quebec, Canada.

1 Introduction

In analogue computer simulation, a basic problem is the representation of second-order systems.¹ The general form of a transfer function to be simulated is

$$T(s) = \frac{P(s)}{s^2 + a_1s + a_0}. \quad (1)$$

This transfer function can be simulated by the use of a number of operational amplifiers. Sometimes a one-amplifier simulation may be necessary. A structure which has evoked considerable interest is the multiple feedback network constrained by an operational amplifier.² For such a double-ladder network, the sensitivity to passive elements is the same as that of a passive network of the same selectivity, while the sensitivity to amplifier gain can be made as small as desired.³ These double-ladder networks were mostly realized by coefficient matching techniques.⁴ Such networks have also been realized by the 'node-introduction' method⁵ and by associating the transfer function with a B -parameter.⁶ In the latter case, the synthesis has been restricted to the low-pass (and, hence, the high-pass) case. For the double-ladder network, the admittance matrix will assume a general form⁵

$$Y = \begin{bmatrix} y_{11} & y_{12} \\ \infty & \infty \end{bmatrix} \quad (2)$$

and, hence, the direct identification of the admittance parameters cannot be achieved. The node introduction method overcomes this dilemma by utilizing the relationship between the signal at any node in the forward path and the signal at the output node to expand the admittance characterizing the network between the input and any internal node. Higher-order functions require the use of a computer due to the increase in complexity.

In the sequel, the network is characterized by the transmission parameters A , B and C . A is the inverse of the open-circuit voltage transfer function V_2/V_1 , B the ratio of V_1 to I_2 with output shorted, and C the ratio of I_1 to V_2 with output open, where V_1 , I_1 , V_2 and I_2 are the input and output voltages and currents, respectively. Hence, A/B has the dimensions of an admittance and A/C the dimensions of an impedance. In associating a B -parameter with the transfer function, the B -parameter is that of a companion passive network⁶ and, as such, A/B is not the actual driving point admittance of the network. In this paper, a method of realizing the network from an impedance basis is discussed. To this end, we associate a C -parameter with the transfer function and develop a synthesis procedure for the driving point impedance z_{11} . This method is referred to as the CA-association. Only transfer functions with second-order denominators are considered, since from sensitivity considerations, it is desirable to realize higher-order functions by cascading second-order functions. Hence, here the transfer function is assumed to have two poles and three zeros (analogue simulation may involve a differentiation). The transmission zeros are all created in the series arm. The method can easily be extended to the case where the number of finite zeros is two or less.

The network under consideration is shown in Fig. 1. Here the operational amplifier is assumed to be an ideal voltage amplifier with an infinite gain. Some useful relationships between the A and C parameters are given in equations (3-7)⁷ which follow:

$$A_5 = Z_5 C_{A5} + A_3 \tag{3}$$

where A_5 and C_{A5} are the A and C parameters of the network in Fig. 1, and A_3 is the A -parameter of the network in Fig. 1 with Z_5 , Y_6 and Y_6' removed. Equation (3) can also be written as:

$$Z_{11} = \frac{A_5}{C_{A5}} = Z_5 + \frac{A_3}{C_{A5}} \tag{4}$$

Further, C_{A5} can be expanded as

$$C_{A5} = (Y_6 + Y_6')A_3 + Y_6 + C_{A3} \tag{5}$$

where C_{A3} is the C -parameter of the network in Fig. 1 with Z_5 , Y_6 and Y_6' removed. A_3 and C_{A3} will have relation similar to equation (4) and this can be written as

$$\frac{A_3}{C_{A3}} = Z_3 + \frac{Z_1 Y_2}{C_{A3}} \tag{6}$$

where

$$C_{A3} = Y_2 + Y_4 + Z_1 Y_2 (Y_4 + Y_4') \tag{7}$$

2 Low-pass Network

Let A be given as $s^2 + a_1 s + a_0$. As the transfer function ($1/A$) has only two transmission zeros (both at infinity) a two-section network is sufficient. If C_A is chosen as $s^2 + c_1 s + a_0$, then:

$$\frac{A}{C_A} = 1 + \frac{(a_1 - c_1)s}{s^2 + c_1 s + a_0} \tag{8}$$

To have positive coefficients, $a_1 > c_1$. By comparing equations (6) and (8):

$$\begin{aligned} Z_3 &= 1 \\ Z_1 Y_2 &= (a_1 - c_1)s \end{aligned} \tag{9}$$

$$Y_2 + Y_4 + Z_1 Y_2 (Y_4 + Y_4') = s^2 + a_1 s + a_0.$$

If we choose $Y_4 = C_4 s + G_4$, $Y_2 = C_2 s$ and $Y_4' = C_4' s$, then from equation (9):

$$\begin{aligned} G_4 &= a_0 \\ C_2 + C_4 &= c_1 - a_0(a_1 - c_1) \end{aligned} \tag{10}$$

$$C_4 + C_4' = \frac{1}{a_1 - c_1}.$$

Hence, for all the capacitors to be positive

$$C_4 < \min \left\{ c_1 - a_0(a_1 - c_1), \frac{1}{a_1 - c_1} \right\} \tag{11}$$

and

$$c_1(1 + a_0) > a_0 a_1.$$

Thus, if A is given as $s^2 + a_1 s + a_0$, C is chosen as $s^2 + c_1 s + a_0$, where

$$a_1 > c_1 > \frac{a_0 a_1}{1 + a_0}.$$

Equations (9), (10) and (11) determine the elements of the two-section network. In this structure Y_2 and Y_4' are capacitances Z_1 and Z_3 are conductances and Y_4 is a

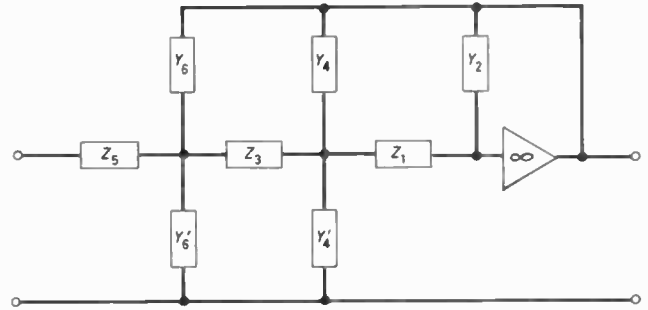

Fig. 1. Network to illustrate the C -parameter.

parallel combination of a capacitance and a conductance. If C_A is chosen without a constant term then Y_4 will also be a capacitance.

3 Transfer Function with Finite Transmission Zeros

The transfer function considered here has either two or three transmission zeros. The former is realized by a two-section network and the latter by a three-section network. If the given transfer function has negative real poles then it is possible to realize the network with only one section (Z_1 and Y_2 are the only elements in the network) by choosing C_A such that A/C_A is an RC impedance function. In this case there will be some bounds on the transmission zeros.

3.1 Two Transmission Zeros

Let

$$A = \frac{a_1 s + a_0}{(s + q_1)(s + q_2)},$$

If C_A is chosen as

$$\frac{c_1 s + c_0}{s + q_1},$$

then

$$\frac{A}{C_A} = \frac{(a_1 q_2 - a_0)/(c_1 q_2 - c_0)}{s + q_2} + \frac{(a_0 c_1 - a_1 c_0)/(c_1 q_2 - c_0)}{c_1 s + c_0} \tag{12}$$

In order that the coefficients in this expansion be positive, either

$$(i) \frac{c_0}{c_1} > \frac{a_0}{a_1} > q_2$$

or

$$(ii) q_2 > \frac{a_0}{a_1} > \frac{c_0}{c_1}$$

and hence, A/C_A is an RC-impedance function.

From equations (6), (7) and (12)

$$Z_3 = \frac{(a_1 q_2 - a_0)/(c_1 q_2 - c_0)}{s + q_2},$$

$$Z_1 Y_2 = \frac{a_0 c_1 - a_1 c_0}{c_1 q_2 - c_0} \cdot \frac{1}{s + q_1} \tag{14}$$

$$Y_2 + Y_4 + Z_1 Y_2 (Y_4 + Y_4') = \frac{c_1 s + c_0}{s + q_1} \quad (15)$$

Here all admittances may be chosen as constants or $Y_4' = C_4 s + G_4$ and other admittances as constants.

In the latter case, if we let

$$Y_2 + Y_4 = k_2 \quad (16)$$

then from equations (14) and (15)

$$Y_4 + Y_4' = [(c_1 - k_2)s + (c_0 - k_2 q_1)] \frac{c_1 q_2 - c_0}{a_0 c_1 - a_1 c_0} \quad (17)$$

From equations (16) and (17) it can be seen that

$$k_2 < \min \{c_1, c_0/q_1\}$$

and

$$Y_4 = G_4 < \min \left\{ k_2, \frac{(c_0 - k_2 q_1)(c_1 q_2 - c_0)}{a_0 c_1 - a_1 c_0} \right\}, \quad (18)$$

If C_A is so chosen that A/C_A is an RC impedance function then equations (14) to (18) determine the elements of the network. In this case the synthesis is always possible.

3.2 Three Transmission Zeros

Let

$$A = \frac{a_2 s^2 + a_1 s + a_0}{(s + q_1)(s + q_2)(s + q_3)}$$

and C_A be chosen as

$$\frac{(s + c_1)(s + c_2)}{(s + q_1)(s + q_2)}$$

where c_1 and c_2 are to be determined. Now we can write

$$\frac{A}{C_A} = \frac{B_3}{s + q_3} + \frac{b_1 s + b_0}{(s + c_1)(s + c_2)} \quad (19)$$

and by equating coefficients in equation (19) we have

$$a_2 = B_3 + b_1 \quad (20a)$$

$$a_1 = B_3(c_1 + c_2) + b_1 q_3 + b_0 \quad (20b)$$

$$a_0 = B_3 c_1 c_2 + b_0 q_3 \quad (20c)$$

$$B_3 = \frac{a_2 q_3^2 - a_1 q_3 + a_0}{(c_1 - q_3)(c_2 - q_3)} \quad (20d)$$

It can easily be seen that for the positiveness of b_0 , b_1 and B_3

$$b_0 < \min \{a_1 - b_1 q_3, a_0/q_3\}$$

$$b_1 < \min \left\{ a_2, \frac{a_1 - b_0}{q_3} \right\} \quad (21)$$

From equations (20a, b and c), after simple algebra, we have

$$B_3(c_1 - c_2) = \sqrt{(a_1 - b_1 q_3 - b_0)^2 - 4(a_2 - b_1)(a_0 - b_0 q_3)}$$

$$= \sqrt{D_1} \quad (22)$$

and from equations (4) and (18):

$$Z_5 = B_3/s + q_3, \quad \frac{A_3}{C_{A5}} = \frac{b_1 s + b_0}{(s + c_1)(s + c_2)} \quad (23)$$

Here Z_3 creates the required transmission zero at $s = -q_3$. From equation (22) it follows that c_1 and c_2

may be both real or complex conjugate numbers. Here we only consider the case where c_1 and c_2 are real. If c_1 and c_2 are to be real, (D_1 positive), b_1 must satisfy the inequality:

$$b_1 q_3^2 - 2b_1[(a_1 + b_0)q_3 - 2a_0] + (a_1 - b_0)^2 - 4a_2(a_0 - b_0 q_3) > 0.$$

The discriminant of this quadratic is always positive and, hence, a positive value of b_1 can be found to satisfy this inequality.

To create the transmission zero at $s = -q_2$, $Y_6 + Y_6'$ is removed as the value C_{A5}/A_3 at $s = -q_2$. From equation (23), on substituting for c_1 and c_2 from equation (20),

$$Y_6 + Y_6' = \frac{Q_1}{(a_2 - b_1)(b_0 - b_1 q_2)} = k_2 \quad (24)$$

where

$$Q_1 = (a_2 q_2^2 - a_1 q_2 + a_0) + (b_0 - b_1 q_2)(q_2 - q_3). \quad (25)$$

Hence, for k_2 to be positive ($b_0 - b_1 q_2$) and Q_1 must have the same sign as $(a_2 - b_1)$ is greater than zero. From equations (5), (23) and (24) we can write:

$$\frac{C_{A3} + Y_6}{A_3} = \frac{(s + q_2)(s + e_2)}{b_1 s + b_0} \quad (26)$$

where

$$e_2 = \frac{Q_2}{q_2(b_0 - b_1 q_2)(a_2 - b_1)} \quad (27)$$

and

$$Q_2 = (b_0 - b_1 q_2)(a_0 - b_0 q_2) - b_0(a_2 q_2^2 - a_1 q_2 + a_0) \quad (28)$$

For positiveness of e_2 , Q_2 and $(b_0 - b_1 q_2)$ must be of the same sign. If C_{A3} is chosen as

$$\frac{d_1 s + d_0}{s + q_1}$$

then from equation (26):

$$s + e_2 = (d_1 s + d_0) + Y_6(s + q_1) \quad (29)$$

implying that

$$d_1 < 1 \quad \text{and} \quad d_0 < e_2. \quad (30)$$

From equations (23), (24) and (29) we have identified Z_5 , Y_6 and Y_6' and thus the first section of the network. To realize the subsequent sections of the network A_3/C_{A3} has to be an RC impedance (see Section 3.1). Hence either

$$(i) \frac{d_0}{d_1} > \frac{b_0}{b_1} > q_2$$

or

$$(ii) q_2 > \frac{b_0}{b_1} > \frac{d_0}{d_1} \quad (31)$$

From equation (29), after some algebra, we can deduce that for the positiveness of Y_6 either

$$(i) \frac{d_0}{d_1} > e_2 > q_1$$

or

$$(ii) q_1 > e_2 > \frac{d_0}{d_1} \quad (32)$$

Similarly from equations (20), (27) and (28) it can be shown that

- (i) if $\frac{b_0}{b_1} > q_2$, then $\frac{b_0}{b_1} > e_2$
- (ii) if $\frac{b_0}{b_1} < q_2$, then $\frac{b_0}{b_1} < e_2$. (33)

The conditions on b_0, b_1, d_0 and d_1 can now be obtained by combining equations (31-33) and they are

(i) $\frac{d_0}{d_1} > \frac{b_0}{b_1} > e_2 > q_1$ and $\frac{b_0}{b_1} > q_1$

or

(ii) $q_1 > e_2 > \frac{b_0}{b_1} > \frac{d_0}{d_1}$ and $q_2 > \frac{b_0}{b_1}$ (34)

These conditions (zero locations) are shown in Fig. 2, where \times denotes the zero of A_3 , \circ the zero of C_{A3} , \triangle the transmission zeros of the given transfer function and $*$ the negative of e_2 as given by equation (27). From equations (24) and (29), it can be shown that, for the positiveness of Y'_6 :

- (i) if $\frac{b_0}{b_1} > q_2$, then $k_2 > 1$
- (ii) if $\frac{b_0}{b_1} < q_2$, then $e_2 < k_2 q_1$ (35)

If condition (i) of equation (35) is satisfied, then from equations (24) and (25):

$$Q_1 > (b_0 - b_1 q_2)(a_2 - b_1) \quad (36)$$

and if condition (ii) is satisfied, then from equations (24), (27) and (28)

$$q_1 q_2 Q_1 < Q_2 < 0. \quad (37)$$

Equations (36) and (37) are additional requirements to be satisfied by b_0 and b_1 . It can further be deduced that:

- (i) if $a_0/a_2 > q_1 q_2$, then $\frac{b_0}{b_1} > \max(q_1, q_2)$
- (ii) if $a_0/a_2 < q_1 q_2$, then $\frac{b_0}{b_1} < \min(q_1, q_2)$ (38)

and no synthesis is possible if $a_0/a_2 = q_1 q_2$.

Table 1

1. $b_0 < \min \left\{ a_1 - b_1 q_3, \frac{a_0}{q_3} \right\}$ $b_1 < \min \left\{ a_2, \frac{a_1 - b_0}{q_3} \right\}$
2. $b_1^2 q_3^2 - 2b_1[(a_1 + b_0)q_3 - 2a_0] + (a_1 - b_0)^2 - 4a_2(a_0 - b_0 q_3) > 0$
3. (i) $\frac{b_0}{b_1} > q_2$, $Q_1 > (b_0 - b_1 q_2)(a_2 - b_1)$ (ii) $\frac{b_0}{b_1} < q_2$, $q_1 q_2 Q_1 < Q_2 < 0$

where

$$Q_1 = (a_2 q_2^2 - a_1 q_2 + a_0) + (b_0 - b_1 q_2)(q_2 - q_3)$$

$$Q_2 = (b_0 - b_1 q_2)(a_0 - b_0 q_2) - b_0(a_2 q_2^2 - a_1 q_2 + a_0)$$

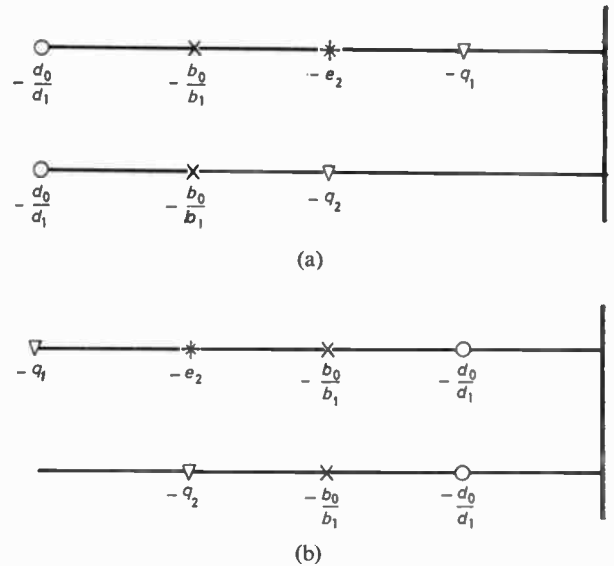

Fig. 2. Conditions of zero-locations.

The conditions to be satisfied by b_0 and b_1 , when c_1 and c_2 are real, are shown in Table 1. The selection of b_0 and b_1 is the most difficult step in the synthesis procedure. Once b_0 and b_1 are selected to satisfy conditions in Table 1, the remainder of the synthesis is straightforward. The synthesis procedure can now be formulated in the following way:

Given

$$A = \frac{a_2 s^2 + a_1 s + a_0}{(s + q_1)(s + q_2)(s + q_3)}$$

- (i) If $a_0/a_2 = q_1 q_2$, then no synthesis is possible.
- (ii) If $a_0/a_2 \neq q_1 q_2$, then b_0 and b_1 have to satisfy conditions in equation (38).
- (iii) b_0 and b_1 are chosen to satisfy equation (38) and conditions 1 and 2 of Table 1.
- (iv) If b_0 and b_1 selected in (c) are such that $b_0/b_1 > q_2$ then Q_1 (equation 25) must satisfy condition 3 (i) of Table 1. If $b_0/b_1 < q_2$ the Q_2 (equation 28) and Q_1 must satisfy condition 3 (ii) of Table 1. (If these conditions are not satisfied then the b_0 and b_1 are reselected to satisfy (iii) and (iv).)
- (v) B_3, c_1, c_2, d_1 and d_2 are selected so as to satisfy equations (20) and (34).
- (vi) Z_5, Y_6 and Y'_6 are determined from equations (23), (25) and (29).
- (vii) The synthesis of subsequent Sections follows Section 3.1.

4 Example

$$A = \frac{5s^2 + 7s + 8}{(s + 10)(s + 4)(s + 0.2)}$$

Let $q_1 = 10, q_2 = 4$ and $q_3 = 0.2$.

$$\frac{a_0}{a_2} = \frac{8}{5} < q_1 q_2.$$

Hence from equation (38), $b_0/b_1 < 4$.

From conditions 1 and 2 of Table 1

$$b_0 < \min \{7 - 0.2b_1, 40\}$$

$$b_1 < \min \left\{ 5, \frac{7 - b_0}{0.2} \right\}$$

and

$$0.4b_1^2 - 2b_1(0.2b_0 - 14.6) + (b_0^2 - 10b_0 - 11) > 0.$$

$b_1 = 4.8$ and $b_0 = 1.6$ satisfy the above conditions and condition (ii) of Table 1 ($b_0/b_1 = \frac{1}{3} < q_2$).

From equation (20),

$$B_3 = 0.2, c_1 + c_2 = 22.1, c_1c_2 = 38.4.$$

Hence c_1 and c_2 are real. Also,

$$Z_5 = \frac{0.2}{s+0.2}, \quad \frac{A_3}{C_{A5}} = \frac{4.8s+1.6}{s^2+22.2s+38.4}.$$

From equations (24), (27) and (29)

$$Y_6 + Y'_6 = 1.954, e_2 = 8.818$$

$$d_1 + Y_6 = 1, d_0 + q_1 Y_6 = 8.818$$

From condition (ii) of equation (34) we must have $b_0/b_1 > d_0/d_1$. If we let $d_0/d_1 = 0.3$, then from equation (39) we have

$$d_0 = 0.0363, \quad d_1 = 0.121$$

$$Y_6 = 0.879, \quad Y'_6 = 1.075$$

Hence from equation (26) we have

$$\frac{A_3}{C_{A3}} = \frac{4.8s+1.6}{(0.121s+0.0363)(s+4)}$$

which can be expanded as

$$\frac{A_3}{C_{A3}} = \frac{39.1}{s+4} + \frac{0.0432}{0.121s+0.0363}$$

Now the synthesis follows as in Section 3.1 (equations (12), (14) and (15)). The elements of the network are

$$Z_5 = \frac{0.2}{s+0.2}, \quad Z_3 = \frac{39.1}{s+4}, \quad Z_5 = \frac{25.64}{s+10}$$

$$Y_6 = 0.879, \quad Y'_6 = 1.075, \quad Y_4 = 0.0018,$$

$$Y'_4 = 2.718s+0.0282, \quad Y_2 = 0.0017$$

Manuscript first received by the Institution on 22nd December 1972, in revised form on 5th June 1973 and in final form on 11th December 1973. (Paper No. 1577/CC 193).

© The Institution of Electronic and Radio Engineers, 1974

5 Discussion

In the proposed synthesis method, the transmission zeros are always created in the series arm. If every series impedance creates one transmission zero; that is, Z_i for $i = 1, 3, 5$ are of the form $K/(s+q)$, then to create a pole at infinity in the transfer function, the feedback admittances must be conductances; that is, the admittances Y_{2r} ($r = 1, 2, 3$) must be constants. This, however, does not restrict the shunt-admittances. Hence, Y'_{2i} may be of the form k, ks or k_1s+k_2 .

It can be seen that a low-pass realization is always possible provided the zeros of C_A are chosen properly. However, when the transmission zeros are finite, the constraints on the zeros of C_A (hence on the constants b_0 and b_1) are such that it may not always be possible to synthesize the network. If $q_1q_2 = a_0/a_2$, where q_1 and q_2 are any two transmission zeros, then again the synthesis by CA-association is not possible.

6 References

1. Bridgman, A. and Brennan, R., 'Simulation of transfer function using only one operational amplifier', *Proc. WESCON Convention Record*, 1, Part 4, pp. 273-8, 1957.
2. Hazony, D. and Joseph, R. D., 'Transfer matrix synthesis with one amplifier but no inductors', *Proc. IEEE*, 52, pp. 1748, December 1964. (Letters).
3. McVey, P. J., 'Sensitivity in some simple RC active networks', *Proc. IEE*, 112, No. 7, pp. 1263-9, July 1965.
4. Wadha, L. K., 'Simulation of third-order systems with one operational amplifier', *Proc. IRE*, 50, pp. 201-2, February 1962; p. 465, April 1962; pp. 1538-9, June 1962.
5. Holt, A. G. J. and Sewell, J. I., 'Synthesis of multiple loop feedback systems, Parts I and II', *Internat. J. Control (GB)*, 9, No. 5, pp. 483-508, May 1969.
6. Aatre, V. K., Ramachandran, V. and Swamy, M. N. S., 'Synthesis of voltage transfer functions using multiple feedback operational amplifier networks', *IEEE Trans. on Circuit Theory*, CT-19, pp. 208-9, March 1972. (Letters).
7. Aatre, V. K., Ramachandran, V. and Swamy, M. N. S., 'Some recursive relations for the chain parameters of a double ladder operational amplifier network', *Proc. Thirteenth Midwest Symposium on Circuit Theory*, May 1970.

Contributors to this issue*



Dr. Nalini Murthy was born in Bangalore, India and received her B.Sc.(Hons.) in mathematics from the University of Mysore in 1957. In 1960 she obtained the D.I.I.Sc. from the India Institute of Science, Bangalore, in 1963 the M.Sc. from Manchester College of Science and Technology, and her Ph.D. was awarded by Nova Scotia Technical College in electrical engineering in 1972. She worked as an engineer with

Siemens, West Berlin during 1961 and as a programmer with AEI in Manchester during 1962 and in 1966 she was with the computer section of the Tata Institute for Fundamental Research, Bombay. At present Dr. Murthy is a lecturer at the University of Zambia, Lusaka, and is working on a problem involving dynamic programming.



Dr. V. K. Aatre received his B.E. from the University of Mysore and M.E. from the Indian Institute of Science, Bangalore and Ph.D. from the University of Waterloo, Ontario, all in electrical engineering, in 1961, 1963 and 1967 respectively. During 1967-68 he was a post-doctoral fellow at the Department of Electrical Engineering, University of Waterloo, and he joined Nova Scotia Technical College in 1968 as a

post-doctoral fellow. Since 1969 Dr. Aatre has been on the Faculty where he is currently an Associate Professor, and his present research interests are in the area of networks and system theory.



Professor V. Ramachandran (Member 1961) received the B.Sc. degree from Central College, Bangalore, in 1953, the diploma in electrical communication engineering, the postgraduate diploma in advanced electronics, and the Ph.D. degree, all from the Indian Institute of Science, Bangalore, in 1956, 1957 and 1965, respectively.

In 1958 he became a Senior Research Assistant at the Indian Institute of Science, and in 1959 was appointed Lecturer. In 1965 he completed his Ph.D. dissertation, which concerned studies on exponential transmission lines. Between September 1966 and June 1969 he was an Assistant Professor at Nova Scotia Technical College. In June 1969 he became Associate Professor at Sir George Williams University, Montreal, and in June 1971 he was appointed to his present chair. He is co-author of a monograph entitled 'Some Aspects of the Relative Efficiencies of Indian Languages (A Study from the Information Theory Point of View)'.

*See also pages 194 and 226.



Mr. A. W. Eva spent 18 years in Government science, commencing at Bawdsey Research Station under Dr. (later Sir) Robert Watson-Watt and finishing at the Radar Research Establishment, Malvern. Here he was responsible under Mr. G. W. A. Dummer for connector, switch, and later relay development, and he was for a period chairman of the Radio Component Research and Development sub-committees on

switches and relays, and connectors.

On leaving the Civil Service in 1954 Mr. Eva was appointed manager and later a director of Paton & Co., a small component manufacturing company (connectors and switches) whose engineering interests were bought out by NSF in 1967. He stayed with the latter company until 1972 when he set up a consultancy specializing in connector and switch problems.

Mr. Eva is chairman or member of several BSI Technical Committees concerned with electromechanical devices and connectors, and he has led U.K. delegations to IEC meetings and represented the MoD in the USA as a consultant to the *Mallard* project. He served on the Second Burghard Committee and its sub-committee on inspection.



Mr. J. C. Mallinson received the M.A. degree in natural philosophy from University College, Oxford, in 1953 and in 1956 joined AMP Inc., Harrisburg, Pennsylvania, to work on the theory and design of all-magnetic logic elements. Six years later he moved to Ampex Corporation, Redwood City, California, where he was initially concerned with fundamental considerations in magnetic tape recording. As

Manager of the Basic Technology Section of the Research Department, he now directs the activities of a group working on magnetic recording theory, micromagnetics, communication theory and the exploration of advanced concepts in various areas of recording.



Mr. D. S. Girling (Fellow 1972) received his technical education at Loughborough College of Engineering and at the School of Signals, Catterick during the war. He joined the capacitor laboratory of Standard Telephones and Cables in 1946, took charge of the laboratory in 1948 and became chief engineer of the capacitor division in 1957. During this time his main interests were the development of tantalum electrolytic

and metallized plastic film capacitors, film circuits, mechanisms of failure, reliability and quality control. In January 1965 he was appointed Quality Manager and he is also Group Quality Manager of ITT Components Group.

Mr. Girling has been active in standardization work through RECMF and BSI and chairs the BSI Capacitor Sub-Committee.

The present paper is the third which Mr. Girling has published in the Institution's Journal on capacitor design and production; for a paper on quality control in 1970 he received the Arthur Gay Premium.

Production testing of capacitors

D. S. GIRLING, C.Eng., F.I.E.E., F.I.E.R.E.*

SUMMARY

The progress of automatic testing of capacitors is summarized and an indication given of future trends. The most promising method of testing is to make contact to a large number simultaneously and to carry out a sequence of tests by automatic switching under computer control. The best place for this testing is while the components are orientated in manufacturing jigs. At the present time the speed of testing is limited by that of the transfer system.

* *ITT Components Group Europe, Standard Telephones and Cables Ltd., Capacitor Division, Brixham Road, Paignton, Devon TQ4 7BE.*

1 Introduction

In the production of electronic components testing is an essential part of the production process. Over the past ten years progress from traditional test methods has been rapid and has taken place in parallel with the development of automatic production methods, which have been necessary because of the increased volumes required by the electronics industry. This volume of production is of course required at lower real costs and with a higher degree of conformity. In this paper the progress of automatic testing of capacitors is summarized and an indication given of future trends.

There are two distinct requirements in the production testing of components:

- (i) Simple high-speed equipment of moderate accuracy (e.g. 1–2%) operating on a go/no-go (attributes) basis capable of being set up and fed by production operators.
- (ii) Equipment of higher accuracy (e.g. 0.1%) operating either on a variables or attributes basis for use by inspectors for acceptance sampling or for quality assurance purposes.

The first of these needs has been met in the past mainly by linear or rotary machines in which the components are transported past various test positions.

The second of these needs can now be met by commercially available equipment which is capable of making precision measurements without manual balancing and with direct read-out. Many of these equipments are programmable and give digital outputs for typewriter print-out or computer processing. While these on their own will give some savings by comparison with manual methods, much greater savings can be made by taking advantage of their inherent speed. This can be done in many different ways depending on the level of performance required compared with the level of investment. Consideration of any of these equipments must be based on a strict investment analysis basis in which cost savings are compared with capital cost and the payback period. Wherever possible use has been made of bought-in building blocks. System and interface design as well as computer programming has been carried out in-house by a small specialized group with the necessary skills supplemented by specialized training courses.

A series of different ways in which this type of equipment can be operated is described and the possible applications and advantages and disadvantages discussed. The limitation of all of these types of production test equipment is the speed at which they can be fed. Different systems are described but the most promising method is when these equipments are built in as part of automatic production equipment. This testing can then take place at the same speed as, and while the capacitors are orientated for, the production process. All of these techniques are seen as steps towards fully integrated production systems in which process spreads are compensated for, sequencing is controlled, testing is carried out, accept/reject decisions taken, and management information is provided, by computer.

2 Tests Required

Tests on capacitors are required in three distinct areas:

(i) *Production sorting*

The production of capacitors, as with most components, is associated with a 'yield'. This normally varies between 80 to 95% overall and is basically due to the fact that the spreads of the parameters exceed those that are acceptable to the customer. It is, therefore, normal practice to carry out 100% testing using automatic equipment by production operators.

(ii) *Acceptance sampling*

This consists of the formation of production lots and the taking of samples to determine acceptability. This sampling (Group A) is carried out in accordance with BS 9000. Since the manufacturer is required to allow for experimental error in his testing, it pays to use the most accurate methods available. Measurements on a variables basis are sometimes needed for recording purposes.

(iii) *Quality assurance*

A further requirement of BS 9000 is for lot-by-lot tests (Group B) periodic tests (Group C) every three months, and (Group D) every 3 years. These tests are of environmental nature and are destructive. All of these tests require the results to be recorded both initially and finally. The cost of this testing is an important factor in determining the acceptability of the BS 9000 scheme.

The main measurements or tests required on capacitors are as follows:

- (i) voltage proof
- (ii) capacitance
- (iii) $\tan \delta$
- (iv) leakage current or insulation resistance (see Appendix)
- (v) impedance (l.f. or h.f.)



Fig. 1(a) Automatic test set.

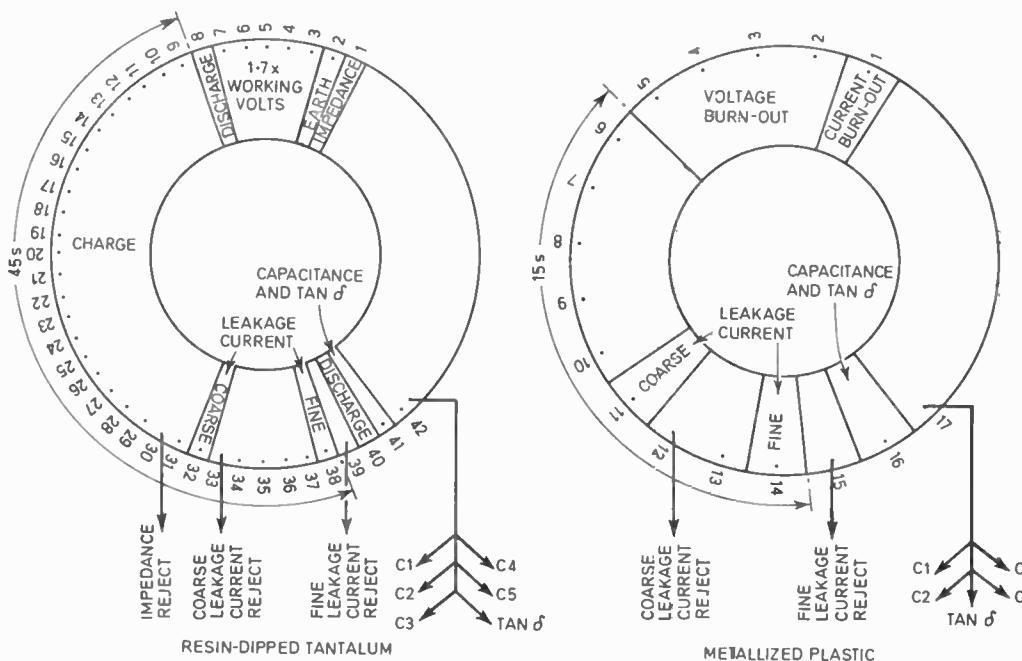

Fig. 1(b). Test positions of automatic test set.

3 Testing Methods

3.1 General Principles

Measurements may be made either on an attributes or a variables basis. The first of these is sometimes referred to as a go/no-go test, although this term strictly applies to dimensional gauging.

In the field of variables measurements the problem is more complex. Let us consider the measurement on a manual bridge. This consists of the following operations:

- (i) load,
- (ii) balance,
- (iii) read result,
- (iv) decide if in limits (some calculation may be required)
- (v) write down (if necessary)
- (vi) unload.

3.2 Manual Equipment

This needs little or no explanation, but it is surprising how much of this equipment is still in use and even sold commercially.

Generally speaking, it is any equipment which requires manual adjustment of controls, visual reading of results, and manual recording if necessary. In these days of high labour costs this type of equipment must disappear in all but the most specialized applications.

3.3 Comparators

These are widely used for production operations, particularly where some adjustment is required. It consists of a standard of the value required and some means of indicating an out-of-balance between that and the work under adjustment. This method is used for the adjustment of silvered mica capacitors down to about 1/2%. A typical accuracy is about 1% but it is possible to expand the scale to give greater accuracy over a limited range provided that the zero can be maintained.

The above is an analogue method but there are, as described later, digital methods using self-balancing bridges with digital limit detectors. These are more expensive but have the advantage that they can be programmed for a particular nominal value and tolerance.

3.4 Automatic Test Set

One of the most well known of these consists of a wheel into which the capacitors are loaded in contact jaws. They are then carried round so that contact is made in turn to each of a number of test equipments. The results of each test is recorded in a memory so that when the capacitors reach the eject position they are ejected into the appropriate drawer. This equipment is shown in Fig. 1(a).

The wheel is basically an analogue of the movement of the capacitor from one test set to another. The limitation is the speed at which it can be loaded (about 1,500 per hour).

Figure 1(b) shows the sequence of tests carried out on the automatic rotary set. There are two basic types of machine, one for tantalum capacitors and one for metalized plastic. They differ mainly in the electrification

time for the measurement of leakage current, being 45s and 15s respectively. In addition, the tantalum capacitors are tested for impedance and subjected to 1.7 times the working voltage which is important in eliminating unreliable capacitors. The plastic film capacitors are subjected to burn-out at about 2 times working voltage prior to measurement.

These automatic rotary machines are used to test 100% the whole of the output so that the acceptance sampling is a check on the correct operation and setting up of these machines. In accordance with BS 9000, Part 1, 2.6.3.1, it is not necessary for all of these tests to be repeated in lot by lot acceptance inspection. It has not, therefore, been found necessary to incorporate voltage proof testing in the equipments described later.

3.5 Measurement of Leakage Current or Insulation Resistance

One of the simplest, and yet the most time consuming, is the measurement of leakage current. This is the conduction current flowing through the capacitor with a direct (either the rated or an arbitrary fixed value) voltage applied. A schematic diagram of the method of measuring leakage current is shown in Fig. 2. The

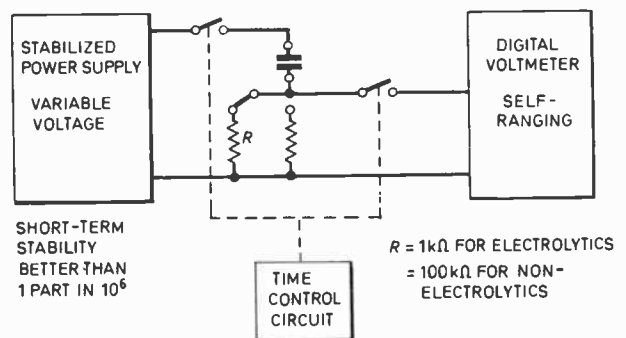

Fig. 2. Method of measurement of leakage current.

resistance of the circuit combined with the capacitance of the capacitor under test result in a time-constant. When the voltage is applied to the capacitor it is necessary to wait for the charging current to decay before the leakage current can be measured. This is illustrated in Fig. 3 which shows the effect of different circuit impedances.

It will be noted that even when the charging current has died away the conduction does not take up a constant value. This continues to fall slowly and it may take as much as 24 hours to reach a steady value. This is due to internal polarization, dielectric absorption, or the building up of space charges in the dielectric.

The normal specified time of electrification is either 1 minute for non-electrolytics or 3 minutes for electrolytics. The limits are therefore applicable at these times. As will be shown later these times are much too long for production sorting and by the use of low impedance measuring circuits and corrected limits tests after 15 s and 45 s are normal practice.

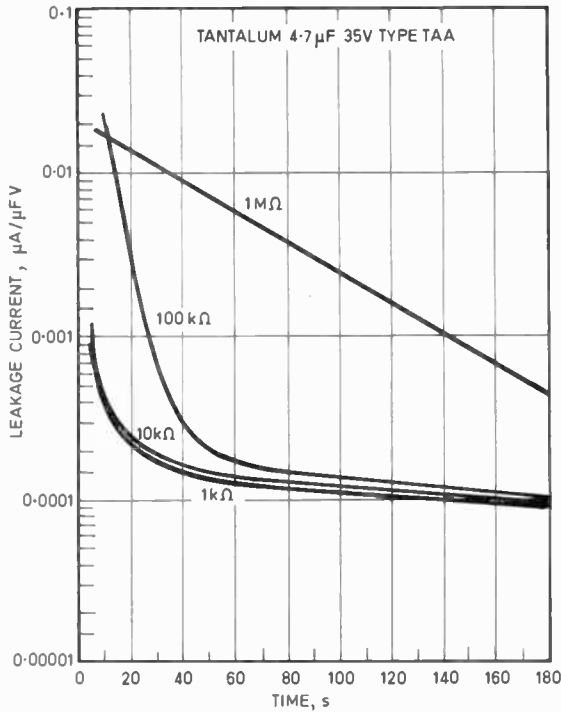

Fig. 3. Effect of circuit impedance on leakage current.

A further possibility which has been used with computer-controlled test equipment is to accept the capacitor as soon as the limit has been reached. Where a large

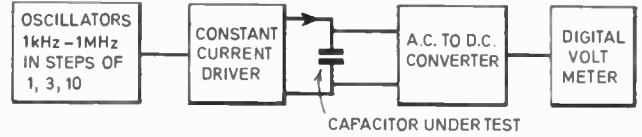

Fig. 4. Method of measurement of h.f. impedance.

RANGES:

Frequency 7 spot frequencies 1 kHz, 3 kHz, 10 kHz, 30 kHz, 100 kHz, 300 kHz, and 1 MHz.

Impedance 3 ranges 12 Ω, 120 Ω and 1.2 kΩ
1 digit on lowest range is 10 mΩ

ACCURACY:

D.V.M. with associated printer ± 5%.

proportion of the product is within limits this represents a considerable time saving. This decision can normally be made after about 5 s.

One complication, handed down from the past, is that the requirements for electrolytics are always specified as leakage current while non-electrolytics are specified as insulation resistance. This unnecessarily complicates the measurements as discussed in the Appendix. Since for electrolytics it is essential to use the rated voltage the same method could be applied to non-electrolytics.

3.6 Measurement of Impedance

Since most capacitors are used in high-frequency circuits, h.f. impedance is of importance to the customer. It is an easy measurement to make in production.

A schematic diagram of the method of measurement of h.f. impedance is shown in Fig. 4. A constant h.f.

Table 1
Evolution of capacitor testing systems

	Balance	Capacitance and tan δ			Leakage current			Impedance			Calculation	Storage of records. Group decision making	Transfer system			Testing speed per hour	Remarks
		Attribute decision	Variable direct reading	Variable recording	Attribute decision	Variable direct reading	Variable recording	Attribute decision	Variable direct reading	Variable recording			Load/unload	Test quantity	Transfer from one test equipment to another		
Manual bridge Self-balancing bridge operated manually with other test equipment as above with computer control	Manual	No	No	No							No	No	Manual	1	Manual	120-200	
	No	No	Yes	No							No	No	Manual	1	Manual	400	
	No	No	Yes	Yes	No	Yes	Yes	No	Yes	Yes	No	No	Jig	10	Switch	200†	
	No	Yes	Yes	Yes	Yes	Yes	Yes	Yes	Yes	Yes	Yes	Yes	Jig	10	Switch	1200	Attributes + variables. Suitable for acceptance sampling
Rotary wheel	No	Yes	No	No	Yes	No	No	Yes	No	No	No	No	Wheel	Continuous	Switch	1500	Attributes only. Suitable for production testing.

†Limited by leakage current electrification time

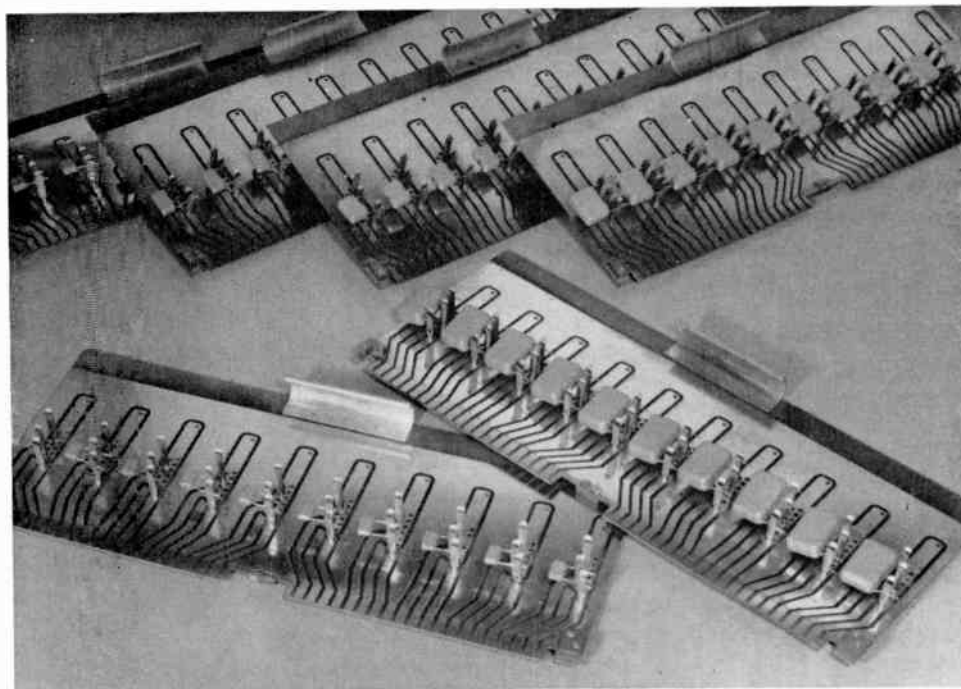

Fig. 5. Multiple test jigs.

current (usually 100 kHz) is passed through the component to be tested. The resultant alternating voltage is converted to d.c. and is indicated on a digital voltmeter (d.v.m.). By an appropriate choice of values the d.v.m. can be made direct reading.

3.7 Self-balancing Bridges

Commercial equipments are now available which are capable of making precision measurements of capacitance and tangent of loss angle without manual balancing and with direct read-out. They employ conventional bridge circuitry but with solid-state switching. The output is given on number indicator tubes, together with a facility for digital print out or punched tape. Four-terminal operation (plus screen) permits the elimination of errors due to leads and switch contact resistance. While these on their own will give some savings by comparison with manual methods, much greater savings can be made by taking advantage of their inherent speed. This can be done in different ways depending on the level of performance required compared with the level of investment:

- (i) by manual operation,
- (ii) with digital limit detectors to give an attributes output as referred to in Section 3.3,
- (iii) with print-out,
- (iv) in association with other test equipment such as leakage current or impedance tests with or without print-out (capacitors tested in groups, e.g. of 10),
- (v) as in (iv) but with computer control and analysis.

The facilities provided by each of these schemes are summarized in Table 1. There is, of course, the alternative possibility of taking advantage of the inherent speed of these equipments using hard-wired logic. The main reason why this option was not used was the need to limit the amount of in-house design and manufacture of hardware. In order to achieve the same level of performance

(including reliability) as with a small computer a very high level of skill would be required. Furthermore similar computers were in use or envisaged, for other process control applications so that there were advantages of flexibility, reliability and maintainability.

In addition, set-up times can be reduced by pre-programming, by building up files of limit data and operation made more versatile (e.g. by accepting on leakage current as soon as the limit value has been reached). There are also many possibilities of processing the data as described later.

The next stage in the development of the equipment described in Section 3.8 was to group a self-balancing bridge with a leakage current and h.f. impedance test circuit. This used a printed circuit board jig as shown in Fig. 5, accommodating capacitors in groups of 10. Control of stepping was manual for capacitance and tangent of loss angle and automatic for leakage current at the end of the specified period.

3.8 Transfer Systems

Typical times taken for the actual measurement by the equipment in use are as follows:

Measurement	Frequency	Time (s)
Capacitance and $\tan \delta$ with polarizing voltage	120 Hz	1
Capacitance and $\tan \delta$ without polarizing voltage	1000 Hz	0.2
Leakage current	d.c.	0.05
Impedance	100 kHz	0.05

Thus an electrolytic capacitor requires a basic measuring time of 1.1 s compared with 0.3 s for a non-electrolytic. To this must be added the time for the electrification for the leakage current measurement. This may

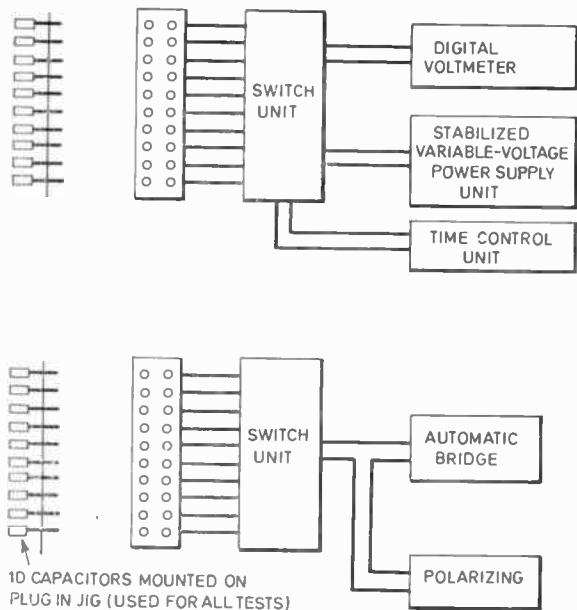

Fig. 6. Automatic test equipment for capacitance, tangent of loss angle and leakage current.

be minimized by charging a number of capacitors up sequentially at the specified time before the measurement is due.

The intrinsic measuring speed for an electrolytic capacitor is 3000 per hour, while for a non-electrolytic it is about 10000 per hour. It must be self-evident that the full benefit of these speeds cannot be achieved without a corresponding improvement in the method of loading and unloading. Thus the development of the transfer system must go in parallel with that of the test equipment. This is primarily a mechanical problem requiring the same skills as are required to develop mechanized component production systems.

There are two basic methods of achieving this transfer. The first is where the component itself moves. The simplest example of this is the manual case where the component is connected manually to a series of different test equipments. At a more sophisticated level the automatic test set described in Section 3.4 carries the components round and acts as a switch connecting the various equipments.

The second method is where the component is stationary and sequential connexion to the various equipments is achieved by switching. This requires that the components be in groups with facilities for electrical connexion to each individually. For leakage current measurement the potential is applied sequentially and the measuring circuit switched in the specified period later (1, 3 or 5 minutes). The simplest example is the 10-way test jigs as shown in Fig. 5. If, however, the testing times are considered, particularly for leakage current, it can be seen that this does not permit a very high testing rate. This is clearly shown in Table 2.

Table 2 shows the number of capacitors to be electrified at any one time to achieve certain testing rates for different electrification times. It shows that in order to meet specified times 120 electrolytics or 160 non-electro-

Table 2
Number of capacitors to be electrified at any one time

Leakage current electrification time (s)	Testing speed (per hour)			
	1000	2500	5000	10 000
5†	2	5	10	20
10†	3	8	15	30
15	4	10	20	40
30	8	20	40	80
45	12	30	60	120
60	16	40	80	160
180	48	120	240	480

† Time sufficient to accept those which pass but not to reject those which fail.

lytics would need to be tested at one time. These numbers would then fully utilize the above intrinsic testing speeds. These numbers can be reduced by a factor of 4 by using a quarter of the time. On the other hand it can be seen that if an acceptance decision can be made in 5 s then the 10-way test jig permits a testing rate of 5000 per hour. This, however, requires the jigs to be loaded at a rate of 10 per minute.

These figures should be sufficient to show that the ultimate method of testing is to make contact to a large number of components simultaneously and to carry out a sequence of tests by automatic switching by computer control. The best place for this testing is while the components are orientated in manufacturing jigs.

3.9 Self-balancing Bridges with Computer Control

The above set-up for acceptance sampling employed an electrification time for the leakage current measurement of three minutes. The total cycle time, therefore, for then capacitors was 3 minutes 20 seconds. In addition it was necessary for the inspector to look up and memorize the limits and to record by pressing push-buttons if any of the capacitors were defective.

It was concluded that many of these things could be significantly improved by controlling the test set by computer as follows:

- (i) To compare the readings with stored limits.
- (ii) To have a memory store of all limit data requiring only the minimum input information to set up the necessary test conditions. These would be lot identity, type of capacitor, capacitance, tolerance, rated voltage.
- (iii) Since this equipment is normally used on an attributes basis and since most of the capacitors offered to it are inside limits, it was considered unnecessary to wait the full 3-minutes electrification time and in fact to accept the capacitor as soon as it fell below the limit value.
- (iv) To store up records of previous lots so that lot acceptance and rejection decisions can be made adequately, as well as if necessary the use of normal tightened or reduced inspection.

Fig. 7. Automatic test equipment with computer control.



- (v) A display unit shows the number of defective capacitors for each parameter.
- (vi) Two equipments can be controlled on one computer.

This equipment is shown in Figs. 7 and 8. Experience so far has shown that a large proportion of batches are accepted within 20 seconds. This corresponds to an average testing time of 2 seconds per capacitor. Further work is still to be done to establish the master store and to link in the second test equipment.

The present mode of operation is 'conversational' which has proved to be an excellent introduction for inspectors who have had no previous experience of conversing with a computer. It familiarizes them with the teletype and gives them an appreciation of how the computer operates.

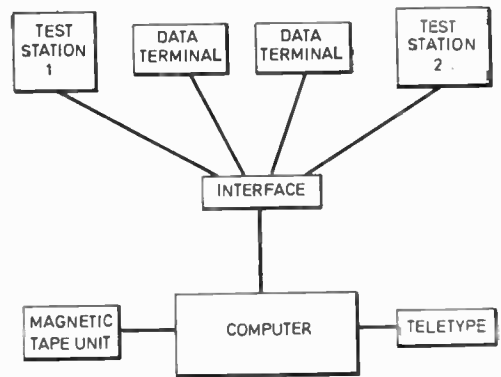

Fig. 8. Use of computer to control two test stations.

PASSED AQL

7401CQ

```

F
FF
>TAG 4.7 M35 473.70  BS
NJ
>5
CP
>4.7
TL
>20
DF
>.1
IM
>5
LI
>3.3
R?
>
OK
    
```

SAMPLE	ELECT	MECH	VIS
50	—	—	—

```

FAIL  C: 00  D: 00  I: 00  L: 00  TOT: 00
    
```

Fig. 9. Typical print-out for batch acceptance.

The facilities provided are:

- (i) indication of capacitor type and inspector's initials,
- (ii) indication of the number of jigs to be tested,
- (iii) manual input of limits of capacitance, tolerance, dissipation factor, impedance and leakage current,
- (iv) check that all sets are on their correct ranges,
- (v) failure analysis by attributes.

A typical print-out is shown in Fig. 9.

4 Conclusions

- (i) Investment in automatic test equipment for large scale component testing can be justified if advantage is taken of their high inherent speeds.
- (ii) Automatic test methods permit the high accuracy testing of capacitors at speeds up to 3000 per hour for electrolytics and about 10000 per hour for non-electrolytics. The difference is mainly due to the different measuring frequency.
- (iii) The main problem is the electrification time before the measurement of leakage current. By the use of low impedance charging circuits early decisions may be made as follows:
 - (a) The use of reduced time periods and corrected limits to take accept/reject decisions.
 - (b) To accept as soon as the limit value has been passed.

In all cases it is necessary to charge a number of capacitors in parallel.
- (iv) In order to achieve the required testing speeds these test equipments must be incorporated into testing systems which include a method of loading and unloading. In the simplest case this can be a multiple jig but for very high testing speeds much more complex transfer systems will be necessary. At the present time these speeds are limited by that of the transfer system.
- (v) Computer control of this test equipment is a method of achieving these testing speeds to take the necessary decisions and to actuate reject mechanisms. These can be based on a file of limits within the computer so that only very basic information needs to be entered via the data terminal. Further extensions of this are possible to accumulate data on current and previous lots and to provide management information.

- (vi) The distinction between leakage current for electrolytics and insulation resistance for non-electrolytics complicates the testing and should be eliminated.

5 Acknowledgment

The author wishes to thank ITT Components Group Europe for permission to publish this paper. The assistance of Graham Williams in the development of the systems and of Roger Kingdon in their practical implementation is gratefully acknowledged.

6 Appendix

Leakage Current or Insulation Resistance

Let the leakage current of an electrolytic capacitor with rated voltage V_R and capacitance C_R be i_R . Let i_R be proportional to both V_R and C_R . Then the reciprocal time-constant (t) of the capacitor (the time taken for the charge to leak away through its internal leakage) is

$$\frac{1}{t_R} = \frac{i_R}{V_R C_R} \quad (\mu\text{A}/\mu\text{FV})$$

$$t_R = \frac{V_R C_R}{i_R} \quad (\text{ohm-farad}) \quad (1)$$

Let the insulation resistance of a non-electrolytic capacitor with test voltage V_T and capacitance C_R be R_T . The time-constant at voltage T is given by

$$t_T = R_T C_R \quad (\text{ohm-farad})$$

But R_T is measured from

$$R_T = \frac{V_T}{i_T}$$

thus

$$t_T = \frac{V_T C_R}{i_T} \quad (2)$$

Thus the two expressions (1) and (2) are identical except that the electrolytic is measured at rated voltage and the non-electrolytic is measured at an arbitrary standard voltage. This is to permit manual test equipments to be scaled in ohms.

Manuscript first received by the Institution on 16th April 1973 and in final form on 14th January 1974 (Paper No. 1578/CC 194).

Connector Standards and BS 9000

A. W. EVA*

Based on a paper presented at an IERE Colloquium on 'Electrical Connectors—Applications and Reliability' held in London on 15th May 1973.

SUMMARY

A brief history of early standards and war-time connectors is followed by an account of the work of the post-war component standardization committees which led to the reports by the Burghard Committee and the BS9000 series of standards. Two sub-committees of BSI, TLE6/8 and TLE21/2 dealt respectively with r.f. and l.f. connectors and after early setbacks which were a result of the unfamiliar nature of BS9000, work on a number of specifications proceeded. Mention is also made of some of the auxiliary work associated with the specifications; the work of the R.F. Committee on crimping is an example. A detailed list of the many projects under way or nearly completed is given.

* Consultancy (PR) Services, 21 Goose Green, Lowertown, Oxenhope, near Keighley, Yorkshire.

1 Introduction

It is accepted that the title of this paper could lead to some misinterpretation, it could for example be argued that BS9000 has no place in modern connector production whether it be professional or commercial (i.e. entertainment) connector production. In fact it could be said with some present justification that to talk of BS9000 and connectors is a nonsense when no such devices exist.

But regarding the relevance of BS9000 to connectors, it must surely be conceded that in the interests of overall equipment reliability it is of greater consequence that connectors of assessed quality are available to users than perhaps any other electronic component. If with the smaller numbers involved this creates difficulty the common family or structural similarity clause should help. This is particularly so in the case of the professional connectors.

As to the current lack of such connectors it must be stressed that this is a situation which should materially change in the next twelve months. As a concept BS9000 is entirely new and cannot be compared with either DEF 5001B or 5001C; BSI sub-committees concerned with BS9000 specifications were originally navigating in largely uncharted waters and this did not make it easy when dealing with such complex components as the modern connector. This resulted in set-backs which admittedly retarded the programmes.

2 Early Standards and Standardization

Whilst it would be true to say that plugs and sockets have probably been subjects of standards and/or standardization (not always the same thing) since the advent of domestic electricity supplies, the same could not be said to be true of the radio plug and socket. Indeed to the writer's knowledge, prior to the 'thirties such components did not exist and before the war only one Standard, BS 666, existed; dated 1936, it is still current and is due for revision by BSI/TLE21/2. This specification covered 'jack plugs and sockets and inlet and outlet plugs and sockets for low-power radio circuits'. Perhaps in any early catalogue of plugs and sockets the ubiquitous wander plug and banana plug and socket, still with us, should not be forgotten.

Such, largely, was the position at the outbreak of war in 1939, although a programme of connector development had been under way at a government establishment for some two years preceding it. Perhaps the imminence of war precipitated this work, at least it bore fruit early on. It became clear as the war proceeded that increasing quantities of electronic items were going to be required and if the massive quantities of such items were to be interchangeable both electrically and mechanically, rigorous standards of manufacture, inspection and test would be essential; this became even more important when contracts were placed abroad, e.g. in America. Naturally this did not happen overnight and the component standards organization as we came to know it did not come into being until well after the war ended. However it was to last for a very long time, in fact until the Burghard Committee's recommendations were implemented but the organization was never static and was evolving the whole time.

Concerning early connector standardization it is perhaps true to say that the ranges already referred to and developed by the Royal Aircraft Establishment at Farnborough for Air Force use, were probably the first purpose designed connectors for use in this country for any of the services. Known as the 'M' moulded, and 'W' diecast shelled, ranges they incorporated many features looked for in connectors today, and subsequently appeared in the Inter-Service Component Standardization list. Although these connectors were of excellent design and were a major advance in the interconnexion of radio and electrical circuits, they did have serious drawbacks, they were large and, to use a modern term, they were not proof against the environment.

It was recognized that sealed and/or pressurized equipments were going to be not only desirable but necessary and hence connectors for use with such equipments must be available. Such a range of connectors was at this time actively under development jointly by another Government establishment, the Signals Research and Development Establishment, and a major British component and equipment manufacturer. Known as Mark 4 connectors they were entirely new in scope and design and they too included many features which are today regarded as standard and necessary in all current designs. It says much for their early design work that although more than thirty years old the range is still in use today, having been subjected to continuous development over the years. Their latest Services form is the Pattern 104 and they must be regarded as one of the really successful connector ranges that emerged from the war.

Before leaving the early standards a brief mention must be made of Unitors, rectangular connectors used for direct interchassis connexion without the intermediate use of cables. Two service ranges were developed, one by the Telecommunications Research Establishment (now the Royal Radar Establishment) and the other by the Royal Aircraft Establishment. Both were rectangular moulded connectors for which metal shells were also provided as accessories, and they could thus also be used as connectors in the more conventional sense. This then really brings the connector scene up to date for it can be shown that the present really started some twenty-five years or more ago.

3 Joint Services Standardization

Reference has already been made to Inter-Service, or more correctly, Joint Services Standardization and in looking at events leading up to BS9000 it is pertinent to look at the earlier organization which was set up by the Ministry of Supply after the war in an effort to rationalize the component scene and carry out necessary standardization. A number of sub-committees were set up under the Inter-Service (later Joint Services) Radio Component Standardization Committee with responsibility for particular component ranges. In this respect *all* connectors were covered by a single sub-committee (S/C.J). A parallel organization was set up by industry and the corresponding sub-committee was also 'J'.

It is important to remember that these committees were set up to rationalize and standardize in the strictest

sense. Any manufacturer wishing to make items from the Services list for the Services had first to assure the authorities that he could work to, and meet, the specification including the testing. Having made good this claim and received approval he was then free to manufacture against government contracts and this meant, among other things, working to drawings supplied with the contract. This last could, and did, at times raise problems; it frequently happened that components diverged from the specification, usually only marginally, but it was a deviation whether it was on test, dimension, or material. The authority could under the circumstances exercise its judgement and if it thought proper grant a concession. This highlights a weakness of such a system: in effect it is the hidden waiver, hidden because only the manufacturer concerned and the authority knows of it. The waiver is one of the weaknesses of the American MIL system, and indeed there it goes very much further, and whilst it may be acceptable to a single system based upon Service needs and requirements it is not acceptable to a national, and even more an international, system based upon mutually accepted disciplines: BS9000 is such a system and it allows no concessions but it does not seek rigidly to standardize in the old Services sense.

4 BS9000 and Connector Specifications

The second Burghard Committee was convened in 1964, and produced its report about two years later. This was subsequently accepted both by Government and Industry and the British Standards Institution undertook responsibility for setting the scheme up and administering it. After considerable discussion a government inspection organization, the Electrical Inspection Directorate (EID), later to become EQD (Electrical Quality Assurance Directorate), was made the supervisory agent for BSI under the scheme. Two of the BSI TLE sub-committees were responsible for connectors; TLE21/2 was to cover the l.f. side and TLE6/8 the r.f. Whether this two committee structure was an entirely good thing for connectors is, in the writer's view, open to question and hence contentious, having due regard for the commonality which exists, and today is increasing between connectors.

Looking first at multipole (l.f.) connectors it is again worth while pausing to look back at the immediate post-war period. In this country we had only one native environmental range of circular multipole connectors, the Mark 4, moreover there was seemingly to be no effort made to produce an alternative range of environmental connectors having only a wartime connotation. The American situation was different, work in many military areas continued and included several connectors for which MIL specifications were being prepared. With the establishment of NATO and its large American participation it was inevitable that large amounts of their equipment should find their way into the European armed services, and this situation was intensified by the purchase for our own armed services of much of this equipment. One result of this activity was the increasing numbers of the more sophisticated MIL type connector now coming into service, and it was not surprising therefor that when priorities were being established for 9000-type connectors

the services made a strong claim for some of these types. Thus it was that with increasing numbers of the MIL connectors either being made here under license or being made and/or assembled here by American companies these types did in fact get the necessary priority. It is an interesting point however that some subsequent development was required on these items in order that they should comply with the rather more stringent requirements of BS9000 and this will have resulted in a component which whilst being interchangeable with its American counterpart will in a number of important areas, be superior.

5 Generic L.F. Connector Specification and Rules for Circular L.F. Connectors

It was said at the beginning of this paper that BS9000 was akin to navigating in uncharted waters and this was particularly unfortunate for such complex items as connectors, resulting as it did in many set-backs and delays. But the situation has now been retrieved and the committee now has the knowledge and experience to write with confidence in the future.

The generic specification for l.f. connectors, BS9520, was published in 1970 and in 1972 the circular rules document BS9522 appeared. Work on a detail specification started between these two dates and after a false start or two it became clear that there were deficiencies in both the generic and the rules documents which made it at first difficult and later impossible to complete the detail specification. The net result of all this meant a very extensive revision of BS9520 and consequent amendments to the rules document, so that the opportunity was also offered to write the detail specification in conjunction with these two. With hindsight it might be thought that this would have been a logical proceeding but one has not always the advantage of hindsight. That the detail specification was subsequently delayed by deficiencies in the MIL drawings, was another issue entirely which could not have been foreseen. The situation has now largely been resolved and amendments and specification should be available early in 1974, the holding factors now being final editing and printing.

6 Detail Specification, Circular, BS9522N-XXX

Four detail specifications are being considered the first of which, BS9522N-003, is based upon MIL-C-3899C and is being made in this country by several manufacturers both British and American, each of whom will be seeking approval. Having a workable rules document the other 'circular' detail specifications should appear in fairly quick order and details of the four under consideration are shown in Table 1. Figure 1 shows typical members of this BS9522 family of connectors.

7 Rectangular L.F. Connectors with Integral Metal Shells

These are connectors of the unitor type but having metal shells or housings integral with the insulator moulding they have a wide usage; particularly in the computer industry. Connexion to these items may, according to type, be by solder joint, crimp, or wire-

Table 1. Circular multipole connectors

BS9522N-	MIL-C-equivalent	Equivalent DEF No.	Current situation
001	26482E	Patt. 603	amending†
002	81511	—	in abeyance‡
003	38999C	—	editing
005	83723 (was 26482F)	Patt. 602 EL 2112	amending†

† 'amending' means that the document is with a BSI working party who are introducing agreed amendments from comments received.

‡ 002 is held pending MIL specification clarification and is not under BSI control.

wrap. The rules document for these items, or rather this family of connectors, has currently completed the sub-committee stage and should be available early in 1974: its number will be BS9523.

The first detail specification to be produced to these rules will be N001 and will be the well-known trapezium connector. It will be based upon the DEF Patt. 110 and will be for solder connexion only; this connector has its MIL counterpart (MIL-C-24308). Work on the detail is proceeding well for the solder version but the crimp type is at present held up by a patent situation. It is a requirement for an 'N' type specification that a would-be user must be able to do so without the risk of a patent infringement, it is hoped that a satisfactory conclusion will have been reached before the end of 1974.

8 Rectangular L.F. Moulded Connectors

When considering rules documents some arguments were advanced for a single document embracing all rectangular families, even including the printed circuit board connectors. There will always be found protagonists for the multi-purpose specification or rules document. In the case of the generic specification the l.f. document is in fact multi-purpose but the writer, in company with some other people, is beginning to have second thoughts even on this but to extend the principle to rules documents is certainly not feasible. Although it might seem attractive to have a single document on the grounds of price etc., the confusion engendered by such a document with its exceptions and often misleading and confusing requirements far outweighs the trifling extra cost of single unique documents.

Separate rules documents were therefore decided to be 'the order of the day' for each different family of connectors even though there were similarities, and even though one document may refer to another or even 'lean' upon it. The rules document for the ranges of rectangular moulded connectors, will be numbered BS9524 and a draft for comment will be circulated probably early in 1974. If all goes well with the document and comments are no more than editorial, it could be with the printer by October. Meanwhile work is proceeding with a detail specification by an Industry working party and has not been seen in committee yet; it will bear the number BS9524N-001 and will also meet

the requirements of DEF Patt. 103 (crimped). A DEF solder contact version has already been published and it is not envisaged that a BS9000 version will appear but the two will be intermateable. There are MIL versions of these items but there is doubt about the intermateability of the solder/crimped versions of these and hence full interchangeability between the MIL and BS/DEF specifications.

9 Printed Circuit Board Connectors

As with the rectangular styles there will be two sets of rules for p.c.b. connectors, one for two-part connectors, BS9525, and the other for the modular (one part) connector, BS9526. Both of the documents are with a BS working group although BS9525 is the more forward of the two documents. Work on the detail specifications is proceeding, for the two-part a forthcoming IEC recommendation has been chosen, based on IEC document 48B (Central Office) 82. This was an original French proposal to IEC and will probably have both wire-wrap and solder version pins the spacing of which will be 0.1 in in each direction. This item could well form an early harmonized specification in view of its IEC origin.

The modular connector is at present with an industry working party and is a very good example of co-operation not only between BSI and RECMF, but also between individual companies. A number of interested companies have worked on a document setting out design principles, and the resulting detail specification will allow each of these manufacturers to offer his existing product for approval with a minimum of modification.

Table 2 sets out the details of all the rectangular connectors, including the p.c.b. types while Fig. 2 illustrates the connector type BS9525 N001.

Table 2. Rectangular multipole connectors including p.c.b. families

BS95XX number	Origin	Current situation
9523 (rules)	—	comments completed
9523N001	DEF Patt. 110	amending
9523N00X	DEF Patt. 110 (crimped)	with BSI S/C (ref. patent)
9524 (rules)	—	S/C preparing comment draft
9524N001	DEF Patt. 103 (crimped)	with industry working party
9525 (rules)	—	with BS working group
9525N001	IEC 48B(C.O.)82	with BS working group
9526 (rules)	—	with BS working group
9526N001	Industry	with industry working party

10 Specification for Removable Contacts

A feature of many modern connectors is the removable contact, and this particularly applies to those using the

crimped contact. Contacts, whether crimped or not, are very frequently made by specialist firms who as often as not have no interest in the completed connector as such. Very often their products are sold direct to the connector user, this is particularly so with crimped removable contacts. It is logical therefore that a user of connectors having assessed quality should expect the same degree of assurance from the contacts which he buys, perhaps from a different source. To this end a specification is being prepared which will control the manufacture of contacts in much the same way as for the connector or indeed any other electronic component covered by BS9000.

Work is proceeding on the preparation of such a document which will be both a generic specification and a rules document. It will bear the number BS9521 but due to the manpower situation it is not expected to be available until later in 1974. Until then special measures will need to be taken by the supervising authority if the need arises or a detail specification (e.g. BS9522 N003) will control the individual contacts.

11 R. F. Connectors, Soldered Connexions

Compared with its l.f. counterpart, the r.f. connector is much less complicated, especially the non-matched styles, and it is disappointing that progress in standardization has been so relatively slow. For a start the generic has only to consider one plan form, the coaxial; only a single set of rules are needed, and these are incorporated in the generic specification. Lastly, the cables are all of a type and the parameters are all well defined and contain no surprises and yet the r.f. picture is not very different from that of the l.f., and r.f. detail specifications are not likely to be very much in front of their l.f. counterparts. The would-be user may well be forgiven for asking why?

It was perhaps unfortunate that the R.F. Committee fell into some of the same traps as the L.F.; a generic specification was written in isolation and with it the rules. As before, when the various working groups started to write the detail specifications deficiencies were found in the generic and to complete the parallel extensive revision of the generic had to be undertaken.

The r.f. specification was originally published in March 1971 and bore the number BS9210. The necessary amendments were completed and published in February 1973, but meanwhile work on the detail documents was going ahead. These at first dealt with BNC variants but later SMB and SMC were added to the list; several of the items at first included were later abandoned, and for quite good reasons; perhaps put in abeyance might be a better term to use. Those so treated were BNC cat. 'C' sealed, BNC tri-axial, and SMB, SMC, cat. 'C'. Meanwhile errors were discovered on the interface (BNC) details; it is interesting to note that errors on the interface have been discovered on these connectors in one way and another over quite a number of years and it is to be hoped that the design has at last been finalized.

The need for these standards is great, as so far there are not even IEC recommendations available for use. Proposals have been put forward for BNC connectors over a large number of years but for one reason and

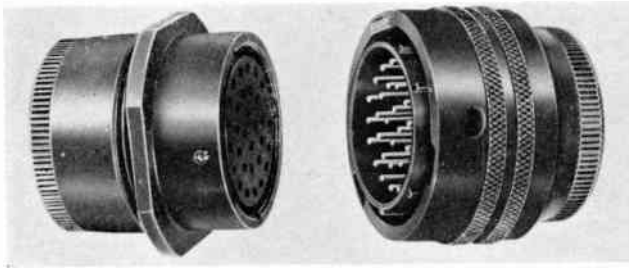

Patt. 105 type. DEF STAN 59-35 Part 1 Sect 3. MIL-C-26482. Thorn 'PT' series.

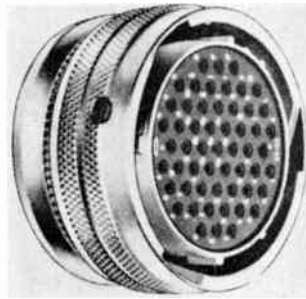

BS9522 N003 type. MIL-C-38999 series IIA. Thorn 'JT' series.

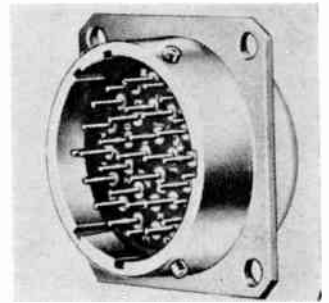

Patt. 602 type. NAS 1599. MIL-C-83723. Thorn 'PTS-DRE'.



Patt. 603 type. BS9522 N001 type. MIL-C-26482. Thorn 'PT-SE' series.



Fig. 1. Circular I.f. connectors.

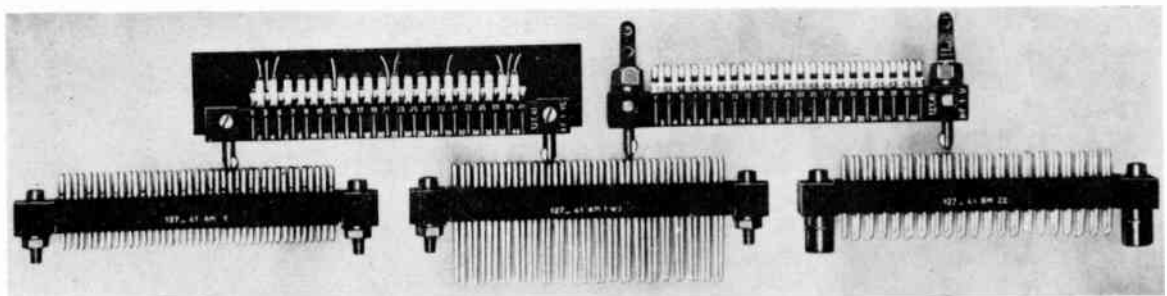

Fig. 2. Two-part p.c.b. connectors.
 Patt. 127 type. BS 9525 N001 type. IEC 48B (C.O.) 82.

Thorn Electrical Components Ltd., photographs.

another they never came finally to fruition. One very good result to come out of our own exercise may well be that the IEC document can at last be finalized.

Table 3 shows the present position as it relates to r.f. connectors for solder connexion, it does not relate to crimp connexions.

12 R.F. Connectors, Crimp Connexions

Although crimp-type r.f. connectors have been available for a long time, their r.f. performance has been poor, with the possible exception of one American maker's products, and his method of crimping was covered by patents and hence not generally available. The outer contact did not give the trouble and generally a satisfactory crimp could be produced. The difficulties lay with the inner contact and the electrical performance at very high frequencies and was caused by the lack of control over the crimp. A working group of the sub-committee was set up with power to co-opt experts from industry if necessary to study the problem. The team which was brought together spent about eighteen months on the project and were successful in their efforts which had to include suitable tool and die design, together with methods of testing.

Table 3. R.f. connectors, soldered connexions

BS9210N-number	Family	Current situation
001	BNC sealed†	editorial
002	BNC sealed‡	in abeyance
003	BNC non-sealed†	editorial
004	BNC non-sealed‡	S/C stage completed
005	BNC tri-axial non-sealed†	in abeyance
006	BNC tri-axial non-sealed‡	in abeyance
007	SMB non-sealed†	with BS S/C working group
008	SMB non-sealed‡	in abeyance
009	SMC non-sealed†	with BS S/C working group
010	SMC sealed‡	in abeyance

† Indicates 'general' or full assessment category.
‡ Indicates 'C' or basic assessment category.
001 is also compatible with DEF Patt. 16.
003 is also compatible with DEF Patt. 15.

Table 4. R.f. and l.f. connector position

BS9XXX number	Document type	Document coverage	Estimated availability	BS9XXX number	Document type	Document coverage	Estimated availability
BS9210	Generic and rules	r.f. connectors all types	available	BS9522N001 & 005	Details	multipole circular l.f. connectors full assessment	4th quarter 1974
BS9210N001	Detail	sealed BNC connectors full assessment	2nd/3rd quarter 1974	BS9523	Rules	rectangular connectors with integral metal shells, l.f.	3rd quarter 1974
BS9210N003	Detail	non-sealed BNC connectors full assessment	"	BS9523N001	Detail	trapezium shaped l.f. connectors full assessment solder contacts	"
BS9210N004	Detail	non-sealed BNC connectors basic assessment	3rd quarter 1974	BS9523NXXX	Detail	trapezium shaped l.f. connectors crimped contacts	1975?
BS9210N007	Detail	non-sealed SMB connectors full assessment	1st quarter 1975	BS9524	Rules	rectangular moulded l.f. connectors with separate shells	3rd/4th quarter 1974
BS9210N009	Detail	non-sealed SMC connectors full assessment	"	BS9524N001	Detail	rectangular moulded l.f. connectors multipole crimped contacts full assessment	3rd/4th quarter 1974
BS9210NXXX	Detail	non-sealed BNC crimp connector full assessment	3rd/4th quarter 1974	BS9525	Rules	two-part p.c.b. l.f. connectors	1st/2nd quarter 1975
BS9210NXXX	Detail	non-sealed SMA connectors soldered full assessment	2nd quarter 1975	BS9525N001	Detail	two-part p.c.b. l.f. connectors full assessment	2nd/3rd quarter 1975
BS9520	Generic	l.f. connectors all types, revision	2nd quarter 1974	BS9526	Rules	modular (one-part) p.c.b. l.f. connectors	2nd quarter 1975
BS9521	Generic and rules	contacts†	2nd quarter 1975?	BS9526N001	Detail	p.c.b. modular l.f. edge connector	3rd quarter 1975
BS9522	Rules	multipole circular l.f. connectors, revision	2nd/3rd quarter 1974				
BS9522N003	Detail	multipole circular l.f. connectors full assessment	2nd/3rd quarter 1974				

† Although this specification is nominally an 'l.f.' one there seems to be no logical reason why it should not cover all contacts including 'r.f.' if and where they are made separately.

A draft detail specification for a crimped BNC connector has been studied by a working group of the sub-committee and will shortly be with the sub-committee preparatory to it being circulated generally for comment. The published document can probably be looked for towards the end of this year but this may be conditional upon the publication of a specification for the tool and dies. Once the first detail specification has been cleared by the sub-committee, the way will be open for crimp versions of all suitable solder types, always assuming a sufficiency of available effort.

It would be fair to assume that by the end of 1974 some r.f. detail specifications in both the full and basic assessment categories may be available with crimped connexions.

Reference was made above to the tools and dies for these crimps and before leaving this Section it might be an advantage to have a brief word on the subject of a tool specification. For obvious reasons crimping methods, tools, and dies must be defined, moreover, in order to maintain r.f. performance, we have seen that the crimp must be controlled. The degree of control is the main area wherein the r.f. crimp differs from its l.f. counterpart, hence a specification is necessary or at least a guidance document, remembering always that the test performance is the ultimate criterion. But assuming a tool specification, and this does appear to be the ideal, the question may be put 'where shall it appear?' Tool specifications have no part in the BS9000 series: this has been said many times and is true, therefore such a specification must lie outside but still within the BS orbit; it will still be written by the same group of the same sub-committee and could perhaps be fitted within the BS6000 series of BS specifications. We already have two which are associated with BS9000, these are BS6000 and BS6001, therefore it is logical for the crimp tools to fit in here.

As a further matter of crimping interest, the l.f. Committee are also very interested in a crimping document; whilst it is obvious that a r.f. crimping specification could be used for l.f. connectors the control may be too tight, or unnecessarily so for the l.f. needs but presumably there would be no objection to the document being studied and, if suitable, amended by additions to cover also the wider needs. Whatever ultimately happens the idea of a single specification covering both r.f. and l.f. crimps seems to the writer both logical and attractive. Despite

what was said in Section 8 about omnibus specifications, there can be exceptions to every rule.

13 BS9000 Connectors in 1974

The final situation may best be summed up in Table 4 which lists the specifications being worked upon, their type, coverage and their estimated availability.

14 Conclusions

In this paper the writer has tried to bring in several different aspects of the world of connector standards. The mention of early standards and the events leading up to Burghard, though brief of necessity, needed to be said; they will all too soon be forgotten yet they played their part and it was an important part. There are criticisms of BS9000 as applied to connectors and it is hoped that this paper may answer some of those critics. The task of producing the basic documents, setting out the disciplines and writing the detail specifications has been, and still is a formidable one for teams of voluntary workers, but progress is being made as reference to Table 4 will show, and the end of 1974 should see a number of companies approved and with a hope that some components should be coming off the line in 1975.

Whilst in the coming year there is still much of the existing programme to be completed, the L.F. Committee in particular, are looking round for fresh fields and these may well be found amongst the IEC recommendations. To this end we may see a renewed interest in the commercial type of connector with a basic assessment. The field for such connectors is wide and on the Continent is likely to be fruitful for already manufacturers there are making components to what we should refer to as basic assessment specifications: to an extent this is what IEC is all about. But in addition the basic assessment categories of the connectors already under consideration in the higher category will be looked at.

Finally, the information given here is given in good faith but forecasts given in Table 4 may turn out to be not quite correct. If this happens the writer offers his apologies and would add that any opinions expressed here are his own.

Manuscript first received by the Institution on 27th August 1973 and in final form on 19th November 1973 (Paper No. 1579/CC195)

© The Institution of Electronic and Radio Engineers, 1974

Noise limitations in digital recording

J. C. MALLINSON, M.A.*

*Based on a paper presented at the IERE
Conference on Video and Data Recording held in
Birmingham from 10th to 12th July 1973.*

SUMMARY

Previous studies have shown that the tape limited signal/noise ratio (s.n.r.), which may be deduced from first principles, is in close agreement with practice on many modern recorders. This s.n.r. depends upon the medium properties and the recording format, in particular the trackwidth and bandwidth. Since the digital linear density usable is related to the bandwidth, it is possible to derive expressions linking the s.n.r., trackwidth, linear and area digital densities. It is concluded that the s.n.r. available at an area density of 10^7 bits/in², which is a factor of ten higher than present maxima, is still adequate to permit reliable digital recording.

* *Advanced Technology Division Ampex Corporation,
Redwood City, California. 4063, U.S.A.*

1 Introduction

Over the last decade the area density of digital recording has increased by almost three orders of magnitude with the result that area densities in the range 10^5 – 10^6 bits per square inch are now commonplace.¹ This increase has been achieved by the adoption of narrower trackwidths and higher linear densities rather than by any fundamental improvement in the recording media used. It is reasonable, therefore, to enquire what further increases in density are conceivable before the basic signal noise ratio limitations of the medium are encountered.

The theoretical maximum signal/noise ratio is related to both the trackwidth and the bandwidth of the recorder. Since the digital data rate achievable in a recording system is closely controlled by the bandwidth, explicit relationships between the trackwidth, s.n.r., and linear and area density exist and will be developed in this paper. The analysis shows that further increases in area density by greater than a factor of ten will be very difficult to accomplish using present media.

The concepts outlined in this paper are extracted from a more comprehensive discussion of the applications of communication and information theory to digital recording to be published shortly.²

2 Maximum S.N.R.

The signal power spectrum and the irreducible minimum noise power spectrum due to the particulate nature of the recording medium may be calculated from statistical arguments and have been given previously.³ The maximum s.n.r.s computed from these spectra are within 3–4 dB of the actual measured s.n.r.s for audio, instrumentation and f.m. video recorders. Here we consider only the maximum s.n.r. of a linearized recording system equalized to have a flat frequency response over a bandwidth corresponding to a minimum wavelength λ_{\min} . The mean signal power to mean noise power ratio is given by

$$\text{s.n.r.} \simeq \frac{1}{2\pi} n w f^2 \lambda_{\min}^2, \quad (1)$$

where n is the number of single domain magnetic particles per unit volume in the medium, w is the trackwidth and f is the fraction of particles upon which the signal is recorded. The particle sizes and packing fractions of standard media (γ Fe₂O₃, Co- γ Fe₂O₃ and CrO₂) are similar; $n = 2 \times 10^{15}$ particles per cubic inch is typical. When a.c. bias is used to linearize the transfer function of a recorder, it is found that 1% and 3% third harmonic distortions correspond to $f = 0.2$ and 0.3 respectively; the value $f = 0.3$ will be used below.

3 Bandwidth Utilization

When viewed as a communication channel, magnetic recording systems have an unusual disadvantage in that there is zero d.c. response. For truly high density recording this has led to the abandonment of n.r.z. and the adoption of Manchester, Miller, f.m. and other coding schemes where extra 'timing marks', requiring additional bandwidth, are recorded.

For our present purposes it is sufficient merely to enquire how efficiently these schemes utilize the recorder bandwidth. For the f.m. video derived and Miller coded modified instrumentation systems current figures are approximately 1.0 and 1.5 bits per cycle of bandwidth.¹

The number of bits per cycle usable in a data channel is, in principle, only limited by coding complexity and channel s.n.r. A practical limit generally assumed and adopted here is two bits per cycle, the Nyquist rate.

It may be remarked that the philosophy adopted for a linear, equalized channel is essentially contrary to that espoused by the proponents of non-linear, unequalized saturation digital recording. When electrical equalization is admitted, for example, the medium coating thickness ceases to be an important parameter governing system performance.⁴

4 Digital Densities

Upon substituting the Nyquist rate,

$$\text{linearity density} = \frac{2}{\lambda_{\min}}, \quad (2)$$

into equation (1) there results:

$$\text{s.n.r.} = \frac{1}{2\pi} \pi w f^2 \left(\frac{2}{\text{linearity density}} \right)^2. \quad (3)$$

Neglecting inter-track spacing, equation (3) may be rearranged into two expressions applicable to linear recording on standard media.

$$\text{linearity density} = \sqrt{w} \cdot \sqrt{\frac{10^{14}}{\text{s.n.r.}}} \quad (4)$$

bits per inch

$$\text{and area density} = \sqrt{\frac{1}{w}} \cdot \sqrt{\frac{10^{14}}{\text{s.n.r.}}} \quad (5)$$

bits per square inch.

It will be seen that these relationships are in accord with common sense. Thus, both linear and area recording densities decrease as the required s.n.r. of the system increases. On the other hand, whereas the linear density increases with trackwidth, the area density behaves conversely.

Neglecting drop-outs, which temporarily reduce the s.n.r., reliable digital recording is possible if the s.n.r. is approximately 20 dB (mean power ratio of 100). Assuming that the minimum trackwidths operable are about one mil (0.025 mm) we deduce, from equations (4) and (5), that the linear density yielding 20 dB s.n.r. is 30000 bits/in and the corresponding area density is 3×10^7 bits/in². This area density is somewhat greater than a factor of ten higher than present maxima (e.g. Ampex TBM— 1.4×10^6 bits/in²).

5 Discussion

It is worthwhile emphasizing the absolute quality of these calculations. The s.n.r. given in equation (1) results from an exact analysis containing no arbitrary factors.

This s.n.r. is the absolute maximum attainable with current media, and it will not be changed by the use of media with greater magnetic moment alone.⁵ Media with higher coercivities will, by reducing modulation noise and permitting more efficient short wavelength recording, merely reduce the small discrepancy (3–4 dB) which presently exists between theory and experiment.³ The only media parameter of significance is the number of particles per unit volume. Improvements in magnetic head and preamplifier design can have no appreciable effect on the subject s.n.r.

On the other hand, some of the criteria used in the preceding example are not fixed, being governed by engineering practicability and feasibility. Thus the Nyquist rate, although a difficult target, is not, in any sense, a maximum. Operation with only 20 dB s.n.r. affords little margin for drop-out activity. Furthermore, the use of one mil trackwidths would severely tax present day head fabrication and head servo capabilities.

It may be concluded, therefore, that operation at area digital densities of approximately 10^7 bits per square inch on current high quality media, is just feasible. This conclusion will be of immediate interest to those concerned with the development of digital video recorders. It is generally acknowledged that transmission of broadcast quality video signals in digital form requires a data rate of about 10^8 bits per second.⁶ The most widely used broadcast quality (analogue) video recorder (Ampex VR-2000) uses approximately 10 in² of media per second for the video signal (1.5 in \times 7.5 in/s). It becomes clear, therefore, that, whilst it is just feasible to make a digital video recorder which uses an equal area of tape, the possibility of operable designs using less tape is remote. The eventual adoption of digital techniques in video recording must depend, therefore, upon considerations other than tape usage.

6 References

1. Mallinson, J. C., and Ragosine, V. E., 'Bulk storage technology: magnetic recording', *IEEE Trans on Magnetics*, **MAG-7**, No. 3, September 1971, pp. 598–600.
2. Mallinson, J. C., 'On extremely high density recording', *IEEE Trans*, **MAG-10**, No. 2, June 1974 (to be published).
3. Mallinson, J. C., 'Maximum signal-to-noise ratio of a tape recorder', *IEEE Trans.*, **MAG-5**, No. 3, September 1969, pp. 182–186.
4. Mallinson, J. C., 'Optimum media thickness for digital recording', *IEEE Trans.*, **MAG-8**, No. 2, June 1972, pp. 239–240.
5. Mallinson, J. C. 'Theory of magnetic recording systems', 'Magnetism and Magnetic Materials (1971)', AIP Conf. Proc. No. 5, 1972.
6. 'Possible techniques for the recording of digital television signals', B.B.C. Research Department Report No. 42, 1969.

Manuscript received by the Institution on 22nd January 1973 (Short contribution No. 171/Com 87).

The thermal rating of metallized film capacitors under pulse conditions

J. A. GEEN, B.Sc.*

SUMMARY

Simple expressions are derived for the power dissipation in metallized film capacitors under some common pulse current conditions. Using these, the sinusoidal current ratings may be used to estimate the suitability of the capacitors for pulse applications. Tables are given to facilitate the use of the results.

List of Symbols

α	general parameter
a_r	coefficient of r th term of a Fourier cosine series
b_r	coefficient of r th term of a Fourier sine series
C	capacitance
C_r	capacitance at frequency r/T
$Ci(\alpha)$	cosine integral of α as defined in the text
ϵ_r	error term, due to approximating $\frac{\sin^2(\alpha r)}{r^3}$ by an integral
f	frequency
f_2	frequency at which true series resistance and dielectric losses dissipate equal power
I	peak current of pulsed waveform
I_m	maximum high frequency current rating used with maximum current vs. frequency ratings
I_n	amplitude of n th harmonic of the current in a television line tuning capacitor
$I(t)$	defining function for pulsed current waveform
i_2	maximum permissible current at f_2
i_m	maximum high frequency current rating used with volt-ampere rating
i_{rms}	root mean square current
i_{rms}^2	mean square current
$\ln \alpha$	Napierian logarithm of α
n	particular value of r
P	total power dissipation $P_R + P_D$
P_D	power dissipated by dielectric loss
P_m	maximum permissible power dissipation
P_R	power dissipated by true series resistance
p	$\phi + s$
ϕ	duration of minor space plus one mark of bidirectional pulsed current asymmetric in time
R	true series resistance (t.s.r.)
r	harmonic number
s	duration time of current pulse in one direction
T	repetition period of non-sinusoidal waveform
t	time
$\tan \delta$	overall loss tangent, $\tan \delta_D + \tan \delta_R$
$\tan \delta_D$	contribution of dielectric losses to loss tangent
$\tan \delta_{Dr}$	$\tan \delta_D$ at frequency r/T
$\tan \delta_m$	maximum value of $\tan \delta$ for frequencies in region II of Figure 1
$\tan \delta_R$	contribution of t.s.r. to loss tangent
V	peak to peak value of varying voltage applied to capacitor
VA_r	maximum reactive volt-ampere rating
V_{pk}	maximum permissible peak voltage on capacitor
y	general ordinate

* Erie Electronics Ltd., South Denes, Great Yarmouth, Norfolk.

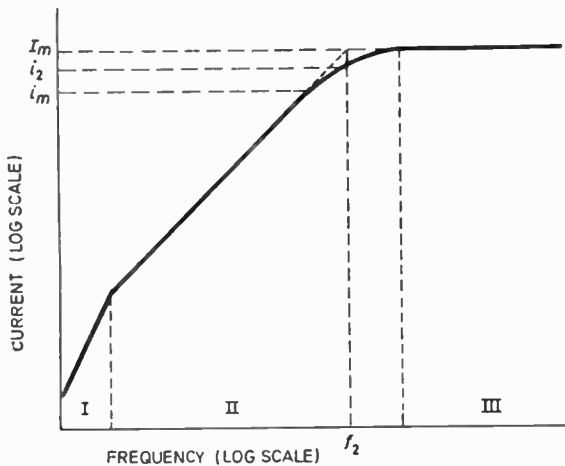

Fig. 1. Typical form of maximum permissible r.m.s. current versus frequency for sinusoidal waveforms.

1 Introduction

Metallized capacitors have, in the past, acquired a poor reputation for pulse performance. This partly arose because of termination failure in which the contact between metallizing and termination pads was disrupted by energy dissipated in the contact resistance.

In fact, the metallized construction can be made capable of carrying very high peak currents. Over the years, improvements in winding techniques and spraying metal terminations have raised the contact disruption currents to the level where they need no longer impose serious restrictions on the peak pulse handling capabilities of this type of capacitor.¹ For example, 0.1 μF and 2.2 μF 250 V capacitors may have absolute maximum ratings of 1000 V/ μs and 50 V/ μs respectively. This means that these capacitors may be continually charged and discharged with 100 A current pulses, quite sufficient for the majority of electronics applications.

However, there is an additional problem in ensuring that the dielectric works within its safe temperature. That is, the ratings must limit the r.m.s. current such that the power dissipated by the capacitor does not cause thermal failure.

Assigning fixed VA_r values has been a very popular method of thermally rating heavy duty capacitors²⁻⁸. From the point of view of the electronics industry, the method has two main disadvantages. First, it is less easy to relate the rating to pulse operation and secondly the rating becomes inapplicable at higher frequencies where the true series resistance (t.s.r.) and the self inductance of the capacitor become significant. Many capacitors are usefully employed in coupling and decoupling applications handling frequencies well above their self resonant frequency. It is therefore, desirable to have thermal ratings which are valid irrespective of self induction. Current ratings retain their validity in this respect and it is the purpose of this paper to relate these ratings to pulse conditions. For completeness however, an extension of the method for VA_r ratings is included.

2 The Problem in Terms of Current Ratings

The rating problem may be appreciated when it is considered that although r.m.s. values of repetitive pulse currents are well defined, and readily determined, they correspond to no single frequency of sinusoidal current. A typical form of sinusoidal r.m.s. current rating versus frequency is shown in Fig. 1. Note that the scales are logarithmic.

The region I, at the lowest frequencies, is equivalent to a voltage limitation imposed by the ionization rating of the construction or the quality of the dielectric, i.e.,

$$i_{\text{rms}} \leq \sqrt{2\pi f C V_{\text{pk}}}$$

The other two regions are restrictions imposed by the permissible power dissipation. Except in the turnover towards region III, the major contribution to the dissipation in region II is dielectric loss. If the maximum power is P_m ,

$$i_{\text{rms}} \leq \sqrt{2\pi f C P_m / \tan \delta}$$

where

$$\tan \delta = \tan \delta_D + 2\pi f C R. \quad (1)$$

Often the dielectric loss tangent, $\tan \delta_D$, is a very weak function of frequency, in which case the inequality corresponds to a constant VA_r rating at frequencies where dielectric loss dominates.

Region III is an upper limit defined by the true series resistance, R , of the capacitor construction. Here, the above expression reduces to

$$i_{\text{rms}} \leq \sqrt{P_m / R} = I_m.$$

At the frequency, f_2 , where the permissible current is $1/\sqrt{2}$ of the maximum level, the two dissipation mechanisms are contributing equally to the total power, i.e.,

$$i_2^2 R = i_2^2 \tan \delta_D / 2\pi f_2 C = P_m / 2$$

where

$$i_2 = I_m / \sqrt{2}$$

or

$$\tan \delta_D = 2\pi f_2 C R \quad (2)$$

Sinusoidal ratings such as these are easily determined and are sometimes published irrespective of pulse considerations. A graph of current versus frequency is not the only format adopted, although others generally require a greater degree of computation on the part of the user. For example,^{8,9} region I is covered by the voltage rating and regions II and III may be specified by giving a power rating together with a graph of $\tan \delta$ versus frequency or by a VA_r rating together with a maximum current rating, i_m say.

In the latter case the VA_r rating must correspond to the maximum value of $\tan \delta$ which may be encountered, $\tan \delta_m$, say. The restriction is of the form

$$P_m \geq VA_r \tan \delta_m.$$

It may be seen from equation 1, that the maximum current rating, i_m , must be appreciably smaller than that which corresponds to region III of the graph. Otherwise, the VA_r rating will fall far below that corresponding to maximum dielectric loss with consequent underrating over the majority of region II.

When working with pulsed currents, r.m.s. current ratings have the advantage over other methods of quoting dissipation ratings in that r.m.s. current is defined for non-sinusoidal waveforms whereas the terms 'volt-ampere product' and 'loss tangent' are meaningful only in a sinusoidal context.

Any periodic current may be represented by a Fourier series. For the current in a capacitor there is no d.c. term so the series takes the form

$$I(t) = \sum_{r=1}^{\infty} \{a_r \cos(2\pi r t/T) + b_r \sin(2\pi r t/T)\}$$

where T is the repetition period.

Corresponding to each term there is a power dissipated in the dielectric such that the total dielectric power loss is given by

$$P_D = \sum_{r=1}^{\infty} \left\{ \frac{(a_r^2 + b_r^2) T \tan \delta_{Dr}}{4\pi r C_r} \right\}$$

where $\tan \delta_{Dr}$ and C_r are the values of dielectric loss tangent and capacitance for a sinusoidal current of frequency r/T . If, as is often the case, $\tan \delta_D$ and C are very weak functions of frequency, this becomes

$$P_D = \frac{T \tan \delta_D}{4\pi C} \sum_{r=1}^{\infty} \left\{ \frac{a_r^2 + b_r^2}{r} \right\}. \quad (3)$$

In addition to P_D there is dissipation in the t.s.r. given by

$$P_R = R \sum_{r=1}^{\infty} \left\{ \frac{a_r^2 + b_r^2}{2} \right\}.$$

This sum is equal to the mean square value of the current, i_{rms}^2 , so,

$$P_R = R i_{rms}^2 \quad (4)$$

combining equations (2), (3) and (4) to give the total power dissipated yields

$$P = P_D + P_R = R \left\{ i_{rms}^2 + \frac{f_2 T}{2} \sum_{r=1}^{\infty} \left(\frac{a_r^2 + b_r^2}{r} \right) \right\}.$$

The limiting condition for P is $P \leq P_m$, but if I_m is the value of the r.m.s. current corresponding to region III of the sinusoidal current rating, one has

$$P_m = I_m^2 R.$$

Therefore,

$$I_m^2 \geq i_{rms}^2 + \frac{f_2 T}{2} \sum_{r=1}^{\infty} \left(\frac{a_r^2 + b_r^2}{r} \right). \quad (5)$$

Expression (5) is a constraint on non-sinusoidal applications in terms of the sinusoidal current ratings.

The available format for sinusoidal ratings may be VA_r, i_m rather than I_m, f_2 . If so, the above expression may be used via the relationship

$$i_m^2 < VA_r \cdot 2\pi f_2 C$$

which ensures that the resulting constraint of the form

$$i_m^2 \geq i_{rms}^2 + \frac{i_m^2 T}{4\pi C \cdot VA_r} \sum_{r=1}^{\infty} \left(\frac{a_r^2 + b_r^2}{r} \right) \quad (6)$$

is compatible with (5). This is usually rather conservative compared with (5) because of the nature of i_m , noted previously. Also as, mentioned in the introduction, one

should be cautious of VA_r ratings if the self-resonant frequency of the capacitor is near or below f_2 . However, if an uncommon dielectric were used such that $\tan \delta_D$ in region II greatly exceeded its value at f_2 , it might become expedient to adopt such a format.

Thus, the problem of thermal rating reduces to the evaluation of

$$\sum_{r=1}^{\infty} \left(\frac{a_r^2 + b_r^2}{r} \right)$$

where a_r, b_r are respectively the Fourier cosine and sine coefficients for the current waveform.

In a number of practical cases the above sum converges rapidly with increasing r . Particular examples are the high current carrying capacitors in television line circuits. In Appendix 1 the approximate waveforms are shown (Fig. 7) and the ease with which the sum of coefficients may be manually calculated is illustrated. (It is interesting to compare these results with those obtained by the use of the appropriate formula from Table 3, Appendix 2.)

Few cases are as fortunate as these examples. In particular, if the current is pulsed with a small mark/space ratio, the number of harmonic terms contributing significantly to the power becomes large and the calculation becomes correspondingly tedious.

It is the purpose of the following Section to develop simple expressions which will avoid term by term evaluation of

$$\sum_{r=1}^{\infty} \left(\frac{a_r^2 + b_r^2}{r} \right).$$

3 Derivation of Expressions for Unidirectional Pulses

Consider Fig. 2 showing a train of unidirectional current pulses together with the voltage waveform it would develop across a capacitor. If the repetition interval is defined as shown, the pulse train may be represented by a Fourier series containing only cosine terms with coefficients:

$$a_r = \frac{2}{T/2} \int_0^{T/2} I(t) \cos(2\pi r t/T) dt$$

where

$$I(t) = I$$

for

$$0 < t < s/2$$

and

$$I(t) = -I \frac{s}{(T-s)}$$

for

$$s/2 < t < T/2$$

i.e.,

$$a_r = \frac{2IT}{\pi(T-s)} \left\{ \frac{\sin(\pi r s/T)}{r} \right\}$$

with $r = 1, 2, \dots$ etc.

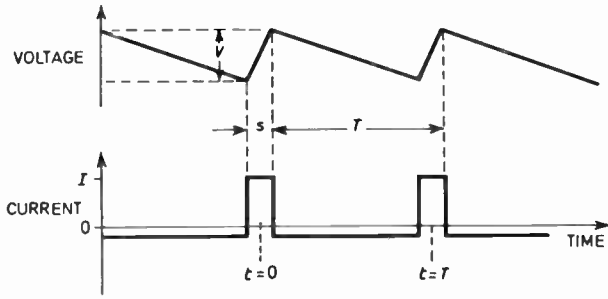

Fig. 2. Unidirectional current pulses and the corresponding voltage waveform.

Now,

$$\sum_{r=1}^{\infty} \left\{ \frac{\sin^2(\pi rs/T)}{r^3} \right\} = \int_1^{\infty} \frac{\sin^2(\pi rs/T)}{r^3} dr + \sum_{r=1}^{\infty} \epsilon_r \quad (7)$$

where ϵ_r is the difference between

$$\int_r^{r+1} \frac{\sin^2(\pi rs/T)}{r^3} dr$$

and the term

$$\frac{\sin^2(\pi rs/T)}{r^3}$$

From Fig. 3 it can be seen that ϵ_r approximates to a triangular area,

$$\frac{1}{2} \left\{ \frac{\sin^2(\pi rs/T)}{r^3} - \frac{\sin^2(\pi [r+1]s/T)}{[r+1]^3} \right\}$$

whence,

$$\sum_{r=n}^{\infty} \epsilon_r = \frac{1}{2} \frac{\sin^2(\pi ns/T)}{n^3}$$

The triangular approximation is least valid for the first few terms. Therefore, one obtains a more accurate value by setting $n > 1$ such that

$$\sum_{r=1}^{\infty} \epsilon_r = \sum_{r=1}^{n-1} \left\{ \frac{\sin^2(\pi rs/T)}{r^3} \right\} - \int_1^n \frac{\sin^2(\pi rs/T)}{r^3} dr + \frac{1}{2} \frac{\sin^2(\pi ns/T)}{n^3}$$

or, if $n \ll T/s$,

$$\sum_{r=1}^{\infty} \epsilon_r = (\pi s/T)^2 \left\{ \sum_{r=1}^{n-1} \frac{1}{r} - \ln(n) + \frac{1}{2n} \right\}$$

This expression converges rapidly with increasing n , as shown in Table 1, the limiting value being,

$$\sum_{r=1}^{\infty} \epsilon_r = 0.577 (\pi s/T)^2 \quad (8)$$

Table 1

$n-1$	1	2	3	4	5	10	20
$\sum_{r=1}^{n-1} \frac{1}{r} - \ln(n) + 1/2n$	0.557	0.568	0.572	0.574	0.575	0.577	0.577

Note: the limit for $n \rightarrow \infty$ is Euler's constant.

The integral in (7) may be evaluated by setting

$$\sin^2(\pi rs/T) = \frac{1}{2} \{1 - \cos(2\pi rs/T)\}$$

and twice integrating by parts. This yields

$$\int_1^{\infty} \frac{\sin^2(\pi rs/T)}{r^3} dr = \frac{1}{2} \sin^2(\pi s/T) + \frac{\pi s}{2T} \sin(2\pi s/T) + \left(\frac{\pi s}{T}\right)^2 \text{Ci}(2\pi s/T)$$

or with the above condition on s/T ,

$$\int_1^{\infty} \frac{\sin^2(\pi rs/T)}{r^3} dr = (\pi s/T)^2 \{1.5 + \text{Ci}(2\pi s/T)\}$$

Values of the cosine integral

$$\text{Ci}(x) = \int_x^{\infty} \frac{\cos u}{u} du$$

may be obtained from tables, but it is readily shown that, for small x , it approximates very closely to the more available function $\ln(1/x) - 0.577$. Substitution of this form, together with (8), in (7) yields

$$\sum_{r=1}^{\infty} \left\{ \frac{\sin^2(\pi rs/T)}{r^3} \right\} = \left(\frac{\pi s}{T}\right)^2 \ln(0.713 T/s)$$

Table 2 gives a comparison of this expression with a computer evaluated sum. It can be seen that the 'fit' is quite good.

Table 2

T/s	10^3	10^2	10	5
$\ln(0.713 T/s)$	6.57	4.27	1.96	1.27
$\sum_{r=1}^{10T/s} \left\{ \frac{T^2 \sin^2(\pi rs/T)}{\pi^2 s^2 r^3} \right\}$	6.57	4.27	1.97	1.28

Therefore,

$$\frac{T}{2} \sum_{r=1}^{\infty} \left(\frac{a_r^2}{r}\right) = \frac{2I^2 s^2 T}{(T-s)^2} \ln(0.713 T/s)$$

The mean square current is given by

$$i_{rms}^2 = I^2 \left(\frac{s}{T}\right) + \left(I \frac{s}{T-s}\right)^2 \left(\frac{T-s}{T}\right) = I^2 \left(\frac{s}{T-s}\right)$$

Fig. 3. Diagrammatic representation of error terms in equation (7).

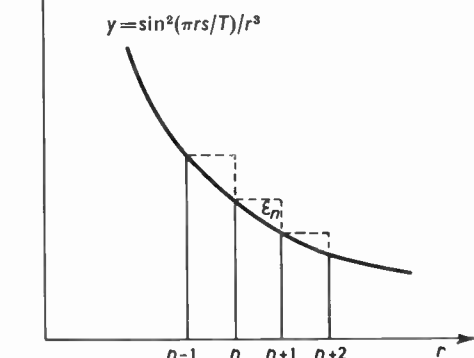

So the constraint in form (5) becomes, approximately,

$$I_m^2 \geq i_{rms}^2 \{1 + 2f_2 s \ln(0.7 T/s)\} \quad (9a)$$

or in form (6),

$$i_m^2 \geq i_{rms}^2 \left\{ 1 + \frac{i_m^2 s}{\pi C \cdot VA_r} \ln(0.7 T/s) \right\}. \quad (9b)$$

Usually a voltage waveform is more conveniently available than a current waveform, so it is useful to express I in terms of voltages.

$I = C(dV/dt)$, or in this case $I = CV/s$, whence one derives the expressions:

$$I_m^2 \geq \frac{C^2 V^2}{T s} \{1 + 2f_2 s \ln(0.7 T/s)\} \quad (10a)$$

$$i_m^2 \geq \frac{C^2 V^2}{T s} \left\{ 1 + \frac{i_m^2 s}{\pi C \cdot VA_r} \ln(0.7 T/s) \right\}. \quad (10b)$$

Note that the voltage across the capacitor is only related in this way to the current when self-inductance may be neglected. Thus expressions (10a) and (10b) are only valid if $1/s$ is well below the self-resonant frequency and such voltage based forms require more careful use than their current counterparts (9a) and (9b).

4 Extension of Expressions for Bidirectional Pulses

Consider Fig. 4, the case of symmetric bidirectional current pulses. This may also be defined as a cosine series with coefficients:

$$a_r = \frac{4I \sin(\pi r s / T)}{\pi r}$$

for $r = 1, 3 \dots$ etc.

$$a_r = 0$$

for $r = 0, 2, 4 \dots$ etc.

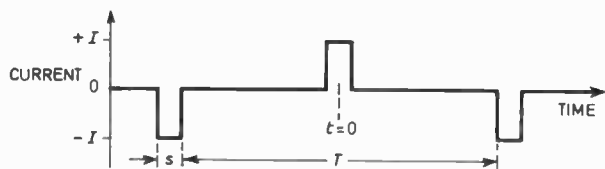

Fig. 4. Symmetric bidirectional current pulses.

By a similar process to that used for the unidirectional case one may deduce that

$$\sum_{r=1,3 \text{ etc.}} \left(\frac{a_r^2}{r} \right) = 8I^2 \left(\frac{s}{T} \right)^2 \ln(1.426 T/s).$$

This also gives agreement to better than 1% with computer evaluated sums.

The mean square current is $I^2(2s/T)$ which gives a set of expressions analogous to (9):

$$I_m^2 \geq i_{rms}^2 (1 + 2f_2 s \ln \{1.4 T/s\}) \quad (11a)$$

$$i_m^2 \geq i_{rms}^2 \left(1 + \frac{i_m^2 s}{\pi C \cdot VA_r} \ln \{1.4 T/s\} \right). \quad (11b)$$

As a further extension, consider bidirectional current pulses asymmetrically disposed in time as in Fig. 5.

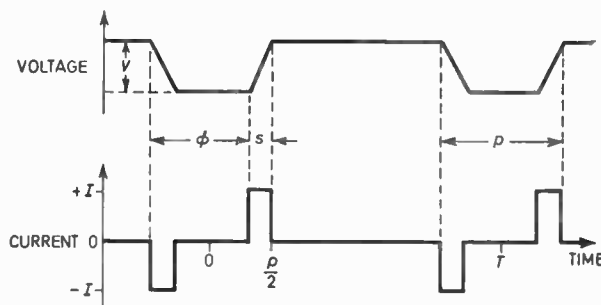

Fig. 5. Bidirectional current pulses asymmetric in time and the corresponding voltage waveform.

The general Fourier sine coefficient is

$$b_r = \frac{4}{T} \int_{p/2-s}^{p/2} I \sin(2\pi r t / T) dt.$$

After integration the sum arising from these coefficients may be evaluated using the previous result that

$$\sum_{r=1}^{\infty} \left\{ \frac{\sin^2(\pi r \alpha)}{r^3} \right\} = \pi^2 \alpha^2 \ln \left(\frac{0.713}{\alpha} \right) \quad \text{for } \alpha \ll 1.$$

The result is

$$\sum_{r=1}^{\infty} \left(\frac{b_r^2}{r} \right) = 8I^2 \left(\frac{s}{T} \right)^2 \ln(4.48 \phi/s) \quad (12)$$

from which one may deduce a further set of constraints as before:

$$I_m^2 \geq i_{rms}^2 \{1 + 2f_2 s \ln(4.5 \phi/s)\} \quad (13a)$$

$$i_m^2 \geq i_{rms}^2 \left\{ 1 + \frac{i_m^2 s}{\pi C \cdot VA_r} \ln(4.5 \phi/s) \right\}. \quad (13b)$$

Once again the validity of equation (12) has been investigated over a wide range of the variables T, ϕ by comparison with computer derived sums. The agreement is good when $s \ll \phi \ll T$ (for example, 1/2% error when $T = 100s, \phi = 10s$) but becomes less accurate as one approaches either of the two physically possible extremes $2\phi = T$ or $\phi = s$.

The former extreme is already covered by expressions (11), so the loss of accuracy is not inconvenient. The inaccuracy in the latter condition is less than 10%, but nevertheless the case has been examined in more detail.

Defining an odd function as in Fig. 6, and proceeding as in the last case, yields

$$\sum_{r=1}^{\infty} \left(\frac{b_r^2}{r} \right) = \frac{16I^2 \phi^2}{T^2} \ln 2, \quad (14)$$

agreeing very well with the computer evaluated sums.

In this way a set of constraints similar to the previous ones have been obtained for this special case. However,

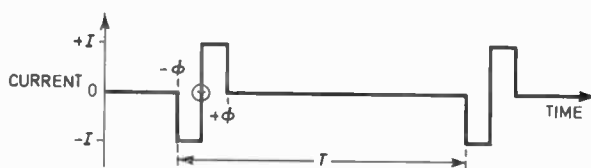



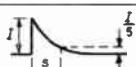

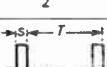

Fig. 6. Limiting case of Fig. 5 when $p = 2s$ (i.e. $\phi = s$).

Table 3

Basic formula $i_m^2 > i_{rms}^2 (1 + 2f_2s \text{ LOG FUNCTION})$

Alternative forms for f_2^* $\frac{i_m^2}{2\pi C.VA_p}$ or $\frac{i_m^2 \tan \delta_D}{2\pi C.P_m}$

REPETITIVE CURRENT WAVEFORM	LOG FUNCTION	i_{rms}^2 IN TERMS OF PEAK CURRENT I (OR PK-PK VOLTAGE V^*)			
					
	$\ln \frac{0.7T}{s}$	$I^2 s / 2 (T-s)$	$I^2 s / (T-s)$	$I^2 s / 3.2 (T-s)$	
		$\pi^2 C^2 V^2 / 2s (T-s)$	$C^2 V^2 / s (T-s)$	$0.8 C^2 V^2 / s (T-s)$	
	$\ln \frac{1.4T}{s}$	$I^2 s / T$	$2I^2 s / T$	$I^2 s / 1.6T$	
		$\pi^2 C^2 V^2 / 4sT$	$2C^2 V^2 / sT$	$1.6 C^2 V^2 / sT$	
	$\ln \frac{4.5\phi}{s}$	$I^2 s / T$	$2I^2 s / T$	$I^2 s / 1.6T$	
		$\pi^2 C^2 V^2 / 4sT$	$2C^2 V^2 / sT$	$1.6 C^2 V^2 / sT$	

*Subject to restrictions on self-resonance

experience has shown that the additional precision is seldom needed and they are not reproduced here.

5 Use of the Expressions

A current-frequency curve similar to Fig. 1 can be used directly with expressions in the form (9), (11) or (13) to predict the suitability of a capacitor under the corresponding pulse conditions. It is not necessary to have the full curve, but merely to know the values of I_m and f_2 . These values may be published in numerical form with the obvious advantage of compactness.

The principles relating f_2 to maximum power or volt-amperes enable the expressions to be reformulated in terms of these ratings. The resulting alternatives are listed in Table 3 together with formulae for calculating the mean square values of the various waveforms.

Practical examples are given in Appendix 2. The procedure is to calculate the mean square current and multiply it by a factor calculated from the mark/space ratio as indicated in Table 3. The resulting value should not exceed the square of the maximum current rating.

The second example illustrates the greater ease with which the example of the line tuning capacitor may be treated using Table 3. The agreement with the more rigorous treatment of Appendix 1 is very good despite the large mark/space ratio.

6 Other Pulse Shapes

Having developed simple expressions for rectangular current pulses one immediately questions the loss in accuracy if these expressions are used with other pulse shapes.

The two most common variants on the square pulse are the semi-sinusoidal and the exponential pulses. The latter poses a slight problem in that the pulse duration is not absolutely defined. The convention adopted here is that exponential pulse time is measured between maximum amplitude and 1/5 of maximum amplitude. This interval corresponds to 1.61 time-constants and has three

advantages: it yields reasonable results, it is easy to measure and it avoids the need for a separate convention when defining absolute maximum dV/dt performance.

The inaccuracies involved in generalized use of expression (11) are illustrated in Appendix 3, Table 4. Calculations for other values of T/s have yielded percentage errors similar to those for $T/s = 25$, while calculations for the other waveforms of Fig. 2, 5 and 6 have yielded rather better results.

7 Discussion of Accuracy

In the majority of applications the errors arising from the generalizations introduced at the end of the last Section would be quite acceptable, for they are of the same order as the errors normally introduced from measurement of the waveforms. For example, a 3% uncertainty in the measurements of I , T , and s would introduce a 15% uncertainty into equations (9) or (11).

Of greater significance than waveform measurement errors are the uncertainties in the physical quantities used for determining I_m and f_2 . High frequency dielectric losses, t.s.r. and heat transfer parameters are seldom known to better than 10%. Additionally, it takes extensive quality control to keep all the influencing constructional factors within tight limits, and for mass production the degree of inspection must be a compromise based mainly on economic constraints. In determining a rating a manufacturer considers the worst values of effective surface area, power factor etc. which have a significant probability of passing its quality control procedures. As a result there is usually a safety margin in the current ratings sufficient to absorb a reasonable error in power dissipation.

Of the assumptions used in deriving this treatment the frequency independence of dielectric losses warrants discussion, for it would seem invalid from the room temperature characteristics of, say, PET (polyethylene terephthalate).

In fact, the relevant dielectric loss values are those at the maximum working temperature of the dielectric.

The maximum working temperature is not well defined. It depends on the reliability required for the particular component, the voltage stress in the dielectric and on the source of plastic film. Although each manufacturer uses his own discretion in this respect, typical values used for the maximum working temperatures of the three commonly used films, polypropylene, polycarbonate and PET are respectively 95°C, 105°C and 115°C. Previous workers¹⁰⁻¹⁴ have shown that the dielectric losses of the three plastics are relatively insensitive to frequency in the region of these temperatures, although the results show a dependence on chemical, mechanical and thermal treatment of the film prior to and during capacitor manufacture.

The seriousness of this source of error is dependent largely on the frequency range covered by region II of the current ratings. In the case of polypropylene the error is insignificant because the very low dielectric losses cause region II to cover only a small frequency range. For the larger polypropylene capacitors region I intersects region III directly such that the ratings simplify to a maximum voltage and a maximum current only.

On the other hand, it is possible to make a PET capacitor with region II covering a frequency range of five orders of magnitude in which the dielectric loss varies by a ratio of 1.7 : 1. In practice such extreme cases are rare, even with PET. For example, a typical dipped type of 1 µF, 250 V PET capacitor with region II extending from 100 Hz to 100 kHz exhibits a dielectric loss variation of only 1.15 : 1.

8 Comparison with Another Technique

It is profitable to compare the results derived in this paper with an established technique for determining the pulse rating of heavy-duty capacitors.

One such technique is to regard the pulses as a sinusoidal waveform of period 2s with a low duty cycle. This approach has recently been formalized in the USA¹⁵ but, with slight variations, has been used in the UK for some years. It can yield results at considerable variance with observation, but it is discussed here because it gives an insight into the relative significance of the lower frequency components of pulse waveforms.

The method relies on the intuitive assumption that power is only dissipated in a capacitor while terminal current is flowing. That is, it ignores the power from lower frequency components in the Fourier analysis of the waveform or, in other words, it underestimates the dielectric relaxation processes with larger time constants.

Using this assumption with the waveforms of Fig. 4 one obtains

$$P = \frac{i_{rms}^2 s \tan \delta}{\pi C} \quad (15)$$

whereas the corresponding result from equations (3) and (4) is:

$$P = \frac{i_{rms}^2 s \tan \delta_R}{\pi C} + \frac{i_{rms}^2 s \tan \delta_D}{\pi C} \cdot \ln \left(\frac{1.4 T}{s} \right) \\ = \frac{i_{rms}^2 s \tan \delta}{\pi C} + \frac{i_{rms}^2 s \tan \delta_D}{\pi C} \left[\ln \left(\frac{1.4 T}{s} \right) - 1 \right] \quad (16)$$

Comparison of the equations shows that the lower frequency losses are associated with the second term of (16). It is interesting to note that, as expected from qualitative considerations, the two equations converge if $T = 2s$ or if $\tan \delta = \tan \delta_R$.

In conditions where dielectric losses dominate, the ratio of the powers predicted by (15) and (16) is simply $\ln(1.4T/s)$. The author has measured the temperature rises of a range of dipped PET capacitors under these conditions with $10^2 \leq T/s \leq 10^3$. The observations deviated from those predicted using equation (16) by 5 to 15% which was rather better than the estimated experimental error.

9 Conclusion

A rigorous approach to thermal rating is both time consuming and unjustified in terms of parametric spreads, whereas some of the very simple techniques now in use yield completely misleading results. The mathematical approximations developed in this paper are a compromise. They are sufficiently precise to throw the major cause of uncertainty onto the physical quantities involved, yet the expressions are simple enough for general use.

Primarily, it is hoped that this paper will aid users of metallized film capacitors by enabling rapid estimation of a capacitor's suitability for given pulse conditions. To this end the limiting expressions are summarized in Table 3.

10 Acknowledgment

The author wishes to thank the directors of Erie Electronics Ltd. for permission to publish this work.

11 References

- Gottlob, H. and Kessler, H., 'Pulse load capacity of metallized plastic-foil capacitors', *Siemens Electronic Components Bulletin*, 5, No. 4, pp. 134-7, 1970.
- 'Specification for capacitors for connexion to power-frequency systems.' B.S. 1650 : 1963.
- 'Induction heating in the metal industries'. A. H. Hunt (Capacitors) Ltd. *Bulletin*, 2, Issue 4, September 1960.
- 'Herstellung von polypropylen-kondensator-folie,' Wellenhofer, P., *Kunststoffe*, 62, No. 6, pp. 373-7, 1972.
- Data for the M.P.K. series of metallized paper s.c.r. commutating capacitors. Robert Bosch GmbH, 1968.
- 'Condensateurs de puissance à dielectrique ceramique.' (Data Sheets for the TP050 Series of Capacitors). L.C.C.-Steafix, September 1963.
- 'Ceramic power capacitors, Type C40' and 'Medium frequency water cooled capacitors for induction heating equipment, Type L200.' A. H. Hunt (Capacitors) Ltd. Catalogues C102 and C103, 1960.
- 'Insulated high voltage ceramic capacitors.' (Data for the CHV series of capacitors). Erie Electronics Ltd. UK 70 Catalogue, p. 20, 1970.
- 'Metallised polyester film capacitors'. (Data Sheets for the C280 Series Capacitors). Mullard Ltd., February 1971.
- Krum, F. and Müller, F. H., 'Vorbehandlung und dielektrisches Verhalten hochpolymerer,' *Kolloid Zeitschrift*, 164, No. 2, pp. 81-107, 1959.
- Reddish, W., 'Chemical structure and dielectric properties of high polymers,' *Pure and Applied Chemistry*, 5, pp. 723-42, 1962.

12. Reddish, W. 'The dielectric properties of polyethyleneterephthalate.' *Trans. Faraday Soc.*, 46, No. 330, pt. 6, pp. 459-75, 1950.
13. Krämer, H. and Helf, K. E., 'Untersuchungen über das dielektrische Verhalten von polypropylen,' *Kolloid Z. u Z. Polymere*, 180, No. 2, pp. 114-18, 1962.
14. Buckingham, K. A. and Reddish, W., 'Low-loss polypropylene electrical purposes,' *Proc. Instn Elect. Engrs*, 114, No. 11, pp. 1810-14, 1967.
15. Robinson, W. M., 'E.I.A. Standards for Commutating Capacitors.' *IEEE International Semiconductor Power Converter Conference*, p. 1.9.1-1.9.11, May 1972.

12 Appendix 1: Practical Examples Using Current/Frequency Rating and Fourier Analysis

Consider first the 'S' correction capacitor in a television line scan circuit. The current waveform in this case is not pulsed, but is a sawtooth as in Fig. 7(a) with $s = 12 \mu\text{s}$, $T = 64 \mu\text{s}$. Its mean square value is $\frac{1}{3}I^2$ and it may be defined as a sine series with general coefficient

$$b_r = (-1)^{r+1} \cdot \frac{2IT^2 \sin(\pi rs/T)}{\pi^2 r^2 s(T-s)}$$

so

$$\sum_{r=1}^{\infty} \left(\frac{b_r^2}{r}\right) = \frac{4I^2 T^4}{\pi^4 s^2 (T-s)^2} \cdot \sum_{r=1}^{\infty} \left\{ \frac{\sin^2(\pi rs/T)}{r^5} \right\}.$$

If $T \gg s$ the right-hand sum converges rapidly, as a $1/r^3$ series, yielding $1.20(\pi s/T)^2$,

so

$$\sum_{r=1}^{\infty} \left(\frac{b_r^2}{r}\right) = 0.486 I^2$$

and

$$I_m^2 \geq \frac{I^2}{3} (1 + 0.73 f_2 T).$$

If, as here, $T \gg s$ the sum converges even more rapidly and term by term evaluation is trivial:

$$\sum_{r=1}^{\infty} \left(\frac{\sin^2(12\pi r/64)}{r^5}\right) \approx 0.309 + 0.027 + 0.004 = 0.340.$$

Therefore

$$I_m^2 \geq \frac{I^2}{3} (1 + 58 \times 10^{-6} f_2)$$

is the required limitation on the peak current, I .

As a second example, take the case of a tuning capacitor for transistor television line output stages. This would be subjected to approximately semi-sinusoidal voltage and current waveforms as shown in Fig. 7(b). The period is identical to that of the previous example but, as the current is pulsed in this case, a greater number of terms contribute significantly to dielectric losses.

The current waveform can be defined as a Fourier sine series with general coefficient:

$$b_r = \frac{2I \cos(\pi rs/T)}{\pi(r - [T/2s]^2/r)}$$

Contributions from third or fifth harmonic tuning can

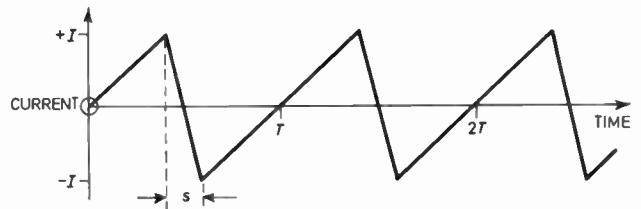

(a) 'S' correction capacitor

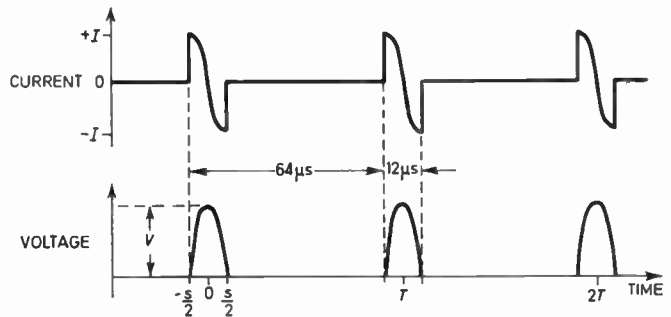

(b) Line tuning capacitor

Fig. 7. Idealized waveforms occurring in a transistor television set.

be similarly calculated using

$$b_{r,n} = (-1)^{(n-1)/2} \cdot \frac{2I_n \cos(\pi rs/T)}{\pi(r - [nT/2s]^2/r)}$$

for the n th harmonic, but in practice are found to be negligible.

So,

$$\sum_{r=1}^{\infty} \left(\frac{b_r^2}{r}\right) = \frac{4I^2}{\pi^2} \sum_{r=1}^{\infty} \left\{ \frac{\cos^2(\pi rs/T)}{r(r - [T/2s]^2/r)^2} \right\}$$

Fortunately $s \ll T$ and the right-hand sum is therefore amenable to manual calculation. The first five terms bring one to 92%, and the first seven terms to 97% of the limiting value, 0.132.

The r.m.s. current is given by

$$i_{rms} = I \sqrt{\frac{s}{2T}}$$

so the constraint takes the form,

$$I_m^2 \geq I^2(0.094 + 1.71 \times 10^{-6} f_2).$$

13 Appendix 2: Examples Using the Method Developed in this Paper

13.1 Example 1

A $50 \mu\text{F}$ (5%) metallized polypropylene capacitor with an f_2 of 100 Hz is to be considered for an s.c.r. commutation application with values $V = 250 \text{ V}$, $s = 0.5 \text{ ms}$, $T = 10 \text{ ms}$ in the waveform of Fig. 4. The I_m is 10A at the maximum anticipated ambient temperature, giving $I_m^2 = 100 \text{ A}^2$.

Taking the maximum value of C ,

$$i_{rms}^2 = \frac{2C^2 V^2}{sT} = 69 \text{ A}^2$$

and

$$2sf_2 \cdot \ln(1.4T/s) = 0.333.$$

So the condition,

$$I_m^2 \geq i_{rms}^2 \{1 + 2sf_2 \cdot \ln(1.4T/s)\} = 92A^2$$

is satisfied, and the capacitor is suitable.

13.2 Example 2

The line timebase waveform of Fig. 7(b) may be considered a limiting case of an asymmetric bidirectional waveform as in Fig. 6. Thus the appropriate expressions in the nomenclature of Table 3 are

$$\text{LOG FUNCTION} = \ln \frac{4.5\phi}{s} \quad \text{and} \quad i_{rms}^2 = I^2 s/T$$

with $\phi = s = 6 \mu s$ and $T = 64 \mu s$.

Therefore,

$$I_m^2 \geq I^2 \{0.094 + 1.69 \times 10^{-6} f_2\}$$

which is in very good agreement with Appendix 1.

14 Appendix 3: Loss in Accuracy of Expressions with Other Pulse Shapes.

Table 4

Variations on the waveform of Fig. 4 for $T/s = 25$

PULSE SHAPE	DEFINITION OF $I(t)$ FOR $0 < t < s/2$	i_{rms}^2	$\frac{1}{i_{rms}^2} \sum_{r=1,3etc}^{4\frac{1}{2}+1} \left(\frac{a_r^2 + b_r^2}{r}\right)$	% ERROR IN USING $4\frac{1}{2} \ln\left(\frac{1.426T}{s}\right)$
	I	$I^2 s/T$	0.572	< 1
	$I \exp^{-1.6t/s}$	$I^2 s/1.6T$	0.620	-8
	$I \exp^{-3.2t/s}$	$I^2 s/1.6T$	0.520	+10
	$I \cos \frac{\pi t}{s}$	$I^2 s/T$	0.500	+14
	$I \cos \frac{\pi t}{2s}$	$I^2 s/T$	0.590	-3

Manuscript first received by the Institution on 9th April 1973, in revised form on 31st August 1973 and in final form on 2nd January 1974. (Paper No. 1580/CC 196.)

© The Institution of Electronic and Radio Engineers, 1974

The Author



Mr. J. A. Geen worked as radio serviceman prior to obtaining his honours degree in chemistry at the University of Manchester in 1968. In the same year he joined Erie Electronics as a design engineer and he has since worked on multiplier and other high voltage systems, instrumentation, thin film and barrier layer ceramics, electrolytic capacitors, metallized plastics capacitors and chemical processing. Mr. Geen

became a member of Society for Electrochemistry in 1969 and obtained his H.N.C. in electrical engineering in 1970, winning an IEE prize.

IERE News and Commentary

NEW INSTITUTION PREMIUMS

It was as long ago as 1946 that the Council first established Premiums to encourage and recognize outstanding contributions to the Journal. With the broadening of subject matter falling within the interests of the membership of the Institution so too has the number of Premiums been increased to cover these new areas. A major extension took place some twelve years ago at the time of the formation of most of the present Specialized Groups but with the increasing activity of these Groups the coverage has become rather unbalanced.

At the request of the Council the Papers Committee, which is responsible to Council for the assessment of papers initially for publication and subsequently for recommendations for premiums, carried out a thorough review of the existing Premiums and prepared a new scheme. This introduces several new Premiums, notably for outstanding papers on education, management techniques and the history of radio electronics, and modifies the terms of award of several others. The opportunity has also been taken to adjust the values of nearly all the Premiums to accord more nearly with present day levels. The leading award, the Clerk Maxwell Premium, is now worth £75 and other Premiums are either £50 or £25. The full list of Institution Premiums with terms of award and values is as follows:

Main Premiums

- CLERK MAXWELL PREMIUM** *Value £75*
For the most outstanding paper on any subject published in the Institution's Journal during the year.
- HEINRICH HERTZ PREMIUM** *Value £50*
For the outstanding paper on the physical or mathematical aspects of electronics or radio.
- MARCONI PREMIUM** *Value £50*
For the outstanding paper on the engineering of an electronic system, circuit or device.

Specialized Technical Premiums

- CHARLES BABBAGE PREMIUM** *Value £25*
For the outstanding paper on the design or electronic engineering application of electronic computers.
- LORD BRABAZON PREMIUM** *Value £25*
For the outstanding paper on a subject associated with aerospace, maritime or military systems.
- A. F. BULGIN PREMIUM** *Value £25*
For the outstanding paper on the theory or practice of electronic components or circuits.
- DR. NORMAN PARTRIDGE PREMIUM** *Value £25*
For the outstanding paper in the field of audio frequency engineering.

REDIFFUSION TELEVISION PREMIUM *Value £50*
For the outstanding paper on advances in communications or broadcasting engineering.

LORD RUTHERFORD PREMIUM *Value £25*
For the outstanding paper on electronics associated with nuclear physics or nuclear engineering.

J. LANGHAM THOMPSON PREMIUM *Value £50*
For the outstanding paper on the theory or practice of control engineering.

P. PERRING THOMS PREMIUM *Value £50*
For the outstanding paper on radio or television receiver theory or practice.

SIR CHARLES WHEATSTONE PREMIUM *Value £25*
For the outstanding paper on electronic instrumentation or measurement.

DR. V. K. ZWORYKIN PREMIUM *Value £50*
For the outstanding paper in the field of medical and biological electronics.

General Premiums

ARTHUR GAY PREMIUM *Value £25*
For the outstanding paper on production techniques in the electronics industry.

ADMIRAL SIR HENRY JACKSON PREMIUM *Value £25*
For the outstanding paper on the history of radio or electronics.

LESLIE MCMICHAEL PREMIUM *Value £25*
For the outstanding paper on management techniques associated with electronic engineering.

ERIC ZEPLER PREMIUM *Value £25*
For the outstanding paper on the education of electronic and radio engineers.

Restricted Premiums

SIR JAGADIS CHANDRA BOSE PREMIUM *Value £25*
For the outstanding paper by an Indian scientist or engineer.

HUGH BRENNAN PREMIUM *Value £25*
For the outstanding paper first read before the North Eastern Section of the Institution and subsequently published in the Journal.

LOCAL SECTIONS PREMIUM *Value £25*
For the outstanding paper first read before any of the Local Sections of the Institution in Great Britain outside London and subsequently published in the Journal.

This new scheme takes effect for papers published in the Journal during 1973 and the award winners will be announced during the summer. Further information about the Institution's Premiums and on the submission of papers for consideration for publication may be obtained from the Editor who will be pleased to send a copy of the booklet 'Guidance for Authors' to those intending to offer papers.

Royal Society Esso Award for the Conservation of Energy

The Council of the Royal Society has announced that, following an approach by Esso Petroleum Company, agreement has been reached between the Royal Society and the Company for the immediate institution of a special Award for outstanding contributions to the advance of science or engineering or technology leading to the more efficient use of any form of energy. It will be known as the Royal Society Esso Award for the Conservation of Energy and will consist of a gold medal and a prize of £1000.

The Award will normally be made annually, the selection being made by the Council of the Royal Society which will receive advice by a specially appointed Committee.

A New Bupa Service for IERE Members

The BUPA Hospital Cash Scheme allays the financial problems that a stay in hospital can bring to a family by providing additional income throughout the period of treatment—be it in a private or National Health Service hospital, or registered nursing home. This new BUPA service can help meet the costs of travelling to and from the hospital to visit the patient, of paid help to care for the children should their mother go into hospital, and even convalescence after the illness.

BUPA Hospital Cash Scheme can provide up to £180 a month, to be used in any way, when a subscriber, or any of his registered dependants, has to go into hospital. Enrolment can cost as little as 60p a month, but now, IERE members have the opportunity to join and get 10% off normal subscriptions. It is *not* necessary to be a subscriber to BUPA's private medical treatment scheme to take advantage of this special offer.

For further details, write to the following address stating membership of IERE:

Mr. R. G. Smith, Manager, BUPA Hospital Cash Scheme Ltd., 41/43 Baldwin Street, Bristol BS1 1RF. Or telephone Bristol 298885.

A Record Time-Delay?

The recent experience of a Member of the Institution living in Nigeria, Mr. N. A. Nze, of Lagos, may reassure, or perhaps alarm, those whose mail is sometimes delayed in the post. On 22nd November 1973 he received his membership certificate which was posted to him from Bedford Square on 4th May 1972! Mr. Nze was unable to determine the voyages or resting places of his certificate during the previous eighteen months, but we understand that it was in quite good condition notwithstanding.

Recent BSI Publications

Exporting Domestic Electrical Goods to the EEC

The Technical Help to Exporters (THE) service of the British Standards Institution, has produced a survey of the technical conditions which still present a technical barrier to trade with the EEC. Although tariff barriers between member states are gradually being removed, individual states still enforce their own national standards and technical regulations.

Household Electrical Appliances—EEC Survey has been published by THE with the object of clarifying the position and assisting British exporters to solve the technical problems which face them. It details the situation in the EEC states with respect to standards and approval requirements for household electrical appliances and similar products, such as electronic equipment, motor operated equipment and cooking and heating appliances.

With the relevant national standards and approval requirements of the EEC states gradually being brought into line with those produced by the International Commission on Rules for the Approval of Electrical Equipment (CEE) the survey concentrates on appliances and equipment coming within the scope of international specifications IEC/65/CEE1, CEE 10 and CEE 11. The main part is divided into three sections related to (i) electronic and related equipment, (ii) motor operated appliances and (iii) heating and cooking appliances. Each section contains tables detailing the national safety and/or performance standards applicable to each EEC state and indicates each state's adherence to, and deviation from, the relevant CEE specifications. Other tables in the survey detail each EEC states electricity supplies and single phase power limitations; state usage of flexible cables; state usage of appliance construction class and related plugs; each states national approval situation with information on approval authorities, application forms and certification scheme.

Available to THE members for £15 and non-members for £17.50 (post and packing included). Order from Technical Help to Exporters, British Standards Institution, Maylands Avenue, Hemel Hempstead, Herts. HP2 4SQ.

Measurement of Radio Noise

The series of British Standards dealing with the abatement of radio interference to radio and television broadcasting is extended now with publication of BS 5049 **British standard method of measurement of radio noise from power supply apparatus for operation at 1 kV and above** (Price £1.50).

For some time the electricity supply industry, manufacturers and other organizations interested in this field have been aware of the problems of radio interference from over-head power lines. Difficulty has been experienced, both nationally and internationally in reaching agreement for limits to this interference because it varies with the type of construction used, the position of the supply line relative to local urban areas and also the position of the supply line relative to local radio and/or television broadcasting transmitters.

Limits for radio interference, to be of any practical value, must be based on a standardized method of measurement. This British Standard gives the method of measurement to be used to measure radio noise from power supply apparatus operating from 1 kV and above. The method is intended to be used in a laboratory or factory test area because of the difficulties of arranging for standard test conditions on site. The standard gives the method for measuring conductor-borne radio noise in the frequency range 500 kHz to 2 MHz arising from such apparatus as insulators, bushings, line and sub-station plant fittings and conductors. The method described gives an indication of the level of radio noise which the apparatus would inject into the line conductor, or sub-station connection and on which the radiated noise level depends. The Standard does not cover measurement of radiated noise nor does it specify radio noise limits.

BS 5049 follows Recommendations of the International Special Committee on Radio Interference (CISPR) but deals in greater detail with the practical aspects of the measurements.

This publication may be obtained from BSI Sales Department, 101 Pentonville Road, London N1 9ND.

space technology

Materials Manufacturing and Processing in Space

The National Physical Laboratory is acting as coordinator for British industrial interests in the European materials processing programme in *Spacelab* on behalf of ESRO (European Space Research Organization).

Spacelab is to be a re-usable manned orbiting laboratory and will be launched in the US by NASA's Space Shuttle in an extended series of flights commencing in 1979. Flights will be of one or two weeks' duration. The facilities carried will be more versatile than in the recent *Skylab* missions and can be tailored to individual requirements.

The zero gravity conditions in space enable materials to be produced that have characteristics and qualities unobtainable on Earth. The *Skylab* missions have already demonstrated this: very much larger semiconductor crystals have been grown under zero-*g* conditions than can be grown on Earth. *Spacelab* offers extended opportunities for further novel experimentation and processing with likely advantages in a number of fields. These include melting and solidification, crystal growth, welding, thermal diffusion, the production of void-free composite materials and many others where the absence of convection and buoyancy effects could be of benefit. These and other facilities in *Spacelab* were discussed by Dr. W. von Braun in his Clerk Maxwell Memorial Lecture, 'Our Space Programme after *Apollo*'. (This will be published in an early issue of the Journal.)

British industry is being invited to participate in the *Spacelab* programme by proposing ideas for space processing and/or material manufacture which utilize the zero gravity (and high vacuum) of space. The National Physical Laboratory is canvassing many likely organizations but wishes to hear, as soon as possible, from any British source which may be interested.

Enquiries should be made to Dr. J. A. Champion, Chairman NPL *Spacelab* Committee, Division of Inorganic and Metallic Structure, National Physical Laboratory, Teddington, Middlesex TW11 0LW or to the Secretary of the Committee, Dr. R. Morrell, (telephone 01-977 3222 ext. 3420).

British Technology Satellite Successfully Launched

Britain's second technology-proving satellite, X4, was named *Miranda* following its successful launch on 9th March 1974 at 02.22 G.m.t. from the US Western Test Range in California.

The satellite is testing in orbit new techniques and components developed in British industry for use in future national and European spacecraft. It is the first UK satellite with three-axis attitude control, previous satellites being stabilized by spinning, and the first to have its solar cells set

out on a flexible array, which deploys telescopically after launch. Some of the systems vital to *Miranda*'s operations were proved in *Prospero*, the first UK technology-proving satellite, which is still in orbit and working successfully over two years after its launch in October 1971.

The launch vehicle for *Miranda* was a four-stage *Scout* rocket, provided by NASA on cost-reimbursement terms under a UK-US agreement signed in January 1973. The satellite is in a circular orbit over the Poles at about 500 miles above the Earth, which should allow it an active life of about six months in continuous sunlight.

Miranda was developed for the Department of Trade and Industry by Hawker-Siddeley Dynamics, acting as prime contractor in a team of UK firms. The contract was placed through the Procurement Executive, Ministry of Defence, whose telemetry, data collection and analysis facilities at the Royal Aircraft Establishment, Farnborough, are being used to pick up experimental data from the satellite.

British Space Technology Survived Launch Failure

Britain's *Skynet II* military-communications satellite survived for several days following the disastrous failure of the American *Delta* rocket. Despite the wild tumble, caused by a fault in the second stage firing of the *Delta* rocket that exerted forces reported as up to 60*g* on the spacecraft, the *Skynet II* satellite was later found to be functioning well and responding to interrogation and commands.

The satellite, which was designed and built by Marconi Space and Defence Systems Limited, was launched at 01.38 G.m.t. on Saturday, 19th January, from the Eastern Test Range at Cape Canaveral. After successful completion of the first stage a fault occurred in the second stage of the *Delta* launcher. The rocket motor jets were jammed hard over producing forces exceeding 60*g* and were originally thought to have shaken the spacecraft to pieces. Stage three of the rocket separated from the satellite while both were 'coning' or 'corkscrewing' madly, and the satellite was lost until 're-acquisition' some six days after lift-off. On Thursday, 24th January, a USAF tracking station in the Pacific Ocean picked up good telemetry signals indicating that the satellite control systems were working well despite overheating due to the incorrect and very low elliptical orbit into which the spacecraft had been injected.

From data received, it was estimated that the satellite could not have survived for many hours in this abnormal orbit and a last minute attempt was made to 'kick' the spacecraft into an orbit clear of the Earth's atmosphere using the on-board apogee boost motor. If this attempt had been successful, engineers would have had access to useful data regarding the satellite communications systems. However, due to the orbit, 65 nautical miles perigee by 1003 nautical miles apogee, the satellite's earth sensors were overloaded by the proximity of the Earth and the attitude of the spacecraft could not be determined accurately. Data received during the last few minutes showed that the apogee boost motor 'burn' was normal and that the satellite still functioned well. However, the attitude of the spacecraft was not correct during the firing and indications were that the orbit decayed rapidly. Ground stations failed to 're-acquire' the satellite and it is presumed that the spacecraft re-entered the Earth's atmosphere and burned up.

This failure to achieve correct orbit has set back the establishment of the first British-built communications satellite in space by several months. A second flight model is scheduled for launch later this year and is nearing completion at the Marconi spacecraft facility at Portsmouth.

Report of the IERE Benevolent Fund Trustees for 1972-73

In 1941 the Council of that year established a Benevolent Fund in order to provide permanent means of helping necessitous members, or their dependants. Such assistance could not, and should not, readily be given from the general funds of the Institution; nor was it possible, as the Institution grew, to rely on the kindness of a few members to alleviate the problems of many. This was highlighted in 1941 when the Institution was already giving some help in providing for prisoners of war in addition to a growing number of requests from the dependants of members.

Since then no deserving case has ever been denied assistance. Nevertheless, as the following Accounts for the year ended 31st March 1973 show, despite some increase in the amount of help given, the reserves of the Fund continue to grow. This is entirely due to the continuing generosity of a comparatively small number of members plus the revenue from judicious investment.

Help provided by the Fund generally takes the form of a grant, either to a member who becomes incapacitated, temporarily or permanently, or to the widow of a deceased

member to assist in her welfare and/or that of her children. Indeed, much of the expenditure over the last thirty years has been concerned with the education and welfare of children. Besides looking at the long-term prospects of the individual in need, the Trustees of the Fund set great store by the immediacy of their aid, where circumstances are pressing. Where the need is seen to be likely to exist over a long period, the Fund often works in collaboration with other sources to share the cost involved.

As will be seen, demands on the Fund have been moderate, but the Trustees must maintain a position where they are able to offer help where needed, and members are earnestly invited to consider this, their own Fund, as worthy of their support.

The most beneficial means of support is by executing a simple Deed of Covenant undertaking to contribute a fixed sum, however small, each year for at least seven years. This enables the Fund to recover income tax from Inland Revenue on the sum contributed. A form of Deed can be supplied for this purpose by the Secretary.

INSTITUTION OF ELECTRONIC AND RADIO ENGINEERS

BENEVOLENT FUND

SCHEDULE OF INVESTMENTS AS AT 31st MARCH, 1973

<i>Nominal</i>		<i>Cost</i>	<i>Nominal</i>		<i>Cost</i>
		£			£
£100	Associated Electrical Industries Ltd. 6% Debenture Stock 1978/83	99			
£1,000	Barnet Corporation 7½% 1982/84	983	£200	Brought forward	20,751
112	Bowater Paper Corporation Ltd. Ordinary Stock	322	£300	Great Universal Stores 5½% Redeemable Unsecured Loan Stock	106
£200	British Electricity 3% Guaranteed Stock 1968/73	156		Great Universal Stores 8¼% Unsecured Loan Stock 1993/98	248
£2,000	British Transport 4% Guaranteed Stock 1972/77	1,864	£150	I.C.I. Ltd. 7¼% Unsecured Loan Stock 1986/91	148
£85	Burmah Oil Co. Ltd. Ordinary Stock	278	1,000	I.C.I. Ltd. £1 Ordinary Stock Units	2,925
£85	Burmah Oil Co. Ltd. Ordinary Stock Warrant 1972/75	85	£100	London County 6% Loan Stock 1975/78	99
£56	Burmah Oil Co. Ltd. 8½% Unsecured Loan Stock 1991/96	56	440	Lonrho Ltd. 25p Ordinary Shares	690
£800	Commonwealth of Australia 5½% Loan Stock 1977/80	788	750	Marks and Spencer Ltd. 25p Ordinary Shares	1,454
300	Commonwealth Unit Trust Fund Units	150	£4,000	New Zealand 7¼% Stock 1977	3,972
£4,000	Consolidated 4% Stock	3,527	600	Plessey Co. Ltd. 50p Ordinary Shares	1,083
340	Courtaulds Ltd. 25p Ordinary Shares	500	156	Reed Group Ltd. £1 Ordinary Shares	392
£500	Courtaulds Ltd. 7% Debenture Stock 1982/87	467	£35	Reed Group Ltd. 10% Unsecured Loan Stock 2004/8	35
750	Currys Ltd. 25p Ordinary Shares	1,580	1,000	Shell Transport & Trading Co. Ltd. 25p Ordinary Shares	3,140
700	E.M.I. Ltd. 50p Ordinary Stock Units	1,229	£1,000	Slough Corporation 8½% Redeemable Stock 1979/80	990
£210	E.M.I. Ltd. 8½% Convertible Unsecured Loan Stock 1981	210	200	Tanganyika Concessions Ltd. 50p Ordinary Stock Units	703
320	English China Clays Ltd. 25p Ordinary Shares	501	1,210	Transport Development Group Ltd. 25p Ordinary Shares	743
£200	European Ferries Ltd. 8% Unsecured Loan Stock 1982	215	£1,990.69	Treasury Stock 8½% 1980/82	2,000
£2,375.46	Funding Stock 5¼% 1978/80	2,000	796	Unicorn General Trust Units	125
£2,225	Funding Stock 5½% 1982/84	1,994	£1,200	3½% War Loan	498
£2,250	Funding Stock 6½% 1985/87	2,007	400	Watts, Blake, Bearne & Co. Ltd. 25p Ordinary Shares	437
2,249	G.E.C. Ltd. 25p Ordinary Shares	885	500	Whitbread & Co. Ltd. 25p 'A' Ordinary Shares	297
£240	G.E.C. Ltd. 7¼% Convertible Unsecured Loan Stock 1987/92	233			
266	Grattan Warehouses Ltd. 25p Ordinary Stock Units	622			
	Carried forward	£20,751			£40,836

INSTITUTION OF ELECTRONIC AND RADIO ENGINEERS

BENEVOLENT FUND

INCOME AND EXPENDITURE ACCOUNT FOR THE YEAR ENDED 31st MARCH, 1973

	1972									
	£	£		£	£		1972	£	£	
	281		Grants and Donations	478			1,396		Subscriptions and Donations	1,319
	150		Purchase of Bursaries	200			1,703		Dividends and Interest on Investments	1,893
	403		Postage, Telephone and Stationery	52						
	2,265		Surplus for the year carried to Reserve Account	2,482						
	£3,099			£3,212			£3,099			£3,212
				£3,212			£3,099			£3,212

BALANCE SHEET AS AT 31st MARCH, 1973

				41,042					40,836
		RESERVE ACCOUNT				INVESTMENTS AT COST			
	32,435	Balance as at 1st April 1972	43,372			(Value at middle market price £39,583			
		<i>Add:</i> Surplus on Redemption of				1972 £43,192)			
	8,672	Investments	32			CURRENT ASSETS			
		Surplus on Income and Expenditure			2,297	Bank Balances on Current and Deposit Accounts	2,482		
	2,265	Account for the year	2,482		613	Income Tax Repayment Claim	268		
	43,372		45,886		—	Sundry Debtors	4		
		CURRENT LIABILITIES			—	Amount due from the Institution of Electronic			
		Amount due to the Institution of Electronic and				and Radio Engineers	2,312		
	494	Radio Engineers	—		2,910				5,066
	86	Sundry Creditors	16			<i>For Trustees</i>			
						<i>Signed</i>			
	580		16			A. A. DYSON			
						G. A. TAYLOR			
						G. D. CLIFFORD			
	£43,952		£45,902						£45,902
									£45,902

**AUDITOR'S REPORT TO THE TRUSTEES OF THE INSTITUTION OF ELECTRONIC AND RADIO ENGINEERS
BENEVOLENT FUND**

In my opinion the above accounts show a true and fair view of the Benevolent Fund's affairs at 31st March 1973 and of the surplus for the year ended on that date, and comply with the Rules thereof.

Signed: R. O. O. FREEMAN
Chartered Accountant
Honorary Auditor

50 Bloomsbury Street,
London, WC1B 3QT.
30th August, 1973

Forthcoming Conferences

Avionics Today and Tomorrow

A symposium on Avionics Today and Tomorrow is being sponsored by The Society of Electronic & Radio Technicians and The Society of Licensed Aircraft Engineers & Technologists.

It will be held at the University College of Swansea on 8th to 11th July 1974 and the following papers will be presented:

Session on Communications

- Aircraft Antenna and Antenna Systems,
C. E. Cooper (*Chelton Electrostatics*)
- Long Range Speech Communication Systems,
I. Stray (*Collins Radio*)
- Satellite Communications,
D. F. Farncombe (*CAA*)
- Reliability and Safety Requirements of Communications Equipment,
J. O. Clarke (*British Airways*)

Session on Instrumentation and Control

- Automatic Flight Control System for Concorde,
D. Salvage (*Elliott Automation*)
- On-board Automatic Test Facilities,
R. S. Hopkins (*Sperry Gyroscope*)
- Computers in Military Aircraft,
Wing Cdr. D. R. West (*RAF*)

Sessions on Navigation and Radar

- Inertial Navigation Systems,
Dr. D. L. Bjorndahl (*Litton Defence Systems*)
- Inertial Navigation and its Impact on Future Avionic Systems,
W. H. McKinlay (*Ferranti*)
- Omega Navigation Systems in Aircraft,
P. R. Burlong (*Marconi-Elliott Avionics*)
- I. L. S. to Category III,
J. G. Flounders (*Plessey Radar*)
- Area Navigation Systems,
M. Tooley (*Decca Navigator Co*)
- Head Up and Other Displays,
R. A. Chorley and J. H. Smith (*Smith Industries*)
- Secondary Surveillance Radar,
M. C. Stevens (*Cossor Radar*)
- MADGE,
D. Atter (*MEL Equipment*)

Session on Maintenance and Training

- Licensing of Aircraft Maintenance Technicians,
D. J. Hawkes (*CAA*)
- The Education and Training of Aircraft Radio Technicians:
(a) In a College, R. Stockham (*Brunel Technical College*)
(b) In REME, Major M. D. Roberts (*AETW, REME*)
- Philosophies of Maintenance for Minimum Cost,
P. Noller (*Airline Engineering*)

Avionic Repair in the Royal Air Force,
Wing Cdr. C. M. Labouchere (*RAF*)

All enquiries concerning the symposium should be addressed to The Symposium Secretary, SERT, 8-10 Charing Cross Road, London WC2H 0HP.

Novel Physical Methods of Winning, Burning and Conserving Fuels

Some of the ways in which scientists and engineers are meeting this problem of new energy sources, commented upon in the March issue of *The Radio and Electronic Engineer*, will be discussed at a one-day meeting which the Combustion Group of the Institute of Physics is to hold under the above title on Wednesday, 10th July 1974, at Imperial College, London S.W.7.

It is stressed that the object of this meeting is to provide a forum not for yet another restatement of problems but for a discussion of possible solutions—even the somewhat visionary ones! The following is the provisional list of contributions:

- 'Will photosynthesis solve the energy crisis?'
Dr. D. O. Hall (*King's College, University of London*)
 - 'Methods of winning solid coal without any men going underground'
Professor M. W. Thring (*Queen Mary College, University of London*)
 - 'Prospects and economics of synthetic fuels'
G. V. Day (*Programme Analysis Unit*)
 - 'Novel combustion methods'
Professor F. J. Weinberg (*Imperial College, University of London*)
 - 'Future prospects for combustion in fluidized solids'
D. H. Desty (*BP Research, Sunbury-on-Thames*)
 - 'The role of advanced batteries in electricity supply and utilization, with particular reference to the sodium-sulphur battery'
W. T. Eeles (*Electricity Council Research Centre, Capenhurst*)
 - 'Novel methods of energy conversion, including thermionic, thermoelectric, magnetohydrodynamic, the Stirling engine and fuel cells'
Dr. G. Rice (*University of Reading*)
- Short contributions from the floor will be welcome.

Further information and application forms are available from the Meetings Officer, The Institute of Physics, 47 Belgrave Square, London SW1X 8QX.

'Engineering and National Goals in a Developing Economy'

The aim of an international conference to be held in Lagos by the Nigerian Society of Engineers from 25th to 28th November 1974 is the exchange of knowledge between engineers, sociologists and economists from many nations on the role of engineers in the planning and achieving of national goals in a developing economy. It is generally recognized that planning should ideally be undertaken by a multi-disciplinary team. In developing countries where there is a shortage of professional manpower generally, it is important and necessary that the role of the engineer in this field is defined in explicit and practical terms.

Offers of papers (by 31st May 1974) and requests for information on participation should be sent to Engr. Dr. A. O. Madedor, Technical Secretary, Nigerian Society of Engineers, P.O. Box 2299, Lagos, Nigeria.

R & D

Laboratory Notes

Deflexions of Large Structures Precisely Measured

An instrument has been developed at Sira Institute, Chislehurst, Kent, to measure the deflexions of radar aerials and similar structures under difficult working conditions. It was designed and constructed for the Admiralty Surface Weapons Establishment as a research tool in investigation into radar aerial characteristics. Observed deflexions while the aerial is rotating on a ship's mast are used to determine the radiation pattern during operation.

The six-channel instrument, which consists of a sealed laser projection head, position-sensitive photocells and electronic control unit, records continuously the flexure of different parts of the aerial structure in a particular plane. It is designed to operate in the harsh environment of a ship-of-war with a minimum of maintenance.

Four measurement ranges are provided so that flexures of from 0.1mm to 0.1 metres at frequencies up to 20 Hz and at a range of up to 4 metres can be continuously monitored. The electronic signal processing unit gives displacement readings which are independent of light intensity. The whole system is self-checking with built-in calibration facilities.

Though designed to meet the requirements of ASWE, the instrument has many wide-ranging applications in the fields of shipbuilding, civil and mechanical engineering where the dynamic deflexion of a bridge or a tower block of flats, the alignment of a tunnel or the sag of a ship's hull, movement of railway track and process engineering plant need to be measured. The instrument is stated to have applications anywhere where the vibration characteristics of a structure are under investigation.

Photodetector Tube for the Picosecond Range

C. Loty and G. Clément of the Laboratoires d'Electronique et de Physique appliquée, Limeil-Brevannes, France (one of the research organizations of the international Philips Group), have worked out an original photodetector tube with a high time definition and high gain. The tube is intended for the measurement versus time of light phenomena in the picosecond range. A need for an instrument of this kind has been felt in plasma research, in the study of laser signals, and other fields.

The tube takes the form of a cathode-ray tube in which the conventional cathode has been replaced by a photocathode, and comprises (see Fig. 1):

- a circular photocathode;
- an electron gun incorporating an electronic focusing system;
- a deflexion unit;
- a microchannel plate;
- a fluorescent screen.

luminous flux is proportional to the flux received by the photocathode.

The electron gun incorporates a control electrode which makes it possible to synchronize the switch-on of the tube with an external electrical signal. The photo-electrons are accelerated by a voltage of 2 kV. The electrostatic deflexion system comprises two pairs of plates at right angles to each other.

A spiral-type scan yields a time of the order of 100 ns for observation of the phenomenon concerned. It is produced by two amplitude-modulated sinusoidal voltages with a frequency of 200 MHz and a phase difference of 90°. The spot speed is 2 cm/ns, with a 200 Vp-p sweep voltage.

The time resolution is 10 ps while the dynamic range is 100. The photon gain depends on the type of photocathode used and its spectral characteristic. For a tri-alkaline photocathode (S 20), the photon gain is over 10000 for a wavelength of 0.5 μ m.

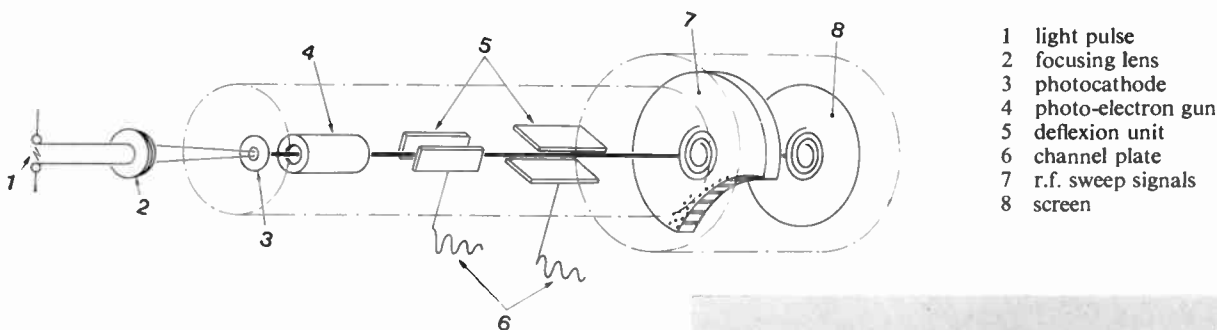
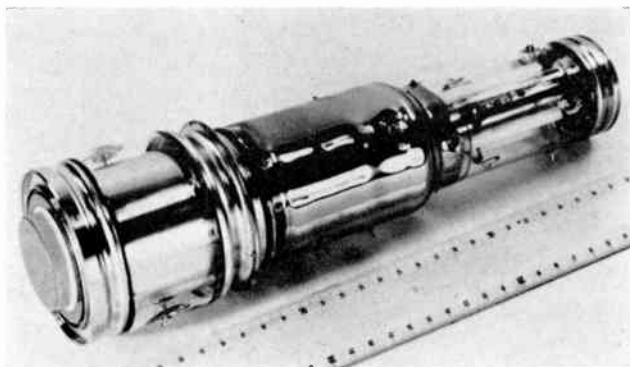

Fig. 1. The new photodetector tube for the picosecond range.

A light signal focused on the cathode is converted into an electron current with an intensity proportional to the illumination received; the electron gun constitutes the cross-over of the photo-emissive surface. The electron-optical system focuses the image of the cross-over on the input end of the channel plate. The intensified beam leaving the channel plate is accelerated and displayed on the fluorescent screen. The final



New Semiconductor Device for Analogue Signal Processing

A new semiconductor device for analogue signal processing, with more than 100 times the computational power and speed of conventional components, has been developed at General Electric Company of the USA's Research and Development Centre, Schenectady, New York. Called a surface charge correlator, the new integrated circuit is expected to make dramatic reductions in the cost and complexity of detecting signals buried in noise and other interference in radar and sonar systems. It is claimed to be able to perform 32 multiplications and additions in less than a microsecond.

The new integrated circuit was described during the Solid State Circuits Conference of the IEEE by J. Tiemann, E. Engeler, and D. Baertsch. Key to the speed and computational power of the surface charge correlator is a new charge-sloshing structure that eliminates a major problem of most charge-coupled devices—charge transfer loss. Presently available charge transfer devices contain many storage capacitors for controlling and moving charge packets across a silicon chip. As current flows from one capacitor to another,

however, a tiny fraction of the signal charge is left behind. After several thousand transfers, the misplaced charges build up to an appreciable fraction of the original charge, causing degradation of the output signal.

With this new surface charge correlator, tests showed that involving some two million transfer operations, charge sloshing prevented any cumulative signal loss whatsoever. Briefly, the new technique causes the charge in the chip to slosh back and forth between portions of a single charge storage region. If any charge is left behind on one transfer, it is picked up on the next transfer.

The new circuit fits into a standard 16-pin integrated circuit package, and performs correlations of 32 binary weights against 32 continuously variable analogue samples. Greater accuracy can be achieved by combining the modules in parallel, while correlations over a greater number of points can be achieved by combining them in series. The integrated circuits are fabricated by the standard process now used to produce l.s.i. m.o.s. chips, and are expected to cost about the same.

Applicants for Election and Transfer (continued from page 235)

Meeting: 19th February 1974 (Membership Approval List No. 178)

GREAT BRITAIN AND IRELAND

NON-CORPORATE MEMBERS

Transfer from Student to Graduate

MILLER, Richard John. *Uffington, Lincolnshire.*

Direct Election to Graduate

CHU, Yu Kai *Southampton, Hampshire.*
DEGUN, Joginder Singh, B.Sc. *Bedford.*
HART, Kenneth Edward. *Chelmsford, Essex.*
OFULUE, Joseph Ndidi. *Uxbridge, Middlesex.*
SHARP, John Clifford Keld, B.Sc. *Flyford Flavell, Worcestershire.*
THIEL, Geoffrey Lawrence, B.Sc. *Hayes, Middlesex.*
WAN, Shiu-Hung Gerald. *Manchester.*

Transfer from Graduate to Associate Member

MISRA, Baboo Ram. *Hounslow, Middlesex.*
SIMMONS, Robin Frank. *Croydon, Surrey.*

Direct Election to Associate Member

CROWCOMBE, David William. *Wedmore, Somerset.*
DOBBS, George Kenneth. *Clayhall, Ilford, Essex.*
DUGGAN, Anthony. *Heslington, York.*
FERRIER, Hugh. *Pershore, Worcestershire.*
JONAS, Andras. *Chorlton-cum-Hardy, Manchester.*
MACEY, Ian David. *Reading, Berkshire.*

Meeting: 5th March 1974 (Membership Approval List No. 179)

GREAT BRITAIN AND IRELAND

NON-CORPORATE MEMBERS

Direct Election to Graduate

LANE, Gregory James. *Chesham, Buckinghamshire.*

Transfer from Graduate to Associate Member

BAKER, Gregory Richard George. *Largs, Ayrshire,*
CANDY, Walton Gwynne. *Langland, Swansea, Glamorgan.*

JAMES, Colin Francis. *Southampton, Hampshire.*
SODHI, Inder Jeet Singh, B.A. *Ashford Middlesex.*

Transfer from Student to Associate Member

TABBAKH, Lewis Antoun George. *Thornton Heath, Surrey.*

MARLER, Roger Walter *Amphill, Bedfordshire.*
MELLOR, Clifford. *Aughton, Ormskirk, Lancashire.*

OGBONNAYA, Samuel Okoronkwo *Weston-super-Mare, Somerset.*
PENDRED, Clifford Robin. *Carlisle.*
PERRY, Roger Pryce *Newport, Shropshire.*
PONTING, John Noel *Bishops Cleeve, Cheltenham, Gloucestershire.*
TYLER, Ralph Geoffrey *Coventry, Warwickshire.*
UPTON, Dudley Keith. *Rochester, Kent.*
VALIANT, Malcolm John *Bordon, Hampshire.*
WARREN, Keith Edward. *London, N19.*
WELLS, Alan William. *Rayleigh, Essex.*
YUSUF, Ramon Olalekan. *London SW12.*

STUDENTS REGISTERED

POLYVIU, Constantinos *London, N7.*
SAW, Robert. *Barnsley, Yorkshire.*
STEWART, Gordon Malcolm. *Newcastle upon Tyne.*

OVERSEAS

NON-CORPORATE MEMBERS

Direct Election to Graduate.

DAN, Tapan Kumar. *Port of Spain, Trinidad.*
LOUTFI, Ziad Chafic *Lebanon.*

Direct Election to Associate Member.

FORD, Sidney John. *Barnet, Hertfordshire.*
HOWES, Keith John. *Amesbury, Wiltshire.*
LEAWORTHY, Colin John. *Portsmouth, Hampshire.*
RAMDHANIE, Shrichan Karan. *London, SW19.*
ROSE, John *Weybridge, Surrey.*
TIMBRELL, Graham William. *Preston, Lancashire.*
WILLIAMS, James Richard. *Peterborough, Northants.*

STUDENTS REGISTERED

GETHING, David Bernard. *Cheltenham, Gloucestershire.*
JASPER, John Charles. *Plymouth, Devon.*
WHEELER, Charles Grayshon. *Southwell, Nottinghamshire.*

Direct Election to Associate Member

BAMGBADE, Stephen Adepoju. *Lusaka, Zambia.*
BARNETT, Roy Keith. *B.F.P.O. 34.*
BARTON, Michael Jonathan. *Tehran, Iran.*
GRAHAM, Trevor. *Lieutenant, R.N. HMS Kent.*
HONG, John. *Kwang Khing Sabah, East Malaysia.*
KUMAR, Narendra. *Colonel. P.O. Hebbal, Bangalore 6, India.*
NG, King Show. *Singapore 12.*
OBASI, Okay Kevin Conleth. *Lagos, Nigeria.*
PEARCE, Percival Lambert. *Auckland 7, New Zealand.*
SAMARATUNGE, Ananda Bandara. *Dehiwela, Sri Lanka.*
SANTOS, Stephen Verissimo Akinola. *Lagos, Nigeria.*
SORRELL, Albert Frederick. *Hong Kong.*
WELCH, Michael. *Jamaica, West Indies.*
WHITE, Gordon James. *Blantyre 3, Malawi.*

STUDENTS REGISTERED

ABAS, Afifuddin. *Kuantan Pahang, W. Malaysia.*
ASWAL, Chander Bir. *Dehra Dun U.P. India.*
CHANG, Kwong Thai. *Singapore 2.*
CHEUNG, Kuen On Tommy. *Happy Valley, Hong Kong*
LEONG, Hou Kit. *Singapore 3.*
SHARMA, Shivaji. *Poona Camp 1, India.*

OVERSEAS

NON-CORPORATE MEMBERS

Direct Election to Graduate

GRAY, Gary David. *Orange, California, U.S.A.*
RAMACHANDRAN, Madathil Nelliiodan. *Perak, West Malaysia.*

Transfer from Student to Graduate

LIM, Sin Leong. *Penang, Malaysia.*

Transfer from Student to Associate Member

ADEBISE, Adegoke Aremu. *Lagos, Nigeria.*

Direct Election to Associate

SANDIFORD, Guy Frederick. *Belize City, British Honduras.*

STUDENTS REGISTERED

ANG, Tok Keong. *Singapore 3.*
ONG, See Ban. *Singapore 16.*

Notice is hereby given that the elections and transfers shown on Lists 174, 175 and 176 have now been confirmed by the Council.

INSTITUTION OF ELECTRONIC AND RADIO ENGINEERS

Applicants for Election and Transfer

THE MEMBERSHIP COMMITTEE at its meetings on 28th December 1973, 19th February and 5th March 1974 recommended to the Council the election and transfer of 158 candidates to Corporate Membership of the Institution and the election and transfer of 62 candidates to Graduateship and Associateship. In accordance with Bye-law 21, the Council has directed that the names of the following candidates shall be published under the grade of membership to which election or transfer is proposed by the Council. Any communications from Corporate Members concerning these proposed elections must be addressed by letter to the Secretary within twenty-eight days after the publication of these details.

Meeting: 28th December 1973 (Membership Approval List No. 177)

GREAT BRITAIN AND IRELAND

CORPORATE MEMBERS

Transfer from Graduate to Member

ATKINS, Stanley. *Whitefield, Manchester.*
BARNETT, Keith Edmund. *Upper Cwmbran, Monmouthshire.*
BENNETT, Harry Donald. *Lieutenant R.N. London, SE9.*
BRIERLEY, Michael Peter. *Swindon, Wiltshire.*
BROOKES, John Haydn. *Borehamwood, Hertfordshire.*
CAKEBREAD, Derek Henry. *Rayleigh, Essex.*
CARTON, David George. *Coventry, Warwickshire.*
CHADDA, Amrit Singh. *Enfield, Middlesex.*
CHADWICK, John. *Lieutenant R.N. Dunfermline, Fife.*
COLLINS, Terence Allan. *Forest Row, Sussex.*
CONNOLLY, James Edmund. *Rochester, Kent.*
COODE, Brian William. *Epsom, Surrey.*
COURT, Jeffrey Thomas. *High Wycombe, Buckinghamshire.*
COWPERTHWAITHE, Thomas Herbert. *Preston, Lancashire.*
COYNE, Gerard Anthony. *Macclesfield, Cheshire.*
CRACKNELL, Peter John. *Guildford, Surrey.*
CULLING, Walter Mark. *Kingswood, Bristol.*
DALE, Howard James. *Upminster, Essex.*
DAVIES, John Dennis. *Bulkington, Nuneaton.*
DAVIES, Trevor Barham. *Calmore, Southampton, Hampshire.*
DAY, Brian James. *Dousland, Yelverton, Devon.*
DINGLE, John Cotterell. *Almondsbury, Bristol.*
D'LEMONS, Noel Brian, B.Sc.(Eng). *London, SE20.*
DOWNING, Michael Howard, B.Eng. *Blackwood, Monmouthshire.*
DOWNES, Edward James. *County Roscommon, Ireland.*
DURRANT, Frank Peter. *Bedhampton, Havant, Hampshire.*
END, Stanley Jacob William. *Chatham, Kent.*
FENDER, Iain Montgomery. *Wooton Bridge, Isle of Wight.*
FILLMORE, John David. *Ottershaw, Surrey.*
FISHER, Derek. *Grappenhall, Warrington, Lancashire.*
FORRESTER, Michael Herbert. *Camberley, Surrey.*
FOSTER, Brian George. *Ascot, Berkshire.*
GIBBS, Ian Grenville. *East Grinstead, Sussex.*
GILCHRIST, Michael William John. *Bushey, Hertfordshire.*
GILMARTIN, James. *Frampton Cotterell, Bristol.*
GRAY, Stuart William. *Suton, Surrey.*
HALLAM, Robert. *Brentwood, Essex.*
HAMMOND, Christopher Michael. *Stoke-on-Trent, Staffordshire.*
HAMILTON, Ian Aitkin. *Blantyre, Lanarkshire, Scotland.*
HARDING, Henry Michael. *Camberley, Surrey.*
HARMER, Douglas Haig. *London, SE9.*
HARRINGTON, William Alan. *Barnet, Hertfordshire.*
HARRISON, Roger Maurice. *Flight Lieutenant R.A.F. Louth, Lincolnshire.*
HERBERT, Geoffrey Charles. *Lieutenant R.N. London, W6.*
HESLOP, David Arnold George. *Leigh on Sea, Essex.*
HEWLETT, John Malcolm. *South Harrow, Middlesex.*
HILDITCH, Philip James. *Gosforth, Newcastle upon Tyne.*
HILL, Michael Edward. *London, W5.*
HILL, William John. *London, SW19.*
HILTON, David William. *Wigan, Lancashire.*

ILIFFE, David William. *Cheltenham, Gloucestershire.*
JACK, Stuart Douglas. *Rothwell, Northamptonshire.*
JACOBS, Jack Solomon. *Bognor Regis, Sussex.*
JONES, Keith. *Weymouth, Dorset.*
KENNY, Stephen Raymond. *Ruislip, Middlesex.*
KING, Leslie Ronald. *Eastleigh, Hampshire.*
KNIGHT, Paul Antony. *Oxted, Surrey.*
LADYMAN, Peter Francis. *Ashby-de-la-Zouch, Leicestershire.*
LAWTON, Rodney James. *Wooton Bassett, Wiltshire.*
LAZENBY, Gordon Philip. *Manton Heights, Bedford.*
LESTER, Christopher John. *Wasingborough, Lincoln.*
LLOYD, Gerald Edward. *Chorley, Lancashire.*
LOCK, Peter John. *Garston, Hertfordshire.*
LOVELL, Brian William. *London, W13.*
LYELL, Alexander Dickson. *Sandy, Bedfordshire.*
McBRIDGE, Robert. *South Queensferry, West Lothian.*
McFARLAND, Ian. *Swinton, Lancashire.*
McGUINNESS, James John. *Wallington, Surrey.*
MACKINLAY, Graham. *Squadron Leader R.A.F. Bampton, Huntingdon.*
MADDOCK, Derek James. *Glais, Clydach, Swansea.*
MADDOCK, Timothy Frederick. *Lieutenant. Fareham, Hampshire.*
MANKLOW, Leonard John. *Barming, Maidstone, Kent.*
MANTRIPP, Keith George. *Lowestoft, Suffolk.*
MARTIN, Robert William George. *Harpenden, Hertfordshire.*
MASON, Brian Skelton. *Ilford, Essex.*
MAUGER, John Shaw. *West Molesey, Surrey.*
MAUNDRELL, Melville John. *Reading, Berkshire.*
MILES, Peter John. *Churchdown, Gloucester.*
MORGAN, Michael John. *Harpenden, Hertfordshire.*
MUNRO, Angus Alexander. *Stevenage, Hertfordshire.*
NEAL, Malcolm Francis. *Stockton-on-Tees, Teesside.*
NEBBETT, Raymond Roger. *Worcester Park, Surrey.*
NEWCOMBE, Christopher Mervyn. *Sittingbourne, Kent.*
NOLAN, James Noel Thomas. *Malahide, County Dublin.*
OLIVER, David James. *Cove, Farnborough, Hampshire.*
PETERSEN, Brian Frank. *Linford, Essex.*
PICKETT, Charles William. *London, SW19.*
PRATLEY, Charles William. *Peterborough, Northamptonshire.*
PREBBLE, Laurence Peter. *Croydon, Surrey.*
PRESCOTT, David John. *Worcester Park, Surrey.*
PRYNN, Robert Michael. *Lieutenant R.N. Portsmouth, Hampshire.*
PYLE, James Clark. *Worcester Park, Surrey.*
SARGENT, James Colin. *Billerica, Essex.*
STEPHENS, Garnik Gerald. *Weybridge, Surrey.*
WARD, James Trevor. *Weston Super Mare, Somerset.*

Transfer from Associate to Member

GIBBS, Gerald Gilbert. *Welwyn, Hertfordshire.*
NASH, John Alan. *Liss, Hampshire.*

Direct Election to Member

ANDREANG, Keith Robert. *London, SE6.*
BAKER, Patrick Frederick. *Christchurch, Hampshire.*
BAKER, John Albert. *Rickmansworth, Hertfordshire.*
BEADLE, Martin Jeffrey. *Dartford, Kent.*

BIRCH, Gary Michael. *Shenfield, Essex.*
BRINSON, Michael Ernest, B.Sc., Ph.D. *Hoddesdon, Hertfordshire.*
BROWN, David Edwin Charles. *Northolt, Middlesex.*
CHAMPION, Michael Cheyney. *Flight Lieutenant R.A.F. Radlett, Hertfordshire.*
COYTE, Raymond George. *Aylesbury, Buckinghamshire.*
DALEY, Edward. *Blackpool, Lancashire.*
DAVIS, Keith Christian. *Aylesbury, Buckinghamshire.*
DANIELS, Brian Stephen. *Greenford, Middlesex.*
DOWDING, Peter William. *Hoddesdon, Hertfordshire.*
DUFOUR, Ian George. *London, N14.*
EKINS, Michael. *Bleichley, Buckinghamshire.*
EMBER, Alvern Albert. *Southampton, Hampshire.*
EVANS, Joseph David. *Llangefni, Anglesey.*
FORRESTER, John, B.Sc., M.Sc., *Southbourne, Hampshire.*
FRANCE, Keith Anthony. *Great Yarmouth, Norfolk.*
GILBERT, Michael Alfred Edward. *Fordcombe, Tunbridge Wells, Kent.*
GREENWOOD, Desmond Francis, Wing Commander R.A.F. *Wokingham, Berkshire.*
HIGGINS, Robert William. *Wigston, Leicestershire.*
JONES, Peter Leslie. *Bebington, Wirral, Cheshire.*
KING, David Hugh Eveleigh. *Bury St Edmunds, Suffolk.*
LEMAN, Richard John. *Tonbridge, Kent.*
LODGE, Michael William. *Swanley, Kent.*
McGILVRAY, Ian Warner. *Hitchin, Hertfordshire.*
MASON, Michael David Lawrence. *Naphill, Buckinghamshire.*
NICHOLS, George Walter. *Sutton Coldfield, Warwickshire.*
OGRAM, Andrew Fraser Young. *Coventry, Warwickshire.*
PAYNE, Ronald, Commander R.N. *Fareham, Hampshire.*
REDFERN, Alan Desmond. *Porthmadog, Caernarvonshire.*
RICHARDS, Malcolm Charles. *Woolton, Liverpool.*
RIDDELL, John Andrew. *Kenilworth, Warwickshire.*
ROGERS, Peter Alan. *Cheltenham, Gloucestershire.*
SCHOFIELD, Peter Derrick. *Camberley, Surrey.*
SHEPPARD, Gary Albert. *London, SE18.*
SHERLOCK, Horace Keith. *London, N14.*
SHERRATT, Robert Alan. *Blackpool, Lancashire.*
SMITH, Brian Bennell. *Stammore, Middlesex.*
TAYLOR, Charles Henry. *B.Sc. Dursley, Gloucestershire.*
THROP, Kevin, Squadron Leader R.A.F. *Leighton Buzzard, Bedfordshire.*
TRUSCOTT, Tom Theodore. *B.Sc. Woodhall Spa, Lincolnshire.*
WYLDE, Alan Roy. *Kirkham, Lancashire.*

OVERSEAS

CORPORATE MEMBERS

Transfer from Graduate to Member

BROWN, Paul Anthony. *Auckland, New Zealand.*
CHERRY, Malcolm Douglas, Captain R. Sigs. *Kuala Lumpur, Malaysia.*
CHRYSTAL, Andrew John. *Tehran, Iran.*
DE FINA, Leonardo Henri. *Victoria, Australia.*
FINGALL, Eugene Vernon. *St. Michael, Barbados, West Indies.*
FROST, Edward Maxwell MBE. *Captain R. Sigs. B.F.P.O. 40.*
KASSER, Joseph Eli. *Maryland, U.S.A.*
OGUNDELE, Solomon Ogunjide. *Lagos, Nigeria.*
OWU, Francis Kwa. *Accra North, Ghana.*
SOYSA, Samindra Weera. *Waihi, New Zealand.*
WALDEGRAVE, John Neate. *Benoni, Transvaal, South Africa.*

Transfer from Associate to Member

SMITH, Robert Edwin Charles Bernard. *Barbados, West Indies.*

Direct Election to Member

ABID, Amir Ahmed. *Karachi, Pakistan.*
DYKE, Linus Onuigbo. *Ikoyi, Lagos, Nigeria.*
GAY, William. *Wilton, Wellington 5, New Zealand.*
EGE, Olawale Adeniji. *Lagos, Nigeria.*
SUSIL, Libor Frank. *Toronto, Ontario, Canada.*

(continued on opposite page)

Forthcoming Institution Meetings

London Meetings

Wednesday, 1st May

COMPONENTS AND CIRCUITS GROUP

Colloquium on INTERACTIVE GRAPHICS FOR ELECTRONICS DESIGN

IERE Lecture Room, 2 p.m.

P.C.B. Layout from Designer's Sketch to Artwork

By W. E. Hillier (*Redac Software*)

An Approach to Display Terminal Optimization for Computer Aided Circuit Design Applications

By J. J. O'Reilly (*University of Essex*)

The Use of a Storage Tube Graphic Terminal for Integrated Circuit Design

By J. D. Eades (*Department of Computer Science, University of Edinburgh*)

The Use of Interactive Graphics and Interactive Computing at Lucas Aerospace Ltd.

By W. C. Dolman (*Lucas Aerospace Ltd.*)
Use of Interactive Graphical Devices for Design and Drafting

By R. R. Gallant (*Computervision Corp.*)

An Interactive Graphical System for Circuit Analysis

By Dr. M. Apperley (*Imperial College of Science and Technology*)

Further details and registration forms from Meetings Secretary, IERE.

Wednesday, 8th May

EDUCATION AND TRAINING GROUP

The Teaching of Electronic Logic Systems

By Dr. K. J. Dean (*S.E. London Technical College*)

IERE Lecture Room, 6 p.m. (Tea 5.30 p.m.)

The rapid development of digital electronic systems has brought with it changes in teaching methods. Whereas in the past we have been primarily concerned with circuit design for linear systems, more emphasis is being placed on binary system design which is comprised of two-state circuits, the design of which is probably of less immediate concern than that of the system of which they are components. The lecture will discuss the impact this state of affairs makes upon teaching techniques and on syllabus content, and will be suitably illustrated.

Wednesday, 15th May

AEROSPACE, MARITIME AND MILITARY SYSTEMS GROUP

The US Navy Navigation Satellite System

By W. F. Blanchard (*Redifon Telecommunications*)

MEETING POSTPONED

Tuesday, 21st May

JOINT IEE/IERE COMPUTER GROUP

Colloquium on LARGE SCALE INTEGRATION—ITS USE AND ITS EFFECT ON SYSTEM ARCHITECTURE

IEE, Savoy Place, 2.30 p.m.

Further details and registration forms from the IEE, Savoy Place, WC2R OBL.

Wednesday, 22nd May

AUTOMATION AND CONTROL SYSTEMS GROUP

Automatic Frequency Response Testing of Non-Linear Control Systems

By M. C. De'Ath (*Marconi Space and Defence Systems*)

IERE Lecture Room, 6 p.m. (Tea 5.30 p.m.)

This paper describes a programming technique which enables a closed loop performance of a non-linear system to be obtained from open loop data. The method is particularly useful where multiple feedback and/or multiple loops are employed.

The measurement is done in the frequency domain and consists of taking a frequency response measurement of all feedback signals at a number of signal input amplitudes, which should cover the full input range of the system. This data is stored in a computer, and thus with interpolation, the gain and phase of the system for any input amplitude or frequency is defined. The effect on the overall response of adding series and shunt compensation can be determined which is of great assistance when developing the system.

An iterative procedure is used to combine multiple feedback signals into a closed loop, instability or low gain and phase margin are detected and warnings given.

The program outputs information on an XY plotter and can present the open or closed loop plots as either Bode, Nyquist or Nichols.

To efficiently collect the necessary data an automatic plotter has been developed which plots frequency response in polar format as the system is measured, and also punches frequency, gain and phase information onto paper tape for computer processing. A brief description of this equipment is given in the paper.

Friday, 24th May

JOINT IEE/IERE MEDICAL AND BIOLOGICAL ELECTRONICS GROUP

Colloquium on NON-INVASIVE MEASUREMENT OF CARDIAC OUTPUT

IEE, Savoy Place, 10.30 a.m.

Further details and registration forms from the IEE, Savoy Place, WC2R OBL.

Wednesday, 29th May

COMMUNICATIONS GROUP

IERE/IEE

Colloquium on MODELLING OF COMMUNICATIONS SYSTEMS

IERE Lecture Room.

Advance Registration necessary. Apply to Meetings Secretary, IERE.

Wednesday, 5th June

COMPONENTS AND CIRCUITS GROUP

Colloquium on J-FETS and MOSFETS

IERE Lecture Room, 2 p.m.

The Development of MOSFETS for use as Variable Resistance Elements

By A. Demetriou (*Standard Telephones Laboratories*) and W. G. Townsend (*University College of Swansea*)

Low Noise Applications for Junction Field Effect Transistors

By A. D. Chappell (*Texas Instruments Ltd.*)

Gallium Arsenide Field Effect Transistors—Their Performance and Application to X-Band Frequencies

By H. E. G. Luxton (*Allen Clark Research Centre*)

Integrated Circuit Analogue Switches

By R. Thomas (*Siliconix Ltd.*)

Dual Gate MOSFET Designs for FM Tuners

By C. McCarthy (*Texas Instruments Ltd.*)

Advance Registration necessary. Apply to Meetings Secretary, IERE.

South Midland Section

Friday, 10th May

Annual Buffet Dance

BBC Club, Evesham, 8 p.m.

Tickets necessary

South Western Section

Monday, 6th May

ANNUAL GENERAL MEETING

The Royal Hotel, College Green, Bristol, 7 p.m.

North Western Section

Thursday, 9th May

ANNUAL GENERAL MEETING

Followed by **European Communication Satellites**

By A. Dickinson (*BAC*)

Lecture Theatre R/H10, Renold Building, UMIST, 6.15 p.m. (Tea 5.45 p.m.)

The paper will summarize the communications requirements of Europe and the part which satellites can take in fulfilling this role. The history of the European studies of such satellites and the plans for the future will be reviewed. Brief technical details of the type of satellite systems at present being developed will be described.

Members' Appointments

AWARD OF GEORGE MEDAL

The Council of the Institution has sent its warmest congratulations to Lt. Col. M. H. Mackenzie-Orr, OBE, RAOC, (Graduate 1965) on the award of the George Medal. Lt. Col. Mackenzie-Orr was posted to Northern Ireland in January 1973 as Chief Ammunitions Technical Officer responsible for bomb disposal operations. Last September he spent eight hours in Belfast city centre de-fusing a 500 lb. bomb which threatened to destroy the city's main telephone exchange. He has now been posted as the Army Guided Weapons Staff Officer to the British Defence Research Scientific Staff at the Weapons Research Establishment, Woomera, Australia.

CORPORATE MEMBERS

Mr. R. Bolton (Fellow 1962, Member 1952, Associate 1948) has been appointed Principal Communications Assistant (Design) in the Department of the Chief Signal Engineer, London Transport. He will be responsible for all design applications covering the telecommunications and ancillary equipment—such as closed circuit television, radio and public address systems—associated with the London Transport railway network. Mr. Bolton joined London Transport in 1966 as a Senior Executive Assistant responsible for communications equipment installation and maintenance. Before that he was Director of the East African Posts and Telecommunications Administration.

Mr. A. C. Bartlett (Member 1973, Graduate 1966) who joined British European Airways and has latterly been a Technical Superintendent with British Airways concerned with computer terminal equipment, has joined British Caledonian Airways as Manager of Teleprocessing.

Mr. R. J. Bishop, Ph.D., M.Sc., B.Sc. (Member 1971) has been appointed to a Lectureship in Physics in the School of Chemical and Physical Sciences at Kingston Polytechnic. Dr. Bishop joined the College staff in 1964 as a Research Assistant and was appointed to the teaching staff in 1966.

Mr. D. J. Brock (Member 1973, Graduate 1970) is now an Experimental Officer in the Department of Electrical Engineering of the University of Surrey. For the past three years he was a Design and Development Engineer with Electronic Visuals Limited, Staines, Middlesex.

Mr. A. L. Cotcher, B.A., M.Sc. (Member 1962) has been appointed Manager, Corporate Communications of Brookhirst Igranite Limited. He joins this electrical control gear and electronics systems company from the London advertising agency, Howard Panton, where for the past seven years he was Managing Director. In his new post Mr. Cotcher will be responsible for projecting the image of the company in all its

aspects both at home and overseas. Mr. Cotcher, who is now a British subject, was born and educated in the USA gaining his B.A. in engineering sciences and applied physics and M.Sc. in electrical engineering at Harvard. He has worked as a development engineer with RCA and on missile fusing with the National Bureau of Standards in Washington.

Mr. P. R. Deacon (Member 1973, Graduate 1965) joined Mullard Limited in 1967 as a Product Engineer concerned with transistors and has now been appointed Deputy Sales Manager of the Computer Electronics Division.

Mr. E. Gibbs (Member 1971, Graduate 1969) who joined Melcom System (UK) Limited in 1971 as Engineering Manager, has moved to Ellar Electronics Limited, Fareham, to become Managing Director.

Mr. G. R. Jessop (Member 1953) is the President of the Radio Society of Great Britain for 1974. An active member of the RSGB for over 40 years (he has held his call sign G6JP since 1930), Mr. Jessop succeeds Dr. J. A. Saxton, CBE, Director of the Radio and Space Research Station (now Appleton Laboratory). The Society which was founded in 1913 as the London Wireless Club and subsequently became the Wireless Society of London, adopted its present name in 1922.



A member of the Institution's Technical Committee for a number of years and Chairman of the Standards and Specifications Sub-Committee, Mr. Jessop has represented the IERE on BSI Technical Committee TLE 5 Electronic Tubes and Valves since 1953 and he has on several occasions attended International Electro-technical Commission meetings as a British representative. He served on the Institution's Components and Circuits Group Committee from its formation in 1968 until some two years ago when he transferred to the Communications Group Committee. He was also for several years the Institution's examiner for the specialist subject of valve technique and manufacture.

Mr. Jessop retired from the M-O Valve Company in 1971 after 45 years service; he was latterly in charge of technical aspects of transmitter valves and microwave devices

throughout the world and from 1950 to 1960 was Technical Manager of the Transmitting Valve department. During the war years he was Chief Technical Engineer at the GEC Ministry of Aircraft Production factory at Shaw in Lancashire, which manufactured a wide range of transmitting and receiving valves and cathode-ray tubes.

Mr. R. Lowe (Member 1961), at present a Principal Lecturer in Electronics at the Wigan and District Mining and Technical College, has been appointed Head of the Department of Electrical Engineering at Reading College of Technology in succession to the late Mr. C. Richardson (Fellow) who died in June 1973. Mr Lowe was a Lecturer at Reading before moving to Wigan in 1969.

Mr. J. H. Smith, B.Sc. (Member 1969, Graduate 1966) who was a Lecturer II at Dacorum College of Further Education from 1956-72 and has been a Senior Lecturer at Tottenham College of Technology since 1972, will take up the position of Deputy Head of Engineering at the College in September.

Mr. G. Taylor (Member 1971, Graduate 1967) who was Regional Chief Test Engineer with Rediffusion (East Midlands) Limited from 1968, is now studying at Trent Polytechnic for the Diploma of the Youth Employment Service Training Board in Careers Guidance on secondment from Nottinghamshire County Council.

Mr. M. J. Tucker, B.Sc. (Member 1965) has been appointed an Assistant Director with the Institute of Oceanographic Sciences and is now in charge of the Institute's establishment in Taunton, Somerset. This deals with research into coastal sedimentation and with oceanography applied to engineering problems. He is also responsible



for the Institute's Instrument Pool Service at the Research Vessel base at Barry, which provides oceanographic equipment for universities and NERC bodies. He was formerly Head of the Applied Physics Group at the Wormley establishment of IOS, originally the National Institute of Oceanography. Mr. Tucker has been a pioneer in the application of electronic and acoustic techniques to oceanographic instrumentation, having first entered this field during the war at the oceanographic group at the Admiralty Research Laboratory, and he has contributed several papers to the Institution's Journal. He has served on the organizing committees of two IERE conferences in this field.

Mr. S. Vaudrey (Member 1973, Graduate 1970) who is with the Department of Chemistry, University of Manchester Institute of Science and Technology, has been promoted to Senior Experimental Officer.

Mr. F. W. Wright (Member 1960, Associate 1956) who joined TAI Inc. of Tehran in 1968 has been promoted to be Manager in charge of Special Projects and Marketing.

NON-CORPORATE MEMBERS

Mr. C. R. Jennings (Companion 1973) who is a Director of Formica Limited, has been elected Deputy-Chairman of the Radio and Electronic Component Manufacturers' Federation.

Mr. M. Asim (Graduate 1971) is now a Development Engineer in the Laboratories of Textronix U. K. Limited, Southgate.

Mr. E. M. O. Davies-Venn, M.Sc. (Graduate 1972) has been with the Posts and Telecommunications Department of the Sierra Leone Government since 1972 and has now been promoted to Telecommunications Engineer.

Mr. B. Gillings (Graduate 1970) has been appointed a Design Engineer with Data Laboratories Limited, Mitcham, Surrey.

Mr. F. J. O'Neill (Graduate 1972) served in the RAF from 1952-1973, latterly as Chief Technician at No. 22 JSTU, RAF Boscombe Down, has been appointed Shift Superintendent Broadcasting at the

British Eastern Relay Station of the Foreign and Commonwealth Office at Masirah Island, Oman. Mr. O'Neill was awarded the Mountbatten Medal in 1968 as the most successful candidate in the Institution's examinations who was serving in H. M. Forces at the time of the examination. He was at RAF Changi, Singapore, at the time.

Mr. R. Richardson (Graduate 1970) has joined the Kelvin Hughes Division of Smiths Industries as an Engineer II. He was previously a Design and Development Engineer with Mullard Mitcham.

Mr. C. J. S. Toogood (Graduate 1966) is now with the Research and Development Department of Tematron Limited as Senior Projects Engineer, where he will be concerned with the design and development of electronic timers and controllers. He was previously a Senior Engineer with Ferranti Limited, Bracknell.

Mr. A. A. Weir (Graduate 1966), formerly an Electrical/Electronic Engineer with the Cumberland Filter Company Limited, has been appointed an Assistant Planning Engineer with the Central Electricity Generating Board at Roosecote Power Station, Barrow in Furness.

Mr. M. Batten (Associate 1972) who was an Electronic Technician at the Rutherford Laboratory, is now a Field Engineer with Tektronix UK Limited.

Mr. E. P. Buckley (Associate 1941) is now Deputy Assistant Controller (Radio) with the HQ No. 4 Signal Group, BAOR.

Obituary

The Council of the Institution has learned with regret of the death of the following member.

Frank Noel Bulley (Associate 1955, Student 1949) died on 9th February 1974 aged 54 years. He leaves a widow, son and daughter.

Born in Maidstone, Kent, Mr. Bulley entered the RAF in 1936 as a wireless operator apprentice and prior to demobilization in 1946 was in charge of a central wireless workshop. From 1946 to 1948 he was Production Manager with ACE Electronics Limited, Croydon. He then joined the Service Department of the General Electric Company where he was a Senior Technical Designer concerned with audio amplifiers, electronic devices and special radio and television development. From 1953 he was Senior Component Life Test Engineer with Philco (overseas) Limited, Chigwell, Essex. In 1962 he joined Walmore Electronics Limited as Chief Inspector. In this capacity he built up the company's quality assurance department designing special-purpose instruments for testing a wide range of imported equipment to the requirements of the EID and ARB. Over the past two years he had broadened these facilities to cover microwave components and equipment.

Mr. Bulley developed a muscular disease about two years ago which eventually led to his admission to hospital in September 1973, and his eventual death.

New Books Received (continued from page 239)

Sound with Vision: Sound Techniques for Television and Film

E. G. M. ALKIN. Butterworths, London 1973. 24.5 x 17 cm. 283 pp. £6.00*

CONTENTS: Fundamental considerations. Microphone technique for continuous take production. Technical facilities. Sound operational practice.

The book discusses the problems encountered in the simultaneous production of sound and pictures and gives practical guidance in methods of solving them. It examines the principles underlying the equipment and its use to obtain the best possible results. The methods developed by the BBC are here made available in a book form for the instruction of television sound operators. Designers and manufacturers of sound equipment will also find the book of use.

(Mr. Alkin is in charge of television sound operations in the BBC's London Studios.)

Practical Relay Circuits

FRANK J. OLIVER. Pitman Publishing, London 1973. 21.5 x 13.5 cm. 363 pp. £3.25.*

CONTENTS: Fundamental relay circuits. Arc and electromagnetic interference suppression. The time delay function. Alarm, limit and monitoring. Audio tone control and resonant-reed relays. Protective functions. Power source and load transfer. Pulse generation and conditioning. Pulse detection,

counting, and registration. Basic relay logic circuits. Binary counting with relays. Selection circuits.

A collection of circuits suitable for a variety of functions is presented. This should be helpful to an engineer wishing to gain a broad view of the many circuits that can solve a particular problem.

For a practising design engineer the book will be useful as a reference work and for students at the H.N.D. and undergraduate level it will serve as a text book.

(Mr. Oliver is a former editor of the *American Journal Electrotechnology*.)

Cryoelectronics

W. P. JOLLY. English Universities Press, London 1972. 21.5 x 14 cm. 88 pp. £2.45 (boards), £1.35 (limp).

CONTENTS: Electrical conductors at low temperatures. Semiconductors at low temperatures. Insulators at low temperatures. Superconductors. Cryotron switches and persistent current stores. Microwave radio effects at low temperatures. Appendices: Superconducting machines and heavy power equipment; Production of very low temperatures.

This is one of a series of books which aims to provide concise and straightforward treatments of advanced modern topics. Cryoelectronics which includes low temperature effects in conductors, insulators and semiconductors, superconduction, microwave effects, cryotrons and memories, is treated for the understanding of those

with a scientific background of a first—or second—year student of a degree course. Many references which serve as a guide for further reading are included.

(Professor Jolly (Fellow 1971) is a visiting teacher at King's College, University of London.)

Electronics for Engineers: An Introduction

H. AHMED and P. J. SPREADBURY. Cambridge University Press 1973. 22.5 x 15 cm. 258 pp. £5.20 (boards) £2.40 (paperback).

CONTENTS: Principles of amplifiers. The p-n junction and the field-effect transistor. The bipolar transistor. Operational amplifiers and linear integrated circuits. Negative feedback. Positive feedback and oscillators. Advanced circuits.

This introductory textbook on electronic circuits covers the early part of degree level courses taken by electrical and electronic engineering students. Some parts of the book will also be useful to practising engineers and scientists who need to refer to electronic circuit design points.

Worked examples are included in the text and problems and multiple-choice tests are printed at the ends of chapters. Answers to problems are given.

(The authors are lecturers in engineering at the University of Cambridge.)

New Books Received

All the books which are described below are available in the Library and may be borrowed by members in the United Kingdom. A postal loan service is available for those who are unable to call personally at the Library.

Fundamentals of Digital Systems

B. R. BANNISTER and D. G. WHITEHEAD.
McGraw-Hill, Maidenhead, Berkshire
1973. 23 × 15 cm. 325 pp. £5.10*

CONTENTS: Combinational logic. Number systems and coding. Minimization. Logic circuits. Inverting logic. The bistable. Sequential logic. Storage systems. Digital computer structures. Digital data transmission. Process control elements.

Beginning with the fundamental concepts of logic and number systems the authors develop analysis, synthesis and miniaturization procedures. Practical logic circuits are then discussed and an assessment of types in current use is presented.

Emphasis throughout is on engineering rather than mathematical aspects of the subject. Theoretical concepts are directly related to practical design examples. Because of this feature the book will be of equal value to H.N.D. and CEI Part 2 students as to engineers specializing in digital systems.

(Mr. Bannister is a Lecturer at the North Staffordshire Polytechnic and Mr. Whitehead is at the University of Hull.)

Communication Systems Analysis

P. B. JOHNS and T. R. ROWBOTHAM.
Butterworths, London, 1972. 21.2 × 13.4 cm. 207 pp. £3.40 (boards). £2.20 (limp).*

CONTENTS: Introduction and basic mathematics. Thermal noise. Analogue modulation methods and interference. Echo and a.m. to p.m. distortion in f.m. systems. Non-linear distortion. Digital modulation systems.

A single international circuit in a modern communications system may not only involve different propagation media such as cable, ionosphere and satellite but also the different modulation systems appropriate to each media. It is thus important for the communications student to master many systems and Johns and Rowbotham give the essentials of these systems in one compact volume.

The book recognizes that a non-linear product is as much a signal in the wrong place as is a weed a plant in the wrong place in the garden; both may be useful elsewhere. Once this is accepted then similarities can be drawn between signal and noise and their similar essential statistical properties determined. The progression from the basic maths and noise properties through amplitude, frequency, phase, pulse and digital modulation systems is logical and refreshing. At each stage in a chapter the student's understanding is soundly searched by appropriate practical problems.

A good example of this approach is the problem concerning a long transmission line fitted with repeaters at intervals. For given line, amplifier characteristics and modulation systems, the bandwidth and transmitter power constraints are separately examined. The solutions are not only useful to the student but make a helpful reference for later.

The book thus has not only the main advantages of a programmed learner but it is still useful to the practising engineer to refresh on a point of importance or quantitative detail. In this way Johns and Rowbotham match the requirement of the student whilst providing a source of reflexion for the practising engineer.

L. A. BONVINI

(Dr. Johns is a Lecturer in Communications at the University of Nottingham; Mr. Rowbotham is a Senior Executive Engineer at the Research Department of the Post Office.)

A User's Handbook of Integrated Circuits

E. HNATEK. Wiley, New York 1973.
25 × 17 cm. 449 pp. £12.50*

CONTENTS: An overview of integrated circuit choices. Bipolar integrated circuit processing. Bipolar integrated circuit characteristics and design. Bipolar logic circuit families. Applications of TTL and tri-state medium-scale integrated circuits. Metal-oxide-semiconductor (m.o.s.) integrated circuits. C.m.o.s. applications. Applications of m.o.s. integrated circuits. Random-access memories (r.a.m.s.). M.o.s./bipolar combinations and trade-offs. Linear integrated circuits: The operational amplifier. Operational-amplifier applications. Monolithic voltage regulators. Thin-film hybrid circuits. Thick-film hybrid circuits. Integrated circuit packaging and interconnection techniques.

Most books on integrated circuits are confined to either digital or linear elements. For that reason, Mr. Hnatek's text is a welcome addition. This substantial volume covers all monolithic technologies, digital and linear circuit techniques with applications, and also thin and thick film hybrid circuits.

The distinct strength of this book is the coverage of the various i.c. processes and techniques. The author is equally at home with bipolar and m.o.s. techniques, and has also given excellent accounts of thin and thick film hybrid circuits. However the extensive coverage of device technology inevitably restricts the material on circuit practice.

Bipolar digital logic concentrates correctly on TTL. TSL, the modified three-state logic of TTL, is treated thoroughly, a good point. The selection of bipolar m.s.i. applications is good on the whole. The only serious weakness is the sketchy treatment of ECL; the MECL system of Motorola

deserves better. The chapters on m.o.s. technologies and applications contain well-chosen selections of p and n enhancement, and c.m.o.s. integrated circuits.

The material on linear i.c.s, confined to operational amplifiers and voltage regulators, is sound but lacking in amplifier circuit techniques. Compared to the broad coverage of digital i.c.s, the subject matter is too restricted; much has been done in other areas, for example power amplifiers, a-d and d-a converters, etc.

The text is non-mathematical throughout and most readable, but contains a commercial slant at the cost of more academic treatment. All in all, this good survey well deserves a place in the libraries of laboratories, universities and polytechnics. It is however hardly a User's Handbook in the sense which might be inferred from the title. The reader primarily concerned with applications will, more likely than not, need to consult other texts in addition to this volume.

L. J. HERBST

(Mr. Hnatek is with Signetics Corporation, California.)

Frequency Synthesis: Theory, Design and Applications

VENCESLAV F. KROUPA. Griffin, London
1973. 234 × 156 mm. 295 pp. £7.00.

CONTENTS: Generation of harmonic frequencies. Frequency multiplication. Frequency division. Frequency mixing. Frequency synthesis. Phaselock Loop. Phaselocked frequency synthesizers. Applications of frequency synthesizers. Phase and frequency fluctuations in frequency synthesizers.

Introducing the new and developing field of frequency synthesis, this book deals with methods of generating any arbitrary frequency from a given standard frequency. It has been written with three groups of readers in view: students of electronic measurement engineering systems designers and equipment users who operate frequency synthesizers. For the engineers many practical frequency synthesis problems are discussed while theoretical consideration and mathematical treatment is also developed.

(Dr. Kroupa is at the Czechoslovak Academy of Sciences)

(continued on opposite page)

Book Supply Service

As a service to members, the Institution can supply copies of most of the books reviewed in the *Journal* at list price, plus a uniform charge of 25p to cover postage and packing.

Orders for these books, which are denoted by an asterisk (*) after the price, should be sent to the Publications Department at Bedford Square and must be accompanied by the appropriate remittance.

STANDARD FREQUENCY TRANSMISSIONS—February 1974

(Communication from the National Physical Laboratory)

Feb. 1974	Deviation from nominal frequency in parts in 10^{10} (24-hour mean centred on 0300 UT)			Relative phase readings in microseconds NPL—Station (Readings at 1500 UT)		Feb. 1974	Deviation from nominal frequency in parts in 10^{10} (24-hour mean centred on 0300 UT)			Relative phase readings in microseconds NPL—Station (Readings at 1500 UT)	
	GBR 16 kHz	MSF 60 kHz	Droitwich 200 kHz	*GBR 16 kHz	†MSF 60 kHz		GBR 16 kHz	MSF 60 kHz	Droitwich 200 kHz	*GBR 16 kHz	†MSF 60 kHz
1	0	-0.1	-0.1	698	593.7	17	+0.1	0	-0.1	700	594.1
2	+0.1	0	0	697	593.4	18	0	0	-0.1	700	593.8
3	0	0	0	697	593.0	19	0	0	-0.1	700	594.1
4	0	0	0	697	593.2	20	+0.1	0	0	699	594.0
5	+0.1	0	0	696	594.1	21	+0.1	-0.1	0	698	594.5
6	-0.1	0	0	697	594.3	22	+0.3	0	-0.1	695	594.1
7	-0.2	+0.1	0	699	594.8	23	-0.4	+0.1	-0.1	699	593.5
8	-0.1	0	0	700	595.0	24	+0.1	0	-0.1	698	593.1
9	+0.1	0	0	699	595.1	25	+0.1	0	-0.1	697	592.7
10	-0.1	0	-0.1	700	594.7	26	+0.1	0	0	696	593.0
11	0	-0.1	-0.1	700	595.2	27	0	0	-0.1	696	593.0
12	0	0	-0.1	700	594.4	28	0	0	-0.1	696	593.0
13	0	0	-0.1	700	594.1						
14	0	0	-0.1	700	594.3						
15	0	0	-0.1	700	594.5						
16	-0.1	0	-0.1	701	594.3						

All measurements in terms of H-P Caesium Standard No. 334, which agrees with the NPL Caesium Standard to 1 part in 10^{11} .

* Relative to UTC Scale; $(UTC_{NPL} - Station) = + 500$ at 1500 UT 31st December 1968.

† Relative to AT Scale; $(AT_{NPL} - Station) = + 468.6$ at 1500 UT 31st December 1968.

DOMESTIC AND MILITARY ELECTRONICS

Safety of Electrical Appliances

Viscount Hanworth asked the Government in the Lords recently why, in spite of urgency, regulations governing the safety of domestic electric appliances had not been made and when, and in what form, such regulations might be expected.

The Minister of State, Home Office, Viscount Colville, replied that such regulations had to be consistent with the EEC directive on low-tension electrical equipment which was formally notified to member Governments in February 1973 for implementation by August 1974. Draft regulations, to be made by the Home Secretary under the Consumer Protection Act 1961, had been prepared in consultation with the Government Departments concerned, and had been circulated to interested bodies for comment. The draft regulations were in general terms, and dealt with electrical and non-electrical hazards in the appliance concerned.

1973 a Record Year for Television and Audio Manufacturers

Deliveries of all television receivers to the UK distributors in 1973 totalled over four million (4 187 000) for the year for the first time, which represented a 16% increase over 1972 (3 607 000), according to the latest figures compiled by the British Radio Equipment Manufacturers Association.

Deliveries of colour television receivers in December reached 218 000 for the month, bringing the total for the year to 2 755 000 (compared with 1 780 000 in 1972) of which 2 077 000 were manufactured in the UK, a rise of 44% over 1972 (1 446 000).

Deliveries of monochrome television sets reached 65 000 for December, giving a total of 1 412 000 for 1973 (a fall of 23% over 1972: 1 827 000) of which 954 000 were UK made.

BREMA members delivered 996 000 audio systems in 1973, a rise of 44% compared with 1972 (693 000). Radiogram deliveries in December of 21 000, gave a total for 1973 of 324 000, a rise of 21% over 1972 (267 000). Radio receiver deliveries in December of 465 000 brought the total for the year to 6 681 000, a rise of 5% over 1972 (6 369 000). Record player deliveries reached 43 000 for the month giving a total of 523 000 for 1973, a decrease of 5% over 1972 (550 000).

Electronic Warfare Development

Tactical passive electronic warfare systems can normally only detect enemy transmissions from just over the horizon. The possibility of increasing range by sending the aerial aloft in a captive, unmanned helicopter is being investigated by using a Dornier *Kiebitz* helicopter to carry a Decca RDL-2, and the project will soon be at the operational trials stage. The *Kiebitz* is a tethered rotor platform, powered by a turbine with torque-free rotor-blade-tip drive. Data are transmitted down through wires in the cable, rendering the system practically immune from jamming. The platform is stabilized by an automatic flight control and has long endurance even in bad weather. The Decca RDL-2 system features a high intercept probability display, automatic and visual pulse analysis, band measurement and frequency measurement. All these functions are incorporated integrally with the *Kiebitz* control unit on the vehicle or ship concerned.