

Founded 1925

Incorporated
by Royal Charter 1961

*'To promote the advancement
of radio electronics and kindred
subjects by the exchange of
information in these branches
of engineering.'*

Volume 43 No. 9

September 1973

The Radio and Electronic Engineer

The Journal of the Institution of Electronic and Radio Engineers

A Maxwell Centenary

1973 marks the hundredth anniversary of the First Edition of that most outstanding contribution to electrical science, 'A Treatise on Electricity and Magnetism' by James Clerk Maxwell. This book, issued in two volumes, Vol. I covering Electrostatics and Electrokinematics and Vol. II Magnetism and Electromagnetism, brought together the established concepts of the day and presented them as a unified treatment. It includes the author's own remarkable work on 'A dynamical theory of the electromagnetic field', first published in 1865 in the *Philosophical Transactions of the Royal Society*. In this enterprise Maxwell's genius is unmistakable and even when subjected to the searching light of the most advanced knowledge of the present time, the precision of statement embodied in his general equations of the electromagnetic field remains unassailable.

Throughout Maxwell's work the influence of Michael Faraday is much in evidence, particularly in translating mathematically ideas of the constitution of the electromagnetic field, and he notably introduced into his theory Faraday's discovery of electromagnetic induction as a source of current in a circuit subjected to a finite rate of change with time of magnetic flux linking the circuit. Maxwell's unique achievement was perhaps in defining a changing electric field as a current which in turn gives rise to a magnetic field and in this one discerns the association of ideas with those for which Faraday was responsible.

Maxwell's theory has proved itself to be of extraordinary value in simplifying relationships and in giving the most precise information about electromagnetic field behaviour in almost any kind of environment. In fact, applications are so impressive that they dominate practically every branch of electrical engineering and have added untold enlightenment to some of its most abstruse problems.

Over the past century the facilities offered by Maxwell's theory have been continuously pursued and the advent of the computer has given fresh impetus to this work, enabling numerical calculations to be made that were previously beyond reach, not because the theory was inadequate, but because the complexity in some cases made exact treatment too laborious. Among radio and electronic engineers, Maxwell's equations have become an all-important tool for use in the design and development of their products. Computer-aided design, based on electromagnetic theory analysis, is now almost the rule and it has led not only to optimization of performance but also to a much deeper insight into detailed behaviour.

Fifty years ago, electrical engineering relied almost exclusively on empirical information; Maxwell's theory played no significant part in the work because its great value was not appreciated and only those in pure science really understood the power behind it. Even today the so-called heavy electrical engineer has probably not reaped the full benefit of Maxwell's approach. He is content to use his lumped-circuit theory on all occasions and, of course, the validity of this treatment at power frequencies cannot, as a rule, be questioned. After all, the lumped-circuit approach is merely applying integrated field theory and in the presence of the very large wavelengths concerned, no difference of any consequence is normally likely to arise. There are, however, a few important cases where the application of field theory can shed new light as, for example, in some of the problems of electrical machines and in circumstances when materials are employed within which the wavelength is comparable with the physical dimensions. Thus, it is not always appreciated that at 50 Hz the wavelength in copper is only about 5.8 cm.

In any electrical enterprise the kind of basic relationships for which Maxwell was responsible are of inestimable value. More recent knowledge of the quantization of energy and of relativity considerations has shown up unsuspected complexity in the full understanding of some of the problems, particularly on a microscopic scale. Macroscopically there are few real hazards in applying the original Maxwell theory and provided this is done properly there seems no limit to the vista of achievement made possible by Maxwell's brilliant work. As always in science and technology there is no ultimate achievement. One invariably finds that the deeper the probe into the unknown the more there is to find out. Therein lies the great challenge set by our Creator.

H. M. BARLOW

Contributors to this issue*



Professor E. A. Faulkner (Fellow 1966, Member 1964) has occupied the Chair of Solid State Electronics at the J. J. Thomson Physical Laboratory at the University of Reading since 1970. Professor Faulkner has published widely in the fields of physical electronics and, latterly, in electronic circuit design, theory and practice. It has recently been announced that he has been awarded the Institution's Clerk

Maxwell Premium for a paper published in the Journal in 1972. He is a member of the IERE Papers Committee and has served on the Thames Valley Section Committee. A fuller note on Professor Faulkner's career was published in the Journal for April 1972.



Dr. J. B. Grimbleby obtained a B.Sc. degree in physics at Reading University in 1965 and for the next four years he carried out research into electron spin resonance and spin-lattice relaxation in S-state rare-earth ions; he was awarded a Ph.D. in 1970. Since completing his doctoral research his interests have been more in the field of electronics and during the period 1969-1971 he worked

on the design of phase-sensitive detectors and coherent filters. In 1971 Dr. Grimbleby received an appointment as a Lecturer at the J. J. Thomson Physical Laboratory, University of Reading.



Dr. T. S. M. Maclean has held a Senior Lectureship in Electromagnetism at the University of Birmingham since 1965. His main lecturing and research interests are radiation and propagation, and microwave engineering. A fuller note of his career was published in the Journal for May 1972.



Mr. R. J. Morrow (Graduate 1968) joined the Guided Weapons Division of the British Aircraft Corporation, Bristol, in 1969, after initial technical training as a Post Office Engineer in the Plymouth Telephone Area. Prior to leaving the Post Office he was involved with the commissioning and maintenance of the prototype CCVT Schools Network in Plymouth. Throughout his career with BAC he has worked on

problems associated with electromagnetic compatibility of radio systems. In 1970 he was given the responsibility of leading a team developing computer techniques for the investigation of the electromagnetic compatibility of digital radio systems. He is currently a Group Leader in the Electronics and Space Systems Division with responsibility for the development of computer based analysis techniques used in the study of communication and radar systems.



Mr. C. S. Warren received the B.Sc. degree in electrical engineering from Bath University of Technology in 1967 and he also completed a Graduate Apprenticeship with the British Aircraft Corporation, Bristol, later that same year.

His subsequent work with electronic and space systems in the Guided Weapons Division of BAC has been concerned with the analysis of communications systems, and in 1970 he was appointed to the post of Design Manager EMC where he was responsible for the technical output of the EMC Analysis Facility at BAC. In 1972 he was made responsible for all communications analysis and simulation within the Electronics and Space System branch of BAC. At the beginning of this year Mr. Warren joined SHAPE Technical Centre, The Hague, Netherlands, as a Senior Scientist.



Mr. J. R. Edwards received his engineering degree from Imperial College in 1959. After completing a graduate apprenticeship with E.M.I. Electronics Ltd. he remained as a Development Engineer in this company's Industrial Electronics Division until 1963, when he joined the Industrial Electronics Division of Flight Refuelling Ltd. as a Senior Engineer. In 1966 he moved to Plessey Automation Ltd. where he was respon-

sible for the design of telegraph signal generators. Since 1969 he has been a Senior Lecturer at the Royal Military College of Science, where he lectures on control system theory, digital electronics and data transmission. He is also currently engaged in research into the relative merits of forward error correcting codes and of error correcting techniques employing feedback.

*See also pages 533 and 544

Fault diagnosis using time domain measurements

H. SRIYANANDA, B.Sc.(Eng.), M.Sc., Ph.D.*

and

Professor D. R. TOWILL,

M.Sc., C.Eng., F.I.Prod.E., F.I.E.R.E.†

Based on a paper presented at an IERE Colloquium on Recent Developments in Systems Performance Measurement held in London on 10th April 1973.

SUMMARY

A voting technique is used to diagnose fault conditions down to component level in a feedback control system using only the input-output cross-correlation function measured at suitable time delays. These time delays are chosen using a new formula based on Bayes's theorem, which ranks the time delays in order of usefulness in fault diagnosis; it can be readily applied at the design stage, thus assisting the integration of system design and test functions. The fault conditions necessary to set up the scheme may be obtained by direct fault generation in an actual system, or by simulation of the system mathematical model. A learning approach to the design of a fault diagnosis scheme is described which makes full use of any available failure data, together with the ranking formula for time delay selection, in the creation of an optimum scheme.

Results obtained on a complex electro-hydraulic servo are presented which show that the scheme works satisfactorily in the presence of measurement noise and parameter drift, two factors which often cause a breakdown in conventional pattern recognition techniques. The computational requirements are extremely modest, and are well within the capacity of present day mini-computers proposed for use in automatic test equipment. In many instances, the scheme is suitable for manual and partially automated test sets, and can be used for fault diagnosis of a wide range of circuits and systems.

List of Symbols

$h(t)$	system impulse response at time delay t
$\phi_{XY}(r\tau)$	cross-correlation function
$\phi_{XX}(r\tau)$	auto-correlation function
y_i	change in cross-correlation function at the i th time delay for the system under test
x_{ij}	change in $\phi_{XY}(r\tau)$ at i th time delay due to fault condition J
F_J	cross product between x_{ij} and y_i
M	number of time delays
N	number of fault conditions
V_{FJ}	'faulty' votes for fault condition J
V_{NJ}	'nominal' votes for fault condition J
V_J	'composite' votes for fault condition J
P_J	<i>a priori</i> failure probability for fault condition J
P_J^*	<i>a posteriori</i> failure probability for fault condition J
V_{JW}	'weighted composite' votes for fault condition J
g_i	diagnosis index
G	cumulative diagnosis index
$\pm E_0$	sensitivity level used to generate the recognition matrix
$\pm E_1$	tolerance on performance used to detect a fault condition
D.R.	detection ratio
'FIRST' detection probability	= probability of detection at resolution level 1
'TOTAL' detection probability	= probability of detection at final resolution level
'INADVERTENT' detection probability	= probability of 'detecting' non-existing faults
'WEIGHTED' detection probability	= detection probability—half inadvertent detection probability

1 Introduction

Modern systems, including avionic systems, communication systems, and control systems, are becoming necessarily so complex that it has become almost impossible to maintain such equipment using manual test methods alone. As a consequence, many new test methods have been developed which utilize varying degrees of automation. There is an increasing tendency to exchange test technician skills for schemes requiring a high level of automation, frequently controlled using a mini-computer, or the part-time use of a large computer provided for systems purposes, such as in a complex weapon system.¹ An American philosophy recently propounded by Garzia,² argues that system availability and reliability may be increased by reducing the number of test access points. To obtain the same amount of useful information about the system under test, it is suggested that dynamic tests requiring only output-input access points be designed, and data processing facilities be used to infer the state of the system and hence the location of a faulty component. This is a

* Formerly with Dynamic Analysis Group, UWIST; now at the University of Sri Lanka.

† Dynamic Analysis Group, University of Wales Institute of Science and Technology, Cardiff CF1 3NU.

dynamic test requirement over and above that necessary for a meaningful dynamic check-out test for such equipment as aircraft autopilots.³

One method of dynamic testing is to excite the system with a periodic pseudo-noise signal, and to form the system cross-correlation function. Under certain well defined conditions, the cross-correlation function approximates to the impulse response of the system under test, although even if these conditions are not met, the cross-correlation function can still be used as a signature describing the condition of the system.⁴ The instrumentation necessary for performing the test is extremely simple, and a number of commercial instruments are available. As a test method, it has the advantage, compared with random signal testing, of removing the uncertainty due to the test signal, leaving only the uncertainties of the system and any corrupting noise present.⁵ This paper is concerned with designing a test scheme using estimates of the cross-correlation function at various time delays to diagnose faults within a feedback control system using only input-output access points.

The voting technique used in the paper has previously appeared in reference 6. This paper extends the technique to the fault diagnosis of actual components within a closed loop system using only the input-output cross-correlation function. A novel and previously unpublished expression is derived for the usefulness of a measurement made at any particular time delay, which is then used to indicate the measurements which are essential for successful fault diagnosis, and those measurements whose contribution to successful diagnosis is only marginal.

2 Basic Methods of Fault Diagnosis

Many different fault diagnosis techniques exist for inferring a faulty component from a set of input-output measurements only. For example, Garzia lists 67 references, and Sriyananda⁷ lists an additional 20 references, whilst a rough classification, showing the considerable overlap between the various proposals has also appeared.⁶ For the purpose of this paper, a simplified classification will suffice as follows.

(a) Parameter Estimation Methods

A mathematical model of the system is available, and the measurements are used to estimate the system parameters. For example, Payne uses the measurements to curve fit a transfer function model, the coefficients of which contain the parameters.⁸ Alternatively, and in a generally different context, Kalman⁹ updates parameter estimates recursively as each set of data becomes available.

(b) Pattern Recognition Methods

A set of measurements is used as a signature of the system under test. The signature is then compared with a dictionary of such signatures corresponding to various faulty conditions. If the signature agrees with one in the fault dictionary, then it is inferred that the system under test has the fault associated with that particular dictionary statement.¹⁰

(c) Probability Methods

A performance index is formed, using the differences between performance deviations from nominal and expected values predicted from a knowledge of system sensitivities. The unknown deviations in parameters may be eliminated, and the performance index calculated for each component in turn. The component found to minimize the index for the measurement set is thought to be the most likely fault.¹¹

The present authors' experience suggests that parameter estimation techniques require an accurate structural model of the system, and a relatively large amount of data. Post-test computing requirements can be large, especially with the curve fit method, since the equations relating parameters to model coefficients are often highly non-linear.

For a realistic system, fault dictionaries become large and, due to parameter drift and noise, there is also the chance that a given set of measurements does not constitute a stored fault, in which case there is no information available for fault diagnosis. Probability methods break down in the presence of parameter drift, and considerable post-test computational effort is necessary unless small perturbation theory is used, with consequent inability to cope with large changes in parameters. To overcome these difficulties, a new fault diagnosis technique has been developed which uses pattern recognition type properties of the system under test, but uses this information to assign 'votes' on likely failure causes, thus combining the better aspects of these two basic techniques. When computer implemented, the test print-out will be the parameters (or components, as appropriate) ranked in the order of likely failure.

3 Time Domain Testing by Correlation

The input-output cross-correlation function is well known as a signature describing the state of a system.¹² Considerable advantages result from estimating the cross-correlation function when the system is stimulated by a pseudo-noise signal of precisely defined properties. If certain rules relating the stimulus to the system under test are observed,¹³ then for a linear system the input-output cross-correlation function approximates to the system impulse response, i.e.

$$h(t) \simeq \phi_{XY}(r\tau) = \frac{1}{T} \int_0^T X(t-r\tau)Y(t) dt \quad (1)$$

which is mechanized in Fig. 1(a), with $r\tau$ being a multiple of the pseudo-noise clock frequency. Two cross-correlation functions are sketched in Fig. 1(b) for the nominal system and a faulty system when both are excited by a binary pseudo-noise sequence generated from a ten-stage shift register, which repeats sequences after a time equal to 1023τ . T , the test time, depends on the signal/noise ratio required to reduce measurement errors to an acceptable level. For the fault diagnosis scheme described in this paper, it is not necessary for $h(t) \simeq \phi_{XY}(r\tau)$ provided the faults are to be detected under similar circumstances to those prevailing when the test schedule is set up.

The two cross-correlation functions shown are

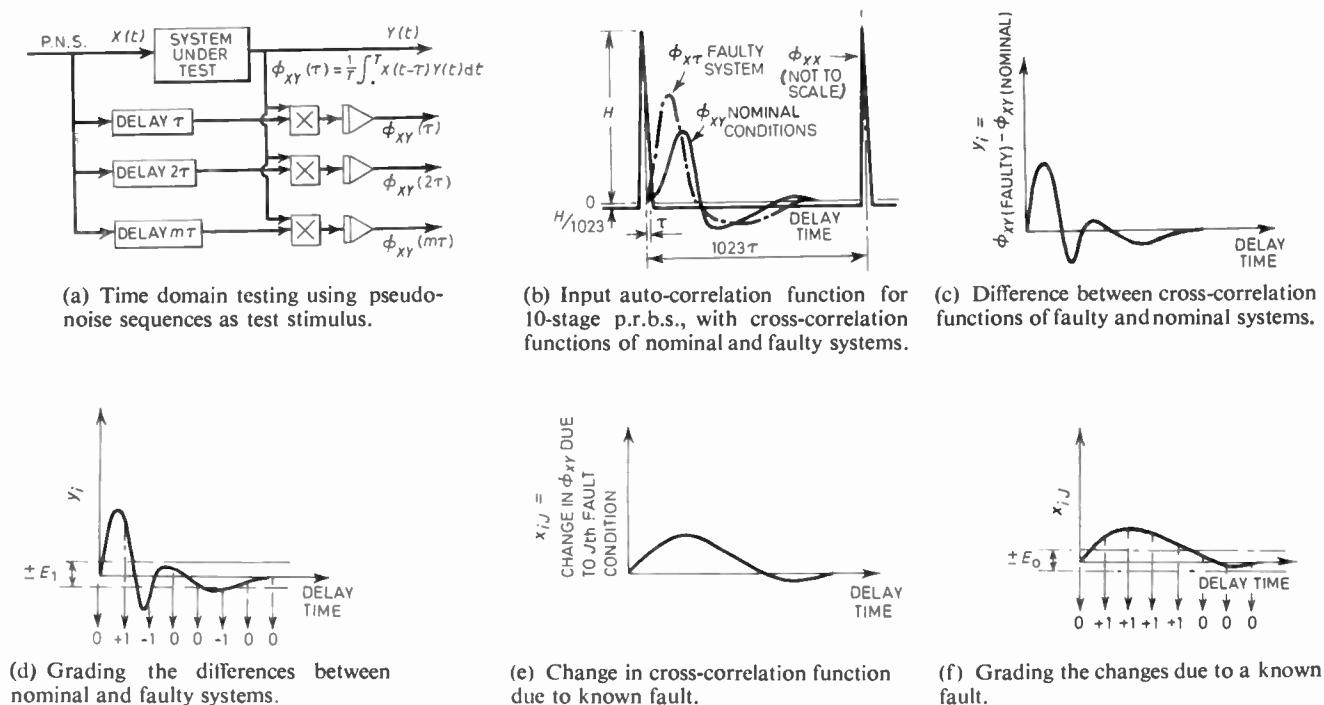

Fig. 1. Time domain testing for fault diagnosis.

'signatures' for the nominal and faulty systems, the difference between the two at the *i*th time delay used in the test being defined as

$$y_i = \phi_{XY} \left\{ \begin{matrix} \text{FAULTY} \\ \text{SYSTEM} \end{matrix} \right\} - \phi_{XY} \left\{ \begin{matrix} \text{NOMINAL} \\ \text{SYSTEM} \end{matrix} \right\}. \quad (2)$$

Pattern recognition methods then require *y_i* to be graded at each time delay, the results coded, and the corresponding signature sought in the fault dictionary.

Suppose the deviation specifically due to the *J*th fault condition is known in advance of the test on a faulty system then we define, at the *i*th time delay,

$$x_{iJ} = \phi_{XY} \left\{ \begin{matrix} \text{JTH} \\ \text{FAULT} \end{matrix} \right\} - \phi_{XY} \left\{ \begin{matrix} \text{NOMINAL} \\ \text{SYSTEM} \end{matrix} \right\}. \quad (3)$$

Then if the faults are independent and there is no parameter drift or measurement noise, the fault for which *x_{iJ}* = *y_i* for all *i* will be the fault condition present in the system under test. As a first step away from this ideal situation, progress may be made by combining equations (2) and (3) to form the cross-products

$$F_J = \sum_{i=1}^{i=M} x_{iJ} y_i \quad (4)$$

and, arguing that since the greatest correlation may exist between the measured deviation and the deviation due to the actual fault,⁷ the fault condition which maximizes *F_J* will be the most likely condition. Furthermore, a ranked list of faults will be produced. The basic data required for pattern recognition have therefore been used to develop a probability approach.

For a realistic size of system, the computer requirements for the cross-products method become considerable. The voting method to be described therefore grades both *x_{iJ}* and *y_i* as +1, 0, or -1, as shown in Fig. 1,

which enormously reduces the computational problem. Specifically, a recognition matrix composed only of elements +1, 0, and -1 representing *x_{iJ}* is necessary.

4 The System under Test

The method discussed in this paper is best introduced through an illustration. The scheme logic, the setting-up and optimization of the recognition matrix, etc., will be presented in relation to a test carried out on an analogue simulation of a complex electro-hydraulic servo system. Figure 2 shows the simulation, together with the 'faults' studied. The faults consist of five electrical components and four parameters (gains and time-constants), together called 'parameters' for convenience. Although there are some minor differences, the simulation is basically similar to the system studied in detail in reference 13, at least over a reasonable frequency band.

The system simulation was very noisy, probably due to the very high gains within the feedback loop (the signal strength at some points was only a thousandth of the input signal); and was also subject to drift (especially of the electrical components). The simulation could have been re-arranged to avoid the high gains, but the present configuration was retained since the real system is known to operate in a noisy environment, and component tolerances are not small, thus resulting in a more realistic test case for the method.

For experimental work, the pseudo-noise signal was generated using a ten-stage shift register, giving a 1023 sequence length, at a clock frequency of 300 Hz. Figure 3 shows the results, averaged over ten cycles, and at 31 time delays, for the nominal system. Even with this amount of averaging, the variation due to noise and parameter drift is still significant, so that the results are plotted as histograms.

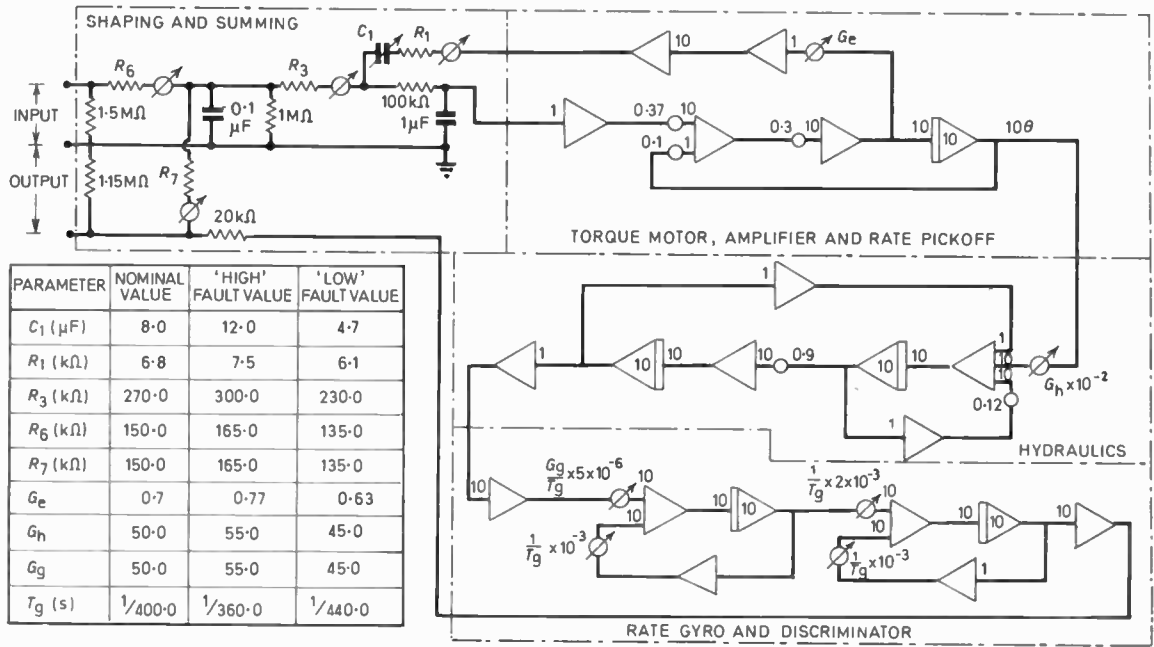

Fig. 2. Electro-hydraulic servomechanism simulation.

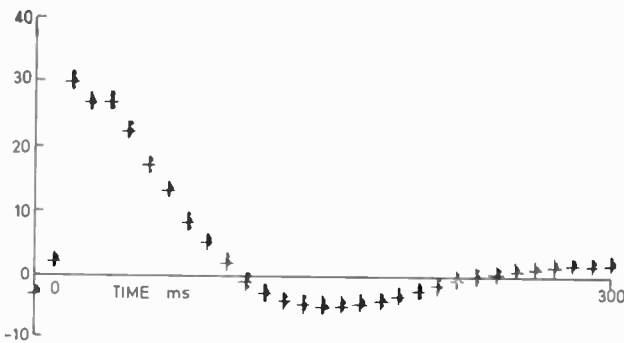

Fig. 3. Nominal system response of electro-hydraulic servo simulation.

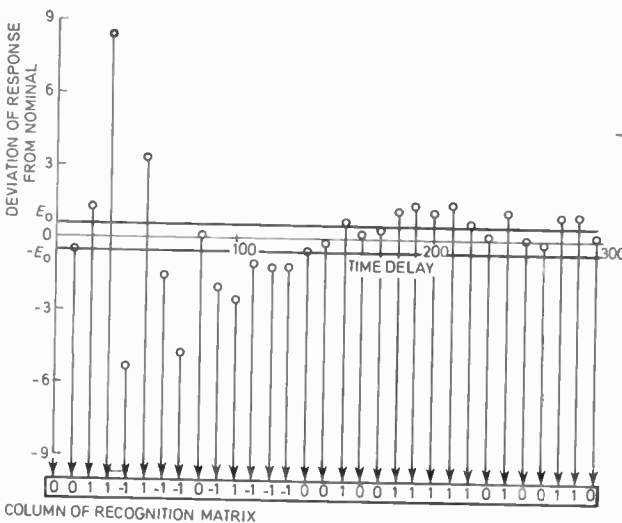

Fig. 4. Formation of recognition matrix from system sensitivity properties (based on one set of observations from system with G_e increased above nominal).

5 Setting-up the Recognition Matrix

To set up a recognition matrix, it is necessary to obtain the system cross-correlation function as shown in Fig. 1 for a series of fault conditions, x_{ij} for $i=1$ to M time delays and $J=1$ to N fault conditions. This can be done in three different ways:

- (1) By forming the classical sensitivity function from the system mathematical model, and subsequent evaluation by analogue or digital simulation.¹⁴
- (2) By perturbing a parameter in the system mathematical model, evaluating the perturbed cross-correlation function, and by subtracting the nominal response, forming the large parameter change sensitivity.⁸
- (3) By physically changing a component or module to introduce a specific fault, and comparing the measured cross-correlation function with the nominal value at the relevant time delays.⁷

Introducing a specific fault is a time-consuming method, but has the considerable advantage that a mathematical model is not required. A sensitivity limit $\pm E_0$ is then set, as shown for a specific fault (gyro gain increased by +10%) in Fig. 4.

This sensitivity limit is a variable in the test procedure, and considerably affects the efficiency of fault diagnosis, and will be discussed further in later sections. A typical nine-fault recognition matrix with five components and four parameters (gains and time-constants) is shown in Table 1. The cross-correlation function is to be measured at 31 time delays, that is, about three times as many time delays as there are possible faults. This ratio of 3 : 1 is an empirical rule based on a number of studies on different systems, and indicates the maximum number of measurements likely to be useful in the voting technique. The optimum number to be used in a particular test scheme will be determined later.

Table 1. Typical recognition matrix for electro-hydraulic servo

Time delay ms	C	R ₁	R ₃	R ₆	R ₇	G ₀	G _h	T _g	G _g
0-0	0	0	0	0	0	0	0	0	0
10-0	0	1	0	-1	0	0	0	-1	1
20-0	-1	1	-1	-1	1	-1	1	-1	1
30-0	-1	1	-1	-1	1	-1	1	1	1
40-0	-1	1	-1	-1	1	-1	1	0	0
50-0	-1	0	-1	-1	1	0	1	1	1
60-0	-1	-1	1	-1	1	1	-1	0	-1
70-0	-1	-1	1	-1	1	1	-1	0	-1
80-0	0	-1	1	-1	1	1	-1	0	-1
90-0	1	-1	1	-1	0	1	-1	0	-1
100-0	1	-1	1	-1	0	1	-1	0	-1
110-0	1	-1	1	0	0	1	-1	0	-1
120-0	1	-1	1	0	0	1	-1	0	-1
130-0	1	0	1	0	0	1	-1	-1	-1
140-0	1	0	1	0	0	1	-1	0	0
150-0	1	0	0	0	0	0	-1	0	0
160-0	1	0	0	0	0	0	0	0	0
170-0	1	1	0	1	0	-1	0	0	0
180-0	0	1	-1	0	-1	-1	0	0	0
190-0	0	1	-1	1	0	-1	1	0	1
200-0	0	1	-1	1	0	-1	1	0	1
210-0	-1	1	-1	0	0	-1	1	0	1
220-0	-1	1	-1	1	0	-1	1	0	1
230-0	-1	1	-1	0	0	-1	1	0	1
240-0	-1	1	-1	0	0	-1	1	0	0
250-0	-1	0	-1	0	0	-1	1	0	1
260-0	-1	0	-1	0	0	0	1	0	0
270-0	-1	0	0	0	0	0	0	0	0
280-0	-1	0	-1	0	0	0	0	0	0
290-0	-1	0	0	0	0	0	0	0	0
300-0	0	0	0	0	0	0	0	0	0

element of the recognition matrix are of the same sign, it indicates that that particular parameter is likely to have too high a value on the basis of that particular test. On the other hand, if they were of opposite signs, it is likely to be too low. The results of a number of tests at different time delays may be accumulated simply by incrementing (decrementing) the 'faulty' vote by one on the results of each test. If the response deviation was zero (i.e. within tolerance limits), no 'faulty' votes would be cast. However, if the deviation was zero at a time delay that had a non-zero entry in the recognition matrix (for a particular parameter), it is likely that that parameter is not faulty. Hence, a separate total of 'healthy' votes is kept for each of the parameters. This sequence of voting is illustrated in Fig. 5 for the case of a simulation with a 'fault' of high gyro gain G_g . At any stage of the test, the current estimate of the most likely fault is the parameter for which the excess of 'faulty' votes V_{FJ} over 'nominal' votes V_{NJ} is the highest, i.e.

$$V_{J^*} = \{|V_{FJ}| - V_{NJ}\}_{\max} \quad (5)$$

The sign of the 'faulty' votes gives the direction of the fault, i.e. whether the parameter is above or below nominal value. The diagnosis scheme is illustrated in the flow diagram of Fig. 6.

Table 2. Voting scheme logic (For the i th time delay and the J th parameter)

Parameter sensitivity x_{iJ}	Measurement y_i		
	Above tolerance band	Within tolerance band	Below tolerance band
high positive	vote for J high	vote for J near nominal	vote for J low
relatively insensitive	no votes cast	no votes cast	no votes cast
high negative	vote for J low	vote for J near nominal	vote for J high

6 The Voting Technique

When the system response at a particular time delay is available as the results of a measurement, it is compared with the nominal response to ascertain whether it is within tolerance limits $\pm E_1$. If so, the deviation at that time delay is taken to be 0, and if not, ± 1 depending on the direction of the deviation. This is compared with the elements of the corresponding row of the recognition matrix and votes are cast as to the likely condition of each of the parameters in turn. The logic of the voting scheme is illustrated in Table 2. If the response deviation and the

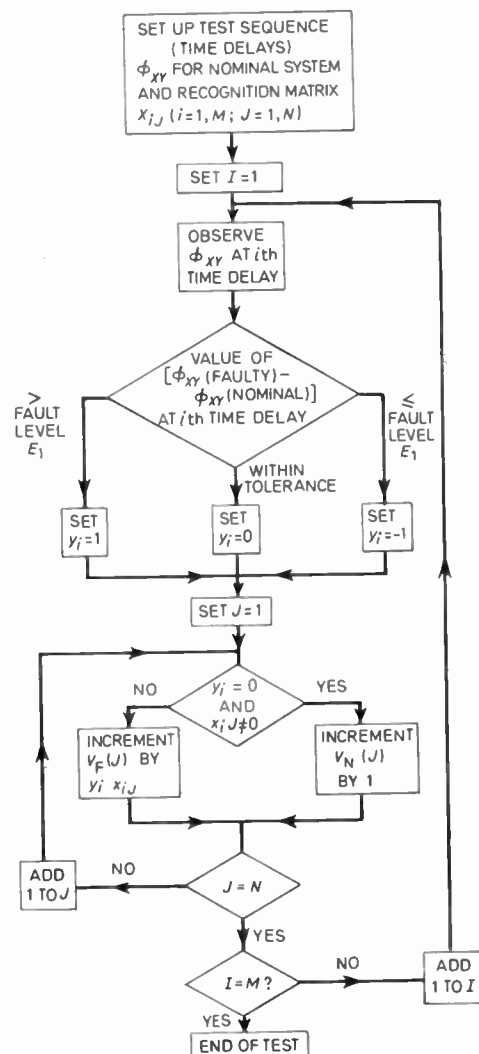

Fig. 6. Flow diagram of voting scheme.

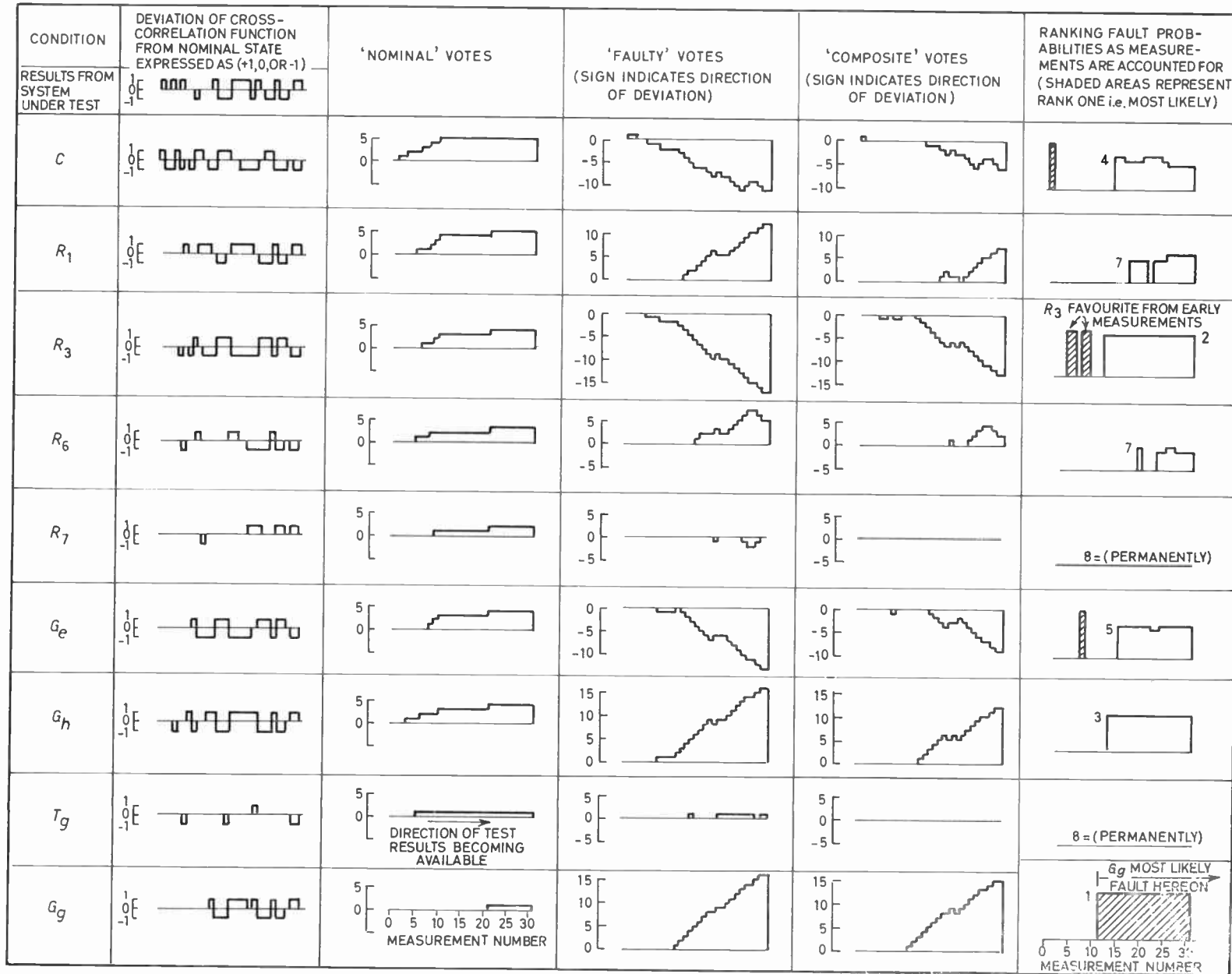

Fig. 5. Build-up of votes as test measurements become available.

In the above description of the test sequence, the *a priori* failure probabilities of the various parameters were assumed to be equal, for simplicity. It is easy to extend the method to cover the case where they are unequal, as all that is required is to weight the 'composite' votes (obtained as described, from the 'faulty' and 'nominal' votes) according to the *a priori* probabilities, P_J , so that the weighted vote is,

$$V_{jW} = P_J \cdot V_J^* \tag{6}$$

The method is also capable of ranking the faults in order of likelihood of failure, i.e. of evaluating the *a posteriori* failure probabilities, P_J^* .⁷ The computer requirements for this diagnostic process, for N fault conditions, and $M = 3N$, are approximately $(200 + 14N + 3N^2)$ words,⁷ and is thus well within modern mini-computer capacity for application to a realistic size system.

7 Ranking of Time Delays

The goodness of any particular time delay depends on its power of discrimination. Intuitively, one can say that a time delay with all recognition matrix elements zero is useless as it will not detect any fault. On the other hand, a time delay with all elements ± 1 will also be of very little use as it would not help in discriminating between the different faults. Between these two extremes, there are a number of possible feature configurations, the best of which would be those with only one non-zero component.

On this basis, it is quite easy to derive a scheme for the ranking of time delays depending on the number of non-zero components. However, a more sophisticated procedure would be required to allow for unequal *a priori* failure probabilities. Other desirable qualities of an index for the goodness of a time delay are that it should lie between 0 and 1, and that it should be additive. It is shown in the Appendix that a suitable diagnosis index g_i would be:

$$g_i = 1 + \log_N \left[\frac{\max(P_J, J = 1, N) \text{ for all non-zero } x_{iJ}}{\sum_{J=1}^N P_J, \text{ for all non-zero } x_{iJ}} \right] \tag{7}$$

where x_{iJ} are the elements of the recognition matrix, P_J are the *a priori* failure probabilities, and N is the number of parameters. ($\log_N 0/0$ is taken to be -1 .)

Once the number of time delays and the sensitivity level $\pm E_0$ are selected, a recognition matrix may be set up as described, and the diagnosis index of the time delays evaluated. Table 3 shows the indices for the time delays given by the recognition matrix in Table 1 assuming equal *a priori* failure probabilities.

It is now possible to decide whether a sufficient number of time delays have been selected for consideration. As it is necessary to isolate faults in any of the parameters with a reasonable degree of reliability, it is imperative that the time delays selected are capable of this. A good test is to ensure that for each parameter, at least two time delays with fairly good discriminatory powers (say an index of more than 0.1) contain non-zero entries under it. As an

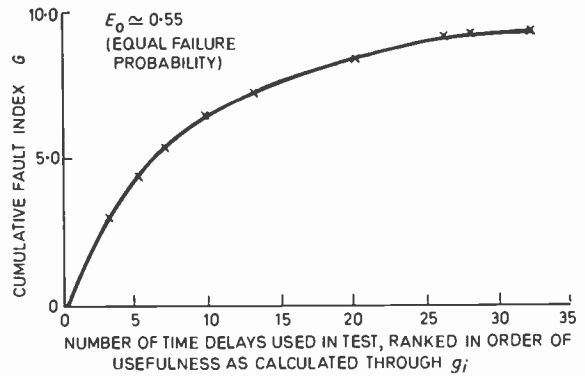

Fig. 7. Pareto curve showing relationship between cumulative fault index and time delays used in test.

example, assume that in the case shown in Table 1 only 16 features (time delays of 0, 20, 40, 60, etc.), were considered. Then, from Table 3 it is seen that the 'good' time delays are 160, 280, 260, 140, 180, 240, 120, 200, 40, 80, 100, and 220 ms. From an inspection of Table 1 it is seen that this does not contain a single non-zero entry under the parameter T_g . This leads to the conclusion that more time delays have to be studied to obtain a satisfactory feature space. The set of 31 time delays is seen to be a satisfactory solution.

Figure 7 shows a Pareto curve¹⁵ relating the cumulative diagnosis index $G = \sum g_i$ to the time delays used in the test ranked in order of the diagnosis index tabulated in Table 3. It can be seen that less than one-third of the time delays account for two-thirds of the final value of the cumulative diagnosis index, thus showing that indiscriminately chosen extra measurements can contribute little extra information for fault diagnosis. The diagnosis index has been used extensively in reference 7 in setting up fault diagnosis schemes. To illustrate the power of the index as a method of ranking time delays, an example is shown in Fig. 8 of the correlation between fault detection probability and the cumulative diagnosis index. Both weighted and total detection probability correlate well, the weighted detection probability lagging because all inadvertent diagnoses are fully offset against successful diagnoses. The point to be made is that the diagnosis index is a practical guide to time delay selection which has been verified experimentally to an extent which will permit the test engineer to schedule tests with confidence even if little data is available with respect to specific systems.

Table 3. Goodness criteria of the time delays given in Table 2

Index	Time delay
1.0	160, 270, 290
0.685	150, 280
0.5	10, 260
0.369	140, 170, 180
0.268	240, 250
0.185	110, 120, 130, 190, 200, 210, 230
0.114	40, 50, 80, 90, 100, 220
0.054	60, 70
0.0	0, 20, 30, 300

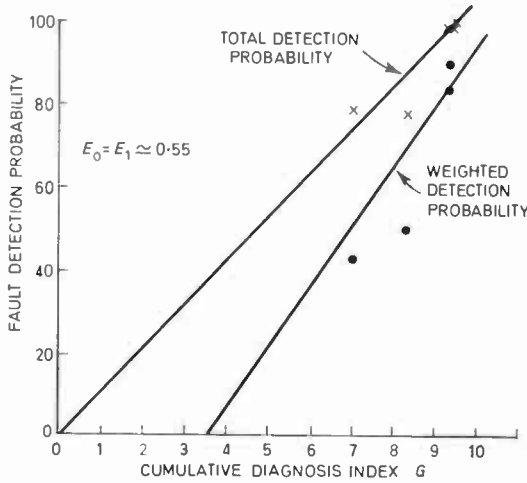

Fig. 8. One example of the correlation between fault detection probability and cumulative diagnosis index.

8 Setting-up the Recognition Matrix from Noisy Measurements

If the setting-up of the recognition matrix is to be accomplished through physical measurements, practical difficulties arise which can be overcome by using a voting procedure similar to that used in actual diagnosis, thus allowing for parameter drift and noise. Table 4 shows the logic required.

As before, the cumulative vote is formed from a series of tests (in this case, a number of measurements at the same time delay are required), and x_{ij} assigned a value 1, 0, or -1.

Table 4. Voting scheme logic for generating recognition matrix
(For the i th time delay and the J th fault condition)

Value for J th fault condition	Measurement		
	Above tolerance band	Within tolerance band	Below tolerance band
high	vote $x_{ij} + ve$	vote $x_{ij} 0$	vote $x_{ij} - ve$
low	vote $x_{ij} - ve$	vote $x_{ij} 0$	vote $x_{ij} + ve$

9 Learning and the Optimization of the Test Procedure

For many systems, the recognition matrix plus *a priori* knowledge leading to time delay ranking is sufficient for setting up the test schedule since the time delays and sensitivity level chosen will lead to an acceptable degree of fault diagnosis. In other cases learning during experimentation with a breadboard model or interactive simulation may be put to good use in the optimization of test schedules for complex systems as shown in Fig. 9. As a first approximation, a reasonable number of features (usually about three times the number of parameters) is selected, and also a suitable sensitivity level $\pm E_0$. The fault level $\pm E_1$ may be chosen from checkout tolerances and subsequently varied if observations suggest that the degree of fault diagnosis is thereby increased. As a starting point the sensitivity level $\pm E_0$ can be made equal to the fault level $\pm E_1$, or may be chosen on the

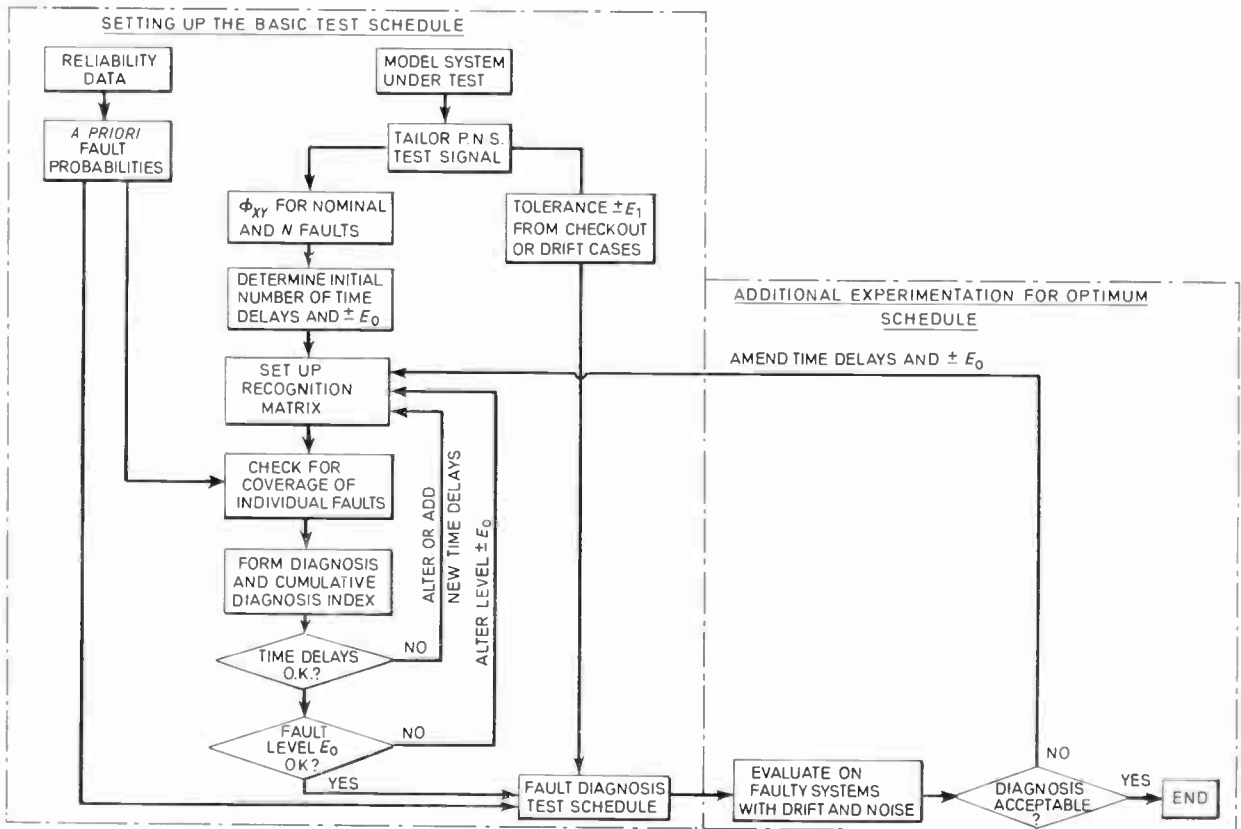

Fig. 9. Setting up the time domain fault diagnosis test schedule.

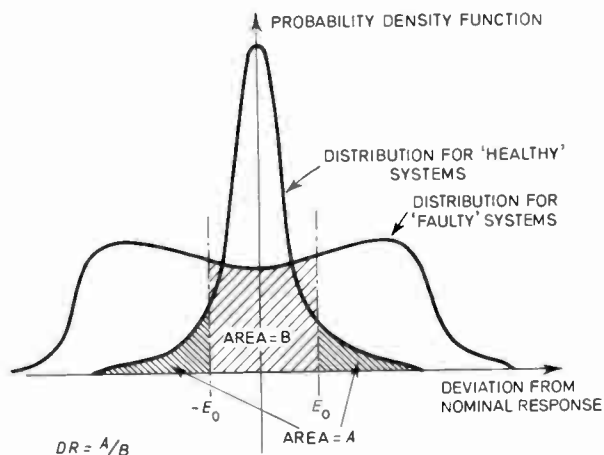

Fig. 10. Definition of the 'detection ratio'.

basis of initial observations so that the detection ratio is unity.

Detection ratio is defined as:

$$DR = \frac{\% \text{ of observations of nominal systems outside } E_0}{\% \text{ of observations of faulty systems within } E_0} \quad (8)$$

which is illustrated in Fig. 10. The distributions need not be symmetrical in practice.

The next stage is to study the effect of the fault level on the goodness of the time delays by repeating the whole procedure until an optimum has been reached. It is necessary to test whether a sufficient number of time delays are considered for each of the fault levels, as changes in fault level alter their relative usefulness. In the

example considered in this paper, measurements were made at 31 time delays (0–300 ms, in steps of 10 ms). A fault level of 0.577 was chosen on the basis of 110 sets of observations (20 sets on 'healthy' systems and 90 sets on 'faulty' systems). This fault level corresponds to a detection ratio of approximately unity. (189 out of 31×20 'healthy' system observations lie outside the limits as opposed to 906 out of 31×90 'faulty' system observations that lie inside the limits. Thus, the detection ratio is $(189/(31 \times 20))/(906/(31 \times 90)) \approx 0.94$.)

10 Some Results

Some results obtained by the application of this technique (i.e. 'learning' and optimization of test sequence followed by the application of the recognition matrix so generated to the diagnosis of faults) are presented in Fig. 11 for a fault level $E_0 \approx E_1 \approx 0.55$ and using measurements at 31 time delays. The detection probability refers to average results from a large number of simulations, and the resolution level is the predicted relative position of the 'true' fault. For example, if out of ten cases with a true fault in parameter J , it has been estimated to be the most likely fault in seven cases, the second most likely fault in two cases, and the third most likely fault in one case, then the detection probability would be 70% at resolution 1, 90% at resolution 2 and 100% at resolution 3 and above. Figure 12 shows how the fault level affects the diagnostic capability and is a summary of a range of three-dimensional plots from reference 7 averaged over all parameters and components. These results compare favourably with results obtained by other, more complex, fault diagnosis techniques as shown in the same reference.

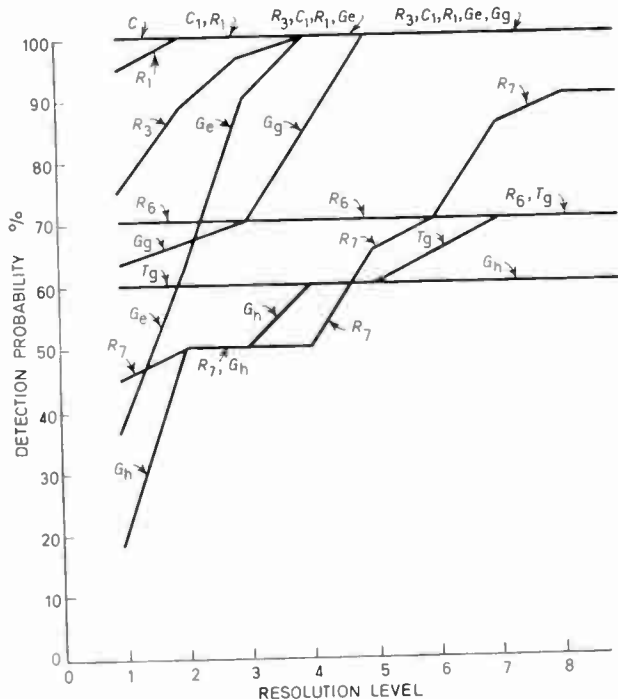

Fig. 11. Analysis of results of fault diagnosis of electro-hydraulic servo simulation by voting technique, using 31 features and E_0, E_1 levels of 0.550, assuming equal *a priori* failure probabilities.

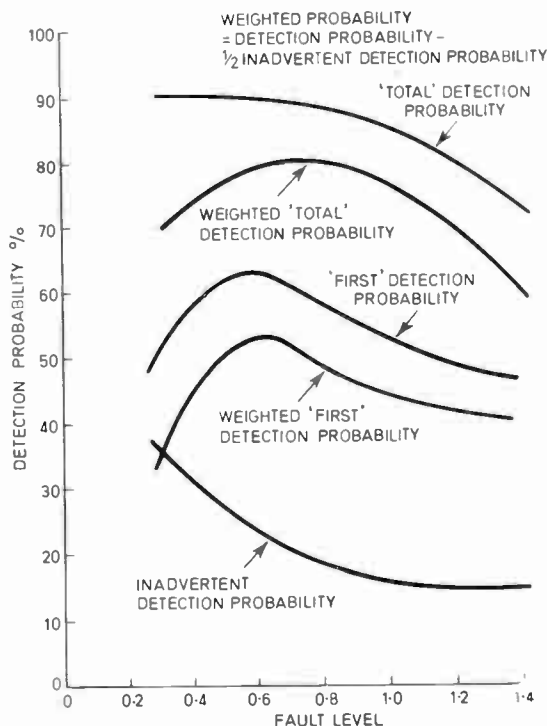

Fig. 12. Detection probability for all parameters taken together as a function of the fault level. (31 features, equal *a priori* probability.)

11 Implications of the Fault Diagnosis Technique at the Design and Quality Assurance Stages

It is clearly advantageous to design (at least in principle) system test procedures at the same time as the system itself is designed. There is often a tendency, particularly with large, complex systems, to dissociate the system design and test phases, a tendency not helped by the long development time associated with such projects. By the time the test procedure is set up, the system designer may have long since moved on to other projects, or even other employment. Such discontinuities mean that the test designer is often in a position of having inherited inadequate data for his purpose since his requirements are not necessarily the same as for the system designer. There is also the danger that the system test designer may have to learn about the system *ab initio* and in isolation necessitating further expensive experimentation. This further experimentation may well suggest the need for additional access points the provision of which may be extremely costly, particularly as by this time the system may well be at a 'pre-production' stage with several prototypes actually working and many manufacturing drawings already sealed. It is astonishing in some instances to find that even relatively obvious vital access points are overlooked, leading as a consequence to avoidable maintenance problems.¹⁶

Using the method proposed in this paper, it is now feasible to integrate the system design and test design phases of dynamic systems by studying the test procedure in parallel with basic design calculations. It is then straightforward to specify a meaningful dynamic test in terms of clock speed and sequence length. Furthermore, if the recognition matrix based on output-input measurements and subsequent analysis does not indicate a satisfactory level of diagnosability the system designer has two alternatives. He can either provide more access points judiciously chosen to increase the diagnosability level as observed by analysing the updated recognition matrix to account for the new measurements, or, knowing the components for which reliable diagnosis is difficult based only on input-output measurements, he can specify high grade components manufactured to tight tolerances. A further advantage of the proposed method of fault diagnosis is that the system designer is forced to think in terms of likely fault conditions and the probability of their occurrence, rather than a blanket consideration of fault diagnosability based on a set of arbitrary changes.

12 Conclusions

The voting technique has been established as a useful fault diagnosis method in the isolation of component fault conditions within feedback control systems using only input-output cross-correlation functions as data in the decision process. A new formula permits the time delays at which measurements are made to be selected at the system design stage to maximize the information yielded on fault conditions. Good correlation is observed between the theoretical fault diagnosis index and the

diagnosability of simulated systems with measurement noise and parameter drift present.

13 Acknowledgments

H. Sriyananda was in receipt of a UWIST Studentship during the period of execution of this work.

14 References

1. Towill, D. R., 'Dynamic test techniques utilized in ATE', *REME Journal*, No. 22, pp. 35-43, April 1972.
2. Garzia, R. C., 'Fault Isolation Computer Methods', NASA Contractor Report NASA CR-1758, 1971.
3. Gibson, J. E., Rekasius, Z. V., McVey, E. S., Sridhar, S. and Leedham, C. D., 'A set of standard specifications for linear automatic control systems', *Trans. Amer. Inst. Elect. Engrs, Applications and Industry*, **80**, pp. 65-77, 1961.
4. Towill, D. R. and Lamb, J. D., 'Pseudo-random signals test non-linear controls', *Control Engineering*, **17**, No. 11, pp. 59-63, November 1970.
5. Briggs, P. A. N., Hammond, P. H., Hughes, M. T. G. and Plumb, G. C., 'Correlation analysis of process dynamics using pseudo-random binary test perturbation', *Proc. Instn. Mech. Engrs*, **179**, Pt. 3H, pp. 37-51, 1965.
6. Sriyananda, H. and Towill, D. R., 'Fault diagnosis via automatic dynamic testing: a voting technique', IEE Conference Publication No. 91, pp. 196-201, September 1972.
7. Sriyananda, H., 'Fault Diagnosis in Feedback Control Systems', Ph.D. Thesis, UWIST, Cardiff, 1972.
8. Payne, P. A., 'S Plane Techniques for Production Testing of Feedback Control Systems', Ph.D. Thesis, UWIST, 1971.
9. Kalman, R. E., 'A new approach to linear filtering and prediction problems', *Trans. Amer. Soc. Mech. Engrs, J. Basic Engng*, **82D**, pp. 35-45, March 1960.
10. Becker, P. W. and Thamdrup, J. E., 'Pattern recognition applied to automated testing', IEE Conference Publication No. 91, pp. 82-86, September 1972.
11. Buschbaum, L., Dunning, M., Hannom, T. J. B. and Math, L., 'Investigation of Fault Diagnosis by Computational Methods', Remington-Rand Univac Report, AD 601204, 1964.
12. Goodman, T. P. and Reswick, J. B., 'Determination of system characteristics from normal operating records', *Trans. Amer. Soc. Mech. Engrs*, **78**, pp. 259-271, 1956.
13. Lamb, J. D., 'Use of Pseudo-Random Binary Signals for the Production Testing of Dynamic Systems', Ph.D. Thesis, UWIST, 1970.
14. Tomovic, R., 'Sensitivity Analysis of Dynamic Systems', p. 79 (McGraw-Hill, New York, 1963).
15. Collier, P. I., 'Use of Control Curve Models in Industrial Engineering', M.Eng. Thesis, UWIST, 1971.

15 Appendix

Derivation of the Fault Index

The goodness of a feature may be measured by its power of discrimination. Thus, intuitively, it can be seen that

$$g_i = \max P(a_j | x_{ij}), \quad J = 1, N \quad (9)$$

is a measure of the goodness of a feature, where x_{ij} are the elements of the recognition matrix and $P(a_j | x_{ij})$ is the conditional probability that fault condition J exists, given that x_{ij} is non-zero. (N is the number of fault conditions.)

In order to generate the necessary additive and other properties, the expression given at (9) may be modified by taking its logarithm (to the base N) and adding one to

yield:

$$g_i = 1 + \log_N [\max \{P(a_J|x_{iJ}), J = 1, N\}] \quad (10)$$

In the worst possible case, the probabilities of failure of all of the parameters are equal, and so their maximum would be $1/N$. This leads to an index of 0. This will be the case if the *a priori* failure probabilities were equal and also all the components x_{iJ} were non-zero for $J = 1, N$. On the other hand, whatever the *a priori* failure probabilities were, if only one component of x_{iJ} was non-zero, then the conditional probabilities will be zero for all parameters except one, for which it would be unity. This leads to an index of 1 for such a feature. If all the x_{iJ} were zero the expression $P(a_J|x_{iJ})$ would be meaningless as the condition x_{iJ} cannot arise. In this case, g_i may be set equal to zero by definition. In the case of unequal *a priori* failure probabilities, the maximum value would always be equal to, or higher than that for the corresponding case with equal probabilities.

Using Bayes's Theorem, equation (10) may be re-written as

$$g_i = 1 + \log_N \left[\max \left\{ \frac{P(x_{iJ}|a_J) \cdot P^*(a_J)}{P(x_{iJ})} \quad J = 1, N \right\} \right] \quad (11)$$

where $P(x_{iJ}|a_J)$ is the conditional probability of x_{iJ} being non-zero given that the J th parameter is faulty, $P^*(a_J)$ is the true probability that the J th parameter is faulty,

and $P(x_{iJ})$ is the probability that x_{iJ} is non-zero. However, since $P^*(a_J)$ is not known, an approximate expression may be obtained by substituting the *a priori* probability $P(a_J)$ to give

$$g_i \simeq 1 + \log_N \left[\max \left\{ \frac{P(x_{iJ}|a_J) \cdot P(a_J)}{P(x_{iJ})}, \quad J = 1, N \right\} \right]. \quad (12)$$

In view of the fact that in this scheme of diagnosis, x_{iJ} take only the values ± 1 and 0, the above expression may be simplified as:

$$g_i = 1 + \log_N \left[\max \left\{ \frac{|x_{iJ}| \cdot P(a_J)}{\sum_{J=1}^N |x_{iJ}| \cdot P(a_J)}, \quad J = 1, N \right\} \right] \\ = 1 + \log_N \left[\max \left\{ \frac{(P_J, \quad J = 1, N) \text{ for all non-zero } x_{iJ}}{\sum_{J=1}^N P_J, \text{ for all non-zero } x_{iJ}} \right\} \right] \quad (13)$$

where the notation has been simplified by writing P_J for the *a priori* failure probabilities.

Manuscript first received by the Institution on 26th January 1973 and in final form on 30th April 1973. (Paper No. 1540/ACS6).

© The Institution of Electronic and Radio Engineers, 1973

The Authors



Dr. H. Sriyananda was educated at Ananda College, Colombo, and the University of Ceylon. He obtained his B.Sc.(Eng.) from the University of Ceylon in 1963, and his M.Sc. at the University of Salford in 1970. Between 1963 and 1969 he worked as an engineer at the Port of Colombo.

In 1970 he joined the Dynamic Analysis Group, UWIST, and engaged in research into system fault diagnosis, for which he was

recently awarded the Ph.D. of the University of Wales. He is now a lecturer in the Electrical Engineering Department of the University of Sri Lanka at Katubedde.



Professor D. R. Towill (Fellow 1970) was appointed to the Chair of Engineering Production in the Department of Mechanical Engineering and Engineering Production in the University of Wales Institute of Science and Technology at the beginning of 1970. He is a graduate of the Universities of Bristol and Birmingham and before joining UWIST in 1969 he was a senior lecturer in automatic control at

the Royal Military College of Science. He has held a number of industrial consultancies and was for some years with the then Bristol Aircraft Company as a dynamic analyst.

Professor Towill is the author of numerous papers and books, four of his papers gaining Institution Premiums. He is chairman of the Automation and Control Systems Group Committee.

Signal/noise ratio of travelling-wave dipole

T. S. M. MACLEAN, Ph.D., C.Eng., M.I.E.E.*

1 Introduction

The resistively loaded travelling-wave dipole antenna was investigated by Altshuler¹ as a transmitting antenna. It consists of a dipole (Fig. 1) with lumped resistances R placed at a distance of $\lambda/4$ from each end, where the current has a maximum value, and was shown to have the characteristics of broad bandwidth and wide beamwidth, with approximately 50% efficiency. Because the antenna is passive its impedance, radiation pattern and power gain will be the same when receiving as transmitting, but the presence of the resistive elements will introduce additional noise, and the purpose of this note is to analyse the signal/noise ratio of this antenna when it is operated in the receiving mode.

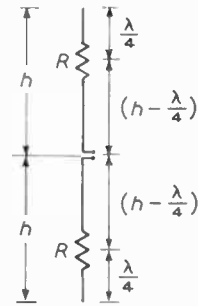

Fig. 1. Travelling-wave dipole of length $2h$.

Unlike the case of conventional networks the location of the thermal noise generated in one of the resistances R may be a substantial fraction of a wavelength distant from the terminals of the antenna. Consequently the thermal noise voltage at the terminals of the antenna due to this R is not $\sqrt{(4kT_{\text{amb}}BR)}$ but rather $\sqrt{(4kT_{\text{amb}}BR_{\text{in}})}$, where R_{in} is the resistive component of the input impedance. This may readily be proved analytically. In addition there is a noise voltage produced by the environment which has value $\sqrt{(4kT_sBR_r)}$ where T_s is the sky temperature and R_r the radiation resistance of the antenna. Hence it may be seen from Fig. 2 that the combined noise power delivered to a load resistance R_L is given by

$$N = \frac{4kT_sBR_rR_L}{(R_r + R_{\text{in}} + R_L)^2} + \frac{4kT_{\text{amb}}BR_{\text{in}}R_L}{(R_r + R_{\text{in}} + R_L)^2}$$

SUMMARY

A travelling-wave dipole consisting of conventional arms with a resistance R placed at $\lambda/4$ from each end is analysed to enable a comparison of its signal/noise ratio with that of a standing-wave dipole of equal length to be made. Numerical results as a function of sky temperature are given when the dipole length is $3\lambda/2$.

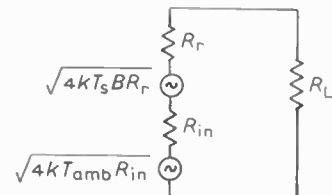

Fig. 2. Noise equivalent circuit for travelling-wave aerial.

R_r = radiation resistance of aerial; T_s = sky temperature
 R_{in} = input resistance of aerial; T_{amb} = ambient temperature

* Department of Electronic and Electrical Engineering, University of Birmingham, P.O. Box 363, Birmingham B15 2TT.

Likewise the signal power delivered to the load is given by

$$S = \frac{V_{oc}^2 R_L}{(R_r + R_{in} + R_L)^2}$$

where V_{oc} is the open-circuited signal voltage at the terminals of the antenna due to an incident plane wave arriving at the angle which gives maximum signal. Hence the required signal/noise ratio is

$$\frac{S}{N} = \frac{V_{oc}^2}{4kB(R_r T_s + R_{in} T_{amb})} \tag{1}$$

From equation (1) it can be seen that it is necessary to evaluate V_{oc} , R_r and R_{in} before a numerical result can be derived for the signal/noise ratio in a given environment. It is convenient to adopt the transmitting approach when finding R_r and R_{in} .

2 Input Resistance R_{in}

Referring to Fig. 3 the currents in the two sections can be written

$$I_2(z) = A \sin k(h-z)$$

$$I_1(z) = B \sin kz + D \cos kz$$

with corresponding expressions for the potentials. The boundary conditions are that at z equal to ah

$$I_1(ah) = I_2(ah)$$

and

$$V_1(ah) - V_2(ah) = RI_2(ah).$$

Solving these equations gives the input impedance as

$$Z_{in} = jZ_c \frac{\cos^2 kah \left[\frac{R}{jZ_c} + \tan kah - \cot k(1-a)h \right]}{1 - \sin kah \cos kah \left[\frac{R}{jZ_c} + \tan kah - \cot k(1-a)h \right]}$$

where Z_c is the characteristic impedance of the monopole. For the particular case when the resistor is placed $\lambda/4$ from the end the input impedance simplifies to

$$Z_{in} = jZ_c \frac{\cos^2 kah \left[\frac{R}{jZ_c} + \tan kah \right]}{1 - \sin kah \cos kah \left[\frac{R}{jZ_c} + \tan kah \right]} \tag{2}$$

The corresponding currents in the two sections are

$$I_2(z) = \frac{V \sin k(h-z)}{\cos kah [R + jZ_c \tan kah]}$$

and

$$I_1(z) = \frac{V}{jZ_c} \left\{ \sin kz + \frac{\cos kz}{\cos^2 kah} \left[\frac{1}{\frac{R}{jZ_c} + \tan kah} - 1 \right] \right\}$$

Since further algebraic operations are required on these expressions for current to find the distant field and hence the radiation resistance, it is desirable to particularize to

the case where the bottom section ah is one half-wavelength. For this case with Z_c equated to R ,

$$\left. \begin{aligned} I_2(z) &= \frac{V}{R} \cos kz \\ I_1(z) &= \frac{V}{R} \exp(-jkz) \end{aligned} \right\} \tag{3}$$

and

$$Z_{in} = R = R_{in}$$

Thus a travelling wave exists in the bottom section and a standing wave in the top quarter wavelength.

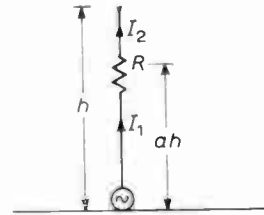

Fig. 3. Currents on travelling-wave monopole of length h .

3 Radiation Resistance R_r

The far field of this aerial is the sum of the fields due to the standing and travelling waves of current given by equation (3). Thus for the standing wave current

$$H\phi_1 = -j \frac{I(0) \exp(-jkr)}{2\pi r} \left[\frac{\cos\left(\frac{3\pi}{2} \cos\theta\right) + \cos\theta \sin(\pi \cos\theta)}{\sin\theta} \right]$$

and for the travelling wave of current

$$H\phi_2 = j \frac{I(0) \exp(-jkr)}{2\pi r} \left[\frac{\sin\theta}{(1-\cos\theta)} \sin\pi(1-\cos\theta) \right]$$

The radiation resistance of the antenna is thus made up of three terms, one each for the travelling-wave and standing wave sections, and a mutual radiation term.

The radiation resistance of the travelling-wave section in isolation can be expressed as

$$R_{r(TW)} = 60[\text{Cin}(4\pi) - 1] = 126.9 \Omega.$$

Likewise the standing wave component can be written

$$R_{r(SW)} = 30 [\text{Cin}(6\pi) + \text{Cin}(4\pi) - 2 \text{Cin}(5\pi) + 2 \text{Cin}(\pi) - 2] = 38.1 \Omega.$$

The mutual term, however, involves the integrands

$$I_1 = \int_0^\pi \frac{\sin\theta}{(1-\cos\theta)} \sin\pi(1-\cos\theta) \cos\left(\frac{3\pi}{2} \cos\theta\right) d\theta$$

and

$$I_2 = \int_0^\pi \frac{\sin\theta \cos\theta}{(1-\cos\theta)} \sin\pi(1-\cos\theta) \sin(\pi \cos\theta) d\theta$$

and these have been evaluated numerically to give $R_{r(\text{mutual})} = 33.8 \Omega$. Hence the total radiation resistance of this $3\lambda/2$ resistively loaded dipole with Z_c equal to R is 198.8Ω . With R equal to zero the corresponding value is 105.2Ω .

4 Open Circuit Voltage V_{oc}

For a linear receiving aerial excited by a tangential electric field $E'(z')$ which is a function of position along the wire, the general form of the current distribution at a point z is²

$$I(z) = A' \cos kz + B' \sin kz - \frac{j}{Z_c} \int_0^z E'(z') \sin k(z-z') dz'$$

where A', B' are constants. Hence referring to Fig. 3 the currents in the two sections when the generator is removed, and the excitation consists of a uniform plane wave incident at an angle θ to the dipole axis, are

$$I_1(z) = F \cos kz + G \sin kz + \frac{jE \cot \theta}{kZ_c} \left[j \sin kz - \frac{\exp(jkz \cos \theta)}{\cos \theta} + \frac{\cos kz}{\cos \theta} \right]$$

$$I_2(z) = H \cos kz + K \sin kz + \frac{jE \cot \theta}{kZ_c} \left[j \sin kz - \frac{\exp(jkz \cos \theta)}{\cos \theta} + \frac{\cos kz}{\cos \theta} \right]$$

with corresponding expressions for the potentials. The boundary conditions are:

$$I_1(0) = 0$$

$$I_2(h) = 0$$

$$I_1(ah) = I_2(ah)$$

$$V_1(ah) - V_2(ah) = RI_1(ah)$$

Solving these equations for the case when the bottom section ah is one half-wave length and the total height of the monopole is $3\lambda/4$, gives for the maximum output voltage

$$V_{oc} = jZ_c K + \frac{jE}{K \sin \theta} [1 + \cos(\pi \cos \theta) + j \sin(\pi \cos \theta)] = -\frac{E}{k} (2.516 - j 1.375). \tag{4}$$

This occurs when the incident wave arrives at an angle of 46° to the dipole axis. For the case with R equal to zero it can readily be shown that the corresponding maximum open circuit voltage, which now obtains with an angle of incidence of 42.5° is given by

$$V_{oc} = -\frac{E}{k} (1.399 - j 0.608).$$

5 Signal/Noise Ratios for $3\lambda/2$ Travelling-Wave and Standing-Wave Dipoles

Using the results developed above enables a comparison to be made between the signal/noise ratios of $3\lambda/2$ travelling-wave and standing-wave dipoles for a given environment. Thus

$$\frac{S/N \text{ for } \frac{3\lambda}{2} \text{ travelling-wave dipole}}{S/N \text{ for } \frac{3\lambda}{2} \text{ standing-wave dipole}} = \frac{V_{oc}^2(R)}{V_{oc}^2(0)} \frac{R_r(0)T_s}{[R_r(R)T_s + R_{in}(R)T_{amb}]}$$

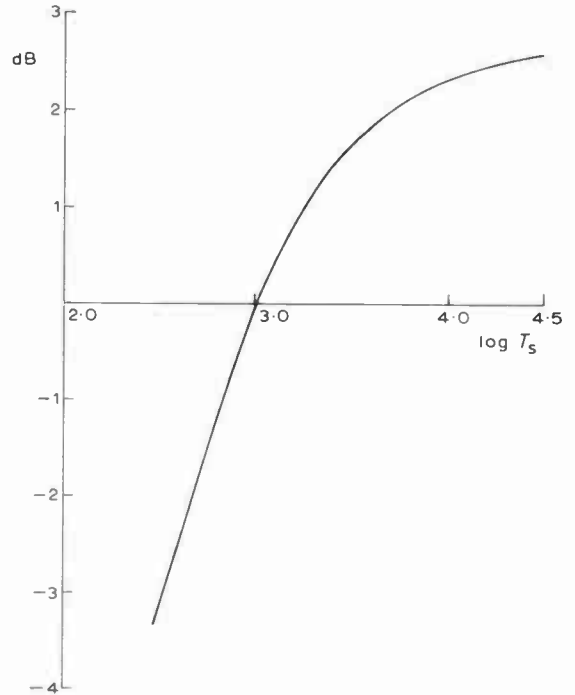

Fig. 4. S/N of travelling-wave $3\lambda/2$ dipole / S/N of standing-wave $3\lambda/2$ dipole as a function of sky temperature for $T_{amb} = 300$ K, and $R = 300 \Omega$

where V_{oc}, R_{in} and R_r are all functions of R , including the case of R equal to zero. This expression is shown in Fig. 4 for an ambient temperature of 300 K and a resistance R of 300 Ω , where it is seen to vary from -3.33 dB to $+2.55$ dB as T_s increases from 300 K to 30 000 K. Thus an improvement in signal/noise ratio may be obtained by using a resistively loaded travelling-wave dipole when the sky temperature is greater than approximately 1040 K. The presence of the resistance R in this case effectively reduces the sky noise power at the terminals by causing it to be shared between the radiation and loss resistances and the open-circuit voltage V_{oc} is increased.

6 References

1. Altshuler, E. E., 'The travelling-wave linear antenna', *I.E.E.E. Trans. on Antennas and Propagation*, **AP-9**, pp. 324-9, 1961.
2. Hall, C. J. and Maclean, T. S. M., 'Simple method of antenna analysis leading to the mode-theory results', *Proc. I.E.E.*, **118**, pp. 511-4, 1971.

Manuscript received by the Institution on 30th April 1973. (Short contribution No. 166/Com. 75.)

Matrices for dual representation of four-terminal non-uniform transmission lines

P. BOWRON, B.Sc., Ph.D., C.Eng., M.I.E.E.*

SUMMARY

The matrix characterization of general four-terminal non-uniform transmission lines is derived by current and voltage gradient considerations and appropriate application of boundary conditions. The parameters allow ready simplification to any particular component cascade for any class of non-uniformities with solutions expressible in separable variables. By invoking the Principle of Duality, the corresponding immittance and transmission matrices of the dual structures can be simply written by inspection. Previous solutions are treated as special cases and, in particular, a useful property of three-terminal autonomic lines is deduced.

List of Principal Symbols

a_{11}, \dots	transmission matrix parameters
D	a constant
D_1, D_2	constants of integration
H_1, H_2	constants
I_1, I_2, I_3, I_4	port and terminal currents
i	current along line length
I_0	modified Bessel function of first kind
K_0	modified Bessel function of second kind
K_1, K_2	constants
L	line length
N	immittance ratio in double-layered transmission line
$P(x)$	first-order differential coefficient in voltage ² 2nd-order linear differential equation
s	complex frequency variable
x	distance variable along line length
$V_1, V_2, V_3, V_{4\pm}$	terminal and port voltages
V	voltage across line length
v	voltage drop along one impedance line
$Y(x)$	line shunt admittance per unit length
$Z(x)$	line series impedance per unit length
σ	irrational operator for tapered transmission line
Δ	matrix determinant
ζ	line integral of admittance
$\theta(x)$	solution function for general transmission line
γ	propagation factor ($=\sqrt{ZY}$)
ρ	characteristic impedance ($=\sqrt{Z/Y}$)
ν	line integral of impedance
$\phi(x)$	solution function for general transmission line
$\psi_{1, 2 \dots 6}$	determinants of θ and ϕ functions

1 Introduction

Non-uniform transmission line concepts have, in the past, been of widespread use in dealing with acoustic horns¹ and aerial matching sections.² More latterly, the distributed resistance-capacitance line^{3, 4} has been found to be of direct relevance to the integrated circuit realization of RC active networks. Various special applications have been suggested^{5, 6, 7} in connexion with amplifiers and the advantages of tapering indicated.⁸ Minimization of the number of auxiliary lumped components together with greater design flexibility can be obtained by resorting to more general four-terminal structures.^{9, 10} A selection of simple configurations is presented in Fig. 1.

The matrix parameters of three-terminal transmission lines with non-uniformities for which the Telegraphers' Equations may be solved have been derived in general terms¹¹ and solutions for lines with dual distributions derived.¹² The principle of duality¹³ will now be extended to general four-terminal non-uniform transmission lines. In integrated circuit form, these occur as R-C-NR and C-R-NC structures. The admittance para-

* Postgraduate School of Studies in Electrical and Electronic Engineering, University of Bradford, Bradford, Yorkshire BD7 1DP.

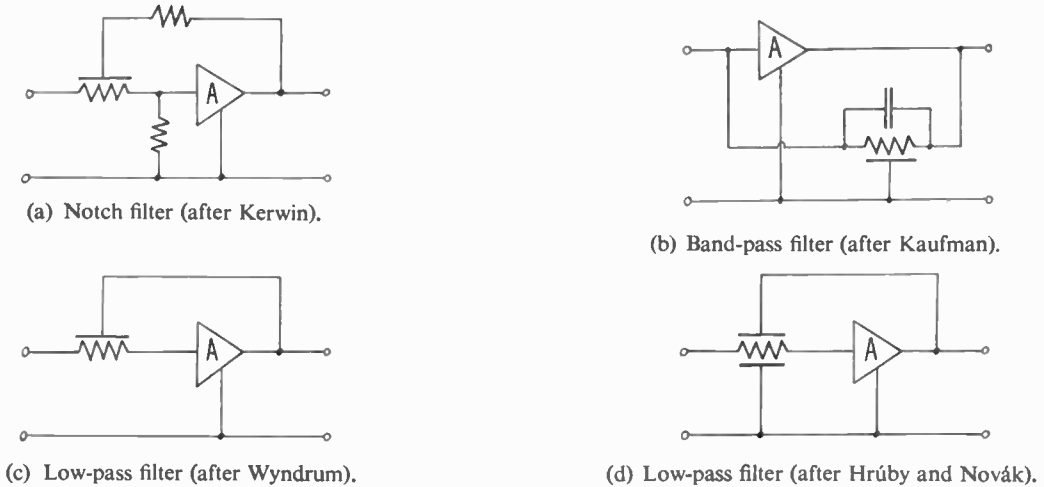

Fig. 1. Configurations of simple active distributed filter networks.

meters of both were first presented by Happ³ and his method extended to circularly¹⁴ and exponentially¹⁰ tapered *R-C-NR* lines and later to *C-R-NC* lines.¹⁵ The nature of the asymmetrical duality between the two stratigraphies has been explained for the special cases of circular¹⁴ and exponential¹⁵ geometry and is established here for any four-terminal line with a closed-form solution.

2 Derivation of Parameters

2.1 Y-Z-NY Line Parameters

While the terminal characteristics of particular types of distributed network have been determined directly,^{3, 10, 15} analysis of the general transmission line can be used to characterize any type of four-terminal structure. Assume that the parameters of the line are time-invariant and distributed in one dimension only. Although, from the point of view of integrated circuit

fabrication, the latter is only valid for uniform and circular geometry, the principle of equivalence^{16, 17} may be applied to re-formulate other non-uniformities.

Consider the general 'T-cascade' form of distributed network model (Fig. 2(a)) in which the upper admittances differ by a factor of *N* from the lower admittances. Each infinitesimal section of such a system is treated as a single network element with elemental series impedance *Z(x)·δx* and shunt admittances *Y(x)·δx* and *NY(x)·δx*. The voltage difference equation is

$$V_0 - (V_0 + \delta V_0) = V_n - (V_n + \delta V_n) = iZ(x)\delta x \tag{1a}$$

where *V₀* and *V_n* are the lower and upper voltages respectively and *i* the current along the line. *Z(x)* is the series impedance per unit length. Kirchhoff's current law at the node gives

$$i - (i + \delta i) = \delta i_n + \delta i_o = N \cdot Y_n(x) \cdot \delta x \cdot (V_n + \delta V_n) + Y_0(x) \cdot \delta x \cdot (V_0 + \delta V_0) \tag{1b}$$

where *Y_n(x)* and *Y₀(x)* are the upper and lower admittances per unit length.

In the differential limit, these become modified forms of the Telegraphers' Equations

$$\frac{dV_0}{dx} = \frac{dV_n}{dx} = -iZ(x) \tag{2a}$$

$$-\frac{di}{dx} = NY_n(x)V_n + Y_0(x)V_0. \tag{2b}$$

Differentiating (2b) and substituting (2a) together with the constituent differential equations of (1b) gives the second-order linear current differential equation

$$\frac{d^2i}{dx^2} - \frac{Y'(x)}{Y(x)} \frac{di}{dx} - (N+1)Z(x)Y(x)i = 0 \tag{3}$$

where

$$Y_n(x) = Y_0(x) = Y(x)$$

and the prime denotes differentiation with respect to *x*.

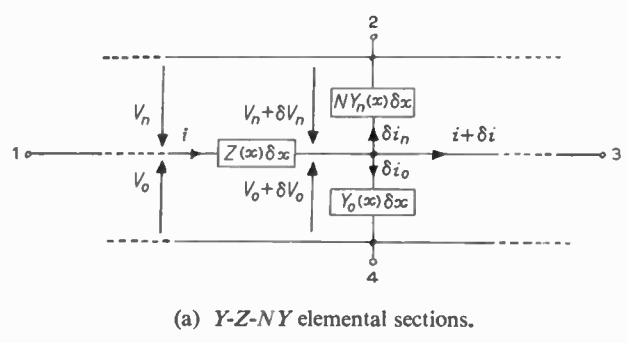

(a) Y-Z-NY elemental sections.

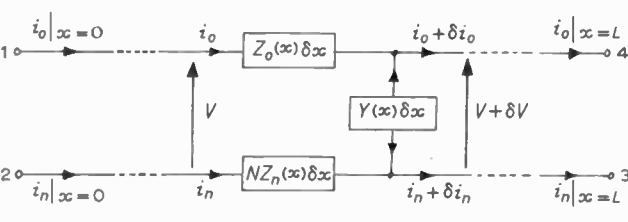

(b) Z-Y-NZ elemental sections.

Fig. 2. Four-terminal cascades

Assume that equation (3) can be solved¹² in the form

$$i(x) = H_1 \cdot \theta(x) + H_2 \cdot \phi(x) \tag{4}$$

where H_1 and H_2 are constants, then a dual procedure¹⁵ to that of Woo and Bartlema¹⁰ may be generalized and applied. However, while this is practicable for the exponentially-tapered case, in general it leads to the introduction of multiple integrals and the unnecessary complication of several subsidiary variables.

It is more convenient first to establish a relation between V_0 and V_n and then work in terms of differentials. Integrating equations (2a) with

$$Y_0(x) = Y_n(x) = Y(x)$$

gives

$$V_0 = - \int iZ(x) dx + D_1$$

and

$$V_n = - \int iZ(x) dx + D_2 \tag{5}$$

where D_1 and D_2 are constants of integration.

Subtracting

$$\begin{aligned} V_n - V_0 &= D_2 - D_1 \\ &= D, \text{ a constant} \end{aligned} \tag{6}$$

Substituting for V_0 from (5) in (2b) with

$$Y_0(x) = Y_n(x) = Y(x)$$

gives

$$- \frac{di}{dx} = Y(x)[(N+1)V_n - D].$$

Re-arranging

$$V_n = - \frac{1}{N+1} \frac{1}{Y(x)} \frac{di}{dx} + \frac{D}{N+1} \tag{7}$$

From (4)

$$V_n = - \frac{1}{N+1} \frac{1}{Y(x)} [H_1\theta^1 + H_2\phi^1] + \frac{D}{N+1} \tag{8}$$

and by (6)

$$V_0 = - \frac{1}{N+1} \frac{1}{Y(x)} [H_1\theta^1 + H_2\phi^1] - \frac{ND}{N+1} \tag{9}$$

Applying boundary conditions from Fig. 3(a) in equation (4) gives

$$i_1 = I_1 - I_2 = H_1\theta_0 + H_2\phi_0 \tag{10a}$$

$$i_3 = I_3 - I_4 = H_1\theta_L + H_2\phi_L \tag{10b}$$

and integrating (8) and (9) after substituting the constituents of (1b) gives

$$i_2 = I_2 - I_3 = \frac{N}{N+1} [H_1(\theta_L - \theta_0) + H_2(\phi_L - \phi_0) - D\zeta] \tag{10c}$$

$$i_4 = I_4 - I_1 = \frac{1}{N+1} [H_1(\theta_L - \theta_0) + H_2(\phi_L - \phi_0) + ND\zeta] \tag{10d}$$

where

$$\zeta = \int_0^L Y(x) dx. \tag{11}$$

Equations (10) can be solved for constants H_1, H_2 and D before substituting in the port voltage expressions

$$\begin{aligned} V_1 = V_0|_{x=0} &= - \frac{1}{N+1} \frac{1}{Y_0(0)} [H_1\theta_0^1 + H_2\phi_0^1] - \frac{ND}{N+1} \\ V_2 = -V_n|_{x=0} &= \frac{1}{N+1} \frac{1}{Y_0(0)} [H_1\theta_0^1 + H_2\phi_0^1] - \frac{D}{N+1} \\ V_3 = V_0|_{x=L} &= - \frac{1}{N+1} \frac{1}{Y_L(L)} [H_1\theta_L^1 + H_2\phi_L^1] + \frac{D}{N+1} \\ V_4 = -V_0|_{x=L} &= \frac{1}{N+1} \frac{1}{Y_L(L)} [H_1\theta_L^1 + H_2\phi_L^1] + \frac{ND}{N+1} \end{aligned} \tag{12}$$

$$\begin{aligned} \psi_1 &= \theta_L^1\phi_0 - \phi_L^1\theta_0 \\ \psi_2 &= \theta_0^1\phi_L - \phi_0^1\theta_L \\ \psi_3 &= \theta_0^1\phi_0 - \phi_0^1\theta_0 \\ \psi_4 &= \theta_L^1\phi_L - \phi_L^1\theta_L \\ \psi_5 &= \theta_0^1\phi_L^1 - \phi_0^1\theta_L^1 \\ \psi_6 &= \theta_L\phi_0 - \phi_L\theta_0. \end{aligned} \tag{13}$$

In order to determine the admittance parameters, consider terminals rather than ports as in the re-labelled arrangement of Fig. 3(b). Voltage equations (8) and (9) become:

$$\begin{aligned} V_b - V_a = -V_n|_{x=0} &= \frac{1}{N+1} \frac{1}{Y(0)} [H_1\theta_0^1 + H_2\phi_0^1] - \frac{D}{N+1} \\ V_a - V_d = V_0|_{x=0} &= - \frac{1}{N+1} \frac{1}{Y(0)} [H_1\theta_0^1 + H_2\phi_0^1] - \frac{ND}{N+1} \\ V_c - V_b = V_n|_{x=L} &= - \frac{1}{N+1} \frac{1}{Y(L)} [H_1\theta_L^1 + H_2\phi_L^1] + \frac{D}{N+1} \end{aligned} \tag{14}$$

and the admittance parameters in the second row of Table 1 emerge after substituting the constants derived from (14) in the corresponding current equations (10).

2.2 Duality

Immittance parameters for the Z - Y - NZ distributed network may be derived in a similar manner by adopting a cascade of infinitesimal 'π-sections' as in Fig. 2(b) yielding the modified Telegraphers' Equations:

$$\frac{dV}{dx} = -Z_0(x)i_0 + NZ_n(x)i_n \tag{15a}$$

and

$$\frac{di_0}{dx} = - \frac{di_n}{dx} = -Y(x) \cdot V. \tag{15b}$$

By considering^{18, 19} the voltage gradient along the upper impedance line followed by application of appropriate boundary conditions from Figs. 3(c) and 2(d), the corresponding admittance and impedance parameters may be determined as given in Table 1.

Alternatively, recognition of the analogous nature of equations (2) and (15) with the roles of V and i (as well

Table 1.
General four terminal immittance and transmission parameters.

Matrix		\overline{ZYNZ}	\overline{YZNY}						
[Z]	$\frac{Z_0}{\psi_5}$	$(N+1)\psi_1$	$N\left[\frac{Z_0}{Z_0}\psi_3 - \psi_1\right]$	$-\frac{1}{Y_0}\psi_2 + \frac{N}{S}$	$-\frac{1}{Y_0}\psi_2 + \frac{1}{S}$	$\frac{1}{Y_0}\psi_3 - \frac{1}{S}$	$-\frac{1}{Y_0}\psi_3 - \frac{N}{S}$		
		$N(\psi_4 - \psi_1)$	$\frac{N^2}{N+1}\left[\frac{Z_0}{Z_0}(\psi_2 - \psi_3) + \psi_1 - \psi_4 + \frac{N}{N}\psi_5\right]$	$N\frac{Z_0}{Z_0}(\psi_3 - \psi_2)$	$\frac{N}{N+1}\left[\frac{Z_0}{Z_0}(\psi_2 - \psi_3) + \psi_1 - \psi_4 - N\psi_5\right]$	$-\frac{1}{Y_0}\psi_2 + \frac{1}{S}$	$\frac{1}{Y_0}\psi_2 + \frac{1}{NS}$	$-\frac{1}{Y_0}\psi_3 - \frac{1}{NS}$	$\frac{1}{Y_0}\psi_3 - \frac{1}{S}$
		$-(N+1)\psi_4$	$N\left[\psi_4 - \frac{Z_0}{Z_0}\psi_2\right]$	$(N+1)\frac{Z_0}{Z_0}\psi_2$	$\psi_4 - \frac{Z_0}{Z_0}\psi_2$	$\frac{1}{Y_L}\psi_4 - \frac{1}{S}$	$-\frac{1}{Y_L}\psi_4 - \frac{1}{NS}$	$\frac{1}{Y_L}\psi_1 + \frac{1}{NS}$	$-\frac{1}{Y_L}\psi_1 + \frac{1}{S}$
		$\psi_4 - \psi_1$	$\frac{N}{N+1}\left[\frac{Z_0}{Z_0}(\psi_2 - \psi_3) + \psi_1 - \psi_4 - N\psi_5\right]$	$\frac{Z_0}{Z_0}(\psi_3 - \psi_2)$	$\frac{1}{N+1}\left[\frac{Z_0}{Z_0}(\psi_2 - \psi_3) + \psi_1 - \psi_4 + N\psi_5\right]$	$-\frac{1}{Y_L}\psi_4 - \frac{N}{S}$	$\frac{1}{Y_L}\psi_4 - \frac{1}{S}$	$-\frac{1}{Y_L}\psi_1 + \frac{1}{S}$	$\frac{1}{Y_L}\psi_1 + \frac{N}{S}$
[y]	$\frac{1}{N+1}$	$\frac{1}{Z_0}\psi_2 + \frac{N}{Y}$	$-\frac{1}{Z_0}\psi_2 + \frac{1}{Y}$	$\frac{1}{Z_0}\psi_3 - \frac{1}{Y}$	$-\frac{1}{Z_0}\psi_3 - \frac{N}{Y}$	$(N+1)\psi_1$	$N\left[\frac{Y}{Y_0}\psi_3 - \psi_1\right]$	$-\frac{1}{Y_0}\psi_3$	$\frac{Y}{Y_0}\psi_3 - \psi_1$
		$-\frac{1}{Z_0}\psi_2 + \frac{1}{Y}$	$\frac{1}{Z_0}\psi_2 + \frac{1}{NY}$	$-\frac{1}{Z_0}\psi_3 - \frac{1}{NY}$	$\frac{1}{Z_0}\psi_3 - \frac{1}{Y}$	$N(\psi_4 - \psi_1)$	$\frac{N}{N+1}\left[\frac{Y}{Y_0}(\psi_2 - \psi_3) + \psi_1 - \psi_4 - N\psi_5\right]$	$N\frac{Y}{Y_0}(\psi_3 - \psi_2)$	$\frac{N}{N+1}\left[\frac{Y}{Y_0}(\psi_2 - \psi_3) + \psi_1 - \psi_4 - N\psi_5\right]$
		$\frac{1}{Z_L}\psi_4 - \frac{1}{Y}$	$-\frac{1}{Z_L}\psi_4 - \frac{1}{NY}$	$\frac{1}{Z_L}\psi_1 + \frac{1}{NY}$	$-\frac{1}{Z_L}\psi_1 + \frac{1}{Y}$	$-(N+1)\psi_4$	$N\left[\psi_4 - \frac{Y}{Y_0}\psi_2\right]$	$(N+1)\frac{Y}{Y_0}\psi_2$	$\psi_4 - \frac{Y}{Y_0}\psi_2$
		$-\frac{1}{Z_L}\psi_4 - \frac{N}{Y}$	$\frac{1}{Z_L}\psi_4 - \frac{1}{Y}$	$-\frac{1}{Z_L}\psi_1 + \frac{1}{Y}$	$\frac{1}{Z_L}\psi_1 + \frac{N}{Y}$	$\psi_4 - \psi_1$	$\frac{N}{N+1}\left[\frac{Y}{Y_0}(\psi_2 - \psi_3) + \psi_1 - \psi_4 - N\psi_5\right]$	$\frac{Y}{Y_0}(\psi_3 - \psi_2)$	$\frac{1}{N+1}\left[\frac{Y}{Y_0}(\psi_2 - \psi_3) + \psi_1 - \psi_4 + N\psi_5\right]$
[a]	$\frac{1}{N+1}$	$1 - \frac{\psi_1}{\psi_4}$	$N\left[\psi - \frac{\psi_6}{\psi_4}Z_L\right]$	$N + \frac{\psi_1}{\psi_4}$	$N\psi + \frac{\psi_6}{\psi_4}Z_L$	$N\left[\frac{\psi_2}{\psi_4}Y_L - 1\right]$	$\frac{1}{Y_0}\psi_5$	$-\left[N + \frac{\psi_2}{\psi_4}Y_L\right]$	$-\frac{1}{Y_0}\psi_5$
		$-\frac{1}{Z_0}\psi_5$	$N\left[1 - \frac{\psi_2}{\psi_4}\frac{Z_L}{Z_0}\right]$	$\frac{1}{Z_0}\psi_5$	$N + \frac{\psi_2}{\psi_4}\frac{Z_L}{Z_0}$	$N\left[\frac{\psi_6}{\psi_4}Y_L - S\right]$	$\frac{\psi_1}{\psi_4} - 1$	$-\left[NS + \frac{\psi_6}{\psi_4}Y_L\right]$	$-\left[N + \frac{\psi_1}{\psi_4}\right]$
		$1 + \frac{\psi_1}{\psi_4}N$	$N\left[\psi + N\frac{\psi_6}{\psi_4}Z_L\right]$	$N\left[1 - \frac{\psi_1}{\psi_4}\right]$	$N\left[\psi - \frac{\psi_6}{\psi_4}Z_L\right]$	$-\left[1 + N\frac{\psi_2}{\psi_4}Y_L\right]$	$-\frac{1}{Y_0}\psi_5$	$\frac{\psi_2}{\psi_4}Y_L - 1$	$\frac{1}{Y_0}\psi_5$
		$\frac{1}{Z_0}\psi_5$	$1 + N\frac{\psi_2}{\psi_4}\frac{Z_L}{Z_0}$	$-\frac{1}{Z_0}\psi_5$	$1 - \frac{\psi_2}{\psi_4}\frac{Z_L}{Z_0}$	$N\left[S + N\frac{\psi_6}{\psi_4}Y_L\right]$	$-\left[1 + N\frac{\psi_1}{\psi_4}\right]$	$N\left[\frac{\psi_6}{\psi_4}Y_L - S\right]$	$N\left[\frac{\psi_1}{\psi_4} - 1\right]$

as Z and Y) interchanged together with the dual geometries of Figs 2(a) and 1(b) suggests immediate invocation of the Principle of Duality.¹³ This enables the Z - Y - NZ impedance/admittance matrices to be written directly from the Y - Z - NY admittance/impedance matrices merely by:

- (i) interchange of Z_0 and Y_0 , and Z_L and Y_L ,

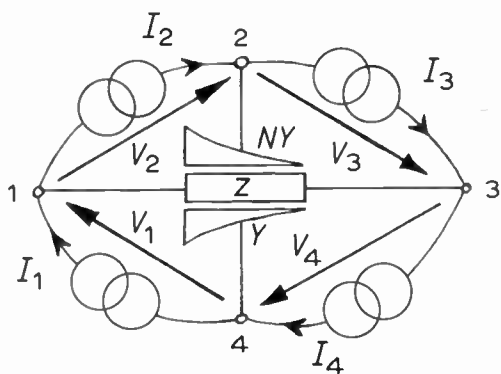

(a) Y - Z - NY port notation.

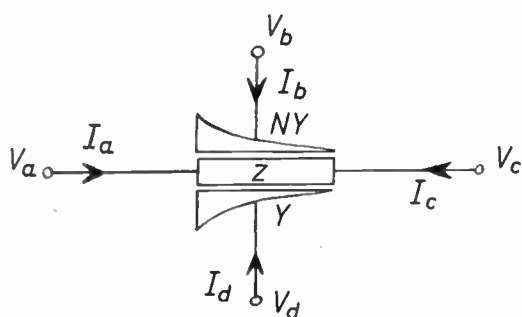

(b) Y - Z - NY terminal notation.

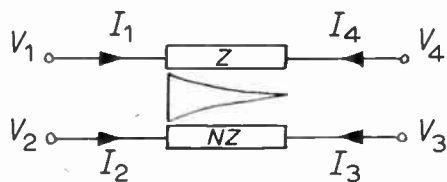

(c) Z - Y - NZ terminal notation.

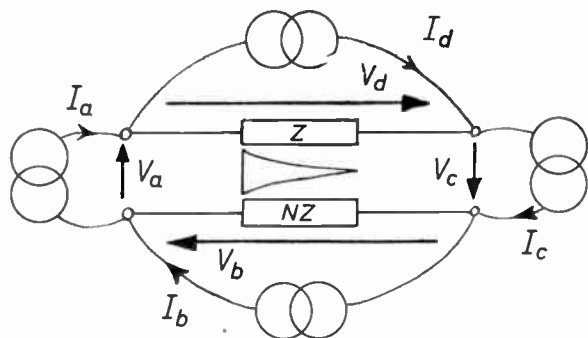

(d) Z - Y - NZ port notation.

Fig. 3. Port and terminal notation for Z - Y - NZ and Y - Z - NY structures.

- (ii) interchange of v and ζ ,

$$\text{i.e. } \int_0^L Z(x) dx = \int_0^L Y(x) dx. \quad (16)$$

The choice of labelling notation for terminals and ports in Fig. 3 obviates the need for reversing the sign of the off-diagonal elements¹² or any adjustment of terminal numbering.¹⁵

2.3 Transmission Parameters

Transmission matrices defined²⁰ by

$$\begin{bmatrix} V_1 \\ I_1 \\ V_2 \\ I_2 \end{bmatrix} = \begin{bmatrix} a_{11} & a_{12} & a_{13} & a_{14} \\ a_{21} & a_{22} & a_{23} & a_{24} \\ a_{31} & a_{32} & a_{33} & a_{34} \\ a_{41} & a_{42} & a_{43} & a_{44} \end{bmatrix} \begin{bmatrix} V_3 \\ -I_3 \\ V_4 \\ -I_4 \end{bmatrix} \quad (17)$$

can be determined by appropriate manipulation of the relevant current and voltage equations constituting the admittance and impedance matrices. The results for both structures are given in the third row of Table 1. As previously demonstrated,¹² the two sets of transmission parameters are dual if, as well as interchanging Z_0 and Y_0 , Z_L and Y_L , the diagonal and off-diagonal elements are interchanged throughout. There is also an overall change in sign not previously¹² noted.

3 Special Cases

3.1 Transformed Normal Class

The simplest class of non-uniform distributions has been solved^{4, 11} by transforming the second-order differential equation into the normal form and then imposing various conditions on the resulting invariant. After a change of variable, the constituents of the general solution (4) can be written

$$\begin{aligned} \theta(x) &= \sqrt{Z(x)} \cdot \exp(-\sigma x) \\ \phi(x) &= \sqrt{Z(x)} \cdot \exp(+\sigma x) \end{aligned} \quad (18)$$

where

$$\begin{aligned} -\sigma^2 &= \text{the invariant} \\ &= -\left[\gamma^2 - \gamma \rho'(x) + \frac{P^2(x)}{4} \right] \end{aligned}$$

and

$$\begin{aligned} P(x) &= \frac{1}{2\gamma} \frac{\rho'}{\rho}, \\ \gamma &= \text{propagation factor} = \sqrt{ZY}, \\ \rho &= \text{characteristic impedance} = \sqrt{\frac{Z}{Y}}. \end{aligned}$$

Therefore

$$\theta'(x) = \sqrt{Z(x)} \cdot \exp(-\sigma x) \left[\frac{P(x)}{2} - \sigma \right]$$

and

$$\phi'(x) = \sqrt{Z(x)} \cdot \exp(+\sigma x) \left[\frac{P(x)}{2} + \sigma \right]. \quad (19)$$

Substitution of (18) and (19) in (13) for the constant propagation factor case followed by application to

Table 1 gives matrices of the type in Table 2. This embraces several simple types of line taper, two of which will now be discussed.

3.1.1 Autonomic lines

The term 'autonomic' in the context of transmission line theory was introduced by Kazansky²¹ in treating the reflexion characteristics of non-uniform transmission lines and is now re-defined.

Definition:

'An autonomic transmission line is one whose taper is such that the derivative of the logarithm of the characteristic impedance is invariant with distance along the line length.'

Mathematically, making the transformation^{4, 16}

$$w = \int \gamma dx + d \tag{20}$$

where d is a constant of integration, gives a new differential equation

$$\frac{d^2V}{dw^2} - \frac{1}{Z(x)} \cdot \frac{d}{dx} \left(\frac{Z(x)}{\frac{dw}{dx}} \right) \cdot \frac{dV}{dw} - \frac{Z(x)Y(x)}{\left(\frac{dw}{dx}\right)^2} = 0. \tag{21}$$

From (20), the first order coefficient,

$$\begin{aligned} &= \frac{1}{Z(x)} \cdot \frac{d}{dx} \left(\sqrt{\frac{Z(x)}{Y(x)}} \right) \\ &= \frac{1}{\gamma} \cdot \frac{d}{dx} (\ln \rho) \\ &= \frac{d}{dw} (\ln \rho) \end{aligned} \tag{22}$$

which is constant for a reciprocal (constant propagation factor) line, if the line is autonomic.

This is the case for the uniform^{3, 22} and exponential^{10, 22} distributions but not for other members of the normal transform^{4, 11} or other classes.¹⁷ The two simplest types of line distribution are thus distinguished from others. They are also the most useful distributions, the uniform line forming the basis for synthesis procedures²³ in the transformed frequency plane and the exponential being the most readily analysed mode of inhomogeneity. Furthermore, other distributions can be made equivalent^{16, 17, 24} to the exponential, and from a response point of view, the specific taper function employed has been found^{4, 22} to be less important than the taper factor.

The four-terminal parameters for autonomic *R-C-NR* and *C-R-NC* lines which have been derived directly in the past^{3, 10, 15} may be deduced by inspection from Table 1 via Table 2.

3.1.2 Non-autonomic lines

These include the parabolic,^{11, 22} trigonometric^{4, 17} and hyperbolic²⁵ distributions for which four-terminal indefinite parameters may be derived in the same manner as for the exponential but do not appear⁴ to offer significant performance or fabrication advantages.

3.2 Other Transform Classes

Other transformations of the linear second-order differential equation may be employed¹⁷ leading to classes of distribution with parameters in terms of functions such as the hypergeometric, Whittaker and Bessel.

From the point of view of accurate one-dimensional formulation, a linear taper is the only convenient type of inhomogeneity available. Fabrication in the form of annular sections ensures circular equipotentials with straight and radial current flow lines.^{4, 14, 22} Other than polar geometries present formidable boundary effects.

The linear taper was also the first to be examined with respect to acoustic horns¹ and is represented⁴ by distributions

$$\begin{aligned} Z(x) &= \frac{Z_0}{\left(1 + \frac{x}{x_0}\right)} \\ Y(x) &= Y_0 \left(1 + \frac{x}{x_0}\right) \end{aligned} \tag{23}$$

with $-x_0$ as the position of the centre of the polar coordinates. The solutions^{1, 4} are as in equation (4) with

$$\theta(x) = I_0[\gamma_0(x_0 + x)]$$

and

$$\phi(x) = K_0[\gamma_0(x_0 + x)] \tag{24}$$

where

$$\gamma_0^2 = Z_0 Y_0$$

and I_0, K_0 are modified Bessel functions of the first and second kind.

The full four-terminal indefinite matrices for this case have already been tabulated by Castro¹⁴ in terms of $n = x_d/x_0$; x_d is the outer polar coordinate, and may also be derived by application of equations (24) and (13) to Table 1.

4 Three-terminal Reduction

Referring to Fig. 3(c) and making terminals 2 and 3 common reduces the *Z-Y-NZ* indefinite admittance matrix of Table 1 to the definite matrix representation of an unbalanced two-port distributed network

$$\begin{bmatrix} y \\ y \end{bmatrix} = \begin{bmatrix} \frac{1}{Z_0} \psi_2 + \frac{N}{v} & -\frac{\psi_3}{Z_0 \psi_6} - \frac{N}{v} \\ -\frac{\psi_4}{Z_L \psi_6} - \frac{N}{v} & \frac{\psi_1}{Z_L \psi_6} + \frac{N}{v} \end{bmatrix}. \tag{25}$$

This, together with similar results for the other matrices, agrees with the results of Bhattacharyya and Swamy¹² when $N = 0$. The determinant of (25), even with finite N , is

$$\Delta y = \frac{1}{Z_0 Z_L} \frac{\psi_5}{\psi_6}. \tag{26}$$

For the transformed normal class, Table 2 gives

$$\Delta y = \frac{1}{Z_0 Z_L} \left[\sigma^2 - \frac{P_0 P_L}{4} + \frac{\sigma}{2} (P_L - P_0) \coth \sigma L \right] \tag{27}$$

Table 2.
Admittance matrix for transformed normal class.

	$\frac{Y}{Z_0} \cdot \coth \gamma L - \frac{Z'_0}{2Z_0^2} + \frac{N}{Y}$	$-\frac{Y}{Z_0} \cdot \coth \gamma L + \frac{Z'_0}{2Z_0} + \frac{1}{Y}$	$\frac{1}{\sqrt{Z_0 Z_L}} \cdot \operatorname{cosech} \gamma L - \frac{1}{Y}$	$-\frac{Y}{\sqrt{Z_0 Z_L}} \cdot \operatorname{cosech} \gamma L - \frac{N}{Y}$
	$-\frac{Y}{Z_0} \cdot \coth \gamma L + \frac{Z'_0}{2Z_0^2} + \frac{1}{Y}$	$\frac{Y}{Z_0} \cdot \coth \gamma L - \frac{Z'_0}{2Z_0^2} + \frac{N}{Y}$	$-\frac{Y}{\sqrt{Z_0 Z_L}} \cdot \operatorname{cosech} \gamma L - \frac{1}{NY}$	$\frac{Y}{\sqrt{Z_0 Z_L}} \cdot \operatorname{cosech} \gamma L - \frac{1}{Y}$
$\frac{1}{N+1}$	$\frac{1}{\sqrt{Z_0 Z_L}} \cdot \operatorname{cosech} \gamma L - \frac{1}{Y}$	$-\frac{1}{\sqrt{Z_0 Z_L}} \cdot \operatorname{cosech} \gamma L - \frac{1}{NY}$	$\frac{Y}{Z_L} \cdot \coth \gamma L + \frac{Z'_L}{2Z_L^2} + \frac{1}{NY}$	$-\frac{Y}{Z_L} \cdot \coth \gamma L - \frac{Z'_L}{2Z_L^2} + \frac{1}{Y}$
	$-\frac{1}{\sqrt{Z_0 Z_L}} \cdot \operatorname{cosech} \gamma L - \frac{N}{Y}$	$\frac{1}{\sqrt{Z_0 Z_L}} \cdot \operatorname{cosech} \gamma L - \frac{1}{Y}$	$-\frac{Y}{Z_L} \cdot \coth \gamma L - \frac{Z'_L}{2Z_L^2} + \frac{1}{Y}$	$\frac{Y}{Z_L} \cdot \coth \gamma L + \frac{Z'_L}{2Z_L^2} + \frac{N}{Y}$

and for autonomic lines in particular,

$$\frac{P_0}{2} = \frac{P_L}{2} = k \tag{28}$$

giving the interesting result that

$$\Delta y = \frac{1}{\Delta z} = \frac{ZY}{Z_0 Z_L} \tag{29}$$

For a constant propagation factor line, this becomes

$$\Delta y = \frac{Y_0}{Z_L} \tag{30}$$

and for a particular \overline{RC} exponential taper

$$\begin{aligned} r &= r_0 \exp(2kx) \\ c &= c_0 \exp(-2kx) \end{aligned} \tag{31}$$

gives the interesting result²⁶

$$\Delta y = \left(\frac{c_0}{r_0} \exp(-2kL) \right) s \tag{32}$$

where k is the 'flare' of the taper,

r_0 is the resistance per unit length,
 c_0 is the capacitance per unit length,
and s is the operator.

Hence Δy may be replaced by a 'capacitance' of value $(c_0/r_0) \exp(-2kL)$. This property is unique to autonomic lines and does not hold for other members of the normal class nor members of other classes. However, autonomic lines are the most common and this simplification is of value in analysing the performance of various interconnexions of amenable distributed elements with active and passive components.^{26, 27, 28}

5 Conclusions

Table 1 gives the most general characterization yet presented of four-terminal non-uniform transmission lines. The matrix elements have been obtained by con-

sidering the current and voltage gradients along the line lengths before applying the appropriate boundary conditions. The duality between Z - Y - NZ and Y - Z - NY lines, which is apparent from the voltage and current equations, has been simply expressed so that one set of matrix parameters may be directly deduced from another by suitable interchanges after correct labelling of the ports and terminals involved. The parameters may be reduced to represent any particular component cascade with any non-uniformity for which solutions may be expressed in separable-variable form.

Of the various special cases considered, the sub-class of autonomic lines in three-terminal form have been shown to have the analytically convenient property of a rational determinant. The value of this is enhanced when it is remembered^{16, 17} that other tapers may be represented by an exponential section of appropriate length.

6 References

1. Ballantine, S., 'On the propagation of sound in the general Bessel horn of infinite length', *J. Franklin Inst.*, 203, pp. 85-102, 1927.
2. Willis, J. and Sinha, N. K., 'Non-uniform transmission lines as impedance transformers', *Proc. Instn Elect. Engrs*, 103B, pp. 166-71, March 1956.
3. Happ, W. W., 'Microsystem circuit analysis', *Electrical Engineering*, 80, pp. 535-42, July 1961.
4. Ghauri, M. S. and Kelly, J. J., 'Introduction to Distributed Parameter Networks', Chapters 4 and 7 (Holt, Rinehart and Winston, New York, 1968).
5. Kerwin, W. J., 'Analysis and synthesis of active RC networks containing distributed and lumped elements', Tech. Report No. 6560-14, Systems Theory Laboratory, Stanford University, August 1967.
6. Wyndrum, R. W., 'Active distributed RC networks', *IEEE J. Solid State Circuits*, SC-3, pp. 308-10, September 1968.

7. Kaufman, W. M., 'Theory of a monolithic null device and some novel circuit applications', *Proc. IRE*, **48**, pp. 1540-5, September, 1960.
8. Walsh, J. and Swamy, M. N. S., 'Design of active distributed RC-filters using exponential lines', *The Radio and Electronic Engineer*, **42**, pp. 409-15, September 1972.
9. Hruby, J. and Novák, M., 'Selective amplifier based on a multi-layer distributed RC network', *IEEE J. Solid State Circuits*, **SC-5**, pp. 162-5, August 1970.
10. Woo, B. B. and Bartlemy, J. M., 'Characteristics and applications of a tapered thin film distributed parameter structure', *IEEE Internat. Conv. Rec.* **2**, p. 56-75, 1963.
11. Dutta Roy, S. C., 'Matrix parameters of non-uniform transmission lines', *IEEE Trans. on Circuit Theory*, **CT-72**, pp. 142-3, 1965. (Corresp.)
12. Bhattacharyya, B. B. and Swamy, M. N. S., 'Dual distributions of solvable non-uniform lines', *Proc. IEEE*, **56**, pp. 1979-80, 1966 (Corresp.).
13. Guillemin, E. A., 'Introductory Circuit Theory', pp. 42-57, p. 535, 1st edn. (J. Wiley, New York, 1957).
14. Castro, P. S., 'RC distributed parameter network with circular geometry', *Proc. Nat. Electronics Conf.*, **14**, pp. 98-104, 1963
15. Bowron, P., Holt, A. G. J. and Stokes, D. J., 'Inhomogeneous distributed C-R-NC structures', *Internat. J. Electronics*, **28**, pp. 197-213, 1970.
16. Hellstrom, M. J., 'Equivalent distributed RC networks or transmission lines', *IEEE Trans. on Circuit Theory*, **CT-9**, pp. 247-51, 1962.
17. Holt, A. G. J., Ahmed, K. U. and Bowron, P., 'Generalized non-uniform transmission lines and their equivalent electrical length', *J. Franklin Inst.*, **288**, pp. 31-41, 1969.
18. Bowron, P., 'Distributed Integrated Networks', Ph.D. thesis, University of Newcastle-upon-Tyne, 1969.
19. Nathan, A., 'Analysis of linear three-port four-terminal networks with applications to distributed circuits', *IEEE Trans. on Circuit Theory*, **CT-20**, pp. 83-5, January 1973.
20. Chirlian, P. M., 'Integrated and Active Network Analysis and Synthesis', pp. 89-92 (Prentice Hall, Englewood Cliffs, N.J., 1967).
21. Kazansky, B. G., 'Outline of a theory of non-uniform transmission lines', *Proc. Instn. Elect. Engrs*, **105**, Pt. C, pp. 126-38, 1957.
22. Kaufman, W. M. and Garrett, S. J., 'Tapered distributed filters', *IEEE Trans. on Circuit Theory*, **CT-9**, pp. 329-36, 1962.
23. Wyndrum, R. W., 'Exact synthesis of distributed RC networks', New York University, Tech. Report, 400-76, 1963.
24. Schwartz, R. F., 'Transformations in the analysis of non-uniform transmission lines', *J. Franklin Inst.*, **278**, pp. 163-74, 1964.
25. Su, K. L., 'The hyperbolic RC transmission line', *Electronics Letters*, **1**, No. 3, pp. 59-60, May 1965.
26. Ghausi, M. S. and Herskowitz, G. J., 'The effect of shaping and loading on distributed RC networks', *J. Franklin Inst.*, **278**, pp. 108-14, 1964.
27. Kuo, F. F., 'Network Analysis and Synthesis', p. 342 (Wiley, New York, 1966).
28. Kleinheins, S., 'Steepness of a loaded exponentially tapered distributed RC notch filter', *Electronics Letters*, **2**, pp. 374-5, October 1966.

Manuscript first received by the Institution on 26th March 1973 and in final form on 30th May 1973. (Paper No. 1541|CC177.)

© The Institution of Electronic and Radio Engineers, 1973.

The Author



Dr. Peter Bowron graduated at the University of Birmingham in 1961. He was then employed as a Scientific Officer at the Royal Aircraft Establishment, Farnborough, investigating ILS automatic-landing systems until 1964. This was followed by periods in industry with English Electric Computers Limited at Kidsgrove and in the Instrument Development Division of ICI Limited, Billingham. In 1969 he obtained

the degree of Ph.D. at the University of Newcastle-upon-Tyne for research on distributed integrated networks. He has subsequently held lecturing posts at Sunderland Polytechnic and the University of Bradford where he is currently a member of the Postgraduate School of Studies in Electrical and Electronic Engineering. Dr. Bowron is author of several papers on distributed and active network theory.

Electrical Connectors

G. W. A. DUMMER,
M.B.E., C.Eng., F.I.E.E., F.I.E.R.E.

A COLLOQUIUM was held at the IERE Headquarters in London on 15th May 1973 surveying the field of electrical connectors including their applications and reliability. It was attended by approximately 80 delegates and this followed a similar Colloquium held on fixed resistors some years ago and a further one on fixed capacitors. Five papers were presented and there was a lively discussion after each paper.

The Chairman, Mr. H. G. Manfield of R.R.E., in his introductory address said that connectors were a neglected area, all the glamour being now on integrated circuits and recently developed devices. The reliability of connectors and connecting systems was very important, particularly as m.t.b.f.'s were now being specified in Ministry contracts. He also commented on the change which had taken place in materials used in connectors and which would be dealt with in one of the papers (by D. Taylor).

The first paper was by Mr. R. T. Lovelock,* for many years with Belling and Lee and now a consultant. Mr. Lovelock said that because systems had to have a guaranteed m.t.b.f. even a low failure rate of connectors was of importance because of the large numbers of connectors involved. Referring to the standard 'bath tub' curve he said that the early failure rate part could be obviated by 100% sorting, whilst the wear-out part could be determined by estimating the expected life. This left the centre part (using Binomial or Poisson distributions) which could be replaced with an approximate straight line. The probability of failure of the connector p , could then be represented by a mathematical equation. To determine this value of p the working life could be specified in terms of number of matings, duty cycle (time at maximum stress) and the environment (temperature, humidity etc.). He suggested the best test to use to determine p was temperature, humidity $\text{SO}_2/\text{H}_2\text{S}$ and salt mist, with half the connectors mated and half unmated. The average of these tests should give a reasonable value of p . This of course gives a probability of failure for the mating parts of the connector and to this must be added the very low failure rate of crimped, soldered etc., cable connexions. Questions on this paper were mainly confined to the effects of SO_2 and H_2S on corrosion of the connector and also the effect of aircraft fuels, silicones etc., in contamination.

The next paper was by Mr. D. Taylor of Amphenol on plastic materials for connectors in which he dealt with the many materials which are in current use in connector systems. (He restricted his paper specifically to circular environmental

style connectors.) He showed by means of slides that thermoplastics had many properties which could be used as replacement for metals; for instance, metal contact retention clips could be replaced by a plastic retention system for high density connectors. Polysulphone mouldings could be used up to 200°C and shell mouldings were being made of this material. Mr. Taylor made the point that specifications will become more severe and the plastic coupling mechanisms can be used to replace metal ones, in fact the use of plastics in place of metals for contact retention systems coupling mechanisms and shell hardware would become more general in the future.

The discussion, centred on the materials themselves, e.g. the value of polyesters versus polysulphones, were polysulphones resistant to many solvents, were they more costly and what was the low temperature performance of some of these plastics? In reply, Mr. Taylor said that polysulphones were more costly but could in some cases be approximately twice the price of nylon. The low temperature performance was adequate to -50°C but then became brittle, and this raised a problem of latching in arctic conditions.

Mr. J. Hodson Smith of Hawker-Siddeley Dynamics then presented a user's view of connectors; his paper covered principally low-frequency connectors up to 1 MHz used for missiles. He made the point that the choice for the user is very difficult. In looking at the specifications for nationally approved components, they were of medium density and no high density ones were listed. There were only two BS 9000 type specifications published and no detail specifications were issued. They had therefore to choose specifications based on MIL and NASA for what they want. He listed the many specifications that were available none of which were co-ordinated and for their requirements they often had to draw up their own specifications taking the best parts of others. This meant that specifications were being proliferated. He also mentioned that most of the British specifications covered soldered joints and not crimped terminations, which were likely to be increasingly used. He gave some interesting side lines on use, misuse and abuse which occurs in connectors. Apart from the specification problems in use, in misuse he cited most of the faults which arise in testing before actual use and also such items as the weight of cable dragging the pins. In abuse he mentioned the use of a pair of pliers to reduce contact resistance, also the collection of debris inside the plug and potting the back of the connector causing mis-alignment. There were, as expected, many questions covering this paper, mainly on the specifications being too controversial. Gold plating was specifically mentioned in this instance. The actual wording in the specification is so important and a great deal of common sense is needed.

The next paper was by Mr. G. M. Matthews and Mr. R. Britton of Plessey on 'Printed circuit board edge connector testing and evaluation for reliability'. The paper examined some of the steps the user of edge connectors can take to minimize reliability with this basically simple device. In devising a test programme for comparative evaluation of various edge connectors, the requirement had been divided into two parts. The first was the ability to withstand the relevant number of insertions and withdrawals of printed circuit boards under typical conditions of use. The second was the variation of electrical properties under environmental stress, with the contact resistance being the major parameter of interest.

Two aspects were discussed in detail, one being the relative merits of using a printed circuit board or a special gauge as the other mated half of the edge connector. This was of particular importance since the edge connector can only ever form one half of the object under evaluation, i.e., 'it is only half a component'. The second topic was that of the dynamic

* 'The assessment of connector reliability', *The Radio and Electronic Engineer*, 43, No. 8, pp. 486-9, August 1973.

characteristics of the mated connector under the conditions of shock, vibration and bump, where in order to assess connector performance, intermittent changes in contact resistance must be detected. He mentioned that for testing, 500 insertions and withdrawals was usual, and discussed at some length the board edge chamfered profile which varied from 0° through 15°, 30°, 45° and back to 0°. A standard of chamfered edge would be useful in view of the variability of board suppliers. The board connexion interface was vital and intermittency was a problem. This had often been found to be due to mechanical mounting.

A great many questions were raised on this paper; does any manufacturer actually profile? and the answer was 'not often'. The difficulty in obtaining printed circuit boards in small quantities was raised by many users. Some details of the actual testing, e.g. whether hard polished steel plates or actual boards should be used, and other questions covering the compatibility between the two types of gold on the board and connector were raised.

The last paper was by Mr. A. W. Eva of Consultancy PR Services on 'Standardization of connectors and BS 9000'. Mr. Eva first dealt with the historical aspect of the plug and socket in which he said that these were probably the subject of some of the earliest component standardization, going back to early domestic standards. The outbreak of the 1939-45 war showed the need for wide scale component standardization. The RAE 'W' range of connectors could be said to form the basis of early connector standardization: they were not environmental. The 'WW' range were an attempt to produce a range of environmental connectors: they were not an unqualified success. The Mk. 4 range were the first successful range of truly environmental connectors and were of small size. Formation of Interservices Components Standardization Committee took place to rationalize components; this later became the Joint Services Radio Components Standardization Committee.

The aftermath of the war saw a great proliferation of American connectors in this field and they dominated the markets. The Burghard Committee was formed to consider the Common Standards, and the Second Burghard report was issued and accepted; a Burghard management committee was formed and BSI was made responsible. The BSI sub-committee TLE 21/2 had the task of producing connector specifications. BS 9000 was published in 1967 and this allowed the component committees to proceed. Both l.f. and

r.f. generic specifications were published and a rules document for circular l.f. connectors quickly followed. Insurmountable difficulties arose as soon as detail specifications were attempted. A complete revision of the generics was necessary together with amendment to the rules before a satisfactory detail could be written. Work on all three proceeded side by side.

A policy decision based the early connector specifications on American designs, in the case of l.f. connectors, MIL-C-26482 and 38999, and for r.f. BNC, SMB and SMC. As a result of the setbacks referred to above, publication of BS 9000 connector specifications had been badly delayed but the position was now well in hand. Generic revision, rules amendments, and the first detail specifications were expected to be generally available by June 1973.

Work on rectangular connectors was proceeding well, rules for metal shell rectangular connectors were being printed, and detail specifications for two ranges were nearly at the comment stage. These two ranges would line up with two similar IEC ranges but should be available well in advance of IEC. Other work to follow would cover rectangular connectors without metal shells and also p.c. board connectors, but these were not likely to be available before next year.

As to whether block 3 specifications were really interchangeable between different manufacturers, Mr. Eva stated that this was carefully checked by both BSI and EQD. Many questions were raised on the delay in producing specifications. Mr. Eva pointed out that most Committee members had a main job and that BSI work was part-time and there was bound to be delay. He felt that the best that could be done in producing specifications from scratch was of the order of 12/18 months.

There is no doubt that this was a most useful colloquium on connectors and there was no lack of discussion, in fact the discussion at times became extremely lively and the Chairman had to intervene. The value of the colloquium was evident in that it became a forum for not only dissemination of present knowledge but also allowed a great many questions to be raised and answered which obviously had worried many of the delegates present. On the whole, therefore, a most successful colloquium.

G. W. A. DUMMER.

This Report was originally published in *Electronic Components* for 29th June 1973.

The effect of amplifier gain-bandwidth product on the performance of active filters

Professor E. A. FAULKNER,
Ph.D., C.Eng., F.I.E.E., F.I.E.R.E.*

and

J. B. GRIMBLEBY, Ph.D.*

SUMMARY

An expression for the sensitivity of a general second-order RC-active filter section to the finite gain-bandwidth product of the active elements (assumed to be first-order operational amplifiers) is derived and used to classify a number of well known active filter configurations according to the values of certain parameters of the general section. The circuits with a good high-frequency performance are found to have a high sensitivity to the values of passive components.

1 Introduction

In recent years it has been increasingly recognized that amplifier gain-bandwidth product is likely to be a major limiting factor in the performance of active filters,^{1, 2} and that some filter configurations are better than others from this point of view. In this paper we shall aim to set up criteria for assessment of the gain-bandwidth sensitivity of any second-order RC-active filter configuration.

Many authors have assumed^{e.g. 3, 4} that the high-frequency performance of active filters can be derived by using a value for the amplifier gain that is reduced as the frequency increases without taking account of the phase-shift that is introduced by the amplifier. In fact, as will be shown, this phase-shift (which is approximately $-\pi/2$ in the frequency range where the gain is inversely proportional to frequency) is a major factor in determining the sensitivity of active filter configurations to the finite gain-bandwidth of their amplifiers. Neglect of the phase-shift leads, for example, to the misconception that filter Q -factors are always reduced as the resonance frequency is increased whereas in many cases the reverse is true.

2 The General Active Filter

Although it is traditional to distinguish between circuits showing 'positive feedback' and circuits showing 'negative feedback' and also between circuits incorporating finite-gain 'voltage amplifiers' and circuits incorporating infinite-gain 'operational amplifiers', it is an inevitable fact that the active element must be embedded in a circuit which gives a high degree of overall negative feedback, and furthermore that the poles of the required system function are the zeros of the feedback network. The network includes any resistor pairs which may be considered to establish a 'voltage amplifier' function in any part of the circuit, and any connexion between output and inverting input which defines a 'voltage follower' function.

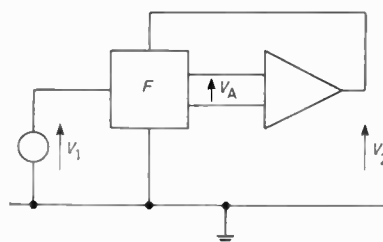

Fig. 1. A general active filter section.

Figure 1 shows the circuit diagram of a general active filter section with input voltage generator V_1 and output voltage V_2 . The linear network F is a three-port whose action is specified by the relation:

$$V_A(s) = V_1(s)F_1(s) + V_2(s)F_2(s) \quad (1)$$

where F_1 and F_2 have real poles and are characteristic of the network F provided that the input admittance of the amplifier is negligibly small. This condition will be satisfied in any normal design but otherwise the input

* J. J. Thomson Physical Laboratory, University of Reading, Whiteknights, Reading, RG6 2AF.

admittance can conveniently be assumed to be incorporated in the network F.

Assuming the amplifier to be compensated for a first-order response we can write for the voltage gain:

$$1/A_v(s) = 1/A_0 + sT_3 \tag{2}$$

where T_3 is the reciprocal of the (radian) voltage gain-bandwidth product of the amplifier and A_0 is the d.c. gain. For the purpose of studying the effect of finite amplifier gain-bandwidth product we now write:

$$V_A(s) = V_2(s) sT_3. \tag{3}$$

Combining equations (1) and (3) we obtain:

$$\frac{V_2}{V_1} = \frac{F_1}{sT_3 - F_2} \tag{4}$$

and it is now clear that the 'ideal' system function, that is the function obtained in the limiting case of infinite amplifier gain, is $-F_1/F_2$. The true sensitivity of the conjugate pole locations to variations of both passive and active components can be calculated from the form of F_2 .

We shall confine our attention to second-order sections for which F_2 will have the form:

$$F_2 = \frac{s^2/\omega_L^2 + s/\omega_L Q_L + 1}{\alpha s^2/\omega_L^2 + \beta s/\omega_L + \gamma} \tag{5}$$

where ω_L and Q_L are the 'ideal' resonance frequency and Q -factor and the parameters α, β, γ define the poles of F_2 . The sensitivity characteristics of any second-order system to finite gain-bandwidth are determined by these parameters. From equations (4) and (5) we find:

$$\frac{V_2}{V_1} = \frac{F_1(\alpha s^2/\omega_L^2 + \beta s/\omega_L + \gamma)}{\alpha s^3 T_3/\omega_L^2 + s^2(1 + \beta\omega_L T_3)/\omega_L^2 + s(1/Q_L + \gamma\omega_L T_3)/\omega_L + 1} \tag{6}$$

The numerator of this function is simply a polynomial due to cancellation of any real poles of F_1 with the poles of F_2 .

The system function defined by equation (6) is of third order and this reflects the fact that the finite gain-bandwidth product will inevitably introduce an extra pole into the response. However, this pole is far above the conjugate poles, and our primary interest in the cubic term is in relation to the effect which it has in perturbing the location of the conjugate poles. It can be shown (see Appendix) that to a first approximation this effect is equivalent to replacement of s^3 by $-\omega_L^2 s$. Equation (6) can therefore be written in the form:

$$\frac{V_2}{V_1} = \frac{F_1(\alpha s^2/\omega_L^2 + \beta s/\omega_L + \gamma)}{s^2(1 + \beta\omega_L T_3)/\omega_L^2 + s(1/Q_L + (\gamma - \alpha)\omega_L T_3)/\omega_L + 1} \tag{7}$$

from which we deduce the following expressions giving the changes in resonance frequency and frequency- Q product to first order in $\omega_L T_3$:

$$\omega_0 = \omega_L(1 - \beta\omega_L T_3/2) \tag{8}$$

$$\omega_0 Q = \omega_L Q_L \{1 - Q_L(\gamma - \alpha)\omega_L T_3\} \tag{9}$$

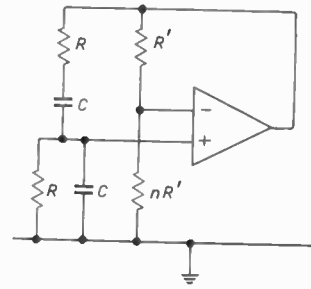

Fig. 2. The Wien bridge filter. ($\omega_L = 1/RC, Q_L = n/(2n-1)$.)

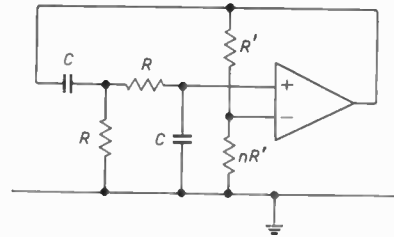

Fig. 3. The gain-of-three Sallen-Key filter. ($\omega_L = 1/RC, Q_L = n/(2n-1)$.)

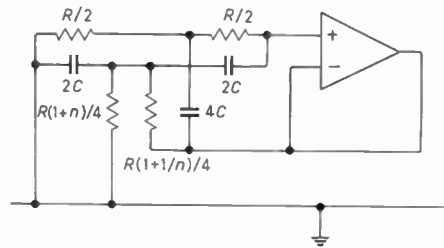

Fig. 4. A filter based on the symmetrical twin-T network. ($\omega_L = 1/RC, Q_L = (1+n)/2$.)

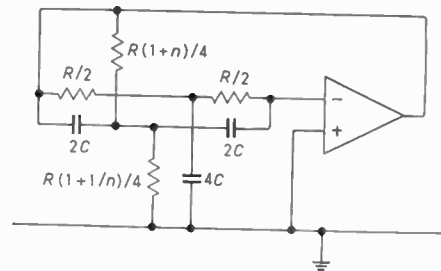

Fig. 5. A filter based on the asymmetrical twin-T network. ($\omega_L = 1/RC, Q_L = (1+n)/2$.)

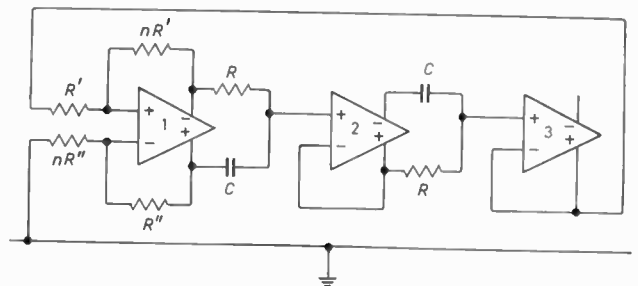

Fig. 6. A filter circuit due to Tarmy and Ghauri. ($\omega_L = 1/RC, Q_L = n+1/2$.)

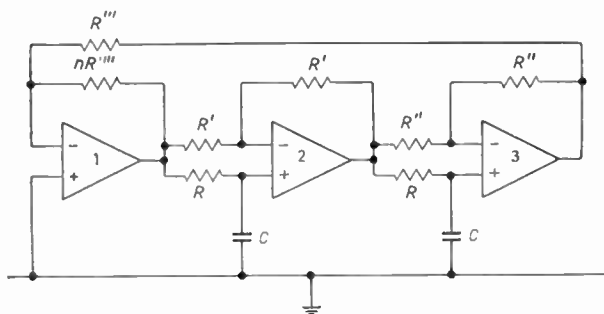

Fig. 7. A filter circuit due to Moschytz.
($\omega_L = 1/RC$, $Q_L = (1+n)/(2-2n)$.)

We can now write the gain-bandwidth sensitivity coefficients of ω_0 and Q (defined by $C_x^y \equiv \frac{1}{y} \cdot \frac{\partial y}{\partial x}$) as:

$$C_g^{\omega_0} = -\beta/2 \tag{10}$$

$$C_g^Q = \beta/2 - Q_L(\gamma - \alpha) \tag{11}$$

where $g = \omega_L T_3$.

We may employ this treatment to cover multiple-amplifier systems by allowing the network F to contain ideal operational amplifiers, that is amplifiers with infinite gain-bandwidth product. The calculation represented by Fig. 1 and equations (1)–(11) is repeated for each amplifier in turn (the others being assumed ideal) and the resulting gain-bandwidth coefficients are added together. This approach is particularly valuable to the designer because it enables him to locate any source of undue sensitivity to amplifier phase shift.

3 Active Filter Classification

We shall now classify some of the standard second-order sections according to their α , β , γ parameters. The circuits are given in Figs 2–13, no input or output terminals being shown on the diagrams because it is only the poles of the system function which are under consideration here.

Class 1. This class includes the Wien bridge filter (Fig. 2) which may be regarded as an optimized n.i.c. section where the n.i.c. is realized by an operational amplifier and two resistors, the gain-of-three Sallen–Key (lead-lag) filter (Fig. 3) and two configurations based on the well known symmetrical twin-T network (Figs 4 and 5). We have also included two filters which have been shown to have a low sensitivity to amplifier gain-bandwidth and which consist essentially of a second-order quasi-passive all-pass section connected in a feedback loop. The first of these is due to Tarmy and Ghausi⁵ (Fig. 6) and the second, which was published by Moschytz⁶ (Fig. 7), is claimed to be an improved version of the circuit due to Tarmy and Ghausi.

It can be seen from Table 1 that all of the filters in this class have the following properties:

$$\alpha = \gamma, \quad \beta \text{ independent of } Q_L.$$

The formulation of equation (9), which expresses the product of the Q -factor and the resonance frequency rather than the Q -factor alone, is of particular importance for this class of filter (and class 2) because it shows that while the Q -factor may increase as a result of amplifier

Table 1.

The α , β , γ parameters, gain-bandwidth sensitivity coefficients (C_g^Q) and passive component sensitivities (S_x^Q) of the filter configurations of Figs. 2–13.

Filter type	α	β	γ	C_g^Q	S_x^Q max
Wien bridge	3	9	3	9/2	$2Q_L$
Gain-of-three Sallen–Key	3	9	3	9/2	$2Q_L$
Twin-T	1	4	1	2	$Q_L/2$
Tarmy-Ghausi:					
amp. 1	1/2	1	1/2	1/2	$Q_L/2$
amp. 2	1/2	1	1/2	1/2	$Q_L/2$
amp. 3	1/2	1	1/2	1/2	$Q_L/2$
Moschytz:					
amp. 1	1	2	1	1	Q_L
amp. 2	1	2	1	1	Q_L
amp. 3	1	2	1	1	Q_L
Unity-gain Sallen–Key	1	$2Q_L$	1	Q_L	1/2
Rauch	1	$2Q_L$	1	Q_L	1/2
Ring-of-three:					
amp. 1	2	$2/Q_L$	0	$2Q_L$	1
amp. 2	1	1	0	Q_L	1
amp. 3	1	1	$1/Q_L$	Q_L	1
Gyrator or p.i.c.:					
amp. 1	-2	$-2/Q_L$	2	$-4Q_L$	1
amp. 2	1	2	1	1	1
Two-amplifier two-lag:					
amp. 1	$3Q_L$	3	$2/3Q_L$	$3Q_L^2$	1/2
amp. 2	$3Q_L$	2	$1/3Q_L$	$3Q_L^2$	1/2
One-amplifier two-lag:	$16Q_L^2$	$12Q_L$	1	$16Q_L^3$	1/2

phase shifts, the product $\omega_0 Q$ remains constant so that systems in this class containing one amplifier never become unstable.

The gain-bandwidth sensitivity coefficients of this class of filter are given by:

$$C_g^Q = -C_g^{\omega_0} = \beta/2 \sim 1.$$

If we temporarily restrict the discussion to configurations containing a single amplifier the function F_2 must have a d.c. gain of less than unity and a Q -factor of less than 1/2. Thus:

$$\alpha = \gamma \geq 1$$

$$\beta/\sqrt{\alpha\gamma} \geq 2$$

so that the theoretical minimum gain-bandwidth coefficient for a one-amplifier configuration is:

$$[C_g^Q]_{\text{minimum}} = 1.$$

It can be seen from Table 1 that none of the one-amplifier circuits attains this optimum although designs which approach the theoretical minimum sensitivity are practicable.

It is a property of all filters of this class in Table 1 that they are highly sensitive to the values of passive components because the term in $1/Q$ is the small difference between two quantities determined by separate circuit

elements (i.e. $S_x^Q \equiv \frac{x}{Q} \cdot \frac{\partial Q}{\partial x} \sim Q$). Two of these filters were originally claimed to be of low sensitivity ($S_x^Q \sim 1$) and the essentially high sensitivity of the circuits is concealed in references 5 and 6 in different ways. In the paper by Tarmy and Ghausi use is made of operational amplifiers (Motorola type 1520) which have two output terminals at which voltages V_0, V_0' are nominally in anti-phase. The operation of the whole circuit depends critically on the assumption that:

$$\frac{V_0}{V_0'} = -1.$$

The ratio of these voltages is in practice equal to the ratio of two resistors internal to the amplifier. In the analysis the voltages are simply expressed as $V_0, -V_0$ so that the true sensitivity to these resistors does not appear.

In the circuit published by Moschytz the amplifiers are single-ended and the generation of the all-pass function depends on the equality of certain resistor values. However in the analysis of the circuit the relevant resistor values are all represented by the symbol R_0 so that the question of inequality does not arise. In a correct formulation the values of these resistors would be separately represented and the sensitivity to these values evaluated.

Class 2. In this class are the unity-gain Sallen-Key filter⁷ (Fig. 8) and the Rauch filter⁸ (Fig. 9). A particular feature of the treatment we present here is that it shows that these two configurations have identical feedback functions F_2 and are therefore indistinguishable⁹ as regards sensitivity both to amplifier gain-bandwidth and to the values of passive components. This treatment is in contrast to the distinction often made between these circuits in the literature on the basis of the sign of the feedback. These filters, unlike those of class 1, have low sensitivity to passive component values and as can be seen

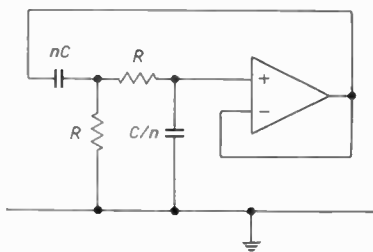

Fig. 8. The unity-gain Sallen-Key filter. ($\omega_L = 1/RC, Q_L = n/2$.)

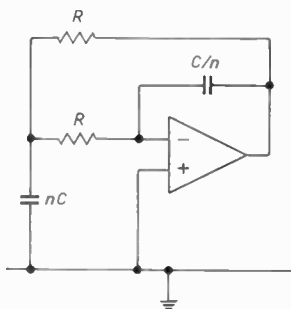

Fig. 9. The Rauch filter. ($\omega_L = 1/RC, Q_L = n/2$.)

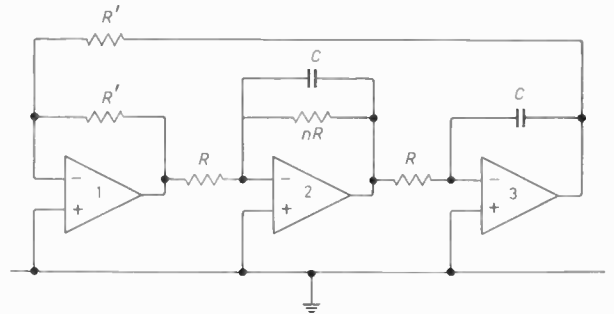

Fig. 10. The ring-of-three filter. ($\omega_L = 1/RC, Q_L = n$.)

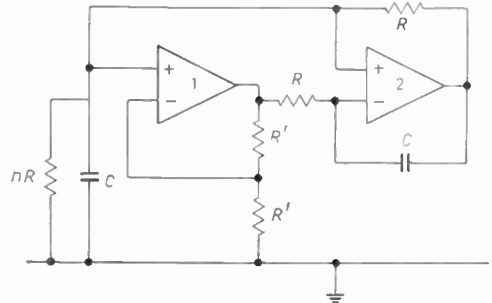

Fig. 11. A filter configuration obtained by using gyrator or positive immittance converters to achieve a second-order section. ($\omega_L = 1/RC, Q_L = n$.)

from Table 1 have the following parameter values:

$$\alpha = \gamma, \quad \beta \sim Q_L$$

In common with class 1 this class of filter has a product $\omega_0 Q$ which is independent of amplifier gain-bandwidth. The coefficients are given by:

$$C_g^Q = -C_g^{\omega_0} = \beta/2 \sim Q_L$$

and the filters are therefore less well suited to high Q -factor applications at high frequencies than those of class 1.

Class 3. In this class we include the well known ring-of-three or two-integrator-loop first published by Good^{10,11} (Fig. 10) and the circuit of Fig. 11 which is representative of the type of filter circuit one obtains if gyrators¹² or positive immittance converters¹³ (realized with operational amplifiers) are used to produce a second-order section. It can be seen from Table 1 that one amplifier in the gyrator type circuit belongs to class 1, but since the gain-bandwidth coefficients of the amplifiers must be added together the relevant class for the filter is that corresponding to the amplifier with the largest coefficient. It is recognized, of course, that operational-amplifier-based gyrator and positive immittance converter approaches to filter synthesis are not appropriate to second-order filters.

The filters in this class have the following parameter values:

$$|\alpha - \gamma| \sim 1, \quad \beta \sim 1$$

from which the gain-bandwidth coefficients can be derived:

$$C_g^{\omega_0} = -\beta/2 \sim -1/2$$

$$|C_g^Q| = |-\beta/2 + Q_L(\alpha - \gamma)| \sim Q_L$$

and it is seen that, contrary to what has been stated in the active filter literature,^{e.g. 14} these filters have a high sensitivity to the effects of finite amplifier gain-bandwidth. However, in common with the filters of class 2 these filters can be designed to have a low sensitivity to the values of passive components.

4 Non-classified Filters

Although, as we have shown, these three classes are sufficient to characterize the majority of the well-known filter configurations, it is nevertheless possible to devise filters which do not fit into any of these categories and a number of such circuits have been published. It is found, however, that these circuits have an inferior high frequency performance to those of classes 1-3. As examples of filters which are unsuitable for high Q-factor applications at high frequencies we shall now consider the properties of the two-lag filter, both in its single-amplifier^{3, 7} and two-amplifier³ configurations.

The circuit of a two-amplifier two-lag filter is shown in Fig. 12 and it has the following properties:

$$\begin{aligned} \text{amp 1 } C_g^Q &= 3Q_L^2 \\ \text{amp 2 } C_g^Q &= 3Q_L^2 \end{aligned}$$

giving a total gain-bandwidth sensitivity coefficient for the filter of

$$C_g^Q = 6Q_L^2.$$

Comparing this with the coefficients of class 1 filters it is seen that the maximum usable frequency of the filter is a factor of $3Q^2$ lower than the best attainable.

An even more extreme example of a filter which is sensitive to amplifier gain-bandwidth is the one-amplifier two-lag filter. A filter of this type is shown in Fig. 13 and has a gain-bandwidth coefficient of Q of

$$C_g^Q = 16Q^3.$$

This is a factor of about $8Q^3$ worse than the best filters of class 1 and a filter of this type with a Q-factor of 10 using a 741 type amplifier would be limited to frequencies below about 10 Hz.

6 Appendix

Consider a second-order active filter section with an ideal system function:

$$H(s) = \frac{N(s)}{s^2/\omega_L^2 + s/\omega_L Q_L + 1}.$$

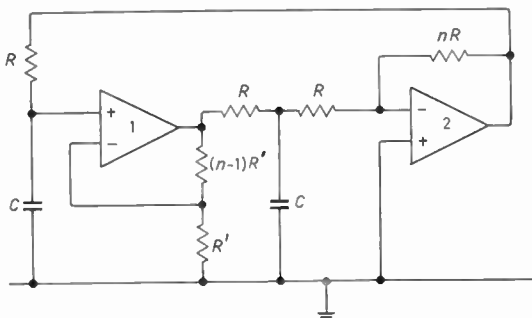

Fig. 12. A two-amplifier two-lag filter. ($\omega_L = n/RC$, $Q_L = n/3$.)

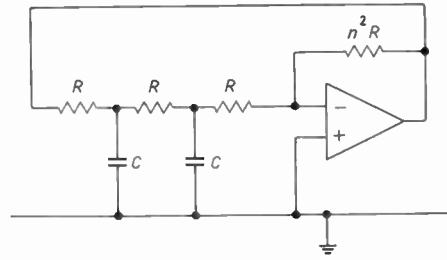

Fig. 13. A one-amplifier two-lag filter. ($\omega_L = n/RC$, $Q_L = n/4$.)

The finite gain-bandwidth products of the amplifiers will raise the system from second to third order and we shall write the denominator as:

$$D(s) = as^3/\omega_L^3 + (1+b)s^2/\omega_L^2 + (1/Q_L + c)s/\omega_L + 1$$

where a, b, and c are assumed to be small (i.e. $\ll 1$) perturbations. We now write this denominator as the product of a real pole at ω_f and a pair of conjugate poles at ω_L :

$$D(s) = (1 + s/\omega_f)\{(1 + b')s^2/\omega_L^2 + (1/Q_L + c')s/\omega_L + 1\}$$

By comparing coefficients with the previous expression we obtain the following relations:

$$\begin{aligned} a &= (1 + b')\omega_L/\omega_f \\ b &= b' + (1/Q_L + c')\omega_L/\omega_f \\ c &= c' + \omega_L/\omega_f. \end{aligned}$$

Neglecting terms which are second-order perturbations and assuming that $Q_L \gg 1$ we can write to a good approximation:

$$\begin{aligned} b' &= b \\ c' &= c - a. \end{aligned}$$

Because we are primarily interested in the effect that the finite amplifier gain-bandwidth has in perturbing the conjugate poles we can omit the far-off pole at ω_f from the denominator. The original third-order denominator can therefore be replaced by the following expression:

$$D'(s) = (1 + b)s^2/\omega_L^2 + (1/Q_L + c - a)s/\omega_L + 1.$$

5 References

1. Faulkner, E. A. and Grimbleby, J. B., 'Active filters and gain-bandwidth product', *Electronics Letters*, 6, pp. 549-50, 20th August 1970.
2. Budak, A. and Petrela, D. M., 'Frequency limitations of active filters using operational amplifiers', *IEEE Trans. on Circuit Theory*, CT-19, pp. 322-8, July 1972.
3. Soderstrand, M. A. and Mitra, S. K., 'Gain and sensitivity limitations of active RC filters', *IEEE Trans. on Circuit Theory*, CT-18, pp. 600-9, November 1971.
4. Moschytz, G. S., 'The operational amplifier in linear active networks', *IEEE Spectrum*, 7, pp. 42-50, January 1970.
5. Tarmy, R. and Ghausi, M. S., 'Very high-Q insensitive active RC networks', *IEEE Trans. on Circuit Theory*, CT-17, pp. 358-66, August 1970.
6. Moschytz, G. S., 'High-Q factor insensitive active RC network, similar to the Tarmy-Ghausi circuit but using single-ended operational amplifiers', *Electronics Letters*, 8, pp. 458-9, 7th September 1972.
7. Sallen, R. P. and Key, E. L., 'A practical method of designing RC active filters', *IRE Trans. on Circuit Theory*, CT-2, pp. 74-85, March 1955.
8. Rauch, L. and Nichols, M. H., 'Radio Telemetry', p. 396 (Wiley, New York, 1956).

9. Foss, R. C. and Green, B. J., 'Q-factor, Q-stability and gain in active filters', *Electronics Letters*, 2, pp. 99-100, March 1966.
10. Good, E. F., 'A two-phase l.f. oscillator', *Electronic Engineering*, 29, pp. 164-210, April 1957.
11. Kerwin, W. J., Huelsman, L. P. and Newcomb, R. W., 'State-variable synthesis for insensitive integrated circuit transfer functions', *IEEE J. Solid State Circuits*, SC-2, pp. 87-92, September 1967.
12. Riordan, R. H. S., 'Simulated inductors using differential amplifiers', *Electronics Letters*, 3, pp. 50-1, February 1967.
13. Gorski-Popiel, J., 'RC-active synthesis using positive imittance converters', *Electronics Letters*, 3, pp. 381-2, August 1967.
14. Geffe, P. R., 'RC amplifier resonators for active filters', *IEEE Trans. on Circuit Theory*, CT-15, p. 418, December 1968.

Manuscript received by the Institution on 18th May 1973. (Paper No. 1542/CC178.)

© The Institution of Electronic and Radio Engineers, 1973

STANDARD FREQUENCY TRANSMISSIONS— July 1973

(Communication from the National Physical Laboratory)

July 1973	Deviation from nominal frequency in parts in 10^{10} (24-hour mean centred on 0300 UT)			Relative phase readings in microseconds NPL—Station (Readings at 1500 UT)		July 1973	Deviation from nominal frequency in parts in 10^{10} (24-hour mean centred on 0300 UT)			Relative phase readings in microseconds NPL—Station (Readings at 1500 UT)	
	GBR 16 kHz	MSF 60 kHz	Droitwich 200 kHz	*GBR 16 kHz	†MSF 60 kHz		GBR 16 kHz	MSF 60 kHz	Droitwich 200 kHz	*GBR 16 kHz	†MSF 60 kHz
1	+0.1	0	0	728	636.7	17	0	0	0	723	630.3
2	0	+0.1	+0.1	728	635.9	18	0	0	0	723	630.3
3	+0.1	+0.1	+0.1	727	635.0	19	0	0	0	723	630.7
4	+0.1	0	0	726	635.0	20	0	0	-0.1	723	630.5
5	+0.1	0	0	725	634.6	21	0	-0.1	-0.1	723	631.1
6	0	+0.1	-0.1	725	633.8	22	0	0	0	723	631.2
7	0	0	+0.1	725	633.7	23	0	0	0	723	631.3
8	0	0	0	725	633.8	24	0	-0.1	0	723	631.7
9	0	0	0	725	633.9	25	0	0	0	723	631.5
10	+0.1	+0.1	0	724	632.9	26	0	0	0	723	631.5
11	0	+0.1	0	724	632.4	27	0	0	0	723	631.1
12	+0.1	+0.1	0	723	631.7	28	0	0	0	723	630.9
13	0	+0.1	0	723	631.2	29	0	0	+0.1	723	631.3
14	+0.1	+0.1	0	722	630.5	30	+0.1	0	+0.1	722	630.9
15	0	0	0	722	630.3	31	+0.1	+0.1	0	721	629.1
16	-0.1	0	0	723	630.6						

All measurements in terms of H-P Caesium Standard No. 334, which agrees with the NPL Caesium Standard to 1 part in 10^{11} .

* Relative to UTC Scale; $(UTC_{NPL} - Station) = + 500$ at 1500 UT 31st December 1968.

† Relative to AT Scale; $(AT_{NPL} - Station) = + 468.6$ at 1500 UT 31st December 1968.

Hybrid computer simulation applied to digital communication systems

R. J. MORROW, (Graduate)*

and

C. S. WARREN, B.Sc., C.Eng., M.I.E.E.†

Based on a paper presented at the IERE Conference on Digital Processing of Signals in Communications held at Loughborough from 11th to 14th April 1972

SUMMARY

A large hybrid computer has been used to simulate modern communication systems, particularly those using digital radio techniques. This paper describes the basic thinking behind these models, outlines some of the techniques used and takes, as an example, a digital f.s.k. radio system. The unique results obtained, especially with regard to co-channel interference show the versatility and power of the simulation technique used.

* British Aircraft Corporation Limited, Electronic and Space Systems, Filton, Bristol.

† Formerly British Aircraft Corporation; now with SHAPE Technical Centre, The Hague, Netherlands.

1 Introduction

Hybrid computer models can offer significant advantages over other types of computer model when the problem is one of specifying subsystem parameters during the design stage of a communications system.

From conception to realization, the specification of a communications system will progress from a definition of the overall system performance to a list of tolerances on a circuit diagram. At each step it is important that the implication of parameter variations are understood and that accurate specifications are issued. If a specification is too 'tight' costs may be too high; if the specification is too 'slack' performance will suffer.

Under the heading of Computer Aided Design (c.a.d.), many programs have been written that relate the performance of circuit components to the performance of the circuit or subsystem to which they belong. These help the designer to ensure that each circuit meets the subsystem specification.

To complement this capability, the system designer needs to be able to assess the impact of variations in subsystem performance on the system. This will then enable meaningful subsystem parameters to be defined.

It is in this area that the hybrid computer models described in this paper have the most impact. They enable the equipment designer to assess the effects of subsystem variations on the overall system performance.

An example of such a problem might be the definition of upper and lower bounds on the group delay characteristic of an i.f. filter in a digital radio receiver where the system performance is defined in terms of a certain path loss at a fixed error rate.

2 The Philosophy of Modelling

Before considering the structure of a computer model suitable for the assessment of parametric changes in system performance it is useful to consider the desirable outputs.

Firstly, as the criterion of acceptability of most, if not all, digital communications systems is the operational bit error rate, an essential output is a curve of bit error rate against signal/noise ratio.

Secondly, the system specification may state that the equipment must be operated within a certain bandwidth, particularly if radio transmission is involved. Even if this is not a definite requirement it is a desirable feature as it can tell the system designer much about the system performance.

Thirdly, if other channels are to be closely spaced in the frequency domain allowing adjacent channel interference to occur, or if some form of crosstalk exists in the system, then the model should be able to include the effects of at least one interfering transmitter.

These points lead us to the basic model shown in Fig. 1. In this model a data message stream passes through a transmitter and receiver and is reconstituted after the receiver. This output data message stream is then compared with the original input allowing the bit error rate to be measured. Interference and Gaussian

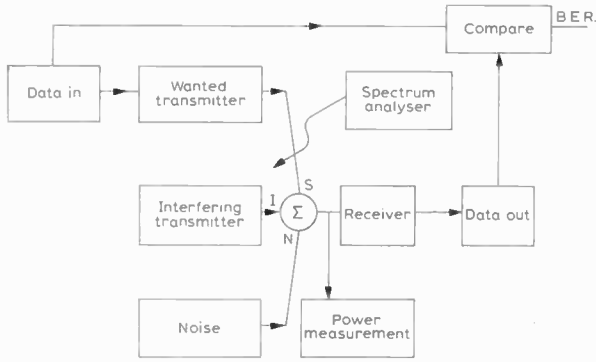

Fig. 1. Basic model.

noise can be added to the signal at any point. The power measurement block is included to monitor the ratios of signal, noise and interferences and the spectrum analyser is used to provide measured spectrum.

To realize this basic model it is necessary to characterize the operation of each of the primary elements that make up the full system. The elements that effect the characteristics of interest here will only be those that either spread or limit the spectrum or act as signal processing elements. The former applies particularly to non-linear modulation processes and filters while the latter applies to demodulators, logic elements and filters. The consideration of a block diagram of a typical digital radio link (Fig. 2), helps to indicate which parts require modelling. The encoder, the premodulation filter, the modulation process, the r.f. amplification process (particularly if a.m. to p.m. conversion takes place), path variations (fast fading etc.), the receiver thermal noise, the i.f. filter, the demodulation process, the post-detection filtering, the bit conditioner and the performance of the digit locked loop all affect either the bit error rate (b.e.r.) characteristic, or the spectrum, or both. On the other hand, any up-conversions associated with modulation, corresponding receiver down-conversions, broadband r.f. filtering and antenna characteristics may be considered broadband and linear as far as error rate performance and detailed transmitter output spectra are concerned.

Bearing in mind the characteristics of the elements to be modelled, a hybrid computer offers some very real advantages over, say, a digital computer. Operations, both analogue and logic, which take place in parallel in

real time can be simulated in parallel using the analogue portion of a hybrid computer.

Inherent difficulties in mathematically characterizing certain complex communication system elements are avoided and parameter changes are relatively simple to perform and can be carried out while a simulation is running. Also, any process that is best carried out using digital computer techniques (such as the Fast Fourier Transform described later) can be included using the digital portion of the machine.

The computer used in the work described here is an EAI 8945 which consists of approximately 250 patchable operational amplifiers and 150 patchable logic elements connected by a 32 channel A to D and D to A conversion equipment to a 32 k word digital computer. A disk of 330 k words is used as back-up store and the usual peripherals are available (both analogue and digital).

3 The Use of the Analogue Section

The previous section has outlined the parts of a system requiring simulation. Many of these can be simulated using the analogue portion of the hybrid computer and in this section we briefly discuss the methods used. Basically, the analogue portion can be used to simulate elements of a communication link definable by linear differential equations, linear equations, non-linear equations and logic processes. Each of these will now be examined in turn.

3.1 Simulation of Elements Defined by Linear Differential Equations

A number of basic elements in communication systems fall into the category of linear time-invariant two-port networks whose input and output voltages are related by linear integral/differential equations which can be easily simulated using an analogue computer. These elements may be conveniently characterized by a general transfer function of the form:

$$F(s) = K \frac{\prod_{r=1}^m (s - Z_r)}{\prod_{r=1}^n (s - P_r)}$$

where s is the complex Laplace transform variable and the complex terms P_r and Z_r are the poles and zeros of the transfer function.

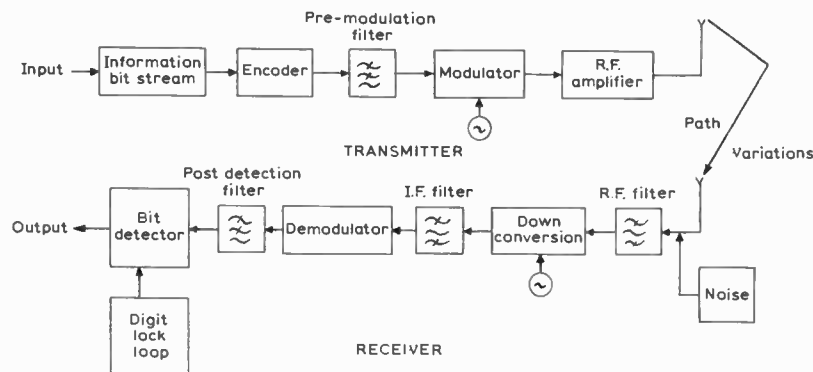

Fig. 2. Typical radio link.

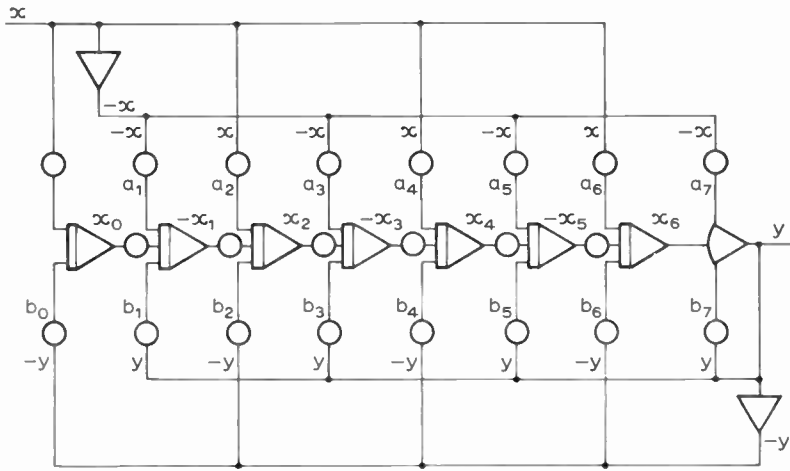

Fig. 3. Seven-element low-pass filter using nested form of equations.

In order to simulate these functions they must first be expanded and frequency scaled into a suitable form. Integrators (analogue building blocks having a transfer function $1/s$) are connected in cascade and the required transfer function is produced by the incorporation of various feed forward and feed back loops and scaling with the aid of potentiometers. Figure 3 shows one form of connexion for a seven-element low-pass filter.

Filters, delay equalizers and oscillators can be described by the above equation and can be simulated using this method. It is, of course, necessary to represent the transfer function of these devices in terms of the Laplace variable, but this does not present a problem.

The theoretical transfer functions of many classes of filter are available in literature.¹ These are usually in a low-pass normalized form but it is a simple operation to perform the transformations necessary before a simulation can take place.

In contrast, delay equalizers are often produced for one specific application but we know that they will have equal number of poles and zeros and that these will form a mirror image set about the $j\omega$ axis in the s plane. This is different from most practical filters where zeroes are on the $j\omega$ axis, but it does not introduce any simulation problems.

Oscillators are represented by a transfer function of the form:

$$\frac{1}{s^2 + \omega^2} \text{ and thus have poles at } s = \pm j\omega.$$

They are therefore quasi-stable and it is usual to incorporate amplitude correction circuits of the form:

$$\cos^2 \omega t + \sin^2 \omega T = 1.$$

3.2 Simulation of Elements Defined by Linear Equations

This section is concerned with those elements of a communication system whose performance may be described in terms of a linear expression (e.g. $V_{OUT} \propto f_{IN}$). Both modulators and demodulators fall into this category.

Modulators may be classified into two groups, linear and exponential. Linear modulation is essentially a low-pass to band-pass transformation of the message spectrum and is usually achieved by a multiplication of the information waveform and a carrier waveform. Modification to the transformed spectrum yield variations such as s.s.b. and v.s.b. As a basic component of an analogue computer is the multiplier, a.m. may easily be simulated by applying the message waveform to one input and the carrier frequency to the other. The output of the multiplier is then added to the original carrier; the ratio of the two determines the depth of modulation.

With exponential modulation either the phase or the frequency of a carrier is varied in proportion to the magnitude of a message waveform. Direct frequency modulation requires the use of a voltage-controlled oscillator. This may be simulated with the aid of multipliers substituted for the frequency potentiometers used with a standard sinewave oscillator simulation. Other methods of simulating exponential modulation may be derived using standard analogue techniques.

Turning now to the large number of different demodulators in use, it is impossible to describe each method of simulation, but two important classes are noted.

In the case of linear demodulation, the detection process usually involves a downward frequency translation and envelope detection. The downward frequency translation is simulated using a multiplier and the envelope detection process is simulated by a diode characteristic followed by a low-pass filter.

The most common form of f.m. demodulator is that class of device known as the limiter-discriminator, the best known of these being the Foster-Seeley discriminator. It is simulated in two parts. Firstly, a diode function generator is used to model the limiter. Secondly, the circuit of the discriminator is analysed using standard circuit analysis techniques and reduced to the form of interconnecting transfer functions feeding the discriminator diodes. This form is then readily amenable to simulation.

3.3 *Simulation of Elements Defined by Non-Linear Equations*

A network with non-linear elements cannot be defined by a transfer function since its integral/differential equation is not linear. Instead, the instantaneous values of input and output are related by a curve or function commonly called a transfer characteristic.

In many cases of system design it is imperative that the most important system non-linearities are included. These might include mixer characteristics, r.f. amplifier non-linearities including both non-linear gain and phase characteristics, limiters etc. Many analogue techniques are available to simulate non-linear transfer characteristics, the most common being the diode function generator. A knowledge of the exact shape of the transfer characteristic allows a piecewise linear representation of the function. This linear segment approximation is obtained by a number of diode switches which are biased so that they present various linear segments in response to the input voltage. These diode function generators can be combined with operational amplifiers and multiplexers to obtain complicated non-linear characteristics, including non-linear phase characteristics.

3.4 *Simulation of Elements Defined by Logic Processes*

The EAI 8945 hybrid computer has a large section of parallel patchable logic including gates, registers, monostables, bistables, differentiators, comparators and digital analogue switches. These elements are used to simulate digital encoders and decoders, digital codes, pseudo-random sequences, digit locked loops and pulse modulated systems.

In the case of modulation systems designed to transmit information in the form of binary digits, the simulated baseband information must be a frequency scaled representative train of pulses. A method of simulating this information is to employ shift registers with appropriate feedback loops to obtain a maximal length pseudo-random bit stream. It is, of course, important that the repetition time of the p.r. sequence is much longer than any inherent system memory. Practical code lengths are $2^{12} - 1$ bits.

Complex forms of digital communication systems employ various types of digital encoders and decoders to obtain certain system advantages (e.g. multi-level modulation systems). To obtain the encoded message format, logic circuitry is required and this may be identical to that envisaged for the practical system. If the quantity of logic needed is larger than the machine's capability then extra external practical circuits may be patched in, provided that this logic is clocked at the scaled simulation rate.

4 The Use of the Digital Computer

The digital portion of the hybrid computer is used to provide the following necessary operations.

4.1 *Simulation Control*

A disadvantage inherent with analogue computation is the time taken to set up a simulation. This is largely due

to the slow process of hand setting each potentiometer. As the hybrid computer has the ability to servo-set the potentiometers, a digital program is used to automatically set up the simulation. This program is incorporated into a much larger control program which is able to take over the manual procedures involved in running a simulation. Basically this program is built up of the following parts:

A main program which allows control to be directed to any number of subroutines or subprograms.

Individual subprograms designed to automatically set up individual system parameters such as signal levels, carrier frequencies and digital delays.

Individual subprograms designed to measure system operating parameters such as signal levels and carrier frequencies.

Individual subroutines designed to monitor for fault conditions such as incorrectly set signal to noise ratios.

Individual subprograms capable of making diverse types of measurements.

An expansion of the last point highlights the digital computer's versatility in analysing random signals.

The hybrid computer can sample any simulated time domain waveform and transmit the value of these samples to the digital core store.

By performing various operations on these samples, the following measurements can be made:

(a) *Probability Density Functions*

With the aid of a program which divides the known voltage range into N increments and counts the number of times each incremental level is obtained, a histogram showing the distribution of signal amplitude may be recorded as a lineprinter output.

(b) *Power Spectra*

Using a version of the Fast Fourier Transform,² the time domain samples can be processed to produce an accurate record of the spectrum existing at the measurement point. Various options exist with regard to averaging in both the time and frequency domain and output may have either logarithmic or arithmetic power scales.

(c) *Correlation*

The correlation may be obtained by a frequency domain multiplication of any two power spectra followed by an inverse transform. Thus, using the Fast Fourier Transform program either the auto-correlation or the cross-correlation function may be obtained as an output.

(d) *Error Rate Estimators*

In the analysis of digital communication systems, the performance of the system is measured in terms of the bit error rate. Bit error rates may be accurately measured by passing the correct input information stream and the reconstructed information to the digital computer. The two streams are compared and the ratio of the total number of errors to the total number of bits is calculated. Where low error rates (10^{-4}) are to be measured, statistical estimation techniques are used to reduce

the measurement time and give a measure of confidence in the results.

5 An Example of the Simulation Technique Applied to the Design of a Radio System

To demonstrate the concepts described previously, the simulation of a hypothetical digital f.m. radio system will be discussed. The specification of this radio system is given in Table 1: the basic model is arranged as shown in Fig. 1. An information bit stream modulates the wanted transmitter; interference in the form of Gaussian noise and like modulated interference is added and the combined signal is fed into the receiver. The reconstructed receiver output is then compared with the original information bit stream and the bit error rate (b.e.r.) measured.

As the system to be analysed employs low deviation ratio binary f.m. modulation, the blocks required in the simulation are shown in Fig. 4. It can be seen that the receiver r.f. filtering and down conversion stages are not simulated and the i.f. filtering, even if split between stages, is simulated as one filter. The r.f. filtering is not simulated as it has a bandwidth much larger than the information bandwidth and as such should not affect the error rate performance. The down conversion stages are assumed to be linear frequency translations and are also excluded.

The premodulation and post detection filters are simulated using nested groups of integrators. The accuracy of the simulated filter is of the order of 0.1 dB of theoretical over a dynamic range of 50 dB. The i.f. filter is simulated as a cascaded set of two-pole sections derived from the theoretical transfer function. The accuracy of the simulated filter suffers from the inherent distortion caused by the low ratio of maximum simulated

Table 1: Characteristics of digital f.m. system

Parameter	Practical value	Simulation value
Carrier frequency	30-70 MHz	1 kHz
Baseband information rate f_b	20 kbit/s	200 Hz
Premodulation filter		
Gaussian to 12 dB transitional 3 dB bandwidth	$0.75 f_b$	150 Hz
I.f. filter		
Gaussian to 12 dB transitional 3 dB bandwidth	$1.24 f_b$	248 Hz
Post detection filter		
Gaussian to 12 dB transitional 3 dB bandwidth	$0.75 f_b$	150 Hz
Receiver digit timing	instantaneous	instantaneous
Demodulation method	limiter + discriminator	limiter + Foster-Seeley discriminator

i.f. carrier frequency to i.f. filter bandwidth, a figure of 10 being used. This produces a skew-symmetric amplitude response. However, a recent paper⁴ indicates that this has very little effect and our comparison of simulated and practical results confirms this.

The most important aspect of any simulation is the accuracy obtainable and, to this end, a high degree of system control is introduced into each model.

This control is provided during the model proving and initial running phases and takes the form of static, modular and functional tests. These tests are performed in the following order:

- (a) Static tests—these ensure that the patching and variable parameters of the analogue and digital patching boards have been set up correctly.

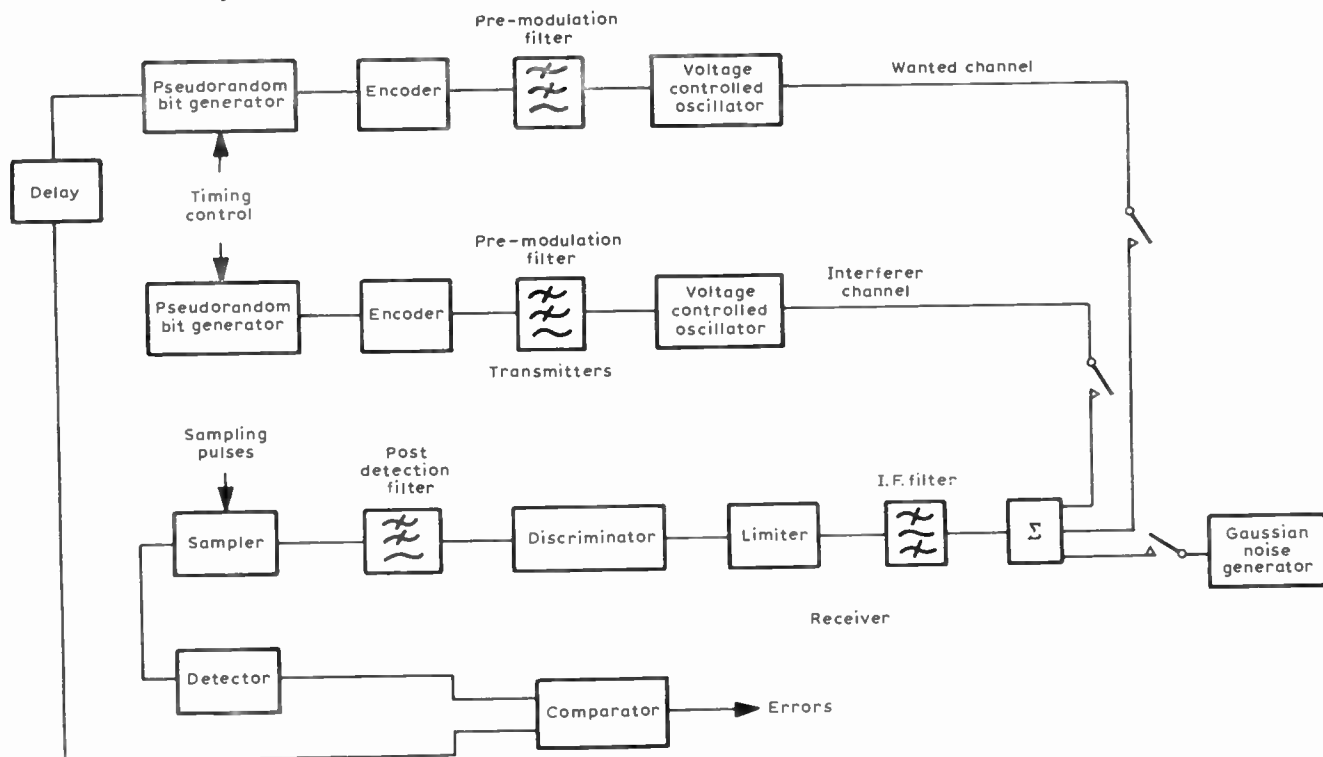

Fig. 4. Basic f.m. simulation.

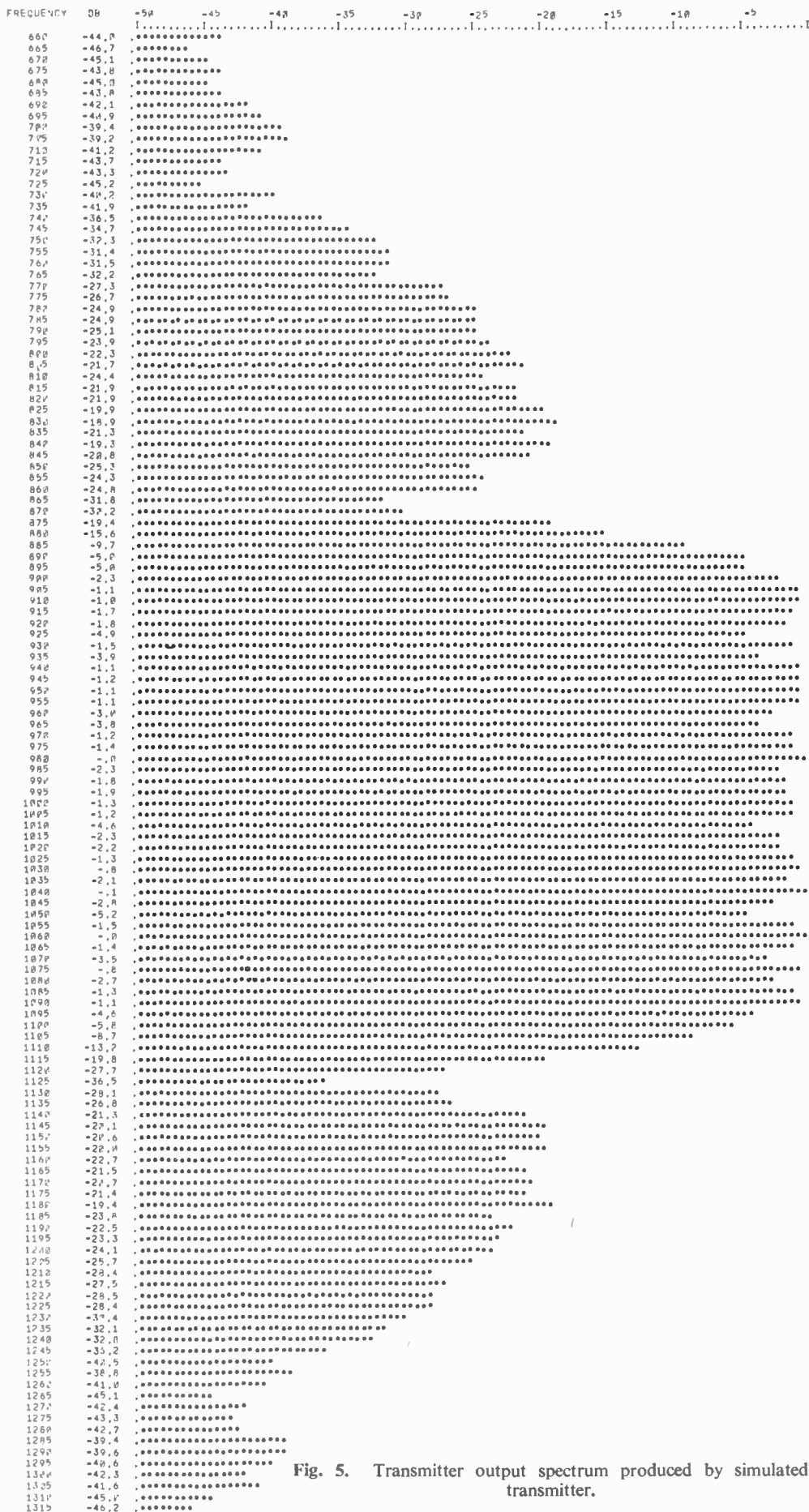

Fig. 5. Transmitter output spectrum produced by simulated transmitter.

(b) Modular functional tests—these are designed to ensure the correct operation and validity of individual simulated communication processes, e.g. filters, oscillators, modulators, etc.

(c) System functional tests—these are employed to optimize the full communication simulation and test the validity of the total representation.

Normal test equipment such as frequency counter, oscilloscope, transfer function analyser and the digital spectrum analyser routine are used to perform these tests which in most cases are identical to measurements made on practical systems.

With the simulation set up and validated the system may then be analysed using the available measurement techniques. To assess the probable channel bandwidth required by the radio system and perhaps the wider implication of how many similar transmitters may be allocated in a restricted frequency band it is necessary to analyse the r.f. emission of the system. With the aid of the digital spectrum analysis program the transmitter output spectrum produced by the simulated transmitter may be recorded. A typical record taken from the system example is given in Fig. 5. The occupied bandwidth may be evaluated from these data. Also, using this information plus a knowledge of the receiver's total r.f. and i.f. filtering, the power rejection to like interference with various channel separations may be calculated. This information then allows an initial assessment of how many such transmitters may be allocated in a restricted frequency allocation without causing unacceptable degradation.

To obtain a qualitative assessment of the effect of the filtering and deviation ratio employed, the technique of recording 'eye patterns'³ at the system output is used. Eye patterns are obtained from the simulation in the form of an oscilloscope trace by sweeping the simulated base-band system output waveform against a linear time-base synchronized with the bit rate. The pattern is then built up from the storage of many bits. A typical oscilloscope trace obtained from the output of the simulated post detection filter in the design example is shown in Fig. 6. This indicates that a certain degree of intersymbol is inherent with this system specification. Minor alterations in the simulated system may be made and a qualitative

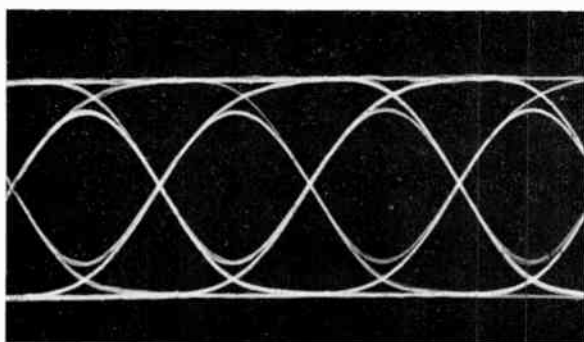

Fig. 6. Oscilloscope trace obtained from output of simulated post detection filter.

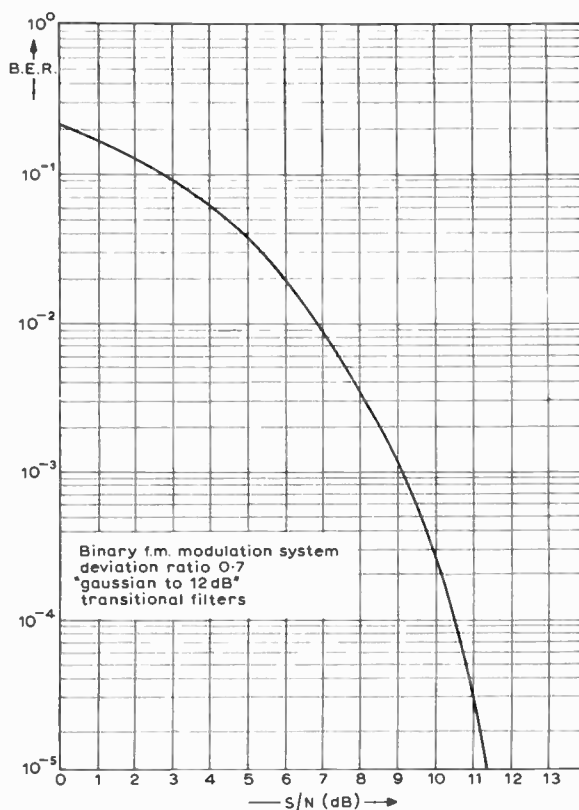

Fig. 7. Error rate with Gaussian noise interference.

assessment of any resulting improvement may be seen from subsequent eye patterns.

In the design example, instantaneous sampling has been used to reconstruct the binary data. The sampling pulse is usually derived from a digit lock loop. To assess the sensitivity of the bit timing parameter, error rate measurements are recorded for various bit timing positions keeping a constant signal to Gaussian noise power ratio. Using the optimum sampling instant derived from the sensitivity to bit timing characteristic a final quantitative error rate characteristic may be measured. The characteristic recorded from the design example is given in Fig. 7. The signal-to-Gaussian-noise power ratios were measured after the i.f. filter. Parametric optimization may be performed by making alterations to the system filtering or deviation ratio and recording the error rate characteristics.

In the case of many similar equipments operating in a limited frequency allocation, the effect of co-channel and adjacent channel interference has important design implications. As shown in Fig. 4, an extra transmitter similar to the wanted link may be simulated. This then allows measurements of the error rate performance with either co-channel or adjacent channel interference. A quantitative assessment of the effect of like interference may be made by taking error rate measurements for various signal-to-interference and signal-to-interference-plus-Gaussian-noise-power ratios. The effect of varying the adjacent channel spacing may be examined by altering the tuned frequency of the interfering transmitter.

With this example, the effect of a like co-channel



Fig. 8. Error rate with co-channel interference.

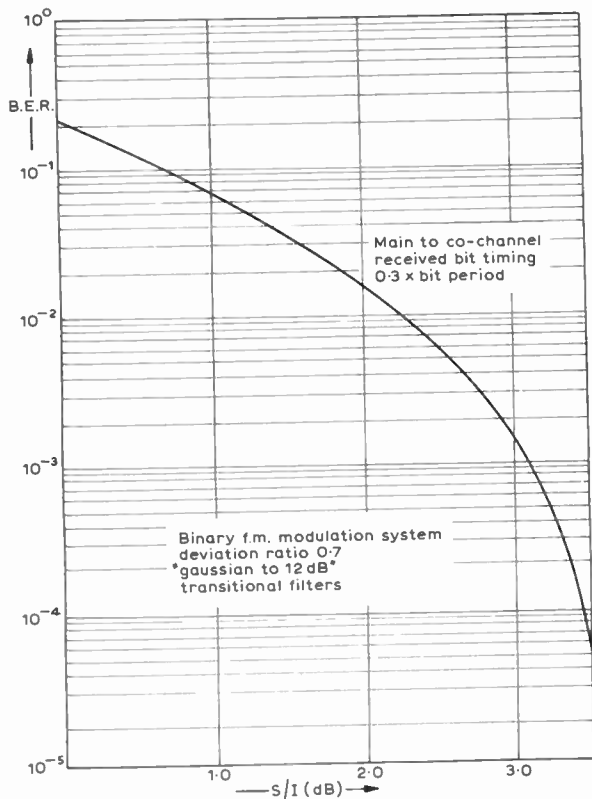

Fig. 9. Sample levels before bit reconstruction.

interferer was found to be less degrading than an equivalent power Gaussian noise interference. The signal to co-channel interference curve obtained from the simulation is shown in Fig. 8. To obtain a better appreciation of the effect of this type of interferer the statistical measurement program is used. A record of the sample levels before bit reconstruction obtained with co-channel interference is shown in Fig. 9. This gives an insight into the complicated interference mechanism that takes place with this type of interference.

6 Conclusion

We have described some basic points of simulation, outlined a few techniques used in hybrid computation and given a brief example of the use of these techniques. The reader will be aware, however, that simulations cannot give opinions on designs; that still requires the judgement of a professional engineer. Simulations exist to give the engineer a qualitative and quantitative basis for his assessments and they are particularly necessary when the interaction between parameters of a system is varied and complex. The ability of the simulation described here to give the engineer a basic 'feel' for the system cannot be overstated. This aspect must be considered one of the main achievements of the work described.

7 Acknowledgments

The authors wish to thank their many colleagues at the British Aircraft Corporation EMC Analysis Facility who have done much to develop the technique discussed in this paper.

The work was carried out as part of a Ministry of Defence (Procurement Executive) Contract. The authors thank the Ministry of Defence and the Directors of the British Aircraft Corporation for permission to publish this paper.

8 References

1. Zverev, A. I., 'A Handbook of Filter Synthesis' (Wiley, New York, 1967).
2. Bice, P. K., 'Speed up the Fast Fourier Transform', *Electronic Design*, 9th April 1970, pp. 60-69.
3. Lucky, R. W., Salz, J. and Weldon, E. J., Jr., 'Principles of Data Communication' (McGraw-Hill, New York, 1968).
4. Marshall, G. J., 'Error probability of a binary differentially coherent phase shift keyed system having a realizable receiver filter', *Proc. Instn Elect. Engrs*, **119**, pp. 1135-9, August 1972.

Manuscript first received by the Institution on 24th February 1972 and in final form on 11th July 1973. (Paper No. 1543/Com. 76.)

© The Institution of Electronic and Radio Engineers, 1973

A comparison of modulation schemes for binary data transmission

J. R. EDWARDS,

B.Sc.(Eng.), A.C.G.I., C.Eng., M.I.E.E.*

SUMMARY

The relationships between bit error probability and transmitter power are presented on a common basis for various binary and M -ary modulation schemes operating with the same system data rate. It is assumed that the channel is disturbed by additive white Gaussian noise of fixed power spectral density and that optimal matched filter reception is used. The results presented allow a comparison of the efficiencies of the systems in the use of transmitter power to provide a specified bit error probability. The theoretical bandwidth requirements of each system have been considered. Sometimes the system designer is constrained to the use of an existing channel of fixed bandwidth and signal/noise ratio. The choice of modulation system under these conditions has also been indicated.

List of Symbols

C	Shannon capacity (bits/s)
E_B	energy per data bit (J)
E_w	energy per word (J)
k	number of data bits per block or symbol
$M = 2^k$	number of discrete symbols in a multi-level system
N_0	noise power per hertz (W/Hz)
P_B	system bit error probability
P_w	system word (symbol, block) error probability
R	system data rate (bits/s)
S	signal power (W)
T	symbol duration(s)
W	bandwidth (Hz)

$$\operatorname{erfc}(x) = \frac{2}{\sqrt{\pi}} \int_x^{\infty} e^{-u^2} du$$

$$\binom{n}{r} = {}_n C_r = \frac{n(n-1) \dots (n-r+1)}{r!}$$

1 Introduction

When designing a system for the transmission of digital information the designer may be faced with the use of an existing communication channel with prescribed signal power, bandwidth and noise parameters. In this case he will have to make a choice of modulation and coding schemes to make the best use of the channel provided. Alternatively, he may be designing a system from scratch and have a fairly free choice of system components. In both cases the primary system parameters are likely to be the data rate of the information to be transmitted and the probability of the signal being corrupted in the channel. To achieve these design objectives he wishes to optimize the cost of the system by finding the best balance between the costs of transmitter power and of transmitter and receiver complexity. This paper concentrates upon comparing the merits of the various modulation schemes available. Further papers will deal with the choice of coding scheme for one-way transmission channels and also for systems having two-way communication available.

Before analysing the performances of the various systems it is necessary first of all to select a model to represent the noise present on the communication channel. The simplest model is that of white Gaussian noise, and this is the model that will be used throughout this paper. Although it does not fully represent the noise conditions present on many communication channels it is still useful as a benchmark for comparing different systems. The noise is assumed to have a constant spectral density of N_0 W/Hz. Error probabilities are evaluated as a function of S/RN_0 , where S is the transmitter power (watts) and R the data rate (bits/s). Both R and N_0 are assumed to be constants for a given system. S/R is equal to E_B , the energy per data bit (J/bit).

The functions relating error probability to signal-to-noise ratio are well documented for various optimal (i.e. matched filter) binary and multi-level modulation

* Electrical and Electronic Engineering Department, Royal Military College of Science, Shri venham, Swindon.

Table 1
Error probabilities for binary modulation systems

Modulation	Detection	Bit error probability, P_B
Baseband bipolar		$\frac{1}{2} \operatorname{erfc} \sqrt{\frac{E_B}{N_0}}$ (1)
unipolar (on-off)		$\frac{1}{2} \operatorname{erfc} \sqrt{\frac{E_B}{2N_0}}$ (2)
Amplitude (a.m.) bipolar = phase-reversal keying (p.r.k.)	coherent	$\frac{1}{2} \operatorname{erfc} \sqrt{\frac{E_B}{N_0}}$ (3)
unipolar	coherent	$\frac{1}{2} \operatorname{erfc} \sqrt{\frac{E_B}{2N_0}}$ (4)
unipolar	incoherent	$\frac{1}{2} \exp\left(-\frac{U_D^2}{2N_0}\right) \left[1 + \exp\left(-\frac{2E_B}{N_0}\right) \sum_{n=1}^{\infty} I_n\left(\frac{2U_D\sqrt{E_B}}{N_0}\right)\right]$ (5)
U_D is the receiver optimum decision-level given by:		
$\frac{2E}{N_0} = \log I_0\left(\frac{2U_D\sqrt{E_B}}{N_0}\right)$		
I_n is the modified Bessel function		
Phase (p.r.k.) p.r.k.	coherent	$\frac{1}{2} \operatorname{erfc} \sqrt{\frac{E_B}{N_0}}$ (6)
p.r.k.	differentially coherent	$\frac{1}{2} \exp\left(-\frac{E_B}{N_0}\right)$ (7)
Frequency (f.s.k.) f.s.k.	coherent	$\frac{1}{2} \operatorname{erfc} \sqrt{\frac{E_B}{2N_0}}$ (8)
f.s.k.	incoherent	$\frac{1}{2} \exp\left(-\frac{E_B}{2N_0}\right)$ (9)

systems. Nevertheless, the results are frequently published in different ways so that the performances of the systems cannot be readily compared. In this paper the error probabilities have been tabulated as functions of E_B/N_0 , and graphs plotted of these functions for the various binary modulation systems and for M -ary modulation.

2 Binary Modulation Systems

In order to optimize the performance of a communications receiver to the received waveforms in the presence of white Gaussian noise it is well known that a set of matched filters should be employed.¹ Using a transversal filter² to compensate for the transmission system variations it is possible to approach closely to this ideal of matched filter reception. The relationships between bit error probability and signal/noise ratio under these conditions are given by Reiger,³ summarized in Table 1. Note that $E_B/N_0 = S/RN_0$; for a given system design

one might assume R and N_0 constant, so that S is the variable.

2.1 Baseband Signalling

The performance of unmodulated signals is included for comparison with those of modulated ones. Bipolar transmission uses pulses of equal amplitude but opposite polarity to represent the two signal conditions '0' and '1'. Unipolar signalling uses the presence and absence of voltage for the two conditions, and, on average, twice as much signal power is needed to produce the same voltage swing.

2.2 Amplitude Modulation

Using linear, multiplicative modulation, the negative elements of a bipolar baseband signal cause the phase of the carrier to be reversed, i.e. phase modulation results. In order for the receiver to demodulate this signal it is necessary for the receiver to have knowledge of the

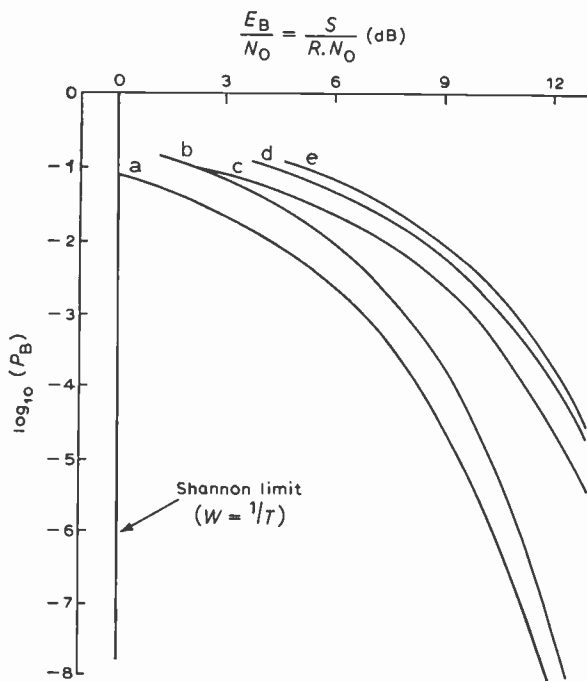

Fig. 1. Bit error probabilities of binary modulation systems as a function of E_B/N_0 .

- (a) bipolar baseband, a.m. or p.r.k. with coherent detection
- (b) p.r.k. with differentially coherent detection
- (c) unipolar baseband or a.m. or f.s.k. with coherent detection
- (d) unipolar a.m. with incoherent detection
- (e) f.s.k. with incoherent detection

phase of the transmitted signal,⁴ so that coherent detection can be employed, and the energy requirements are identical to those for bipolar baseband signals.

Unipolar amplitude modulation is most commonly used when an unsophisticated, incoherent receiver is required. As well as the 3 dB penalty due to the use of unipolar signalling, a further loss of about 1 dB (see Fig. 1) occurs due to the non-optimum method of detection. Furthermore, to achieve this performance it is necessary to set the decision level as a function of signal and of signal/noise ratio. With increasing signal power the incoherent performance is asymptotic to that of the coherent keyed carrier system.

2.3 Phase Modulation

Binary phase modulation is also known as phase-reversal keying (p.r.k.), and is identical to bipolar amplitude modulation.

Differentially coherent detection may be implemented without an absolute standard of phase by comparing the current signal with that of the previous one. Viterbi⁵ has shown that this is equivalent to incoherent detection of one of two orthogonal signals of 2 bit duration. Since each of these signals will contain twice the energy of a single bit the resulting performance is 3 dB better than the equivalent orthogonal system with noncoherent detection (e.g. f.s.k.).

2.4 Frequency Modulation

Digital frequency modulation is also known as frequency-shift keying (f.s.k.). Provided that the two

carrier frequencies chosen for binary f.m. are properly spaced⁶ the two possible signals are orthogonal to one-another, i.e. each signal produces no output from the receiver filter which is matched to the other signal. The system may be regarded as two independent 'on-off' keyed channels, the demodulated outputs of these being subtracted from one-another to produce an antipodal output to the decision element. The system thus transmits the same average power as an antipodal a.m. (p.r.k.) system with equal signal levels, and produces the same signal to the decision element. However, there are two channels in the f.m. system, each requiring a bandwidth equal to that of the p.r.k. system. The noise power reaching the decision element is therefore twice as great, and consequently a 3 dB degradation is experienced compared with p.r.k.

Frequency modulation is most commonly used in conjunction with incoherent detection. The optimum detector computes the r.m.s. power content of the signal at each modulation frequency. Again the outputs of the demodulators are subtracted from one-another and the optimum decision level is zero volts. This has positive advantages over incoherent detection of a.m. which requires a knowledge of the signal and noise levels to achieve optimum detection. The post-detection noise is now Rician and the probability of error may be shown to be $\frac{1}{2} \exp(-E_B/2N_0)$. The performance of detectors using narrow-band filters and envelope detectors will be close to this for practicable signal/noise ratios. As might be expected the error probability using an incoherent detector is higher than with a coherent detector, but the curves are asymptotic to one another with increasing signal power.

2.5 Comparison of Binary Modulation Systems

The choice of modulation system is primarily a consideration of the trade-off between transmitter power requirements and transmitter/receiver complexity. If low transmitting power is a prime requirement then phase-reversal keying with coherent or differentially coherent reception will be the first choice. If the receiver complexity of coherent reception is not warranted then unipolar a.m. with incoherent detection gives the simplest receiver and a slightly better performance than incoherent f.m. Over dispersive media such as h.f. radio, variations in carrier phase due to multipath effects occur, and these tend to make the use of coherent detection impracticable. The effects of signal fading introduce problems in maintaining an optimum decision level for unipolar a.m., and incoherent f.m. is the preferred choice.

A further consideration is the bandwidth required by the signals actually transmitted. To achieve the minimum baseband bandwidth equal to half of the bit rate it is necessary to transmit Nyquist ($\sin x/x$) pulses. These pulses are impractical to produce, and so a practical system will use pulses approximating to the ideal and rather more bandwidth will be needed. Such pulses may be linearly modulated to generate amplitude modulated or phase-reverse keyed signals occupying twice the baseband bandwidth. Since frequency modulation is a non-linear modulation process the analysis of the signal

Table 2
Error probabilities for multi-level modulation systems

Modulation	Detection	Symbol error probability, P_w	Bit error probability, P_B
Baseband and suppressed carrier a.m. M equi-spaced voltage levels (+ve and -ve)	coherent	$\left(1 - \frac{1}{M}\right) \operatorname{erfc} \left[\frac{3}{(M^2 - 1)} \frac{E_w}{N_0} \right]^{\frac{1}{2}}$ (10)	$\approx \frac{\left(1 - \frac{1}{M}\right)}{k} \operatorname{erfc} \left[\frac{3}{(M^2 - 1)} \frac{k \cdot E_B}{N_0} \right]^{\frac{1}{2}}$ (11)
Phase (p.m.)		$M = 4, P_w = 1 - \left[1 - \frac{1}{2} \operatorname{erfc} \sqrt{\frac{E_w}{2N_0}} \right]^2$ (12)	$\frac{1}{2} \operatorname{erfc} \sqrt{\frac{E_B}{N_0}}$ (13)
M equi-spaced phases around 2π	coherent	$M > 4, P_w \approx \operatorname{erfc} \left(\frac{E_w \sin^2 \frac{\pi}{M}}{N_0} \right)^{\frac{1}{2}}$ (14)	$\approx \frac{1}{k} \operatorname{erfc} \left[\frac{k \cdot E_B \sin^2 (\pi/M)}{N_0} \right]^{\frac{1}{2}}$ (15)
Orthogonal frequency (f.s.k.) pulse position (p.p.m.) M -ary coding	{ coherent { incoherent	$\frac{1}{\sqrt{\pi}} \int_{-\infty}^{+\infty} \exp - \left(\omega - \left(\frac{E_w}{N_0} \right)^{\frac{1}{2}} \right)^2 \times [1 - (1 - \frac{1}{2} \operatorname{erfc}(\omega))^{M-1}] d\omega$ (16) $\frac{1}{M} \exp \left(-\frac{E_w}{N_0} \right) \sum_{j=2}^M (-1)^j \binom{M}{j} \exp \left(\frac{E_w}{jN_0} \right)$ (18)	$\frac{1}{2} \frac{M}{(M-1)} P_w$ (17)

spectra of f.m. waveforms is rather complicated. The shape of the spectrum⁶ depends upon the value of $\Delta = 2f_d T$, where f_d is the frequency deviation and T the signal period. If Δ is less than 0.7, most of the energy is contained within a bandwidth equal to the bit rate, $1/T$. If Δ is less than 1.5, most of the energy is contained within a bandwidth of $2/T$. To meet the requirement of orthogonality assumed in calculating the error probability Δ must be an integer. Practical f.s.k. systems used over dispersive media often use a frequency spacing much larger than the minimum in an attempt to combat frequency-selective fading.

2.6 Comparison with the Shannon Capacity

Shannon's theorem tells us that it should be possible to signal in a bandwidth of W Hz at a bit rate $C = W \log_2 (1 + S/WN_0)$ without error. Assuming the signal occupies twice the Nyquist bandwidth it can easily be shown that this is equivalent to signalling with an energy per bit given by $E_B/N_0 = 0$ dB. Even the best binary transmission scheme needs 4.5 dB more than this to obtain the rather high error probability of 10^{-2} , and considerably more power is required to obtain lower error rates.

3 Multi-level Modulation Systems

In the search for a more efficient method of obtaining low error rates one might consider multi-level rather than binary systems. The error probabilities for multi-level digital signalling systems are given in Table 2. The expressions for bit error probability have again been expressed as functions of E_B , the energy per data bit transmitted.

3.1 Amplitude Modulation

The expression for symbol error probability is easily derived⁶ and is given in eqn. (10). It can be seen that if $M = 2$ ($k = 1$) the equation reduces to the binary form (1). Provided the signal/noise power ratio is high enough to provide a low error probability, then the majority of errors will be single level errors, which will cause only a single bit error provided that the normal practice of Gray re-coding is employed at the transmitter. Thus the bit error probability may be obtained for low error probabilities (say $< 10^{-1}$) by dividing the symbol error probability by $k = \log_2 M$, the number of bits in the word which is encoded into a symbol. Writing $E_w = k \cdot E_B$ produces eqn. (11). This equation is equivalent to the binary case, but with a modification factor of $3k/(M^2 - 1)$ to E_B/N_0 . The factor $(1 - 1/M)/k$ has a relatively small effect at low error probabilities.

Figure 2 shows the curves for $k = 1$ to 4. To achieve the same error probability as binary signalling at the same data rate an increase in E_B/N_0 of approximately 4 dB is needed for 4-level ($k = 2$) signalling and of 8.5 dB for 8-level ($k = 3$) signalling.

It is apparent that multi-level a.m. is not of interest if one is attempting to design a system which is efficient in its use of transmitted power. If, on the other hand, a channel of fixed bandwidth is available, multi-level a.m. can be employed to increase the system bit rate by a factor k , provided that ample power is available at the transmitter. In many practical systems it is not possible to maintain the transmission system gain constant, and consequently it is difficult to maintain the receiver decision thresholds correctly set. For this reason multi-

level phase modulation is more likely to be chosen as a means of increasing bit rate per bandwidth.

3.2 Phase Modulation

Four-phase modulation may be employed without any loss of efficiency (eqn. (13)); i.e. using the same energy per bit (but twice as much per symbol) will result in the same error probability as for binary p.r.k. signalling. This is because the four-phase modulation may be considered as being the superposition of two binary p.r.k. systems each acting upon the orthogonal sine and cosine components of the carrier signal. Because of the orthogonality there is no interaction between channels at the receiver.

For M greater than 4 the word error probability is given approximately by eqn. (14). Making similar assumptions as for a.m. gives the bit error probability as in eqn. (15). In this case the E_B/N_0 modifying factor is $K \sin^2 \pi/M$, and it is necessary to increase E_B/N_0 by 3.6 dB relative to the binary case for 8 phase signalling. This is 5 dB better than for 8-level a.m. signalling.

Figure 3 shows the curves for $k = 1$ to 4.

3.3 Orthogonal Modulation

An orthogonal modulation system is one employing M different signals all of which have a zero cross-correlation with any of the other $(M - 1)$ signals over the signal period. Examples of these signal groups are multi-frequency f.s.k. such as is employed in the Piccolo system,⁷⁻⁹ pulse-position modulation (p.p.m.) and M -ary coded binary signals.⁵ The code words in this last case are the rows of a Hadamard matrix. When the digits of a row are used successively to modulate the

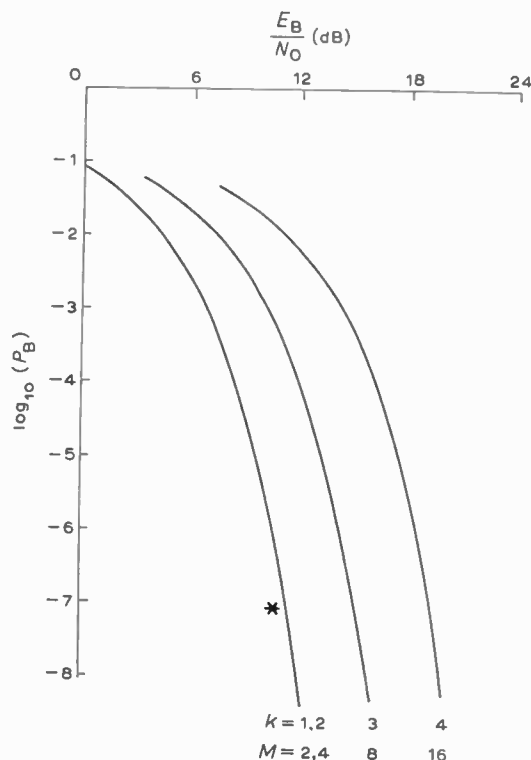

Fig. 3. Bit error probability against E_B/N_0 for multi-level p.m.
* Optimal binary system.

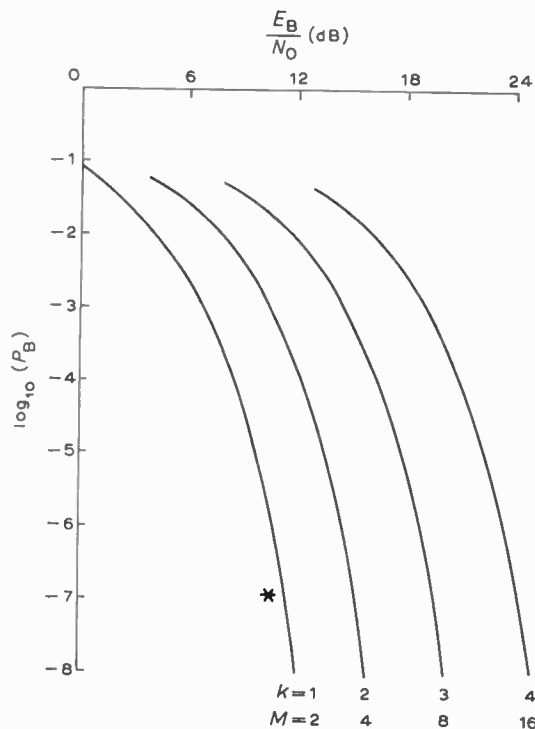

Fig. 2. Bit error probability against E_B/N_0 for multi-level a.m.
* Optimal binary system.

output of a binary modulation system (e.g. p.r.k.) a signal is produced which is orthogonal to the signals generated from the other rows. In order to achieve optimal detection, cross-correlation over the whole signal is necessary. The symbol (word) error probabilities with coherent and with non-coherent detection are given⁵ in Table 2 by eqns. (16) and (18). Since the system is orthogonal, an error will produce any of the $(M - 1)$ incorrect outputs with equal probability; thus the output code word is virtually random and approximately half the bits of the received word will be incorrect. Since one of the M possible words is the correct one and this will not be produced in the case of an error the actual bit error probability will be $\frac{1}{2} \cdot (M/(M - 1))P_w$ as given by eqn. (17). Curves of bit error probability are given in Fig. 4 for the coherent case. The curves for the incoherent system are asymptotic to those for the coherent system with increasing bit energy and so these have not been included. The theoretical performance as k tends to infinity is also shown.⁵ This is equal to the performance of a power-limited system with infinite bandwidth as given by Shannon's formula. Here, then, we have a method of theoretically achieving the Shannon ideal. Unfortunately even with $k = 10$ the system performance is still a long way from the ideal, and this system would need $2^{10} = 1024$ matched filters, which would be prohibitive in cost. Practical f.s.k. orthogonal coding is limited⁸ to about $k = 5$. Some simplification in receiver complexity is possible using pulse-position modulation. Since all pulses are identical in shape and differ only in their time location, a common matched filter can be used and its output sampled at the end of each element period. Optimal detection then consists of deciding

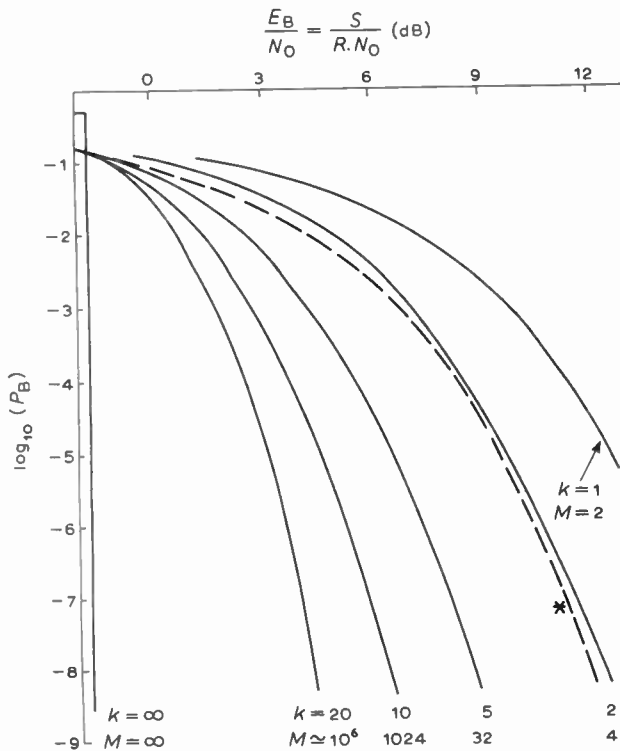

Fig. 4. Bit error probabilities for orthogonal modulation using $M = 2^k$ signals and coherent detection.
 * Optimal binary system.

which sample is greatest. A serious disadvantage of the p.p.m. system is that the transmitter has to deal with very high peak powers, since all the transmitted power is compressed into $1/M$ th of the signal duration. One way of overcoming this problem is to use orthogonal sequences⁵ generated from a Hadamard matrix to modulate the transmitter in a binary fashion. The effect of this technique is to spread the signal energy over the whole symbol duration. In order to reassemble the energy at the receiver a bank of M cross-correlators is again required.

For a constant element signalling rate all orthogonal modulation systems expand in bandwidth with increasing M . However, as M increases, the number of bits per symbol, k , also increases, so that if a constant data rate is required the symbol signalling rate may be reduced by a factor k . The nett result is that the bandwidth required is $M/k \times$ (modulated binary bandwidth). In applications such as satellite communications ample bandwidth is available, and this bandwidth expansion is acceptable.

Other codes closely related to the M -ary orthogonal binary codes are the transorthogonal and bi-orthogonal families. The transorthogonal signal set omits one column of the Hadamard matrix. For large M the bandwidth required and the performance achieved are practically identical to those of the orthogonal system. The bi-orthogonal code uses all the codes of the orthogonal system plus the inverse of each. The bandwidth expansion factor is consequently reduced by a factor of 2 for a given k . In exchange a slight degradation of performance has to be tolerated.

4 Binary Coding and Decoding

The use of orthogonal binary codes simplifies the structure of the transmitter, but to get the optimum performance from the system M analogue correlators are still required at the receiver. A further simplification can be achieved by making a hard decision on each element of the code. This allows modulo-2 correlation to be performed at the receiver using logic circuits. Although information is lost in the hard decision process, the use of digital rather than analogue circuitry in the receiver allows longer, more complex codes to be employed. As a consequence a nett gain in performance is often achieved with the digital system when it is assessed on a cost/performance basis.⁶ The characteristics of binary-coded systems will be considered more fully in a further paper.¹⁰

5 Summary

In order to compare the merits of various digital communication systems this paper assumes that the communication channel is subject to additive white Gaussian noise. Although this simple model is not strictly applicable to many practical channels, it does provide a basis for the comparison of various modulation options. The performances of all the modulation systems have been compared on the basis of bit error probability and energy per data bit, thus allowing the power requirements of the systems to be compared.

5.1 Binary Modulation Systems

Section 2 shows that of the binary modulation methods available to the system designer, phase-reversal keying with coherent detection requires the smallest energy per bit in order to achieve a given bit error probability. However, other systems may be of interest if a simple receiver is desirable. All the modulation methods have performance curves which are similar in shape but displaced in signal/noise ratio. None of the binary systems have a very rapid decrease in bit error probability with increasing signal power and are therefore very inefficient compared with the Shannon performance bound if a low bit error probability is required. They are also inefficient for existing channels which inherently have a very high signal/noise ratio, since only one bit of information can be transmitted per channel symbol.

5.2 Multi-level Modulation Schemes

To make more efficient use of existing channels having unnecessarily high signal/noise ratio for binary signals, multi-amplitude or multi-phase signalling may be employed. This allows more bits to be sent per channel symbol without increasing the system bandwidth in exchange for a higher bit error probability. Generally, phase modulation is more efficient than amplitude modulation, but use of more than four phases introduces an increasing loss of efficiency relative to the binary case in terms of energy required per bit in order to achieve a given bit error probability. These methods of modulation are therefore only of value in systems which already exist and have unnecessarily high signal/noise ratios for binary signalling or in new systems where considerations

of conservation of bandwidth outweigh those of efficient use of transmitter power.

5.3 Orthogonal Modulation Systems

This class encompasses multi-frequency f.s.k., pulse-position modulation and M -ary coded binary signals. All these systems give a bandwidth expansion of M/k relative to binary modulation and can be shown theoretically to provide error-free signalling at the Shannon capacity as $k \rightarrow \infty$. Practical implementation problems tend to limit the number of frequencies employed in multi-frequency f.s.k. systems to about 32 ($k = 5$). An orthogonal system with $k = 5$ does offer an improvement over binary signalling for error rates less than 10^{-1} , but does not approach anywhere near the Shannon limit. Pulse-position modulation systems are simpler to implement at the receiver but are again limited in the usable value of k by the increase in peak transmitter power with increasing k . This problem may be overcome by transmitting orthogonal binary codes, but this again introduces more receiver complexity, since M cross-correlators are required. No decision is made until the whole code word has been received and cross-correlated.

5.4 Binary Coding and Decoding

The information loss due to quantization of the received signal may be more than offset by the economic implementation of long, complex codes. This topic is the subject of a further paper.

6 Conclusions

The merits of digital modulation schemes may be compared in terms of equipment simplicity, the efficient use of transmitter power, and of bandwidth occupancy.

When a minimum amount of equipment is desirable, one of the binary modulation methods is likely to be chosen. None of the binary systems is very efficient in producing low bit error probabilities. All can occupy a bandwidth approximately equal to the bit rate, although when transmitting over dispersive media, frequency-shift keying using a much wider shift than the minimum is often used.

Theoretically M -ary orthogonal modulation techniques offer transmission at the Shannon capacity as $M \rightarrow \infty$. However practical considerations severely restrict the value of M , so that only a limited improvement over the best binary system is obtainable. To obtain this improved performance the bandwidth of the system is increased compared with narrow-band binary modulation.

If the bandwidth available for the transmission of data is severely constrained, M -ary orthogonal modulation is

obviously not a good choice. The use of M -ary a.m. or p.m. will allow higher data rates than binary modulation. Four-phase p.m. can be employed with no loss of efficiency compared with binary modulation, but if M increases beyond 4 the energy required per data bit increases. Consequently a.m. and p.m. systems with large M are feasible only if the supply of transmitter power is not severely restricted.

None of the digital modulation methods considered seem to provide a practicable method of transmitting at a rate close to the Shannon capacity. Even if the complexity of M -ary orthogonal modulation systems with a value of M greater than 1000 were acceptable, a bandwidth expansion of 50 times relative to binary transmission would be required. An alternative method of spreading the transmitted information over a long period is to use binary error-correcting codes. The merit of such an approach when only a limited bandwidth expansion is available is considered in a further paper.¹⁰

7 Acknowledgments

The continuing encouragement and helpful discussions with Professor P. C. J. Hill of the Royal Military College of Science and with Mr D. E. Hampton of the Signals Research and Development Establishment are gratefully acknowledged.

8 References

1. Turin, G. L., 'An introduction to matched filters', *IEEE Trans on Information Theory*, IT-6, pp. 311-29, June 1960.
2. Rudin, H., Jr., 'Automatic equalization using transversal filters', *IEEE Spectrum*, pp. 53-9, January 1967.
3. Reiger, S., 'Error probabilities of binary data transmission systems in the presence of random noise', *IRE National Convention Record*, 1953, pt. 8, pp. 72-79.
4. Stiffler, J. J., 'Synchronous Communications' (Prentice-Hall, Englewood Cliffs, N.J., 1971).
5. Viterbi, A. J., 'Principles of Coherent Communication' (McGraw-Hill, New York, 1966).
6. Lucky, R. W., Salz, J. and Weldon, E. J., Jr., 'Principles of Data Communication' (McGraw-Hill, New York, 1968).
7. Robin, H. K., Bayley, D., Murray, T. L. and Ralphs, J. D., 'Multitone signalling system employing quenched resonators for use on noisy radio-teleprinter circuits', *Proc. IEE*, 110, No. 9, pp. 1554-68, September 1963.
8. Bayley, D. and Ralphs, J. D., 'The Piccolo 32-tone telegraph system', *Point-to-Point Telecommun.*, 13, No. 2, pp. 78-90, 1969.
9. Bayler, D. and Ralphs, J. D., 'Piccolo 32-tone telegraph system in diplomatic communication', *Proc. IEE*, 119, No. 9, pp. 1229-36, September 1972.
10. Edwards, J. R., 'The choice of data transmission system for efficient use of transmitter power', *The Radio and Electronic Engineer*, 43, No. 10, October 1973. (To be published).

Manuscript first received by the Institution on 2nd April 1973 and in final form on 26th June 1973. (Paper No. 1544/Com. 77).

© The Institution of Electronic and Radio Engineers, 1973

The Annual Report of the Council of the Institution for the year ended 31st March, 1973

The Council has much pleasure in presenting the Twelfth Annual Report of the Institution since Incorporation by Royal Charter. The Annual General Meeting will be held on Thursday, 25th October, 1973 at the London School of Hygiene and Tropical Medicine, Keppel Street, Gower Street, London, W.C.1, commencing at 6 p.m.

Notice of the meeting and Agenda were published in the August issue of The Radio and Electronic Engineer.

INTRODUCTION

HOW best to meet change largely summarizes the work of the Institution during the past year.

In such a fast-changing technology as electronics, the activities of the Institution must be under constant review in order that it can provide information on the various and ever-increasing applications of electronic technology. Today, the professional engineer must be aware of any scientific and technological development which may affect his work—hence his need of membership of a professional body and learned society. The Annual Report records how, by meetings and publications, the IERE meets these needs.

Currently, however, the very definition of a professional engineer and his concomitant qualifications are more subject to change than ever before. Governments are urged to provide better education and training facilities because of the economic, social and defence dependence on engineering products. There are also the wider political and social implications of correlating international, and especially European, qualifications. An example is the interpretation of Articles 52 to 58 of the Treaty of Rome concerning the registration of all European engineers. The decisions taken may affect the present structure of the engineering profession as well as the means of securing adequate recognition of individual achievement.

All these matters affect the decisions of Membership, Education and Academic Standards Committees of the IERE, but the overall political consideration is for the entire engineering profession. For this and other good reasons, all chartered engineers have accepted alliance within the Council of Engineering Institutions (CEI). Federal membership of CEI not only preserves for corporate members recognition as 'Chartered Engineers' but also enables the unified view of the entire engineering profession to be expressed on wider issues of public interest. This federation does *not* however, abrogate the right of every CEI member Institution to remain independent as to its internal affairs so far as those 'internal affairs' do not run contrary to any majority decisions taken by the Board of CEI—which includes representatives from each of the fifteen Chartered Engineering Institutions.

Radio and electronic engineering has provided the most influential media for securing public awareness of the importance of science and technology; perversely, the potential growth of radio and electronics does not command the support required to improve education and training opportunities or increase private investment in research and development programmes. This 'shortfall' may be because the industry is too often judged on the basis of consumer products; much more could be done to increase the use of electronics as a tool for improving industrial efficiency, and utilizing more effective aids to transport and national and international communications systems. It is the task of the Institution to record and promote discussion of these and other developments.

Because it represents the youngest branch of engineering, it is inevitable that the Institution's financial limitations sometimes restrict full exercise of the contributions that it can make toward promoting radio and electronic science and engineering. Membership of all Engineering Institutions is, however, still voluntary and this regulates the ability of such societies to fulfil entirely their avowed objects. It is one argument in favour of basing compulsory registration of engineers on membership of a Chartered Institution. For the present and especially in the past year, inflation has subjected all voluntary bodies to the acid test of being able to maintain existing services, let alone improve on their achievements. How well the IERE has met this challenge must be judged by this 47th Annual Report to its subscribing members.

The 47th Annual Report

This report embraces the work of the Standing and Group Committees and through them the Committees of Local Sections. These activities provide the background to the decisions by the Council during the year.

Leaving out the overseas Councils and their Committees and the Local Section Committees in Great Britain, the Standing Committees of the Institution held a total of 72 meetings during the year. In the same period there were four meetings of the Council.

EXECUTIVE COMMITTEE

Every activity of the Institution requires the framing of immediate and future policy. In these tasks the Executive Committee acknowledges the considerable help it has received from its own 'Working Parties' and other Standing Committees in preparing final recommendations to Council.

Drafting revisions to the Institution's Bye-Laws, Regulations for the future admission of members, contributions to CEI discussions, participation in 'joint' activities in exhibitions and learned society activities, overseas activities, staff arrangements and the financing and planning of future membership services are a few examples of the items reported on by the Executive Committee.

Some of the major issues considered by the Committee have already been recorded in *The Radio and Electronic Engineer*; other decisions are reflected in the news of the Standing Committees which are incorporated in this Annual Report.

Anticipating change is the reason for framing future policy. A myriad of altered conditions, outside and within the engineering profession, have affected the Institution since its foundation 47 years ago. The decisions taken by Council will determine the Institution's ability to meet the challenge of the future.

Alterations to Bye-Laws. In the Annual Report for last year it was announced that a Working Party drawn from members of the Executive Committee had been set up to consider revision of the Institution's Charter and Bye-Laws. Since the grant of the Royal Charter, revision became necessary because of the establishment of the Council of Engineering Institutions,* which itself received a Royal Charter in 1965. The IERE was a founder member of CEI because it has always believed that it is essential to establish commonality of standards and public recognition of professional engineers, irrespective of discipline.

Alterations to the IERE Bye-Laws concerned mainly (a) the introduction of a Code of Conduct for Professional Engineers, embodying the principles to which all the constituent members of CEI are to conform; (b) provision for the admission of Technician Engineers as Associate Members of the Institution, enabling them to be admitted to the appropriate register maintained by CEI; and (c) making common regulations for membership in respect of age and qualifications for all Chartered Engineering Institutions.

As members know, the Special General Meeting of Corporate Members convened by the Council and held on 7th September, 1972, gave unanimous approval to seeking the approval of the Privy Council to changes in the Royal Charter and in the Bye-Laws of the Institution.

Subsequent correspondence from the Office of the Privy Council only concerned the new (proposed) Bye-Law 37 regarding the Code of Conduct which it considered should be binding on *all* Chartered Engineers. The fifteen Institutions comprising CEI have not yet agreed a common Code of Conduct, so at the time of compiling this Annual Report it

is not possible to confirm that the Institution's draft of Bye-Law 37 will be approved. There is no reason to suppose otherwise, but discussions within CEI are, of course, still being carefully considered by the Executive Committee of IERE.

Admission of Mature Candidates to Membership. In commenting on the proposed alterations to the Institution's Charter and Bye-Laws, the Privy Council Office suggested that the admission to membership of mature candidates, who were unable to satisfy current academic requirements, should be phased out after an arbitrary period of ten years. The IERE Council still believes that it is undesirable to close this avenue to membership. The main argument is that if this route had not existed in the past, many capable and, indeed, now famous engineers would have been ineligible for membership. This especially applies to new disciplines, and radio and electronics is only just emerging as a publicly recognized technology.

Other founder Institutions of CEI received the same suggestion from the Privy Council and all were of the view that whilst mature candidates not possessing the established qualifications would, in course of time, become increasingly rare, they should not at any time be denied membership if they are, without doubt, worthy engineers whose recognition as members by their appropriate professional body would be of mutual benefit to the applicant and the Institutions concerned.

It is on such issues that the Council especially welcomed the views of the senior members consulted by the Executive Committee.

Industrial Relations Act. Council also depended largely on the very detailed consideration given by the Committee on the implications of first the Bill and then the Act covering industrial relations in Great Britain.

The Executive Committee had meetings with delegations of those members who were in favour of, as well as members who were against trade union registration of professional engineers. In the event the IERE Council made clear that membership of a trade union must remain a personal decision of the individual member and that the Council had no right to commit or recommend the whole membership to join any trade union Association.

Nevertheless, and democratically within the Bye-Laws, a number of corporate members urged the Council to seek a closer relationship with, and to foster the aims of, trade unions generally and the United Kingdom Association of Professional Engineers (UKAPE) in particular. A requisition supported by the required number of members, was made to consider five Resolutions relating to the Institution's support of UKAPE. The Council therefore convened a Special General Meeting which was held on 14th June, 1972. Many divergent views were considered sympathetically by members attending the meeting. However, all the Resolutions were defeated by a substantial majority.

Members present at the Special General Meeting agreed that there might be excellent reasons for the Institution to seek registration on the special register to be set up to cover

* Throughout the remainder of this Annual Report the Council of Engineering Institutions is referred to as CEI.

the professions. Registration would permit the Institution to intercede in matters affecting Chartered Engineers collectively within the compass of regulating relations between employers and employees, but which are outside the area of collective bargaining.

The Executive Committee has been requested to advise on this possibility in concert with the views of other Institutions comprising the CEI.

An Engineers' Centre. There has been a revival of interest among constituent members of CEI in the proposal, initiated by the IERE, that administration of all the Chartered Engineering Institutions should be accommodated under one roof, to cover such services as an engineering library, lecture theatres, computer and accounts services, sales of publications, etc. The Chairman of CEI, Sir Arnold Lindley (Fellow) has devoted much effort to persuade all Institutions to support this project. In consequence, he was able to arrange for discussions to be held between Government and CEI with the object of securing a central site in London for building an 'Engineers' Centre'.

This is, inevitably, a long-term project, and the Executive Committee recommended that further building work should be undertaken in order to gain maximum use of the IERE lease of 8 and 9 Bedford Square following the decision of Council to vacate 50 Bloomsbury Street, as reported by the Finance Committee.

European Economic Community. Britain's entry into the European Economic Community gave importance to a number of issues affecting professional engineers. Foremost is securing mutual recognition of established engineering qualifications in member countries. A CEI EEC Committee was set up and is still considering the problems involved. Dr. G. Wooldridge (Fellow), formerly Chairman of the Institution's Membership Committee, is the Institution's representative on the CEI Committee.

Membership. The Executive Committee has progressed the view that the interests of students were not necessarily best served by their registration with individual Institutions, and that there is a strong case for a 'Common Studentship' under the aegis of CEI. Council has placed this view before the

Board of CEI, who have now set up a Working Party (Chairman, Sir Leonard Atkinson (Past President of the Institution)) to consider if it is possible to implement the IERE proposal.

Fiftieth Anniversary of the Foundation of the Institution. On 31st October 1975 the Institution will celebrate the fiftieth anniversary of its foundation. Readers of the official history of the Institution* know that the first Institution devoted to encouraging the application and development of radio science was founded in New York in 1913. The incidence of the first world war undoubtedly delayed any similar British development, but in 1922 a society known as the Radio Association was formed. The Radio Association gave way to the IERE as it is known to-day.

The Radio Association offices were in Basinghall Street in the City of London, and the Executive Committee has therefore proposed that as part of the Institution's Golden Jubilee celebrations a function should be held in the City of London. It is also recommended that one of the principal features of the anniversary celebrations should be a Convention, and that this should cover the development of radio and electronics over the last fifty years, with visions for the future, rather than a specialized theme. It is hoped to mount an exhibition to illustrate the growth of radio and electronic engineering from its primitive transmitter and 'crystal set' days to modern sophisticated equipment.

Summary. Without the help of the other Standing Committees the Executive Committee could not devote its time to planning the future of the Institution.

Difficulties have to be overcome, for instance in ensuring an adequate administrative staff and in the containment of expenditure. The Executive Committee believes, however, that members can look back on a satisfactory year, and anticipate the future of the Institution with very considerable confidence.

Council Comment. The Council of the Institution gratefully acknowledges the help it receives from the Executive Committee. The accumulated experience in all facets of Institution activity as represented on the Executive is of inestimable help to Council in framing future policy.

OVERSEAS RELATIONS

The challenge of change is especially evident in the manner of relationship between engineers throughout the world. The accreditation of professional engineers which started with such British societies as the Institution of Civil Engineers (founded 1818) and then separated into specialist bodies, has now been further divided by the emergence of national groups. Governments of independent countries have sponsored their own national Engineering Institutions and accept members of such societies as accredited engineers.

The effect of such developments has been recorded in previous Annual Reports. For the present the Council records that it continues to see advantages to all members in continuing the policy of maintaining Institution offices in Bangalore and Ottawa and continuing sponsorship of present arrangements in New Zealand, France, Israel and South Africa. These Divisions or Sections continue to provide services to their local members as well as providing a positive and active international link with the Institution.

The complexity of promoting good international relation-

ship between all engineers is beyond the ability of any one Institution, confined, as it must be, to its own specialization. The advent of the European Community creates a further challenge to all Institutions which is best met by the consortium mustered under the banner of CEI.

The Secretariat of CEI is now also the Secretariat to 'The Commonwealth Engineering Conference' whose next meeting will be held in London in September 1973. As with similar conferences concerned with political and economic affairs it is difficult to make meaningful reports but effort will be made to communicate to IERE members in *The Radio and Electronic Engineer* any proceedings of the conference which may especially concern members of the Institution.

Little can be reported on the proceedings of the 'World Engineering Conference' of importance to the radio and electronic engineer. Here again CEI expresses the viewpoint of the British Chartered Engineer and whenever possible, report on the WEC has and will be made in *The Radio and Electronic Engineer*.

* 'A Twentieth Century Professional Institution'. The first edition was published in 1960 and is now being revised. It is hoped to publish the 2nd edition in May 1974.

PROFESSIONAL ACTIVITIES COMMITTEE

When the Institution was founded in 1925 its objects were stated to be 'To promote the advancement of radio (electronics), and kindred subjects by the exchange of information in these branches of engineering'. In the intervening years the purpose of the Institution has broadened considerably, particularly in the fields of education and as a qualifying body. There has, however, been no diminution of the work in disseminating knowledge and for this reason Council regards the work of the Professional Activities Committee as of great importance. The majority of the meetings, colloquia and conferences which are organized on a national basis are promoted by one or other of the Specialized Group Committees, and thus the main task of the Professional Activities Committee is one of co-ordination.

It is also incumbent upon the Committee to keep the specialized group structure under continual review and to ensure that it meets the present and foreseeable future needs of the Institution. It was for this reason that the Instrumentation and Control Group came under close scrutiny during the year. It was concluded that the specified interests of this Group were too diverse and that consequently a committee of reasonable size could not be convened which would provide a solid body of opinion in any one of the fields which should be covered. Thus it was decided to disband the existing Instrumentation and Control Group and in its place to create two new Groups dealing with Automation and Control Systems and Measurement Science and Technology respectively. The Automation and Control Systems Group has already held a number of very successful meetings and is now making a significant impact in the field of electronic control engineering. The Measurement Science and Technology Group is in process of being formed and it is expected that its first meetings will be held early in 1974.

Meetings held in London. In the last two Annual Reports it has been noted that attendances at evening meetings in London have been declining and investigation shows that this is common to all Learned Societies. It has become increasingly clear that a more useful purpose can be served by half and whole-day colloquia at which a subject can be treated in greater depth. Thus, while the average attendance at evening meetings is around 50 the average attendance at half and whole-day colloquia during the last session has been over 100 and has been as high as 300. In several instances it has been possible to include overseas speakers at colloquia, and international audiences have been attracted.

These facts were borne in mind in compiling the programme for the year and this is reflected in the increased number of colloquia which have been held compared with evening meetings, the number of colloquia being 14, and the number of evening meetings 17.

The colloquium held at The Royal Society on the 13th February 1973 to celebrate the 25th Anniversary of the Invention of the Transistor, merits special mention. This colloquium was based on the papers published in the January/February issue of *The Radio and Electronic Engineer* (see page 576 of this Report). It was opened by Dr. Ieuan Maddock (President-elect), a Fellow of the Royal Society, and was attended by the President and Professor William Shockley, one of the co-inventors of the transistor, both of whom took an active part in the discussion. It attracted a capacity audience of 260 and it is noteworthy that parties of up to 10 students were sent by several technical colleges within the London area.

Local Sections in Great Britain. The 15 Local Section Committees in the United Kingdom have again been very

active in promoting technical meetings, the total number held during the year being 134 as against 128 in the previous year. In addition many of the Sections have organized technical visits and social functions.

The Professional Activities Committee is constantly looking at ways in which greater co-operation can be engendered between the Specialized Groups and the Local Sections and during the year two short tours were arranged for a demonstration lecture on 'Modern Dynamic Measurement Techniques'. This was organized in association with the Automation and Control Systems Group Committee and took in six locations in the Midlands and the South of England. It is hoped that similar meetings will be arranged in the future and that a proportion of the specialized group meetings will be held in locations other than London.

While the activities of the individual Sections are dictated to a large extent by local conditions, the exchange of information and the discussion of common problems between the Sections is of obvious benefit. To this end, meetings of Local Section Chairmen are held from time to time. Such a meeting was held in May 1972 and was attended by the Chairmen, or their representatives, from the fifteen Local Sections, the President, several members of Council and appropriate members of the Institution's staff. A wide ranging discussion was held embracing many aspects of the Institution's work and activities, C.E.I. examinations, the Institution Appointments Register, Section finances, Section boundaries and revision of the rules for Local Sections.

Terotechnology. Following the appointment of Major General Sir Leonard Atkinson (Past President) as Chairman of the Department of Trade and Industry Committee on 'Terotechnology', a colloquium was organized by the constituent members of CEI and several other Institutions to determine how best the Institutions could make a contribution on this important subject. This colloquium was held on 24th May 1972, and in addition to serving on the Organizing Committee this Institution made an important contribution to the proceedings through the involvement of several members as speakers and session chairmen.

Terotechnology is defined as the technology of installation, commissioning, maintenance, replacement and removal of plant, machinery and equipment, of feedback to design and operation thereon, and of related subjects and practices. While it cannot be claimed that this is in any way a new approach to engineering it is clearly of great importance and one in which this Institution can make a significant contribution. The way in which this can best be progressed is currently being considered.

Convention of the Electrotechnical Societies of Western Europe. In recent years there have been a number of moves to increase the collaboration between professional engineers both at national and international level. Thus in the United Kingdom there is the Council of Engineering Institutions, in Europe there is the Fédération Européenne d'Associations Nationales d'Ingenieurs (FEANI) while at trans-continental level there is the World Federation of Engineering Organization (WFEO). All of these organizations are multi-disciplinary and, while they have an extremely important role to play, they cannot, by their nature, meet all the detailed needs peculiar to individual disciplines.

It was against this background and coupled with the increasingly close ties between European countries that in November 1972 representatives from electronic and electrical institutions of Austria, Belgium, Denmark, Finland, France, Germany, Italy, Netherlands, Norway, Spain, Switzerland

and the United Kingdom met in Zurich to sign the Convention of the Electrotechnical Societies of Western Europe.* The primary objects are to increase co-operation between the Institutions having similar interests throughout Europe and to promote a freer interchange of information between them. At this meeting the Institution was represented by Professor W. Gosling, Vice-President, and Mr. R. C. Slater, Deputy Secretary.

Conferences Organized by the Institution. In 1972 three major conferences were organized by the Institution; the first of these was on Digital Processing of Signals in Communications and was held at the University of Technology at Loughborough from 11th–13th April 1972. This was a truly international conference with no less than 23% of the 305 attendees coming from overseas. During the three days of the conference 45 papers were presented. Co-sponsors of the Conference were the Institution of Electrical Engineers and the Institute of Electrical and Electronics Engineers.

The second conference was on Radio Receivers and Associated Systems and this was held at the University College of Swansea from 4th–6th July 1972. During this conference 34 papers were presented to an audience of 190. Added interest was given to this event by a number of static and working demonstrations which were housed in a laboratory above the lecture theatre. Co-sponsors of the Conference were the Institution of Electrical Engineers and the Institute of Electrical and Electronics Engineers.

The third conference to be held during the year was on Computers—Systems and Technology, and this took place at the Middlesex Hospital Medical School, London, from 24th–27th October 1972. This was the sixth in a series of Joint IERE/IEE/BCS Computer Conferences. At the two previous events held in 1967 and 1969 the attendances were 300 and 239 respectively. It is, therefore, gratifying to report that at the latest conference in this series the attendance was 347. Although originally planned as a three-day event its duration was extended by a further half-day to accommodate the 43 papers which were included in the programme.

The full text of all the papers presented at these Conferences are published in the IERE Conference Proceedings Nos. 23, 24 and 25 respectively, and these are currently on sale in the Institution's Publications Department. Due to the fact that these volumes are produced on a very much shorter time-scale than is possible in the case of standard textbooks they

represent the most up-to-date treatises available on their respective subjects. This is a very valuable adjunct to the forum for discussion which is provided by such conferences.

Joint Conferences. In addition to the conferences organized by the IERE the Institution acted as co-sponsor for a number of other conferences including:

- Trends in On-line Computer Control Systems
- Industrial Measurement and Control by Radiation Techniques
- Computer Aided Design
- Advances in Marine Navigational Aids
- Metering Apparatus and Tariffs for Electricity Supply
- Aeronautical and Maritime Satellite Systems
- Gas Discharges
- International Broadcasting Convention
- The Automation of Testing
- Satellite Systems for Mobile Communications and Surveillance

These examples of inter-disciplinary activity are emphasized in the renewal of the joint IEE/IERE publication of the 'Combined Programme of Meetings'. Such co-operation between Institutions avoids conflicting dates and gives the maximum opportunity for engineers to participate in learned society activities.

Representation on BSI Committees. The Institution continues its support of the work of the British Standards Institution and a list of IERE representatives on BSI Technical Committees is given in Appendix 5.

Representation on other Organizations. The Institution is also represented on a number of outside technical committees and organizations, and details of these appointments are included in Appendix 8.

Acknowledgments of Council. The Council especially wishes to thank Universities and Technical Colleges and other organizations for accommodation for meetings; the editors of scientific periodicals for publicizing details of Institution meetings and other activities in Great Britain and Overseas, the many Institution members who contribute to the success of learned society activities by serving on various Institution committees (national and local) and also the many members who represent the Institution on BSI and similar organizations.

EDUCATION AND TRAINING COMMITTEE

Members of all grades will be pleased to note that the Technician Education Council and SCOTEC, the corresponding body in Scotland, have been set up† to implement the recommendations of the Haslegrave Report. The Institution's advice was sought and acted upon regarding the constitution of these bodies and the 'founder members' of the Technician Education Council include two members of the IERE. The Council is firm in its belief that every encouragement should be given to the proper education and training of technician engineers for they are a most important element in the structure of the engineering industry. Without them the Chartered Engineer cannot adequately fulfil his functions and it was to enable the closer association of Technician Engineers and Chartered Engineers that the Bye-Laws were revised and the new class of Associate Member was created.

An important element in progressing to the status of Chartered Engineer is post-graduate training and experience. In order to define these requirements more closely and to give greater guidance to both trainees and employers, the Committee has drafted a proposed publication on 'Training Regulations'. This has been circulated to a number of the major employers in the electronics industry for comment and, in the light of these the draft has been amended where considered desirable. Coincident with this CEI has set up a Working Party to consider a revision of Statement No. 6, 'Guidelines on Training'. Thus Council has decided to withhold publication of the Institution's Training Regulations until revision of the CEI Statement has been completed as it is clearly in the interests of the engineering profession as a whole to have a unified approach to such matters.

* See *The Radio and Electronic Engineer*, 43, p. 234, March 1973.

† 'A new deal for technicians', *The Radio and Electronic Engineer*, 43, p. 241, April 1973.

An attempt is also being made to obtain general agreement between the constituent members of CEI on the 'Mature Candidate' route to C.Eng. registration and on a proposal for a 'Professional Competence Test' which would form part of the qualification for registration. Whilst, in the long term, unification in standards of qualification and methods of assessment will lead to an enhancement of the status of the engineer, there is clearly difficulty in reconciling the differing approaches which have become traditional in the various engineering disciplines concerned. Both of these matters have now passed from the 'overall policy' to the 'detailed consideration' stage and are now being handled by the Academic Standards Committee.

The Committee continues to give attention to the progress of the Student through all the stages from the awakening of interest in electronics to the achievement of employment and in this context is currently considering the implications of the increasing emergence of inter-disciplinary specializations. Discussions are continuing on the structure of engineering qualifications and their relevance to Parts 1 and 2 of the

CEI examination. Of particular concern is the fact that the HND is now only regarded as an entry qualification to Part 2 of the CEI examination. The consequence of this is that some Polytechnics are tending to transfer their more able HND students to CNAAL degree courses. Unfortunately this often leads to a minimal pass degree which narrows the gap which industry sees between an HND and a pass degree holder. It is considered that this is not in the best long-term interest of the profession or of the individuals concerned.

In collaboration with the Professional Activities Committee consideration is being given to the arrangement of colloquia which allow subjects to be treated in greater depth than is possible at evening lecture meetings. The Committee is also currently concerned with the organization of the Conference on 'The Electronics Industry and its Interface with Higher Education' which is scheduled for March 1974.

As always, the Committee has been greatly assisted by a number of distinguished members several of whom have recently had to retire. Council takes this opportunity of thanking them for their valuable services.

ACADEMIC STANDARDS (formerly EXAMINATIONS) COMMITTEE

In the last Annual Report reference was made to the 'changing role' of the Examinations Committee. For 43 years the Institution conducted its own Graduateship Examination, not only as a direct means of determining academic ability, but also as a comparative means of assessing the standard of alternative examinations in radio and electronic engineering. Now that the CEI examination has replaced the IERE (and other Institutions') Graduateship Examination, the Council has appointed an 'Academic Standards Committee' to replace the former Examinations Committee. The new Committee will primarily be concerned with assessing the academic qualifications of applicants for admission to membership and/or entry to all or part of CEI examinations. Dr K. E. Everett, who is also the IERE representative on the CEI Exemptions Sub-Committee, was appointed the first Chairman of the new Committee.

In determining the degree of exemption from the CEI examination which may be granted to candidates holding University Degrees, or similar qualifications, the new Committee's task has been made more difficult by the re-assessment of many courses which led to academic qualifications hitherto accepted by most Institutions. An outstanding example is the different valuation now placed on Higher National Certificates. In order to help candidates who were in difficulty as a result of changes in academic requirements, it was agreed throughout CEI to operate certain bridging schemes until the end of 1973. These schemes are not wholly adequate, and so the Committee has encouraged some applicants to submit technical papers for exemption purposes in cases where previously the candidates would have been requested to obtain endorsements to their Higher National Certificates or take specified subjects in the IERE examination. Additionally, the Committee has also invited candidates to attend 'professional interviews'.

The submission of a report or paper to indicate the standard of a candidate's technical knowledge and the use of 'professional interviews' have also been proposed within CEI as necessary tests for mature candidates, i.e. candidates whose age and/or professional appointment is a deterrent to undertaking studies for a new (CEI) examination. Moreover, the proposal limits entry by such a 'mature candidate' route to the next ten years or even earlier. Whilst the IERE Council welcomes the opportunity to admit such candidates to membership it considers the proposed procedures to be unduly cumbersome. The Academic Standards Committee

has therefore made a number of suggestions to CEI and stressed that a 'mature candidate' is, almost by definition, a person whose talents have been so well developed that lack of complete academic qualifications has proved no obstacle to his progress. This being so, his early opportunities, including perhaps absence of educational facilities to study his present discipline, and his professional achievements are material factors which must be taken into account; any completely standardized assessment procedure may be unfair, and even unworkable.

All sectors of education are undergoing change and the changes being wrought in the field of engineering education underline the need for the Institutions to be involved with the architects of these new policies. CEI Statement No. 10 contains the revised Regulations and Syllabuses for CEI examinations from May 1974 onwards. IERE committees, and some individual members, contributed a great deal to the revision of the Part II Syllabus, and the Council is gratified that the proposal to permit the taking of that part in two sittings of three subjects each, has been accepted. On the debit side, it regrets that the gain in flexibility achieved in this direction has been, to some extent, negated by the impending withdrawal of recognition of certain College Diplomas and Associateships as exempting qualifications as a result of a majority decision within CEI.

As a consequence of the Institution's founder membership of the Technician Engineer Section of the Engineers Registration Board, the Academic Standards Committee also undertakes assessment, where necessary, of the academic qualifications of applicants for T.Eng. registration, and monitors the 'training' aspects of the qualifications of applicants for both C.Eng. and T.Eng. registration.

The IERE, in association with the Institution of Electrical Engineers, forms the Joint Committee for Higher National Certificates and Higher National Diplomas in Electrical and Electronic Engineering. Both Institutions were invited to submit comments on the proposed structure and terms of reference of both TEC (Technician Education Council) and SCOTEC (Scottish Technical Education Council).

The Academic Standards Committee is continuing its discussions with colleagues in other Institutions on the necessity to retain, within the European engineering community, the best of British traditional methods in the training and recognition of the Chartered Engineer, the Technician Engineer and the Technician.

MEMBERSHIP COMMITTEE

The increasing and widespread interest in membership is shown in the fact that during the year 1349 enquiries were dealt with directly from Headquarters in addition to the considerable number which was dealt with by the Local Sections, Overseas Divisions, and industrial and educational liaison officers. In this period the Committee considered 1075 proposals of which 478 were for direct election, 593 for transfer to higher grades and four for reinstatement.

The detailed movement in membership figures is shown in Table 1. An encouraging feature is the 7.3% increase in the number of corporate members; it is especially interesting to note that no less than 447 members from non-corporate grades succeeded in their applications for transfer to corporate membership. It is, of course, the whole purpose of the membership structure that members should make a steady progression through the grades, with Fellowship as the final goal for the professional engineer. While the overall gain in membership is low compared with recent years, this is largely due to the removal from the Register of a further 220 students who clearly would not progress to the higher grades.

An increase of 4% in the number of Associates can be regarded as satisfactory in view of the result for the previous year. There may still be some misunderstanding about this grade. The Institution is a Professional and Chartered organization for Engineers which has seen the need for a closer liaison between the professional engineer and the senior technician and has opened its doors to the latter. This grade of Associate does not carry registration as Chartered Engineer but the Council hopes that by their association, competent technicians will be encouraged to work towards full professional membership. The IERE is a founder member of both the Chartered Engineer and Technician Engineer Sections of the Engineers Registration Board (ERB) and it is

worth noting that five other CEI Professional Institutions have taken the same step, that two others have since joined both sections and one other is in negotiation with ERB to join.

While the Committee is primarily concerned with the assessment of applications for membership it is also responsible to the Council for membership recruitment. In this context the most important problem at the present time is the comparative lack of interest shown in Institution activity by younger people. Particularly does this seem to be the attitude of a number of newly qualified degree holders who feel that they are fully qualified professional engineers *ab initio*. However, as all employers will know, a degree is but the starting point to eventual qualification. The elements of post-graduate training and responsibility in the existing requirements for corporate membership and the status of 'Chartered Engineer' have been evolved through the long experience of this and the other constituent members of CEI. It is this interval of time, properly utilized, that marks the important difference between a newly qualified graduate and the professional engineer. It is thought that greater efforts are needed by the whole of the engineering profession to impress this fact on the younger aspirants to professional status. The establishment of the Engineers Registration Board will, no doubt, go some way towards encouraging a closer involvement with a professional Institution.

The difficulty of bringing about the involvement of undergraduates in Institution activities is also considerable but not peculiar to any one discipline or indeed to this country alone. Information being collected by the Convention of the Electro-technical Societies of Western Europe shows that it is widespread. This is an area in which this Institution has always shown a keen interest and it was as a result of the ideas put forward to CEI by Mr. Harvey Schwarz, when President,

Table 1. Institution Membership April 1972 to March 1973

	Member- ship at 31.3.72	ADDITIONS			Total Additions	DEDUCTIONS				Total Deduc- tions	Net Gain or Loss	Member- ship at 31.3.73
		Direct Elections	Reinstatements	Transfers		Deaths	Resignations	Expulsions	Transfers			
Honorary Fellows . . .	12	—	—	—	—	2	—	—	—	2	— 2	10
Fellows	666	7	2	15	24	7	3	3	—	13	+ 11	677
Members	5569	84	1	447	532	15	36	22	13	86	+446	6015
Total Corporate Membership	6247	91	3	462	556	24	39	25	13	101	+455	6702
Graduates	6220	138	—	49	187	3	49	7	433	492	—305	5915
Companions	19	—	—	—	—	—	—	—	—	—	—	19
Associates	873	48	—	7	55	—	14	1	7	22	+ 33	906
Students	1821	163	1	—	164	1	50	220	65	336	—172	1649
Total Membership	15180	440	4	518	962	28	152	253	518	951	+ 11	15191

that the CEI Working Party on Student Recruitment was set up under the Chairmanship of Sir Leonard Atkinson (Past President). This Working Party is currently considering in depth the whole subject of recruitment to the engineering profession. Meanwhile, new registrations of Students have continued at a satisfactory level. The Institution also has a scheme for registration as 'Non-Member Entrants' of examination candidates who are over-age (25 or above) for initial registration as Students. This enables the late developer to submit qualifications for assessment and, if acceptable, to be sponsored by the IERE for the CEI examination. They are not included in the membership figures.

Members will know that during the year a petition was laid

before the Privy Council for approval of some radical changes in the Bye-Laws, especially concerning the grade of Member, sponsorship for that and other grades, the introduction of a formalized Code of Conduct, the revised designation of 'Associate Member' for those qualified for registration as Technician Engineers with the ERB, and the constitution of Council itself.

The Council again expresses thanks for the co-operation of Liaison, Training and Personnel Officers and its appreciation of the unselfish work carried out by members on an individual basis and through the Local Sections and Overseas Divisions to encourage membership and to help and advise candidates.

PAPERS COMMITTEE

The main role of the Committee is to obtain papers for publication and to assess their suitability for inclusion in the Institution's Journal as being of interest and value to members. This clearly defined role of the Committee has now operated for two years, the former parallel task of planning and co-ordinating meetings and conferences having been passed to the Professional Activities Committee. Concentration of the Committee's work has enabled it to look more critically at the ways in which it carries out its various tasks although the major part of its time is still concerned with considering referees' reports on papers and reaching decisions on the suitability or otherwise of papers for publication.

Encouragement of Papers. Members of the Committee, all of whom have had first-hand experience of the time-consuming task of preparing papers, are well aware that there are many obstacles in the way of the engineer wishing to describe work which he has carried out, not the least of which is the pressure to concentrate on the next project as soon as the previous one has been concluded. The desirable course is for the writing of a paper to be kept in mind throughout the duration of the project so that much of the framework will exist and, in theory at least, only results and conclusions will need to be added!

Most engineers, however, do not think about this aspect until it is almost too late and the pressures of the next job have started to be felt. How to increase the awareness in the engineer of the desirability of publishing his work concerns all who wish to promote the development of engineering. Probably the most promising line of approach is to convince senior members who are directing research and development work of the advantages to their organizations, particularly the commercial advantages, as well as to individual engineers of publishing work in the Institutions's Journal.

While to encourage the submission of a paper is one thing, frequently authors, particularly if they are inexperienced, ask for advice in preparing their manuscript to meet the Institution's requirements. It was therefore decided to revise the leaflet 'Guidance for Authors' which was written in 1957 and this has now been published. Copies are sent free of charge to intending authors.

The year 1973 was the 25th anniversary of the invention of the transistor and to mark this event, one of the most significant in the history of technology, a special issue of the Journal was designed. It was planned that this should describe the bewildering sequence of discoveries which led from the simple point-contact device of 1948 to the minute but incredibly complex l.s.i. chip of today which can fulfil the functions of, for instance, a small computer, and survey the impact of the transistor in many fields of application. With the support of the President of the Institution, who personally

issued invitations to submit papers for this issue, a comprehensive series of 18 review papers by British Engineers who have played or are still playing an active part in the 'Semiconductor Revolution' was assembled and published within the covers of the combined January/February 1973 issue of *The Radio and Electronic Engineer*. This issue will, it is believed, serve as 'required reading' for many years to come by engineers wishing to gauge the impact and potentialities of the transistor and its numerous descendants. Certainly the issue has attracted much favourable comment and a considerable number of copies have been sold both to individual engineers and to libraries all over the world.

The success of the Transistor Issue has led the Committee to initiate, as a long-term development, publication of 'feature issues' of the Journal which will consist wholly or mainly of papers on a particular theme. The extent of electronic engineering today is such that one man's specialization will be almost a closed book to the next man and it would not be to the benefit of members as a whole if such issues were to predominate and moreover were to deal with highly specialized themes. The level of approach of these issues will therefore be 'graded' in that the aim will be to include an introductory review, followed by application papers where appropriate, as well as the original research type of contribution. The Committee has drawn up a list of subjects for some half-dozen feature issues to appear over the next two years and the first of these, to be devoted to 'Optical Fibre Research and Communications', will appear in November 1973. An issue on Logic Design is scheduled for January 1974 and advance notice will be given of subsequent issues as the dates of these are settled.

Assessment. During the period from April 1972 to March 1973, the number of papers submitted to the Committee for consideration for publication totalled 190, considerably more than in 1971/72 and almost exactly the same as for 1970/71. The figures include papers selected from three IERE conferences held during 1972, all of which were basically Electronic Engineering, i.e. were not orientated towards the application of electronics to other disciplines. Details are as follows (1971/72 figures are given in parentheses):

Number of papers considered:	190 (131)
Accepted for publication:	85 (64)
Returned for revision:	26 (22)
Rejected:	79 (45)

The assessment of so large a number of papers must obviously be spread over a fairly wide panel of referees if members of the Committee (who now number 14) are not to be unduly overburdened. While maintenance of consistent

refereeing standards would be aided by a very small panel of referees, this is impracticable and to help referees from outside its ranks, particularly those called upon to referee a paper for the Institution for the first time, the Committee has prepared a leaflet entitled 'Guidance for Referees'. Usually referees are or have been members of one of the specialized group committees although from time to time other members assist in this important work. The council especially thanks all these members and others who acted as referees.

Selection. On previous occasions, the Committee has expressed its disappointment that more papers read at meetings of the Institution whether in London or before Local Sections are not submitted for publication. During 1972/73 the total was 6 out of 140. Ways are being explored to encourage more authors of these oral contributions to convert them into written papers and thereby reach a potential readership which is without exaggeration hundreds of times larger than the audience which can possibly be present at a meeting.

Reference has already been made to the contribution to the Journal resulting from the selection of papers from the proceedings of conferences organized by the Institution. The

three 1972 conferences dealt respectively with Digital Processing of Signals in Communications, Radio Receivers and Allied Systems, and Computer Systems and Technology; out of the total of 119 papers read at these conferences, 50 were considered for publication and 21 were selected.

Premiums and Awards. This year a record 12 of the annual Premiums and Awards for outstanding papers are to be presented. This assessment covers the 1972 issues of the Journal; three of the papers had been presented first at meetings of the Institution, one at a Local Section meeting and two at conferences.

Norman Hayes Award. The Institution assists the Institution of Radio and Electronics Engineers Australia in the assessment of papers published in their Proceedings for the Norman W. V. Hayes Memorial Award. This task was carried out during 1972 in respect of papers published in the *Proceedings of the IREE Australia* for 1971. The paper which received the award was entitled 'An experimental adaptive echo canceller for long distance telephone circuits' and this was reprinted in *The Radio and Electronic Engineer* for April 1973, under the long-standing arrangement between the two Institutions.

INSTITUTION PUBLICATIONS

The Radio and Electronic Engineer. The format of the Journal has remained substantially the same during 1972 as in 1971 and only a few changes were made at the beginning of 1973. The Journal now contains technical papers in its first part which averages about 48 pages in an issue, while the second part, average length 16 pages, deals with affairs within the Institution and profession and with matters of technical news interest. This second section, formerly referred to as the 'Supplement' has since the beginning of 1973 been entitled 'IERE News and Commentary'.

The statistics of the Journal for 1972 represent a small increase in total pages over those for 1971 as follows (1971 figures in parentheses):

Papers: 568 pages (572)

Supplement: 208 pages (184)

The total number of papers published was exactly the same as for 1971, namely 75.

The total number of pages published in the Journal over the years has shown a fairly steady decrease. This has been due to the adoption of a larger format but especially to editorial effort in encouraging shorter papers. The policy regarding the publication of papers originally read at conferences has also had a significant effect since special, separate, Conference Proceedings are now prepared and it is now the practice to republish in the Journal a small selection of papers which have a general interest to the membership. Members can, however, purchase the complete record of any conference.

'New Products' information continues to be published and every month several hundred requests for further details are received from members all over the world. The service is intended for the convenience of members and feedback to the Institution of their views on the effectiveness with which manufacturers provide information requested would be useful. In turn the response of members for further information on particular products gives guidance to manufacturers on the effectiveness of the Journal as an advertising medium. The fullest use of the service by members can therefore prove mutually helpful to themselves and to the Institution.

Although there are signs that the Electronics Industry is coming out of its period of recession, this has not so far appreciably affected expenditure on advertising. Over the year advertisement revenue has increased by 7% compared with 1971/72, but it is hoped that next year it will be possible to record a further improvement.

Increase of advertisement revenue is, of course, vital since production costs continue to show considerable advances in each area. For instance, during the year printing and

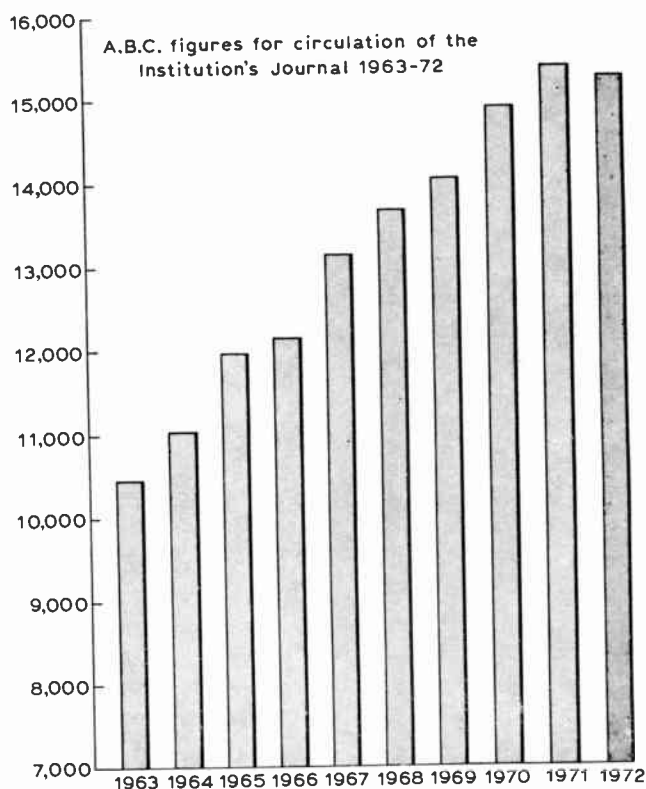

production costs rose by 10%, the cost of paper by 12%, whilst postage is now nearly 20% above the level for 1971/72 (a year in which a 100% rise was incurred!). These figures will illustrate the formidable financial battle which an Institution journal has to wage.

For the first time in many years the total circulation of the Journal has not shown an increase from one year to the next. The difference between the Audit Bureau of Circulations' figure for 1972 of 15,221 is only 169 fewer than the figure in 1971 but, as the accompanying chart shows, there have been annual increases during the past ten years of anything up to 1000 copies. Part of the decrease has been due to the small net increase in membership but there has also been a significant falling-off of subscriptions from libraries of Universities and of Government and Industrial Organizations. It was suggested in an Editorial article in the July issue of the Journal that the growing use of photocopying may well have contributed to the latter decrease and is in many respects false economy for the user.

Many of the problems faced by the Institution in its publishing activities are shared by other similar bodies. During the year the IERE supported the setting-up of the Association of Learned and Professional Society Publishers and welcomes the opportunities for co-operation which this should offer.

Overseas Publications. The bi-monthly publication, 'IEE-IERE Proceedings—India' has continued to be issued to members of both Institutions and its broadness of coverage provides a valuable extra service to these members. The six issues contained a total of 21 papers, and comprised 232 pages.

Several other of the Overseas Divisions and Sections have

produced occasional Newsletters or Bulletins for their members.

Conference Proceedings. Three major Conferences were held in 1972 and volumes of Proceedings were published as follows:

Digital Processing of Signals in Communications (No. 23)

Radio Receivers and Associated Systems (No. 24)

Computers—Systems and Technology (No. 25)

The three volumes totalled 1366 pages of text.

Sales of Conference Proceedings following the events, as well as standing orders, are growing and indicate the value to engineers all over the world of the Institution's learned society activities.

Electronics Review. This bi-monthly journal which the Institution publishes for the National Electronics Council continues to provide a bridge between research and management. It is particularly notable for its dissemination of material which is not easy to find elsewhere, for instance the research programmes of British and Commonwealth Universities, and for articles on subjects which involve very different disciplines.

The National Electronics Council (NEC) is only concerned with the 'forward' application of radio and electronics and how best to marshal the British effort in this area of technology. Thus it has been concerned with introducing electronics as an 'A' Level subject in schools while electronics in navigation, satellites and transport are examples of the reports that NEC makes to Government. All these activities justify the support of the chartered radio and electronic engineer.

LIBRARY AND INFORMATION SERVICE

The number of technical inquiries referred to the Institution has steadily grown, and during the year numerous requests for current awareness literature and for information retrieval have been successfully met.

In consultation with the Technical Colleges which run courses for the revised CEI Parts 1 and 2 examinations a list of recommended textbooks has now been prepared by the Institution's Education Department. A selection of these books is held in the Library for loan. Attempts are always made to increase the stock of books available on loan and

during the year 130 new titles were acquired. Many of these are listed and reviewed in the Institution's Journal from time to time.

While many members resident in the British Isles make use of the postal loan facilities, the Library's reading room is widely used by students and prospective members and, especially, by members from industrial and government organizations mainly in the London area carrying out the literature study necessary for research and development projects.

FINANCE COMMITTEE AND ADMINISTRATION

The Institution shares the problem now facing every professional body in maintaining standards on a fixed revenue whilst coping with ever increasing charges for all materials and services needed for Society activities. With inflation continuing every Institution has had to consider revision of subscription revenue, although, as stated in the last Annual Report, the Council has striven to avoid making increases. Absolute necessity, however, makes a revision of subscription rates inevitable before the commencement of the 1974/75 Financial Year. At the last Annual General Meeting members accepted this proposal and with the delay of another year Council hopes for the goodwill of all members in meeting the small increases to be proposed.

How necessary are these increases is shown by the Accounts appended to this Report. Comparative figures shown for the preceding year enables members to note not only the

increases in costs, but the improvement in revenue indicating the efforts made by Council to achieve a balance between revenue and expenditure. Even so, it has been impossible to secure a return to a favourable Reserve Account.

Income and Expenditure Account. Subscriptions showed an increase of 3% but if the exceptional increase of the previous year (6%) is taken into account, the average for the past two years exceeds 4%, which is in keeping with the average progress of most Institutions.

As stated in last year's report, examination fees no longer feature in Institution accounts since the Council of Engineering Institutions has now taken over entire responsibility for conducting the qualifying Examination for all fifteen Chartered Engineering Institutions. The IERE last held its own independent examination in 1971. Fees were then very much lower, but receipts of over £10 000 helped to off-set the

cost of administering the examination. Although the Institution no longer conducts the examination, there remain some staff costs (exceeding about £2,000 per annum), in respect of administering examination enquiries and progressing approved entries for admission to CEI Examination Centres.

In addition, the IERE contribution to CEI, has more than doubled since 1966. Whilst this is consonant with the growth of the IERE—the levy is on a *per capita* basis of corporate membership (Chartered Engineers)—future budgeting must also pay regard to the necessary costs of maintaining the Council of Engineering Institutions which has itself managed to keep the present impost down to the 1969 figure. This is a creditable achievement, but must not mask the probability of an increase if CEI is properly to represent professional engineers at all levels.

IERE accounts show that administration charges bore a minimum increase. This is partly due to the fact that the Institution has been operating at only two-thirds of its required strength because of the difficulty of staff recruitment. This has placed a heavy burden on the existing staff which cannot continue.

In the event, the total increase in costs has been lower than the relevant percentage in revenue. Significantly, increases in subscription and sales revenue have again proved the continuing attraction of Institution membership and services.

Balance Sheet. As shown there have again been alterations and improvement charges on 8 and 9 Bedford Square. These

follow negotiations started to dispose of the remainder of the short lease on 50 Bloomsbury Street. The alterations being made in 8 and 9 Bedford Square will enable the accommodation hitherto used in Bloomsbury Street to be absorbed in the main building. Builders' costs are, however, very high in the inflation 'table'; the warmly welcomed donations to the 'Building Improvements Reserve' help but do not anywhere meet the costs involved and the leeway must be met out of normal revenue.

Administration. The recruitment of suitable staff is a national problem, especially in the London area. Shortage of assistants has placed a severe burden on senior staff, most of whom have been working for the Institution for many years. Although there is a continual effort to fill vacancies, the present complement of 38 is the lowest since 1968. The achievements of the past year, therefore, give testimony to the co-operation which exists between the administrative staff and the members who provide technical expertise.

For these reasons the Council especially records thanks to all the members who have assisted the Institution and to the permanent staff.

Conclusion. There has been a substantial saving in the cost of collection of subscriptions by the introduction of the Direct Debit System. The Council especially appreciates the co-operation of all members who have agreed to this method of remitting subscriptions and thereby contributed to reducing costs.

INSTITUTION OF ELECTRONIC AND RADIO ENGINEERS
GENERAL FUND
SCHEDULE OF INVESTMENTS AS AT 31st MARCH, 1973

<i>Nominal</i>		<i>Cost</i>	<i>Nominal</i>	<i>Cost</i>
		£		£
500	Allied Textile Cos. Ltd. 25p Ordinary Shares	511		
£1,000	7½% Barnet Corporation 1982/4	983	660	Brought forward
1,500	B.B.A. Group Ltd. 25p Ordinary Shares	1,115		11,738
£500	Beecham Group Ltd. 5% Convertible Unsecured Loan Stock 1984/94	486	500	R. Green Properties Ltd. 10p Ordinary Shares
3,000	Bonochord Ltd. 5p Ordinary Shares	401	665	E. G. Herbert Ltd. 25p Ordinary Shares
700	Boots Pure Drug Co. Ltd. 25p Ordinary Shares	882	505	I.C.I. Ltd. £1 Ordinary Shares
500	British Land Co. Ltd. 25p Ordinary Shares	627	500	Lonrho Ltd. 25p Ordinary Shares
1,000	British Oxygen Co. Ltd. 25p Ordinary Shares	653	500	Mann Egerton & Co. Ltd. 25p Ordinary Stock Units
£500	British Petroleum Co. Ltd. 8% Cumulative First Preference Stock	685	600	Marks & Spencer Ltd. 25p Ordinary Shares
1,000	A. F. Bulgin & Co. Ltd. 5p Ordinary Stock Units	390	£1,000	Middlesex County Council 6½% Redeemable Loan Stock 1975/77
333	A. F. Bulgin & Co. Ltd. 5p 'A' Non-voting Ordinary Stock Units	—	£2,000	New Zealand 7½% Stock 1977
800	Courtaulds Ltd. 25p Ordinary Shares	1,175	500	Plessey Co. Ltd. 50p Ordinary Shares
200	Decca Ltd. 25p Ordinary Shares	645	400	Shell Transport & Trading Co. Ltd. 25p Ordinary Shares
125	Decca Ltd. 25p 'A' Ordinary Shares	424	£1,000	Slough Corporation 8½% Redeemable Stock 1979/80
200	Distillers Co. Ltd. 50p Ordinary Shares	342	£521.20	Southern Rhodesia 6% Stock 1978/81
320	Dunlop Co. Ltd. 50p Ordinary Shares	560	£500	Stock Exchange London 7½% Mortgage Debenture Stock 1990/95
200	E.M.I. Ltd. 50p Ordinary Stock Units	545	500	Tanganyika Concessions Ltd. 50p Ordinary Shares
£60	E.M.I. Ltd. 8½% Convertible Unsecured Loan Stock 1981	60	£500	Thorn Electrical Industries Ltd. 5% Convertible Unsecured Loan Stock 1990/94
320	English China Clays Ltd. 25p Ordinary Shares	495	660	Transport Development Group Ltd. 25p Ordinary Shares
300	Grattan Warehouses Ltd. 25p Ordinary Stock Units	804	500	United Gas Industries Ltd. 25p Ordinary Shares
	Carried forward	£11,783		413
				<u>£27,255</u>

INSTITUTION OF ELECTRONIC AND RADIO ENGINEERS

GENERAL FUND

INCOME AND EXPENDITURE ACCOUNT FOR THE YEAR ENDED 31st MARCH 1973

1972 Expenditure					1972 Income				
£	£		£	£	£				£
		ADMINISTRATION EXPENSES			134,087	Subscriptions received, including arrears	138,019
59,659		Salaries and State Insurance	60,886	57	Donations from Industry	57
3,460		Superannuation Scheme	4,030	710	Exemption Fees	818
7,102		Postage and Telephone	6,789	3,324	Entrance and Transfer Fees	4,620
3,143		Printing and Stationery	3,474	18,412	Sales of Journal and Publications	27,513
3,894		Computer Service	4,306	1,726	Dividends and Interest on Investments (Gross)	1,108
1,388		Travelling and Entertaining	1,421					
3,391		Council and Committee Expenses	2,716					
852		Delegates Expenses	844					
1,355		Bank Interest and Charges	971					
472		Audit Fees	573					
3		Legal Charges	65					
1,820		Sundry Expenses	1,437					
86,539				87,512					
		INSTITUTION PREMISES							
6,198		Rent, Rates and Insurance (Net)	6,557					
700		Lighting and Heating	985					
3,044		Office Expenses and Cleaning	3,736					
1,322		Repairs and Maintenance	4,641					
11,264				15,919					
		INSTITUTION JOURNAL							
33,388		Publishing Journal	39,595						
5,338		Less: Advertising Receipts	5,724						
28,050				33,871					
10,732		Postage		12,719					
1,085		Envelopes and Wrappers		900					
39,867				47,490					
1,324		GENERAL MEETING AND CONFERENCE EXPENSES		1,084					
		DIVISIONS AND SECTIONS OPERATING EXPENSES							
4,628		Salaries, Printing, Stationery, Postage and Office Expenses	3,920						
4,804		Hire of accommodation, Lectures and meeting expenses	3,847						
1,983		Travelling Expenses	1,688						
1,219		Indian Proceedings	1,728						
12,634				11,183					
3,116		SUBSCRIPTION TO THE COUNCIL OF THE ENGINEERING INSTITUTIONS	3,367						
549		GRANTS TO OTHER INSTITUTIONS	382						
279		PREMIUMS AND AWARDS	430						
		DEPRECIATION							
1,045		Office Furniture and Fittings	1,002						
512		Library	556						
1,557				1,558					
1,187		SURPLUS FOR YEAR TRANSFERRED TO GENERAL ACCOUNT	3,210						
£158,316			£172,135	£158,316					£172,135

Appendix 1

Membership of the Council and its Committees as at 31st March 1973

The Council of the Institution

President:

A. A. Dyson, O.B.E. (*Fellow*)

Past Presidents:

Professor E. Williams, Ph.D., B.Eng. (*Fellow*)

Major-General Sir Leonard Atkinson, K.B.E., B.Sc. (*Fellow*)

Harvey F. Schwarz, C.B.E., B.Sc. (*Fellow*)

Vice Presidents:

J. Bilbrough (*Fellow*)

Professor W. A. Gambling, D.Sc., Ph.D. (*Fellow*)

Air Commodore S. M. Davidson, C.B.E. (*Fellow*)

Professor W. Gosling, B.Sc. (*Fellow*)

Group Captain C. K. Street, M.B.E. (*Fellow*)

A. St. Johnston, B.Sc. (*Fellow*)

S. R. Wilkins (*Fellow*)

Ordinary and ex-officio Members of Council:

P. A. Allaway, C.B.E., D.Tech. (*Fellow*)

Captain A. W. Allen, R.N.(Retd.) (*Member*)*

H. Arthur, M.Sc., Ph.D. (*Fellow*)

P. Atkinson, B.Sc. (*Member*)*

Professor H. M. Barlow, Ph.D., F.R.S., F.C.G.I. (*Honorary Fellow*)

G. R. Barnes (*Member*)*

N. E. Broadberry (*Member*)*

D. Chalmers (*Fellow*)*

Professor G. B. B. Chaplin, M.Sc., Ph.D. (*Fellow*)

Professor D. E. N. Davies, D.Sc., Ph.D. (*Member*)

D. Dick, D.I.C. (*Fellow*)*

R. I. Edgar (*Fellow*)*

D. G. Enoch (*Member*)*

W. J. Fry (*Fellow*)

Major-General P. H. Girling, C.B., O.B.E. (*Fellow*)

E. F. Gooda, M.Sc. (*Member*)*

J. R. James, Ph.D. (*Member*)

Brigadier R. Knowles, C.B.E. (*Fellow*)

R. T. Lakin, M.B.E. (*Fellow*)

R. Larry (*Fellow*)

K. A. Mackenzie (*Fellow*)*

J. D. Parsons, B.Sc., M.Sc. (*Member*)*

A. S. Prior (*Member*)*

A. M. Reid (*Member*)*

A. J. Shapland (*Member*)*

D. Simpson (*Fellow*)

W. E. Wheeldon, B.Sc. (*Member*)*

Honorary Treasurer:

G. A. Taylor (*Fellow*)

Director and Secretary:

Graham D. Clifford, C.M.G. (*Fellow*)

*Chairman of a Local Section in Great Britain and ex-officio a Member of Council

Standing Committees of the Council

Executive Committee

Chairman: The President

Major-General Sir Leonard Atkinson, K.B.E., B.Sc. (*Fellow*)

Professor W. A. Gambling, D.Sc., Ph.D. (*Fellow*)

D. W. Heightman (*Fellow*)

F. N. G. Leever, B.Sc.(Eng.) (*Fellow*)

I. Maddock, C.B., O.B.E., D.Sc., F.R.S. (*Fellow*)

A. S. Pudner, M.B.E. (*Fellow*)

H. F. Schwarz, C.B.E., B.Sc. (*Fellow*)

A. St. Johnston, B.Sc. (*Fellow*)

Professor E. Williams, Ph.D., B.Eng. (*Fellow*)

Finance Committee

Chairman:

F. N. G. Leever, B.Sc.(Eng.) (*Fellow*)

J. G. Geary, B.Sc. (*Fellow*)

D. W. Heightman (*Fellow*)

A. S. Pudner, M.B.E. (*Fellow*)

G. A. Taylor (*Fellow*)

S. R. Wilkins (*Fellow*)

Trustees of the Institution Benevolent Fund

Colonel G. W. Raby, C.B.E. (*Fellow*)

The President (*ex-officio*)

G. A. Taylor (*Fellow*), *Honorary Treasurer*

G. D. Clifford, C.M.G. (*Fellow*), *Honorary Secretary*

Education and Training Committee

Chairman:

D. L. A. Smith, B.Sc. (*Fellow*)

H. Arthur, M.Sc., Ph.D. (*Fellow*)

A. W. H. Carter (*Member*)

D. Dick, D.I.C. (*Fellow*)

Major-General P. H. Girling, C.B., O.B.E. (*Fellow*)

B. F. Gray, B.Sc.(Eng.) (*Fellow*)

Professor J. W. R. Griffiths, B.Sc., Ph.D. (*Fellow*)

Professor D. P. Howson, D.Sc. (*Fellow*)

A. J. Hymans, M.Sc. (*Member*)

C. H. G. Jones (*Member*)

F. R. J. Langridge (*Fellow*)

Captain P. J. Poll, M.Sc., B.A., R.N. (*Member*)

J. Powell, M.Sc. (*Fellow*)

W. L. Price, O.B.E., M.Sc. (*Fellow*)

W. D. Thomas (*Member*)

Professor E. Williams, Ph.D., B.Eng. (*Fellow*)

A. G. Wray, M.A. (*Fellow*)

Membership Committee

Chairman:

J. Powell, M.Sc. (*Fellow*)

C. W. Brown, M.A. (*Member*)

R. F. C. Butler, M.A. (*Member*)

E. Carr (*Member*)

D. N. J. Cudlip (*Member*)

D. Dibsdall, O.B.E., B.Sc. (*Member*)

Wing Cdr. P. J. Dunlop, RAF(Retd.) (*Fellow*)

J. D. Esler (*Member*)

N. L. Garlick, M.Sc. (*Fellow*)

H. Hudson (*Member*)

I. C. I. Lamb, M.B.E. (*Member*)

Col. R. W. A. Lonsdale, B.Sc., REME (*Fellow*)

S. H. Perry (*Member*)

R. S. Roberts (*Fellow*)

Captain F. Simm, M.A., RN (*Member*)

D. L. A. Smith, B.Sc. (*Fellow*)

S. J. H. Stevens, B.Sc.(Eng.) (*Fellow*)

Group Capt. G. Taplin, D.U.S., B.Sc., RAF (*Fellow*)

I. S. Thompson (*Member*)

W. F. Williams, B.Sc., Ph.D. (*Fellow*)

G. Wooldridge, M.Sc., Ph.D. (*Fellow*)

M. M. Zepler, M.A. (*Member*)

Examinations (now Academic Standards) Committee

Chairman:

K. E. Everett, Ph.D., M.Sc.(Eng.) (*Fellow*)

P. Atkinson, B.Sc.(Eng.) (*Member*)

Captain J. S. Brooks, RN (*Fellow*)

B. S. Pover (*Fellow*)

W. L. Price, O.B.E., M.Sc. (*Fellow*)

C. C. Richardson, B.Sc.(Eng.) (*Fellow*)

A. Tranter, B.Sc.(Eng.) (*Member*)

Col. J. Vevers, O.B.E. (*Fellow*)

Papers Committee

Chairman:

R. J. Cox, B.Sc. (*Member*) (To 28.2.73)

J. R. James, Ph.D., B.Sc. (*Member*)

(From 1.3.73)

L. W. Barclay, B.Sc. (*Fellow*)

J. Bilbrough (*Fellow*)

L. A. Bonvini (*Fellow*)

H. R. Bristow (*Fellow*)

W. G. Burrows, Ph.D. (*Member*)

K. J. Dean, Ph.D., M.Sc. (*Fellow*)

Professor E. A. Faulkner, Ph.D. (*Fellow*)

K. G. Freeman, B.Sc. (*Member*)

Professor D. W. Lewin, M.Sc. (*Member*)

E. Robinson, Ph.D. (*Fellow*)

L. A. Smulian, B.Sc. (*Fellow*)

A. G. Wray, M.A. (*Fellow*)

Professional Activities Committee

Chairman:

Professor W. Gosling, B.Sc. (Fellow)
Lt. Col. F. G. Barnes, M.A. (Member)
A. Churchman (Member)

J. R. Halsall, Dip.El. (Member)
A. Hann, B.Sc. (Fellow)
Brigadier R. Knowles, C.B.E. (Fellow)
R. Larry (Fellow)
F. Oakes (Fellow)
J. M. Peters, M.Sc.(Eng.) (Fellow)

D. L. A. Smith, B.Sc.(Eng.) (Fellow)
A. St. Johnston, B.Sc. (Fellow)
F. E. Whiteway, B.Sc.(Eng.) (Fellow)
W. E. Willison (Member)
Commander J. R. Young, M.A., RN (Fellow)

Specialized Group Committees

Aerospace, Maritime and Military Systems

Chairman:

C. Powell (Fellow)
N. G. Anslow (Member)
Lt. Col. W. Barker, REME (Member)
Professor J. W. R. Griffiths, B.Sc.(Eng.), Ph.D. (Fellow)
A. Hann, B.Sc. (Fellow)
A. Harrison, B.Sc. (Fellow)
J. A. C. Kinnear (Fellow)
R. N. Lord, M.A. (Member)
C. H. Nicholson (Fellow)
D. M. O'Hanlon (Fellow)
J. Savage (Companion)
Wing Cdr. G. E. Trevains, RAF (Member)
R. M. Trim, O.B.E. (Fellow)
T. W. Welch (Fellow)

L. A. Bonvini (Fellow)
R. W. Cannon (Fellow)
Professor J. W. R. Griffiths, Ph.D. (Fellow)
Professor D. E. N. Davies, D.Sc. (Member)
L. W. Germany (Fellow)
A. N. Heightman (Fellow)
R. C. Hills, B.Sc. (Fellow)
I. J. P. James, B.Sc. (Fellow)
G. R. Jessop (Member)
A. A. Kay (Fellow)
P. L. Mothersole (Fellow)
R. S. Roberts (Fellow)
J. Savage (Companion)
K. Veseley (Fellow)
K. E. Ward (Member)
Commander J. R. Young, M.A., RN (Fellow)
M. M. Zepler, M.A. (Member)

Lt. Col. R. A. Garrad, REME (Member)
Professor D. W. Lewin, M.Sc. (Member)
D. M. MacLean, B.Sc. (Fellow)
T. J. Stakemire (Member)
E. R. Tomlinson (Member)
W. E. Wilson (Member)

Automation and Control Systems

Chairman:

Professor D. R. Towill, M.Sc. (Fellow)
P. Atkinson, B.Sc. (Member)
M. S. Birkin (Member)
A. E. Crawford (Fellow)
A. F. Giles, B.Sc. (Fellow)
J. R. Halsall, Dip.El. (Member)
W. F. Hilton, D.Sc. (Fellow)
Brigadier R. Knowles, C.B.E., (Fellow)
R. W. A. Siddle (Member)
D. E. O'N. Waddington (Member)

Components and Circuits

Chairman:

Professor D. S. Campbell, Ph.D. (Fellow)
H. Blackburn (Member)
G. W. A. Dummer, M.B.E. (Fellow)
A. F. Dyson (Member)
R. R. Harman (Member)
A. G. J. Holt, Ph.D. (Member)
D. R. Ollington (Fellow)
A. Pugh, Ph.D. (Member)

Management Techniques

Chairman:

F. Oakes (Fellow)
D. W. Bradfield (Member)
T. G. Clark (Fellow)
Air Commodore S. M. Davidson, C.B.E. (Fellow)
P. Diederich (Member)
W. J. Fry (Fellow)
G. L. Hamburger, Dr. Ing. (Fellow)
M. W. Lauerma, M.A. (Member)
S. J. H. Stevens, B.Sc.(Eng.) (Fellow)
D. Simpson (Fellow)
J. Langham Thompson (Fellow)

Communications

Chairman:

R. Larry (Fellow)
L. W. Barclay, B.Sc. (Fellow)

Computer

Chairman:

K. J. Dean, Ph.D., M.Sc. (Fellow)
K. D. F. Chisholm (Fellow)
S. G. Crow (Fellow)
G. S. Evans (Fellow)

Medical and Biological Electronics

Chairman:

R. Brennand (Member)
K. Copeland (Member)
C. M. Cade (Fellow)
J. D. Gasking, M.Phil. (Member)
R. E. George (Member)
A. J. Huelin (Member)
L. W. Price, M.A. (Member)
A. S. Velate (Member)
F. E. Whiteway, B.Sc.(Eng.) (Fellow)

Appendix 2

Representatives of the Institution on the Board and Committees of the Council of Engineering Institutions

Board

Major-General Sir Leonard Atkinson, K.B.E., B.Sc. (Past President)
Professor Emrys Williams, Ph.D., B.Eng. (Past President)
Graham D. Clifford, C.M.G. (Fellow)

General Purposes and Finance Committee

Major-General Sir Leonard Atkinson, K.B.E., B.Sc. (Past President)

Finance Sub-Committee

J. Langham Thompson (Past President)

'Register' Working Party

J. Langham Thompson (Past President) (Chairman)

Education and Training Committee

Professor E. Williams, Ph.D. (Past President)

Exemptions Sub-Committee

K. E. Everett, Ph.D., M.Sc. (Fellow)

Membership Committee

J. Langham Thompson (Past President)

Student and Graduate Recruitment Working Party

Major-General Sir Leonard Atkinson, K.B.E., B.Sc. (Past President) (Chairman)

CEI-CSTI Interdisciplinary Board

R. C. Slater (Member)

Training Sub-Committee

H. Arthur, M.Sc., Ph.D. (Fellow)

Overseas Relations Committee

Graham D. Clifford, C.M.G. (Fellow)*

Careers and Recruitment Sub-Committee

D. L. A. Smith, B.Sc. (Fellow)

EEC Committee

G. Wooldridge, M.Sc., Ph.D. (Fellow)

*Joint Representation of IEE and IERE.

British National Committee on Ocean Engineering
P. W. Warden (*Member*)
M. J. Tucker, B.Sc. (*Member*)

Board Working Party on Industrial Affairs
M. W. Lauerman, M.A. (*Member*)

Council for Environmental Science and Engineering
Professor H. M. Barlow, Ph.D., F.R.S. (*Hon. Member*)

Engineers Registration Board
Technician Engineer Section Board, Supervisory Committee and Admission Committee
K. J. Coppin, B.Sc. (*Member*)

Technician Engineer Section Qualifications Committee
Colonel R. W. A. Lonsdale, B.Sc. (*Fellow*)

Appendix 3

Institution Representation at Universities

Convocation of the University of Aston in Birmingham
Professor D. G. Tucker, D.Sc., Ph.D. (*Fellow*)

Court of the University of Bradford
Major-General Sir Leonard Atkinson, K.B.E., B.Sc.
(*Past President*)

Court of the University of Surrey
Graham D. Clifford, C.M.G. (*Fellow*)

Court of the Institute of Science and Technology of the University of Wales
Professor E. Williams, Ph.D., B.Eng. (*Past President*)

Appendix 4

Institution Representation on College Advisory Committees

Barnsley College of Technology
Electrical Engineering Advisory Committee
D. Shaw, B.Sc. (*Fellow*)

City of Birmingham Further Education Sub-Committee
Electrical Engineering Advisory Committee
R. A. Lampitt (*Fellow*)

Bournemouth College of Technology
Electrical Engineering Advisory Committee
J. F. Noyes (*Member*)

Bristol Polytechnic
Electrical Engineering Advisory Committee
G. F. N. Knewstub (*Member*)

Brunel Technical College
Advisory Committee on Electrical Engineering
G. F. N. Knewstub (*Member*)

Darlington College of Technology
Electrical Engineering and Science Advisory Committee
R. W. Blouet (*Member*)

East Ham Technical College
Electrical Engineering Advisory Committee
D. W. Bradfield, B.Sc. (*Member*)

Glamorgan Polytechnic
Advisory Committee for Applied Physics
Professor Emrys Williams, Ph.D., B.Eng. (*Past President*)

City of Gloucester College of Technology
Electrical Engineering Advisory Committee
H. V. Sims (*Fellow*)

City of Leeds Polytechnic
Advisory Committee for Electrical Engineering and Physics
Professor G. N. Patchett, Ph.D. (*Fellow*)

Leicester Regional College of Technology
Electrical Engineering Advisory Committee
Representative to be appointed

City of Liverpool Polytechnic
Electrical Engineering Advisory Committee
A. W. Mews (*Member*)

Newcastle-upon-Tyne Polytechnic
Electrical and Electronic Engineering Advisory Committee
J. Bilbrough (*Fellow*), R. E. Ross (*Fellow*)
Physics Advisory Committee
A. M. Reid (*Member*)

Newport and Monmouthshire College of Technology
Engineering Advisory Committee
Professor Emrys Williams, Ph.D. (*Past President*)

North East London Polytechnic
Electrical Engineering Advisory Committee
Professor J. C. Anderson, Ph.D., M.Sc. (*Member*)

City of Nottingham Education Committee
Electrical Engineering Advisory Committee
F. W. Hopwood (*Member*)

Nottingham College of Further Education
Electrical Engineering Advisory Committee
Representative to be appointed

Paddington Technical College
Governing Body
E. H. Ashley (*Fellow*)

City of Portsmouth Polytechnic
Electrical Engineering Advisory Committee
Representative to be appointed

Slough Technical College
Engineering Advisory Committee
Representative to be appointed

Southall College of Technology
Governing Body
B. S. Pover (*Member*)
Administrative Committee
A. G. Wray, M.A. (*Fellow*)

South East London Technical College
Governing Body
J. I. Collings (*Fellow*)
Electrical Engineering and Applied Physics Consultative Committee
L. W. D. Pittendrigh (*Fellow*)

Southampton College of Technology
Engineering and Science Advisory Committee
K. G. Nichols, M.Sc. (*Fellow*)

Thames Polytechnic
Electrical and Electronic Engineering Advisory Committee
L. W. Dudley (*Member*)

Trent Polytechnic
Electrical Engineering Advisory Committee
Wing Cdr. D. R. McCall, B.Sc. (*Member*)

Twickenham College of Technology
Board of Governors
 A. P. J. Edwards, B.Sc. (*Fellow*)

Wakefield Technical and Art College
Engineering Advisory Committee
 A. Martinez (*Fellow*)

Watford College of Technology
Engineering Advisory Committee
 F. P. Thomson (*Member*)

Widnes Technical College
Electrical and Instrument Engineering Advisory Committee
 D. Chalmers (*Fellow*)

Willesden College of Technology
Governing Body and Appointments Sub-Committee
 F. A. Wilson, C.G.I.A. (*Member*)

Yorkshire Council for Further Education
Advisory Committee on Electrical Engineering
 D. Shaw, B.Sc. (*Fellow*)

Appendix 5

Members representing the IERE on Technical Committees of the British Standards Institution

TLE/-	Telecommunication Industry Standards Committee Brigadier R. Knowles, C.B.E. (<i>Fellow</i>)	E/-/12	Maintenance/Terotechnology L. A. Bonvini (<i>Fellow</i>) Colonel R. W. A. Lonsdale (<i>Member</i>)
TLE/5	Electronic Tubes and Valves G. R. Jessop (<i>Member</i>)	ELE/103	Medical Electrical and Radiological Equipment R. Brennand (<i>Member</i>)
TLE/5/8	Tube and Valve Performance—Light Conversion I. J. P. James, B.Sc. (<i>Fellow</i>)	ELE/103/2	Electro-Medical Equipment A. J. Huelin (<i>Member</i>)
TLE/8/7	Electronic Instruments for Voltage Measurement D. L. A. Smith, B.Sc. (<i>Fellow</i>)	ELE/103/-/4	Safety—Medical Electrical and Radiological Equipment A. J. Huelin (<i>Member</i>)
TLE/8/8	Oscilloscopes D. Styles (<i>Member</i>)	ELE/103/-/5	Installations—Medical Electrical and Radiological Equipment A. J. Huelin (<i>Member</i>)
TLE/12/5	Microwave Semiconductor Devices R. R. Harman (<i>Member</i>)	ELE/TLE/1	Terminology Common to Power and Telecommunications E. H. Jones, B.Sc.(Eng.) (<i>Fellow</i>)
TLE/16	Electronic Reliability Brigadier R. Knowles, C.B.E. (<i>Fellow</i>)	ELE/TLE/1/1	Fundamental Terminology E. H. Jones, B.Sc.(Eng.) (<i>Fellow</i>)
TLE/17	Integrated Electronic Circuits T. M. Ball (<i>Member</i>)	ELE/TLE/1/10	General Heavy Electrical Terminology E. H. Jones, B.Sc.(Eng.) (<i>Fellow</i>)
TLE/17/1	Performance of Integrated Electronic Circuits T. M. Ball (<i>Member</i>)	ELE/TLE/1/20	Magnetism Terminology E. H. Jones, B.Sc.(Eng.) (<i>Fellow</i>)
TLE/23	Safety of Telecommunication and Electronic Components and Equipment Lt. Col. F. R. Spragg, REME (<i>Fellow</i>) and D. M. Field (<i>Member</i>)	ELE/TLE/2	Graphical Symbols for Electrical Engineering and Telecommunications R. A. Ganderton (<i>Member</i>)
TLE/24	Electro-Acoustics S. Kelly (<i>Fellow</i>)	MEE/10/2	Drawing Practice for Point to Point and Circuit Diagrams D. M. Field (<i>Member</i>)
TLE/24/1	Audio Engineering S. Kelly (<i>Fellow</i>)	M/68/6	Audio Aids (School Music) M. H. Evans (<i>Member</i>)
TLE/25	Radio Communications R. Larry (<i>Fellow</i>)	ELCP/-	Codes of Practice Committee for Electrical Engineering Brigadier R. Knowles, C.B.E. (<i>Fellow</i>)
TLE/25/4	Aerials C. Hale (<i>Member</i>)	ELCP/29	Diodes, Transistors and Related Semiconductor Devices G. Hennessey (<i>Fellow</i>)
TLE/26	Performance of Household High Fidelity Audio Equipment R. S. Roberts (<i>Fellow</i>)		

Appendix 6

Representatives on Joint Committees for National Certificate and Diplomas

England and Wales

Higher National Certificates and Diplomas in Electrical and Electronic Engineering

B. F. Gray, B.Sc.(Eng.) (*Fellow*): *Chairman*
 C. C. Richardson, B.Sc.(Eng.) (*Member*)
 A. Tranter, B.Sc.(Eng.) (*Fellow*)

Schemes Sub-Committee:

C. C. Richardson, B.Sc.(Eng.) (*Member*)

Ordinary National Certificates and Diplomas in Engineering

B. F. Gray, B.Sc.(Eng.) (*Fellow*)

Scotland

National Certificates in Electrical and Electronic Engineering

D. S. Gordon, Ph.D., B.Sc. (*Member*)
 A. L. Whitwell, B.Sc. (*Fellow*)

Northern Ireland

Higher National Certificates in Electrical and Electronic Engineering

Captain A. W. Allen, RN(Retd.) (*Member*)
 J. A. C. Craig, B.Sc. (*Member*)

Ordinary National Certificates and Diplomas in Engineering

J. A. C. Craig, B.Sc. (*Member*)

Appendix 7

Institution Representation on Other Educational Bodies

City and Guilds of London Institute

Telecommunications Advisory Committee

B. F. Gray, B.Sc.(Eng.) (*Fellow*)

Radio Amateurs' Examination Advisory Committee

R. G. D. Holmes (*Fellow*)

Council for National Academic Awards

Electrical Engineering Board

B. F. Gray, B.Sc.(Eng.) (*Fellow*)

A. G. Wray, M.A. (*Fellow*)

London and Home Counties Regional Advisory Council for Technological Education

Advisory Committee on Electrical and Electronic Engineering

K. J. Coppin, B.Sc. (*Member*)

North Western Regional Advisory Council for Further Education

A. G. Brown (*Member*)

Radio, Television and Electronics Examination Board

W. B. K. Ellis, B.Sc. (*Member*)

J. W. Graham (*Member*)

A. A. Smith (*Member*)

Appendix 8

Members Appointed to Represent the Institution on External Bodies

Royal Society

Committee on Scientific Information

Admiral of the Fleet the Earl Mountbatten of Burma, K.G.,

F.R.S. (*Past President*)

Panel on Mechanized Information Retrieval

Graham D. Clifford, C.M.G. (*Fellow*)

Convention of the Electro-technical Societies of Western Europe

Professor W. Gosling, Ph.D. (*Fellow*)

R. C. Slater (*Member*)

British National Committee for Non-Destructive Testing

A. Nemet, Dr.Ing. (*Fellow*)

British Nuclear Energy Society

R. J. Cox, B.Sc. (*Member*)

IEE Committee on Radio Equipment for Civil Aircraft

R. N. Lord, M.A. (*Member*)

Medical Research Council Committee on Non-Ionizing Radiations

R. N. Lord, M.A. (*Member*)

National Council for Quality and Reliability

F. G. Diver, M.B.E. (*Fellow*)

National Electronics Council

A. A. Dyson, O.B.E. (*Presidnet*)

Graham D. Clifford, C.M.G. (*Fellow*)

Parliamentary and Scientific Committee

Executive Committee

J. Langham Thompson (*Past President*)

Graham D. Clifford, C.M.G. (*Fellow*)

British Electrotechnical Approvals Board

R. S. Roberts (*Fellow*)

Economic Development Committee for the Electronics Industry

Working Group on Scientific and Technological Manpower

Graham D. Clifford, C.M.G. (*Fellow*)

Association of Learned and Professional Society Publishers

F. W. Sharp (*Fellow*)

U.K. Automation Council

A. St. Johnston, B.Sc. (*Fellow*)

W. M. Houston (*Fellow*)

U.K. Liaison Committee for Sciences Allied to Medicine and Biology

R. E. George, B.Sc. (*Member*)

R. H. Harding (*Member*)

Standing Committee of Kindred Societies

Major-General Sir Leonard Atkinson, K.B.E., B.Sc.

(*Past President*)

Graham D. Clifford, C.M.G. (*Fellow*)

Appendix 9

Institution Premiums and Awards for 1972

CLERK MAXWELL PREMIUM

The most outstanding paper of the year. (Value £30.)

'The Principles of Pulse Signal Recovery from Gravitational Antennas'

by Dr. M. J. Buckingham and Prof. E. A. Faulkner (University of Reading).

(Published in April 1972).

J. LANGHAM THOMPSON PREMIUM

Control engineering. (Value £50.)

'Predicting Servomechanism Dynamic Errors from Frequency Response Measurements'

by Mrs. M. J. Brown, Prof. D. R. Towill and Dr. P. A. Payne (UWIST Cardiff).

(January).

DR. VLADIMIR K. ZWORYKIN PREMIUM

Medical and biological electronics. (Value £50.)

'An Automatic Biochemical Analyser'

by R. Wyld (formerly with Vickers Medical Engineering).

(September).

HEINRICH HERTZ PREMIUM

Mathematical or physical aspects of radio. (Value £20.)

'Point-matched Solutions for Propagating Modes on Arbitrarily-shaped Dielectric Rods'

by Dr. J. R. James and I. N. L. Gallett (Royal Military College of Science).

(March).

and

'Engineering Approach to the Design of Tapered Dielectric-rod and Horn Antennas'

by Dr. J. R. James.

(June).

A. F. BULGIN PREMIUM

Measurements. (Value £15.)

'Absolute Measurement of Submillimetre and Far Infra-red Laser Frequencies'

by Dr. C. C. Bradley, Dr. G. Edwards and Dr. D. J. Knight (National Physical Laboratory).

(July).

DR. NORMAN PARTRIDGE MEMORIAL PREMIUM

Audio frequency engineering. (Value £10.)
'Statistical Stability in Spectrum Analysis'
by R. E. Bogner (Imperial College, London).
(September).

LESLIE MCMICHAEL AWARD

Radio communication. (Value £10.)
'An Experimental Adaptively Equalized Modem for Data
Transmission over the Switched Telephone Network'
by R. J. Westcott (Post Office Research Department).
(November).

LORD BRABAZON AWARD

Radar and navigational aids. (Value £15.)
'A 16-Channel Digital Acoustic Telemetry System'
by D. Cattnach (Marine Laboratory, D.A.F.S., Aberdeen).
(March).

LORD RUTHERFORD AWARD

Electronics associated with atomic physics. (Value £15.)
'Ion Implantation in Semiconductor Device Technology'
by Dr. J. Stephen (A.E.R.E., Harwell).
(June).

MARCONI AWARD

Engineering. (Value £10.)
'Annular Resonant Structures and their uses as Microwave
Filters'
by R. T. Irish (Royal Military College of Science).
(February).

CHARLES BABBAGE AWARD

Electronic computers. (Value £15.)
'Magnetic Bubbles and their Applications'
by R. D. Lock and Dr. J. M. Lucas (Bell Canada Northern
Electric Research, Ottawa).
(October).

LOCAL SECTION AWARD

First read before a Local Section in the United Kingdom. (Value
£15.)
'A Special-purpose Computer for the Direct Digital Control of
Processes'
by A. J. Allen and P. Atkinson (University of Reading).
(February.)

The following Premiums and Awards have been withheld as suitable
papers were not published during the year.

REDIFFUSION TELEVISION PREMIUM

For an outstanding paper on Television Broadcasting. (Value £15.)

P. PERRING THOMS PREMIUM

For an outstanding paper on Television Receiver Design. (Value
£15.)

ARTHUR GAY PREMIUM

For an outstanding paper on Production Techniques in the Elec-
tronics Industry. (Value £15.)

SIR J. C. BOSE PREMIUM

For an outstanding paper by an Indian Scientist or Engineer
published in the Journal. (Value £15.)

HUGH BRENNAN PREMIUM

For the most outstanding paper read before the North-eastern
Section of the Institution and subsequently published in the Journal.
(Value £15.)

IERE News and Commentary

Dinner of Council and Committees

Leaflets have been included with all copies of this issue of the Journal sent to members of the Institution in the British Isles giving details of the 15th Dinner of the Council and its Committees. This will be held at the Savoy Hotel, London, on the evening of Wednesday, 21st November.

Members who live outside the British Isles but who are likely to be in London on that date and are interested in attending the Dinner should get in touch as soon as possible with Mr. R. W. Stobbart at the Institution's headquarters. Tickets for the Dinner, which include cocktails, wines and liqueurs at the table, cost £7.25 per person. This is of course the main function of the Institution at which the attendance of ladies is especially welcomed.

1973 Royal Garden Parties

The President of the Institution, Mr. A. A. Dyson, O.B.E., and Mrs. Dyson, and one of the Vice-presidents, Professor W. A. Gambling and Mrs. Gambling, had the honour of being present at the Royal Garden Party on 26th July.

Programme of London and South East England Meetings 1973/4

The booklet giving programmes of meetings of the IERE and IEE to be held in London in the first half of the present session (September 1973 to January 1974) is being sent with this issue of the Journal to all IERE members living in London and the areas covered by the East Anglian, Kent and Thames Valley Sections, whose programmes are also included in the booklet. The booklet also contains details of IEE district meetings to be held in the South East and it is emphasized that all meetings, whether in London or in the Sections, are open to any member of both Institutions.

Members residing outside South Eastern England may obtain copies of the booklet on application to: The Meetings Secretary, IERE, 8/9 Bedford Square, London, WC1B 3RG. The enclosing of a self-addressed envelope with such requests will be appreciated.

IERE Christmas Cards 1973

Details and order forms for IERE Christmas Cards are given on pages (iv)-(v) of this issue. Proceeds from the sale of these cards are donated to the Institution's Benevolent Fund.

CEI Conference on Total Technology

The Science Research Council has invited the Council of Engineering Institutions to sponsor a half-day Conference on Total Technology in which this subject could be introduced to the engineering profession as a whole and to interested representatives from the public service, centres of higher education and industry. The Conference is to be held at the Institution of Mechanical Engineers on the afternoon of Tuesday, 30th October. Speakers will include Professor H. Ford of Imperial College, Professor J. H. Horlock of Cambridge University and Sir Alastair Pilkington of Pilkington Bros. Professor Ford was Chairman of the Total Technology Panel whose report was recently published by the SRC, while Professor Horlock and Sir Alastair were among the other members of the Panel.

Total Technology was defined in the SRC Report as follows:

The practice of engineering comprises research, development, design, production, marketing and operation of plant. In addition the service and construction industries require a special emphasis on planning and operations management. The parts of this continuum of functions merge into each other with ill-defined boundaries and any one has a marked influence on the interrelationship with the others. Success can only be achieved with well-balanced synthesis of all the functions. Total Technology is the name given to cover this wide spectrum of functions in the practice of engineering coupled with the skills required for welding them together.

The Terms of Reference for the Panel were to consider and advise on postgraduate education in Total Technology as a suitable preparation for people entering industry and to advise the Engineering Board on a course of action. Also to consider research grant applications and training courses of a Total Technology nature and make recommendations to the Engineering Board.

Further information on the Conference may be obtained from Mr. Dudley Paget-Brown, Public Relations Officer, CEI, 2 Little Smith Street, Westminster, SW1. (Telephone 01-799 3912-4).

Woolmer Memorial Lecture

The 1973 Woolmer Memorial Lecture of the Biological Engineering Society is to be given by Sir Peter Medawar, C.H., F.R.S., Nobel Laureate, of the M.R.C. Clinical Research Centre, Harrow. His subject will be 'All Engineering is Bio-Engineering', and the lecture will be given on Friday, 19th October at 6 p.m. in the Botany Theatre at University College London, Gower Street, London WC1. Admission is free and tickets are not required.

Guidance for Authors

A new edition of the Institution's booklet 'Guidance for Authors' has just been published and intending authors of papers are invited to write to the Editor for copies. The booklet identifies the various types of papers, including short contributions, and gives brief hints on points which the author should bear in mind in preparing a paper. Requirements and advice in connection with the preparation of the manuscript and illustrations are also given and a bibliography of publications which will be found helpful by authors is included.

Private Treatment in Illness

The reputation of the British National Health Service is justifiably the highest of such schemes throughout the world. There is no delay in the treatment of serious and complicated

illnesses but in the non-urgent field, generally speaking, one has to wait to be admitted to hospital. This can be a problem for the Professional man—the solution is private treatment.

Private treatment can usually be arranged to fit in with domestic and business schedules. The use of a private room with few restrictions on visiting hours and the use of a telephone enables the patient to keep in touch with both family and business. To pay for this out of your own pocket can be expensive, but not when you are insured with the British United Provident Association (BUPA), the largest Provident Association in the country.

The Institution of Electronic and Radio Engineers has a BUPA Group Scheme providing special terms for members: (i) a 10% rebate on basic rates, (ii) immediate cover upon acceptance instead of the usual three-months waiting period, (iii) own choice of cover from a very comprehensive BUPA scheme, (iv) payment annually or quarterly; the latter method is not loaded.

The IERE BUPA Group renews in November. Members of this Group should be aware that the Department of Health increased hospital charges from 1st April 1973 as follows: General Hospitals now charge £96.00 per week, Provincial Teaching Hospitals £114.10 per week and London Teaching Hospitals £137.20 per week.

Many members of this Group are in the 'Standard Scheme' which no longer provides adequate cover, and such members should now transfer to the Unit Scheme. It is important that all subscribers should check their present BUPA scale to ensure that they have adequate cover. For General Hospitals the recommended BUPA Scale is 98/3, for Provincial Teaching Hospitals 119/4 and for London Teaching Hospitals 140/4. To effect a change of scale simply complete the tear-off portion of the BUPA renewal leaflet which you should have already received, and return to the BUPA Branch at the address below.

Full details about the IERE Group membership with BUPA and other services can be obtained direct from: BUPA, 24 Newport Road, Cardiff CF2 1SF.

Engineering Industry Training Levy Order

Mr. Maurice Macmillan, Secretary of State for Employment, has approved proposals submitted by the Engineering Industry Training Board for a levy on engineering employers within the scope of the Board equal to 1.5% of their payroll. Total payroll will be reduced by £50 000 before assessment. This is the effect of an Order* made by Mr. Macmillan and laid before Parliament, and which came into operation on 12th September 1973.

The levy on engineering establishments will be used to pay the following grants:

General Grant covering all training for all employment groups except first year craft and technician trainees. This is calculated from a performance rating based on the amount and quality of training provided by employers in relation to their own needs.

Supplementary Grants covering certain items of training which the Board wishes to encourage such as group training; module training; management development and courses for advanced technology.

Specific Grant payable as a fixed sum for the first year 'off-the-job' training of craftsmen and technicians.

Employers may appeal to an industrial tribunal against assessment.

The Engineering Industry Training Board was constituted in July 1964 and covers approximately 26 500 establishments and 3 242 000 employees. The Chairman of the Board is Sir Arnold Lindley, Hon. D.Sc., C.G.I.A. (Fellow) and the Director is Mr. F. Metcalfe.

The Employment and Training Act which received Royal Assent on 25th July 1973 will modify the Industrial Training Act 1964 under which the recent Order operates. The new Act establishes an upper limit for levy of 1% of an employer's payroll, unless there is an affirmative resolution of both Houses of Parliament for a levy of more than 1%. It provides for the exemption of firms whose training is adequate, except where the majority of employers concerned do not want exemption, and requires the establishment of a new appeal body against non-exemption from levy. It also provides for the exclusion of small firms from levy. The Secretary of State will continue to be responsible for appointing board members and making levy orders. The commencement date for the section of the Employment and Training Act which will alter the present Industry Training Boards' operations is expected to be April 1975.

The Costs of Communications

Research and development expenditure by the British Post Office increased by 8.5% to £20.4M during 1972-73 according to the Annual Report and Accounts just published. Of this, £19M was spent on telecommunications and £1.3M on posts. About half of the telecommunications money was spent on developing new systems, about a third on sustaining and improving existing systems, and the remainder largely on exploratory research.

The main effort on the postal side was directed primarily to improving mechanical letter and parcel sorting. The largest single item on postal research was into optical character recognition of postcodes.

In 1972-73 there was continued big growth in the telecommunications services, an increase in the amount of mail handled, and by the end of the year National Giro was making a positive contribution to the Post Office finances. Despite all this, for the first time since 1956-57 the Post Office as a whole made a loss, amounting to £64.1M. The Postal business loss was £42.5M and Telecommunications lost £9.7M which means that overall there was a shortfall of £153M on the financial targets set by the Government for posts and telecommunications.

As a result of expansion, mainly of work from the other businesses, Data Processing service income increased by 30% to just over £18M, but the loss on the year fell to £0.2M, compared with £0.6M in 1971-72. It is pointed out that in recent years computer power in the Post Office has almost doubled annually, and there are now 38 computers in operation. The number of data transmission terminals increased by 28.6% to 24 450. This is more than the total use in all the other countries of Europe.

The Post Office aims to finance about half its £4250M, five-year investment programme from its own resources. This, however, will depend on the extent to which counter-inflation policies will allow charges to be increased.

Since the publication of the Report, an application has been made to the Prices Commission to increase inland telecommunications charges. It is stressed that since 1970 costs have risen by £450M. As a capital intensive, technology-based industry telecommunications has done much to help itself, and its productivity programme has produced savings totalling £84M since the Corporation was set up. During the past ten years, in which the telephone system has doubled, staff has increased by only 25% with a productivity improvement totalling £200M.

* SI 1973 No. 1425 HMSO, price 8p.

Brighton Conference on Microwaves

The trend towards specialized exhibitions in support of conferences took a significant step forward this summer with Microwave 73, which was held at Brighton from 19th to 21st June. The conference, which was organized by an international committee, supported by the IERE, assembled a programme of 76 papers,* which attracted an impressive attendance of over six hundred. Several thousands attended the associated exhibition, which was opened by His Royal Highness the Duke of Kent. In his speech His Royal Highness said:—

‘It is highly appropriate that Microwave 73, which is certainly the first of its kind held in Europe, should be taking place in England where so much of the basic technology was evolved and I believe that it falls at a most opportune time. In April next year we shall be celebrating the centenary of the birth of Guglielmo Marconi—and it is with some astonishment that one remembers it is only 72 years since he first transmitted a radio signal across the Atlantic. I’m told there is some doubt about the exact frequency which was used for this, but that radio legend seems to have established it at around 1000 kHz. Since that epoch-making achievement, radio and electronic engineers have been making constant efforts to exploit the possibilities of higher and higher frequencies. The reasons for this have been twofold: certain applications, such as radar, in themselves demanded very high frequencies while the very rapid expansion of radio techniques meant that the lower end of the frequency spectrum became hopelessly overcrowded. The latter problem has led to a continual upward movement in frequency, so that at the present time we have frequencies in common use which are at least 100 000 times greater than those used by Marconi. It is I think no exaggeration to say that the huge growth in the use of microwave techniques has brought about something of a revolution in the telecommunications, data handling and radar fields with the almost innumerable derivative applications that flow from these.

‘Microwave 73 is truly international in character, and the concept of a combined Exhibition and Conference promises to be a most fruitful and imaginative one. The Exhibition on the one hand gives an opportunity for engineers and designers to demonstrate their ideas in terms of practical hardware, as well as enabling manufacturers to expose their products to critical eyes, and also to have a look at what the competition is up to—and it is world-wide competition. At the same time the very full and comprehensive Conference itself will provide an admirable forum for the presentation of the latest thinking by the best brains in their fields from all over the world, and for the immensely valuable exchange of ideas between experts working in related disciplines.

‘As a member of the National Electronics Council, I am naturally most interested in the proceedings that will be taking place here during the next three days. The interests of the Council cover a very broad front and indeed it is vitally concerned in every aspect of electronics as they affect the social,

* Copies of the Conference proceedings of Microwave 73 containing all the papers presented are now available from the IERE Publications Department, price £11 post free.



H.R.H. The Duke of Kent discusses the application of an electronically tuned c.w. Gunn oscillator in the Tellurometer electronic distance measuring equipment shown on the Plessy stand.

economic and industrial life of this country. Not surprisingly a number of matters which NEC is currently pursuing are connected with the exploitation of microwaves. To take one example, the Council has recently begun an investigation into how satellites can best be employed to improve navigation and communication facilities for both aircraft and ships. Other working parties are involved with integrated circuits and hybrid micro-electronics which are increasingly becoming the basic building-bricks for the designers of microwave systems. I think it is also worth mentioning the efforts that NEC is making to promote a practical interest in electronics at an early age by means of the Schools Link Scheme with industry. This scheme, whose purpose is to establish close links between individual schools and electronic manufacturers has important implications since the future of the electronics industry generally is so heavily dependent on the next generation of electronic engineers.

‘The electronics industry itself is still a young organism—indeed there are many people who will remember days when none of the familiar systems we know and take for granted existed at all. The history of microwave development is of course a shorter one still, heavily accelerated in its early stages by the demands of defence, as has so often been the case—but its youth and relative insignificance in direct financial terms belie the strength and growth which this branch of electronics has already demonstrated in its short lifespan, and which shows every promise of multiplying many times over in the future. It is as an instrument stimulating and encouraging such progress that I greatly welcome the Microwave 73 Convention.’

Members' Appointments

CORPORATE MEMBERS

Mr. P. A. Allaway, C.B.E. (Fellow 1971), chairman and managing director of EMI Electronics Limited, Hayes, Middlesex, has been awarded the Honorary Degree of Doctor of Technology by Brunel University. This Award is in recognition of Mr. Allaway's distinguished services to the electronics industry, and to the University, with which he has been closely associated since it was established; he has been a



member of the Senate Board of the Institute of Industrial Training at Brunel University since 1971. Mr. Allaway became a member of the Council of the Institution in 1972 and he is now nominated for election as a Vice-President. He is chairman of the Defence Industries Quality Assurance Panel, immediate past-chairman of the National Council for Quality and Reliability, and past-president of the Electronic Engineering Association, as well as being a member of the councils of other technical and professional institutions.

Mr. P. Huggins (Fellow 1961, Member 1952, Associate 1945) has been appointed Technical Director of Mangood Limited of Pontypool, Monmouthshire. Mr. Huggins had been with the Joseph Lucas Group for some ten years, latterly as Chief Electronic



Engineer of Girling Limited at Cwmbran. During the early '50s he was Chief Engineer of Sargrove Electronics Limited and he then moved to the Tube Investments Technological Centre, Walsall, Staffordshire. The author of a number of papers on automation subjects in the Institution's Journal,

one of which on 'Statistical computers as applied to industrial control' gained him a 1954 Convention Premium, Mr. Huggins is a past-chairman and member of the Committee of the West Midlands Section.

Mr. H. A. C. Krieger (Fellow 1960) who was formerly with Westdeutscher Rundfunk Cologne and is now Director of Engineering at Norddeutscher Rundfunk Hamburg (NDR) has been nominated ARD representative at the EBU Technical Centre, Brussels, with effect from January next.

Mr. A. Brown (Member 1956, Graduate 1950) who has been a research engineer with the BBC Research Department since 1955, has been seconded to the European Broadcasting Union's Technical Centre in Brussels where he is mainly concerned with the applications of satellite systems to broadcast distribution. Mr. Brown served as a member of the Papers Committee from 1964 until moving to Brussels at the beginning of this year and he was for a number of years the IERE representative on the BSI technical committee concerned with radio and television aerials.

Mr. D. M. Dixon (Member 1965, Graduate 1964) is now works manager of Astaron-Bird Limited. Mr. Dixon was recently with Plessey South Africa Limited in Cape Town.

Mr. G. A. Duguid (Member 1971) has been appointed engineer in charge of digital vision equipment with Independent Television News. He was previously senior maintenance engineer with EVR Partnership, Basildon.

Mr. P. Fagge (Member 1971, Graduate 1967) who retired from the Royal Navy earlier this year, has joined Litton Systems (Canada) Limited of Rexdale, Ontario, as a senior avionic engineer.

Mr. D. J. Gibbs, B.Sc. (Member 1972, Graduate 1967), previously a senior commissioning engineer with GEC (Telecommunications) Limited of Coventry, has joined Unilever Limited as a telecommunications engineer.

Mr. E. Hitchen (Member 1961, Graduate 1951) is chief engineer with United Telecasters Sydney Limited. He was previously a senior project officer with the Australian Broadcasting Commission and before emigrating to Australia in 1957 he held appointments with Marconi Company in Chelmsford.

Mr. F. Kocsis, Dipl.Ing. (Member 1967, Graduate 1958), previously technical director with A. P. Besson & Partner Limited, Hove, has been appointed director of Acoustic Laboratories Limited, Bodmin, Cornwall.

Mr. A. J. Lawrence (Member 1971, Graduate 1968) is an executive engineer in the Post Office and has been appointed head

of the Audio Cable and Equipment Standards Group in the Operational Programming Department of Telecommunications Headquarters. He was previously with the Microwave Planning Group of the Network Programming Department.

Sqdn. Ldr. A. T. Luto, RAF (Member 1965, Graduate 1964) has been posted to the Royal Radar Establishment, Malvern, as RAF Project Officer in the G.W. Division since June 1970. He was Officer Commanding Electrical Engineering Squadron, RAF Bruggen, Germany.

Mr. C. S. Makan (Member 1973, Graduate 1967) who was previously a development engineer with the Research Division of Rediffusion Limited, has joined the CATV Division of EMI Sound and Vision Limited as a senior development engineer.

Mr. W. McSweeney (Member 1972, Graduate 1963) has been appointed manager of advanced development with Consolidated Video Systems Inc., Santa Clara, California. He was previously Staff Engineer with Cartrivision. Before moving to the United States in 1967 Mr. McSweeney was a senior engineer with British Relay (Electronics) Limited.

NON-CORPORATE MEMBERS

Mr. M. H. Chawner, B.A., M.Sc. (Graduate 1970) who is with the Post Office, has received the degree of M.Sc. in Telecommunication Systems and B.A. in Electronic Engineering from the University of Essex and is now an Executive Engineer at the Post Office Research Department, Ipswich.

Flt. Lt. G. S. Clark, RAF (Associate 1970) has been posted to RAF Henlow as Officer Commanding Technical Supply Flight of the Radio Engineering Unit.

Mr. B. T. Davies (Associate 1957) has been appointed an instructor in the Electronics Department for the South Alberta Institute of Technology, Calgary. Mr. Davies was previously at the Confederation College of Art and Technology, Thunder Bay, Ontario, and has held various senior engineering posts in Canada, Bermuda and the UK, where he worked for Rediffusion Television Limited and British Broadcasting Corporation.

Flt. Lt. P. M. Eckert, RAF (Graduate 1972) has been posted on promotion to No. 1020 Signals Unit, Royal Radar Establishment, Malvern, as a signature analyst.

Mr. W. T. Herring (Associate 1961) is now a Mobile Maintenance Team Leader with the Independent Broadcasting Authority in the South Wales Area.

Mr. C. L. Lawson (Associate 1972) has joined Philips Electrologia Gm BH at Eiserfeld, West Germany as a Computer Development Engineer following 13 years service in the Royal Air Force, latterly as Sergeant Technician concerned with mobile ground radar equipment.

INSTITUTION OF ELECTRONIC AND RADIO ENGINEERS

Applicants for Election and Transfer

THE MEMBERSHIP COMMITTEE at its meetings on 24th July and 16th August 1973 recommended to the Council the election and transfer of 81 candidates to Corporate Membership of the Institution and the election and transfer of 26 candidates to Graduateship and Associateship. In accordance with Bye-law 21, the Council has directed that the names of the following candidates shall be published under the grade of membership to which election or transfer is proposed by the Council. Any communications from Corporate Members concerning these proposed elections must be addressed by letter to the Secretary within twenty-eight days after the publication of these details.

Meeting: 24th July 1973 (Membership Approval List No. 162)

GREAT BRITAIN AND IRELAND

CORPORATE MEMBERS

Transfer from Graduate to Member

BROWN, Harry Winston. *Alton, Hampshire.*
HARLAND, Peter Geoffrey. *Wetherby, Yorks.*
HOLMES, Michael John. *Newbury, Berkshire.*
HUMPHREY, Ralph. *Shepperton, Middlesex.*
HUMPHREYS, Elfryn John. *Chippenham, Wiltshire.*

JACKSON, Keith. *Ilford, Essex.*
NEWMAN, John Leslie Gareth. *Bracknell, Berkshire.*

ROURKE, Christopher Paul. *Orpington, Kent.*
WEBSTER, Richard Martin, Flight Lieutenant. *Kinloss, Morayshire.*
WILSON, Richard Loveridge, Flight Lieutenant. *Norwich, Norfolk.*

Transfer from Student to Member

PETTIFER, John. *Woking, Surrey.*

Direct Election to Member

FISHER, Harry David. *Farnham, Surrey.*
JOY, John Holland. *Carshalton, Surrey.*
PORTER, Ian Trenaman. *Basingstoke, Hampshire.*

NON-CORPORATE MEMBERS

Transfer from Student to Graduate

BUTTLE, Anthony Paul, B.Sc. *Leicester.*
LAM, Kam Tong, B.Sc. *Wellington, Northants.*
PARDY, Robert Andrew, B.Sc. *Cutnall Green, Droivich, Worcestershire.*

Meeting: 16th August 1973 (Membership Approval List No. 163)

GREAT BRITAIN AND IRELAND

CORPORATE MEMBERS

Transfer from Member to Fellow

PONTZEN, George Raoul. *Amersham, Buckinghamshire.*
SWAIN, Reginald William. *Whitton, Middlesex.*

Transfer from Graduate to Member

BAIRD, George Boyd. *Dundee, Angus.*
BARNES, David William. *Haywards Heath, Sussex.*
BATEMAN, Michael Frank. *Ruislip, Middlesex.*
BAWN, Martin Russell. *Carrickfergus, N. Ireland.*
BAXTER, Ronald James. *Billinghurst, Sussex.*
BLUNKELL, Martin Edward, Flight Lieutenant. *Medmenham, Bucks.*
BROWN, Christopher Paul Tolfree, Captain. *REME, B.Sc. (Eng.). Catterick, Yorkshire.*
CANT, Graham Oliver, Major, REME. *Arborfield, Berkshire.*

CORNFORTH, Peter. *Reading, Berkshire.*
DUNLOP, Bruce Edward, B.Sc. *Chelmsford, Essex.*
DURKIN, George Edgar, Flight Lieutenant. *West Drayton, Middlesex.*

FARMER, Toby John, Flight Lieutenant. *Cranwell, Lincs.*
FLANDERS, John Raymond, Flight Lieutenant. *Louth, Lincolnshire.*

FOSTER, Brian. *Rochester, Kent.*
GLEN, Thomas. *Kirkintilloch, Glasgow.*
GOLDSMITH, Barry John. *Flackwell Heath, Bucks.*

HADDOW, Ronald William, A.F.M., Squadron Leader. *Locking, Somerset.*
HALLAM, Gordon Patrick, Flight Lieutenant. *Medmenham, Bucks.*

HARRIS, Roy William. *Hemel Hempstead, Herts.*
HAWTHORNE, David Bruce Hope. *Romford, Essex.*

HOLLIS, Ivan Alec, Flight Lieutenant. *Albrighton, Staffs.*
KEELING, Colin Leonard. *Rayleigh, Essex.*
LAMBERT, Brian Joseph. *Bradford 7, Yorkshire.*

LAYER, Richard Anthony, Flight Lieutenant. *Farnborough, Hampshire.*
LILLY, Christopher John. *Tonbridge, Kent.*
MCDONALD, Allan Dickson. *Gullane, East Lothian.*

Direct Election to Graduate

BOSWELL, Ernest John, B.Sc. *Grantham, Lincolnshire.*
GORRELL, Ronald William. *Epping, Essex.*
JEZZARD, Frank, B.Sc. *London, N.8.*
LEVER, Edward Frederick, B.Eng. *Wallasey, Cheshire.*
SHIRT, David Godfrey, B.A. *London, N.W.2.*

Direct Election to Associate

COCKRAM, Peter Robert. *Weybridge, Surrey.*
DAVIS, Peter Alfred. *Crowborough, Sussex.*
FLETCHER, Leslie Ronald. *Enfield, Middlesex.*
HANDLEY, Roy, Squadron Leader. *Wolverhampton, Staffordshire.*
LAMPARD, Derek George. *Somerton, Somerset.*
MJAMTU-SIE, Henry Moses. *Brighton, Sussex.*
NICHOL, Brian Christopher. *Middlesbrough, Teeside.*

STUDENTS REGISTERED

BARKER, Michael Hunt. *Hayes, Middlesex.*
HAMMOND, Nigel Ralph. *New Malden Surrey.*
MILES, Francis Elvet. *Marston Moreteyne, Bedfordshire.*
REED, John Style. *Luton, Bedfordshire.*
WILLIAMS, Lewis Iestyn. *Llandyssul, Cardiganshire.*

MACHRAY, Alexander Brown. *Dunipace, Stirlingshire.*

MACLEAN, Alexander Murdo. *Langniddry, East Lothian.*
MAGILL, Hugh Carson. *Ruislip, Middlesex.*
NEALE, Noel William Thomas. *Halstead, Essex.*
PAGE, Timothy Stapley, Flight Lieutenant. *Stornoway, Isle of Lewis.*
PARRY, Glyn Frederick, Squadron Leader. *Bracknell, Berkshire.*
PASS, Geoffrey. *Newthorpe, Nottingham.*
PEACOCK, Alan Rodney, M.Sc. *Mytchett, Surrey.*
PINTO, Edward Ephraim. *London, N.14.*
TAYLOR, James Cedric. *Heywood, Lancs.*
WEST, Peter Thomas, Squadron Leader. *Saxa Vord, Shetlands.*
YOUNG, Keith Richard. *Rainham, Kent.*

Transfer from Associate to Member

PORTANIER, Joseph Anthony William. *Mitcham, Surrey.*

Direct Election to Member

BELBEN, Michael John, Squadron Leader. *Ripon, Yorkshire.*
PUGH, John. *Coventry, Warwickshire.*

NON-CORPORATE MEMBERS

Direct Election to Graduate

ATKINS, Stanley. *Whitefield, Manchester.*
BASU, Jugtar Singh, B.Sc. *Barking, Essex.*
VASUDEVA, Sateesh. *Yeovil, Somerset.*

STUDENT REGISTERED

ADANRI, Victor Tunde. *London, N.5.*
PINCHIN, Raymond. *Rochester, Kent.*
SALAMI, Michael Olakunle. *London, N.16.*
SCHARF, Thomas Frederick. *Edgware, Middlesex.*
WYATT, John Douglas. *London, N.21.*

OVERSEAS

CORPORATE MEMBERS

Transfer from Member to Fellow
MURTY, Dangety Satyanarayana, Professor, M.Sc. *D.Sc. HaliJax, Nova Scotia.*

OVERSEAS

CORPORATE MEMBERS

Transfer from Graduate to Member

ADEOYE, Charles Adedapo. *Lagos, Nigeria.*
APPLETON, Roy Ivan. *Sr. Michael, Barbados.*
ILUBE, Nathaniel Oyakhire. *Kampala, Uganda.*
JOHNSON, Emanuel Henry. *Wilberforce, Sierra Leone.*
PILLAI, A. Sivasankara. *Chantongia, Nagaland State, India.*
SUMMERS, Brian. *Dollard des Ormeaux, Canada.*
XAVIER, Stanislaus Kisito. *Ottawa, Canada.*

Transfer from Student to Member

GUHA BARMAN, Jiban Krishna. *Jamshedpur, India.*

NON-CORPORATE MEMBERS

Transfer from Student to Graduate

NAIR, Saradamma Vijayachandran. *Trombay, Bombay 85, India.*

Direct Election to Graduate

PERKINS, Frederick Leslie. *Darwin, N.T. 5794, Australia.*
SINGH, Dalip, B.Tech. *Dist. Parganas, West Bengal, India.*

Direct Election to Associate

EHIZOKHALE, Paul Ebosele. *Benin City, Nigeria.*
NWABUNIKE, Emmanuel Okani. *Enugu, Nigeria.*

STUDENTS REGISTERED

CHING, Po Kwong. *Hung Hom, Kowloon, Hong Kong.*
FOO, Sek Pui. *Singapore 3.*
HAN, Kim Guan. *Singapore 13.*
LEE, Cherk Koon. *Kuala Lumpur, Malaysia.*
LEOW, Ban Siong. *Singapore 11.*
LIM, Buan Teng. *Singapore 13.*
LIM, Tian Seng. *Singapore 3.*
PIGERA, Angodage Cecil Sriyantha. *Kaduwela, Sri Lanka.*
PHEE, Swee Hong. *Singapore 3.*
WANG, Kim Chuan. *Alor Star, Kedah, Malaysia.*

Transfer from Graduate to Member

ALWAY, Brian Stanley. *Hong Kong.*
BENERAGAMA, Don Kingsley Wimalasiri. *Panadure, Sri Lanka.*
BHASIN, Karam Chand, Flight Lieutenant. *Lucknow, India.*
CHAN, Sun-po David. *North Point, Hong Kong.*
CLARKE, Arthur Philip Blake. *Brussels, Belgium.*
EASAW, George John. *Johore Bahru, Malaysia.*
EDET, Arthur Antigha Robert. *Port Harcourt, Nigeria.*
GIBBY, David Rowland, B.Sc., M.Sc. *The Hague, Holland.*
HATCHER, Robert Grant, Flight Lieutenant. *B.F.P.O. 40.*
IGBOSANYA, Lawrence Funlade. *Ibadan, Nigeria.*
KOHLL, Mahendra Singh. *Delhi 9, India.*
KUSHWAHA, Ramesh Chandra, Flight Lieutenant. *c/o 56 APO, India.*
OJODIT, Daniel Odeoca. *Kampala, Uganda.*
PETTS, Alan. *Kingston, Jamaica.*

Transfer from Student to Member

SINGH, Avtar, Major. *c/o 56 A.P.O., India.*

NON-CORPORATE MEMBERS

Transfer from Student to Graduate

ESQUEDA, Paul David. *Caracas, Venezuela.*

Direct Election to Graduate

DUTTA, Santanu, B. Tech. *Calcutta 60, India.*
KYBETT, Harry, B.Sc. *Ann Arbor, Michigan, U.S.A.*

STUDENTS REGISTERED

BAN, Swee Hock. *Kuala Lumpur, Malaysia.*
GAN, Teck Koon. *Singapore 15.*
GODAWELA, Kamalsiri. *Kelaniya, Sri Lanka.*
LOH, Wing Hoe. *Singapore 3.*
MOK, Yiew Hon. *Singapore 3.*
PANG, Che Fong. *Kuala Selangor, Malaysia.*
TAN, Chin Keng. *Singapore 3.*
WICKREMERATNE, Mary Iromi Evadne (Miss). *Colombo 4, Sri Lanka.*

Notice is hereby given that the elections and transfers shown on Lists 159 and 160 have now been confirmed by the Council.

Forthcoming Institution Meetings

London Meetings

Wednesday, 10th October

AEROSPACE, MARITIME AND MILITARY SYSTEMS GROUP

Colloquium on Electromagnetic Compatibility or Confusion on Land, in Ships and in Aircraft

Postponed

Wednesday, 17th October

EDUCATION AND TRAINING GROUP

The Feedback Classroom

By K. Holling (*Chesterfield College of Technology*)

IERE Lecture Room, 6 p.m. (Tea 5.30 p.m.)

The Feedback Classroom is a group teaching/testing machine in which each student in a class is provided with a response unit so that responses to objective type questions can be made by the operation of switches. The responses are displayed to the teacher on a control console. This lecture will describe the design and construction of a Feedback Classroom and its use for teaching and testing purposes. Examples will be shown of the objective test questions suitable for use at various levels ranging from craft to degree type courses.

Thursday, 25th October

ANNUAL GENERAL MEETING

at 6 p.m. (Members only).

Followed at 6.45 p.m. by the

Presidential Address:

The Engineer—On Tap or on Top?

Dr. I. Maddock, C.B., O.B.E., F.R.S. (*DTI*).
London School of Hygiene and Tropical Medicine (Tea 5.30 p.m.).

Wednesday, 31st October

AUTOMATION AND CONTROL SYSTEMS GROUP

Colloquium on REMOTE CONTROL SYSTEM ORGANIZATION

The Middlesex Hospital Medical School, 10.15 a.m.

Advance Registration necessary. Apply for details and registration forms to Meetings Secretary, IERE.

Error detecting codes and their application.
By J. D. Martin (*Bath University*)

Bandwidth and speed requirements for binary command signalling.

By F. D. Pullen (*CEGB*)

Adaptive sampling in telemetry systems.

By I. G. Dewis (*National Physical Laboratory*)

An optimum solution for security, speed and communication channel for general purpose telemetry—some basic considerations.

By G. White (*GEC-Elliott Process Automation*)

Optimizing the bandwidth–security–access time merry-go-round.

By P. D. Cooper (*Westinghouse Brake & Signal*)

Operational integrity in supervisory control systems.

By D. Keast (*Intelogic Ltd.*)

The design and applications of a general-purpose telemetry system.

By M. S. Jennions (*Kent Automation Systems*)

Remote supervisory control—some aspects of system security.

By C. J. Williams (*Quinder Wirral*)

A secure data link between autonomous data handling systems in CAMAC.

By J. A. Laver (*CEGB*)

Organizing a telecontrol system for distribution network control.

By T. D. Dawson (*Terminal Display Systems*)

A simple data transmission system for use in area traffic control systems.

By J. T. M. Garrioch and P. C. M. Kay (*Plessey*)

Wednesday, 14th November

COMPONENTS AND CIRCUITS GROUP
Colloquium on DOMESTIC EQUIPMENT CONTROL SYSTEMS

IERE Lecture Room, 2.30 p.m.

Further details and registration forms from Meetings Secretary, IERE.

Tuesday, 20th November

AEROSPACE, MARITIME AND MILITARY GROUP MEETING

Developments in Position Measurement Techniques

By D. J. Phipps (*Decca Survey*)

IERE Lecture Room, 6 p.m. (Tea 5.30 p.m.)

Wednesday, 21st November

Dinner of Council and Committees
Savoy Hotel, London.

For details see p. 588 and insert.

Wednesday, 28th November

AUTOMATION AND CONTROL SYSTEMS GROUP
Design and Application of Active Compensation Circuits for Servo Control Systems

By Dr. D. R. Wilson (*Polytechnic of Central London*)

IERE Lecture Room, 6 p.m. (Tea 5.30 p.m.)

East Anglian Section

Wednesday, 17th October

JOINT MEETING WITH IEE

Radio Astronomy

By Dr. R. S. Booth (*Jodrell Bank Observatory*)

The Civic College, Ipswich, 6.30 p.m. (Tea 6 p.m.)

Wednesday, 24th October

JOINT MEETING WITH IEE
Sonar and Underwater Communications

By Dr. V. G. Welsby (*University of Birmingham*)

Assembly House, Norwich, 7 p.m. (Refreshments 8 p.m.)

A review is given of modern techniques based on the use of sound waves in the sea and in lakes, rivers, etc. Systems for diver communication and navigation are described. High resolution sonars, sometimes using focused acoustic arrays, have uses which range from the study of the behaviour of fish shoals to aiding police searches in muddy canals. Acoustic telemetry is used to control submersible vehicles and to channel collected information back to the surface. Acoustic waves can also be used to count migrating fish in rivers.

Thursday, 25th October

JOINT MEETING WITH IEE
Situation Display—A New and Unique Approach to Radar Presentation

By F. K. H. Birnbaum (*Kelvin Hughes*)

The University Engineering Laboratories, Trumpington Street, Cambridge, 6.30 p.m. (Tea 6 p.m.)

The whole philosophy of 'Situation Display' is based on the fact that the officer responsible for conning and navigating the ship is perfectly able to make correct decisions in complex situations when the weather is clear and he can see for himself what is happening, without making recourse to prediction apparatus and similar aids. Many years of experience accumulated in clear weather navigation have proved the human brain to be the best possible 'computer' in this application. The real difficulties arise in fog and low visibility conditions when the navigator has to rely on radar. Kelvin Hughes' approach is to present him in these conditions with the same information that he would obtain for himself in clear weather, in a way that is simple to understand and easy to assimilate, thereby enabling him readily to determine for himself the correct collision avoidance manoeuvres.

Friday, 26th October

Annual Dinner/Dance

The Meads Ballroom, Brentwood.
Details to be circulated to members.

Wednesday, 7th November

ANNUAL GENERAL MEETING at 6 p.m.

Followed by a lecture and film on

The RAF 'Red Arrows' Aerobatic Team (at 6.30 p.m.)

The Havering Technical College, Ardleigh Green Road, Hornchurch.

Kent Section

Wednesday, 3rd October

Recent Advances in Radio Navigation

By J. E. Viles (*Marconi-Elliott Avionic Systems*)

Medway and Maidstone College of Technology, Chatham, 7 p.m.

A general survey will be given of new navigational aids such as Omega and Microwave Landing Systems and the integration of aids in area navigation and mixed systems, with reference to some modern techniques which have helped these advances in the airborne equipment field.

Thursday, 1st November

Electronics in the Commercial Vehicle Industry

By G. Leonard (*CAV*)

Medway and Maidstone College of Technology, Chatham, 7 p.m.

Thames Valley Section

Wednesday, 10th October

Digital Phase Lock Loops

By K. Thrower (*Racal*) and P. Atkinson (*University of Reading*)

J. J. Thomson Physical Laboratory, University of Reading, Whiteknights Park, Reading, 7.30 p.m.

The digital phase-locked loop is widely used for frequency synthesis and control. The lecture is concerned with the design, performance and practical applications of the loop. The shortcomings of the conventional Type 1 loop are discussed and it is shown how the Type 2 loop, which has integral control, overcomes these. In considering the applications of the digital phase-locked loops the problems of oscillator design, noise, jitter and frequency range are considered.

Thursday, 8th November

Stereophonic and Ambisonic Reproduction of Sound

By Professor P. B. Fellgett (*University of Reading*)

The J. J. Thomson Physical Laboratory, University of Reading, Whiteknights Park, Reading, 7.30 p.m.

Thursday, 29th November

Digital Filters

By A. R. Owen (*University College of North Wales*)

The J. J. Thomson Physical Laboratory, University of Reading, Whiteknights Park, Reading, 7.30 p.m.

Southern Section

Wednesday, 10th October

CEI LECTURE

Carry On Civil Engineering

By Sir Harold Harding, F.C.G.I. (*Consulting Engineer*)

Portsmouth Guildhall, 7 p.m.

Wednesday, 17th October

Charge Coupled Devices

By J. D. E. Beynon (*University of Southampton*)

Lanchester Theatre, University of Southampton, 6.30 p.m. (Tea served in Senior Common Room from 5.45 p.m.)

Although the charge-coupled device was conceived only three years ago it is already challenging many conventional integrated circuit techniques, particularly in the memory and solid state imaging field. This is because of the device's extreme simplicity which is leading to circuits having high packed density, low power dissipation and low cost per function. The lecturer will explain the operation of the charge-coupled device and describe some of the techniques used for fabricating c.c.d. circuits. Some of the c.c.d.'s many present and future applications will be discussed.

Wednesday, 24th October

Multiphonic Organs

By J. H. Asbery

Queen's Hotel, Farnborough, 7 p.m.

The principle of the multimorphonic organ (usually abbreviated to multiphonic) involves the use of a small number of oscillators, the frequency of these being determined according to the keys pressed. Attention will be drawn to the relative advantages of a.c. resistance, a.c. capacitive and d.c. keyboard switching and to systems using the divider principle. Aperiodic frequency multipliers may be used as an alternative to dividers. Tone forming by use of non-linear elements and modulation of one footage by another will be mentioned. Some of the techniques can be used where a conventional melodic section is provided in a polyphonic organ. While the concept of the multiphonic organ is over a quarter of a century old its commercial exploitation has hitherto been inhibited by lack of inexpensive components of sufficient stability. The lecture will be supported by comprehensive demonstrations.

Wednesday, 31st October

JOINT MEETING WITH IEE

Exploring the Deep Oceans

By K. R. Haigh (*HMS Vernon*)

Portsmouth Polytechnic, 6.30 p.m.

Wednesday, 7th November

Solid State Microwave Sources

By J. J. Finlay (*Plessey*)

University of Surrey, Guildford, 6.30 p.m.

This paper relates to the design of microwave oscillators using IMPATT and TRAPATT devices. A discussion of circuit aspects will demonstrate how reliable sources can be obtained. A design of c.w. IMPATT oscillators with output powers up to 1 W and pulsed TRAPATT oscillators with peak powers up to 100 W will be discussed. Typical applications will indicate how these devices are gaining acceptance in practical systems.

Friday, 9th November

Colour Television

By A. C. Maine (*I.O.W. Technical College*)
Isle of Wight Technical College, 7 p.m.

Wednesday, 14th November

What's New in Multilayer Printed Wiring Board Manufacture

By G. C. Wilson (*Ferranti*)

Portsmouth Polytechnic, 6.30 p.m.

The speaker will discuss problems which arise in the manufacture of multilayer printed wiring boards, and methods of overcoming them by the use of buried through-plated holes. Laminate shrinkage, resin viscosity testing, drilling and chemical etching of interconnecting holes together with the environmental testing of the finished product, will be discussed.

Tuesday, 20th November

Solid State Microwave Sources

By H. J. Finlay (*Plessey*)

Bournemouth Technical College, 7 p.m.

See under Wednesday, 7th November.

Wednesday, 28th November

Cash, Credit and Electronics

By B. W. Parker and M. J. Davies

Portsmouth Polytechnic, 6.30 p.m.

Yorkshire Section

Friday, 19th October

CEI LECTURE

Suspension Bridges

By Dr. O. A. Kerensky, C.B.E., F.R.S. (*Freeman, Fox and Partners*)

City Hall, Sheffield, 7 p.m.

Wednesday, 28th November

JOINT MEETING WITH IEE

World Wide Communication

By R. T. Mayne

University of Sheffield, 6.30 p.m. (Tea 6 p.m.)

West Midland Section

Tuesday, 16th October

The Electronic Control and Communication Network Employed on the Midland Links Motorways

By Chief Inspector W. A. Hambrey (*Midland Links Motorway Police Group*)

RAF Cosford, Altringham, Wolverhampton, 7 p.m.

As part of a national programme for the control and signalling of motorways, the Department of the Environment has equipped the Midlands section with a computer-based signal and surveillance system. Some of the control and communications aspects of the system will be dealt with by the lecturer, including the functions of the Perry Barr control room.

Wednesday, 21st November

Pin-Wheels to Pulses: Electronics—Servant of Postal Sorting

By S. W. Godfrey (*Midland Postal Region*)
City of Birmingham Polytechnic, Franchise Street, Perry Barr, 7 p.m.

The British Post Office has led the world in the development of postal mechanization. The lecture will describe how the postal

service has used electronics to aid letter and parcel sorting. A description of the machinery and systems now in use will be given.

East Midland Section

Wednesday, 10th October

Delta Modulation Systems

By R. Steele (*Loughborough University*)

Lecture Theatre 'A', Physics Block, Leicester University, 7 p.m. (Tea 6.30 p.m.)

The lecture will describe how the basic linear delta modulator works and discuss factors which limit its performance. In particular, quantization, noise, slope overload noise and signal to noise ratio will be examined.

The second half of the lecture will deal with companded delta modulators. Syllabically companded delta modulators are used for speech encoding, and analogue and digital versions will be considered. Instantaneously companded delta modulators which can be used to encode television signals will be reviewed. Comparisons will be made between delta modulation, pulse code modulation and differential pulse code modulation in order to give some perspective to the relatively complex subject of digital encoding in telecommunications.

Wednesday, 24th October

Space Instrumentation

By R. Young and B. R. Kendall (*Hawker Siddeley Dynamics*)

RAF College, Cranwell, 7.30 p.m. (Tea 7 p.m.)

Tuesday, 13th November

JOINT MEETING WITH IEE

Fourier Analysis of Video Telephone Systems

By Dr. D. E. Pearson (*Essex University*)

Edward Herbert Building, Loughborough University of Technology, 7 p.m. (Tea 6.30 p.m.)

South Midland Section

Thursday, 18th October

Provision of Communications for Remote Clustered Visual Display Units

By F. B. Sanders (*West Midlands Gas Board*)

Gloucester College of Technology, 7.30 p.m.

West Midlands Gas today makes extensive use of visual display units (v.d.u.) and typical applications include information retrieval and data input to assist in the administration of accounts and service work in an area containing 1½ million gas consumers (domestic and commercial). The v.d.u.s are connected into the central computer hardware via a communications network shared by other systems. The paper includes a description of the computer and communications system and details the evolution of v.d.u. systems from the design to post-design stages. Storage media, c.p.u. message transmission and multiplexing, microwave network, u.h.f. scanning techniques, P.O. lines, modems, and polling techniques are discussed for the hardware aspects while network planning, implemen-

tation and support including project co-ordination, system acceptance, commissioning and maintenance are also covered. Mention will also be made of future developments.

Tuesday, 20th November

JOINT MEETING WITH IEE

Value for Money in Project Management

By T. G. Clark (*Mullard*)

G.C.H.Q. Oakley, Cheltenham, 7.30 p.m.

South Western Section

Thursday, 18th October

JOINT MEETING WITH IEE

Optical Fibre Communications

By F. F. Roberts (*Post Office Research Department*)

Lecture Room 4E3. 10, University of Bath, 6 p.m. (Tea 5.45 p.m.)

A rapid survey will first be given of the development of existing cable communication systems. The relative repeater cost contributions for optical fibre and coaxial cable systems will then be estimated with stated assumptions about attenuation in relation to communication rate per pathway. Finally after a summary of cable make-up requirements the materials contribution to fibres and coaxial cables of equal transmission capacity will be compared on defined bases. It is concluded that fibre systems will have good prospects of competing with coaxial cables systems under conditions likely eventually to be met, but that considerable further R & D is still required.

Wednesday, 14th November

The Planning of Maplin Airport

By D. W. Turner (*British Airports Authority*)

No. 1 Lecture Theatre, School of Chemistry, University of Bristol, 7 p.m. (Tea 6.45 p.m.)

Thursday, 15th November

JOINT MEETING WITH IEE

Development in Digital Transmission Systems

By G. H. Bennett

Main Hall, Plymouth Polytechnic, 7 p.m. (Tea 6.45 p.m.)

Wednesday, 28th November

JOINT MEETING WITH IEE

Video Recording

By J. Jeffrey (*Bell and Howell*)

Queen's Building, University of Bristol, 6 p.m. (Tea 5.45 p.m.)

North Western Section

Thursday, 11th October

Video Cassette Recording

By K. R. Firth (*Philips Electrical Ltd.*)

Bolton Institute of Technology, 6.15 p.m. (Tea 5.45 p.m.)

Thursday, 8th November

Automatic Testing

Speaker from Marconi

Renold Building, UMIST, 6.15 p.m. (Tea 5.45 p.m.)

North Eastern Section

Tuesday, 23rd October

JOINT MEETING WITH I.O.P.

Solar Cells—Power from the Sun

By Dr. R. W. Gale (*IRD*)

Main Lecture Theatre, Ellison Building, Newcastle upon Tyne Polytechnic, Ellison Place, Newcastle upon Tyne, 6 p.m. (Refreshments available in Staff Refectory from 5.30 p.m.)

Wednesday, 14th November

Codes and Coding

By J. T. Kennair (*University of Newcastle upon Tyne*)

Main Lecture Theatre, Ellison Building, Newcastle upon Tyne Polytechnic, Ellison Place, Newcastle upon Tyne, 6 p.m. (Refreshments available in Staff Refectory from 5.30 p.m.)

Merseyside Section

Wednesday, 17th October

The Semiconductor Story

By Dr. K. J. Dean (*South East London Technical College*)

Department of Electrical Engineering and Electronics, University of Liverpool, at 7 p.m. (Tea 6.30 p.m.)

Wednesday, 14th November

The Role of Electronics in the Movement of Shipping

By K. D. Jones, Extra Master Mariner

Department of Electrical Engineering and Electronics, University of Liverpool, 7 p.m. (Tea 6.30 p.m.)

The paper will examine the two fields of ship movement, that in the open sea and that within the port confines, to describe how traditional methods of making a safe passage have been changed by modern marine developments and electronic equipment. By the successful application of electronic solutions to old questions, many changes have simplified the mariner's problem, but others have increased the dangers through presenting incomplete information.

The future safety and economic operation of ships will lean heavily on the electronics industry. The introduction of on-board computers and their special sensors is an active field of study. The paper will look to the future to suggest the outline requirements on an automatic ship working into a computer controlled port.

South Wales Section

Wednesday, 10th October

New Integrated Circuits for Television Receivers

By G. Baskerville (*Plessey Semiconductors*)
Department of Applied Physics, UWIST, Cardiff, 6.30 p.m. (Tea in College Refectory from 5.30–6 p.m.)

(cont. on p. 596)

Reports from Australia

Plans to Accelerate Australian Technology

The Australian Government is planning new moves to accelerate the advance of technology in Australia. The Minister for Overseas Trade and Secondary Industry, Dr. James Cairns, outlining the plans, envisaged the establishment in the near future of a fund to reward inventors, the setting up of an Invention Development Corporation, and a Small Enterprise Administration. In addition, there would be panels or committees to bring together inventors and inventions in industry and Government facilities.

Dr. Cairns said industrial development was a matter of big enterprise as well as small. It was a matter in which unions and workers could be expected to play a more active role. He believed that the Department of Secondary Industry needed at least two new sections—an Industry Research Bureau and an Industry Development Division.

Electronic Goods to be Cheaper

Members of Australia's Electronics Importers' Association have announced that the prices of all imported electronic consumer goods have been reduced in line with the cut in Australian tariffs.

Sonic Measuring of Wool

Australian textile physicists have developed a rapid and simple method of measuring the average diameter of fibres in a sample of wool by means of sound waves. The instrument was conceived and prototypes built by a research team in the Australian Commonwealth Scientific and Industrial Research Organization Division of Textile Physics.

It was developed to a commercial stage in co-operation with Patons Industries Limited of St. Peters, South Australia. Evaluation tests under the auspices of the International Wool Textile Organization are expected to result in approval of the new method as a basis for issuing international wool fineness certificates. It has already been accepted by the Standards Association of Australia for measuring wool fineness.

Previously, wool fibre diameter measurements were based on the resistance of a plug of fibres to a flow of air, but the complex technique involved restricted the application of such so-called WIRA air-flow fineness meters to the laboratory. The recently developed sonic fineness tester is based on the degree of attenuation of a 50-Hz sound wave passed through a chamber containing a known weight of wool. The sound wave is generated by a small loudspeaker and its attenuation

measured by a transducer on the other side of the chamber. The electrical output of the transducer varies in response to the attenuation of the sound which varies in turn with the diameter of the wool fibres.

The new instrument is particularly important in the rapidly developing field of objective measurement of commercial wool characters. Merino fleece fibres range in diameter from about 18 to 25 μm .

A more elaborate model has a digital read-out display in millivolts which is calibrated in micrometres. The output will allow adaptation to automatic print-out or computer acquisition and processing of vast numbers of samples. It is expected to find a main use in wool test houses issuing certificates to buyers describing measured attributes of the wool in which they trade.

ICAO to look at Interscan

The Australian invention of a microwave landing system (MLS) for aircraft has now been developed to the point where it is desirable to construct, install, and test the system under operational conditions. With Australian Government financial support this phase has now begun.

The new system, known as Interscan, is to be submitted soon to the International Civil Aviation Organization, ICAO, for consideration for world-wide use. It is designed to replace the v.h.f. landing aid which is becoming inadequate with increasing airport traffic.

The new MLS permits curved flight paths and a variety of approach angles thereby greatly increasing airport utilization and reducing noise level, as arriving planes will not have to wait or circle airfields. The MLS is based on an antenna of novel design invented a few years ago by the CSIRO's Division of Radio-physics.

ICAO has been seeking a more versatile approach and guidance system than that provided by v.h.f. to meet the needs of civil aviation over the next 20 years or so.

Australian scientists and engineers associated with the project hope to have the system ready for gradual installation at airports round the world by the late 1970s. Cost of conversion should be acceptable to most civil aviation administrations because the system is being planned around modular construction to allow easy expansion and simplicity for easy maintenance and siting.

These reports are from *Australian News* (published in London by the Australian Information Service).

Forthcoming Institution Meetings (cont. from p. 595)

South Wales Section (cont.)

Wednesday, 24th October

JOINT MEETING WITH IEE

Recent Developments in the Design of Transfer Function Analysers

By W. A. Evans (University College of Swansea)

University College, Swansea, 6.15 p.m.
(Tea 5.30 p.m.)

Wednesday, 14th November

Solid State Microwave Power Amplifiers

By G. B. Morgan (UWIST)

Department of Applied Physics, UWIST, Cardiff, 6.30 p.m.

A brief review of power saturation mechanisms in various types of microwave solid state amplifiers will be given and the competition offered to valves discussed. The power-impedance product limitations of the more important power amplifiers will be considered.

Northern Ireland Section

Wednesday, 10th October

Annual General Meeting followed by a talk on

'T. Eng. and All That'

By J. T. Attridge

Board Room, Ashby Institute, Queen's University, Belfast, 6.30 p.m.

A discussion on the recent changes in the rules relating to Technician Engineering qualifications.