

The Journal of THE BRITISH INSTITUTION OF RADIO ENGINEERS

FOUNDED 1925

INCORPORATED 1932

*"To promote the advancement of radio, electronics and kindred subjects
by the exchange of information in these branches of engineering."*

VOLUME 19

MAY 1959

NUMBER 5

HOSPITALITY IN CAMBRIDGE

PREVIOUS notes on Convention arrangements have stressed the many advantages to delegates of getting away from their normal surroundings to an atmosphere conducive to considered thought.

Thus, with two exceptions—one before the war and one immediately after the war—all Institution Conventions have been held within the precincts of Universities. Lecture theatre accommodation, as well as added facilities for demonstration are readily available and are this year due once more to the courtesy and help given by the authorities of the Cavendish Laboratories. In that respect, the facilities of the Cavendish may very well be considered as the hub of the whole Convention.

Not the least of arrangement problems, however, is the important one of securing accommodation for delegates. In past years it has been found that insufficient accommodation has been reserved in colleges, resulting in some disappointment for those who make late application.

This year, more extensive arrangements have been made with the very kind co-operation of the Bursars and Stewards of Christ's, Downing,



Radio Times Hulton Picture Library
CHRIST'S COLLEGE GATEWAY

Peterhouse, Sidney Sussex and Girton—the latter college for the ladies of our delegates.

To many delegates, residence in the colleges affords opportunity for nostalgic indulgence. To others, it provides an opportunity to experience college life.

The present rate of applications for attendance at the Convention certainly indicates that members appreciate the facilities which are being provided. It is opportune, therefore, to thank the colleges concerned for their early help in providing a suitable background for residential attendance at the Institution's 1959 Convention.



DOWNING COLLEGE

Photo Precision

“Television Engineering in Science, Industry and Broadcasting”

CONVENTION TIME-TABLE

Wednesday, July 1st

12.00 — 1.30 p.m.	Registration in the Cavendish Laboratory.
2.00 — 2.15 p.m.	Opening address by the President, Professor E. E. ZEPLER.
	SESSION 1. General
2.15 — 3.45 p.m.	<i>Session 1 (a)</i> Surveys, Planning, Operations and Systems.
3.45 — 4.00 p.m.	Break—Tea.
4.00 — 4.30 p.m.	Discussion on Session 1 (a) papers.
4.30 — 5.30 p.m.	<i>Session 1 (b)</i> Fundamentals.
5.30 — 7.00 p.m.	Break—Dinner.
7.00 — 8.00 p.m.	<i>Session 1 (c)</i> The Arguments for and against the full restoration of the D.C. Component with special reference to Mean Level Automatic Gain Control.

Thursday, July 2nd

9.00 — 10.00 a.m.	SESSION 2. Receiver Techniques
10.00 — 11.00 a.m.	<i>Session 2 (a)</i> Manufacturing Methods.
11.00 — 11.15 a.m.	Discussion on Session 2 (a) papers.
11.15 — 12 noon	Coffee Break.
12.00 — 12.45 p.m.	<i>Session 2 (b)</i> Design.
12.45 — 2.15 p.m.	Discussion on Session 2 (b) papers.
2.15 — 2.45 p.m.	Lunch Break.
2.45 — 3.15 p.m.	<i>Session 2 (c)</i> Reception and Aerials.
	Discussion on Session 2 (c) papers.
	SESSION 3. Picture Display Problems
3.15 — 4.00 p.m.	<i>Session 3 (a)</i> Synchronization.
4.00 — 4.15 p.m.	Tea Break.
4.15 — 5.30 p.m.	<i>Session 3 (b)</i> Scanning.
5.30 — 7.00 p.m.	Break—Dinner.
7.00 — 8.00 p.m.	Clerk Maxwell Memorial Lecture—Dr. V. K. ZWORYKIN.

Friday, July 3rd

9.00 — 10.00 a.m.	SESSION 4. Cameras and Video Engineering
10.00 — 11.00 a.m.	<i>Session 4 (a)</i> Design, Tubes and Tube Operation.
11.00 — 11.15 a.m.	Discussion on Session 4 (a) papers.
11.15 — 12 noon	Coffee Break.
12.00 — 12.45 p.m.	<i>Session 4 (b)</i> Programme Switching.
12.45 — 2.15 p.m.	Discussion on Session 4 (b) papers.
	Lunch Break.
	SESSION 5. Television Recording
2.15 — 3.00 p.m.	Discussion on Session 5 papers.
3.00 — 3.45 p.m.	Tea Break.
3.45 — 4.00 p.m.	

Friday, July 3rd—cont.

4.00 — 5.00 p.m.	SESSION 6. Colour Television
5.00 — 6.00 p.m.	Discussion on Session 6 papers.
7.30 p.m.	Convention Banquet.

Saturday, July 4th

9.00 — 10 a.m.	SESSION 7. Industrial and Scientific Television
10.00 — 10.45 a.m.	<i>Session 7 (a)</i> General Applications and Techniques.
10.45 — 11.00 a.m.	Discussion on Session 7 (a) papers.
11.00 — 12.45 p.m.	Coffee Break.
12.45 — 2.15 p.m.	<i>Session 7 (b)</i> Equipment.
	Lunch Break.

SESSION 8. Transmission and Transmission Equipment

2.15 — 3.00 p.m.	<i>Session 8 (a)</i> Transmitters and Aerials.
3.00 — 3.30 p.m.	Discussion on Session 8 (a) papers.
3.30 — 4.15 p.m.	<i>Session 8 (b)</i> Transmission and Links.
4.15 — 4.30 p.m.	Tea Break.
4.30 — 5.30 p.m.	Discussion on Session 8 (b) papers.

Note: There may be slight adjustment to the time allotted to the various sessions to take into account the number of papers finally accepted.

GENERAL ARRANGEMENTS

Technical Sessions

All sessions will take place in the Clerk Maxwell Lecture Theatre of the Cavendish Laboratory, Free School Lane.

As preprints of all papers will be available before the Convention, authors will present their contributions briefly during the first half of the session; the second half of the session will be devoted to discussion of the papers.

Accommodation

Accommodation, including meals, will be available in Downing, Peterhouse, Christ's and Sidney Sussex Colleges for delegates staying for the *whole* period of the Convention, that is, from mid-day on Wednesday, July 1st to Sunday morning, July 5th.

Convention Banquet

Following the pattern of previous Institution Conventions, an official banquet has been arranged for Friday, 3rd July, at 7.30 p.m.

Preprints

Registration for the Convention will entitle delegates to receive in advance preprints of all the papers being presented. These will *not* be available to persons not attending the Convention. All papers presented at the Convention will subsequently be published in the Institution's *Journal*, together with a record of the discussions.

Demonstration of Equipment

Provision is being made for authors of papers to demonstrate equipment in an adjoining room in the Cavendish Laboratory. Demonstrations will be given before and after each session, and an exhibition of equipment will be open to delegates during the period of the Convention.

All equipment will be relevant to the papers presented. In cases where the exhibition of a large installation is impracticable, models, photographs or similar portable demonstration material may be displayed.

Synopses of Papers to be presented at the Convention

This is a selection of a few of the papers accepted for presentation during the eight sessions of the Convention. A total of between 40 and 50 papers will be presented and a further list will be given in the June issue of the Journal.

Reduction of Television Bandwidth by Frequency-Interlace.

SESSION 1

E. A. HOWSON, B.SC. AND D. A. BELI, M.A. PH.D.

(Department of Electrical Engineering, University of Birmingham.)

A method analogous to the N.T.S.C. colour television system is used to obtain a bandwidth reduction of a black-and-white video signal by a factor of approximately 2 : 1. The normal signal is split into two frequency bands, nominally zero to 1.5 Mc/s. and 1.5 to 3.0 Mc/s. The latter is used to amplitude modulate a sub-carrier, whose frequency is an odd multiple of half the lines scanning rate. The lower sideband of the modulator output is selected and combined with the original zero-to-1.5 Mc/s. band, so that the spectra of the two signals interleave. The combined signal may now be sent over a channel of 1.5 Mc/s. nominal bandwidth.

At the receiving end of the channel the composite signal is applied to a synchronous demodulator, fed also with subcarrier of the same frequency as at the transmitter. The lower sideband of this demodulator is taken and combined with the received signal, to yield a "normal" video signal extending from zero to approximately 3 Mc/s. together with an "interleaved" signal from zero to 1.5 Mc/s.

The interleaved signal is such as to give an interference pattern on the display which in a stationary picture should optically cancel after four successive frame scans. However, the pattern is built up in such a way as to give rise to a "crawling" motion which is very noticeable at close viewing distances. Photographs of typical picture obtained with an experimental apparatus are given, showing various interference effects produced.

Some aspects of the Design of a Small Television Station.

SESSION 1

AUBREY HARRIS, ASSOCIATE MEMBER.

(Formerly Bermuda Radio & Television Co. Ltd.; now Ampex Corp.)

The technical planning and operation of a commercial television station are influenced to a large extent by economic factors. This is particularly true of a small isolated community such as Bermuda with a limited maximum audience and no possibility, due to the great distances from the nearest mainland, of taking live network programmes. For economy of engineering staff the transmitter and studio are in the same building. The size of the transmitter is 500W and the type of aerial system is such that the power is concentrated towards the most populated areas. Studio and film reproduction equipment is all-vidicon; the camera used for the projection equipment is of the same type as is used for the studio—thus simplifying the problem of stocking of spares. All engineering and production operations are controlled from a central control room overlooking the studio, which is of area 1,000 square feet. Vision facilities are arranged so that continuity of service may be maintained with a minimum of standby equipment. Adequate lighting for the vidicon cameras is provided with a small number of fixed lighting units, controlled without dimmers. Some novel arrangements for cable trunking and facility outlets in the studio are described. Other aspects of the planning design and operation of a small self-contained television station include studio acoustic treatment, talkback facilities, film projector multiplexing and details of preventive maintenance procedures.

Assessment of X-radiation from Television Receivers.

SESSION 2

A. CIUCIURA, B.SC. (ENG.) (*Mullard Radio Valve Co., Ltd.*)

The paper puts forward an analytical approach to the x-radiation problem. The x-radiation properties of cathode ray tubes are specified in terms of spread, e.h.t. potential and beam current. Similarly the properties of e.h.t. generators are specified in terms of mean potential, spread and internal impedance. The two sets of properties are allowed to act simultaneously and a statistical analysis is applied. The final results are produced in terms of the number of receivers exceeding the safe dose rate, the amount of x-radiation emitted in an extreme case and the amount of shielding required, if any. Although, of necessity specific cases are quoted, the paper is of a general nature.

Design of Dual-standard Television Receivers for the French and C.C.I.R. Standards.

SESSION 2

C. J. HALL, B.SC. (ENG.) (*Television Grammont, Paris.*)

There are several regions near the borders of France with Germany, Switzerland and Italy where a demand exists for a television receiver capable of functioning on either the French or C.C.I.R. systems.

An inspection of typical television receivers for each of the two systems shows that there are essential differences in all parts of the circuit except the power supply, frame time-base and audio frequency sections. Consequently direct switching from one system to the other could involve a very large number of switching operations, including many in critical circuits where switching may introduce difficulties. It is therefore necessary to see where, by a suitable compromise it is possible to use the same circuits for both systems with little or no degradation of performance.

Where an acceptable compromise cannot be found the problem may be simplified by duplicating circuits and simply switching the h.t. supply. The extra cost of material in this case must be balanced against the extra complication of switching in critical circuits, taking account of the limited demand for dual-standard receivers which limits the amount of effort which can reasonably be spent on development.

The design of a complete dual-standard receiver is treated section by section, alternative methods of switching are examined against the background of current practice and a preferred solution is outlined where possible or the lines along which such a solution may be sought are indicated.

Time-base Synchronization and Associated Problems.

SESSION 3

P. L. MOTHERSOLE, ASSOCIATE MEMBER. (*Mullard Research Laboratories.*)

The definition and quality of a television picture is determined by the effectiveness of the time-base synchronization when the receiver is used in a noisy situation. The requirements of the synchronizing and time-base oscillator circuits for use with both positive and negative modulation systems are described. Circuit techniques are surveyed to show the difference in approach due to the sense of the video modulation.

The Testing and Operation of the 4½ in. Image Orthicon Tube.

SESSION 4

D. C. BROTHERS, B.SC. (ENG.) (*British Broadcasting Corporation, Designs Department.*)

Much has been written on the manufacture and testing of image orthicon tubes from the point of view of the manufacturer and of various research organizations. It is felt that there may be some interest in a paper giving details of methods used by a broadcasting organization to check the performance of tubes. As a corollary to the results of such tests, some conclusions are drawn on particular aspects of operating these tubes.

Communications in Independent Television.

SESSION 4

L. F. MATHEWS, MEMBER. (*Associated Television Limited.*)

The Independent Television Network has been progressively expanding with the advent of each additional programme contractor, and as a result the problems connected with general communications have also been increasing. In this paper the author will describe how the growth has effected the design of a network for the conveyance of vision, sound and the control of programmes within one programme contractor's organization, and how the increased complexity of programme networking is being dealt with.

A new microwave link which has been installed for the author's company for monitoring purposes will be described, with particular reference to the automatic switching and monitoring facility carried out over an associated u.h.f. link. The latter equipment also operates annunciator panels at the monitor points, and it is hoped to demonstrate such a panel operating from the link during the course of the lecture.

Recent Developments in Video Tape Recording.

SESSION 5

C. P. GINSBURG. (*Ampex Corporation.*)

The rapidity with which video tape recording has become a major part of television broadcasting throughout the world has hastened the development and inclusion of new and improved techniques affecting basic performance as well as operational flexibility of the machines. This paper describes the method used to obtain complete interchangeability of video tape recordings; a new servo system which will increase the time base stability by more than an order of magnitude, and will allow a machine to be used either as master or slave in lap dissolves, supers, split-screens, and other special effects; conversion of video tape recorders to colour; operation on different line and frame rates; and duplication of taped programmes.

Methods of Performance Measurement on Colour Television Receivers.

SESSION 6

A. J. BIGGS, PH.D., AND E. RIBCHESTER, B.SC. (*Research Laboratories, General Electric Co. Ltd.*)

The methods of measurement involved in assessing quantitatively the basic performance characteristics of colour television receivers are considered. The methods are specifically applied to receivers designed for systems based on N.T.S.C. principles and incorporating a display tube of the shadow mask type. The scope is restricted to include only questions of overall performance and not measuring techniques which would be involved at the design stage of individual circuits. Traditional monochrome testing methods are still necessary but care is needed in interpreting results under such headings as i.f. response, a.g.c., spurious responses and cross-modulation, because of the additional requirements which the satisfactory handling of a colour signal demands.

An X-ray Image Amplifier using an Image Orthicon Camera Tube.

SESSION 7

E. GARTHWAITE, M.B.E., AND D. G. HAIEY. (*Marconi Instruments Limited.*)

Special requirements of a television camera for use as an x-ray image amplifier are outlined. The differences in approach to this problem are that whereas in the television application the illumination can be controlled, in the x-ray application the illumination is controlled by the thickness of the subject under examination.

Details are given of the special camera tube which has been developed to operate under these conditions and also of the ancillary apparatus required to obtain maximum sensitivity and definition from such a tube. The reason for adopting a scanning system not compatible with any of the accepted standards is also discussed.

Design Techniques for Space Television.

SESSION 7

A. J. VITERBI, B.S., M.S. (*Jet Propulsion Laboratory, California Institute of Technology.*)

A narrow band television system for relaying to earth images of the planets is described. The principal consideration is the necessity of communicating over extremely long ranges. Because of the resulting high noise environment, the channel bandwidth is severely restricted. Bandwidth compression is achieved by storing the video signal on magnetic tape or photographic film and transmitting at a reduced information rate.

An f.m.-p.m. telemetry system is utilized. The doppler-shifted carrier is recovered from the noise by a very narrow tracking filter or phase-locked loop. The derived carrier is mixed with the incoming signal to yield the noisy video information. The discriminator is also a phase-locked loop with sufficient bandwidth to track the information signal. The recording operation is reversed at the receiver to present the video image at periodic intervals, or a facsimile technique may be employed.

Waveform Distortion in Television Links.

SESSION 8

I. F. MACDIARMID. (*Post Office Research Station.*)

The linear transmission performance of television links is now measured and specified in terms of their response to certain standardized test waveforms. The aim of the paper is to provide a simple non-mathematical introduction to the basic ideas connected with the measurement of waveform distortion. A number of examples of simple waveform distortions are given to illustrate the advantages of waveform measurements and their connection with the more familiar steady-state responses. The application of tolerance limits to waveform responses is then considered and an outline is given of the routine- and acceptance-test methods of determining the rating factor of a link. Finally a brief introduction is given to the basic ideas of the correction of waveform distortion without reference to the conventional steady-state measurement and equalization techniques.

Gap Filling Translators and Transmitters.

SESSION 8

W. J. MORCOM. (*Marconi's Wireless Telegraph Company Limited.*)

Pockets of population surrounded by high hills present a special problem when providing television coverage. A way to solve this problem is to use so called "gap-filling transmitters." These are equipments, designed to operate completely unattended, which, sited on high ground, overlooking the area to be served, and in a region of high field strength, receive the television signal, convert it to a new frequency and re-radiate it.

Such equipment must be simple and reliable and flexible so that special designs are not required for each and every channel of the television bands. An extension of the design so that locally produced programmes may be introduced is a feature which in many cases may be required and this is also described.

In addition to the above papers and those listed in the programme circulated with the April Journal, the following papers will be presented at the Convention :

- "Television Field Scan Linearization"—H. D. Kitchin (Mains Radio Gramophones Ltd.).
- "A Television Master Switcher"—B. Marsden (Associated Television Ltd.).
- "The Development and Progress of Medical Colour Television"—R. D. Ambrose and A. R. Stanley (Smith Kline & French Laboratories Ltd.).
- "Photo-electric Image Techniques in Astronomy"—B. V. Somes-Charlton (Pye Ltd.).
- "Phosphors for Cathode Ray Tubes in Industrial and Low Scanning Speed Display Systems"—M. D. Dudley (Ferranti Ltd.).
- "Applications of Closed-circuit Television in the Nuclear Industry"—P. Barratt and I. M. Waters (Pye Ltd.).
- "A Medium Screen Colour Projector"—T. M. Lance (Rank Cintel).
- "A High-grade Industrial Channel with special reference to Infra-red operation"—J. H. Taylor (E.M.I. Ltd.).

INSTITUTION NOTICES

Students' Essay Competition

The Council announces that the subject for the Students' Essay Competition for 1959 will be:—"The Future of Electronics in Industry."

Entries are now invited from registered Students of the Institution as well as from Graduates who will be under the age of 23 years at the closing date of the competition. Essays, which should be between three thousand and five thousand words in length, should preferably be typed, using one side of the paper only. The closing date for both home and overseas competitors is 30th June 1959.

A prize of £10 10s. will be awarded for the best essay; additional prizes may be awarded at Council's discretion for essays which are highly commended. The Council reserves the right to publish the prize-winning essay in the *Journal*.

List of Members

The eighth issue of the Institution's List of Members will be published in November 1959. It will contain the names of all members of the Institution (other than Students) and copies will be sent free of charge to all those whose names appear therein.

Changes of address since the publication of the previous issue will be recorded and members whose personal details, such as honours and academic distinctions, differ from those already published should notify the Institution without delay.

The Radio Trades Examination Board

The Board has announced that after 1960 it will no longer conduct separate Servicing Certificate Examinations in radio and television.

The Examination will instead be in two stages. The Intermediate examination will be taken at the conclusion of a three years' course which will include television servicing at 3rd year level. Success in this examination will be necessary before a candidate can take the Final examination and secure the Board's Certificate.

The numbers of candidates for the 1959 Examinations, to be held during May and June, have reached the record level of 1894 for Radio Servicing and 485 for Television Servicing.

Electronics Technicians' Examination

The Radio Trades Examination Board has also approved the extension of its work by holding examinations for electronics technicians and servicing mechanics. The first examinations will be held in 1961 and the scheme as at present envisaged will include an Intermediate examination at the end of the third year's study, which will have a common paper with the radio and television servicing examination.

Graduateship Examination

The November Graduateship Examination will be held on November 18th and 19th. The closing date for entries from candidates wishing to sit the examination in Great Britain will be October 1st; for overseas candidates the closing date was May 1st last, and entries for the May 1960 examination should be lodged with the Institution by November 1st.

Copies of the papers set for the May 1959 and previous examinations may be obtained from the Institution, price 2s. 6d. per set.

Conferences on Dielectric Devices and Network Theory

The Electrical Engineering Department of the University of Birmingham is arranging two informal residential conferences in September 1959. The first, on Dielectric Devices, will be held from Monday, 14th September, to Thursday, 17th September 1959; and the second, on Modern Network Theory, will be held from Monday, 21st September, to Thursday, 24th September 1959. Preliminary programmes of papers and discussions have already been arranged and those interested in attending are invited to write to the Secretary of the Electrical Engineering Department, The University, Birmingham 15, for full details. In order to preserve the informal nature of the conferences, numbers will have to be strictly limited.

Correction

The following correction to the Discussion on Mechanical Speech Recognition, published in the April 1959 issue, should be made:

Page 230, right hand column, line 22 should read ". . . less than 1000 bits/sec."

Detectors for Low Energy X-Radiation†

by

A. LONG, ASSOCIATE MEMBER‡

Summary : A general description of Geiger, proportional and scintillation counters is given from the viewpoint of the types useful for low energy detection. It is shown how each detector may be designed to give maximum efficiency at a particular X-ray energy while taking into account the limitations that exist in the three different types of detector.

1. Introduction

The remarkable increase in the application of X-ray diffraction and X-ray spectro-analysis to many fields of research and routine quality control has brought the need for X-ray detectors of greater flexibility.

The wide scope of X-ray analysis entails operating with large differences in wavelength, X-ray intensity and complexity of instrumentation. These factors alter the required specification of the detector so that no single type is ideal for all X-ray analysis, each type having to be selected on its merit for a particular application.

For many years the Geiger counter has taken pride of place as the alternative to the film method because of the simple nature of the associated control equipment required. Some of the more recent instruments have either scintillation or proportional counters. The main reason for this development is the Geiger counter's comparatively large dead-time which limits the maximum count rate, while the scintillation and proportional counters have sufficiently short dead-times to enable count rates in excess of 10^5 pulses per second to be recorded. They also have the characteristic that the amplitude of their output pulse is an indication of the energy of the incident radiation. This feature allows the detector to be tuned to a selected band of wavelengths or to be used for wavelength analysis.

† Manuscript first received 14th May, 1958 and in final form on 25th February, 1959. Based on a thesis accepted for exemption from the Graduateship Examination. (Paper No. 499.)

‡ Hilger & Watts Ltd., St. Pancras Way, London, N.W.1.

U.D.C. No. 621.386:621.387.4

Apart from the technical advantages of any type of detector the fact has to be borne in mind that both scintillation and proportional counters require considerably more expensive control equipment than the Geiger counter.¹

These detector characteristics are discussed later along with other features such as X-ray window materials and X-ray absorption within the active detection media. It is possible by considering this information to select the most suitable type of detector and to match its performance to a particular application.

2. The Geiger Counter

The use of these counters for X-ray diffraction gave the first real chance to obtain direct intensity measurements of diffracted patterns and line profiles. This facility greatly accelerates an analysis, since with the film technique a microphotometer is required to obtain this information.

As with most other detectors the requirements for a Geiger counter are that its wavelength response should match that of the source being measured, and that the dead time should be short, in other words, the quantum counting efficiency should be as high as possible.

The wavelength response of a counter is controlled by the X-ray window and the percentage absorption of the incident beam within the active path length.

With all counters a window is necessary, either to maintain the difference in pressure between atmosphere and the filling or to keep the filling free from air contamination. A window material has therefore to be chosen which has a low absorption of the desired wavelength and is also vacuum tight.

The most satisfactory materials are beryllium, aluminium and mica, all of which can be said to be efficient in the middle wavelength range. The percentage transmission for these materials are shown in Fig. 1, the results being

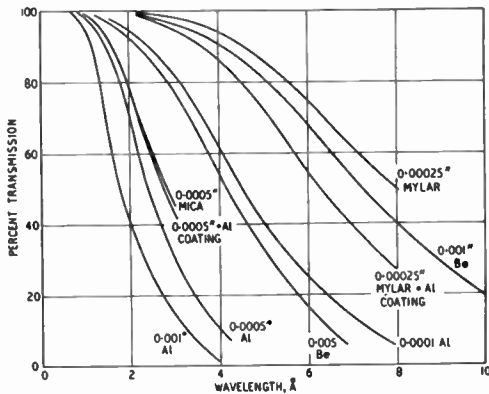

Fig. 1. Percentage transmission for various window materials.

Note.—“Mylar” and “Melinex” are trade names for polyethylene terephthalate.

obtained from the usual absorption expression $I = I_0 \exp -(\mu/\rho) \rho x$; where I is the transmitted intensity, I_0 the initial intensity, μ/ρ the mass coefficient of absorption, ρ the density in g/cm^3 and X the path length in cm.

In Fig. 2, the mass coefficients of absorption of these materials are shown plotted against wavelength, the figures being the mean result of several observations. As the results obtained for mica above 3\AA are uncertain, the curve has

not been extended beyond this wavelength. These variations are mainly caused by the different types of mica available and by the impurities of heavy elements in the sample which obviously greatly increase the absorption. For the results in Fig. 1, the density of beryllium was taken as $1.8 \text{ g}/\text{cm}^3$, that for aluminium as $2.7 \text{ g}/\text{cm}^3$ and the figure of muscovite, $2.8 \text{ g}/\text{cm}^3$, used for mica.

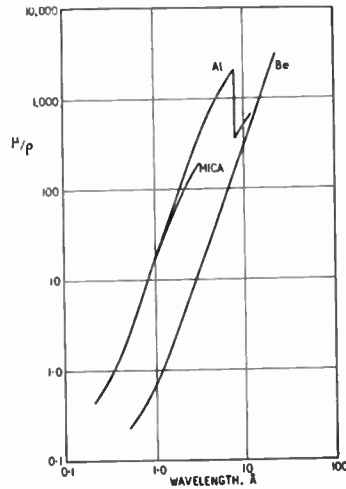

Fig. 2. Mass coefficients of absorption for beryllium, aluminium and mica at different wavelengths.

From these percentage absorption curves it can be seen that for a given thickness beryllium produces the best performance for any wavelength longer than 0.4\AA . Unfortunately beryllium is difficult to obtain free from pin holes in any thickness less than 0.005 in. and

Table 1
Characteristics of Window Materials

X-ray Target Material	$K\beta$ Filter	Thickness required to reduce the $K\beta$ to 0.0017 of $K\alpha$ (in.)	Percentage transmission of $K\alpha$ through the filter.
Cr	V	0.0008"	50
Fe	Mn	0.0008"	46
Co	Fe	0.0008"	44
Cu	Ni	0.0008"	40
Mo	Zr	0.004"	31
Ag	Pd	0.003"	29

therefore if the wavelength does not exceed 2\AA aluminium foil between 0.0001 in. - 0.0005 in. is found satisfactory. For the wavelengths longer than this, two foils of beryllium 0.001 in. thick cemented together can be made vacuum tight and to give approximately 50 per cent. transmission at 6\AA .

Since only the $K\alpha$ wavelength of the X-ray tube target material is wanted for most X-ray diffraction studies, the window of the counter

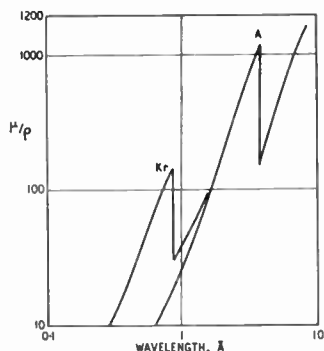

Fig. 3. Mass coefficients of absorption for argon and krypton at different wavelengths.

may serve the dual purpose of vacuum seal and β filter. Foils to facilitate this are commercially available for a number of radiations and a list is given with desired thickness in Table 1.

Any of the four noble gases may be used for counter filling but usually either argon or krypton are favoured, since between them, most

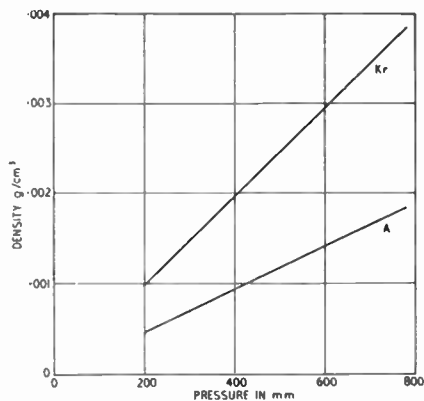

Fig. 4. Density of argon and krypton at different pressures.

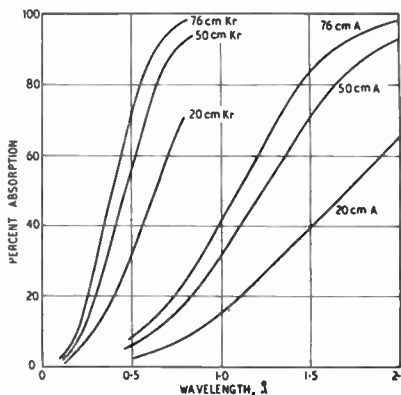

Fig. 5. Percentage absorptions for 10 cm path lengths of argon and krypton.

X-ray K spectra wavelengths can be absorbed within the active path length of the counter.

Using the same expression as for the X-ray window, the absorption of the incident X-ray beam within the counter is calculated from the mass coefficient of absorption, the density and the path length. These figures are shown in

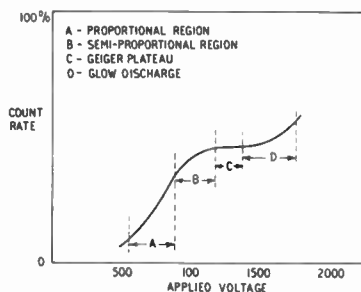

Fig. 6. Operating conditions for G-M counters.

Figs 3 and 4, the former depicting the μ/ρ over the range 0.2\AA to 10\AA for argon and krypton while the latter shows the density of the filling at various pressures, using the perfect gas law and ignoring the small amount of quenching agent. Fig. 5 displays the percentage absorption for these gases at different pressure fillings between the range 0.2\AA to 2.0\AA for a 10 cm path length.

A counter operating in the Geiger region has two main assets, the working potential is on a plateau. (Fig. 6), and the output pulse may have an amplitude of a few volts. These factors greatly ease the duties of the electronic control

Therefore, when high count rates are encountered and a high accuracy is required an external electronic quenching circuit has to be incorporated. In general, these circuits take the form of a multi-vibrator which is triggered by the leading edge of the counter pulse and produces an output pulse approximately 200V negative with a duration a little in excess of the normal inactive time of the Geiger counter. This pulse is fed back on to the anode of the counter so that after each avalanche the voltage on it is reduced below the Geiger threshold, therefore rendering it inactive during the length of the negative pulse, which is constant.

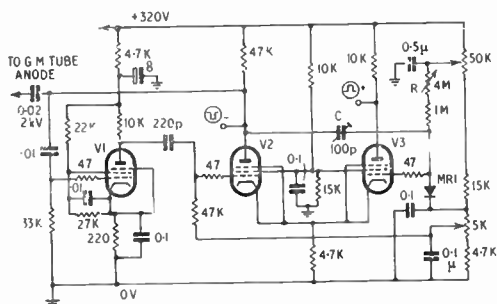

Fig. 8. Quenching circuit.

Figure 8 shows a typical quenching unit for use with counters having inactive times between 70-700 microsec. V1 forms a normal pulse amplifier the output of which is used to trigger the inoperative valve V2 of the multivibrator. The sensitivity of the circuit is adjusted by the standing bias on V2, allowing some measure of discrimination since small noise pulses are quite common from the X-ray high voltage generator. The length of the negative feed back pulse taken from the anode of V2 is controlled by the values of C and R, the latter being made the variable in this case. In order to keep the bias on the control grid of V3 approximately constant with changing value of R the diode MR1 is coupled between it and a point of fixed potential. Positive or negative outputs are available at the anodes of V2 and V3, the amplitude being approximately 90V positive and 230V negative.

In order to measure the intensity of the X-ray beam falling on the detector the number of pulses in a given time period have to be measured. This is the case with all three of the

detectors being described and therefore the measuring systems common to them all are described later.

3. Scintillation Counters

It may be said that the scintillation counter outdates both the proportional and Geiger counter since many of the fundamental atomic physics experiments relied upon this type of detector. It consisted of a fluorescent screen, such as zinc sulphide, which when bombarded with α particles emitted light scintillations visible to the human eye. The speed at which they could be counted therefore depended upon the skill of the observer, but obviously it was always a comparatively slow rate.

Little if any improvement was made to these detectors until 1944 when Curran and Baker replaced the human observer with a photomultiplier (Fig. 9). The main reason for the lack of interest shown in the scintillation detector prior to this was the development of the ionization chamber and the Geiger counter, both of which using electronic amplifiers, produced an output pulse suitable for electronic counting.

By using a photomultiplier to record the scintillation from the luminescent material a pulse was made available which could be counted on similar equipment to that used for the other two detectors.

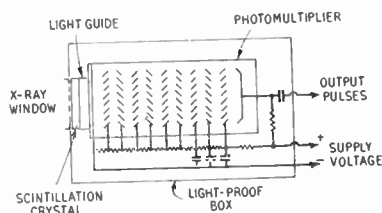

Fig. 9. Scintillation counter.

From this time great interest has been shown in the scintillation counter resulting in many improvements in the luminescent material which in turn have gradually increased the operating wavelength range.

Although for many years the advantages of these counters for X-ray diffraction work have been realized, little use has been made of them, due to the poor signal-to-noise ratio at the longer wavelengths. This failing is caused by

the low amplitude of the light scintillation from the luminescent materials which, being proportional to the energy of the incident radiation, eventually only produces a pulse of the same order as the noise pulses from the photomultiplier and therefore becomes indistinguishable.

Of the luminescent materials available at present, sodium iodide activated with thallium has proved the most successful for the wavelength range between 0.1Å and 5.0Å.^{4, 5} Large single crystals of this material are available, the best of which produce sufficiently good results for the detector to be used up to the longer wavelengths at which the X-ray window becomes a limiting factor. As with the Geiger counter a window is still required, since the one serious disadvantage of this material is that it is deliquescent. The characteristics affecting the performance of this crystal as a scintillator are shown in Table 2, along with the characteristics of other materials commonly used. From this table it can be seen that NaI(Tl) has a very high efficiency and a decay time of 0.25 microseconds; both of these factors make it a satisfactory material, especially since the light scintillation produced has a peak intensity at 4100Å which does match quite well the spectral response of a photomultiplier using a SbCsO photocathode.⁶

In order to obtain the maximum efficiency for the transfer of the light scintillation to the photocathode, the sodium iodide crystal has to be no thicker than just sufficient to absorb the incident X-ray energy.

Figure 10 depicts the mass coefficient of absorption for sodium iodide plotted against wavelengths. These results are obtained from the separate figures for sodium iodine and ignore the thallium content. The sudden drop in level at 0.374Å is caused by the iodine K absorption edge, necessitating the use of a thicker crystal than normal if a linear detecting

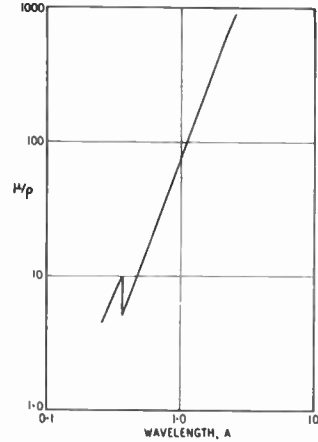

Fig. 10. Mass coefficient of absorption for sodium iodide (thallium activated).

efficiency is required over a range of wavelength containing this value. Three typical absorption curves are shown in Fig. 11 covering the range 0.2Å to 10Å for crystals 0.25 mm, 1.0 mm and 4 mm thick. As can be seen, the 1.0 mm thickness shows a 10 per cent. drop in absorption at 0.374Å while the 4 mm thickness completely evens this out.

Table 2

Properties of Luminescent Materials

Material	Maximum Emission (angstroms)	Decay Time (microsec.)	Refractive Index	Density (g/cm ³)	Efficiency (%)
NaI(Tl)	4100	0.25	1.7	3.67	100
CdWo ₄	5200	100.0	2.3	7.9	100
CsI(Tl)		1.0			70
Anthracene	4400	0.03	1.59	1.25	48
ZnS(Ag)	4500	5.0	2.37	4.087	20
CdS(Ag)	7600	100.0			20
CaWo ₄	4300	10.0	1.93	6.1	4

Normally the content of thallium is less than 1 per cent. which makes little difference to the absorption coefficient but changes in its concentration do alter the performance. In general, as the thallium content is increased the light output is increased until a point is reached about 1 per cent. when no further light gain is obtained. Before this saturation content is reached the energy discrimination of the crystal

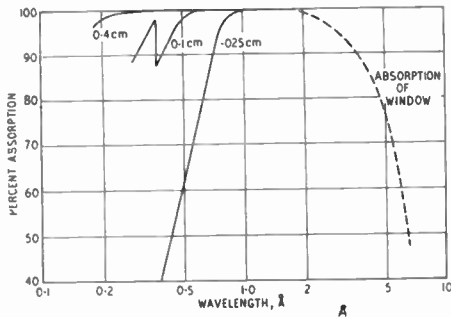

Fig. 11. Percentage absorption of NaI(Tl).

is usually spoilt. The optical properties of the crystal are impaired also because it becomes cloudy. It is therefore necessary in order to preserve the long wavelength sensitivity to choose a crystal as thin as possible with the highest light yield and to sacrifice some of the performance regarding energy discrimination. It has been found that crystals satisfying this requirement are usually slightly cloudy but it is desirable that the cloudiness is evenly distributed over the whole volume. If this is not so the energy discrimination is further reduced since the amount of light reaching the photocathode will depend upon the location of the initial ionization.

The mounting of the crystal plays an important part in the characteristics of a scintillator. Firstly, this is due to the absorption of the incident X-ray beam by the window material which reduces the number of quanta reaching the crystal. Secondly, the optical loss in the transfer of the scintillations to the photomultiplier lowers the signal-to-noise ratio.

All the window materials recommended for Geiger counters are applicable for crystal mounts along with some plastics films which, although not strong enough to stand large

differential pressures, are reasonably impervious to water vapour. Of the plastic materials so far tried Melinex has proved the most satisfactory, the percentage X-ray transmission between 0.5Å and 8.0Å being shown for a 0.00025 in. thick film in Fig. 1. For both this film and mica a second plot depicts the absorption with a thin aluminium coating which has the advantage of reducing the light transmitted, increasing the resistance to water vapour and forming a light reflectant surface. A coating approximately 0.00002 in. thick reduces the light transmitted to the order of 10^{-10} of the incident which would enable the counter to be operated in medium levels of illumination. Unfortunately it is difficult to produce such a coating free from pin-holes, and it is therefore necessary to use either two such films or some other light absorbent material.

To obtain good optical coupling between the adjacent surfaces of the crystal and the glass light-guide this crystal face is polished while all the other crystal surfaces are left with matt finish. This forms a diffuser so that the light reflected back from the aluminium coating or alternative reflector does not produce bright

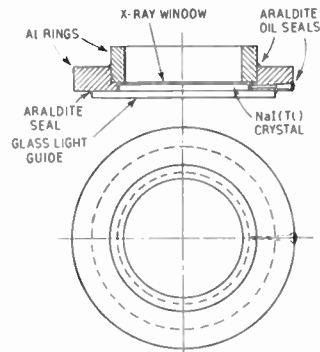

Fig. 12. Scintillation crystal mount.

spots on the photocathode. For completion of the optical coupling between the crystal and light-guide the free volume around the crystal is filled with low absorption silicone fluid which also gives extra protection from water vapour. The light-guide, which must be made of a glass with low absorption between 3200Å and 5500Å is joined by the same fluid to the window of the photomultiplier. A typical mount designed in this way for an end-window photomultiplier is shown in Fig. 12.

Because of the difficulty in obtaining good optical coupling to the side-window photomultiplier the end-window type is favoured for most low energy X-ray detection. The size of the photocathode depends upon the particular application, but in general it may be smaller for diffraction studies than for spectrum-analysis. This is due to the diffracted beam being a fine line in cross section approximately 8 mm long and 0.1 mm wide, whereas spectrum analysers may have an X-ray beam as large as 20 mm square. To obtain maximum sensitivity it has been found desirable to use a crystal and photocathode about 1.25 times larger than the X-ray beam as there is scatter within the crystal which would otherwise partly be lost in the mount.

Practically all the commercially-available photomultipliers have circular photocathodes and therefore the diameter nearest to 1.25 times the desired diagonal dimension has to be selected. This does entail a larger than necessary background from the unused area of the photocathode but this has not proved excessive except when wavelengths greater than 5Å have to be measured.

Two photomultipliers particularly suitable are the E.M.I. 6094 and 6097, the former having a 9.5 mm and the latter a 43 mm diameter photocathode. All the other characteristics for these tubes are the same and are given in Table 3, along with those of other types of tube.

For such a photomultiplier crystal combination the limit of detection can be estimated since a NaI(Tl) crystal produces for approximately 50 eV of incident energy 1 blue light photon which can be transferred with about 90 per cent. efficiency to the photocathode. The conversion efficiency of this varies greatly from tube to tube but an average figure of 1 electron per 10 blue photons may be taken. These electrons are collected with a 10 per cent. loss by the first dynode. At normal room temperature and discrimination level of 250 mV across a total shunt capacitance of 20 pF the number of noise pulses counted at the collector averages 8 per second plus any high energy cosmic count. Taking this as a threshold, 250 mV into a 20 pF capacitance represents 5×10^{-12} coulombs per pulse or 3×10^7 electrons. With 160V per stage on the multiplier an overall gain of about 10^7 is obtained so that three electrons reaching the

Table 3
Characteristics of Photomultiplier Tubes

Type	Manufacturer	System	Window Position	Stages	Cathode Material	Cathode Area (mm ²)	Average Sensitivity (amperes per lumen)
6094B	E.M.I.	Venetian blind	End	11	SbCs	80	200
IP21	R.C.A.	Focused	Side	9	SbCs	100	20
VMP11/10	20th Century	Venetian blind	End	11	SbCs	80	200
9528B	E.M.I.	Box grid	End	11	BiAgCs	390	200
9526B	E.M.I.	Box grid	End	11	SbCs	390	200
50AVP	Mullard	Focused	End	11	SbCs	800	130
6097B	E.M.I.	Venetian blind	End	11	SbCs	1550	200
VMP11/44	20th Century	Venetian blind	End	11	SbCs	1550	200
9514S	E.M.I.	Venetian blind	End	13	SbCs	1550	2000
6199	R.C.A.	Focused	End	10	SbCs	100	140

first dynode produce a pulse of this amplitude. In order to equal this, the energy of the incident beam has therefore to be

$$3 \times \frac{100}{90} \times 10 \times \frac{100}{90} \times 50 \text{ eV} = 1851 \text{ eV,}$$

$$\text{or } \frac{12400}{1851} = 6.7\text{\AA}$$

If it is required to reduce the low energy background count to less than 1 per second, the threshold has to be increased to 750 mV, and therefore only incident energy above 5499 eV, or below 2.25\AA will be recorded.

Thermal noise from the photocathode is the largest contribution to background, equalling about 150 electrons per square centimetre per second at 18°C and approximately double this figure for an increase of 10°C. Other sources of noise from the photomultiplier are the ionization of the residual gas, direct leakage through and over the insulation and cold emission due to sharp points on the electrodes.

In order to minimize the effect of these last three it is advantageous to keep the early stages of the photomultiplier near earth potential or to reduce the electrical field by the use of an external shield. These two methods are shown in Fig. 13; in (a) the collector electrode is

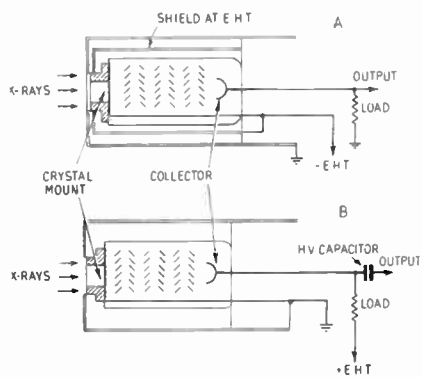

Fig. 13. Methods of screening photomultiplier tubes.

earthed and there is a shield around the photocathode at high potential; in (b) the photocathode is at earth potential thus requiring a low leakage high voltage capacitor to isolate the high tension from the output.

The energy discrimination of such a detector depends upon the wavelength of the radiation

being measured and decreases with increasing wavelength. To take the case of copper K radiation, commonly used for X-ray diffraction studies, the energy is equal to 7960 eV which, with a conversion of 50 eV per blue light photon, produces 159 photons from the crystal. With a 10 per cent. loss in the transfer to the photocathode 143 are collected and, for a 10 per cent. conversion efficiency, release 14.3 electrons. These are collected by the first dynode with approximately 10 per cent. loss leaving 12.9. The root mean square deviation due to the statistical nature of the process involved is therefore (12.9)^{1/2} or 28 per cent. of the measured pulse amplitude. Because the secondary emission from the successive dynodes is also a

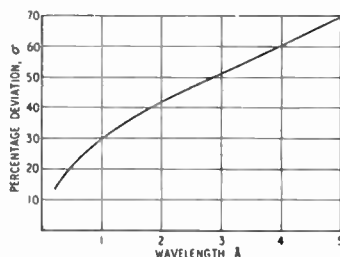

Fig. 14. Relation between wavelength and energy distribution for copper K radiation.

statistical process the distribution is further increased by a factor between 1.2 and 1.3. Taking the latter figure the final width at half peak amplitude is approximately ±36 per cent. Figure 14 depicts the relationship between wavelength and width at half peak amplitude.

Under certain conditions the fluorescence of iodine in the crystal affects the energy distribution by producing extra escape peaks. Both the L and K spectra peaks may be observed, but generally, the energy of the incident X radiation is not high enough to excite the K spectrum and therefore only the L lines at 3.142\AA are detected.

Apart from the pulse height distribution due to these factors, any instability of the photomultiplier high voltage supply and subsequent pulse amplifier gain will obviously adversely affect these figures.

The overall electron gain of the photomultiplier may be expressed by $G = k\delta^n$ where

k is the collection efficiency, δ the secondary emission ratio and n the number of stages.

Due to the different characteristics of individual tubes even of a similar type it is difficult to calculate the general stability for a particular photomultiplier with its associated high voltage supply. Collection efficiency as high as 90 per cent. is obtainable while an average secondary emission ratio of 4 with about 120V per stage is normal. An overall gain

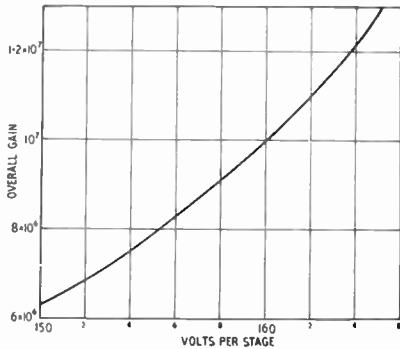

Fig. 15. Gain of E.M.I. photomultiplier type 6097B for varying voltages per stage.

of 10⁶ with approximately 1300V over 11 stages is thus easily obtained. In order to decide the required stability for the high voltage supply it has been found necessary to obtain the gain at various applied voltages for each individual photomultiplier.

For a particular E.M.I. 6097B tube this relationship is shown in Fig. 15, from which it can be seen that at 160 volts per stage the overall gain is 10⁷ and is increased by 5 per cent. at 161 volts. Therefore, assuming that over this small part of the curve the relationship is linear, a gain stability of 0.5 per cent. will require a supply voltage stability of 0.1V or .0625 per cent. Although it is not difficult to obtain this figure of stability the equipment necessarily becomes somewhat more complex than that required for Geiger counters.

Figure 16 shows a current stabilized high voltage supply which provides a long term stability of better than 0.05 per cent.⁷ A normal half wave rectifier circuit supplies a voltage of about 600V in excess of the desired output.

The stabilizing action is obtained by cathode followers in cascade which produce an almost stable current through the photomultiplier resistance chain. R11, as long as the potentials on the grids of V6 and V7 are constant. These potentials are maintained by the gas-filled voltage-reference tubes V2, V3, V4 and V5, and since the voltage across the latter is the most important its input is first stabilized by the three other tubes.

For X-ray energies in the region of 3-10 keV the average output pulse from the detector may be between 1 and 3V so that some measure of amplification is required before pulse height analysis or counting may be undertaken. In general amplitudes between 50-100 V are convenient, requiring an amplifier gain of 30-100 which is quite low but calls for special attention to the bandwidth and stability if full use is to be made of the detector's characteristics. Assuming that the input pulse has very short rise and fall times compared with its length, the amplifier will be required to have a rise-time equal to, or less than, the input pulse length, in order to reproduce the correct amplitude at the output.

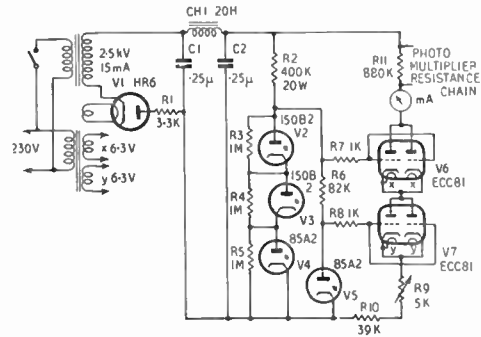

Fig. 16. Current stabilized photomultiplier supply.

The rise-time of the amplifier would therefore have to be less than 1 microsec which may be approximated to the bandwidth of the amplifier by $f_2 = \frac{1}{2T}$ where f_2 is the frequency at which the amplitude response is $\frac{1}{\sqrt{2}}$ of that at mid-frequency and T is the input pulse length in seconds. From this relationship it would appear that 3×10^5 c/s would be sufficient for f_2 but since the input pulses are not square sided, higher bandwidths are required. The shape of the pulses from the photomultiplier depends

mainly upon the scintillation crystal since the time spread within the multiplier itself is usually less than 5×10^{-8} sec. For an average crystal photomultiplier combination the rise-time is in the order of 0.1 microsec with a decay time a little longer, and it is therefore necessary for the amplifier to have a rise-time less than 0.1 microsec or a bandwidth higher than 3×10^6 c/s. An amplifier with these characteristics and incorporating high slope pentodes may still use ordinary resistance-capacitance inter-stage coupling but when higher bandwidths are required in order to obtain a more faithful reproduction of the input pulse some form of inductive compensation is required.⁸

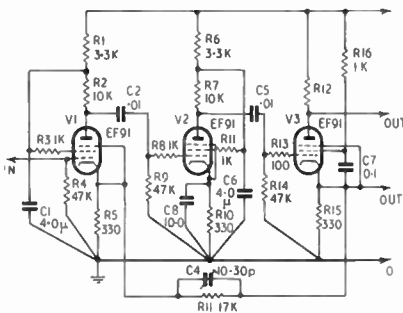

Fig. 17. Pulse amplifier.

Figure 17 shows a simple three-valve unit, the total gain of which is 50; assuming that the stray wiring capacitances are equal to the valve capacities the bandwidth is 3.5 Mc/s. At the cathode of V3 the output impedance is 15Ω , while at the anode an inverted pulse is available with an output impedance approximately equal to R12.

Considering all these limitations it has not proved possible to produce an accurate wavelength analysis with these detectors, but their energy discrimination is sufficiently good to enable the unwanted white radiation to be removed for X-ray diffraction. For spectroscopy it is possible to resolve characteristic lines of equal intensity differing in wavelength by a factor of 1.4 over the range 0.5\AA to 4.0\AA .⁹

4. Proportional Counters

As their name implies these detectors produce an output pulse proportional in amplitude to

the energy of the ionizing radiation. The main difference between these and Geiger counters is the amount of gas amplification used. As stated previously, the Geiger counter operates with sufficiently high potential to enable the ionization, independent of its energy, to spread along the total anode length, therefore producing pulses of equal amplitude for widely different incident energies. The potential applied to a proportional counter is between a critical voltage when gas amplification commences and the point where space charge limitations curtail the energy discrimination.

In general these counters take the form of a sealed-off device filled to a pressure between 10 and 76 cm of mercury, but where low-energy detection is required the continuous flow types are favoured.¹⁰ They have the advantage that the X-ray window material may be porous, in fact, under certain conditions non-existent.

Naturally when either a very thin window such as Melinex is used or just an uncovered hole, the counter has to operate at either atmospheric pressure or, in the latter case, slightly above it.

The window material used for the sealed type of counter may be the same as for Geiger counters, but in order to keep an even field within the active volume of the counter, materials that are electrical conductors have an advantage. Normally the long wavelength limit of the sealed counter does not exceed 5\AA . This is due to the window material which, as was seen from Fig. 1, reduces the transmitted radiation to 35 per cent. with a 0.005 in. beryllium foil at this wavelength. It can therefore be said that the sealed type is quite practical for most X-ray diffraction work where the wavelength seldom exceeds 2.5\AA but that it is not sufficiently sensitive for the longer wavelengths encountered in X-ray spectrum analysis. Here the longest wavelength normally encountered is that of the aluminium K line at 8.32\AA but of course the aim is always to exceed this figure. It is in this long wavelength region that the continuous flow proportional counters excel due to their window material. Using 0.00025 in. Melinex film the transmitted X-ray intensity at 8.32\AA is approximately 30 per cent and at even 11\AA 12 per cent. is obtained. The counter without a window covering can obviously increase the detection

efficiency, but since it is necessary to have a path of either hydrogen, helium or vacuum in order to transmit the radiation to the detectors gas contamination presents extra difficulties.

The sealed-off end window counters often use the same gas fillings as Geiger counters, whereas the side window type (Fig. 18), with a shorter path length, requires a gas with a greater μ/ρ such as xenon. Conversely, the flow counter working with long wavelength radiation is more

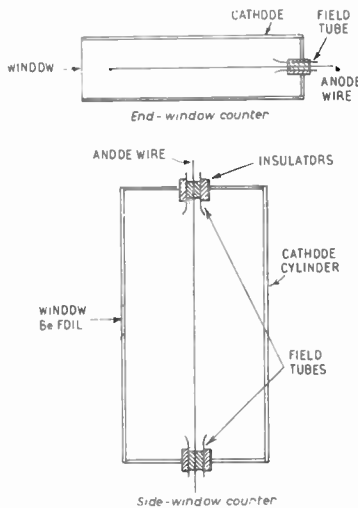

Fig. 18. Construction of end window and side window proportional counters.

conveniently filled with either argon, neon or methane-argon mixtures. Methane alone may be used but the high voltage required for a given gas amplification is reduced to half by the addition of 25 per cent. argon.

In both sealed and flow counters the pressure of the filling is selected so that total absorption of incident radiation takes place, as with Geiger counters, but great care has to be taken to keep the gas free from electronegative contamination if the proportional characteristics of the counter are to be preserved. When this is not achieved the pulse produced for a given incident energy will vary with the location of the primary ionizing event in the counter and will ruin the resolution. If energy resolution is an important factor in the characteristics of the counter extra care has to be taken over the shape of the electrode system in order to maintain an even field.

It is in this direction that the side window type has an advantage because the window, if it is an electrical conductor, may form a part of the cathode cylinder. Another method is to make the path length long enough for the amount of radiation absorbed in the volume near the window to be small compared with the total. This latter method can be improved by shaping the cathode cylinder and anode wire so that the open-end effect is partly compensated.

The measured performance of these detectors in general does not agree very well with the calculated values and it has therefore been found desirable to obtain some of the characteristics by measurement.^{2,3} In order to calculate the gas amplification for a given applied voltage V_A , it is necessary to know accurately the voltage V_I when gas amplification starts. This is best obtained by measuring but may be approximately calculated from

$$V_I = \frac{V_A r_1}{L_e} \log_e \frac{r_2}{r_1}$$

where V_I is the starting potential, V_A the gas filling ionization voltage, L_e the mean free path for an electron in the gas, r_1 the anode radius and r_2 the cathode radius.

The ionization potential and mean free path for an electron in various filling gases are shown in Table 4. Having obtained the point V_I the amplification may be obtained with a reasonable accuracy by:—

$$A = \exp \left\{ 2 \left[\frac{V_a a r_1}{\log_e (r_2/r_1)} \right]^{\frac{1}{2}} \cdot \left[\left(\frac{V_a}{V_I} \right)^{\frac{1}{2}} - 1 \right] \right\}$$

using the same symbols and the value of a given in Table 4.

An average counter filled to a pressure of 10 cm of argon and 0.1 cm methane with r_1 equal to 0.0025 cm and r_2 0.5 cm will have a starting potential of approximately 700 volts. Substituting this value in the gas amplification equation and assuming V_A to be 1500 A becomes 7.4×10^2 . In practice this figure is seldom obtained. Amplifications of about 70 per cent. of this value are reached with these parameters, but it is possible to increase V_a until the actual amplification is between 10^4 and 10^5 before the proportional characteristics are lost. When such high amplifications are required it is not possible to use a simple filling such as argon

because of the high possibility of producing a photoelectron. This, coupled with the low absorption of ultra-violet quanta in such a gas increases the value of A to such an extent that above a gain of approximately 10^2 the counter goes into continuous discharge.

Using the figure of 7.4×10^2 with 1500V applied and noting that this figure is doubled at 1560V, the stability required for the high voltage is 0.30V on 1500V or 0.02 per cent. for a gain stability of 0.5 per cent. This is the same order as that required for scintillation counters and therefore a similar high voltage stabilizer can be used.

The long wavelength limit of detection ignoring the window material is dependent upon the gas amplification and the noise produced by the subsequent pulse amplifier. It is generally accepted that a well designed low-noise amplifier with a band width of 1 Mc/s will be capable of measuring a pulse of about 2×10^{-5} V. Taking the capacitance of the counter as 2.0×10^{-11} farads this potential is equal to 2.4×10^2 electron charges. Therefore, in order to obtain a measurable signal the incident energy has to be above 2.4×10^3 multiplied by the eV required to produce an ion pair. For argon this is 25.4 eV making the result

6×10^4 eV or 0.48Å. In order to increase this latter figure gas amplification, which is noiseless, is introduced and since gains in excess of 6×10^4 are obtainable a single ion pair is theoretically detectable.

The energy resolution is better than that obtained from a scintillation counter for a given wavelength.¹¹ This is due to the lower electron-voltage required to obtain a single ionization and the better energy conversion efficiency. There are two main reasons for the spread in pulse heights of a proportional counter, namely the statistical fluctuation of the number of ion pairs produced for a given energy and the variation in the number of ionizing collisions made by the electrons before being collected by the anode.

Assuming that the counter does not suffer from defects such as uneven field, pitted anode wire, or contaminated gas, and is not limited by space charge, the distribution has been found to be of the form $(\frac{2}{3}n)^{\frac{1}{2}}$ when n is the number of primary ionizations. Taking the case of copper K-radiation of energy 7960 eV and argon-methane as the gas filling, approximately 310 ion pairs are produced and

$$\sigma = \left(\frac{930}{4}\right)^{\frac{1}{2}} \cong \pm 5\%$$

Table 4
Characteristics of Filling Gases used in Proportional Counters

Gas	Average Energy to produce an Ion Pair (eV)	Ionization Potential V_i (eV)	Electron Mean Free Path at N.T.P., L_e (cm)	a at N.T.P. $a \cong \frac{s}{V - V_i}$ (See Note)
Hydrogen	33.0	13.59	7.2×10^{-5}	160.0 H +
Helium	27.8	24.58	12.0×10^{-5}	35.0 He +
Nitrogen	35.0	14.54	3.7×10^{-5}	227.0 N +
Oxygen	32.3	13.62	3.9×10^{-5}	182.0 O +
Neon	27.4	21.56	6.9×10^{-5}	42.5 Ne +
Argon	25.4	15.76	4.0×10^{-5}	540.0 A +
Krypton	22.8	14.00	3.8×10^{-5}	
Xenon	20.8	12.133	3.1×10^{-5}	
Methane		14.5	8.0×10^{-5}	372.2

Note. S = differential ionization coefficient.
 V = voltage equal to the energy of electron.
 V_i = gas ionization potential.

Due to the slow travelling speed of the positive gas ions the total output pulse length is of the order of 10^{-5} to 10^{-3} seconds so that if the total pulse is to be collected the count rates will necessarily be slower than scintillation counters but still much faster than those of Geiger counters. In practice it is usual to differentiate the output pulse so that higher count rates are obtainable with a certain loss of energy discrimination. This is most satisfactorily carried out by making the rise-time of the amplifier between 1×10^{-7} sec and 5×10^{-7} sec which is short enough to reproduce the sharply rising part of the pulse (Fig. 19). Differentiating

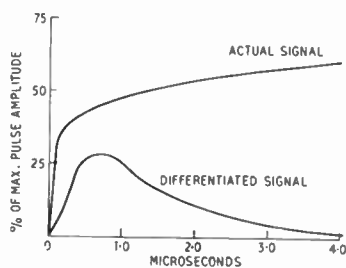

Fig. 19. Illustrating the need for short rise-time to reproduce sharp leading edge of signal.

with a time period of about 2×10^{-6} sec sharpens the pulse sufficiently to produce a similar resolving time as scintillation counters using NaI(Tl) crystals. The amplification required is between one and two orders of magnitude greater than for a scintillation counter since the normal gas amplification is 10^4 against the 10^7 electron amplification of the photomultiplier (the latter figure is reduced because of the 10 per cent. photocathode conversion loss and the higher energy required to produce a light photon within the crystal). This extra amplification is most conveniently arranged as a head amplifier coupled very near to or directly to the counter itself, allowing the inter-coupling cables between the control equipment and instrument to carry a reasonable signal.

At present the most useful applications of these detectors appear to be for the low energy radiation, as encountered with X-ray fluorescence, and to improve the energy discrimination

where very low signal strengths are encountered or where the sample being examined is radioactive.

5. Recording Equipment

Since the signal from all three detectors takes the form of a pulse and the number of pulses in a given time is the measure of the incident radiation intensity some form of pulse accumulating system is required. Basically the measurement method takes one of two forms, either a definite counter recording the number of discrete pulses received or some form of integrating system. The former, which in general gives the higher accuracy, may vary in principle depending upon the resolving time required. For Geiger counters, where the maximum repetition rate is approximately 10^4 per second, use is made of such counting tubes as the Ericsson Dekatrons or the Mullard EIT tubes.^{12, 13} Both of these counters are in themselves a complete scale-of-ten. The Ericsson Dekatron is a gas-filled multicathode tube, one type of which will count up to 2×10^4 pulses per second. The Mullard EIT tube is a deflected electron beam tube arranged so that the electrons fall on a different fluorescent patch for each counted number and it has a maximum rate of about 4×10^4 pulses per second. When shorter resolving times are required, as with both the other detectors, a hard valve scaler is necessary. In general these take the form of a scale-of-two which consist of a bistable multivibrator arranged such that the input pulse switches on or off alternate valves of the circuit so that the output from one valve is only every other pulse. With care these counters will count with less than 1 microsec resolving time and can give either a normal binary display or can be arranged with feedback lines to produce the more convenient scale-of-ten. It is obviously simpler to use the Dekatron or similar tube for the latter stages of a counter preceded only one or two scales-of-ten with hard valves. Scalers of this type are commercially available in various forms to suit a particular requirement.

The second system of recording a given count rate may vary considerably in complexity but basically is nearly always built around some form of capacitor charging system. The most simple of these consists of a resistance-

capacitance integrator but this suffers from the lack of linearity due to the charging current through the resistance falling as the voltage on the capacitor increases. Linearity is improved if the input voltage is large compared with the maximum voltage developed across the capacitor. Such a system is shown in Fig. 20 where the input pulses are fed through the diodes V1A and V1B into a normal scale-to-two circuit comprising V2 and V3. At the anode of V3, C1 is alternatively charged and discharged through V4 into the tank circuit C2 and R1, producing a voltage across C2 which is approximately proportional to the input count

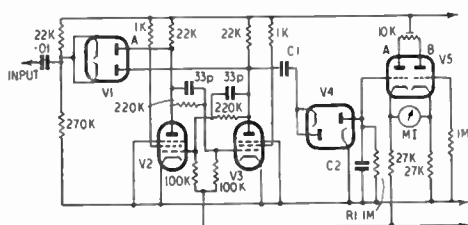

Fig. 20. Counting rate circuit.

rate. To enable low resistance measuring instruments and chart recorders to be used as indicators a low resistance output is available between the cathode of V5. The time-constant of the current is controlled by the tank circuit C2 and R1 whereas the sensitivity depends upon the value of C1.

Circuits of this type have proved quite satisfactory for use with scintillation and proportional counters although it is advantageous to have at least one hard valve scale-of-two before feeding into the rate-of-count circuit. When Geiger counters are used the counts lost due to the dead-time of the detector may be compensated for by the introducing of feedback after the tank circuit.

6. Conclusion

Where simplicity and low cost are important factors the Geiger counter has advantages. Its main failings are long dead-time and lack of energy resolution. Both scintillation and proportional counters operate satisfactorily over the range 0.5Å to 4.5Å, the former having the advantage of a constant counting efficiency

while the proportional counter has better energy resolution. For the longer wavelengths between 4.5Å and 12.0Å the gas flow counter produces the best efficiency and similar resolution to the normal proportional counter.

7. Acknowledgments

The author wishes to thank Messrs. Hilger & Watts Ltd. for permission to publish this paper.

8. References

1. W. Parrish and T. R. Kohler, "Use of counter tubes in X-ray analysis," *Rev. Sci. Instrum.*, **27**, pp. 795-808, October 1956.
2. J. S. Sharpe, "Nuclear Radiation Detectors," Chap. 6.4.5. (Methuen Monograph, London, 1955).
3. S. C. Curran and J. D. Craggs, "Counting Tubes, Theory and Applications," (Butterworths, London, 1949).
4. J. T. Nelson and R. T. Ellickson, "Scintillation counters for detection of X-rays," *J. Opt. Soc. Amer.*, **45**, pp. 984-986, November 1955.
5. J. C. M. Brentano and I. Ladany, "Scintillation counting of low energy photons and its use in X-ray diffraction," *Rev. Sci. Instrum.*, **25**, pp. 1028-1029, October 1954.
6. S. C. Curran, "Luminescence and the Scintillation Counter," (Butterworths, London, 1953).
7. P. Fellgett, "A current stabilized photomultiplier power supply," *J. Sci. Instrum.*, **31**, pp. 217-219, June 1954.
8. I. A. D. Lewis and F. H. Wells, "Millimicrosecond Pulse Techniques," (Pergamon Press, London, 1954).
9. T. R. Kohler and W. Parrish, "X-ray diffractometry of radioactive samples," *Rev. Sci. Instrum.*, **26**, pp. 374-379, April 1955.
10. C. H. Hendee, S. Fine and W. Brown, "Gas flow proportional counter," *Norelco Reporter*, **3**, March-September 1956.
11. A. R. Lang, "Wavelength resolution of X-ray proportional counters," Letter in *Proc. Phys. Soc.*, **65**, pp. 372-373, May 1952.
12. E. J. van Barneveld, "Fast counter circuits with decade scaler tubes," *Philips Tech. Rev.*, **16**, No. 12, pp. 360-370, June 1955.
13. L. Burnett and M. Hawkes, "The dekatron in nuclear instrumentation," *Atomics*, **6**, pp. 283-290, September 1955.

DINNER OF COUNCIL AND COMMITTEES

St. George's Day, April 23rd, was an appropriate day for George A. Marriott, B.A., and Mrs. Marriott to be the guests of honour at a dinner given by members of Council and Committees at the Savoy Hotel. Nearly 200 members and their guests assembled to thank the Immediate Past President for his term of service as President of the Institution.

Presiding at the dinner was Mr. Marriott's successor, Professor Eric E. Zepler, Ph.D., who was supported by all the Past Presidents who had held office during the previous 10 years.

A message from Her Majesty The Queen, thanking members for their address of Loyal Greetings, was received with acclamation. The President also read telegrams from the Vice-Patron, Admiral of the Fleet the Earl Mountbatten of Burma, and from many members overseas, all of which were most warmly received.

Professor Zepler proposed the toast of his predecessor, and referred to Mr. Marriott's characteristic of always looking ahead and the stimulating effect which that policy had on the growth and financial stability of the Institution.

"It was not surprising, therefore, to find that Mr. Marriott took a keen interest in extending the Institution's work beyond the boundaries of Great Britain and indeed of Europe, and it was largely through Mr. Marriott's international outlook that the Institution was truly an international body. Always eager to put his ideas into practice, Mr. Marriott had agreed to extend the American tour which he was undertaking for his Company in order to meet members in Canada and to explore the possibility of inaugurating yet another overseas Section."

Members signified with much applause their association with the President's expression of good wishes to Mr. Marriott for the success of his visit to Canada.

After referring to the part which Mrs. Marriott had played in so ably supporting her husband, Professor Zepler said that it was the wish of the Officers and Council to show tangible appreciation of the work done by Mr. and Mrs. Marriott. On behalf of the Institution he presented a silver tea tray to Mrs. Marriott.

In his reply, Mr. Marriott first thanked all members of the Council and Committees for their help and support during his term of office, and for their good wishes for the success of his visit to Canada. He had a strong belief in trying to cement friendship between engineers of all nations, particularly in the Commonwealth countries, and he was most willing to assist in the Institution's future work in this connection.

Speaking perhaps as an "elder statesman" of the Institution, Mr. Marriott said that he felt succeeding Councils and Committees had three main responsibilities: firstly to maintain membership standards to ensure that the radio and electronics engineer could truly be regarded as a professional man; secondly to ensure that all members, wherever they may be, had the same privileges and opportunities for meetings and exchange of ideas and information as those enjoyed by members in Great Britain. Lastly, to inculcate in the youngest members that the main object of the Institution is the advancement of science for the benefit of man. The application of knowledge was greatly helped by the prosperity of such Institutions as our own and if the older members continued to pass on these three principles then the Institution would go on to a great future.

Proposing the toast of the Guests, Rear Admiral Sir Philip Clarke, a Past President of the Institution, emphasised the strength of the Institution's membership in the Commonwealth countries. Members in Toronto and Montreal were looking forward to Mr. Marriott's visit. In turn, the Council had great pleasure in extending the full warmth of their welcome and hospitality to Mr. B. C. Butler, the Canadian Minister of Commerce in London, Mr. Butler had expressed his great interest in the work of the Institution and his desire to give every assistance to Mr. Marriott to ensure the success of his visit to Canada.

Sir Lynn Ungoes-Thomas, Q.C., M.P., who was to have replied to the toast of the guests, was unfortunately called away to a division of the House of Commons. The reply was therefore made at short notice and in a most informal and witty manner, by Mr. Butler.

Recent Advances in Potted and Printed Circuits†

by

H. G. MANFIELD‡

A paper presented before the South Western Section in Bristol on 29th January 1959.

In the Chair: Captain L. Hix, R.N. (Member)

Summary: The various potting resins are described in relation to the variation of properties with different proportions of hardener and the effects on the parameters of the potted components. The causes of failure of potted circuits are discussed. Design problems in the use of printed circuits are examined with particular reference to questions of conductor thickness and spacing. A method of sealing printed circuits by a thin polysulphide rubber layer which is sprayed or brushed on is described.

1. Introduction

From a slow start the use of potted circuits has over a period of about eight years gradually become an accepted method of construction—although it is limited to high-quality electronic units where freedom from damage either from moisture, shock or vibration is essential. The fact that such units are, in general, unrepairable has eliminated the employment of the technique in domestic radio and television, since the high cost would prohibit its use and indeed it is, in temperate climates, unnecessary.

Printed circuits and wiring are now accepted as standard production methods for radio, television, computers and practically every other type of electronic assembly with the exception of equipment for the Armed Services where the technique is only just gaining acceptance—this reluctance has been due mainly to the difficulties encountered in maintenance.

A combination of the two techniques has much to commend it and a new construction for transistorized circuits has recently been developed in which a soft, rubbery material is used as the potting resin. This material can

easily be cut for replacing components and it seals very simply.

2. Potted Circuits

Much has been written about the potting of electronic circuits^{1, 2, 3, 4} and the general principles are by now well known although a steady flow of complaints about component failures is proof that many of the first principles are barely understood—the great majority of such failures are caused by faulty design of the unit or by the use of unsuitable materials.

Nothing could seem more simple than casting a piece of circuitry in a liquid resin which sets at room temperature but in practice there is such a wide choice of materials and conflicting reports on their respective merits that the whole process is fraught with difficulty and requires the knowledge of the chemist and the electronics engineer, and the indulgence of the production engineer, before success can be achieved.

2.1. Potting materials

It might be thought that casting resins are very like moulding materials such as phenolics, etc. These thermo-setting plastics are compounded with various fillers by the manufacturer and despatched to moulders with full instructions on their usage. The application of pressure and heat after a certain pre-heating cycle results in a fully-cured synthetic resin with

† Manuscript received 16th February 1959. (Paper No. 500.)

‡ Ministry of Supply, Royal Radar Establishment, Malvern, Worcestershire
U.D.C. No. 621.396

an enormous number of uses from saucapan handles to switch boxes; water cisterns to valve-holders.

With a casting resin the manufacturer supplies just the unfilled resin with a catalyst or hardener—this latter to be used in a certain proportion with the resin. First attempts to use this in a trial assembly resulted in the development of terrific heat, caused considerable shrinkage and cracked on cooling and was in every way unsatisfactory. It is now standard practice to mix inorganic fillers with the resin but here again there is a wide choice and it is found in practice that only very few are satisfactory.

The two types of casting or potting resin are (a) polyester, and (b) epoxy. The former is still used for some applications but it has largely been superseded by the epoxies and recent histories of failure have made it clear that from a long term point of view polyester resins are inferior to epoxies for this purpose.

The advantages^{5,6} of epoxies over polyesters are their much greater adhesive strength, better mechanical properties and low shrinkage when setting. Against them must be set the difficulties in handling together with the risk of skin irritation from the amine hardeners, and the shorter pot life and greater cost. Mechanical handling is almost essential for these resins and their increased cost makes them acceptable only in high cost apparatus such as radar and guided missiles, which is their obvious application. It has been proved over several years that when epoxy resins with suitable hardeners and fillers are used in well-designed units, they can withstand all the shocks, vibration and climatic tests that are common to Services equipment.

The types of epoxy resins used for potting are as follows :

- (1) Unmodified resin with amine hardener;
- (2) Unmodified resin with acid anhydride hardener;
- (3) Modified resin with amine hardener;
- (4) Unmodified or modified resin with polyamide hardener.

There are other combinations but these are not in general use.

Obviously all resins start off in the unmodified form but some are modified by the manufacturers and this may or may not be known to the user. Most epoxy resins are of high viscosity at room temperature and in order to make them usable, so-called "cold-setting", a diluent is often added; this can be either reactive or non-reactive. Other modifiers can be added by the user to obtain some special result, for example liquid polysulphide rubbers are used with great success on difficult assemblies where an unmodified resin would be

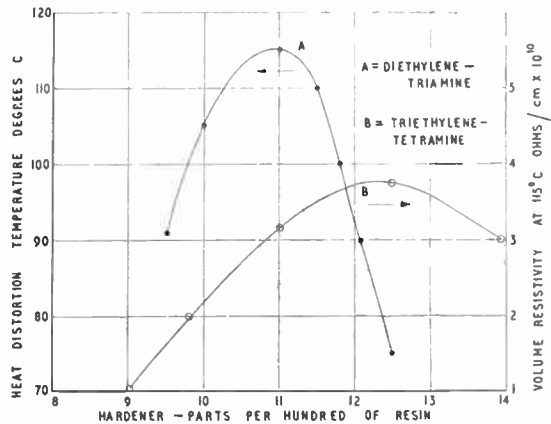

Fig. 1. Relationship of hardener content to heat resistance of resins.

unsatisfactory. It is extremely important that the correct amount of hardener as recommended by the manufacturers is used to cure the resin, as otherwise inferior electrical and mechanical properties, particularly in respect of heat resistance, will result. There is a so-called stoichiometric quantity of hardener for each type of resin and this is critical as can be seen from Fig. 1, where two primary aliphatic amines are compared.

Recent improvements in hardeners have greatly increased the heat resistance of the resins. Early ones were characterized by softening at temperatures around 70°C. but now it is possible to operate suitably constructed units up to at least 200°C. This improvement is not brought about without some sacrifice. It is obtained by the use of highly cross-linked materials, which, being stiffer structures, are

more brittle and possess poorer adhesive properties than the less highly cross-linked ones. This means that it is not always advisable to change over from one material to another with greater heat resistance without a thorough test, as a brittle material which cracks at low temperatures is useless for many electronic purposes even if it has excellent electrical and thermal properties.

A very useful modifier for resins is polysulphide rubber—this is a liquid of low viscosity which is partly reactive when added to the resin. It can be added in more or less any quantity and in consequence a variety of materials for a range of applications is possible with one resin and polysulphide added in the ratio from 10 : 1 to 1 : 1. In the 1 : 1 form it is particularly easy to use as the amine hardener can be added in advance to the polysulphide, and an equal amount of the mixture then added to the resin; this sets at room temperature and has a particularly good adhesion to a variety of materials. It has been used for the back sealing of plugs and sockets with great success; such connectors have withstood the arduous climatic and pressure-sealing tests imposed by Service requirements.

The choice between amine and acid anhydride hardeners is usually made on the grounds of expediency as the latter are more difficult to use and require curing at elevated temperatures⁷. On the other hand they have better electrical properties and the later versions have improved heat resistance. Some of the better amine hardeners are solid so in practice there is little difference in using either type of hardener. The benefits of so-called "cold curing" are largely illusory as an exothermic reaction develops to raise the temperature of the casting. It is quite impossible to cure the resins without heat although they sometimes set at room temperature—it is preferable to gel and set the resin in an oven as the process is thereby controlled. A typical resin-hardener system is gelled at 65°C.—sufficiently low to avoid damage to most electronic components including semi-conductors.

As most synthetic resins have high expansion rates compared with metals, glasses and ceramics, there is risk of cracking when the

casting is exposed to cold cycling, i.e. at -40°C . Modifiers in the form of plasticizers can be incorporated and in fact these often form the "modifier" already referred to; unfortunately these act rather like oil to lubricate the molecular chain and as such cease to function at low temperatures—just where they are needed. The inclusion of inorganic fillers such as mica, chalk, silica flour, etc., reduces the thermal expansion rate, improves the thermal conductivity and cheapens the final product. There is some degradation of electrical properties with an increase in the absorption of water but on the whole the inclusion of suitable fillers well dispersed in the resin is wholly beneficial to such an extent that for the great majority of applications the resins should never be used without them.

All resins shrink when changing from liquids into solids. Part of this shrinkage occurs before setting or "gelation". After gelation further shrinkage occurs and of the two stages this is the more serious, as it sets up a stress which can damage such components as strain-sensitive magnetic cores, thin film resistors, etc.⁸ Shrinkage before gelation can be a nuisance as it lowers the level in moulds but it is otherwise harmless.

2.2. *Some failures encountered in potting*

The mechanism of failure having been examined some examples taken from recent experience will show how faults develop and their cure.

A rather larger than usual potted circuit block was failing through cracking at low temperatures. Its dimensions were about 8 in. \times 3 in. \times 1 in. and it was contained in a metal case which ensured good thermal contact to the chassis and provided a convenient assembly through the production stages as no mould was required. A polyester possessing exceptionally good heat resistance was used for the resin and a suitable filler had been added. When high-stability resistors of the cracked carbon type were potted these failed at an alarming rate. Somewhat similar blocks cast in epoxy resin were quite satisfactory and so it was decided to carry out a controlled experiment⁹ using similar blocks with similar components mounted alike but some potted in polyester resin and the others potted in epoxy. High-stability resistors

from two different manufacturers were assembled between wafers, various values being used as the thin pyrolytic carbon film used in high value (> 1 megohm) resistors is susceptible to damage during casting. The units are shown in Fig. 2.

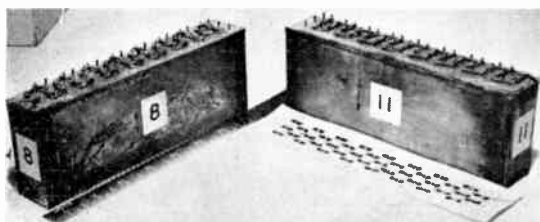

Fig. 2. Test blocks potted in polyester resin.

The blocks were submitted to climatic cycling including low temperatures in accordance with Service specifications. The polyester blocks cracked early in the experiments and those that did not crack showed signs of crazing and other damage, water seeped into the metal container where adhesion between it and the resin was poor—after prolonged exposure this water entered the base of the casting and caused low insulation. Another particularly interesting case was where all the resistors of one type—regardless of value—went open circuited whilst those of the other type went short circuited (within the limits of the measuring apparatus). Those cast in epoxy resin survived the entire series of tests with the values of the potted components remaining unchanged within experimental error.

The reason for the original failure was partly differential expansion. Assemblies should never be cast into metal cases as even if they do adhere to them they will break away at low temperatures resulting in a fracture of the casting; if they do not adhere there is a risk of water entering and remaining trapped at a vital spot where the cross connections between the components are situated and the resin is thin.

The explanation of the resistor failures is a little more difficult. The particular type of resistor which went short circuited has a silicone varnish as a protective coating, which is easily attacked by aromatic solvents such as benzene. Polyesters contain a high proportion of styrene,

a near relative and use peroxide catalysts and metal accelerators. Any or all of these materials could attack the silicone varnish when the resin is still liquid, it could be locally inhibited and, remaining a liquid with polar properties, act as an ionic conductor across the resistor. In the case of the resistors which were open circuited, this was probably an example of differential expansion loosening the brass end caps from the ceramic rods on which the carbon film is deposited.

The case history of this block was completed when it was dissolved in a suitable solvent and all the resin mixture removed. On testing, all the resistors except one had returned to their original value; the only one that did not do so had been accidentally damaged during the process.

The damage to magnetic cores is more subtle and may only show up when the apparatus is used at low temperatures. Ordinary silicon iron is not greatly disturbed when potted although with gapped chokes of critical inductance there is the risk of an alteration of gap width. When

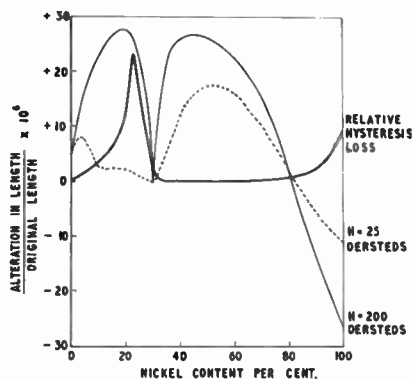

Fig. 3. The effect of nickel content on the magnetostrictive properties of magnetic alloys.

nickel-iron cores are used in such devices as magnetic amplifiers the permeability of the material and hence the inductance of the unit changes considerably when stressed by the contraction of the resin on setting. This effect is at a maximum with a magnetic material with a large magnetostrictive movement such as 50 : 50 nickel-iron and at a minimum when the alloy consists of 80 per cent. nickel. This can be

seen from Fig. 3. It is unfortunate that the 50 : 50 alloy is of the greatest use in transducers for magnetic amplifiers where stability of magnetic properties is essential.

The only way to overcome this defect is by keeping the resin away from the core. Three ways of doing this are shown in Fig. 4. That in (a) uses a silicone rubber of low modulus as a barrier between the core and the resin. Provided this is not too solid to trap air during the

dissolved and a layer of cold-setting silicone rubber used to coat the core. Further potting and measuring showed that the magnetic properties were almost unimpaired. The particular choice of this silicone rubber is based on the fact that it is inert chemically, very good electrically, and can be used up to 200°C. These characteristics make it unique among materials which can be used without the application of heat or pressure.

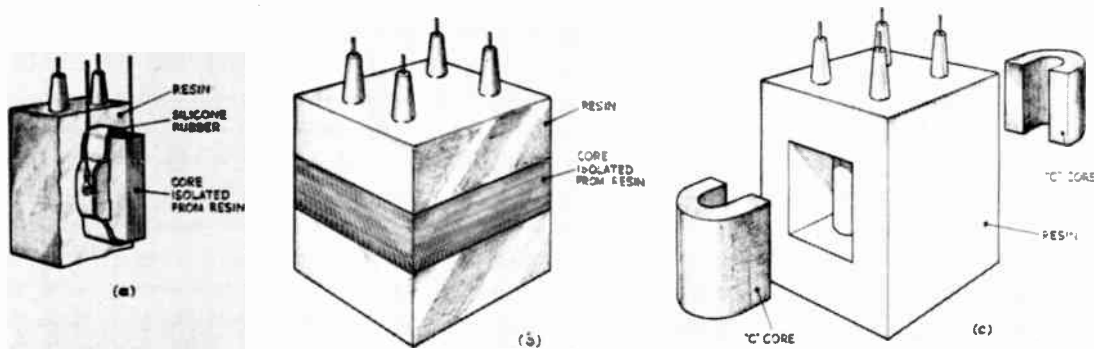

Fig. 4. Methods of making resin cast inductors using strain sensitive alloys.

coating process, it is an effective safeguard against degradation of magnetic properties as can be seen from Fig. 5. Here a 50 : 50 nickel iron core was first measured for magnetizing current (other parameters could be used but this is very simple) and then potted in an unfilled "cold-setting" resin. The change of properties was plotted over a temperature range from -60°C. to +60°C. and then the resin was

The other ways of avoiding this trouble are obvious from the diagram. The castings are made before the core is added; in the case of (b) this results in a substantial saving in weight—a very important consideration in airborne equipment.

When it is essential to save weight, as in airborne electronic equipment, expanded materials or foams have been used¹⁰. Rigid

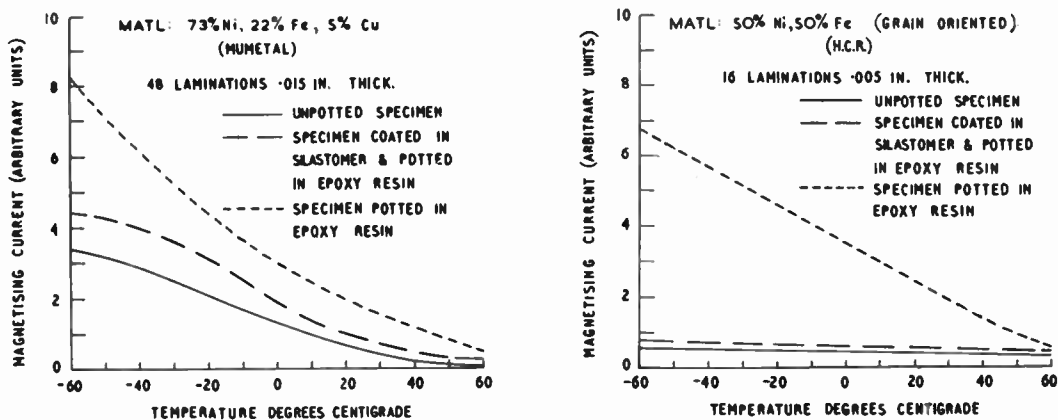

Fig. 5. The effects of temperature change on magnetic cores both potted and unpotted.

"Sebalkyd" foams or flexible "Flexalkyd" ones have been used. These are made from isocyanates cross-linked with alkyd resins, the resulting reaction heating the material and causing it to expand. The substance is a thermosetting material and in consequence its setting point must coincide with the time taken to reach the required density—usually in the case of a rigid foam this is about 6 lb./ft.³. As the isocyanates are extremely unpleasant to handle—even by experienced chemists—they are often frozen and used in pellet or powder form; the application of heat starts the reaction which is completed at the required density.

The sub-units for the expanded technique are usually made in metal containers in which, after assembly, the foam is poured and allowed to expand. The generation of heat and pressure can damage heat sensitive components and the performance of sub-units made in this way has been unsatisfactory. There is also the danger of powdering under shock and vibration. On the whole, foamed material should not be used in potted circuits unless there is no other way of achieving the desired result, and even then it should be used with great care and an awareness of the difficulties.

2.3. *Electrical properties of potting materials*

It is a fundamental property of all materials which have good adhesive properties that they contain polar dipoles¹¹ which do not always follow the applied electric field; this produces

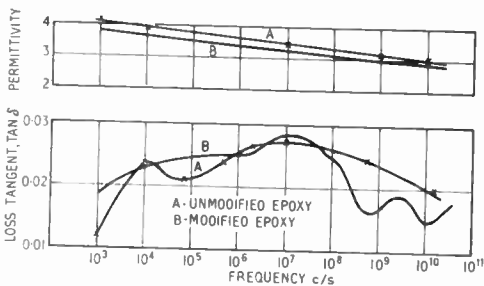

Fig. 6. Variation of loss tangent and permittivity of various resins with frequency.

a loss factor which is dependent on both frequency and temperature as can be seen from Figs. 6 and 7. All the resins which are of any use at all for potting are of this type and

inspection of the dielectric properties of the materials enables the useless ones to be eliminated, namely those having a permittivity of less than 2.5 and tan δ of less than 0.001 when measured at a frequency of 1 Mc/s. Unfortunately all the low-loss materials which are so desirable at ultra high frequencies are also eliminated and so it is impossible to pot such equipment as r.f. circuits and oscillators.

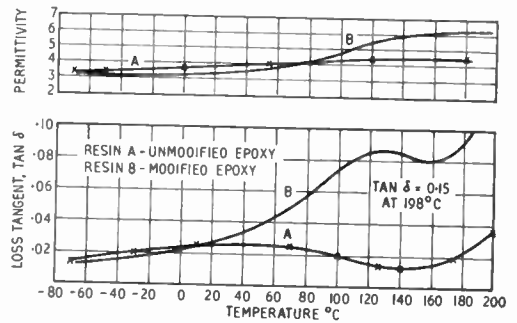

Fig. 7. Variation of loss tangent and permittivity of various resins with temperature.

i.f. strips and circuits where the utmost stability of constants over a wide range of temperatures is required. Many manufacturers have attempted to overcome this defect but without success. For instance, a resin made from styrene/divinylbenzene has excellent low-loss characteristics but it also has a high shrinkage rate and poor resistance to heat; its adhesive properties are so weak that the junction between outgoing leads and the resin is an entry point for water.

The permittivity of typical resins is about 3.5 to 4.0 at 1 Mc/s with a loss factor (tan δ) of about 0.01 to 0.05 at the same frequency. In practice these properties are adequate for all low frequency circuits but there is another property which is particularly important with high voltage apparatus which must work at high temperatures, namely the volume resistivity of the material. To some degree the surface resistivity is also of interest but this is not an intrinsic quantity like volume resistivity as it is conditioned by such details as the amount of mould release remaining after casting and the local climatic conditions. Resistance to tracking is important: some materials leave a

carbonaceous residue when current flows across the surface (phenolics are particularly prone to this fault): in this respect the epoxy resins are above reproach and can be considered to be completely anti-tracking.

statements are only general, and each case should be decided on its own merits.

It can be seen that the unmodified resins using aromatic amine hardeners are very good, showing a flat characteristic over the range of temperatures 20°C. to over 100°C. Any modification causes some deterioration of electrical properties and in the case of the polysulphide rubber this results in a resistivity of 10^9 ohms/cm as 100°C. which is still more than adequate for most applications. A mixture of 1 : 1 epoxy resin/polysulphide rubber is used, for instance, in the back-sealing of plugs and sockets. At a temperature of 70°C. an insulation resistance of several hundred megohms is measured after long submission to high humidity; for the majority of uses an insulation resistance of 10 megohms is adequate and in fact this figure is the acceptance figure for the plugs and sockets only, i.e. without being connected to the cables.

One important objection to potted circuits is that they are almost unrepairable and are completely so in the field, and it is this fact, together with their weight and cost that has restricted their uses. Recent work has adapted them for use with printed circuits, in particular transistors where low voltages, low impedances and, in general, low frequencies are employed. This adaptation will be described later.

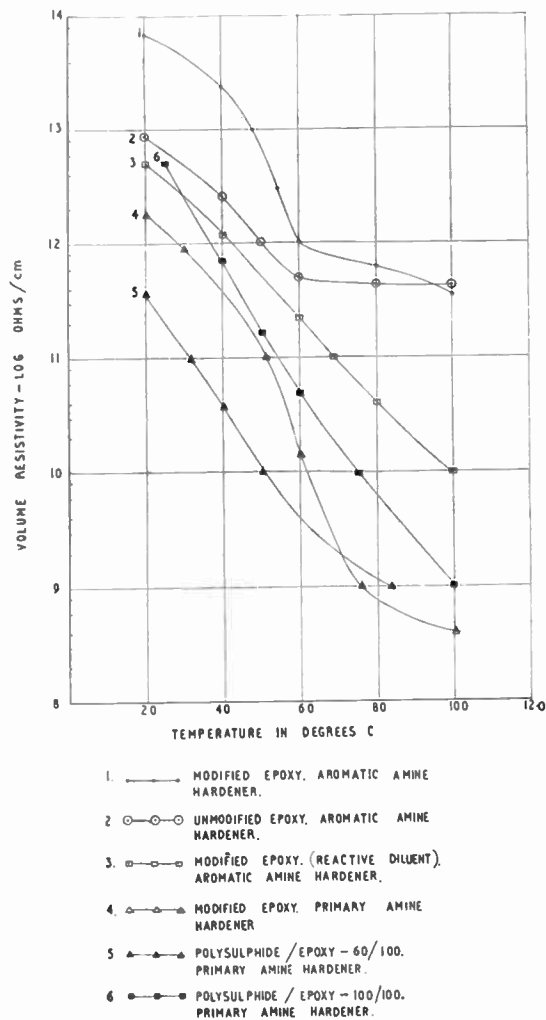

Fig. 8. The effect of temperature on volume resistivity of various resins.

Volume resistivity varies with temperature and characteristic curves for some typical resin systems are shown in Fig. 8. A figure of 10^{16} ohms/cm is generally considered to be as high as can be obtained with standard equipment used under normal conditions, while 10^8 would be considered rather poor. However, these

3. Printed Circuits and Wiring ^{12, 13}

It is as well to define the difference between printed circuits and printed wiring. The former implies the use of printed or derived components; these are at present confined to small capacitors and inductors, to strain-gauge elements and to parts of microwave networks generally known either as "microstrip" or "striplines"¹⁴. Printed wiring refers to the more general case where the wiring pattern is printed and the components are added separately.

Printed circuits are at an early stage of development. As they are often used at high frequencies, the physical properties of the material on which they are printed becomes of major importance; this material forms the backbone of the component and so it is relevant to consider it here.

3.1. *Methods employed in printing circuits and wiring*

In order to make the best possible use of the technique, it is essential to understand the methods of printing the circuit or wiring pattern. Over a period of about ten years, numerous methods of printing have been suggested. The most important requirement is that the method can be used for mass production, and many of the proposed techniques have been discarded in favour of those in which mechanisation is practicable.

Perhaps the most important change from traditional manufacturing methods is that multiple or dip soldering of all the connections becomes possible with a two-dimensional assembly. This can be done only by a machine in a completely controlled process.

The automatic insertion of components is also being developed, and several machines are at present being constructed in the United Kingdom^{15, 16, 17}. In the United States of America a large effort has been put into this type of work and several machines—many much more ambitious than anything attempted over here—have been discussed in the literature.

The printing process may be carried out in a variety of ways which may be classified into two groups:—

(1) The subtractive method, in which a metal foil (usually of copper, although other metals may be used) is cemented to a plastic base (usually a laminated material). A pattern of the required wiring is printed on to the metal in one of several well known ways. All the unwanted metal is removed by etching in an acid, leaving the required circuit pattern on the face of the plastic base.

(2) The additive method, in which a piece of plastic (usually a laminate) is punched with the necessary component mounting holes and then the required wiring pattern is built up by plating on to a previously prepared conductive or chemically sensitized layer. Alternatively, the wiring pattern may be obtained by hot pressing a metal powder into the plastic, or copper foil may be stamped into the surface with a die, causing the imprint of the wiring to be made.

In general, the first method—the so-called “etched foil” process¹⁸—gives the best definition. Most of the effort has so far been put into this process, and it is more highly developed than the others, although there are signs that the plated process is gradually gaining favour.¹⁹ The big advantage of the latter is that it is possible to plate through holes and so ensure a better connection to the component lead; it also allows simple interconnections between the sides of a double-sided unit.

3.2. *Base materials*

It has taken several years to develop base materials to the state where, for example, the bonding of the copper foil is reasonably satisfactory. Special materials are required where greater mechanical strength, better electrical properties, or improved resistance to heat are required.

In printed circuits, the base material is an integral part of the component; the stability of the plastic base directly affects the stability of the circuit itself. For use at radio frequencies the design calls for a dielectric with low permittivity and loss factor, and with close mechanical tolerances. Very few materials meet this requirement even before the metal foil is attached, and adding this makes the problem very much more difficult.

Paper laminates with phenolic resin impregnation are the most commonly used materials. Recent introductions include materials with high resin-content (and excellent electrical properties) which can be punched at quite low temperatures, and some of these are translucent—an excellent method of inspection is to place such materials over a light-box to look for flaws in the wiring pattern. Although such materials are widely used and have much to recommend them, including low cost, they have limitations. There is a risk of delamination or of blistering during automatic soldering operations; if the wiring pattern is broken up and large areas are hatched, there is little danger but if an attempt is made to resolder on to the wiring pattern with a standard-sized soldering iron there is a risk of blistering or of weakening the bond between the copper foil and the laminate causing the printed line to lift—if this happens it is almost impossible to repair.

One type of material recently introduced and indeed still under development is glass-fibre laminate impregnated with epoxy resin. This material has great mechanical strength together with good electrical properties—good volume and surface resistivity but again, being a polar material, it has high losses at high frequencies. It is easily possible to solder by practically any method and the bond strength is so great that it is possible to solder the components to the front wiring instead of by threading through holes as usual—this technique is very useful when making prototype and experimental units. Where large unsupported panels are used as in the back wiring boards for computers, this material should be used as its extra cost is well justified by its superior properties.

Sometimes a material is required with very low losses. I.f. strips are one example but microwave components require an even greater control of losses combined with high stability. A glass fibre laminate impregnated with silicone resin is available and this possesses losses ($\tan \delta$) of the order of 0.001 at 1 Mc/s but this figure is not maintained in the presence of high humidity; the resin fails to wet the glass fibres and these, by capillary action, absorb water.

Another defect of most grades of this material is that it is easily delaminated by shock.

The only available material suitable for microwave circuits is glass-fibre laminate impregnated with polytetrafluoroethylene (PTFE). This is very stable mechanically and unaffected by heat up to a temperature of at least 250°C. It has low loss and low permittivity, and is the only material which can be considered to be non-polar, i.e., its dielectric properties are almost independent of temperature and frequency.

There is a constant development of new materials with properties tailored to suit various applications such as flexible materials for the making of coils and coil screens, semi-cured materials in which after printing heat and pressure impress the circuit into the surface to provide a flush pattern, materials with high resistance to various chemicals used in processing and many others.

3.3. Design factors in printed wiring

For the etched foil process electrolytic copper foil is bonded to either one or both surfaces of the laminate. This foil is available in a range of thicknesses from 0.00135 to 0.0045 in. These

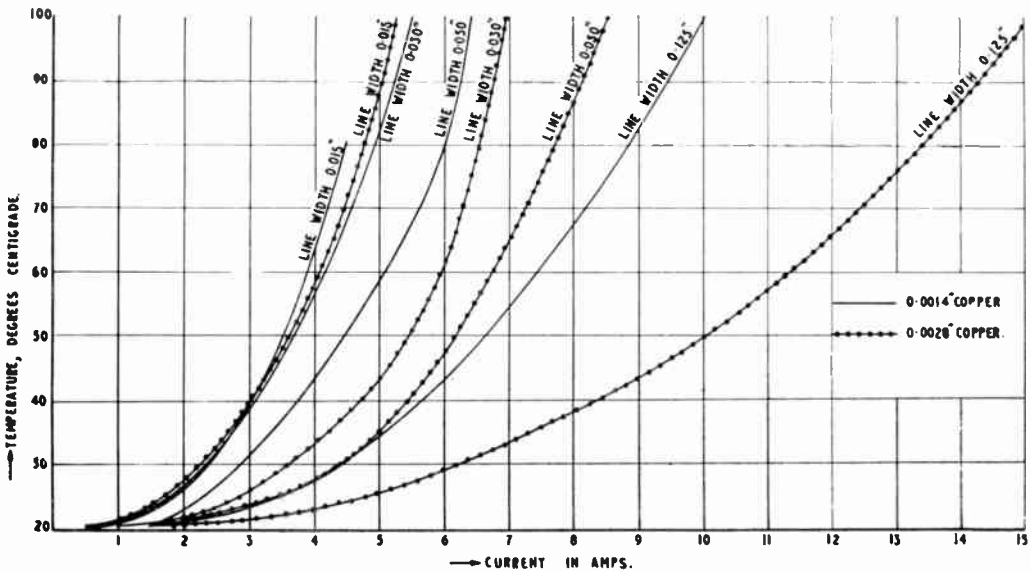

Fig. 9. Current carrying capacity of printed wiring 0.0014" and 0.0028" copper on 1/16" thick S.R.B.P. (Type L (B.S.2076)).

are only nominal thicknesses as the foil is measured by its weight per square foot, the 0.00135 in. type weighing 1 ounce per square foot. For convenience it is usual to refer to this foil as being $1\frac{1}{2}$ thousandths of an inch in thickness. This is the type most commonly used and most circuits can be printed in this preferred thickness. It is possible to print very narrow lines, but the presence of flaws in the metal and the possibilities of damage during

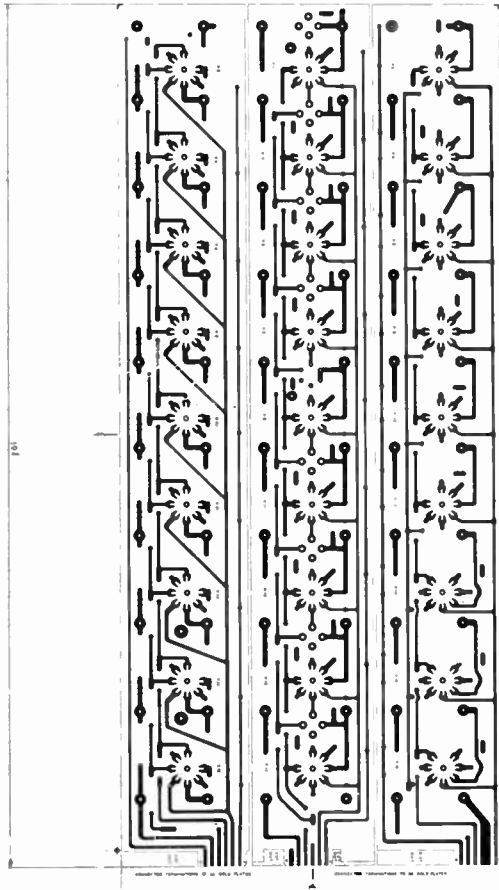

Fig. 10. Example of printed wiring layout master—showing registration marks and processing instructions.

processing preclude the use of lines less than 0.015 in. in width and, in general, lines narrower than 0.030 in. are rarely used. In most valve circuits it is unusual to find currents of more than 100 mA, and much more usual to find 10 mA—except, of course, in heater lines where

several amperes must be carried at the ends of a line of valves in parallel. It is desirable to design this heater run separately taking into account the temperature rise of the conductors but, for the general wiring, a line width of 0.030 in. will be found to be satisfactory.

In Fig. 9, current carrying capacity of printed lines of 0.0014 in. and 0.0028 in. thickness is plotted against temperature rise. Both electro-formed and cold-rolled copper foil were used in the experiment, but there was virtually no difference between them, and one curve suffices for both. It will be seen that a line 0.030 in. wide and 0.0014 in. thick carries a current of 3 A for a temperature rise of 20°C. As stated, apart from valve heaters, currents found in conductors used for normal circuitry do not approach this value: thus, temperature rise and current carrying capacity may generally be forgotten and all the design emphasis placed on maintaining insulation and avoiding cross-talk between circuits.

Space is always at a premium when laying out a circuit and, as the surface properties of printed wiring boards are important, it is essential to allow the maximum room between conductors, especially those carrying high voltage supplies.²⁰ This leads to a compromise between conductor width and spacing. Where necessary, conductor width should be sacrificed to spacing.

Certain conductors must be placed carefully in relation to others. High impedance lines must be kept clear of heater lines to reduce the chance of induced hum, and anode and grid leads must be spaced to avoid interaction.

The advent of transistors with their low impedance characteristics, low current drain, low voltage and absence of heaters, eliminates many of the defects encountered in the printed wiring layouts for valve assemblies. The small physical size allows close packing and therefore smaller assemblies, but this in turn means that the line definition must be good and the surface of the foils free from defects. Unless these two needs are met, it is uneconomical to reduce the size to the degree that is possible with the transistorized circuit.

Some examples of printed wiring layouts, both single and double sided, are shown in

Fig. 10. The marks for punching or drilling outside the circuit pattern allow accurate registration between the opposite sides of double-sided assemblies. The thin line around the perimeter is a cutting line; the corner reinforcements also aid the cutting of the pattern from the parent laminate, and the centre lines allow of accurate alignment in the camera and also accurate placing of negatives when a multiple negative is made. At least one dimension is stated on the drawing so that the photographer can make his negatives to size; unless otherwise stated, it is assumed that the scale of reduction is 4 : 1.

The master drawing is made over a light box engraved with the standard grid pattern of 0.4 in. (4 × 0.1 in.). A transparent material based on polyethylene terephthalate or polyvinyl chloride is used, as these are dimensionally stable over a period of time in varying atmospheric conditions.

Negatives are made in "lith" type emulsions on a film base; these give high contrast results but suffer from serious pin-holing. Careful handling of negatives is essential at all stages as every defect can cause a degradation, either of the insulation or of the copper conductor. It is good practice to make a master positive which is used only to produce negatives by contact printing since in this way it remains undamaged from contamination with processing materials or in handling.

A few examples of printed *circuits* are shown in Fig. 11. The aerial filters are a good example of the simplicity which can be achieved by printing compared with winding coils, adding capacitors, etc. Such units are cheap and repeatable in production.

The multimeter shunts are another good example of design. If made by conventional methods very accurately controlled winding of resistance wire is essential. When printed, a resistance lower than that required is aimed at, and adjustment is made by cutting through the trimming bars as required. These shunts do not use ordinary copper-clad laminates but a variety of noble metals and alloys which can be bonded to suitable base materials.

The increasing demand for computers has arrived at a fortunate time when printed wiring

techniques are highly developed, since the large number of basically simple circuits repeated many times is ideal for construction on a printed wiring production line combined with

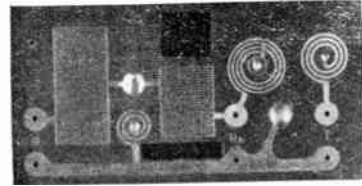

(a) Aerial filters (Diplexers).

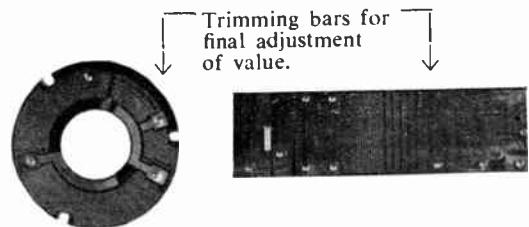

(b) Multimeter shunts.

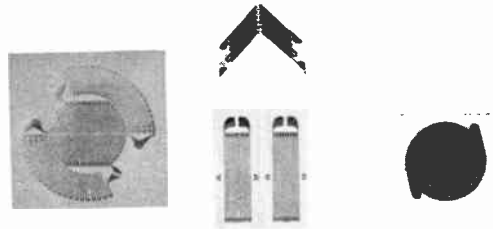

(c) Resistance strain gauges.

Fig. 11. Examples of printed circuits.

multiple soldering. This type of circuit is usually of an "on/off" nature in which transistors are more effective than valves. A supply voltage limited to 50 volts is common and this imposes no stringent requirement for insulation materials which can be of a grade considered rather poor for use in valve circuits but with better punching properties. Similarly, the low heat dissipation of the transistor eliminates the need for many high temperature materials once considered essential—particularly when sub-miniature valves were used.

The choice of materials is therefore not so much on grounds of electrical performance as on the ease of processing, including soldering

and repair. Vibration and shock testing is now very severe, particularly for equipment intended for use in airborne apparatus including guided missiles; such equipment must have a long storage life even though its own duty cycle is short.

4. A New Technique for Potting Printed Circuits

A new form of construction utilizing printed wiring and a form of "potting" has just been developed in the laboratory and is about to be evaluated under Service conditions. It has been designed around the transistorized, low-frequency navigation apparatus which is being used in some of the latest aircraft. It is shock

A rubbery sealant based on polysulphide rubber is sprayed or brushed on to the surface, covering all the components and the printed wiring with a layer about 20 mils. in thickness. This film sets at room temperature but is best given a post-curing cycle of an overnight period (about 18 hours) at 55°C. The adhesion of the material to clean surfaces of metal, plastic, etc., is remarkable and it is in fact very useful as an adhesive in bonding together materials with different rates of thermal expansion. A good bond to the wiring pattern and to the outgoing terminations is especially vital as any failure here will allow of the entry of water with consequent failure of the assembly during exposure to climate.

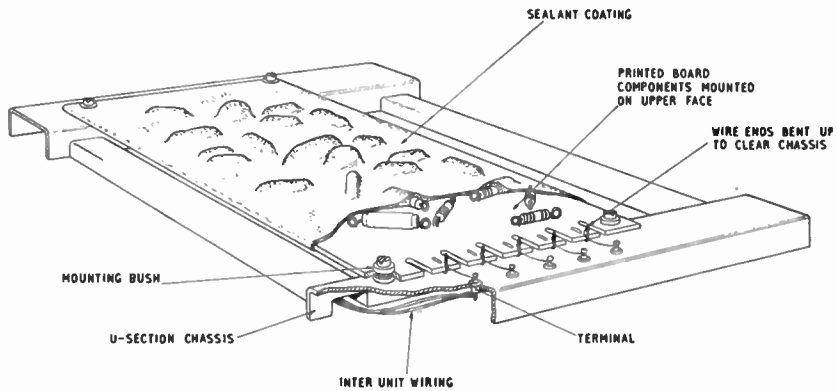

Fig. 12. Examples of vibration and climatic sealing in repairable transistorized assembly.

and vibration proof, withstands arduous climatic conditions, is light in weight, cheap to make and, when necessary, can be repaired in the field.

The construction is shown in Fig. 12. A printed wiring unit is chosen because it makes an almost two-dimensional assembly with the minimum of terminations breaking the surface; where required terminations are either simple wire spills or short lead-out wires. Components are mounted with a gap of about 20 to 30 mils. between the body and the board, which can be done either with a crimp or by making a loop on which the component can "sit". It is essential that all strain is taken by this and not by the soldered joint. Terminations are bent over on to the wiring in the usual way and soldered either by hand or by machine.

The electrical properties of this material are not as good as those of ordinary potting resins but as already stated, this is not of importance for low impedance, low voltage transistorized circuits.

The sealant, being soft and rubbery is easily repaired by cutting with a knife or razor blade; after repair or replacement of a component, additional sealant can be added by knife or spatula; this adheres strongly to the previous layer and makes a perfect seal again. An interesting point is that a soldering iron can be laid on the material without damage and thus components can be soldered in place.

Experimental units made as described have been tested over a period of two months in high humidity and heat. The units were simple three-

stage amplifiers with a gain of about 60 db and a centre frequency of 100 kc/s. These units were mounted on simple metal chassis using PTFE lead-through connectors to anchor the terminating wires. These lead-throughs have remarkable recovery when wet; they can be thoroughly wet but as soon as leads from a megohmmeter are attached and the insulation resistance measured at a potential of 500 volts, the recovery is so rapid that it is impossible to measure. Such a chassis makes an ideal test platform for the sealed units as in the humidity chamber the shunt resistance of the chassis assembly can be neglected.

The assemblies were connected to a signal generator, an oscilloscope and power supplies so that the amplifiers were functioning under conditions of high humidity—this is not usually the case, most components and equipments are measured *after* humidity conditioning and after an allowed period for recovery.

The response of the amplifiers was measured at periodic intervals and was found to be substantially constant within the limits of experimental errors and transistor ageing (commercial transistors were used). Long term tests will be made on actual assemblies but as the sealant is the same as that used on back-sealing plugs and sockets which have passed every test—including 84 days humidity and dry-heat cycling at 150°C.—it is known that the material is more than adequate in every respect.

One disadvantage of this type of rubber is that it has a very short pot-life which is dependent upon ambient temperature and humidity—the higher both these factors, the shorter is the pot-life. This disadvantage can be partly overcome by spraying the sealant through a pressurized spray gun of the "De Vilbiss" type. Passing through an infra-red heated zone cures the rubber very quickly, and passing the unit three or four times, alternately through the spray and the heated zone allows a thick coat to be built up. The sealant must be thinned to allow it to be sprayed, and the addition of a solvent such as toluene or methyl-ethyl-ketone in fact extends the pot life.

With a printed wiring pattern, all the vulnerable electric elements are exposed to damage from climate, handling, etc., and so far

there is no satisfactory way of protecting them for use under Service conditions. Coating the exposed surfaces with flux or other varnishes is not satisfactory as many of these materials hydrolyse under conditions of high humidity. Putting the complete assembly into a sealed or pressurized container adds unduly to the weight and is expensive. In addition vibration and shock can dislodge components which are merely held by soldered leads. The new method of sealing offers a solution to these problems and eases manufacture and repair.

5. Conclusion

Summing up, it can be said that "solid" potted circuits should be used where the maximum protection from climatic conditions, shock and vibration are essential and where their weight, cost and non-repairability are of little consequence. The new method can be used for low-voltage, low-frequency circuits where shock and vibration resistance are essential but where electrical performance of a high order is not required.

In both techniques printed wiring and, wherever possible printed circuits, can be profitably used; in the case of "solid" potted circuits they ease manufacturing problems; in the case of the repairable, sealed assembly, they are essential to its successful operation.

6. References

1. A. E. Javitz. "The epoxy resin system for embedded circuits and components", *Electrical Manufacturing*, April 1955.
2. H. E. Blanke. "Embedment techniques for sub-miniaturization", *Electrical Manufacturing*, May 1955.
3. K. A. Fletcher, "Casting resin applications in electronic equipment", *British Plastics*, March 1957.
4. H. G. Manfield. various unpublished Ministry of Supply reports.
5. H. G. Manfield, "Electrical applications of epoxide resins particularly in the electronics industry". *Chemistry & Industry*, May 4, 1957.
6. F. B. Stanley, "Where and how to use epoxies", *Modern Plastics*, July 1955.
7. H. L. Lee and K. O. Neville, "Epoxy Resins" (McGraw Hill, New York, 1957.)
8. H. G. Manfield, "Component design for embedded circuits—a British view", *Electrical Manufacturing*, December 1958.
9. Unpublished Ministry of Supply Test Report.

10. L. N. Phillips, "Foamed in place techniques with sebalkyd and flexalkyd foams", *British Plastics*, September 1957.
11. A. R. von Hippel, "Dielectric Materials and Applications" (Wiley & Co., New York, Chapman & Hall, London, 1954.) 284 pp.
12. H. G. Manfield, "Etched foil printed circuits", *Wireless World*, 61, p. 436, September 1955.
13. G. W. A. Dummer and D. L. Johnston, "Printed and potted electronic circuits", *Proc. Instn Elect. Engrs*, 100, Part III, pp. 177-186, July 1953.
14. J. M. C. Dukes, "The application of printed circuit techniques to the design of microwave components", *Proc. Instn Elect. Engrs*, Paper 2401R, August 1957. (100, Part B, pp. 155-172, 180-181).
15. G. W. A. Dummer, "The automatic assembly of electronic sub-units", *Automation Progress*, November 1956.
16. G. W. A. Dummer, "Automation in the assembly of electronic sub-units", *British Communications & Electronics*, December 1956, 3, pp. 642-645.
17. L. H. Gipps and K. M. McKee, "Recent advances in automatic assembly", *J. Brit.I.R.E.*, 17, pp. 501-11, September 1957.
18. P. Eisler, "Printed circuits: some general principles and applications of the foil technique", *J. Brit.I.R.E.*, 13, pp. 523-41, November 1953.
19. W. I. Flack, "The plated circuit in the large-scale production of television receivers". A paper to be presented at the 1959 Brit.I.R.E. Convention on Television Engineering.
20. "Guide to the Uses of Printed Wiring in Electronic Equipment". Defence Guide DEF-DG-5007.

SYMPOSIUM ON POTTED CIRCUIT TECHNIQUES

Some 150 engineers from industry and Government establishments were present at Malvern on April 15th—16th to hear a group of eleven papers read on various aspects of encapsulation. The symposium was arranged by the Royal Radar Establishment and although the techniques described are now mainly used in equipment for the armed services, there are other spheres in which the high reliability claimed would be useful.

The six papers read on the first day of the symposium dealt comprehensively with applications, as the following list of titles shows:

- "Recent Advances in Casting Resins and Techniques"
- "Effects of Encapsulation on Electronic Components"
- "High Voltage Applications of Casting Resins"
- "Resin Cast Transformers"
- "Light Weight 'Potted' Circuits for Guided Missiles"
- "Production Problems in the use of Casting Resins".

One of the most striking advantages of resin fillings for transformers was shown in a film which illustrated the effects of short circuiting a resin-filled type and one of the conventional oil-filled type. The oil-filled transformer virtually exploded and would have scattered oil over the surrounding components, with obvious fire risk, whereas the resin filled transformer merely cracked and evolved a small quantity of gas.

Four of the second day's papers were statements on the properties of the potting materials,

while the final paper, by Mr. H. G. Manfield, summed up the lessons which could be learned from the symposium, particularly with reference to the reliability which might be obtained.

Many of the matters discussed at length during the symposium are referred to in the paper by Mr. Manfield, which appears in this issue of the *Journal*. Perhaps the principal point which emerged from the symposium papers is that the properties of the encapsulated system are very dependent on the relative proportions of resin and hardener. The matter is essentially one of compromise—long life depends mainly on a high exotherm, but this is not desirable for many types of circuits. Consequently the choice of a hardener which will give satisfactory mechanical and electrical properties without generating too much heat is most important.

The question of cost was raised several times in the course of discussion, and admittedly the casting compounds are expensive. However, the matter was given proper perspective when it was considered that the components contained in an assembly might include transistors worth many pounds, whereas the cost of the resin would be of the order of shillings. Another matter touched upon was the difficulty of recovering expensive components from an unsatisfactory casting: solvents which can dissolve the resin tend to have an unfortunate effect on the components themselves.

of current interest . . .

Progress of Dip. Tech. Scheme

The number of students taking advanced courses leading to the award of the new Diploma in Technology has increased more than two-and-a-half times during the past eighteen months. In a foreword to the second report of the National Council for Technological Awards Lord Hives, the Chairman of the Council, states that 2,518 students are now following 66 courses leading to the Diploma at 20 colleges as compared with 965 students following 37 courses at 11 colleges in November, 1957.

Since the Council was set up by the Minister of Education just over three years ago the first Diplomas in Technology have been awarded and shortly several hundred diplomates will be taking their place in industry each year. The Council express their great indebtedness to the technical colleges and to the industrial organisations whose efforts have made possible "this rapid and striking development". Lord Hives in paying his tribute to industry refers to the fact that 82 per cent. of students following sandwich courses leading to the Dip. Tech. have their fees paid by their employers.

The Council are impressed by the number of fine and well-equipped buildings being planned and constructed. In no case so far has the absence of residential facilities prevented courses being recognized by the Council, but they point out that when renewals of recognition are considered they will expect to see "at least firm plans for the provision of hostels at those colleges where there is a substantial number of students attending courses leading to the Diploma in Technology".

Airborne Technique for Propagation Studies

The Radio Research Station, Slough, is collaborating with the Meteorological Research Flight of the Air Ministry in obtaining new data affecting radio wave propagation. Changes in the refractive index of the lower atmosphere are being measured and recorded at heights up to at least 10,000 ft. using a microwave refractometer specially built for this work.

Under certain meteorological conditions the

signal strength of v.h.f. waves beyond the horizon is considerably influenced by the atmospheric structure and the variation of the refractive index. Earlier methods of measurement have produced only limited information on this feature of the lower atmosphere.

The first stage in this research began at Slough about a year ago, when a microwave refractometer was built which could be installed into a Hastings aircraft. Equipment proving flights followed, during which the apparatus was tested under varying conditions. Actual measurement work has now commenced.

The apparatus—which was demonstrated at the recent Radio Components Exhibition records the refractive index changes on a photographic-type recorder. The sensitivity of the instrument can be varied to measure either the large fluctuations extending over a considerable height or the smaller variations which occur, for example, in or near clouds. Compared with conventional methods, this instrument can record rapid fluctuations, but a new model now being made at Slough will have an even smaller response time.

New Telephone Cable to Iceland and Faroes

An agreement has been reached between the British Post Office, the Danish and Icelandic Administrations and the Great Northern Telegraph Company for the laying of a submarine telephone cable between Scotland, the Faroes Islands and Iceland. The new cable will provide about 20 telephone circuits as well as a large number of telegraph circuits. It will improve telephone communication with Iceland and the Faroes and make it possible to establish telex services with these countries. Some of the circuits will be used by the civil aviation authorities in connection with the control of the transatlantic air routes.

There will be 15 repeaters in the Iceland-Faroes section and 10 between the Faroes and Scotland. The repeaters are the rigid type designed by the British Post Office and the cable will be the 0.46 in coaxial armoured submarine type. It is expected that the cable will be in service before the end of 1961.

News from the Sections . . .

NORTH WESTERN SECTION

The Section held its final meeting of the 1958-9 Session on 2nd April when Mr. B. R. A. Bettridge (Member) read a paper on "Transistor Circuitry." The particular aspect of this vast subject which the author discussed was the extremely important one of transistor ratings. Their real basis and relationship to circuitry was comprehensively explained to an appreciative audience.

With the transistor in a cut-off state the collector voltage rating might be fixed by "punch-through," avalanche breakdown or surface leakage. The first factor was normally a limitation only in the case of types with an extremely narrow base region. In other types the limitation was usually the amount of leakage current which could be tolerated in a typical circuit and this would be in part due to avalanche multiplication and part to surface leakage. These two forms of leakage current increased at different rates with temperature. With the transistor forward biased, avalanche multiplication caused breakdown of charac-

teristic to occur at a lower voltage and, furthermore, a dangerous region of negative resistance appeared. The voltage limit under these conditions was usually referred to as the softening voltage (V_s). Thermal run-away could also place a limit on the permissible applied voltage.

There appeared to be no current limit to transistors apart from that due to dissipation. However, the decrease of current gain at high values of collector current placed a limit on the usable current in a given circuit arrangement.

The prime factor limiting dissipation was the maximum allowable temperature (T_j) and the ambient temperature and on the thermal resistance of the device and its mounting.

These essential ratings were finally related to two typical circuits. The first was a Class B amplifier and the other a d.c. converter. In the latter circuit V_s was of great importance.

The meeting was very well attended and a keen discussion resulted. A demonstration of the performance of a transistorized amplifier was given.

F. J. G. P.

Technical Visits during the Summer

Manufacture of Transistors

The Technical Committee, in conjunction with the Committee of the North Western Section, has arranged a visit to the General Electric Company's Transistor Factory at Hazel Grove, near Stockport, Cheshire, on Tuesday 23rd June.

Members of the North Western Section have already been notified; other members wishing to participate in this visit should write to the Institution at 9, Bedford Square, London, W.C.1. Since numbers are restricted, it will be necessary to confine the visit to members only.

Ground Radar Equipment

On June 6th members of the West Midlands Section will pay their second visit to the Royal Air Force Station at Shawbury, Shropshire. The visit will take place in the morning and will

enable members to see a large variety of ground radar equipment in use by the R.A.F. Requests to take part in the visit should be addressed to the Hon. Local Secretary, Mr. R. A. Lampitt, 20, Northfield Grove, Merry Hill, Wolverhampton.

Broadcasting and Communications

The South-Western Section will arrange two visits to take place on the evening of June 18th to the B.B.C.'s television and sound broadcasting studios in Bristol, and to the Post Office radio station at Portishead. In both cases the numbers will be strictly limited but second visits will be arranged to both these places for unsuccessful applicants. Further information may be obtained from the Hon. Local Secretary, Mr. W. C. Henshaw, School of Management Studies, Unity Street, Bristol 1.

On Asymmetric Information Channels†

by

R. B. BANERJI (ASSOCIATE MEMBER)‡

Summary: The application of Shannon's coding theorem for noisy channels has been extensively studied in the literature in connection with symmetric channels. However, certain methods of modulation exist which endow the transmission channels with asymmetric properties. In the present paper, the capacity of asymmetric channels has been studied in terms of the probability of the possible errors. The theory sheds interesting light on pulse code modulation using amplitude keying.

1. Introduction

Since the publication of Shannon's¹ pioneering work on the capacity of noisy information channels, a considerable amount of work has been carried out on coding discrete channels for the actual realization of error-free transmission. Most of this work has, however, been confined to symmetric binary channels. In these channels, the only allowed symbols are 0 and 1. Also, the effect of the noise is such as to make the probability of a transmitted 1 being received as 0 the same as the probability of a transmitted 0 being received as 1. Shannon has shown that the capacity of such a channel is given by

$$1 + p \log_2 p + (1 - p) \log_2 (1 - p)$$
 bits/symbol where p is the probability of an error. Also, this value is reached when the coding is such that the probability of transmitting a 1 and a 0 are equal.

The value of p in a channel is dependent on the method of modulation and the signal-to-noise ratio. Also, while many methods of modulation make the channel inherently symmetric (as in frequency keying²), there are some channels where the symmetric property of the channel can be removed by changing the criterion of decision. In these cases it may be more advantageous to force asymmetry on the channel. An a.m. channel used for transmitting a binary code is such a channel.

It is the purpose of the present paper to discuss the application of Shannon's formula for the capacity of a noisy channel for asymmetric

binary discrete channels. This will be done in Section 2. Effort will be made to deduce the expressions *ab initio*, so that the relation between the asymmetric and symmetric channels can be seen, as well as their relation to the general theory.

In Section 3 we shall discuss the amplitude-modulated binary channel and the relation between the signal-to-noise ratio, decision level and the error probabilities. This, in the light of the expressions developed in Section 2, will indicate the optimum decision level for given signal-to-noise ratios.

Some general concluding remarks will be made in Section 4 regarding coding requirements.

2. The Binary Channel§

A binary channel has two possible transmitted symbols, 1 and 0. The probability of a 1 being transmitted is x (< 1); and of a 0 being transmitted is therefore $1 - x$.

The noise in the channel is characterized by the following probabilities

α = the probability that a 1 is received when a 0 is transmitted.

β = the probability that a 0 is received when a 1 is transmitted.

Given x , α and β , we have the probability y that a 1 is received as

$$y = x(1 - \beta) + (1 - x)\alpha$$

§ The author's attention has just been drawn to a paper by R. A. Silverman "On binary channels and their cascades" in the *I.R.E. Transactions on Information Theory* (IT-1, No. 3, p. 19, 1955). This section is a less sophisticated approach to the same problem as studied by Silverman. The common results are identical.

† Manuscript received 9th February 1959. (Paper No. 501.)

‡ Case Institute of Technology, Cleveland, Ohio, U.S.A.

U.D.C. No. 621.391:621.376.56

The Rate, R , of such a channel is given by $H(Y) - H(Y/X)$ where $H(Y)$ is the entropy of the received message, and $H(Y/X)$ is the conditional entropy of the received message averaged over the probability of the transmitted messages. In both cases, the errors introduced by the channel have to be considered. This yields

$$R = -y \log_2 y - (1-y) \log_2 (1-y) + x\beta \log_2 \beta + x(1-\beta) \log_2 (1-\beta) + (1-x) \alpha \log_2 \alpha + (1-x)(1-\alpha) \log_2 (1-\alpha)$$

which yields

$$R = -[(1-x)\alpha + x(1-\beta)] \log_2 [(1-x)\alpha + x(1-\beta)] - [(1-x)(1-\alpha) + x\beta] \log_2 [(1-x)(1-\alpha) + x\beta] + x\beta \log_2 \beta + x(1-\beta) \log_2 (1-\beta) + (1-x)\alpha \log_2 \alpha + (1-x)(1-\alpha) \log_2 (1-\alpha)$$

By definition, the channel capacity C is the value of R maximized over x . On differentiating R with respect to x and equating to zero we obtain

$$(\alpha + \beta - 1) \log_2 \frac{y\alpha + x(1-\beta)}{y(1-\alpha) + x\beta} = \alpha \log_2 \alpha - \beta \log_2 \beta + (1-\alpha) \log_2 (1-\alpha) - (1-\beta) \log_2 (1-\beta)$$

Putting

$$T(\alpha, \beta) = \frac{\alpha \log_2 \alpha - \beta \log_2 \beta + (1-\alpha) \log_2 (1-\alpha) - (1-\beta) \log_2 (1-\beta)}{\alpha + \beta - 1}$$

and $t = e^T$,

this yields

$$x = \frac{(1-\alpha)t - \alpha}{(1-\alpha-\beta)(1+t)}$$

By combining this value of x with the expression for R we obtain the value of C for given values of α and β .

In Fig. 1 the contours of equal C are plotted on the (α, β) plane. These are shown by solid lines. The significance of the dotted lines will be discussed in Section 3.

It can be seen from the formula that these curves are symmetrical about the line $\alpha = \beta$, i.e. $C(\alpha, \beta) = C(\beta, \alpha)$. This is intuitively clear since an interchange of the definition of 1 and 0 should not change the channel capacity.

Another point of symmetry to be noted is the one about $\alpha = 1 - \beta$, i.e. that $C(\alpha, \beta) = C(1 - \beta, 1 - \alpha)$. This, again, is due to the fact that a re-definition of 1 and 0 at the receiving end should not change the channel capacity.

It ought to be pointed out in this connection that when $\alpha = \beta$, that is, in the symmetric case, the second symmetry is the only one of importance. Hence, when plotting C as a function of α or β in the symmetric case, it is sufficient to plot for values up to $\alpha = 0.5$. In our case, however, plotting in this range is not sufficient since $C(\alpha, \beta) \neq C(\alpha, 1 - \beta)$.

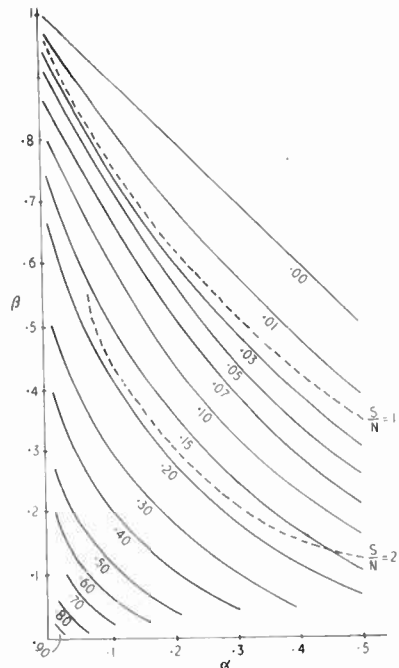

Fig. 1. Contours of equal channel capacity for various values of α and β (Solid curves). The dotted curves show the relation between α and β for two signal to noise ratios in an amplitude keyed p.c.m.

However, it is sufficient to plot between the line $\alpha = \beta$ and $\alpha = 1 - \beta$ for $\alpha = 0$ to 0.5 . Our figure, therefore, is somewhat redundant.

3. The Amplitude-Modulated Binary Channel

As an example of a binary channel we take the case of a carrier wave whose amplitude is either 0 or a fixed finite quantity. This pulse-modulated carrier wave can be used to transmit information by looking at the amplitude of the wave as conveying a bit of information.

This, essentially, is a component of a p.c.m. system.

This wave at the receiving end will have random noise superposed on it. The wave, before rectification, then is a band-limited signal of the form

$$X \sin \omega t + I_s \sin \omega t + I_c \cos \omega t$$

where X is 0 or a fixed finite number depending on the transmitted bit; I_s and I_c are random amplitudes having Gaussian distributions with equal standard deviations, which are related to the noise power ψ by the relation

$$\psi = \overline{I_s^2} + \overline{I_c^2}.$$

The amplitude r of this wave, or the result of linear rectification of this wave, has a distribution given by³

$$P(r) = \frac{r}{\psi} \exp \left[-\frac{(r^2 + X^2)}{2\psi} \right] I_0(rX),$$

where I_0 is the Bessel function of zero order with imaginary argument. The above expression, normalized in terms of ψ , can be written

$$P(v) = v \exp \left[-\frac{(v^2 + P^2)}{2} \right] I_0(vP)$$

where v is the amplitude expressed in units of r.m.s. noise voltage and P^2 is the signal-to-noise ratio.

When a 0 is being transmitted the above expression takes the form

$$P(v) = v \exp \left[-v^2/2 \right].$$

Figure 2 shows a plot of this distribution and the general distribution when $P=1$.

To decide whether the received signal is 1 or 0, we can set a decision voltage (by passing the rectified wave through a biased clipper, say) and decide that any received voltage exceeding this decision voltage be counted as 1, otherwise it will be chosen as 0. This decision procedure, of course, will be open to error except in the case of large signal-to-noise ratio (for a form of the distribution for large signal to noise ratio, see McNicol⁴). In Fig. 2, the total probability α and β of reading a 1 for 0 and vice versa are shown by the shaded areas.

Evidently, the values of α , and β are functions of the signal-to-noise ratio as well as the decision level. For a given signal-to-noise ratio α and β are connected through two parametric equations involving the decision level. This relationship between α and β for two signal-to-noise ratios are shown with dotted lines in Fig. 1. These curves bring out the inherent asymmetry of the a.m. binary channel and its effect on the channel capacity as follows.

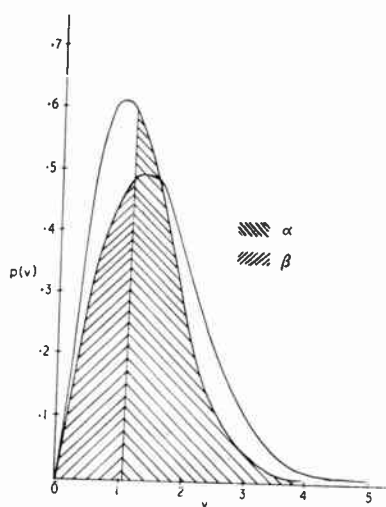

Fig. 2. The distribution of received signal amplitudes in an amplitude keyed p.c.m. The shaded areas give the values of α and β .

Let us look at the relation between α and β for signal-to-noise ratio 1. It will be seen that for all values of the decision voltage, the channel capacity lies between 0.01 and 0.03 bits per symbol. However, if we fix the decision level so as to make $\alpha = \beta$, thus forcing symmetry on the channel, the channel capacity attained (0.02 approximately) is not necessarily the maximum attainable from the channel.

However, it is to be appreciated that the maximum channel capacity is attained when the (α , β) curve becomes parallel to a C curve. In the case of signal/noise = 1, this is attained when $\alpha = .06$ and $\beta = .83$ approximately, yielding a capacity of about 0.025. It is clear that the channel capacity can be increased by forcing asymmetry on the channel. Whether the gain of 25 per cent. at such low level of signal-to-noise ratio is of practical value depends entirely on the circumstances.

4. Concluding Remarks

The evaluation of the capacity of asymmetric noisy channels made above is a direct application of Shannon's formula. According to the coding theorem, a code can always be constructed which could transmit information at the rate arbitrarily approaching the channel capacity in such a way that the percentage of errors of reception be arbitrarily low. Such a coding, however, presupposes very long messages. Efforts at coding for shorter messages to approach the channel capacity and their evaluation have been made for symmetric channels only. Codes are known which are effective for channels of high asymmetry, but so far as is known they have not yet been completely evaluated.

Channels using relays are inherently asymmetric and codes like the "two-in-five" are suited to it and probably more efficient codes could be developed. However, many of the modulation methods for radio transmission are essentially symmetric. In the case of amplitude keying discussed above an asymmetry forced upon the channel improves it. However, this improvement is marked only at low signal-to-noise ratios. It will be seen in Fig. 1 that for signal/noise = 4, the asymmetry of the maximal capacity point is much lower than in the case of signal/noise = 1. For higher signal-to-noise ratios this requirement for asymmetry is reduced further. In view of this, it is an open question whether the development of involved coding schemes are worthwhile.

A second point which need be raised is the value of the input probabilities at which the channel capacity (or maximum information rate) is attained. For the symmetric channel the capacity is attained when the input is symmetric, i.e. when x , the probability of transmitting a 1, is 0.5. As can be expected, asymmetric channels need an asymmetric input to realize the channel capacity. However, actual computations show that even highly asymmetric channels need very little asymmetry at the input. Figure 3 shows contours of equal x (x being the probability of 1 at the input which maximizes the information rate) for various values of α and β . The asymmetry needed at the input is seen to be small. Moreover, the information rate obtained by using $x=0.5$ instead of the optimal

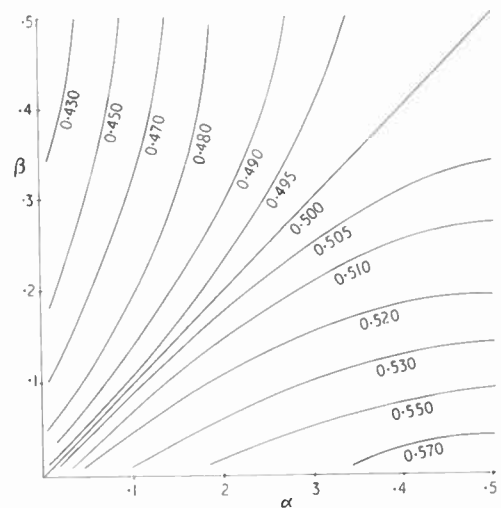

Fig. 3. Contours of equal values of the optimal input probability of a "one," for various values of α and β .

value, falls short of the channel capacity only by very small amounts.

According to the coding theorem¹, the optimal coding scheme has to be subsets of the set of those sequences which are representative of the maximizing source, i.e. which have occurrences of 1 with the same probability as that of the maximizing source. As to whether this requirement will hold also when coding for shorter messages is not known. The existing coding for the symmetric channels all have 1's occurring with equal probability. Whether this will or will not carry over to the asymmetric case remains to be seen.

5. Acknowledgments

The work reported above was carried out at Case Institute of Technology.

6. References

1. C. E. Shannon, "A mathematical theory of communication," *Bell Syst. Tech. J.*, **27**, pp. 379-423, July 1948, pp. 623-656, October 1948.
2. "Performance of predicted wave systems in the presence of additive white Gaussian noise," Collins Radio Company Report No. CER-W592, January 29, 1958.
3. S. O. Rice, "Mathematical analysis of random noise," *Bell Syst. Tech. J.*, **24**, pp. 24 et seq, January 1945.
4. R. W. E. McNicol, "Author to insert full correct reference please," *Proc. Instn Elect. Engrs.*, **96**, Part III, p. 366, 1949.

Current and Field Stabilization of the 9-kw Electromagnet of the A.E.I. Magnetic Spectrograph †

by

R. BAILEY, B.SC. and E. C. FELLOWS, GRADUATE‡

Summary : The current stabilized power supply for energizing the electromagnet provides variation of magnet current over the range 20-200A, corresponding to a magnetic field in the gap of the electromagnet of approximately 2,000-16,000 oersteds. The d.c. generator, which supplies power to the magnet, is converted into a low noise, high power, wideband amplifier which can be incorporated into the current stabilizing loop without excessive phase shifts. The current in the magnet is regulated by comparing the voltage drop across a standard resistance, in series with the magnet, with a reference voltage which can be checked against a standard cell. The error voltage is amplified and used to control the field current of the generator. The magnet current is regulated to ± 0.01 per cent. and the resultant magnetic field is measured by a nuclear magnetic resonance fluxmeter to an overall accuracy of ± 0.05 per cent. Precision field stabilization is achieved by using the signals obtained from nuclear resonance equipment to control the output current of the generator. Using this system the magnetic field of the spectrograph is controlled to an accuracy of ± 0.01 per cent.

1. Introduction

One of the factors affecting the accuracy of energy measurements in a magnetic spectrograph is the stability of the magnetic field. To satisfy the energy resolution requirements for the spectrograph at this Laboratory, it is necessary to maintain the magnetic field stable to 0.01 per cent. over a period of several hours. Two methods of stabilization are described, one giving magnetic field stabilization at six fixed points to an accuracy of 0.01 per cent. using nuclear magnetic resonance techniques; the other gives current stabilization for the magnet over a range 20-200A, the magnetic field being measured to an overall accuracy better than 0.05 per cent. using a nuclear magnetic resonance fluxmeter.

A block diagram of the complete system is shown in Fig. 1.

2. Characteristics of the Electromagnet and D.C. Generator

The electromagnet design has been discussed in detail by Firth¹ and only the relevant items will be mentioned here. The magnet is a low

impedance device ($L = 0.2\text{H}$, $R = 0.065\Omega$) requiring a m.m.f. of about 22,000 ampere-turns to produce its maximum design flux density of 15,000 gauss. The corresponding value of magnetizing current required is 180 amperes. Temperature changes affect the magnetic field by varying the permeability and dimensions of the core. To minimize this, the magnet windings are water cooled.

The power source is a motor-generator set consisting of a 50 h.p. induction motor driving a 4-pole, 50 V, 500 A d.c. generator. The d.c. generator also had a compound-wound exciter but the residual magnetism therein made it difficult to obtain very small outputs from the generator and the alternative of exciting the generator field from a magnetic amplifier was used.

The ideal d.c. generator for this application should satisfy the following requirements:—

(i) The magnetic circuits should be laminated in order to minimize eddy currents. This reduces the field circuit time constant which mainly determines the frequency response of the generator.

(ii) The field winding should have an impedance which is convenient to match to electronic circuits.

(iii) A large power gain is advantageous.

† Manuscript received 28th January 1959. Communicated by D. R. Chick (Member). (Paper No. 502.)

‡ Associated Electrical Industries Ltd., Research Laboratory, Aldermaston, Berkshire.

U.D.C. No. 621.318.381:539.152.2

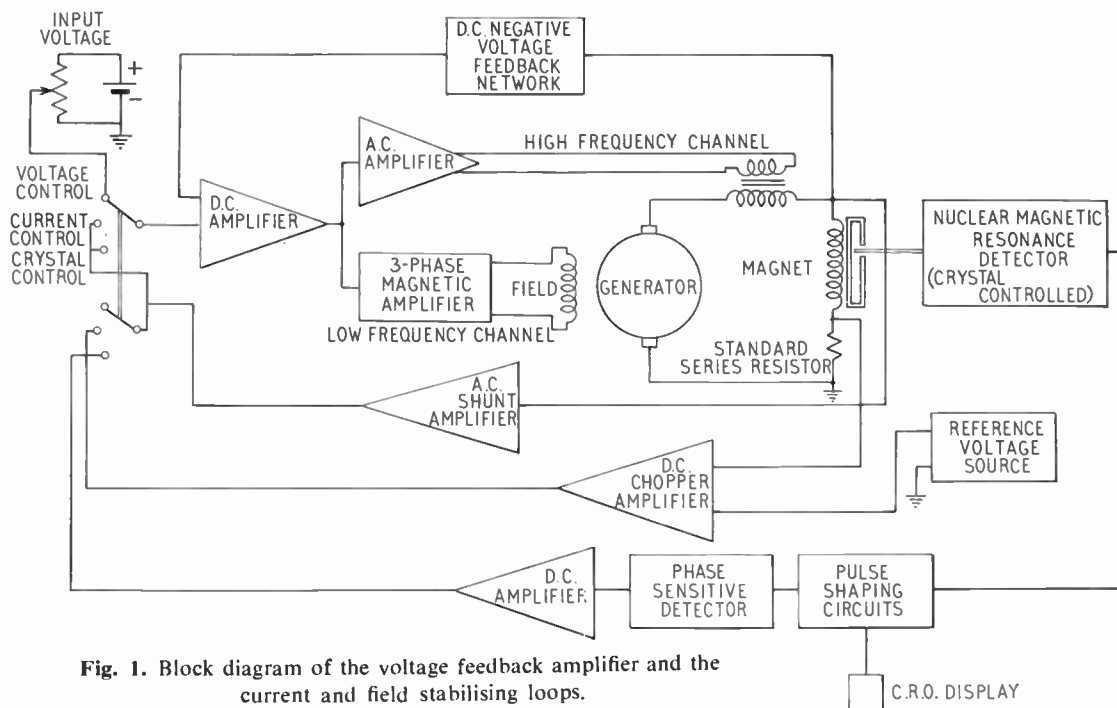

Fig. 1. Block diagram of the voltage feedback amplifier and the current and field stabilising loops.

The particular generator used was an old electro-plating machine and was not really suitable for its new application. It has unlaminated poles which permit the flow of large eddy currents and causes the frequency response to fall at approximately 1 c/s, even when the field winding is fed from a high impedance source (see Fig. 2(a)). To obtain maximum generator

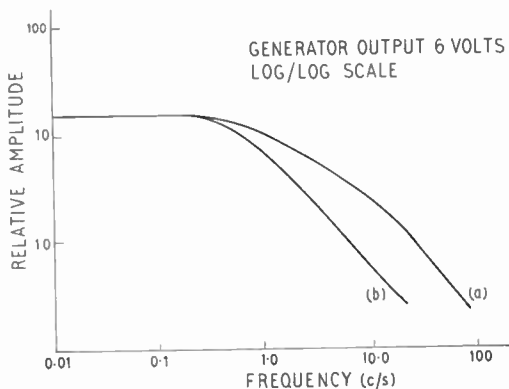

Fig. 2. (a) Frequency response of generator with constant current source. (b) Frequency response of generator plus 3-phase magnetic amplifier with constant input voltage to the magnetic amplifier.

output, the field winding requires 35 V at 1.75 A which is inconvenient to supply from a high-impedance valve circuit. Due to the heavy eddy-current losses the equivalent shunt resistance across the generator field is low and the use of a magnetic amplifier of moderate output impedance does not significantly deteriorate the response time as shown in Fig. 2(b).

Fluctuations of generator output voltage, due to any cause, will produce variations in the magnetic field of the spectrograph and will have to be cancelled by the stabilizing circuits. These fluctuations can be separated into two groups:—

(a) Slow changes due to variation in magnet resistance with temperature and change in generator speed due to mains voltage and frequency variation.

(b) Rapid changes due to rotor unbalance and commutator ripple. A spectrum analysis of the major frequency components above 25 c/s is shown in Fig. 3.

These variations are reduced by incorporating the generator in a voltage feedback loop discussed in the next section.

The generator had an additional peculiar effect. At intervals, which varied between a few seconds and perhaps an hour, the generator produced a positive pulse of amplitude up to 200mV and of duration up to 0.3 second. These pulses were normally obscured by the generator

sists of a d.c. amplifier in cascade with the parallel combination of a high frequency (h.f.) channel and a low frequency (l.f.) channel which incorporates the generator; overall negative voltage feedback is applied from the output of the generator to the input of the d.c. amplifier. The effect of the feedback is to reduce the amplitude of any fluctuation which would have been present by a factor equal to the loop gain of the system at the frequency of the fluctuation. The h.f. channel ensures that the high frequency components of the generator's noise are adequately attenuated and is also used to control the gain-phase characteristics in such a way that the feedback loop is stable.

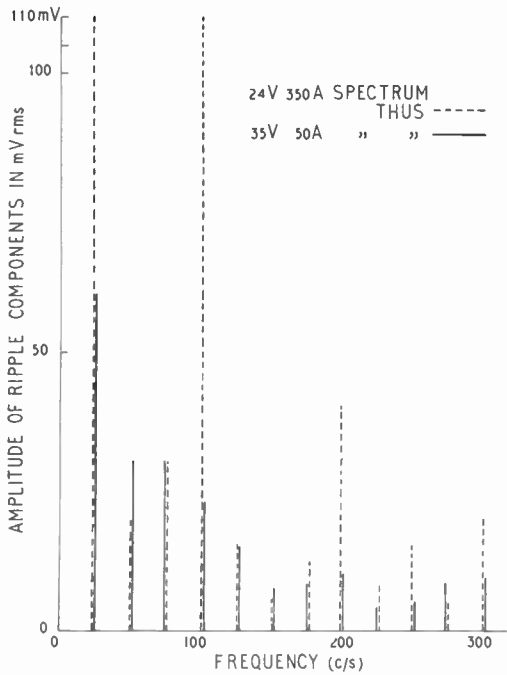

Fig. 3. Spectrum analysis of generator noise (d.c. excitation).

ripple and were discovered after careful investigation into the causes of amplifier overload. The cause of these pulses is still uncertain but may be due to a small axial movement of the rotor. It will be seen later they have a profound effect on the design of the stabilizer.

3. Voltage Feedback Amplifier

The ill effects of generator fluctuations can be largely eliminated by incorporating the generator into a feedback amplifier system which then acts as a low-noise, wideband amplifier with high power output. This technique has been fully described by Sommers, Weiss and Halpern^{2,3}. The system is shown in Fig. 4.

The voltage feedback amplifier con-

3.1. Generator noise

A spectrum analysis of the generator noise is shown in Fig. 3. Although the magnitudes of the components that make up the noise are larger for a 350 A load than a 50 A load, the magnitudes are not proportionate and therefore it is more difficult to satisfy the stability requirements when the load current is 50 A. The total noise voltage is 100 mV (r.m.s.) when the magnet voltage and current is 3.5 V and 50 A respectively. The major component of this noise occurs at 25 c/s with an amplitude of 60 mV (r.m.s.). The current variation due to this 25 c/s noise component is adequately reduced by the filtering effect of the magnet's inductance but a loop gain of about 100 for a frequency range 10-100 c/s is provided to keep the noise level well below its maximum tolerable value.

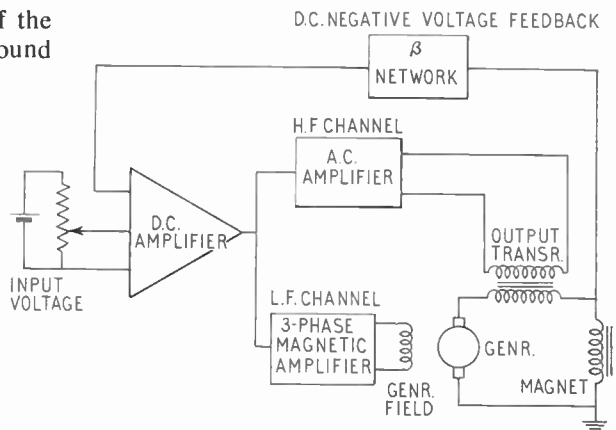

Fig. 4. Block diagram of voltage feedback amplifier.

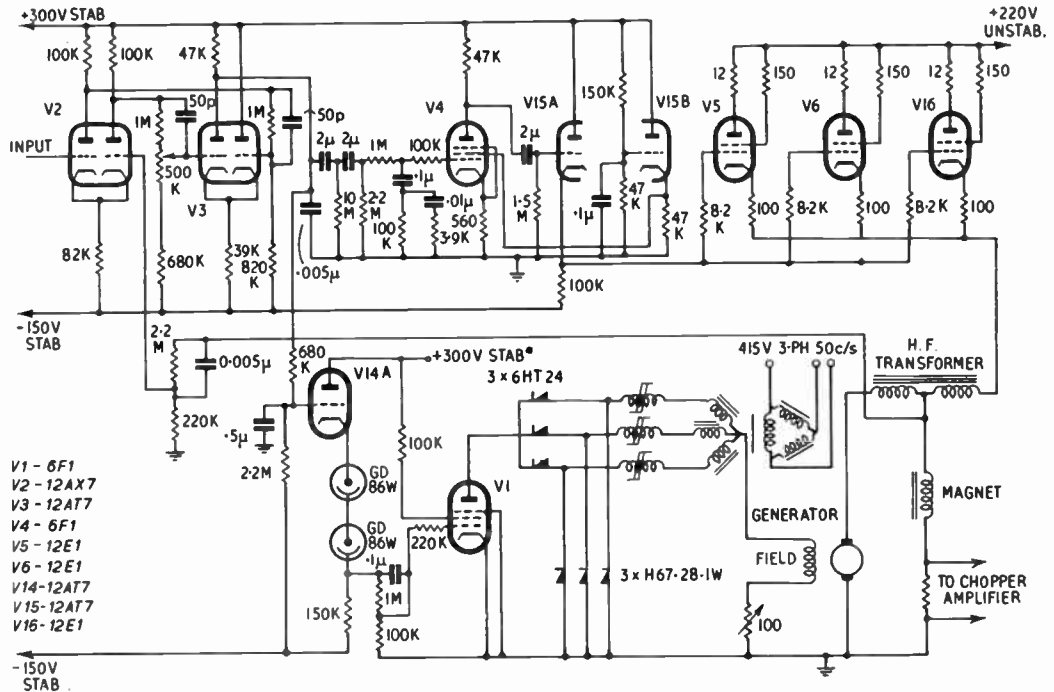

Fig. 5. Circuit diagram of voltage feedback amplifier.

3.2. D.C. amplifier

The input and feedback voltages are amplified by a two stage d.c. amplifier (V2 and V3) which has a gain of about 800. This amplifier is common to both l.f. and h.f. channels. The d.c. and low frequency components of the signal pass through a cathode follower (V14A) via response shaping networks to the grid of the control valve (V1) of the three-phase, fast-response magnetic amplifier.

3.3. L.F. channel

This channel consists of the three-phase magnetic amplifier and d.c. generator (see Fig. 5). The generator field requires 35 V at 1.75 A for maximum output and this supply can be more conveniently obtained from a magnetic amplifier than a valve circuit. A three-phase, fast-response magnetic amplifier is preferred to a single-phase transductor circuit in order to reduce a.c. ripple in the generator field and to minimize the time constant of the circuit. The circuit of the magnetic amplifier used is due to Kelsall *et al*⁴ and is shown in Fig. 6.

L1, L2, L3 are coils wound on HCR toroidal cores which have rectangular hysteresis loops. In the absence of d.c. each reactor is designed to absorb the mains alternating voltage applied to it without saturating. The alternating voltage supply to the magnetic amplifier is obtained from a three-phase, 415 V, 50 c/s delta-star transformer.

A brief outline of the operation of the circuit is as follows:—

The volt-second storage of a core is directly proportional to the number of turns on the core and the maximum flux swing, and this quantity is made to correspond to the voltage time integral of the supply over one half cycle. If at the beginning of the load half cycle the flux starting point is other than $-\Phi$, a fraction of the applied voltage time integral cannot be absorbed by the reactor and must, therefore, appear across whatever impedance there is in the circuit. During the saturated interval the impedance of the reactor is very low resulting in large load currents flowing in the circuit.

An input voltage signal to control valve (VI) sets the flux levels of reactors L1, 2, 3 in the "reset" half cycle by controlling the magnitudes of their respective magnetizing currents through rectifiers A1, 2, 3 and the control valve. This flux level determines the angular instant in the

output current of approximately 3 A to compensate for the 200 mV 0.3 sec. pulses produced by the generator. This was impracticable and so the inductor was converted into a transformer with a ratio of 7.7:1, by the addition of a secondary winding; the ratio being determined largely by the winding space available. This reduced the peak current requirements to a more reasonable value which could be met by using three 12 EI's in parallel.

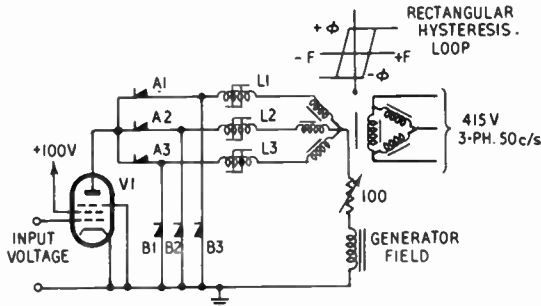

Fig. 6. Circuit diagram of 3-phase magnetic amplifier.

following load half cycle when the reactor saturates. The response time of the amplifier is about one-third of a cycle of the supply frequency.

Over the linear range of the characteristic shown in Fig. 7, the d.c. voltage gain is 6.

3.4. H.F. channel

The requirements of the h.f. channel are twofold: firstly it must inject voltages into the magnet circuit large enough to cancel the high frequency components of generator ripple which cannot be handled by the l.f. channel and secondly, the combined frequency response of the amplifier must be adjusted to preserve stability in the feedback loop under all conditions. These requirements were met by arranging the frequency response of this channel to be complementary to that of the l.f. channel and suitably shaping the response in the high frequency region to preserve stability.

The circuit for the h.f. channel is shown in Fig. 5. The most convenient method of injecting the noise-cancelling signals is by a series inductor in the magnet circuit as used by Sommers *et al.* Since the series inductor has to carry up to 200 A d.c., the maximum attainable inductance, for an economic design, is 10 mH. This inductance was adequate for the measured 25 c/s and higher frequency components of ripple but it would have required a change of

High-frequency components of the signal are amplified by V4 and fed to the grids of the output cathode followers V5, V6 and V16 via a cathode follower V15 A, the screen grid voltage of V4 is stabilized by V15 B. Because of the large and fluctuating current demands of V5, V6, V16 these valves are supplied from a separate h.t. source.

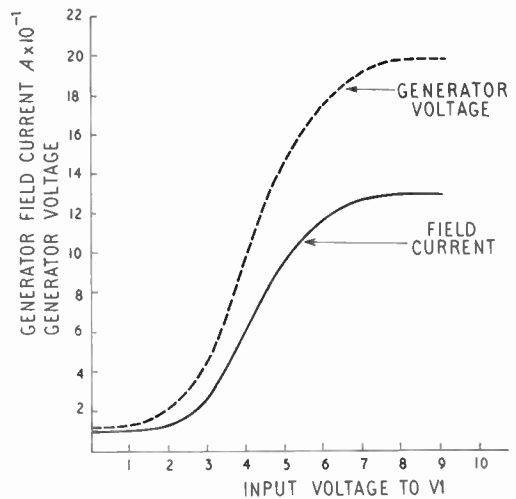

Fig. 7. D.c. static characteristic of 3-phase magnetic amplifier with generator field as load.

3.5. Frequency response of voltage feedback amplifier

The design of the entire system was carried out using straight line approximations for the frequency responses; after the system had been in use, it became possible to check the performance using a commercial transfer function analyser and these results are plotted as Nyquist diagrams. The accuracy of this instrument is 1 per cent. over the frequency range 0.5 c/s—1kc/s but points, of lower accuracy, have been taken between 0.1 c/s and 11kc/s.

Before considering the overall loop response of the complete voltage feedback amplifier, each of the subsidiary channels, which make up this main loop, are considered.

The open-loop frequency response of the l.f. channel and feedback network is shown in Fig. 8. The dominant lag of this channel is due to the inductance and the equivalent eddy-current loss resistance of the generator field, resulting in a corner frequency of 0.4 c/s. (Calculated from Fig. 8.) The loop gain at d.c. of this channel is 25 which is somewhat lower than theoretical expectations—probably due to component variations.

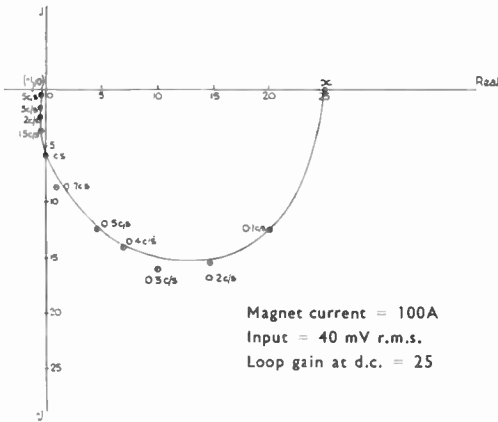

Fig. 8. Open-loop frequency response of l.f. channel plus feedback network.

The open-loop frequency response of the h.f. channel is shown in Fig. 9. The Nyquist diagram of this channel indicates stability with adequate gain and phase margins. The loop gain of this channel, in the frequency range (25-800 c/s) is higher than that of the l.f. channel, this being due principally to the phase-lead feedback network. As the feedback loop is stable, the increased loop gain is useful in that it reduces still further the high frequency components of the generator's output ripple.

The open-loop frequency response of the voltage feedback amplifier is shown in Fig. 10. Although both channels have responses approaching 20 db/decade and phase shifts of approximately 90 deg, the overall response shows that there is a drop in loop gain in the cross-over region (~ 2 c/s) and that the phase

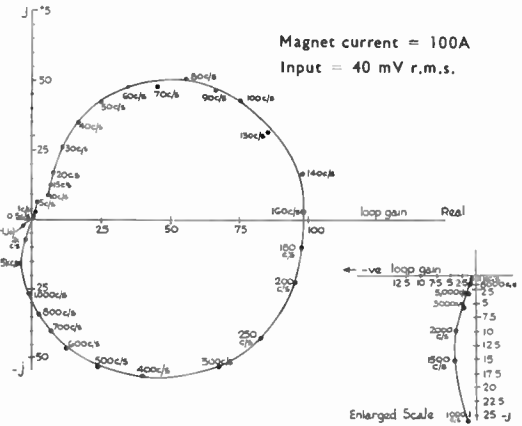

Fig. 9. Open-loop frequency response of h.f. channel plus feedback network.

shift approaches 75 deg in the lag direction and 70 deg in the lead direction; this is because the frequency responses of the two channels are not fully complementary. This is not serious as the generator ripple components are not large at this frequency. The Nyquist plot of the complete loop is in good agreement with the sum of the responses of the l.f. and h.f. channels, except in cross-over region. Although Fig. 10 is not complete, due to the limitations imposed by the transfer function analyser, the response locus shows there is no net encirclement of the point $(-1, j0)$ and therefore corresponds to a stable system. At frequencies greater than 11k c/s, the transformer and valves will produce total phase

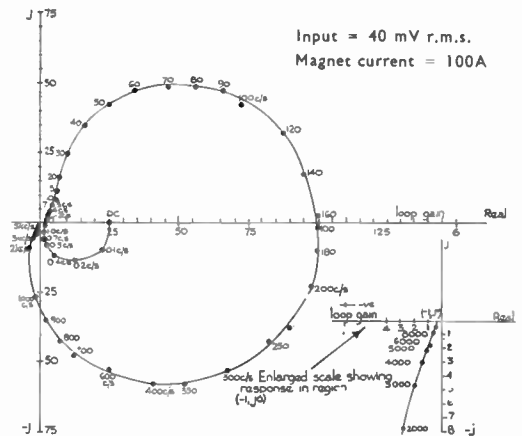

Fig. 10. Open-loop frequency response of the complete voltage feedback amplifier.

over several hours and can be checked periodically against a standard cell. The voltage drop across the standard resistor at a maximum current of 300 A is 100 mV. For a stability of one part in 10^4 the input stability of the chopper amplifier should be at least $10 \mu\text{V}$ and at lower magnet currents $1 \mu\text{V}$. This requirement is easily satisfied by the Sunvic D.C.A.1 chopper amplifier used; the drift referred to the input, being less than $0.3 \mu\text{V}$ after the initial warming-up period.

The d.c. voltage gains of the various elements in the current stabilizing loop are:

D.c. chopper amplifier 2.5×10^5 .

Voltage feedback amplifier 10.

Magnet 3.33×10^{-3} .

This gives a loop gain at d.c. of approximately 8.3×10^3 which is more than adequate.

4.2. Reference voltage source

The magnet current passes through the standard resistor which drops 100 mV at 300 A. Therefore it is necessary for the reference source to provide a stable potential which can be varied between 3 mV and 100 mV. To ensure that the current can be reset to any given value it is necessary to have some means of checking the state of the battery supplying the reference voltage and a standard cell is convenient for this purpose. The circuit diagram of the reference unit is shown in Fig. 12. The power source is a 1.5 volt Mallory cell which has a very low temperature coefficient. The voltage across AB is adjusted to 1.083 volts by variable resistors RV1 and RV2 and this voltage is checked against a standard cell by means of the chopper amplifier. A known fraction of this voltage is tapped off by means of RV4 and this, in turn, is compared with the voltage across the standard resistor by means of the chopper amplifier. The resistor RV4 is a 37 turn helical potentiometer driven by a remotely-controlled motor. The position of RV4 is indicated remotely by a coarse and fine magstrip system which enables the current setting to be repeated accurately.

4.3. D.C. chopper amplifier

This unit is a standard product of Sunvic Controls Ltd. The d.c. input signal is chopped into square waves by a vibrating contact driven at 50 c/s. The a.c. signal is amplified and then rectified by a phase-sensitive detector. The out-

put circuit of the unit is modified, by the insertion of a $4.7\text{k}\Omega$ load resistor, for an output voltage swing of $\pm 25 \text{ V}$ on its most sensitive range ($\pm 100 \mu\text{V}$). The frequency response of the chopper amplifier is inherently poor having a corner frequency at about 2 c/s.

4.4. A.C. shunt amplifier

The frequency response of the magnet and chopper amplifier combination is inherently poor. To ensure stability without excessive response time, an a.c. amplifier is connected in parallel across this combination⁶. The low frequency cut off of the a.c. shunt amplifier has been designed for 0.01 c/s which makes it complementary to the magnet and chopper amplifier response. Thus the bandwidth is extended and the overall loop gain is substantially independent of the detailed shape of the magnet and chopper amplifier frequency responses above 0.01 c/s.

The circuit diagram of the a.c. shunt amplifier is shown in Fig. 12. Since high frequency voltage variations across the standard resistor are attenuated by the magnet inductance, the input of the shunt amplifier is connected, via a high-pass filter, to the high potential end of the magnet, thus reducing the gain requirements of the amplifier. The disadvantage of the system is that the a.c. amplifier tends to overload easily when the magnet voltage is changed though this effect is minimized by using d.c. couplings wherever possible, restricting its bandwidth and short circuiting the input to earth when making large current changes as described below.

The magnet current can be set approximately to the value required by adjusting the input voltage potentiometer RV3 (see Fig. 12). When the magnet current is within the control range of the chopper amplifier, switch S1 is operated and this replaces the signal from potentiometer RV3 by an error signal from the chopper amplifier. Simultaneously the shunt amplifier is brought into operation and the current through the magnet is now stabilized. The exact value of current can be controlled by varying the reference voltage set by RV4 but the permissible rate of change is limited by overload considerations.

The Nyquist diagram of the a.c. shunt amplifier is shown in Fig. 13.

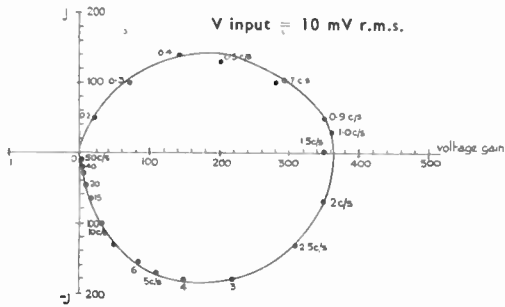

Fig. 13. Frequency response of the a.c. shunt amplifier.

4.5. Open-loop frequency response of current stabilizing system

The frequency response of this loop is influenced greatly by the magnet current because of incremental inductance variations of the magnet. However, an open-loop frequency response measurement was carried out with the magnet current set to 100 A and can be seen in Fig. 14(a). Quantitative measurements between d.c. and 0.05 c/s are practically impossible to obtain without elaborate instruments but from theoretical considerations the curve will continue in an anticlockwise direction, with decreasing frequency, reaching the d.c. point with a loop gain of 8.3×10^3 . There is a drop in loop gain at 0.05 c/s, due to the magnet time-constant and a further drop at 2 c/s probably due to the d.c. chopper amplifier. With reference to Fig. 14 (b), it can be seen that the system is adequately stable, having approximately 45 deg phase margin and a high gain margin.

5. Field Stabilizing Loop

The magnetic field of the spectrograph is stabilized at fixed values using nuclear magnetic resonance techniques^{7, 8}. The principles of nuclear magnetic resonance (N.M.R.) are well known^{9, 10, 11}, etc. and will not be discussed in detail in this paper. The technique used to obtain information on the magnetic field strength is based on the absorption effect of N.M.R. If a substance containing magnetic nuclei is subjected to crossed magnetic fields, one being static and the other a weak alternating field of high frequency, nuclear resonance will occur and energy is absorbed from the alternating field, providing the fields obey the relation-

ship $H = 2.3489 \times 10^{-2} V^2$ where H is the magnetic field strength in oersteds and V is the frequency in Mc/s.

Use is made of this fundamental property to relate magnetic field strength, in which the nuclei are placed, to the N.M.R. frequency. Hence the absolute magnitude of the magnetic field may be determined by measuring this frequency which can be carried out with a high degree of accuracy. The simplest nucleus to exhibit this effect is hydrogen hence it is convenient to use a water sample. The sample, a decinormal solution of ferric nitrate (to broaden the line width), is surrounded by a radio-frequency coil which is placed in the magnetic field with its axis perpendicular to the direction

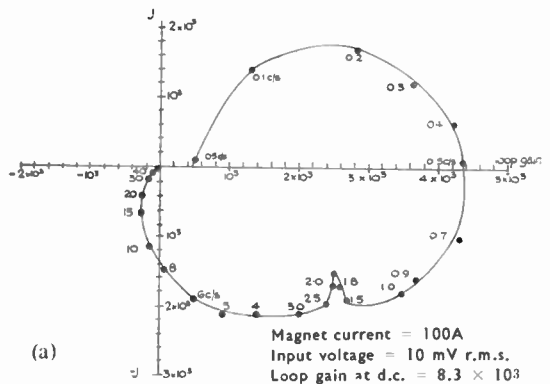
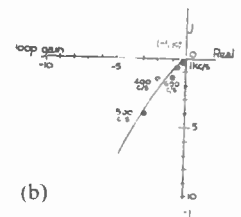

Fig. 14. (a) Open-loop frequency response of current stabilizing loop.

(b) Enlarged scale showing response of current stabilizing loop in the region $(-1, j0)$.



of the field. The r.f. coil forms part of a crystal-controlled oscillator which operates on the threshold of oscillation. At nuclear resonance the sample absorbs energy from the r.f. field, causing a variation of the effective Q of the coil, thus damping the oscillation. To locate the N.M.R. signals the unknown magnetic field, in the vicinity of the sample, is varied by applying a 50 c/s sweep voltage to a pair of Helmholtz coils mounted on either side of the sample. If the main magnetic field is within three oersteds of the required value, resonance occurs in the sample at some point of the sweep. When this

occurs the amplitude of the oscillation drops and, after detection, this damping effect appears as a pulse having a p.r.f. of 100 c/s. The phase of the pulse in relation to that of the sweep field is determined by the deviation of the magnetic field from its nominal value. (See Fig. 15.) If the oscillator frequency is that corresponding to H_0 the N.M.R. signals will occur at equal time intervals (t_3). Should the field deviate by an amount δH then a phase displacement will occur

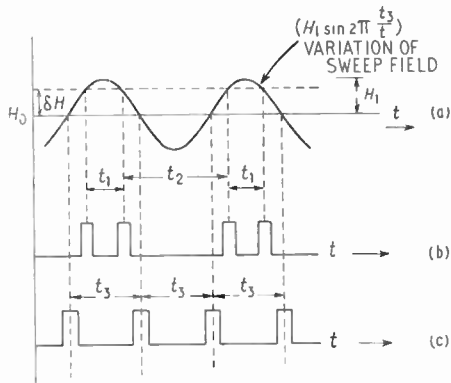

Fig. 15. Phase variations of n.m.r. signals with change in magnetic field.

between the N.M.R. pulses as shown in Fig. 15(c). After amplification the pulses are passed through a phase sensitive detector which gives a d.c. error signal proportional to the phase deviation, and of a polarity consistent with the sense of the error. This error signal is used as an alternative to the current stabilizing signal from the d.c. chopper amplifier.

5.1. Description of the N.M.R. equipment

5.1.1. Probe, oscillator and detector circuits

The probe consists essentially of the sample, the r.f. coil and a pair of Helmholtz coils mounted either side of the sample. The r.f. coil is wound on a perspex former which contains a hollow cavity in which is placed the ferric nitrate solution. The Helmholtz coils are fixed on a separate perspex former which fits over the main former. The length and diameter of the probe are 3.5 in. and 0.5 in. respectively, these dimensions being fixed so as not to impede the passage of particles through the spectrograph.

A circuit diagram of the oscillator and detector circuits is shown in Fig. 16. The crystal-controlled oscillator (V1), which provides r.f. energy to the probe coil L1, is of the grounded grid type. As the oscillation frequencies involved in this application are in the 30-60 Mc/s range, overtone crystals are used in the circuit, resulting in a high order of frequency stability and accuracy. The required level of oscillation is obtained by varying the bias voltage to the oscillator.

The input of the detector V2A, which is of the anode bend type, is coupled to the tank circuit of the oscillator. The second half of this valve is used as a cathode follower to provide a low-impedance output stage.

5.1.2. Pulse amplifier, display and phase-sensitive detector circuits

The N.M.R. signal, from the cathode follower (V2B), is amplified by a three-stage amplifier (V3, V4 and V5). V3 is a conventional pentode stage. This is followed by V4 which is a voltage amplitude discriminator circuit amplifying a selected fraction of the pulse signal. The output of this stage is fed to cathode follower (V6) which provides signals for the Y plates of a c.r.o. display unit and for the phase-sensitive detector. In order to display the N.M.R. signals on a c.r.o., the sweep voltage (50 c/s) is applied to the X plates and the resonance signals to the Y plates. Small phase shifts occur in the circuit resulting in a slight separation of the pulses on the display.

The phase sensitive detector is a conventional balanced ring modulator circuit suitable for low frequency systems. The reference carrier is a 50 c/s sinusoidal voltage, of preset phase and amplitude, and the modulating signal consists of N.M.R. pulses. The amplitude and polarity of the error signal, which is of pulsed form, is a function of the relative phase of the modulating signal. The error signal is smoothed and applied to a single stage d.c. amplifier whose output can be switched to control the input to the voltage feedback amplifier, hence providing absolute magnetic field stabilization.

5.2. Dynamic behaviour of the field stabilizing loop

It is difficult to analyse theoretically the frequency response of the N.M.R. servo loop

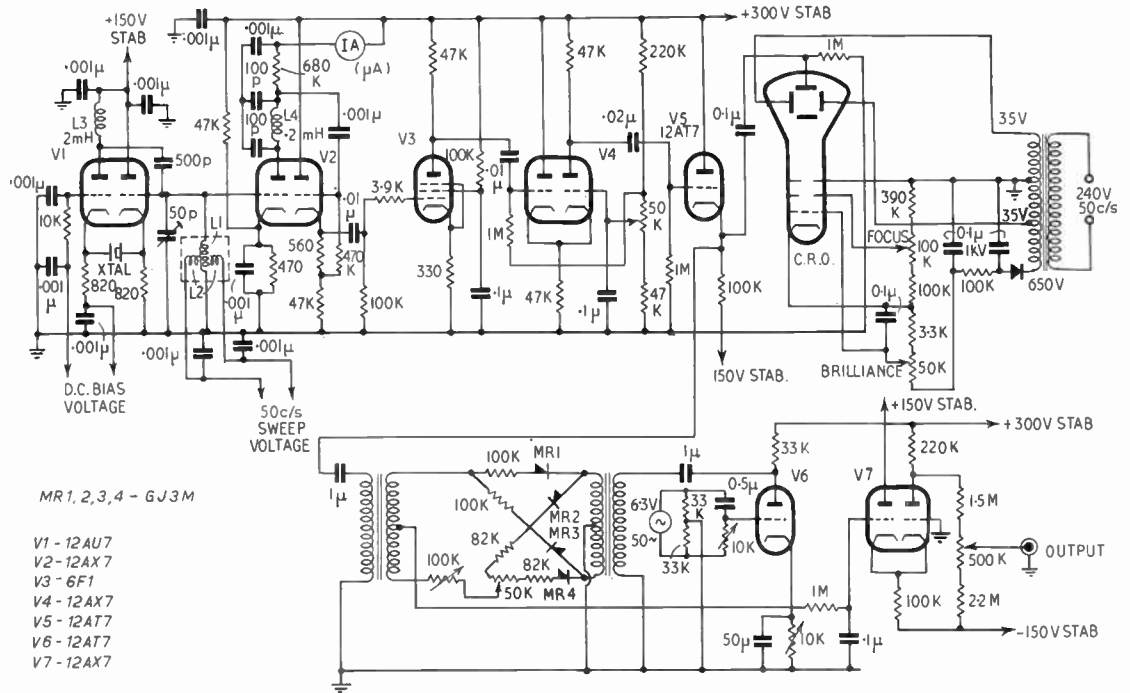

Fig. 16. Electronic circuit details of the n.m.r. equipment.

because changes of field due to a change of voltage on the magnet are affected by the magnet geometry, by the incremental permeability of the iron at that particular field and also by the effect of eddy currents in the core. There is, in addition, a further lag due to the long integrating time constant at the output of the phase sensitive detector. Experimental measurements of the dynamic behaviour of this loop were not made due to the inherently poor frequency response of the magnet and Nuclear Magnetic Resonance equipment.

A procedure, similar to that adopted in the current stabilizing system, has been used to stabilize the field loop. An a.c. shunt amplifier, whose low frequency response extends well below the high-frequency cut-off of the N.M.R. equipment, is connected in parallel with the magnet plus field stabilizing equipment combination. The exact shape is unimportant since in the overlap region there is only double the loop gain. This amplifier is the same as that used to shunt the magnet-chopper amplifier combination which has a similar type of response.

6. Accuracy and Performance

6.1. Voltage feedback amplifier

The main purpose of the voltage feedback loop is to produce a smooth d.c. voltage from the generator. This is achieved by adequate attenuation of the individual frequency components of the generator's output ripple. The magnet current will still vary if the system is operated with only the voltage feedback loop. The cause of these variations are due mainly to changes in input voltage, changes of magnet resistance with temperature and d.c. amplifier drift. The total variations of magnet current are about 1 part in 100 over a period of several hours.

6.2. Current stabilizing loop

As described in Section 4.1, the ultimate accuracy and performance of this loop depends principally on the stability of the standard series resistor and of the reference voltage supply, and also on the voltage drift of the d.c. chopper amplifier. Adequate precautions were taken in the design to keep these variations below the desired value.

The overall performance of this loop was obtained by stabilizing the current and measuring the change in the magnetic field with the N.M.R. equipment described previously in Section 5.1. Variations in magnetic field were observed on a c.r.o. display, the horizontal X-deflection being calibrated in oersteds. The measurements were carried out and fixed values of field, using crystal frequency control, over a period of six hours. The drift in magnetic field over this period was about 1 part in 10^4 , the accuracy of the magnetic field measurement being limited by the line width of the nuclear resonance signal and the signal to noise ratio.

6.3. Field stabilizing loop

This loop stabilizes the absolute value of the magnetic field. Since the error signal is obtained directly from the magnetic field, it corrects for hysteresis effects and changes in magnet geometry, such variations being outside the current stabilizing system. As the magnetic field is measured in terms of a frequency, the frequency stability of the crystal-controlled oscillators, which energize the probe coils, must be of a high order. Care must be taken in adjusting the relative phase of the N.M.R. signals with reference to the sweep field, as this affects the accuracy of the field stabilizing system. The theoretical loop gain at d.c. for the field stabilizer is about 25,000 (see Appendix); thus the loop regulates the absolute value of the magnetic field to an accuracy of better than 0.01 per cent.

7. Control System

Due to the neutron hazard in the vicinity of the magnet during certain experiments, provision is made to operate the control system of the stabilizers from either one of two positions. The control system is mainly automatic.

8. Conclusion

The stabilizing system described has worked very satisfactorily during the past few years. The current stabilizing loop regulates the magnet current to 1 part in 10^4 and the N.M.R. field stabilizer gives absolute field control to an accuracy of better than 1 part in 10^4 .

9. Acknowledgments

The authors wish to express their appreciation for assistance received from many of their

colleagues during the progress of the work, in particular Mr. D. R. Chick, Dr. K. Firth, Mr. D. Keith-Walker and Mr. D. Allenden for many helpful discussions, and Mr. I. Collip for development and constructional work on the N.M.R. probes. Thanks are also due to Dr. T. E. Allibone, F.R.S., Director of the Research Laboratory, Associated Electrical Industries Ltd., for permission to publish this paper.

10. References

1. K. Firth, "A magnetic analyser for charged particles from nuclear reactions and its use to measure the angular distribution of protons from N^{14} (d.p.) N^{15} reactions." A.E.I. Research Report No. A.662, June 1957.
2. H. S. Sommers Jr., P. R. Weiss and W. Halpern, "Conversion of a motor generator into a low noise power amplifier," *Rev. Sci. Instrum.*, **20**, pp. 244-51, April 1949.
3. H. S. Sommers Jr., P. R. Weiss and W. Halpern, "Magnet current stabilizer," *Rev. Sci. Instrum.*, **22**, pp. 612-18, August 1951.
4. R. H. Kelsall, J. Sherlock and J. M. Foye, "Improvements relating to saturable core reactance devices." British Prov. Patent No. 890/54.
5. I. Collip, "Measurement of Magnetic Field Strength by the Proton Magnetic Resonance Method." A.E.I. Research Report No. A.475, October 1955.
6. M. W. Jervis, "A precision direct-current stabilizer." I.E.E. Paper M.1730, July 1954. (*Proc. Instn. Elect. Engrs.*, **102B**, pp. 274-8, 1954).
7. H. A. Thomas, "Nuclear-resonance magnetic field control," *Electronics*, **25**, pp. 114-18, Jan. 1952.
8. F. A. Hadden, "Precision Magnetic Field Regulation using N.M.R.," M.I.T. Thesis. D.S.I.R. Library Ref. PB/118698.
9. F. Bloch, "Nuclear induction," *Physical Review*, **70**, pp. 460-74, October 1st and 15th, 1946.
10. F. Bloch, W. W. Hansen and M. Packard, "The nuclear induction experiment," *Physical Review*, **70**, pp. 474-85, October 1st and 15th, 1946.
11. M. Lipsicas, "Nuclear magnetic resonance," *Metropolitan-Vickers Gazette*, **28**, pp. 256-261, November 1957.

11. Appendix : D.C. Loop Gain Requirements of the Magnetic Field Stabilizing Loop

Symbols

- H Instantaneous magnetic field strength (oersteds).
 H_0 Nominal magnetic field strength.
 δH Variation in magnetic field produced by δV change to A2 input.
 H_1 Peak amplitude of 50 c/s sweep field.

- t_2 One cycle of sweep frequency (20 m sec.).
- t_1 Pulse width of phase-sensitive detector output.
- Δt Time equivalent of magnetic field variation δH .
- v Output voltage amplitude of phase-sensitive detector.
- ΔV Error voltage from phase-sensitive detector.
- δV Input to amplifier A2 to provide a variation in magnetic field δH .
- α Volts per oersted (constant of the magnet = 6.5×10^{-4}).
- A_1 Gain of voltage feedback amplifier.
- A_2 Gain of d.c. amplifier.

The method of stabilization has been discussed in detail in Sect. 5. A block diagram and the relevant waveforms are shown in Fig. 17. in idealized form.

The instantaneous magnetic field at the proton sample $H = (H_0 - \delta H) + H_1 \sin 2\pi t/t_2$ and is shown in Fig. 17(b).

The rate of change of magnetic field at any instant is $\frac{dH}{dt} = H_1 \frac{2\pi}{t_2} \cos \frac{2\pi t}{t_2}$

Consider the rate of change in the region $t = \frac{1}{2}t_2$

then $\frac{dH}{dt} \cong - \frac{H_1 2\pi}{t_2}$ for small values of Δt (1)

The output waveforms of the phase-sensitive detector are shown in Fig. 17(c).

When $\delta H = 0$ the waveform is symmetrical about the time axis and the resultant mean output voltage is zero. If the magnetic field deviates by an amount δH , the symmetry is disturbed producing an error voltage (ΔV) whose waveform is as indicated by the dashed lines in Fig. 17(c). The error voltage ΔV which is the d.c. component of the waveform in Fig. 12(c) is equal to

$$\frac{2v}{t_2} \left[\left(\frac{t_1}{2} + \Delta t \right) - \left(\frac{t_1}{2} - \Delta t \right) \right] = 4v \frac{\Delta t}{t_2}$$

.....(2)

If Δt is small then from eqn. (1)

$$\Delta t = \frac{-\delta H t_2}{H_1 2\pi}$$

.....(3)

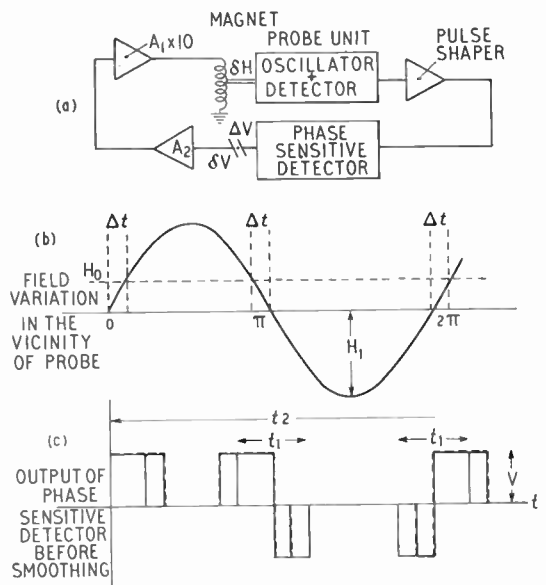

Fig. 17. Block diagram and idealized waveform used in theoretical loop gain calculation.

Substituting (3) in (2) $\Delta V = - \frac{2v}{\pi} \cdot \frac{\delta H}{H_1}$ (4)

To find the loop gain of the system, consider the loop open circuited at the output of the phase-sensitive detector.

The loop gain of the system is then given by $\Delta V/\delta v$ where δv is the input to amplifier A2 to provide a variation in magnetic field of δH .

Let δH equal a voltage variation at the magnet of α which is equal to 6.5×10^{-4} volts per oersted.

Therefore $\delta v = \frac{\alpha \delta H}{A_1 A_2}$ (5)

and from (4) and (5) the loop gain

$$\frac{\Delta V}{\delta V} = - \left[\frac{2v \cdot A_1 A_2}{\pi \cdot \alpha H_1} \right]$$

.....(6)

Taking typical values:

- $v = 0.25$ volts; $A_1 = 10$; $A_2 = 30$.
- $\alpha = 6.5 \times 10^{-4}$ volts per oersted.
- $H_1 = 3$ oersteds.

Therefore the loop gain $\frac{\Delta V}{\delta V} = - 24.5 \times 10^3$.

Note that the loop gain is independent of the pulse width t_1 (to the first order) but t_1 determines the range of linearity.

APPLICANTS FOR ELECTION AND TRANSFER

As a result of its April meeting the Membership Committee recommended to the Council the following elections and transfers. The list also includes names of six Graduates whose elections or transfers from Student were recommended at a Meeting held at the end of March.

In accordance with a resolution of Council, and in the absence of any objections, the election and transfer of the candidates to the class indicated will be confirmed fourteen days after the date of circulation of this list. Any objections or communications concerning these elections should be addressed to the General Secretary for submission to the Council.

Transfer from Associate Member to Member

CADE, Cecil Maxwell. *Harlow, Essex.*

Direct Election to Associate Member

CHRISTOPHER, Percy Frederick, Sqdn. Ldr. D.F.C., R.A.F. *Greenford.*
 COOP, Geoffrey Hinton, M.Sc. *Auckland, New Zealand.*
 DEAN, John Percival, B.Sc.(Eng.). *Esher.*
 EDWARDS, James, Sqdn. Ldr. R.A.F. *Kidderminster.*
 FARROW, Henry Ernest. *Evesham.*
 HENDLEY, Dennis Alfred. *New Malden.*
 NIKLAS, Wilfrid F., Ph.D. *Chicago.*
 SIMPSON, Alan Leslie. *Cheltenham.*
 TAIT, Jack James, B.Sc. *Christchurch, New Zealand.*
 TREVAINS, Gerald Edward, Sqdn. Ldr. *Woomera, S. Australia.*

Transfer from Associate to Associate Member

GRIFFIN, Norman Bernard, Ph.D. *Great Malvern.*
 HUGGINS, John Hubert Gibson. *Epsom.*

Transfer from Graduate to Associate Member

BEARDALL, James Howitt. *Willowdale, Canada.*
 CHERETAKIS, Argyrios. *Geneva.*
 CHRISTMAS, Bernard Harrison. *Ashford, Middlesex.*
 COLLINS, Vernon John William. *North Weald.*
 ELLIOTT, Alan Tilbury. *Dunmow.*
 HEARN, Peter John. *Stevenage.*
 KEARTON, Malcolm Christopher. *Stevenage.*
 MONCRIEFF, Alexander William. *Boreham Wood.*
 SOHRABJI, Nariman. B.E.(Hons.). *Bangalore.*
 TAYLOR, Douglas Raymond. *Hull.*
 THAKER, Kantilal Jethalal, B.Sc. *London, N.19.*

Transfer from Student to Associate Member

BACON, Roy Harold. *Kingston-upon-Hull.*
 BURNS, John Fotheringham. *Edinburgh.*

Direct Election to Associate

BURCH, Leslie Lawrence Robert. *Cheltenham.*
 CAMERON, James Dalziel. *Ottawa.**
 CASALI, Aureliano. *Rimini, Italy.*
 CASSON, Sydney. *Beckenham.*
 DADSWELL, Peter John. *Bristol.*
 DOWDING, Peter. *Chilwell.*
 FOX, Bernard. *Loughton.*
 HOLMES, Alfred Stanley. *Cobham.*
 HOULT, Hickson James. *Slough.*
 NAMBUDIRIPAD, Moothiringot Narayan, B.Sc. *Ernakulam, S. India.**
 PASSMORE, Reginald. *Sidcup.*
 WHITHAM, Eric. *Bracknell.*

Transfer from Student to Associate Member

BATT, Brian Sidney. *Harlow.*

Direct Election to Graduate

ALLINSON, Martin Vernon, B.Sc. *Calgary, Canada.*
 ANGELIDES, Odysseas Christodoulou. *Nicosia.*
 BASTIN, Anthony John. *London, N.W.7.*
 FLINT, Reginald Arthur. *Leicester.*
 HANDFORD, Michael Phillip. *Camberley.*
 HASLER, Brian Edward. *Oxford.*
 ODUNSI, Olatunde Isola. *London, S.E.23.*
 QASAS, Hamdi. *Jordan.**
 UZOIGWE, Onuoha Dennis. *Coventry.*
 WALMSLEY, Graham Harry. *Shrewsbury.*
 WILKINSON, James. *Blackpool.*

Transfer from Student to Graduate

ASLAM, Mohammad. *Thelum, W. Pakistan.*
 FOSTER, David Bernard. *Shelford, Cambs.*
 KHAW POH KEAT. *Finchley, N.3.*
 SIWACH, Hans Raj Singh. *Bangalore.*
 SOAMES, Michael Richard. *March.*
 WHITEMAN, John. *Maidstone.*

STUDENTSHIP REGISTRATIONS

The following 61 Students were registered at meetings in March; the names of the 18 Students registered at the April meeting will be published later.

ADOPHY, Felix Obiorah. <i>Onitsha.</i>	GOSSAGE, Plt. Off. William Alan, R.A.F. <i>Welwyn Garden City.</i>	PRYCE, James. <i>Barnet.</i>
AGAMAH, John Komla. <i>London, S.E.3.</i>	GRIFFITHS, William Thomas Gwynne. <i>London, N.W.6.</i>	RANSOM, Bernard. <i>Guildford.</i>
AHMED, Manzur, Capt., B.A. <i>Kohat, West Pakistan.</i>	GROS, Chajim. <i>London, N.W.8.</i>	REJWAN, Yaron. <i>Tel-Aviv.</i>
BAMFORD, Thomas Arthur. <i>London, N.22.</i>	GUNARATNE, Waragoda G. <i>Colombo.</i>	ROPER, Russell. <i>Middlesbrough.</i>
BIEGHUN, Ephraim. <i>London, N.W.3.</i>	HARDING, Robert Harold. <i>London, W.9.</i>	RUSHWORTH, Alan. <i>Basingstoke.</i>
BIRCHAM, John. <i>Chelmsford.</i>	HARTWELL, Edward H. <i>Southampton.</i>	RUTISHAUSER, E. A. O. <i>London, W.11.</i>
BISHOP, Lance Reginald. <i>Southampton.</i>	HASAN, Masood Ul, B.Sc. <i>London, N.W.10.</i>	SADHU, Kamal Kumar, B.Sc. <i>West Bengal.</i>
BLACKBURN, Maurice Cecil Mitford, B.Sc.(Eng.). <i>Cheam.</i>	HO KWOK KI. <i>Hong Kong.</i>	SALAMI, Lawrence Alofoje. <i>Lagos.</i>
BRIDGEWATER, Thomas Austin St. C. <i>London, W.9.</i>	HOWARD, Trevor N. <i>Pietermaritzburg.</i>	SANDMAN, Aubrey Max. <i>London, N.5.</i>
BROOKS, Peter John. <i>Hamilton, Canada.</i>	KAVANAGH, Lt. Bryan John. <i>Dublin.</i>	SIMONS, Richard James. <i>Northampton.</i>
BROWN, Charles John. <i>Bristol, S.</i>	LEE, Ngian Tong. <i>Singapore.</i>	SMITH, George Donald. <i>Northampton.*</i>
BURLEIGH, William A. <i>London, S.E.12.</i>	LEUNG, Tze Yuen. <i>Hong Kong.</i>	STREATER, Barry Brangwyn. <i>Crawley.</i>
BURNS, John Fotheringham. <i>Edinburgh.*</i>	LODGE, John William. <i>Fareham.</i>	SWEETMAN, Thomas A. <i>Kasama, N. Rhodesia.</i>
CLAXTON, Geoffrey Dudley. <i>Norwich.</i>	MACCALLUM, William A. <i>Gainsborough.</i>	THOMAS, David Geoffrey. <i>Cardiff.</i>
CRAIG, James. <i>Wallsend.</i>	MANN, Richard Barnaby. <i>Cambridge.</i>	TREHEARN, Brian Leslie. <i>Cape Town.</i>
CUSSONS, Ashley Roy. <i>Dorking.</i>	MOORE, Brian. <i>Coventry.</i>	TYRRELL, Ronald William. <i>London, S.W.19.</i>
GAZI, Cawasji Framroze. <i>London, S.E.21.</i>	O'DONOVAN, Michael V. <i>Cambridge.</i>	van der NEUT, Cornelis A.. B.Sc. <i>Pretoria.</i>
GIBBONS, Derek William. <i>Ifford.</i>	OSUJI, Simon Oham. <i>Enfeda.</i>	WILLIS, Kenneth James. <i>Pinner.</i>
GIBSON, Roy Alan. <i>Eastleigh.</i>	PARSONS, James Thomas. <i>Edgware.</i>	WOOD, Peter Albert Harold. <i>London, N.W.</i>
GOONEWARDANE, Hemawansa M. <i>London, S.E.27.</i>	PIGHILLS, Charles K. <i>Cheadle Hulme.*</i>	WRAY, Alan. <i>Stevenage.</i>
		YAHAYA, Tunka Ahmad. <i>Chelmsford.</i>

* Reinstatement.

Radio Engineering Overseas . . .

The following abstracts are taken from European and Commonwealth journals received in the Library of the Institution. Members who wish to borrow any of these journals should apply to the Librarian, stating full bibliographical details, i.e. title, author, journal and date, of the paper required. All papers are in the language of the country of origin of the Journal unless otherwise stated. The Institution regrets that translations cannot be supplied.

APPLICATIONS OF LIGHT WAVES

Light as a transmitting medium has been used so far in modulated form only. By the development of spark discharge circuits of high luminous density pulse techniques could be extended to the field of light applications as well. A recent German paper first deals mathematically with the influences of luminous density, optical systems, visual range, and daylight illumination on pulse-optical transmission systems. The second part of the paper presents examples of applications beginning with a motor-car overtaking device as the simplest application; an example of the use of very high luminous density and peak power is the pulse-optical cloud ceiling meter which, using a 60-cm reflector, produces up to 200 megawatts peak luminous power in the axial direction; finally, an example of a source of pulsed light developed for maximum time stability of the peak emission is the transmissometer for the measurement of visual ranges from infinity down to 30 m with which the extinction can be measured far beyond the visual range. Pulse-optical transmission systems present advantages wherever simple signals, e.g. switching commands, are to be transmitted with very simple technical effort and where the particular characteristic of light is desirable, namely high directivity and the possibility of shadowing-off in unwanted directions. The higher absorption in the case of light of shorter wavelength is compensated by the extremely high transmitter outputs due to high spark temperature with a radiation maximum in the blue-violet. Because of the low influence of daylight pulse-optical systems can be said to be nearly immune to ambient light.

"Signal transmission with light pulses." F. Frungel and G. Hands. *Archiv der Elektrischen Übertragung*, 13, pp. 121-131 and 175-183, March and April 1959.

TRANSMISSION LINES

A solution to the problem of radiation from a slot in a parallel-plate transmission line when excited by an E-polarized, dominant mode wave is given in a Canadian paper. Expressions are obtained for the reflection and transmission coefficients, and the polar diagram of the radiated field. Explicit calculations are performed when the width of the slot is much greater than the free-space wavelength of the incident radiation. An application of the Lorentz reciprocity theorem

yields, without further analysis, the amplitude and phase of the propagated wave which is excited in the line by an incident cylindrical or plane wave. Consideration is then given to the case in which only a TEM wave is propagated in the parallel-plate region. The reflection and transmission coefficients, and the polar diagram of the radiated field are determined. The amplitude and phase of the propagated wave excited in the line by an incident cylindrical or plane wave are determined by reciprocity arguments. Curves are presented to illustrate the dependence of the field on the slot width and the distance between the parallel plates, for the two field types considered.

"Radiation and reception properties of a wide slot in a parallel-plate transmission line." R. F. Millar. *Canadian Journal of Physics*, 37, pp. 144-159, 160-169.

SEMI-CONDUCTOR MEASUREMENTS

Resistivity and Hall-coefficient measurements, which are of great importance in semi-conductor research, are normally carried out on samples shaped such that the current stream-lines run parallel or virtually parallel. A Dutch paper shows that these measurements can also be made on arbitrarily shaped lamellae in which the stream-line pattern is not at all uniform. On the periphery of the lamella, four contacts are made at arbitrary positions. The resistivity and the Hall coefficient are derived from two measurements, whereby the potential difference between a pair of contacts is determined per unit current through the other pair.

"A method of measuring the resistivity and Hall coefficient on lamellae of arbitrary shape." L. J. van der Pauw. *Philips Technical Review*, 20, No. 8, pp. 220-224, February 1959. (In English.)

POWER SUPPLIES

A Czechoslovakian paper describes a new type of current stabilizer based on the transductor principle. The paper first deals with the theoretical analysis of its operation by means of a comparison with a series-connected transductor with a high impedance in the control circuit. An elaboration of the improvement in stabilizer operation which results by introducing a new circuit, compensating the magnetization current, is then given. Experimental results are given. The apparatus is robust, operates without attendance and requires no maintenance. Its regulation is of the order of 0.1% for a wide range of variations in supply voltage and

load. Its independence of frequency and surrounding temperature is also very good. A further advantage claimed is its short time response.

"Theory of a new current stabilizer based on the transductor principle." J. Krusek and B. Dudas. *Slaboproudy Ohzor*, 20, pp. 212-216, April 1959.

STORAGE OF RADAR INFORMATION

A German paper has described the development of magnetic tape recorders for recording bandwidth-compressed radar pictures with a bandwidth of up to 100 kc/s at a tape speed of 76 cm/sec. The characteristics of the tape at high signal frequencies and the required equalization measures are described and test results are quoted. A bridge circuit for the injection of the high frequency used for premagnetization is treated in detail. The conversion of the radar signal by means of a "signal dependent carrier modulation" avoids the recording of low frequencies and leads to better signal/noise ratios. An integration before recording and the resulting advantages are discussed in detail.

"The storage of radar pictures with bandwidth compression." H. Groll and E. Vollrath. *Nachrichtentechnische Zeitschrift*, 12, pp. 113-120, March 1959.

ERRORS IN SIGNAL STORAGE OF RADAR INFORMATION

It is shown in another paper from the Munich Institut für Hochfrequenztechnik that during error-containing measurements of random time processes the measurement error is not reduced according to a square root law when the number of averaged measurements is increased. On the contrary the error increases when the measured values vary noticeably during a storage period. This is explained with an example illustrating the radar tracking of a meteorological balloon. The case of a measured stationary process is treated analytically. Formulae and curves for optimum storage period, the reduced minimum measurement errors and the improvement obtained are reported as results.

"Storage processes for improving the signal-to-noise ratio of approximately periodical signals with particular reference to radar." H. Meinke and K. Rihaczek. *Nachrichtentechnische Zeitschrift*, 12, pp. 176-180, April 1959.

TELEVISION NOISE EVALUATION

A visual acuity curve for the 625-line television system has been derived from detailed human measurements by the German telephone organization. The result is compared with results obtained from other sources. Furthermore, it has been possible to give data for a practical noise evaluation filter which has the advantage of great simplicity and the attenuation response of which remains

within ± 1 db of the measured visual acuity curve. This value has been confirmed by measurements with strongly deviating noise spectra and thus the validity of the visual acuity curve determined from human measurements and the usefulness of the noise evaluation filter has been proved.

"The deduction of data for a television noise evaluation filter." J. Muller and E. Demus. *Nachrichtentechnische Zeitschrift*, 12, pp. 181-186, April 1959.

V.H.F. VALVE THEORY

Modern v.h.f. triodes occasionally exhibit considerable deviations of the space-charge reduced shot noise from the theoretical value. The reasons for these deviations have been investigated experimentally by the German firm of Valvo. The measurements have revealed that the noise in valves exhibiting such deviations is composed of a portion without frequency sensitivity and one portion with a frequency characteristic. The part without frequency sensitivity is identical with the space-charge reduced shot noise current and in all cases agrees well with the theoretical value given by Rack's relationship. The frequency sensitive portion is explained by current or fluctuation noise.

"The reason for differences between the theoretical and practical values of the shot noise in high gain v.h.f. triodes." R. Thielert. *Nachrichtentechnische Zeitschrift*, 12, pp. 201-204, April 1959.

TELEVISION BROADCASTING IN AUSTRALIA

The November issue of our Australian contemporary is devoted entirely to papers on all aspects of television transmission and reception but particularly with reference to the television service established in 1956. The first two papers deal with a transmitter and a studio centre.

The ABN transmitter (operated by the Postmaster-General's Department for the national service) is located adjacent to the studio building at Gore Hill. High reliability is ensured by having standby, as well as main, transmitters for both vision and sound. A description is given of the video input equipment, the four transmitters, the r.f. output circuits, the aerial and the associated buildings and auxiliaries.

A general description is given of the ATN Television Centre, which is part of the commercial service. The Centre houses television studios, offices and the wide range of facilities and services necessary for the production of television programmes. Factors which influenced the design are outlined and the provision which has been made for the expansion of the Centre in accordance with the development of the industry is described.

"ABN television transmitter." F. M. Shepherd. "The ATN television centre." M. H. Stevenson. *Proceedings of the Institution of Radio Engineers, Australia*, 19, pp. 609-614, 614-621, November 1958.