

# The Journal of THE BRITISH INSTITUTION OF RADIO ENGINEERS

FOUNDED 1925

INCORPORATED 1932

*"To promote the advancement of radio, electronics and kindred subjects  
by the exchange of information in these branches of engineering."*

VOLUME 18

SEPTEMBER 1958

NUMBER 9

## NOTICE OF THE THIRTY-THIRD ANNUAL GENERAL MEETING

NOTICE IS HEREBY GIVEN that the THIRTY-THIRD ANNUAL GENERAL MEETING (the twenty-fifth since Incorporation) of the Institution will be held on WEDNESDAY, NOVEMBER 26th, 1958, at 6 p.m., at the London School of Hygiene and Tropical Medicine, Keppel Street, Gower Street, London, W.C.1.

### AGENDA

1. To confirm the Minutes of the 32nd Annual General Meeting held on November 27th, 1957. (Reported on pages 666-668 of Volume 17 of *Journal* dated December 1956.)
2. To receive the Annual Report of the Council. (To be published in October 1958 *Journal*.)
3. To elect the President.

The Council is unanimous in recommending the election of Professor E. E. Zepler, PH.D., as President of the Institution for the year 1958-59.

4. To elect the Vice-Presidents of the Institution.

The Council unanimously recommends the re-election of John L. Thompson and Professor Emrys Williams, PH.D., B.ENG., and the election of Air Vice-Marshal C. P. Brown, C.B., C.B.E., D.F.C., and Colonel G. W. Raby, C.B.E.

5. To elect the Ordinary Members of the Council.

In addition to the vacancies caused by the nomination of 2 Members as Vice-Presidents, the following members retire from Council in accordance with Article 28:

A. D. Booth, D.SC., PH.D. (*Member*); F. G. Diver, M.B.E. (*Member*); E. M. Eldred (*Member*); R. H. Garner, B.SC. (ENG.) (*Associate Member*); H. J. Leak (*Member*); Captain A. J. B. Naish, R.N., M.A. (*Member*); E. W. Pulsford, B.SC. (*Associate Member*).

In addition, S. J. H. Stevens, B.SC.(ENG.) (*Associate Member*) retires because of an overseas appointment.

Consequently, vacancies arise for ordinary members of Council as follows:—

7 Members; 3 Associate Members.

In accordance with Article 30, the Council nominates:—

- (a) Members for re-election: A. D. Booth, D.SC., PH.D.; F. G. Diver, M.B.E.; Captain A. J. B. Naish, R.N., M.A.
- (b) Members for election: A. A. Dyson, O.B.E.; R. H. Garner, B.SC.(ENG.); H. Schwarz, B.SC.; Professor D. G. Tucker, D.SC., PH.D.
- (c) Associate Member for re-election: E. W. Pulsford, B.SC.
- (d) Associate Members for election: T. B. Tomlinson, PH.D.; Major P. A. Worsnop.

Any member who wishes to nominate a member or members for election must deliver such nomination in writing to the Secretary, together with the written consent of such person or persons to accept office if elected, not later than October 6th, 1958. Such nomination must be supported by not less than 10 corporate members.

6. To elect the Honorary Treasurer.

The Council unanimously recommends the re-election of G. A. Taylor (*Member*).

7. To receive the Auditors' Report, Accounts and Balance Sheets for the year ended March 31st, 1958.

The Accounts for the General and other Funds of the Institution will be published in the October 1958 *Journal*.

8. To appoint Auditors and to agree their remuneration.

Council recommends the re-appointment of Gladstone, Jenkins & Co., 42 Bedford Avenue, London, W.C.1.

9. To appoint Solicitors.

Council recommends the re-appointment of Braund & Hill, 6 Grays Inn Square, London, W.C.1.

10. Awards to Premium and Prize Winners.

11. Any other business. (*Notice of any other business must reach the Secretary 40 days before the meeting.*)

## INSTITUTION NOTICES

### Institution Premiums and Prizes for 1957

The Council of the Institution announces that the following awards are to be made for outstanding papers published in the *Journal* during 1957:—

#### Clerk Maxwell Premium :

To T. B. Tomlinson, B.Sc., Ph.D. (Associate Member). "Principles of the Light Amplifier and Allied Devices," (published in March 1957).

#### Heinrich Hertz Premium :

To R. A. Waldron, B.A.(Cantab.) (Associate Member). "Theory of the Helical Waveguide of Rectangular Cross-section," (October 1957).

#### Louis Sterling Premium :

To A. van Weel, Dr. Techn. Sc. "The Design of Phase-linear Intermediate Frequency Amplifiers," (May 1957).

#### Brabazon Premium :

To W. Kiryluk (Associate Member). "The TALBE—a V.H.F. C.W. Radio Aid for Air/Sea Rescue," (September 1957).

#### Marconi Premium :

To D. H. O. Allen, B.A., and J. M. Winwood, M.A. "A Low-noise Travelling-wave Tube Amplifier for the 4,000-Mc/s Communications Band," (January 1957).

#### Leslie McMichael Premium :

To A. F. Wilkins, O.B.E., M.Sc., and E. D. R. Shearman, B.Sc.(Eng.). "Back-Scatter Sounding: An Aid to Radio Propagation Studies," (November 1957).

The recipients of prizes for outstanding performances in the Institution's Graduateship Examinations in 1957 will be:—

#### President's Prize :

Alan Robson (Graduate)  
(For the most successful candidate in Section B of the Examination):

#### S. R. Walker Prize :

Edward James Bassett (Student).  
(For the most successful candidate in Section A):

#### Electronic Measurements Prize :

Dennis Lewin Halton (Graduate).

The premiums and prizes will be presented by the President at the Annual General Meeting in London on Wednesday, 26th November.

Also to be awarded at the Annual General Meeting will be the Students' Essay Competition prize, which has been won by F. J. Shipgood. Mr. Shipgood's essay on "The Evolution of Radio Communication" was published in the June issue of the *Journal*.

Details of the subjects for the next essay competition will be published shortly.

### Obituary

John Hasson (Associate Member) died on the 27th June last, aged 47 years, following a brief illness. Mr. Hasson, who started his career as a Radio Officer in the Merchant Navy, was from 1936 to 1939 with the Post Office Engineering Department. He was then appointed Assistant Controller (Radio) in the Malayan Post and Telegraphs at Penang; during the occupation of Malaya he was interned. He resumed his appointment in 1945, and in 1949 was promoted to Controller of Telecommunications (Radio) in Kuala Lumpur. In 1957 he retired from the Malayan Government Service and returned to the United Kingdom, where he settled in Coulsdon, Surrey. Mr. Hasson was elected an Associate Member in 1947.

### Programme of Meetings

Folders giving details of all meetings of the Institution in London and of local Sections for the first half of the Session 1958-59 have been sent to all members in the British Isles. A similar folder for the meetings in the second half of the Session, that is, from January 1959 onwards, will be distributed in December.

Members are reminded that they may attend any meeting of the Institution, whether in London or elsewhere. Any member who resides in a district different from his permanent address should notify the Institution offices in order that he may be placed on the list of his local Section and receive regular information about the subjects of meetings.

### Indian Radio and Electronics Exhibition

The Indian Advisory Committee of the Institution recently organised an Exhibition at Bangalore, in association with the Society of Electronics Engineers, illustrating the work of the Indian Ministry of Defence Electronic Research and Development Establishment, Bangalore. The Exhibition showed the results of development work carried out by the Establishment with a view to bulk production by Indian industry for the Services. The Establishment is also concerned with standardization of electrical and electronic equipments, systems and accessories, and with evaluating the performance of new equipment.

# TROPOSPHERIC SCATTER SYSTEM EVALUATION\*

by

M. Telford, B.Sc. (Eng.)†

*Read before the Institution in London on 30th October, 1957.*

*In the Chair: Mr. D. W. Heightman (Member)*

## SUMMARY

A study of the mode of propagation and changes in attenuation found along typical paths forms the basis for the evaluation of signal strength requirements in the design of communication systems employing tropospheric scatter. A chart is presented to enable performance and/or equipment parameters to be determined for a wide range of conditions. Particular reference is made to the requirements of f.m. multi channel telephony systems. The economics, present engineering limitations, and possible future trends in such systems are discussed.

### 1. Introduction

In the course of the last decade numerous investigations, at frequencies considerably higher than may be propagated via the ionosphere, have shown the existence, "beyond the horizon," of radio signals the levels of which are greatly in excess of those predicted by classical diffraction theory. Although these signals are weak compared to free-space signals and are subject to deep and continuous fading of various types, they are present at all times. The median signal levels are sufficient to make relatively broadband communication practicable over distances of a few hundred miles without repeaters, although somewhat costly transmitting and receiving equipment is required. A number of operational communications systems using these signals have been established and are operating with considerable success. The number of radio "links" involved is probably well over a hundred.

The physical basis of the propagation mode involved, the so-called "tropospheric scatter" mode, will be discussed and a method of evaluating the requirements of a "scatter" communications system will be presented.

### 2. Propagation Theory

The following short discussion will refer primarily to the u.h.f. band (300-3000 Mc/s). It is within this band that the most extensive developments of tropospheric scatter systems have taken place and this position is likely to continue within the foreseeable future. In the v.h.f. band other long-distance modes of tropospheric propagation also assume considerable importance, but it is not very likely that there will be any large-scale exploitation in view of the difficulty of constructing very-high-gain aeriels and the already crowded state of this part of the frequency spectrum.

In the s.h.f. band there appears to be a tendency for the "scatter attenuation" to rise to a certain extent. It does not seem possible to counteract this completely by increased aerial gain because of the so-called "aerial-to-medium" coupling loss. This loss is caused by the non-uniform phase of the wave front across the aperture of a receiving aerial, arising from the random multi-path nature of scatter propagation. In addition, transmitters having the required high continuous-power output are not readily available for frequencies above 3000 Mc/s.‡

In common with any other propagation phenomenon involving change of direction,

\* Manuscript first received 30th October 1957, in revised form on 30th April 1958, and in final form 26th July 1958. (Paper No. 467.)

† Marconi's Wireless Telegraph Co. Ltd., Communications Division, Chelmsford.

U.D.C. No. 621.396.11.029.63

‡ Since this paper was written, klystron amplifiers with outputs of 1 or 2 kW in the higher frequency bands have become commercially available.

tropospheric scatter may be illustrated by the use of Huyghens' principle—that is, whenever a wave encounters a physical change in its propagation medium, secondary wavefronts are generated, the direction and character of which are determined by the nature of the obstacle. The most widely held view is that the necessary irregularities in the case of tropospheric scatter propagation consist of adjacent volumes of the atmosphere, formed by turbulent mixing, which differ in temperature, pressure, and content of water vapour and hence have differing refractivity. Theoretical investigations have been carried out by various authors<sup>1, 2, 3</sup> based on the above described model. An alternative model<sup>4</sup> is that of randomly distributed reflecting layers of limited extent, formed by relatively sharp vertical gradients in the refractive index of the atmosphere. Whichever view is taken, the result is that the irregularities cause sufficient energy to be scattered from the transmitted beam to allow reception below the optical horizon. The scattered signals arrive at the receiving aerial with random relative phase and amplitude: the resultant signal varies rapidly in amplitude, but the hourly median level is fairly steady through the day so long as weather conditions along the path remain constant. Very marked *seasonal* changes in level do occur and are mentioned later. Nevertheless, it is useful to establish a long-term median level about which the various types of fluctuation take place. This may best be done by using the concept of median path attenuation, or median basic transmission loss<sup>5</sup>, methods of calculation of which are discussed below.

**3. Calculation of Path Attenuation**

A number of methods have been proposed, one of the earliest being that due to K. Bullington<sup>6</sup> which is based on an empirical examination of a large volume of collected data. It is too early to say that any one method gives the best results over the whole range of variables; the most comprehensive appears to be that of K. A. Norton<sup>5</sup> based on the Villars-Weisskopf scatter theory. Equations for path attenuation derived from the work of Norton and Bullington are compared below:

Bullington:  $L = 20 \log f + 80 \log d - 44.6$  (in db) .....

Norton:  $L = 30 \log f + 30 \log d + 50 \log \theta + F_a + G + H_t + H_r - 30.2$  (in db) .....

Equation (1) is the result of combining the usual expression for free-space attenuation between isotropic radiators, as a function of frequency and distance, with the relationship between scatter loss and distance given in Fig. 4 of ref. 6. Equation (2) is a direct conversion, to the units concerned, of eqn. (29) in ref. 7, with some alterations in the symbols used. In both equations *L* is the median path attenuation between isotropic radiators, *f* the frequency in Mc/s and *d* the path length in km.  $\theta$  is the scatter angle<sup>5</sup>, i.e. the angle between the directions of radiation of the transmitting and receiving aerials, in milliradians.

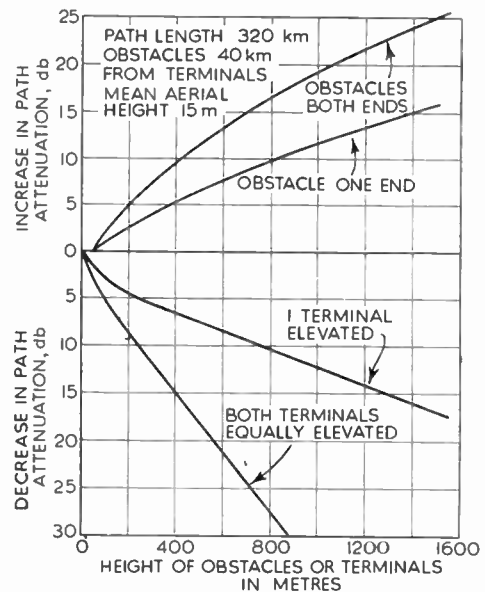

Fig. 1. Effect of topography on path attenuation.

The subsidiary terms in eqn. (2), *F<sub>a</sub>*, *G*, *H<sub>t</sub>* and *H<sub>r</sub>*, have been fully explained and evaluated by Norton<sup>5, 7</sup>, but a brief statement on their significance may not be out of place here. *F<sub>a</sub>* is an asymmetry factor, which is only required when a path is made asymmetrical by, for example, different terminal heights at the two ends. *G* is Norton's "blob size correction factor" and makes allowance for the observed

decrease in the scale of turbulence and hence in the efficiency of scattering, when the scatter volume is close to the earth's surface.  $H_t$  and  $H_r$  (Norton's "frequency-gain functions") allow for the increased path attenuation that results from combination of the direct and ground-reflected waves when the aerials are not greatly elevated above the surrounding terrain. They do not include the full effect of change of aerial height on path attenuation, since the scatter angle  $\theta$  is also affected. All the above factors arise in the process of integration over the scatter volume used by Norton to determine the scatter attenuation. Except at low frequency and over short paths their values are generally small.

The equations differ in important respects. Firstly, eqn. (1) allows no correction to be made for the effect of irregular terrain on the zenithal angle of radiation and hence on the scatter angle and the path attenuation. Considering the mode of propagation, it is obvious that the attenuation must be sharply dependent on scatter angle, which represents the deviation from the direct-ray path. Secondly, in eqn. (2) the dependence on frequency appears sharper than in eqn. (1), and thirdly, the subsidiary terms are neglected in eqn. (1). Over smooth earth paths, for frequencies in the range 100-1,000 Mc/s, there is however little difference in the results, due to the decrease with frequency of  $G$ ,  $H_t$ ,  $H_r$ , offsetting the sharper rise of the basic frequency term. Above 1,000 Mc/s  $G$ ,  $H_t$ ,  $H_r$ , approach zero. So far the great majority of tests have been made at frequencies below 1,000 Mc/s, so that the frequency dependence of Norton's equation cannot be said to have been definitely proved.

The effect of terrain on path attenuation is shown in Fig. 1, in which the curves are plotted from eqn. (2). The upper pair gives the increase of attenuation due to mountain obstacles 40 km distant from the ends of a 320 km path and the lower pair the decrease in attenuation which results from elevation of the terminals above a 320 km smooth earth path. These curves serve to emphasize the importance of proper terminal siting.

It is of interest to note the extent to which the results of certain propagation tests carried out under different conditions of terrain,

climate and frequency, etc., have confirmed the Norton formula. According to the authors of two recent papers<sup>8,9</sup>, tests at 858 Mc/s over distances of 98, 187 and 200 miles and on a 173-mile path at 3,480 Mc/s have given median path attenuation figures within 6 db of those

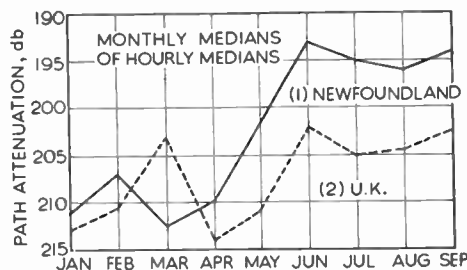

Fig. 2. Seasonal level variations.

calculated. The level of the "scatter-type" signal at 200 Mc/s over a 200-mile path from Portsmouth to Coverack<sup>10</sup> checks almost exactly with that derived from the Norton equation. V.h.f. tests over a path from Cyprus to Israel<sup>11</sup> gave a 6 months median level (July-December) equivalent to a path attenuation of 152 db, but the trend of the results was such as to suggest that the yearly median would have been about 6 db lower; the figure obtained from eqn. (2) is 161 db. On the other hand, tests at about 900 Mc/s over a 91-mile path in the U.S.A.<sup>12</sup> gave a median level some 20 db lower than the calculated value. The "scatter point" for this path was directly above the urban area of New York—whether this has any significance or not remains to be seen. Another series of tests (results not published) at 80 Mc/s over an 83-mile path in the Persian Gulf gave the median path attenuation as 25 db less than the calculated value. However, in view of the low frequency, short distance and unusual climatic conditions of the area, it is certain that propagation modes other than "scatter" must have played a major part in the tests. Out of some 15 reported sets of data which have been checked against eqn. (2), only the above two have been more than 6 db out.

**4. Allowances for Fading, Climatic Conditions, etc.**

On the available evidence it may be concluded that for u.h.f. paths of, say, 150-500 km

length under average climatic conditions a reasonably satisfactory method exists for the calculation of the median path attenuation. Attempts have been made<sup>13</sup> to extend this method by means of a climatic correction factor based on the surface index of atmospheric refraction, but there is not very much evidence to suggest that this correction is reliable in application. However, there is a strong possibility that median path attenuation in tropical regions, particularly over sea, may be 10-20 db lower than in temperate regions for the same scatter angle and frequency, etc. There have also been reports that in Arctic regions the path attenuation tends to rise. Highly accurate planning for all conditions of climate and terrain will not be possible until much more experimental evidence has become available. Long-period surveys are strongly recommended in new areas before any communications scheme is planned, to ensure an economic and reliable system as well as to provide more basic propagation information.

On the majority of paths so far investigated, hourly and even monthly median levels vary widely through the year. Fig. 2 shows the variation of monthly median path attenuation for two series of tests, one path being about 150 miles long and situated in Newfoundland<sup>14</sup>, the other being a 200-mile path situated in this country<sup>8</sup>. In the Newfoundland test (Fig. 2, curve 1) there was a difference of 19 db between the highest and lowest monthly medians and the standard deviation of hourly median signal level with respect to long term was 9 db. The corresponding figures for the British test (Fig. 2, curve 2) were 12 db and about 6 db. In both cases the distribution of hourly median levels approached log-normal. For general system planning work, in the absence of reliable measured propagation data, the author assumes a log-normal distribution with a standard deviation of 8 db. This is not likely to be an optimistic assumption for the majority of paths. A decrease of slow fading depth with length of path has been reported,<sup>15</sup> but the evidence appears rather slender.

In addition to the slow variation of signal level, rapid fading occurs, presumably due to multipath effects. The hourly distribution of instantaneous signal level, at u.h.f., has in many tests been found to approximate to the Rayleigh

distribution. This would be expected from a composite signal originating from a number of adjacent scatter paths. The mode of propagation and the resulting character of the signal suggest that diversity operation should lead to a considerable improvement in system performance, although of course it cannot affect slow fading. Operational experience has in fact shown that the anticipated improvement does occur. Its extent may be gauged from curves which show, under various conditions, the distribution of the instantaneous signal level with respect to the long-term median, taking account of both slow and rapid fading. Fig. 3 includes the following curves:—

1. Assuming Rayleigh fading within the hour and a log-normal distribution, with a standard deviation of 8 db, of hourly median levels with respect to long-term median.
- 2, 3. As 1 but including the effects of dual and quadruple diversity, respectively, assuming complete lack of correlation of signals on the separate diversity paths and ratio-squared combination of the base-band signals. The methods of Staras<sup>16</sup> have been used in evaluating the effects of such combination but an empirical allowance has been made for the deterioration resulting from the threshold effect in f.m. systems.
- 4, 5. Rayleigh fading within the hour, dual and quadruple combination diversity, no slow fading. These curves give the lower limiting values in evaluation of fading margins. In practice the necessary fading margin to establish protection for a given time percentage is likely to lie somewhere between one of the curves 2, 3, and one of 4, 5, depending on the order of diversity and the character of the path.

In planning a system it is important to establish the margin between predicted long-term median signal level and that level which the achieved instantaneous signal may be confidently expected to exceed for a specified high proportion of time. For a dual diversity telephony system a value of 30 db might be regarded as adequate for this margin, made up of 20 db for protection during 99 per cent. of time (Fig. 3, curve 2) and 10 db to cover uncertainties in the prediction of path attenuation and other system constants. With

quadruple diversity the overall figure could be reduced to, say, 25 db (Fig. 3, curve 3). Subsequent discussion and calculation will refer to dual diversity only since the effects of quadruple diversity can be assessed by considering it as equivalent to an increase of approximately 5 db in system gain.

If reliable long-term radio survey data is available for a given path it should be possible to deduce the required safety margin more accurately. If it is required to transmit telegraph signals by means of voice frequency tones within the "speech" channels of an f.m. system, the margin should be increased or automatic error correcting equipment specified. The effect of inadequate margin is that short bursts of noise occur as the signal level falls below threshold. This might be tolerable in a speech circuit, but could lead to an unacceptably high telegraph error rate at certain times of the year.

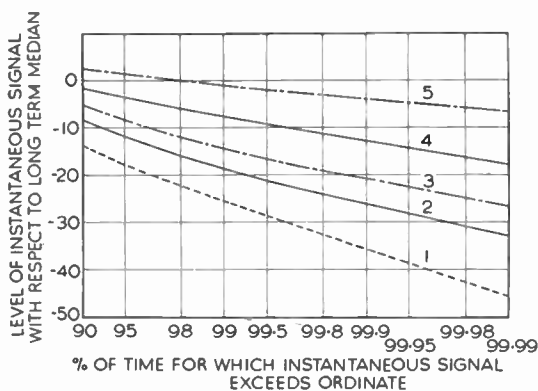

Fig. 3. Distributions of fading signal.

1. Rayleigh rapid fading, Gaussian slow fading; non-diversity.
2. As 1; dual diversity.
3. As 1; quadruple diversity.
4. No slow fading; dual diversity.
5. As 4; quadruple diversity.

### 5. Modulation Methods and the Necessary Received Signal Levels

To the communications engineer, the natural application of tropospheric scatter is to extend the range of multi-channel radio telephony systems—particularly where physical conditions make the provision of intermediate repeater stations difficult. Because of relative simplicity in equipment and the possibility of obtaining improved performance on a bandwidth exchange basis, frequency modulation of

a carrier by a multiple signal containing single-sideband channels in frequency division multiplex (f.d.m.) is the most popular technique for line-of-sight systems, and has been used on nearly all the operational tropospheric scatter systems so far installed. There is some controversy at present on the relative merits of f.m. and direct s.s.b. a.m. of the carrier by the multi-channel signal. F.m. transmission would appear to have economic advantage when quality must be kept reasonably high. In view of the continuing tendency towards higher quality on communications networks, it would seem to be a retrograde step to advocate a system which shows up best only for low performance standards. There may be cases where s.s.b. a.m. will be useful however, and it does have certain advantages in respect of bandwidth utilization. Even with f.m. some compromise in quality must for the present be tolerated on tropospheric scatter systems, for economic reasons.

The low level and rapid deep variations of the received signal make a different approach to the planning problem necessary from that used for "line-of-sight" systems. In particular, if the maximum range possibilities of an f.m. system are to be exploited, the received signal must be allowed to approach the "threshold" (i.e. the peak noise level) in the i.f. stages, at the bottom of fades. Thus it is necessary that the i.f. bandwidth should be kept as small as possible in order that the threshold may be low. On the other hand, it is desirable that the signal-to-noise ratio in individual channels, which increases with deviation index and hence with bandwidth, should not be less than some predetermined value. The i.f. bandwidth, in conjunction with whatever margin above threshold is decided on, will determine the path attenuation (or the range) that can be tolerated with a system of given gain, and the required signal-to-noise ratio at threshold will determine the number of channels allocated to this bandwidth. In line-of-sight systems there is rarely any question of the signal level reaching the threshold so that such criteria do not apply directly.

For planning a commercial quality f.d.m. f.m. telephone system over an untested path, assuming adequate information on the physical characteristics of the path and dual diversity

operation, the following performance criteria are tentatively proposed:

- (i) Margin of long-term median received signal above threshold—30 db.
  - (ii) L.t.m. test-tone signal-to-receiver noise ratio in top channel, on systems without pre-emphasis - 62db.
- } i.e. signal/noise at threshold  
} 32 db.

The above values do not represent very high standards—economic factors as well as quality have had to be considered in deciding them.

The margin above threshold is simply the fading and uncertainty margin derived in the previous section. The somewhat arbitrary method of deciding on the 62 db figure for test-tone signal-to-noise ratio has been given in a previous paper<sup>17</sup>. It is assumed that receiver noise will be the limiting factor in tropospheric scatter system design, at least during the important small fraction of the time when signal level is low. At times when the signal level is relatively high, intermodulation noise may be greater than receiver noise, unless the deviation per channel is kept at a low figure. If it is accepted, however, that the signal-to-receiver-noise ratio will fall to, say, 30-40 db for a small but appreciable fraction of the time, there is little point in designing for a signal-to-intermodulation noise ratio greater than 40-50 db or a penalty will be paid in respect of increased receiver bandwidth and hence in greater susceptibility to bursts of noise due to signal fading below threshold level. Taking into consideration the above arguments the following empirical formula may be used for calculation of receiver i.f. bandwidths:—

$$B_{IF} = 2K(F + 1) f_m \dots\dots\dots(3)$$

*K* being the index of test-tone deviation per channel, *F* the multi-channel loading factor and *f<sub>m</sub>* the mid-frequency of the top speech-channel in the frequency multiplexed a.m. signal.

The method of calculation of the values of i.f. bandwidth from the above equation, for a given number of channels and test-tone signal-to-noise ratio at threshold, has been described elsewhere<sup>17</sup>.

### 6. Calculation of Received Signal Level and Main Equipment Parameters

Using the path attenuation concept, received signal level is simply obtained from the following equation:—

$$P_R = P_T + G_T + G_R - L_F - L_A - L \dots\dots\dots(4)$$

where *P<sub>R</sub>* is received signal power } in dbW.  
*P<sub>T</sub>* is transmitted power }

*G<sub>T</sub>* and *G<sub>R</sub>* are the gains of the transmitting and receiving aerials over isotropic radiators, *L<sub>F</sub>* is the feeder loss, *L<sub>A</sub>* the so-called “aerial-to-medium” coupling loss, and *L* the path attenuation, all in db. The first five terms on the right-hand side of the equation may be thought of as the “system gain.”

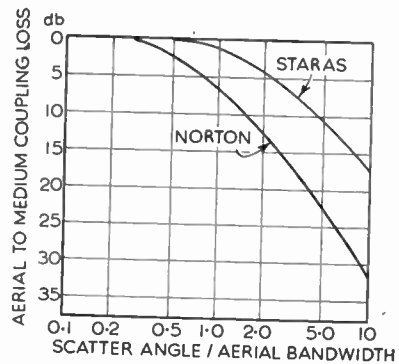

Fig. 4. Estimates of aerial to medium coupling loss.

The feeder loss is assumed to include that in any duplexing filters used and possibly also that in r.f. band-pass filters at the receiver, although this is sometimes included in the receiver noise factor. Aerial-to-medium coupling loss occurs because of phase incoherence across the aperture of large receiving aerials and is a function of aerial beamwidth and path length or scatter angle. Fig. 4 shows a comparison of the values for this parameter plotted against the ratio scatter angle/aerial beamwidth, as evaluated by two methods<sup>5, 18</sup>. It is apparent that there is considerable disagreement between them but either method leads to the conclusion that there is a limiting aerial size beyond which increased gain may not be economically achieved. The few measurements reported seem to indicate that actual values lie roughly mid-way between the curves of Fig. 4.



A typical figure for path attenuation is 200 db, while (for a 1 Mc/s bandwidth) the necessary received signal level allowing 8 db receiver noise factor, 10 db peak/mean ratio for white noise and 30 db margin, is 96 dbW. Thus, for the example, the system gain must be 104 db, relative to the use of isotropic aerials and 1 watt of transmitter power. This can be made up of 73 db for aerials (30 ft dishes each end, 60 per cent. illumination efficiency, frequency 900 Mc/s), 40 db for transmitter (10 kW klystron amplifier), less, say, 4 db for feeder and filter losses and 5 db for  $L_A$ . The aerials used in practice are nearly all of the reflector type, ranging from 10 to 120 ft in major aperture dimension. Up to 30 ft they are generally circular (Fig. 5), but for greater size rectangular elevation self-supporting structures ("billboard" aerials) are gaining favour. The dimensional tolerance of the reflector profile from the theoretical curve must ideally be a small fraction of a wavelength and hence at u.h.f. the mechanical problem is severe. Cost appears to be roughly proportional to the major dimension of the aperture raised to a power between 2 and 3, so that very large aperture aerials are not economically advantageous, particularly when the effects of aerial-to-medium loss are also considered.

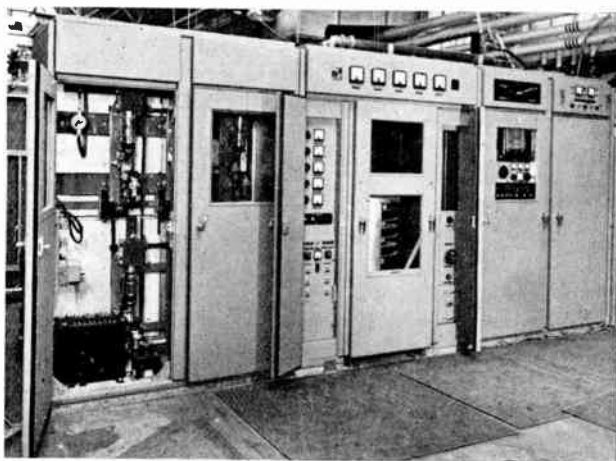

Fig. 5. 30 ft parabolic dish aerial with dual polarization horn feed.

Figure 6 shows two current designs of high-power amplifiers; the first has 1,000-500 watts output in the frequency range 470-900 Mc/s, using a tetrode valve in the final stage; the second gives 10 kW output, 700-960 Mc/s, and uses a 4-cavity klystron with a gain of about 35 db. The latter valve is liquid-cooled, but



(a)



(b)

Fig. 6. Tropospheric scatter transmitters. (a) 500 watts 470-900 Mc/s. (b) 10 kW 720-960 Mc/s.

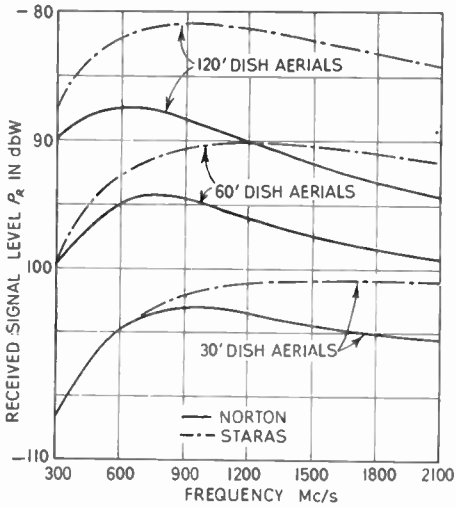

(a)

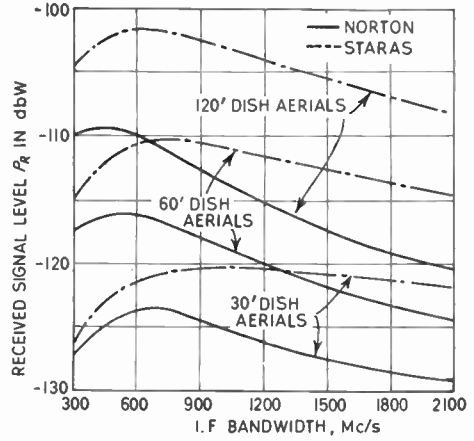

(b)

Fig. 7. Effect of frequency and aerial size on received signal. (a) Scatter angle  $\theta=20$  milliradians. (b) Scatter angle  $\theta=40$  milliradians.

air cooling is used for klystron amplifiers of 1 or 2 kW output. Experimental klystrons of up to 50 kW output have been designed.

In attempting to assess the optimum frequency for tropospheric scatter systems, aerial-to-medium loss, scatter angle and aerial size are among the parameters to be considered. Figs. 7 (a) and (b) show long-term median received signal plotted against frequency for scatter angles of 20 and 40 milliradian (equivalent to path lengths of about 200 and 380 km respectively over smooth earth) and for

dish sizes ranging from 30 to 120 ft. On each figure the full-line curves have been obtained using Norton's methods of calculation throughout but the broken curves include the Staras calculation of aerial-to-medium coupling loss (Fig. 4). It will be noted that the optimum frequency decreases with increase of both dish size and scatter angle, and that it is always higher when the Staras data is used.

The receivers in current use do not differ widely from those of conventional f.m. multi-channel equipments and generally have inter-

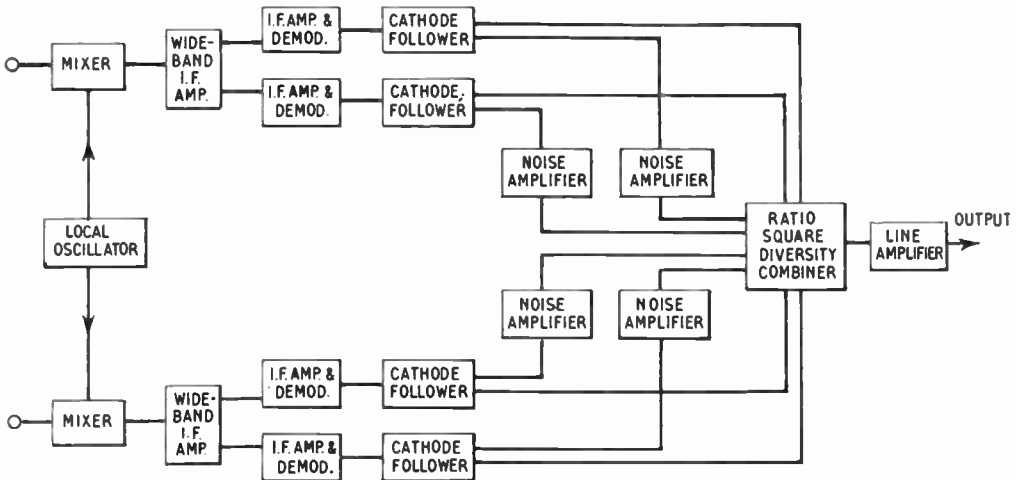

Fig. 8. Block diagram of quadruple diversity receiver.

mediate frequency stages operating in the range 30-70 Mc/s. It is important to attempt to realize the lowest possible noise factor and special efforts have been made to this end. Of course the diversity requirement means multiple paths through the receiver as far as the diversity combiner, which invariably operates at base-band frequency. Ratio-square diversity combining or some variant of it is favoured. Its use does not lead to any great advantages over the method of selection of the strongest path, in terms of signal-to-noise ratio, but switching clicks and the finite level difference necessary for selection in a switching system are eliminated.

A block schematic of a typical receiver for quadruple diversity operation is shown in Fig. 8.

7. Performance of Tropospheric Scatter Systems

All the more important parameters required for tropospheric scatter system planning and evaluation have now been considered. One convenient method of presenting results of calculations based on these parameters is the chart shown in Fig. 9. This chart has been computed for a carrier frequency of 900 Mc/s but because of the slow variation of received signal with frequency it is accurate, in so far as the methods used in its compilation are correct, to within a decibel or two over the frequency range 600-1,200 Mc/s. It combines a series of curves showing range (or path attenuation) plotted against i.f. bandwidth with another series showing number of channels plotted against i.f. bandwidth. Using them the necessary system parameters for a given range and number of channels may be quickly calculated,

or the performance of a system of given gain assessed.

The range curve marked 0 db is for a reference system having 1 kW transmitters, 30 ft diameter dish aerials, and 30 db margin of long-term median signal above threshold level. Other range curves are marked with figures for system gains relative to the reference system. The channel capacity curves are for a signal-to-noise ratio at threshold of 32 db (A and C) and 22 db (B and D). The following is an example of the use of this chart.

A system is required to operate with 60 channels over a smooth earth path 250 km long. From curve A, for 32 db signal/noise at threshold, a 60-channel capacity system requires an i.f. bandwidth of about 2 Mc/s. Imagine a point on the chart with co-ordinates 2 Mc/s, 250 km. It lies between range versus bandwidth curves marked +13 and +17db, say at

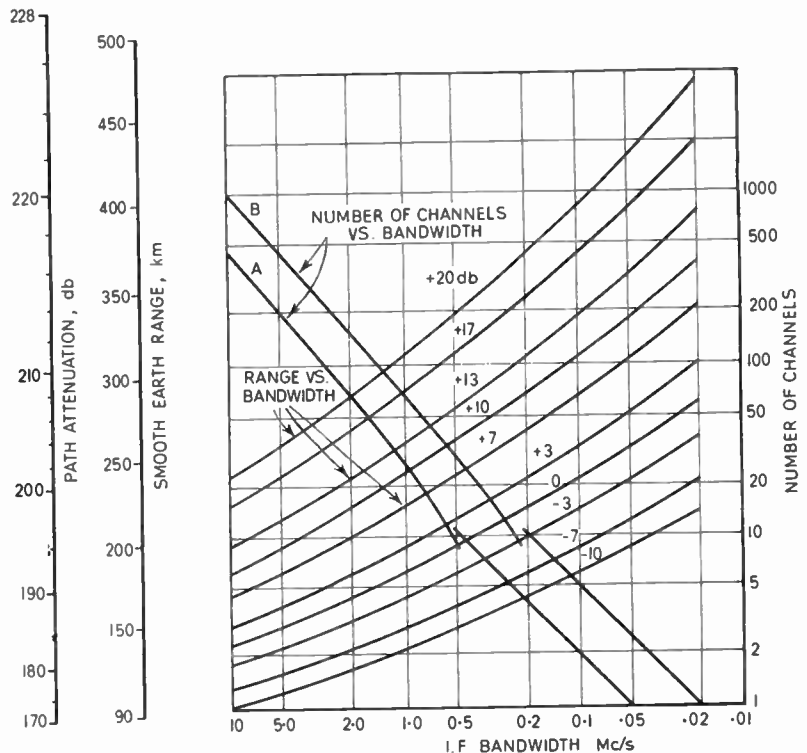

Fig. 9. Optimum utilization for f.d.m. f.m. on 900 Mc/s.

+14 db. Thus for the reference system the realized margin above threshold would be 30 - 14 = 16 db, corresponding (Fig. 3, curve 3)

to about 99.5 per cent. reliability, as expressed by percentage time above threshold, for a quadruple diversity system, and 98 per cent. reliability for a dual diversity system (Fig. 3, curve 2). It is apparent that some more gain is necessary particularly if a safety factor is to be allowed in the calculations. This gain could be supplied by the use of a 10 kW transmitter (10 db) or 60 ft dishes (7-10 db). The system might well be thought to be reliable enough with either of these alternatives plus quadruple diversity.

Direct use of the chart is limited to a certain extent by the values allocated to the various factors involved in its preparation (i.e. receiver noise factor, signal/noise ratio at threshold, and margin above threshold). However, it can be used more generally; for example, the different curves nominally representing increased or decreased system gain may also be used for changes in signal quality with a constant system gain, provided it is remembered that margin above threshold and channel signal-to-noise will vary together. An improvement in receiver noise factor gives an equal improvement in signal quality. These points have been further illustrated in examples given in another paper<sup>17</sup>.

A study of Fig. 9 will reveal the fact that economical and practicable tropospheric scatter systems of reasonable quality appear at present to be limited in range to about 400 km, even for a few channels, except under very favourable conditions of terrain or climate. One American path (Florida to Cuba) has been reported to have a median path attenuation about 15 db lower than predicted from the standard method of calculation. In this case it is proposed to install 120 telephone channels or an alternative television relay channel over a range of some 300 km using 10 kW transmitters and 60 ft "billboard" aerials.

**8. System Economics**

Table 1 shows a comparison of the cost of three arrangements, which meet a requirement for a total route length of 800 km and a channel capacity of 60. Allowing for the cumulative increase in noise through the system, four hops using 10 kW transmitters and 30 ft dishes are specified. The radio equipment cost is shown in the left-hand column, £260,000, and the total capital cost, including buildings, channelling equipment, etc., £424,000, i.e. about £14 per channel/mile. Of course, it must be realized that these figures are typical and there will be

**Table 1**  
60-Channel System Costs for 800 km Route

|                                      | <i>A</i>                      | <i>B</i>                      | <i>C</i>                      |
|--------------------------------------|-------------------------------|-------------------------------|-------------------------------|
| 10 kW Amplifier ... ..               | £13,000                       | £13,000                       | £26,000 (2)                   |
| Drive ... ..                         | £ 2,000                       | £ 2,000                       | £ 3,000                       |
| Receiver ... ..                      | £ 3,000                       | £ 3,000                       | £ 4,000                       |
| Two Dishes + Feeders & Filters       | £12,000                       | £42,000                       | £15,000                       |
| Channelling Equipment ...            | £ 6,000                       | £ 6,000                       | £ 6,000                       |
| Test Equipment, etc. ... ..          | £ 1,500                       | £ 1,500                       | £ 1,500                       |
| <b>Total for Radio Equipment ...</b> | <b>£37,500 × 8 = £260,000</b> | <b>£67,500 × 6 = £405,000</b> | <b>£55,500 × 6 = £333,000</b> |
| Buildings, etc. ... ..               | £ 6,000                       | £ 6,000                       | £ 7,000                       |
| Installation ... ..                  | £ 5,000                       | £ 6,000                       | £ 6,000                       |
| Standby Power Plant ... ..           | £ 9,500                       | £ 9,500                       | £14,000                       |
|                                      | <b>£20,500 × 8 = £164,000</b> | <b>£21,500 × 6 = £129,000</b> | <b>£27,000 × 6 = £162,000</b> |
| <b>Totals ...</b>                    | <b>£424,000</b>               | <b>£534,000</b>               | <b>£495,000</b>               |

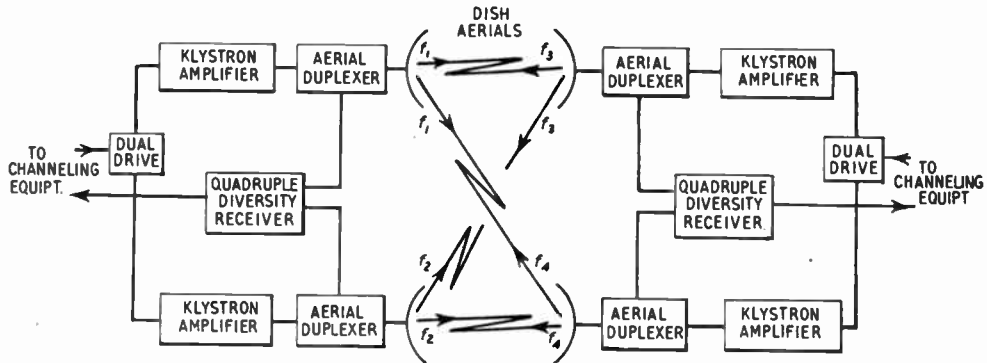

Fig. 10. Arrangement of quadruple diversity tropospheric scatter system. The difference between transmitted frequencies at each terminal (e.g.  $f_1$  and  $f_2$ ) is about 5 Mc/s.

considerable variations, depending on the country in which the system is installed, the source of supply of equipment, etc.

By the use of 60 ft dishes a gain of 8 or 10 db on each path could be expected, and hence only three hops would be required. The relevant costs are shown in the centre columns of Table 1. On radio equipment only the balance is in favour of the 30 ft dish system but on total capital outlay the difference is less. The advantage of having to maintain and possibly staff four stations instead of five must also be considered.

A further alternative is given in the third column. This postulates quadruple diversity, obtained by having two transmitters operating on frequencies spaced by a few Mc/s, in conjunction with space diversity reception. This does not require any more dish aerials since one transmitter and two receiver paths may be combined into each aerial using suitable filtering arrangements and dual polarization. A schematic diagram of such a system is shown in Fig. 10. It will be observed that there are four distinct paths between the transmitting and receiving aerials in each direction. Hence the separation in frequency between the two transmitters is not essential to the diversity action, but is used so as to be able to separate the two paths terminating at each receiver, in advance of the baseband combiner.

It is apparent from Table 1 that the cost of the quadruple diversity system using 30 ft dishes lies between the other two. On the other hand the route performance may be slightly inferior,

since the additional diversity gain may be 2 or 3 db less than that achieved by increasing dish size from 30 to 60 ft. It does have the great advantage, however, that operation at reduced level can continue in the event of failure of one transmitter or one or more receiver paths.

This type of system is often referred to as "active standby", and is usual to adopt it for cases where high reliability and continuity of communication are essential. When propagation conditions are good, only one transmitter need be operated at each terminal, thereby saving on running costs, but the extra gain, effectively greater than that which would be obtained by simple paralleling of the transmitters, is available when the path attenuation is high.

### 9. Limitations on System Performance and Application

The tropospheric scatter mode of propagation offers a basis for the engineering of multi-channel telephony circuits under conditions where the provision of the established type of system, relying on microwave link or cable connection, is not possible for geographical, economic, or political or military reasons. There is certainly no intention, however, of claiming that the scatter system will eventually replace the more conventional type; a realistic view would be that it is a supplement to existing techniques, another tool in the kit of the communications system engineer. At present it suffers from certain drawbacks, of both an economic and a technical nature, which would

seem to indicate that its applications will remain restricted in the foreseeable future at least.

For example, from the chart of Fig. 9, it may be seen that the single-hop range for a high information capacity, exceeding 120 or 240 telephone channels say, is at present limited to some 200 km. Under these conditions the tropospheric scatter system will hardly be competitive. It must be further borne in mind that Fig. 10 has been based on standards of performance which are some 20 db below those laid down by the C.C.I.R for multi-channel radio links which are to be suitable for connection into the international telephone network<sup>19</sup>. There is little doubt that the great majority of high channel capacity systems will, in future, have to conform to these standards.

Even if the transmitter output power can be substantially increased, or the sensitivity of the receiving equipment can be improved, there will still remain a fundamental limitation in the propagation mode itself—that of intermodulation noise caused by multipath delay effects. With presently proposed channel capacities this is only a marginal problem, but if the above-mentioned developments occur, giving rise to expectations of higher performance standards or greater range, there is no doubt that it will assume considerable importance. Since maximum delay time is proportional to beamwidth, increase of aerial size is one possible step towards a solution, but at rather a high price, particularly considering that a proportionate increase of realized aerial gain is not achieved.

A further point, which doubtless deserves extensive consideration, is the interference potentiality of tropospheric scatter systems. Effective radiated powers of the order 100 megawatts are in current use and even though it may be claimed that the area of the earth's surface illuminated with a high field strength is relatively small, owing to the narrow aerial beamwidths used, the problem cannot be disregarded. The perfect aerial, lacking minor lobes of radiation, has yet to be designed.

It should also be mentioned that reflections from aircraft, sometimes shifted in frequency by the Doppler effect, have been observed during many tests. They generally give rise,

on a frequency-modulated system, to rapid deep fading, with signal minima well below threshold, although the general signal level may be enhanced. There is no doubt that frequent occurrences of this nature would lead to a considerable deterioration of performance, so that it is advisable to site terminals away from airports and air routes whenever possible.

Finally, although the use of scatter for television relaying has not been discussed here, references to the possibility of this have been made in various quarters. The range, over smooth earth, of a tropospheric scatter link employing 10 kW transmitters, 60 ft dish aerials and quadruple diversity, is only about 100 miles if it is required to relay a television signal of 3 or 4 Mc/s bandwidth to C.C.I.R. standards using conventional modulation methods, under the most common propagation conditions. Hence striking advances in technique are obviously essential before, for example, a Trans-Atlantic television relay system will become possible, considering the fact that certain of the stages involved are about 300 miles long.

#### 10. Future Developments and Conclusion

Extensive developments of communications systems employing the mode of propagation discussed in this paper have already taken place and there is no doubt that such developments will continue. The techniques used differ only in scale from those employed by conventional line-of-sight links, so that improvements in receiver sensitivity or bandwidth utilization will be applicable to both the established and the new type of system. However, if such improvements lead to substantial reduction in required transmitter power or aerial gain they will have greater effect on the cost and applicability of scatter. Recent developments in solid state physics which offer the possibility of receivers with very low inherent noise may herald a particularly relevant advance in technique. Other well-established noise reducing devices, such as compandors, may find more immediate application.

In conclusion, it may be said that although much propagation information is now available, there still remains a great need for radio surveys in the accurate and economic planning of systems.

**11. Acknowledgment**

The author wishes to acknowledge the permission, granted by the Engineer-in-Chief of Marconi's Wireless Telegraph Co. Ltd., to publish this paper.

**12. References**

1. E. C. S. Megaw, "Scattering of electromagnetic waves by atmospheric turbulence," *Nature, Lond.*, **166**, p. 110, 1950.
2. H. G. Booker and W. E. Gordon, "Theory of radio scattering in the troposphere," *Proc. Inst. Radio Engrs*, **38**, p. 401, 1950.
3. F. Villars and V. F. Weisskopf, "On the scattering of electromagnetic waves by turbulent atmospheric fluctuations," *Proc. Inst. Radio Engrs*, **43**, p. 1232, 1955.
4. H. T. Friis, A. B. Crawford and D. C. Hogg, "A reflection theory for propagation beyond the horizon," *Bell Syst. Tech. J.*, **36**, p. 627, 1957.
5. K. A. Norton, P. Rice and L. E. Vogler, "The use of angular distance in estimating transmission loss and fading range for propagation through a turbulent atmosphere over irregular terrain," *Proc. Inst. Radio Engrs*, **43**, p. 1488, 1955.
6. K. Bullington, "Radio transmission beyond the horizon in the 40-4,000 Mc/s band," *Proc. Inst. Radio Engrs*, **41**, p. 132, 1953.
7. K. A. Norton, "Point-to-point relaying via the scatter mode of tropospheric propagations," *Trans. Inst. Radio Engrs*, **CS-4**, No. 1, p. 39, 1956.
8. G. C. Rider, "Some tropospheric scatter propagation measurements and tests of aerial siting conditions at 858 Mc/s," *Proc. Instn Elect Engrs*, Paper No. 2528R, January 1958. (**105B**, Supplement No. 8, p. 143, 1958.)
9. B. C. Angell, J. B. L. Foot, W. J. Lucas and G. T. Thompson, "Propagation measurements at 3,480 Mc/s over a 173-mile path," *Proc. Instn Elect. Engrs*, Paper No. 2510R, January 1958. (**105B**, Supplement No. 8, p. 128, 1958.)
10. F. A. Kitchen, E. G. Richards and I. J. Richmond, "Some investigations of metre-wave radio propagation in the trans-horizon region," *Proc. Instn Elect. Engrs*, Paper No. 2509R, January 1958. (**105B**, Supplement No. 8, p. 106, 1958.)
11. M. W. Gough, "Some features of v.h.f. tropospheric propagation," *Proc. Instn Elect. Engrs*, **102B**, p. 43, January 1955.
12. F. G. Altman, R. E. Gray, A. G. Kandoian and W. Sichak, "900 mc PTM over-the-horizon radio link," *Trans. Inst. Radio Engrs*, **MTT-3**, No. 6, p. 22, 1955.
13. B. R. Bean, "Some meteorological effects on scattered radio waves," *Trans. Inst. Radio Engrs*, **CS-4**, No. 1, p. 32, 1956.
14. K. Bullington, W. J. Inkster and A. L. Durkee, "Results of propagation tests at 505 mc and 4,090 mc on beyond-horizon paths," *Proc. Inst. Radio Engrs*, **43**, p. 1306, 1955.
15. G. L. Mellen, W. E. Morrow, A. J. Pote, W. H. Radford and J. B. Wiesner, "UHF long-range communications systems," *Proc. Inst. Radio Engrs*, **43**, p. 1269, 1955.
16. H. Staras, "Statistics of combiner diversity," *Proc. Inst. Radio Engrs*, **44**, p. 1057, August 1956 (Correspondence).
17. M. Telford, "Communications potentialities of tropospheric scatter," *Point-to-Point Telecommun.*, **1**, No. 2, 29, 1957.
18. H. Staras, "Antenna to medium coupling loss," *Trans. Inst. Radio Engrs*, **AP-5**, No. 2, p. 228, 1957.
19. C.C.I.R., Documents of the VIIIth Plenary Assembly, Warsaw, 1956, Recommendation No. 200.

# APPLICANTS FOR ELECTION AND TRANSFER

As a result of its August meeting the Membership Committee recommended to the Council the following elections and transfers.

In accordance with a resolution of Council, and in the absence of any objections, the election and transfer of the candidates to the class indicated will be confirmed fourteen days after the date of circulation of this list. Any objections or communications concerning these elections should be addressed to the General Secretary for submission to the Council.

## Transfer from Associate Member to Member

DANZIGER, Rudolf. *Tel-Aviv.*

## Direct Election to Associate Member

ANDERSON, Thomas. *Malvern.*

COOKE, Dick. *Scunthorpe.*

DEAN, Noel Spencer, B.Sc., Dip.El. *Wigan.*

ELLISON, Ernest John. *London, S.E.2.*

GWYNN, Samuel Betton. *Portslade.*

O'CONNOR, Joseph Francis. *Poulton-le-Fylde.*

ROBERTS, Sqdn. Ldr. William Jeffrey, Dip.El., R.A.F. *London, S.W.1.*

WINTERBOTTOM, John Frank, B.Sc. *Lichfield.*

## Transfer from Associate to Associate Member

BOUDOURIS, George. *Meudon, France.*

DIKE, Albert Victor Terence. *Hazel Grove.*

FONG YAN, Alick. *Hong Kong.*

HOWELL, Kenneth Lamb. *Kenton.*

REEDER, Flt. Lt. Frank Ernest, R.A.F. *Cyprus.*

YOUAKIM, Mansour Francis. *Amman.*

## Transfer from Graduate to Associate Member

BEAUMONT, Raymond Kenneth. *Causeway, Southern Rhodesia.*

BURKE, Alan. *London, N.10.*

HALE, Leslie Norman. *Quebec.*

HOLMES, Peter William. *Bishop's Stortford.*

JACKSON, Peter, B.Sc. *Gillingham.*

ROSEN, Solomon. *Tel-Aviv.*

## Transfer from Student to Associate Member

CORBEN, Clifford Bernard. *Portsmouth.*

GREEN, Kenneth Henry. *Woodmansterne.*

KENTLEY, Eric William. *Harlow.*

NICE, Capt. Richard Keith, Royal Signals. *Essen, Germany.*

## Direct Election to Associate

CLARKE, Capt. George David, R.E.M.E. *Cyprus.*

HARDING, Michael Gilbert. *Nairobi.*

HODGE, Sydney Francis. *Exeter.*

HUGGONS, Eric Stanley. *London, W.1.*

JONES, Robert Arthur. *Llandyssul.*

MARSHALL, Jack. *London, W.2.*

SELLERS, Haydn George John. *Iver Heath*

PREECE, Marsden John. *Southall.*

YOUNG, Alexander Macnab. *Newcastle-on-Tyne.*

## Transfer from Student to Associate

CURRAN, Andrew Brewster. *Edinburgh.*

## Direct Election to Graduate

FELLOWS, Edgar Clayton. *Reading.*

HEMANS-MENSAH, Henry Mark. *Hove.*

REYNOLDS, Robin Edwin. *Sutton.*

ROSS, Clive William. *Barrhead.*

WELLEN, Peter Antony. *Chatham.*

WOOD, Flt. Off. Peter Edric, R.A.F. *Doncaster.*

## Transfer from Student to Graduate

BARCLAY, Andrew Duncan. *Newmilns.*

BENTLEY, Edward Leslie. *Cambridge.*

CHAR, Mandayan Kannappan Narasimha. *Durgapur.*

COLLINS, Cyril Raymond. *Troon.*

FRAZER, Charles Henry. *North Shields.*

FREEMAN, Kenneth George, B.Sc. *Redhill.*

HARIDAS, Krishnan, M.Sc., B.Sc. *Birmingham.*

KUNDU, Sati Nandan. *Jalahalli.*

LARGE, Douglas Blake. *Bletchley.*

MARIOUW, Rudi Gijsbert Ferdinand. *The Hague.*

MEDROW, David Graham. *H.M.S. Sheffield.*

PAIS, Aloysius Francis, B.Sc. *Newport, Mon.*

RYNKIEWICZ, Arthur Edward. *Harlow.*

SMITH, James Bernard. *Wigan.*

STRANGWAYS, Ian Colville. *St. Helens.*

THOMAS, Philip Robinson. *Plymouth.*

VIRDI, Harbans Singh. *Lucknow.*

## STUDENTSHIP REGISTRATIONS

ARMSTRONG, Dennis Howard, B.Sc. *Tipton.*

ATMA SINGH. *Brighton.*

AZIZ, Ismail Bin Abdul. *Kuala Lumpur.*

BERTHELSEN, David Ernest. *Toowoomba, Queensland.*

BRIGHT, Norman Harry. *Stafford.*

DAS, Narendra Narayan. *Bombay.*

ELSTEIN, Moses Herbert. *Haifa.*

LARGE, James Arthur. *Crewe.*

McBRIDE, John. *Renfrew.*

MAHMUD AHMAD. *London, W.2.*

MARTIN, Roger Oscar Bruno. *London, S.W.8.*

MASON, Richard Stanley Walton. *Rochester.*

MILLS, Gerald. *Elgin.*

MINES, Frank Austin. *London, S.W.4.*

NAGARAJAN, Alliyalamangalam Sundararaman, B.Sc. *Kurnool.*

NEILSON, Mervyn Leslie. *Bundaberg, Queensland.*

OBODAI, Emmanuel A. Kwaku. *Newcastle, Staffs.*

RESHEF, Amos. *Tel-Aviv.*

ROBERTSON, William Richard. *Newcastle-on-Tyne.*

RUTSON, John Charles. *Ailhorn, Germany.*

SHAH, Ramesh Kalyandas. *Thana.*

SITHARAMAN, Mannargudi Rajagopal, B.Sc. *Madras.*

SPRING-RICE, Barry Noel. *Auckland.*

WILKINS, Bryan Percy. *Bracknell.*



# DESIGN OF DETECTOR STAGES FOR SIGNALS WITH SYMMETRICAL OR ASYMMETRICAL SIDEBANDS\*

by

A. van Weel, Dr. Techn. Sc.†

## SUMMARY

The design of detector stages for signals with symmetrical-sideband components can be improved over conventional designs by properly using the long-established theory of such stages. For asymmetrical-sideband signals (i.e. television signals), an improved design is possible using the results of recent investigations. The conditions for the i.f. amplitude curve to fall by a factor of two at the carrier frequency and for the v.f. section of the detector stage to have a wide-band transfer impedance are shown to be unjustified.

## 1. Introduction

The design of the detector stage of television receivers for vestigial-sideband signals is in many cases carried out according to a trial-and-error method. Designers usually try to fulfil two conditions:

(1) An i.f. amplitude characteristic for which the carrier frequency is a factor of two down in amplification;

(2) A v.f. section of the detector with a flat transfer impedance.

However, very often it is found that although these conditions are met, the overall v.f. amplitude characteristic is not flat and adjustments in the v.f. section are subsequently made to correct for these deviations.

In order to give such a design a better theoretical basis the author started an investigation into the properties of detector stages for signals with asymmetrical sidebands. The theoretical results of this investigation have been published elsewhere<sup>1</sup>; they will be summarized in a later section of the present paper. Although this theory turned out to be too intricate for use in practical design, the investigations involved lead to a better understanding of the performance of detector stages for this kind of signals and hence to an improved design. A remarkable point of this improved

design is that both conditions mentioned above are dropped.

During the investigation it was also realized that the conventional design of detector stages for double-sideband signals is very often based on an incorrect conception of the actual performance of such a stage. The correct theory for this case was given long ago<sup>2,3,4</sup>, but is rarely applied in practice. However, improved performance (better  $R_{ac}/R_{dc}$  ratio) can be achieved without additional costs or loss in other properties if the design is correctly made. The author thought it worthwhile to start this article with a discussion of the design of a detector for a double-sideband signal, although it is the application of a theory which ought to be generally known and used.

## 2. Basic Considerations of Detector Stages for Double-sideband Signals

In the case of a symmetrical double-sideband voltage on the detector, a very simple equivalent circuit holds. Fig. 1(a) gives the detector circuit itself with an i.f. tuned circuit  $C_T-L_T$  and the detector loading admittance consisting of a conductance  $G_a$  and a capacitance  $C_a$  in parallel. The equivalent circuit for the intermediate frequency is given by Fig. 1(b) (see refs. 2, 3, 4); in this equivalent circuit (which holds for an ideal diode) the influence of the detector on the i.f. circuit is seen to be given by a conductance  $2G_a$  in parallel with a circuit  $L_a C_a$  which is tuned to the frequency of the carrier. Very often, this last parallel circuit is overlooked in the treatment of detector stages,

\* Manuscript first received 14th March 1958., and in final form on 27th June 1958. (Paper No. 468.)

† Philips Research Laboratories, N.V. Philips' Gloeilampenfabrieken, Eindhoven, Netherlands.

U.D.C. No. 621.376.232.2:621.397.62

although it can be derived in an analogous way as the equivalent conductance of  $2G_a$ , whereas its importance for the correct design of a detector is obvious.

The equivalent conductance  $2G_a$  is found by considering the amount of dissipated power in the right halves of the circuits of Figs. 1(a) and 1(b); this dissipated power is in both cases  $G_a V_p^2$  ( $V_p$  = peak value of i.f. voltage). Let it be assumed that the i.f. circuit has a zero impedance for all frequencies, except the i.f. band, and that the a.f. impedance is zero for all frequencies except for the audio frequencies. The input impedance of the detector, seen from the i.f. side and given by the ratio of i.f. voltage and fundamental component of the diode detector current, must then be a conductance of the value mentioned.

The equivalent parallel circuit  $L_a C_a$  can in the same way be derived by considering the energy accumulated in the loading capacitance  $C_a$ . This capacitance is charged to the peak value of the i.f. carrier voltage; as long as this voltage remains constant, the presence of this capacitance does not influence the properties of the i.f. circuit. If, however, the i.f. amplitude changes, the voltage across  $C_a$  will change to the same extent and therefore the amount of energy accumulated in  $C_a$  varies also. With increasing i.f. voltage, the corresponding increase of energy has to be delivered by the i.f. circuit; in the same way the i.f. circuit is the only element that can accept the flow of energy

The amount of electrical energy that is accumulated in the tuned circuit  $L_a C_a$  in the equivalent circuit equals  $\frac{1}{2} C_a V_p^2$ , as can be seen by considering the energy at the moment that the current in the circuit is zero. This energy  $\frac{1}{2} C_a V_p^2$  is equal to the d.c. energy that is stored in the loading capacitance  $C_a$  of the actual circuit. Thus the i.f. energy stored in the parallel circuit  $L_a C_a$  is seen to vary in exactly the same way as the d.c. energy that is stored in the actual loading capacitor. From this it follows that an i.f. parallel circuit  $L_a C_a$  will have the same influence on the i.f. circuit proper as the loading capacitance of the detector.

The general rule for finding the i.f. equivalent of the v.f. loading impedance is to tune all v.f. capacitances to the carrier frequency with a parallel inductance; to take all v.f. inductances at one quarter of their value and tune them with a series capacitance, and to take resistances with half their value. These theoretical equivalent circuits are to a satisfying extent corroborated by measurements on practical detectors.

The overall transfer properties of the detector stage can be found from the equivalent circuit of Fig. 1(b) by calculating the transfer impedance for the various sideband frequencies. These overall properties can even easier be seen from the equivalent circuit of Fig. 1(c), which holds for the audio or video frequencies. The validity of this second equivalent circuit

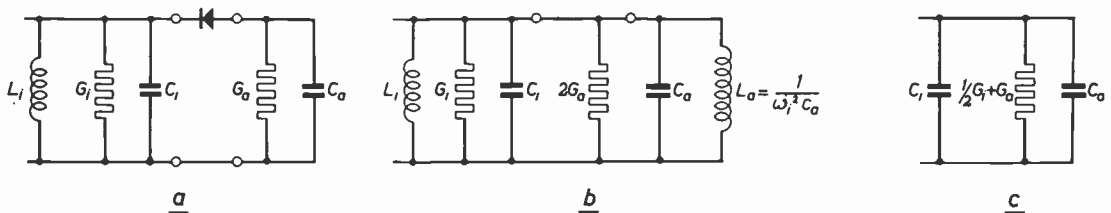

Fig. 1. (a) Simple detector circuit; (b) and (c) are equivalent circuits for Fig. 1(a) for the i.f. sideband component and the r.f. components respectively in the case when the i.f. frequency coincides with the resonance frequency of the i.f. circuit  $L_i C_i$ .\*

in the reverse direction from the loading capacitance during a decrease of the peak voltage.

follows directly from Fig. 1(b), in which the admittances of the three sections in parallel for a sideband frequency  $\omega_i + \omega_a$  are given by  $G_i + 2j\omega_a C_i$ ,  $2G_a$  and  $2j\omega_a C_a$  respectively. The admittances in Fig. 1(c) are, apart from a factor of two difference, exactly the same. This factor of two difference is because Fig. 1(b)

\* In Figs. 1, 2, 4 and 5, the equivalent circuits incorporate conductances for which there is no British Standard symbol. The continental symbol for a resistor has therefore been used.

holds for each of the sidebands of the i.f. signal, whereas Fig. 1(c) gives the resulting output voltage as caused by the two sideband components together. This output voltage is found by applying to the circuit of Fig. 1(c) an audio-frequency input current equal in magnitude to one of the sideband components of the i.f. input current. It is of course also

conclusion follows from the fact that, due to the presence of the extra tuned circuit  $C_a-L_a$  in the equivalent circuit, the effective capacitance of the secondary circuit is increased from  $C_2$  to  $C_2+C_a$ , whereas the total loading conductance increased from  $G_2$  to  $G_2+2G_a$ . As a consequence, the effective quality or selectivity of the secondary i.f. circuit changes in the ratio

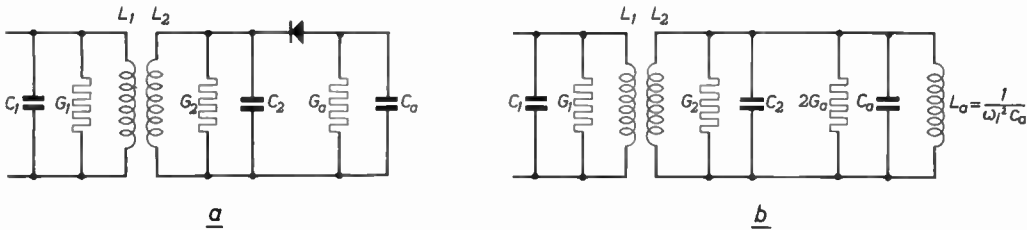

Fig. 2. (a) Detector circuit with two coupled i.f. circuits; (b) Equivalent circuit for the i.f. sideband components (i.f. carrier frequency coinciding with i.f. resonance frequency). (See footnote to Fig. 1.)

possible to use the equivalent circuit of Fig. 1(c) with doubled admittances, in which case the doubled input current should be applied.

In practical detector stages the i.f. section consists usually of an inductively coupled band-pass filter and the v.f. section contains at least a resistance and capacitance in parallel (Fig. 2(a)). The equivalent circuit is given in Fig. 2(b); from this equivalent circuit may be drawn immediately a very important practical conclusion:

*Although the equivalent loading of the secondary tuned circuit of the i.f. band-pass filter by the detector amounts to one half of the v.f. loading resistance proper, the effective selectivity of this secondary circuit need not be decreased by the presence of the detector but can even be increased, depending on the magnitude of the elements included.*

This statement holds with one restriction, namely, the condition that parasitic signals on the detector, with respect to which the selectivity is considered, are smaller than the carrier. If this is not the case, the transfer properties of the detector will change fundamentally, because the parasitic signal will act as the "carrier."

The last part of the foregoing practical con-

$$\frac{C_2/G_2}{(C_2 + C_a)/(G_2 + 2G_a)}$$

This ratio can be either larger or smaller than one.

From this it follows that the advantage of the usual practice of connecting the diode detector to a tap on the secondary inductance of the i.f. band-pass filter in order to increase the selectivity is very questionable.

This practice is the consequence of the fact that an unjustified importance is usually attached to the amplitude characteristic of the i.f. section of the detector stage measured by determining the d.c. output voltage of the detector as a function of the frequency of an unmodulated i.f. input voltage on the grid of the last i.f. amplifying valve. In this situation the influence of the extra  $C_a-L_a$  parallel circuit in the equivalent circuit is not found because this circuit is always tuned to the momentary value of the carrier frequency.

From this follows a second important practical conclusion:

*It is not possible to measure a selectivity characteristic of the i.f. section of a detector by using an unmodulated measuring signal. The only correct way of measuring the properties of a detector stage is to apply a modulated input*

voltage to the grid of the last i.f. valve and to measure the magnitude of the v.f. voltage on the output terminals of the detector as a function of the modulating frequency.\*

It follows from the theory as given in reference 1 that it is to a first approximation immaterial whether this overall transfer characteristic is measured with a single or double-sideband modulated signal provided the carrier frequency coincides with the central frequency of the i.f. circuits of the detector stage.

The i.f. section and the v.f. section of a detector stage are very tightly coupled by the detector and should not be thought of as being connected in tandem by way of a kind of isolating frequency-converting device. Just as it is impossible with ladder networks to calculate the overall properties by assuming the different sections to be connected in cascade without any mutual influence, it is incorrect with detector stages to calculate, for instance, the overall amplitude characteristic from the product of i.f. and v.f. amplitude characteristics.

A third practical conclusion to be drawn from the equivalent circuit of Fig. 2(b) is:

*Due to the presence of an extra tuned circuit in parallel with the secondary circuit proper of the i.f. band-filter, the effective coupling coefficient of this band-pass filter is decreased in the ratio  $\sqrt{\{C_2/(C_2 + C_a)\}}$*

Again, this changed coupling coefficient is not found if the amplitude curve is measured with a single carrier signal, but is only found when measurements are made with a modulated signal as described in the above.

### 3. Practical Design of a Detector Stage for Double-sideband Signals

The theory of a detector stage will now be applied to the design of a practical detector so as to demonstrate to what extent this leads to a different design as compared with the conventional procedure.

\* Consequently, the i.f. circuits of the detector stage should not be thought of as a part of the i.f. amplifier; between the i.f. section and the v.f. section there should be considered to be a separate detector section. The i.f. amplifier proper thus ends at the grid of the last i.f. valve; the detector section is between this grid and the grid of the first v.f. valve.

The following points have to be considered in the design of a detector:

- (1) Amplification
- (2) I.f. selectivity
- (3) Distortion.

(1) In the case of transitional coupling the *transfer impedance* for the centre frequency of a band-pass filter equals  $\frac{1}{2}\sqrt{(R_{prim} \cdot R_{sec})}$ . The impedance of the primary circuit is not influenced by the detector and can therefore be considered to have a given magnitude. From Fig. 2(b) it follows that the total secondary conductance equals  $G_2 + 2G_a$ , the magnitude of which determines the necessary amplification, because  $R_{sec}$  equals  $1/G_0$  as given by

$$G_2 + 2G_a = G_0 \dots\dots\dots(1)$$

(2) The *selectivity* of the secondary i.f. circuit without detector is determined by

$$R_2 C_2 = \frac{C_2}{G_2} = t_0 \dots\dots\dots(2)$$

This time-constant  $t_0$  equals the reciprocal of the  $r/L$ -value of the secondary circuit, which is often used to indicate the selectivity of a circuit. With detector, the corresponding time-constant is

$$\frac{C_2 + C_a}{G_2 + 2G_a} = t_1 = \alpha t_0 \dots\dots\dots(3)$$

For values of  $\alpha$  smaller than one, the selectivity has decreased; obviously  $\alpha$  should not be much smaller than one in order to maintain a reasonable selectivity.

(3) To prevent *audio-frequency distortion*, the time-constant  $R_a C_a = C_a/G_a$  should not be too long, because the voltage over the v.f. loading capacitor should be able to follow even the fastest variation in the envelope of the i.f. signal.

Therefore we can write

$$\frac{C_a}{G_a} = t_a \dots\dots\dots(4)$$

the value of  $t_a$  being determined by the bandwidth of the audio-frequency band.

Another condition for undistorted detection is that the ratio of the magnitude of the detector loading impedances for modulation frequencies and for d.c. (the so-called  $R_{ac}/R_{dc}$ -ratio) should be as near the value of one as possible. A high value for the loading conductance  $G_a$  is advantageous for this second condition.

With a practical design, the values of  $G_0$ ,  $t_0$ ,  $\alpha$  and  $t_a$  are prescribed; they follow from the necessary amplification, the quality of available coils, the necessary selectivity and the highest audio-frequency, respectively. The magnitudes of the elements  $G_a$ ,  $C_a$ ,  $G_2$  and  $C_2$  can then be calculated from eqns. (1)-(4) to be:

$$\begin{aligned} G_a &= G_0 \cdot \frac{t_0(1-\alpha)}{2t_0-t_a} \\ C_a &= G_0 t_a \cdot \frac{t_0(1-\alpha)}{2t_0-t_a} \\ G_2 &= G_0 \cdot \frac{2\alpha t_0-t_a}{2t_0-t_a} \\ C_2 &= G_0 t_0 \cdot \frac{2\alpha t_0-t_a}{2t_0-t_a} \end{aligned} \quad \dots\dots(5)$$

These formulae will be used for the design of a detector stage for an a.m. receiver with an intermediate frequency of 450 kc/s. In the conventional design the following magnitudes for the various elements are often met.

(1) Quality of the coils alone  $Q=100$ , corresponding to  $t_0=36 \times 10^{-6}$  sec.

(2) I.f. circuit capacitances 100 pF; detector tapped on 0.7 of the secondary windings, therefore the effective secondary capacitance and conductance seen from the detector amount to  $C_2=200$  pF and  $G_2=6 \times 10^{-6}$  ohm<sup>-1</sup> respectively.

(3) Detector load consists of 500,000 ohm in parallel with 70 pF (wiring and a.f.-valve capacitance):

$$\begin{aligned} t_a &= 35 \times 10^{-6} \text{ sec.}, \\ 2G_a &= 4 \times 10^{-6} \text{ ohm}^{-1}. \end{aligned}$$

In the conventional design, the total secondary conductance is thus

$$G_0 = G_2 + 2G_a = 10 \times 10^{-6} \text{ ohm}^{-1}$$

and the selectivity, according to the (erroneous) *conventional theory and measurement*, is determined by

$$t_1 = \frac{C_2}{G_2 + 2G_a} = 20 \times 10^{-6} \text{ sec.}$$

Thus, the value of  $\alpha$  which in the conventional design is considered to be acceptable is

$$\alpha = \frac{t_1}{t_0} = \frac{5}{9}$$

Proceeding now to give the design according to the correct theory, using the same values of  $G_0$ ,  $t_0$ ,  $t_a$  and  $\alpha$ , the following values for the

different circuit elements are found from eqn. (5):

$$\begin{aligned} G_a &= 4.3 \times 10^{-6} \text{ ohm}^{-1} \\ C_a &= 150 \text{ pF} \\ C_2 &= 49 \text{ pF}. \end{aligned}$$

The loading resistance has a magnitude

$$R_a = \frac{1}{G_a} = 230,000 \text{ ohm},$$

as compared with 500,000 ohm in the conventional design. Assuming the a.c. impedance in parallel to this loading resistance to be 1.5 MΩ, the  $R_{ac}/R_{dc}$ -ratio is found in the conventional design to be 0.75, whereas according to our design it is 0.87. This means that with the conventional design, distortion will begin at a modulation depth of the signal at the diode of 75 per cent., whereas in the new design the corresponding figure is 87 per cent. This is a substantial improvement, and it can be reached without any sacrifice of other properties or increase of costs.

A further decrease of  $R_a$  (increase of  $G_a$ ) can be brought about by either increasing  $G_0$ , which means smaller amplification, or by making  $\alpha$  smaller, which means decreasing the selectivity. The second measure cannot give much gain in  $G_a$ , because  $\alpha$  can never be smaller than  $\frac{1}{2}t_a/t_0$ , otherwise  $G_2$  and  $C_2$  would have to be negative (see eqn. (5)). With the figures given above, the minimum value of  $\alpha$  amounts to 0.49, for which the impedance of the secondary circuit becomes infinite ( $G_2$  and  $C_2$  both nil); the corresponding values for  $G_a$  and the  $R_{ac}/R_{dc}$ -ratio are  $5 \times 10^{-6}$  ohm<sup>-1</sup> and 0.88, giving hardly any improvement whatsoever.

The other way to realize a better  $R_{ac}/R_{dc}$ -ratio is to decrease  $G_0$ . For instance a decrease with a factor of two will bring the  $R_{ac}/R_{dc}$ -ratio to 0.91, which improvement has been reached at the price of a factor  $\sqrt{2}$  loss in amplification. The amplification could be restored to the original magnitude by decreasing the primary circuit capacitance from 100 to 50 pF.

The practical results of this design procedure will be illustrated with some measurements, made on a detector stage which was first designed along conventional lines and subsequently changed according to the theory.

Fig. 3 gives the circuit and the amplitude characteristics. The curves  $I_c$  and  $I_m$  were measured in the conventional circuit with a pure carrier and with a modulated carrier respectively; curves  $II_c$  and  $II_m$  were the corresponding curves for the new design. It can be seen in this figure that curves  $II_m$  and  $I_c$  are

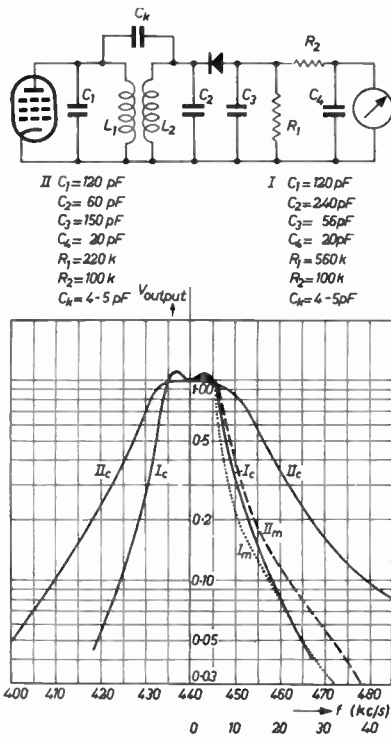

Fig. 3. Measured amplitude characteristics for the circuit at the top of the figure with component values according to columns I and II. Curves with index  $c$  are determined by measuring the d.c. output voltage as a function of the (unmodulated) i.f. carrier frequency. Curves with index  $m$  are measured with a fixed carrier frequency and give the a.f. output voltage as a function of the modulation frequency.

almost the same, demonstrating that the effective transfer characteristic of the new design equals the projected transfer characteristic of the conventional design, whereas the effective characteristic in the latter case is given by curve  $I_m$ .

The fact that the curves  $I_m$  and  $I_c$  show less mutual difference than curves  $II_m$  and  $II_c$  follows directly from the lower impedance of the secondary i.f. circuit and the higher im-

pedance of the audio-frequency section in case I; the influence of the detector is then of course smaller. But curve  $II_m$  demonstrates clearly that this influence, even if it is larger, can be well controlled.

It may be mentioned here that the response to a pure single-sideband signal is, apart from a factor of two in amplitude, the same as to a double-sideband modulated signal, provided the i.f. circuits are tuned to the carrier frequency. This means that the amplitude curve  $II_m$  can also be used to judge the selectivity to interfering signals.

The amplification proved in both designs to be about 140 (d.c. output voltage divided by the peak value of the grid voltage on the last i.f. valve), with the slope of the i.f. valve 2 mA/volt. The actual difference in amplification amounted to 5 per cent. in favour of the conventional design; the theoretical difference should be 2.5 per cent. for the two cases, which shows how well the experiment agrees with the theory.

In practical circuits, an a.v.c. diode is sometimes connected to the primary circuit of the i.f. band-filter. Its influence can be taken into account according to the above theory, provided this a.v.c. diode has no bias voltage, as it has in certain delayed a.v.c. systems. In that case the situation is considerably more complicated.

The design of a detector stage for a wide-frequency-band double-sideband signal (for instance in a radar receiver) is somewhat more complicated because of the  $\pi$ -section that is often used in the video-frequency part. However, the above theory can easily be extended to these cases; some of the points to be mentioned in the following sections have to be taken into account in the double-sideband case as well.

#### 4. Basic Considerations for Detector Stages for Asymmetrical-sideband Signals

With symmetrical sideband signals the properties of a detector stage can be satisfactorily given by equivalent circuits that are not too intricate for practical use. In the case of asymmetrical-sidebands, for instance, with detectors for a vestigial-sideband television signal, the situation is far less advantageous<sup>5</sup>.

The author derived equivalent circuits<sup>1</sup> which are in themselves already substantially more intricate than the simple circuits for the symmetrical-sideband case. Apart from this intricacy, experiments showed that some of the restrictions used in the derivation of these equivalent circuits do not hold too well in practice, necessitating a correction that is quite complicated in itself. These two effects together make it rather unpracticable to try to design the detector stage along rigid theoretical lines as could be done in the foregoing section for the double-sideband case.

Such a design can therefore only be made on a more or less trial-and-error basis; however, some knowledge about the properties of detector stages for asymmetrical-sideband signals is obviously a great help in this trial-and-error procedure. We therefore firstly give the results of the theoretical and practical investigations as described in reference 1.

In Fig. 4, a general detector circuit has been indicated. The i.f. admittance  $Y_{0,1,2}$  has the

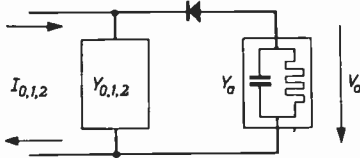

Fig. 4. Basic detector circuit; indices 0, 1 and 2 refer to i.f. carrier and upper and lower-sideband frequencies, respectively. Index *a* refers to video or audio-frequency. (See footnote to Fig. 1.)

magnitude  $Y_0$ ,  $Y_1$  and  $Y_2$  for the carrier frequency, upper and lower sideband frequency respectively, while  $Y_a$  denotes the v.f. admittance, consisting minimally of a capacitance in parallel with a conductance. The input current has three components  $I_0$ ,  $I_1$  and  $I_2$  which refer to the same frequencies as  $Y_0$ ,  $Y_1$  and  $Y_2$ .

An equivalent three-port circuit for this detector stage can be derived and is depicted in Fig. 5. This three-port holds for any of the three modulation frequencies (upper sideband frequency, lower sideband frequency, video frequency) and should be used in the following way. If the overall properties are to be considered, the six-pole is taken at the video frequency with  $Y_a$  equal to the admittance of the v.f. section, whereas  $Y_1$  and  $Y_2$  should be

given at the video frequency, the magnitude and phase angle they have in reality at the corresponding frequencies of upper and lower sidebands, respectively. In the same way,  $I_1$  and  $I_2$  should be considered as video-frequency

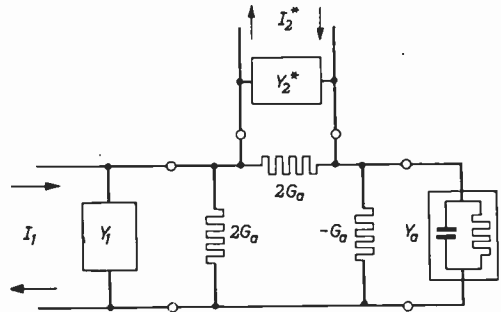

Fig. 5. Equivalent three-port circuit of Fig. 4. The way in which this equivalent circuit should be used is described in the text. (See footnote to Fig. 1.)

current components, but with the magnitude and phase angle they have at the frequencies of upper and lower sideband respectively.

An analogous condition holds when the equivalent circuit is to be studied at upper or lower sideband frequency.

In cases where the loading conductance  $G_a$  is connected directly across the input terminals of the v.f. section, this equivalent circuit simplifies because  $-G_a$  and  $+G_a$  in parallel cancel each other. It may be verified that in the case of symmetrical-sideband modulation the circuit of Fig. 5 simplifies to that of Fig. 1 because in this case  $I_1 = I_2^*$  and  $Y_1 = Y_2^*$ .

For the simplest detector stage, containing a single tuned circuit on the i.f. side and a R-C combination on the v.f. side, the equivalent circuit in the case of a detuned carrier can to a certain extent be simplified, allowing a relatively simple calculation of the overall properties. However, if an i.f. band-pass filter is used, the corresponding equivalent circuits become quite complicated.

Apart from this, experiments have shown that there is another effect to be taken into account. This effect can be described as follows by considering a detector stage of which the i.f. section has symmetrical properties with respect to a certain centre frequency, as is for instance the case with a single tuned circuit. The over-

all v.f. amplitude characteristic is next measured by determining the amplitude of the v.f. output voltage as a function of the modulation frequency (double-sideband modulation is assumed) as discussed in the foregoing sections. This overall amplitude curve is first measured with the carrier frequency positively detuned with respect to the centre frequency of the i.f. section. Next the same measurement is performed with the carrier frequency detuned in the opposite direction but over the same frequency distance. Both intuition and the equivalent circuit of Fig. 5 would predict that the transfer amplitude curves would be the same in both situations. However, this is not the case and substantial systematic differences are measured.

Further analysis of the detector working reveals that this effect is caused by the asymmetrical shape of the current peak that passes the detector diode once in every period of the carrier frequency. This asymmetry causes phase differences between the various harmonics that are present in this current peak and this leads to the effect just described. The influence on the transfer properties is rather difficult to calculate numerically.

Thus, in the design of a detector for a vestigial-sideband signal there is the situation in which:

(1) The equivalent circuit, even when derived with rather crude approximations, is too intricate for practical purposes.

(2) An "asymmetry-effect" is present that has not fully been accounted for quantitatively.

As far as the practical design goes, the sole but important conclusion to be drawn is that here, as in the case of a double-sideband signal, the design should not be based on the properties of i.f. section and v.f. section separately but on measurements of the overall characteristic determined with fixed carrier frequency and varying modulation frequency. This obviously holds for every type of modulation, whether double-sideband, vestigial-sideband or pure single-sideband modulation. An interesting consequence for pure single-sideband modulation is the fact that the impedance of the i.f. section of the detector stage at the frequency of the non-existent sideband is important for detection, as follows directly from

the equivalent circuit of Fig. 5. This effect can easily be observed experimentally by inserting in the detector stage a trap circuit for a frequency at one side of the carrier and measuring the transfer characteristic for a pure single-sideband modulation at the other side of the carrier frequency. Where such trap circuits are necessary (for instance for suppression of an adjacent sound channel in television receivers), obviously the trap should not be incorporated in the detector stage by preference.

However, there is a certain difference between the situation with double-sideband modulation and pure-single-sideband modulation on the one hand and with vestigial-sideband modulation on the other hand. In the first two cases the i.f. input signal to be applied to the grid of the last i.f. valve is well defined, and therefore no problems arise as to the way in which the transfer properties of the detector stage should be measured. But how should the input signal to the detector stage be defined in the case of a vestigial-sideband signal, for instance a television signal?

It should certainly not be the signal as radiated by the transmitter, because in that case the i.f. amplifier proper would have a flat amplitude curve at the vestigial-sideband side of the carrier as well as over the main sideband and would thus not contribute to the selectivity at the vestigial-sideband side of the carrier frequency. But here a high selectivity is urgently needed to suppress possible interference from an adjacent sound channel. The only possible definition is that the i.f. amplifier and detector stage *together* should have a flat overall amplitude characteristic. This indicates that the properties of the detector should be matched to those of the i.f. amplifier. In practice one has to begin to define one of the two and the choice is entirely free for the designer. It will be recalled that the i.f. amplifier proper was considered to end at the grid of the last i.f. valve.

The author developed the practice of designing the i.f. amplifier proper along the same lines as is usually done for the combination of i.f. amplifier + detector, namely, by prescribing that the i.f. amplitude curve, measured between converter valve and grid of the last i.f. valve, should fall by a factor of two at the carrier fre-



quency. This definition is as arbitrary as any other definition but has at least the psychological advantage that, at the output terminals of the i.f. amplifier proper, the signal contains in its envelope all modulation frequencies with the same relative amplitudes. In the experimental design, the detector is next adjusted so as to give this i.f. amplifier and the standardized transmitter signal a flat overall v.f. characteristic.

With certain detector designs it turned out to be more practical if the amplitude curve of the i.f. amplifier proper was either more or less than a factor of two down at the carrier frequency. Such changes were then introduced in the i.f. amplifier, giving up the psychological advantage just mentioned for the ease of the design of the detector stage. This demonstrates the arbitrariness of the definition used, but one has to start with something.

##### 5. Practical Design of a Detector Stage for Asymmetrical-sideband Signals

Some of the most important applications of the detection of an asymmetrically modulated signal is the detector of a television receiver, which will therefore be considered in detail. Properties of special interest here are amplification and distortion, the selectivity of the detector stage being of less importance than with a.m. sound receivers, because the i.f. amplifier proper usually contains a greater number of tuned circuits.

As regards amplification, there is not much to be predicted from the theoretical side. However, it is known from the theory of wide-frequency band amplifiers to be advantageous for all damping to be concentrated in one resistance. Applying this result to the present case indicates that all damping should be concentrated in the loading resistance of the detector and that the i.f. circuits proper should not be damped separately.

With band-pass filters as interstage coupling circuits it is known that the concentration of the loading resistance in one of the two tuned circuits yields 3 db gain in amplification as compared with symmetrically damped circuits. Such single-sided damping is, however, rarely applied because of the fact that this circuit is much more sensitive to the influence of slight

detunings. This argument may be of smaller importance in a detector stage because of two reasons. In the first place, the secondary circuit of the band-pass filter is loaded with a diode and not with the grid admittance of a tube. The latter admittance is much more liable to vary than the diode admittance. The primary circuit is loaded with the anode admittance of the foregoing valve, which is again a rather stable admittance as compared with a grid admittance.

In the second place, the equivalent circuit of the detector, as seen from the i.f. side, consists in some intricate way of circuits that are tuned to the instantaneous value of the i.f. carrier frequency. This part of the total circuit is therefore to a first approximation independent of detuning caused by variations of components, but does depend strongly on any change of the carrier frequency. As this equivalent circuit comes directly in parallel to the secondary circuit of the i.f. band-pass filter, the relative importance of a detuning of the latter circuit might be smaller than in an ordinary interstage-coupling band-pass filter.

As regards distortion, no  $R_{ac}/R_{dc}$  distortion needs to be anticipated because of the d.c. coupling to the grid of the v.f. valve. However, the condition that the time-constant of the v.f. loading impedance of the detector should be sufficiently small as to enable the voltage over this loading impedance to follow even the fastest falling transients of the i.f. signal, holds here as in any other detector stage. A consequence of an insufficiently small time-constant is that the passage of diode-current peaks is temporarily interrupted, which means that the detector properties change fundamentally. Distortion can be anticipated, which will firstly be found with large modulation depths.

Apart from these rather vague theoretical indications, television detector stages have to answer certain practical conditions. It is, for instance, usual to have an inductively coupled band-pass filter at the i.f. side to enable the secondary circuit together with the diode and the input capacitance of the v.f. section to be more or less insulated from the chassis. In this way the possibility of the harmonics of the i.f. carrier frequency, which are generated

in the detector, interfering with the input signal of the receiver can be reduced. This circumstance determines therefore the kind of circuit to be used in the i.f. section of the detector.

At the v.f. side a  $\pi$ -section of two capacitances and an inductance is often used for two reasons: firstly, the separation of the capacitances allows a higher v.f. impedance, and secondly, such a low-pass filter section gives an effective suppression of i.f. components.

The loading resistance of the v.f.  $\pi$  section is usually connected in parallel to the input capacitance, thus directly following the detector diode (Fig. 6). The reason for placing the resistance here is no doubt the fact that the transfer impedance of such a  $\pi$ -section has its optimum bandwidth if the capacitance ( $C_1$ ) in parallel to the resistance ( $C_2$ ). In practice, the input capacitance of the v.f. valve is much

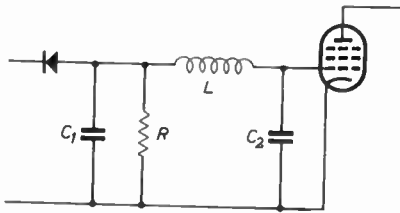

Fig. 6. The v.f.  $\pi$ -section with a resistance across the input terminals as frequently used in television detector stages.

larger than the minimum necessary input capacitance of the  $\pi$ -section, seen from the diode. This leads to the design with the resistance connected across the input terminals.

From theoretical considerations it is known that a flat transfer impedance for the v.f. section separately is in itself not necessary at all. So this condition can be dropped altogether; the only condition that is certain to be of some importance is the requirement that the input impedance of the v.f. section should have a small time-constant, which means a wide bandwidth. It is remarkable that the conventional  $\pi$ -section with the resistance at the input does not answer this condition, as can be seen in Fig. 7 where the magnitudes of input and transfer im-

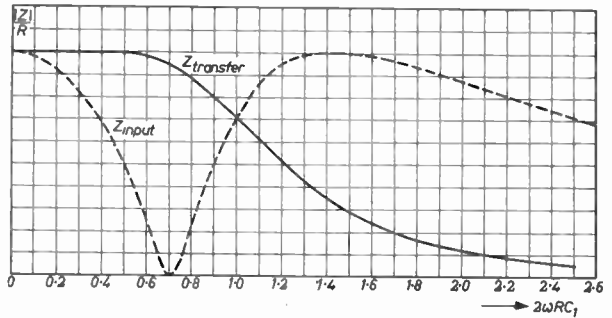
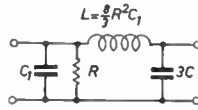

Fig. 7. Frequency dependence of input impedance and transfer impedance of the  $\pi$ -section shown in Fig. 6 and repeated at the top of this figure.

pedances are shown in relation to frequency. There is a factor of 2.5 difference between both bandwidths. The resulting distortion will be discussed in Section 8.

The conditions for a flat input impedance are that the resistance should be connected in parallel to the output capacitance  $C_2$ , and that  $C_1 = 3.8 C_2$ . This second condition is rather unfortunate because it increases the input capacitance to a value that is much larger than necessary for good detection and therefore decreases the possible v.f. impedance. To get round this difficulty another half- $\pi$ -section is added (Fig. 8). One can calculate the values of the elements for maximally flat input impedance; the author refrained from this calculation and used the values that follow from filter theory if the resistance  $R$  would have been the ideal image impedance:

$$C_1 = C_2 = C_2' + C_2'' = \frac{2}{\omega_1 R}$$

$$L_1 = 2L_2 = \frac{2R}{\omega_1}$$

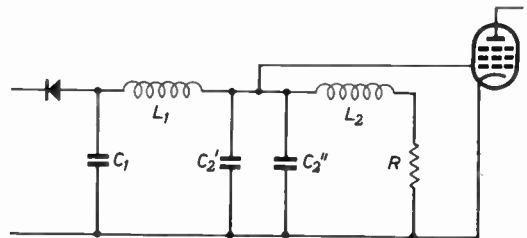

Fig. 8. The v.f. section of a detector stage with a wide-band input impedance.

In the case of the C.C.I.R. system the v.f. band extends to 4.5 Mc/s; therefore the cut-off frequency  $\omega_1$  is chosen to be equal to  $2\pi \times 6.0 \times 10^{-6}$  rad/sec. With  $C_1=C_2=12$  pF, this leads to

$$R = 4000 \text{ ohm}$$

$$L_1 = 200 \mu\text{H}$$

$$L_2 = 100 \mu\text{H}.$$

Thus a design of the v.f. section of the detector stage can be derived. No theoretical indications are available for the resonant frequencies and coupling factor of the two i.f. circuits, so these data have to be found empirically by adjusting tunings and coupling until satisfactory overall properties are realized. This empirical procedure is very much simplified if it can be done with the aid of a v.f. wobbulator generator which makes oscilloscopic observation of the overall performance possible.

Such an empirical design procedure may seem unsatisfactory; it should however be taken into account that the conventional method is not less empirical, the difference being that in the conventional design an i.f. amplitude curve is defined, which is exactly a factor of two down at the carrier frequency, and the v.f. section is next adjusted to give a flat overall characteristic. The first of these conditions is unnecessary, as will be shown presently, whereas the necessity of having a flat v.f. input impedance is completely overlooked in this conventional design procedure.

**6. Results of the Described Design Procedure**

The i.f. amplifier used in these experiments was of the phase-linear type<sup>6</sup>. The amplitude curve is depicted in Fig. 9, curve I. Once again this is the curve measured for the i.f. amplifier proper, i.e. between the converter valve and the grid of the last i.f. valve. Curve II in Fig. 9 gives the i.f. amplitude curve measured in the conventional (but for determination of the detector properties incorrect) way, i.e. the d.c. output voltage of the detector as a function of the frequency of the i.f. input to the converter. Curve III is the amplitude curve of the i.f. section of the detector alone, measured from the grid of the last i.f. valve to the (d.c.) output of the detector.

Figure 10 gives the overall characteristic, measured from the input terminals of the

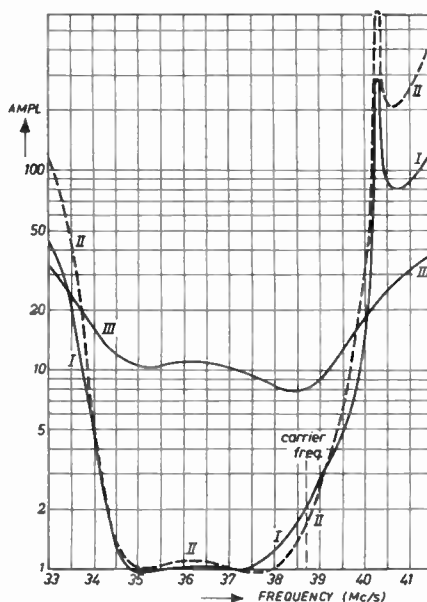

Fig. 9. Curve I: Amplitude characteristic of the i.f. amplifier proper (between converter valve and control grid of the last i.f. valve). Curve II: Overall i.f. amplitude characteristic, determined by measuring the d.c. output voltage of the detector as a function of the i.f. carrier. Curve III: Amplitude characteristic of the i.f. section of the detector, measured in the way as Curve II.

modulator of a (two sideband) transmitter to the grid of the v.f. valve; Fig. 11 shows the transient response to a unit-step signal measured between these same two pairs of terminals. This transient response was measured at 20 per cent modulation depth; it was found, however, that an increase of the modulation depth to 70 per cent. had but very

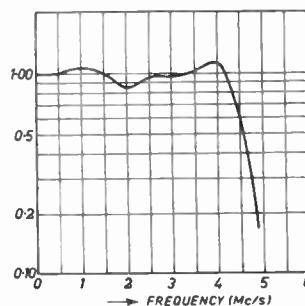

Fig. 10. Overall v.f. amplitude characteristic of i.f. amplifier plus detector stage.

little influence on the shape of the transient response.

The amplification of the detector stage was quite satisfactory and amounted to 15-20 as measured in a number of experimental detectors (i.f. valve of type EF80). This figure is the ratio of the d.c. output voltage to the peak i.f. voltage on the grid of the last i.f. valve, measured at the carrier frequency.

## 7. Discussion of the Improved Design and its Practical Properties

A striking difference between the new design and the conventional design is the fact that the

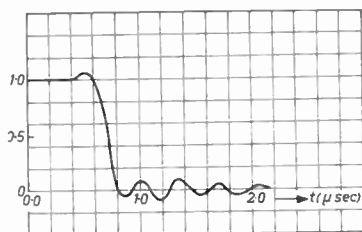

Fig. 11. Overall transient response of i.f. amplifier plus detector stage, measured at small modulation depth.

amplitude of the total i.f. amplifier falls by a factor of only 1.55 at the carrier frequency, whereas a factor of two is generally prescribed. This factor of two comes from the original conception of vestigial-sideband television transmission, which is based on two assumptions, neither of which is satisfied in practical detector stages, namely:

(1) The i.f. amplitude curve indicates the magnitude of the sideband components at the detector;

(2) The v.f. output signal is measured directly behind the detector diode, that is, at the input terminals of the v.f. loading impedance.

It has been discussed in the preceding sections that the i.f. amplitude curve, measured by determining the d.c. output voltage of the detector as a function of the frequency of a pure sinusoidal i.f. voltage, is not a measure for the magnitudes of the sideband components. These magnitudes can and do show marked deviations from what would follow from this i.f. amplitude curve.

As regards the second point, the normal practice is to take the v.f. signal from the output terminals of the v.f.  $\pi$ -section. The ratio of input voltage to output voltage of such a  $\pi$ -section is definitely not constant over the range of video frequencies.

In the conventional design of a television receiver, the total i.f. amplitude curve is often painstakingly adjusted so as to cause the amplification to drop by a factor of two at the carrier frequency. The next step in the design is to give the v.f. section a flat transfer characteristic. Finally a flat overall v.f. transfer characteristic is realized by way of empirical adjustments in the v.f. section of the detector stage or of the output stage.

The first step of this design procedure is now seen to be rather arbitrary, because it does not guarantee what it is thought to guarantee. The second step is fully irrelevant as follows both from the theory developed above and from the necessity of subsequent adjustments. However, the need to guarantee a sufficiently short time-constant for the loading impedance of the detector is overlooked.

In the new design a certain, in itself, arbitrary shape of the amplitude curve of the i.f. amplifier proper has been defined which can be changed if this proves to be advantageous for any reason. The v.f. section is designed so as to have a sufficiently small time-constant for the input impedance.

Finally, the i.f. section of the detector stage is adjusted until an acceptable overall v.f. amplitude curve is obtained. The amplitude characteristic of the total i.f. amplifier is not of direct importance for the design, but is measured afterwards.

The fact that the amplification at the carrier frequency is less than a factor of two down indicates that the quadratic distortion component, caused by the detection of a vestigial-sideband signal, might be smaller than in conventional circuits. It has already been mentioned in Section 6 that this was found to be the case.

## 8. Distortion in the Detector Stage

Some possible causes for signal distortion have been mentioned in the preceding sections. In practical design work it is important to be

able to identify the causes of distortion from measurements made on a detector stage. Five possible distortions, which can occur in such a stage, are:

- (1) Non-linear distortion, due to detection of an asymmetric-sideband signal or to a non-linear diode characteristic.
- (2) Distortion due to a too-long time-constant of the v.f. loading impedance.
- (3) Linear amplitude distortion.
- (4) Linear phase distortion.
- (5) Distortion due to the  $R_{ac}/R_{dc}$  ratio being smaller than one.

The general character of the first four distortions has been given in Fig. 12(a)-(d) for transient responses to a square-wave modulation. The full-drawn lines give the undistorted response (undistorted as far as the detector stage goes), while the broken lines give the transient responses in the presence of distortion. The influence of the  $R_{ac}/R_{dc}$  distortion is given in the separate Fig. 13 because this distortion can best be demonstrated with a sine-wave modulation.

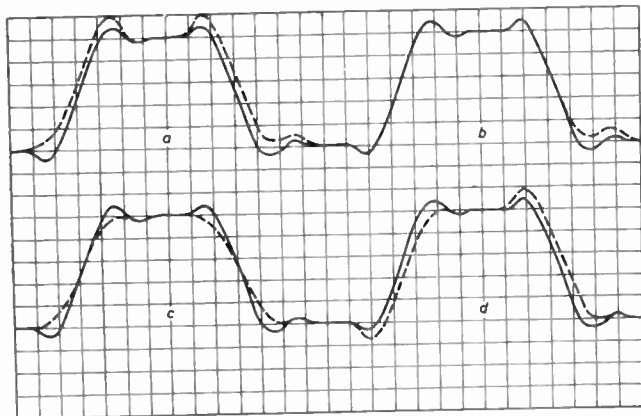

Fig. 12. Square wave response in the presence of different kinds of distortion: (a) non-linear distortion as caused by unequal sidebands; (b) distortion caused by a detector stage of which the v.f. loading impedance has too long a time-constant; (c) linear distortion caused by a non-flat amplitude characteristic; (d) linear distortion caused by a non-linear phase curve.

The influence of non-linear distortion is the same at rising and at falling sides of a square wave (Fig. 12(a)), whereas the distortion due to a too-long time-constant of the v.f. loading impedance is only found at the lower end of a

down-going transient response (Fig. 12(b)). Both distortions occur with large modulation depths; they can be distinguished by their different symmetry properties.

Linear distortion does not depend on the modulation depth; linear amplitude distortion does not disturb the symmetry properties of a

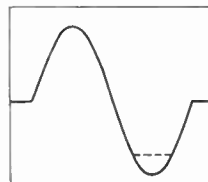

Fig. 13. Influence of  $R_{ac}/R_{dc}$  distortion on the signal shape.

transient response (Fig. 12(c)), whereas linear phase distortion causes an asymmetric change (Fig. 12(d)).

The  $R_{ac}/R_{dc}$  distortion is characterized by the fact that it flattens the lower peaks of the signal (Fig. 13). This distortion occurs only with modulation depths of the signal at the diode larger than the ratio  $R_{ac}/R_{dc}$ .

The detector stage as described in the preceding sections hardly introduced any phase distortion at all.

### 9. Conclusion and Acknowledgment

The investigation, the results of which are discussed in the present paper, was a logical follow-up to earlier work on the influence of phase distortion in television transmission<sup>6,7,8</sup> because both subjects concern properties of the transmission path in a television system that have not always been completely clear in the design of television equipment. This has led to a situation where such design is not infrequently found to be based on trial-and-error methods, whereas a correct

understanding of all factors involved undoubtedly yields better results. The present and the foregoing papers have aimed at giving a contribution to such a better understanding.

The author is indebted to his colleagues from the Television Apparatus Design Laboratory for the stimulus to attack these problems and for many helpful and critical discussions during the work.

#### 10. References

1. A. van Weel, "Analysis of diode-detector circuits for signals with asymmetrical sidebands," *Philips Research Reports*, **13**, pp. 301-326, 1958.
2. H. A. Wheeler, "Design formulas for diode detectors," *Proc. Inst. Radio Engrs*, **26**, pp. 745-780, 1938.
3. F. C. Williams, "The modulation response and selectivity curves of a resonant circuit loaded by a diode rectifier," *Wireless Engineer*, **15**, pp. 189-197, 1938.
4. J. Haantjes and B. D. H. Tellegen, "The diode as converter and as detector," *Philips Research Reports*, **2**, pp. 401-419, 1947.
5. T. Murakami and R. W. Sonnenfeldt, "Transient response of detectors in symmetric and asymmetric sideband systems," *R.C.A. Review*, **16**, pp. 580-611, 1955.
6. A. van Weel, "Phase linearity of television receivers," *Philips Technical Review*, **18**, pp. 33-51, 1956/57.
7. A. van Weel, "Some remarks on the radio-frequency phase and amplitude characteristics of television receivers," *J.Brit.I.R.E.*, **16**, pp. 271-280, 1956.
8. A. van Weel, "The design of phase-linear intermediate-frequency amplifiers," *J.Brit.I.R.E.*, **17**, pp. 275-286, 1957.

#### WRITTEN DISCUSSION ON PAPERS

Members are reminded that the Papers Committee welcomes short contributions commenting on papers which have been submitted for publication only, as well as on papers which have been read at meetings. It is desirable that contributions should not be more than about 500 words in length.

## ELECTRONICS AND THE AIRCRAFT INDUSTRY

WHEN members of the Institution visited London Airport and the Southern Air Traffic Control Centre earlier this year, there was some surprise at the methods by which the data for air traffic control were handled. The radar equipment in use at both the Airport and at the Control Centre was extremely up-to-date, but there was a lack of modern methods of data handling. This state of affairs is apparently fairly general in the world's airways, and it was therefore interesting to see at this year's Exhibition of the Society of British Aircraft Constructors at Farnborough that the electronics industry has produced equipment which enables the incoming traffic information to be passed to the controllers automatically and with the highest possible efficiency.

Some hint of possibilities in this direction was given at last year's Exhibition, and the Marconi Company has now designed a series of display units which, in conjunction with, for instance, a 50 cm radar, can provide a number of controllers with comprehensive information about the aircraft being handled. The final scheme which is envisaged will employ a digital track store with a capacity of up to 160 tracks, giving positional information on each track in terms of co-ordinates, velocities and height, and call sign, route and destination data. To give an idea of the way in which the control rooms should be equipped, a working demonstration was given of a simpler air traffic control system which could easily augment existing methods.

Three associated display units have been developed: an airways control console, a tracker's console, and an approach control console. The airways control console has been designed to overcome two problems which confront the controller. Firstly, the current type of p.p.i. shows far more information than the controller needs since he is normally only interested in aircraft under his control; other aircraft, rain clutter, noise and permanent echoes tend to confuse the picture. Secondly, a high lighting level is desirable for use with the flight progress board, while the usual radar display must be used in low ambient light. The console therefore employs a simple form of synthetic display in which the display consists only of symbols representing the aircraft under

control. The plan positions of these symbols are identical with those of the control aircraft on a normal p.p.i. and they accurately keep to the same tracks. In addition, inter-trace markers can be added and the positions of ground beacons, etc. are displayed by the use of a video map. This display can therefore be much brighter than the normal type, and alongside it in the desk is the flight progress board, which a television camera reproduces on monitor screens on the other consoles. A further refinement on the airways control console is the future position indicator. By means of an inter-trace marker the controller is able to estimate the time of arrival at a given point, or alternatively the position of the aircraft at a certain time can be shown, assuming that the aircraft maintains its ground speed and track. The system can be used to determine whether a conflict between aircraft tracks is likely to arise in the near future.

The tracker's console provides a normal picture with moving target indication (m.t.i.) of approximately 100 miles radius, with a video map and inter-trace markers. The tracking operator places symbols on the various aircraft, and these can be transferred to the controller's display as required. The symbols are automatically locked to the aircraft responses, and if a response fades, the symbol continues to move with the same direction and speed, any correction necessary being automatically applied when the response reappears. The approach console has a normal type short range display with m.t.i. and marked aircraft responses are handed to the approach controller from the airways controller, and vice versa in the case of outward bound aircraft. A television monitor showing the airways controller's flight board supplies the approach controller with the additional information he requires.

An associated working demonstration by Kelvin and Hughes showed how synthetic display pictures could be fed through a rapid processing projector which displayed the picture on a large screen. The Marconi radar in use had an aerial speed of 10 rev/min, and the projector exposes a film frame during one sweep of the p.p.i., develops and fixes it during the next, and projects it on to a screen twelve

seconds after it is taken.

Other exhibits concerned with air traffic control included a long range surveillance radar manufactured by Cossor, which was operating in conjunction with a new p.p.i. display employing a video map, markers, and identification symbols, and permitting the incorporation of secondary radar and automatic direction finding information.

A new automatic v.h.f. d.f. equipment was demonstrated by Ekco which uses an Adcock aerial rotating at 250 rev/min. A narrow pulse is generated from the signal minimum, and this pulse, which is largely unaffected in width or timing by signal strength variations is given a polar display. To obtain sense information, coding in the form of a slight asymmetry is introduced by the addition of a correctly phased omnidirectional signal; the unwanted pulses corresponding to reciprocal aerial directions are then eliminated by time delay filter circuits.

A limited amount of additional information was presented at this year's Exhibition on guided weapons. Of particular interest to the radio engineer was the disclosure of details of telemetry systems although these were all implied to have been superseded by more ambitious techniques. The E.M.I. and Mc-Michael Radio systems employ frequency modulation of a pulse rate modulated carrier for the various channels which were sequentially sampled by means of a 24 position rotating switch. The Bristol Aircraft system is a frequency multiplex f.m.-a.m. equipment with sub-carrier frequencies in the band 250-500 kc/s and a radio frequency in the 465 Mc/s band. It provides up to six simultaneous continuous channels having a useable bandwidth of from 10 c/s to 10 kc/s.

Exhibits by Pye Telecommunications and Vickers showed how guided weapons could be employed by infantrymen, but in this case the directional information to the rockets was passed along two trailing wires. The operator views the missile through a binocular periscope and directs the missile by a small joystick.

A system has been evolved by the Royal Aircraft Establishment known as the pilot's view simulator, which is applicable to training or research. Television monitors or large pro-

jection screens are used to present a picture which is entirely artificial, being generated by an optical or electro-mechanical system from either a photo-mosaic or a scale model of an area of country. The apparatus employs a computer derived from a flight instrument simulator which, in response to pilot's control column movements calculates the values of attitude heading, speed and height to give a realistic picture movement.

Various techniques in the application of liquid cooling of electronic equipment are being investigated by the Royal Radar Establishment, and experimental examples were shown of the chassis for an airborne radar equipment in which hollow aluminium sheets are part of a pump circulated cooling system with a rejection heat exchanger external to the electronic equipment.

The techniques of miniaturization are of vital importance in aircraft equipment, and both components and complete equipments were shown. Many of these incorporated transistors, and they included airborne teleprinters, radio altimeters and speed indicators for jet engines.

In the field of research and production equipment, two items may be mentioned. Solartron showed a new small analogue computer contained in a cabinet measuring 20 in. x 30 in. and 51 in. high. This comprised ten d.c. amplifiers, non-linear elements and all necessary input and feedback components, potentiometers, control and patching panels and power supplies. Each of the amplifiers may be used for summing, sign reversing, integration or the simulation of a transfer function over a wide range. This enables such problems to be solved as fourth or fifth order differential equations, network analysis, or servo systems with multiple loops.

A demonstration was given of the operation of the three-dimensional tape control inspection machine developed by the I.E.M.E., Ministry of Supply. Correctly machined components are taken through a series of movements which is programmed by a machine tool control system to follow the true mean path. A stylus is in contact with the components and any deviation from the correct form is plotted on a chart.

Altogether a most interesting and stimulating show for the electronics engineer.



# APPLICATION OF GAS DISCHARGE TUBES AS NOISE SOURCES IN THE 1700-2300 Mc/s BAND\*

by

M. Kollanyi (Associate Member)†

## SUMMARY

The paper gives the design aspects, description and performance of a gas discharge helix-coupled noise source for the 1700-2300 Mc/s band. A minimum coupling of 15 db is maintained throughout the band. Satisfactory matching is obtained in both the struck and unstruck state, thus facilitating easy noise figure measurements with an accuracy of 0.2 db.

### 1. Introduction

The application of a noise source for the measurement of the noise figure of a receiver is widely known. The simplicity and reliability of noise measurement using a noise generator compared with the measurements made with a signal generator are so obvious that noise generators have been developed and manufactured for almost the whole frequency range occupied by telecommunication and navigation systems.

Temperature-limited diodes are used up to 300 Mc/s. Above this frequency difficulties are encountered in connecting the diode system to the line properly, and in keeping stray residual inductance and capacitance to the minimum.

In the upper frequency bands (C, X, K, Q) the problem may be solved by placing a gas discharge tube across the waveguide at a shallow angle. The dimensions required for adequate coupling are a practical proposition even at a frequency as low as 5,000 Mc/s.

However, to maintain satisfactory coupling between the gas discharge and the transmission line, whilst keeping the size reasonable in the frequency band around 2,000 Mc/s, means that an alternative approach has to be made. A practical solution utilizes a helical line which reduces the phase velocity bringing the wavelength down under the length of the tube. This gives satisfactory coupling with a practicable size of discharge tube mount.

### 2. Gas Discharge as a Noise Source

The field induced by the charged particles involved in the discharge contains all the frequencies with equal probability and without phase coherence, thereby resulting in a white noise. (The velocity of the particles has a Maxwellian distribution.)

The average power of this noise generator depends mainly on the gas content and to a lesser extent on various other factors, namely the bulb wall temperature and the current.<sup>1</sup> Since the gas in all the tubes supplied by the manufacturer is identical the effect of the gas content will be omitted from this discussion.

The noise source is either described by its equivalent noise temperature or by the ratio between the noise power available from it and from a resistor at room temperature (290° K).

The available noise power from a resistor is expressed by the formula

$$P_N = kTB \quad \dots\dots(1)$$

where  $P_N$  is the available noise power in watts  
 $T$  is the absolute temperature of the resistor in °K

$B$  is the bandwidth in cycles/sec

$k$  is the Boltzmann constant

$$(1.38 \times 10^{-23} \text{ joule/}^\circ\text{K})$$

A similar equation can be applied to the noise tube except that  $T$  means the equivalent noise temperature of the source. This temperature lies normally in the region 10,000°–15,000°K.

Often the excess noise power of the source is quoted, i.e. the ratio (overall noise power—noise power of a resistor at room temperature)/ (noise power of the resistor).

\* Manuscript first received 18th March 1958, and in final form on 21st June 1958. (Paper No. 469.)

† Marconi Instruments Ltd., St. Albans, Herts.  
U.D.C. No. 621.387.22:621.396.822.029.63

If the discharge current is well above a critical value, the noise power is independent of the current.<sup>1</sup> This is an important fact since it means that the power supply of the tube need not be stabilized. An equally significant consequence is that the plasma oscillations, which inevitably occur, do not modulate the noise output. Since the gas pressure may have a considerable effect on the noise power, the temperature of the bulb wall which controls the temperature of the gas, may have a noticeable effect on the noise output. Some authors have found that in the case of a mercury-argon filling the change in noise is -0.055 db per °C change in temperature.<sup>2</sup> This excessive change is caused by the mercury vapour, therefore mercury should be omitted if good stability is required.

**3. Coupling the Noise Power to the Transmission Line**

A suitable coupling device has to be chosen to transfer the available noise power to the coaxial transmission line system. The degree of coupling is measured in terms of attenuation, i.e. the ratio of the signal levels at the two ends of the coupling device, if one end is connected to a signal generator and the other end is connected to a matched load. It is assumed that this attenuation is due merely to the power absorbing ability of the ionized gas, other conductivity losses being neglected.

Since the coupling between the gas discharge and the transmission line is always less than infinity, the effective noise temperature of the source is less than that of the noise tube. If the coupling changes with frequency, a deviation from white noise is experienced in the output.

The effective noise temperature of a passive two-pole network is the weighted average of the noise temperature of the individual components. They are weighted according to their partial contribution to the total power absorbing ability of the network.

If the overall attenuation of the helical line with the tube struck is  $A$  ( $A > 1$ ), the effective noise temperature at the output terminal is  $T_{eff}$

$$T_{eff} = T_{\infty} \left( 1 - \frac{1}{A} \right) + T_R \cdot \frac{1}{A} \dots\dots\dots(2)$$

where  $T_{\infty}$  is the actual noise temperature of the tube and  $T_R$  is the temperature of the termination at the far end of the line. It is assumed that this is matched and is at room temperature.

Equation (2) divided by  $T_R$  gives the noise temperature ratio:

$$t_{eff} = t_{\infty} \left( 1 - \frac{1}{A} \right) + \frac{1}{A} \dots\dots\dots(3)$$

Dividing this by  $t_{\infty}$  we obtain the error factor to be expected:—

$$\frac{t_{eff}}{t_{\infty}} = 1 - \frac{1}{A} + \frac{1}{A \cdot t_{\infty}} \dots\dots\dots(4)$$

Since both  $A$  and  $t_{\infty}$  are much greater than unity, the third term on the right of eqn. (4) is negligible. Thus

$$E = \frac{t_{eff}}{t_{\infty}} = 1 - \frac{1}{A} \dots\dots\dots(5)$$

The minimum attenuation required to limit the errors to a given value can be calculated from eqn. (6).

$$A = 10 \log \frac{1}{1 - E} \text{ db} \dots\dots\dots(6)$$

$E$ , the error factor, is always less than unity. The reciprocal of  $E$  could be used as a correction factor if  $A$  is known.

The graph shown in Fig. 1 indicates this function.

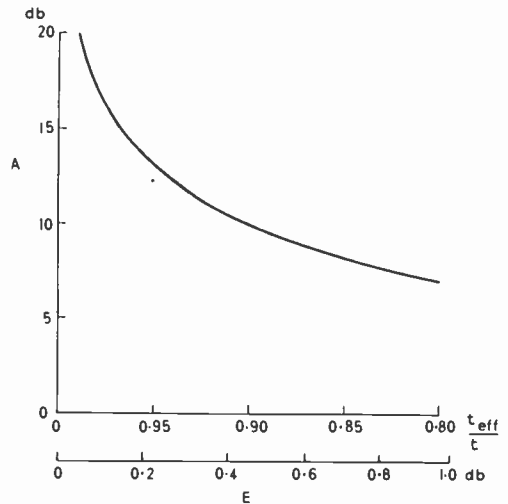

Fig. 1. Minimum attenuation on the helical line in terms of the error factor.

According to the curve  $A = 13.5$  db minimum attenuation is required to limit the variations in the output noise to 0.2 db. Since the attenuation usually falls to minimum at the lower end of the band, the attenuation is calculated for that region.

The attenuation requirement calculated above can be satisfied with a helical line. A wire or strip helix is wound on the glass tube and is surrounded by a cylindrical surface, these elements being the continuation of the inner and outer conductor of the transmission line respectively. (See Fig. 2.) The far end of the helical line is terminated in a resistance equal to its characteristic impedance.

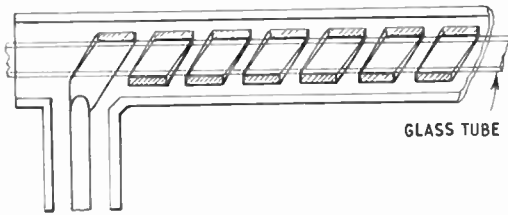

Fig. 2. The helical line.

The propagation takes place along the turns of the helix while some portion of the electric field lies in the gap between the helix and the cylindrical wall. A substantial part of the field lies within the helix producing locally longitudinal fields, thus resulting in a coupling between the helical line and the ionized gas. Unfortunately this field dies away very quickly as the axis of the helix is approached. (See Fig. 3.)

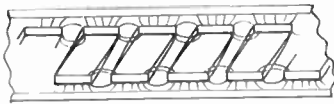

Fig. 3. Field configuration along the helical line.

This coupling is responsible for the attenuation along the line and in turn for the noise power coupled out from the gas discharge which contains charged particles moving parallel to the internal  $E$  field.

#### 4. Result of Mismatches

The presence of the gas discharge within the helix is equivalent to an evenly distributed parallel conductance,  $g$ . (See Fig. 4.)

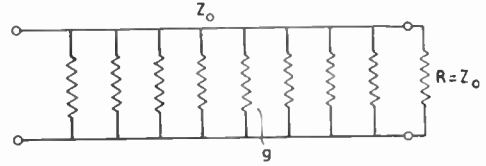

Fig. 4. Equivalent circuit for a gas discharge along the helix.

During one cycle of the noise figure measurement the gas discharge is switched off to read the noise output of the receiver generated by itself (including  $kTB$  at the input). The definition of the noise figure assumes that the input terminals of the receiver during this period are terminated by the characteristic impedance which is at room temperature.

This requirement could be satisfied only at the expense of the match in the ignited condition. Once the characteristic impedance of the helical line is made equal to that of the transmission line when the tube is ignited, the match between the transmission line and the helical line cannot be maintained if the tube is extinguished due to the removal of  $g$ .

If  $\rho_i$  is the modulus of the reflection coefficient of the noise generator in the ignited condition, the error  $E_i$  introduced by the mismatch is expressed by the formula

$$E_i = 10 \log \frac{1}{1 - \rho_i^2} \text{ db} \quad \dots\dots\dots(7)$$

$$\text{where } \rho_i = \frac{\sigma_i - 1}{\sigma_i + 1} \quad \dots\dots\dots(8)$$

The result of a mismatch in the extinguished condition can be investigated on the basis of the definition and the method of measurement of the noise figure.

The linear noise figure  $F$  of a receiver is expressed by the formula\*

$$F = \frac{N_o}{G \times kTB} \quad \dots\dots\dots(9)$$

where  $N_o$  is the output noise power

\* This formula is valid if  $G$  is constant over the band  $B$ , or  $B$  means the effective bandwidth.

$G$  is the overall gain of the amplifier

$kTB$  is the same as in eqn. (1)

If the noise tube is switched off the output meter of the receiver will read  $D_A$

$$D_A = G \times F \times kTB \quad \dots\dots\dots(10)$$

If the gas discharge is switched on, the output meter of the receiver will read  $D_B$

$$D_B = D_A + G \times (C - 1) \times kTB \quad \dots\dots\dots(11)$$

where  $C = \frac{P_G}{kTB} \quad \dots\dots\dots(12)$

$P_G$  = total output power of the noise generator

From (10) and (11)

$$F = \frac{C - 1}{\frac{D_B}{D_A} - 1} \quad \dots\dots\dots(13)$$

The noise output of the receiver with the discharge switched off can be resolved in two components. (Fig. 5.)

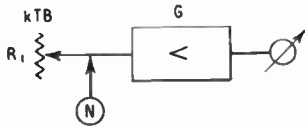

Fig. 5. Equivalent circuit of the noise output of a receiver.

$N$  is the noise contribution of the receiver to the thermal noise.

$$D_A = G (kTB + N) = G \times F \times kTB \quad \dots\dots\dots(14)$$

Hence  $N = kTB (F - 1) \quad \dots\dots\dots(15)$

If the cold source is mismatched by a factor of  $\rho_c^*$ , the noise power delivered into the line and to the receiver will decrease by a factor of  $m$ , which is given by the following equation:

$$m = 1 - \rho_c^2 \quad \dots\dots\dots(16)$$

where  $\rho_c = \frac{Z_c - Z_0}{Z_c + Z_0} = \frac{\sigma_c - 1}{\sigma_c + 1} \quad \dots\dots\dots(17)$

$Z_c$  and  $\sigma_c$  are the impedance and voltage standing wave ratio looking into the noise

\*  $\rho_c$  is the modulus of the reflection factor of the source, when the tube is extinguished.

generator with the discharge switched off.

If this mismatch exists the reading  $D_A$  and  $D_B$  will change to

$$D_A = G (m kTB + N) = G [m kTB + kTB (F - 1)] \quad \dots\dots\dots(18)$$

and  $D_B = G \times kTB (m + F - 1 + C - 1) \quad \dots\dots\dots(19)$

From (18) and (19)

$$F = \frac{\frac{D_B}{D_A} (1 - m) + m + C - 2}{\frac{D_B}{D_A} - 1} \quad \dots\dots\dots(20)$$

Comparing the result with  $F$  given by (13), and denoting the latter by  $F_a$ , the error factor is given by the following formula

$$E_c = \frac{F}{F_a} = \frac{F}{F - \rho_c^2} \quad \dots\dots\dots(21)$$

Equation (21) expresses the relationship between the true noise figure  $F$  and the apparent one  $F_a$  as a function of  $F$  and  $\rho_c$ .

According to eqn. (21) if a 5 per cent. error (0.2 db), i.e.  $E_c = 1.05$  is allowed and  $\sigma_c = 2.5$ , the smallest noise figure is 3.9 (5.9 db) which can be measured within the given tolerance.

These statements are valid only in the case when the incorrect termination of the receiver input does not modify the noise factor. If it is affected by the reflection, the errors may be higher.

The effect of this mismatch can be evaluated by measuring the noise figures with various lengths of cables between the noise source and the receiver. If it would be impractical to carry out this investigation and it is necessary to obtain accurate results, the noise source should be replaced by a correct termination when taking the reading  $D_A$ .

Since a receiver may have spurious transmission bands, discrepancies may be experienced in the noise figures measured by noise generator and signal generator. It is because the noise source produces signal in the spurious bands too, thus resulting in a lower apparent noise figure. Since the convention is to accept the highest noise figure (i.e. measured with a

signal generator), the noise figure obtained by a noise generator is to be corrected, the correction being +3 db in the case of a superheterodyne receiver without image band suppression.

## 5. Description of the System Developed

### 5.1. The Discharge Tube

The filling of the gas tube is pure argon having a pressure of 10 mm Hg. Although the noise temperature of the argon is slightly less than that of the mercury argon mixture, in compensation it has a much better stability. Within practical limits it is independent of temperature.

According to Sees and Corbett the excess noise temperature of the argon tube is  $15.5 \pm 0.25$  db.<sup>1</sup>

The principal dimensions of the tube are shown in Fig. 6. The cathode is indirectly heated. The recommended discharge current for the tube is 130 mA.

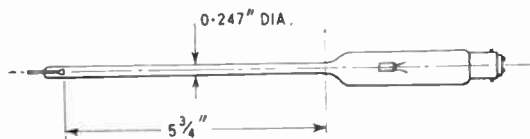

Fig. 6. Physical dimensions of the gas-discharge tube.

Johnson and De Remer established an empirical formula for the critical current, above which the microwave effects of the current fluctuations are suppressed:<sup>1</sup>

$$I_c = \log_{10} \frac{42}{p} (0.13 + 0.56 R^2) + 0.11 \dots\dots(22)$$

where  $I_c$  critical current in amperes  
 $p$  gas pressure in mm of Hg  
 $R$  interior tube radius in cm.

The formula is valid for argon filling. Applied to this particular case it results in an  $I_c$  of 207 mA. It would be impractical to maintain this discharge current constantly, although provisions are made to produce this current for shorter intervals.

It was found that the formula (22) gives too high values for the critical current. In practice the noise output does not change above 150 mA.

### 5.2. The High Frequency System

From an electrical point of view the high frequency system can be sub-divided into three main parts:

- (1) Helical line
- (2) Transition
- (3) Termination

#### 5.2.1. The Helical Line

The helical line consists of a tubular outer conductor and a helical inner conductor. The inner conductor is manufactured from a precision brass tube by cutting a spiral slot in it. The inner diameter of the helix is slightly greater than the outer diameter of the glass tube (0.248 in. and 0.247 in. respectively).

The dimensions of the helical line are given in the following table:

|                 |                     |
|-----------------|---------------------|
| Outer conductor | 0.4 in. i.d.        |
| Helix           | 0.286 in. i.d.      |
|                 | 0.248 in. i.d.      |
|                 | 0.262 in. pitch     |
| Length for both | 5 in. (See Fig. 7.) |

Various methods for evaluating the impedance of helical lines have been developed by different authors.<sup>3,4,5</sup> Although they give only approximate results they are very helpful in the first attempt to approach the required impedance. One of these methods gives a  $Z_0 = 55$  ohm impedance for the helical line outlined above. This impedance suffers some reduction due to the insertion of the glass tube and a further reduction due to the conductivity of the gas discharge when struck.

The impedance of the helical line seems to be greatly affected by deviations from the centre position and the true shape. Provision is therefore made for accurate centering of the helix by nylon screws displaced at 120° which support the helix at the two ends. Deviations from the true shape can be prevented only by using stiff material and close tolerance glass tubes. It seems to be advisable to keep these radial tolerances as low as 0.005 in.

#### 5.2.2. The Transition Section

The noise power extracted from the noise tube by the helical line is coupled to the output point by a short section of 50-ohm line. The line, although of circular cross-section, is a tangential continuation of the helix. Mismatch owing to the discontinuity between the two

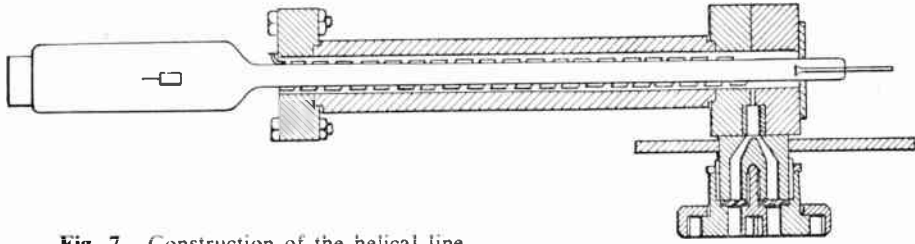

Fig. 7. Construction of the helical line.

different structures is eliminated by circumferential grooves on the centre conductor placed near the junction to the helix. With this method a good match was obtainable throughout the 1700–2300 Mc/s band with the tube struck.

The short coaxial line has a smaller diameter than the standard output coupling, therefore it is tapered up to that size in a short transformer section.

5.2.3. The Termination Section

The end of the helix opposite to the output is terminated in a ¼ watt carbon resistor of nominal value 100 ohm. To reduce its stray inductance it is mounted flush on the end block. The increase in resistance due to the skin effect seems to be offset by the increasing effect of the intergranular capacity as the frequency is increased.

5.3. The D.C. Circuit

The discharge tube is fed from an unregulated high internal resistance d.c. source. (See Fig. 8.) Since the tube can work in the uncritical current region there is no need for stabilizing the power supply. The purpose of the high internal resistance is to maintain a current which is independent of the conditions within the tube.

The ignition of the tube is accomplished by a high voltage pulse applied to the cathode and anode of the tube. The high voltage pulse is produced by a coil connected in series with the tube. The ignition switch short circuits and releases the latter. The voltage of the surge is given by the formula

$$E = I \sqrt{\frac{L}{C}} \dots\dots(23)$$

where  $E$  = peak voltage of the pulse in volts  
 $I$  = current flowing through the coil in amperes

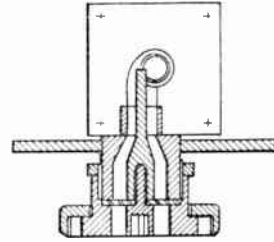

$L$  = inductance of the coil in henries  
 $C$  = parallel capacitance of the coil including other shunt capacitances in farads

Since the current is 190 mA, the inductance 25 henries, the capacitance 0.01 µF, the surge voltage  $E$  is 9.5 kV.

Although this voltage cannot build up due to the much lower breakdown voltage of the tube, it gives a safety factor in the striking process, thus allowing for ageing.

The current regulating resistance is added to reset the current to the same value in the case

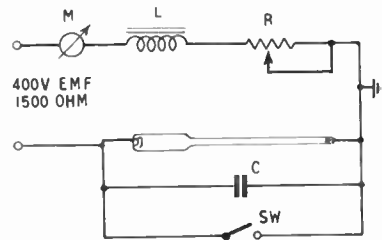

Fig. 8. Power supply circuit for the noise source.

of change or ageing of the tube. In addition, it gives the facility to make sure that the current is in the non-critical region.

## 6. Performance

The noise source having the structure outlined above was tested for coupling, matching and oscillations.

The insertion loss of the system, which is equivalent to the coupling factor, was measured.

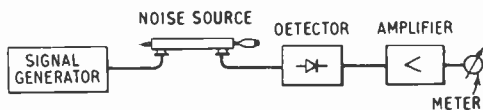

Fig. 9. Testing arrangements for a noise source.

The helical line had been provided with a coupling flange at both ends and was inserted between a signal generator and a matched detector. (See Fig. 9.)

The output of the detector was connected to a selective amplifier, the output of which was indicated by a meter. The attenuation was taken as equal to the difference in setting of the attenuator of the signal generator to get the same deflection on the meter in the two cases, i.e. when the noise source was inserted and removed.

The cold attenuation of the system was found to be approximately 1.5 db. A small fraction of this (approx. 0.1 db) might be produced by the output transition as a reflection loss.

Since the remaining part (dielectric and resistive losses) is evenly spread along the helix (approx. 0.1 db/cm) its total effect on the output noise is approximately only 0.05 db, if a minimum coupling of 15 db is assumed for the tube struck. For high values of coupling this error is even less.<sup>8</sup>

The attenuation with the tube struck was measured as a function of frequency and discharge current. It was found that to obtain a minimum attenuation of 15 db at the lowest frequency (1700 Mc/s) a current of 65 mA is required. The attenuation (in decibels) seems to increase linearly with current and with frequency within the limits investigated (40–90 mA and 1700–2300 Mc/s). A slope of 1.3 db/10 mA and 0.83 db/100 Mc/s respectively was found graphically. Since the tube is normally operated above 100 mA, the coupling is always well above the required value. If the attenuation is 19 db, the error due to the non-infinite

coupling according to eqn. (6) is 1.26 per cent. (0.05 db).

The matching of the system was investigated by s.w.r. measurements carried out in the normal way. Matching was found to be far better with the tube struck, than with the tube extinguished.

With the tube struck a v.s.w.r. of 1.05–1.12 was measured depending on the attention paid to the adjustment of the helix. The v.s.w.r. changes very little throughout the band indicating that there is only one source of reflection, namely the transition from the coaxial to the helical line.

With the tube extinguished the v.s.w.r. increased to 1.5 and in some cases even more. The v.s.w.r. curve plotted against frequency is a rapidly changing curve having several maxima and minima throughout the band indicating that there are several sources of reflection. These are the transition between the coaxial and helical line, which is substantially different from that with the tube struck, the irregularities in the helix causing impedance variations, and also the termination which inevitably contains reactive components. The situation is complicated by the fact that the characteristic impedance of the helical line is a function of the frequency, although this effect is less important than the others.

The possible error in noise figure measurement caused by this mismatch can be calculated from eqn. (21). If  $\sigma_c=2$  and the noise figure  $F=10$ , the error  $E_c$  is equal to 1.014 (approx. 0.06 db) if the noise figure of the receiver does not change rapidly with input impedance changes, which is the case with normal receivers.

The tubes developed strong oscillations both in voltage and current. The frequency and amplitude of these varied from tube to tube and with the current. The wave shape of the current oscillation is complex. The analysis of the wave indicated the presence of two basic components lying at 12 and 15 kc/s.

In the low current region (60 mA) the amplitude of the oscillation could be reduced to 1/40th of the original value by inserting a high inductance into the anode circuit of the tube. This method seems to be less efficient at higher

currents but the effect of the oscillations on the noise output is negligible being nearer to the critical current.

In fact no evidence was given by conventional detecting devices of any modulation of the noise.

### 7. Conclusion

A simple and reliable noise source has been developed for noise figure measurements in the u.h.f. band. The accuracy of the measurement is better than 0.2 db once the accurate noise temperature of the tube has been established in the 1700–2300 Mc/s range and with wider tolerances the measurements can be extended to 1000–3000 Mc/s.

Since the noise power of the source is 15.5 db, its usable range of noise figure is 0–30 db. At the lower end insertion of the attenuator may be necessary to facilitate accurate readings on the output meter.

The instrument is suitable for quick measurements both in the field and on the production line. The speed and simplicity of such measurements compares very favourably to the signal generator method in addition to lower cost.

### 8. Acknowledgment

The author is indebted to Marconi Instruments Limited for their kind permission to publish this article.

### 9. References

1. H. Johnson and K. R. De Remer, "Gaseous discharge super high frequency noise sources," *Proc. Inst. Radio Engrs*, **39**, p. 908, August 1951.
2. M. A. Easley and W. W. Mumford, "Electron temperature vs noise temperature in low pressure mercury argon discharges," *Journal of Applied Physics*, **22**, p. 846, June 1951.
3. A. J. Lichtenberg, "Helical Coupling System" (M.I.T. Technical Report 290. October 1954.)
4. J. R. Pierce, "Travelling Wave Tubes" (van Nostrand, New York, 1950.)
5. O. G. Owens, "Coupled Helix Attenuators for Travelling Wave Tubes" (Electronic Research Laboratories, Stanford University, Tech. Report 68.)
6. C. C. Cutler, "Experimental determination of helical wave properties," *Proc. Inst. Radio Engrs*, **36**, p. 230, February 1948.
7. E. L. Chinnock, "A portable direct reading microwave noise generator," *Proc. Inst. Radio Engrs*, **40**, p. 160, February 1952.
8. E. M. Wareham, "Technique of microwave measurements," *J. Brit. I.R.E.*, **16**, p. 397, July 1956.
9. R. E. Burgess, "Noise in receiving aerial systems," *Proc. Phys. Soc., Lond.*, **53**, p. 293, May 1941.
10. H. T. Friis, "Noise figure of radio receivers," *Proc. Inst. Radio Engrs*, **32**, p. 419, July 1944.



## I.T.A. STATION IN ISLE OF WIGHT

ON Saturday, August 30th, the Independent Television Authority's transmitting station at Chillerton Down, Isle of Wight, came into official programme service. Chillerton Down station is designed to serve some 2½ million people living within the area bounded by Weymouth in the West, Newbury in the North and Brighton in the East, and is the seventh I.T.A. station to come into service.

The Authority's Chief Engineer, Mr. P. A. T. Bevan, has stated that the opening of the Chillerton Down station marks the first step in the second stage of providing an alternative programme on a full national basis. The first stage was completed when the St. Hilary station in South Wales went into service at the beginning of this year. Chillerton Down is the first of the next group of five stations of medium power which fill in the areas not served by the first six transmitters. Mr. Bevan said that it was the Authority's view that the Government's declared technical policy for the utilization of Band III, arrived at on theoretical grounds, had now been proved right. With careful overall planning, careful selection of sites and by insisting on the maximum possible performance from the stations it would be possible to extract two programme services, each of virtually national coverage, from the eight channels of Band III (174-216 Mc/s). One further channel for each of these services would provide coverage up to the technically and economically realistic limit.

The Chillerton Down transmitting station embodies many interesting new technical features. The vision transmitters are the first of an entirely new type and represent an important step forward in engineering practice. A considerable reduction has been made in the number of valves used; this has permitted a straightforward layout and the incorporation of a simple, yet effective, cooling system. The need for under-floor ducting to carry the cooling air stream for the transmitter has been dispensed with, the cooling arrangements being such that this type of transmitter can be installed on any flat floor surface, with installation time reduced to the minimum. The heated air from around the valves is extracted and can be discharged to augment the room heating.

The transmitter is housed in three standard cabinets which stand side by side to form a continuous front of only 7 ft. 6 in., the depth being 3 ft. 9 in. Viewed from the front, the right-hand cabinet contains the r.f. stages and the final stages of the modulator, with the cooling fan in a lower compartment. The central cabinet houses the low power units, while the left-hand cabinet houses the main and auxiliary h.t. supplies, which employ xenon rectifiers, and miniature circuit breakers.

"Switching on" procedure is governed entirely by the circuit breakers mentioned above and by only two contactors. These provide the necessary interlocks to ensure the correct sequence of operation, and also include overload circuits to protect the transmitter in the event of a circuit fault. All doors and units giving access to high voltages are interlocked by Yale type keys in conjunction with an earthing switch, thus providing full safeguarding of the operating personnel.

The crystal drive output feeds into a single tetrode valve stage (QQV.0640) which operates as a tripler. The output of this is taken to an r.f. stage which is a tetrode valve (QV1-150A). The output of this drives the penultimate stage, which consists of four tetrode valves (QV1-150A's) in parallel push-pull. The circuits linking the penultimate r.f. stage to the final r.f. stage have been especially designed for a wide bandwidth.

The final r.f. stage employs two tetrode valves (CR-1100's) in push-pull. The anode-tuned circuit for this stage has been combined with a vestigial sideband filter which shapes the response to give appreciable cut-off for the vestigial sideband thus avoiding the use of an external filter. The tuned circuits are of open-line construction and designed for ease of tuning and maintenance.

The low-power stages of the modulator are mounted on a sub-modulator chassis and housed in the centre cabinet. This chassis contains the facilities for stretching synchronizing signals and for linearity correction in the picture region. Stability of black level is ensured by the use of overall feedback and of noise-immune clamps in the sub-modulator.

The modulator voltage amplifier and final cathode follower are contained in the right-hand cabinet. The modulator voltage amplifier consists of two tetrode valves (EL-34's) while the cathode follower stage uses three QV1-150A valves. The modulation output is applied to the grid circuit of the final r.f. amplifier.

The associated sound transmitter has a power output of 1 kW and is of conventional design. It feeds into an aerial combining unit inside the building.

The aerial is a twin-eight stack array (used in the present instance as a sixteen-stack) mounted on a 750 ft. triangular mast. The radiation pattern is directional in character with a minimum of back-radiation southwards across the English Channel and the maximum extending in an arc across the South coast of England. The aerial gain is of the order of 16 db in the forward direction over an arc of 180°. It is the intention of the Independent Television Authority to use one pair of vision and sound transmitters as "MAIN" with the other pair as "STANDBY", so that the aerial, fed by a vision output of 4 kW (and allowing for feeder losses) provides a vision e.r.p. of approximately 100 kW over this arc. The station operates on Channel 11 (vision 204.75 Mc/s, sound 201.25 Mc/s).

A further feature of interest in connection with the aerial is the use of a new type of feeder for conveying the power from the transmitter to the aerial. To counteract the effects of expansion and contraction on such a long run of feeder line, a complex system of expansion joints has hitherto had to be employed. On the Chillerton Down feeder, however, the cable is supported flexibly by means of runners and springs so that expansion can take place without any significant stress along the length of the run.

All transmitting equipment, including the aerial system, has been manufactured by Marconi's Wireless Telegraph Co. Ltd.

The programmes for the Southern Television Company are carried to the transmitter at Chillerton Down over a link provided and operated by the Post Office. This link is in two parts: one carries the I.T.A. national network programme from London to the Southern

Television Plaza studio at Southampton, the other carries the network programme, locally provided programmes and advertising material inserted at the studio, to the transmitter at Chillerton Down. The link is some 125 miles in length, most of which is by microwave relays.

The London to Southampton system comprises:—

(1) A two-hop microwave radio-relay link, of 83 miles length, operating in the 4,000 Mc/s frequency band and installed on the existing route from Museum Telephone Exchange, London via a repeater station at Golden Pot, near Alton, Hants, to the receiving terminal situated in the B.B.C. Television broadcasting station at Rowridge, Isle of Wight;

(2) a video link of 3½ miles length on coaxial cable from Rowridge to the I.T.A. station at Chillerton Down;

(3) a single-hop microwave radio-relay link, of 18 miles length, operating in the 2,000 Mc/s frequency band, from the I.T.A. station at Chillerton Down to the Post Office Telephone Exchange in Southampton;

(4) a video link of 1½ miles length on coaxial cable from the Southampton Telephone Exchange to the Plaza Studio.

The Southampton to Chillerton Down system comprises:—

(1) A video link of 1½ miles length on coaxial cable from the Plaza Studio to Southampton Telephone Exchange;

(2) a single-hop 2,000 Mc/s microwave radio-relay link, of 18 miles length, from Southampton Exchange to Chillerton Down.

The 4,000 Mc/s link transmitters employ travelling-wave tubes as r.f. amplifiers, while the 2,000 Mc/s equipment has triode amplifiers. In both cases the video signal frequency-modulates an intermediate frequency carrier. For the 4,000 Mc/s link this carrier of 60 Mc/s phase-modulates a travelling-wave tube; the 70 Mc/s carrier for the 2000 Mc/s link is translated to the link frequency by means of a triode valve mixer. Over the 4,000 Mc/s link to and from Rowridge common aerial systems and feeders are used for I.T.A. and B.B.C. services. All link equipment, with the exception of aerials, is duplicated in order to ensure continuous service.

# THE DESIGN AND PERFORMANCE OF MAGNETIC TAPE RECORDING HEADS\*

by

C. W. Ross (Graduate)†

## SUMMARY

Magnetic heads of the conventional ring type used for high quality sound recording and reproduction are discussed in detail. Factors governing their performance and design and the importance of various mechanical relationships are pointed out. The choice of operating conditions for optimum performance and the importance of correct mechanical adjustments is considered.

### 1. Introduction

The object of this paper is to illustrate the problems in the design of the conventional ring-type magnetic heads, and to study their various performance characteristics. The design of magnetic heads has become very specialized; the assembly and finish of their component parts require the utmost precision where high grade end-products are required.

There is a wide variety of applications for magnetic recording machines, from computers to sound and television, and in general the highest frequency that it is desired to reproduce governs the speed of tape transport across the magnetic heads. The replay head provides a limitation to the maximum number of cycles of signal per inch of recording media which can be resolved satisfactorily.

The three main factors to be considered when dealing with tape heads and associated circuits are frequency response, distortion and signal-to-noise ratio. Good quality magnetic heads are now commercially available and with suitable circuits will perform satisfactorily up to a frequency limit of 1800 cycles per inch per second.

In normal audio-frequency applications the recording machine has three magnetic heads on an easily-detachable rigid plate. The tape is first demagnetized by the erase head, saturation of the tape taking place at its gap which is

large in relation to the record and replay heads, and the tape is taken through many cycles of magnetization which gradually decrease in amplitude due to its motion past the head.

The record head has two magnetizing components, one signal and the other a high frequency "bias" to linearize the shape of the lower part of the hysteresis curve of the tape. The signal on the tape is then reproduced by the replay head and fed into suitable amplifiers. These three types of head will now be discussed in more detail.

### 2. Erase Heads

The impedance of the erase head is chosen so that the high-frequency voltage across the head is not excessive when operating normally. The oscillator anode coil can then be designed for ease of manufacture. Dielectric heating effects are also kept to a minimum when the erase head is a low or medium impedance device at its operating frequency. Core losses can be minimized by using a ferrite material in connection with a non-conducting gap spacer. In practice it has been found that although a conducting gap spacer (phosphor-bronze, etc.) has a better flux distribution about the working gap, the heat generated due to eddy currents is excessive in "full track" erase heads and the insulator type is superior. The metal spacer tends to "throw out" the flux, while the poorer flux distribution about the non-conductive gap spacer is approximately balanced by its lower losses. Harmonic distortion of the erase and bias current waveforms should be kept to an absolute minimum, as distortion causes noise to be left on the tape. A figure of less than 0.5 per cent. total harmonic distortion

\* Manuscript first received 3rd January 1958, in revised form on 29th May 1958, and in final form on 1st July 1958. Based on a thesis accepted in lieu of the Institution's Graduateship Examination. (Paper No. 470.).

† Kelvin and Hughes Ltd., Hillington, Glasgow.  
U.D.C. No. 621.395.625.3

is usually required in practice to give a clean, low noise background to the recording.

### 3. Record Heads

The basic requirements of a record head are a low reluctance magnetic circuit with small hysteresis and eddy current losses, and a well-defined straight-edged gap, its length being relatively unimportant compared with the replay head front gap. Ferrite material is inherently granular and unsuitable for the gap portion of the record head, although successful heads have been made by using pole shoes of high permeability metal to form a clean, straight, gap.

The C.C.I.R. recording standard is widely adopted now. This means that the tape has been recorded to a definite induction/frequency characteristic. Taking the characteristic adopted for the tape speed of  $7\frac{1}{2}$  in. per sec which is "100 microseconds" and providing that the replay amplifier has the inverse of this response of 100 microseconds, the output would be constant over the band of frequencies recorded on the tape. This is only true if the replay head has no losses whatsoever and is in fact "ideal."

The response is conveniently described in microseconds, for it is the response of a simple R-C combination as shown in Fig. 1.

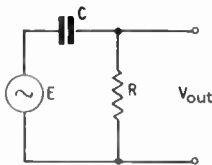

Fig. 1. Equivalent circuit of "ideal" replay head.

$V_{out}$  represents the voltage across the "ideal" replay head winding when a tape is reproduced having the C.C.I.R. induction/frequency characteristic of 100 microseconds.

A certain amount of high frequency pre-emphasis or "equalization" is required in the recording amplifier due to losses in the recording head and the tape magnetizing process. For a tape speed of  $7\frac{1}{2}$  in./sec approximately +11 db of equalization is needed at 10 kc/s (reference 1 kc/s=0 db) to produce a recording

which has the C.C.I.R. characteristic, given a good quality record head. A typical record current versus frequency curve is shown in Fig. 2, for  $7\frac{1}{2}$  in./sec tape speed, head at optimum bias peak at 1 kc/s.

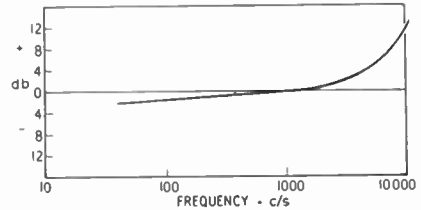

Fig. 2. Frequency response for a C.C.I.R. recording at 7.5 in. per sec.

The manufacture of a C.C.I.R. standard frequency test tape "from scratch" so to speak, is not a very straightforward matter, as can be seen from the following extract taken from the relevant British Standard:—

*"Methods of measuring the magnetization of a tape."*

There are two general ways in which the surface induction/frequency characteristic of a tape may be determined.

1. By means which do not affect the surface induction. This implies the use of a non-magnetic reproducing device. For example, reproduction by means of a simple non-magnetic conductor placed in the field at the surface of the moving tape is practicable as a laboratory method and may therefore be used to establish a primary standard. This can be used to determine the relative change of surface induction with wavelength created by the presence of a magnetic head.

2. By means of a magnetic reproducing device, which necessarily affects the surface induction of the tape in a manner dependent on recorded wavelength. In this category there are two ways in which conventional magnetic heads have been used, one method involving heads with a short gap, the other involving heads with a long gap. In both cases the gap in the reproducing head must be sufficiently accurate, magnetically, to give well-defined minima of reproduced level, one in the short gap method or several in the long gap method. In order to ensure that

the same results will be obtained with both magnetic and non-magnetic reproducing devices, a coated high coercivity tape must be used."

Further details are given in the Appendix.

The sensitivity of a record head largely depends on the front-to-back depth of the working gap and the type of tape used, but it is difficult to calculate because it depends upon the leakage and fringing across the gap. In general the back-to-front depth is made as small as possible consistent with reasonable working life of the head. This also applies to the erase and replay heads.

The optimum bias required is governed by three major factors, high-frequency loss, nature of the tape coating and the signal frequency. It has been found that it is advantageous to slightly over-bias the record head, until the output from the replay head that is monitoring the recording of 1 kc/s drops by 2 db, because this ensures that the effects of any discontinuities in the tape coating, contact between head and tape, etc., are kept to a minimum. A typical bias current versus replay output curve for 1 kc/s signal is shown in Fig. 3.

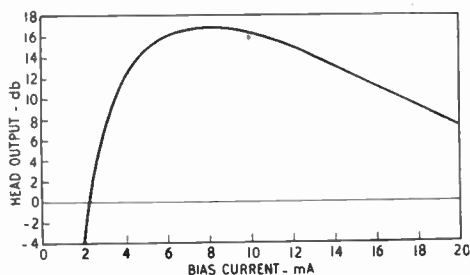

Fig. 3. Variation of output on replay with bias on record. Bias frequency 75 kc/s, speed 7.5 in./sec.

Normally the bias current is set to give a maximum replay output at 1 kc/s. Therefore, at frequencies above 1 kc/s the record head is effectively over-biased, and similarly at low frequencies below 1 kc/s it is under-biased. A curve of peak optimum bias versus frequency is shown in Fig. 4. Ideally, a record head should be operated at peak optimum bias all over the signal-frequency range, providing the signal source consists of single-frequency components.

From Fig. 4 it can be seen that when a record head is set up for maximum tape signal by suitable adjustment of the high frequency bias current (signal at 1 kc/s), the record head is effectively 100 per cent. over-biased at 10 kc/s signal frequency. This particular figure applies only to the particular magnetic head and tape used for this test.

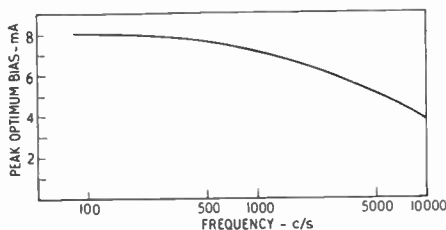

Fig. 4. Variation of peak optimum bias with frequency. Bias frequency 75 kc/s, speed 7.5 in./sec.

Distortion of the signal on the tape can be caused by an excessive magnetization level. The maximum signal allowed in practice is usually a level which produces 2 per cent. total harmonic content on the tape, the signal frequency being 1 kc/s. Some types of tape can accept more magnetization than others, and if the signal-to-noise ratio on replay is to be as high as possible the tape with the maximum magnetization level for 2 per cent. distortion should be chosen.

#### 4. Replay Heads

The losses in a replay head can be split into two groups: frequency dependent losses and wavelength dependent losses.

Other factors to be considered are sensitivity, e.g. the voltage output should be as high as possible from a given signal level on the tape, and the voltage waveform should be an exact replica of the magnetic signal on the tape. There is a limitation to the number of turns of wire wound on the magnetic core, for high frequency resonance with the self-capacitance of the winding is undesirable; this applies to transformer coupled replay heads also. High frequency resonance is an extreme condition usually, and the leakage reactance of the head may cause a pronounced loss of output at high frequencies, so a compromise is adopted

between the high frequency loss due to leakage, and output voltage.

The back-to-front depth of the gap (Fig. 5) directly affects the sensitivity, because the shunting effect is greater when the gap depth is large. This dimension is also a compromise, the back-to-front depth being made as small as possible consistent with an allowance made for head wear during service. A figure of between 0.007 in. and 0.010 in. is commonly used in practice.

4.1. The Effect of Front-to-back Depth of Sensitivity

Figure 5 shows a typical magnetic head and a simplified equivalent circuit is shown in Fig. 6.

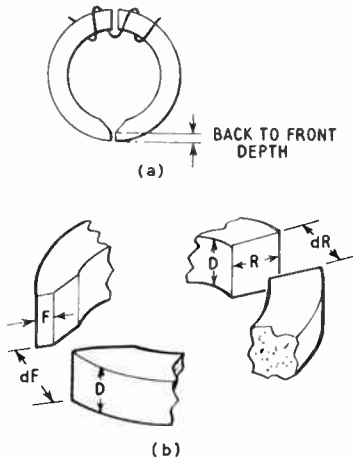

Fig. 5. (a) Plan view of a typical magnetic head. (b) Dimensioned, exploded view of same head.

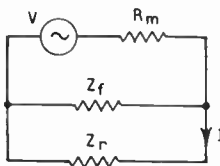

Fig. 6. Simplified equivalent circuit for the head of Fig. 5.

Referring to Figs. 5 and 6,

$R_m$  = reluctance of tape + tape contact with head

$Z_f$  = front gap reluctance

$Z_r$  = core + rear gap reluctance

$I$  = flux through core (and hence coil)

$l$  = mean length of magnetic path

$\mu$  = permeability

$V$  = m.m.f.

$$\text{Now } I = \frac{V}{R_m + Z_f \cdot Z_r} \cdot \frac{Z_f \cdot Z_r}{Z_f + Z_r} \cdot \frac{1}{Z_r}$$

$$= \frac{V \cdot Z_f}{R_m (Z_f + Z_r) + Z_f \cdot Z_r}$$

Therefore

$$\frac{I_1}{I_2} = \frac{Z_{f1}}{Z_{f2}} \cdot \frac{(R_m (Z_{f2} + Z_r) + Z_{f2} \cdot Z_r)}{(R_m (Z_{f1} + Z_r) + Z_{f1} \cdot Z_r)}$$

Now from Fig. 5(b)  $Z_f \propto \frac{dF}{DF}$ ;

and  $Z_r \propto \frac{dR}{DR} + \frac{l}{DR\mu}$

$$\cong \frac{dR}{DR} \text{ if } \frac{l}{DR\mu} \ll \frac{dR}{DR}$$

Now if  $I_1$  = circuit flux when front gap =  $F_1$

$I_2$  = circuit flux when front gap =  $F_2$

Hence

$$\frac{I_1}{I_2} = \frac{F_2}{F_1} \left\{ \frac{R_m \left( \frac{dF}{F_2} + \frac{dR}{R} \right) + \frac{dF \cdot dR}{D^2 \cdot F_2 \cdot R}}{R_m \left( \frac{dF}{F_1} + \frac{dR}{R} \right) + \frac{dF \cdot dR}{D^2 \cdot F_1 \cdot R}} \right\}$$

$$= \frac{R_m \left( dF + \frac{dR \cdot F_2}{R} \right) + \frac{dF \cdot dR}{D^2 \cdot R}}{R_m \left( dF + \frac{dR \cdot F_1}{R} \right) + \frac{dF \cdot dR}{D^2 \cdot R}}$$

Now consider:

$F_1 = 10 \times 10^{-3}$  in.,

$F_2 = 20 \times 10^{-3}$  in.,

$dF = 0.25 \times 10^{-3}$  in.,

$dR = 10 \times 10^{-3}$  in.,

$R = 125 \times 10^{-3}$  in.,

$D = 90 \times 10^{-3}$  in.,

$R_m = \text{unknown} = R_m' D$

Then

$$\frac{I_1}{I_2} = \frac{90R_m' \left( 0.25 + \frac{10 \times 20}{125} \right) + \frac{0.25 \times 10}{8.1 \times 125}}{90R_m' \left( 0.25 + \frac{10 \times 10}{125} \right) + \frac{0.25 \times 10}{8.1 \times 125}}$$

$$= \frac{90R_m' (0.25 + 1.6) + 2.47 \times 10^{-3}}{90R_m' (0.25 + 0.8) + 2.47 \times 10^{-3}}$$

$$\frac{I_1}{I_2} = \frac{1.85}{1.05}$$

assuming that  $90R_m' (0.25 + 1.6) \gg 2.47 \times 10^{-3}$ .

Therefore percentage change in output due to variation of back-to-front depth  $F$  from 0.01 to 0.02 = 43.3%, or 56.7% of its original output, i.e. -4.9 db.

4.2. The Effect of Gap Length  $dF$  on Sensitivity

Similarly,

$$\frac{I_1}{I_2} = \frac{dF_1}{dF_2} \frac{\left( R_m \left( \frac{dF_2}{DF} + \frac{dR}{DR} \right) + \frac{dF_2 dR}{D^2 FR} \right)}{\left( R_m \left( \frac{dF_1}{DF} + \frac{dR}{DR} \right) + \frac{dF_1 dR}{D^2 FR} \right)}$$

$$= \frac{0.25}{0.5} \frac{\left( 90R_m \left( \frac{0.5}{90 \times 10} + \frac{0.1}{90 \times 125} \right) + \frac{0.5 \times 0.1}{8.1 \times 10 \times 125} \right)}{\left( 90R_m \left( \frac{0.25}{90 \times 10} + \frac{0.1}{90 \times 125} \right) + \frac{0.25 \times 0.1}{8.1 \times 10 \times 125} \right)}$$

$\cong 2.$

Therefore the output will be doubled by changing the gap length  $dF$  from 0.00025 in. to 0.0005 in., the output being proportional to the gap length.

4.3. Track Width  $D$

The output is proportional also to  $D$ , i.e. change in output for a change of  $D$  from 0.090 in. to 0.085 in. is

$$\frac{8.5}{9.0} \times 100\% = 5.55\% = -0.5 \text{ db}$$

4.4. Frequency Response

The gap length  $dF$  is the most important dimension. The gap loss, or the amount of deviation from the 6 db/octave characteristic (neglecting other losses) can be calculated by simple integration. The gap loss at any given wavelength  $\lambda$  is represented by the average value of the sine wave signal between the limits set by the length of the effective magnetic gap  $dF$ .

It can be seen from Fig. 7 that when  $dF$  is very small the output is a maximum, also when  $dF = \lambda$  the output is zero. By taking the average value of the curve  $f(\omega t)$  between the points  $-dF/2$  to  $+dF/2$  in terms of  $2\pi$  a general expression is obtained. The reference axis '0' is placed where  $f(\omega t)$  is a maximum,  $f(\omega t)$

becomes  $\cos \omega t$ . This average value is thus:

$$\frac{1}{2\pi \frac{dF}{\lambda}} \int_{-\pi dF/\lambda}^{+\pi dF/\lambda} \cos \omega t d(\omega t)$$

$$= \frac{1}{2\pi \frac{dF}{\lambda}} \left[ \sin \omega t \right]_{-\pi dF/\lambda}^{+\pi dF/\lambda}$$

$$= \frac{\sin(\pi dF/\lambda)}{(\pi dF/\lambda)}$$

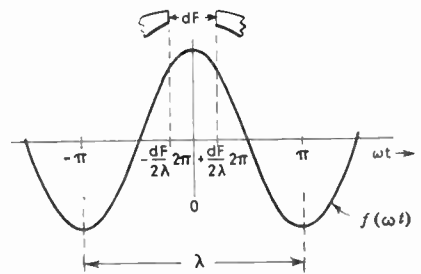

Fig. 7. Magnetization along recorded tape.

Therefore gap loss

$$= 20 \log_{10} \frac{\sin(\pi dF/\lambda)}{(\pi dF/\lambda)} \text{ db}$$

where  $\lambda$  = recorded wavelength  
and  $dF$  = mean effective magnetic gap.

Table 1 shows the gap loss at 7 kc/s with various lengths of gap for a tape velocity of 3.75 in./sec and allowing +20 per cent. to bring the mechanical gap to the effective magnetic gap  $dF$ .

Table 1  
Gap Loss for Various Lengths

| Normal Gap (in.) | Effective Gap (in.) | Gap Loss (db) | Output relative to 0.00025 in. gap (db) |
|------------------|---------------------|---------------|---|
| 0.00020          | 0.00024             | 2.6           | +2.1                                    |
| 0.00025          | 0.00030             | 5.74          | 0                                       |
| 0.00030          | 0.00036             | 7.56          | -1.8                                    |
| 0.00035          | 0.00042             | 11.8          | -6                                      |

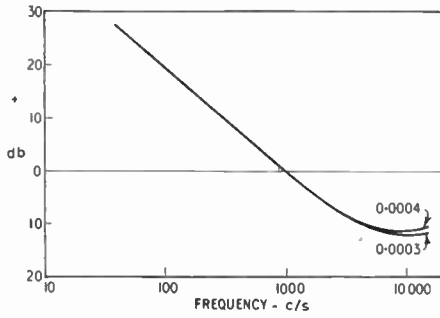

Fig. 8. C.C.I.R. replay chain response 15 in. per sec. (35 microsec+gap loss only).

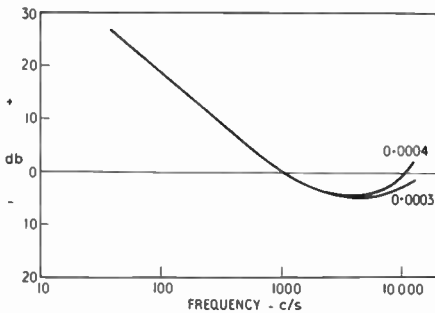

Fig. 9. C.C.I.R. replay chain response 7.5 in. per sec. (100 microsec+gap loss only).

The theoretical replay response can therefore be calculated for various speeds (Figs. 8 and 9). This does not take into account eddy and hysteresis losses in the core of the magnetic head, but these losses may be found by experiment, using a thin bifilar wire carrying an alternating current of the required frequency placed close to the gap and parallel with it. This arrangement is shown diagrammatically in Fig. 10.

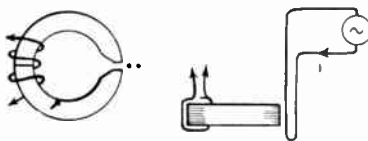

Fig. 10. Arrangement for finding eddy and hysteresis losses in core of magnetic head.

A typical graph of output versus frequency using this system is shown in Fig. 11.

Therefore, total losses = wavelength dependent losses + frequency dependent losses.

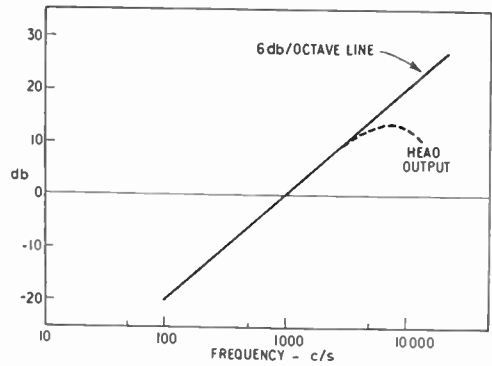

Fig. 11. Replay head output voltage on static test showing departure from 6 db/octave characteristic due to hysteresis and eddy current losses, etc. (Frequency dependent losses.)

#### 4.5. The Effect of Screening Can and Pole Shape

The replay head is usually screened magnetically against hum pick-up from nearby motors, etc., in the machine, and also erase and bias pick-up from the erase and record heads, assuming in the latter case that the signal recorded is being monitored by the replay head.

When the screening can is in close proximity to the tape it sometimes acts as a secondary pole piece and has the effect of increasing or decreasing the field from the tape according to the length of the tape embraced.

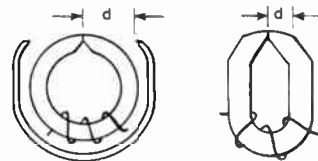

Fig. 12. Screened magnetic head.

The effect of a secondary pole-piece at a frequency  $f_B$  may be expressed as follows:

$$f_B = \frac{NS}{2d}$$

where  $d$  is the length of gap in can or length of pole in close proximity to the tape (Fig. 12), and  $S$  is the tape speed.



At points where  $N$  is a whole number,  
 when  $N$  is even, there is no effect  
 when  $\frac{N-1}{2}$  is even, the output is reduced  
 when  $\frac{N-1}{2}$  is odd, the output is increased.

The deviation can be as much as  $\pm 3$  db with a poorly designed head unit, and is usually negligible when  $N$  is greater than 9.

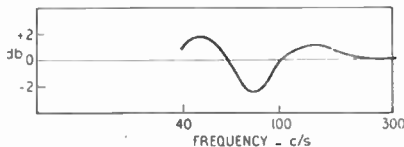

Fig. 13. 15 in./sec equalized low frequency response.

A typical low-frequency response curve for a poorly designed head unit is shown in Fig. 13.

To overcome poor low-frequency response, it is advisable therefore to make the pole pieces of the replay head a smooth curve up to, and away from, the tape. Where a screening can be used, the edges of the aperture through which the pole pieces protrude should be far enough away from the tape to prevent its influence upon the tape magnetic field.

4.6. Alignment of Replay Gap to Recorded Signal Azimuth

Correct azimuth alignment is very important where good high frequency performance is to be obtained. This is obtained by rotating the replay head about an axis located at the mid-point of the gap width and at right angles to the tape surface. This mid-point location ensures that lateral movement of the head during adjustment is kept to a minimum. The replay head is rotated until its gap is exactly parallel with the azimuth of the recorded signal.

Adjustment is made at the high-frequency end of the audio-frequency band covered by the recording machine, i.e. where the wavelength of the recorded signal on the tape is short, usually about twice the length of the effective magnetic gap in the replay head. This can be calculated in a similar manner to the gap loss.

Referring to Fig. 14, the loss is given by

$$\frac{1}{2\pi w \tan \alpha} \int_{-\frac{\pi w \tan \alpha}{\lambda}}^{+\frac{\pi w \tan \alpha}{\lambda}} \cos \omega t d(\omega t)$$

$$= \frac{1}{2\pi w \tan \alpha} \left[ \sin \omega t \right]_{-\frac{\pi w \tan \alpha}{\lambda}}^{+\frac{\pi w \tan \alpha}{\lambda}}$$

$$= \frac{\sin \frac{\pi w \tan \alpha}{\lambda}}{\frac{\pi w \tan \alpha}{\lambda}}$$

Therefore loss

$$= 20 \log_{10} \frac{\sin \frac{\pi w \tan \alpha}{\lambda}}{\frac{\pi w \tan \alpha}{\lambda}} \text{ db}$$

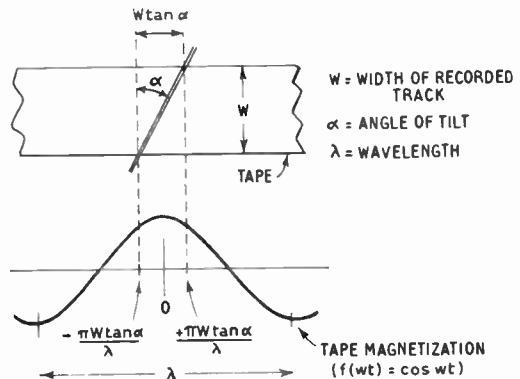

Fig. 14. Magnetization across recorded tape.

It can be said that any misalignment has the effect of increasing the replay head gap to the amount  $w \tan \alpha$  which of course is quite an additional effect to the actual gap loss itself, previously calculated.

For a machine running at 7.5 in./sec, a misalignment of only 2 minutes of arc at a recorded frequency of 10 kc/s will cause a reduction of output of 0.6 db, assuming a full width recording on a standard 1/4 in. tape.

Using the above formula to display graphically the relation between head rotation and

output for a given wavelength and recording width, it can be seen from Fig. 15 that a number of peaks in output can be obtained, of different amplitudes, the main peak occurring at the true azimuth. The solid line represents the ideal case, where the gap is perfect in every respect. In practice, however, various curve shapes are obtained, depending on gap straightness, and variations in length, etc., along the gap length. The dotted curve shows a typical curve obtained in practice. In some cases, one of the secondary peaks may be quite large in amplitude compared with those illustrated in the ideal case, and may be mistaken for the true azimuth peak. Providing the magnetic head is rotated over a fair range, from about  $-2$  deg. to  $+2$  deg. (taking true azimuth to be 0 deg.) selection of the major peak is not difficult.

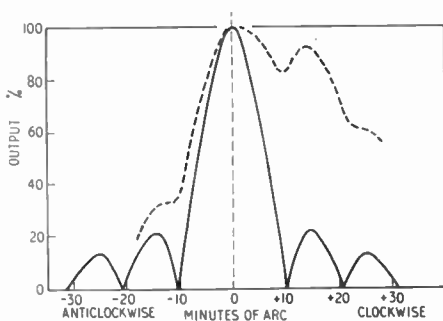

Fig. 15. Showing variation of output voltage when replay head is rotated about azimuth axis.  $w = 0.250$  in.  $\lambda = 0.00075$  in.

## 5. Conclusions

The main points discussed in the paper cover recording techniques as applied to audio-frequency engineering, and it is hoped that they will prove useful to engineers concerned with the development and servicing of magnetic sound recording equipment.

There are various methods employed for very-low-frequency and high-frequency work, and the conventional ring type magnetic head discussed is sensitive only to changes in core flux, and is unsuitable for direct low-frequency application unless a frequency or amplitude modulated carrier is used. However, flux sensitive heads can be used, which have an auxiliary magnetic circuit included in the main circuit to

provide the initial excitation for very-low-frequency work.

The construction of magnetic heads for high-frequency work makes the use of ferrite essential for the main magnetic circuit, and the use of bias for the recording process is usually dispensed with.

## 6. Acknowledgments

The author wishes to thank Messrs. Kelvin & Hughes Limited for permission to publish the experimental results described in this paper.

## 7. Bibliography

1. E. D. Daniel, P. E. Axon and W. T. Frost, "A Survey of factors limiting the performance of magnetic recording systems," *Proc. Instn Elect Engrs*, (Paper No. 2296), **104B**, pp. 158-168, March 1957.
2. M. B. Martin and D. L. A. Smith, "Reproduction from magnetic tape records," *Wireless World*, **62**, pp. 215-218, May 1956.
3. M. B. Martin and D. L. A. Smith, "Design of magnetic recording and reproducing equipment for domestic use," *J. Brit. Instn Radio Engrs*, **16**, pp. 65-77, February 1956.
4. Amendment No. 1, July 1954, to B.S. 1568:1953. "Magnetic tape sound-recording and reproduction for programme interchange." (British Standards Institution, London.)
5. E. D. Daniel and P. E. Axon, "The reproduction of signals recorded on magnetic tape," *Proc. Instn Elect Engrs*, **100**, Part III, pp. 157-167, May 1953.
6. E. D. Daniel, "The influence of some head and tape constants on the signal recorded on a magnetic tape," *Proc. Instn Elect Engrs*, **100**, Part III, pp. 168-175, May 1953.
7. P. E. Axon, "An investigation into the mechanism of magnetic tape recording," *Proc. Instn Elect Engrs*, **99**, Part III, pp. 109-124, May 1952.
8. R. L. Wallace, "The reproduction of magnetically recorded signals," *Bell Syst. Tech. J.*, **30**, pp. 1145-1173, October 1951.
9. M. Rettinger, "A magnetic record-reproduce head," *J. Soc. Mot. Pict. Televis. Engrs*, **55**, pp. 377-390, October 1950.
10. S. J. Begun, "Magnetic Recording." (Murray Hill, New York, 1949.)

**8. Appendix : Methods of Measuring the Magnetization of a Tape** (From B.S. 1568:1953 Amendment No. 1, 1954)

(a) *The "Short-Gap" Method.* The longest wavelength at which a minimum of reproduced level occurs is called the effective gap length  $dF$ . The necessary correction for the gap length is calculated on the assumption that output is proportional to

$$\frac{\sin \frac{\pi dF}{\lambda}}{\frac{\pi dF}{\lambda}}$$

where  $\lambda$  = wavelength and  $dF$  = effective gap.

This correction must not exceed 5 db at the shortest wavelength considered. Any necessary correction for eddy current losses must also be determined, for example, by comparing outputs at various tape speeds or by the use of an inducing loop. Once these corrections are known and applied, the head may be used as an "ideal" head to measure relative surface inductions on the tape over the wavelength range considered.

(b) *The "Long-Gap" Method.* In this method a head is used with a gap some 50 times longer than that of the normal reproducing head. In practice an erase head can usually be adapted for the purpose. The response of such a head should show a series of well defined maxima and minima.

A curve through the successive maxima is a measure of the relative surface induction on the tape, when the necessary correction for the eddy current losses of the head has been made. This curve falls approximately 4 db/octave compared with the curve of surface induction/frequency in air as determined by a non-magnetic reproducing device, or by a "short-gap" head. This correction must therefore be applied.

The precise steps by which the above procedures may be applied in practice are outlined as follows:

*Standardization by the Short-Gap Magnetic Head*

Using the short-gap method a recording equipment is set to the standard condition in the following way:

1. A "gliding tone" is recorded on a tape and reproduced by means of the head to be used for the measurements. The longest wavelength at which the output disappears is noted. This wavelength will be equal to the effective gap length, from which the gap correction may be deduced. If this correction exceeds 5 db the head is unsuitable for this measurement.

Since the measurement must take place at a very short recorded wavelength, a high coercivity tape should be used, and a certain amount of pre-emphasis will be found useful. In order to avoid making the measurements at an unnecessarily high frequency the lowest tape speed available should be used.

2. The tape with the gliding tone is reproduced at two different speeds and the output curves are compared. If the curves can be brought to coincidence by displacing one frequency scale so that equal wavelengths coincide, it may be assumed that frequency-dependent losses are negligible. If not, these losses may be deduced from the two curves mentioned or, alternatively, from a measurement with an inducing loop.

3. The frequency response of the reproducing chain is now adjusted to be that specified together with the gap correction noted in 1 above and the compensation for frequency dependent losses noted in 2 above.

4. The recording equalization is then adjusted so that a flat overall response is obtained.

*Standardization by the Long-Gap Magnetic Head*

Using the long-gap method a recording equipment is set to the standard condition in the following way:

1. The reproducing head used has a well-defined gap long enough to give successive maxima of response at intervals of 1 kc/s or less, in the audio-frequency range. (With a tape speed of 30 in./sec (76.2 cm/sec) the gap length required would be about 800 microns.) If the successive minima in the response curve are not equally well-defined the head is not suitable for this measurement. A short preliminary experiment is carried out to determine the exact frequencies at which the successive maxima occur at the relevant tape speed.

2. A "gliding tone" test tape of the audio-frequencies of maximum level is then recorded with constant voltage input to the recording chain and the tape is reproduced using the long-gap head. The open circuit voltage of the head around these frequencies is then plotted against frequency, and a smooth curve is drawn through the successive maxima.

3. The tape with the gliding tone is reproduced at two different speeds using the long-gap head and the output curves are compared. If the curves can be brought to coincidence by displacing one frequency scale so that equal wavelengths coincide it may be assumed that frequency-dependent losses are negligible. If not, these losses may be deduced from the two curves mentioned or, alternatively, from a measurement with an inducing loop.

4. When the curve drawn in 2 has been corrected by a 6 db/octave rise with increasing frequency together with the correction for frequency-dependent losses, and a correction of 2 db/octave falling with increase of frequency, the result defines the relative surface inductions on the tape.

5. The equalization of the recording amplifier is now altered to obtain a characteristic of surface induction/frequency that is the inverse of the compensation specified for the reproducing chain (without allowance for the replay head losses).

6. The reproducing amplifier equalization is then adjusted so that a flat overall response is obtained when using a normal reproducing head.

## 25th NATIONAL RADIO SHOW

**T**HE first truly national Radio Show was held at Olympia, London, in 1926, and due to the War and other circumstances, this year's Exhibition was the twenty-fifth. The public attendance of over 328,826 was only slightly less than for last year. Public interest was mainly centred on television and sound reproduction equipment. Thirty-seven of the 200 exhibitors were manufacturers of radio and television receivers.

**Television receivers.**—The trend noted last year of larger television screens with a 90 deg. scanning angle has been consolidated, but so far 110 deg. tubes have not made their appearance in production models. With the aim of reducing the depth of sets and also increasing the useful picture area, a number of manufacturers have adopted the device of pushing the tube face through the surrounding cabinet instead of having the mask lapping slightly round the edge. These developments have meant the abandonment of the horizontal chassis containing most, if not all, of the various parts of the circuit, and instead each of the different sections is mounted on its own sub-chassis—making very full use of printed wiring which in some cases has had the components inserted automatically—and these sub-chassis are grouped around the tube neck. This development will of course have to be used in order to make most of the reduced depth which will be obtained with 110 deg. scanning angle tubes in future. An immediate associated advantage which several manufacturers have seized is the opportunity of simplifying serviceability. These sub-assemblies are often arranged on hinges so that all components are readily accessible and easily unsoldered, and it seems probable that it will not be long before the logical development of this trend, namely the clearing of faults by complete replacement of the unit concerned, will become general. Associated with bulk saving construction has been the increasing use of elliptical loudspeakers, often 8 in. wide by only 2 in. deep.

The transportable receiver is an example of a comparatively new type of set which is gaining in popularity; these have been developed now to the extent of using 17 in. tubes. Some of these sets provide Band II sound broadcasting.

Within the receiver the circuits adopted show only detailed improvements due to careful design rather than completely new techniques. While flywheel synchronizing is the usual method adopted with receivers for operation under "fringe area" conditions, some manufacturers have returned to direct synchronizing which does have the advantage of avoiding line raggedness, giving cleaner vertical lines in the picture. Automatic gain control of the vision signals now operates over considerably wider limits, a particularly useful feature where there is a great difference in the signal strength of the Band I and Band III transmissions or when aircraft "flutter" occurs. A valve manufacturer showed a circuit which kept the picture constant over an input variation of 80 db.

Improvements in the phase response of i.f. circuits and in response of the video sections are two other courses which have been adopted to give better picture quality and make circuit alignment less critical. A number of refinements have been adopted in the tuners such as the use of low noise valves and, to make the user's station-changing easier, instant tuning without the necessity for fine tuning control, the positioning of available stations on adjacent switch position, and the use of push buttons.

**Broadcast receivers.**—This year the B.B.C. laid great emphasis in its own exhibit on the advantages to be obtained from the frequency modulated sound transmissions in Band II.

While the use of printed wiring and miniaturization is essential for portable receivers, many table models and even radio-gramophones employ these techniques for ease of production and servicing.

The mains transportable is now even smaller than formerly and the use of built-in ferrite rod aerials is general. The true portable, operated by dry batteries, shows the influence of the use of the transistor, and while the cost of transistorized receivers is still considerably above that of the receiver using miniature valves, the negligible current consumption is a great attraction, apart from the reduction in size.

Other applications for transistors are in a table model receiver for listeners who have no mains electricity, and in car radio. The completely transistorized car radio is not yet in

general production although a transistor manufacturer showed an example; the most general arrangement makes use of transistors in push-pull as the output of a receiver in which the r.f., i.f. and detector stages use valves of a new series which operates with an h.t. of only 12 volts. Another possibility for the use of transistors in car radio is in place of the mechanical vibrator to generate the h.t. voltage from a 12-V battery.

**Sound reproduction equipment.**—This year's Show was, however, particularly notable, both to the engineer and to the general public, for the very great increase in the number of exhibits devoted to sound reproduction; a whole section did in fact consist of the demonstration rooms of some 40 manufacturers of this type of equipment. The innovation has been given considerable impetus by the very rapid introduction of stereophonic sound on disc records.

The two stereophonic channels are recorded in a single groove, the cutting stylus being driven in two directions at 45 deg. to the surface of the record so that the position of the stylus at any instant is the resultant of two signals. During reproduction the signals are separated by the reverse action: the stylus is connected to transducers, either piezo-electric or moving coil, each of which responds only to movements in one direction. The two outputs are then amplified by separate channels. The stereo pickup can play a single-channel record, but an ordinary pickup cannot play a stereo disc without damaging it. However, the practice in equipment seems to be to use a stereo head solely for stereo, and interchangeable or turnover heads are therefore employed.

In order to meet the various price ranges a number of different methods of providing the two loudspeaker outlets have been adopted. In some of these a technical compromise has been made which makes use of the controversial view that, since the lower frequencies are not directional, only one of the two speakers need have a response which extends over the full range. In these equipments one or two small high frequency reproducers are employed in extension type cabinets, with the bass and middle range speaker in the player console.

Apart from the intricacies of the pickup, the technical features of the reproducing channels

follow the standard practice for high fidelity equipment. Many reproducers include a balance control for equalizing the gain for each channel and there is also a facility for parallel operation of the two channels on monaural reproduction. In the more elaborate radio-gramophones the pre-amplifiers incorporate equalizing networks to allow for inputs from various sources. As far as loudspeaker design is concerned the aim is to obtain a wide frequency response from small units and cabinets.

**Careers in Electronics.**—The Radio Industry Council again included a Stand which showed methods by which qualifications and training in the electronics industry can be obtained, and this was supplemented by demonstration exhibits provided by the technical colleges covering communications, radar, radio-astronomy, radio and television servicing. The Institution again provided comprehensive information in the form of the booklet "Radio and Electronics as a Career", and "*The Times* Radio and Television Supplement", issued at the beginning of the Show, included an article on this subject by the Education Officer.

**Services and Post Office Exhibits.**—The Stands of the Royal Navy, R.A.F. and General Post Office were similarly concerned with the respective career opportunities; guided weapons, complete aircraft, radio, radar and navigational equipment, and working demonstration models all combined at the Services Stand to emphasize the importance of radio and electronics in modern defence.

The use of electronics in the Post Office was illustrated by electronic letter sorting and the subscriber trunk dialling system.

**Other exhibitors.**—The independent television companies provided public interest by emphasizing programme content.

In general, engineers found most to interest them in the exhibits of the valve and component manufacturers and those manufacturers showing assembled units for broadcast and television reception and the application of electronics to a wide range of industries. Essentially, however, the show is a "public show" in the widest interpretation of that expression.

551.510:629.136.3

**The CARDE I.G.Y. upper air research program.** R. F. CHINNICK. *The Engineering Journal of Canada*, 41, pp. 61-67, August 1958.

A brief review of the objectives of the Canadian Armament Research and Development Establishment high altitude experiment is given, and the design considerations and techniques employed in preparing a nose cone are discussed. Methods of packaging electronic components and problems resulting from the environment are considered. Instrumentation techniques for transmitting data are described.

621.318.13:681.14

**Square loop ferrites and tests of their storage properties.** C. HECK and H. REINER. *Nachrichtentechnische Zeitschrift*, 11, pp. 360-369, July 1958.

In the case of ferrites it is possible to produce a macroscopically anisotropic material with a square hysteresis loop in contrast to metallic materials. Ferrites are suited particularly for use as ring cores for rapid storage devices because of their high specific resistance. The requirements for storage cores are discussed with the aid of designs for storage matrices. This leads to specifications as to properties of the material and shape of the storage cores. Various possibilities for testing these properties are discussed.

621.372.8

**Theory of the helical line of finite wire thickness and applications to the rotation of the plane of polarization of guided waves.** G. PIEFKE. *Archiv der Elektrischen Übertragung*, 12, pp. 309-316, July 1958.

A theory is set up for a helical line with finite wire thickness and an arbitrary outer medium, and a general equation is calculated, from which the propagation constants of all modes can be determined that can exist on the helical line. It is here assumed that the line wavelength always is far more than the separation between centres of neighbouring wires. Unlike other lines the helical line presents no modes whose plane of polarization is independent of place and time. Modes with a dextrorotatory field have a propagation constant other than that of modes with a levorotatory field. When linearly polarized waves come in, there results a turning of the plane of polarization, when these modes propagate along the helical line. This is shown by reference to a metallic tube whose inside is grooved in the form of a helix.

621.372.851/2

**Iris for bandpass waveguide filters.** J. HORNA. *Slaboproudy Obzor*, Prague, 19, pp. 221-225, April 1958.

Various types of irises in rectangular waveguides with mode  $TE_{10}$  for use in waveguide bandpass filters are compared. The mean bandwidth should be 0.3 - 3%, requiring normalised susceptances of about 4 to 15. The irises must satisfy heterogeneous conditions to be successfully applicable. From the electrical point of view these are in particular the frequency characteristics and field distortion. The reasons for hitherto unexplained parasitic passbands are indicated. Production considerations are very important, but are neglected in the literature. From all points of view inductive-post triplets are very advantageous. Hitherto unverified frequency characteristics were measured and compared with the results of the theoretical analysis. The measurement setup is described and the results summed up in a susceptance-value graph.

*A selection of abstracts from European and Commonwealth journals received in the Library of the Institution. Members who wish to borrow any of these journals should apply to the Librarian, stating, full bibliographical details, i.e. title, author, journal and date, of the paper required. All papers are in the language of the country of origin of the Journal unless otherwise stated. The Institution regrets that translations cannot be supplied.*

621.375.4

**Noise figure for transistor amplifier with high input impedance.** A. E. BACHMANN. *Archiv der Elektrischen Übertragung*, 12, pp. 331-334, July 1958.

The noise figure of a conventional transistor amplifier circuit presents a flat minimum for low values (approx. 1 k $\Omega$ ) of the source impedance. The "Darlington" circuit of two transistors however presents the property that this minimum of the noise figure appears for high values of the source impedance (approx. 1 M $\Omega$ ). The circuit consists of two d-coupled transistors and performs like a single transistor having very high current gain and input impedance. The noise figure of the circuit is calculated as a function of the source impedance, and compared with some measurements made on typical n-p-n junction transistors. At a frequency of 15 kc/s and with a source impedance of 1 M $\Omega$  a noise figure of 4 db was attained. The following conclusions can be made: In order to minimize the noise figure for a high optimum source impedance, the transistors used must have a low collector capacitance (r.f. transistors) and a high current gain even with low operating currents.

621.396.621.54

**Neutralization of additive mixers.** J. NOVAK. *Slaboproudy Obzor*, Prague, 19, pp. 490-496, August 1958.

The article is concerned with the analysis of u.h.f. broadcast receiver additive-mixer circuits. As a result of the grid-anode capacitance, the normal input resistance of the valve is reduced, leading to an undesirable damping of the first bandpass filter. A method of neutralizing this capacitance is demonstrated theoretically from general relationships for feedback. The general calculations are in the majority of cases presented in simple graphs which may be used for the solution of similar problems in neutralization. The final value of the neutralizing capacitor is verified experimentally, and the method of measurement described. The conditions for stability of the additive mixer are also presented.

621.396.677.43:681.142

**The preparation of radiation patterns of Australian army rhombic aerials by an electronic computer and their applications.** A. JACOBY and G. GAY. *Proceedings of the Institution of Radio Engineers, Australia*, 19, pp. 417-422, August 1958.

Using the C.S.I.R.A.C. computer the gains and directivity patterns of two new standard army rhombic antennas have been calculated. The parameters of the antennas are (a)  $L = 492$  ft.,  $\theta = 70^\circ$ ,  $H = 96$  ft. and (b)  $L = 350$  ft.,  $\theta = 70^\circ$ ,  $H = 72$  ft. Calculations were carried out at  $2^\circ$  intervals of azimuth for frequencies between 2 and 28 Mc/s (2 Mc/s intervals) and at vertical angles from  $5^\circ$  to  $30^\circ$  ( $5^\circ$  intervals).

621.396.677.6

**The reduction of bearing errors during multiple incidence in Adcock d.f. systems with a large base.** H. STEINER and H. STITZGEN. *Nachrichtentechnische Zeitschrift*, 11, pp. 417-423, August 1958.

The paper contains an investigation of those bearing errors which can be explained by the "Heiligtag"-effect and which occur during simultaneous incidence of coherent waves from different directions. The fact that the loci for equal phase (the criterium for location) are lines, which swing around straight lines perpendicular to the angle of incidence for the stronger wave, suggests the use of large base Adcock systems for the determination of this direction by means of averaging. These conditions are investigated for the case of a large base Adcock system and for a so-called Doppler direction finder. It can be shown that the errors decrease for increasing base lengths. The errors can be calculated relatively easily for field strength ratios  $< \frac{1}{2}$ .

621.396.967.2:621.3.018.42

**Further progress in the work relating to bandwidth compression for radar p.p.i. pictures.** H. MEINKE and A. RIHACZEK. *Nachrichtentechnische Zeitschrift*, 11, pp. 398-404, August 1958.

A method for the compression of the bandwidth required for the transmission of radar p.p.i. pictures is described. The scanning velocity in a line store for the radar signals is varied in such a way that short pulses and short interpulse periods are expanded at the expense of long picture elements. The bandwidth of the transmission channel can be reduced in accordance with the expansion of short signals. A radar picture of Munich has been transmitted over a telephone channel with the aid of this method.

651.513:621.37/9

**Marginal punched cards for a reference file in the field of electronics.** W. G. HOYLE. *The Engineering Journal of Canada*, 41, pp. 61-66, June 1958.

As an improvement on the card reference information file commonly used by engineers, a modified system using marginal punched cards is described. This punched card system enables information to be retrieved from a file on the basis of several classifications. Specifically, the system described uses date, authors, subject matter, source, and miscellaneous. Combined selections using any of the above bases are both possible and extremely useful. Rapid collation of the cards, either chronologically by date, or alphabetically by author, is possible. Normally the cards are not kept in any particular order. Only one card is used per reference and costs are similar to those of the more common card file systems.

621.658.62:397.51

**The circle concept of quality control applied to tv receiver manufacture.** T. J. BROWN. *Proceedings of the Institute of Radio Engineers, Australia*, 19, pp. 423-432, August 1958.

The responsibility of commercial, design and production departments for overall product quality is indicated. A practical treatment is given on (1) Designing for reliability with reference to component performance and receiver layout. (2) Recommendations on inwards goods inspection techniques and allied instrumentation. (3) Inspection procedures in production assembly, wiring and electrical testing of television receivers.

658.562:621.37/9

**Control of quality and reliability.** M. GERVAISE. *L'Onde Electrique*, 38, pp. 335-341, May 1958.

The principal functions of quality control are the laying down of rules and checking of quality. The check on the quality can be subdivided into two activities; establishing standards of quality and then certification to see that these have been achieved. The control methods discussed have been the subject of diverse and abundant literature, but this has applied to very large scale manufacture. The complexity of some electronic systems justifies the use of these same methods for reducing scale production, when a systematic study of reliability is demanded.

681.14

**Automatic input for business data-processing systems.** K. R. ELDRIDGE, F. J. KAMPHOFNER and P. H. WENDT. *Nachrichtentechnische Zeitschrift*, 11, pp. 393-397, August 1958.

Computers for business applications require excessive manpower for data preparation. This can be reduced, and gains can be made in speed and reliability if the data forms for the computer and human being are compatible. The numbers and symbols on the document are printed in magnetic ink in conventional form and size. Documents with suitable format arrangements can be fed directly to the computer input with the techniques described and machine reading can be accomplished at rates exceeding 5,000 characters per second.

Abstracts in English are available for the following papers from *The Journal of the Institute of Electrical Communication Engineers of Japan*:

Vol. 41, No. 3, March 1958.

**Microwave delay compensator.**

**The inverted V aerial system.**

**Parametric excitation using variable capacitance of ferroelectric materials.**

**Motional equations of vibrating part of electromagnetic relays.**

**Semi-phenomenological theory of transmission lines with distributed noise.**

Vol. 41, No. 4, April 1958.

**Calculation of optical characteristics in triode section of television cathode-ray tube.**

**Characteristics of a hybrid duplexer.**

**A scale of naturalness for rating transmission quality.**

**Switching characteristics of the avalanche transistor.**

This issue also contains 25 papers on components and materials.

Vol. 41, No. 5, May 1958.

**Optical characteristics between grid 2 and final anode of a pentode television cathode ray tube.**

**An antenna constructed from parallel wires.**

**Reflections and mode conversions of the circular electric waves at the step discontinuities in the cylindrical waveguide.**

Vol. 41, No. 6, June 1958.

**New method of measuring the noise parameters of the electron beam by using "selective beam coupler".**

**Frequency purity of the carrier current provided by a harmonic generator.**

**Pulse forming networks.**

**Coaxial directional couplers.**