

# The Journal of THE BRITISH INSTITUTION OF RADIO ENGINEERS

FOUNDED 1925

INCORPORATED 1932

*"To promote the advancement of radio, electronics and kindred subjects  
by the exchange of information in these branches of engineering."*

VOLUME 17

JULY 1957

NUMBER 7

## ELECTRONICS IN AUTOMATION

*(A report on the 1957 Convention)*

IF the title given to this year's Convention provoked a philological challenge to the word *automation*, there was certainly no disagreement on the purpose and usefulness of the Convention, which has been widely commended as one of the most successful the Institution has ever staged.

The importance of electronics, and what has been termed the second industrial revolution, and the economic and social implications involved were discussed by the President when he opened the Convention in the Clerk Maxwell Lecture Theatre of the Cavendish Laboratories. In his address, Mr. G. A. Marriott stated that the technique of electronics has spread very rapidly into fields other than sound and picture communication; indeed, the term *electronics* was adopted when describing the use of radio technique at work in ways other than communication.

Mr. Marriott continued: "So much has been written and spoken on the subject of automation that it is very easy to plagiarize, but there are some things which cannot be stressed too often.

"There exist ill-informed or wilfully obstructive people who are opposed to automation on the grounds that it will cause unemployment: the same voices are frequently raised demanding higher pay and shorter hours of work. Everyone in this room, I am sure, wants more money and probably shorter hours during which they must work to earn that money. What on earth are those people doing who are developing automation if it is not towards just that goal?

"But there is a more pressing need for automation than that of making possible higher

standards of living and greater national wealth. Throughout the world men and women seek greater individual freedom; freedom from the need to work long hours at uninteresting tasks, and freedom to have more leisure in which to pursue personal interests.

"Here in Great Britain we have long realized that we must maintain our engineering ingenuity in order to increase still further the standard of living which the people of this country enjoy. Many of our products can bring blessings to other nations too, for it is largely a world problem that labour has to be released from repetitious work, either manual or mental, in order that people shall be free to use their brains and brawn in more intelligent and productive ways.

"The object of this Convention is to review for the benefit of industry generally the ways in which the Electronics Industry can contribute to automation. It is of the greatest importance that the other branches of engineering should know just what assistance they can expect from electronics and conversely what are the limitations of electronics.

"It is equally important that the users of automation should appreciate what training is necessary to feed new machines with information, to maintain them, and to get the best out of them.

"In London yesterday (26th June) the Commonwealth Conference was opened, and it is natural therefore that I first of all extend a welcome to those representatives from Australia, Canada, India, Pakistan and New Zealand.

"Science, however, knows no boundaries of Commonwealth or other distinction, and we

particularly appreciate and welcome the attendance of delegates from America, Belgium, Denmark, Finland, France, Germany, Holland, Israel, Italy, Japan, Norway, Poland, Russia, Sweden and Switzerland.”

There was an overflow attendance for the opening address—accommodated in the Arts Theatre which the President also visited before the first two sessions started. Indeed, for most of the Convention, three theatres were in use.

The official programme, which was circulated to all delegates, corporate members and Graduates of the Institution, considerably helped delegates in the arrangements they made from day to day for attending the presentation of papers, visits, and film shows. Over 40 papers were presented and in addition the Third Clerk Maxwell Lecture was given by Sir Lawrence Bragg, M.C., O.B.E., F.R.S.\*

By courtesy of the Pye Company Limited, closed link television enabled delegates in the Arts Theatre to follow closely the demonstrations given by Sir Lawrence Bragg during the course of his address. The slides shown in the Clerk Maxwell Theatre were reproduced with amazing clarity on the receivers used in the Arts Theatre and made unnecessary the employment of duplicate slides.

Before the Convention Banquet, the President welcomed all delegates to a sherry party, for which the Provost and Fellows kindly gave permission to use the Lawn of King's College.

The Banquet which followed was, of course, the main social function held during the Convention, and the beauty of the Hall of King's College was particularly appreciated on this occasion. Although the Hall and Gallery were filled to capacity, it was unfortunately impossible to accommodate all the delegates who would have liked to attend.

An account of the speeches is given on pages 347-349 but they lack in print and reporting not only the humour, but the great attention every speaker secured. Many members present well remembered Mr. C. O. Stanley addressing the Institution eight years previously on the subject “Television Today and Tomorrow.”† Then he imparted enthusiasm for the project of

developing television services—anticipating by some five years alternative and regional television networks. Mr. Stanley's speech at Cambridge pithily touched upon the importance of production efficiency, European free trade, and the need for not being content with present achievements either in the development of electronics or the extension of technical education.

The occasion resulted in some very late retirements, but did not in any way affect the attendance at the final two sessions on the Saturday. After the serious business of that day, the majority of delegates attended an organ recital which had been organized by the Chairman of the Convention Committee, Mr. L. H. Bedford.

In his recital, the organist, Charles Proctor, F.R.C.O., exhibited to the full the range and tonal quality of the King's Chapel Organ. The technical details contained in the programme were also not without interest, giving the information that in the organ “. . . there are at least 8 wind pressures, ranging from 3 to 18 inches: the action is electric. The pitch is C. 522 Hz at 60°F.”

On the Sunday, the greater part of the congregation at Matins in the University Church, Great St. Mary's, comprised delegates to the Convention, led by the President and his lady. There was great appreciation of the Service which was largely directed at the work and responsibility of the engineer and in particular the electronics and telecommunications engineer. The Lessons were especially chosen and the Address by the Reverend Canon C. E. Raven, M.A., D.D., provoked much thought and attention.

The final plenary session in the afternoon attracted a surprisingly large number of delegates who made contributions not only on the achievements of the Convention, but arguments in favour of the Institution holding another Convention very soon!

Before finally dispersing on the Monday, many delegates visited factories and other establishments which are using some of the electronic equipment discussed during the course of the Convention.

G. D. C.

\* To be published in *J.Brit.I.R.E.*, September, 1957.

† An address given on 22nd September, 1949.

# The 1957 Convention Banquet

## “THE INSTITUTION”

by

**Charles Orr Stanley, C.B.E.\***

*The Toast proposed at the Institution Banquet in the Hall of King's College, Cambridge.*

“I would like to find words to express to you in the simplest possible way that your Convention has been a great success. I feel to say much more than that would be gilding the lily. The numbers that are here, the places those numbers come from and the quality of what has gone on at your Convention all add up as a great tribute not only to the people who have built your Institution but in particular to the people who have run this Convention. My mind returns very readily to when the Institution was formed some thirty years ago—when to those of us already in the industry it seemed that little encouragement was being given to development of the art. In spite of that, we have passed from the first stage of transmitting a signal, to becoming the basis of the greatest entertainment industry in the world and to being an essential part in waging a war, and have now reached the stage when it is quite clear that in our industrial activity, if the standard of living is to be kept up, it is only the efficiency of applied electronics that will allow us to achieve this end.

“To-day you have taken that one step further in this Convention on electronics in automation. Nobody is going to deny that the professional institutions such as yours must have a very real appreciation of this problem of improving production efficiency particularly in the economy of this country. People sometimes think that because England led the way in bringing the industrial revolution to the world, she is not so active in the present era. These very problems have figured in a great deal of the work that has been carried out in this country during the last generation, and it is pleasurable to note that your Institution was

the first to recognize the very great contribution which Clerk Maxwell made to the discovery of radio science; when we think of computers we have to give praise to original work done by Babbage.

“We realize that science is not the nationalistic right of any one country. It is a work that knows no frontiers but we must feel some pride in knowing that in practically every fundamental electronic development, somewhere right at the beginning a British scientist had made a substantial contribution. What we have done in this country we have always been willing to share with the rest of the world but in so doing we have recognized the great contributions which have been made by other countries towards the fuller development of some of our own scientific ideas.

“I am interested to see the way, Mr. President, in which you welcome people from all over the world to this Convention and I was interested when I was at the I.R.E. Convention and Show in America this year to see that they did the same thing. It has been delightful to learn from you, Mr. President, that you are considering going one step further towards this international idea: I refer to the proposal you have had from the American Institute of Radio Engineers that in the years to come you should hold a joint convention, possibly in Europe. We here in England have heard so much about the common market and the free trade area that we are conscious of the fact that this idealism of integrating economies, if it can succeed, may well be invaluable. We should all examine in the greatest detail the pros and cons of this new approach to international industry. However, all the time we must all accept the fact that if it is not possible—except at the expense of wrecking industry—we will have to find other ways of getting an international platform.

\* Chairman and Managing Director, Pye Ltd., Cambridge. (Address No. 14.)  
U.D.C. No. 061.27(425.9).

Surely there is no better way than a common ground of exchanging scientific opinions between the nations.

"One cannot help thinking that when people come to a Convention such as this in a town like Cambridge, they must be sensitive to all the history in the great grey walls of these wonderful buildings. Here in this university man after man has made contributions that have added to the wealth of this great industry we have now. These men were there when there was little profit and practically no recognition. When you think of them, surely Milton's words have great meaning:

'Fame is the spur that the clear spirit doth raise  
(That last infirmity of noble mind)

To scorn delights, and live laborious days; . . .'

"I want particularly to mention the necessity

for continued and more intensive education; not only in the purely scientific education which is so lacking in this country but also for the coupling of scientific education with the broader philosophy and teachings in the other fields of culture. It is interesting to know that this University of Cambridge is today considering a Tripos that will jointly recognize the necessity of balancing the intense specialization, which we must have, with the broader aspect that will teach us the significance of the worthwhile reasons and causes for the very things we are doing from day to day."

Finally Mr. Stanley paid special tribute to Mr. George A. Marriott, whom he had known personally for over thirty years, and stressed the qualities which he brought to the office of President of the Institution.

#### RESPONSE BY THE PRESIDENT

"We were all very pleased, Mr. Stanley, when you agreed to be our guest of honour this evening. You have referred to the Institution in most generous terms, and I know I speak on behalf of everyone present in thanking you for your words of encouragement."

After a humorous anecdote in reference to the development of automation, Mr. Marriott referred to the great skill now required of craftsmen and the further demands which would be made as methods of automation became more widely adopted. Mr. Marriott also emphasised the increasing need for training more professional engineers and to the fact that the Institution's examination was held throughout the British Commonwealth and other overseas countries. Stating that the Institution had been asked to conduct its examinations in foreign languages, the President

suggested that the development of a character reading machine might well enable the Institution to meet this demand!

Mr. Marriott continued: "I assure you, Mr. Stanley, that we have appreciated your proposal of this toast. The Institution has never rested on its laurels, and we are already considering plans for our next Convention in a year or two's time. We do not believe in having conventions for the sake of having them, but only when the time is ripe to discuss new ideas and meetings can serve a really useful purpose.

"We are a growing body and jealous of a considerable international reputation. I again thank you, Mr. Stanley, for the way in which you have proposed the toast, and you gentlemen, from all over the world, who have so kindly honoured it."

#### THE GUESTS

The proposal of this important toast was made by Mr. J. Langham Thompson, Vice-President of the Institution. He stated that it gave particular pleasure to every member of the Institution to welcome so many delegates from overseas. Such opportunities for East and West to meet and exchange views on the latest aspects of modern science could lead to greater understanding.

The Institution had always enjoyed an

international attendance at its Conventions and Mr. Thompson referred to many of the delegates from the 20 countries mentioned in Mr. Marriott's address on opening the Convention. Mr. Thompson coupled with the toast the names of Professor K. Sreenivasan, a distinguished Indian telecommunications engineer, and Major T. M. Manley of the United States Air Force, a body responsible for many contributions to the art of radio and electronics.

## RESPONSES TO THE TOAST OF "THE GUESTS"

**Professor K. Sreenivasan.**—I deem it a great privilege to be asked to respond to the Toast of the Guests proposed by Mr. J. L. Thompson in such graceful terms.

On behalf of the Institution of Telecommunication Engineers, India, of which I have the honour to be President, may I convey to you, Mr. Marriott, and to all the members of the Institution, our warmest greetings, and our best wishes that the Institution may continue to serve in ever-increasing measure the progress of radio in Great Britain and thereby throughout the world.

To scientists and engineers throughout the world, Cambridge is holy ground, a place of pilgrimage to which one comes with a feeling of reverence and almost awe. Here have lived and worked scientists who by their researches and discoveries have become benefactors of mankind, whose names have become immortal and who act as beacon lights for successive generations. As one goes about the streets of Cambridge and visits the laboratories, one almost feels the presence of these great men, Maxwell, Rayleigh, J. J. Thomson, Bragg, Sherrington and many others. Scientists the world over will wish that Cambridge may continue in future, as in the past, to be a foremost leader in scientific research.

We have long known about the British Institution of Radio Engineers through its *Journal*. When my good friend, Mr. Graham Clifford, the General Secretary of the Institution, toured India he visited the city from which I come—Bangalore—where is situated the Indian Institute of Science, one of the leading centres of advanced education and research in science and engineering. The Institute was perhaps the first in India to start instruction and research in electronics and radio communication, and it is therefore a source of immense pleasure for me to be here among electronics and radio engineers of Great Britain.

There are in India quite a number of members of the British Institution of Radio Engineers, and I know that they value their membership and your *Journal*.

I am therefore pleased and honoured to be present on this occasion.

**Major T. M. Manley.**—My country has acquired a reputation for getting things done in a hurry. In spite of my previous experience in this regard, however, I really have to compliment the members of the British Institution of Radio Engineers for cramming into four days an account of research and development work covering years.

When I was asked to attend this Convention as a representative of the Air Force I thought to myself—this will be a period of quiet in a dear old English University town, and I was looking forward to it as a sort of holiday. The past two days have shown that nothing could have been further from the facts! I doubt if I have been driven so hard since I left the States!

I am well aware that none of the delegates have been compelled to attend, but have come here voluntarily and have done a tremendous amount not only in the real work of the Convention, but in cementing friendship.

You have been very kind, Mr. Thompson, in proposing this toast. You have yourself visited many countries, and we hope to welcome you back in the States in the not too distant future. As a Vice-President of this Institution, you will be assured of a very hearty welcome wherever you meet American engineers.

I count it an honour to speak on behalf of so many visitors from overseas, and on behalf of all of them, I thank you, Mr. President, for the cordial welcome you have extended to us, for the intellectual fare you have provided, and now for this very excellent Banquet this evening.



# INSTITUTION NOTICES

## Birthday Honours List

The Council of the Institution has congratulated Lt. Cdr. Robert Andrew Williams, R.N. (Associate Member), on his appointment as a Member of the Military Division of the Most Excellent Order of the British Empire.

Lt. Cdr. Williams, who is at present with H.M. Underwater Development Establishment, was elected an Associate Member in 1951.

## Merseyside Section

As a result of recommendations arising out of the Annual General Meeting of the Merseyside Section, a special meeting was held to appoint a new Committee on the 6th June, 1957. The following members were elected to office: Squadron Leader R. Brickwood, Chairman, F. C. Potts, Vice-Chairman and Hon Treasurer, J. Gledhill, B.Sc., H. Hipple, D. R. Houldcroft, J. Kershaw.

Mr. Kenneth N. Coppack was elected Honorary Secretary, and his address is:

16 Lightfoot Street, Hoole, Chester.

During the 1957-8 Session, it is intended to hold only four meetings in Liverpool. The dates of these will be arranged so that members can also take part in the North Western Section meetings held at Manchester.

## Radio Trades Examination Board

Professor H. F. Trewman, M.A. (Member), has been nominated to serve as one of the Radio Industry Council's representatives on the Council of Management of the Radio Trades Examination Board. He succeeds the late Mr. E. J. Emery (Member), whose death was reported in the June issue of the *Journal*.

The Institution's representatives on the Council of Management are:

- E. J. G. Lewis (Member).
- E. A. W. Spreadbury (Member),
- W. E. G. Scott (Associate).

Other members of the Institution also serve on the Examination, Finance and Moderating Committees of the Board.

## Obituary

The Council has learned with regret of the death, on 1st January last, of Mr. Lim Chin Bee at the age of 53. Mr. Lim was elected an Associate Member of the Institution in February 1940.

During the Japanese occupation Mr. Lim lost all contact with the Institution. He was, however, one of the first members in the Far East to resume his membership at the conclusion of hostilities when he re-organized his business in Penang.

## Corrections

It is regretted that misprints occurred in the paper "The Characteristics of Magnetic Recording Heads and Tapes," published in the April 1957 issue of the *Journal*. The following corrections should be noted:—

Page 228:

**Fig. 9:** The letters N and S on both the second and fourth magnets should be interchanged.

Left-hand column: The second equation *should read*

$$\varphi = \varphi_{\max} \cdot \sin 2\pi \frac{vt}{\lambda} = \varphi_{\max} \cdot \sin 2\pi \frac{x}{\lambda}$$

The third equation *should read*

$$B = \frac{d\varphi_x}{dx} = \frac{2\pi f}{\lambda} \cdot q \cos 2\pi \frac{x}{\lambda}$$

Page 229:

Right-hand column, Line 5, Equation *should read*

$$\varphi = \dots = -\varphi_{E(\max)} \cdot \frac{\lambda}{2\pi g} \cos 2\pi \cdot \frac{x_2}{\lambda} + \varphi_{E(\max)} \cdot \frac{\lambda}{2\pi g} \cos 2\pi \frac{x_1}{\lambda}$$

In the next three lines the symbol *s* should be replaced by symbol *g* throughout.

Page 230:

**Fig. 10:** The ordinate of this graph *should read* HF:  $mV/100\Omega$ .

Page 231:

The last equation *should read*

$$x = (\pi \cdot \tan \alpha \cdot b) / \lambda$$

(*b* = width of tape or track).

# THE DEVELOPMENT OF A BUSINESS COMPUTER SYSTEM\*

by

A. St. Johnston, B.Sc.† and S. L. H. Clarke, B.A.†

*A paper presented at the Convention on "Electronics in Automation" in Cambridge on 27th June 1957. In the Chair: Dr. A. D. Booth.*

## SUMMARY

The shortcomings of the scientific type of digital computer when applied to data processing jobs in general, and the business accounting type in particular, have led to the evolution of an electronic digital system more in tune with the requirements. The basic logical arrangement of the Elliott 405 system is outlined, followed by a more detailed description of the units. Particular reference is made to a new type of store using 35-mm film coated with magnetic oxide. Two specific applications of the use of the system are quoted as examples.

### 1. Introduction

In a paper presented to the Institution at the previous Convention three years ago, the authors sought to indicate possible methods of applying a scientific machine—402—to business accounting problems.‡ The continued study of specific office organizations based on the premise of a solution in the form of an extended 402 brought out two basic, and perhaps obvious, facts—

- (a) No two office systems are the same.
- (b) The development of some new equipment was essential.

The first means that the machine designed for scientific work is not generally flexible enough, particularly as regards input/output arrangements. The second meant that, as mentioned in the paper, the storage capacity of the usual drum type of machine was quite inadequate to cater elegantly with the file up-dating problem. The development of a magnetic tape type of equipment was, therefore, the most pressing requirement. This was being actively pursued at that time, 35-mm magnetic film being the medium chosen. This type of store will be referred to as "film," "tape"

implying perforated paper tape at all times.

The use of standard (plug-in) units was already well established as a method of constructing different types of machines. It was felt that a similar technique applied at the level of complete "sub systems" (now called catalogue assemblies) which could be interconnected as required, might well be a solution which escaped the need either of having to make something unique for each new requirement, or else having to foist a maximum machine on already reluctant potential users.

### 2. General Principle of 405 System

The 405 system is based on the principle of a simple calculator backed by an elaborate arrangement of data transfer units. The realization of this was much helped by being able to use the long 16-word (1.6 msec) nickel delay line which had been developed since the inception of the 402. A 4-word version of this was used in the 403, which is the large general-purpose computer WREDAC at the Weapons Research Establishment in Australia. Co-operation with the Mond Nickel Company had resulted in a material which allows the construction of a long delay line having a

\* Manuscript received 26th February 1957. (Paper No. 404.)

† Elliott Bros (London) Ltd., Borehamwood, Herts. U.D.C. No. 681.142.

‡ "Applications of a high-speed electronic computer to a business-accounting problem," *J. Brit. I.R.E.*, 14, pp. 293-302, July 1954.

temperature coefficient sufficiently near zero under production conditions to be able to do away with any form of temperature control in the equipment other than the usual cooling measures. The working store of the machine can, therefore, be distributed both functionally and physically. Fig. 1, the block diagram, and

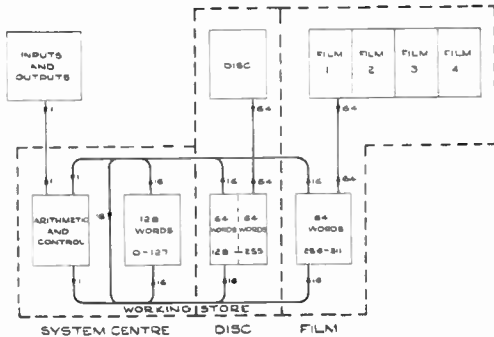

Fig. 1. Block diagram of Elliott computing service 405 system.

Fig. 2, the "map" of a typical arrangement show how this fact has been used. The store out of which the calculator works is also in most cases the buffer storage for the transfer of information to or from the slower access units.

**3. The System Centre**

The system centre as the "simple calculator" is termed, works from a nickel delay line store of up to 512 words total capacity. High speed calculating being not in general a feature of data processing systems, the system centre can work fast enough from the store of 1.6 msec maximum access time, even though a single address code is used. The single address code has two main advantages. The more obvious is that the instruction becomes shorter, and thus two orders make up a computer word. The second advantage is that the programmer need not think specifically of where the next order is situated.

However, the majority of system centre instructions take only one word time to obey, and thus it is wasteful in time to have to wait 16 word times for the next instruction. To save time it is arranged that the locations within the 16-word cycle appear out of sequence such

that successive addresses occur at three-word time intervals (Table 1). This means that by careful choice of operand addresses and use of orders with no store access, pairs of orders can be executed at a maximum speed of 300 microseconds per pair.

The comparatively fast access working store eliminates the need for this form of optimum programming in all but a few particularly fast routines. The control part of the system centre is the "master mind" for all operations of the system. A separate set of order codes is used for controlling the other units of the system and the overall system functions. These are called one code orders, and eight different sets of these are possible. Table 2 shows the one code order allocation.

**Table 1**

Time	Address	Time	Address
0	0	8	8
1	11	9	3
2	6	10	14
3	1	11	9
4	12	12	4
5	7	13	15
6	2	14	10
7	13	15	5

**Table 2**

0	Input
1	Output
2	Drum/Disc
3	Magnetic Film
4-6	Spare
7	Overall Machine Control.

The detailed order code structure of both 0 and 1 code orders is given in the Appendix.

Two of the 0 code orders are of particular relevance to data processing as opposed to scientific calculations.

- (1) A direct multiplication order enabling multiplication by 0, 2, 4, 8, 10, 12, to be carried out quickly.



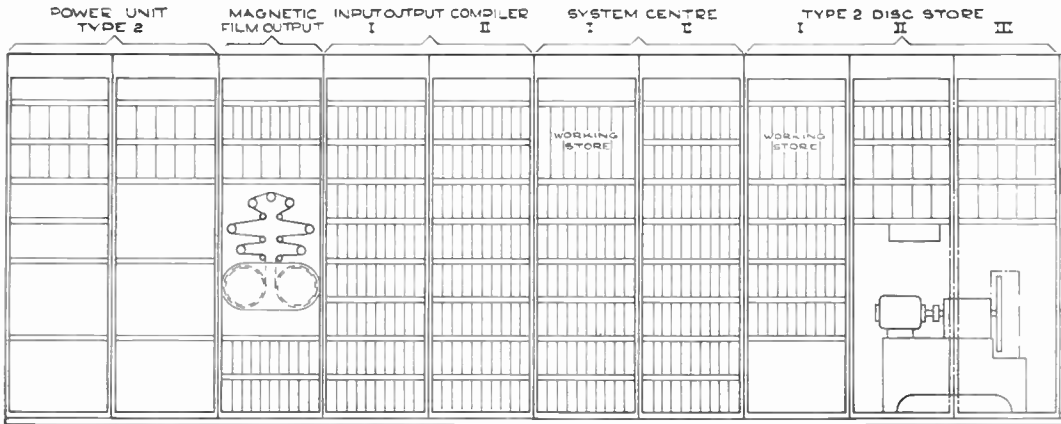

Fig. 2. Diagram showing layout of the 405 system.

- (2) A block transfer order enabling the contents of one 16-word line to be transferred to another part of the working store in one operation.

Additional working storage not tied up to any transfer equipment can be fitted to bring the total number of words of working storage up to 512 in any one system.

Immediate access storage (I.A.S.) can also be fitted in a system if thought economically desirable. This uses the usual nickel line register units and is made up in blocks of 16 words. The block transfer order mentioned above still applies and is useful as a means of loading or unloading all I.A.S. registers at one time.

**4. Drum/disc Store**

The drum/disc store is taken next as it is physically next to the system centre. The 405 is a synchronous machine in that the timing or clock is taken from the drum or disc and the logical units, registers and working store are all directly controlled from this waveform. The address track is also generated by the drum or disc. Although it is possible to have a system which does not require either of these devices, no such machine has yet been seriously proposed.

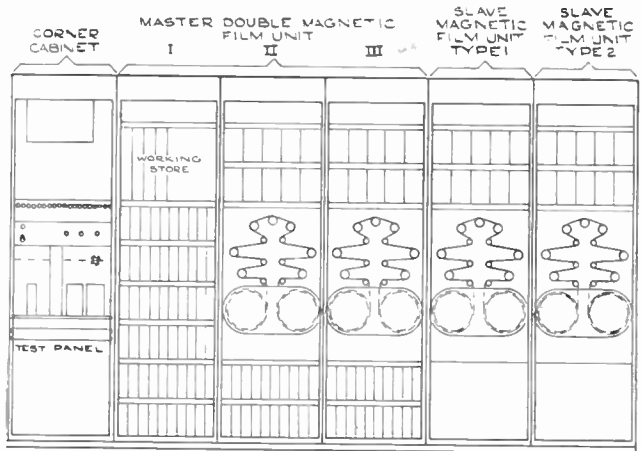

Transfer of information between drum or disc and the appropriate section of the working store is done in blocks of 64 words. As this is quite a large unit of information as far as the system centre is concerned, relay switching is considered to give fast enough access to different tracks, and is used therefore in preference to electronic switching, which is considerably more complex and expensive. Transfers between drum or disc and working store are carried out independently of the system centre once initiated, a busy line technique ensuring that the system centre cannot read "partially transferred" information. This philosophy of independent or multiplex transfers spreads to all one-code orders and it means that several operations can take place simultaneously in the system as a whole. This gets the most effective use out of the total mass

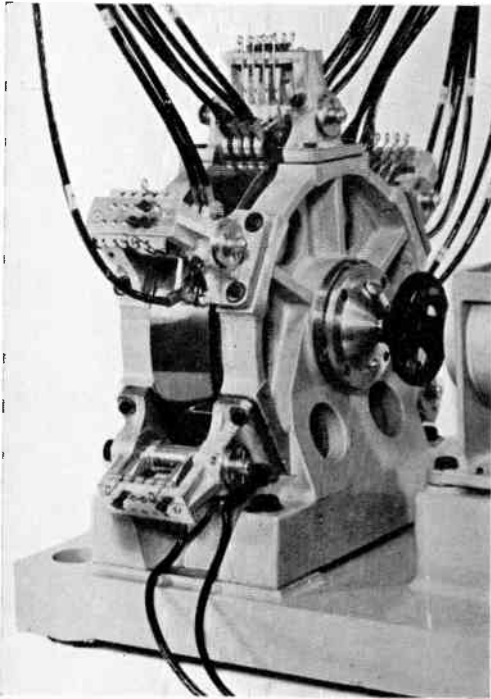

Fig. 3. Type 1 drum store—4,096 word store.

of equipment, as well as giving a considerable advantage in speed.

Mechanically the drum (Fig. 3) is identical to that used in the 402, except that here there are 32 working tracks, plus clock and address, each working track containing 128 words, giving a total drum capacity of 4096 words. As 405 uses long delay lines the speed control has to be of an order of magnitude better than that of 402, which depends on a servo referring to a tuned circuit in a conventional form of Foster-Seeley discriminator. In 405 (disc as well) a fine speed control circuit beats the 333 kc/s clock with a 330 kc/s crystal and carries out a discrimination on the 3 kc/s difference frequency. As the grasp of this circuit is narrow the coarse speed control is still necessary to bring the speed from the rough standby value to a position where the fine speed control circuits can lock on. Provision is made in the amplifier of the servo which controls the d.c. motor to be able to vary the speed over a narrow range by means of keys on the console. This has the same effect as varying the *lengths* of all the nickel lines, and

hence allows a marginal check on all delay lines to be made from one point.

The disc (Fig. 4) is the same design as that installed in the 403. It has 64 working tracks, each of 256 words giving a capacity of 16,384 words. This is not the place to go into the engineering reasons why both disc and drum type memories are used, but for large capacities the disc is a preferable solution and one of its virtues can be shown by the fact that the capacity of the disc can be doubled by an increase in diameter of only  $\frac{1}{4}$  in.

It is technically possible to have more than one disc in a system, but the transfer equipment would be more elaborate because the slave mechanisms would be asynchronous.

### 5. Magnetic Film Storage

In order to carry out bulk data processing it is necessary to develop a means of storing large quantities of information with relatively long access time. Magnetic tape presented a solution to the problem, but unfortunately brought with it numerous difficulties. One of these troubles was the effect of small dust particles coming between the reading head (usually in contact) and the magnetic surface.

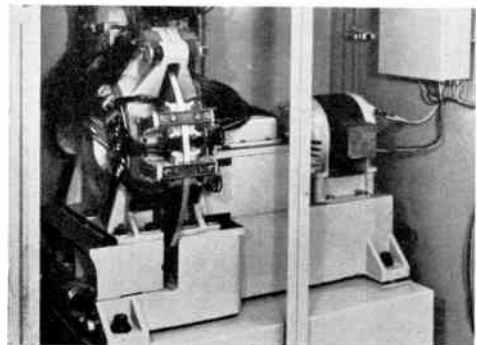

Fig. 4. Type 2 disc store—16,384 word store.

This can cause loss of signal and unreliable operation. The UNIVAC system uses a metallic tape which can be wiped before passage under the head. Oxide coated tape is not easily wiped, and running out of contact seems the only alternative to a costly air cleaning plant. It is, however, not an easy task to keep a constant clearance between the

reading head, and the very thin magnetic tape. Thus, 35-mm film coated with magnetic oxide is used in the 405 system. The stouter, sprocket fed film can be run under tension over an accurately machined drum, thus keeping the necessary clearance. The film is basically an optical medium, and therefore homogeneous in consistency, which leads to very few, or no flaws, in a 1,000 ft reel. However, due to this drum and sprocket wheels, a greater mass is involved when starting and stopping the transport mechanism. These considerations, amongst others, led to the design of the existing mechanism (Fig. 5), which will be described in subsequent paragraphs.

The film mechanism was designed to move the film at a speed of 30 in. per second, since this speed, while not being excessive from a starting and stopping point of view, allows information to be recorded at 5 kc/s on each track with a digit length of 0.006 in. At this speed it is possible to start and stop the film in 50 millisecc and reverse direction in 60 millisecc. These times are slow compared with those achieved by some magnetic tape transports, but the film has the virtue that it is possible to carry out more than 30,000 reversals over the same small piece of film before any appreciable wear is apparent. At this stage a certain amount of tearing begins at the sprocket holes with the recording surface remaining efficient. There is, of course, no head wear due to contact with the abrasive oxide. The film reels, which are enclosed in a removable cassette, are driven by servo-motors controlled photo-electrically by the arms, which form the film reservoirs on each side of the main mechanism. These arms are fitted with trip circuits so that if one side either becomes too tight or too loose, the whole unit switches off in order not to cause damage to the film record.

The method of recording on the film uses a phase modulation technique, similar to that used in the disc circuits. In the disc a permanent clock track times information being written, and provides a strobe pulse with which to sense the information being read. On the film it is necessary to write a new clock track each time information is written. This is because it would be neither practical to read clock on one track of a multiple head at the same time as writing on other tracks, nor, due

to possible film expansion, to read clock with a separate head displaced along the film. This does, however, lead to a simplification of the logical circuitry connected with writing on the film. Since the clock track is to be written the whole operation can be carried out in complete synchronism with the rest of the machine. The word time of the machine is 100 microseconds and thus each digit on the film, written at 5 kc/s, will last two word times. Thus the clock waveform (Fig. 6 (a)) which is written on the film consists of one word time up, followed

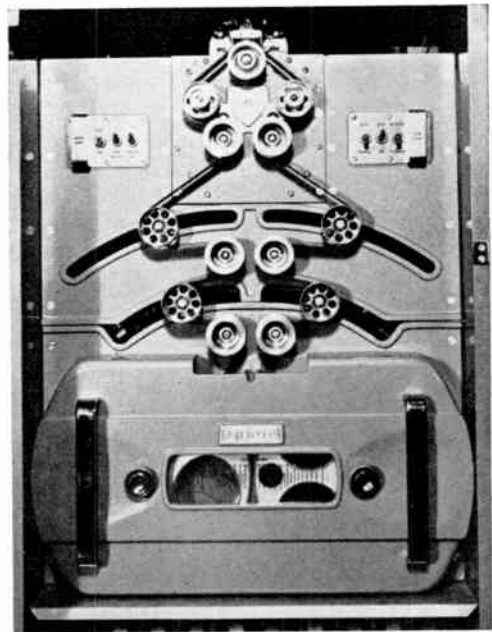

Fig. 5. Magnetic film unit. 300,000 words per 1,000 ft. reel of film.

by one word time down, and so on. Where a "one" is to be recorded the wave form (Fig. 6 (b)) consists of one word time down followed by one up, whereas a "nought" is produced by one word time up, followed by one down (Fig. 6 (c)). It will be noticed that the clock waveform is displaced by about half a word time relative to the information. This is in order that, when reading, a strobing digit (Fig. 6 (d)) can be produced from the leading edge of the clock waveform, which will occur in the middle of the second word time. This will produce a digit when a "one" is read, and

no digit for a "nought." This method of recording is particularly suitable for an a.c. coupled system, since the minimum frequency necessary is 2.5 kc/s, or half the normal frequency. This is produced when a "one-o-one" configuration is recorded, on a particular track.

The disposition of the tracks on the film is shown in Fig. 6(e). Since the film has nearly one inch of working width it is possible to have several tracks in parallel. This means that the effective digit frequency can be raised considerably. Each track will need individual reading and writing circuits, together with

was found to be a suitable size. It is convenient to use the eight remaining tracks as two sets of four tracks each. This combines the economy of needing only four amplifiers, with the reasonably high effective "bit" rate of 15 kc/s. This is achieved by having three parallel information channels working at 5 kc/s, the fourth channel being used for the clock track. As has been mentioned above, information is written in synchronism with the computer, but when a "read" order is being carried out, the amplifier waveforms have no direct connection in time with the computer. Consequently, the strobing pulse, and then the result of strobing the three information waveforms must be staticized in order to use the information at the right phase of a computer word time.

The arrangement of the digits of a computer word, when written on film is shown in Fig. 6(f). Since there are 32 binary digits in each word, they can be recorded on the three magnetic tracks in eleven rows, with one spare cell left over. This cell is used for a parity check, whereby the number of ones in the word is automatically made into an odd number by the addition of the 33rd digit where necessary. When the information is read back from the film the number of ones is checked and any word containing an even number will set a warning register so that the programme can take appropriate action, such as re-reading the block. During both reading and writing operations, the film clock pulses are counted, and every time eleven is reached a new word is taken from, or fed to, the assembly register. This register shifts its contents three places each time a clock pulse is encountered, so that all thirty-three digits are used.

The facilities provided to the programmer which are most often used in this section of the system are those of reading or writing the next block, going back a specified number of blocks, and finding a certain block. The first two use a particular portion of the high speed working store as a destination and source, respectively, of the recorded information. The third order is self-explanatory, whereas the last is more complex. There is no address track on the film, and thus the first word in each block carries the so-called "address" of the block. The order in question causes the film

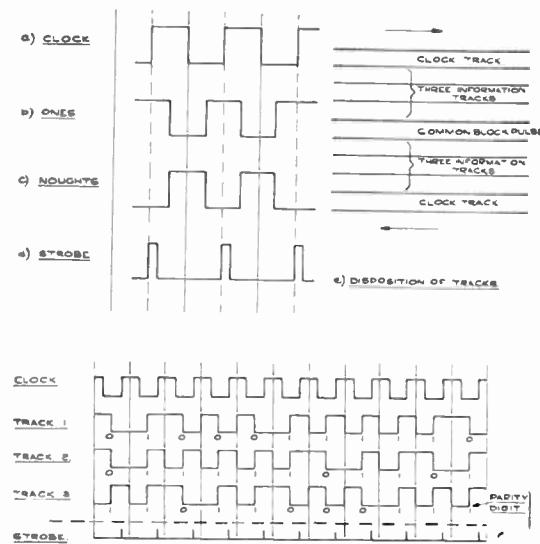

Fig. 6. Magnetic film recording.

extra logical units for conversion to and from serial form. It is quite easy to record nine tracks on the film. At least one of these tracks must be used for a clock track, and a second must be used for recording block markers. If the film is to be used as a true store, it must be possible to change one item of information without disturbing adjacent items. This means that there must be a gap between items since the speed of the film may vary slightly from day to day.

Thus it is desirable to record information in fairly large quantities, so that the ratio of gap to information is small. A block of 64 words



to move forward until a block is read which has an address corresponding to the number specified in the second half of the order word. It will be noted that this system does not require addresses to be serial although an increasing sequence is generally desirable. All film instructions can be obeyed independently from the rest of the system, which is only held up when a second film order occurs before the first one is complete. It is arranged that when a block has been read or written the film is automatically positioned so that the next block can be read. In order that the gap is not too long, allowing for stopping and starting, this is achieved by making the film reverse into the block which has just been operated on. This would mean that it is necessary to reverse the mechanism twice between successive blocks, which would be rather tedious under certain circumstances. Thus it is arranged that if a second order is presented to the film control unit before the reading or writing of the first one is completed, the mechanism will proceed at full speed. Other facilities which are provided are for changing from one set of four tracks to the other, and for testing the parity register. When the tracks are changed the direction of motion is also changed, so that in a serial application the film will travel from one end or one set of tracks and back to the same end on the other. The controlling circuitry is designed to serve up to 16 film

mechanisms, of which only one can be used at a time. Each film is capable of storing about 220,000 words, or 4,400 blocks.

**6. Input/Output**

Input and output, taking a computing system as a whole, should refer only to the introduction of information into the system from outside and vice versa. The up-to-dating of the electronic file is really an extended system store, although it may possibly use input and output apparatus. The sophisticated data processing system aims at utilizing the memory and decision ability of the main machine to reduce, as far as possible, input to changing information and output to an essential minimum. In practice it is here that natural conservatism has its strongest hold and probably where time and usage alone will demonstrate the true power of the digital computing technique.

Several alternative arrangements of input/output units will be described below, but new ones will evolve where other existing methods appear to limit the speed of a proposed system or new apparatus becomes available to the designer.

The control console can legitimately be described at this point, as it is a means—a vital one—of input control, and also forms an output display for programming and other work. It is illustrated in Fig. 7. Functionally

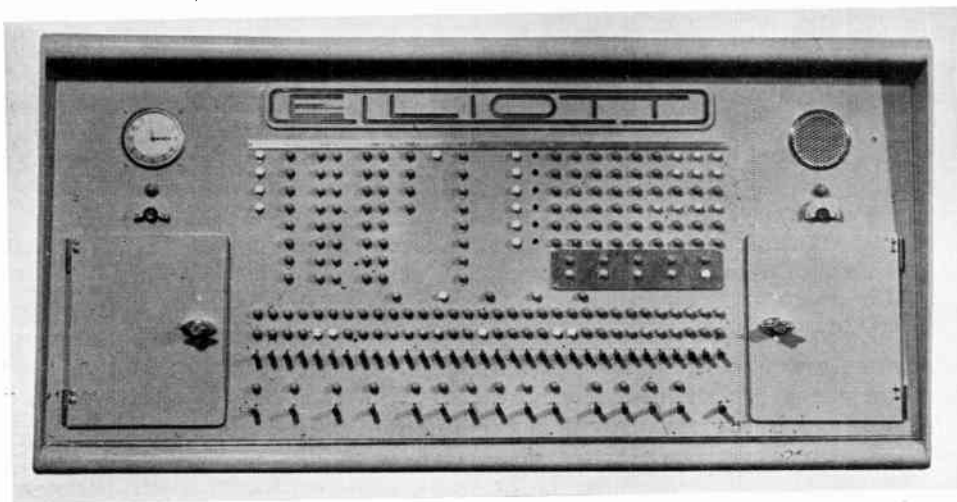

Fig. 7. Control console.



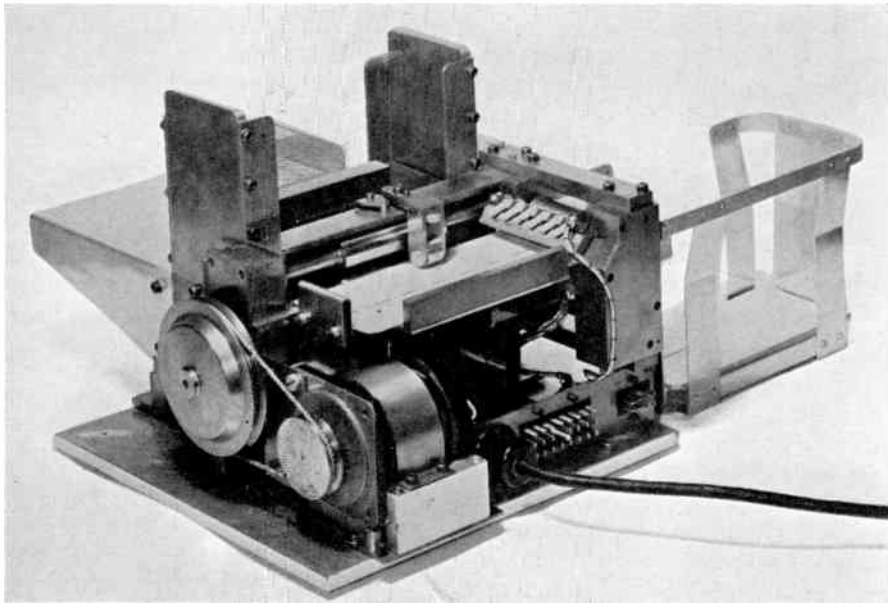

Fig. 8. Punched card reader—600 cards per minute

it splits into three main parts. Firstly, the the major part of its front surface is covered with miniature filament lamps, which are relay controlled from pulse lengthened digit pulses in the machine. The use of filament lamps allows different colours to be used, and also makes for considerably better visibility than neon lamps. Speed of response is not serious as little can be gathered from a display changing at computing speed, the normal use being for display under step-by-step conditions. The fixed spatial distribution of lamps is far easier to understand than pulses on a cathode ray tube, and this contributes to the speed of programme development. Various registers in the machine can be displayed as selected by switches and the information is in some cases semi-decoded. A loudspeaker is also provided as an output channel and is useful for keeping track of the rhythm of the machine while calculating.

The row of switches across the lower middle portion of the panel is a number generator (hand switches) and is read by the computer as location 0. These can be used for data input but one of their main functions is for starting a programme off at a manually selected point. The dynamic pulse train is generated

from the number generator by means of a special nickel delay line which has 32 drive coils spread along the line instead of the usual one. These are all in series and pulsed at the same instant. Pulses would be generated at all points but those not required are eliminated by short circuiting the appropriate coil or coils with the hand switches. Control of the machine is exercised from a group of five keys at the bottom right hand corner of the console. The normal facilities of step-by-step working, and optional stops are available, together with the built-in facility of transferring control to the number generator or to the first location of the drum.

The third console function is associated with power supply, the machine being switched on entirely from the control console. Behind the two locked doors are, on the right, the power and h.t. controls with an hour meter, and on the left, marginal operation setting keys and a meter for monitoring supply voltages. Emergency "power off" buttons are mounted on the main panel.

The input medium used in business accounting is usually either perforated paper tape or punched card. The ubiquitous Ferranti reader is used for paper tape. For punched

card reading a new form of card reader has been developed for computer use. The Mark I model of this reads the standard 80-column IBM or Hollerith type of card endwise at speeds up to 10 per second (Fig. 8). The endwise reading technique uses germanium photocells to generate the information serially, thus making the information available in a more economical form for computer application than the normal method of reading which implies a parallel to serial conversion. Cards can be demanded one at a time but once in motion a card cannot be stopped. Redundant zero punching must be used on the cards. Both these mechanisms are connected directly to the computer.

Output mechanisms may be connected directly to the machine but in general this is not the most economical arrangement. Jobs vary so widely in printing requirements that unless fortune is unusually kind the coupling

could only be achieved, if at all, by an extravagant amount of working storage.

By running the printing equipment remote from the computer buffered by paper tape, punched card or magnetic film, the choice of many slow printers or few fast line printers becomes a question of the quantity of printing involved, coupled with the degree of flexibility required. This, of course, does not eliminate the necessity for one slow direct output device which can be used for summaries, queries, etc., and is also needed for programming work. The mechanism of output can, therefore, be split into two categories, buffer output and actual printing equipment.

Buffer output equipment may use as a medium paper tape, punched card or magnetic film. The Creed 25 characters per second perforator is the simplest and at present the fastest available method of producing perforated tape in this country. The use of



Fig. 9. Compuprinter mechanism—20 characters per second.

of a fast line printer directly to the computer will either mean that the computer is waiting on the printer or else that the printer, which is an expensive piece of equipment, is idle for unsatisfactory periods of time. To couple a number of slow printers to a computer directly, though technically feasible, would require an almost impossible programming task, which

punched cards as a medium is, with present equipment, rather unwieldy. New developments may help to rectify this but except for special requirements (e.g. local office filing) cards are a rather expensive medium to be used merely as a buffer.

Magnetic film is used in two forms, as has been indicated already—

- (1) Written in a manner for subsequent typing by a single character printer. In this case information is written at 300 characters a second and played back to a perforator for subsequent printing at the much slower speed of 20 characters per second.
- (2) The normal storage film method when used to feed a line printer.

Single character printing in its simplest form is the teleprinter, which is too well-known to require further discussion. The electric printer used in the 405 system is a new development. The Compuprinter, as it is called, has the type hammers directly operated by solenoids; also the carriage is positively driven forward by a motor so that speeds up to 20 characters a second are achieved (Fig. 9). Only upper case letters are available, as in the teleprinter.

The line-at-a-time printer that was used with the 403, and is also available under certain circumstances for the 405 system, is the Bull printer. This has 92 alpha-numerical columns and can print at up to  $2\frac{1}{2}$  lines per second.

Three methods of utilizing this range of equipment are described below, being in increasing degrees of sophistication.

*Simple Input/Output* : This uses the Ferranti tape reader for input and the Creed 25 and/or compuprinter as output. In this case all organization and conversion must be carried out by the system centre under programme control.

*Input/Output with Compiler* may use paper tape and punched card inputs and the output may be paper tape, direct typewriter or magnetic film. The facilities indicated by the order code in the appendix show that both binary to decimal conversion and some degree of data organization can be carried out by this equipment.

*Input/Output with Compiler and Block Transfer* has all the facilities of the above with the addition of the automatic build up of complete blocks of information for printing. This is used for example when several outputs are run simultaneously and to programme using multiplexing would be involved. Alternatively, in conjunction with the magnetic film controlled line printer, complete 16 word

blocks can be built up and transferred to the store film to be subsequently printed from there.

Data raising equipment for input information may be conventional direct keyboard apparatus, or as a by-product of unit accounting machines.

Ancillary printing equipment may be the paper tape driven teleprinter, the paper tape compuprinter, magnetic (output) film controlled perforator, or magnetic (store) film controlled line printer. This last is a large piece of apparatus in its own right, containing buffer nickel line storage to convert from the serial data film to the parallel channels of the multi-column line printer.

## 7. Power Supplies

The power supply is built up in separate cabinets, as necessitated by the quantity of equipment involved in the main cabinet assembly of the system. In all cases a motor alternator set (a.c. to a.c. three-phase) is used both to stabilize the mains, mostly for the benefit of the heaters, and also to iron out any missing half-cycles in the raw supply. A no-break supply type of motor alternator diesel set can be used if the local main supply is in the habit of failing completely. These sets are, of course, located remote from the machine and are stopped and started from the console.

Each cabinet of the main equipment has its own cooling fan requiring a through flow of air of 200 cubic feet per minute. The limit on ambient air inlet temperature is set by the germanium diodes in the equipment and should not rise above  $35^{\circ}\text{C}$ . Provided this is maintained no form of air conditioning is required.

## 8. Typical Applications of the 405 System

In the paper presented at the 1954 Convention two possible computer applications were discussed in some detail. These applications were payroll and invoicing, which, together with many other problems, have been programmed in varying extents during the past year. The payroll of some 800 workers in one group has been computed regularly for nearly a year, whereas some other applications have reached the pilot stage, and many others have been demonstrated in a general form. One of the points which has become plain in all the

system investigations carried out is that, although a demonstration has been planned and programmed, this generally does not mean that all situations are covered. It appears usually that no case is completely catered for, and so the demonstration programme can only be used as a framework on which to hang a practical application. Much hard work is necessary before all the exceptions and minor variations have been included. It is necessary for all circumstances to be foreseen in the programme, if only so that the computer can reject the most exceptional cases for human attention. In practice such rejections are most inconvenient, since they lead to incomplete analyses at the end of a run. It is thus that a comparatively small basic programme, doing the majority of the data processing, becomes a large one with many small sub-routines for dealing with exceptional cases. Programmes of two or three thousand pairs of orders are quite common in practice.

### 8.1. *Small System*

The 405 system can vary widely in size and composition, depending on the application. The smallest system which demonstrates the power of the fully electronic method of accounting is that installed by Norwich City Corporation. This machine consists of the basic system centre, together with a drum store (4096 words) and two magnetic film units. The input and output facilities are limited to paper tape feeding straight to and from the accumulator of the machine. The most noticeable of the uses to which this machine is being put is, to Norwich ratepayers at least, the production of Rate Demand Notes, and the subsequent account keeping. In actual fact the basic use of the machine will be in the keeping and analysis of the many costs accounts of a busy municipality. One important fact is demonstrated in this system, in that although it is very small there are still two film units. This is due to the desirability of up-dating from one film to another. In this way an effective copy of all films is kept, since if any mishap should occur to the current film, it can always be reproduced from the old film with the same input data. This system consists of nine standard cabinets with the control console and paper tape equipment on a separate table.

### 8.2. *Medium-sized System*

A medium-sized system is being used for the internal accounting of its maker's group of companies (Fig. 2). The system has stretched in this case to fifteen cabinets with the addition of two more film units, a compiler, and a disc (16,384 words) instead of a drum. The original payroll is being extended to cover four thousand employees and also to carry out cost analysis. A start is being made in the field of production control using this machine since it is felt that it is here that the greatest economies are to be made. In the past (and also the present) the yardstick by which the feasibility of a computer has been measured is the number of staff to be replaced by the machine. It has yet to be proved in practice that the application of this type of machine can lead to far greater efficiency and productivity, but all the results of present experiments lead one to the conclusion that this will be the case. The 405 is capable of still greater extension, with a maximum size of eighty-two cabinets (most of which would be film units). This maximum has not been approached by a long way, but with the use of two or more master film units and immediate access stores the system described above has been exceeded several times.

## 9. Conclusion

It can perhaps be said that whereas the paper presented to the Oxford Convention was a chapter of hopes and gazing into the future, this paper is the chapter of realization of those hopes, although the amount of practical experience gained so far is limited. The age of "Automation" brings with it many challenges which must be met with machines such as the 405. It is hoped that the next Convention may be presented with a chapter of successful reflections.

## 10. Appendix : Order Code

The 405 order code is single address. The least significant digit determines whether the order refers to the System Centre or to other units. For all System Centre orders this digit is zero (0 Code orders), for orders referring to any other unit the digit is one (1 Code orders).

There are two orders to each word which are normally obeyed successively.



1. System Centre Orders (0 Code)

$d_{16}$  is the most significant digit.

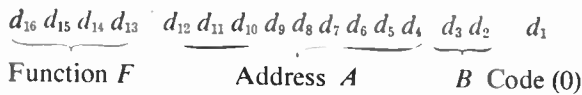

The  $A$  group either defines the address of the number to be operated on in the store or further specifies the function.

The  $B$  group specifies one of three storage locations the content of which is added to the order as it enters the order register. These locations are immediate access registers in the System Centre having addresses 1, 2 and 3. Address 0 is used for the manual insertion of information via the number generator.

The Code digit always zero for System Centre orders.

1.1. Functions

The following abbreviations are used:

$N$  denotes the number given in the  $A$  group.

$C(N)$  denotes the content of storage location  $N$ .

$C(A)$  denotes the content of the accumulator.

The results of operations in the accumulator are always left in the accumulator.

The functions provided are:

- 0 Add  $C(N)$  to  $C(A)$
- 1 Collate  $C(N)$  with  $C(A)$
- 2 Subtract  $C(N)$  from  $C(A)$
- 3 Negate and add (subtract  $C(A)$  from  $C(N)$ )
- 4 Fast multiplication by common numbers (the number is specified by  $N$  and may be 0, 2, 4, 8, 10 or 12)
- 5 Left shift (double  $N$  times)
- 6 Multiply  $C(A)$  by  $C(N)$
- 7 Divide  $C(A)$  by  $C(N)$
- 8 Unconditional transfer to location  $N$
- 9 Transfer control to location  $N$  if  $C(A)$  is negative, otherwise proceed normally
- 10 Swap: place  $C(A)$  in location  $N$  and  $C(N)$  in  $A$
- 11 Replace  $C(A)$  by  $C(N)$
- 12 Count: if the content of I.A.S.1 (known as  $C(1)$ ) is non-zero transfer control to location  $N$ , otherwise proceed normally. Increase  $C(1)$  by  $2^{-12}$
- 13 Right shift (halve  $N$  times)
- 14 Transfer 16-word block from first half of store
- 15 Transfer 16-word block from second half of store

2. Drum and Disc Store Orders (1 Code)

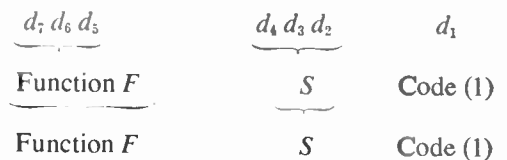
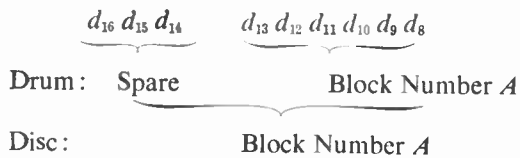

The  $A$  group specifies the number  $N$  of the 64-word block, two more digits being required for the disc than for the drum.

The  $S$  group is always 2 for drum and disc orders.

The drum and disc stores have 128 words of quick-access storage considered as first and second halves, each of 64 words.

2.1. Functions

- 0 Read block  $N$  into first half
- 1 Read block  $N$  into second half
- 2 Write from first half into block  $N$
- 3 Write from second half into block  $N$
- 4-7 Spare



3. 35-mm Magnetic Film Store (1 Code)

The film is divided into two halves, one of which may be read from or written on when the film is moving in each direction. Each half contains three parallel information tracks and

a synchronization track.

In film store orders the second half of the word may have a separate address significance (see Function 6 below).

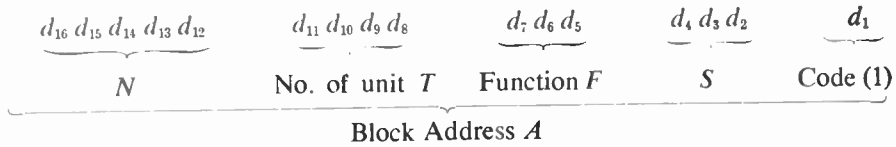

The  $N$  group specifies the number of blocks to be passed (see Function 1 below).

The  $T$  group specifies which of the 16 units is concerned.

The  $S$  group is always 3 for film store orders.

3.1. Function

- 0 Spare
- 1 Run the film back  $N$  blocks
- 2 Examine parity check (checks errors in stored information)
- 3 Change from one half of the film to the other

- 4 Spare
- 5 Read next block
- 6 Find block (the address being given by the second half of the order word)
- 7 Write next block

4. Input (1 Code)

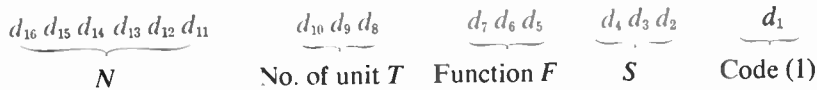

The  $N$  group is as specified in the Function. The  $S$  group is always for 0 input orders.

The  $T$  group specifies which input channel is concerned.

4.1. Functions with a Paper Tape Reader

- 0 Find a character which is the telecode equivalent of  $N$
- 1 Ignore  $N$  character positions
- 2 Input  $N$  characters ( $1 \leq N \leq 6$ ) in telecode
- 3 Input a decimal integer of up to  $N$  characters
- 4 Replace  $C(A)$  by the content of the input register
- 5 Test check register (to guard against reading errors)
- 6 Spare
- 7 (Without block input) Read a character to the accumulator
- 7 (With block input) Read a block (96 characters off the tape, forming 16 words)

4.2. Functions with a Card Reader

- 0 Find a column containing the telecode equivalent of  $N$
- 1 Ignore  $N$  columns
- 2 Input  $N$  columns ( $1 \leq N \leq 6$ ) in telecode
- 3 Input a decimal integer
- 4 Replace  $C(A)$  by the content of the input register
- 5 Test check register
- 6 Spare
- 7 Read a complete card

Note that when simple input alone is provided the only function available is that of reading a single character from paper tape into the accumulator (Order 7 in Section 2.4.1 above).

### 5. Output (1 Code)



The  $N$  group is as specified in the Function.  
The  $S$  group is always 1 for output orders.

The  $T$  group specifies which output channel is concerned.

#### 5.1. Functions with a Paper Tape Output Punch

- |   |   |
|---|---|
| <ul style="list-style-type: none"> <li>0 Output a character whose telecode equivalent is <math>N</math></li> <li>1 Output <math>N</math> spaces</li> <li>2 Output a group of <math>N</math> characters (<math>1 \leq N \leq 6</math>)</li> <li>3 Replace content of "constant register" by <math>C(A)</math>. This register is used for binary to decimal conversion, etc.</li> <li>4 Output the <math>N</math> most significant digits of a decimal integer</li> </ul> | <ul style="list-style-type: none"> <li>5 Output a decimal fraction of <math>N</math> characters</li> <li>6 Output <math>N</math> characters of remainder left by Functions 2, 4 or 5</li> <li>7 (Without block output) Output a character</li> <li>7 (With block output) Output a block</li> </ul> <p>Note that when simple output alone is provided the only function available is that of sending out a single character from the accumulator to the output punch (Order 7 in Section 5.1 above).</p> |
|---|---|

### 6. Overall Input and Output Control

This control is specified by a 7 in the  $T$  group of the order.

#### 6.1. Overall Input Functions

- 0 Stop when the last character or card is read.

#### 6.2. Overall Output Functions

- 0 Replace  $C(A)$  by content of the assembly register
- 1 Stop when last character or card has been punched.
- 2 Switch output to block
- 3 Switch output to accumulator.

### 7. Overall Machine Control

These functions are characterized by a 7 in the  $S$  group of a 1 Code order and affect the operation of subsequent 0 Code orders.

- 0 Spare
- 1 Sequence register to location 1
- 2 Set single-length multiplication
- 3 Set double-length multiplication.

# FLUID DENSITY MEASUREMENTS BY MEANS OF GAMMA RAY ABSORPTION\*

by

R. Y. Parry† and A. E. M. Hodgson, D.L.C.‡

*A paper presented at the Convention on "Electronics in Automation" in Cambridge on 27th June 1957. In the Chair: Dr. Denis Taylor.*

## SUMMARY

The paper discusses the phenomena involved and the parameters controlling the usefulness of a method of measuring the specific gravity of liquids flowing in a pipe (during manufacturing processes), and of detecting the interface between liquids having different specific gravities, e.g. petroleum products. To ensure stability and accuracy a pressurized ionization chamber is used in conjunction with a vibrating reed electrometer, and a heavily shielded gamma source of the order of one curie. Changes in specific gravity of 0.2% of liquids in steel walled pipes of up to 14 inches diameter have been detected. Details are given of typical industrial installations.

## 1. Introduction

Gauges which measure the amount of radioactivity transmitted through a material, and use the resultant signal to indicate the thickness or substance of the material, have been very widely reported<sup>1,2,3</sup>, but the use of this method to measure the density of fluids flowing in a pipe or tank has received less attention. It is the purpose of this paper to describe an equipment which is capable of detecting changes in density of the order of 0.2 per cent. and to outline some of the problems involved.

In general, the measurement of fluids is carried out in pipes or tanks of from a few inches in diameter up to several feet. The walls are usually of iron or steel and may be surrounded with lagging or refractory materials. It is therefore necessary to use gamma radiation and this paper is primarily concerned with the use of caesium 137; this is a relatively cheap source of 0.661 MeV gamma rays, and its half-life (the time taken for the quantity of radiation to reduce to one-half of its initial value) of 33 years makes it very suitable for use in an industrial plant.

## 2. General Requirements of System

Gamma radiation consists of electromagnetic quanta which are the result of random disintegration with time within the source, and are therefore subject to statistical variation. This means that the accuracy will depend upon the number of quanta detected, 250,000 being the required number for a mean probable error of 0.2 per cent., and therefore a very high counting rate is needed for high accuracy.

The well-known Geiger-Müller tube has a dead time of from 100 to 400 microseconds after a discharge has been initiated, and as a result is not suitable for accurate measurement under these conditions due to its limited count rate.

The scintillation counter is capable of counting at sufficiently high speeds, but the associated electronic equipment becomes extremely complex.<sup>4,5</sup> It may also be used in a d.c. manner but in either condition it is difficult and expensive to obtain the necessary stability because of the large temperature coefficient of the photomultiplier tube, and its susceptibility to changes in the voltages applied to the dynodes.

Ionization chambers, on the other hand, are fast enough and capable of extreme stability but require considerably larger radioactive sources

\* Manuscript received 28th May 1957. (Paper No. 405.)

† Ekco Electronics Ltd., Southend-on-Sea, Essex. U.D.C. No. 621.387.42:531.756:656.56.4.

than the other detectors, and as the signal resulting from the radiation is a small direct current at high impedance, a very stable electrometer is required as the measuring element. Except for the heavy shielding needed by the gamma source, these problems are the same as have been successfully overcome in the several thousands of beta gauges in use throughout the world; indeed, due to the fact that a thin window to permit the entry of beta particles into the ionization chamber is not needed, the ionization chamber becomes probably the most rugged component of the whole installation.

The use of a vibrating reed electrometer, in which the d.c. signal is converted to a.c. by a vibrating capacitor and subsequently applied to an a.c.-coupled amplifier, virtually eliminates the zero drift experienced in the older types of direct-coupled electrometer without significantly increasing either complexity or cost.<sup>6</sup>

With a 1 curie source of caesium, 2 inches of lead shielding is sufficient to reduce the level of radiation to below the tolerance level (7.5 mr/hr) at a distance of 1 yard, and this is suitable for most applications. Additional shielding may be added where necessary.

A typical equipment would therefore consist of:—

- (a) 1 curie caesium source.
- (b) T.P.A. ionization chamber filled with argon to a pressure of 20 atmospheres.
- (c) Vibrating reed electrometer with ancillary supplies etc.

### 3. Practical Considerations

For the purpose of evaluating the performance of such an equipment, the problem of measuring the density of water in a 12 inch (30.4 cm) diameter iron pipe with a wall thickness of ½ inch (1.27 cm) will be considered.

Under these conditions the distance from the source, treated as a point, to the centre line of the ionization chamber, will be set at 20 inches. At this distance, in free air, the radiation intensity at the detector will be 1.35 roentgens per hour (r/hr).

The effect on the radiation level of the water-filled pipe can be calculated from the expression:

$$I = I_0 \exp(-\mu_w \rho_w x - 2\mu_r \rho_r t)$$

where  $I_0$  = original intensity  
 $I$  = intensity after absorption  
 $\mu_w, \mu_r$  = mass absorption co-efficients for water and pipe respectively  
 $\rho_w, \rho_r$  = density of water and pipe respectively  
 $x$  = length of path in water  
 $t$  = thickness of pipe wall

The values for water and for an iron pipe are as follows:

$$\begin{aligned} \mu_w, & 0.0864 \text{ cm}^2/\text{gm} \\ \mu_r, & 0.073 \text{ cm}^2/\text{gm} \\ \rho_w, & 1.0 \text{ gm/cm}^3 \\ \rho_r, & 7.5 \text{ gm/cm}^3 \end{aligned}$$

From this expression

$$\begin{aligned} I &= I_0 \exp[-(0.0864 \times 1 \times 30.4) - 2(0.073 \times 7.5 \times 1.27)] \\ &= I_0 \exp[-2.6144 - 1.3907] \\ &= I_0 \exp[-4.0051] \\ &= I_0 \times 0.01822. \end{aligned}$$

Taking  $I_0$  as 1.35 r/hr as stated above,  $I$  therefore is 24.6 milliroentgens per hour.

The sensitivity of the system, that is the change in radiation intensity with change in density of the water, can be obtained by differentiating  $I$  with respect to  $\rho_w$ .

$$\begin{aligned} \frac{dI}{d\rho_w} &= -\mu_w x I \\ \text{and } \frac{dI}{I} &= -\mu_w x d\rho_w \end{aligned}$$

Calculating for a 1% change in the density of the water:

$$\frac{dI}{I} = -0.02614$$

$$\text{and } dI = 0.02614 I$$

Turning now to the electrical side of the system, an ionization chamber converts radiation into a direct current, the expression for calculating this current being:

$$I = 9.24 \times 10^{-14} \text{ amps per cm}^3 \text{ at N.T.P. in a flux of 1 r/hr.}$$

The sensitivity of an ionization chamber depends on the quantity and type of gas in the

sensitive volume, the parameters affecting this being the volume, the pressure and the atomic number of the gas. By using a U.K.A.E.A. type T.P.A. chamber which has a volume of 5 litres and filling it with argon to a pressure of 20 atmospheres, an increase in sensitivity of 30 is obtained over a chamber of the same volume filled with air at N.T.P.

Applying these values to the above expression results in a current of  $1.5 \times 10^{-8}$  amps per r/hr and the calculated level of 24.6 mr/hr will therefore produce a current of  $3.7 \times 10^{-10}$  amps.

This current, if passed through a  $5 \times 10^{10}$  ohms resistor will develop 18.5 volts and a change in density of the water of 1 per cent. will change the voltage by 480 millivolts, which is a change of 2.6 per cent.

Taking two further examples, one of small dimensions and one large, it is found that with a 3-in. inside diameter iron pipe having  $\frac{1}{4}$ -in. thick walls and filled with water,  $I=1.4$  r/hr and a 1 per cent. change in the density of the water results in a 0.66 per cent. change. Using a  $5 \times 10^9$  ohms resistor as the load, the change in output voltage will be 700 millivolts.

With a 2 ft diameter iron pipe or tank having  $\frac{3}{4}$  in. walls,  $I=0.17$  mr/hr and a 1 per cent. density change will produce a 5.8 per cent. change, which, across a  $5 \times 10^{12}$  ohms resistor, will produce 700 millivolts.

Resistors of this value are not easily obtainable with sufficiently stable characteristics, and in this latter example it would be advisable to use cobalt 60 in place of caesium 137. The gamma energy from cobalt 60 is 1.1 and 1.3 MeV, and this would produce a radiation level at the chamber of 60 mr/hr. A 1 per cent. change in density would produce a 4 per cent. change which, across a  $10^{10}$  ohms resistor, would be 360 millivolts.

The previously mentioned random nature of the radiation from the source results in a noise signal superimposed on the standing d.c. level. The final reading accuracy will depend upon the ratio of this noise signal to the change in d.c. level resulting from the change in density of the measured material. This is a normal signal-to-noise ratio problem which limits the smallest density change that can be detected. The calculation of this noise signal is lengthy and the typical figures given below are the result of visual observation.

With caesium:

- 3" dia. pipe  $\pm 0.03\%$  of density
- 12" " "  $\pm 0.5\%$  " "
- 24" " "  $\pm 2.0\%$  " "

With cobalt:

- 24" dia. pipe  $\pm 0.3\%$  of density

These figures relate to a 1 second time-constant and the magnitude of this noise can be reduced by integrating over a longer time or by increasing the strength of the source.

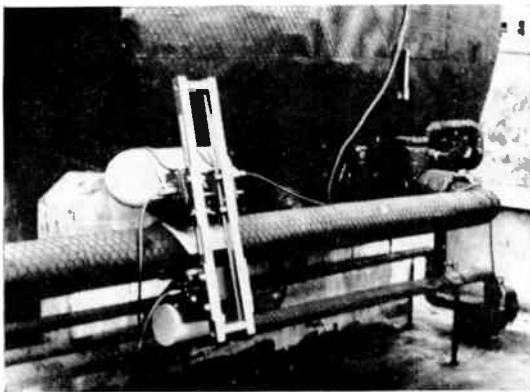

Fig. 1 (above). The source and chamber clamped to a pipe.



Fig. 2 (right). The indicator



#### 4. Applications

The equipment used in an industrial installation is shown in Figs. 1 and 2.

The source is contained in a lead "bomb" giving a 2 in. shielding in all directions, except a collimated exit hole. Provision is made to retract the source to a "safe" position by either mechanical or electro-mechanical means. The ionization chamber is a standard T.P.A. fitted with a smaller source of caesium 137 in a shuttered holder. The purpose of this second source is to enable the calibration of the system to be checked without removing the chamber and source from the pipe or tank.

Installation is extremely simple since both source and chamber are external to the vessel and do not need to be in contact with it. They may be mounted independently on opposite sides of a vessel or fitted to a pipe with the special clamping device shown in Fig. 1. An essential point is that the source and chamber must be rigidly mounted with respect to each other and the pipe or tank.

The indicator is identical with that used for beta measurements and consists of a vibrating reed electrometer, and a stabilized voltage supply which is applied in opposition to the signal from the ionization chamber. This voltage is adjusted to balance out the standing signal produced in the ionization chamber at the mean value of density, thus enabling the electrometer to measure changes from this standing signal. The purpose of this arrangement is to increase the sensitivity to small changes in density.

The sensitivity is adjustable and in its most sensitive position, the electrometer will give full scale deflection for 220 millivolts. The day-to-day drift of the zero will be less than  $\pm 2$  millivolts.

For the examples already given, this sensitivity would permit full scale deflection to represent a change in density of less than 1 per cent. with a zero stability of 0.01 per cent. of the density.

Limit alarm and automatic control facilities can be built into the indicator.

One of the most promising uses for this equipment is to detect the interface between petroleum products of different specific gravities

when flowing sequentially in a common pipe line. It is important to be able to detect the change in product quickly to enable it to be routed to the correct storage tank.<sup>7</sup>

The specific gravity for some types of fuel is as follows:—

Paraffin	0.775
Commercial petroleum	0.737
Premium quality petroleum	0.707
High octane petroleum	0.697

As this instrument will detect a difference in specific gravity of 0.002 it can be seen that the detection of interfaces is quite practicable.

Other possible applications include the measurement of the solid contents of slurries, the specific gravity of solutions, and the measurement of the level of corrosive or high temperature fluids in tanks or furnaces. Other applications will undoubtedly arise as the capabilities of this relatively new tool become appreciated by engineers in the chemical and other industries.

#### 5. Acknowledgments

Grateful acknowledgment is made by the authors for assistance from Mr. H. W. Finch and Mr. L. E. Taylor in the preparation of this paper, and to the Directors of Ekco Electronics Ltd. for permission to publish it.

#### 6. References

1. K. Fearnside, "Beta ray thickness gauges for industrial uses." *J.Brit.I.R.E.*, **11**, p. 361, September 1951.
2. R. Y. Parry, "A combined beta and dielectric gauge," *J.Brit.I.R.E.*, **14**, p. 427, September 1954.
3. M. G. Hammett and H. W. Finch, "Beta-particle and gamma-ray thickness gauges," *Electronic Engineering*, **24**, p. 536, November 1952.
4. "Radio-isotopes in metal gauging," *Nuclear Engineering*, **2**, p. 72, February 1957.
5. G. Syke, "A gamma ray thickness gauge for hot steel strips and tubes," *J.Brit.I.R.E.*, **14**, p. 419, September 1954.
6. D. G. A. Thomas and H. W. Finch, "A simple vibrating condenser electrometer," *Electronic Engineering*, **22**, p. 395, September 1950.
7. D. C. Brunton and T. P. Pepper, *Oil and Gas Journal*, p. 79, 30th August 1954.

# THE INDUCTOSYN AND ITS APPLICATION\*

by

H. J. Findent† and B. A. Horlock (Associate Member)†

*A paper presented at the Convention on "Electronics in Automation" in Cambridge on 27th June 1957. In the Chair: Mr. E. E. Webster.*

## SUMMARY

The inductosyn is a new control element manufactured in rotary and linear forms. In its rotary form it is capable of indicating angular position to an accuracy of 5 seconds of arc with a repeatability of 1 second of arc whilst in its linear form it is capable of a positional accuracy better than 0.0001 in. with a repeatability of 25 microinches. This paper describes both forms in some detail, together with digital to analogue converters suitable for use primarily with the linear inductosyn when used as a position control device. A generalized description of the associated electronic circuits is given enabling the linear inductosyn to be used for machine tool control. Particular reference is made to a programmed co-ordinate table measuring 10 in. by 8 in. which may be positioned in one plane in the  $x, y$  co-ordinates to an accuracy of  $\pm 0.0002$  in. Co-ordinate information is given in the form of punched cards and any number of co-ordinates may be specified and programmed. This is illustrated by considering a typical machining problem, that of placing hole centres in a small gearbox casting to the accuracy specified.

## 1. Introduction

### 1.1. Rotary Form of the Inductosyn (Fig. 1)

The development of the Rotary Inductosyn was undertaken for the American Air Force by the Farrand Optical Co. Inc., New York, U.S.A., in an attempt to produce an angular measurement device of very high accuracy. As a result of four years development work the Inductosyn reached its present form, having an accuracy of 5 seconds of arc, repeatability of 1 second of arc and a sensitivity of 0.25 seconds of arc. These figures are quoted for a unit having a diameter of 5 in.; by increasing this diameter to 10 in. an accuracy of 0.25 second of arc has recently been achieved.

The Inductosyn may be likened to a resolver in that the quantity that varies as a function of mechanical motion is the electro-magnetic coupling between two conductor formations. In a resolver these conductor formations are coils of wire wound on suitable iron cores, and in its simplest form two windings are arranged to

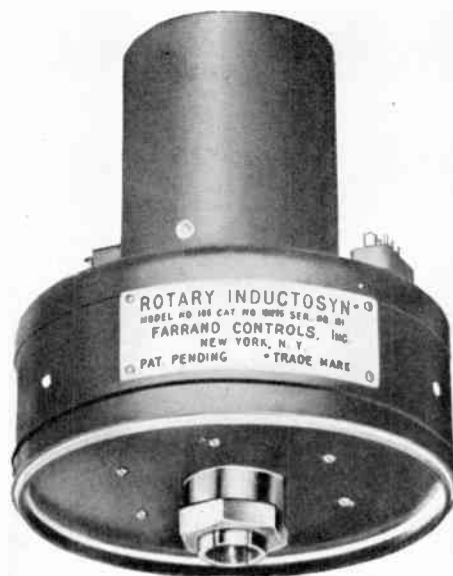

Fig. 1. Rotary Inductosyn.

\* Manuscript received 16th April 1956. (Paper No. 406.)

† The Plessey Company Limited, Roke Manor Electronic Research Establishment, Romsey, Hants. U.D.C. No. 621.314.2:621-52.

be in space quadrature, normally called the stator, whilst a third winding capable of rotation in the magnetic fields of the stator windings, is called the rotor (Fig. 2(a)).

Alternating voltages are applied to the two quadrature windings such that the magnitude is in proportion to  $\sin \theta$  for one and to  $\cos \theta$  for the other. An output is obtained from the rotor until it is turned to an angle  $\theta$  deg. from its reference when there is a null voltage, continued rotation produces an output voltage but now of opposite phase until it is turned through an angle  $(\theta + 180^\circ)$  when another null is obtained. Consequently in a rotation

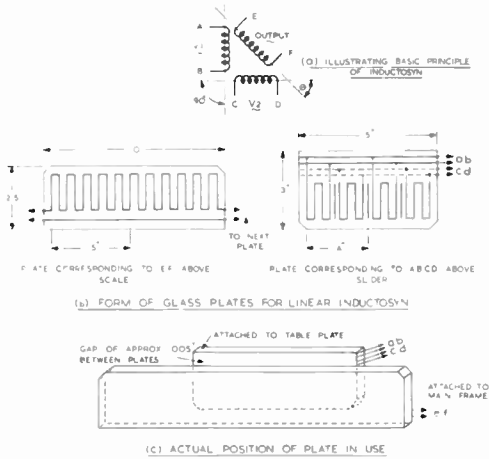

Fig. 2. Diagrammatic representation of the Linear Inductosyn.

of 360 deg. two nulls occur and the resolver is said to be a two pole resolver. There is then a uniquely defined angular position of the shaft for every  $\sin \theta$  and  $\cos \theta$  ratio of voltages applied to the quadrature windings.

In the Rotary Inductosyn the conductors are formed by printing hairpin type windings on circular glass plates, the two stator windings being printed on one plate and the rotor winding being printed on another plate (Fig. 3). They are arranged to be in line axially and the magnetic coupling between the plates is through a small air-gap. Large numbers of poles are provided and in the case where there are 180 poles then a rotation of 4 deg. corresponds to a rotation of 360 deg. of the simple two-pole resolver. This therefore performs the same function as a simple resolver which has been geared up 90 to 1. Any number of poles may be provided and when used as a digital/analogue converter and binary numbers are used then it is convenient to use 128 poles

resulting in 64 cycles per revolution, but for decimal notation then 100 or 200 poles would be more suitable.

Because of the low magnetic coupling between rotor and stator the frequency of the excitation voltage is normally made about 10 kc/s. Having a large number of poles all virtually in parallel helps to increase the coupling as well as to reduce any random errors which may be present. It should be pointed out that the masters used to reproduce the elements have been made up using optical measuring techniques and permit the high accuracy claimed to be realized.

There are many uses to which this rotary form may be put, for example, an electronic servo-controlled dividing head, an electronic gear ratio free from backlash, precision theodolite, etc. For machine tool use the Rotary Inductosyn would be mounted on the lead-screw and whilst the angular position of this lead-screw would be defined accurately the linear position of the machine table would be dependent on the accuracy of the lead-screw. It was to overcome this drawback that a Linear Inductosyn was developed.

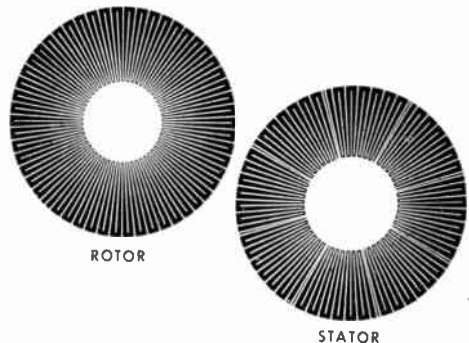

Fig. 3. Rotary Inductosyn rotor and stator windings.

### 1.2. The Linear Inductosyn (Fig. 4)

A scale corresponding to the rotor of the rotary form consists of a single hairpin winding printed on a glass block approximately 10 in. long by 2½ in. wide and ⅜ in. thick. The slider, analogous to the stator of the rotary form, has two space phase windings printed on a glass block approximately 5 in. long by 3 in. wide and ⅜ in. thick. Fig. 2 shows the Inductosyn diagrammatically.

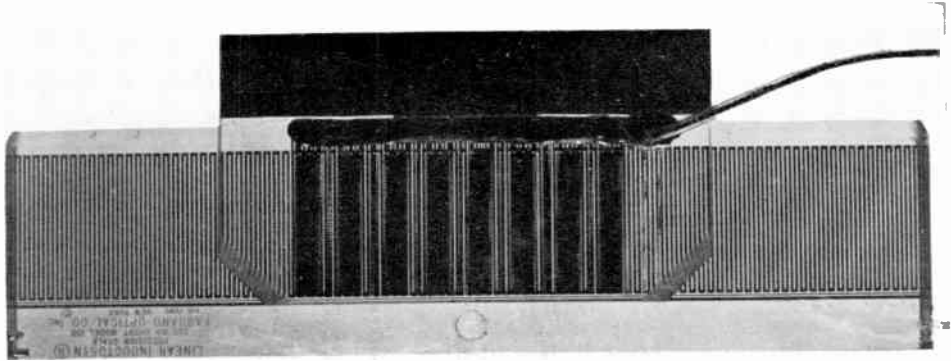

Fig. 4 (above).  
Linear Inductosyn.

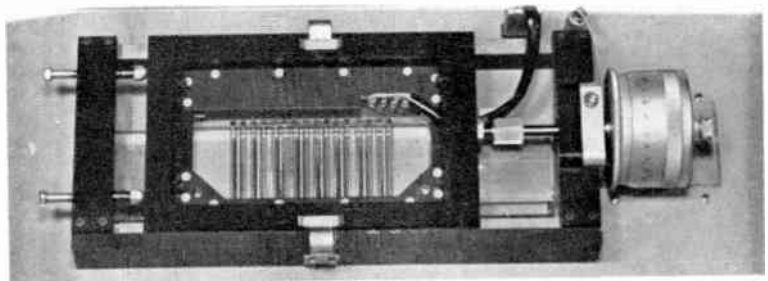

Fig. 5 (right).  
Linear Inductosyn mounting.

Glass is used as the scale and slider material as it is stable and readily available; it is also relatively easy to secure metallic patterns firmly to its surface. When high accuracies are sought temperature effects must be considered and a glass with a similar co-efficient of expansion to that of steel is available, the actual difference being only 1.1 microinch per °F. Fig. 6 shows the effects of operating a set of three scales at 80°F., i.e. 12° above standardization temperature. Ruling of the masters used in the printing process has been accomplished using an extremely accurate dividing engine, capable of ruling 14,000 lines to the inch. Pole spacing represents one twentieth in. and this dimension represents the 180 deg. of the simple resolver. There are 32 pairs of poles and the outputs from all pairs are parallel so that any random errors in spacing are minimized. It is possible to control the positioning of the Inductosyn to an angle of one milliradian which gives the linear form an accuracy of approximately 16 microin. In use it is often required to control movements greater than can be accommodated by one scale, and several scales may be placed end to end connected electrically in series. As the

output signal is dependent on the averaging of a large number of poles there is no discontinuity at the gap between adjacent scales.

GLASS SCALES STANDARDIZED AT 68 F  
MOUNTED ACCURATELY EVERY 10" ON STEEL  
AND OPERATED AT 80 F  
ADDITIONAL ERROR DUE TO GLASS SCALE  
EXPANSION

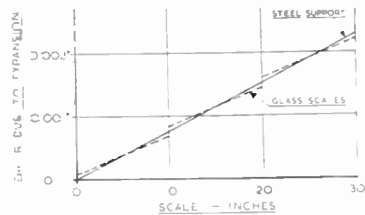

Fig. 6. Expansion of steel and glass plate.

When the machine tool to be controlled comprises a work table moving linearly past a fixed part of the machine it is convenient to affix the scales to the table and the slider to the fixed part (Fig. 5). The air-gap between scale and slider is not critical but obviously the closer they are the greater is the coupling. A spacing of 0.005 in. is recommended and this should be maintained over the whole length of travel.

2. Digital to Analogue Conversion

2.1. Resolvers

The shaft position of a resolver can be uniquely defined by impressing an alternating voltage  $V_1$  on one winding proportional to  $\sin \theta$  and an alternating voltage  $V_2$  on the quadrature winding proportional to  $\cos \theta$ , when its shaft position will be at angle  $\theta$  deg. Such a representation of position may be used with the Linear Inductosyn. The 360 deg. now represent

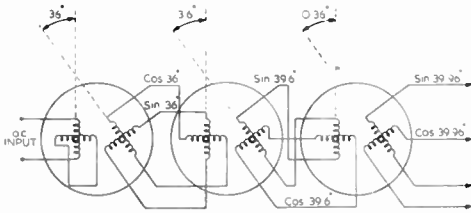

Fig. 7. Resolver digital/analogue converter.

0.1 in. linear travel and this may be divided into 1,000 parts, i.e. each 0.36 deg. being equivalent to one ten thousandth of an inch. Resolvers can be used to divide the 360 deg. into a thousand parts in decade form; this is shown in Fig. 7, where the first resolver divides the 360° into ten parts of 36°, the second divides 36° into ten parts of 3.6° and the final resolver divides 3.6° into ten parts of 0.36°. Voltages  $V_1$  and  $V_2$  appearing at the outputs are then the trigonometric additions of the three decaded angles. The accuracy of this method is dependent on the resolver accuracy and in the mechanical accuracy of setting the shaft angles correctly. These inaccuracies may be overcome by using tapped transformers and selecting the tappings by switches.

Resolvers may be used conveniently to provide vernier control and for obtaining a zero offset, these applications are shown in Fig. 8.

2.2. Transformers

Figure 9 shows the arrangement for 3 digit representation in decimal form. Voltages are added trigonometrically and are impressed on the slider of the Inductosyn as  $V_1 = \sin \theta$  and  $V_2 = \cos \theta$ ,

The addition conforms to:

$$V_1 \equiv \sin(a + b + c) = \sin c (\cos a \cos b - \sin a \sin b) + \cos c (\sin a \cos b + \cos a \sin b) \dots \dots (1)$$

$$V_2 \equiv \cos(a + b + c) = \cos c (\cos a \cos b - \sin a \sin b) - \sin c (\sin a \cos b + \cos a \sin b) \dots \dots (2)$$

In (1) and considering the decimal number 111 where each unit is 0.36°, each ten is 3.6° and each hundred is 36°, then assuming 1 volt is equivalent to  $\sin 90^\circ$  or  $\cos 0^\circ$

$$V_1 \equiv \sin(36 + 3.6 + 0.36) = 0.6413 \text{ volts}$$

$$V_2 \equiv \cos(36 + 3.6 + 0.36) = 0.7665 \text{ volts.}$$

For very small angles the sine is equal to the angle and the cosine remains very nearly unity, consequently for the least significant figure the sine transformer may comprise nine equal windings and the cosine transformer does not require to be tapped.

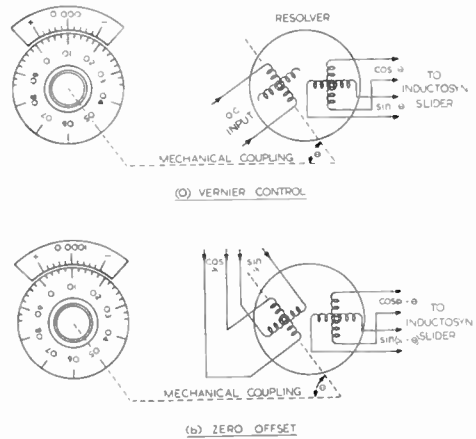

Fig. 8. Resolver control (a) vernier; (b) zero off-set.

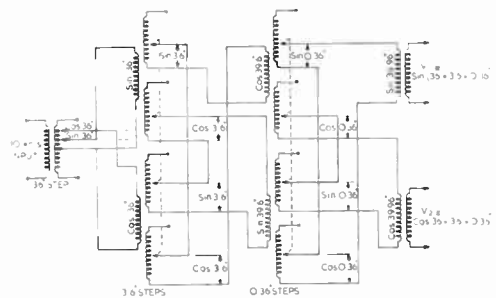

Fig. 9. Transformer digital/analogue converter using sin/cos transformers.



When the dimension is such that the represented angle exceeds 90 deg. then a centre-tapped transformer must be used in order to cater for the changing sign of the sine and cosine functions in all four quadrants: this is shown in Figs. 9 and 10.

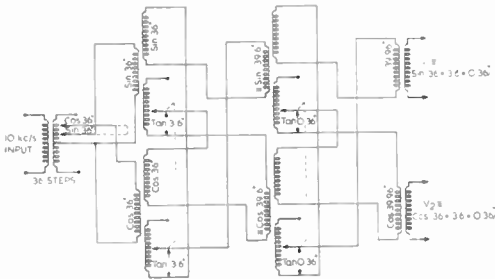

Fig. 10. Transformer digital/analogue converter using sin/cos/tan transformers.

As the inputs to the Inductosyn slider are required to be in the ratio of the sine and cosine of the represented angle a further practical simplification can be made.

The addition conforms to:—

$$V_1 \equiv \sin(a+b) = \sin a \cos b - \cos a \sin b \dots(3)$$

$$V_2 \equiv \cos(a+b) = \cos a \cos b - \sin a \sin b \dots(4)$$

then by dividing (3) and (4) by  $\cos b$  the ratios remain the same and the following results:

$$V_1 \equiv \sin a + \cos a \tan b \dots\dots\dots(5)$$

$$V_2 \equiv \cos a - \sin a \tan b \dots\dots\dots(6)$$

This then necessitates only one secondary winding of the transformers to be tapped per transformer and only two switch banks are required per decade to effect the tap changing.

Table 1  
Voltage Ratio Measurement

FUNCTION	VOLTAGE RATIO LIMITS	MEASURED RATIO TRANSFORMER		
		1	2	3
$\sin 72^\circ = 0.95106$	0.95194 0.25015	0.9515	0.9515	0.952
$\cos 36^\circ = 0.80902$	0.80730 0.81072	0.8095	0.8098	0.8092
$\sin 36^\circ = 0.58778$	0.59014 0.58544	0.5880	0.5889	0.5878
$\cos 72^\circ = 0.30902$	0.30625 0.31178	0.3094	0.3106	0.3064
$-\cos 72^\circ = 0.30902$	0.31178 0.30625	0.3085	0.3090	0.3057
$-\sin 36^\circ = 0.58778$	0.58544 0.59014	0.5869	0.5869	0.5892
$-\cos 36^\circ = 0.80902$	0.81072 0.80730	0.8087	0.8087	0.8050
$-\sin 72^\circ = 0.95106$	0.95015 0.95194	0.9511	0.9511	0.950

It is this simplified method of conversion from digital to analogue form which has been adopted and is shown in Figs. 10 and 11.

Construction of the transformers may take many forms but single "C" cores using 0.004 in. strip would seem well suited enabling ease of manufacture of the multi-tapped windings. Care must be taken to maintain the correct number of turns although some tolerance is allowable. Table 1 sets out these tolerances and indicates the measured values of some samples of a typical sine and cosine transformer.

### 3. Application of the Inductosyn

A description of the various units required to be connected to form a system for position control in one axis follows. It is visualized that the position of a machine tool table is to be controlled and hence the Linear Inductosyn would be employed. However, similar units would be required to operate an angular system employing the Rotary Inductosyn.

Figure 18 shows how these units are connected to give control in two axes for a co-ordinate table; provision for automatic input of the co-ordinate data is also shown.

#### 3.1. Digital/Analogue Conversion

Initially the digital information must be converted into information suitable for feeding the Inductosyn element. As stated previously a trigonometric voltage analogue is used and a unit comprising transformers and switches accomplishes this conversion. The same method can conveniently be used for feeding a resolver which acts as the coarse position element and provision is made to overlap the least significant figure of the resolver with the most significant figure of the Inductosyn (Fig. 11).

Whilst the resolver may be fed direct from the transformers a matching unit must be employed to couple the transformers to the Inductosyn.

#### 3.2. Coupling Digital/Analogue Transformers to Inductosyn

Two voltages, whose ratio is that of the sine and cosine of the represented angle form the output from the transformers. For any given

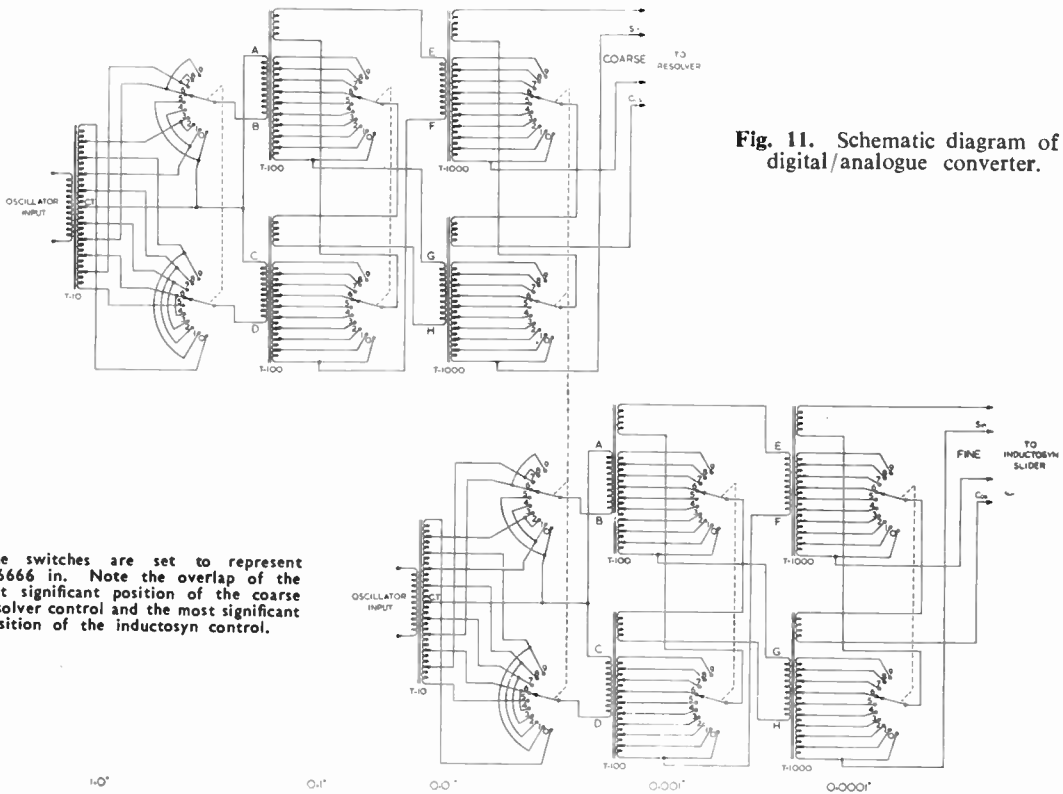

Fig. 11. Schematic diagram of digital/analog converter.

The switches are set to represent 6.6666 in. Note the overlap of the last significant position of the coarse resolver control and the most significant position of the inductosyn control.

setting of the switches the tapping points of the sine and cosine outputs are not similar, consequently any loading on the transformers due to the Inductosyn must be minimized in order that the ratio of outputs remains correct. Since the voltage output from the transformers is about 1 volt for representing  $\sin 90^\circ$  or  $\cos 0^\circ$  and the optimum voltage input to the Inductosyn winding under these conditions is required to be approximately 100 mV, and as the output impedance of the transformer is approximately 600 ohms whilst the impedance of the slider winding is approximately 0.5 ohms, a matching unit is required having a voltage ratio of 10 to 1 and an impedance ratio of 1200 to 1. Two of these units are required per axis, one for the sine winding and one for the cosine winding, with the important consideration that the final ratio of outputs be exactly that set up in the transformers. A negative feedback amplifier fulfils these requirements satisfactorily (Fig. 12).

### 3.3. Inductosyn Element

The voltage output from the scale is dependent upon its position from the electrical null of the slider. For a movement of 0.0001 in. from the null the voltage output is in the order of 6 microvolts r.m.s.

As the inductance of the scale and slider are only a few microhenries the impedance is mainly resistive at 10 kc/s therefore the output from the scale lags the input to the slider by almost 90 deg.

### 3.4. Error Amplifier

Amplification of the 10 kc/s signal from the scale has to be carried out to a suitable level to enable its phase and amplitude to be detected. This level is dependent upon the type of detector employed but in general it is required to be of the order of a few volts for a positional error of the scale and slider of 0.0001 in.

Amplitude stability of the error amplifier is

not a serious problem as the whole system is a null seeking device, ability to provide low noise at null is by far the most important requirement as the ultimate resolution of the system is dependent upon the discrimination between 10 kc/s signal and noise.

Owing to the very low impedance of the scale a large amount of amplification may be obtained in the input transformer itself and a factor of 1000 to 1 may be realized. For consideration of noise the input stage should be tuned to a narrow pass-band around the signal frequency. A cascode amplifier is used in the input stage and further amplification is followed by a cathode follower feeding the primary winding of the phase detector transformer.

### 3.5. Coarse/Fine System

Ambiguity of position occurs every 0.1 in. travel between the scale and slider of the Linear Inductosyn, so for measurements greater than 0.1 in. a coarse positioning device must be used. It has been stated that a resolver would seem best suited for this application.

The resolver can be geared to the table and made to represent any desired length, the limit being set by the usable resolution of the resolver, that is, the resolution must be somewhat greater than the distance between nulls of the fine control. Using the Inductosyn this sets the overall resolution of the coarse control, including gear train and electrical error, to be about 0.02 in.

It is convenient to gear the resolver so that one complete revolution represents ten inches of table motion. The sine/cosine supply can then take exactly the same form as that supplied to the Inductosyn (Fig. 11). Resolvers may be obtained to work at 10 kc/s or greater but those designed for use at 400 c/s have been found eminently suitable.

Further resolvers may be geared to extend the range of table movement still further, e.g. 1 revolution to represent 1000 in. giving a coarse/medium/fine system.

The input to the phase detector must come from the most significant resolver until the table is moved to within the range of the fine control. An electronic switch is used to accomplish this and it is inserted between the error amplifier

and the phase detector. The most significant signal is used to bias off the least significant signal until some pre-determined take-over point is reached.

### 3.6. Phase Detector

This may take one of many forms but ultimately the output is a signal suitable for feeding the servo amplifier, the polarity being determined by the relative phases of the signal and reference voltages, and its magnitude determined by the amplitude of the signal input.

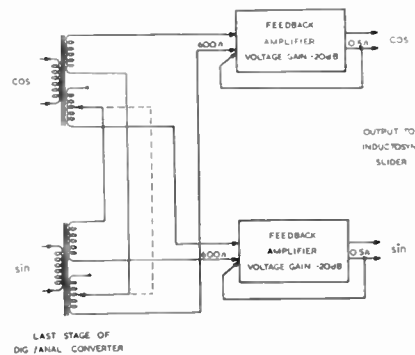

Fig. 12. Coupling digital/analog transformers to Inductosyn.

Dependent on the type of servo amplifier employed its input may require to be a d.c. voltage or a 50 c/s voltage. In the former case the d.c. signal can be obtained direct from the detector and in the later case the d.c. signal must be used to produce a 50 c/s signal the amplitude and phase of which is determined by the magnitude and polarity of the d.c. signal from the detector (Fig. 13).

### 3.7. 10 kc/s Oscillator

The supply to the Inductosyn is nominally 10 kc/s, the actual frequency being of no real significance except that it should give good mutual coupling between scale and slider and be low enough to use without undue screening of cables, components, etc. Frequency stability should be good, in the order of 0.5 per cent. and the harmonic content should be low. These requirements are required due to the tuning of the error amplifier and the addition of the sine/cosine magnetic fields in the scale, and may be met by a resistance capacitance oscillator fed from a stabilized h.t. supply.

Two 10 kc/s outputs per axis are required, one providing the input to the digital/analogue converter, the other providing the reference voltage for the phase detector. Provision must be made to enable the relative phase of these two outputs to be adjusted to cater for the phase change of signal input as mentioned earlier.

3.8. Servo System

The size of the machine to be controlled and the speed of setting the table determines the power requirements of the servo system. Electronic servos are perhaps best suited for powers up to a few kilowatts but for moving large masses quickly a hydraulic servo has much to offer.

Considering the electronic servo the power amplification of the error signal may be performed in several ways and those may be classified as follows:

(1) A.C. Valve Amplifier: Under normal industrial conditions this would be required to work at 50 c/s and for low powers of up to about 100 watts a reliable and efficient unit can be achieved. It would feed a 50 c/s two-phase motor and the range of these motors is rather

limited and confined mainly to low power machines up to about 100 watts.

(2) D.C. Valve Amplifier: Large powers are obtainable using d.c. amplifiers and they are used to control split field d.c. motors. Large stabilized power supplies are required and problems of drift have to be overcome.

(3) Magnetic Amplifiers: Magnetic amplifiers are probably the most reliable types being completely static and again large power outputs are obtainable. Where only 50 c/s excitation is available the ultimate size is usually considerable. Difficulties are also encountered due to time lag in response to the control signal but for a purely positioning device this may not be important.

(4) Rotary Magnetic Amplifier: Magnetic amplifiers of the amplidyne type may be controlled by very small d.c. signals, in the order of a few milliwatts for each 100 watts controlled. The overall size is somewhat smaller than the equivalent static magnetic amplifier. Again split field d.c. motors are controlled and for powers greater than 100 watts, this type of amplifier is well suited.

Whatever type of servo system is employed it would be controlled by the error signal

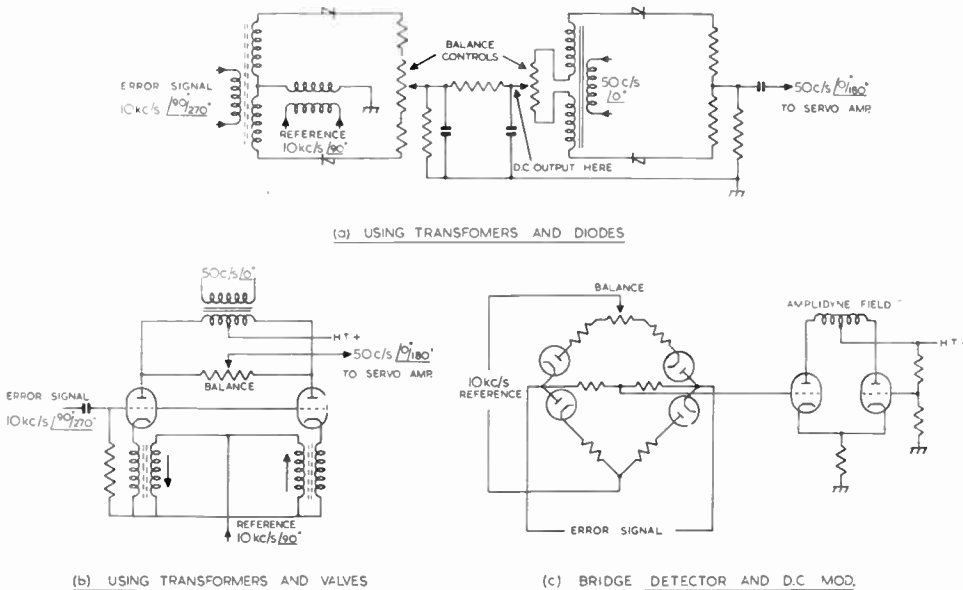

Fig. 13. Typical phase detector and modulator circuits.

appearing at the phase detector. In order to stabilize the overall response of the system and to prevent undesirable overshoot and subsequent hunting it is expedient to provide negative feedback. A tachogenerator coupled to the motor can be used to provide a feedback voltage which is proportional to the angular velocity of the generator and hence proportional to the velocity of the machine table, this feedback signal may be introduced into the system in series with the error signal at the input to the servo amplifier.

**4. Programmed Co-ordinate Table using the Linear Inductosyn as the Measuring Element**

**4.1. Desirability**

There are many instances where the machining of frequent short-run production quantities are involved, and usually it is not economic to have expensive jigs made nor is it economic to have each work piece "hand made" for this type of production.

in co-ordinate form, as explained later, so that the table can be moved along its x and y axes in order to position the casting correctly. It is desirable to set the whole of this data into the machine so that the entire drilling operations can be performed in sequence, and this may be accomplished using punched cards for the intermediate storage of the data. Provision for manual input of the data is also required to enable initial setting up operations and for the "one-off" job.

Thus the accuracy of expensive jigs is retained whilst giving economic flexibility in being able to cater for any positioning job capable of being accommodated on the table.

**4.2. Input Medium**

The co-ordinate data required to be set into the machine comprises two five-digit dimensions, i.e. ten digits per hole centre. Standard business accounting cards are divided lengthwise into eighty columns, each of which provides twelve possible punching positions.

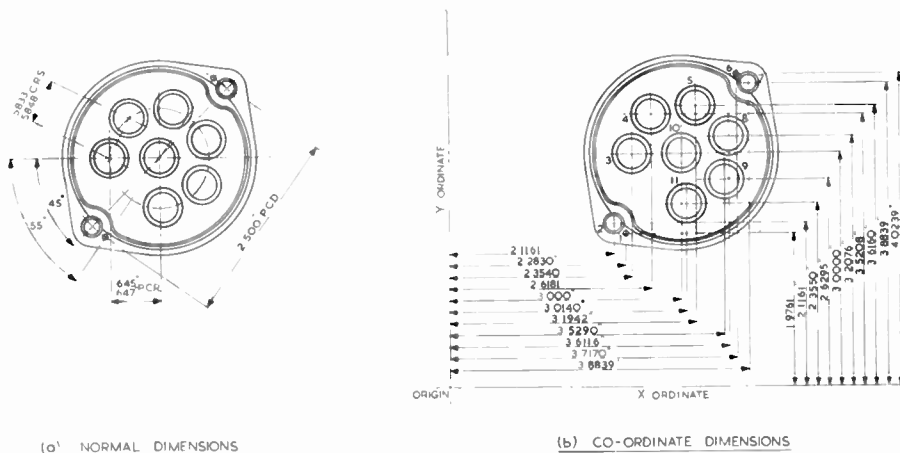

Fig. 14. Actuator gear-box.

A typical problem concerns the manufacture of actuator gearboxes used in the aircraft and allied industries (Fig. 14 (a)); this problem is used to illustrate the use of a programme-controlled co-ordinate table where the requirement is that of accurately positioning the centres of holes numbers 1 to 11 to within  $\pm 0.0002$  in. of the dimensions stated.

Definition of the hole positions must be given

Ten of these cater for the digits 0 to 9 and one other is reserved to indicate the last group of data in any one job. Each card can therefore accommodate all the relevant data for locating eight hole centres. Fig. 15 (b) shows two cards containing all the data for the eleven holes required in the gearbox casting; note the hole at the head of the final column indicating "job finished."



TITLE ACTUATOR GEARBOX			USED ON CZ 55495	ISSUE No	1							No. Z 55519/P
CARD PREPARATION TABLE				CHANGE NOTE No	110 55							
				A.S. OR MOD No								
				APPROVED FOR DTD								

CARD No 1				CARD No 2			
POS'N No	'X' ORDINATE	'Y' ORDINATE	HOLE DATA	POS'N No	'X' ORDINATE	'Y' ORDINATE	HOLE DATA
1	2 2830	1 9761		9	3 5290	2 6295	
2	2 1161	2 1161		10	3 0000	3 0000	
3	2 3540	3 0000		11	3 0140	2 3550	
4	2 6181	3 5208					
5	3 1942	3 6160					
6	3 7170	4 0239					
7	3 8839	3 8839					
8	3 6116	3 2076					

MATERIAL	ALUMINIUM ALLOY
DRILL SIZE	CENTRE DRILL W 5 2
DRILL SPEED	3000 RPM
RATE OF FEED	6" / MIN
LUBRICANT	PARAFFIN

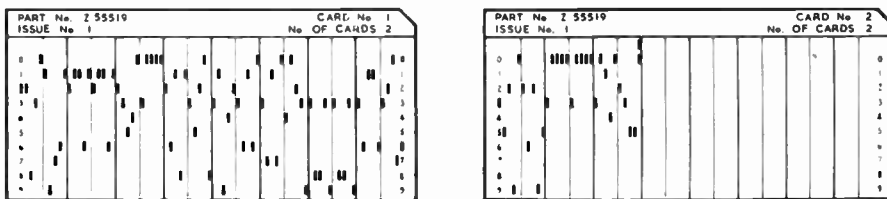

Fig. 15. Card preparation.

Some of the advantages in using punched card control for this type of work are:—

- (1) Card readers are widely available in various reliable forms, the reader used in the programme control unit comprises a standard "Hollerith" card sensing and transport mechanism.
- (2) Desirable ancillary equipment such as card verifiers and reproducers are standard items and often already available in an engineering organization.
- (3) Simple visual checking is possible.
- (4) Cards are readily stored enabling easy selection of any one programme from a large collection of programmes.
- (5) Speed of operation is already much higher than actual machining times.

4.3. *Switching Components*

It has been pointed out that it is desirable to cater for automatic input and manual input of the co-ordinate data. The sequence of the setting operation is shown in Fig. 16 (a) and by using selector switches that can be set manually or automatically a considerable reduction in the size of the digital/analogue converter can be achieved (Fig. 16 (b)).

Actual switch requirements in the converter described in Sect. 2.2 are for 2-pole 10-position switches for  $X_1, X_2, X_4, X_5$  and  $Y_1, Y_2, Y_4, Y_3$ , and 4-pole 10-position switches for  $X_3$  and  $Y_3$ . Switch positions are also required to enable the contents of the converter to be displayed and further positions are required for control and checking purposes.

Eight level double-ended Post Office type 2 uniselectors form efficient and reliable switches and it is possible to set them other than by the card reader, as described in Sect. 4.5.2. Two or four levels as necessary are used for the transformer switching, one level being wired to the display panel and three levels used for control and checking circuits. The converter contains ten uniselectors, i.e. five for each axis and two further uniselectors are used for controlling the converter when the data input is from the punched card. (See Fig. 21 (b).)

4.4. *Co-ordinate Table*

The size of the gearboxes considered enables them to be readily mounted on a small co-ordinate table. Such a table measuring 10 in. by 8 in. has been used and modified for automatic control of its position in the  $x$  and  $y$  ordinates (Fig. 17).

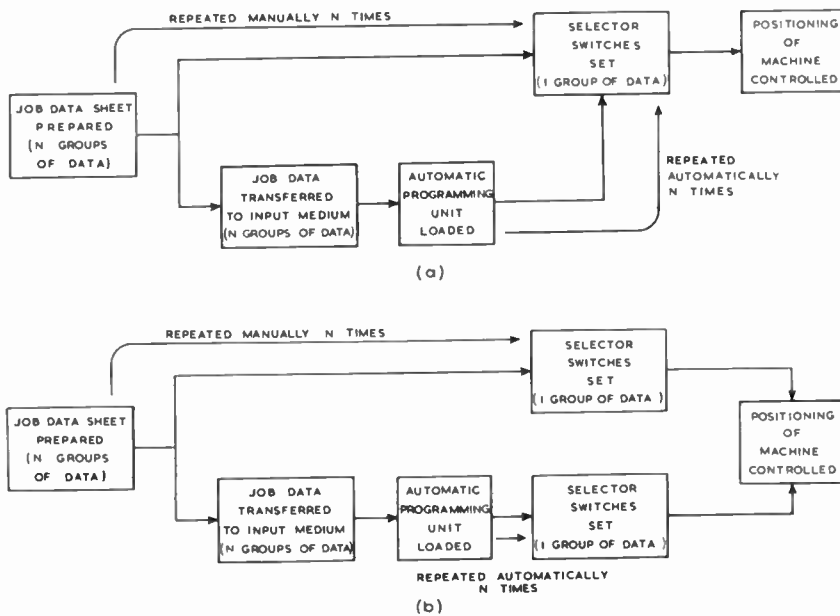

Fig. 16. Data sequence.

In using such a table the power requirements are kept sensibly low and it can be accommodated on a variety of machine tools.

Figure 18 shows the overall block schematic for the complete system using the Linear Inductosyn as the measuring element.

4.5. Operation

The first stage in the operation is that of transcribing the normal workshop drawing into one in co-ordinate form (Figs. 14 (a) and (b)) where the origin is chosen so that all the ordinates are positive and the hole positions are then numbered in an order such that the total distance between consecutive positions is minimized. A card preparation table is then made from this drawing showing the co-ordinate information together with other relevant data such as size and type of tool, drill speed, lubricant, rate and depth of feed. From this table the positioning data is punched on the card or cards, and the data is then in a suitable form to be read into the machine. Normally the operator would receive a copy of the card preparation table and the associated cards, as this enables a visual check to be made on each position set up and informs the operator of the other relevant machining data.

4.5.1. Automatic data input

After the cards have been loaded into the card feed hopper and the power to the machine has been switched on, operation of the INITIATE DATA INPUT push-button first checks that the selector switches are in their dormant position and then, assuming this check is satisfactory, causes the first card to be transferred to the column 1 reading station. After a check is made that the card

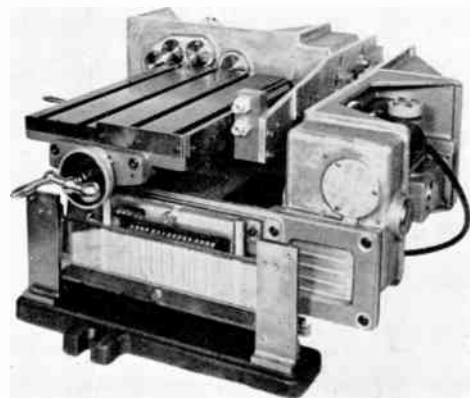

Fig. 17. Co-ordinate table.

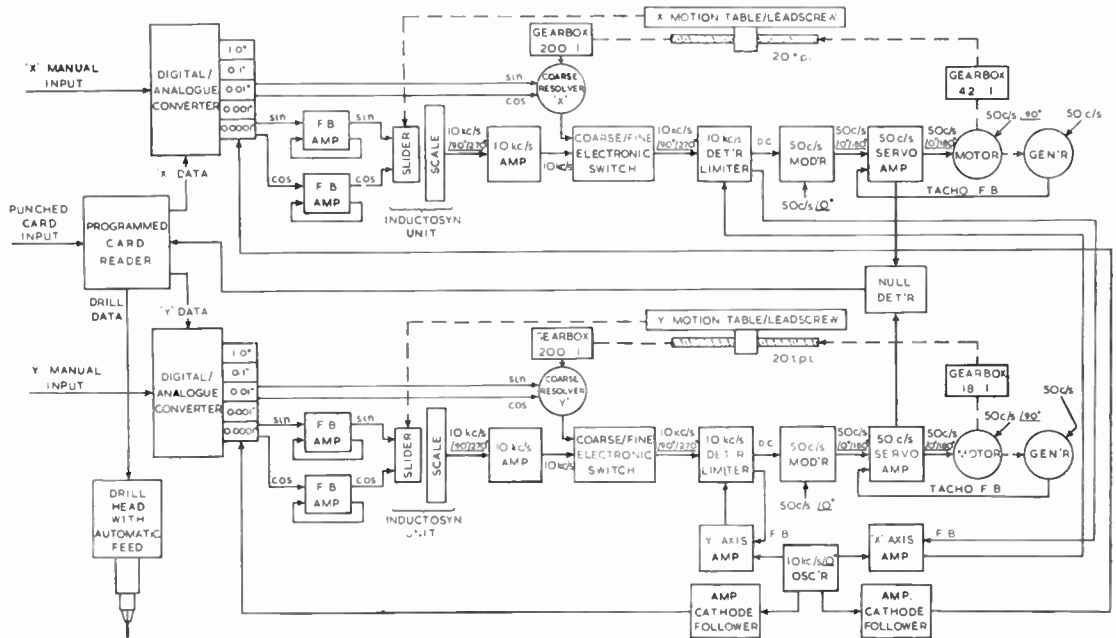

Fig. 18. Block diagram for programmed input co-ordinate table using the Linear Inductosyn.

has been fed correctly the most significant  $X_1$  position uniselector is then stepped to rest on the position indicated by the digit punched in column 1. At the end of this cycle the card is shifted to column 2 and  $X_2$  uniselector is stepped to rest on the digit punched in column 2. The cycle is repeated until all the uniselectors  $X_1$  to  $X_5$  have been set according to the digits punched in columns 1 to 10 respectively.

A further check is made to ensure that all the selector switches have been stepped to a valid position and if this is satisfactory power is fed to the servo motors to enable the table to move to its first position. When the table has reached this position the output from the null detector monitoring the error signal is used to disconnect power to the servo, to initiate the machining operation and to clear the selector switches to their dormant position. As soon as this occurs the previous events are repeated according to the digits in columns 11-20 and

when the machining operation is finished power is again applied to the table so that it takes up its second position. These processes are repeated until the "job complete" punching is

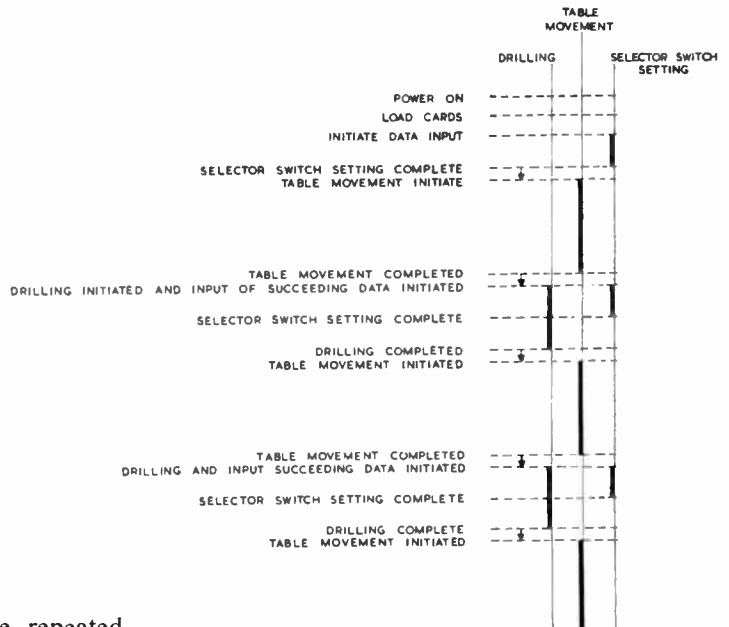

Fig. 19. Sequence chart for fully automatic control.

detected, the last machining operation takes place and the card is ejected.

Figure 19 shows the sequence of events diagrammatically.

#### 4.5.2. Manual data input

All the selector switches are wired to a display unit where the positions of the switches are shown at any instant. Manual control of the machine uses this display unit together with ten "digit push-buttons" each of which is associated with one selector switch. Depression of any one of these push-buttons causes stepping pulses to be applied to its particular switch. Thus to set in the co-ordinates manually, each push button is depressed in turn until the required digit is displayed. Operation of the INITIATE DATA INPUT push-button supplies power to the table allowing it to move to the defined position. Output from the null detector now operates a signal lamp to indicate that the table has come to rest and that the machining operation can take place, when this operation is complete the lamp goes out signalling that the

second position can be set on the selector switches. These processes are repeated as necessary for the completion of the job.

#### 4.5.3. Operating using alternative drill units

Although the word drill is used it is meant to convey all types of vertical boring machines, and it has been assumed that this unit has a power feed capable of being automatically initiated. In the interests of greater flexibility in the use of the programmed co-ordinate table, the drilling control has been arranged to cater for other types of drill units such as:—

(1) Power feed but manually initiated when required. This is useful during initial setting up of depth of feed.

(2) Simple manual feed.

Figure 20 shows the sequence of operation for the possible combinations.

#### 4.6. Construction and Layout

The complete equipment comprises a modified co-ordinate table (Fig. 17) connected

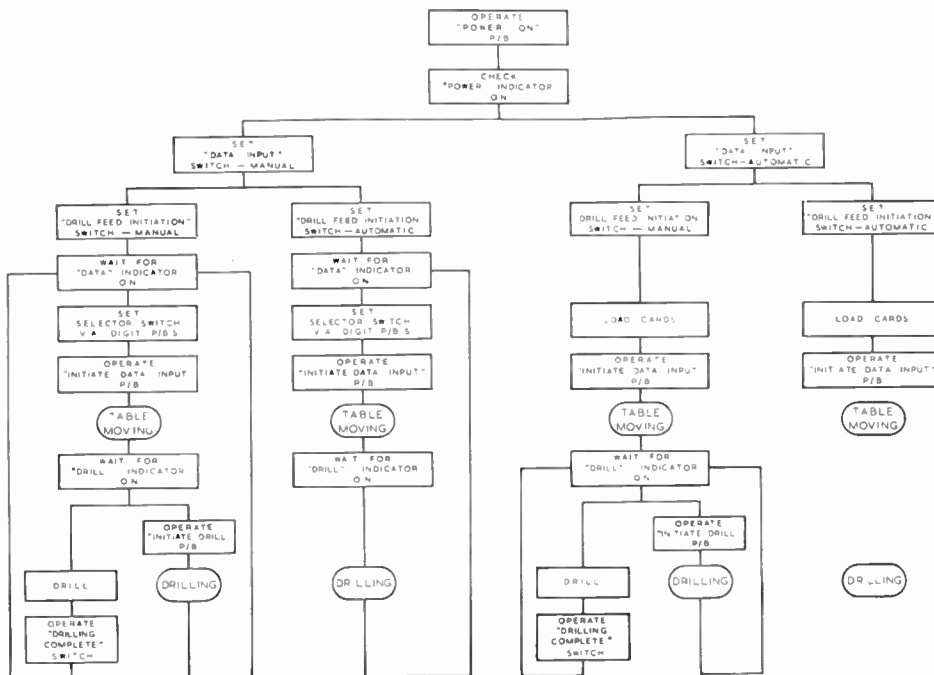

Fig. 20. Operating sequence.

via a multi-way cable to the Programme Control Unit (Fig. 21).

#### 4.6.1. Co-ordinate table

As already stated the work table measures 8 in. by 10 in., and it is carried in a vee slide by a 20 turns per inch lead-screw. A similar vee slide assembly, but at right angles to the top slide, carries this top slide, and again motion is effected by a 20 t.p.i. lead-screw. The bottom slide is contained in the base which may be bolted to any suitable machine tool table. Provision is made for mounting the following components on each axis of the table:—

- (1) The Inductosyn element, mounted so that the slider moves parallel to the scale and the direction of motion.
- (2) A coarse position resolver geared to the lead-screw by a 200 to 1 reduction gear. This ratio together with the 20 turns/in. of the lead-screw enables 10 in. of linear motion to be represented by one complete revolution of the resolver.
- (3) A servo-motor geared to the lead-screw by a reduction of 18 to 1 on the top slide. On the bottom slide this ratio is increased to 42 to 1 as this slide carries not only the weight of the work piece but also that of the whole top slide assembly. Motor generators are used to supply a velocity feedback voltage.

All gearing from the motor to the lead-screw to the resolver is contained in one gear-box for each axis. These gear-boxes are mounted at one end of both the top and bottom slides so that direct coupling to the lead-screws may be obtained. The calibrated hand wheels at the other end of the lead-screws are retained. The servo-motors and resolvers are mounted on the gear-boxes direct whilst the Inductosyns are carried on arms cast integrally with the gear-boxes.

#### 4.6.2. Programme control unit

Mounted on the top of the desk are the card transport and sensing mechanisms, and the control panel, whilst the complete control equipment is housed in the base.

Three sub-panels make up the control panel, one sub-panel has all the control switches and indicator lamps, the other sub-panels are both identical, one for the  $x$  axis and one for the  $y$

axis, comprising five vertical columns of lamps indicating the ten digits 0 to 9, and one push-button for each row. Every defined co-ordinate is displayed on these sub-panels whether it be set automatically by the card reader or manually by the push-buttons.

A knee-hole is provided in the desk giving a right hand, a left hand and a rear centre compartment. By sub-dividing the control equipment each of these compartments is used for a particular section; in the right-hand side is contained the programme unit which includes the uniselectors and digital/analogue transformers, the left-hand side contains the electronic section mounted in sub-unit rack form and the power supplies are contained in the rear centre compartment.

To assist in servicing and maintenance of the equipment the components in each of these compartments are readily accessible. A multi-range meter is built into the power supplies to enable spot checks to be made on all supply lines as well as to enable balance conditions to be set in the detector modulator circuits when setting up. Valve types have been kept to a minimum, CV 455's (12AT7) forming the largest group, CV 2136's (6BW6) are used for the power output valves of the servo amplifiers and the power unit utilizes a CV 2523 (6AS7G) as the series regulator and a CV 449 (QS83/3) as the reference valve. All rectifiers used are selenium types.

### 4.7. Summary of Performance

#### 4.7.1. Co-ordinate table

- (1)  $x$  and  $y$  co-ordinates may be specified up to 9.999 in. and 7.9999 in. respectively, and positioned to an accuracy of  $\pm 0.0002$  in.
- (2) Movement in the two axes is  $7\frac{1}{2}$  in. per minute for the top slide and 3 in. per minute for the bottom slide. As the total movements envisaged are small the time taken for the table to move from one specified co-ordinate to the next is not great.
- (3) An area of approximately 24 in. by 18 in. is required to allow full operation of the table, and thus it may be accommodated on a variety of machine tools.

#### 4.7.2. Programme control unit

- (1) On automatic data input, the machine will programme for jobs requiring any number



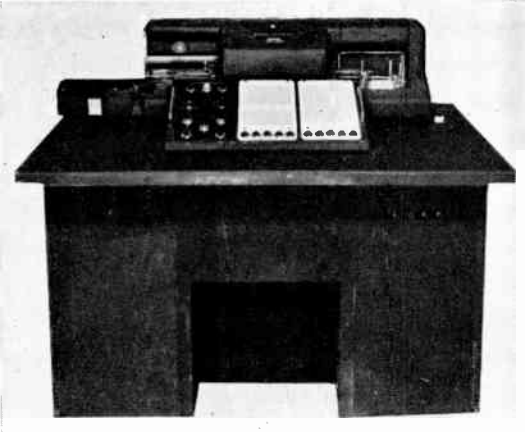

Fig. 21. Programme Control Unit.



of positions to be defined up to a total of approximately 1,500 without any intermediate operator control.

- (2) The alternative of manual data input is provided, the operating requirements having been simplified as far as possible to reduce operator fatigue.
- (3) The reading-in and setting-up time of the programme unit on automatic data input is of the order of 4 seconds for each position. For all positions except the first this is carried out coincidentally with the drilling operation so that for the majority of cases where drilling takes more than 4 seconds the effective reading-in and setting-up time tends to zero.

- (4) Any length of time may be specified for the machining operation so that all cutting speeds and feeds may be accommodated.

### 5. Acknowledgments

The authors wish to acknowledge the work carried out by the Farrand Optical Co. Inc., New York, U.S.A., in developing the Inductosyn, and the help and advice of the Company's President, Mr. C. L. Farrand, on the application of the Linear Inductosyn.

Finally we wish to thank the Directors of the Plessey Company Limited, for permission to present this paper.

## APPLICANTS FOR ELECTION AND TRANSFER

As a result of the June meeting the Membership Committee recommended the following elections and transfers to the Council.

In accordance with a resolution of Council and in the absence of any objections, the election or transfer of the candidates to the class indicated will be confirmed fourteen days after the date of circulation of this list. Any objections or communications concerning these elections should be addressed to the General Secretary for submission to the Council.

### Direct Election to Full Member

BARLOW, Derek Heseltine, B.Sc. *London, S.W.15.*  
RITSON, Frederick James Utrick, M.Sc. *Hexham.*

### Direct Election to Associate Member

BROWN, Frank Spencer, B.Sc.(Eng.). *Newport, Mon.*  
CORNES, Sqdn. Ldr. Stanley William, R.A.F. *Marlow.*  
GREEN, Lieut. Cdr. George, R.N. *Cosham.*  
GRIFFITHS, John William Roger, B.Sc.(Hons.) *Bromsgrove.*  
HANNAFORD, Sqdn. Ldr. Albert William, R.A.F. *Kentley.*  
KIME, Frederick William. *Chelmsford.*  
SWIFT, John, B.Sc. *Lidcombe, New South Wales.*  
WORRALL, John. *Blackburn.*

### Transfer from Associate to Associate Member

BOONHAM, Sqdn. Ldr. Arthur, R.A.F. *Walton-on-Thames.*  
HENNESSEY, Gerard. *London, W.5.*  
MOON, Arthur Walter Letcher. *Grahamstown, South Africa.*  
WILKINSON, Sqdn. Ldr. William, R.A.F. *London, S.W.19.*

### Transfer from Graduate to Associate Member

CHANNON, Dennis Edward. *Eastcote.*  
CHEW, Kam Pok. *Muar, Malaya.*  
CHISHOLM, Kenneth Duncan Fraser. *Alsagar, Cheshire.*  
CLAYTON, Leonard. *Nairobi.*  
COLEMAN, William Frank, B.Sc.(Eng.). *Accra.*

FOSTER, Alan George Lindup. *London, W.14.*  
MCLAREN, Robert Ian. *Edinburgh.*  
ROBINSON, Geoffrey Spencer. *Farnborough, Hants.*  
SEARS, John. *Farnborough, Hants.*  
STUCKEY, John Bernard. *Hayes, Middlesex.*  
WARD, Cyril Walter. *Plymouth.*

### Transfer from Associate to Graduate

DEDMAN, William Leonard. *Arborfield.*  
GREEN, Lawrence Young. *East Barnet.*

### Direct Election to Graduate

HILFI, Armed Abdulrazak, D.L.C. *Kuwait.*  
DAS GUPTA, Probodh Chandra. *Berlin-Charlottenburg.*  
DIAMOND, Robert Lindsay. *Glasgow.*  
EATON, Arthur Rupert. *Hayes, Middlesex.*  
MORRIS, Ian Glynn. *Liverpool.*  
SATYANARAYANA, Madabhushi, M.Sc. *Kakinada.*

### Transfer from Student to Graduate

BASHYAM, R., B.Sc. *Tiruchirappalli.*  
KAPOOR, Mulk Raj. *Barrackpore.*  
MADAN, Amrit Lal. *Barrackpore.*  
MAIHOTRA, Bahri Jagmohanlal, B.Sc. *Amritsar.*  
MARTLEW, Allan. *Wigan.*  
NAMBIAR, Kunhi Kannan, B.Sc. *Knhangad.*  
SAUNDERS, Michael William. *North Cheam.*  
VASSILIOU, Miss Athena. *Athens.*

## STUDENTSHIP REGISTRATIONS

AHMAD, Habeeb. *Ramandgaon.*  
AHLUWALIA, Daljeet Singh, B.Sc. *New Delhi.*  
ALLAN, William. *Lochwinnoch Renfrewshire.*  
APPLEGATE, Brian. *Welwyn.*  
AWACHAT, Vaman Keshav, B.Sc. *Poona.*  
BEN-JEHUDA, Oriel. *Haiifa.*  
BHOWAL, Kamal Kantii. *Madras.*  
BLOOR, John Eric. *Kimberley, Notts.*  
COLLINS, Cyril Raymond. *Cyprus.*  
COUSINS, Ralph Walter. *Burlington, Ontario.*  
DAVIES, John Deric Gillett. *Llandoverly.*  
HARMS, Peter Leonard. *Slough.\**  
ILBURY, Gerald Wyndham. *Wembley.*  
KEMP, Paul Courtney. *Plymouth.*

KIRKUS, John Rodger. *Hornsea.*  
KOHLI, Suraj Parash. *Ambala.*  
KONIECZNY, Gustaw. *London, W.3.*  
KULTAR SINGH, B.Sc. *Dehra Dun.*  
LOBO, James Joseph, B.Sc. *Bombay.*  
MADAN MOHAN, Kallay, M.A., B.Sc. *Calcutta.*  
MAKKAR, Gurdial Singh. *New Delhi.*  
MARSHALL, William Northam. *Cirencester.*  
MISTRY, Adi Hormasji. *Bombay.*  
MOORJANI, Motiram Issarsing, B.Sc. *Bombay.*  
NICHOLAS, Peter Chaston. *Cambridge.*  
PARDASANI, Roche Ramchand. *Bombay.*  
PARKER, William Robert. *Ruislip Manor.*  
PULLAPERUMA, Don Gilman. *Mt. Lavinia, Ceylon.*

RAJARAM, Tukaram Rokade. *Jalahalli.*  
RAMADORAI, T. C., B.Sc. *Tiruchirappalli.*  
REES, Heath Watkin, B.Sc. *Pinner.\**  
RENGASWAMY, P. B.E. *Tiruchirappalli.*  
SADASIVAN, Veerabhadra Thanu, B.Sc. *Madurai.*  
SALZBERGER, Yesaia. *Bnei-Berak, Israel.*  
SAUNDERS, George Brian. *Coventry.*  
SAUNDERSON, John Joseph. *Melbourne.*  
SHAW, Alan Gordon. *Sheffield.*  
SHINGLES, Derek George. *Hadleigh.*  
SIVARAMAN, K. R., M.Sc. *Poona.*  
TERZOPOULOS, Christos. *Athens.*  
VAZIFDAR, Shiavax Jehangir, B.Sc. *London, W.10.*  
WASSENAAR, Dirk Jan. *Schaarsbergen, Holland.*  
ZEGEL, Melle. *Rigswijk, Holland.*

\* Reinstatement.

# BARIUM TITANATE AND ITS USE AS A MEMORY STORE \*

by

D. S. Campbell, B.Sc.†

*Read before the Institution in London on 22nd May 1957.*

*In the Chair: Dr. G. L. Hamburger.*

## SUMMARY

The use of barium titanate single crystals for memory matrices is considered. It is shown that the discrimination between read-out "one" and read-out "zero" on a matrix is reasonably high and that the response times and current flows involved compare reasonably with other types of store. However the lack of definite coercive field and heating effects limit the minimum access time of such a store to 10  $\mu$ sec. The energy dissipation per bit is shown to be slightly less than for a ferrite, and there will be a further energy gain over ferrite stores due to the low current flows involved. Transistor drive circuits can be used with such stores due to the low currents. The over-all size of a store is small and the maximum number of digits that can be stored is shown to be limited by the growing of suitable crystals.

## 1. Introduction

Ferroelectric memory stores are based on the existence of states of permanent polarization in certain crystals. The application of a voltage pulse in the same sense as the crystal polarization results in only a small current flow to the crystal, while the application of a pulse of sufficient amplitude in the opposite sense reverses the direction of the polarization and therefore is accompanied by a relatively large current flow to the crystal. Thus it is possible to detect the previous state of polarization. This behaviour is analagous to the reversal of magnetization in a magnetic material.<sup>1</sup> The rate at which the reversal takes place as a function of applied field, the accompanying conversion of electrical energy to heat, and the charge change on switching are the important parameters in considering the use of such crystals as stores. It is also essential in most practical applications that small pulses in the opposite sense to the polarization should not cause reversal. This implies that the relationship between the polarization ( $P$ ) and the

electric field ( $E$ ) shall take the form of a square hysteresis loop.

Of the known ferroelectrics, barium titanate has been the subject of most study and would appear to be the most practically suitable material.<sup>2</sup> Thin single crystals of sufficient area can be grown and suitably orientated. They do not contain water of crystallization and are not directly affected by humidity, though workers have reported a slight effect due to the surrounding atmosphere.<sup>3</sup> The material is tetragonal in structure between temperatures of approximately  $-5^{\circ}\text{C}$  and  $100^{\circ}\text{C}$ . The longer axis, "c" axis, is the optic axis and is parallel to the direction of spontaneous polarization. Above approximately  $100^{\circ}\text{C}$  the structure becomes cubic, the ferro-electric properties disappear and the permittivity falls off with temperature according to the Curie-Weiss law. The room temperature coercive field at 50 c/s is approximately 1 kV/cm and the saturation polarization 26 microcoulombs/cm<sup>2</sup>.

## 2. Method of Growth and Mounting

Single plate-like crystals of barium titanate can be grown from a flux of potassium fluoride by the method due to Remeika<sup>4</sup>; with pure raw materials, however, it is found that only

\* Manuscript received 15th May 1957. (Paper No. 407.)

† Plessey Co. Ltd., Research Labs., Caswell, Towcester, Northants.

U.D.C. No. 621.315.612.4:621.395.65:681.14.

approximately one-tenth the amount of iron he recommended is needed to obtain satisfactory

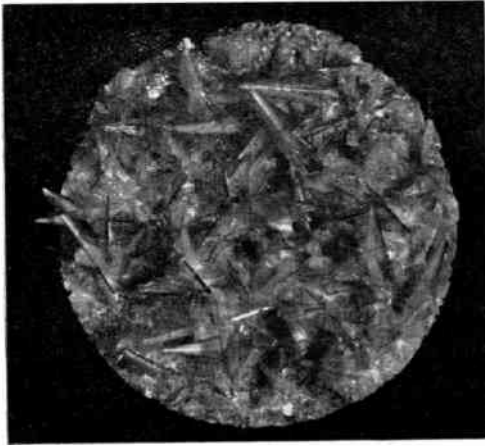

Fig. 1. Appearance of crystal melt showing "butterflies" on edge.

results. Fig. 1 shows the manner in which the crystals grow, as thin clear plates and joined in pairs forming "butterfly wings." The effect of the iron would seem to be that it limits the number of "butterfly wings" which start growing and hence allows only a few large plates to develop. Fig. 2 shows a single "butterfly." Such a pair can be split along the joining side forming two right-angled triangular plates, the hypotenuses of which can be up to 2 centimetres.

Before one can form a cell that can be used to investigate the switching properties of the material the crystal has to be etched to the

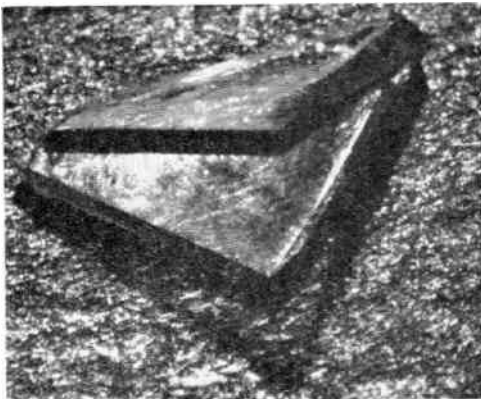

Fig. 2. Single "butterfly" ( $\times 13$ ).

required thickness. The plates grow with thicknesses varying from 0.4 mm downwards, and a useful thickness for a practicable operating voltage is around 0.1 mm. Crystals that are too thick can be etched down in hot ( $130^{\circ}\text{C}$ ) phosphoric acid using a platinum basket for holding the crystals. It is necessary to etch the crystals above the Curie point otherwise differential etching in the "c" and "a" directions is found to occur.

The crystals are found to be heavily twinned, containing laminae and wedges in which the "c" axes are parallel to the plate surface. As it is desired to orientate as much of the crystal as possible with the "c" axes perpendicular to the plate surface it is necessary to "polarize" the crystals. This can be done by placing the crystals on a metal plate, and immersing the plate in de-ionized water. The plate is then connected to one side of a 50 c/s source, and a carbon electrode in the form of a rod to the other. With 200–300 V across the system the carbon electrode is moved over the crystals, without actually touching them, using a stroking motion, for up to 5 seconds. With correctly placed illumination, it is possible to observe the mis-orientated sections of the crystals actually being moved out, until little, if any, twinning is left. Figs. 3 and 4 show crystals before and after "polarization" treatment.

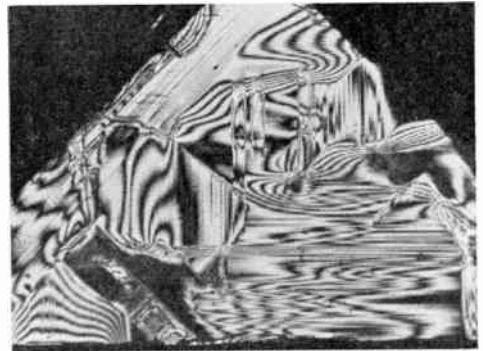

Fig. 3. Crystal before "polarization" treatment (monochromatic polarized light.  $\times 5$ ).

The largest crystals are usually found to be so irregular in surface structure and difficult to orientate that they are unsatisfactory. Accordingly there appears to be, with the



techniques at present in use, a limit to the size of usable crystals.

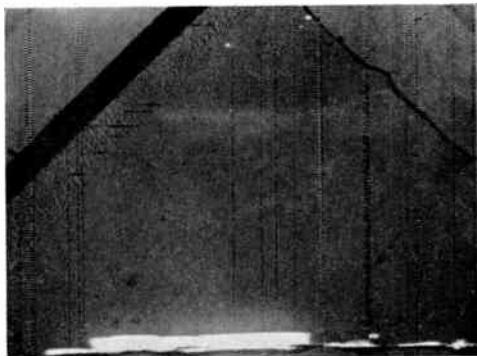

Fig. 4. Crystal after "polarization" treatment (monochromatic polarized light.  $\times 5$ ).

To investigate the switching properties a cell can be formed by evaporating on a clean crystal, a bar of silver or gold on one side and a perpendicular bar on the other. Such a simple cell is shown in Fig. 5. By extending the principle, a matrix of cells can be formed by evaporating more than one bar on each side and Fig. 6 shows such a crystal containing 100 cells. The bar widths and spaces on this unit are 0.3 mm which is approximately three times the crystal thickness, but units have been constructed with bar widths and spacings of 0.2 mm.

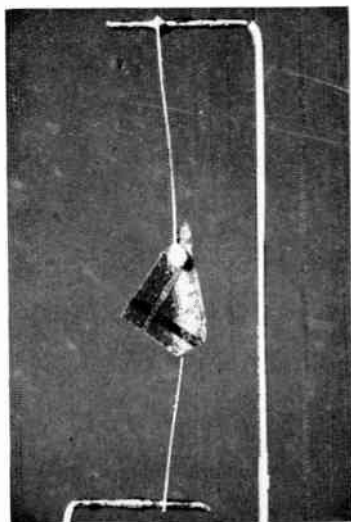

Fig. 5. Mounted crystal with single matrix element ( $\times 1.7$ ).

Because of the limiting size of crystal there will be a limit to the size of the matrix that can be obtained on any one cell. Units with bar widths and spacings the same as the crystal thickness (0.1 mm) are feasible, and this will allow of a  $32 \times 32$  matrix on a single crystal. This seems to be the practical limit at the moment.

### 3. Electrical Properties

For use as a storage device, the following properties are desirable:

- (1) The hysteresis loop shall be as rectangular as possible so that, amongst other things, the read-out "zero" signal shall be as small as possible.
- (2) The switching time and the current require-

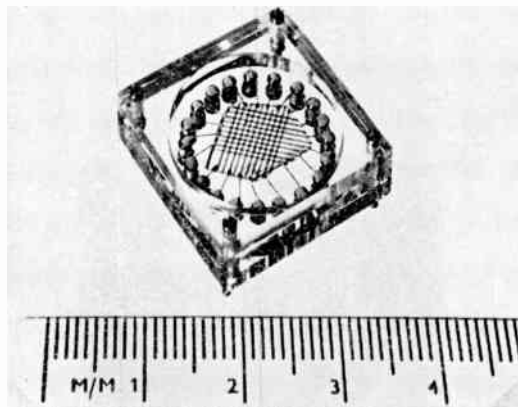

Fig. 6.  $10 \times 10$  matrix store on a single crystal.

ments shall be such that it can compare with existing storage systems.

- (3) The coercive field shall be small so that the power consumption of the material is relatively small.

It is proposed to deal with these three aspects in more detail.

#### 3.1. Hysteresis Loops

As has been mentioned above, the hysteresis loop of barium titanate is relatively rectangular; Fig. 7 shows such a loop taken using a 50 c/s alternating voltage on a specimen with wide electrodes (2 mm). In a matrix, the loops will be less rectangular due partially to clamping<sup>5</sup> (i.e. restriction of domain-wall movements by



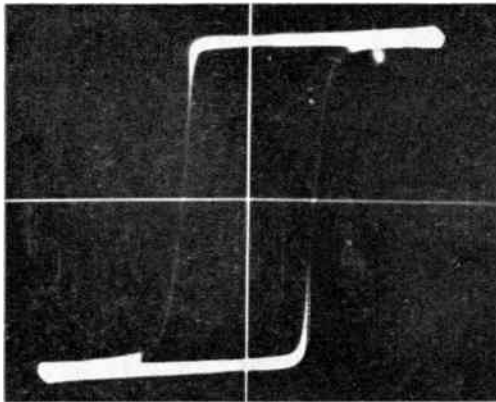

Fig. 7. Hysteresis loop of crystal with wide electrode bars (2 mm).

the fixed structure of neighbouring domains), and partially to the stray capacitance of the circuit being relatively large. However, quite satisfactory loops are obtained as are shown in Fig. 8, the nine loops corresponding to the nine cells of a 3x3 store (bar widths and spacing 0.2 mm).

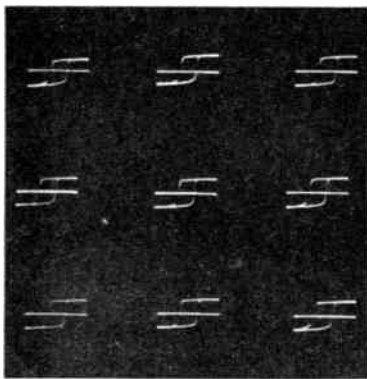

Fig. 8. Hysteresis loops of 3x3 matrix (0.2 mm bars).

The squareness ratio of a ferroelectric hysteresis loop can be defined as the ratio of the polarization (or displacement) at plus the complete field, i.e.

$$S.R. = \frac{P_{(-E/2)}}{P_{(+E)}} \dots\dots(1)$$

This ratio will vary with the maximum field considered, and Fig. 9 shows some typical curves obtained with normal samples that give hysteresis loops similar to those shown in Figs. 7 and 8. It can be seen that a maximum

value of 96 per cent. is obtained with crystals having large electrodes, but for a normal matrix element, the maximum is somewhat lower.

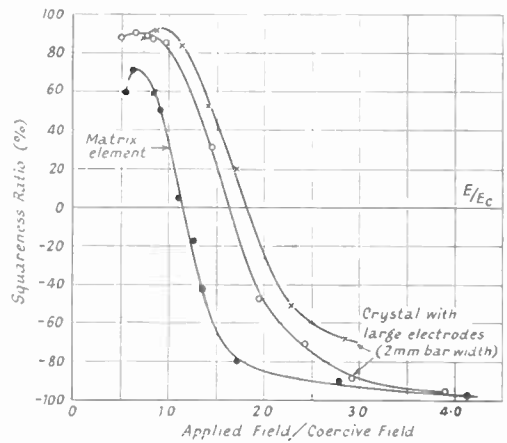

Fig. 9. Squareness ratio for various values of the ratio, applied field: coercive field (50 c/s). (Curves shown for different electrode widths.)

It should be noted that maximum rectangularity is only obtained with a crystal after it has been "exercised" by applying an alternating voltage for a few minutes. This phenomena is noticed as a squaring of the corners of the loop. It is presumably associated with the clamping effects of domains noted by Drougard and Young.<sup>5</sup> Domains having opposite orientations and lying adjacent to each other tend to be strained in opposite directions by a given half cycle of field and therefore to mutually clamp each other. On exercising, these small mutually clamping groups tend to get broken up, resulting in the squaring of the hysteresis loop. A similar effect is observed when a crystal is switched with a low field, and will be referred to later.

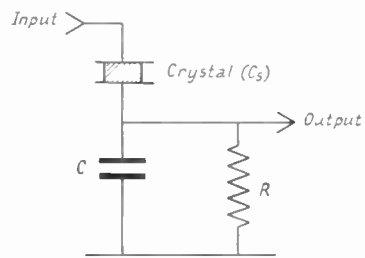

Fig. 10. Circuit for discrimination measurements.

Closely associated with the squareness ratio is the discrimination, i.e. the ratio of output pulse when the crystal is switched, to the output pulse when it is not switched. Discrimination is usually measured using the simple circuit shown in Fig. 10. The ferro-electric capacitor  $C_s$  is connected in series with the resistor  $R$  and the integrating capacitor  $C$ . The time-constant value of the series  $R$  and  $C$  must naturally be less than the maximum repetition rate that is expected in use. The discrimination obtained depends on the value of the stray capacitance, and with a crystal of large electrode area ( $9 \text{ mm}^2$ ) about 50:1 is possible. This is illustrated in Fig. 11; the input consists of two groups of pulses in a sequence, the first of two positive pulses and the second of a positive

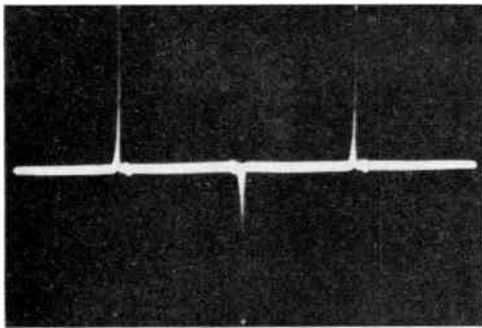

Fig. 11. Discrimination of read out "one" and read out "zero" for a wide electrode cell ( $2 \text{ mm}$  bar width). Input 3 positive, 1 negative pulse.

followed by a negative pulse. A single cell of more practical dimensions formed as illustrated in Fig. 6 ( $0.1 \text{ mm}^2$ ) will give a discrimination of 8:1. Fig. 12 shows the discrimination plotted against input pulse voltage for such a cell. Shown on the same curve is the voltage developed across the integrating capacitor and it can be seen that an output pulse of  $0.16 \text{ V}$  is possible. These figures shown are typical of the behaviour of a matrix element.

A more practical figure is that of the discrimination across a complete matrix. Measurements of smallest read-out "one" to largest read-out "zero" in matrices of 100 cells ( $10 \times 10$ ) have yielded values of 6.5:1.

### 3.2. Response Time Characteristics

The information on response time charac-

teristics of barium titanate is perhaps best considered separately for high fields and low fields.

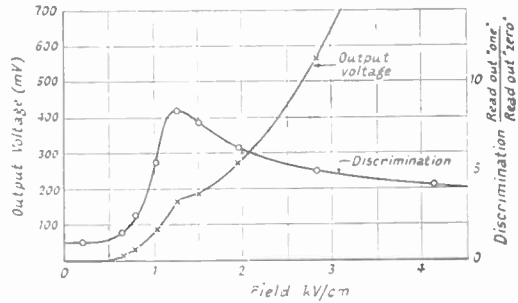

Fig. 12. Discrimination and voltage developed across output circuit for various pulse inputs. (Matrix element, bar width  $0.2 \text{ mm}$ ).

#### 3.2.1. High field response times

High field response times can be measured by eliminating the integrating capacitor of Fig. 10 and observing the current flow through the resistor  $R$ . In this connection,  $R$  should be as small as practicable (3-4 ohms) since, during switching, the instantaneous capacitance of the crystal will reach a high value, and  $R$  must be small so that, in spite of this, there is a very small voltage drop across  $R$ . The read-out current pulse will be as shown in Fig. 13,  $t_r$

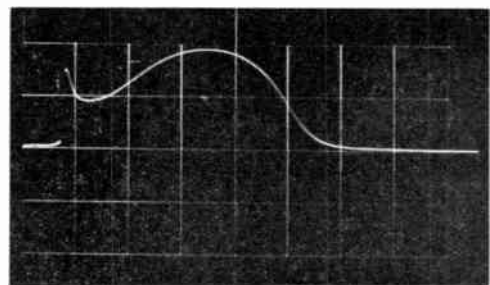

Fig. 13. Typical current response for high field switching (1 division =  $0.5 \mu\text{sec}$ ).

being the response time, and  $i_{\text{max}}$  the maximum current flow. Merz has published two of the most important papers<sup>6,7</sup> on this aspect of barium titanate. It is found that for large fields ( $>3 \text{ kV/cm}$ ) the response time,  $t_r$ , is inversely

proportional to the field and directly proportional to the crystal thickness. The maximum current is directly proportional to the field at large fields and also directly proportional to the electrode area.

From the figures given in Merz's papers and from our own work it is seen that it is possible for barium titanate to compare with existing materials in switching time and current requirements. Thus a pulse of 35 V (5 kV/cm) applied to a crystal 0.07 mm thick will give a response time of approximately 1.0  $\mu$ sec and a maximum current flow for a cell of the dimensions shown in Fig. 6 of approximately 50 mA. This latter figure will reduce to 5 mA if a bar width of 0.1 mm is used.

These high field characteristics are the criteria that one should examine when considering reading out information from a matrix store. Such information can be obtained by applying a correct polarity pulse to a particular column and observing the current flow to the individual rows simultaneously across a resistor and a capacitor (i.e. a parallel system of operation). With such a system only the cells in the pulsed column are affected and advantage can be taken of the short response time at high driving voltage.

Partial switching can be observed at high fields. At high fields it is possible to apply a positive pulse of such a length that the crystal is not completely switched. If so, any subsequent positive pulses will complete the switching, the total time taken for the crystal to switch remaining constant. This effect is illustrated in Fig. 14. Two positive pulses followed by a negative were applied to a crystal and the current response observed. The response when the first positive pulse was longer than the switching time is shown in Fig. 14 (a); the effect of the second pulse (read-out zero) was just observable. When the first pulse was shortened to a length of half the response time, the second pulse completed the switching. This is shown in Fig. 14 (b). It can be seen that the total response time remained constant.

More than two positive pulses have been used to complete the switching and the time interval between subsequent pulses has been made as long as 10 minutes. Thus it would appear that switching takes place progressively during any

time for which a field is applied.

### 3.2.2. Low field response times.

To read-in information to a matrix cell, voltage pulses are applied to the appropriate row and column so that only the selected cell receives sufficient voltage to switch it. Thus the maximum voltage that can be applied is limited since one of the pulses, by itself, must have little or no effect on the other cells of the row or column to which the pulse is applied. The read-in speed is thus limited.

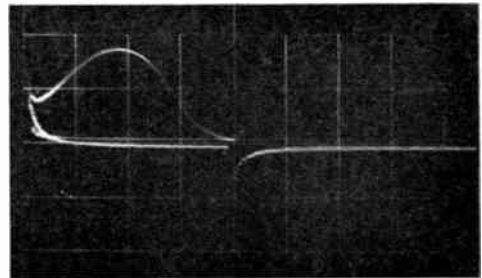

(a)

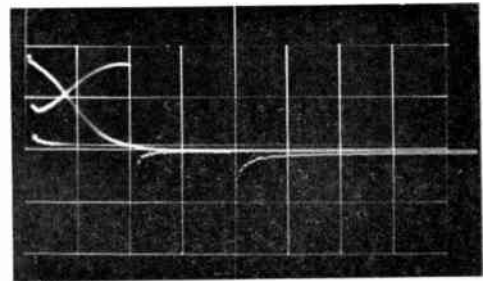

(b)

Fig. 14. (a) Current response showing effect of second positive pulse (1 division = 1  $\mu$ sec). (b) Current response showing effect of second positive pulse when first pulse too short (1 division = 1  $\mu$ sec).

The possibility of such a read-in system depends therefore on the existence of a definite coercive field. With single crystal barium titanate this is not the case, and it is possible to switch a crystal slowly at a field that is only a fraction of the coercive field as measured at 50 c/s. The possibility of this has already been noted by Merz<sup>6</sup> and can be expected from the fact that the coercive field measured from a 1 c/s loop is only about half of the coercive field measured from a 50 c/s loop.

Switching at low fields has been investigated by making use of the pyroelectric effect. It has

been shown by Chynoweth<sup>8</sup> that measurable pyroelectric currents can be produced in barium titanate by the alternative heating and cooling produced by a train of light pulses. Since there is a variation of polarization with temperature, the temperature rise of the crystal will cause the polarization to change and this change can be recorded as a current flow.

Now the pyroelectric current,  $i$ , per unit area of a crystal is given by

$$i = \frac{dP_s}{dt} = \frac{dP_s}{dT} \cdot \frac{dT}{dt} \quad \dots\dots\dots(2)$$

where  $P_s$  is the spontaneous polarization at a temperature  $T$ . Thus to obtain a measurable pyroelectric current:  $dT/dt$  must be made large.

A diagram of the apparatus is shown in Fig. 15. A light beam from a bulb fitted with an infra-red transmitting window was focused on a chopper so that the beam was interrupted 800 times per second synchronously with an 800 c/s amplifier. The chopped beam was then re-focused onto the crystal which had semi-transparent bar electrodes on its surface. The pyroelectric output was measured by the 800 c/s variable bandwidth amplifier and passed to a milliampere-recorder. In practice the bandwidth had to be narrow to reduce noise; the resulting loss in signal could be counteracted by slightly defocusing the beam on the chopper blade. Although  $dT/dt$  was reduced, more 800 c/s component was introduced into the pyroelectric current waveform.

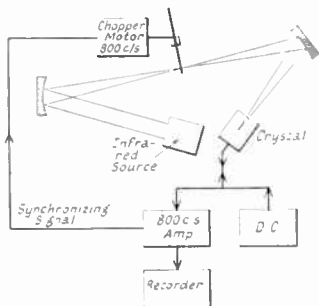

Fig. 15. Apparatus for pyroelectric measurements.

Using such an apparatus and applying low, steady voltages to a crystal, it was possible to observe the slow change of polarization with time. Fig. 16 shows some sample curves obtained on a crystal with a coercive voltage at

50 c/s of 20 V. It can be seen that not all the curves show complete switching; at very low voltages there appears to be a locking in of domains before the crystal switches completely. The 50 c/s hysteresis loop of a crystal in such a state will appear somewhat distorted when first examined and it will take several hundred cycles to return the crystals to normal.

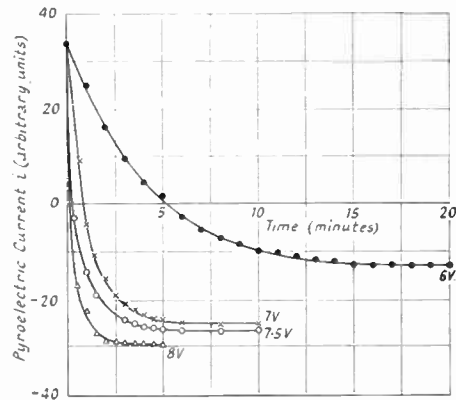
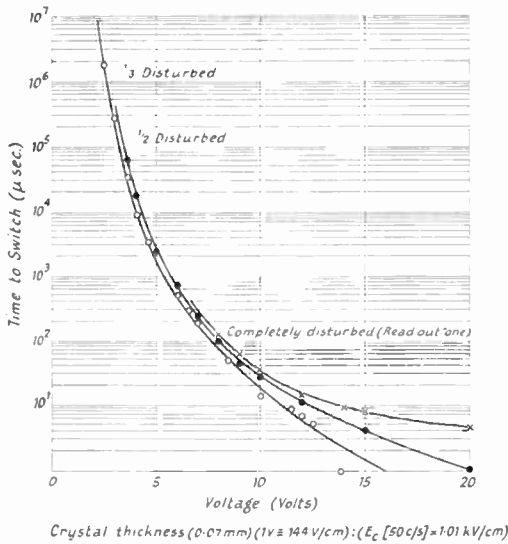

Fig. 16. Pyroelectric current/time curves for various d.c. bias voltages. ( $E_c$  [50 c/s]=30 V.).

Allowing for the incompleteness of switching in some cases it is found that the change of polarization is exponential with time. This behaviour has been confirmed by other workers.<sup>9</sup> Thus the current flow is exponential with time and contrasts with the current flow at high fields (Fig. 13). The change-over from one form to the other occurs smoothly as the switching field is lowered through a value corresponding approximately to the 50 c/s coercive field value.

Since it can be shown that the accumulative property of switching applies at low as well as high fields, it is important to examine the effect of the lack of definite coercive field on the use of barium titanate as a matrix store. Before this can be done, however, it is necessary to decide exactly what level of interaction can be tolerated. A practical criterion that has been adopted is that the maximum disturbance that can be tolerated in a stored "zero" is such that the read-out signal is one-third of the signal for a read-out "one." Using this criterion, a curve can be plotted of the total time of pulse that is

needed to disturb "zero" to the one-third level for various voltages. Other levels can be decided on, however, and Fig. 17 shows some sample values, taken on a matrix element of 0.1 mm<sup>2</sup> on a crystal 0.07 mm thick. The lower curve is for a disturbed "zero" of one third, the middle curve for a disturbed zero of one-half and the upper curve for complete switching. If the input pulse length is limited to the response time of the crystal and assuming that the row and column amplitude is one half of the total voltage needed to switch a cell, then for a given response time and hence voltage it is possible to calculate the number of half voltage pulses that will disturb a "zero" to the level selected.



**Fig. 17.** Time to switch so that "zero" disturbed to one-third for various voltages. (Crystal thickness 0.07 mm. E<sub>c</sub> [50 c/s] = 1.01 kV/cm.)

Figure 18 gives a plot of this number for varying response times: curve A is derived from the middle curve of Fig. 17 (1/2 level disturbance), curve B from the lower curve of Fig. 17 (1/3 level disturbance) and curve C from a similar plot to Fig. 17 on a thick (0.16 mm) crystal with a large electrode area (1 mm<sup>2</sup>).

The curves of Fig. 18 are thus representative of what can be expected from a barium titanate store. For an access time of 10 μsec (so that

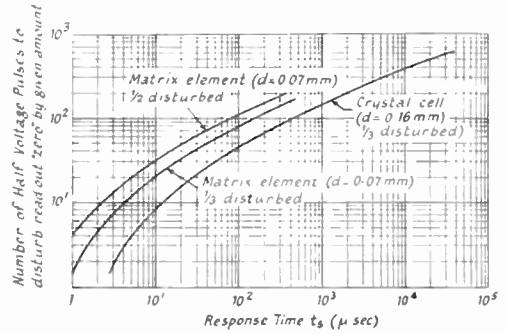

**Fig. 18.** Number of half voltage pulses to disturb "zero" by given amounts for various response times.

a maximum read-in time of 9 μsec can be allowed), it can be seen from curve B of Fig. 18 that approximately 20 disturbing pulses can be tolerated before regeneration becomes necessary. This figure can be improved considerably if a parallel read-in system is adopted and the input voltages are divided in some ratio other than half on a column and half on a row. Fig. 19 illustrates the situation on an elementary 3 × 3 store; the read-out is shown for comparison. For read-in the voltage is divided in some ratio between row and column; in Fig. 19, for example, 3V/4 is shown on a

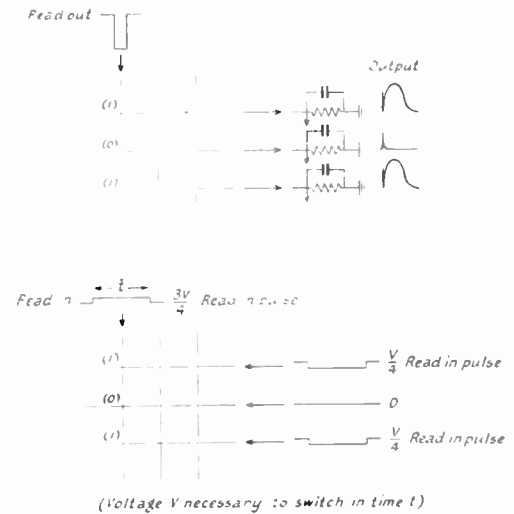

**Fig. 19.** Schematic diagram of read-out and read-in circuitry.

column and V/4 on a row. With a parallel read-in system, the "zero" cell shown will only



receive a voltage pulse of height  $3V/4$  once until the column is read out, all the other disturbance coming from  $V/4$  pulses for the other columns.

The improvement that results from such division is shown in Fig. 20 for a read-in speed of  $9 \mu\text{sec}$ . The number of row (lower voltage) pulses that can be allowed, subsequent to the column (higher voltage) pulse, for the various ratios of row to column voltage, is shown. It can be seen that it is possible for a "zero" to withstand over 500 interrogations if the voltages are divided in the ratio 3:1 before it is disturbed enough to give an output of one-third read-out "one."

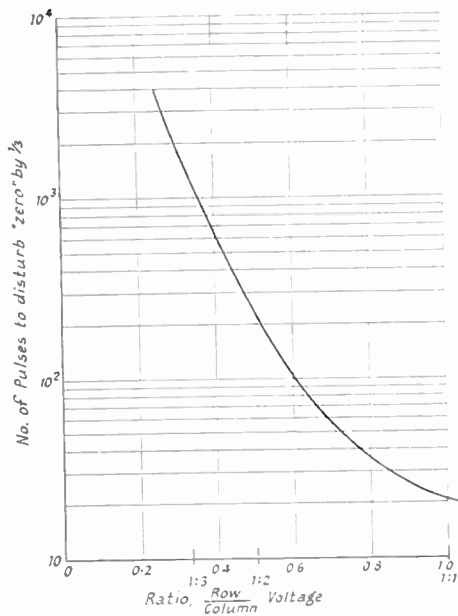

Fig. 20. Number of row pulses to disturb "zero" to  $\frac{1}{3}$  for various values of the ratio of row:column voltage ( $10 \mu\text{sec}$  access time).

For slower speed operation there is a considerable improvement on these figures. Thus for a read-in speed of  $100 \mu\text{sec}$ , a disturbed "zero" would just be produced by seventy pulses if divided in the ratio  $(\frac{V}{2} : \frac{V}{2})$  but it would need  $10^6$  pulses if divided in the ratio  $(\frac{3V}{4} : \frac{V}{4})$  as described above.

Thus it can be seen that the switching time

at read-in is limited so that, although fast read-out is possible, access times less than  $10 \mu\text{sec}$  are not practical. Such an access time implies the need for regeneration approximately every 500 interrogations. This figure could be further improved by the use of suitable gating.

### 3.3. The Coercive Field and Power Consumption

As noted above, there is a considerable change of coercive field with frequency, the coercive field increasing as the frequency as raised.<sup>10,11</sup> At a certain frequency however, heating effects begin to cause a reduction of coercive field due to temperature and this limits the increase due to frequency. The frequency of maximum coercive field can thus be taken as the point at which heating effects become noticeable and can be used as a guide to the maximum frequency at which the crystal can be

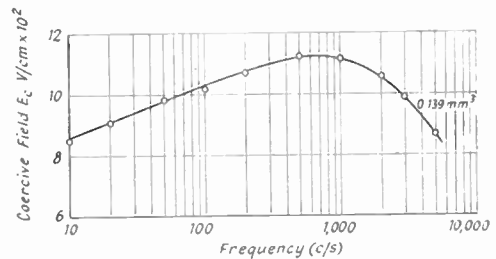

Fig. 21. Variation of coercive field with frequency (Crystal vol.  $0.14 \text{ mm}^3$ ).

operated. This maximum frequency will vary with the cell volume that is switched. Fig. 21 shows a typical coercive field/frequency curve for a volume of approximately  $0.14 \text{ mm}^3$  ( $0.1 \text{ mm}$  thick). Plotting a curve of maximum frequency for different cell volumes, the crystal thicknesses lying in the usable range,  $0.1-0.2 \text{ mm}$ , it is found that a volume of the size to be expected in a matrix cell will operate at  $100 \text{ kc/s}$  (Fig. 22).

The heating effect thus imposes a further limitation on the minimum access time that is possible. The time-constants for the heating effects are of the order of 5 seconds so that it is only the sequence rate that is of importance.<sup>11</sup> The actual positioning of the pulses within a sequence does not appear to affect the observed response, even when consecutive pulses are as close as  $2 \mu\text{sec}$  and the sequence

is repeated several million times.<sup>11</sup> (This is in contrast to references in the literature<sup>12,13</sup> to a failure of barium titanate crystals to give consistent response on prolonged pulsing, although in agreement with a recent statement by Anderson<sup>14</sup> that crystals can be prepared free from this limitation).

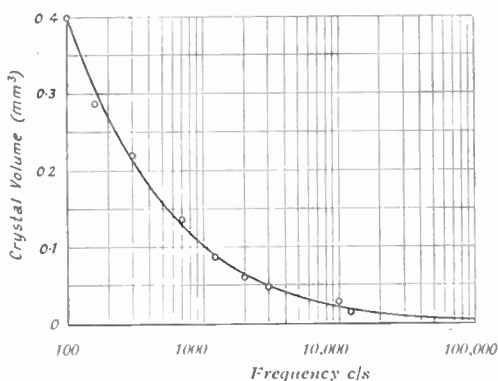

Fig. 22. Frequency at which heating effects become noticeable for various crystal volumes (Crystal thickness 0.1–0.2 mm).

It is of interest to compare the energy dissipated in barium titanate with that of a ferrite. The unit in a ferrite store is normally a toroid of 2 mm outside diameter ( $5 \times 10^{-3} \text{ cm}^3$  by volume). It is made of material such as Ferramic S1, which can be switched in  $1 \mu\text{sec}$  by a field of value twice its coercivity. The smallest practicable barium titanate unit is a 0.1 mm cube ( $10^{-6} \text{ cm}^3$ ) which can be switched in  $1 \mu\text{sec}$  by a field of five times the coercive field at 50 c/s. On this basis the barium titanate element requires half as much energy for switching as the ferrite.

For slower speeds of operation (5  $\mu\text{sec}$ ) titanate must be compared with a different ferrite, for example Ferramic S3, and again barium titanate uses approximately one half the energy.

In the case of a ferrite matrix, due to the relatively high maximum currents and fast rise-times, the lead inductances cause considerable reactive voltage drops whereas for barium titanate, operating on voltage and with small maximum currents the dissipation is much reduced. There will be some loss due to

charging up cells which are not switched, but this will be small, and the effect of cells in parallel with the switching (column) cells can be eliminated by earthing the unused columns.

#### 4. Conclusions

It has been shown that barium titanate single crystals can be used for memory matrices although they are essentially slower than ferrites. Limitations to speed are imposed by heating in the crystal and also by the amount of regeneration that is considered tolerable. Crystal matrices can be only used as two co-ordinate systems and are incapable of the versatility given by three or four co-ordinate systems which are possible with ferrite rings. In particular they are not easily adapted as switching matrices.

However, barium titanate stores are voltage operated devices requiring currents only of the order of milliamperes. Thus it is very simple to design transistor drive circuits using transistors that are at present commercially available. There is also a saving in power, both due to the material and due to the low current flows in the circuits. A further advantage is that less space is required for the store; a practical  $10 \times 10$  unit can be constructed in a square inch (Fig. 6) and using smaller pins and electrode bar widths (0.1 mm) a  $20 \times 20$  is possible. Limitations in the crystal sizes at present available make it very unlikely that a store larger than  $32 \times 32$  on one crystal will be commercially available without radical alteration of the crystal growing process.

#### 5. Acknowledgments

It is a pleasure for the author to thank Mr. P. Bickley for supplying the crystals and to thank Mr. R. Moffat and Mr. N. Owen for experimental and constructional help. The helpful discussions held with Mr. J. M. Herbert must also be gratefully acknowledged. The author is grateful to The Plessey Company for permission to publish this paper.

#### 6. References

1. A. von Hippel, M.I.T. Lab. for Insulation Research, Report No. 99, August 1955.
2. J. R. Anderson, "Ferroelectric storage elements for digital computers and switching systems," *Electrical Engineering*, 71, pp. 916-22, October 1952.

3. J. R. Anderson, G. W. Brady, W. J. Merz and J. P. Remeika, "Effects of ambient atmosphere on the stability of barium titanate," *J. Appl. Phys.*, **26**, pp. 1387-8, November 1955.
4. J. P. Remeika, "A method for growing barium titanate single crystals," Note in *J. Amer. Chem. Soc.*, **76**, pp. 940-1, February 1954.
5. M. E. Drougard and D. R. Young, "Domain clamping effect in barium titanate single crystals," *Phys. Rev.*, **94**, pp. 1561-4, June 15th 1954.
6. W. J. Merz, "Domain formation and domain wall motions in ferroelectric BaTiO<sub>3</sub> single crystals," *Phys. Rev.*, **95**, pp. 690-8, August 1st, 1954.
7. W. J. Merz, "Switching time in ferroelectric BaTiO<sub>3</sub> and its dependence on crystal thickness," *J. Appl. Phys.*, **27**, pp. 938-43, August 1956.
8. A. G. Chynoweth, "Dynamic method for measuring the pyroelectric effect with special reference to barium titanate," *J. Appl. Phys.*, **27**, pp. 78-84, January 1956.
9. D. Epstein, Report of the 1954 conference on Electrical Insulation (Division of Engineering and Industrial Research, National Academy of Sciences—National Research Council), p. 19.
10. H. H. Weider, "Activation Field and Coercivity of ferroelectric barium titanate," *J. Appl. Phys.*, **28**, pp. 367-9, March 1957.
11. D. S. Campbell, "Heating effects in single crystal barium titanate," *J. of Elec. and Control*, **3**, 1957 (to be published).
12. W. J. Merz and J. R. Anderson, "Ferroelectric storage devices," *Bell Lab. Record*, **33**, pp. 335-342, September 1955.
13. A. N. Holden, W. J. Merz, J. P. Remeika and R. T. Matthias, "Properties of guanidine aluminium sulphate hexahydrate and some of its isomorphs," *Phys. Rev.*, **101**, pp. 962-6, February 1st 1956.
14. J. R. Anderson, "A new type of ferroelectric shift register," *Trans. Inst. Radio Engrs (Electronic Computers Group)*, **EC-5**, No. 4, pp. 184-91, December 1956.

## of current interest . . .

### Summer School on Computer Programming

A Summer School in programme design for automatic digital computing machines will be held in Cambridge during September, 1957. It will be similar to those held in previous years and will take place in the University Mathematical Laboratory. Teaching will be by members of the Laboratory staff and others associated with the Laboratory.

The course is intended to provide basic training for those who are entering the field of computer programming. The subject will be treated throughout from the point of view of the user and, from an early stage, emphasis will be laid on practice in programme design and the actual running of simple programmes on a computer. For the sake of clarity, programming will be taught, during the early part of the course and throughout the practical classes, in terms of a machine in use in the Mathematical Laboratory.

### Mr. H. F. Smith

Personal references in the Institution's *Journal* are normally confined to items about members. It is however appropriate to record that Mr. H. F. Smith, Editor of *Wireless World* since 1941, retired on May 20th last after thirty-two years' service with this well-known journal.

Aged 65, Mr. Smith has been connected with radio for forty-six years, starting his career with the Marconi Co. at the age of nineteen. After serving with the Naval Reserve during World War I, he joined *Wireless World* in 1925 as a technical editorial assistant. He later became assistant Editor, and assumed editorial control sixteen years ago.

### New Element Discovered

A joint research effort by scientists from Sweden, Great Britain and the United States has led to the discovery of element 102. This is the first time this element, to be called nobelium, has been observed. The new element was produced by bombarding curium, which is element 96, with carbon ions accelerated in the 225 cm cyclotron at the Nobel Institute, Stockholm. Radioactive atoms were first observed and isolated on March 23rd.

In making nobelium, curium 244, itself an element produced artificially by irradiation, was deposited upon a thin foil and exposed to a stream of accelerated carbon ions generated by the cyclotron. The carbon ions included both carbon 13 and carbon 12 particles, of which carbon 13 particle absorption in the curium led to the formation of nobelium. This was collected on a separate foil placed near the target foil, along with other atoms produced and ejected by the interaction of the beam of particles and the target. The experiment required very close control of the energy of the incident beam of bombarding ions since the probability of observing the formation of the new element is critically dependent upon the number of neutrons lost in the reaction; the number of neutrons lost in the reaction is increased as the energy of the beam is increased beyond the lowest energy at which the reaction begins to occur.

The new element was identified among the products on the capture foil by radiochemical methods; the isotope identified had a half-life of about 10 minutes and emitted alpha particles with 8.5 MeV energy. The isotope probably has a mass of 253 but this has not yet been established with certainty.

### B.B.C.'s Television Station in North Scotland

The B.B.C.'s new television transmitting station at Rosemarkie near Inverness is now nearing completion and will be brought into service on August 16. It will transmit on Channel 2 (vision 51.75 Mc/s, sound 48.25 Mc/s) with horizontal polarization and maximum effective radiated power of 1.5 kW. By the summer of 1958 v.h.f. sound transmitters will also be installed at Rosemarkie.

The Rosemarkie station, which has a 350 ft aerial mast and is built on a commanding site some 680 ft above sea level overlooking the Moray Firth, will cover an area which includes most of the counties of Nairn and Morayshire (where it will link up with the service area of the station at Meldrum), a substantial portion of Inverness-shire, including the Royal Burgh of Inverness, and the eastern coastal areas of Ross and Cromarty and of Sutherland.

# AUTOMATIC COUNTING TECHNIQUES APPLIED TO COMPARISON MEASUREMENT\*

by

C. C. H. Washtell (Member)†

*A paper presented at the Convention on "Electronics in Automation" in Cambridge on 28th June 1957. In the Chair: Mr. E. E. Webster.*

## SUMMARY

**The paper discusses the repetitive counting of independent pulse sources which are required to be measured in ratio form, and for which the results are presented as a paper record. Examples in X-ray diffraction, tachometry and meter-testing are given to illustrate the technique.**

### 1. Introduction

The use of comparison methods in test and inspection procedure is an acknowledged technique. The application of counting to such methods, with the advantages of enhanced accuracy and the possibilities of automatic presentation, is now receiving considerable attention at the hands of instrument designers.

If a measurement is ultimately required in the form of a percentage or ratio of a standard or other reference, and the parameter to be examined can be translated into a number of pulses, then the use of a ratio counter provides a convenient approach to the solution of many problems.

The fundamental principle involved in making a comparison of two sources of pulses which, when counted, will portray a direct-reading of the ratio or percentage existing between the two independent channels, is to accumulate a "unit-count" in one of the channels to which the other is to be referred, and to use the time occupied in making the unit-count to examine the other source. In adopting this treatment, it does not matter whether the measurement of the reference pulse source and that of the source undergoing examination are measured simultaneously or separately after an interval of time. The principle remains the same, requiring the accumulation of a unit-count as a triggering

point in the former case and the time for a unit-count for the latter case.

### 2. Comparison Counting

We will consider first the method of simultaneous examination, as required for instance in X-ray diffraction measurements where the pulse distribution is random in time, and a unit-count method is employed. The unit-count number is chosen to be  $10^n$  where  $n$  is an integer. This most conveniently suits conventional decade counting systems which will thus display the unit-count as 100 per cent., i.e. figure 1 followed by  $n$  zeros. Therefore, if counting in both the reference and monitor channels is started at the same instant of time, and is also stopped simultaneously by a pulse coincident with the registration of the selected unit-count ( $10^{nth}$ ) in the reference channel, then it is plain that the count displayed in the monitoring channel, having been accumulated during precisely the same counting period, may be directly read as a percentage of that displayed in the reference channel.

Where it is required that the count-rate should also be known, a third counting channel is introduced. Into this channel may be fed a source of regular pulses whose frequency has been suitably chosen for sub-division as a time-count. If the input to this third channel is gated simultaneously with the previous operation, the count-rate may be easily deduced from the count-controlled time display. The addition of this channel also provides the means of obtaining a time-controlled count simul-

\* Manuscript received 11th May, 1957. (Paper No. 408.)

† Labgear (Cambridge) Ltd., Cambridge.  
U.D.C. No. 621.374.32.



taneously in the other two channels, where the count-rate in these two independent channels is required to be directly displayed. It should be noted, in passing, that the use of a unit-count as a gating pulse derived from the secondary channel enables a reciprocal result to be obtained.

In the case of separate examination of pulse sources, as may sometimes be required for repetitive measurements, the time-count method of triggering may be used. This method of measurement is particularly applicable under circumstances which do not demand that comparisons be made at the same interval in time (or where it is inadvisable due to deterioration of the standard, or just impossible) providing that the information translated into regularly spaced pulses has a common feature of derivation.

For this method, a unit-count run is carried out on the reference pulse source and the time taken for the run accurately measured. The time-count obtained is then used as a fixed gating-period for subsequent determination of the count-rate of the pulse sources to be examined. To memorize a time-count for use as a gating interval, it will be necessary to employ a selector type of counter incorporating coincidence circuits which may be subsequently set to the registered time-count number in order to furnish gating pulses at the appropriate time intervals when making future ratio measurements.

### 3. The Ratio Counter

The essential unit in such a scheme of instrumentation is a ratio counter of the type shown in Fig. 1 comprising a dekatron counting chain and three electronic gates (which are connected to operate in parallel) associated with one or more ancillary counters. Gate B controls the input pulse-drive to the ratio counter dekatron chain. This chain is normally employed as the reference count channel, and hence is equipped with a unit-count selector associated with the output cathodes of the dekatrons and the facilities for automatically operating the three control gates. The gates marked A and C control the input pulse drive to the additional dekatron counters required to measure the work under examination and/or count-time.

The three gates are identical, each using short suppressor cut-off type valves. They are operated with the control grids normally held at a cut-off potential, and are suitable for positive-going pulses having an input amplitude of 5 volts minimum peak, 5 to 150 microseconds duration. The band width of the gates is from 150 c/s to 5 Mc/s (-3 db), the anode circuits being inductance-compensated to achieve this.

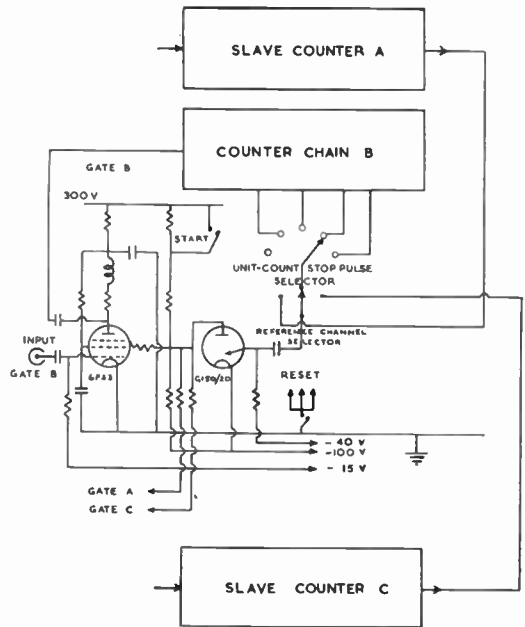

Fig. 1. Triple gate ratio counter control unit.

The gates are operated in unison using the suppressor grids as the control electrodes, the potentials of which are altered by variations at the anode of a gas-filled trigger tube operated by the stop pulses. Output pulses from the zero carry-cathodes of the dekatron chain are available at  $10^2$ ,  $10^3$ ,  $10^4$ , and  $10^5$  counts.

Using pulses of random distribution in time, the accuracy of a count is subject to sampling errors. The standard deviation is  $1/\sqrt{n}$ , where  $n$  is the number of counts in a given run;  $10^3$  counts would thus provide a statistical accuracy of only 3 per cent., so that the normally used unit-count is  $10^4$ , which provides an accuracy of 1 per cent. (This is for the reference channel; it would not be identical for the channel under measurement unless the ratio approached unity.)

4. Associated Apparatus

As the ratio counter forms its own programme unit, ratio measurements can be continuously or progressively repeated if means are provided to change the work to be examined, cancel the previous record of measurement, and re-open the control gates. In a completely automatic scheme, a printing counter is substituted for the slave counter employed in the monitoring channel, and thus provides the necessary signals for this purpose from its printing sequence mechanism. Such an arrangement then gives a printed record of each measurement in traditional form, without the attendance of an operator.

The print-out unit\* developed for use with the dekatron glow-transfer tubes employed in the counters under discussion is of special interest, due to its importance in the operation of automatic counting schemes and will now be considered in some detail.

Dekatrons provide both a decade scaling-factor and a visual display in a single tube, and

have a long useful life. Except on the occasions when the glow-discharge invests the zero or carry-cathode, the standard counter tube provides no electrical information of its indicated position. Whilst photographic film and light-sensitive pick-ups both offer a possible solution to obtaining a permanent record of a displayed count, these methods have not so far progressed beyond the experimental stage.

The production unit to be described, shown in Fig. 2, is an electro-mechanical device which utilizes the re-cycling principle to obtain information of the glow-discharge position. The action of feeding ten recycling pulses into a dekatron will cause it to make one complete revolution and finally register its original count. In the process, an output pulse will occur as the glow-discharge invests zero, and thus the original position can be determined from the number of pulses required to obtain this signal. Plainly, such a read-out system is impracticable when applied to the input of a conventional multi-decade counter, firstly, because of the problem of preventing the carry-pulse, so produced, from actuating the next decade; and secondly, because of the time required to

\* British Provisional Patent Application No. 10242/55. U.S.A. Patent No. 576994.

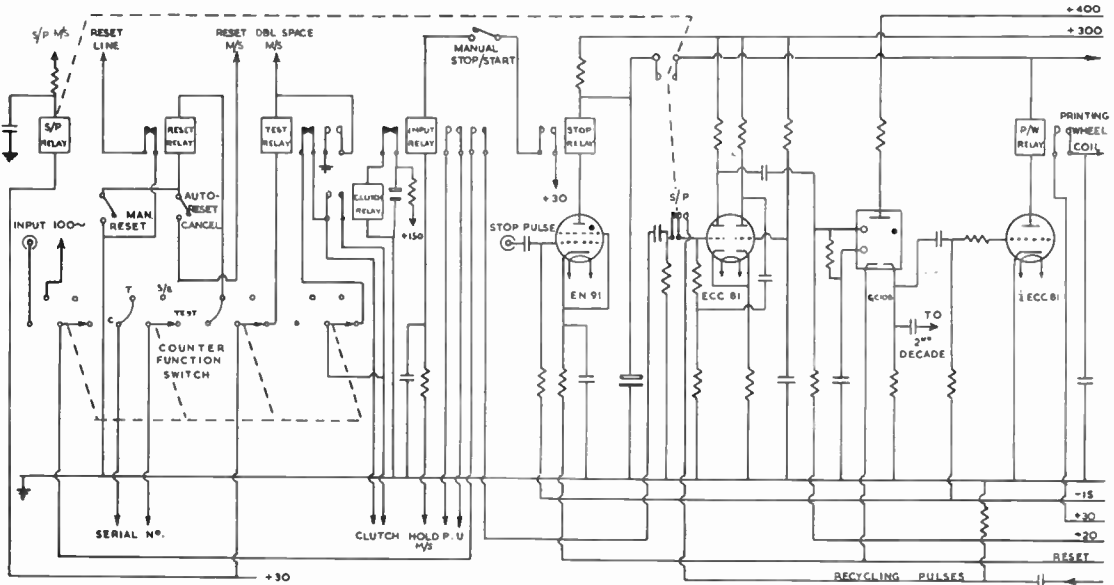

Fig. 2. Decade, drive, trigger and control circuits.

re-cycle a chain of tubes, even if the input pulse rate were increased to the maximum permitted by the tube.

The dekatron counter employed with the print-out unit under discussion is, therefore, of special design to overcome these difficulties. Each decade is arranged so that its input may be switched in "series" for counting and in "parallel" for printing, to accommodate the re-cycling principle of read-out.

The operation of the complete apparatus is as follows:—At the conclusion of a counting period, the counter decades are switched from their normal cascade connection and simultaneously re-cycled through one complete revolution in a clockwise direction to again indicate the original count. The printing wheels are rotated in synchronism with the dekatron driving pulses, but in the reverse direction. The output pulse produced as the glow-discharge passes through zero operates an electromagnetic clutch associated with the appropriate printing wheel assembly within the print-out unit and thus halts the wheel. At this point, the wheel will have progressed the equivalent of the complement of the dekatron number and thus will be in a position in conformity with the original dekatron count. After indexing, a solenoid-operated printing-bar in alignment with a standard typewriter ribbon causes a record of the count to be printed on a paper roll, together with a progressive five-figure serial number and a batch or identification symbol. This print-out is automatically performed in approximately one second after the conclusion of the count.

Following the print-out action, the paper is advanced one space, and the printing wheels, the counter dekatrons and external apparatus are reset to zero, and the serial number advanced one digit in preparation for the next print. At the conclusion of the printing sequence, a signal re-starts the counting programme.

The equipment provides facilities for self-testing, double-spacing of the print, auto-reset cancellation, timing, stand-by and manual operation, and is therefore admirably suited to the conversion of counting equipment to automatic operation.

## 5. Application to X-Ray Diffraction Measurements

Figure 3 shows a printing counter arranged for use with a ratio counter and other electrical instruments in conjunction with an X-ray diffractometer. The equipment includes two accurate ratemeters and a ratio recorder, so that both an integrated rate and a digital measurement of count ratios may be obtained. The counting scheme also includes a third channel giving a time indication when making an experimental measurement of a count ratio for the determination of an appropriate dead-time correction, where this is required. The detection apparatus illustrated consists of two argon-filled glass-window  $\text{CuK}\alpha$  X-ray Geiger tubes polarized from the ratemeters, and two quenching-type pre-amplifiers having adjustable dead-time.

This group of units represents the necessary instrumentation for the control of a suitable diffractometer table to form an automatic equipment for routine X-ray measurements.

The ratemeters are normally used for general profile examination, and the pulse-counting and printing arrangement for accurate analysis. The ratemeter time-constants are chosen to indicate a measure of statistical fluctuation, and are connected respectively to the fixed reference tube and the movable monitoring or analyser tube. The diffractometer table is set to make a continuous scan of the specimen under examination. The combined outputs of the ratemeters drive the ratio recorder, and thus produce a graphical record of the ratio of the count rates obtained from the two pulse sources. The use of two detectors compensates for the short term instability and superimposed slow drift of the X-ray tube output.\*

The ratio counter and its associated equipment is used to provide an accurate evaluation of the intensities within the line-contour measurements obtained from the count-rate observations. To achieve this, the ratio counter is connected to operate from the source of reference pulses with the printing counter operating from the monitor tube pulses, and the diffractometer table drive mechanism is set to make small angular increments after

\* "X-ray Diffraction by Polycrystalline Materials," p. 210. (Institute of Physics, London, 1955.)

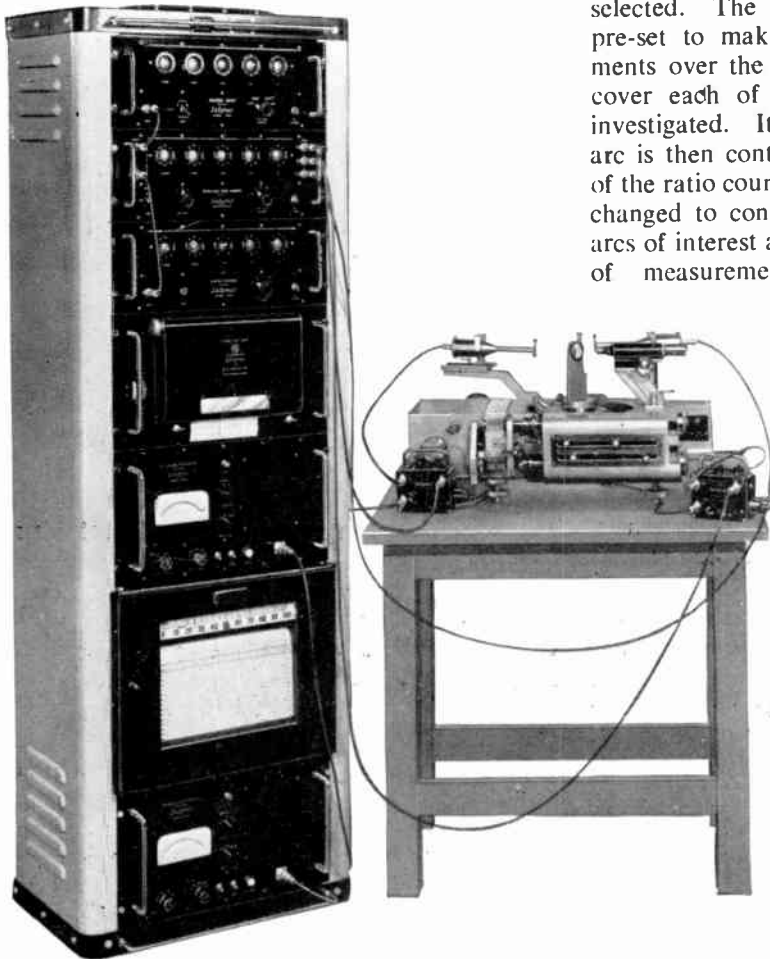

Fig. 3. Printing counter, and ratio counter arranged for X-ray diffraction measurements.

each individual ratio measurement. The ratio counter provides its own counting-time programme, and at the conclusion of each counting period initiates the movement of the table to a new position in preparation for the next measurement whilst the previous result is being printed.

If the table can be readily switched from continuous rotation to incremental angular movement over pre-determined arcs, the analysis time can be considerably reduced. For this purpose, the graphical record obtained from the ratemeter observations is inspected, and the angles of special interest requiring accurate evaluation by counting techniques are

selected. The table drive mechanism is then pre-set to make a number of angular increments over the total angular range required to cover each of the individual sections to be investigated. Its operation within the selected arc is then controlled by the programme cycle of the ratio count, and the table is automatically changed to continuous movement between the arcs of interest at the termination of each group of measurements and returned again to incremental scanning at the angular position selected for the next group of measurements. Upon the completion of the entire analysis, a trip circuit shuts down the equipment.

Investigations are being made into the possibility of employing the ratemeters to control a stepped pre-sampling scheme in place of continuous rotation between the ranges of specific interest. Such an arrangement could use relatively large angular steps to sense a given increase in the rate of change of count-rate as a means of locating the position of the peak intensities, without the necessity for obtaining prior knowledge of the range of angles in which the counting technique is to be concentrated and subsequently pre-setting

the machine. The unpredictable level and changing slope of the mean background count, and the need to refer continuously to it, constitutes the main problem to be solved.

#### 6. Other Applications of the Ratio Counter

In the field of revolution counting, the ratio counter has many uses in torque and clutch-slip measurements, where comparisons between the driving and the driven apparatus are required to be analysed. In its simplest form, the technique is illustrated by the measurement of clutch efficiency which is related to the ratio of the revolutionary speed of the driving shaft to the speed of the driven shaft. By applying

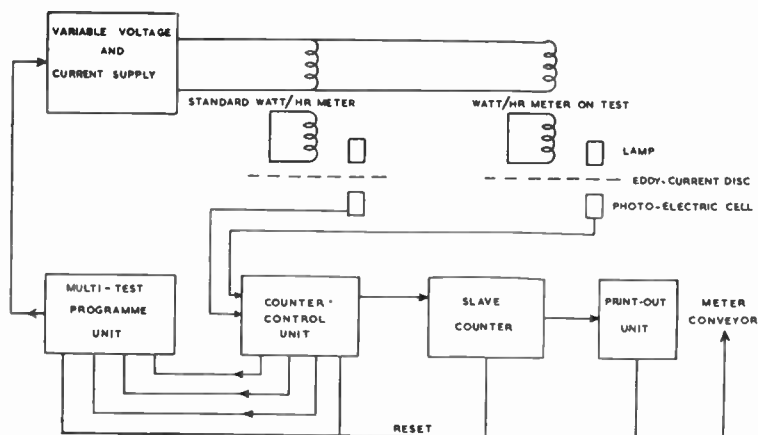

Fig. 4. Automatic meter test and calibration system.

a photo-electric pick-up to each shaft in turn, and measuring the number of revolutions per unit of time, it should be possible to compare the two results, providing only that the driving shaft speed is constant. This complication is completely avoided and the result obtained automatically by the use of the ratio counter and slave counter examining both sides simultaneously, and the direct reading of the ratio also presents the result directly as a percentage efficiency. Where routine repetitive or progressive readings are required, possibly aligned to load applications in an unattended series of measurements, the printing counter will replace the slave counter, as before, to permit an automatic technique.

A further application of this method of measurements to routine final inspection of a manufactured item is illustrated by an automatic watt-hour meter calibrating scheme which has been successfully devised for industrial use.

Figure 4 shows the simplicity of the scheme which provides a printed inspection slip

showing the deviation in a number of tests against a standard. The meters under test are sequentially offered to the equipment by a rotary conveyor and are continuously energized from a variable voltage and current supply. Photo-electric pick-ups are applied to the eddy-current discs of the standard, and the meter under test, and the pulses from these pick-ups are routed to a ratio counter and a printing counter. Ten measurements are made on each instrument and a programme-sequence unit triggered by the ratio counter at the conclusion of each count makes the necessary changes in the conditions of test. As the ratio unit-count gating pulses are required to occur at 100, 400 and 800 counts and to be selected by the programme cycle unit, the instrument is modified to operate from a GC10/4B type of dekatron in the appropriate stage, and its output cathodes brought out to a suitable selector device.

These variations of the use of counting and gating techniques to comparison measurements indicate the attractive possibilities of this method of treatment.



## . . . Radio Engineering Overseas

621.3.018.7

**Calculation of the amplitude characteristic of an alternating voltage containing harmonics.** R. CIGNETTI. *Elettronica*, 6, pp. 16-21, March 1957.

The calculation is made of the peak and mean value of an alternating voltage with harmonics in terms of their percentage in order to obtain the instrument error when measurements are made with a peak- or mean-voltmeter calibrated in r.m.s. units. These readings and their relative errors are tabulated together with the five first harmonics.

621.314.2:621.374.4.029.3

**The output transformer of a high fidelity audio amplifier.** P. CREMASCHI. *Elettronica*, 6, pp. 26-33, March 1957.

After a short summary of the requirements of a push-pull high fidelity a.f. output transformer several equivalent circuits at low, medium and high frequency are proposed from which the expressions giving the response are deduced. Formulae are obtained in terms of the windings and core materials which will give parameters similar to those of the equivalent circuits. The laboratory methods used to measure directly parameters to check the theoretical calculations are described. An example is given of a 20 watt push-pull output transformer and the measurement of its performance.

621.315.59

**Collector bias, the transistor equivalent of cathode bias, and some applications.** R. F. TREHARNE. *Proc. Instn Radio Engrs, Aust.*, 18, pp. 149-159, May 1957.

A self-bias circuit for stabilizing the operating point of a transistor amplifier without unduly decreasing the gain at very low frequencies is discussed. The circuit is similar to the cathode bias arrangement commonly used with thermionic valves and may have equivalent general application in transistor circuits. Expressions for the frequency response, stability and input impedance are derived and the application of the circuit to amplifiers, oscillators and active filters is considered.

621.317.341

**Gas-discharge noise tubes in the range of high discharge admittances.** H. SCHNITGER. *Nachrichtentechnische Zeitschrift*, 10, pp. 236-240, May 1957.

The operational range of gas-discharge tube noise generators can considerably be increased when the tubes are fitted with delay lines instead of being coupled to waveguides or coaxial lines as employed so far. Quantities for equivalent circuits are given thus permitting approximating calculations of the attenuation response for such arrangements with relatively high plasma densities. Measurements of attenuation as a function of pressure at various currents confirm the calculations. The attenuation in helium at 0.1 mm Hg is still adequate for producing noise factors of approximately 30 db. Noise generators containing diodes can be calibrated in the region of 1,000 to 100 Mc/s by means of the usual gas-discharge noise tubes.

*A selection of abstracts from European and Commonwealth journals received in the Library of the Institution. All papers are in the language of the country of origin of the journal unless otherwise stated. The Institution regrets that translations cannot be supplied.*

621.317.75

**Photographic recording of physical phenomena with cathode-ray tubes.** P. E. KLEIN. *Elettronica*, 6 pp. 22-25, March 1957.

The arrangements illustrated are the recording sections of multichannel instruments used to record simultaneously various amplitudes even when not related. This instrument comprises two parts: the photographic camera and the indicator with cathode-ray tubes all assembled in a common chassis. A time-base is not required because of the film traverse. A special arrangement reduces the c.r.t. anode voltage when the film does not record. The whole assembly can be remotely controlled and used in full daylight.

621.373.421

**Simultaneous generation of two frequencies in one generator and the stability of the frequency difference.** W. FEIST. *Nachrichtentechnische Zeitschrift*, 10, pp. 215-222, May 1957.

Two frequencies can simultaneously be produced in an oscillator with feed-back, when the feed-back network exhibits steep enough slopes in the phase response at the frequencies of oscillations and when suitable operating conditions are chosen for the valve. The stability of "difference oscillators" is discussed with the aid of an example.

621.375

**Amplifiers with grid-leak bias.** V. SANSONE. *Elettronica*, 6, pp. 10-14, March 1957.

After a very brief note on the effect produced in the grid circuit of a grid-leak current a simple method of measurement is outlined based on the equivalence of this effect with a load resistance across the grid circuit. To illustrate this an example is added to show the use of this method with valves type 6BA6 (EF93) and 6DA6 (EF89).

621.385.16

**Space charge waves for a finite magnetic field at the cathode of a cylindrical electron current.** R. LIEBSCHER. *Archiv der Elektrischen Übertragung*, 11, pp. 214-221, May 1957.

The development and investigation of transit-time tubes requires a knowledge of the plasma wavelength. The calculation of the plasma wavelength is known for the following limited cases of magnetic focusing:

- infinitely strong magnetic field throughout the beam generating system,
- finite magnetic field along the electron beam, but no magnetic at the cathode of the electron gun (magnetically shielded cathode, Brillouin flow).

The plasma wavelength is calculated under the assumption of a finite magnetic focusing field at the cathode.

621.396.5:621.395.74

**Planning of radio link networks operating with metric and decimetric wavelengths.** H. PAUL. *Nachrichtentechnische Zeitschrift*, 10, pp. 223-233, May 1957.

A classification of radio relay links into various "grades of channel performance" on the basis of obtainable noise power per kilometre results in noise characteristics which can be combined with the path characteristics (path attenuation plus fading margin) by means of a handy slide rule. The latter then provides a ready information of the "performance grade" which can be expected or of precautions which may be required for obtaining an optimum performance of the link. The mutual interference in radio link networks, particularly in those employing mobile stations, can quickly and easily be determined with the aid of two further slide rules which take into account factors which depends upon propagation and frequency.

621.396.11

**Some comparative measurements of propagation conditions in the frequency bands II and IV.** W. KNOPFEL. *Nachrichtentechnische Zeitschrift*, 10, pp. 233-240, May 1957.

Measurements of attenuation in band IV behind diffracting edges and in populated areas were performed in order to provide data for the planning of networks. These measurements resulted in a 6 db larger local attenuation and a 12 db larger diffraction attenuation in band IV as compared with band II. Larger transmitter powers and more transmitters are required in band IV to provide an adequate service.

621.396.621.621.396.666

**Theoretical examination of a diversity method.** E. HENZE. *Archiv der Elektrischen Uebertragung*, 11, pp. 183-194, May 1957.

The mean power and the probability distribution of the power fluctuations primarily determine the quality of a communication circuit. General equations are set up for the characteristics of the resultant signal obtained with certain receiver and antenna diversity methods, without previous specialization onto some predetermined probability distribution of the signals originally picked up by individual antennas. The antenna diversity method is investigated with statistically independent individual signals, and the receiver diversity method as well as the antenna diversity method is investigated for statistically dependent individual signals, with a discussion of the attained improvement in transmission performance. The influence of external noise on the distribution of the individual signal is also taken into account.

621.397.813:535.6

**Level clamping and its effect on colour television reception.** W. DILLENBURGER. *Archiv der Elektrischen Uebertragung*, 11, pp. 195-213, May 1957.

Studio equipment for television in natural colours for a separate amplifier channel for each primary colour (red, green and blue). The amplitude ratio of the three video signals given at the input of the amplifier by the colour information of the picture must be preserved. The colours undergo a change due to slight variations in the shape of the amplitude characteristics of the individual amplifiers, the amplification values, and the lift. Level clamping in such amplifiers turns out to be far more difficult than in black-and-white television.

In the N.T.S.C. system channel level variations are less critical, and the same holds for variations in the shape of the amplitude characteristic in the amplifiers through which the N.T.S.C. signal passes. Particularly exacting demands, however, are placed on the constancy of the differential group delay as a function of the luminance signal. Dependent on frequency, carrier interference as a more serious effect in the N.T.S.C. channel in the black-and-white channel. The signal-to-noise ratio for carrier interference whose frequency is near the colour subcarrier must be far higher than in black-and-white television.

Equipment has been developed for investigation into the effects mentioned above. This equipment is described and the results of preliminary measurements given which agree fairly well with experimental results abroad.

681.142

**Studies on a high-speed electronic differential analyser.** N. S. NAGARAJA, S. SAMPATH and V. RAJARAMAN. *Journal of the Institution of Telecommunication Engineers*, 3, pp. 130-139, March 1957.

This paper describes the principles of operation of high-speed electronic analogue computers used as differential analysers, with particular reference to the analyser set up at the Indian Institute of Science. The potentialities of such an analyser in solving linear differential equations and also in dealing with physical systems in which several types of non-linearities occur are discussed. The paper then describes the solution of some typical problems with the aid of the computer installed at the Indian Institute of Science.

Extended summaries of papers from the November and December 1956 and January and February 1957 issues (Volumes 39 and 40) of the *Journal of the Institute of Electrical Communication Engineers of Japan* are available in English. The following are included:

**Current-inversion type negative impedance converter.** T. YANAGISAWA.

**A new differential type RC oscillator.** Z. ABE & H. SUGAWARA.

**Design of electron gun strip beams.** K. FUJISAWA and T. KANEKO.

**D factor of electron guns for TV cathode ray tubes.** R. NISHIZAWA.

**10-75 Mc/s quartz crystal units.** K. TAKAHARA, I. IDA, M. KOBAYASHI and Y. ARAI.

**M-derived waveguide filter.** H. YANAI & J. HAMASAKI.

**Electric field displacement in the ferrite-loaded rectangular waveguide.** S. KUMAGAI & Y. NAKANISHI.

**Increase of the interference noise caused by nonlinear distortion of the discriminator.** T. OYATSU.

**An experiment on magnetic noise in ferrite of rectangular B-H characteristic.** H. UNO.

**Microwave transverse magnetic type uni-directional strip circuits.** S. YOSHIDA.

**S-curve measuring procedures for the dissipative shunt admittance.** K. SUETAKE.

**Active RC transfer networks.** T. YANAGISAWA.

**Theoretical analysis of electro-mechanical filters.** I. NAKANO.

**Mutual inductance of coaxial shielded coils.** K. ITO

**New microwave radio relay equipment.** T. FUKAMI, M. MORITA and I. KONISHI.

**Parametric excitation using barrier capacitance of semi-conductor.** K. ZENITI, K. FUSIMI, K. KATAOKA and K. YAMANAKA.