

JOURNAL OF The British Institution of Radio Engineers

(FOUNDED IN 1925 - INCORPORATED IN 1932)

*"To promote the advancement of radio, electronics and kindred subjects
by the exchange of information in these branches of engineering."*

Vol. 16 No. 5

MAY, 1956

THE PROBLEMS OF AUTOMATION

In Great Britain much time is being devoted to studying the possible effects of automation on full employment. Paradoxically there is most concern on the question of redundancy of manpower at a time when, notwithstanding financial limitations, Britain continues to be short of manpower, particularly in the engineering industries. This problem is not peculiar to Great Britain alone. Several other countries, including France, are faced with a similar situation.

Almost every country in the world is enjoying increased standards of living by a greater consumption of goods. This demand has to be met in an era when there is a sharp tendency toward shorter working hours and an urgent need to reduce costs. These facts alone create the necessity for increased production and warrant the careful consideration of every engineer, especially the electronics engineer.

Modern industry has been developed mainly by mechanization, which has in turn led to increased production facilities. The editorial in the March *Journal* referred to the demands made by Britain's industrial and commercial undertakings on a total working population of 24½ millions.* No more than 10 millions are actually concerned with engineering in the broadest sense, from the factory floor to the designer, development and research engineer. The remaining working population is employed in offices, sales, H.M. forces and other services.

Automation creates a demand for still more engineers to design and produce the equipment being used by a wide variety of other industries. It is at that stage that manpower can be released from monotonous tasks—often indeed, poorly paid in order to maintain an economic production cost.

The absorption of such released manpower into more remunerative and interesting channels of employment will require a wider acceptance of opportunities for technical training than is at present evident. Whilst automation is a means of increasing personal happiness, it also presents a very direct challenge to our educational system. Labour, in the usual sense of the word, has almost disappeared, and is being gradually replaced by a requirement for skill in craftsmanship.

Automation itself, higher living standards, and shorter working hours all call for increased production facilities, and the comparatively new scientific developments of nucleonics, electronics, plastics, and other 20th-century discoveries all make new demands on production capacity.

In our own field of engineering, radio valves, cathode ray tubes, and now the printed circuit can only be produced in sufficient quantities by automatic assembly. Apart from automatic control and production, there are also many complex techniques which cannot be done by human labour, for example, the control of the atomic reactor. The flight simulator is really an automation system, saving the time of instructors in the training of pilots. Computers aid scientific investigation and accountancy in a way which cannot be matched by tedious and lengthy human endeavour.

Developments in electronics, hydraulics, and pneumatics, all contribute to the development of automation. The design of machinery which can respond to certain actions, or reactions, usually demands some electronic equipment. Thus, radio engineering, which started as a means of improving communication, created new fields of entertainment and thereby a demand for more leisure, is now required to play a very important part in the development of automation.

* "Encouraging More Technologists"—*J.Brit.I.R.E.*, 16, page 113.

NOTICES

Indian Advisory Committee

During his recent visit to India the Vice-Patron of the Institution, Admiral the Earl Mountbatten of Burma, K.G., received at Rashtrapati Bhavan, New Delhi, the Chairman of the Institution's Indian Advisory Committee, Brigadier B. D. Kapur.

Recently the Council concluded an arrangement with senior members in India, very ably led by Brigadier Kapur, to provide facilities for Indian members through a central office in Bangalore. Under the aegis of the main Examinations Committee, the Indian Advisory Committee will now make arrangements for the Graduateship Examination in India, and handle appropriate correspondence. Other activities proposed by the Indian Advisory Committee include the establishment of an employment service for members in India which will also give advice and introductions to Indian members proceeding overseas for further training and experience.

The Bangalore office was established on January 1st last, and the Vice-Patron's discussions were particularly concerned with the development of technical education in the field of radio and electronic engineering. The increasing number of Indian candidates entering for the Graduateship Examination has stimulated the demand for technical training, and India's technical education programme provides for more courses in all fields of communication. Some Indian universities are now extending facilities for training in electronics and nuclear engineering.

Admiral Mountbatten also discussed the importance of encouraging the young Indian engineer to obtain recognized qualifications, and the promotion of regular meetings and discussions in the five Sections established during the General Secretary's visit to India in 1951/2.

Northampton Polytechnic Extensions

The Rt. Hon. Sir David Eccles, Minister of Education, opened the extensions to the Northampton Polytechnic, Finsbury, on May 7th. The Northampton Polytechnic is one of the senior engineering colleges in London, and was referred to in the recent White Paper on Technical Education.

The extensions are only part of an ambitious scheme to double the size of the Polytechnic. These extensions include a new Library block which houses aeronautics, hydraulics and metrology laboratories on the basement, production engineering workshops on the ground floor, and further workshops and laboratories for instrument engineering measurements, instrumentation and process control. The top floor contains a new Library with accommodation for 12,000 volumes, contributed by the Worshipful Company of Skinners.

Sir David Eccles commented on what he considered to be a misinterpretation of the technical education White Paper. It had been apparent that the 24 colleges listed in the White Paper, and which were at present receiving grants for advanced work, were assumed to be the exclusive homes of advanced technology. This was not, in fact, the case, and other technical colleges will be built up to the same high standard. Sir David said also that he hoped for "free trade" amongst students doing advanced work. This would require the abolition of the present out-County fees paid by one authority to another for the training of students.

As an indication of the size of Northampton Polytechnic, in the year 1954-5 a total of over one million student hours was worked; twenty-eight per cent. of that time represented full-time day courses. The number of students attending part-time day release courses was 1,854, drawn from 456 firms. Degrees were awarded to 118 students during 1955, of whom 70 were studying part-time.

New Director of N.P.L.

The appointment has been announced of Professor G. B. B. M. Sutherland, Sc.D., F.R.S., Professor of Physics and Director of the Biophysics Research Centre of the University of Michigan, to be Director of the National Physical Laboratory. It is expected that Professor Sutherland will take up the appointment in September of this year.

Professor Sutherland will succeed Sir Edward Bullard, Sc.D., F.R.S., who retired last December. Dr. R. L. Smith-Rose, C.B.E., D.Sc., the Director of the Radio Research Station at Slough, will continue as Acting Director of the N.P.L. until Professor Sutherland takes up his appointment.

UNDERWATER ECHO-RANGING*

by

Professor D. G. Tucker, D.Sc., (Member) †

SUMMARY

The paper reviews the whole field of underwater acoustic echo-ranging, and attempts to give a reasonably up-to-date account of the basic principles and many of the engineering aspects of the subject.

TABLE OF CONTENTS

1. Introduction	3.1.3. Electronic deflection and scanning of beams
2. Basic Principles	3.1.4. Bearing determination or direction finding
2.1. Pulse systems	3.2. Cavitation on Transmission
2.2. "Frequency-modulated" systems	3.3. Choice of Frequency
2.3. Ship-fitting and Operational Aspects	3.4. The Transducer Itself
2.4. Propagation of Sound in the Sea	3.4.1. Magnetostriction transducers
2.5. Formation of Echoes	3.4.2. Crystal transducers
2.6. Background Noise, Echoes, Reverberation, etc.	3.4.3. Barium titanate transducers
2.6.1. Random noise arising in the physical resistance of the receiving transducer, in the valves of the amplifier, etc.	4. The Display and Electronics
2.6.2. Random noise arising acoustically in the sea itself	4.1. The Rectification of Signal-plus-noise
2.6.3. A fixed or moving background produced by the echoes from objects such as rocks, debris, and sea-weed on the sea-bottom, or in the body or on the surface of the water	4.2. The Chemical Recorder and Trace-to-trace Correlation
2.6.4. "Reverberation"	4.3. The Cathode Ray Display with A-Scan
3. Transducers and the Design of the Acoustic System	4.4. The Cathode Ray Display with Intensity-modulation
3.1. Directional Patterns	4.5. Some Limitations of Intensity-modulated Displays
3.1.1. Directional patterns of rectangular and strip transducers	4.6. The Effect of the Shape of the Target Signal as Displayed
3.1.2. Directional patterns for non-uniform transducers	4.7. The Choice of Bandwidth and Pulse Duration
	5. Conclusion
	6. Acknowledgments
	7. References

1. Introduction

Systems of underwater echo-ranging are much less well-known than their younger counterpart, radar. The general principles of radar are now comparatively widely known and the various applications of radar to aircraft detection, marine and aerial navigation and even to speed-checks on motorists are generously publicized. By contrast, underwater echo-ranging is, generally speaking, known only to a

relatively few people who have had occasion to use it; it has never been publicized and its applications have raised little public interest.

It is interesting to compare the main quantitative features of radar and asdic as in Table 1, and to see where they are completely different and where they are similar. Radar, of course, uses electromagnetic waves in air; underwater echo-ranging systems use acoustic waves. Electromagnetic waves cannot be efficiently propagated in water, but acoustic waves suffer relatively little loss, although maximum ranges of detection of distant objects are always much less than in radar in air—they are typically of the order 100–1,000 yards or metres. Frequencies and time-scales in

* Manuscript received 12th March, 1956, (Paper No. 353.)

† Electrical Engineering Department, University of Birmingham.

U.D.C. No. 621.395:623.983:639.2.

the two cases are very different, naturally. Most underwater acoustic systems operate at frequencies in the range 10–200 kc/s (as compared with frequencies up to 10,000 Mc/s in radar), and since the velocity of sound in water is about 5,000 ft/sec (1,520 m/sec), pulse durations are of the order of milliseconds (instead of the microseconds of radar) and echo times are of the order of a second (instead of the millisecond of radar). But the order of wavelength is the same in the two cases, being usually a few centimetres. These differences mean that the equipment of a typical underwater system has usually no physical similarity to that of a radar system, except for the dimensions of the radiating and receiving devices. However, a great deal of the fundamental theory of the systems is common to both.

Table 1
Comparison of Radar and Asdic
(Approximate figures only)

	RADAR	ASDIC
Frequency:	100–10,000 Mc/s	10–200 kc/s
Wavelength:	300–3 cm.	15–0.75 cm
Velocity of propagation:	186,000 miles/sec (3×10^8 km/sec)	1 mile/sec (1.5 km/sec)
Maximum range of detection of target:	100 miles (160 km)	1 mile (1.6 km)
Speed of military target:	500 miles/hr (800 km/hr) (aircraft)	5 miles/hr (8 km/hr) (submarine)
Time available between detection and final action:	12 min	12 min
Pulse duration:	0.1 to 1 microsec	0.3 to 100 millisc
Pulse repetition period:	0.01 to 1 millisc	0.05 to 2 sec

Underwater echo-ranging systems have been given names in Britain and the U.S.A. The British Admiralty has used the name ASDIC ever since its introduction during World War I* as the initials of the “Allied Submarine Devices Investigation Committee,” and the name ASDIC is still current in both naval and civilian circles in Britain. In the U.S.A. the name SONAR has been in use for many years; it abbreviates “Sound Navigation And Ranging,” and is analogous to RADAR.

* An excellent and fully-documented account of the early history of underwater echo-ranging systems is given by Hunt.³

Another rather curious feature of nomenclature is that vertical echo-ranging (e.g. the determination of the depth of water under a ship) has been called “echo-sounding,” and the name asdic has been generally reserved for echo-ranging in an approximately horizontal direction. The reasons for this distinction are mainly historical, and in this paper we shall usually mean asdic to include both horizontal and vertical ranging.

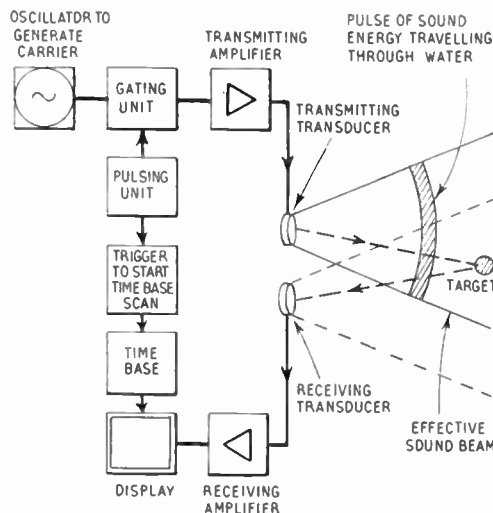

Fig. 1.—Schematic arrangement of a typical pulsed asdic system.

The applications of asdic are manifold. The most spectacular is no doubt its success in the anti-submarine struggle in World Wars I and II. During the most critical period of the last war the Allies said¹: “History is repeating itself; as in 1914-18, so in 1939-42; although we shall not win the war by defeating the U-boat, we shall assuredly lose the war if we do not defeat them.” It was touch and go, but a thousand enemy submarines were sunk, and mainly because they were detected and located by asdic. The Axis realized the power of our asdic. A letter from Gross-Admiral Doenitz in December, 1943, is reported¹ to have said: “For some months past the enemy has rendered the U-boat war ineffective. He has achieved this objective, not through superior tactics or strategy, but through his superiority in the field of science; this finds its expression in the modern battle weapon—detection. By this means he has torn our sole offensive weapon in the

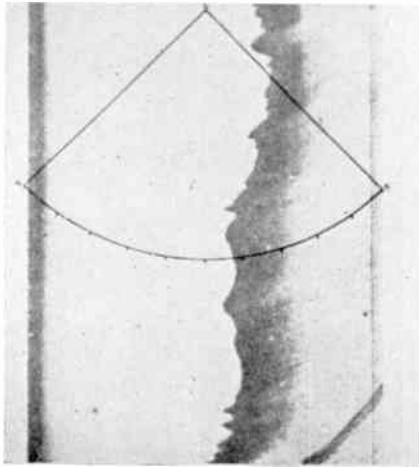

Fig. 2.

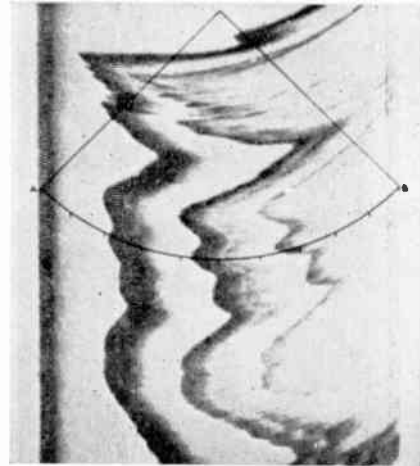

Fig. 3.

Typical echo-sounder traces on chemical recorder paper, showing sea-bottom profiles. Transverse (curved) scale represents depth; longitudinal scale represents time and therefore distance.

war against the Anglo-Saxon from our hands.”

A more commonplace, but nevertheless important, application of asdic is in the Echo-Sounder, which nearly all ships nowadays use as a very valuable navigational aid. It is a vertical asdic, recording or displaying the depth of the sea under the ship.⁶⁵ It is of particular assistance in shallow coastal waters and in making entrance to harbours approached by tortuous channels amidst shoals and mud-flats. Reference 31 lists the characteristics of most commercial echo-sounder equipments.

An application of rapidly-growing importance is to the detection of fish. The fishing industry has always had great difficulty, and often great losses, through the wandering habits of the fish and the consequent inability of the fishermen to find them.³² The use of asdic, both vertical and horizontal, has led to rapid fish survey methods and to the more efficient detection of fish shoals, and even to the identification of the species of fish.³³⁻⁴¹ Similarly, asdic has been used with success in the whaling industry, and has also been of value in marine biological research.^{29, 64, 66}

Asdic has also been found a valuable aid in hydrographic survey²; it can give, when used with a nearly horizontal beam, a great deal of information about the topography of the sea-bottom, and even about its structure (or “lithology”). A vertical echo-sounder can

also be used to investigate the bottom structure by examining the evidence (shown in the recorder chart) of penetration of the acoustic energy into the sea-bottom and of its reflection at different interfaces.^{62, 63}

2. Basic Principles

2.1. Pulse Systems

Most asdic systems, like most radar systems, use the transmission and reflection of a pulse of energy as their basis. The system comprises the main components shown in Fig. 1. Individual systems show many variations on this theme, such as the use of a single electro-acoustic transducer for both transmission and reception with a changeover switch controlled by the main pulsing unit with a suitable time delay. Another variation is the use of an oscillatory discharge into the transmitter so that no separate continuous oscillator and gating unit are required. The pulses are always bursts of carrier frequency, and never unidirectional.*

The commonest type of display is the chemical recorder,^{6, 7, 8, 9} a remarkably efficient

* This statement refers to asdic systems as such; unidirectional pressure pulses produced by explosives are used in geophysical and oceanographical research on sedimentation, etc., and acoustic receivers enable the form and spectrum of the echoes to be analysed. Similarly, explosive charges are a convenient source of energy for acoustic transmission investigations.

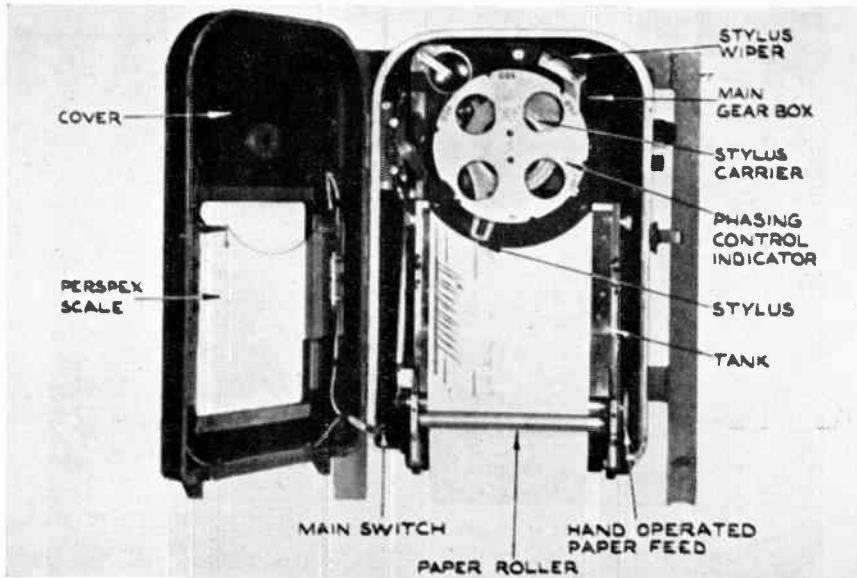

Fig. 4.
Chemical recorder as
used in an echo-sounder.

instrument which records the received information on damp paper impregnated with potassium iodide (sometimes a dry electrolytic paper such as Teledeltos is used). The time base is then the mechanical drive of the recording stylus across the paper; received signals are indicated by the density of the iodine released, and the returns from successive pulse-transmissions are marked along adjacent lines since the paper is moved slowly in a direction perpendicular to that of the stylus traverse. Typical recorder traces are shown in Figs. 2 and 3 and the type of instrument used in echo-sounders in Fig. 4. This type of instrument is the commoner of the two main types in current use, even for horizontal asdics; its styluses are swung round on a rotating arm, so that the trace is curved, but it has the advantage of no lost time due to flyback. The other type of recorder has the stylus drawn across the paper in a straight line, but even though it is then drawn back as quickly as possible, yet the lost time due to flyback may be a considerable proportion of the total time on the shorter range scales. It is also a more expensive instrument.* However, the straight-line type is better for accurate surveying work using a horizontal beam, since it does not distort the geographical picture; and it has the

advantage that the flyback can be initiated at any point in the traverse, so that when a single target is being followed the stylus can be returned for a new pulse as soon as the target has been recorded, and the rate of obtaining information is thus kept a maximum. If there is a definite reflecting object—or “target”—in the sound beam, then the echo-pulses it produces give consistent marks on the trace at each traverse and form a line down the paper. If the range of the target from the transducers does not vary, then this line is parallel to the direction of motion of the paper. If the range changes, e.g. due to the motion of the target, or of the ship on which the equipment is fitted, then the line is sloped relative to the paper motion.

The transducers for converting the electrical signal into an acoustic one, and vice versa, may be regarded as a sort of loudspeaker and microphone respectively, although they generally rely

* There is available a straight-line chemical recorder with no flyback⁵; this uses the principle that iodine is deposited at the contact between a fixed straight bar on one side of the paper and a helical wire on a rotating roller on the other side. There is thus no stylus required, and the machine is no doubt very robust, but the author does not know how its efficiency compares with the other types of recorder.

on either the magnetostrictive or piezo-electric effects for their operation. They, like other parts of the system, will be discussed in more detail later.

When a chemical recorder is used, the motor which drives the stylus across the paper also drives a cam switch which acts as the pulsing unit; its contacts cause the pulse to be transmitted normally at the instant when the stylus is just beginning its traverse. Further contacts with an angular displacement from the first pair can be used to switch a single transducer from "transmit" to "receive." If a cathode-ray display is used, however (as in a radar system), then the pulsing unit is a separate independent unit, and the time base is controlled by it.

It is evident that the speed of the time-base (or stylus traverse) is dependent on the time required for the acoustic pulse to travel from the transducer to the most distant target-range and back. As the velocity of sound in water is about a mile per second, and few systems have an effective range against normal targets of more than a mile, the longest time of scan is about 2 seconds. Range-scales down to 40 yards (37m) are provided on some vertical echo-sounders, so the shortest time of scan is about 50 milliseconds.* In the chemical recorder, with a paper width of five inches, these times represent stylus velocities which are readily realizable. It would not, of course, be possible to use such an instrument in radar, where the time of scan might be only 1 millisecond, and there the cathode-ray display is in universal use. One advantage of the recorder is the permanence of its paper record; one disadvantage is the expense of the paper which may well cost several pounds per day. Cathode-ray displays are becoming increasingly common in commercial equipment. Other forms of display, such as flashing neon lights, are also used.²¹

It should be noted that the receiving amplifier needs to have either a wide-range automatic gain control or a time-varied gain synchronized to the pulse transmission, because the amplitude of the returning echo-pulse falls off rapidly with range, and so the gain needed to record an echo rises rapidly during the time following each transmission. Since the display has a limited dynamic range and it is desirable that

* One of the referees of this paper has stated that range-scales down to 45 feet have recently been achieved.

signal levels should be kept between those corresponding to the marking threshold and saturation (see Section 4.5), it is not sufficient merely to use a large gain all the time.

2.2. "Frequency-modulated" Systems

While a pulse asdic appeals to the designer because of its simplicity, yet there are considerable advantages in the use of so-called "frequency-modulated" asdic. This is exactly analogous to "f.m. radar"^{10,11} in its general conception. Fig. 5 shows a block schematic of a suitable system for general purposes, and Fig. 6 shows the way in which the frequency changes with time. The system is not analogous to a f.m. communication system, because the variation of frequency is imposed on the transmitter by a saw-tooth generator

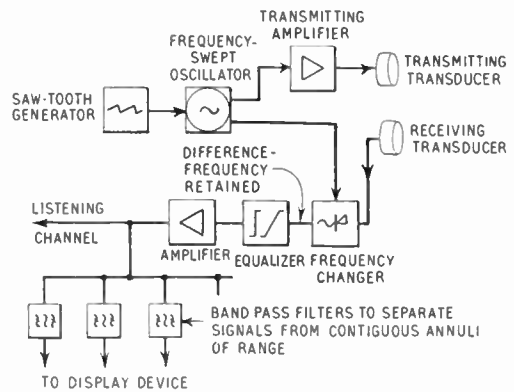

Fig. 5.—Schematic of "frequency modulated" asdic.

and, in itself, conveys no information. The sweep repetition period may conveniently be made twice that required for sound to travel from the transducer to the most distant target range specified and back again. If the transmission is continuous as shown in Fig. 6, then the difference-frequency output from the receiving frequency-changer produced by the reflection from a fixed small target is a steady frequency (e.g. f_1 or f_2 in Fig. 6) from the time the signal first returns from the beginning of a new sweep, until the end of the sweep at the transmitter. The actual frequency of this output is a measure of the range of the target, and can either be estimated by the ear, or measured within certain bands by recording the outputs of a series of band-pass filters with contiguous pass-bands. Each of these bands corresponds

to a particular interval (or annulus, as it is often called) of range. From the time of the end of the transmitter sweep until the end of the sweep of the received signal, the output frequency from the frequency-changer jumps to a different value giving a wrong indication of range, as shown in Fig. 6. To avoid this difficulty, the simplest solution* is to make the transmission only semi-continuous, and to suppress the transmission over the second half of each sweep, although leaving the full sweep to operate the frequency-changer. In this way, the output is always of the same frequency for a target at a fixed range, but is present only half the time.

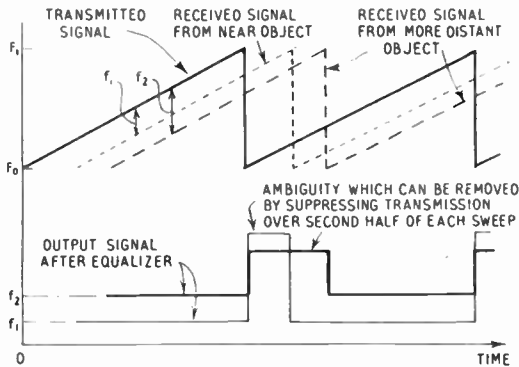

Fig. 6.—Frequency/time graph for a "frequency-modulated" asdic

Since signals received from targets at different ranges have amplitudes varying very greatly according to range, it is clear that the receiving frequency-changer has to handle a wide range of signal levels simultaneously. This may lead to difficulties, since when overloading occurs, false (intermodulation) frequencies may be produced which lie in the same frequency range as true signals from distant targets. Careful design is needed at this stage. After the frequency-changer, since different ranges correspond now to different frequencies, lower frequencies have larger amplitude than higher frequencies; consequently an equalizer network, having an insertion loss diminishing from low to high frequencies, can be made to give the signals a relatively narrow range of amplitudes for the amplifier and presentation channels.

The ear provides a very efficient detector of signals, and is particularly suitable for the f.m.

* Other solutions have been patented giving fully-continuous operation.¹²

system. Provided the frequency sweep $F_1 - F_0$ is not more than about 10 kc/s, so that the target signals leave the frequency changer in the audio range 0-5 kc/s, then the ear can detect target echoes which are feeble compared with the general background of reverberation and noise. This is because the ear behaves, in listening to a signal against a background of wide frequency spectrum, as though it were a filter of bandwidth of about 50 c/s (increasing somewhat with increasing frequency of signal) centred on the signal frequency. Provided an aural presentation of the information is acceptable, the f.m. system compares reasonably well with a pulse system as regards complexity of equipment. If a visual display is required, then the f.m. system requires either recorders on each filter channel, or a scanning system which will sample the output of each filter in turn and present the information on a cathode-ray tube against a time-scan. This involves greater complexity than that of a pulse system, especially when it is borne in mind that the range resolution of the f.m. system (corresponding to the ratio of pulse duration to repetition period in the pulse system) is given by the reciprocal of the number of filters, assuming these cover the whole output frequency-range of $\frac{1}{2}(F_1 - F_0)$.

The f.m. system requires separate transducers for transmitting and receiving, since the signals are present simultaneously on both. In general, then, it can be said that a f.m. system is more complicated than a pulse system. But it does have some advantages, which can be listed thus:

- (a) Since the transmission is continuous (or semi-continuous), and since the signal/noise performance of an asdic set is more-or-less proportional to transmitted energy for a given set of performance parameters (e.g. range resolution), irrespective of whether it is pulse or f.m., it is clear that the power required from the transmitter is very much smaller in the f.m. than in the pulse system. Now, in underwater acoustic transmission, the limit to the acoustic power which can be transmitted into the water is set by the fact that cavitation sets in at a given value of watts/cm² at the transducer face (see Section 3.2). Thus for the same power, the f.m. set can have a higher performance (e.g. longer range of detection) than the pulse set, or for the same performance can have smaller transducers.

(b) In the pulse system, the transducers cannot be swung to look in a different direction until the pulse has returned from the maximum range. In a continuous f.m. system with all-round transmission, this is not a requirement, and search can be much more rapid. Actually in a practical system with a cathode-ray display, the signal/background ratio falls off as the speed of search is increased, but, at any rate, the speed of search can be made as fast as the detection conditions permit. The pulse system is inflexible in this respect.

Frequency-modulated asdic is not yet available commercially. It will be discussed no further in this paper.

2.3. Ship-fitting and Operational Aspects

Asdic sets are normally fitted to ships, but there is no reason why sets with horizontal beams should not be fitted in harbour entrances in fixed positions to act as a shore-based navigational aid (by locating ships from the echoes received from their hulls) rather on the lines of a harbour radar installation. The way in which they are fitted to ships varies according to their purpose.

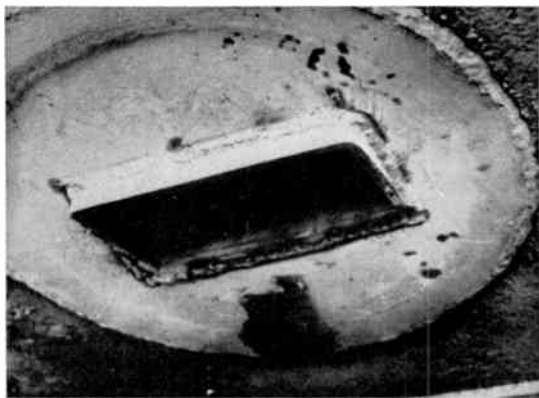

Fig. 7.—“Fishfinder” vertical asdic: transducer shell welded in position in hull.

Echo-sounders of the ordinary navigational type very often have the transducers fitted *inside* but against the bottom of the hull in a water-filled tank. If the hull is of steel, then the loss of acoustic energy caused by the transmission through the hull is small enough to be acceptable provided the thickness of the hull is considerably less than one-quarter of a

wavelength of the acoustic wave. Since the wavelength in steel is generally (at say 15 kc/s) of the order of 16 inches (40 cm), no difficulty arises in this respect. However, for vertical asdics required to perform more exacting tasks than the bottom-sounder (e.g. fish detection requires the asdic to be more efficient and consistent), it is generally preferred to mount the transducers so that their active faces are on the outside of the hull, which has therefore to be pierced; and dry-docking is thus necessary for the fitting operation. An example of transducers (magnetostriction type, operating at 35 kc/s, face area about 8 in. \times 4 in.—20.4 cm \times 10.2 cm) fitted in this way is shown in Figs. 7 and 8.

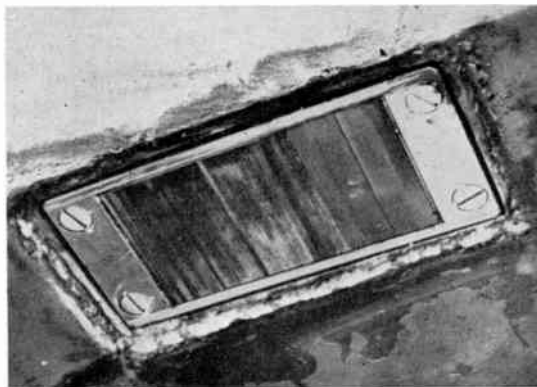

Fig. 8.—“Fishfinder” vertical asdic: magnetostriction transducer in place.

Separate transmitting and receiving transducers are used in this particular equipment*, and a fairing is fitted around them to prevent turbulence in the water flow past them.

There are, unfortunately, severe limitations in the methods of mounting described above. They are not suitable for horizontal-beam asdics, and since most ships carry a flowing stream of air-bubbles along the bottom of the hull, owing to the pitching of the ship, “quenching” of the sound beam is common with flush-mounted transducers. By quenching is meant the almost total suppression of the sound transmission due to the fact that a mass of air-bubbles acts as a good reflector of sound in water. Thus echo-sounder records are often marred by quenching; nevertheless, the effect is

* The “Fish-Finder” by Pye Marine Limited.

not serious for purely navigational purposes, since the bottom shows up as a good echo in between quenchings.

For horizontal-beam asdics and for any asdic where quenching needs to be minimized, the transducers are mounted on fittings external to the hull. The ship has to be dry-docked for the fitting operation.* But once an external fitting is available, the transducers can be made "trainable," i.e. their orientation can be controlled via a "training-shaft," and the asdic beam can point in any desired direction. One commercial set†, for example, provides training through ± 120 deg. from the ahead bearing in the horizontal plane, and provides tilt control

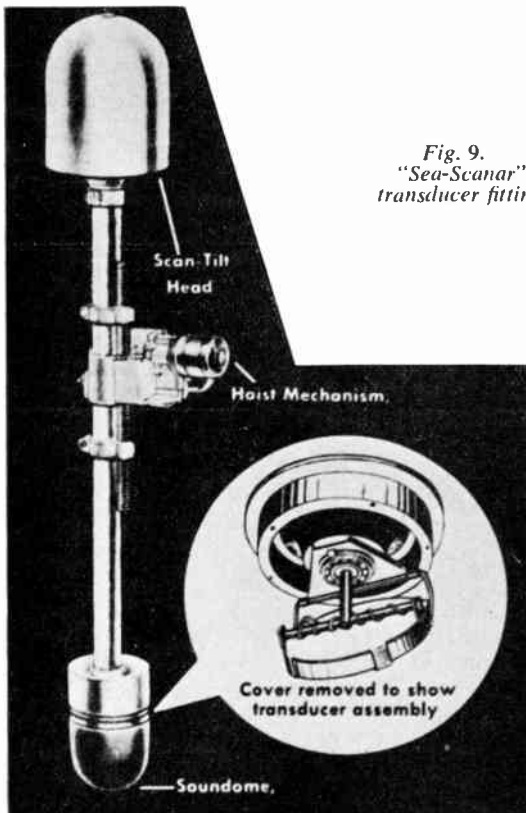

Fig. 9.
"Sea-Scanar"
transducer fitting.

between 0 and 90 deg. relative to the horizontal. If the transducer is mounted far enough below the hull (mountings are usually retractable into the hull) then it can be below the stream of bubbles around the hull, and quenching will be very infrequent.

The transducer mounting and training-shafts of the set referred to above, together with the hoist mechanism for retracting the transducer into a housing on the hull, are shown in Fig. 9. The transducer is a small one, made of barium titanate and operating at 175 kc/s. For protection it is enclosed in a small "dome," in this case of rubber, filled with an oil the impedance of which matches that of sea-water.

It is usual for all horizontal-beam asdics to fit the transducer(s) in a dome. An example of a much more massive construction is shown in Fig. 10, which shows the arrangements made for mounting, protecting, training and retracting the transducer of a whale-finding asdic set.‡ The transducer itself (shown in Fig. 11) is very heavy, being of the magnetostrictive type and having one face active at about 14 kc/s and the other at 22 kc/s, the face dimensions being about 15 in. square (38 cm square). The dome is of thin stainless steel supported on an iron frame and is streamlined, and the whole unit can be withdrawn bodily into the hull when not in use.

When a fixed asdic is used, the chemical recorder is from most points of view the ideal display. But when horizontal training is provided, a separate bearing indication is needed. In these circumstances a cathode-ray display of the p.p.i. (polar plot) or B-scan (cartesian plot of range against bearing) type is very attractive, since an immediate presentation of the relative locations of targets is available. However, the design considerations of displays are very technical, as will be seen in a later section of the paper.

2.4. Propagation of Sound in the Sea

From the points of view both of the overall operation and of the detailed design of the asdic set the quantitative relationships of the propagation of sound in the sea are very important. A complete account of propagation would be prohibitively complex; indeed knowledge of this subject is still very incomplete. All we can do in this section of the paper is to outline some of the major features.

* The transducers can be towed at the end of a cable, and the need for piercing the hull thus obviated; this also has the advantage of permitting the transducers to be lowered to a considerable depth, giving improved resolution of fish shoals and other targets.⁶¹

† The "Sea-Scanar" by Minneapolis-Honeywell Regulator Co.

‡ The "Whale-Finder" by Kelvin & Hughes, Ltd.

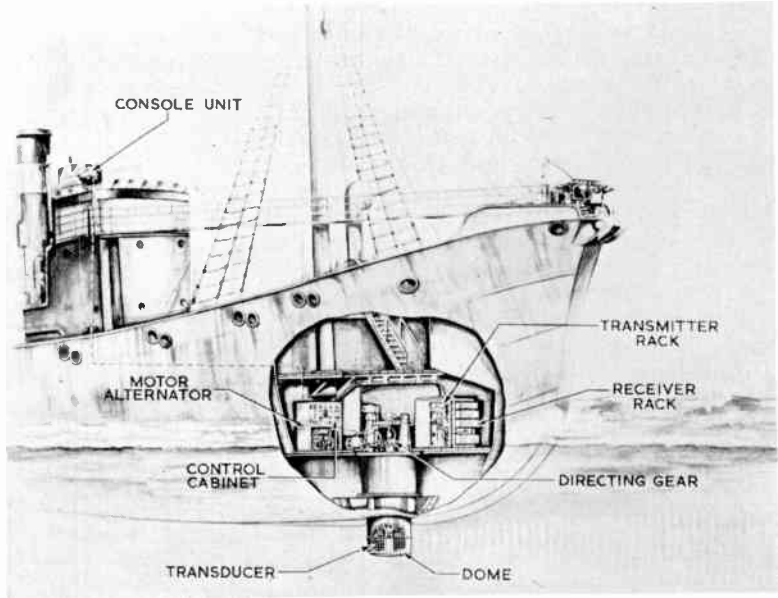
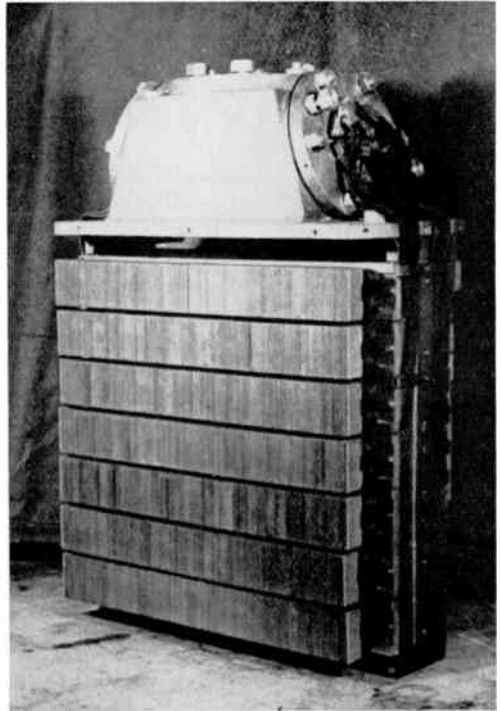
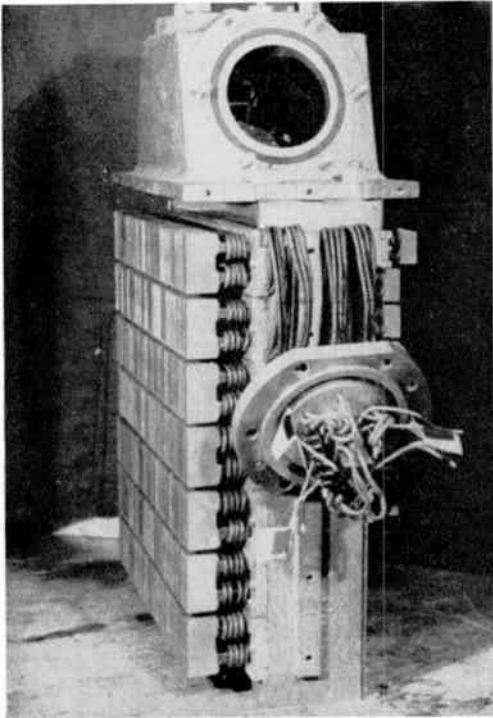

Fig. 10 (right).—"Whale-Finder" ship-fitting arrangements.

Fig. 11 (below).—"Whale-Finder" transducer (two views).



If the medium, i.e. the sea, were infinite in all directions and uniform in all respects, then the spreading of the sound would be spherical; in other words the beam would expand uniformly in all directions perpendicular to its axis. Under these conditions the well known inverse-square law relates the sound intensity to the distance from the transmitter. (Sound intensity corresponds to power per unit area of cross-section.) This relationship is usually expressed as a loss of 6 db per doubling of range.

The sea is not, of course, infinite in all directions, but is bounded by the surface and the sea-bed. Thus in practice the spreading does not follow the inverse-square law, but the sound intensity, being to some extent canalized, falls off less rapidly than the inverse-square law. In the extreme case, called cylindrical spreading, the sound intensity is proportional to the reciprocal of the range, i.e. the loss is 3 db per doubling of the range.

In addition to this loss due to spreading, there is an additional loss due to absorption (and conversion into heat) of the sound energy by the water. This loss is, as would be expected, very variable. It is small at low frequencies but rises very rapidly with increase of frequency, and, over the range of frequencies in common use at present, the loss expressed as decibels per kiloyard is approximately proportional to the square of the frequency.⁵⁸ At 50 kc/s the absorption loss varies from about 8 to about 16 db/kiloyard.

Further propagation effects which are of great importance are caused by variations of the velocity of sound from one part of the sea to another.¹⁵ Under normal conditions the velocity of sound in the sea is about 5,000 ft./sec. (1520 m/sec.). The main causes of variation of this velocity are, in the usual order of importance: temperature³⁰, pressure due to depth, and salinity. The actual magnitudes of the effects can be stated in approximate terms as follows:

Temperature—Velocity changes between about +7 and +15 ft./sec. per deg. C. (210 and 450 cm/sec. per deg. C), or about +1 per cent. for +3.5 deg. C change at a temperature around 10 deg. C.

Depth—Velocity changes +0.0182 ft./sec. per ft. increase in depth, i.e. about +1 per cent. for 2,500 ft. (760m.) increase in depth.

Salinity—Velocity changes about +1 per cent. for +10 parts per thousand change in salinity.

A convenient empirical formula for the velocity of sound in the sea in the temperature range 6 to 17 deg. C is given by Wood²², and adding the depth effect is as follows:

$$V = 4626 + 13.8t - 0.12t^2 + 3.73S + 0.018d$$

in ft./sec.,

where t = temperature in deg C,
 S = salinity in parts per thousand,

d = depth in feet,

or $V = 1410 + 4.21t - 0.037t^2 + 1.14S + 0.018d$
 in m/sec.

if d is expressed in metres.

A more learned discussion of the subject is given by Beyer.²³

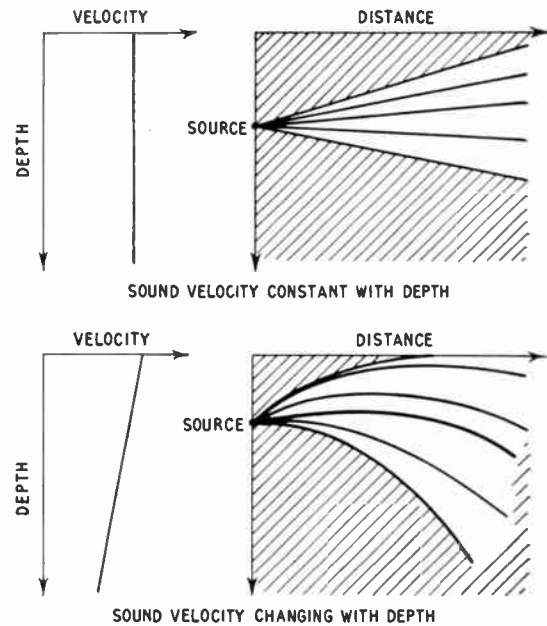

Fig. 12.—Bending of sound beam due to velocity gradient.

The most serious and the best known effect of variation of velocity is the bending of the sound beam when the temperature of the sea changes with depth.^{15, 58, 60} If any line in the beam is already inclined downwards, it will be bent further downwards if it enters a region of lower velocity. If the velocity gradient is continuous from the surface downwards, giving, as is usual, a lower velocity at the greater depth, then the whole beam tends to get bent downwards even if its axis starts horizontally from the transducer. The effect is illustrated in Fig. 12. When the beam eventually strikes the

sea-bottom, it is reflected upwards, only to be gradually bent down again, and so on. Along any straight line of range, therefore, there are intervals of range where detection is impossible and others where detection is possible. This condition does actually occur in practice with low-frequency asdic systems.

What happens to the sound beam at distances fairly remote from the transmitter is never really predictable. In addition to the effects discussed above there are many other factors which appear to influence asdic performance, but are not very well understood at present. However, knowledge of temperature gradients does greatly assist the prediction of asdic performance, and can fairly readily be obtained by lowering through the water an instrument known as a bathythermograph, which provides a graph of temperature against depth. From the accumulated data of many years' observations, some knowledge of the incidence of temperature gradients is now available.⁴²⁻⁴⁹

2.5. Formation of Echoes

When an acoustic pulse of a carrier frequency is transmitted into a fluid medium, such as water, which is homogeneous except that it contains a rigid "target," then an echo is produced whenever the area of the target, as seen from the transmitter, suddenly changes along the range axis. Thus a smooth sphere, the area of which has only one sudden change—at the nearest point of the surface—returns a single echo which has, of course, an envelope shape identical with that of the transmitted pulse. A perfectly smooth sea-bottom returns no echo at all except at normal incidence, and an irregular or rough body returns numerous individual echoes. If the number of separate echoes is small, they may remain separate or overlap according to the pulse duration, as shown in Fig. 13. When they overlap, the resultant envelope shape depends on the phase relationships between the various component echoes, as shown in (c) and (d) in Fig. 13. As these phase relationships vary with the angle of view of the target, the echo envelope is variable and, in practice, usually unpredictable.

It can be seen that when the target is of complex shape the wave-form of the resultant echo will also be very complex. If the pulse duration is such that the various echo components overlap, then the echo envelope may be considered to approximate to the

random wave-form, and will thus be the same in nature as the background noise, etc., which will be discussed in the next section. This is what happens as a rule with fish-shoal echoes. In such circumstances detection will be possible only by virtue of the echo having a larger amplitude than the background. When the pulse duration is short enough to resolve the returns from the individual discontinuities, improved detection might be expected if the shape of the target were known—e.g. a whale might prove to have a recognizable "acoustic shape"; but this is not likely to be the case in fishery applications, where it is probable that long pulses would be advantageous.

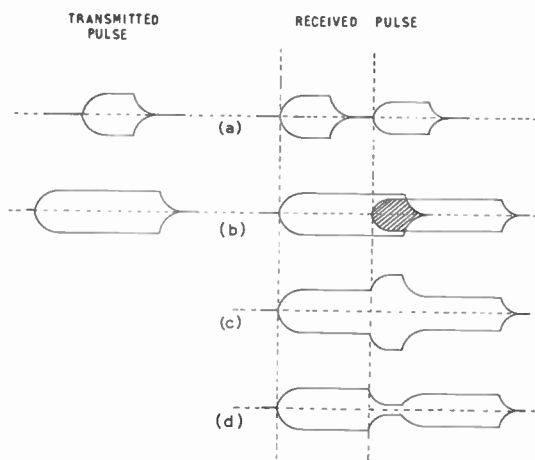

Fig. 13.—Echo envelopes with short and long pulses.

- (a) Short pulse: echoes resolved.
- (b) Long pulse: echoes overlapping.
- (c) Long pulse: echoes in same phase.
- (d) Long pulse: echoes in antiphase.

As regards the echo amplitude to be expected from a target, calculation of this is always likely to be very inaccurate owing to the propagation uncertainties described in the previous section of the paper. But it is rare for the *actual* echo amplitude to be of first importance, since, as will be discussed in the next section, detection is usually limited by the echo amplitude *relative* to the reverberation background, and the relativity is little affected by propagation effects. The important quantity is then the "Target Strength," which is the source strength of the

sound energy reflected (or re-radiated) by the target relative to the intensity of the sound field in which the target lies. For complex targets, target strength is difficult to define, calculate, or measure, but for a simple, smooth, spherical, rigid target, well removed from the surface or bottom of the sea, it is easy. There is only a single simple echo, and if it is assumed that the sphere re-radiates equally in all directions, that its range from the asdic set is large compared with its diameter, and that its diameter is large compared with the wavelength, then the calculation proceeds as follows:

Let it be assumed that (as is usual in this work) the source strength is defined as the sound intensity at 1 yard from the source. If the sound field at the target has intensity I , and the sphere has radius A yards, then the sound power intercepted by the target is $\pi A^2 I$. This power is re-radiated equally in all directions, so that at 1 yard from the centre of the sphere the sound intensity is $\pi A^2 I / 4\pi = A^2 I / 4$. This then is the actual source strength of the target. The source strength relative to the intensity of the incident field is therefore $A^2 / 4$. This is the "target strength," but it is usually expressed in decibels, thus

$$\text{target strength} = 10 \log_{10} \frac{A^2}{4} \text{ or } 20 \log_{10} \frac{A}{2} \text{ db}$$

and a unit target is a sphere of radius 2 yards (or similarly for any other unit of length).

If ideal transmission is assumed (i.e. inverse-square law with no absorption), and if the range is R yards, and the source-strength of the transmitter is I_1 , then the received echo-strength would clearly be

$$I_2 = I_1 \times \frac{1}{r^2} \times \frac{A^2}{4} \times \frac{1}{r^2} = \frac{A^2 I_1}{4r^4}$$

More rigorous treatments of this matter may be found in Ref. 15.

2.6. Background Noise Echoes, Reverberation, etc.

So far we have discussed echoes from targets, but have been very vague about the background against which they have to be detected. This background has several components, as follows:

- (a) random noise arising in the physical resistance of the receiving transducer, in the valves of the amplifier, and so on;
- (b) random noise arising acoustically in the sea itself;

- (c) a fixed or moving background produced by echoes from objects such as rocks, debris and seaweed on the sea-bottom, or in the body or on the surface of the water;
- (d) reverberation.

These components of the background will now be discussed separately.

2.6.1. Random noise arising in the physical resistance of the receiving transducer, in the valves of the amplifier, and so on

This is the ordinary thermal-agitation noise in resistance, and shot and flicker noise in the valves. These effects are well-known and adequately discussed elsewhere. In any case, they are not usually dominant in underwater equipment.

2.6.2. Random noise arising acoustically in the sea itself²⁸

There are many causes of this. One is a form of thermal noise in the water which gives an electrical output from the transducer exactly corresponding to that which would arise if the effective transducer resistance (or "radiation resistance") caused by the loading effect of the water on its face were an ordinary electrical resistance. As with (a), this noise is rarely an important component. Other, more important, noises arising in the sea are those caused, for example, by the waves breaking, by fish and other marine animals, such as porpoises or shrimps, by the rolling of shingle under the action of currents, by the ship's propellers, and by human activities such as dockyard work. Omitting from the discussion the last-mentioned cause, the overall effect of these "macroscopic" sources of noise is often a limiting factor in asdic performance; and although it has many of the properties of thermal noise, e.g. a continuous spectrum, yet it differs in having a spectrum density which falls at a rate approaching 6 db per doubling of frequency. A good deal of data on actual noise levels from different causes, and their frequency relationships, is given in Ref. 28. This dependence on frequency means that sea noise is much more of a limitation at low frequencies than at high, and it is unlikely to need to be taken into account in the design of asdic sets working at frequencies above say 200 kc/s, since except in the worst weather conditions it is unlikely to exceed the electrical noise.

Sometimes the noise emitted by marine animals can be detected separately from the

general noise background, and a good deal of work has been done, particularly in the U.S.A., on the association of such sounds with the species causing them.¹³ It is clear that positive identification of fish, etc., in this way (i.e. by listening passively, instead of echo-ranging) would be a real help to the fishing industry.

2.6.3. A fixed or moving background produced by the echoes from objects such as rocks, debris, and sea-weed on the sea-bottom or in the body or on the surface of the water

These objects could legitimately be called "targets" from the designer's point of view, and it must rest with the operator to separate them from the objects he is really looking for. But obviously the designer can help by making the resolution of the set such that some identification is possible by means of shape and size. For example, a sufficiently short pulse and narrow beam would enable the display of a wreck and of a shoal of fish to be distinguished on the basis of shape alone. However, operators acquire by experience the ability to make distinctions of this kind often from a consideration of just the nature, texture, or appearance of the trace.

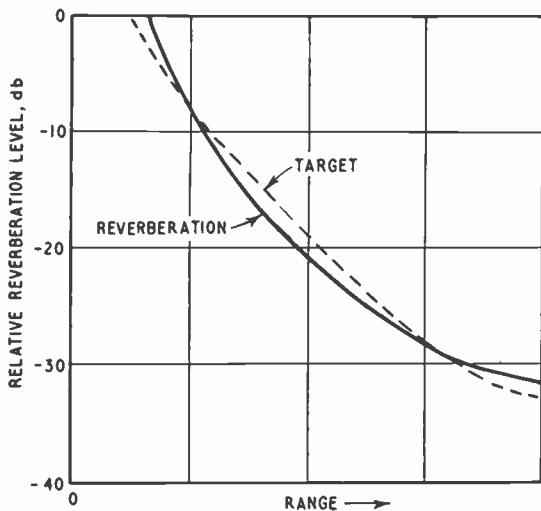

Fig. 14.—Typical variation with range of reverberation and target-echo levels.

Generally, in asdic sets which have to be small and cheap enough for commercial applications, the beam width is not made very narrow, because, as we shall see later, this

would involve too large a transducer. Beam-widths are commonly of the order of 15 deg., which gives little resolution in this respect. But the pulse duration can be reduced to values around 1 millisecc without difficulty, and this gives a resolution in range of about 2.5 feet (76 cm). Pulse duration can be reduced only so long as the bandwidth of the transducer response is adequate to pass the pulse. For a pulse duration of τ sec, a bandwidth of approximately $1/\tau$ c/s is required, and if the operating frequency is f c/s, this means the Q -value of the transducer must not exceed τf . Thus for a pulse of 1 millisecc at 15 kc/s, the Q -value must not exceed 15.

2.6.4. "Reverberation"^{15,54}

This is not strictly analogous perhaps to ordinary room reverberation; it is the sum of all the numerous small echoes produced by back-scattering of the sound from the sand and stone particles of the sea-bottom,⁵⁶ from minute air-bubbles and other discontinuities in the water, which may be small marine organisms,^{24-27,64} from the waves on the surface,⁵⁵ and so on. Under normal conditions, reverberation has many of the characteristics of random noise, discussed above. It has a practically continuous spectrum, and has the same statistical distribution of amplitude with time; it is, in fact, quite random. But it has these most important differences:

- (i) Its general amplitude level is a function of the range from which it is returned, just as is the echo-amplitude from a target. Thus, whereas ordinary noise affects detection only of the weaker signals from long ranges, reverberation is a serious factor in detection at all ranges. It is not *equally* important at all ranges, however, because its relationship to the echo from a fixed size of target varies with range due to the fact that a different area of sea-bottom and sea-surface and a different volume of water is energized or "insonified" by the pulse at different ranges, whereas a simple target presents more-or-less the same area at all ranges. There are many other factors, also, which cause a difference. A typical relationship is shown in Fig. 14, from which it can be seen that signal/reverberation ratios generally fall at long ranges, and detection is often limited by reverberation and not by noise.

(ii) The amplitude of reverberation is dependent on that of the transmitted pulse, since the reverberation energy is derived entirely from the transmitted energy. It is clear, too, from this energy relationship, that the reverberation amplitude is dependent on the duration of the pulse. Thus, in a practical system, the power of the transmission can usually be made sufficient to make the effects of noise unimportant in relation to reverberation, which is then dominant at all ranges at which detection is possible according to Fig. 14. Reducing the pulse duration evidently improves the ratio of the peak signal amplitude of a single target-echo to the reverberation level if there are no other limitations; but if the target is complex in shape and thus produces a complicated or even random echo envelope as discussed earlier, then reducing the pulse duration has the same effect on target signal as on the reverberation background, and there is no improvement in the ratio. In any case, any potential improvement is not always realized because, for example, the display may act as a low-pass filter and smooth out the short pulse-return.²⁰

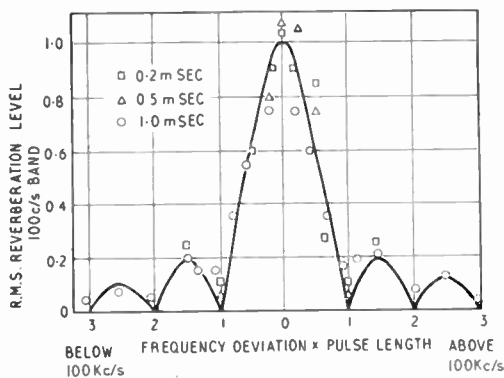

Fig. 15.—Spectrum of reverberation. (Experimental results are indicated corresponding to various pulse durations. Bandwidth of analyser = 100 c/s.)

(iii) The spectrum of the reverberation is not uniform like that of “white” noise. It is, in fact, of very similar shape to that of the pulse which produces it—not a very surprising result!—and on the assumption of a rectangular pulse envelope, the transmitted pulse spectrum is shown by full

lines in Fig. 15; some actual measured reverberation spectra are shown as individual points.¹⁴ The graph has been arranged so that the abscissa scale is independent of pulse duration, but the experimental values are for pulse durations of 0.2, 0.5 and 1.0 msec, which are all short pulses by normal standards. There is evidence that longer pulses show less resemblance between their reverberation spectra and that of the transmitted pulse.¹⁵ The difference between noise and reverberation spectra means that restriction of the receiver bandwidth has different effects in the two cases.¹⁴

(iv) It is clear that the level of reverberation returned from a particular patch of sea-bottom depends on the nature of the bottom and is not likely to vary greatly with time; for example, shingle gives a very high reverberation level, while smooth hard sand gives a very low level because most of the incident energy is reflected onwards and not scattered backwards. This effect is one that can be exploited in hydrographic surveying by asdic, since the nature and level of bottom-reverberation gives a good clue to the bottom structure. “Volume reverberation”—i.e. the back-scattered energy from bubbles, organisms, etc., in the volume of the water—is, by contrast, not related closely with locality and varies from time to time; in this respect it is like sea-noise.

3. Transducers and the Design of the Acoustic System

It is obvious that the successful operation of an asdic set depends very greatly on the correct choice and design of the electro-acoustic transducer. In many ways the design of the transducer is the most important part of the design of the set. The design considerations are manifold, since not only does the electro-acoustic performance have to be taken into account, but there must also be consideration of the size, weight, cost, reliability, etc. If the transducer is mounted outside the hull of the ship, then it will be normally accessible for repair only when the ship is docked, unless special precautions are taken to see that the transducer can be put in place and removed either by retracting it into a trunk inside the ship or by “keelhauling” it.

The size of the transducer is intimately related to the beam pattern required. By beam pattern is meant the pattern of sound intensity or sensitivity (according to whether the transducer is transmitting or receiving) across the surface perpendicular to the beam. When the radiating face of the transmitter is circular, the directional pattern is the same across any diameter of the beam. In such a case the width of the beam (generally measured between the half power or 3-db points) is approximately inversely proportional to the diameter of the transducer. From previous discussion it is clear that resolution of a target often requires the beam to be as narrow as possible—so also does the attainment of a good echo-reverberation ratio; thus in general there is a conflict between the requirements of directionality and restriction of size. Other operational considerations, such as the effect of rolling and pitching of the ship, also have to be taken into account unless the transducer mounting is stabilized.⁴¹

3.1. Directional Patterns

We shall now consider in more detail the way in which desired directional patterns can be obtained before going on to discuss the more intimate details of the transducer design.

3.1.1. Directional patterns of rectangular and strip transducers

The simplest case to consider is that of the strip transducer, and the consideration of this forms the basis for the rest of the work. A strip transducer is one which has length but supposedly zero breadth. In the plane perpendicular to the length, the directional pattern is obviously the same as that of a point-transducer, i.e. the response is the same in all directions in this plane. In any plane containing the length of the transducer the directional pattern is of the well-known $(\sin x)/x$ shape,¹⁶ as shown in Fig. 16. In this figure the peak height of the curve, which represents the sound pressure from a transmission or sensitivity of reception on the axis, is shown as unity; and the abscissa scale is in terms of x which is equal to $(l\pi/\lambda)\sin\theta$, where l is the length of the transducer, λ is the wavelength, and θ is the actual geometrical angle of any direction relative to the normal to the length of the transducer. It will be observed that the beam has a "secondary lobe," with an amplitude (or pressure) response of 22 per cent. of the main beam, and there are other similar but smaller

lobes on each side. These represent not only a waste of useful sound power but also a possibility of false indications and ambiguity of bearing. It will be shown later that this effect can be considerably reduced.

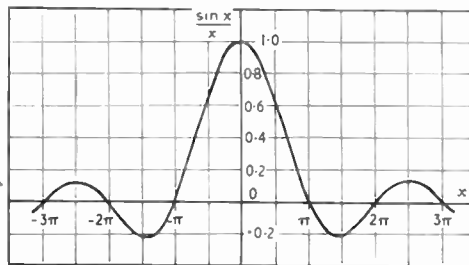

Fig. 16.—Directional pattern of $(\sin x)/x$ type, as given by a uniform strip array.

When the transducer face has a rectangular shape, the directional pattern in a plane containing either of the axes is, of course, of the $(\sin x)/x$ shape except that the scale of x depends on the dimension along the axis concerned. In a plane not containing one of the axes, e.g. a plane containing a diagonal, the directional pattern is different, and it is often necessary to take account of this fact. This will be discussed further in Section 3.1.2.

3.1.2. Directional patterns for non-uniform transducers

We have seen in the previous section that a directional pattern of a transducer in a plane containing an axis along which the transducer is uniform is of the simple $(\sin x)/x$ type. By uniform is meant that the sound intensity at a considerable distance from the transducer is made up of equal contributions from each unit length of the transducer in the plane considered.

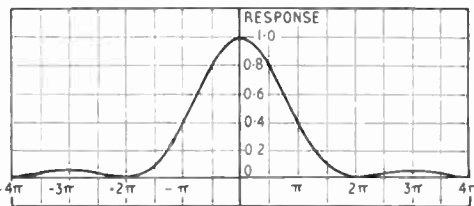

Fig. 17.—Directional pattern corresponding to a linear taper.

It has already been pointed out that when we consider the directional pattern in a plane containing, say, a diagonal of a rectangular

transducer it is no longer of the $(\sin x)/x$ shape. This is due to the fact that in such a plane the transducer is not uniform. If the transducer is square, it has maximum excitation as a transmitter or maximum sensitivity as a receiver at the centre of its length, "tapering" off to zero at each extremity. The word "taper" is generally used to describe such a variation along the length of the transducer. The particular kind of taper described above is called a linear taper and it gives the directional pattern shown in Fig. 17. It will be seen that secondary lobes have been very considerably reduced (although even in relation to the increased length of the diagonal the width of the main part of the beam has been increased).

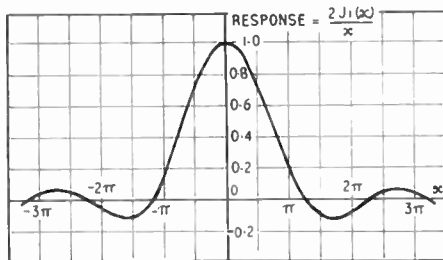

Fig. 18.—Directional pattern of a circular transducer.

Transducers with a circular face are frequently used, and it should now be clear that a directional pattern in any plane containing a diameter will be that corresponding to a circular "taper." This directional pattern is shown in Fig. 18. The calculation of directional patterns corresponding to particular forms of taper and, even more important, the determination of the taper required to give a particular directional pattern is too involved to be discussed here, but fuller discussions are available in the literature.¹⁶

In the simplest forms of asdic set the transducers usually are circular or rectangular, in the latter case with a relatively small ratio of length to breadth. However, there are considerable advantages for special applications in using a strip type of transducer where the length is very much greater than the breadth and where in consequence the fan-shape type of beam is obtained. If the length of the transducer is horizontal, then the fan beam has its greater width vertically and is narrow horizontally, and proves very useful in delineating targets which are small horizontally. If the transducer is used with this length vertically, then the fan beam

is horizontal and proves valuable in distinguishing targets which are small vertically. With such systems it is obviously necessary to provide some means of swinging the beam as part of the search or delineation process.

Strip transducers or strip arrays, as they are often called, can be very readily divided in a number of equal sections along the length, which can be given varying amounts of excitation or sensitivity. In this way amplitude taper can be readily obtained without any shaping of the transducer itself. This gives more flexibility in the design of beam shapes, and it is simple to ensure that secondary beams are small in the narrow-beam pattern of the fan beam.

3.1.3. Electronic deflection and scanning of beams

It has been pointed out above that when the fan beam is used some means of swinging the beam is desirable. This can of course be obtained by mechanical means, i.e. by swinging the transducer bodily. It can, however, be achieved by purely electronic means. If a strip transducer is divided into equal sections, as previously mentioned, and if a phase shift network is connected in series with each section, before they are joined together, as shown in Fig. 19, in such a way that the phase shift increases uniformly from one end of the transducer to the other, then the main lobe of the directional pattern will have been deflected to one side of the normal to the transducer face.

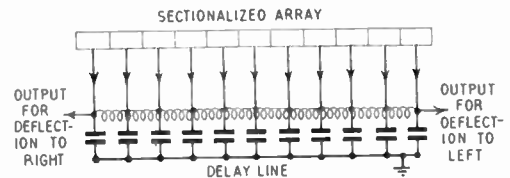

Fig. 19.—Connection of delay lines to deflect beam of transducer.

This can be readily seen by considering the progressive phase shifts as equalizing the relative phase angles of an acoustic signal arriving at the transducer face from a direction inclined to the normal.

Any one set of phase shift networks will give one deflected direction of the beam, and thus if a number of deflected positions are needed for search purposes, it is necessary to have several sets of phase networks. Such a system can of course get rather complicated, but it

does give the advantage that all the various beam directions exist simultaneously, but at separate electrical terminals. They can therefore be scanned by an electronic switch, so as to provide something of the nature of a p.p.i. or B-scan display on a cathode-ray tube. When such a display is provided by mechanical scanning, i.e. by rotating the transducer itself, the information on the display is intermittent and far less useful.

3.1.4. Bearing determination or direction finding

One of the functions of an asdic set is of course to determine the location of the target. This involves measuring the bearing of the target, and when the acoustic beam is wide, it is difficult to obtain sufficient accuracy without some special device.

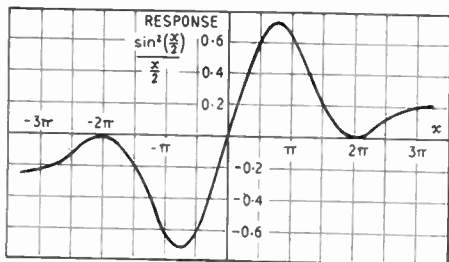

Fig. 20.—Directional pattern of "split-beam" system.

The device which can generally be most simply applied is what is erroneously called the split beam system. This is a method which gives a null indication when the signal is being received along the normal to the length of the transducer. The transducer is divided at the centre into two half-length transducers, and the outputs of the two halves are subtracted one from the other. When the target is on the normal to the transducer face its echo signals cancel out. In any other angular position an output is obtained, so that a relatively sharp null occurs. The "directional pattern" of this system is shown in Fig. 20; this is in fact the graph of the output obtained for different angular positions of the target. It is obvious that this system is far more sensitive than the use of a normal beam where the target bearing would be determined by finding the peak response.

A discussion on some refinements to this system is given in another paper.¹⁶

3.2. Cavitation on Transmission

So far we have discussed the size and shape of transducers only in relation to the corresponding directional pattern. There is, however, another feature of performance which depends on the area of the transducer face. The effect is that of cavitation on transmission.

When sound is transmitted from the transducer at a sufficiently high power level, the pressure at the face of the transducer on negative half-cycles of excitation will be reduced sufficiently to cause dissolved gases to emerge from solution and to form bubbles on the transducer face. This effect is known as cavitation.* It is of course a well-known phenomenon in other circumstances; it occurs on propeller blades and elsewhere, and there is no need to discuss the mechanism of it in any detail here; but the fact that it can occur is of importance to the asdic designer, for it is an undesirable effect causing loss of efficiency and distortion both of the beam and of the signal. It is necessary therefore in every design to consider whether the face area is adequate for the power specified. If it is not, then the difficulty can often be overcome by making the face curved and not plane. This enables a larger area to be obtained for a given beam-width.

Information on the actual relationship between cavitation and transmitted power is scanty. As a guide, it may be stated that at the more usual frequencies, say, below 50 kc/s, cavitation is unlikely to occur at power densities below 1 watt/cm². As the frequency increases so the permissible power density increases—probably much faster than the frequency.

3.3. Choice of Frequency

The choice of the frequency to be used for the asdic transmission is a matter requiring careful consideration of a large number of factors.

In the discussions above on the directional patterns obtained from transducers of different sizes and shapes, it will have been observed that all the relationships are expressed in terms of the ratio of length of transducer to wave-length.

* Several authors^{58, 59} define cavitation as occurring when the peak acoustic pressure exceeds the hydrostatic pressure in the water, i.e. the water is torn apart, and vacuum cavities are formed. No doubt, in practice, the whole process is very complex. Crawford⁴ devotes a chapter to a summary of the present state of knowledge of cavitation.

are met with. This is very inconvenient. The effect of cable capacitance added to this is serious and needs to be tuned by special inductors if large losses are to be avoided. Then, too, the high impedance means that high voltages are needed to drive the transducers as transmitters. A typical figure is 1,500 V for a transmitted acoustic power of 1 W per cm² of face area. This is unsatisfactory, since it is often near the breakdown voltage of ordinary cable.

Crystal transducers obviously have to be watertight. They are usually enclosed in rubber bags filled with castor oil, which has an acoustic impedance nearly the same as that of water and therefore transmits the acoustic energy without reflection losses.

The construction of typical quartz-steel transducer is illustrated in simplified form in Fig. 22.

3.4.3. Barium titanate transducers

Recently barium titanate in ceramic form has been found an excellent transducer material. It is piezo-electric,* like the crystals discussed above, but can be moulded into the size and shape required instead of having to be ground. Owing to its high permittivity, it gives a transducer with low impedance (typically around 100 ohms), which avoids the cable-capacitance troubles and the high-voltage dangers of the crystal transducers. In order to be piezo-electric it has to be subjected to a large unidirectional electric stress (30 kv/cm), but it is possible to make a material where this has to be applied only for a short time, the effect remaining permanently.

There is at least one commercial asdic† system which uses barium titanate transducers, and there is no doubt that the material shows very great promise.

4. The Display and Electronics

Hitherto we have been concerned mainly with the acoustic side of the asdic system. Acoustic considerations naturally are dominant in the initial design and specification of an equipment,

* Many authors reserve the term "piezo-electric" for the effect in crystals, where the dimensions change in sympathy with the electric field, and use the term "electrostrictive" for the effect in ceramics, where the dimensions change according to the magnitude but not the polarity of the field.

† The "Sea Scanar," by Minneapolis-Honeywell Regulator Co.

but considerations of the electronic equipment and in particular of the display cannot be relegated to a secondary role. However excellent the acoustic design of a set may be, it will be useless to the operator if the display is inefficient or unsuitable.

It is assumed here that the information regarding the target will be presented to the operator by means of a visual display. It is not essential to use such a display, as aural presentation of information can often be very satisfactory. The circumstances in which aural presentation is useful are those where a relatively long pulse is transmitted, say, from 50 millisecon upwards. With such a pulse length the received signal can be heterodyned to a readily audible frequency, such as 1,000 c/s, and the pulse is long enough for the operator to appreciate the pitch and character of the received pulses. A highly skilled operator can extract from such signals more information about a target than is usually obtained from a visual display; in particular he can easily distinguish a small change of pitch produced by the Doppler effect when the target is moving and has a component of motion along the axis of the sound beam. These long pulses are useful mainly when large targets are involved, for example, submarines or whales.

It was shown in Section 2.6 that the level of the reverberation background was dependent on the pulse duration, and if the target is small, then the peak signal/reverberation ratio is worsened as pulse duration is increased. Consequently, for small targets short pulses have to be used, and these are not suitable for aural presentation, since they sound merely like clicks and preserve no tonal quality.

Practically all asdic sets are provided with a visual display, and we shall now consider the problems involved in this.

4.1. Rectification of Signal-plus-Noise

It is often desirable, though not generally essential, to rectify the received signal before displaying it. However, the received signal is inextricably mixed with noise and reverberation, i.e. with a random background. We must therefore consider what happens when signal-plus-noise is rectified.

It has been shown in many papers, e.g. Ref. 7, that when the signal/noise ratio is low, say, well below unity, then the law of the rectifier makes no difference to its behaviour. Whether the rectifier is a so-called linear rectifier or is of

square-law type or has any intermediate law, the effect on the signal/noise ratios will be that given by a square-law rectifier. When, however, the signal/noise ratio is well above unity, the law of the rectifier matters considerably. A square law rectifier gives higher output signal/noise ratios than a linear rectifier, and while it is not certain that detection of the signal would be better on an ideal display using a square law rectifier, yet there is little doubt that with a practical display improvement of detection may result from what we can call the more "contrasty" output of the square law rectifier.¹⁸

There are other ways in which the operation of the rectifier can affect detection. A bias is frequently used to give an effect of contrast on a display; it is so arranged that only amplitudes exceeding the bias show up on the display. It is fairly certain that when this process is correctly used an improvement in detection can be obtained when the display is of the intensity-modulated type.¹⁹ It is, however, dangerous to give the operator control of contrast of this type, since when the bias is excessive, detection is worsened, although the display may have a more satisfying appearance to the operator.

4.2. The Chemical Recorder and Trace-to-Trace Correlation

The way in which the chemical recorder works and some of its merits *vis-à-vis* cathode ray displays have already been discussed in Section 2.1. It has, however, one other rather remarkable feature of performance.

When returns are received from a target on a number of successive traces, the line which is produced on the paper by the target signal becomes more and more detectable as successive returns cause it to grow in length. The minimum signal/background ratio at which the target signal can be detected therefore diminishes as the number of returns increases. Over the range of signal/noise ratios from about -10 to 0 db, the minimum signal/noise ratio, or threshold, is reduced about 2.4 db for each doubling of the number of traces, as shown in Fig. 23. This improvement continues until the line becomes too long for the eye to appreciate without scanning. This limit is probably around 3 inches (7.5 cm) in practice. The improvement in detection is not seriously affected if the target is moving, since the line is still produced although it may have a slant relative to the axis of the paper.

Had the successive traces merely been superposed, so that, assuming an infinite dynamic range in the paper, the process is that of plain addition, or integration as it is usually called, then the improvement over the same range of input signal/noise ratios would have been only 1.5 db per doubling of the number of traces. The improvement due to the side-by-side presentation is rather remarkable. The matter is more fully discussed in a recent paper.⁸

It is worth noting that the side-by-side presentation can be obtained on a cathode-ray tube, as well as on a chemical recorder, by suitable time-base arrangements; experiments have shown⁸ that the detection of a signal by this presentation is almost as good as that of the chemical recorder, and it has the advantage that it can be operated on much faster scan rates (e.g. it could be used in radar).

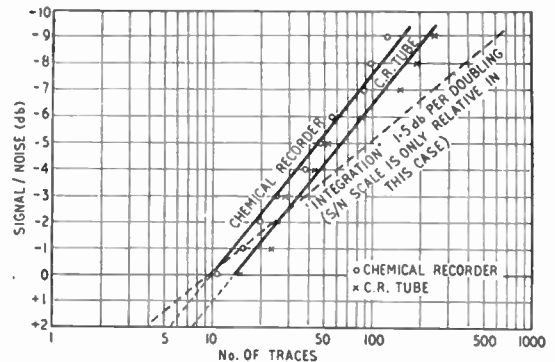

Fig. 23.—Improvement of detection threshold with number of scans in chemical recorder.

An advantage of the recorder which is hardly susceptible to measurement is the permanence of its paper record, and the fact that long lengths of record can be easily examined. An example of this feature and the benefits it gives is shown in Fig. 24, where echo-sounder records are displayed. The depth of water was about 120 fathoms (220 m), but the zero is offset so that the chart covers a range of depth of only 55 fathoms (100 m). In both records the echoes from cod of length about 2 to 3 feet (60–90 cm) are clearly shown; but in the upper record, taken in daylight, the fish form agglomerated shoals, while in the lower record, taken after nightfall in the same locality, the fish are spread out in a diffuse shoal.

4.3. *The Cathode-Ray Display with A-Scan*

The well-known A-scan display, which was much used in early radar sets, can be and often is used in an asdic system, although it is not usually found really adequate in itself. In this display the amplitude of the received signal is displayed by a vertical deflection of the spot, while a horizontal deflection corresponds to time, i.e. to the progression of the pulse through the water. It is thus a graph of amplitude versus range. In the A-scan successive returns cannot reasonably be displayed side by side as with the chemical recorder, but if they are superposed the threshold of detection decreases as the number of traces is increased. It has been shown¹⁷ that the depression of threshold is about 1.5 db per doubling of the number of traces; thus the experimental result agrees with the theoretical figure for the effect of integration, and is much smaller than the 2.4 db/doubling

obtained in the trace-to-trace correlation of the chemical recorder.

Several commercial fish-detection echo-sounding sets use an A-scan with unrectified signal, as illustrated in Fig. 25, the time-base scan representing only a small proportion of the total depth (usually just the portion near the sea-bottom, where the fish which can be trawled are to be found). These sets frequently use a chemical recorder in addition. The use of unrectified signal has been found advantageous in distinguishing fish very close to the bottom; what may be only a small wriggle in the envelope of the leading edge of the very large bottom echo shows up also as a difference in brilliance over an area when the unrectified signal is displayed.

One advantage of the A-scan is that its efficiency as a detector depends very little on the conditions under which the cathode ray tube

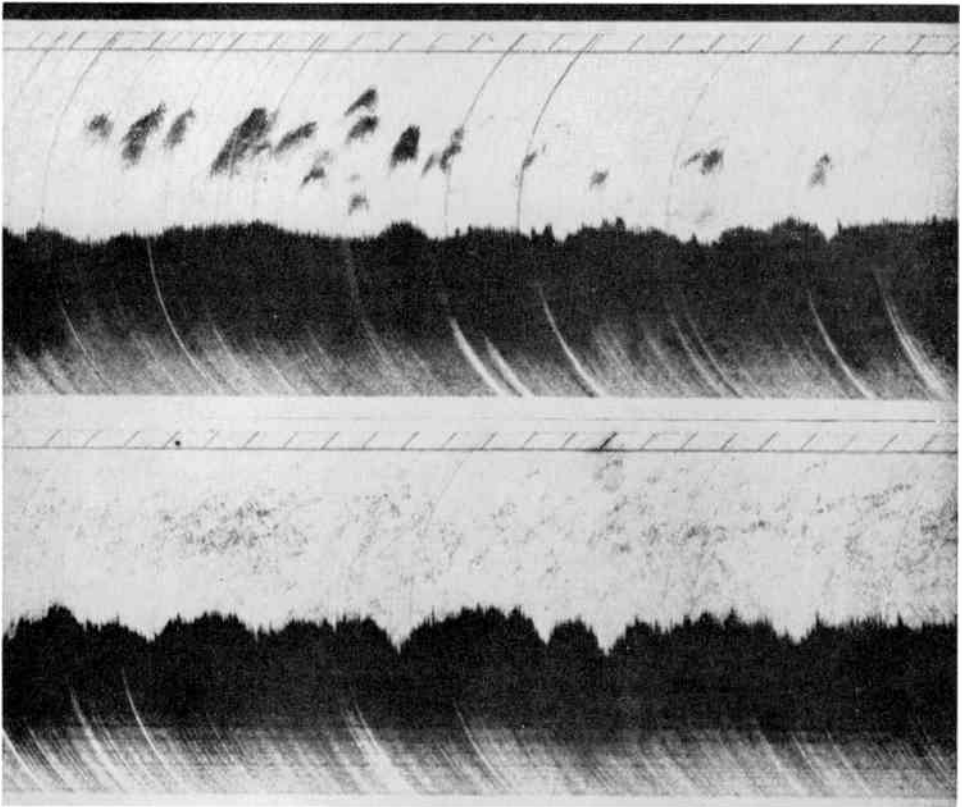
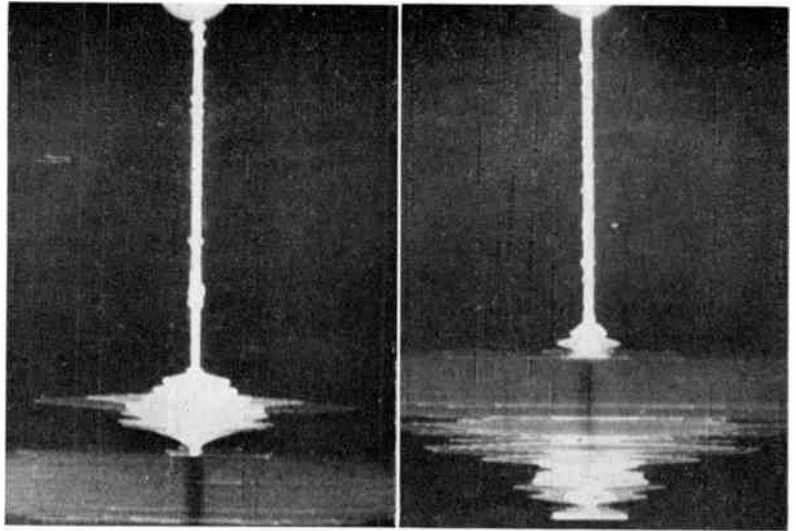

Fig. 24.—Echo-sounder records showing cod.

Fig. 25.—Two unrectified A-scan traces showing fish near the sea-bottom: depth of water about 30 fathoms, but the length of the trace corresponds to only 7 fathoms.



is operated. A wide range of brilliance and ambient illumination and of amplitude of deflection can be tolerated. The choice of the horizontal scale is, however, somewhat more critical, and if the length of the pulse as seen on the screen is very small, then the eye behaves as a low pass filter, and tends to smooth out the pulse, thus worsening detection.¹⁷ The pulse length on the screen should not be smaller than about 1 mm.

4.4. *The Cathode-Ray Display with Intensity-Modulation*

The cathode-ray display can be used with intensity modulation in several ways. The usual method is to take advantage of the possibility of having a two-dimensional presentation, that is to say, range and bearing can be displayed on Cartesian or polar co-ordinates. If Cartesian co-ordinates are used, the display is usually called the B-scan; polar co-ordinates give the p.p.i. (plan-position-indicator). The p.p.i. system is almost universal with radar sets, but is not quite so attractive with asdic, because firstly, in searching for a target, such as a fish shoal, one is generally concerned only with the sector lying ahead of the ship; secondly, even if an all-round search were made, so much time would elapse between successive rotations that the p.p.i. would not at any one time present a complete picture. However, if only a sector of the p.p.i. is used, these objections do not apply,

but the B-scan would generally be found superior, because it would avoid crowding of information from short ranges. One commercial asdic set has used a p.p.i. display successfully, but this may be because it is a high-frequency, short-range set. Two interesting photographs of results obtained with it are shown in Fig. 26. The maximum range on these photographs is 400 feet (120 m).

When the p.p.i. or B-scan displays are used successive sets of information, i.e. from successive searches, have to be displayed on top of one another. There will in general be some effect of integration from scan to scan due to the afterglow of the screen, but, whereas in radar successive pictures can be superposed relatively rapidly, in asdic the intervals are often so large that the effect of integration is lost. Nevertheless, some improvement of detection is obtained through the operator's ability to correlate successive pictures with one another and thus observe where the consistent echoes occur and ignore the random background.⁵⁷

It has already been pointed out in Section 4.2 that another way of using the intensity-modulated cathode-ray display is to make it present the same picture as the chemical recorder; that is to say, successive traces from the same bearing are recorded side by side. When this is done the same results are obtained as with the chemical recorder⁸, provided the afterglow is sufficient to enable a reasonable

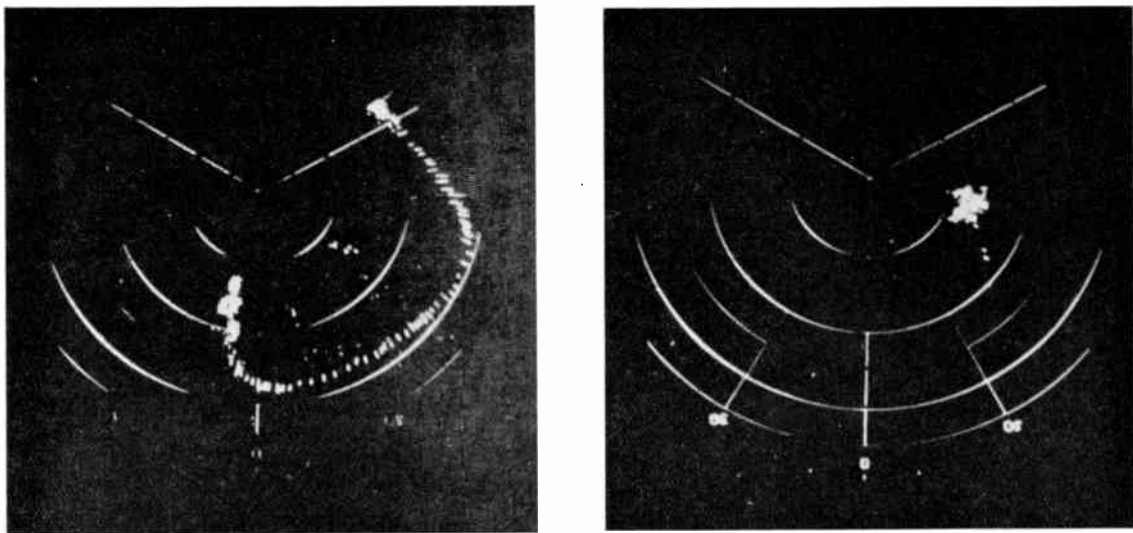

Fig. 26.—Two p.p.i. displays obtained on the "Sea-Scanar" equipment :
 (a) a pursa seine net being towed, with a few salmon in it.
 (b) a small shoal of herring.

The pattern of circles and lines is that of the range and bearing markers.

length of line to be visible at any one time. From the point of view of efficiency of detection, this display has a great deal to commend it, since it has the advantages of the chemical recorder in giving efficient detection without the disadvantage of using large quantities of expensive paper. No cathode-ray display gives a permanent record and in some applications the chemical recorder has an overwhelming advantage through avoiding the necessity of constant watching of the display.

4.5. Some Limitations of Intensity-Modulated Displays

Both the chemical recorder and the cathode-ray display with intensity modulation have a serious disadvantage compared with the A-scan due to their limited "dynamic range." There is a limited range of response between a signal which just causes a mark and that which causes saturation. It is essential that this limited range is used efficiently and that the applied signal voltages are subject to some efficient kind of automatic volume control so that they lie within this range, except where it can be shown that some part of the signal voltage range contains very little information about the target.

It can be shown¹⁹ that the lower end of the range of signal voltages contributes little to the detection of the target signal and therefore a certain amount of "contrast"—usually obtained by bias—benefits detection.

Any calculation of the response of an intensity modulated display involves a consideration of what are known as "just-noticeable-differences" or JND's. The JND is the increment of voltage or current which causes a just noticeable change in the marking of the display. When the number of such steps contained in the dynamic range of the display is small, then detection is worsened. Unfortunately the investigation of this subject is difficult, and no complete study has yet been made. It can, however, be said with confidence that the number of JND's provided by the chemical recorder paper or by the phosphor of the cathode ray tube is a measure of its efficiency. The matter is discussed fairly fully in Ref. 19.

4.6. The Effect of the Shape of the Target Signal as Displayed^{8,57}

Whatever the type of display used, the threshold of detection is affected by the shape of the target signal as presented on the display

relative to the random background. We have already seen that extending the target signal in one dimension on the chemical recorder by the juxtaposition of successive traces gives an improvement of threshold of 2.4 db for each doubling of the length of line. Inspection of such a trace when the background is uniformly-random noise shows that the same result must necessarily have been obtained if the line had been produced by extending the pulse in range and not from trace-to-trace. It is thus probable that increasing the pulse duration while leaving the bandwidth and therefore the structure of the noise background unchanged would lead to an improvement of detection of 2.4 db per doubling. It must be emphasized that this result would be obtained only when the background is noise, because when it is reverberation it would have a structure dependent upon the pulse length.

As far as A-scans are concerned increase in the pulse duration, while leaving the background unchanged, improves detection in a similar way.

4.7. *The Choice of Bandwidth and Pulse Duration*

We have already discussed in Section 2.5 some factors affecting the choice of pulse duration. We have seen that a short pulse is required to delineate a small target and that reducing the duration of a pulse in general improves the echo/reverberation ratio. On the other hand, reducing the pulse length necessitates the use of a wider bandwidth in the receiver and this increases the level of thermal noise. Moreover, the benefit of shortening the pulse may be lost—in fact performance may actually be worsened—when the pulse duration as displayed on the chemical recorder or on the intensity modulated cathode-ray display is short compared with the stylus width or the spot size;²⁰ in this case the display acts as a low-pass filter smoothing the signals.

It is usually desirable to consider pulse duration in relation to the size of target expected and in relation to the manner of echo formation described in Section 2.4.* The interval of range from which simultaneous returns are received is about 2.5 ft. (0.75 m) for a pulse of 1 millisecond duration.

The choice of bandwidth is of course primarily related to the pulse duration. When only fixed or stationary targets are to be detected, a bandwidth (in c/s) of the reciprocal

of the pulse duration (in seconds) is near the optimum.¹⁴ When moving targets, such as whales, have to be detected, allowance must be made for the shift of frequency due to the Doppler effect, and this means an increase in the bandwidth. The change of frequency due to target motion in the direction of the acoustic beam is about 0.65 c/s per knot per kc/s.

5. Conclusion

The author has attempted to review the whole subject of underwater echo-ranging as comprehensively as possible within the limitations of the published literature, and of the information supplied by commercial organizations, on which sources alone this paper is based. A middle course has been necessary between the extremes of "hardware" on the one side and abstract theory on the other, although there is much of interest at both extremes. For example, the practical problems of arranging trunks through the ship's hull and of stabilizing the transducers against roll and pitch and yaw are of considerable magnitude and importance. The fundamental theory of information and its application to the detection of signals in a noisy background⁵³ is also of great interest and importance not only in showing some of the basic limitations of echo-ranging systems, but also in pointing the way to the efficient exploitation of a system's potentialities.

There seems no doubt that underwater echo-ranging will find ever-widening fields of application, but a great deal of research is still necessary, perhaps most of all in those aspects of the subject where acoustics and oceanography are linked together.

The scientific relationships between underwater echo-ranging and forms of industrial ultrasonics⁴—such as flaw detection in castings—may have occurred to readers, but there is little relationship in most of the practical details.

* In the case of echo-ranging on fish shoals, which may be large diffuse targets, the pulse duration can probably with advantage be much greater than is normally used, since there is little hope of accurate delineation of the shoal unless pulse durations much shorter than normal are used. If it is desired to retain a fairly short pulse in the hope of detecting small targets also, then a second display which uses a low-pass filter (i.e. smoothing) after the rectifier might give better detection of large shoals of low density; this is because it smooths out the random envelope, leaving a clear difference in the mean levels (target present—target absent) which is the only factor by which the target can be detected. (See Section 2.5)

6. Acknowledgments

The author is grateful to many people for helpful discussions and information. In particular he would like to mention Mr. W. Halliday of Kelvin & Hughes Ltd., who provided Figs. 10, 11, 21 and 24; Mr. R. Woodgate of Pye Marine Ltd., who provided Figs. 7, 8 and 25; Mr. C. M. Good of Minneapolis-Honeywell Regulator Co., who provided Figs. 9 and 26 and several useful references; and Dr. D. H. Cushing of the Fisheries Laboratories, Lowestoft, Dr. J. N. Carruthers of the National Institute of Oceanography, and Mr. W. K. Grimley of H.M.U.D.E., who each provided several important references.

7. References

(All these references, with the exception of Nos. 45 and 47, have been inspected by the author and their relevance confirmed.)

1. A. P. Hilar, "Sonar" (U.S.N. Publication, OPNAV P413-104, given to Press 6th April, 1946).
2. Brief reference to Asdic in Surveying: Paper by Vice-Admiral Day in *International Hydrographical Review*, 32, p. 9, May 1955.
3. F. V. Hunt, "Electroacoustics," pp. 44-53 (Harvard University Press, Cambridge, 1954).
4. A. E. Crawford, "Ultrasonic Engineering" (Butterworth, London, 1955).
5. J. A. B. Davidson, "Facsimile transmission of weather charts and other material by landline and radio," *J. Brit.I.R.E.*, 16, p. 115, March 1956.
6. J. W. R. Griffiths and I. G. Morgan, "The chemical recorder and its use in detecting pulse signals in noise," *J. Soc. Instrum. Tech.*, in course of publication.
7. D. G. Tucker and J. W. R. Griffiths, "Detection of pulse signals in noise," *Wireless Engr*, 30, p. 264, 1953.
8. P. McGregor, "A note on trace-to-trace correlation in visual displays," *J. Brit.I.R.E.*, 15, p. 329, 1955.
9. S. C. Sparling, "Echo-Sounder Engineering" (Kelvin-Hughes, London, 1945).
10. D. N. Keep, "Frequency-modulation radar for use in the mercantile marine," *Proc. Instn Elect. Engrs*, 103, Part B, 1956.
11. D. G. C. Luck, "Frequency Modulated Radar" (McGraw-Hill, New York, 1949).
12. J. E. Pateman, British Provisional Patent No. 11868, 1954.
13. M. P. Fish, A. S. Kelsey and W. H. Mowbray, "Studies on the production of underwater sound by North Atlantic coastal fishes," *J. Marine Res.*, 11, p. 180, 1952.
14. J. W. R. Griffiths and A. H. Pryor, "Underwater acoustic reverberation," in course of publication.
15. "Physics of Sound in the Sea" (N.R.D.C., Washington, 1947).
16. D. G. Tucker, "Some aspects of the design of strip arrays," *Acustica*, in course of publication.
17. J. L. Lawson and G. E. Uhlenbeck, "Threshold Signals," M.I.T. Radiation Laboratory Series, Vol. 24 (McGraw-Hill, New York, 1950).
18. D. G. Tucker, "Signal/noise performance of multiplier (or correlation) and addition (or integrating) types of detector," Institution of Electrical Engineers Monograph 120R, February 1955.
19. D. G. Tucker and J. W. R. Griffiths, "Detection of pulse signals in noise: theory of intensity-modulated display in terms of just-noticeable differences," *Wireless Engr*, 32, p. 290, 1955.
20. J. W. R. Griffiths and D. A. White, "The effect of stylus size on the performance of a chemical recorder," *International Hydrographical Review*, in course of publication.
21. G. J. Sonnenberg, "Radar and Electronic Navigation," Chapter 2 (Newnes, London, 1955).
22. A. B. Wood, "A Textbook of Sound," p. 262 (Bell, London, 1949).
23. R. T. Beyer, "Formulas for sound velocity in sea water," *J. Marine Res.*, 13, p. 113, 1954.
24. R. W. Raitt, "Sound scatterers in the sea," *J. Marine Res.*, 7, p. 393, 1948.
25. N. B. Marshall, "Bathypelagic fishes as sound scatterers in the ocean," *J. Marine Res.*, 10, p. 1, 1951.
26. G. H. Tucker, "Relation of fishes and other organisms to the scattering of underwater sound," *J. Marine Res.*, 10, p. 215, 1951.
27. J. B. Hersey, H. R. Johnson and L. C. Davis, "Recent findings about the deep scattering layer," *J. Marine Res.*, 11, p. 1, 1952.
28. V. O. Knudsen, R. S. Alford and J. W. Emling, "Underwater Ambient Noise," *J. Marine Res.*, 7, p. 410, 1948.
29. M. W. Johnson, "Sound as a tool in marine ecology, from data on biological noises and the deep scattering layer," *J. Marine Res.*, 7, p. 443, 1948.
30. P. Rudnick and J. D. Cochrane, "Diurnal fluctuations in bathythermograms," *J. Marine Res.*, 10, p. 257, 1951.
31. "Radio communications and navigational aids to shipping," *Communications and Electronics*, 1, p. 36, December 1954.
32. "Missing herring shoals," *The Times*, 31st October 1955.
33. W. C. Hodgson and I. D. Richardson, "The experiments on the Cornish pilchard fishing in 1947-8," *Fishery Investigations*, Series II, 17, No. 2 (H.M. Stationery Office, London, 1949).
34. D. H. Cushing, F. Devold, J. C. Marr and H. Kristjonsson, "Some modern methods of fish detection," *F.A.O. Fisheries Bulletin*, 5, 1952 (Food and Agriculture Organization of the United Nations, Rome).

35. H. Kristjonsson, "A Brief Survey of the Fisheries on the Black Sea Coast of Turkey," General Fisheries Council for the Mediterranean, Technical Paper No. 44, 1954.
36. "Census of fish populations . . .," *Commercial Fisheries Rev.*, 16, p. 25, November 1954 (U.S. Fish and Wildlife Service).
37. D. H. Cushing, "Echo sounding and fishery research," *The Listener*, 52, p. 170, 1954.
38. D. H. Cushing and I. D. Richardson, "Echo sounding experiments on fish," *Fisheries Investigations*, Series II, 18, No. 4 (H.M. Stationery Office, 1955).
39. D. H. Cushing, "Some echo-sounding experiments on fish," *J. Conseil International pour l'Exploration de la Mer*, 20, p. 266, 1955.
40. I. D. Richardson and D. H. Cushing, "New echo-sounding methods at Bear Island," *World Fishing*, London, October 1955.
41. C. M. Good, "Considerations in the application of asdic to commercial fisheries problems," *World Fishing*, London, 1956. (In the press.)
42. G. Dietrich, "Die natürlichen Regionen von Nord und Ostsee auf hydrographischer Grundlage," *Kieler Meeresforschungen*, 7, p. 35, 1950.
43. G. Dietrich, "Influences of tidal streams on oceanographic and climatic conditions in the sea as exemplified by the English Channel," *Nature*, 168, p. 8, 7th July 1951.
44. E. Goedecke, "Über Intensität und Jahresgang der thermohalinen Schichtung in der Deutschen Bucht," *Veröff. des Inst. für Meereskunde in Bremerhaven*, 1, p. 236, 1952.
45. "Summary of North Atlantic Weather Station Bathythermograph Data, 1946/1950," A. and M. College of Texas Tech. Rep., 3, 1952.
46. J. J. Schule, "Effects of Weather upon the Thermal Structure of the Ocean," U.S. Naval Hydrographic Office, Misc. 15360, 1952.
47. "Atlas der Klimatologischen, geographischen und ozeanographischen Faktoren der Nordsee und der angrenzenden Gewässer," Deutsche Demokratische Republik, Seehydrographischer Dienst, Hydro-Meteorologisches Institut, Berlin, 1953.
48. K. Kalle, "Zur Frage der inneren thermischen Unruhe des Meeres," *Deutsche Hydrographische Zeitschrift*, 6, Nos. 4, 5, 6, Hamburg, 1953.
49. G. Dietrich, "Einfluss der Gezeitenstromturbulenz auf die hydrographische Schichtung der Nordsee," *Archiv für Meteor., Geophys. and Bioklimatologie*, Serie A (Met. and Geophys.), 7, p. 391, 1954.
50. W. P. Mason, "Piezo-Electric Crystals and their Application to Ultrasonics" (Von Nostrand, New York, 1950).
51. F. A. Fischer, "Fundamentals of Electroacoustics" (translated by S. Ehrlich and F. Pordes) Interscience Publishers, New York, 1955.)
52. P. Vigoureux and C. F. Booth, "Quartz Vjbrators" (H.M. Stationery Office, London, 1950).
53. P. M. Woodward, "Probability and Information Theory, with Applications to Radar" (Pergamon Press, London, 1953).
54. C. F. Eyring, R. J. Christensen and R. W. Raitt, "Reverberation in the sea," *J. Acoust. Soc. Amer.*, 20, p. 462, 1948.
55. L. N. Liebermann, "Reflection of underwater sound from the sea surface," *J. Acoust. Soc. Amer.*, 20, p. 498, 1948.
56. R. J. Urick, "The backscattering of sound from a harbor bottom," *J. Acoust. Soc. Amer.*, 26, p. 231, 1954.
57. "Human Factors in Undersea Warfare," Nat. Research Coun., Washington, 1949.
58. L. E. Kinsler and A. R. Frey, "Fundamentals of Acoustics," Chap. 15 (Chapman and Hall, London, 1950).
59. L. Bergmann, "Ultrasonics" (Bell, London, 1938).
60. P. Vigoureux, "Ultrasonics" (Chapman and Hall, London, 1950).
61. "Keeping an Electronic Eye on Fish," *The Times*, p. 5, 6th February, 1956.
62. O. Pratzje and F. Schüler, "Bodenkartierung des Seegebietes Hoofden (Südliche Nordsee) mit Hilfe von Grundproben und Echogrammen," *Deutsche Hydrographische Zeitschrift*, 5, p. 189, 1952.
63. F. Schüler, "Untersuchung über die Mächtigkeit von Schlickschichten mit Hilfe de Echographen," *Deutsche Hydrographische Zeitschrift*, 5, p. 220, 1952.
64. M. Blackburn, "Some scattering layers of heteropods," *Nature*, 177, p. 374, 25th February, 1956.
65. F. Schüler, "On the accuracy of configuration of sea-bottom profiles with high-frequency echo sounders," *Int. Hydrographic Rev.*, 29, p. 126, 1952.
66. D. H. Cushing and I. D. Richardson, "A record of plankton on the echo-sounder," *J. Mar. Biol. Assn. U.K.*, 35, p. 231, 1956.

APPLICANTS FOR MEMBERSHIP

New proposals were considered by the Membership Committee at a meeting held on May 10th, 1956, as follows: 15 proposals for direct election to Graduateship or higher grade of membership, and 38 proposals for transfer to Graduateship or higher grade of membership. In addition, 65 applications for Studentship registration were considered. This list also contains the names of four applicants who have subsequently agreed to accept lower grades than those for which they originally applied.

The following are the names of those who have been properly proposed and appear qualified. In accordance with a resolution of Council and in the absence of any objections being lodged, these elections will be confirmed 14 days from the date of the circulation of this list. Any objections received will be submitted to the next meeting of the Council with whom the final decision rests.

Direct Election to Member

HITCHCOX, Gerald Ivor. *London, S.W.13.*

Transfer from Associate Member to Member

MADDUX, Herbert Frederick. *Pinner Hill.*

Direct Election to Associate Member

HEATH, Richard Charles. *Kingston-on-Thames.*
KIRKHAM, Peter. *Sydney, N.S.W.*

Transfer from Associate to Associate Member

COOK, Lieut.-Com. Dennis John, R.N. *Arundel.*
LOWE, Albert. *Karachi.*
SIMPSON, Arthur Ian Forbes, M.B.E. *Leamington Spa.*
STAMOPOULOS, Charalambos Denis, M.Sc. *Sao Paulo.*

Transfer from Graduate to Associate Member

EDGAR, Ronald Ian. *Romford.*
QUIRK, William James. *Carshalton.*
SHORT, Harry, B.Sc. *Stoke-on-Trent.*
SMITH, Darrell Alfred. *Oxford.*
TAWADEY, Capt. Ashok Bapuji, B.Sc., Indian Sigs. *New Delhi.*
TAYLOR, Robert William. *London, W.5.*
WADDELL, Gavin. *Cheadle.*

Transfer from Student to Associate Member

PIERCEY, Alfred William S. *Cheltenham.*

Direct Election to Associate

FONG YAN, Alick. *Hong Kong.*
SPACEY, Sqdn. Ldr. William Alfred, R.A.F. *Bromham, Wilts.*
SULLY, Ernest Frank. *Cardiff.*
WOODVINE, William Orlando. *Newark.*

Transfer from Student to Associate

BROWN, Frank Ridley. *Arbroath.*
MYLONOPOULOS, Evangelos. *Athens.*

Direct Election to Graduate

BECKETT, George Walter. *London, S.W.12.*
CLAYTON, Leonard. *Nairobi, Kenya.*
FOGARTY, Michael John. *Southend-on-Sea.*
GILES, Henry Alfred. *London, S.W.13.*
TROTMAN, Donald Rex, B.Sc. *West Bridgford.*

Transfer from Student to Graduate

ATKINS, Peter James, B.Sc. *Woodley, Berks.*
BAKER, Charles Thomas. *London, S.W.6.*
CLARKE, Arthur Philip Blake R.A.F., *Medmenham.*
ISMAIL, Sulman. *Basrah.*
RAMACHANDRA RAO, N., B.Sc. *Trichinopoly.*
SEALE, Edward Gilbert. *Terlure, Co. Dublin.*
VENKATESWARLU, Uppala, B.A. *Bombay.*
WADDINGTON, Damer Evelyn O'Neill. *Mool River, Natal.*
WALKER, Roderick William. *Newcastle-on-Tyne.*

STUDENTSHIP REGISTRATIONS

AGRAWAL, Jagdish Behari. *I.A.F., Agra.*
ANANDA, M. V., B.Sc. *Bangalore.*
ANWAR, Salahuddin Nurul, B.Sc. *London, N.W.6.*

ARORA, Surendra Prakash. *New Delhi.*
ARUNACHALAM, Haniyur Srinivasadas. *Bombay.*
ATKINS, John Robert Rawson. *Devonport, Tasmania.*

BALASUBRAMANIAN, K., B.Sc. *I.A.F., Kanpur.*
BALFRE, Paul Victor. *London, S.W.16.*
BHALLA, Parkash Chander. *Calcutta.*
BHOGENDRA KRISHNA, V. K., B.Sc. *Bangalore.*

BOWEN, Trevor. *B.A.O.R. 19.*
BRACE, William James. *Newport, Mon.*
BROOKES, Plt. Off. Stephen Stuart. *R.A.F., Sheffield.*
BUNYAN, Stanley Andre. *Baghdad.*

CHAUDHARI, Nagesh Ganpatrao, B.Sc. *Bombay.*

DE BRUYNE, Pieter. *The Hague.*
DE SYGTER, Trevor Norman. *London, W.C.2.*
DU PLESSIS, Isak Dawid. *Pretoria.*

FLANAGAN, Robert Gerald Patrick. *Stillorgan, Co. Dublin.*
FOOT, George Owen. *Hertford.*

GRICE, William Henry. *London, W.13.*
GUHA, Nirmal Chandra, B.Sc.(Hons.), M.Sc., *Sodepore, West Bengal.*

HOLE, Denis Reginald. *Shoreham-By-Sea.*
HORE, Lalmohan, B.Sc.(Hons.), M.Sc. *Calcutta.*

IBRAHIM, Tipu Mohamed, B.Sc. *Bangalore.*
ISRANI, Indur Kumar P. *Poona.*

JACKSON, Brian David. *Dododa, Tanganyika.*
JAIN, Jagdish Chandra. *Delhi.*
JAIN, Sant Perkash. *Hissar, Punjab.*
JOSHI, Devendra. *Bombay.*

KANWAR, Satyapal Singh. *I.A.F., Bangalore.*
KAPOOR, Gopal Krishan. *Ambala.*
KARUNATILAKE, Kusa Basnayake Mudiyan-selara A. *Kandy.*
KENTLEY, Eric William. *Harlow, Essex.*
KHARBANDA, Gopal Dass. *Agra.*

LAKSHMINARAYANAN, Thirunillai Mahadevan, B.Sc. *Olavakkot, South India.*
LANGDON, Paul Stephen Moriarty. *Malvern.*
LAWRENCE, Brian Richard Henry. *Dagenham.*

MCDONNELL, William George. *Liverpool.*
MALHOTRA, Madan Mohan. *Delhi.*
MATTA, Sushil Kumar, B.Sc. *New Delhi.*
MISRA, Girish Chandra. *I.A.F., Bangalore.*
MUKHERJEE, S. S. *I.N.S. Ranjit.*

NAGARAJA RAO, B. K., B.Sc. *Bangalore.*
NAMBUDIRIPAD, T. M. Sankaranarayanan. *B.Sc. Cherpuichery, S. Malabar.*
NORMAN, Malcolm Roderick. *Ilford.*

QURESHI, Capt. Mohd Aslam. *Rawalpindi.*

RANSON, Brian Malcolm. *Ilford.*
RYAN, Thomas Philip. *Dublin.*

SADASIVA DASS. *I.A.F., Ambala.*
SAEED AHMAD BUTT. *Lahore.*
SASTRY, Nukala Venkata, B.A. *Kurnool, South India.*

SEN, Rabindranath. *Saharpura, Bihar.*
SILVERTON, John Edward. *London, N.W.10.*
STICKLER, Gordon Alan. *Newport, Mon.*
SURI, Sham Lal. *Bombay.*

TAYLOR, Kenneth Henry. *West Bridgford.*
THOMAS, Kenneth Francis. *New Delhi.*
THOMPSON, Brian. *Coventry.*
TOEG, Haim. *Iafa.*

VENKITCHALAM, Y., B.Sc. *Bombay.*
VIRDI, Harish Singh. *Lucknow.*

WALKER, Robert Anthony. *London, N.W.11.*
WHEELER, Frank Alfred. *Pietermaritzburg.*
WHITING, Capt. John. *Rawalpindi.*

SOME REMARKS ON THE RADIO-FREQUENCY PHASE AND AMPLITUDE CHARACTERISTICS OF TELEVISION RECEIVERS*

by

A. van Weel, Dr. Techn. Sc. †

SUMMARY

The influence on the picture of the steady state characteristics of the radio frequency part of a television receiver is considered especially for the frequencies close to the carrier frequency (the so-called Nyquist flank). It follows from numerical calculations that the shape of the amplitude characteristics of this Nyquist flank has but little influence on the picture quality. The performance of a receiver will be substantially the same in combination with a double-side band transmitter as with a vestigial-sideband transmitter, provided the latter has been compensated for its own phase errors. The performance of a vestigial-sideband transmitter should be monitored with a phase-linear receiver, of which the exact shape of the Nyquist flank is not very critical.

1. Introduction‡

The theoretical conception of the television-transmission method on which the various television standards are based is simple and straightforward. In the so-called "Gerber Standard," the hypothetical amplitude characteristics for transmitter and receiver are as shown in Fig. 1; the phase characteristics of the transmitter and the receiver are not specified and should therefore be presumed to be linear. Nobody expects that either a transmitter or a receiver can be made exactly according to these hypothetical characteristics, nor is this necessary to ensure a good picture on the receiver.

1.1. Radio frequency amplitude and phase characteristics of the transmitter

As far as the transmitter is concerned, the broadcasting authorities of each country ultimately specify a tolerance scheme for the amplitude curve, as has for instance been depicted in Fig. 2, which gives the tolerances for the transmitter-amplitude curve as prescribed by the Nord-West Deutscher Rundfunk (N.W.D.R.).¹ As can be seen in this figure, the tolerance scheme at the vestigial-sideband of the carrier frequency leaves space for different shapes of the amplitude characteristics, such as can be realized by different kinds of vestigial-sideband filters.

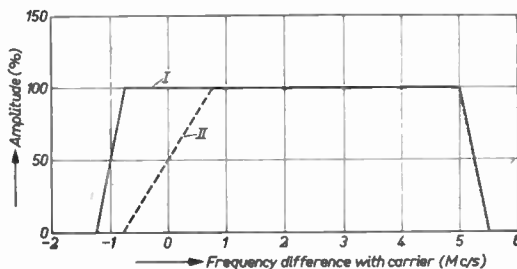

Fig. 1.—Amplitude characteristic of transmitter (curve I) and receiver (curve II) according to the "Gerber Standard."

The phase characteristic in this part of the frequency band depends of course on the kind of vestigial-sideband filter used but for all filters of which details have been published it is markedly non-linear.^{2, 3} Large group-delay variations and the corresponding phase errors are measured in the vestigial-sideband at frequencies close to the cut-off frequency. Phase equalization in the radio-frequency part of the transmitter is, in view of the large power to be handled, considered to be technically impossible. Therefore, these phase errors have to be compensated for in the video-frequency part of the transmitter.

* Manuscript received 16th January, 1956 (Paper No. 354).

† Philips Research Laboratories, N.V. Philips' Gloeilampenfabrieken, Eindhoven, Netherlands.

U.D.C. No. 621.397.5.

‡ This paper is based on the "Gerber Standard" for the European 625-line system. It can be expected that the conclusions hold for the British 405-line system as well, because the phase errors in transmitters or receivers for this system need not be larger.

However, the influence of the radio-frequency phase errors introduced by the transmitter on the ultimate video-frequency signal and therefore the output of the demodulator in a receiver depends on the shape of the amplitude characteristic of the receiver in the neighbourhood of the carrier frequency.⁴ This part of the amplitude characteristic is sometimes

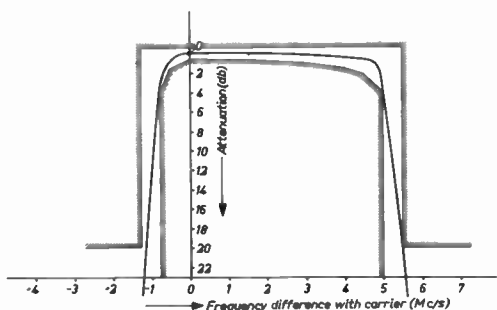

Fig. 2.—Tolerances for the amplitude characteristic of a transmitter according to a N.W.D.R. specification.

referred to as “Nyquist flank.” A simple hypothetical example may illustrate this dependence on the Nyquist flank. For this purpose a vestigial sideband characteristic with the lower sideband attenuated is considered.

Let us suppose the phase curve in the higher sideband to be linear and in the lower sideband to be linear as far as a certain frequency, for example -0.5 Mc/s, and that it presents pronounced non-linearities at frequencies beyond -0.5 Mc/s. The group-delay curve is in this case flat for frequencies to -0.5 Mc/s and shows a deviation at frequencies beyond -0.5 Mc/s (Fig. 3).

A receiver with a steep Nyquist flank, which would effectively suppress all frequencies beyond -0.5 Mc/s (curve I in Fig. 3) would not be influenced by the phase errors of this transmitter however large these might be. But these phase errors would influence the picture of any receiver with a Nyquist flank of smaller slope and which therefore would pass frequencies beyond -0.5 Mc/s (curve II in Fig. 3).

As a consequence of this dependence on the Nyquist flank, the transmitter designer is confronted with the problem of choosing the shape of the Nyquist-flank at the receiver side in order to compensate for the phase errors of the vestigial-sideband filter.

A possible solution is to maintain the linear Nyquist-flank of Fig. 1 as a “standard” receiver. Theoretically the situation is then determined and the necessary video-frequency compensation in the transmitter of the phase errors of the vestigial-sideband filter could be calculated exactly.

However, this only transfers the difficulties to the receiver, and even then the transmitter designer does not escape from the problem because he has to provide a monitor receiver for the transmitter. The practice of the phase compensation of a transmitter will, in many cases, be, that the final adjustment of the phase predistortion is made using the picture quality on the monitor receiver as an indicator.

1.2. Radio-frequency amplitude and phase characteristics of the receiver

Therefore a monitor receiver should be available with a Nyquist-flank closely following the linear characteristic of Fig. 1, but which should not introduce phase errors itself. The approximation of the necessary linear amplitude characteristic can, to a reasonable degree, be achieved by circuits which are not too intricate. However, the phase characteristic of such a receiver will in general be markedly non-linear. Therefore the receiver should be provided with a phase-equalizing network, which could in this case be inserted in the carrier frequency part either at the transmitter frequency itself or after frequency conversion, because the receiver does not need to handle power. Video-frequency compensation is therefore not necessary.

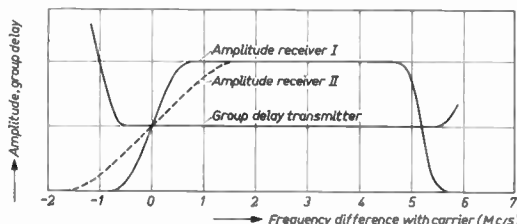
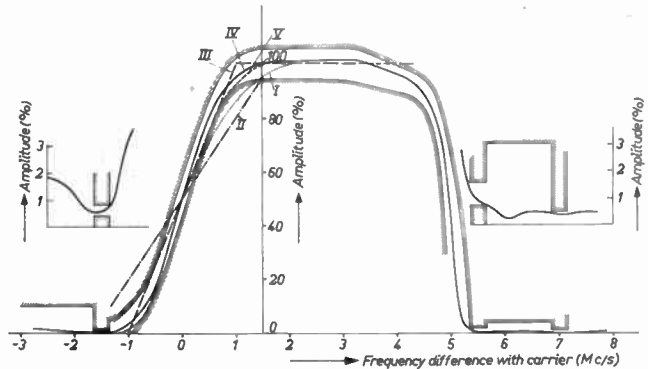

Fig. 3.—Influence of the transmitter-group-delay errors will be present in receiver II and not in receiver I.

As far as the author knows, this solution has not been used in practice. This is probably due to the fact that the transmitter designer is aware of the presence of phase errors in conventional receivers. He may therefore suppose

Fig. 4.

Amplitude curves of a practical phase-linear receiver (I), two hypothetical phase-linear receivers (II and III), the N.W.D.R.-model receiver (IV) and a conventional receiver (V), together with the tolerances of the N.W.D.R. model receiver.



that the phase-errors of his monitor receiver will not differ too much from those of an "average" receiver, if such a receiver could be defined. Or, alternatively he may just use one conventional receiver to monitor the transmitted picture and adjust the phase compensation. The owners of this type of receiver would certainly be pleased with the picture; however, other receivers which might have far better characteristics would show a worse image. The author found, as a result from group-delay measurements made on a number of receivers of different makes, that very large variations between different receivers do exist.

1.3. Different solutions for the non-linearity of the receiver phase characteristics

A well defined way out of these difficulties is proposed by the N.W.D.R. in Germany.⁵ A model receiver has been defined, which guarantees a certain selectivity (especially as regards the suppression of the adjacent sound carrier), and of which the Nyquist-flank is specified with certain tolerances (curve IV in Fig. 4) whereas the group-delay characteristic has also to be given (curve IV, Fig. 5). The substantial phase-errors present in this model receiver are compensated for in the video-frequency part of the transmitter together with the phase errors introduced by the vestigial-sideband filter. A receiver built according to these specifications will give a good picture, provided it is carefully tuned to the carrier frequency of the transmitter.

Recent developments in receiver technique,⁶ however, have shown that it is possible to build receivers which, while satisfactorily answering selectivity demands, do present a

linear intermediate-frequency phase curve. These receivers are in no way more complicated than the conventional receiver. According to the principle that in a chain of communication equipment, each part should be self-contained in that it does not introduce errors which have to be compensated in another part of the chain, such a phase-linear receiver gives the best solution.

The amplitude characteristic of the phase-linear receiver has a Nyquist-flank with a rather flat slope (curve I in Fig. 4), which therefore extends over a wide frequency band. With such a receiver the phase errors of the vestigial-sideband filter, which are very pronounced in the frequency band between -0.5 and -0.1 Mc/s, would have a disturbing influence on the overall performance.

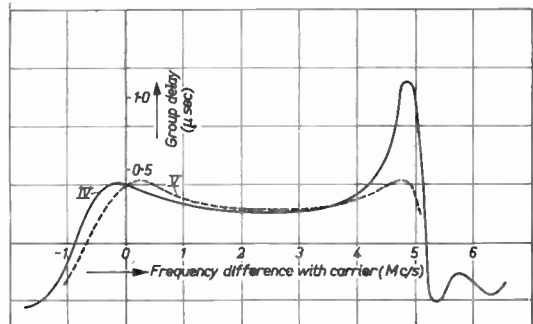

Fig. 5.—Group-delay characteristics of the N.W.D.R.-model receiver (IV) and a conventional receiver (V).

To investigate this effect, the influence of various shapes of the Nyquist-flank of the receiver on the resulting phase and amplitude

errors of various transmitter-receiver combinations has been studied. The calculations made for this purpose are given in the following section; the numerical results show that this influence is remarkably small. The consequences for transmitter and receiver design will be discussed, and are summarised in some conclusions given in the last section.

2. Calculation of Modulation-Amplitude and Modulation-Phase Characteristics

The modulation amplitude and phase characteristics, such as would be measured at the output of an ideal amplitude detector, can be calculated from the radio-frequency amplitude and group-delay characteristics of the combination transmitter with vestigial-sideband filter and receiver.

We will limit our considerations for the present to small modulation depths; in a later section we will deal with large modulation depths. The formula for modulation amplitude (A) at angular video frequency p is, for small modulation depth⁷:

$$A(p) = (a_1 + a_2) \sqrt{1 - \frac{4a_1a_2}{(a_1 + a_2)^2} \sin^2 \frac{(\Delta\varphi_2 - \Delta\varphi_1)}{2}} \approx (a_1 + a_2) [1 - \frac{1}{2} a_1a_2 (\Delta\varphi_2 - \Delta\varphi_1)^2] \dots\dots\dots(1)$$

The quantities a and $\Delta\varphi$ are shown in Figs. 6a and 6b; the sign of $\Delta\varphi_1$ and $\Delta\varphi_2$ should be chosen positive or negative according to the indications in Fig. 6b.

The modulation phase angle $\Delta\psi$ and phase delay ($\Delta\tau_p$) follow from

$$\tan \Delta\psi = \frac{a_1 \sin \Delta\varphi_1 + a_2 \sin \Delta\varphi_2}{a_1 \cos \Delta\varphi_1 + a_2 \cos \Delta\varphi_2} \dots\dots\dots(2)$$

$$\Delta\psi \approx \frac{a_1 \Delta\varphi_1 + a_2 \Delta\varphi_2}{a_1 + a_2} \dots\dots\dots(3)$$

$$\Delta\tau_p = \frac{\Delta\psi}{\omega_{\text{video}}} \approx \frac{a_1 \Delta\tau_{p1} + a_2 \Delta\tau_{p2}}{a_1 + a_2} \dots\dots\dots(4)$$

The last equation gives a relationship between the modulation-phase delay $\Delta\tau_p$ and the "sideband modulation phase delays" $\Delta\tau_{p1}$ and $\Delta\tau_{p2}$, the latter being defined by

$$\Delta\tau_{p1,2} = \frac{1}{\pm p} \int_{\omega_0}^{\omega_0 \pm p} \Delta\tau_{\nu} d\omega, \dots\dots\dots(5)$$

with ω_0 = angular frequency of the carrier and $\Delta\tau_{\nu}$ variation of radio-frequency group-delay (see Fig. 6c).

The sequence of the calculations was such that first $\Delta\tau_{p1}$ and $\Delta\tau_{p2}$ were determined by graphical integration of the i.f. group-delay characteristic. Next $\Delta\psi$ and $\Delta\varphi$ were calculated from equations (3) and (4); finally the modulation-amplitude characteristic determined with the aid of equation (1).

3. Numerical Results

The calculations, outlined in the preceding section, have been made for various combinations of transmitter and receiver; the results are listed in Table 1. The first combination considered (section I of Table 1) is a phase-linear receiver together with a transmitter of which the phase errors of the vestigial-sideband filter are compensated in the video-frequency part of the transmitter.

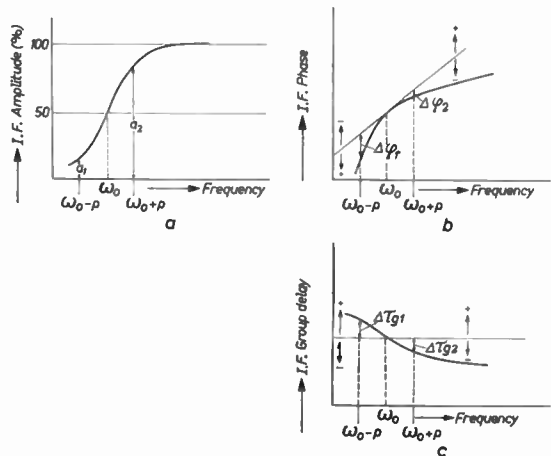

Fig. 6.—Definition of the magnitudes $a_{1,2}$, $\Delta\varphi_{1,2}$ and $\Delta\tau_{1,2}$ and their respective signs as used in equations (1)-(5).

The group-delay characteristic of a vestigial-sideband filter is asymmetrical with respect to the carrier frequency (Fig. 7, curve I), whereas the high frequency group-delay deviations equivalent to video-frequency phase compensation are the same on both sides of the carrier frequency (Fig. 7, curve II). As a consequence, the phase equalization can never be achieved for both sidebands at the same time. The practice is to equalize the wanted sideband; as a consequence the vestigial-sideband shows a larger phase distortion than

would be caused by the vestigial-sideband filter alone (Fig. 7, curve III). Due to the fact that the ratio between wanted- and vestigial-sideband amplitude increases rapidly with increasing modulation frequency, this phase distortion of the vestigial sideband has but little influence on the phase of the total modulation signal.

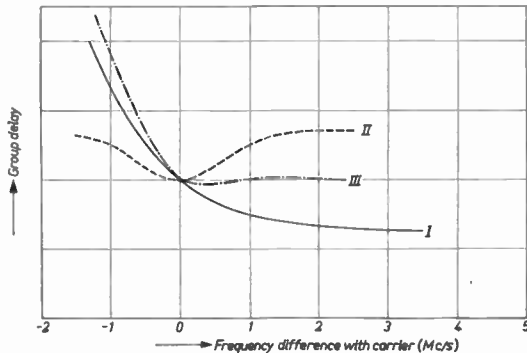

Fig. 7.—Compensation of the asymmetrical group-delay characteristic of a vestigial-sideband filter (curve I) by a video-frequency phase predistortion, the radio-frequency equivalence of which is indicated by curve II, cannot be effective for both sidebands simultaneously (curve III).

We wanted to base our calculations on the amplitude and phase (or group-delay) curves of an actual transmitter. A report by W. Händler and D. Bünemann⁸ gives these characteristics, together with the influence of phase compensation in the video-frequency part of the transmitter.

However, the phase predistortion discussed in this report compensates not only for the phase distortion of the vestigial-sideband filter of the transmitter, but also for the phase distortion of a specified model receiver. The group-delay curve of the vestigial-sideband filter and of the model receiver do show the same general trend and the deviations are of the same order of magnitude. Therefore we chose as the group-delay curve of a transmitter that is compensated for its own phase errors only, the overall group-delay curve of compensated transmitter and model receiver together as given in the N.W.D.R. report, but with all group-delay deviations divided by two (Fig. 8). It may be assumed that this approximates to a reasonable degree the corresponding characteristic of an actual transmitter.

The results of the calculation of modulation amplitude, phase delay and phase angle for the combination of this compensated transmitter with vestigial-sideband filter and the phase-linear receiver which has been described elsewhere⁵ and of which the amplitude characteristic is curve I in Fig. 4, are given in section I in the columns marked *v s t*. The same quantities for the combination of a phase-linear *double*-sideband transmitter with the same phase-linear receiver are tabulated in the columns marked *D s t*. The column marked $(v s t)_{\Delta\psi=0}$ gives the video-frequency amplitudes omitting the influence of the phase errors on the amplitude. An appreciable difference between the columns *v s t* and $(v s t)_{\Delta\psi=0}$ will only occur in cases where substantial phase errors are present, as is for instance the case with section V and VI of this Table.

Sections II and III give analogous results for combinations of the same transmitter with hypothetical phase-linear receivers with Nyquist flanks, which are either much flatter or much steeper (curves II and III in Fig. 4) than the Nyquist flank of the receiver of section I.

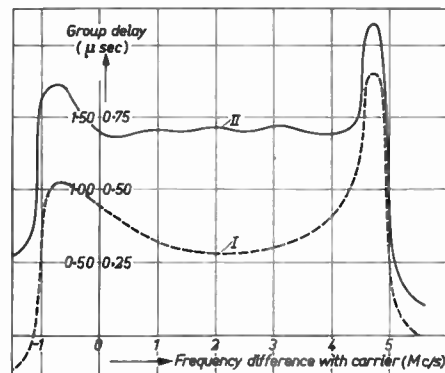

Fig. 8.—Group-delay curve of the N.W.D.R. transmitter and model receiver together, with and without video-frequency phase compensation (curve I and II respectively with left-hand scale). Curve II with right-hand scale is used for the transmitter considered in the table, section I-III.

Section IV has been calculated for the combination of the N.W.D.R. transmitter and model receiver with the video-frequency phase compensation of transmitter and receiver together according to the N.W.D.R. report (characteristics IV in Figs. 4 and 5).

The results for the combination of the same transmitter with the same phase predistortion but with a "conventional" receiver are tabulated in section V. The conventional receiver referred to is the receiver that has been used in comparison with the phase-linear receiver as described in an earlier publication.⁵ Its amplitude curve deviated from that of the N.W.D.R. model receiver in that the frequency width of the trap is substantially larger (curve V in Fig. 4). The group-delay curve is for this reason rather different from the corresponding curve of the N.W.D.R. model receiver (see curves IV and V in Fig. 5).

4. Discussion of the Results

Inspection of the numerical results collected in sections I-V of Table 1 permits some interesting conclusions to be drawn. In the introduction we mentioned that the exact compensation of the phase errors of the vestigial sideband in the video-frequency part of the transmitter is theoretically only possible for one specified shape of the Nyquist flank of the receiver. However, comparison of the columns " $\Delta\psi$ -vst" of the first three sections shows that the variation of the video-frequency phase characteristic caused by a variation of the shape of the Nyquist flank is small.

The largest variations amount to 0.06 radian and this only in a narrow frequency band around 1 Mc/s. We will give some details of the influence of such phase errors on the transient response in a later section, but mention here the fact that relative amplitude distortion and phase distortion measured in radians are about equivalent as regards the magnitude of their influence on the transient response. A phase distortion of 0.06 radian may therefore be considered to be roughly equivalent to amplitude distortion of 6 per cent.

Inspection of the columns "Amplitude vst" of the first three sections shows that the effect on the video-frequency amplitude curve of a variation in the shape of the Nyquist flank is again not very pronounced; the maximum variation even with an extreme Nyquist flank is not more than 16 per cent. and occurs again in a rather narrow frequency band around 1 Mc/s.

During the alignment of receivers in factory or workshop, the picture is usually monitored with the aid of a simple double-sideband transmitter without phase errors or phase predistortion. To check the influence of the

replacement of the actual vestigial-sideband transmitter by such a double-sideband transmitter, the values given in columns "DST" have been calculated.

Sections I-III refer to phase-linear receivers; as a consequence the combination double-sideband transmitter plus receiver does not show any phase errors (columns " $\Delta\tau$ -DST" and " $\Delta\psi$ -DST").

As can be seen in the columns "vst", the phase errors in the combination with a vestigial-sideband transmitter are only small; the replacement of the latter by a double-sideband transmitter will therefore only cause a very slight variation in the shape of the overall video-frequency phase characteristic.

The corresponding changes in the video-frequency amplitude characteristic amount to a maximum of 16 per cent. for the extreme flat Nyquist flank (section II), and to 7 per cent. and 5 per cent. for the Nyquist flanks of sections I and III.

It therefore seems justified to draw the conclusion, that the replacement of a vestigial-sideband transmitter, of which the radio-frequency phase errors are compensated in the video-frequency part, by a double-sideband transmitter without any phase errors, does have but little influence on the picture quality.

The results tabulated for the N.W.D.R. vestigial-sideband transmitter in combination with the model receiver (section IV) show that the phase errors of the first combination amount to 0.15 radian. As mentioned before, this can roughly be compared to an amplitude distortion of 15 per cent. It is known from practice that this combination gives a good picture, which indicates that phase and amplitude distortions of this magnitude can be tolerated.

Replacing the N.W.D.R.-model receiver by the "conventional" receiver causes quite a pronounced variation in the overall video frequency phase characteristic, as follows from inspection of the columns " $\Delta\psi$ -vst" of sections IV and V. This is not surprising considering the differences between the group-delay curves of the two receivers (see Fig. 5). The variations in overall video-frequency amplitude characteristic in both cases (columns "Amplitude-vst" of section IV and V) are much smaller.

The differences between the video-frequency phase characteristics of these two combinations (IV and V) are substantially larger than those between the first three combinations (I-III).

Table 1

Phase and amplitude distortion for various transmitter-receiver combinations.

Sections I, II, III: transmitter compensated for own phase errors only; receivers phase-linear with amplitude curves I, II and III of Fig. 4.

Sections IV and V: transmitter compensated for phase errors of receiver and transmitter together; N.W.D.R.-model receiver and "conventional" receiver respectively (amplitude curves IV and V in Fig. 4).

Combination transmitter-receiver	Frequency (Mc/s)	Phase delay $\Delta\tau_p$ (nanosec, 10^{-9} sec)		Phase angle $\Delta\psi$ (radians)		Amplitude A (percentage)		
		VST	DST	VST	DST	$(VST)_{\Delta\psi=0}$	VST	DST
I	0.00	0	0	0.00	0.00	100	100	100
	0.25	+2	0	0.00	0.00	100	100	100
	0.50	-1	0	0.00	0.00	94	94	96
	0.75	-3	0	-0.02	0.00	91	90	96
	1.00	-10	0	-0.06	0.00	89	89	96
	1.50	-6	0	-0.05	0.00	95	95	95
	2.00	-4	0	-0.05	0.00	100	100	100
II	0.00	0	0	0.00	0.00	100	100	100
	0.25	+3	0	0.00	0.00	100	100	100
	0.50	+4	0	0.01	0.00	97	97	100
	0.75	+4	0	0.02	0.00	92	91	100
	1.00	-7	0	-0.04	0.00	84	84	100
	1.50	-6	0	-0.05	0.00	95	95	95
	2.00	-4	0	-0.05	0.00	100	100	100
III	0.00	0	0	0.00	0.00	100	100	100
	0.25	+2	0	0.00	0.00	100	100	100
	0.50	-1	0	-0.00	0.00	98	98	100
	0.75	-4	0	-0.02	0.00	96	95	100
	1.00	-13	0	-0.08	0.00	100	100	100
	1.50	-6	0	-0.05	0.00	100	100	100
	2.00	-4	0	-0.05	0.00	100	100	100
IV	0.00	0	0	0.00	0.00	100	100	100
	0.25	0	-13	0.00	-0.03	100	100	100
	0.50	-11	-33	-0.04	-0.10	96	95	95
	0.75	-19	-49	-0.09	-0.23	95	92	97
	1.00	-23	-79	-0.15	-0.50	96	95	97
	1.50	-11	-96	-0.11	-0.90	102	102	102
	2.00	-7	-116	-0.09	-1.46	102	102	102
V	0.00	0	0	0.00	0.00	100	100	100
	0.25	+13	-3	+0.02	0.00	96	96	96
	0.50	+32	+6	+0.09	+0.02	91	90	90
	0.75	+36	+4	+0.16	+0.02	93	89	91
	1.00	+38	-3	+0.24	-0.02	94	92	94
	1.50	+40	-56	+0.38	-0.53	99	99	99
	2.00	+40	-68	+0.50	-0.85	100	100	100

VST: vestigial-sideband transmitter.

DST: double-sideband transmitter without any phase compensation.

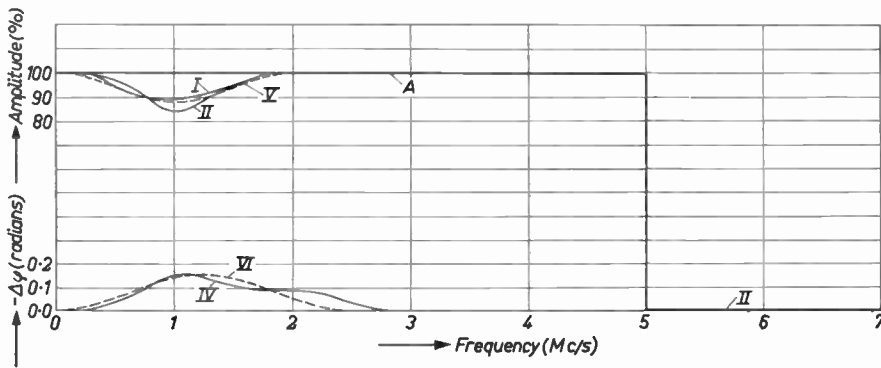

Fig. 9.—Modulation amplitude characteristics (curves I, II, III and V) and phase characteristics (curves IV and VI) corresponding to combinations considered in the table.

This demonstrates the importance of an accurate control and measurement of the phase properties of television receivers.

The replacement of a vestigial-sideband transmitter of which the phase predistortion compensates the model-receiver's phase errors as well, by a double-sideband transmitter without any phase predistortion, causes, of course, a considerable variation in the overall video-frequency phase characteristics (sections IV and V, columns "Δψ-DST"). The variation in the video-frequency amplitude characteristic is again small (columns "Amplitude-DST"). However, the change in phase properties is such that it is not possible to check a receiver which has to work in combination with the N.W.D.R.-vestigial-sideband transmitter, with a simple double-sideband transmitter. It will be necessary to provide the latter with a phase predistortion which should compensate for the phase distortion of the model-receiver alone. This phase predistortion differs therefore from the phase predistortion as applied in the vestigial-sideband transmitter, because here the phase distortion of the vestigial-sideband has to be compensated as well.

5. Influence of Amplitude and Phase Errors on the Transient Response

To calculate the magnitude of the distortion of the transient response due to distortions of the video-frequency amplitude and phase characteristics such as are indicated in the table, the amplitude characteristics according to section I (vST) and section II (vST) have been drawn in Fig. 9, curves I and II. To simplify matters, the undistorted amplitude curve has been assumed to be rectangular with a maximum frequency of 5 Mc/s (curve A).

The dotted line curve (V), which gives a reasonable approximation to both characteristics, corresponds to a distortion function: $a=0.06(1-\cos \omega\tau)$, with $\omega\tau = 2\pi$ for $\omega = 2\pi \times 2 \times 10^6$ rad/sec. The corresponding transient distortion can be calculated quite simply and is shown in Fig. 10, curve V, together with the transient response, corresponding to the rectangular amplitude characteristic. This transient response is a sine integral function (curve A). The maximum of the distortion component amounts to 3.7 per cent.

In the same way the phase-distortion characteristic according to section IV (vST) has been depicted in Fig. 9, curve IV. The dotted line curve (VI) is again a cosine function, which approximates to the actual phase curve reasonably well. The corresponding distortion component of the transient response is shown in Fig. 10, curve VI. The maximum amplitude of this curve is 2 per cent.

As a consequence of the fact that these distortions are restricted to the lower frequency of the video spectrum, the corresponding transient component changes but slowly with the time. Therefore these small transient deformations will hardly be noticed in the picture.

The combination of N.W.D.R. transmitter and N.W.D.R. model receiver is reported to give a good picture. This can well be understood from Fig. 10, even if the transient distortion due to the 5 per cent. amplitude distortion of this combination (see section V, column "Amplitude-vST") is taken into consideration as well.

For the same reason the picture quality of the combination of a vestigial-sideband transmitter, compensated for its own phase errors, and a phase-linear receiver will be acceptable,

Fig. 10.—The transient distortion components (V and VI) corresponding to the amplitude and phase distortion curves V and VI in Fig. 9.

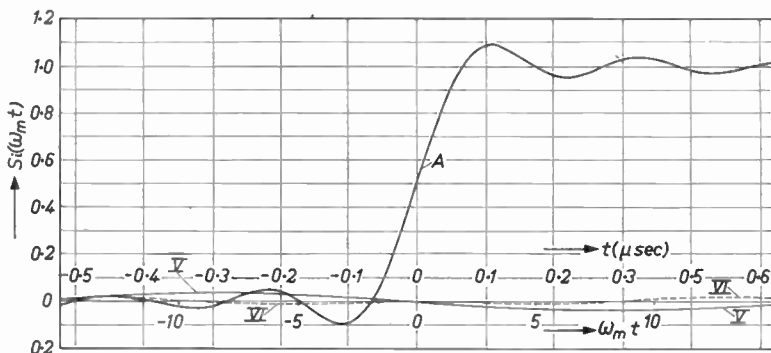

even with a Nyquist-flank that would be quite as flat as the one considered in section II. Finally, the possibility of monitoring a phase-linear receiver by means of a simple double-sideband transmitter is also corroborated by the fact that phase- or amplitude differences of the magnitude as occur in the table between the columns "vst" and "DST," will not have a marked influence on the transient response.

6. Influence of Large Modulation Depth

A small modulation depth has been presumed in the preceding sections. For a complete proof of the postulation, that the picture in the receiver is to a large extent unaffected by the replacing of a vestigial-sideband transmitter with a double-sideband transmitter, we have to consider the case of large modulation depth as well. The detection of a vestigial-sideband signal with large modulation depth causes a certain distortion, due to the inequality of both sidebands. The ratio between wanted and vestigial sideband changes when passing from a vestigial-sideband transmitter to a double-sideband transmitter. This can be understood by considering Figs. 2 and 4. With receivers with a flat Nyquist flank which extends beyond -0.75 Mc/s (curve II, Fig. 4), the magnitude of the vestigial-sideband components at these frequencies will depend on the magnitude of these frequencies in the transmitter signal. We therefore proceed to investigate this effect for the flattest Nyquist flank considered (curve II, Fig. 4). In Fig. 11, this same flank has been drawn (curve II), giving the ratio of wanted and vestigial-sideband components when receiving a double-sideband transmitter. Curve IIa gives this ratio with a vestigial-sideband transmitter according to the amplitude characteristic of Fig. 2.

In the lower part of Fig. 11, the difference between characteristics II and IIa has been drawn (curve A). This curve is the same as curve II in Fig. 9, because at small modulation depths, it indicates the deficiencies of the video-frequency amplitude characteristic. To investigate the influence on the detection process with large modulation depth, this curve A (Fig. 11) has to be considered as the sum of the curves B and C, which two characteristics are, with regard to the carrier frequency, symmetrically and asymmetrically respectively.⁹

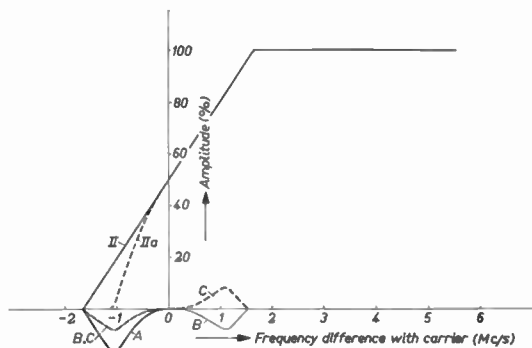

Fig. 11.—Vestigial-sideband filter of transmitter (Fig. 2) causes overall amplitude characteristic to change from curve II (receiver only) into curve IIa. Difference between curves II and IIa is given by curve A, which can be split up in symmetrical and asymmetrical components (B and C).

The symmetrical curve B again causes a distortion of the video-frequency amplitude characteristic as given by curve II, Fig. 9, with a corresponding distortion component of the transient as indicated in Fig. 10. The influence

of the asymmetrical component is such that it causes a distortion component of the transient of the same shape and the same magnitude, but which has to be added quadratically to the main signal. This quadratic adding process can be indicated by

$$\sqrt{(1+mS+mD)^2+(mD)^2},$$

where

m = modulation depth,

S = main transient,

D = distortion component due to curves B and C in Fig. 11.

From Fig. 10 it follows that curve B causes a transient distortion of 3.7 per cent. maximum; due to the quadratic adding procedure, the influence of curve C will be smaller and the more so because even with the largest black-to-white transitions, the modulation depth does not exceed 70 per cent.

Considering that we regarded an extremely flat Nyquist flank, which will not often be encountered in practice, we may conclude that the possibility of replacing a vestigial-sideband transmitter by a double-sideband transmitter without influencing the picture quality holds for large modulation depths as well as for small modulation depths.

7. Conclusions

I. Theoretically, the exact compensation of the phase errors of the vestigial-sideband filter in the video-frequency part of a transmitter can only be achieved for one well-defined shape of the Nyquist flank; however, the influence of variation of this shape on the overall transient response is extremely small for all shapes of receiver-resonance curves to be met with in practice.

II. Replacing a vestigial-sideband transmitter, compensated for its own phase errors, by a double-sideband transmitter will hardly have any influence on the picture quality of a receiver.

III. A receiver intended to work on signals from a transmitter which has been compensated for phase errors of receivers, will show a marked difference in picture quality when working with a double-sideband transmitter, unless the double-sideband transmitter is predistorted for the receiver phase errors only.

Conclusion II is of considerable importance for practical conditions in development labora-

tories, production-line control, repair workshops, etc., because it proves that it is possible to check receivers with a simple double-sideband transmitter.

The corresponding conclusion for transmitters is:

IV. The compensation in the video-frequency part of a transmitter of the phase errors introduced by the vestigial-sideband filter should be monitored by a phase-linear receiver, of which the exact shape of the Nyquist flank is not very critical.

8. References

1. "Fernsehsender in Band I und III," Pflichtenheft nr. 5/2. Arbeitsgemeinschaft der Rundfunkanstalten der Bundesrepublik, Deutschland, 1954.
2. H. J. Griese, "Possibilities of equalization in vestigial sideband transmission of television." *Fernmeldetech. Z.*, **8**, pp. 94-103, February 1955.
3. E. C. Cork, "Vestigial-sideband filter for Sutton Coldfield television station." *Proc. Instn. Elect. Engrs.*, **98**, Part III, pp. 460-464, November 1951.
4. R. D. Kell and G. L. Fredendall, "Standardization of the transient response of television transmitters." *R.C.A. Review*, **10**, pp. 17-34, March 1949.
5. J. Peters, "Phase predistortion in television transmitters and receivers." *Tech. Hausmitt. Nordwestdsch. Rdfk.*, **7**, No. 7/8, pp. 125-129, 1955.
6. A. van Weel, "Phase linear television receivers." *Philips Res. Rep.*, **10**, No. 4, pp. 281-298, 1955.
7. H. J. de Boer and A. van Weel, "An instrument for measuring group delay." *Philips Tech. Rev.*, **15**, pp. 307-316, May 1954.
8. W. Händler and D. Bünemann, "Untersuchungen von Einschwingvorgängen unter Berücksichtigung der Europäischen Fernsehnorm." Bericht Nr. 5 der Hauptabteilung Forschung, Zentraltechnik des N.W.D.R., Hamburg, 1954.
9. L. Bourassin, "Asymmetric sideband television transmission systems." *Onde Electrique*, **34**, pp. 897-913 and 1020-1040, November and December 1954.

RECENT EXHIBITIONS

Radio Components Show

The Thirteenth Exhibition arranged by the Radio and Electronic Component Manufacturers' Federation was held in London during April. The increasing scope of the Show was demonstrated by the fact that there were one hundred and fifty five individual stands, an increase of fourteen over last year.

In his opening speech, the President of the Federation, Sir Robert Renwick, Bart, K.B.E. (Member), referred to the steady increase in the number of exhibitors, which reflected the continuing expansion of the electronic component industry. Production in the industry had doubled in the last five years, and over the last decade had increased five-fold. Indeed, current output had now reached a level of over five million components every working day. Discussing the principal function of the Show, to acquaint engineers, technologists and manufacturers with the latest developments in the design of British electronic components, Sir Robert said that it also served as a guide to future trends, thus enabling consultation between the designer and the component manufacturer in the initial stages of design and development.

This year's Exhibition gave further evidence of the widening extent of the application of transistors and printed circuits to many different fields. Nearly every manufacturer of fixed and variable resistors, mica, paper and electrolytic capacitors, of valve holders and even of transformers, showed examples specially designed for incorporation into a printed circuit. A new development known as Pin Assembly Circuits was shown by Erie Resistors; designed to obviate the tangle of wiring associated with conventional circuits, the P.A.C. units are in such compact form that fifteen components occupy only one square inch of chassis space. Each unit consists of resistance and capacitance elements $\frac{1}{8}$ in. in diameter and $\frac{1}{4}$ in. long, varying in number from three or four to ninety, and all connections are embodied in the moulded assembly. These elements terminate in special spill-type pins for insertion in the holes or eyelets of printed circuits ready for dip soldering.

The trend towards the achievement of ever smaller components to match the dimensions of the transistor was also a noteworthy feature; many of these developments are complementary to

printed circuit techniques. A direct-drive loud-speaker with centre-tapped voice coil, designed specially for push-pull transistor output circuits, was shown by Plessey. Mullard have introduced a photo-transistor, consisting of a germanium *p-n-p* junction, which is sensitive to visible and infra-red light and will operate a suitable relay directly from a 12-18 V battery.

Turning next to complete equipments, the use of transistors has revolutionized the design of hearing aids, and a Fortiphone spectacle hearing aid, using a four-transistor amplifier fitted in the tortoise-shell side arms, was shown. A portable fully-transistorized power amplifier, which it was suggested might be suitable for use in a portable record-player, was shown by Lustraphone. This provides an output of 10 W into an output impedance of 3 Ω to 15 Ω , while the input is 5 mV into 1 k Ω —an effective frequency response of 70 to 15,000 kc/s is claimed. A single-stage pre-amplifier for use with microphones was also shown by the same firm.

A range of ceramic valves suitable for use in the u.h.f. range was shown by Ferranti. It is claimed that these allow higher operating temperatures than glass-enveloped valves, and are thus smaller for a given power dissipation; another feature claimed is greater reliability.

In the cathode-ray tube field, it was interesting to note that the 9-in. screen, usually considered to be obsolete, is returning with the suggestion that it is suitable for either portable sets or for cheaper models.

Audio-frequency equipment included a very compact three-speed record changer with a die-cast aluminium pick-up arm, and a battery-operated single record player for 7-in. 45 r.p.m. disks, both made by Garrard. The likelihood of the introduction of 16 $\frac{1}{2}$ r.p.m. records was foreshadowed by the introduction by Collaro of a four-speed record changer.

Television aerials were shown which combined high gain arrays for Bands I and III, and two interesting models by Telerection and J-Beam showed variations based on the "slot" principle. It is claimed that the slot for one particular type provides an exceptionally wide bandwidth over Band III, so that no channel adjustments are necessary. However, for Band I this aerial requires adjustment of the lengths of the single vertical rods.

A development which may well prove to be of particular importance is the use of irradiated polyethylene as cable insulation, by the Wandleside Cable Works. The effect of irradiating polyethylene is virtually to change it from a thermoplastic to a thermosetting material, and results in stability at temperatures upwards of 200° C, thus permitting jointing and soldering of cables. The new material is insoluble in mineral oils (unlike ordinary polythene), its insulation values are improved, although the power factor is lower. It is also less affected by mechanical damage with little loss of flexibility.

The principal markets for components during 1955 were India (nearly £800,000), Canada, Holland, Sweden, New Zealand, South Africa, Australia, France, Pakistan, Belgium, Norway, U.S.A. and Italy. The U.S.A. (£900,000) was the largest purchaser of sound reproduction products, followed by Australia, South Africa, New Zealand and Canada.

London Audio Fair

A total attendance of some 23,000 was recorded at the first Audio Fair to be held in this country, which took place at the Washington Hotel in London during April. Forty-one exhibitors had stands and demonstration rooms, and it is stated that the success of the venture—it was extremely over-crowded for nearly the whole period of three days—has ensured its repetition on a more ambitious scale next year. Considerable interest was shown by overseas buyers in this new exhibition, a number of American visitors being present who had flown over from the United States especially for the show.

Although mainly aimed at that part of the general public which is interested in high fidelity reproduction, there was much to interest the professional engineer. Probably the most notable advance was the introduction by three manufacturers of electrostatic loudspeakers. Two of these claimed to cover the whole audio range, while the third was more conservatively claimed to be for the upper half of the frequency range.

Tape recorders for the domestic reproduction of music were featured by several manufacturers, and also the elaboration of this technique to permit binaural reproduction.*

An increasing number of firms are now carrying out the manufacture of all the various items of

reproducing equipment, instead of merely concentrating on the production of one or two component parts. This has led to more attention being paid to the appearance of the equipment—a point which is of particular importance in view of the declared aim to attract the layman.

French Components Exhibition

The French Components Exhibition held in Paris at the beginning of March showed a trend of development which was very similar to that indicated at the British R.E.C.M.F. Exhibition in London. French manufacturers are vigorously exploiting the latest techniques in printed circuitry, and several have produced complete r.f. and i.f. amplifier strips in which the printed i.f. transformers are joined by a metal disk mounted closely to the printed windings.

The use of encapsulation for complete e.h.t. rectifier units for television receivers is being extended, and has enabled a reduction to be made in the size of the e.h.t. smoothing capacitor to a block approximately 1 in. diameter and $\frac{1}{2}$ in. thick.

The majority of radio receivers incorporate ferrite rod aerials, and there are a number of manufacturers who have produced small vibrator units for operating portable radio receivers from 6 and 12 V accumulators.

Considerable interest was shown in tape recorders and disk reproducers. An example of the latter is a portable model having a specially constructed lid which acts as an acoustic chamber, housing two 7 in. speakers and one h.f. crystal speaker.

A very large part of the exhibition was devoted to components for military and other "non-entertainment" purposes, and particularly noteworthy in this respect were the advances in backward-wave oscillators for use at s.h.f., as well as various types of klystron. A series of lectures was held in conjunction with the exhibition, and dealt with recent developments in component manufacture, such as semi-conductors and ferrites.

The latest figures for the number of television receivers in France are surprisingly low when compared with those for the United Kingdom and other European countries. A national publicity campaign has recently increased the number of licensed receivers from 200,000 in October 1955 to 300,000 in February 1956.

In spite of this relatively small market for its products, the French components industry obviously does not lag behind that of other countries.

* M. B. Martin and D. L. A. Smith, "Design of magnetic recording and reproducing equipment for domestic use." *J. Brit.I.R.E.*, 16, pp. 65-79, February 1956.

MATERIALS USED IN RADIO AND ELECTRONIC ENGINEERING

A Survey by the Technical Committee of the Institution

4. Plastics *

1. Introduction

Plastics are mainly synthetic organic materials which are capable of flow at some stage in their existence. There are about twenty major types, but by modifying the chemical structure or by mixing with other materials, most types can be produced in a considerable number of grades. These grades will have differing properties, each intended for a particular use or for a particular processing method. A useful guide to the subject and its nomenclature is B.S. 1755:1951—Glossary of terms used in the plastics industry.

Most plastics divide into two groups: thermosetting, which, when heated (usually with pressure), undergo a chemical change, become set, and cannot be reshaped by the further application of heat; and thermoplastics, which soften when heated and harden when cooled.

The data tables 1 and 2 give electrical and physical properties of the more important types used in radio and electronic engineering. Table 3 lists the trade names of many British and American plastics, also indicating the forms available, their manufacturers, and their chemical type. Natural and synthetic rubbers and the silicone compounds are not included in this survey.

The natural plastics, shellac and bitumen, were known to the ancient Chinese and Egyptians, but it was not until the discovery by Alexander Parkes, in 1865, of cellulose nitrate, Parkesite, Celluloid or Xylonite, as it is variously called, that the foundation of the synthetic plastics industry was laid. Casein, a milk protein, was accidentally discovered in 1885, but was not developed commercially until 1904.

In 1907 Dr. Leo Baekeland modified certain phenol (carbolic acid) and formaldehyde (formalin) compounds, first discovered by Adolf von Baeyer in 1869. The development of a large group of thermosetting compounds followed from this work.

The development of basic discoveries was rapid after Baekeland's lead, and various compounds were commercially introduced as follows: cellulose acetate, 1911; urea formaldehyde, 1924-9; acrylic resins, 1931; vinyl chloride, polyethylene, 1935; ethyl cellulose, 1936; polystyrene, 1938; vinyl acetate, 1940; polytetrafluoroethylene (P.T.F.E.), 1945. Contemporary advances include the production of polychlorotrifluoroethylene (P.C.T.F.E.)³⁸ and Terylene⁵⁴. Certain other plastics, when subjected to high energy radiation, are found to have different, and in some cases improved properties.^{43, 50, 51, 53}

2. General Applications

Most plastics are produced as solid or liquid resins or polymers, as solutions and emulsions, as moulding and extrusion compounds, and in forms such as rod, tube and sheet. Thermoplastics are also produced as film and foil. Polyvinyl chloride (P.V.C.), for instance, can be produced as a flexible film or as a thick sheet; it can be extruded as tube, rod or profile (in various degrees of flexibility, or completely rigid); it can be moulded, expanded into rigid or flexible cellular forms or made into a paste for coating or spreading. Not all plastics are available in all these forms, but this versatility of shaping and fabricating methods, often to very close tolerances, is one of their principal advantages.

The six main processing methods are: compression moulding, which is used when thermosetting materials are to be shaped; laminating, in which paper, fabric, asbestos or wood are bonded with thermosetting resins to

* Report approved by the General Council for publication on 29th February, 1956. (Report No. 11.) Prepared for the Committee by Mr. C. S. Fowler (Associate Member).

U.D.C. No. 679.5:621.37/9.

Table 1. Thermo-setting Plastics

PROPERTY	Phenol Formaldehyde						Urea formaldehyde	Mineral-filled melamine formaldehyde	
	Cast Unfilled†	Wood Flour Filled	Mineral Filled	Fabric Filled	Nylon Filled	Laminated Paper Base			
Dielectric Strength (V/mil $\frac{1}{8}$ " at 25°C)	100—450	200—500	250—400	200—400	300—500	200—1000	300—400	300—450	
Volume Resistivity (ohm-cm)...	10 ¹⁰ —10 ¹⁴	10 ¹⁰ —10 ¹²	10 ¹¹ —10 ¹⁴	10 ⁸ —10 ¹¹	10 ¹¹ —10 ¹³	10 ⁹ —10 ¹³	10 ⁹ —10 ¹²	10 ⁹ —10 ¹²	
Power Factor (tan δ)	{ 50 c/s	0.02—0.5	0.04—0.3	0.05—0.3	0.08—0.3	0.01—0.2	0.02—0.2	0.02—0.15	0.07—0.7
	{ 1 Mc/s	0.01—0.2	0.02—0.2	0.02—0.4	0.05—0.2	0.02—0.05	0.03—0.1	0.05—0.2	0.03—0.05
	{ 100 Mc/s	0.01—0.1	0.04—0.07	0.01—0.2	0.05—0.2	0.02—0.05	0.03—0.04	0.04—0.05	0.02—0.04
Permittivity	{ 50 c/s	5—20	5—12	5—20	5—10	3—6	5—6	7—8	6—12
	{ 1 Mc/s	5—10	4—6	5—10	4—6	3—4	3—5	6—7	6—7
	{ 100 Mc/s	4—5	4—6	4—5	4—5	3—4	4—5	4—5	5—6
Water Absorption (% after 24 hr. at 25°C)	0.01—0.5	0.2—0.6	0.01—0.3	1.0—1.3	0.1—0.5	3—7	1—3	0.07—0.6	
Modulus of Elasticity (lb/in ²)	0.5—1.5 × 10 ⁵	10—15 × 10 ⁵	10—15 × 10 ⁵	7—12 × 10 ⁵		4—20 × 10 ⁵	4.6—5 × 10 ⁵	0.5—10 × 10 ⁵	
Tensile Strength (lb/in ²) ...	5—10 × 10 ³	6—9 × 10 ³	4—6 × 10 ³	5—8 × 10 ³	5—8 × 10 ³	7—18 × 10 ³	5—9 × 10 ³	5—7 × 10 ³	
Compressive Strength (lb/in ²)	1.5—3 × 10 ⁴	1.6—3.6 × 10 ⁴	1.8—3.6 × 10 ⁴	2—3 × 10 ⁴	2—4 × 10 ⁴	2—4 × 10 ⁴	2.4—3.5 × 10 ⁴	3 × 10 ⁴	
Linear Expansion per °C ...	30—150 × 10 ⁻⁶	40—70 × 10 ⁻⁶	25—40 × 10 ⁻⁶	20—60 × 10 ⁻⁶		17—25 × 10 ⁻⁶	25—30 × 10 ⁻⁶	20—40 × 10 ⁻⁶	
Max. Working Temp. (°C) ...	70°	120°	160°	120°	90°	100°	70°	120°	
Machining Qualities	Good	Good	Fair	Good	Good	Good	Fair	Fair	
Forms Available*	C.F.R.S.T.	P.R.S.T.	P.R.S.T.	P.R.S.T.	P.R.S.T.	L.S.T.R.	I.L.P.	I.L.P.	
Effect of Sunlight			Colours tend	to darken			None	None	
Inflammability	Low	Low	Very low	Low	Low	Low	Very low	Very low	
Specific Gravity	1.2—1.7	1.2—1.5	1.6—2	1.35—1.4	1.2	1.3—1.4	1.55	1.5—1.9	

* See Table 3 for explanation of abbreviations used.

† Cast unfilled phenol formaldehyde has a refractive index of from 1.5 to 1.7. This material hardens with age.

Table 1.—Thermo-setting Compounds (opposite)

Notes: It is emphasized that the values given in Tables 1 and 2, especially power factor, resistivity, and tensile strength, are dependent on the moisture content of the material, the temperature and also on the exact composition and methods of manufacture. Where specific properties are required these should be measured on the samples available, and under the expected operating conditions. It should also be noted that the machining qualities are only given as a broad guide.

All the materials mentioned in Table 1 show excellent resistance to animal, vegetable and mineral oils, but are decomposed by strong acids and alkalis. The majority of the materials are not affected by ageing.

produce laminated sheet; injection moulding, a production technique developed for shaping thermoplastics; extrusion, a means of producing continuous lengths of a profile such as tube or rod, in which mainly thermoplastics are employed (cable covering is an important example of this process): calendering, a method of rolling out continuous lengths of sheeting of various thicknesses and degrees of flexibility; and forming, which entails drawing or blowing a heated (and therefore very pliable) plastic sheet over or into a shaped mould.

Injection moulding, extrusion, calendering and forming all take advantage of the heat sensitivity of thermoplastics, a property which is of the utmost importance in processing but which of necessity limits the uses of thermoplastics to applications where high temperatures are not encountered.

Plastics have many applications in radio engineering due to the generally very good electrical and mechanical properties they possess. Broadly speaking, the thermosetting types are used as constructional materials, where good insulating properties are required together with high mechanical strength. The thermoplastic types find their largest application in components intended for use at the higher radio frequencies. The choice of the correct material must depend on an accurate knowledge of the conditions under which it has to operate. Typical considerations to be borne in mind in addition to mechanical strength and electrical characteristics are dimensional stability, moisture absorption, cold flow, effect of ultra-violet light on permittivity, behaviour in the tropics, etc.

The information given in Tables 1 and 2 shows wide tolerances for many of the listed properties; these are, in general, the extremes of different manufacturers' data. In connection with their use in radio engineering, some properties are mentioned in the following sections.

3. Thermosetting Plastics (Table 1)

The basic resins tend to be brittle and are seldom cast or moulded without a filler such as asbestos, cotton, mica, nylon or woodflour. When used as impregnating compounds with paper, wood or fabric sheets and heated under pressure, they can be formed into laminated sheets or blocks which can then be cut or machined into a wide range of shapes.

Electrical properties of moulded components are greatly influenced by the type of filler used in the moulding material, and the techniques used during the moulding process. The comparative properties of phenolic type resins with different fillers are given in Table 1a. (See also Table 1, and B.S. 771 and B.S. 1540.)

Phenol-furfural is similar to phenol-formaldehyde (P.F.) but has slightly better moulding qualities and higher moisture resistance. Compared with P.F., urea-formaldehyde (U.F.) has poor moisture resistance and requires considerable care during moulding to prevent overheating; it is however available in a wide range of colours, and its anti-tracking properties are better than those of P.F.

Melamine-formaldehyde (M.F.) possesses to a considerable degree, the advantages of both P.F. and U.F. Mineral filled M.F. in particular has excellent anti-tracking properties.

Certain of the alkyd resins are also used as impregnating material to produce high grade bonded mica laminate with good heat resisting and electrical properties.

Table 1(a)

Effect of various fillers on phenolic type resins

<i>Filler</i>	<i>R.F. Properties</i>	<i>Mech. Strength</i>
Mica	very good	poor to fair
Nylon	very good	good
Woodflour	fair	good
Asbestos	fair to poor	weak to fair

Table 2. Thermoplastic Compounds

PROPERTY	Cellulose acetate	Polyvinyl-chloride	Polyethylene (Polythene)	Polystyrene	Super-polyamide (nylon)	Polytetrafluoroethylene	Poly-methyl methacrylate	Aniline formaldehyde	
Dielectric Strength (V/mil $\frac{1}{8}$ " at 25°C) ...	250—400	350—600	400—600	500—700	350—400	400—500	400—500	400	
Volume Resistivity (ohm-cm)...	10 ¹⁰ —10 ¹²	10 ¹² —10 ¹⁶	10 ¹⁶ —10 ¹⁷	10 ¹⁴ —10 ¹⁸	10 ⁹ —10 ¹²	10 ¹⁶ —10 ¹⁸	10 ¹⁴ —10 ¹⁶	10 ¹⁰ —10 ¹⁴	
Power Factor (tan δ)	50 c/s	0.01—0.06	0.02—0.1	0.0001	0.0006—0.0008	0.014—0.04	0.0008	0.05—0.068	0.003—0.004
	1 Mc/s	0.06—0.1	0.09—0.15	0.0002	0.0001—0.0003	0.02—0.06	0.0002	0.02—0.06	0.008—0.01
	100 Mc/s	0.02—0.05	0.01—0.05	0.0003	0.0003—0.001	0.02—0.06	0.0002	0.005—0.01	0.004—0.006
Permittivity	50 c/s	4—7	5—6	2.3	2.5—2.7	4—10	2—3	2.5—3.5	3.7—3.8
	1 Mc/s	3—6	3.0—3.6	2.3	2.5—2.7	3—4	2—3	2.5—3.0	3.5—3.6
	100 Mc/s	3—4	3.0—3.6	2.3	2.5—2.7	3	2—3	2—3	3.5—3.6
Water Absorption (% after 24 hr. at 25°C)	1.4—4.0	0.2	0.01 (Non-polar)	Up to 0.06 (Non-polar)	0.5—2.0	None (Non-polar)	0.6	0.05	
Modulus of Elasticity (lb/in ²)	1—4 × 10 ⁵	5—6 (rigid) × 10 ⁵	0.2 × 10 ⁵	1.7—6 × 10 ⁵	2.6—4 × 10 ⁵	0.6 × 10 ⁵	4—6 × 10 ⁵	5 × 10 ⁵	
Tensile Strength (lb/in ²) ...	3—7 × 10 ³	1—8 × 10 ³ †	1.3—2.5 × 10 ³	3—10 × 10 ³	9—11 × 10 ³	1.8—4 × 10 ³	5—9 × 10 ³	8—10 × 10 ³	
Compressive Strength (lb/in ²)	1—2 × 10 ⁴			1.1—1.7 × 10 ⁴	1.4—1.6 × 10 ⁴	0.17 × 10 ⁴	1.3—1.5 × 10 ⁴	2 × 10 ⁴	
Linear Expansion per °C ...	100—170 × 10 ⁻⁶	60—80 × 10 ⁻⁶	160—250 × 10 ⁻⁶	60—80 × 10 ⁻⁶	100—150 × 10 ⁻⁶	100 × 10 ⁻⁶	80—90 × 10 ⁻⁶	50—60 × 10 ⁻⁶	
Max. Working Temp. (°C) ...	60°	80°	70°	80°	90°	250°	80°	80°	
Refractive Index ...	1.46—1.5	1.53	1.51	1.59	1.53	1.3—1.4	1.49		
Machining Qualities ...	Good	Fair	Good	Fair	Good	Fair	Good	Good	
Forms Available* ...	F.R.T.S.P.	C.R. Res. F. S.T.P.L.I.	P.E.S.	R.S.T.P.L.	I.P.	P.	C.P.R.S.T.I.	P.I.L.	
Effect of Sunlight ...	Slight	Very slight	Degrades	Degrades	Slight	None	None	None	
Effect of Ageing ...	Slight	None	Degrades	None	None	None	None	None	
Inflammability ...	Slow	Slow	Slow	Slow	Self-exting.	Nil	Slow	Very low	
Specific Gravity ...	1.27—1.4	1.2—1.6	0.92—0.94	1.05—1.07	1.1—1.16	2.1—2.3	1.2	1.22—1.25	
Resistance to Strong Acids ...	Decomposes	Good	Excellent	Good	Poor	Excellent	Excellent	Poor	
Resistance to Strong Alkalis ...	Decomposes	Good	Excellent	Excellent	Excellent	Excellent	Excellent	Fair	
Resistance to oils ...	Good	Varies	Excellent	Poor—Good	Excellent	Excellent	Excellent	Good	
Burning Odour ...	Acetic acid	Chlorine	Paraffin wax	Hyacinth	Celery	Decomposes at 400° C	Sweet flowers		
Soluble in ...	Acetone	Ethylene dichloride	Hot Toluene >80°C	Toluene	Toluene (Partial)		Chlorinated hydrocarbon		
Flame colour ...	Dark yellow Black smoke	Yellow White smoke	Yellow Black smoke	Orange Black smoke	Blue, yellow top		Yellow, blue centre		
Electrical Losses ...		Fair †	Nearly constant to >3000 Mc/s	Good to >3000 Mc/s		Constant to >3000 Mc/s			

* See Table 3.

† Depends on plasticizer.

3.1. Polyester Ethoxyline (Epoxy) and Polyurethane Resins^{37, 44-49}

These thermosetting compounds are being increasingly used in the "potting" of radio components and circuits. There are, however, various problems in the successful employment of these techniques which it is not possible to cover in detail in this review. In cases where they have not been used before, a study of the latest information is advised.

In general, the electrical and mechanical properties are dependent on the operating temperature and humidity, but they can be greatly influenced by the method of curing employed. In the case of so-called cold setting resins, considerable stabilization of the electrical and mechanical properties can be obtained by subjecting the moulding to a cyclic change of temperature after curing has taken place. In the cold setting types it should also be noted that under certain conditions the exothermic rise of temperature during the curing process can reach 140° C, with consequent damage to the potted components, either directly or by stresses set up when the moulding cools.

Most of the potting resins are polar in nature and their dielectric properties are consequently not as good as some other plastics. At 1 Mc/s the power factor ($\tan \delta$) can range from 0.005 to 0.1, while the permittivity varies between 3 and 10.

Representative types are Araldite B (Aero Research Ltd.); Bakelite SR 17438 (Bakelite Ltd.); Beetle 4111 (B.I. Plastics); Epikote 828 (Shell Chemicals Ltd.); Marco 28C (Scott Bader Ltd.); Paraplex P13 (Rohm and Haas); Stypol 25/15 (Robertson Thane Ltd.).

4. Thermoplastics (Table 2)

Casein and the cellulose plastics, i.e. cellulose acetate, cellulose acetate butyrate and cellulose nitrate, have limited uses in radio or electrical applications.

Aniline formaldehyde is used as an impregnating resin for laminate material required to have good electrical properties at high frequencies and good weathering qualities. It can also be used for unfilled mouldings.

Polyethylene (polythene) has a very low power factor. On exposure to sunlight the power factor of the pure material increases due to oxidation but this effect can be reduced by

incorporating a small percentage of carbon black and certain anti-oxidants.

Polyvinyl chloride (P.V.C.) has electrical properties which are poor compared with those of polythene, but which are adequate for its use as an insulating material for wires and cables. P.V.C. contains additives such as plasticizers and lubricants which greatly affect the electrical properties. These additives may also react with cellulose finishes, and the two should not be used together. To reduce stiffening at low temperatures, P.V.C. can be specially formulated.

Other members of the vinyl family to which P.V.C. belongs include polyvinyl acetate and polyvinyl acetals; these are used mainly for lacquers and flexible varnishes for wire insulation purposes.

Polystyrene has excellent electrical properties and has many uses at the higher radio frequencies. One disadvantage, namely brittleness, has now been overcome by the introduction of improved grades of medium and high impact strength, while grades with better temperature resistance are also available.

Nylon is the generic name of the plastics known as super-polyamides. There are various chemical types with differing properties, but all of them have good or excellent mechanical properties; the coefficient of friction in particular is very low. Electrical characteristics are only moderate compared with many other thermoplastics, but the strength and resilience of nylon make it a valuable material for components in electro-mechanical apparatus.

Polymethyl methacrylate has excellent optical properties. Its anti-tracking properties are good, while other electrical properties are fair.

Polytetrafluoroethylene (P.T.F.E.) has a serviceable temperature range of -100° C to +250° C. As its electrical properties are similar to polythene, it has many potential uses in radio and electronics. At present, however, it is expensive, and because of its inertness, toughness and resistance to temperature changes it is not easy to manipulate, but certain fabrication techniques are now well established, and complex shapes can be produced.

Polychlorotrifluoroethylene (P.C.T.F.E.) has the trade names of Kel F and Hostafion. It has great mechanical strength and chemical stability up to 300° C. It is polar in nature but is not affected by water. The power factor at 100 Mc/s is 0.004, and the permittivity 2.4.

At 50 c/s the values are 0.015 and 2.7 respectively. Volume resistivity is 5×10^{17} ohm-cm, and specific gravity 2.1.

Neither P.T.F.E. nor P.C.T.F.E., although included with the thermoplastics, melt or flow like P.V.C. or polythene.

Table 3 Some Proprietary Products and their Manufacturers

This list is not comprehensive, and the omission of any particular product has no significance.

FORMS AVAILABLE

- | | | | |
|------|--------------------|------|--|
| S. | Sheet. | F. | Film. |
| R. | Rods. | P. | Moulding powders, compounds, materials, etc. |
| T. | Tubes. | Res. | Resin. |
| L. | Laminated. | C. | Cast. |
| Exs. | Extruded sections. | I. | Impregnating varnishes. |

Where more than one chemical type is given, the forms available do not necessarily apply to all types. Also, the manufacturers of the basic chemicals do not always supply fabricated forms.

CHEMICAL TYPE

Thermo-setting:

1. Phenol Formaldehyde.
2. Phenol Furfural.
3. Urea Formaldehyde.
4. Melamine Formaldehyde.

Thermo-plastic:

5. Aniline Formaldehyde.
6. Cellulose Nitrate.
7. Cellulose Acetate.

8. Cellulose Acetate Butyrate.
9. Ethyl Cellulose.
10. Casein.
11. Polyethylene or Polythene.
12. Polyvinylchloride and Vinyl types.
13. Polystyrene.
14. Polyamides (Nylon).
15. Polytetrafluoroethylene.
16. Polymethyl Methacrylate
17. Polychlorotrifluoroethylene.

<i>Trade Names</i>	<i>Forms Available</i>	<i>Manufacturer</i>	<i>Chemical Type</i>
Adamite	P.	Resinous Chemicals Ltd.	1
Aeroflex	Exs.	Anchor Plastics Co. Inc., U.S.A.	11
Alathon	Res.	E. I. DuPont De Nemours & Co. Inc.	11
Alkathene	R.T.F.P.	I.C.I. Ltd.	11, 1
Amberol	Res.	Charles Lennig & Co. (G.B.) Ltd.	1
Amoride	S.	Amoride Ltd.	12
Ampacet	P.	American Moulding Power & Chem. Corp.	7, 9, 13
Arathene	R.F.T.	Arabol Manufacturing Co. Ltd.	11
Aravin	T.	Arabol Manufacturing Co. Ltd.	12
Ashlam	L.	Ashdowns Ltd.	1
B.X.	All	B.X. Plastics	9, 11, 13
Bakelite	All	Bakelite Co., U.S.A.	1, 11, 13
Bakelite	L.P.	Bakelite Ltd.	1, 3
Beckacite	Res.	Beck Koller & Co. (England) Ltd.	1
Beckamine	Res.	Beck Koller & Co. (England) Ltd.	3
Beetle X	Paper filled P.	British Industrial Plastics Ltd.	3
Beetle X.P.	Plasticised	British Industrial Plastics Ltd.	3
Beetle Scarab	Woodflour filled P.	British Industrial Plastics Ltd.	3
Beetle M.	Paper filled P.	British Industrial Plastics Ltd.	4
Beetle K.	Special	British Industrial Plastics Ltd.	4
Bextrene	P.	British Industrial Plastics Ltd.	13

MATERIALS USED IN RADIO: 4. PLASTICS

Table 3 (contd.)

<i>Trade Names</i>	<i>Forms Available</i>	<i>Manufacturer</i>	<i>Chemical Type</i>
Catalin	R.T.S.C.	Catalin Ltd.	1
Catalin Styrene	P.	Catalin Ltd.	13
Corvic	Res.	I.C.I. Ltd.	12
Darvic	Rigid S.	I.C.I. Ltd.	12
Delaron	L.	Thomas de la Rue & Co. Ltd.	1
De la Rue	Exs.	Thomas de la Rue & Co. Ltd.	7, 8, 11, 12, 13
Denco	S.R.	Denco (Clacton) Ltd.	13
Diakon	P.	I.C.I. Ltd.	16
Distrene	P.	British Resin Products Ltd.	13
Durastrip	Exs.	Duratube & Wire Ltd.	12
Durite	Res.	Durite Plastics Inc., U.S.A.	2
Epok	Res.	British Resin Products Ltd.	1
Erinoid	S.R.T.P. Exs.	Erinoid Ltd.	7, 10, 12, 13
Fabroil-A	L. Cotton	British Thomson-Houston Ltd.	1
Fabrolite	P. Res.	British Thomson-Houston Ltd.	1
Fiberlon	Res.	Fiberloid Corp., U.S.A.	1
Fluon	Res.	I.C.I. Ltd.	15
Formapex	L.	loco Ltd.	1, 3
Fromoplas	S.	Wallington, Weston & Co. Ltd.	12
Geon	Res.	British Geon Ltd.	12
Idelite	L.	Bakelite Ltd.	1
Indur	Res.	Reilly Tar & Chem. Corp., U.S.A.	1
Indurite	P.	British Resin Products Ltd.	1
Insmat	L.	Insulated Materials Ltd.	1, 3
Kel F.	P.	Kellogg Corp., U.S.A.	17
Kerit	P.	O.C. Partners Ltd.	1
Lacrinte	P.	Lacrinoid Products Ltd.	1
Lacrinyl	Exs.	Lacrinoid Products Ltd.	12
Lactoid	S.R.T.	B.X. Plastics Ltd.	1
Lamalac	S.R.T.L.	Mica and Micanite Supplies Ltd.	1
Lamtic	Glass fibre filled T.	J. Mitchel & Sons Ltd.	1
Lucite	S.R.T.P.	E. I. DuPont de Nemours & Co. Inc.	16
Lustrex	P.	Monsanto Plastics Ltd.	13
Marblette	S.R.T.C.	Marblette Corp. U.S.A.	1
Megohmax	L.S.R.T.	Albert Taylor (Manchester) Ltd.	1
Melmac	Res.	American Cyanamid Co.	4
Melopas	P.	Ciba Ltd., Switzerland	4
Micarta	L.S.T.	Westinghouse Electric Corp., U.S.A.	1
Mouldensite	P.	Bakelite Ltd.	1
Mouldrite	P. Res.	I.C.I. Ltd.	1, 3

Table 3 (contd.)

<i>Trade Names</i>	<i>Forms Available</i>	<i>Manufacturer</i>	<i>Chemical Type</i>
Nestorite	P.	J. Ferguson & Sons Ltd.	1
Nylon	Fibres P.	I.C.I. Ltd.	14
Panilax	L.P.	Micanite & Insulators Co. Ltd.	5
Paxolin	L.S.T.R.	Micanite & Insulators Co. Ltd.	1
Perspex	S.R.T.	I.C.I. Ltd.	16
Philite	P.	Philips Electrical Ltd.	1, 3
Pyralin	S.R.T.	E. I. DuPont de Nemours & Co. Inc.	6
Resin 285	Res.	Ciba Ltd., Switzerland	4
Rockite	P.	British Resin Products	1, 3
Siluminite	Asbestos paper board L.	Turner & Newall Ltd.	1
Styron	P.	Dow Chemical of Canada, Ltd.	13
Teflon	Res.	E. I. DuPont de Nemours & Co. Inc.	15
Telcovin	Res.	Telegraph Construction and Maintenance Co. Ltd.	12
Telcothene	P.	Telegraph Construction and Maintenance Co. Ltd.	11
Tenatube	Exs.	Tenaplas Sales Ltd.	12
Textolite	L.S.R.T.	General Electric Co., Inc., U.S.A.	1
Thermold	P.	Thermotank Ltd.	1, 3
Tufnol	Paper & Fabric L.	Tufnol Ltd.	1
Urformite	Res.	Charles Lennig & Co. (G.B.) Ltd.	3, 4
Vynylite	R.S.T.	Bakelite Co.	12
Vybak	P.	Bakelite Co.	12
Welvic	P.	I.C.I. Ltd.	12
Wresin	Res.	Resinous Chemical Ltd.	1, 3

5. Specifications

A number of selected British Standards* and D.T.D.† specifications relating to plastics are given below:

B.S. 771:1948: Synthetic resin (phenolic) moulding materials.

Mandatory requirements are prescribed for the following properties of eight types of phenolic moulding materials: tensile strength, impact strength, surface resistivity, volume resistivity, heat resistance, power factor and permittivity. The standard also lays down optional requirements, any of which may be specified by a purchaser, for water absorption, plastic yield, electric strength and acetone soluble matter. Methods of test for each of the specified mandatory

and optional properties are given and methods of test are also provided for powder density and bulk factor, flow properties of powder, shrinkage on moulding, density of mouldings, crushing strength, crossbreaking strength, shear strength and elastic modulus in tension.

B.S. 1137:1949: Synthetic-resin bonded-paper sheets for use at power frequencies.

Applies to sheets of thickness from 1/64 in. up to 1 in., the material being intended for electrical insulation purposes for use with direct current, and with alternating current of frequencies up to 100 c/s only. The specification is divided into Part 1, mandatory clauses, and Part 2, optional clauses. Amongst the former are requirements for finish, tolerance on thickness, electric strength along laminae, tensile strength, water absorption and resistance to hot oil. The optional clauses cover insulation resistance, power factor, and mechanical properties. This specification supersedes B.S. 316 and B.S. 547 in so far as they applied to sheets.

* British Standards Institution, British Standards House, 2, Park Street, London, W.1.

† Prepared by The Director of Materials Research and Design (Air), and published by H.M. Stationery Office.

B.S. 1314:1946: Synthetic-resin bonded-paper tubes, for use as electrical insulation, for power circuits.

Three types of tube are covered, the internal diameters ranging from $\frac{1}{4}$ in. up to 3 in. The tubes are intended for electrical insulating purposes for use on power circuits with direct current, and with alternating current for frequencies up to 100 c/s. Electrical and mechanical properties are specified, together with tolerances on dimensions. Methods of test are fully described.

B.S. 1322:1946: Synthetic resin (aminoplastic) moulding materials and mouldings.

The materials and mouldings are classified into two types, one of which has the greater tensile strength, impact strength and electric strength. The section of the specification covering materials gives requirements, for each type, for tensile strength and impact strength; water absorption and swelling after immersion in water, plastic yield, electric strength and surface resistivity. Methods of test for these and for other properties are specified.

The section covering mouldings gives requirements for density, degree of cure, finish and freedom from moulding defects.

B.S. 1330:1946: Interim report on suggested methods of testing finished mouldings (plastics).

Methods of cutting the mouldings are discussed and specimen sizes suggested, tests on specimens cut from the mouldings are described for impact strength, cross breaking strength, crushing strength, electric strength, surface resistivity, plastic yield with temperature, resistance to heat, specific gravity, and water absorption. The results obtained by these tests are compared with those of standard tests to see how far correlation is obtained, and tentative conclusions are drawn.

B.S. 1493:1948: Polystyrene moulding materials.

Covers two grades of polystyrene moulding materials: general purpose and electrical. Acceptance limits for the properties of each of these grades are specified, together with standard methods of testing these properties. The more important properties covered are sieve analysis, methanol soluble matter, volatile matter, viscosity in benzene, impact strength, softening point, power factor, and permittivity.

B.S. 1524:1949* Cellulose acetate moulding materials.

Deals with cellulose acetate material for injection and compression moulding. The standard specifies methods of test and qualifying requirements for the physical properties of three grades of material, which are distinguished by different softening points. The standard also lays down optional requirements for electric strength, fines and impurities, and colour bleeding; any of which may be specified by a purchaser.

* Under revision.

B.S. 1540:1949: Moulded electrical insulating materials for use at radio frequencies.

Covers hard, moulded, electrical insulating material for use under working conditions which subject the materials to alternating electric fields at frequencies greater than 10 kc/s. The standard groups the material into classes and types according to certain radio-frequency electrical properties and, in some cases, mechanical properties. Mandatory qualifying limits are set for the essential properties of each type of material and optional qualifying limits are given for other physical properties. The methods of test are given in appendices.

B.S. 1755:1951: Glossary of terms used in the plastics industry.

The glossary includes 450 terms which have been grouped in sections to cover: chemistry, industrial applications, constituents, properties, moulding processes, other manufacturing processes. The terms listed in these sections are fully defined.

B.S. 1885:1952: Synthetic-resin bonded-paper insulating tubes (rectangular cross-section) for electrical power circuits up to 1,000 volts.

Two types of tube are specified, the internal side dimensions ranging from $\frac{1}{4}$ in. up to 6 in. with wall thicknesses from $\frac{1}{32}$ in. to $\frac{1}{4}$ in. inclusive. The tubes are intended for electrical insulating purposes for use on power circuits with direct current and with alternating current for frequencies up to 100 c/s. Electrical and mechanical properties are specified, together with tolerances on dimensions. Methods of test are fully described.

B.S. 1951:1953: Thermosetting synthetic-resin bonded-paper round tubes for use at radio frequencies.

Two grades of tube up to a maximum external diameter of 1 in. are covered. The tubes are intended for use at radio frequencies and their electrical, as well as some of their physical, properties are specified, together with dimensional tolerances. Methods of test to check compliance with the specific requirements are described in appendices.

B.S. 1973:1953: Polythene tube for general purposes, including chemical and food industry uses.

Specifies requirements for black, white and natural colour polythene tube made from three grades of material having various viscosities. It provides detailed compositional and physical requirements and lays down dimensions, limits and test pressures for light, medium and heavy tubes as well as tubes for screwing. An appendix gives notes on the installation of polythene tube.

B.S. 2004:1955: Polyvinyl chloride insulated cables and flexible cords for electric power and lighting.

Replaces the supplement to the 1946 edition of B.S. 7 which permitted the use of P.V.C. as an alternative to

vulcanized rubber for insulation or sheath or both for flexible cords and for 250-volt and 660-volt cables up to 0.06 sq. in. conductor cross-section. This standard, however, deals only with P.V.C. insulated cables and flexible cords (with or without sheath) for working voltages up to 250-volts. Tables of dimensions are included as well as standard colour identification schemes for cords and sheaths, and detailed test requirements are specified for the various cable components. The insulation thicknesses and physical tests are similar to those in B.S. 7 except that the insulation thickness for the unsheathed single-core P.V.C. insulated cable is greater than for the corresponding rubber cable. A fire-resisting test has been included.

B.S. 2067:1953: Determination of power-factor and permittivity of insulating materials (Hartshorn & Ward method).

Details are given of the techniques to be followed for testing solid (including sheet) materials and liquids, at radio frequencies between 10 kc/s and 100 Mc/s. The appendices include a description of the underlying theory.

B.S. 2076:1954: Thermosetting synthetic-resin bonded-paper insulating sheets.

Applies to natural-coloured material and specifies the requirements for two types of thermosetting synthetic-resin bonded-paper sheets for use at frequencies up to 30 Mc/s. It specifies the electrical as well as some of the physical properties of such sheets and includes appendices describing methods of test to check compliance with the specification.

B.S. 2571:1955: Flexible polyvinyl chloride extrusion compounds.

Covers three classes of compounds and specifies requirements for the following properties: tensile strength, elongation at break, volume resistivity at 23°C., cold bend temperature, cold flux temperature before ageing, deformation under heat, effect on polythene (increase in power factor), softness, water absorption, fastness to daylight exposure, colour bleeding, volume resistivity at 60°C. electric strength at 23°C., loss on heating, water soluble matter, heat stability, degree of flammability. Methods of test are provided in appendices.

B.S. 2572:1955: Phenolic laminated sheet.

Covers 14 types of material sub-divided into two groups depending on mechanical strength characteristics and various classes depending on the filler; provides clauses covering appearance, flatness, tolerance on thickness and marking, together with reference to the British Standard certification mark. Physical requirements are laid down for the following properties: cross breaking strength (minimum); impact strength (edgewise); water absorption; electric strength (both flatwise and edgewise); insulation resistance after immersion in water; crushing strength after heating. Methods of test are given in appendices.

B.S. —:1956: P.V.C. insulation and sheath of electric cables. (*To be published in the near future.*)

Specifies the requirements and methods of test for three types of insulant and three types of sheath for wires and cables. The tests are all designed to be carried out on the finished cable.

DTD:339C: Polymethyl Methacrylate, sheets, panels, etc., Grade A.

DTD:442: Laminated synthetic resin bonded mouldings.

DTD:845: Polymethyl Methacrylate, sheets, panels, etc., Grade B.

6. Acknowledgments

Thanks are due to manufacturers and others who have given assistance in the preparation of this review.

7. References and Bibliography

7.1. References

1. "Polystyrene (general information, with table of data of 'Plax' polystyrene)." Plax Corporation. *Rev. Sci. Instrum.*, **15**, p. 137. May 1944.
2. "The future of synthetic plastics." Bruce-Preller lecture, Malville. *Proc. Roy. Soc., Edinburgh, Sec. A*, **62**, pp. 1-9. 1943/4.
3. "Metal-plated plastics as alternatives for critical metals: including shielding applications (e.g. at high frequencies and the production of electrical units combining properties of conductor and insulator)." Metaplast Corporation. *J. Appl. Phys.*, **15**, p. 628, August 1944.
4. "Plastics in aircraft electricity and some of their limitations: lack of several significant data in usual tables of plastics; etc." E. B. Cooper. *Electrical Engng*, **63**, p. 313. August 1944.
5. "The insulating power of synthetic materials under the influence of moisture." R. Vieweg and F. Gottwald. *Elek. Tech. Z.*, **65**, p. 100. March 1944.
6. "Polythene data." Du Pont de Nemours. *Rev. Sci. Instrum.*, **15**, pp. 212-213, August 1944.
7. "Plastics developments in 1944: including 'Textolite,' of high dielectric constant." *Gen. Elect. Rev.*, **48**, p. 59. January 1945.
8. "The development of polythene as a high frequency dielectric." W. Jackson and J. S. A. Forsyth. *J. Instn Elect. Engrs.*, **92**, Part 3, pp. 23-31 and 31-37. March 1945.
9. "Plastics in high frequency insulation." P. I. Smith. *Electronic Engng*, **17**, pp. 515-516. May 1945.
10. "Fabricating plastics: new uses of plastics for electronic components require careful evaluation of published characteristics." *Electronic Industries*, **4**, pp. 86-87 and 132, with table of properties of various types. February 1945.

11. "Thermoplastics for insulating and protecting electrical conductors." H. C. Crafton, Jr., and H. B. Slade. *Communications*, **25**, pp. 52, 54, 88-91. June 1945.
12. "Properties of plastics in tropical conditions." S. Rogerson, W. J. Tucker, and P. I. Smith. *Electronic Engng*, **17**, p. 698. September 1945.
13. "A review of plastic materials." H. L. Brouse. *Proc. Inst. Radio Engrs*, **33**, pp. 825-834. December 1945.
14. "The effect of high humidity and fungi on the insulation resistance of plastics." J. Leutritz, Jr., and D. B. Hermann. *A.S.T.M. Bull.*, No. 138, pp. 25-32. January 1946.
15. "Plastics in the electronic and high frequency industries" W. S. Penn. *Electronic Engng*, **18**, pp. 280-281. September 1946.
16. "Plastics and the electrical industry: parts 1-4." P. R. S. Gibson. *Electrician*, **137**, pp. 443-445, 517-520, 582-585, 649-652. 16th, 23rd, 30th August and 6th September 1946.
17. "Polytetrafluoroethylene." M. M. Renfrew and E. E. Lewis. *Industr. Engng Chem.*, **38**, pp. 870-877. September 1946.
18. "Plastic compositions for dielectric applications." W. C. Goggin and R. F. Boyer. *Industr. Engng Chem.*, **38**, pp. 1090-1096. November 1946.
19. "Polystyrene plastics as high frequency dielectrics." A. von Hippel and L. G. Wesson. *Industr. Engng Chem.*, **38**, pp. 1121-1129. November 1946.
20. "Taking stress out of styrene." C. A. Breskin. *Scientific American*, **176**, pp. 11-14. January 1947.
21. "A plastics primer for engineers." K. Rose. *Materials and Methods*, **25**, pp. 119-138. April 1947.
22. "Teflon—an improved plastic for r.f. use." W. S. Penn. *Electronic Engng*, **19**, p. 220. July 1947.
23. "The growing importance of plastics in the electrical industry." G. Haefely. *J. Instn Elect. Engrs*, **94**, Part II, pp. 301-308 and 308-312. August 1947.
24. "The intrinsic electric strength of polythene and its variation with temperature." W. G. Oakes. *J. Instn Elect. Engrs*, **95**, Part I, pp. 36-44. January 1948.
25. "Ultrasonic lenses of plastic materials." D. Sette. *J. Acoust. Soc. Amer.*, **21**, p. 61. January 1949.
26. "Electrical properties of plastics." A. J. Warner. *Elect. Comm.*, **26**, pp. 33-39. March 1949.
27. "Properties of conductive plastics." *Electronics*, **22**, pp. 96-99. October 1949.
28. "Araldite." C. J. Moss. *Electronic Engng*, **21**, pp. 389-392. October 1949.
29. "Radio frequency welding of plastics." L. Grinstead and H. P. Zade. *J. Brit.I.R.E.*, **9**, pp. 322-338. September 1949.
30. "Ethoxylines." E. Preiswerk and C. Meyerhans. *Elect. Mfg. N.Y.*, **44**, pp. 78-81, 166. July 1949.
31. "Outdoor weather ageing of plastics under various climatological conditions." S. E. Yustein, R. R. Winans and H. J. Stark. *A.S.T.M. Bull.*, No. 173, pp. 31-43. April 1951.
32. "Wire and cable insulating materials with polyvinyl chloride as base." E. A. J. Mol. *Philips Tech. Rev.*, **12**, pp. 97-110. October 1950.
33. "The properties of insulating materials used in instruments." C. G. Garton. *Proc. Instn. Elect. Engrs*, **98**, Part II, pp. 728-737. December 1951.
34. "Behaviour of insulating materials at radio frequencies." J. J. Chapman, and others. *Elect. Mfg.*, **48**, pp. 107-109. July 1951.
35. "The newer laminated plastic insulating materials." A. N. Hawthorn and S. W. Messent. *Engineer*, **195**, pp. 436-437. March 1953.
36. "New electrical insulating materials." P. Jolivet. *Rev. Gen. Elect.*, **62**, pp. 267-275. June 1953.
37. "Epoxy Resins." R. A. Johnson. *Electronic Engng*, **26**, pp. 136-142. April 1954.
38. "Symposium of papers on insulating materials." *Proc. Instn Elect Engrs*, **100**, Part IIa, pp. 1-308. 1953.
39. "Use of foamed materials for insulation in high frequency coaxial cables. L. Krügel. *Fernmelde- tech Z*, **7**, pp. 221-226. May 1954.
40. "Dielectric properties of Teflon from room temperature to 314° C and from frequencies of 10² to 10⁵ c/s." P. Ehrlich. *J. Res. Nat. Bur. Stand*, **51**, pp. 185-188. October 1953.
41. "Conductivity induced in insulating materials by X-rays." J. F. Fowler and F. T. Farmer. *Nature, Lond.*, **173**, pp. 317-318. February 1954.
42. "Direct-current transients in polymethyl methacrylate and in polystyrene." P. Ehrlich. *J. Appl. Phys.*, **25**, pp. 1056-1058. August 1954.
43. "Irradiated polyethylene." J. B. Campbell. *Materials and Methods*, **40**, pp. 91-95. September 1954.
44. "Encapsulation and potting techniques. K. A. Fletcher. *British Comm. and Electronics*, **2**, pp. 44-49. April 1955.
45. "Polyester resins in the electrical industry." B. Porykyn. *British Plastics*, **24**. February 1951.
46. "Casting Resin Techniques for Potted Circuits." H. G. Manfield. T.R.E. Technical Note, No. 85. August 1950.*
47. "Cold Casting as a Constructional Technique for Subminiature Electronic Assemblies." E. N. Shaw. T.R.E. Technical Note, No. 90. October 1950.*
48. "Casting Resins, their Application to Electrical and Electronic Engineering." H. G. Manfield. R.R.E. Memorandum, No. 1097. December 1954.*
49. "Recent developments in ethoxyline resins." *Adhesive and Resin*, p. 179. September 1953.
50. "Applications of high energy electrons to the sterilization of pharmaceuticals and the irradiation of plastics." C. W. Miller, *J. Brit.I.R.E.*, **14**, p. 637. December 1954.
51. "The effect of high energy radiation on some long chain polymers." A. Charlesby. *Plastics*, **18**, p. 142. 1953.

* These are unpublished reports obtainable from the Central Radio Bureau, Ministry of Supply, London, W.C.1.

52. "Properties of irradiated polyethylene; the effect of initial molecular weight." E. J. Lawton, J. S. Balwit and A. M. Bueche. *Ind. Engg. Chem.*, 46, pp. 1703-9. 1954.
53. "Irradiated polyethylene." P. A. Goodwin and J. W. Wetzel. *Gen. Elect. Rev.*, 58, p. 48. September 1955.
54. "The dielectric properties of polyethylene terephthalate (Terylene)." W. Reddish. *Trans. Faraday Soc.*, 46, pp. 459-75. June 1950.

7.2. Bibliography

"Modern Plastics," H. Barron. (Chapman & Hall, London, 1945.)

A text-book for the general scientific or technical reader, rather than for the specialist.

"The New Plastics," H. R. Simmonds, M. H. Bigelow and J. V. Sherman. (D. Van Nostrand Co., New York, 1945.)

A semi-technical volume devoted almost exclusively to plastic materials, processes and uses which have been developed since 1940. An excellent attempt to condense the more important information into one volume.

"Plastics: Scientific and Technological," H. R. Fleck. (English Scientific Press, London, 3rd edn., 1951.)

Instructive and comprehensive treatise which will be of considerable value to all connected with the application of plastics in industry. Contains a survey of literature.

"Plastics for Electrical and Radio Engineers," W. J. Tucker, R. S. Roberts. (Technical Press, Kingston, Surrey, 2nd edn., 1947.)

Written with informed judgment and a wide knowledge of the requirements of electronic equipment. A very useful review.

"Plastics for Production," P. I. Smith. Chapman & Hall, London, 2nd edn., 1946.)

Will help those interested in plastics as materials of construction to appreciate their many advantages, as well as shortcomings.

"British Catalogue of Plastics," E. Molloy (Ed.). (National Trade Press, London, 1953.)

This guide to selection, processing and uses is encyclopaedic in character and dimensions. Specialist articles by thirty-five contributors are followed by makers' recommendations on moulding, fabricating and finishing. A brief reference to uses in the electrical industry is mainly illustrative, and nine pages are devoted to the radio industry.

"Experimental Plastics and Synthetic Resins," G. F. D'Alelio. (J. Wiley & Sons, New York, Chapman & Hall, London, 1946.)

This book is of considerable value to the graduate student starting upon a career in the plastics

industry. Ninety-seven experiments are described and twenty-seven test methods. A distinctive feature of the book is the way in which these exercises are put together; they all need thought rather than mere routine attention.

"The British International Plastics Annual, 1947." (Coombe Hill International, London.)

Covers the whole field of "Laboratory synthesized resins and products made therefrom." An outstanding feature is the mass of data under the heading "The properties of commercial plastics," giving fifty-four items of technical information and interest in relation to several hundred grades, each listed under its trade name.

"Modern Plastics Encyclopedia and Engineer's Handbook." (Plastics Catalogue Corporation, New York, 15th edn., 1951.)

A record of developments in plastic materials, machinery, engineering, techniques and applications, with a special section, "Plastics in defense," giving information on applications of plastics by the U.S. Services and related government bureaux and on the location of the relevant government offices. The directory section lists all U.S. manufacturers of plastic materials, machinery and equipment.

"Handbook of Chemistry and Physics." (Chemical Rubber Publishing Company, New York, 33rd edition, 1951/2.)

"Tables of Dielectric Materials," Vol. 14. Technical Report No. 57. Laboratory for Insulation Research, M.I.T. January 1953.

A comprehensive survey giving the dielectric constants and complex permittivities of most American dielectric materials.

"The Insulation of Electrical Equipment," W. Jackson (Ed.). (J. Wiley & Sons, Inc., New York, Chapman & Hall, London, 1954.)

"Dielectric Materials and Applications," A. R. von Hippel, Ed.). (J. Wiley & Sons, Inc., New York, Chapman & Hall, London, 1954.)

"British Plastics Yearbook." (Associated Iliffe Press Ltd., London.)

"Plastics Progress, 1955." (Associated Iliffe Press Ltd., London, 1955.)

A report of the papers read at the British Plastics Convention.

"Buyers Guide to Plastics Materials and Machinery and Equipment for the Plastics Industry." (British Plastics Federation, London, 1955.)

Technical Journals:

"British Plastics," Associated Iliffe Press.

"Plastics," Temple Press.

. . . Radio Engineering Overseas

522.6:621.396.9

A receiver for the waves from interstellar hydrogen. I. The investigation of the hydrogen radiation. C. A. MULLER. *Philips Tech. Rev.*, 17, pp. 306-315, May 1956.

Deals briefly with the structure of the Galactic System and the role played by interstellar hydrogen as a source of radio waves of sharply defined frequency; this is followed by a short description of the principles of operation of a receiver used to detect these waves and measure their intensity set up by the Netherlands Foundation for Radio Astronomy. The hydrogen radiation from space is picked up by a dipole antenna in the focus of a parabolic reflector 7.5 m in diameter. The radiation has the character of noise and is very weak, many times weaker than the noise level in the receiver itself; this necessitates special methods of measurement in order to achieve a reasonable accuracy. If the received noise power is expressed as a temperature defined by means of the Rayleigh-Jeans law, the maximum received intensity corresponds to a temperature of about 110°K. The accuracy of measurement reached is 1°K, i.e. 0.1 per cent. of the receiver noise.

537.311.33:621.314.632

Rectification and crystal structure. K. R. DIXIT. *Indian Journal of Physics*, 30, pp. 10-15, January 1956.

The work done by Welker on alloy rectifiers, by Hoffman and Rose and Strosche on the structure of selenium barrier layer, and by the author and his colleagues on the structure of cuprous oxide rectifiers is critically examined. It is concluded that a structure like that of diamond is necessary for an efficient rectifier.

621.314.632

Germanium power rectifiers. M. SASSIER. *Onde Electrique*, 36, pp. 224-9, March 1956.

Following a brief review of definitions and properties relating to *n-p* junctions, the author describes the method of producing a germanium power rectifier. Different circuit possibilities and arrangements of rectifiers are also discussed, and the advantages of germanium rectifiers in comparison with older types are stated.

621.319.42

Development of a standardized line of impregnated paper capacitors. C. M. LAURENT. *Onde Electrique*, 36, pp. 194-213, March 1956.

This paper gives the technical considerations underlying the design of two lines of metal cased paper capacitors (rectangular and tubular cases). It is divided into six parts covering standardization, characteristics, initial choice of parameters, minimum volume considerations, conditions of use, and construction.

A selection of abstracts from European and Commonwealth journals received in the Library of the Institution. All papers are in the language of the country of origin of the journal unless otherwise stated. The Institution regrets that translations cannot be supplied.

621.372.21

On the control of electromagnetic waves in cylindrical waveguides near cut-off frequency with respect to finite wall-conductivity.—W. SCHAFFELD and H. BAYER. *Archiv der Elektrischen Übertragung*, 10, pp. 89-97, March 1956.

The paper gives a theory concerning the propagation of electromagnetic waves in cylindrical waveguides near the cut-off frequency, under the assumption that the skin depth is small with respect to the radius of the tube and the wall thickness. Formulae are stated for the propagation constant, attenuation constant, phase constant, and guide wavelength for all TE and TM modes. The theory was checked and verified experimentally for the TE₁₁ mode. Finally it is shown how a reflex klystron operating near the cut-off wavelength of the waveguide can be stabilized using the latter within a range of $\Delta f/f \cong 10^{-8}$. Under certain conditions this constancy can even be improved by filling the waveguide with a gas resonating approximately at the cut-off frequency of the waveguide. Use is here made of the strong variation of the dielectric constant in the vicinity of the resonance line and the resulting change in the position of the waveguide frequency. In this manner it is simultaneously possible to create a frequency standard locked to the resonance line.

621.372.8

Investigation of the energy exchange and field distribution of surface-type waveguides.—D. MARCUSE. *Archiv der Elektrischen Übertragung*, 10, pp. 117-124, March 1956.

It is shown that the coupling between two surface type waveguides can be calculated by considering both wire waveguides as a two-wire system. Any initial condition can be realized by the superposition of a longitudinal wave and a transversal wave as possible modes of the two-wire system. It is found that with identical lines after a certain length *l* (the exchanging length) the full current injected into a guide is coupled over to the other waveguide. The presence of a conductor of different type near a surface type waveguide disturbs its field concentration and an extension of its field occurs.

621.373.423

The multi-reflex klystron as a transmitting valve in beam transmitters. F. COETIERER. *Philips Tech. Rev.*, 17, pp. 328-333, May 1956.

It is shown that the optimum transit time of the electrons as a function of the moment of time at which they pass through the resonator enables the requisite potential curve to be easily established

between the repeller electrodes. It is then demonstrated that the large bandwidth of the valve is due to its low electronic admittance, which in its turn is due to the repeated reflection of electrons. From tests made on the valve, it appears that the electrons which surrender energy are reflected four times. As compared with other high-frequency valves, the multi-reflex klystron is very simple in design. Most of its components are made from molybdenum sheet mounted on a sintered glass base.

621.375.4

The design of circuits using transistors at high frequencies. J. VASSEUR. *Onde Electrique*, 36, pp. 230-51, March 1956.

The paper presents a group of formulæ which will permit the design of linear transistor circuits at high frequencies. The use of a natural equivalent circuit leads to expressions which hold good at all frequencies. Formulæ derived from the z and h parameters are also recalled; these have the disadvantage of being frequency-dependent. It is found that a transistor amplifier can oscillate because of internal feedback alone over a wide range of frequencies. Various common neutralizing circuits to avoid this instability are discussed. Many of the basic circuit values vary with frequency according to the same law. This is notably true for input and output impedances with the input and output open- and short-circuited, as well as for the current gain. Universal curves and tables of limiting values are given which allow these quantities to be found for any frequency. Finally the value of the maximum power gain as a function of frequency is discussed. An explicit function is given for the common-emitter circuit.

621.375.4

On transistor equivalent circuits. J. GASCHI. *Onde Electrique*, 36, pp. 268-76, March 1956.

The paper traces the main steps in the evolution of equivalent circuits for transistors. After a brief recapitulation of Shockley's theory, various proposed circuits are examined, using the theory of four-terminal networks to do so. Reasons leading to the choice of any particular system of parameters thus derived are also examined. Progress in transistor techniques has led to their use at increasingly high frequencies, and the equivalent circuits previously discussed prove inadequate to describe their operation under such conditions. A circuit based on the solution of the diffusion equation and taking account of frequency-dependent factors is then examined by means of certain simplifying assumptions, in particular that of the limitation of the frequency band to be used. A relatively simple circuit is developed comprising eight elements and giving a sufficiently close approximation for practical calculations.

621.396.11

Polarization of the echoes from the ionosphere. J. K. D. VERMA and R. ROY. *Indian Journal of Physics*, 30, pp. 36-46, January 1956.

Experimental studies on the polarization characteristics of the echoes from the ionospheric layers are presented, and details are given of an improved

type of radio polarimeter which can work in conjunction with a high resolution radio sonde equipment. The high resolving limit of the equipment makes it possible to record the true polarization patterns of the echoes due to normal reflection and those due to irregularities in the ionized regions. A method is indicated for the identification of the thin layer type of E_s echoes from other types. On the basis of their polarization characteristics.

621.396.621 : 621.396.666

The improvement of reception by means of diversity techniques. R. HEIDESTER and E. HENZE. *Archiv der Elektrischen Übertragung*, 10, pp. 107-116, March 1956.

The quality of a communication link is determined primarily by the average signal-to-noise ratio and the probability distribution of the fluctuations of the signal-to-noise ratio about this average. The paper calculates for two kinds of diversity circuit these signal-to-noise ratios averaged in time and the probability densities for the fluctuations about these values. From the average signal-to-noise ratio thus obtained, a conclusion is made as to the average error figure (probability of the occurrence of a letter error) with a specific modulating method. On the basis of the probability densities, the paper derives the probabilities for the exceeding of a certain signal-to-noise ratio threshold in a positive or negative direction. Finally the practical realization of a diversity circuit is described.

621.396.67

Some comments on wide band and folded aerials. E. O. WILLOUGHBY. *Proc. Instn Radio Engrs, Aust.*, 17, pp. 79-87, March 1956.

The impedance-frequency characteristic of simple cylindrical aerials is discussed and it is shown that the band-width may be considerably improved by the use of appropriate correcting networks. The folded type of aerial automatically makes use of some of these principles. Folded aerials with equal and unequal legs are considered and experimental results illustrating the analysis are given.

621.397.8

Determination of signal-to-noise ratio in television by means of statistical fluctuations.—R. THEILE and H. FIX. *Archiv der Elektrischen Übertragung*, 10, pp. 98-104, March 1956.

In order to determine the signal-to-noise ratio in television, it is necessary to consider the type of the statistical fluctuations. So far the influence of the noise distribution as a function of frequency (flat or peaked noise) has been well investigated. Of similar importance, however, is the noise distribution on the individual signal amplitudes. The existing differences in this respect in currently used pick-up systems are described and illustrated by oscillograms. Investigations are then reported on the dependance of the disturbing effect of statistical fluctuations as a function of signal amplitude (brightness). From these results a new figure of merit is proposed to define the signal-to-noise ratio from measurements at three characteristic signal amplitudes.