

JOURNAL OF
The British Institution of Radio Engineers

(FOUNDED IN 1925 - INCORPORATED IN 1932)

*"To promote the advancement of radio, electronics and kindred subjects
by the exchange of information in these branches of engineering."*

Vol. XV No. 7

JULY, 1955

LIBERAL EDUCATION IN A TECHNICAL AGE

An ever-present topic of discussion in recent years has been that of education and technical training, a subject which has no doubt been thrown into prominence by the world shortage of scientific workers and engineers.

In 1953, the National Institute of Adult Education formed a committee "to enquire into the relationship between the vocational and non-vocational elements in further education and training." Its recent report* is the result of enquiries concentrated on technical institutions, colleges of art, residential colleges and professional and examining bodies.

The statistics compiled from the Committee's inquiries, and from the 1952-3 report of the Ministry of Education, show that there is a tendency, particularly in science and engineering courses, for a greater proportion of time to be devoted to vocational studies. This particularly applies to part-time courses. The Committee feels, however, that there is a need to develop in scientists and technologists the further qualities which will fit them to deal with problems of policy and management, but recognizes the problem of colleges in obtaining the staff to teach those broader aspects.

It has long been recognized that more must be done to attract recruits to the teaching profession. Graduate teachers of science and mathematics are required at the rate of 600 a year over the next five years and the Burnham Committee's recent proposals include increased allowances for teachers doing advanced work. Bearing in mind the financial considerations involved in taking up teaching, the Federation of British Industries has asked all its members to refrain from raising salaries in competition with the Burnham Committee's proposals. Nevertheless, a survey of advertising space in the national, local and technical press is evidence

* "Liberal Education in a Technical Age," Max Parrish, London, 1955.

of the intense competition which exists among industry and Government departments for radio and electronics engineers as well as offers of attractive employment overseas.

Addressing the recent Scottish Radio Congress, Mr. E. E. Rosen averred that new technologies take the place formerly held by cotton, coal and other industries. Changes in industrial development were not matched by changes in systems of technical training, and in reiterating the call for more trained engineers, Mr. Rosen stated that in Great Britain "we are living on D-day technical personnel."

The Government's Advisory Council on Scientific Policy has emphasized the shortage of scientific manpower in seven reports published since the end of the war. Addressing the Parliamentary and Scientific Committee on this subject on July 12th, Professor Sir Alexander Todd, F.R.S., the Council's Chairman, gave some interesting statistics.

In 1939, 0.5 per cent. of the working population in Great Britain held engineering qualifications at the level of Higher National Certificate, professional examinations or university degree standard. The corresponding percentage in America was 0.9. The 1954 American figure of 2 per cent. compares with 0.9 per cent. in Great Britain for the same year. (The percentage in Russia is estimated to be at least the same as for America.) Despite the shortage of engineers, less than 35 per cent. of undergraduates in British universities are studying science and engineering.

Whilst not decrying the desirability of a liberal education, the fact remains that more technological development requires specialized technical training. To meet the different approaches to this fundamental subject calls for greater co-operation between teaching authorities and the interested professional Institutions.

NOTICES

OBITUARY

The Council has learned with regret of the deaths of the following members:

Henry Daniel Bance, at Discovery, Transvaal, during May of this year. Born in Halifax, England, in 1900, Mr. Bance commenced a period of service in the Royal Navy during the first world war. In 1925 he joined the South African Railways and Harbour Administration, firstly as a radio engineer, and in 1944 was appointed Inspector and Traffic Officer (Radio).

Mr. Bance was elected an Associate of the Institution in 1934 and was transferred to Associate Membership in 1948. He played an active part in the formation of the South African Section and took office as Treasurer and Chairman of the Section. In 1952 he read a paper before the Section on "Radio Beacons."

Phiroze Darabshaw Bharucha, who died on January 16th last, aged 39 years, was elected an Associate Member in 1952. For some 10 years Mr. Bharucha was Works Manager of the National Radio and Engineering Co., Ltd., of Bombay, (with which E. K. Cole Ltd. are associated) where he was concerned with the manufacture of components and assembly of broadcast receivers. He obtained a degree of Bachelor of Arts of Bombay University in 1937.

Election of General Council 1955-56

The August issue of the *Journal* will contain formal notice of the 30th Annual General Meeting of the Institution. In accordance with Article 32, the notice will include Council's nominations for the vacancies about to occur in the offices of President, Honorary Treasurer, and ordinary members of Council.

Vacancies will arise for five ordinary members of Council, of whom three must be Members, one an Honorary Member, and one a Companion.

Corporate members of the Institution are invited to submit nominations for election to the General Council. Each nomination, supported by not less than 10 corporate members, together with the written consent of such person or persons to accept office if elected, must be submitted in writing to the Secretary of the Institution not later than 21 days after the issue of Council's nominations.

Speech Day at Reed's School

Reed's School, which is supported by the Institution's Benevolent Fund, held the Boys' Speech Day and Prize Giving on Saturday, June 25th, at the Boy's School, Cobham, Surrey.

The chief guest was the President of the Institution, Rear-Admiral Sir Philip Clarke, K.B.E., C.B., D.S.O. In his address to the boys, Admiral Clarke advised them to remember three E's—Enthusiasm, Energy and Enterprise—as being essential qualities to bring to their future careers.

Lady Clarke presented the prizes.

International Telecommunications Award

In memory of and to honour Christopher Columbus, an "International Prize of Communications," value 5,000,000 lire (approximately £2,750), has recently been instituted in Italy, under the auspices of the city of Genoa. The prize is to be awarded for any important discovery made, or outstanding research work done, in the past four years, to aid communications. It may be awarded to an individual, an organization, or collectively to a group of workers.

For the purpose of making a selection, the subject of communications has been divided into the following four categories: Maritime, Air and Land Communication, and Telecommunications. The award is to be for only one of these categories each year. This year the prize will be for Telecommunications.

The President of the Institution has been invited to nominate a candidate or candidates for the Telecommunications award, which is to be made on October 12th next.

Sir Edward Appleton

Sir Edward Appleton, G.B.E., K.C.B., F.R.S., has accepted an invitation to become president of the Radio Industry Council in succession to Lord Burghley, who has held office since 1952. Sir Edward, whose research work in the field of radio-physics was an important factor in the development of radar, was awarded the Nobel Prize for Physics in 1947. He has been principal and vice-chancellor of Edinburgh University since 1949 and for ten years before that appointment was secretary to the D.S.I.R. He was the president of the British Association in 1953.

THE MAGNETRON BEAM SWITCHING TUBE

Its Operation and Circuit Design Criteria*

by

S. P. Fan, M.S., Ph.D.†

SUMMARY

The properties of a magnetron type of beam switching tube (a tube operated with crossed electric and magnetic fields) and its operation as a switching component are described. The tube is called the magnetron beam switching tube (abbreviated MBS tube). Because of the electron beam-forming property of crossed fields, a tube with 10 anode segments individually connected through proper impedances may operate with 10 stable beam positions at each of which the electron beam will strike only one of the segments; or it will operate in an astable state, in which the electron beam sweeps from one segment to another successively. A stable operation of the tube is the result of a relaxation oscillation. By combining the stable and astable operations, the tube may be very useful in switching circuits. A description of electron paths in the tube is given to help one acquire an insight into the tube operation. A method is given for designing MBS tube circuits. The stability of the stable states and the consistency of the switching operation are discussed. Comparisons are made between the MBS tubes and other counting devices.

LIST OF SYMBOLS

Rationalized MKS units are used throughout unless otherwise specified.

V_s, i_s	total spade supply voltage and current.	R_m, R_M, R_h	critical spade load resistances shown in Figs. 3 and 4.
V_l, i_l	$l = 0, 1, \dots, 9$, individual spade voltage and current of l th spade.	R'_m, R'_M	alternate critical spade load resistances as defined in equns. (5) and (6).
$V_m, I_m, I_M, I_0, I_1, I_L$	spade voltage and currents defined in Fig. 7.	t_1	time lag for the leading-spade potential to reach V_e after applying the input pulse.
V_T, i_T, V_t	target voltage and current, $V_t = V_T + i_T R_T$.	t_s	switching time of the electron beam from the holding spade to the leading spade.
V_f	filament voltage.	$\tau_i \Delta V_i$	pulse duration and amplitude of input pulse.
V_a, i_a	grid voltage and current.	ΔV_0	minimum input voltage for triggering.
V_c	magnetron cut-off voltage in the cylindrical region between the cathode and the spades.	$j+1, j, j-1$	denote the particular number of the spade in discussion; j th spade is usually the electron beam-holding spade; $(j-1)$ th spade the lagging spade and $(j+1)$ the leading spade.
B	magnetic induction.		
$R_s C$	resultant individual spade load resistance and capacitance.		

*Manuscript received January 24th, 1955. Edited and communicated by Dr. Hilary Moss (Member), Department Manager, Burroughs Research Center, Paoli, Pa., U.S.A. (Paper No. 321.)

†Formerly of Burroughs Tube Research Department, Burroughs Research Centre.

U.D.C. No. 621.318.57 : 621.374.32 : 621.385.16.

e/m	charge to mass ratio of electron.
r_c	cathode radius of the MBS tube.
r'_s	equivalent spade radius of the MBS tube.
d	spacing between the spades (Fig. 1).

1. Introduction

In recent years a great deal of attention has been given to the problems associated with the counting and distribution of electrical pulses, particularly at high speed. This has arisen partly as a result of the numerous applications of such counters in the field of atomic energy and also because in the last decade the whole concept of circuit engineering has been profoundly affected by the increasing attention given to digital as distinct from analogue concepts.

About 1942, Professor Alfvén and his co-workers at the Royal Institute of Technology, Stockholm, began investigations on certain electron discharge devices in which the electrons were constrained to move under the influence of perpendicular electric and magnetic fields. These electron paths are trochoidal in form and Alfvén gave the name "trochotron" to tubes embodying this type of electron motion.¹ The work of Professor Alfvén and his group was very largely concerned with the more theoretical aspects of these devices. The tubes they produced as working samples were for the most part of planar form, and had mechanical and electrical characteristics not too well suited to their use in practical circuits. Basically, each array in their trochotron was of two-element form. One element was designed to lock the beam, and the second extracted the current. This necessarily entailed using either of these electrodes for the purpose of controlling the switching mechanism. The versatility of the circuits used to perform this function was reduced by the fact that both these electrodes consumed current and existed for logically different purposes.

About nine years later work was initiated in the United States designed to develop more practical forms of trochotron which would be of direct use in a wide variety of applications. These tubes utilize the basic principles of trochoidal motion, but are radically different in their physical form from the early trochotrons.

The two major differences lie in the use, firstly, of a cylindrical type of structure and, secondly, in the development of a zero current switching grid. The name, Magnetron Beam Switching Tube (abbreviated MBS tube), was given to describe this type of construction, first developed by S. Kuchinsky.²

Figure 1 shows a cross-section of a typical tube of this form. There are 10 identical sections arranged symmetrically around the cathode. Each section consists of three basic elements: (1) the spade or the electron beam-forming and holding electrode, (2) the switching grid, the input or electronic switching electrode, and (3) the target, or the output or the electron beam-collecting electrode. A constant and uniform magnetic field B is applied parallel to the axis of the tube as indicated. Because of the beam-forming property of the crossed electric and magnetic fields, the individual spade current-voltage characteristic is such that, as the voltage on a spade is lowered, the current to it increases, comes to a peak and then decreases to zero. The non-linear current-voltage charac-

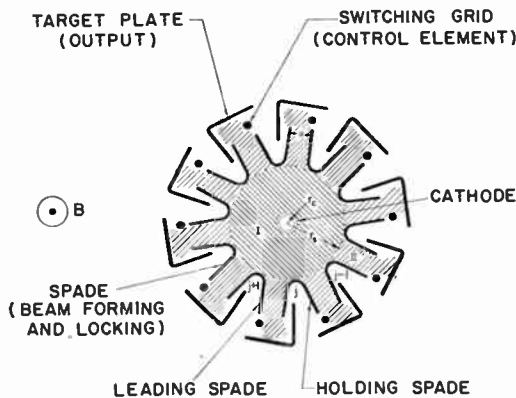

Fig. 1.—Cross-section of magnetron beam switching tube type MO-10.

teristic of the spades is similar to that of the anode in the split-anode magnetron and can result in either stable or astable states when resistive loads are connected to the individual spades. In the stable-state operation, the electron beam is formed toward one particular spade, whereas in the astable state, the electron beam rotates in the tube from spade to spade in discrete steps. The astable state is the relaxation oscillation of the magnetron beam switching tube. Unlike harmonic oscillation,³ this

type of oscillation involves the charging and discharging of the spade capacitance. Starting from a particular stable state, a definite time interval of astable operation causes the electron beam successively to advance an integral and a definite number of steps to another spade. This oscillation may be started or stopped by controlling the grid voltage. This electronically controlled oscillation constitutes the switching operation of the tube.

A typical MO-10 tube-switching circuit is shown in Fig. 2. Statically, the switching circuit can have one of the 10 stable electron-beam-conducting *states* (abbreviated as 10 *states* later on) as shown in Fig. 2. If a negative

second, the *consistency* of the switching operation.

To design an MBS tube-switching circuit, it is necessary first to find the upper and lower bounds of the operating parameters for which the circuit has 10 states; then to design the circuit to place the operating point within this region. Because an analysis of the electron-beam paths in the MBS tube is very complicated, a purely mathematical method of designing the tube circuit is not practicable. Hence design consideration must be based on experimental results, leading to a graphical method of design. This approach permits the *stability* of the circuit to be studied, and leads to a method of designating an MBS tube circuit with components of specified tolerance.

The MBS tubes can be operated with large voltage and wide frequency ranges. As explained later, the operating voltage depends only on the magnetic induction B and the spade load resistances. The MBS tube has been operated satisfactorily from 15V to 300V with suitable changes in operating parameters and has delivered about 60 mA to the target. The upper figure is limited by electrode dissipation. When the repetition rate of input triggering pulses is varied from zero to above 4 Mc/s, the electron beam within the tube is consistently switched from one spade to the next.

The MBS tube suggests wide application in digital information systems because of the simplicity of the tube and circuit, versatility of the primary functions, and the reliability of its operation. It has possible applications in the fields of electronic digital computing, telemetering, television, nuclear physics, instrumentation, industrial automatic control, and communications.

In the following sections, the formation of the electron beam and the mechanism of the stable states are studied first. In studying the stable states (Sections 2 and 3) the magnetic field is assumed to be constant, and the grid and target are held at spade-supply potential in order not to confuse the reader by too many operating parameters. After discussing the existence of the stable states, the effects of the different grid and target voltages on the stable states are studied and method of switching is demonstrated. Comparison of the MBS tube circuit with other tube circuits which can perform similar operations is also given.

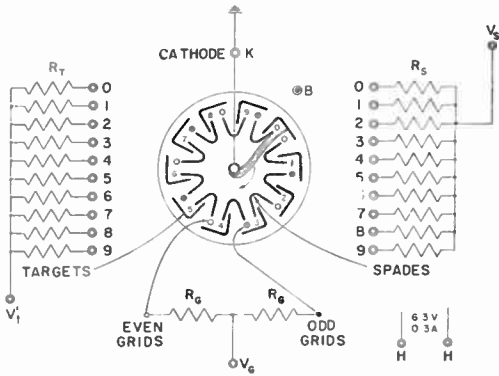

Fig. 2.—Typical MO-10 tube circuit with odd and even grids tied together for push-pull input operation.

voltage is applied to the switching grids, the electron beam will advance from one spade to the next successively in the tube, resulting in relaxation oscillation. In this operation, the MBS tube circuit is similar to an electronic selector's switch with the electron beam as the selector's arm.

One of the basic criteria for determining whether or not a switching circuit is useful, is its *reliability*. There are two ways to specify the reliability of a switching circuit; first, the operating states should be stable against variations of other operating conditions than the input signal, and second, the operating state must switch from one to another consistently for each input triggering signal. For brevity, the first sense of the circuit reliability is termed the *stability* of the circuit condition and the

2. Static Characteristics of the MBS Tube

The static current-voltage characteristic of the MBS tube with all its spades connected together is similar to that of a cylindrical magnetron diode. As in a magnetron, there exists a cut-off spade voltage, below which the electron current decreases very rapidly. The operating voltage of the MBS tube in the switching current is much less than the cut-off voltage, so that normally there should be little or no electron current to the spades.

these i_j-V_j curves with $V_{j-1} = V_s$ and $V_{j-1} = 0$ (Figs. 3 and 4), there is one common characteristic; that is, the current to the varying-potential spade increases at first, and, after reaching a maximum, decreases as the voltage on this spade is lowered. These non-linear current-voltage curves exhibit a region of negative resistance; it is this property upon which the switching operation of the MBS tube is based. A study of the electron paths in the MBS tube suggests an explanation for the non-linear current-voltage characteristic.

The discussion of the electron paths in the MBS tube is simplified by considering the space inside the plate to be divided into two regions—region I, the space between the cathode and all the spades, and region II, all other spaces as shown in Fig. 1.

When all spades are connected together, the electric field pattern in Region I is very similar to that of the cylindrical magnetron diode in which the anode is a continuous cylinder instead of 10 separate segments. The paths of electrons in this region should be similar to those in the magnetron when all spades are at

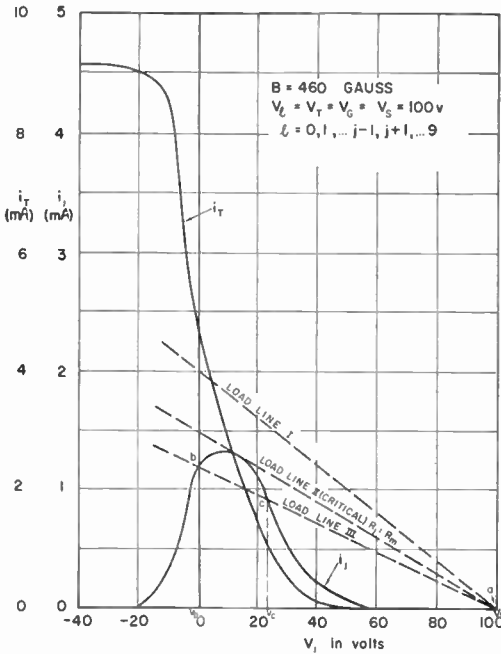

Fig. 3.—Holding-spade current i_j and target current i_T as a function of V_j .

When the potentials on the spades are not the same, the current-voltage characteristics of each spade are quite different. Fig. 3 shows the current characteristic curves when one spade voltage V_j is varying and the potentials of the other spades, the grid and the target are held constant at $+V_s$ to cathode.* Fig. 4 shows the current characteristics of the j th and $(j-1)$ th spades when V_j is varying and $V_{j-1} = 0$. In all

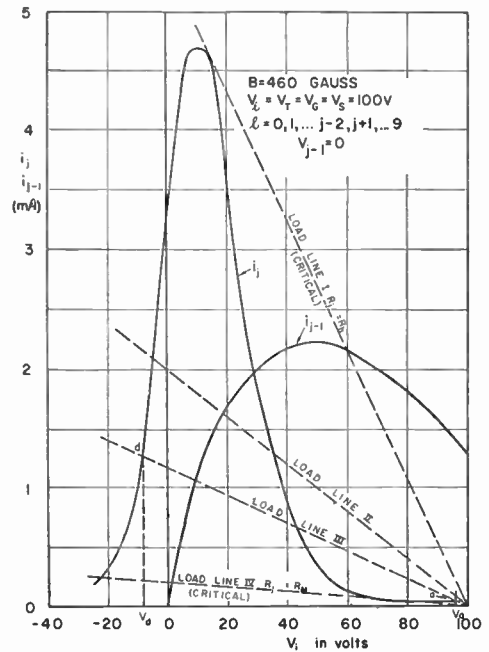

Fig. 4.—Spade currents as a function of V_j when $V_{j-1} = 0$.

*The phenomenon that electron beam current flows to the spade of negative potential will be explained in Section 6.

the same potential. The corresponding cut-off spade voltage (equivalent to the cut-off anode voltage of the magnetron diode⁴) is given by:

$$V_c = \frac{e}{8m} B^2 r_s'^2 \left(1 - \frac{r_c'^2}{r_s'^2}\right)^2 \dots \dots (1)$$

Equation (1) is obtained from the consideration of electron paths.

When the magnetic induction B is large and the electric field is non-uniform radially, the electrons travel in small loops that drift away from, or around, the cathode. The direction of the drift is important in the operation of the tube. The typical electron paths and electric field patterns with the potential of one spade, and with the potential of two spades, held at the cathode potential are shown in Figs. 5 and 6. Electrons leaving the portion of cathode facing the high-potential spades, travel around the cathode as in a cut-off magnetron, until they approach the cathode facing the low-potential spades, where the electric field deviates markedly from that of a uniform radial field. Because the change in field occurs so gradually along the path of the electron beam, the electrons drift more or less along an equipotential line^{5,6} as shown in Figs. 5 and 6.

In region II, the electric field between two adjacent spades is approximately uniform. The path of an electron moving in crossed, uniform electric and magnetic fields has been studied in detail and found to be a trochoid.⁷ When an electron in the MBS tube following the equipotential line enters the first gap that separates the high- and low-potential spades, it will move parallel to the sides of the spades toward the target as shown in Figs. 5 and 6 and the target collects the electrons, when the target voltage is high.

From Figs. 5 and 6 it is seen that the electron paths in region I always lead to one of the gaps that separate the high-potential spades from the low-potential spades. The particular gap chosen by the electrons, called the leading gap, is determined by the direction of the magnetic field. The direction of the magnetic field also controls the direction in which the electron paths shift when the potential of adjacent high-potential spades are lowered. A change in potential of the lagging spade has little effect on the electron paths as is evident from Figs. 5 and 6.

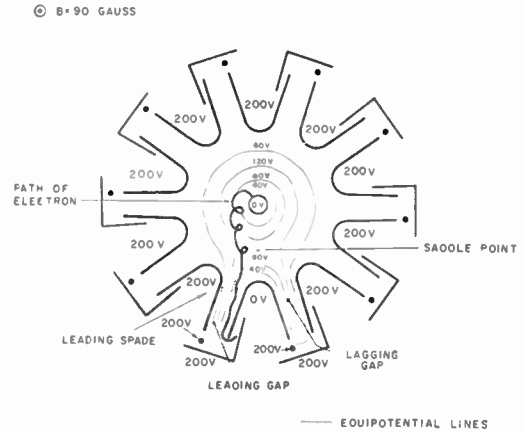

Fig. 5.—Electron path in MBS tube (I).

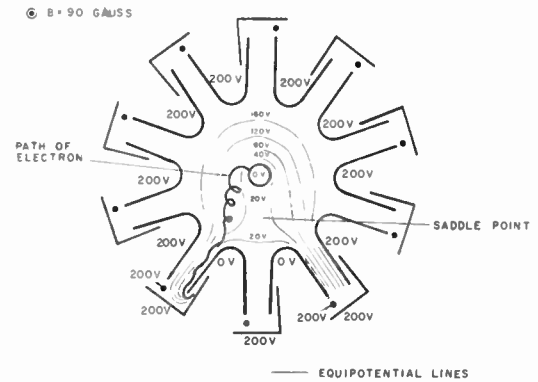

Fig. 6.—Electron path in MBS tube (II).

The electron paths shown in Figs. 5 and 6 were obtained from photographs taken of a simplified, enlarged and slightly gassy MBS tube in which the electrons are emitted only in a few longitudinal filaments along the cathode.

For stable operation of the MBS tube in the switching circuits that are described later, the high-potential spade of the leading gap, that is, the leading spade, should not receive electron current. For the case in which the potential of the leading spade is V_s and the potential of the lagging spade is zero, the criteria in both regions I and II for electrons not reaching the high-potential spade are:

$$V_s < V_c = \frac{e}{8m} B^2 r_s'^2 \left(1 - \frac{r_c^2}{r_s^2}\right)^2$$

and $V_s < V_{II} = \frac{e}{2m} B^2 d^2 \dots \dots \dots (2)$

where V_c and V_{II} are the equivalent cut-off voltages in regions I and II with zero entrance velocity.⁸ Thus, if the spade supply voltage V_s is near one of these two cut-off voltages, the leading spade may be able to receive some electrons.

The preceding description applies to the typical path of a single electron in the MBS tube. When electrons from the entire cathode surface are considered, some of them will reach the leading gap as described, while others will return to the cathode. When large numbers of electrons are packed into a narrow stream from the cathode to the spades, the effect of space-charge repulsion cannot be neglected. The space-charge effect in the MBS tube at cut-off is similar to that of a static magnetron, an effect that has been studied by various authors.^{9,10} The space-charge effect of the electron beam in the MBS tube under various operating conditions is very involved and will not be discussed here. It may be said that, in general, the path of the electron beam, when space-charge effects are present, still follows the shape of the "envelope" of the paths of single electrons.

Based upon the knowledge of the electron paths in the MBS tube, the static characteristic curves in Figs. 3 and 4 can be explained qualitatively as follows: starting from the cut-off condition, the lowering of the voltage on one of the spades will change the electric field configuration so that some electrons begin to reach this spade. In addition, the lower the spade potential, the more the electrons drift into the leading gap and the greater the spade current. When the spade voltage approaches zero, the electrons lose velocity on approaching the spade and the spade current decreases. This explains the non-linear character of the spade current-voltage characteristics as shown in Fig. 3. If one spade is already at cathode potential, the lowering of the potential of the leading spade will send more electrons toward the corresponding leading gap, and therefore increase the current to the leading spade. This is the reason for the large spade

current i_j in Fig. 4 as compared with that in Fig. 3. When the leading spade ($j+1$) is at cathode potential, there is no current flowing to the lagging spade (j th) as is clearly indicated by the study of electron paths in Figs. 5 and 6.

3. Stable and Astable States of the MBS Tube Circuit and Its Design

When there is spade-load resistance R_j in the j th-spade circuit, the spade voltage V_j will be monostable or bistable because of the non-linear spade-current characteristic. For small load resistance R_j to the j th spade, the load line has only one intersection, a, to the $i_j - V_j$ curve as shown by the load line I (Fig. 3). Then, the spade can only have the voltage V_a and the tube remains stable at cut-off condition. For large load resistance, R_j , the load line may have three intersecting points with the $i_j - V_j$ curve as indicated by the load line III and the points a, b, and c (Fig. 3). The spade therefore can have two stable voltages V_a and V_b and one unstable voltage V_c .¹¹ With the spade at the potential V_a , the MBS tube is cut off whereas, with the spade at the potential V_b , the electron beam is formed toward the low-potential spade and the tube conducts. In the conducting condition, only a small part of the electron current flows to the j th spade in order to hold the electron beam while a large portion flows to the target as shown in Fig. 3 and can be used as an output current. There is a critical load line, i.e., load line II, which is tangential to the $i_j - V_j$ curve and the corresponding value of the critical load resistance is R_m . If $R_j < R_m$, the spade has only one stable voltage, $V_a = V_s$, while if $R_j > R_m$, the spade can have two stable voltages (V_a and V_b) on the load line III.

If the corresponding lagging spade, ($j-1$)th is connected to the cathode potential, the j th-spade current-voltage curve changes and so do the critical resistances. As shown in Fig. 4, load lines are drawn to represent different values of R_j . It is seen that there are now two critical load lines, i.e., load lines I and IV. The load line I in Fig. 4 determines the value of a critical resistor R_h and is similar to the critical load line II in Fig. 3. If $R_j < R_h$, the j th spade cannot hold the electron beam at all, while if $R_j > R_h$, the j th spade can hold the beam. In addition to the critical load line I, there is another critical load line IV which is tangential to the bottom part of the $i_j - V_j$

curve and determines another critical value of spade resistance R_M . If $R_j > R_M$, the j th spade will *always* be held at the conducting state. The electron beam is instantaneously shifted from the $(j - 1)$ th spade to the j th spade and no electron current flows to the $(j - 1)$ th spade when the j th spade holds the electron beam. With $R_h < R_j < R_M$, the j th spade can have two stable voltages (for example, V_a and V_d on load line III).

Now consider the case with R_{j-1} and R_j connected to the $(j - 1)$ th and j th spades respectively. If $R_{j-1} > R_M$ and the $(j - 1)$ th spade is holding the electron beam, the stability of the electron beam position at the $(j - 1)$ th spade depends on the value of R_j . There are four possible conditions:

- (1) If $R_j > R_M$, the j th spade can have only the conducting state and the electron beam current will shift from the $(j - 1)$ th spade to the j th spade. Then, the electron beam is not stable at the $(j - 1)$ th spade.
- (2) If $R_M > R_j > R_m$, the electron beam is stable at the $(j - 1)$ th-spade position. But it can also be shifted to the j th spade by external

means and be stable there (load line III in Figs. 3 and 4).

(3) If $R_m > R_j > R_h$, the electron beam is stable at the $(j - 1)$ th-spade position and it can also be shifted to the j th spade (load line II in Fig. 4). But when the electron beam is at the j th spade, the voltage on the $(j - 1)$ th spade, V_{j-1} will be raised to V_s and the electron beam at j th spade is not stable (load line I in Fig. 3). Then the electron beam will finally be cut off.

(4) If $R_j < R_h$, the j th spade cannot hold the electron beam at all and the $(j - 1)$ th-spade beam position is stable.

In summary, the above results clearly indicate that the stability of the electron beam holding at the j th spade depends on V_s^* and R_j as well as on the corresponding leading-spade resistance R_{j+1} . If all spades of the MBS tube circuit have the same resistance R_s as shown in Fig. 2, then the tube circuit will be operated in the following four modes: (a) when $R_s > R_M$ and $R_s > R_m$, the tube oscillates; (b) when $R_M > R_s > R_m$, the tube has 10 stable conducting states; (c) when $R_s < R_m$ and $R_s < R_M$, the tube is cut off, and (d) when $R_M < R_s < R_m$, either cut-off or oscillation is possible.

A proper MBS tube circuit for switching operation requires 10 static stable states with provision for making these states astable during the switching. The design of an MBS tube circuit involves finding the proper R_s within its upper and lower bounds, i.e. R_M and R_m , for stable operation. The value of R_M and R_m depends on the spade-current characteristics which are functions of all operating parameters such as V_T , V_a , V_l ($l = 0, 1, \dots, 9$) and B . For the sake of simplicity, let us assume that:

- (a) The magnetic induction B is constant and uniform.
- (b) $V_l = V_s$, ($l = 0, 1, \dots, j - 2, j + 1, \dots, 9$); V_j is the potential of the j th spade when j th spade is holding the beam or when the electron beam is switching from $(j - 1)$ th spade to j th spade.
- (c) $V_T = V_a = V_s$ because the voltages V_T and V_s will not affect the holding operation but only the switching operation, which will be discussed in detail later.

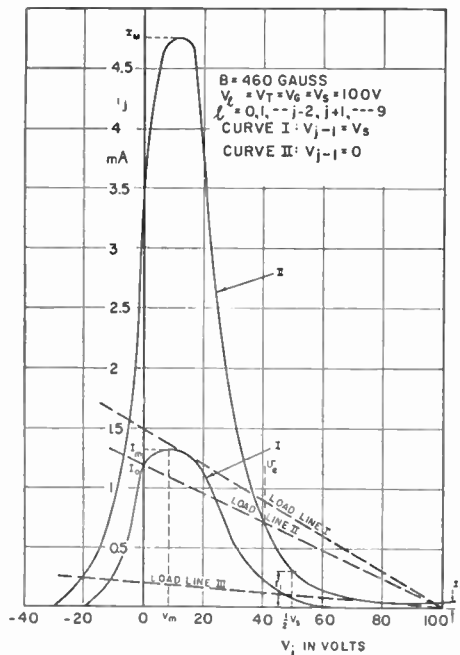

Fig. 7.—Holding- and leading-spade characteristics.

*Note that the grid and the target are at V_s in this discussion. Their effect is discussed in Section 4.

Therefore, the current of the $(j - 1)$ th and the j th spades are functions of V_{j-1} , V_j and V_s . For convenience in the discussion later on, two curves of the spade current I_j as a function of V_j for two values of V_{j-1} are redrawn in Fig. 7 from Figs. 3 and 4.

The values of R_m and R_M are determined by the spade current-voltage characteristics as shown in Fig. 7. It is very difficult to obtain the analytical expression of the spade current-voltage relationship owing to the complicated

must be obtained from the spade characteristic for each V_s such as Fig. 7. This is a tedious procedure, and a simpler method to find alternative but safe bounds is described in the following. If, instead of the exact value of R_m and R_M , the other values R'_m and R'_M can be easily found such that $R_m \leq R'_m$ and $R'_M \leq R_M$, then the new values can be adapted as the corresponding lower and upper bounds, i.e.,

$$R_m \leq R'_m < R_s < R'_M \leq R_M \dots \dots \dots (3)$$

The method for finding new bounds R'_m and R'_M will now be described.

3.1. Investigation of the lower bound of R_s

The value of R_m depends on the holding-spade characteristic of an individual spade when all other spades are at V_s (i.e. Curve I in Fig. 7). To find R_m it is necessary to take this holding-spade characteristic for each value of V_s . An alternative lower bound R'_m can be found in the following manner. By examining the spade characteristic more closely, it is found that the maximum value of I_j or I_m always occurs at a small positive value of V_j . Because of this fact, we have

$$I_0 (V_j = 0) \leq I_m (V_j = V_m) \text{ and } V_m \geq 0 \dots (4)$$

For simplification in circuit design, the lower bound R_m may be substituted by the value

$$R'_m = \frac{V_s}{I_0} \dots \dots \dots (5)$$

which is larger than but close to R_m because of the shape of the spade current-voltage characteristic, and which can be evaluated from a simple measurement of I_0 at V_s .

3.2. Investigation of the upper bound of R_s

The value of R_M depends on the shape of the leading-spade characteristic (curve II of Fig. 7); more specifically, on the slope of the load line tangential to the curve II (load line III). The shape of the leading-spade characteristic depends on the spade-supply voltage. Fig. 8 shows the normalized leading-spade characteristics for different values of V_s/V_c . It shows that the normalized leading-spade current at $(V_{j+1})/V_s = 1$, or the leakage current I_L , increases with V_s/V_c . To have reliable stable states, this leakage current must be small. This is the reason that the spade-supply voltage, V_s , should be very

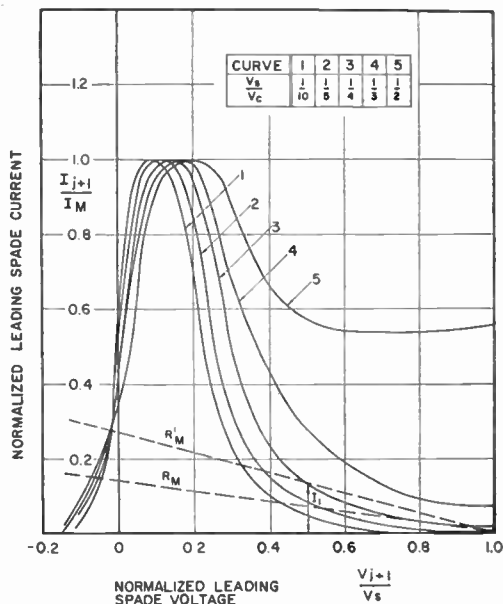

Fig. 8.—Normalized leading-spade characteristics.

beam-forming action of the crossed electric and magnetic fields as well as the space-charge effect. Therefore, the analytical method is abandoned in favour of an experimental and graphical method in which the spade-current characteristic is obtained experimentally and the tube circuit is designed by a graphical method.

As stated before, the first step of the design is to find the lower and upper bounds (i.e. R_m and R_M) of R_s for different V_s . The exact values of R_m and R_M depend on the load lines that are tangential to the spade current-voltage characteristics. The shape of the spade current-voltage characteristic depends on V_s , so if the exact bounds are necessary, the value of R_m and R_M

much less than V_c ; for example, $V_s < \frac{1}{5} V_c$. For small values of V_s/V_c , the leading-spade current seems to have a relatively flat portion near

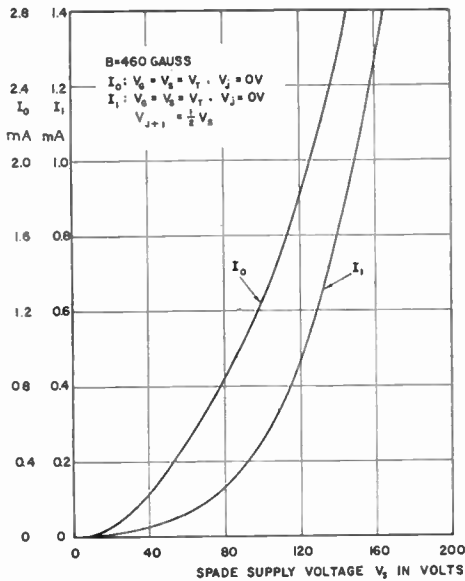

Fig. 9.—Spade currents I_0 and I_1 as a function of V_s .

$(V_{j+1})/V_s = 1$ and have a sharp rise as $(V_{j+1})/V_s$ decreases. In the normal operating voltage range, the sharp rise of $(I_{j+1})/I_m$ occurs near or below $(V_{j+1})/V_s = 0.40$.

On the other hand, the equivalent load resistance of the load line joining the point (1,0) and the point $V_{j+1}/V_s, (I_{j+1}/I_m) / (V_{j+1}/V_s)$ on the leading-spade characteristic is less than or equal to the corresponding critical load resistance R_M . As shown in the curve of Fig. 8 for $V_s/V_0 = \frac{1}{2}$, $R'_M < R_M$, where R_M is the critical load resistance. Based upon the above observations, an alternative and safe upper bound of R_s can be obtained as follows: Let I_1 be leading-spade current under the conditions $V_l = V_s = V_T = V_0, (V_l = 0, 1, \dots, j-2, j+1, \dots, 9), V_j = 0_v$ and $V_{j+1} = \frac{1}{2} V_s$. Then the new upper bound of R_s is

$$R'_M = \frac{V_s}{2 I_1} < R_M \dots \dots \dots (6)$$

If a curve $I_1 - V_s$ is taken, the values of R'_M for different V_s can be calculated.

3.3. Design

The design of the MBS tube circuit is based on the two curves, i.e., $I_0 - V_s$ and $I_1 - V_s$. From these curves the values of R'_m and R'_M can be calculated.

Typical curves $I_0 - V_s$ and $I_1 - V_s$ for magnetic induction $B = 460$ gauss are shown in Fig. 9. The calculated values of R'_m and R'_M are shown in Fig. 10 which has been verified experimentally. The dotted lines are the approximate values of R_M and R_m which defines the four modes of operation as shown by four regions.

4. Stability of the MBS Tube Circuit

In Section 3, a method has been given for designing an MBS tube circuit having 10 discrete states. For the circuit to be reliable for a large range in operating parameters, it is necessary to investigate the stability of the discrete states of the MBS tube circuit and learn how the stability depends on various parameters. In the following discussion, the magnetic field is assumed to be constant.

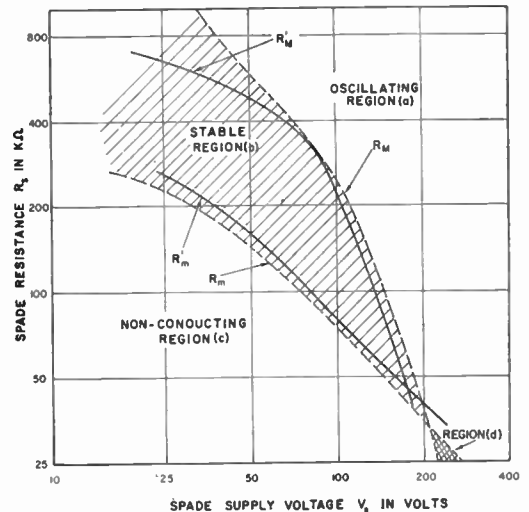

Fig. 10.—Regions of operations shown on the $R_s - V_s$ plane.

For the operation condition described in Section 3, i.e., $V_0 = V_T = V_s$, there are only two operation parameters V_s and R_s , which can be represented by a point in the $R_s - V_s$ plane of Fig. 10, shown replotted in Fig. 11. If the

voltage and resistance vary so that the corresponding operating point is still inside the region of 10 stable states, the MBS tube circuit is reliable for these variations. Accordingly, the most reliable operation is at the middle of this region; for example, $(V_s, R_s) = (55V, 260 k\Omega)$, as shown in Fig. 11. The regions of 10 per cent. and 30 per cent. tolerance in both V_s and R_s are indicated. It is obvious that the maximum tolerance depends on the operating point, and that the maximum allowed variation of one parameter depends on the allowed variation of other parameters. In this manner, the stability of the MBS tube circuit can be stated quantitatively in terms of the maximum tolerance of the operating parameters.

4.1. Effect of V_T and V_G

In the preceding discussion of the stable region, the target voltage V_T and the grid voltage V_G are the same as spade-supply voltage V_s . Because of output and switching considerations, V_T and V_G may be different from V_s . The electric field pattern will then be different and will change the shape of the electron beam.

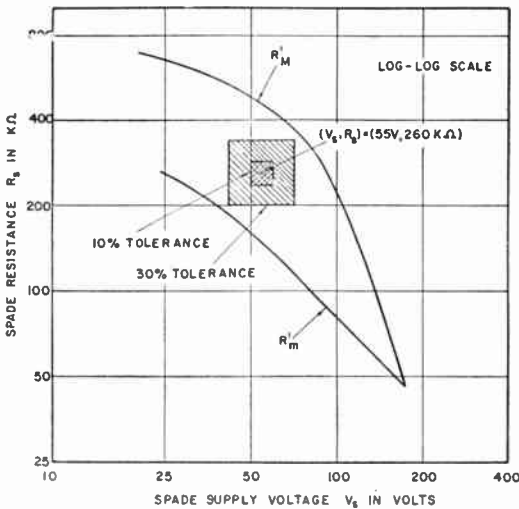

Fig. 11.—Tolerance of parameters shown on the R_s - V_s plane for the optimum operating condition.

The current distribution, which depends on the shape of the electron beam, will also be changed accordingly. It is found that the holding spade

characteristic is not affected greatly so as to change the value of R'_m , the lower bound of R_s , but the leakage portion of the leading-spade characteristic is affected so as to change the value of R'_M , the upper bound of R_s . It is found that, in general, the lower the voltage on the target or on the grid, the larger the leakage current, and consequently the less the upper bound of R_s . The dependence of R'_M on different values of V_T and V_G will now be examined.

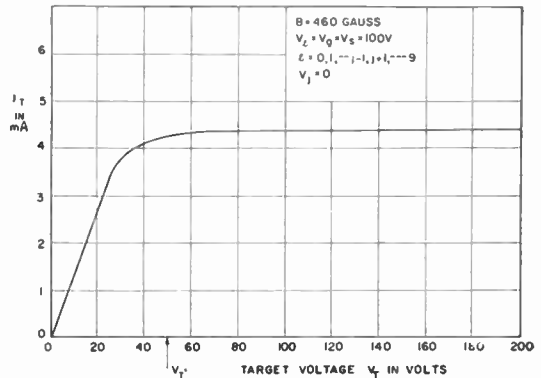

Fig. 12.—Constant output current characteristic of the target.

The target, or the output electrode, has the constant-current characteristics shown in Fig. 12. The amplitude of the target current in the constant portion is controlled predominantly by the crossed electric and magnetic fields in the space between the spades and the cathode. The holding spade receives only a very small fraction (about 1/10) of the electron current for the beam-holding action, and the rest of the beam is collected by the target. The target receives almost constant current over a voltage range (for example, from V'_T up), in which the electron beam does not shift away from the target. Within the operating range of V_s , V'_T is approximately $\frac{1}{2}V_s$. If the target voltage is lower than V'_T , the electron beam is drawn closer to the leading spade and the leakage current I_i is increased; thus decreasing the upper bound of R_s . It is found that the operation of the tube circuit is stable with the target voltage above the value of V'_T for which the circuit is designed.

It is desirable that a small triggering voltage should be required to shift the beam. The switching grid therefore should be biased at a low voltage so that a small increment of grid voltage will change the position of the electron beam effectively. The lower grid voltage results in a large leakage current, I_L as shown in Fig. 13, thus reducing the upper bound of R_s , and the reliability. The effect of V_G on R'_M can be

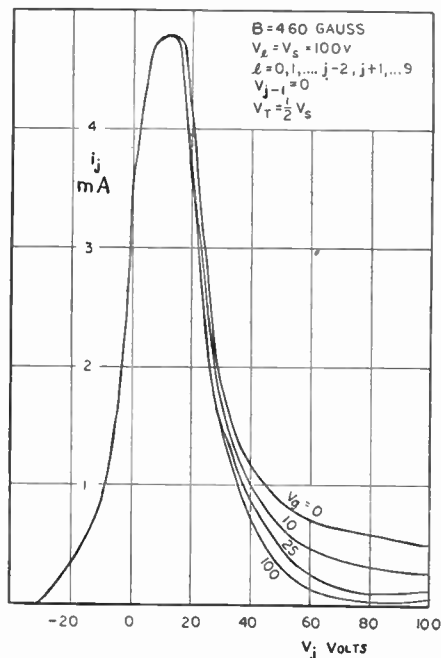

Fig. 13.—Effect of grid voltage on the leading-spade characteristics.

studied by means of a set of I_1-V_s curves (Fig. 14) for different V_G . The corresponding values of R'_m and R'_M can be calculated from Fig. 14, and plotted against V_s as abscissa (Fig. 15). These $R_s - V_s$ curves define the regions of operation in the same manner as in Fig. 10. When the curves of R'_m and R'_M do not intersect, no stable-state operation can be obtained, as demonstrated by curve I in Fig. 15.

5. Input Requirements and Consistency of the Switching Operation

The switching operation of the MBS tube circuit is obtained by combining the stable and astable conditions. If a sufficiently large negative

input pulse is applied to the grid, the circuit is changed from the stable state to the astable or oscillating state in which the electron beam is shifted successively from each spade to the next

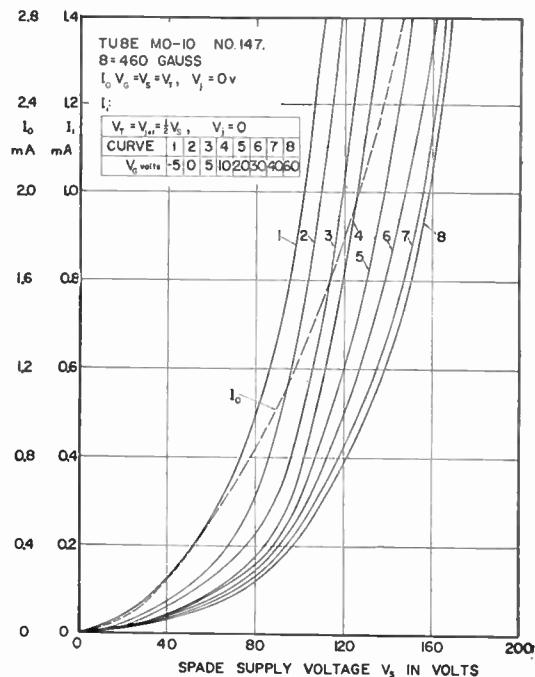

Fig. 14.—Spade currents I_0 and I_1 as a function of V with different V_G .

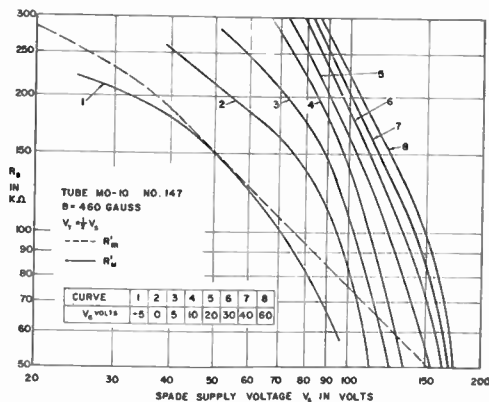

Fig. 15.—Effect of V_G on the regions of operations shown on the R_s-V_s plane.

leading spade, during the pulsing period. The number of spades advanced depends on the

amplitude and the duration of the input pulse. For a reliable switching, states must be switched consistently to a predetermined spade within the allowed variation of the amplitude and duration of the input pulse.

The MBS tube is normally operated in the stable region as defined in Fig. 10. Suppose that the circuit just starts to oscillate when the grid voltage is lowered by ΔV_0 . Then the input pulse must have an amplitude greater than ΔV_0 (i.e., $\Delta V_i > \Delta V_0$) to trigger the tube into oscillation. Also the duration of the input pulse must be longer than the time required by the leading spade to lower its potential to V_e (Fig. 7) after the input pulse is applied. The time lag t_1 depends on the time constant of the spade-load impedance, and also on the input pulse amplitude, that is, a large input pulse amplitude shortens the time lag.

Once the tube starts to switch, the number of spades that the electron beam advances depends on the time $(\tau_i - t_1)$ during which the tube is allowed to oscillate. The switching time, t_s , for the electron beam to shift from one spade to the next leading spade is the charging time of spade capacitance, C , which is in parallel with the spade resistance R_s ,

$$t_s = \int_{V_e}^{V_0} \left(\frac{-C}{i_j - \frac{V_s - V_j}{R_s}} \right) \cdot dV_j \dots\dots\dots(7)$$

where i_j is a function of V_0, V_T, V_l ($l = 0, 1, \dots, 9$) and V_a is the holding-spade voltage. Furthermore, the electron beam advances m spades when

$$(m - 1) < \frac{\tau_i - t_1}{t_s} < m \dots\dots\dots(8)$$

This situation can be visualized by means of the diagram given in Fig. 16, where the value of t_1 and $(t_1 + nt_s)$ is plotted as a function of ΔV_i ($n = \text{integer}$). If the input pulse has an amplitude and duration such that it can be represented by an operating point below the t_1 curve, the circuit will not switch at all. If the operating point is above the t_1 curve, the tube circuit will switch as indicated. For one-spade switching, the amplitude and duration of the input pulse must be in the one-spade-switching region, with the tolerances in input variations as shown.

Figure 16 shows that the switching operation of the MBS tube circuit is sensitive to the amplitude as well as the duration of the input pulse. There are several methods of improving this feature by different circuit connections, or by making use of "gating" and pulse-delay principles.

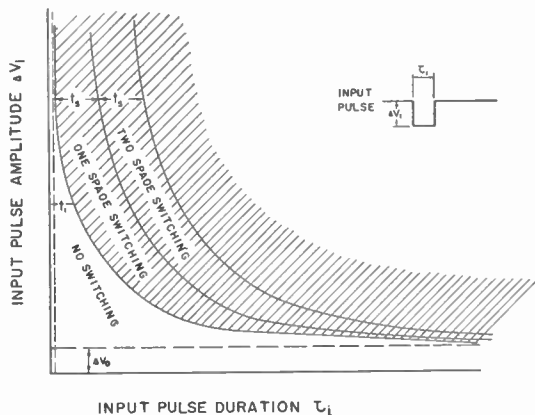

Fig. 16.—Input pulse requirement for switching operation.

One reliable method is based on the fact that the switching action of each grid is localized at each spade, that is, when the j th spade is holding the electron beam, a change of voltage on any grid not at the j th-spade position will not cause the beam to shift. Therefore, by connecting the grids into two groups, as shown in Fig. 2, and driving each group by the two outputs of a suitable Eccles-Jordan circuit triggered by the input pulses, the electron beam will shift one and only one spade ahead for each input pulse. In this arrangement the requirement on the input pulse becomes that necessary to operate the Eccles-Jordan circuit reliably. A typical counting target voltage waveform is shown in Fig. 17.

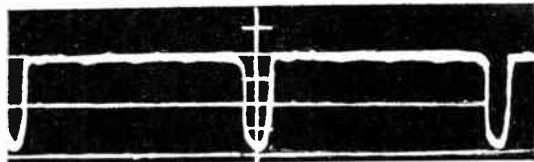

Fig. 17.—Typical target voltage waveform at a counting speed of 1 Mc/s.

Another important consideration regarding the input circuit is the grid current that flows during switching, which, together with the switching voltage, determines the necessary input driving power. Since the switching grid draws negligible current, for practical purposes the grid can be considered to draw no electron current. Hence the input driving source need only supply the power to charge the capacitance of the grids to the proper voltage.

6. Other Design Considerations

6.1. Operating voltage range and output current

The proper operating voltage of the MBS tube has been discussed in the preceding sections. The upper bound of the operating voltage is set by the leakage current I_L , and it is shown in Section 3 that $V_s < \frac{1}{5}V_c$. For the tube MO-10, the maximum operating voltage is therefore

$$V_s \leq 10^5 B^2 \dots\dots\dots(9)$$

The available output current from the electron beam is set by the space-charge limited condition between the holding spade and the leading spade (see Appendix 1). When the voltage on the holding spade is assumed to be zero and the voltage on the leading spade is assumed to be V_s , the available target current is

$$I_T = 4 \cdot 10^{-8} \frac{V_s^2}{B} \dots\dots\dots(10)$$

In actual operation, the output or target current varies from spade to spade because of the variations of the spacing, d (Appendix 1), but the value given by eqn. (10) should be within 10 per cent. accuracy. If the power rating of the target is taken into account, there is another upper limit of the operating voltage. Let $V_T = V_s$. Then the power dissipated at the target is:

$$P_T = V_s I_T = 4 \cdot 10^{-8} \frac{V_s^3}{B} \dots\dots\dots(11)$$

The power rating of a single target of the tube MO-10 is estimated to be about 2W. Therefore, the upper operating voltage for static operation is also limited by

$$V_s = 3.70 \cdot 10^2 B^{1/3} \dots\dots\dots(12)$$

For dynamic operation, assuming that the dissipation is divided equally between all 10 targets, the upper limiting voltage is then

$$V_s = 7.94 \cdot 10^2 B^{1/3} \dots\dots\dots(13)$$

6.2. The holding-spade voltage

In studying the reliability of the MBS tube, the leading-spade characteristic is taken with the holding spade at cathode potential. In practice, the holding-spade potential is slightly negative with respect to the cathode potential, the amount depending on the spade-load resistance R_s (Fig. 3). This negative potential may change the leading-spade characteristic and therefore affect the upper bound of R_s . It is found that the leakage current to the leading spade is reduced when the holding spade is slightly negative. For this reason the corresponding upper bound of R_s is actually higher than that with the holding spade at cathode potential. Since the holding-spade potential depends on V_s and B as well as R_s , it is difficult to obtain the actual upper bound of R_s . The method described in Section 4, however, gives a conservative design.

6.3. Resolving time and maximum operating speed

The requirement on input pulses has been discussed in Section 4. The switching time of the electron beam from spade to spade, t_s (eqn. (7), gives the minimum resolving time for the tube to be ready for the next input pulse. In addition, the time for $(n - 1)$ successive pulses (for n -state operation) should be long enough for the first spade to discharge. If T is the time between the first pulse and the $(n - 1)$ -th pulse, then the tube will respond correctly when $T \geq 5R_s C$.

Therefore if the tube is switched at a uniform rate in 10-state operation, the maximum repetition frequency is

$$f_{max} = \frac{1}{t_s} \quad \text{if } \frac{1}{t_s} < \frac{9}{5R_s C} \dots\dots\dots(14)$$

$$f_{max} = \frac{9}{5R_s C} \quad \text{if } \frac{1}{t_s} > \frac{9}{5R_s C} \dots\dots\dots(15)$$

Usually, the switching time t_s is very small so that eqn. (15) gives a good estimation for the maximum operating frequency. For n -states operation, the maximum frequency is

$$f_{max} = \frac{(n - 1)}{5R_s C} \quad \text{if } \frac{1}{t_s} > \frac{n - 1}{5R_s C} \quad (n < 10) \dots\dots(16)$$

From eqns. (7) and (16) it is seen that the maximum switching frequency is inversely proportional to the capacitance C . Therefore the smaller the spade capacitance the higher the

operating speed. To eliminate the unnecessary lead wire capacitance, the spade resistors can be mounted internally as in the tube type MO-10R (Fig. 19). In this tube the spade capacitance C is reduced to the inter-electrode capacitance which is approximately 2 pF between the spades. A counting speed of 4 Mc/s (limited by the signal generator available) has been obtained.

by connecting two adjacent spades together, the tube circuit will be more reliable than a 10-state tube circuit. Furthermore, the increase of the peak spade current and the decrease of the spade-load resistance will also decrease the charging and discharging time of the spade. Thus, the resolution to detect random pulses, as in nuclear physics, is also increased.

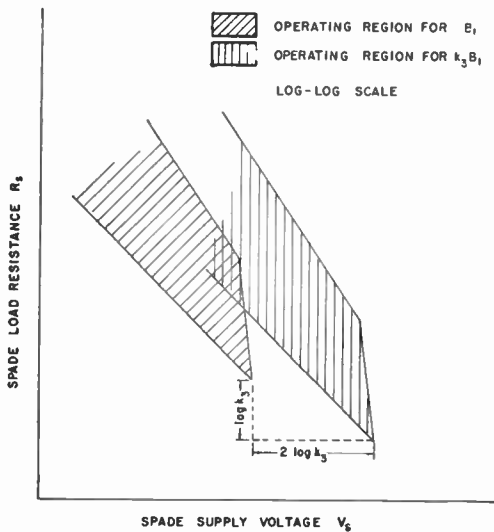

6.5. Different magnetic induction B

The scaling of the MBS tube as it relates to the electron beam has been discussed in Appendix 2. For a given tube with different magnetic induction, the scaling of other operating parameters is as follows: Let single and double primes denote the values before and after the scaling, respectively, and let k_3 be the magnetic induction scaling factor. Then

$$\begin{aligned}
 B'' &= k_3 B' \\
 V_s'' &= k_3^2 V_s' \\
 I'' &= k_3^3 I' \\
 R_s'' &= k_3^{-1} R_s'
 \end{aligned}
 \dots\dots\dots(17)$$

The effect of changing B on the operating parameters R_s and V_s is shown in Fig. 18. It is seen that the region of stable operation is only shifted in position with the tolerances of the operating parameters still the same.

Fig. 18.—Effect of magnetic induction B on the regions of operation.

6.4. Less than 10-states operation

There are two ways of obtaining less than 10-states operation for the MO-10 tube. First, if n ($n < 10$) spades are adjusted for astable operation, then $(10 - n)$ -state operation is obtained. To make the potential of one spade unstable it is only necessary (a) to increase the value of spade resistance, R_s , of its leading spade so that $R_s \geq R'_s$, or (b) to increase the leakage current to its leading spade by decreasing the target voltage or grid voltage (Fig. 13). Second, two or three spades may be connected together. To design a circuit of this type, the procedure is the same as before, except the spade characteristic of two or three spades connected together should be used, instead of that for one spade, as shown in Fig. 14. Because of the large peak current of the holding-spade characteristic when two or three spades are connected together, the lower bound of R_s , or R_m , is greatly decreased. So if a five-state tube circuit is obtained

6.6. Permanent magnet for MBS tubes

For proper operation of the MBS tubes described in preceding sections, a constant and uniform field is required. A Helmholtz coil was used to provide the required uniform magnetic field for experimental tests, but such a magnetic field source is cumbersome and not very practical. A magnetic field source that is simple, compact, and inexpensive may be obtained from a permanent magnet sleeve (shown in Fig. 19) uniformly magnetized along its length and placed so that it surrounds the MBS tube. Tube characteristics measured in the field of a Helmholtz coil and in the field of a permanent magnet do not differ significantly. In addition, operation of the tubes in actual switching circuits appears to be independent of the field source used.

In order that the MBS tube operate properly, it is important that the tube axis be carefully aligned parallel to the magnetic field. Proper alignment may be carried out by joining all the electrodes and applying to them a positive potential with regard to cathode. When the

tube is properly aligned in the field, the cathode current will be a minimum. Once proper alignment is obtained, the tube may then be cemented to the inner surface of the magnet. The magnet and tube are then permanently cemented together so that the unit can be moved from socket to socket without disturbing the field alignment.

6.7. Harmonic and space-charge oscillations

Like the multiple-anode magnetrons, the MBS is also able to produce harmonic oscillations. During the static measurement of the cut-off characteristic curves, harmonic oscillation was found because of the long lead wires to the spades. The oscillating frequency was about 100 Mc/s.

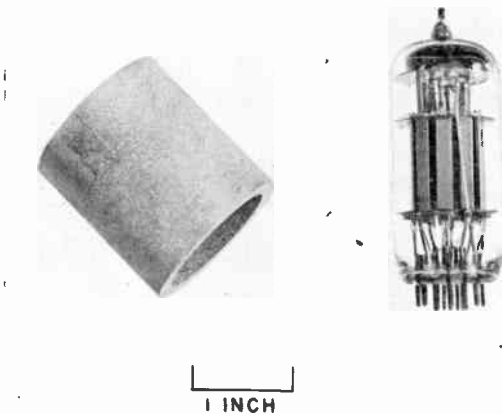

Fig. 19.—Photograph showing the MBS tube with internally mounted spade resistors and the magnet sleeve.

Another phenomenon observed in the measurement of spade current-voltage characteristics (Figs. 3 and 4) is that the electron current flows to a negative potential spade.* From the point of view of conservation of energy, an electron leaving the cathode with zero initial velocity should not reach a spade at negative potential. But in all the measurements, this “negative” current has been observed, which was also found in the box-type “trochotrons.”¹² The “negative” current decreases and becomes very small, if the cathode temperature is reduced

*The magnitude of the current is so large that it cannot be explained by the Maxwellian distribution of emission velocities.

so that the cathode emission is temperature-limited, rather than space-charge limited. The reduction of the “negative” current at low cathode temperatures suggests an explanation to the riddle of violation of conservation of energy. It suggests, that along the electron beam there exists an electronic oscillation,¹³ the amplitude of which depends on the space-charge density. An electron leaving the cathode with low initial velocity will gain or lose its velocity as it travels inside the beam, owing to this electronic oscillation. The electrons that gain velocity, therefore, will be able to reach the negative potential electrode.

7. Comments on the Comparative Performance of the MBS Tube

A proper evaluation of this new component is a detailed study in itself and we can include here only a few brief comments.

A considerable variety of circuits can be set up which closely simulate the MBS tube. The best simulations are those employing rings of flip-flops. Such circuits, however, consume far more power than the MBS tube which they replace.

In the past few years some ingenious gas discharge glow tubes such as the “Dekatron” have appeared on the market. These tubes are remarkably simple in construction and they provide an interesting “bonus” to the user, in the form of an automatic beam position indicator. This is a very agreeable feature for a number of applications, since the single tube is acting both as a counter and as a register. They also require no heater power. However, in all other respects their performance falls short of that of the MBS tubes. This is particularly true of the speed. Gas discharge glow tubes are limited to about 10 to 20 kc/s counting rate, whereas modern experimental versions of the MBS tube have been driven at nearly 10 Mc/s. Furthermore, the impedance of the MBS tube is very much lower than that of the glow tubes. The output power levels are such that MBS tubes can be cascaded in a great variety of ways without intermediate active circuits. An astonishing variety of electronic applications are covered by the MBS tube, and papers now being prepared will show the great versatility of this device.

Other competitors to the MBS tube which have appeared are those employing the principles

of beam deflection. For example, there is the ribbon electron tube called the EIT developed by Jonker¹⁷ and associates, and a pencil-type deflection tube made by Hollway.¹⁸ Compared with the MO-10 tube these have relatively small current for the same voltage. For the EIT tube the resulting time is also limited by the fly-back period of about 25 μ sec which sets the maximum operating frequency. However, the EIT does incorporate its own indicator system.

An outstanding advantage of the MBS tube over the beam deflection tubes lies in the freedom from cross-modulation between the output electrodes. One of the great difficulties with all beam-deflection-type tubes lies in contact "spill-over." It is difficult to produce a really sharp beam unless the current is unduly restricted and this tends to lead to a considerable degree of cross-modulation. One of the most interesting features of the MBS tube is the perfection of its switching characteristic. When the current is striking the j th target, the current to any other target is less than 10^{-4} of that to the excited one.

Large-scale production of the MBS tube has now started in the United States. Experience to date seems to show that it is likely to be a very reliable component. The cathode is always emitting electrons so that there is little likelihood of the formation of an interface in the cathode core. The spacings between the electrodes is not nearly so critical as in most standard high-performance radio receiving tubes and furthermore, there is no grid in the conventional sense of the word. The manifold troubles known to all vacuum tube engineers arising from the volatilization of material from the cathode on to the closely adjacent grid wires are too well known to need much comment. The MBS tube with its very open cathode structure should be an ideal product in this respect.

Since it is a basically ultra-high-speed 10-pole switch, its application possibilities cover a very wide field indeed, and it is expected to play an increasing part in a great variety of applications. It is at the moment by far the fastest 10-pole switch available.

8. Acknowledgment

This paper describes a portion of the MBS tube research and development by the Burroughs Corporation Research Center. The author wishes to acknowledge the help and assistance of all members of the tube research laboratory.

9. References and Bibliography

1. H. Alfvén, L. Lindberg, K. G. Malmfors, T. Wallmark, and E. Åström, "Theory and applications of trochotrons," *Transactions of the Royal Institute of Technology, Stockholm*, No. 22 (1948).
2. S. Kuchinsky, "Multi-output beam switching tubes for computers and general-purpose use," *IRE Convention Record*, 1953, Pt. 6. pp. 43-53.
3. K. Posthumus, "Oscillations in a split-anode magnetron-mechanism of generation," *Wireless Engineer*, 12, p. 126, 1935.
4. A. W. Hull, "Effect of a uniform magnetic field on the motion of electrons between coaxial cylinders," *Physical Review*, 18, p. 31, 1921.
5. J. C. Slater, "Microwave Electronics," (Van Nostrand, New York, 1950).
6. H. Alfvén, "Cosmical Electro-dynamics," (Oxford University Press, 1950).
7. K. Spangenberg, "Vacuum Tubes," (McGraw-Hill, New York, 1948).
8. W. W. Harman, "Fundamentals of Electronic Motion," (McGraw-Hill, New York, 1953).
9. L. Marton, (Ed.), "Advances in Electronics," Vol. III and Vol. V. (Academic Press Inc.). Chapters by L. Brillouin and F. Bloch and by R. Q. Twiss, "Electronic theory of the cylindrical magnetron," "Electron theory of the plane magnetron," "On the steady-state theory of the magnetron."
10. D. L. Reverdin, "Electron optical exploration of space charge in a cut-off magnetron," *Journal of Applied Physics*, 22, p. 257, 1951.
11. A. A. Andronow and C. E. Chaikin, "Theory of Oscillations," (Princeton University Press, 1949).
12. H. Alfvén, etc., *op. cit.*
13. G. G. MacFarlane and H. G. Hay, "Wave propagation in slipping stream of electrons: small amplitude theory," *Proc. Phys. Soc.*, B, 63, p. 409, 1950.
14. A. B. Thomas, "Principles and method of operation of some modern gas-filled counter tubes," *J. Brit. I.R.E.*, 13, p. 414, 1953.
15. J. R. Acton, "The single-pulse dekatron," *Electronic Engineering*, 24, p. 48, February 1953.

16. K. Kandiah, "Decimal counting tubes," *Electronic Engineering*, **26**, p. 56, February 1954.
17. J. L. H. Jonker, A. J. W. M. Van Overbeek and P. H. DeBeurs, "A decade counter valve for high counting rates," *Philips Research Reports*, **7**, p. 81, 1952.
18. D. L. Holloway, "An electron-beam decimal counter tube," *Nature*, **165**, p. 856, 1950.
19. O. Sternbeck, U.S. Patent No. 2,659,814, (November 17th, 1953).
20. L. Marton, *op. cit.*
21. J. R. Pierce, "Theory and Design of Electron Beams," p. 16 (Van Nostrand, New York, 1949).

10. Appendix 1: Properties of Electron Beam Current and Estimation of Target Current

In Section 2 the typical paths of a single electron within the MBS tube were shown as it moves in the crossed electric and magnetic fields. When electrons from the entire cathode surface are considered, some of them will reach the leading gap as described, while others will return to the cathode. When large numbers of electrons are emitted from the cathode and packed into a narrow stream from the cathode to the spades, the effect of space-charge repulsion cannot be neglected. The resultant effect will be that the electron beam will have approximately the shape of the *envelope* of the paths of *single* electrons and individual electrons will follow almost the equipotential lines as the electron stream in the non-oscillating magnetron. The detailed analysis is very difficult and will not be discussed here. However, by the use of dimensional analysis and borrowing the result from the study of non-oscillation magnetron,²⁰ a relationship can be found that estimates the properties of the electron beam within the MBS tube.

Assume firstly that the shape of the electron beam is determined primarily by the electric and magnetic fields, existing in the absence of any beam, and secondly, that the electron beam when formed is space-charge limited and of the single-stream type as in the static magnetron. The electron beam current can then be written as the product of two independent functions of (a) the beam shape, and (b) the space-charge effect.

The shape of two electron beams will be similar if the individual electron paths are similar. It can be shown by dimensional analysis that the shape of two electron paths will be geometrically similar if the ratio²¹ V/B^2L^2 remains constant. The envelope of the electron paths or the shape of the electron beam in a MBS tube can be represented by the shape function,

$$\Gamma = f\left(\frac{mV_a}{eB^2L^2\gamma^2}\right) \dots\dots\dots(18)$$

where V_a is related to the voltages applied to the tube, L is the scale of linear dimension of cross-section of the MBS tube and γ is a dimensionless function relating to the geometric structure in the cross-section of the tube.

The space-charge effect of the electron beam in the crossed electric and magnetic fields is difficult to analyse. However, the basis to start the analysis is still the Poisson's equation, i.e.,

$$\nabla^2V = -\rho/\epsilon \dots\dots\dots(19)$$

where ρ is the space-charge density and ϵ is the dielectric constant. From the dimensional analysis of eqn. (19) an approximate formula may be obtained.

If there is non-oscillation in the electron beam and the electron velocity, v , is a single-valued function of the geometrical co-ordinates like the single-stream case in the static magnetrons, the electron current density i , is then,

$$i = \rho v \dots\dots\dots(20)$$

where

$$v = \frac{[B \times \nabla V]}{B^2} \dots\dots\dots(21)$$

substituting eqn. (20) and eqn. (21), eqn. (19) becomes

$$\nabla^2V = -\frac{1}{\epsilon} \frac{B^2}{[B \times \nabla V]} \dots\dots\dots(22)$$

The dimensional equivalent of eqn. (22)

$$\frac{[V]}{[L]^2} = \frac{1}{[\epsilon]} \frac{[I]}{[L]} \frac{[B]}{[V]} \dots\dots\dots(23)$$

Hence,

$$[I] = [\epsilon] \frac{[V]^2}{[B]} \frac{1}{[L]} \dots\dots\dots(24)$$

Therefore, to combine eqns. (18) and (24), the electron current I will have the form,

$$I = k_1 \frac{V^2}{BL} f\left(\frac{mV_a}{eB^2L^2\gamma^2}\right) \dots\dots\dots(25)$$

or

$$I = k_2 V^{3/2} F\left(\frac{mV_a}{eB^2L^2\gamma^2}\right) \dots\dots\dots(26)$$

where k_1 and k_2 are proportional constants and F is the new shape function. Equation (26) is very similar to the space-charge limited current in tubes without magnetic field. To state this in another manner, if the beam shapes of the tubes are similar, the beam current will follow the $3/2$ th law of voltage.

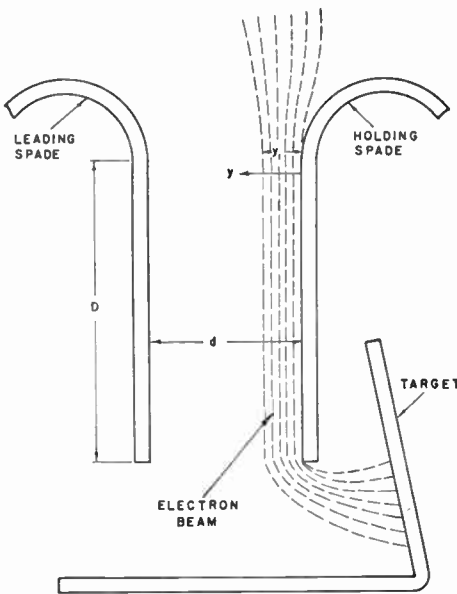

Fig. 20.—Sketch of spades for discussing the target current.

An experimental evaluation of the current equation (26) by keeping $V_a/B^2L^2\gamma^2$ constant, shows a very close check in the usual operating voltage range. The slight disagreement that was found may be due to discrepancies in the original assumptions. It was originally assumed that there was no interference between the beam shape and the space-charge effect. Actually there is some interference because the formation of the electron beam is dependent upon the electric field pattern which, in turn, depends on the space charge of the electron beam. Further-

more, it was assumed that the electron beam is of single-stream type and no oscillating phenomena happens along the beam. If the velocities, distribution and non-uniformity of the fields are considered, the electron beam is not strictly a single-stream type and there is also oscillation in the beam as shown by the "negative" current phenomena in Figs. 3 and 4.

The electron beam current available from the cathode depends on the electric and magnetic fields in the space between the spades and the cathode. This current is not necessarily the target current. The electron current to the target depends on the field in the space between the holding and leading spades through which the electron beam must pass. The available target current is also limited by the space charge in the electron beam as shown in Fig. 20. To calculate the target current the following conditions are assumed:

- (1) The two adjacent edges of the spades are parallel, i.e., $d = \text{const}$.
- (2) $D \gg d$.
- (3) A single-stream electron flow condition is present.

From the first two conditions, the field configuration between the spades can be considered as that of a cut-off plane magnetron. Then the target current, I , passing through this region can be evaluated by the single-stream electron flow condition:

$$I = \int_0^{y_1} \rho v dA \dots\dots\dots(27)$$

where $\rho =$ charge density of electron beam

$$= \frac{\epsilon_0 e}{m} B^2$$

$v =$ velocity of electrons in the direction of electron current flow

$$= \frac{e}{m} B y$$

$dA =$ elementary area of the cross-section of the electron beam

$$= l dy$$

$l =$ axial length of electron beam flow section

$y_1 =$ thickness of the electron beam.

Then

$$I = \frac{\epsilon_0 e^2}{2m} B^3 / y_1^2 \dots\dots\dots(28)$$

To evaluate y_1 from the boundary condition

$$\begin{aligned} y = 0 \quad V = 0 \\ y = d \quad V = V_s \\ = \frac{1}{2} \frac{\rho}{\epsilon_0} y_1^2 + \frac{\rho}{\epsilon_0} y_1 (d - y_1) \end{aligned}$$

$$y_1 = d - d \sqrt{1 - \frac{2\epsilon_0 V_s}{d^2 \rho}} \text{ for } y_1 > 0 \dots\dots(29)$$

If $\frac{2\epsilon_0 V_s}{d^2 \rho} < 1$

$$y_1 \approx \frac{\epsilon_0 V_s}{d \rho} \dots\dots\dots(30)$$

Therefore

$$I = \frac{\epsilon_0 V_s^2}{2d^2 B} \dots\dots\dots(31)$$

For the tube MO-10.

$$I \approx 4 \cdot 10^{-8} \frac{V_s^2}{B} \text{ amperes} \dots\dots\dots(32)$$

11. Appendix 2: Scaling of MBS Tube

In the design of the MBS tube and its operating circuits, there are three fundamental design parameters, namely, voltage, magnetic induction, and the geometrical configuration of the tube. Once these design parameters are determined, the operating parameters, such as

Table 1
MBS Tube Scaling Factors

		Voltage Scaling		Geometrical Scaling		Magnetic Induction Scaling	
Design Parameters	Independent variable	k_1	k_1	k_2	k_2	k_3	k_3
	Parameters held constant	$k_2 = 1$	$k_3 = 1$	$k_1 = 1$	$k_3 = 1$	$k_1 = 1$	$k_2 = 1$
	Dependent parameters	$k_3 = k_1^{1/2}$	$k_2 = k_1^{1/2}$	$k_3 = k_2^{-1}$	$k_1 = k_2^2$	$k_2 = k_3^{-1}$	$k_1 = k_3^2$
Operational Parameters	Current I	$k_1^{3/2}$	$k_1^{3/2}$	1	k_2^3	1	k_3^3
	Spade-load resistance $R_s = V/I$	$k_1^{-1/2}$	$k_1^{-1/2}$	1	k_2^{-1}	1	k_3^{-1}
	Inter-electrode spade capacitance	1	$k_1^{1/2}$	k_2	k_2	k_3^{-1}	1
	Time constant of spade-load impedance* $T = R_s C$	$k_1^{-1/2}$	1	k_2	1	k_3^{-1}	k_3^{-1}
	Max. operating input pulse rate $= \frac{9}{5R_s C}$	$k_1^{1/2}$	1	k_2^{-1}	1	k_3	k_3
	Power to electrode $P = VI$	$k_1^{5/2}$	$k_1^{5/2}$	1	k_2^5	1	k_3^5
Electrode loading density $\frac{P}{L^2}$	$k_1^{5/2}$	$k_1^{3/2}$	k_2^{-2}	k_2^3	k_3^{+2}	k_3^5	

*Here we are considering only the MBS tube with internally mounted spade-load resistors, since that is the only tube suitable for high-speed switching.

current, load resistance, power, etc., are also determined. In this appendix, the scaling relation among the three design parameters is discussed and the effects of scaling on the operational parameters are also tabulated.

The purpose of the scaling is to reproduce similar operational characteristics when the design parameters are changed, because the operation of the MBS tube depends entirely on the non-linear characteristics of the spade current-voltage curves. In order to reproduce similar operational characteristics, the currents before and after the scaling should have the similar property. From equn. (26), if the factor $mV_a/eB^2L^2\gamma^2$ remains the same, I will have the same beam-shape function, F and so the same non-linear characteristics. If the tubes have similar geometrical structures, i.e., their linear dimensions are in proportion to each other, their corresponding dimensionless functions γ are the same. In the latter discussion, the tubes are assumed to have the similar geometrical structures. Then, if the factors V_a/B^2L^2 before

and after the scaling are the same, i.e.,

$$\frac{V_a}{B^2L^2} = \text{constant} \dots\dots\dots(33)$$

the corresponding currents will also have the similar non-linear characteristic. Equation (33) is then the basic equation for scaling the design parameters.

Table 1 gives the relations of scaling between two of the design parameters while the other is held constant as well as the corresponding effects on the operating parameters. k_1, k_2 and k_3 represent the ratios of voltages, geometrical dimensions and magnetic induction after and before the scaling, respectively.

For the same tube, i.e., $k_2 = 1$, the changed operational parameters, for the voltage scaling, are shown in the first column where k_2 is the independent variable. For example, the maximum operating input pulse rate is increased by $k_1^{1/2}$ times if the operating voltage is increased k_1 times for the voltage scaling.

THIRTIETH ANNIVERSARY OF THE INSTITUTION

The Thirtieth Anniversary of the Institution was marked by a dinner of the Council and its Committees held on June 15th last, at the Savoy Hotel, London. The Guests of Honour were William E. Miller, M.A. (twelfth President of the Institution), and Mrs. Miller.

The Vice-Patron and Past President of the Institution, Admiral the Earl Mountbatten of Burma, K.G., and the Countess Mountbatten of Burma, C.I., honoured the occasion. Two other Past Presidents, Mr. Paul Adorian and Mr. Leslie H. Bedford, accompanied by their ladies, were also present.

A toast to the Immediate Past-President was proposed by Rear-Admiral Sir Philip Clarke, K.B.E., C.B., D.S.O. Recalling that the Institution had reached its thirtieth birthday, Admiral Clarke reminded members that Mr. Miller had been associated with the Institution for nearly 25 of those 30 years. He was, in fact, one of the signatories to the original Memorandum of Association.

During the whole of that time, Mr. Miller had served the Institution continuously on every standing Committee and had represented the members on Council for an unbroken period of 15 years. Mr. Miller had at all times been unswerving in his loyalty to the Institution and members would remember with gratitude the considerable work he did in assisting the Institution during its earliest and most formative years. During his two years as President he had more than maintained the excellent examples which had been set by his predecessors and had made a valuable contribution toward the prestige which was now associated with membership of the Institution.

On behalf of the officers and Council of the Institution, Admiral Clarke presented Mr. and Mrs. Miller with a pair of antique silver candlesticks.

In his response, Mr. Miller stated that his term of office as President had been greatly helped by the co-operation which was always readily forthcoming from the Council and from members of all the Institution's Committees at home and overseas. Voicing the pleasure given

to him and his wife in seeing so many of the Past Presidents attending the dinner, Mr. Miller referred to the cumulative benefits which the Institution had derived from the active service of its Past Presidents and to which he readily subscribed his promise of continued assistance.

Mr. Miller said that it gave him particular pleasure to refer to the progress made with the Institution's Building Appeal, which had been originally suggested by Mr. L. H. Bedford and for which so much work had been done by his immediate predecessor, Mr. Paul Adorian. With the benefit of a £5,000 covenant, and the further generous contribution given by a member attending the dinner, the Building Appeal had now reached £20,000. It was hoped that £50,000 would eventually be subscribed by members and industry. Mr. Miller said that he regarded it as a personal compliment that many of his friends in the radio industry had been able to contribute to the Appeal during his term of office.

The toast of "The Guests" was proposed by Mr. Leslie H. Bedford, O.B.E., M.A., B.Sc., Past President, and the response was by Sir Hugh Linstead, O.B.E., M.P., Chairman of the Parliamentary and Scientific Committee, with which the Institution has been closely associated for many years.

Mr. J. W. Ridgeway, a Member of Council, proposed a toast to the Institution's Vice-Patron. In his reply, Admiral the Earl Mountbatten of Burma, K.G., said that he welcomed the opportunity to pay tribute to Mr. Miller's services to the Institution and recalled the pleasure and satisfaction he had felt at having had Mr. Miller as Chairman of the General Council during his own Presidency. Speaking as one of the early members, Lord Mountbatten mentioned the considerable progress which the Institution had made during recent years, and in this connection paid a particular tribute to the work of Mr. Graham D. Clifford, General Secretary of the Institution.

During dinner music was provided by the band of the Irish Guards, under the direction of their director, Captain C. H. Jaeger, Mus.Bac., and the evening concluded with a cabaret.

APPLICANTS FOR MEMBERSHIP

New proposals were considered by the Membership Committee at a meeting held on June 2nd, 1955, as follows: 15 proposals for direct election to Graduateship or higher grade of membership, and 32 proposals for transfer to Graduateship or higher grade of membership. In addition, 32 applications for Studentship registration were considered. This list also contains the names of two applicants who have subsequently agreed to accept lower grades than those for which they originally applied.

The following are the names of those who have been properly proposed and appear qualified. In accordance with a resolution of Council and in the absence of any objections being lodged, these elections will be confirmed 14 days from the date of the circulation of this list. Any objections received will be submitted to the next meeting of the Council with whom the final decision rests.

Transfer from Associate Member to Member

HEDGE, William Criswell. *Montreal.*
 JOSHI, Chhattra Pati, M.Sc. *Lucknow.*

Direct Election to Associate Member

HILTON, Frank. *Hull.*
 PRITCHARD, Lieut.-Com. Sidney Evlyn, R.N. *Lee-on-Solent.*
 RICHINGS, William Victor. *Amersham.*
 SHUTE, Ralph Ashley. *Cambridge.*
 SMITH, Flt. Lt. Ronald Herbert, R.A.F. *Wittering.*

Transfer from Associate to Associate Member

HOUSTON, William Mason, B.Sc. *Higher Bebington.*
 MACEWAN, James Duncan, B.Sc. *Prestwick.*
 ROBINSON, Raymond Gray Rippon, B.Sc. *Caldecote.*
 THOMAS, William Derrick. *Burnham-on-Sea.*

Transfer from Graduate to Associate Member

BENSON, Flt. Lt. Francis William, R.A.F. *Medmenham.*
 JAMES, Michael. *Harpenden.*
 NARAYANAN, Flt. Lt. Vettakkorumakankav Sivarama, B.Sc.(Hons.),
 I.A.F. *Delhi.*
 WHITE, Colin James. *London, S.W.17.*

Transfer from Student to Associate Member

VINNELL, Lionel Frederick. *Wells, Somerset.*

Direct Election to Associate

DEDMAN, William Leonard. *Arborfield.*
 PECK, Charles Owen. *Chelmsford.**
 SWIFT, James Walter. *Crawley.*

Transfer from Student to Associate

GLOVER, Reginald Arthur. *Portland.*
 STEVENS, Graham John Lloyd. *Selsdon.*

Direct Election to Graduate

ANDREWS, Roy William James. *Basildon.*
 DICKSON, Lt. Thomas William, R.E.M.E. *Tonfanau.*
 KIMBER, Colin Spencer. *London, N.W.11.*
 MARSHALL, Terence Alfred Anthony, B.Sc. *Seven Kings.*
 STANFORTH, Geoffrey Morris. *Hford.*

Transfer from Student to Graduate

ANANIHARAMIAH, A. V. *Bangalore.*
 BHATTI, Dharam Singh. *Nagpur.*
 DANIEL, Michael, B.Sc. *Trichinopoly.*
 DUTTA, Asim Kumar. *Barrackpore.*
 GOROWARA, Satya Pal. *Ahmednagar.*
 HALE, Leslie Norman. *Wells, Somerset.*
 MUSGROVE, Stephen Victor. *Orpington.*
 SUBRAMANIAN, Venkata D., M.A. *Madras.*
 TUCK, Leslie. *Johannesburg.*

*Reinstatement.

STUDENTSHIP REGISTRATIONS

ABRAHAM, Arefe Aine. *London, N.W.6.*
 AHMAD, Jalal-Ud-Din. *London, W.8.*
 ANAGNOS, George. *Rhodes.*
 AZAR, Yoram. *Haifa.*

BASHYAM, R., B.Sc. *Trichinopoly.*
 BAWA, Gurkirpal Singh. *Ferozepore.*
 BHAT, Somaje Mahalinga, B.Sc. *Madras.*

CHONA, Ram Murti. *Allahabad.*

DESHMUKH, Sharadehandra Chintaman. *Koledia.*
 DHINDAW, Rabindra Nath, B.Sc. *New Delhi.*

EDWARD, William David. *Perth.*

GODBOLE, Manohar Vinayak, B.Sc. *Ahmednagar.*
 GOODWIN, William David. *Hebburn.*

HIZKIL, Muhammad. *Karachi.*

JAFRI, Flg. Off. Syed Arshad Hussain, B.Sc., R.P.A.F. *Peshawar.*
 JONES, Philip Frank. *South Ruislip.*

KALLIANPUR, Vasudev Sripad, B.Sc. *Bombay.*
 KERSH, Cyril. *London, N.W.6.*

MAHMUD-UL-HASAN, *Karachi.*
 MALHOTRA, Plt. Off. Shadi Lall, M.Sc., I.A.F. *Bangalore.*
 MOHAMMAD IBRAHIM, B.Sc. *Madras.*
 MOHAMMED IQBAL AHMED, T. *Bangalore.*
 MURALIDHARA RAO, Akkinapalli, B.Sc.(Hons.). *Andhra.*

NAMBIAR, Kunhi Kannan, B.Sc. *South Kanara.*

OM PRAKASH CHOPRA, B.Sc. *Delhi.*

PERERA, Prangae Wimaladassa. *Mount Lavinia, Ceylon.*
 PURUSHOTTAM RAO, Avaral. *Bombay.*

RAJASEKHARAIH, Durgam Nanjundappa. *Bangalore.*

SANDYS, Maurice Arthur. *London, W.14.*
 SHARMA, Vishnu Kant, B.Sc. *Lucknow.*
 SHER, Harold Mendel. *Johannesburg.*

THOMAS, Stanley Richard. *Romsey.*

ULTRASONIC TANNING AND DYEING*

by

Felix Gutmann, Ph.D.†

A Paper presented during the Industrial Electronics Convention held in Oxford in July 1954

SUMMARY

Ultrasonic tanning and dyeing experiments are reviewed. The similarities and dissimilarities of both processes are discussed in the light of the physico-chemical processes involved. The increase in ultrasonic power required for large-scale industrial employment is estimated. Since these power requirements cannot be met by crystal transducers, it is suggested that the operating frequency be reduced to the higher sonic or low ultrasonic range in order to permit the use of magnetostrictive devices. The relative effectiveness of sound at high and low frequencies is discussed. Some sources of high ultrasonic power are described.

1. Introduction

Some of the most interesting and valuable applications of sonic and ultrasonic sound occur at interfaces. We shall here consider the action of such fields on the interface between a colloidal solution and a membrane as applied to tanning and dyeing.

The action of intense ultrasonic radiation on an aqueous medium is complex, but is most pronounced in the case of a colloidal system. The depolymerizing action of the soundfield throughout the solution tends to break up the molecular aggregates into smaller units. There is cavitation, production of hydrogen peroxide which may react with the system, degassing which may cause foaming and surface reactions, and, finally, strong localized forces are caused by the collapse of the cavities. Local accelerations of several hundred thousand times the force of gravity are liable to occur, and a radiation pressure is exerted in a direction perpendicular to the surface of the transducer, assuming that the dimensions of the radiating surface are large compared to a quarter wavelength of sound.

Because of these actions of ultrasonic fields, R. L. Ernst and the writer¹ have employed ultrasonic irradiation as an aid to tanning, and some Russian and German workers have applied it to dyeing.

2. Tanning

The tanning processes most commonly employed are chrome and vegetable tanning. While the first is a comparatively fast process, tanning of heavy leathers with vegetable tanning materials is slow, even modern methods taking anything up to 6 or 10 weeks. Considerable interest therefore attaches to processes which promise to reduce the tanning time without impairing the quality of the finished product.

All tanning materials are colloids and their solutions are polydisperse systems containing particles ranging from molecular size up to coarse suspensions rendering the solution cloudy. The tanning process itself consists essentially in the formation of secondary valency compounds with the hide collagen on the surface and in the interior of the fibres. In this process particle size plays a decisive role.

2.1. Apparatus

The pelts were suspended horizontally, parallel to the surface of the quartz transducer, about 1 in distant from its upper surface. They were always kept completely immersed. The crystal was mounted in a holder² permitting the direct irradiation of the electrically conductive liquid without interposing oil buffers.

The transducer was excited from a conventional power oscillator employing four 807's in double push-pull, via an impedance matching inductor with adjustable taps. The oscillator

* Manuscript first received June 16th, 1954, and in final form on April 6th, 1955. (Paper No. 322.)

† The New South Wales University of Technology, Sydney, Australia.

U.D.C. No. 534.23 : 667.2 : 675.

was capable of an output of about 200 W, but in order to minimize the danger of crystal fracture, the experiments were carried out at much reduced power. The quartz crystals used were X-cuts free from twinning, both surfaces silver or gold plated, and working at their resonance frequency of 760 kc/s. They were circular and of 2 in diameter.

2.2. Materials

Calf skin was dehaired, limed and bated in the conventional way, then pickled for 24 hours with 0.5 per cent. H_2SO_4 (96 per cent.) calculated on pelt weight and 10 per cent. NaCl, calculated on the quantity of liquor. A pH of 2.9, uniform throughout the pelt cross-section, was obtained. After hydro-extraction, the pelt was shaved down to a thickness of 2 mm, cut into 4-cm squares and stored in dry salt till required. For some experiments flesh split of cow hides, similarly prepared, was employed.

A chrome tanning liquor was prepared by dissolving 500 gm of organically-reduced chrome extract of 18 per cent. Cr_2O_3 content and 315 gm NaCl in 8.5 litres of water, yielding 9 litres of solution of 1 per cent. Cr_2O_3 , basicity 35 per cent., specific gravity 1.045 at 20°C, pH 2.9.

Two vegetable tanning liquors were used. A wattle bark liquor was prepared by leaching the ground bark with cold water in a proportion of about 1 : 3 for 24 hours, and the decanted clear liquor was adjusted to specific gravity 1.015 at 20°C. This had a pH of 4.6 and a tannin content of about 1.9 per cent.

For other experiments, a sulphited mimosa extract was prepared by disintegrating 500 gm of solid commercial mimosa extract of about 66 per cent. tannin to pea size, stirring it into 1 litre of cold water and leaving overnight. It was then heated to 90°C in a water bath with occasional stirring till dissolved; 4 per cent. of $Na_2S_2O_4 \cdot 2H_2O$, calculated on solid extract, was added with further stirring for 30 minutes. For use, this was diluted with water to a specific gravity of 1.015 at 20°C. The pH was 4.4 and the tannin content about 2 per cent.

A synthetic tannin solution was obtained from a commercial synthetic tanning material of the naphthalene type (auxiliary syntan), specific gravity 1.25 at 20°C, containing 25 per cent. tan (filterable). This was diluted with water 1 : 9, 4 per cent. salt calculated on quantity of

solution was then added, and the liquor thus prepared was found to have a specific gravity of 1.054 at 20°C and a pH of 1.7.

2.3. Experimental Results

The vegetable tanning process was studied under irradiation at 760 kc/s, the pelts being completely immersed in the tanning solution and mounted parallel to, and 1 in away from, the vibrating quartz. The ultrasonic power was about 4.25 W/cm². Due to degassing, foam formed, its formation reaching a peak after about 20 minutes' irradiation, thereafter decreasing slowly. The resonant frequency of the electro-acoustical system decreased during the first 25 minutes, then remained constant for about 35 minutes, when it commenced shifting to higher values. After about 3½ hours, this frequency shift exceeded the tuning range of the oscillator and the experiments had to be broken off.

The results quoted were reasonably well reproducible. Inspection of the irradiated pelts showed a very considerable speeding up of the tanning process. The structure of the pelts was profoundly altered and exhibited already a leather-like appearance. A study of cross-sections confirmed that the tanning agent had deeply penetrated; the depth of penetration, in a number of experiments, was found to vary between 20 and 25 per cent., a result which appeared to be highly satisfactory in view of the comparatively short duration of the tannage.

The frequency shift observed showed that the radiating system was seriously affected by its environment and the physico-chemical process, constituting the tannage, taking place therein. Employment of a master-oscillator power-amplifier apparatus instead of the simple power oscillator would, of course, prevent these difficulties and permit continuous irradiation at a fixed frequency for any desired length of time.

Blank experiments on adjacent pieces of felt were run parallel to these tests, all experimental conditions, particularly the temperature, being kept very nearly identical in both the irradiated and the non-irradiated specimen. Since the absorption of sound causes a temperature rise, the vessel containing the irradiated pelt was cooled from outside by means of a cooling jacket containing crushed ice. The temperature

of the tanning solution was measured at about 5-minute intervals and the temperature of the blank solution near the pelt adjusted to the same value within $\pm 2^\circ\text{C}$, starting from the same temperature. The temperature was at no time allowed to exceed 27°C .

The non-irradiated blanks, after the same time interval, showed very little, if any, trace of either structural change or penetration of the tanning agent.

Irradiation with twice the above-mentioned ultrasonic power of the tanning solution by itself, in the absence of a pelt, produced no improvement in the subsequent tannage using the irradiated solution; irradiation was applied for $3\frac{1}{2}$ hours. Very little foaming occurred and no frequency shift was observed. The pH of the solution did not alter.

Synthetic tanning liquors gave even more positive results.

Comparatively very low power ultrasonics—about 1.5 W/cm^2 —resulted in considerably improved tannage, but most experimental runs employing synthetic tannage were carried out at power levels of about 3 W/cm^2 , each experiment involving irradiation for 3 hours. Application of a 0.1 per cent. solution of indigotin on cross-sections showed deep penetration to about one-third from each side, indicating a more rapid progress of the tanning process than in the case of the non-irradiated blanks. These were affected by the tanning agent to a small degree below the surface only. The frequency shifted in the manner indicated and irradiation of the tanning liquor by itself again failed to produce any enhanced tanning powers.

No appreciably increased tanning rate was obtained with chrome tanning solutions, but a certain improvement in the quality of the finished product was apparent.

2.4. Discussion

This experimental evidence indicates that vegetable tannage can be considerably speeded up by ultrasonic irradiation, its action occurring at the pelt-solution interface. The process of tanning alters the acoustic impedance of the system and thus the damping of the transducer. In the highly-damped system considered, the resonant frequency of the quartz will therefore shift with any change in the acoustic impedance of the load. The change in acoustic impedance

will also alter the coupling between the transducer and its load, again resulting in a shift of the resultant resonance frequency of the whole system. The change in frequency first observed seems to be associated purely with a surface reaction and with degassing. The later frequency changes are associated with the progress of the tannage itself: no frequency shift was observed during the irradiating of the tanning solution only in the absence of a pelt.

The vegetable (and sytan) tanning processes present favourable conditions for the action of ultrasound. The colloidal particles involved are very large, highly polymerized and of a complicated, coiled-up chain-like structure. H. Mark³ has shown that even relatively strong chemical bonds can be disrupted under such conditions. The depolymerizing action of the soundfield greatly facilitates the penetration of the tanning agent into the pelt. The large frictional forces set up at the pelt-solution interface tend to break up any adsorbed clusters of tanning agent which otherwise would clog the pelt openings and only very slowly diffuse inside, rendering vegetable tannage such a slow process.

Such forces acting at the interfaces have recently been studied semi-quantitatively by Schmid and Knapp.⁴ Working with porous clay membranes in a $N/1000$ potassium chloride solution and at a frequency of 350 kc/s, they find that indeed "a strongly enhanced relative motion occurs at the interface" which also persists, to a lesser degree, throughout the whole interior of the thoroughly wetted membrane. The amplitude of this motion decreases with distance from the surface of the membrane. The existence of strong mechanical forces at the interface between a vibrating solvent and a relatively rigid network of macromolecules has been theoretically treated by Schmid.⁵

The soundfield also tends to open the residual linkages between opposite side-chains of the collagen material of the pelt and thereby facilitates the attachment of the tanning groups.

Many workers, particularly Stiasny,⁶ maintain that the size of the compound is of fundamental importance in the tanning process: compounds of too low molecular size will not tan and those that are too large are unable to diffuse adequately into the hide fibre.⁷ The width of the channels separating adjacent

polypeptide chains in collagen is of the order 15 Å; it increases with the water content, values of 17 Å on swollen collagen having been measured.⁸ The complex chromium ions, even if hydrated, are comparatively small: the radius of the unhydrated chromium ion is 1.62 Å. They will thus have little difficulty in diffusing into these channels. Thus ultrasonic irradiation cannot be expected to speed up the chrome tanning, which inherently is already a fast process. The sound field, acting on the relatively small chromium complexes would only be expected to remove the hydration shell of these aggregates,⁹ either partly or wholly, and thus set free secondary valency forces. These then become available for combination with the polypeptide chains. This would explain the improvement in quality obtained in our experiments with chrome tanning.

A much larger molecular aggregate is being met with in the case of vegetable tanning. With its hydration shell it is probably just about as large as the channels between adjacent polypeptide chains and, in the absence of the sound-field, is likely to be adsorbed at the skin surface and only very slowly to diffuse inside. Ultrasonic irradiation strips off at least part of the hydration shell and reduces the size of the molecular aggregates; the particles having lost their hydration shell are also in a more reactive state. This coincides with the breaking of the salt-like bonds between the protein molecules caused by the irradiation,¹⁰ which thus further facilitates the tanning.

The chemical structure of syntans is somewhat similar to that of vegetable tanning agents and it is thus to be expected that positive results are also obtained with syntans.

That the tanning agent, even in conventional vegetable tanning, is indeed able to penetrate the fibre and to react with the molecules in the interior of the fibre has been shown, e.g. by Kuentzel;¹¹ and Lloyd¹² considers "the protection of the polypeptide links" as one of the essentials of tanning; however, it appears that the reagent molecule in vegetable tanning presents rather a close fit to the channels whose penetration is essential for proper tanning; thus the diffusion process becomes very slow indeed, and it is the speeding up of this diffusion process which results in the fast action of ultrasonic vegetable tanning.

3. Dyeing

A very similar situation is met in certain dyeing processes, where the diffusion of the dye from the surface of the material, where it has become adsorbed, into its interior is the rate determining step. One should therefore expect ultrasonic irradiation to be capable of causing an improvement in such dyeing techniques. That such is the case has been found by Brauer.¹³ This author reports a reduction of the dyeing time between one-fourth and one-sixth of the time required in the absence of irradiation. He used frequencies of 22 kc/s and 175 kc/s on cellulose, synthetic and animal fibres and reports good results even without previous scouring. A frequency of 50 c/s had little effect on dye penetration in hard fabrics like linen, cotton and poplin, but did considerably deepen the shade in rayon, cotton-linen and nylon. This low frequency produced hardly any effect on wool and silk. Only a slight improvement is reported with 3 kc/s. However, even the lower frequencies speed the equalization of the dye bath concentration and improve the dye dispersion. The latter effect had already been reported by Zezulinski and Tumanski,¹⁴ who found that the dispersion of indanthrene dyes was considerably improved by irradiation of the solution. These workers did not actually dye in a sound-field, but studied the effect of irradiation on the dyestuff solution only. While some dyes were slightly discoloured, probably by the hydrogen peroxide developed in an aqueous solution, a better dispersion is reported than that obtained with a colloid mill. Low audible frequencies did not affect wool fibres and generally were not as effective as the higher frequencies.

The above results have been only partially confirmed by an investigation by Alexander and Meek.¹⁵ These authors report a faster dyeing-rate following the application of soundfields of 250 kc/s and 17.3 kc/s, similar to that to be expected from conventional agitation. However, the uniformity of dyeing was much improved. They find no evidence of a break-up of the dye micelles.

The rate of uptake of dyestuff in ultrasonic fields has been studied by Rath and Merck,¹⁶ who report no difference in the improvement obtained by ultrasonic irradiation between 22 and 175 kc/s.

4. Comparison Between Tanning and Dyeing

The molecular structure of a typical dyestuff molecule (Fig. 1) is somewhat similar to that of many kinds of vegetable tans. It is not surprising therefore, that there is much in common between dyeing and tanning in a soundfield: in both cases, at high frequencies, a considerable speeding up of the process is obtained. Wool is a somewhat difficult

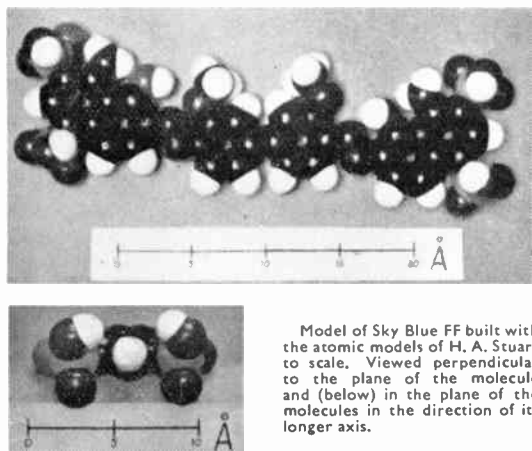

Fig. 1.—Molecular model of a typical dyestuff molecule. Many vegetable tannins exhibit a somewhat similar structure.

(Reproduced from E. I. Valko, "The Physical Chemistry of Dyeing," in J. Alexander, "Colloid Chemistry," Vol. 6, p. 598. (Reinhold Publishing Corporation, New York, 1946).)

proposition in view of the scale cells which form an outer shell on the fibre and impede the penetration of the dyestuff. That the fibre itself reacts to the soundfield is shown by the work of Wukomen *et al.*¹⁷ who obtained extraordinarily fine cotton fibres after 3 to 10 minutes ultrasonic irradiation. There is, however, one feature, which distinguishes ultrasonic dyeing from ultrasonic tanning: irradiation of the dyestuff solution by itself yields a considerable improvement in subsequent dyeing,¹⁴ while irradiation of a tanning liquor by itself produces no lasting result.¹ This difference is probably a question of the relative stability of the highly dispersed systems formed by the action of the soundfield in both cases: while the dye dispersion remains stable, the tanning dispersion apparently reverts quickly to the more highly polymerized state. This, of course, could be prevented by the addition of suitable

stabilizers. In other words, the acceleration of the tanning process presumably results from a breaking-up of aggregates at the interface, whereas in dyeing irreversible polymerization occurs.*

5. Problem of Industrial Application

There thus exist two examples of industrially important applications of ultrasonics, where success has been achieved in the laboratory, but where, so far, no large-scale employment of these modern techniques has even been contemplated. It is an interesting engineering problem: how to apply a process, which works well in a 250-c.c. beaker, to a 250-gallon vat. This involves necessarily a large step-up of the power requirements, and vibrating quartz crystals are out of the question for these industrial applications. To obtain the same volume concentration of ultrasonic power, we would need a transducer radiating at the rate of about 50 kW over an area of, say, 6 by 2 feet. To maintain the same radiation density per unit area would require a power output about 2,000 times as great as that used in our laboratory experiments. It might be possible to produce titanate transducers of the required size and power-handling capabilities, but the cost of such units may well prove to be prohibitive. However, magnetostrictive transducers could be built in this size, radiating the required power, if a considerably lower frequency could be employed.

Most of the action of the soundfield is due to the sudden acceleration and deceleration which takes place¹⁸ and is thus proportional to $A\omega^2$, that is to the square of the frequency ω and to the first power of the amplitude A . The latter is, in the first approximation, proportional to the voltage applied to the transducer and thus to the square-root of the power P . For equal effect, therefore, the quantity $\omega^2\sqrt{P}$ should be kept constant, which would mean that a reduction of the frequency by half would require 2^4 , that is 16 times as much power to produce the same effect.† Actually, things are not quite as bad. Firstly, the radiation pressure exerted on the

* The author is obliged to the Referee of the Papers Committee for having suggested this formulation.

† The instantaneous displacement of a vibrating particle is given by $X = A \sin \omega t$. The acceleration is $d^2x/dt^2 = -\omega^2 A \sin \omega t$. In a piezoelectric transducer $A = KV$, where K is a constant of proportionality, and V is proportional to \sqrt{P} . The acceleration effect E thus is given by $E \propto \omega^2\sqrt{P}$.

interface by the soundwave plays an unknown but certainly large part in these effects. This quantity is equal to the mean energy density of the soundfield in front of the interface and thus proportional to $\omega^2 A^2$. To maintain equal radiation pressure therefore, requires only $2^2 = 4$ times as much power if the frequency is halved. This, of course, assumes that the radiating surface of the transducer remains large compared to one quarter of the wavelength of the soundwave; if this is not so the radiation pressure yield will be seriously reduced. Moreover, the total impedance of the electro-acoustical system remains by no means constant as the power is increased, but tends to rise likewise. Furthermore, cavitation is very important in all ultrasonic effects. Noltingk and Neppiras¹⁹ have studied the frequency dependence of the maximum fluid pressure occurring in cavitation by setting up the differential equations of the vibrating cavities. Their theory predicts that all cavitation effects should fall off with increasing frequency. Another theoretical treatment due to Meyer and Tamm²⁰ shows that the critical effective sound-pressure just sufficient to produce the onset of cavitation, P_c , remains virtually independent up to about 100 kc/s, whence it commences to rise slowly. The experimental investigations by Esche²¹ show little rise in P_c up to about 50 kc/s, whence it starts to increase rather more rapidly than Tamm and Meyer predict, but less steeply than one would expect from Noltingk and Neppiras's treatment. In view of the approximations involved in the mathematical discussion, and the inaccuracies inherent in the measurements themselves, Esche's results can be considered as in reasonable agreement with theory. Finally, there is the question of how much of the efficiency of ultrasonic tanning might not be due to an uncoiling of the vegetable tans, followed by their orientation parallel to the field. The energy to bring about such orientation is not large.²²

As a rough approximation, therefore, it appears that, for a given ultrasonic effect, the quantity $\omega^2 P$ rather than $\omega^2 \sqrt{P}$ should be kept constant. Assuming, which is reasonable, a geometric equipartition of the total ultrasonic power absorbed between "useful effect" and "side-effects"—probably mainly heating—one would expect the total power absorbed would increase about linearly with frequency. Such a

relationship has been observed, in experiments with animal tissues, by Esche^{21, 23} and others,²² for the frequency interval of 800 to 4,500 kc/s.

There is a tendency in the design of ultrasonic laboratory experiments to select a frequency which is rather too high; firstly, to reduce the power requirements, and secondly, to avoid the use of unduly thick and expensive quartz crystals. In the light of Braeuer's experiments¹³ it is quite probable that ultrasonic tanning would work equally effectively at the same power level at 200 kc/s as it did at 760 kc/s. This is further supported by the author's own experience in the relative effectiveness of sonic and low-frequency ultrasonic fields in the rupture of bacterial membranes. There is little difference, in this respect, between 7 and 12 kc/s at equal power levels, and a frequency of about 35 kc/s at the same power produced a reduction in the exposure times required, only about one-half of the time necessary at 12 kc/s. Bacteria, of course, are very much larger entities than the colloidal and molecular aggregates which are active in tanning and dyeing.

To bring ultrasonic tanning within the range of magnetostrictive transducers would thus require an increase of power of only about 15 fold* even assuming that the power applied in our experiments really represented the minimum requirements, which might not have been the case.

The problem of the relative effectiveness of audible and ultrasonic sound has been the subject of a number of investigations. Freundlich and Gillings²⁴ studied it working at 400 c/s and 100 W electrical input to the transducer, at 5,000 c/s and 750 W delivered to the plate circuit of the oscillator, and at 214 kc/s at an unstated power level. Their results are thus only semi-quantitative. Even so, they find that neither cavitation nor emulsification took place at 400 c/s, but did occur at 5,000 c/s. They conclude that, while the ultrasonic frequencies are certainly more effective, good results may also be obtained with high sonic frequencies.

It is not quite clear why these authors failed to observe cavitation at 400 c/s; such effects have been observed by Pielemeier,²⁵ even at

* Accepting the above reasoning, requiring $\omega^2 P$ to be kept constant if the frequency is altered:

$$\omega_1^2 P_1 = \omega_2^2 P_2$$

This yields, for 760 and 200 kc/s, respectively, $P_2/P_1 = 0.58/0.04 = 14.5$.

30 c/s, and Esche¹⁸ has observed cavitation from zero frequency upwards. Schmid and Poppe²⁶ find no difference in the depolymerizing action between soundfields of equal intensity, namely, 1 W/cm^2 , of 284 kc/s and of 10 kc/s. The molecular weight of polymerized methyl-metacrylic acid ester, dissolved in 0.3 per cent. benzene, was reduced by 70 per cent. after 25 minutes of irradiation, even at the lower frequency. (Fig. 2.)

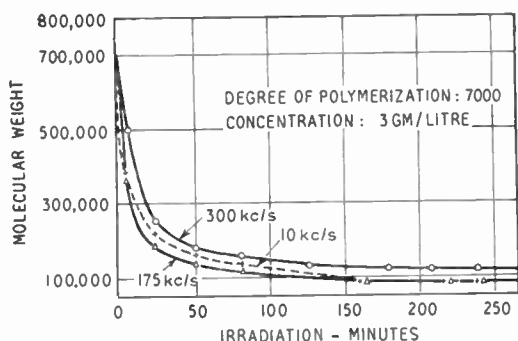

Fig. 2.—Illustrating the depolymerizing action of soundfields at various frequencies. No significant difference is found between the action of soundfields of 10, 175 and 300 kc/s. The molecular weight of polymerized methyl-metacrylic acid ester is plotted (ordinate) against time in minutes (abscissae) of irradiation.

(After Schmid and Poppe.²⁶)

It is of interest, in this context, briefly to consider results obtained in ultrasonic and sonic laundering of fabrics and cleaning of metal parts. Florisson²⁷ mentions good results in ultrasonic laundering at 18 kc/s. Samsel, Henry and Fehr²⁸ report no change in the efficiency of ultrasonic cleaning of metal parts between 300 and 1,000 kc/s. They ascribe the effect mainly to cavitation. At the still lower frequency of 30 kc/s they report only negligible cleaning effect, due to cavitation occurring at the surface of the transducer, thus preventing energy transfer into the solution.

It thus would appear that a frequency between, say, 10 and 25 kc/s would show promises for the industrial application of ultrasonic tanning and dyeing.

As the frequency is reduced the wavelength of the soundwave in the liquid medium increases proportionally. Thus, in a liquid having a velocity of propagation of sound of 1,200 m/sec,

a frequency of 400 kc/s yields a wavelength of 3 mm, whereas at 24 kc/s the wavelength is already 5 cm: therefore at lower frequencies, the location of the interface may have to be watched. In a stationary wavefield acceleration and pressure are 90 deg out of phase. According to Fark²⁹ the emulsifying action takes place mainly in regions of pressure maxima, while effects like, for instance, haemolysis, take place at the acceleration maxima, where friction is highest. However, in practical cases one finds that the soundfield is so distorted that positioning would not become too critical.

The heating effect produced by large amounts of acoustic power will also require attention: tanning vats might have to be artificially cooled, although the heating of a dyebath is not unwelcome.

Both the tanning and the dyeing process are cases where the composition of the solution alters as the reaction proceeds; thus the damping and the resonant frequency of the system vary also. Should the reaction come to a halt due to the exhaustion of an essential component, the damping and the frequency can shift very quickly: we have shattered two quartzes through this effect, which can be avoided by working in a sufficient excess of bath concentration. It should be less critical with magnetostrictive transducers and electronic means could be readily devised to safeguard against it, for instance, a master oscillator-power amplifier system would eliminate it.

Great importance attaches to correct load matching: it should be borne in mind that the load consists not only of the transducer itself, but also of the acoustic impedance into which the transducer works and which is reflected into the coupling circuit.

The industrial application of these two promising fields thus seems to hinge on the availability of a high-power generator.

A variety of such generators are described in a review by Noltingk³⁰ covering a period up to 1950. Since then, a number of useful suggestions have been put forward; we shall mention but a few. An ultrasonic "whistle" capable of delivering several kilowatts of acoustic power in liquids, at frequencies between 4 and 32 kc/s has been developed by Janovski and Pohlman and is described by Goebel;³¹ it has been applied in the soap industry.³²

Barium titanate transducers are now available to yield several kilowatts of ultrasonic power and have already found industrial application to flotation processes in ore treatment plants³³ and to large-scale industrial cleaning.³⁴

While the efficiency of a quartz transducer is in the vicinity of 90 per cent., even a permendur magnetostrictive transducer has an efficiency of only 70 per cent.³⁰ and, in general, magnetostrictive devices are much less efficient than electrostriction devices;³⁵ this is due partly to the presence of the transverse magnetostrictive effect and to the heat developed: the electric insulation in the laminated stack represents also thermal insulation.

In the present author's experience, nichrome, or still better, monel, have a higher efficiency than the frequently used pure nickel, but the higher temperature coefficient, particularly of monel, introduces difficulties in prolonged operation. We have found careful annealing (3 hours at 850°C) to be essential for satisfactory operation of magnetostrictive laminated transducers. Some of the modern ferrite magnetic ceramics exhibit large values of their magnetostrictive coefficient, and materials like ferroxcube show promise as ultrasonic transducers. The low crushing strength of some of these materials imposes limitations, but the National Physical Laboratory have demonstrated such transducers yielding several hundred watts between 15 and 150 kc/s.

The efficiency of conventional magnetostrictive transducers can also be considerably improved, according to Rust³⁶ by operating the transducer from a pulsed wavetrain, developed by means of a quenched spark generator. An iron transducer, while having a lower magnetostrictive coefficient than pure nickel, exhibits a discontinuity in its Villari magnetostrictive curve and thus is capable of generating higher harmonics. This would be of great importance in industrial applications because of the highly efficient high-frequency components thus present.

Whether pulse systems would really lead to a worth-while improvement is doubtful, the idle time necessarily involved might lengthen the irradiation time; then cavitation in a liquid is time dependent,³⁷ and this would render pulse methods unsuitable for any application relying largely on cavitation.

5. References

1. R. L. Ernst and F. Gutmann. *J. Int. Soc. Leath. Chem.*, **34**, p. 454, 1950.
2. F. Gutmann. *J. Sci. Instrum.*, **24**, p. 10, 1947.
3. H. Mark. *J. Acoust. Soc. Amer.*, **16**, p. 183, 1945.
4. G. Schmid and H. Knapp. *Z. Angew. Phys.*, **5**, p. 463, 1953.
5. G. Schmid. *Phys. Z.*, **41**, p. 326, 1940.
6. E. Stiasny. "Colloid Chemistry" (Edited by J. Alexander), Vol. 4 (Chemical Catalogue Co. Inc., New York, 1932).
7. G. D. McLaughlin and E. R. Theis. "The Chemistry of Leather Manufacture," p. 523 (Reinhold Publishing Corp., New York, 1945).
8. *Ibid.*, p. 35.
9. N. Sata and N. Narux. *Kolloid Z.*, **89**, p. 341, 1939.
10. W. W. Lepeschkin. *J. Phys. Coll. Chem.*, **53**, p. 335, 1949.
11. A. Kuentzel. *Collegium*, **1929**, p. 207, **1934**, p. 1.
12. D. I. Lloyd. *J. Int. Soc. Leath. Chem.*, **18**, p. 144, 1934; *Leather World*, **25**, p. 906, 1933.
13. M. Braeuer. *Melliand Textilber.*, **32**, p. 701, 1951.
14. V. M. Zezyulinski and S. S. Tumanski. *J. Phys. Chem. USSR.*, **11**, p. 801, 1938.
15. P. Alexander and G. A. Meek. *Melliand Textilber.*, **34**, pp. 57, 133, 214, 1953.
16. H. Rath and H. Merck. *Melliand Textilber.*, **33**, p. 859, 1952.
17. K. Wukomen, A. Heuberger and K. Muehlenthaler. *Experientia*, **2**, p. 105, 1946.
18. For example, G. Schmid et al. *Kolloid Z.*, **124**, p. 150, 1951.
19. B. E. Noltingk and E. A. Neppiras. *Proc. Phys. Soc.*, **B63**, p. 674, 1950.
20. W. Meyer and K. Tamm. *Akust. Z.*, **4**, p. 145, 1939.
21. R. Esche. *Akustische Beihefte*, No. 4, p. 208, 1952.
22. K. Söllner. *Chemical Review*, **34**, p. 384, 1944.
23. R. Esche. *Akustische Beihefte*, No. 2, p. 71, 1952.
24. H. Freundlich and D. W. Gillings. *Trans. Faraday Soc.*, **35**, p. 319, 1939.
25. W. H. Pielemezier. *J. Acoust. Soc. Amer.*, **23**, p. 224, 1951.
26. G. Schmid and W. Poppe. *Z. Elektrochem.*, **53**, p. 28, 1949.
27. C. Florisson. (Discussion.) *Acustica*, **4**, p. 211, 1954.
28. R. W. Samsel, G. E. Heary and R. O. Fehr. *Acustica*, **4**, p. 207, 1954.
29. H. Fark. *Frequenz*, **6**, p. 255, 1952.
30. B. E. Noltingk. *J. Brit. I.R.E.*, **11**, p. 11, 1951.
31. R. Goebel. *Nachrichtentechnik*, **2**, p. 7, 1952.
32. G. Troeger. *Fette und Seifen*, **52**, p. 115, 1950.
33. W. Petersen. *Z. Erzbergbau Metallhuettenw.*, **4**, pp. 62, 142, 1951.
T. Oyama and S. Tanaka. *Science Repts. Research Insts. Tohoku Univ.*, **A2**, p. 925, 1950.
34. T. J. Kearney. *J. Acoust. Soc. Amer.*, **26**, p. 244, 1954.
35. B. Carlin. "Ultrasonics," p. 225, 1st ed. (McGraw-Hill, New York, 1949).
E. G. Richardson. "Ultrasonic Physics," p. 23 (Elsevier, Amsterdam, 1952).
36. H. H. Rust and H. Drubba. *Z. Angew. Phys.*, **5**, p. 251, 1953.
H. H. Rust. *Kolloid Z.*, **131**, 158 (1953).
37. R. Esche. *Akustische Beihefte*, No. 4, p. 214, 1952.
Th. Lange, *ibid.*, No. 2, p. 75, 1952.

DISCUSSION ON "An Electronic Random Selector"*

Dr. R. Wilson (*Communicated*)†: In his paper Mr. Walker refers to a design for a selector which I made some years ago.¹ It is the purpose of this note to point out that the deviation from the frequency test of the original selector was about 0.3 per cent. in a long series of digits, in agreement with the expectation from the circuit parameters. In case greater accuracy is desired, the same principle is still applicable, and different circuit parameters may be employed. For example, independently, Tillman² built a selector on similar principles with a similar accuracy.

The circuits of both these selectors were conventional circuits as used in computers and nuclear physics equipment, and the ordinary methods of testing apply. Walker's failure to obtain reliable results with this type of circuit, can therefore be only an accident, and does not discredit the circuit or the principle on which it was based.

Both these selectors had an inherent freedom from sequence preferences. That is to say, the chance of one selection being influenced by the previous selection is very small. In Walker's selector this freedom is not automatic. If the mark/space ratio of one of the multivibrators differs from 1/1, and is, for example, $1/(1+x)$, then the chance that a digit will repeat itself is increased from 1/4 to approximately $1/4(1+x)$. This will occur in spite of the frequencies of the digits being correct.

Defects of random series due to serial preferences have, in the past, been shown to give a possibility of spurious results in psychical research experiments.³ The statement that "Ratios of 2:3 and 3:2 have been used with no noticeable change in the final results" seems therefore misleading, and if it is desired to avoid sequence preferences with Walker's circuit, it is necessary to take special care on this point.

A detailed paper discussing electronic random selectors, their design and use is to be submitted shortly to one of the statistical journals.

R. W. Walker (*in reply*): The fact that a similar electronic random selector to that of Dr. Wilson's circuit was constructed, and which did not work quite so well as the original, should not in any way discredit the original circuit or principle. I found a defect (p. 263, para. 4) which was obviously not in Dr. Wilson's own selector, nor in the selector built by J. R. Tillman.

In that same paragraph I referred to "a similar electronic random selector to that described by Wilson . . .," and in fairness to Dr. Wilson, I feel that I should have included the word "circuit" after "selector." The layout of components and screening was carefully considered, but even so, it is possible that a change in construction could have produced the unwanted effect.

It was with this in mind that a different circuit with altered layout of components was made up, this circuit being described in my paper. It was found that any one digit would still occur more times than the other three, but in this case balancing the feeds to V4 and V8 by C_B (Fig. 5) allowed the series to conform to the requirements of the frequency test. (Test (a), p. 262.)

I agree that in Dr. Wilson's circuit it is essential to have the mark/space ratio of the scaling circuits as near 1/1 as possible if the requirements of Test (a) are to be met. In the circuit under discussion the mark/space ratios are not critical so far as Test (a) is concerned, but, as Dr. Wilson has rightly pointed out, it is necessary for them to be 1/1 to avoid sequence preferences. The statement to which he refers does, in fact, only apply to Test (a) and as this was not mentioned in the paper it is therefore misleading. In this selector both multivibrators were actually set to produce a mark/space ratio of 1/1.

References

1. R. Wilson, *Proc. Soc. Psych. Res.*, **48**, p. 213, 1946.
2. J. R. Tillman, F. H. Reynolds and P. J. Hilton, *Phil. Mag.*, **39**, p. 807, 1949.
3. G. N. M. Tynell, *Proc. Soc. Psych. Res.*, **44**, p. 99, 1936.

* R. W. Walker, *J. Brit. I.R.E.*, **14**, pp. 262-268, June 1954.
† Received by the Institution on May 6th, 1955.

THE PEACEFUL USES OF ATOMIC ENERGY

An event of considerable significance in the field of international scientific co-operation is to take place in Geneva next month, when scientists and engineers from over 80 countries will meet at a conference on the peaceful uses of atomic energy, arranged by the United Nations.

The conference arises directly out of the desire of the United Nations to emphasize the vital role which atomic energy techniques will play in the generation of power and in many medical and scientific applications. Indeed, during the meeting of the General Assembly which decided that this International conference should be held, it was announced that the United States and the United Kingdom were to make available 100 kg and 20 kg respectively of fissionable material (enriched U235 fuel) to serve as fuel in experimental reactors to be erected in various countries: this represents probably enough fuel for 60 such reactors.

At the beginning of July it was announced from the European office of the United Nations that over 1,000 papers had been submitted from 20 countries. A fair proportion of these will not be read at the conference, but it is understood that all the papers will eventually be published. There are also to be exhibitions of nuclear equipment, including a working reactor of a simple type as well as numerous models of reactors for the generation of power.

At the conference, which will last from August 8th to 20th, the opening session will discuss the need for a new power source and papers will describe the power needs of the various nations during the next 25 to 50 years. It is well known that power requirements are increasing rapidly and in the not too distant future the world will see the end of conventional energy sources, such as coal, oil, water power, natural gas and wood. Obviously, now is the time to plan for the eventual exhaustion of these resources.

After general discussion on the individual needs of each country, the safety, economic and technical considerations of nuclear reactors will be discussed. Detailed questions of the physics, chemistry and general technology of reactors will be the prime interest of the conference as far as scientists and engineers are concerned; electronics engineers will be especially interested in papers describing dosimetry techniques, instrumentation and automatic control.

Other sessions will be devoted mainly to the

production and use of isotopes, and survey papers will outline applications in science and industry; these include applications similar to those which were described at last year's Industrial Electronics Convention, such as thickness measurement and engineering inspection, as well as tracer techniques in chemical engineering. Other papers will deal with medical, biological and agricultural problems in which isotopes are used either as tracers or as sources of radiation to effect change in the organism under examination. The disposal of radioactive waste and the long-term problems which it poses will be a particularly vital matter to be considered during this session.

As far as Great Britain is concerned, the development of the peaceful uses of atomic energy is largely the responsibility of the Industrial Group of the United Kingdom Atomic Energy Authority, in conjunction with various engineering firms who have recently announced their plans for work in this field. The Government White Paper, "A Programme of Nuclear Power", published earlier this year, envisages the development of two types of reactor to be brought into use on a commercial scale within the next 10 years. These are the so-called "slow" reactor of the air-cooled type such as is being erected at Calder Hall in Cumberland, and the thermal reactor of a much higher heat rating, using possibly liquid coolant. In addition, work is in progress in the north of Scotland on a fast-fission reactor of an experimental nature which presents even more complex problems.

The Research and Development Branch of the Group recently invited a representative of the Institution to visit the laboratories at Culcheth in Lancashire, where investigation of the properties of materials for use in reactors is principally carried out. Investigations of a physical nature deal with the properties of different metals under the arduous conditions met in the core of reactors, while methods of extraction and processing are also of considerable importance. One method of melting small quantities of metals which oxidize in air—electron bombardment—consists virtually in using the specimen as the cathode of a large evacuated diode, across which a potential of 10 kV is applied.

In common, however, with almost every branch of British industry, the expansion and consolidation of the work is dependent on increased recruitment of suitably qualified staff, mainly in this case group leaders in the salary range £1,000-£1,500.

SOME RECENT DEVELOPMENTS IN COMMUNICATION RECEIVER DESIGN*

by

A. E. Pope (*Associate Member*)†

SUMMARY

Improvements in the achievement of frequency stability of local oscillators are described, particular reference being made to methods of compensating for the effects of temperature and humidity changes, and of changes in valve characteristics. Receiver circuits employing crystal-controlled first oscillators are described. The advantages and disadvantages of electromechanical filters in increasing selectivity are considered, but it is concluded that these are not at present practicable because of their sensitivity to shock and the difficulties of production. Methods of improving frequency presentation are discussed, and optical and film scales are described which enable high resolution of frequency setting; band-switching arrangements are also described. Brief mention is made of the possible future use of transistors in communication receivers.

1. Introduction

During the last decade, research and development work in electronic engineering has been concentrated mainly in the fields of television, industrial electronics and equipment for use with guided missiles. In the realm of communication in the l.f., h.f. and v.h.f. bands, progress has, perhaps, not been so rapid; nevertheless, certain advances in technique have occurred and it is intended in this paper to discuss those which have influenced post-war receiver design.

Communication receivers which were designed during the war years and before usually followed a stereotyped pattern; single superheterodyne circuits were usually employed, using one or two stages of r.f. amplification and two or three stages of i.f. amplification, with a variable number of selectivity steps including, usually, a crystal gate. As far as mechanical design was concerned, frequency presentation was usually on a circular dial or on a large open scale with a moving pointer, the scale length of each band varying from a few inches to a foot or so. In some of the better sets an arbitrary logging scale was fitted to assist in resetting to a previously received signal. The tuning unit usually consisted of a multi-gang capacitor, and band switching was usually accomplished by means of a wafer-type rotary switch. No more care was

taken in the design of oscillator circuits than with that of the r.f. circuits, although the frequency stability of the former was, of course, much more important than that of the r.f. circuits. Although in some ways these sets were satisfactory, there was need for much improvement. A desirable feature, lacking in pre-war sets, was the means of tuning accurately to a given frequency without searching and to remain tuned to that frequency for lengthy periods.

2. Frequency Stability

In receivers using conventional superheterodyne circuits, the frequency of the signal applied to the i.f. amplifier is usually equal to the difference between the input signal frequency and local oscillator frequency. In order to keep modulation distortion to a minimum, it is necessary that this signal be kept in the centre of the pass band of the i.f. amplifier: in other words, the local oscillator frequency must be as stable as possible. Oscillator frequency variations are mainly caused by the effects of temperature and humidity changes in the tuned circuit elements, and by variation of valve characteristics during the warming-up period and with supply voltage changes. These causes will now be briefly dealt with.

2.1. Temperature Effects

Change of inductance and capacitance with temperature is usually due to the expansion or contraction of the materials of which the components are made, and so the use of materials

*Manuscript first received December 3rd, 1954, and in final form on May 16th, 1955. (Paper No. 323.)

†Ministry of Supply, Signals Research and Development Establishment, Christchurch, Hants.

U.D.C. No. 621.396.62.

having small coefficients of expansion is desirable. It is also necessary that the coefficient of expansion does not vary with different batches of the material. It is, of course, necessary also to use materials which are electrically suitable, and the number of materials which can be used in the manufacture of inductors and capacitors is therefore limited. Inductors usually consist of single or multi-layer coils wound on a former of some insulating material. In addition, to increase inductance and Q , dust-iron material is sometimes used, either fixed or as an adjustable slug. The most suitable material for formers is high-grade ceramic. This has a low and repeatable temperature coefficient and is also an excellent electrical insulator; unfortunately, it is a very hard and brittle material which cannot be machined easily. It is, however, used almost exclusively as a former material in the oscillator section of most modern high-grade receivers.

Single-layer inductors are usually wound with silver or Invar wire, the latter being an alloy of nickel and iron and specially produced to have a small temperature coefficient. Alternatively, inductors have been made with the turns plated on to the ceramic former. Multi-layer inductors must be wound with copper wire either in single strand or litz. form, but this type of inductor is inherently less stable than the single-layer variety. Dust-iron material should be used as little as possible in oscillator inductors, since the composition can vary considerably between different samples, with consequent variation of temperature coefficient. If a dust-iron slug is used for adjustment of inductance, only sufficient should be used to obtain the requisite variation. A method of temperature compensation of inductance sometimes used is to mount a small piece of ferrous material on a bi-metal strip in such a way that the inductance is reduced as the temperature increases. It is possible, with attention to the above points, to make an inductor with temperature coefficient variation of about ± 10 parts in $10^6/^\circ\text{C}$.

With capacitors, variations in dimensions of the plates and dielectric with temperature are the main causes of capacitance change. Silver is usually used for the plates of fixed capacitors, but the dielectric may be waxed paper, mica, ceramic or air. Most variable capacitors use air as dielectric, but fixed capacitors of small volume usually employ mica or ceramic. Where mica sheets are used between silver plates, it is difficult

to avoid a layer of air in the construction, and variations in the amount and humidity of this can cause large variations in temperature coefficient. Stacked mica capacitors are therefore to be avoided in stable oscillator circuits. Mica capacitors with plates silvered on to the mica, however, overcome this difficulty and a recent capacitor of this type has a temperature coefficient of $+30 \pm 30$ parts in $10^6/^\circ\text{C}$. Silvered ceramic capacitors are also used and by employing different grades of ceramic material, capacitors can be made with temperature coefficients varying between $+100$ and $-2,500$ parts in $10^6/^\circ\text{C}$. Variations about these mean values are ± 20 parts in $10^6/^\circ\text{C}$ for the lower values but considerably higher for the capacitors with the higher temperature coefficient. Silvered ceramic capacitors with negative temperature coefficients are frequently used to compensate for the positive temperature coefficients of the inductors and capacitors of oscillator circuits.

In receivers covering a considerable frequency range, compensation is complicated by the fact that the temperature coefficient of the variable elements can vary over the band. For this reason it is best to use as many bands as possible and thus restrict the frequency coverage of each band. An additional advantage of this is that the scales do not have to be so long and in the case of capacitance-tuned circuits a large minimum capacitance can be used. This reduces the effect of the temperature coefficient of stray capacitance which is difficult to compensate. A recently designed British Army receiver using this principle covers 2 – 16 Mc/s in seven bands, the top five of which cover a band of 2.3 Mc/s each and the top band has a minimum capacitance of about 180 pF. The stability of this receiver is within ± 20 parts in $10^6/^\circ\text{C}$ at all frequencies.

2.2. Humidity Effects

The effect of humidity variations on the stability of inductors can be considerable, the amount depending, of course, on the construction of the particular inductor. Humidity can also seriously affect the stability of variable capacitors. Since compensation for humidity changes is very difficult, it is common practice now, in military equipment at any rate, to put receivers in hermetically sealed cases. The front panel is sealed to the case, usually by a rubber gasket clamped between the panel and the case, and rubber spindle seals are fitted on all the

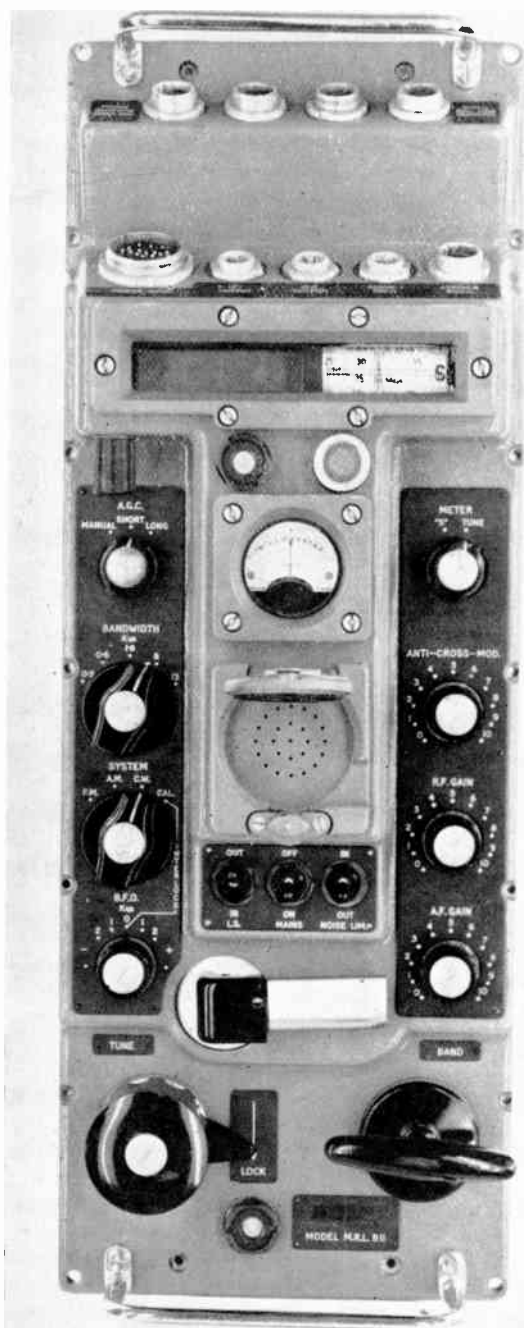

Fig. 1.—Modern Army communication receiver.

control shafts entering the receiver. Considerable work has been done to perfect these sealing methods and the sealing of complete equipments presents very little difficulty and pays large dividends where sets are to be used in conditions of high humidity. Sealed sets have been put into tropical chambers for months on end with no reduction of performance. In some sets which are rather bulky and where it is inconvenient to seal the whole receiver, oscillator circuits themselves are sometimes sealed.

2.3. *Effect of Change in Valve Characteristics*

It is usual nowadays to reduce the effects of frequency variations due to change in valve characteristics by stabilizing supplies where possible. This does not overcome the effect of the initial heating of the valve, but it has been found that this time is only of the order of a few minutes, due partially to the small thermal capacity of modern miniature valves.

Oscillator circuits have been devised in which drift due to h.t. and l.t. variations have been arranged to neutralize each other, but it is usually the case that complete neutralization only occurs at one frequency and therefore these circuits are not of great use in receivers having a large frequency coverage.

2.4. *A Stable Post-war Receiver*

The receiver illustrated in Fig. 1, developed for the Services by Mullard Ltd., is an example of a receiver in which every effort has been made to obtain the best possible frequency stability using a conventional superheterodyne circuit. It has six bands, a single superheterodyne circuit being used on the two lower frequency bands and a double superheterodyne circuit on the upper four. Special precision capacitors are used which have a resetting accuracy of less than a minute of arc and a temperature coefficient of 10 parts in $10^6/^\circ\text{C}$. The overall stability of the receiver above 10 Mc/s is ± 10 parts in $10^6/^\circ\text{C}$. The optical scale illustrated in Fig. 7 is used on this set. Humidity effects are eliminated by hermetical sealing, and internal heat rise is reduced by projecting the i.f. and audio valves from the rear of the set in sealed cans. The h.t. for the oscillator is stabilized by means of neon stabilizers.

If a higher frequency stability is required than can be obtained from this receiver, it is necessary

to use different techniques which will now be briefly discussed.

2.5. Use of Crystals

Since most of the frequency shift in the oscillator is due to variations in the tuning elements, it is obvious that if these variations can be eliminated by any means, then it should be quite easy to produce a stable oscillator. This can be done for a given frequency by replacing the circuit tuned elements by a quartz crystal. Crystals can be produced to give a very high frequency stability with variations dependent on the type of cut, but of the order of 1 part in $10^6/^\circ\text{C}$. Unfortunately, it is not possible to tune a

order to cover a wide band, several crystals are needed, but the second local oscillator can be a low-frequency oscillator covering, for instance, a band of 1 Mc/s or multiples thereof. The number of crystals required will then correspond to the number of times the local oscillator frequency coverage will divide into the total frequency coverage. With this type of circuit it is difficult to achieve single-knob tuning, since unless the r.f. circuits have the same number of ranges as the number of crystals used, ganging of the r.f. circuits to the variable i.f. and second oscillator necessitates a complicated mechanism. An example of splitting the r.f. circuits in this way is the Collins 51J3, produced in the U.S.A. This receiver covers a frequency band of 0.5 to 30 Mc/s in 30 ranges; it uses permeability tuning throughout. A block diagram of the set is given in Fig. 2.

Different r.f. ranges are obtained not by changing inductors or capacitors but by moving dust-iron cores by a given amount inside the inductors. Thus one coil can be used for several bands. The receiver has a very high frequency stability and it can be accurately set to within 1 kc/s at any frequency in the band. The tuning mechanism is, however, complicated and the whole set is rather expensive.

One of the main disadvantages of this set is the time it takes to go from one end of the frequency range to the other. Only 10 crystals are used, as it is possible to use most of them more than once by having a local oscillator frequency above and below the signal frequency. However, the number of crystals is still rather excessive, and circuits have been evolved using only a single crystal in conjunction with an harmonic generator. A typical example of this circuit is the Wadley receiver,¹ a block diagram of which is shown in Fig. 3. It is seen from this diagram that, although an r.f. oscillator (L.O.) is used, its stability is not important since the output fed to the i.f. is a function only of the signal frequency and the particular harmonic of the harmonic generator being used. The other oscillator (I.O.) has only a frequency coverage of 1 Mc/s and works at a low frequency where high stability is easily obtainable. The design of such a receiver, however, is much more critical than that of a normal single superheterodyne, since the harmonics of the second oscillator (I.O.) and the harmonics from the harmonic generator must be reduced to negligible proportions at the

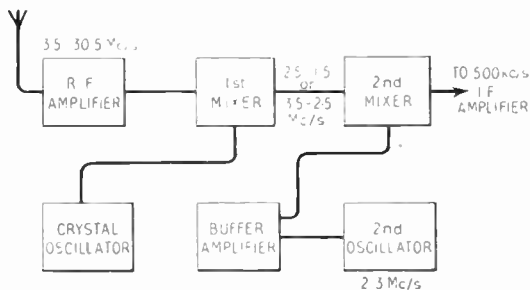

Fig. 2.—Block schematic of the Collins 51J3 communication receiver, using a crystal-controlled first oscillator.

crystal other than over a very small percentage of its initial frequency and, therefore, the first oscillator in a single superheterodyne receiver cannot make use of a crystal, if the receiver is to be tunable over a continuous frequency range. Circuits have been developed, however, for obtaining crystal stability in the first oscillator, but this entails using double or even treble superheterodyne circuits. There have been several circuits of this type developed since the war, both in this country and in the United States, and a short survey of such developments will not be out of place at this point.

2.6. Receivers with Crystal Controlled First Oscillators

The most straightforward method is the use of a double superheterodyne circuit, having the first oscillator crystal controlled and the first intermediate frequency variable over the band equivalent to that of the second oscillator. In

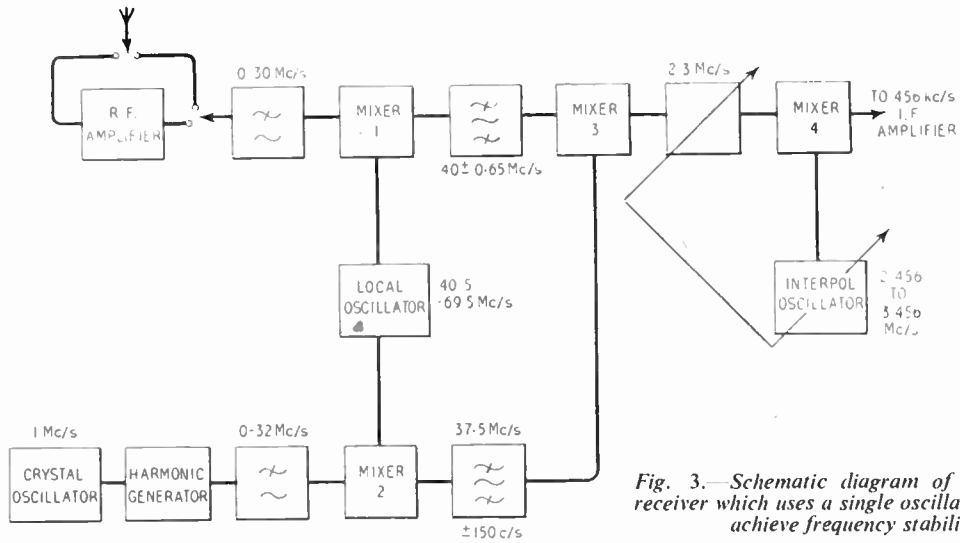

Fig. 3.—Schematic diagram of the Wadley receiver which uses a single oscillator crystal to achieve frequency stability.

receiver input to prevent spurious responses being troublesome. In addition, it is difficult to reduce cross-modulation at the second mixer unless a third tuning control is used to tune the r.f. amplifier independently of the local oscillator and harmonic generator, and a control for this purpose is in fact fitted. This type of set is not very suitable for rapid searching of a band owing to the number of controls to be adjusted to give the maximum signal. It is therefore more suitable for static use on a fixed communication link.

3. Improvements to Selectivity

3.1. Conventional Circuits

Since the days when the superheterodyne became popular it has been common practice to have most of the frequency selective circuits incorporated in the i.f. amplifier. This was convenient since the high-*Q* tuned circuits formed suitable coupling impedances between the i.f. amplifier valves.

Usually, communication receivers have several degrees of selectivity. The wider bandwidths used for speech reception, etc., are normally obtained by the use of over-coupled tuned circuits, together with a critically coupled circuit to flatten out the response. On cheaper sets, the narrower bandwidth positions are obtained by a reduction of coupling between tuned circuits. The main disadvantage of this method of distri-

buting the selectivity along the i.f. amplifier is that cross-modulation can occur towards the beginning of the chain where the selectivity is not very great.

3.2. Crystal Filters

To overcome this, several communication sets have used a "crystal gate" circuit at the beginning of the i.f. amplifier. These frequently have a phasing control which enables the operator to position the wanted signal to a peak of response, whilst the unwanted adjacent signal is tuned into a trough. As will be seen from the typical curves in Fig. 4, response curves with extremely steep sides can be obtained with these circuits, but a considerable degree of skill is required to obtain the best results, owing to the narrow bandwidths of the peaks. These circuits are not very suitable in receivers which are left unattended for any length of time.

Improved crystal circuits have been fitted to certain military receivers made during and since the war. These have symmetrical characteristics with flat tops and very steep sides approximating to the ideal i.f. amplifier response. A typical example (see Fig. 5) is that of a crystal filter circuit having a bandwidth of 2.5 kc/s centred on 500 kc/s and with a cut-off slope of 20 db per kc/s. Filters can be made with bandwidths between about 500 c/s and 3 kc/s, but design becomes more difficult for wider bandwidths.

3.3. Electromechanical Filters

A recent development in the U.S.A. has been that of the electromechanical filter which uses the principle of magnetostriction. The construction is as shown in Fig. 6, energy being supplied to the input coil which has in its centre a nickel rod.

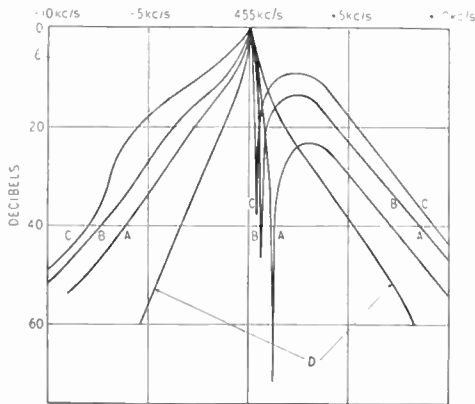

Fig. 4.—I.F. response curves showing the effect of crystal phasing control.

Bandwidth position 1 with crystal phasing at various positions:

- A curve with rejection at +1.2 kc/s.
- B curve with rejection at +600 c/s.
- C curve with rejection at +400 c/s.
- D with crystal phasing control at centre.

Application of an alternating current to the coil causes the nickel to resonate at the frequency of the applied voltage. The nickel is coupled to a series of steel rods and disks, to the other end of which is coupled a second nickel rod surrounded by the output coil. The steel disks are of such dimensions that they resonate mechanically at the frequency of the applied voltage and their mechanical Q is very high. The overall effect is that of a highly selective band-pass circuit similar to that obtained from the crystal filter previously mentioned. It is easier to get a greater bandwidth than with a crystal filter at the same resonant frequency. Furthermore, the size of the electromechanical filter is considerably less than that of the crystal filter with the same performance. There are no electrical circuits which require accurate adjustment, and therefore the whole unit can be hermetically sealed.

Unfortunately, the electromechanical filter has at present several serious disadvantages which preclude its production in any quantity. Firstly, the construction of the filter is inherently fragile as any support between the ends other than that required for the functioning of the device tends to alter the characteristic of the filter. It is thus not suitable for equipments which are subject to vibration or other mechanical shock. There is also danger of the filter being resonated by external sources having harmonics equal to the filter frequency. Secondly, the insertion loss is much higher than that of the equivalent crystal filter, being of the order of 30 db. This, of course, can be overcome by additional amplification, but this tends to offset the small volume of the electromechanical filter. Thirdly, the resonant elements of the filter have to be made with extreme accuracy in order to maintain the characteristic tolerances of the order of ± 0.0001 inch are necessary and it is, of course, very difficult to achieve these by mass-production methods.

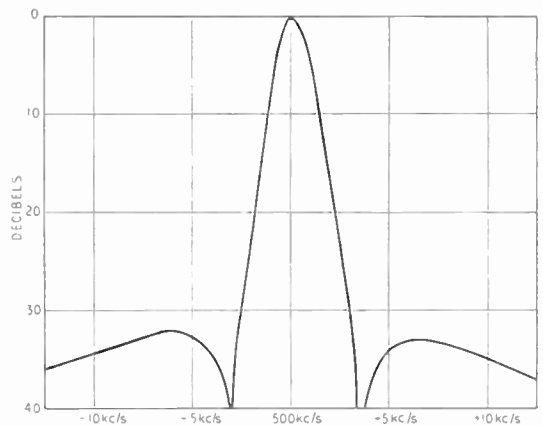

Fig. 5.—Typical response using a bridged-T crystal filter circuit.

A further method of concentrating selectivity at the front of the set is to use a conventional line type of filter, using ferrite inductors to reduce bulk, and following this by an aperiodic i.f. amplifier. This method, however, necessitates a more bulky unit and perhaps is most advantageous at higher frequencies where other methods are at present impracticable and the inductance values required for the filters are low.

4. Useful Sensitivity

As far as receivers designed to cover frequencies below about 30 Mc/s are concerned, no substantial improvement over the performance obtained on pre-war receivers is possible, due to the fact that ultimate useful sensitivity is limited by the noise generated in the first tuned circuit of the receiver. Above 30 Mc/s, however, the noise generated in the first r.f. valve due to shot

The input impedance of a grounded-grid triode is roughly equal to $1/g_m$ and therefore it is possible to connect low-impedance feeders directly into the cathode circuit with little mismatch. In addition to improving the signal-to-noise ratio of the receiver, the grounded-grid triode has the advantage that the anode circuit is not damped so much as it would be if the aerial were coupled directly into the tuned circuit. Using a properly designed grounded-grid input circuit it is possible to obtain noise figures in the region of 4 db at frequencies of the order of 200 Mc/s.

5. Valves and Components

The receiver designer has, of course, to rely on the components and valves available at the time of design. During the war considerable advances were made in the design and construction of components and the standard obtained from manufacturers has been maintained at a high level, due to the fact that, since the war, the Services have insisted on components being subjected to stringent approval tests by a Government establishment prior to their use in Service equipment. At the same time, considerable development to improve the performance and reduce the size of components has been in progress. A good example of this is the reduction in size of paper capacitors used for decoupling purposes. This has enabled manufacturers to construct smaller sets with no degradation of performance.

effect, etc., becomes comparable to the thermal circuit noise and, as the frequency increases, the valve noise has more and more effect on useful sensitivity. This is because at the higher frequencies the dynamic impedance of practical tuned circuits falls off rapidly. At 10 Mc/s dynamic impedances of $50,000\ \Omega$ are readily obtainable, but at 100 Mc/s figures exceeding $5,000\ \Omega$ become difficult to obtain, particularly in receivers having fairly wide band coverages. To increase useful sensitivity at higher frequencies, therefore, it becomes necessary to reduce the noise due to the first valve. Present-day low-noise pentode valves, e.g. the 6AK5, have equivalent noise resistances of the order of $1,000$ to $2,000\ \Omega$. Where the associated grid circuit impedance is less than this, improvements can usually be obtained by using a triode valve which, due to its lack of partition noise, is inherently quieter than the pentode, equivalent noise resistance of the order of 300 or $400\ \Omega$ being obtainable.

It is, of course, impossible to use a triode at these frequencies in a normal circuit, due to the high anode-grid capacitance and it is therefore necessary to use a grounded-grid circuit^{2, 3, 4} in which the input is fed between cathode and earth and output taken in the normal way from the anode load.

As far as improvement in valve design is concerned work has mainly been progressing towards making existing types of valves more reliable, although sub-miniature valves have been developed and are now in considerable use for some purposes. Most manufacturers of communication receivers, however, find that miniature valves, e.g. the B7G series, are quite suitable for their purpose.

6. Mechanical Design

6.1. Frequency Presentation

One of the chief failings of pre-war communication receivers was that they usually had totally inadequate means of frequency presentation. Some of the better sets had arbitrary logging scales incorporated which enabled signals to be tuned to a position previously noted on this scale. The scale usually consisted

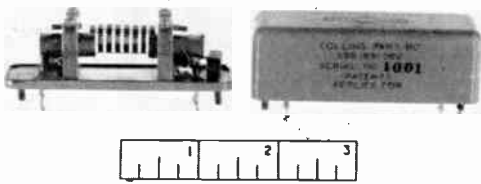

Fig. 6.—Electromechanical filter.

of a dial calibrated in degrees, coupled to the slow-motion dial in such a way that it rotated several times per band. By this means a long effective arbitrarily marked scale was obtained.

With present technique the operator is enabled to tune directly to any frequency with a degree of accuracy sufficient to receive the signal without searching around the point at which it should be

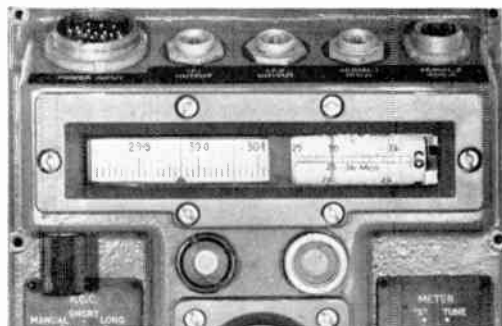

Fig. 7. A modern optical frequency scale.

heard. In order to do this, it is necessary to have a very long scale directly calibrated in frequency. For instance, if 10-kc/s channels are to be resolved on a 15 to 25 Mc/s band, the scale must be divisible into 1,000 divisions. Assuming a 0.1-in channel separation, this means that a scale length of 100 in is necessary. It is to be noted that this is for one band of the receiver only. This scale length can be obtained either by using a film strip with the frequency bands marked in parallel or by using an optical magnification system. Both these methods are in use on present-day British equipment. With the optical system it is possible to eliminate errors due to back-lash in the gearing by mounting the tuning scale directly on the oscillator capacitor shaft. Fig. 7 shows a close-up view of an optical scale fitted to a post-war British Army receiver. On the left is the optical scale, with a coarse tuning scale on the right to assist the operator when tuning rapidly over the band. The tuning scale consists of a circular piece of transparent material on which scales are photo-etched. Light from a bulb illuminates the appropriate scale and an image of this scale is formed at a distance on a ground-glass screen by means of a small lens. Magnifications up to 15 times are readily obtainable whilst still obtaining fairly

bright illumination on the ground-glass screen from a bulb of only a few watts.

With the film scale it is necessary to keep back-lash between the scale and the tuning element down to a minimum, otherwise errors will be apparent on the scale. This is best achieved by using the smallest amount of gearing and spring-loading that which is necessary. In a typical British Army receiver using this system the tuning control drives, via bevel gearing, a vertical shaft bearing on its upper end a sprocket wheel and on its lower a worm wheel. The worm wheel engages with a pinion wheel mounted directly on the oscillator capacitor shaft. This latter wheel is spring-loaded and the amount of back-lash noticeable when using a film length of 4 ft is less than 1 mm. The film is contained on two spools which are spring-loaded against each other by a constant tension. The film goes from one spool around the sprocket previously mentioned, across the scale window and around a toothless sprocket, back on to the other spool. The scale illustrated in Fig. 8 uses a 4 ft length of 70-mm film and has seven scales engraved in parallel on it.

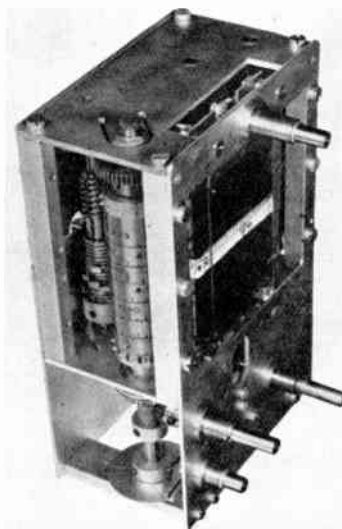

Fig. 8.—Tuning control using a film scale.

It is, of course, necessary to use tuning elements which have a high degree of resetting accuracy. The capacitor used in the set mentioned above has a resetting accuracy of about 2 minutes of

arc. A variable capacitor produced by Mullard has an even higher resetting accuracy and has been used in the set with the optical scale illustrated in Figs. 1 and 7.

Where a receiver has to be used in extreme climatic conditions, it is necessary that any small amount of frequency drift due to temperature changes should be compensated for. Most modern sets, therefore, have an internal crystal calibrator incorporated working at 100 kc/s or multiples thereof. Output from this calibrator is

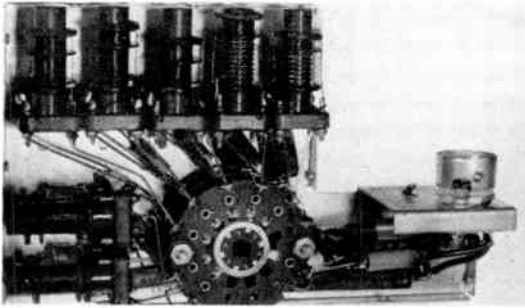

Fig. 9.—A compact coil assembly using a wafer switch.

fed into the r.f. stages of the receiver and with the receiver adjusted for c.w. reception, signals can be heard at every 100 kc/s throughout the band. Usually an adjustable cursor is fitted which can be set to the point corresponding to the appropriate signal. The scale around this point will then be accurately calibrated.

So far, the frequency scales discussed have been for use in sets employing conventional super-heterodyne circuits, where the frequency law is not necessarily a linear one. In circuits such as the Wadley, however, or where all the tuning elements have a straight-line frequency characteristic, it is possible to use "speed counter" dials calibrated in kilocycles or multiples thereof. The frequency required is then obtained by setting the indicators to the correct frequency by means of the tuning controls. For instance, the first control would be set to the nearest 100 kc/s figure and the second control to the nearest kc/s. This type of presentation takes up very little panel space and there is no ambiguity as to the frequency to which the set is tuned.

6.2. Band Switching

Communication receivers normally have to cover large frequency ranges and it is necessary to split the ranges into several bands. In order to do this some type of r.f. switching must be used. The oscillator section of the switch is more critical than that of the r.f. section: it must have a low capacitance and contact resistance, the resetting accuracy must be of a high order and the switch should be positive in action. The wafer-type switch which has been used for many years is usually satisfactory up to about 20 Mc/s where lead lengths do not form a considerable part of the oscillator inductance. It has the advantage that it can be built into a compact coil sub-assembly, an example of this being shown in Fig. 9. The star-type click mechanism gives positive and accurate location of the rotating contacts. Silver-plated contacts are used which have a low resistance and are self-cleaning.

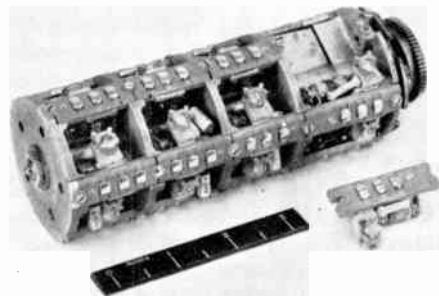

Fig. 10.—Coil assembly of the turret type.

At higher frequencies where the connecting wires form a considerable part of the circuit inductance, turret switches are frequently used. In these the fixed contacts can be adjacent to the associated valve and by rotation of the switch, the appropriate tuned circuit can be brought up to the fixed contacts, thus reducing the total stray inductance. A British military receiver operating in the v.h.f. band uses the turret illustrated in Fig. 10. The moving contacts are rhodium plated and the fixed contacts have platinum points. Single ball bearings are used to obtain accurate alignment and resetability. The click mechanism consists of a spring-loaded roller which locates in a V-groove at each of the switching positions.

7. Future Developments

The present-day communication receiver is, on the whole, satisfactory for the work for which it is intended. Little improvement appears to be necessary as regards electrical performance; the limit of sensitivity has long been reached and almost ideal response curves can be obtained by using crystal filters. Although these may eventually be replaced by the electromechanical type, as has already been mentioned, considerable development is still required on these. Any further improvements in communication receivers will probably be in technique rather than in the improvement of performance. Several firms are now developing printed circuits⁵ and, although these have obvious limitations, they are applicable to i.f. and audio circuits to a certain extent. For large-quantity production there is considerable saving in cost due to the saving of time which is usually spent in wiring, checking and "trouble-shooting." Once the initial design work has been completed more repeatable performance will be obtainable than with conventional wired equipment, since variations are almost non-existent.

A revolutionary development which will eventually affect receiver design is that of the transistor to replace the thermionic valve. This requires no heater and when used as a voltage amplifier the power dissipated is only a few milliwatts. Since considerable power in the thermionic valve is wasted in heating, the use of transistors will greatly reduce temperature rise in equipment with a consequent reduction of frequency drift. At present, transistors available in this country are only suitable for use in audio and video circuits, although considerable development work, which is going on at present, will ultimately result in transistors with a higher working frequency. Transistors are not very suitable as replacements for valves in conventional i.f. amplifiers, since they have low input

impedances of a few hundred ohms. They would be more suitable, however, in aperiodic amplifiers with concentrated selectivity such as crystal or electromechanical filters. Germanium transistors, which are at present the only ones commercially available in this country, are considerably affected by temperature, but eventually, by the use of silicon in place of germanium, temperature effects will probably be eliminated. Although transistor development is still in an early stage, it is quite likely that eventually it will be possible to design communication receivers with transistors replacing thermionic valves throughout.

8. Acknowledgment

The author wishes to express his thanks to Mr. E. Forster, Superintendent, Radio Division, S.R.D.E., for advice on the preparation of the paper and to the Ministry of Supply for permission to publish it.

9. References

1. T. L. Wadley, "Variable-frequency crystal-controlled receivers and generators," *Trans S. African Inst. Elect. Engrs*, **45**, pp. 77-90, February 1954.
2. R. E. Burgess, "Signal/noise characteristics of triode input circuits," *Wireless Engineer*, **22**, pp. 56-61, February 1945.
3. Milton Dishal, "Theoretical gain and signal-to-noise ratio of the grounded-grid triode at ultra-high frequencies," *Proc. Inst. Radio Engrs*, **32**, pp. 276-284, May 1944.
4. M. C. Jones, "Grounded-grid radio-frequency voltage amplifiers," *Proc. Inst. Radio Engrs*, **32**, pp. 423-429, July 1944.
5. P. Eisler, "Printed circuits: some general principles and applications of the foil technique," *J. Brit.I.R.E.*, **13**, pp. 523-538, November 1953.