

JOURNAL OF The British Institution of Radio Engineers

(FOUNDED IN 1925—INCORPORATED IN 1932)

*“To promote the advancement of radio, electronics and kindred subjects
by the exchange of information in these branches of engineering.”*

Vol. XIV. No. 5

MAY 1954

THE CLARENDON LABORATORY—OXFORD

The original Clarendon Laboratory was built in 1872 and was the first laboratory in the world especially designed for the study of physics; the building has now been embodied in the Geology Department.

The present Clarendon Laboratory was completed in 1940 and in 1946 the Electrical Laboratory (built in 1910) was joined to it and a further extension added.

The main subjects of research carried on in the Laboratory are nuclear physics and low temperature physics. There is now accommodation for some sixty Degree students per year.

All the meetings of the 1954 Convention will take place in the Lecture Theatre of the Clarendon Laboratory or in one of the Lecture Rooms of the adjoining Electrical Laboratory.

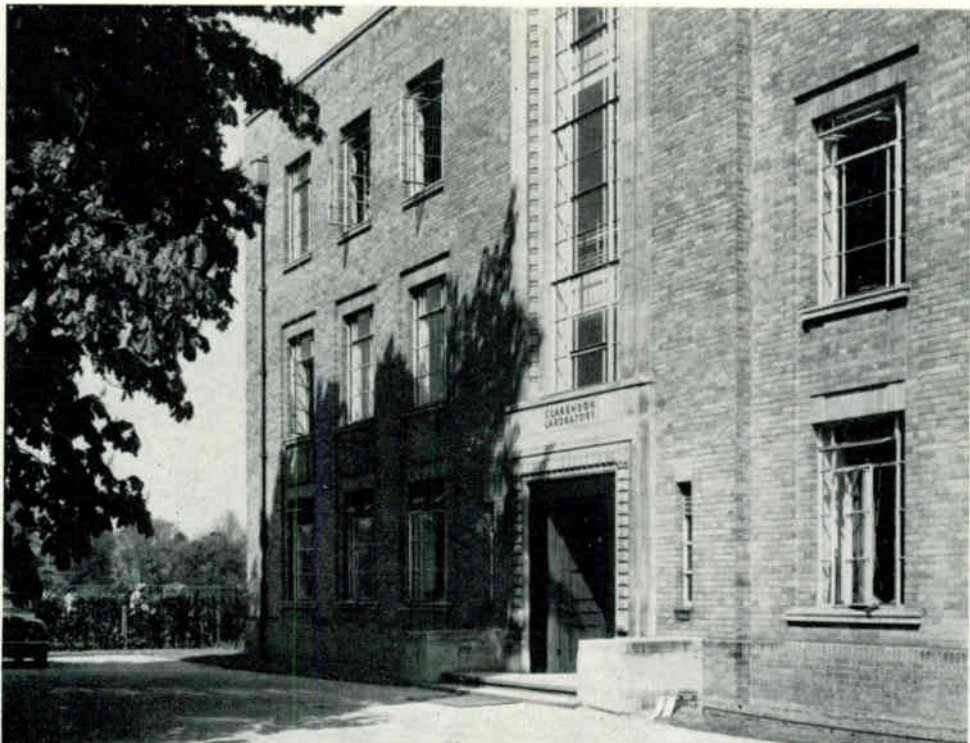

Photograph by courtesy of A. J. Croft, Esq.

CLARENDON LABORATORY—MAIN ENTRANCE

INDUSTRIAL ELECTRONICS CONVENTION TIME-TABLE

THURSDAY, JULY 8

2 p.m. In the Clarendon Laboratory Lecture Theatre
Opening address by the President, Mr. W. E. Miller,
M.A.(Cantab)

SESSION 1—INDUSTRIAL APPLICATIONS OF ELECTRONIC COMPUTORS

2.30 p.m. Presentation of papers

4 p.m. Tea and light refreshments

4.15 p.m. Discussion of papers

6.30 p.m. Dinner

7.45 for 8 p.m. In the Clarendon Laboratory Lecture
Theatre

The Second Clerk Maxwell Memorial Lecture
by Sir John Cockcroft, K.C.B., C.B.E., F.R.S.

FRIDAY, JULY 9

9.15 a.m. Assemble in the Electrical Engineering
Laboratory Lecture Theatre

SESSION 2—INDUSTRIAL APPLICATIONS OF X-RAYS AND SONICS

9.30 a.m. Presentation of papers

11 a.m. Coffee and light refreshments

11.15 a.m. Discussion of papers

1 p.m. Lunch

2.15 p.m. Assemble in Electrical Engineering Labora-
tory Lecture Theatre

SESSION 3—NUCLEONIC INSTRUMENTATION AND APPLICATION

2.30 p.m. Presentation of papers

4 p.m. Tea and light refreshments

4.15 p.m. Discussion of papers

7.30 for 8 p.m. Institution Banquet in Hall
at Christ Church

SATURDAY, JULY 10

9.15 a.m. Assemble in the Electrical Engineering
Laboratory Lecture Theatre

SESSION 4—ELECTRONIC SENSING DEVICES (TRANSDUCERS)

9.30 a.m. Presentation of papers

11 a.m. Coffee and light refreshments

11.15 a.m. Discussion of papers

1 p.m. Lunch

2.15 p.m. Assemble in the Electrical Engineering
Laboratory Lecture Theatre

SESSION 5—PROCESS CONTROL

2.30 p.m. Presentation of papers

4 p.m. Tea and light refreshments

4.15 p.m. Discussion of papers

7 p.m. Dinner

SUNDAY, JULY 11

Morning Service in Christ Church

1 p.m. Lunch

3 p.m. Conference of Local Section representatives

5.15 p.m. Assemble in Clarendon Laboratory Lecture
Theatre

SESSION 6—ELECTRONIC AIDS TO PRODUCTION

5.30 p.m. Discussion "How Electronics can Increase
Production"

Supported by several short papers

8 p.m. Supper in Hall, Christ Church

MONDAY, JULY 12

Visits to industrial and research organizations,
including the Atomic Energy Research Establishment,
Harwell, will be arranged.

In addition to the above time-table, programmes of films on appropriate topics will be screened during the latter part of the evening on Saturday and Sunday.

Group Discussions, to be organized by the Chairmen as required, will take place in Christ Church.

Tickets for admission to the various sessions will be sent before the start of the Convention to those registering; members wishing to invite guests to the Clerk Maxwell Lecture or the Institution Banquet should apply for tickets beforehand to the Institution Offices in London, as accommodation will be limited.

The cost of tickets for the Banquet will be 2 guineas for those not in residence at Christ Church.

Application to take part in visits should be made to the Convention Registration Office in Christ Church immediately on arrival. The visits will only be open to those attending the Convention.

A CRITICAL REVIEW OF SYNCHRONIZING SEPARATORS WITH PARTICULAR REFERENCE TO CORRECT INTERLACING*

by

G. N. Patchett, Ph.D., B.Sc. (Member)†

Read before the Merseyside Section of the Institution on January 7th, 1954

SUMMARY

Modern systems of television use interlaced scanning systems in order to reduce the bandwidth required but difficulties occur in obtaining a correctly interlaced picture on a receiver. Various common synchronizing separator circuits are reviewed with particular reference to interlacing and it is shown why many circuits do not result in a correctly interlaced picture. A number of circuits are then described which produce correct interlace.

1. Introduction

All modern television standards (British 405 lines, American 525 lines, Continental 625 lines and French 819 lines)¹ are 2/1 interlaced systems. In theory, it should be an easy matter to design a receiver which will produce a correctly interlaced picture, but unfortunately, in practice, this does not appear to be the case. In the author's experience few receivers produce a really correctly interlaced picture, and the cause of many of the complaints of "lininess" of a 405-line picture is incorrect interlace. If the picture is correctly interlaced the two sets of lines (one belonging to each frame) should fit between each other and be *exactly* equally spaced.

One would expect that a receiver would interlace correctly or show complete lack of interlace; however, in practice, most sets attempt to interlace but the lines are not equally spaced.

2. Effect of Incorrect Interlace

It might appear at first sight that a small deviation of the lines from equal spacing would not be noticeable. It is surprising what a difference a small error in the spacing does make to the visibility of the lines. In Fig. 1a is drawn a set of lines

corresponding to a correctly interlaced picture, the width of the line being taken as 70 per cent. of the total space between lines, leaving 30

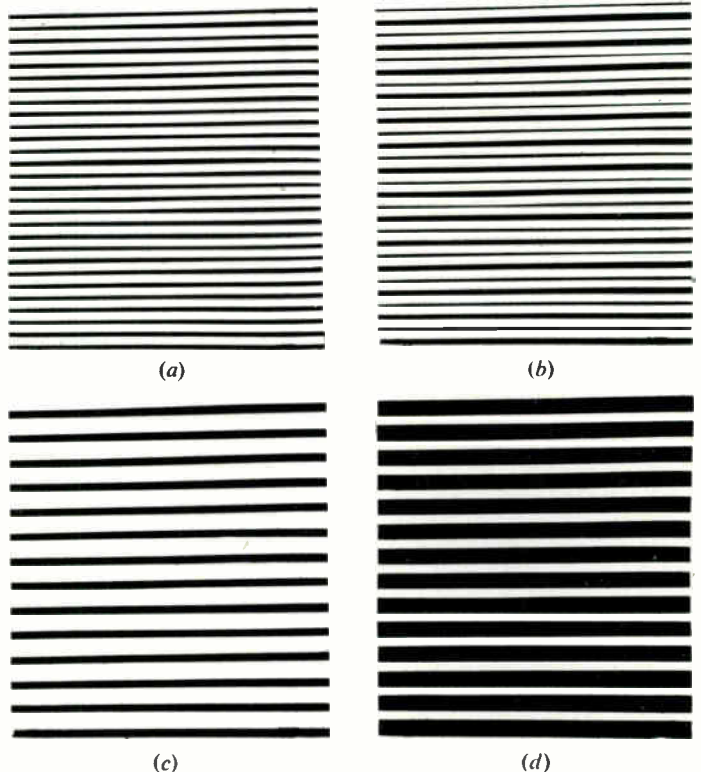

Fig. 1.—Drawing showing the importance of correct interlace.

- (a) Correct interlace.
- (b) Approximately 20 per cent. from correct interlace.
- (c) Approximately 30 per cent. from correct interlace.
- (d) Complete lack of interlace.

* Manuscript first received on December 3rd, 1953, and in final form on March 15th, 1954. (Paper No. 262.)

† Bradford Technical College.

U.D.C. No. 621.397.335.

per cent. dark portion between the lines. This is probably of the correct order for a 12-in tube. Fig. 1b shows the effect of moving one set of lines so that they are approximately 20 per cent. out-of-correct interlace. This reduces one space from 30 per cent. to 10 per cent. of the total (i.e., a reduction of 67 per cent.) and increases the other space from 30 per cent. to 50 per cent. (i.e., an increase of 67 per cent.). If these two figures are examined at a suitable distance (they correspond to a height of approximately $\frac{1}{2}$ in on a 12-in tube) there is little doubt that the lines on (b) are considerably more pronounced than on (a). If the lines are moved so that they correspond to 30 per cent. out-of-correct interlace the result is shown in Fig. 1c. In this case the lines touch and the space on the opposite side is increased from 30 per cent. to 60 per cent. (i.e., an increase of 100 per cent.) and the lines become much more pronounced. If no interlace takes place the result is as shown in Fig. 1d.

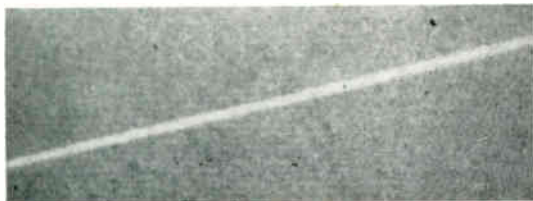

(a) Correct interlace.



(b) No interlace.

Fig. 2.—Photographs showing the effect of lack interlace on unmodulated raster.

In Fig. 2 is shown a portion of a synchronized but unmodulated raster on a 12-in tube, (a) showing the effect of correct interlace and (b) of no interlace. In both cases the exposure, brilliance and focus settings were identical. Photographs of a portion of a test pattern are shown in Fig. 3, (a) being a correctly interlaced raster and (b) a raster with little interlace. The

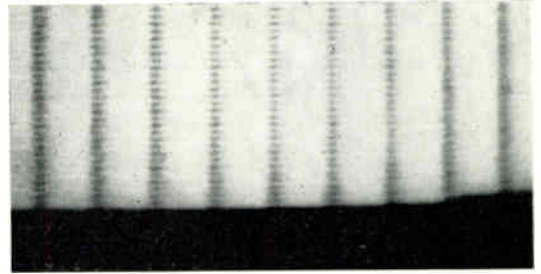

(a) Correct interlace.

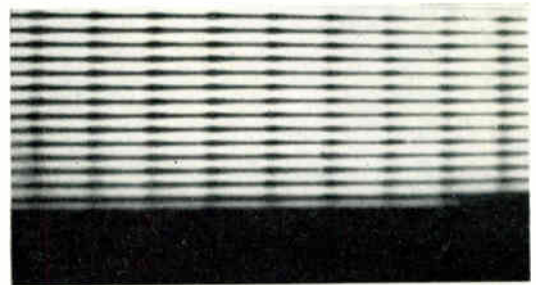

(b) Little interlace.

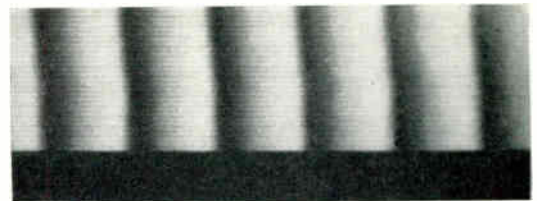

(c) Perfect interlace.

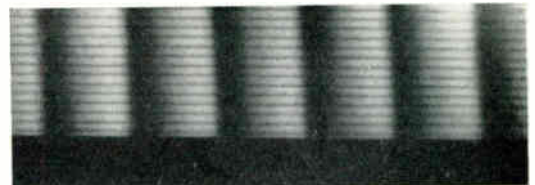

(d) Approximately 20 per cent. from correct interlace.
Fig. 3.—Photographs showing the effect of interlace on portion of test pattern.

only difference in this case was a change in the frequency setting of the time base. Fig. 3c shows an absolutely correctly interlaced picture while that of 3d shows pairing. The error in case (d) is quite small, being of the order of 20 per cent., but the difference between the two is quite obvious. As we have seen, the effect of

incorrect interlace is to increase the "lininess" of the picture very considerably, but it also reduces the definition of the picture, the result of complete lack of interlace being worse than a 202-line picture. This is due to the fact that the two sets of lines which are superimposed on one another are not identical.

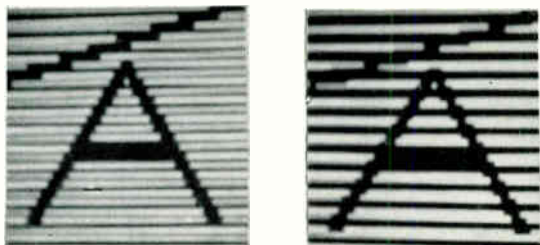

(a) *Approximately correct interlace.*

(b) *60 per cent. out of interlace.*

(c) *No interlace.*

(d) *One frame only.*

Fig. 4.—Photographs showing the effect of interlace on definition.

The effect is shown artificially in Fig. 4. These photographs were obtained by making two slides, one with lines corresponding to the even frame and the other with lines corresponding to the odd frame. The two slides were then projected from two lanterns on to a screen and superimposed in their correct positions. Fig. 4a shows approximately correct interlace, (b) approximately 60 per cent. out of interlace and (c) complete lack of interlace. It will be noted that as we go from (a) to (c) the definition of the sloping bars becomes poorer, the width of the bar being reduced due to the overlapping of one frame on the other. (c) gives the impression of the sloping bars being out of focus as the edges change in brilliance in two steps. (d) shows the lines of one frame only where the definition is rather better than (c) but, of course, much worse than (a). These figures correspond to approximately a $\frac{1}{2}$ -in square on a 12-in tube.

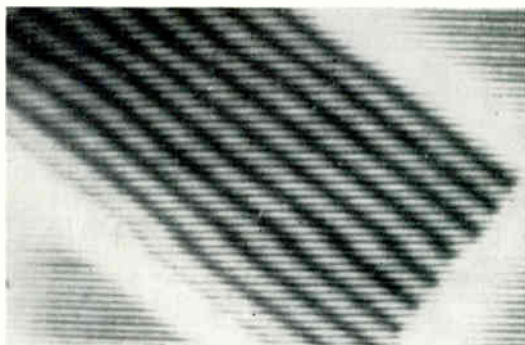

(a) *Correct interlace.*

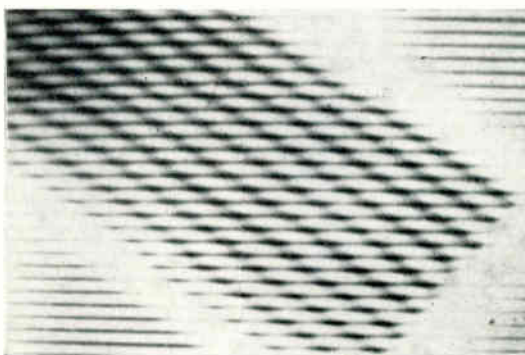

(b) *Partial interlace (approximately 30 per cent. from correct interlace).*

Fig. 5.—Photographs showing the effect of interlace on definition.

In Fig. 5 is shown photographs of the corner of test Card C taken from a receiver with a 12-in tube. (a) is with correct interlace and (b) is with an interlace error of approximately 30 per cent. In case (b) not only are the lines more obvious, but the definition is reduced, the diagonal bars being clearer in (a). This is due to the overlapping of the two sets of lines in a similar manner to Fig. 4.

3. Problem of Interlacing

The synchronizing of the line time-base from the line synchronizing pulses is comparatively easy and will not be considered further. The accurate synchronizing of the frame time-base to the frame synchronizing pulses is a much more difficult problem. The only difference between line and frame synchronizing pulses is that of time duration. In the B.B.C. signal the line

pulses have a length of 1/10th of a line or 10 μ sec (taking round figures) and the frame pulses have a length of 2/5th of a line or 40 μ sec. The frame synchronizing period consists of eight frame pulses extending over four lines at the end of each frame. At the end of the even frame the pulses start at the end of a line, while on the odd frame the pulses must start half-way along a line. In Fig. 6 is shown, at (a) and (d), the line pulses only, and at (b) and (e) the frame pulses only, correctly placed relative to the line pulses, on odd (d and e) and even (a and b) frames. The actual signal transmitted is the composite pulse waveform as shown in (c) and (f). This consists of the addition of the line and frame pulses, with the line pulses suppressed during the period of the frame pulses.

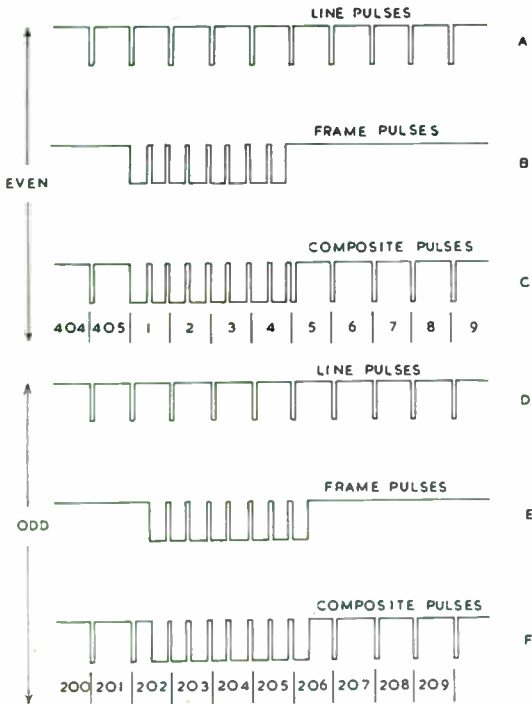

Fig. 6.—Waveforms during frame synchronizing period.

For correct interlace it is essential that the time base be either synchronized to the leading edge of the first frame pulse (not a practical proposition) or, with a *fixed* time delay from this leading edge which must be *identical* on odd

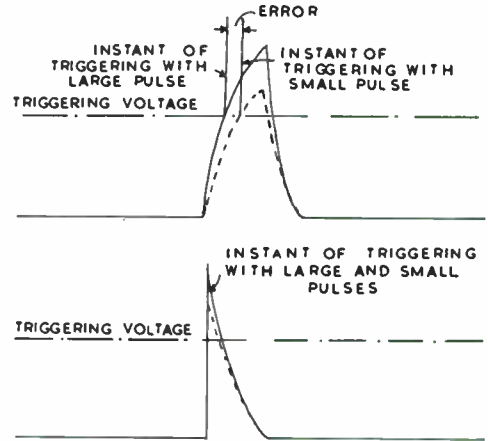

Fig. 7.—Diagram showing the synchronizing error produced by a pulse without a sharp leading edge.

and even frames. The purpose of the frame synchronizing separator is to produce a suitable triggering pulse, related in this way to the train of frame pulses. This triggering pulse should have a sharp leading edge in order to obtain accurate synchronizing. The reason for this is shown in Fig. 7.

3.1. Accuracy of Synchronizing Required

Before going further let us consider the accuracy of synchronizing required for the frame time-base. Suppose that we consider that the interlace should be correct to 10 per cent. With this error the time base would be triggered 1/10th of $\frac{1}{2}$ a line (5 μ sec) late or early. The time of one frame is 20,000 μ sec and the allowable error is, therefore, only 0.025 per cent., an extremely small percentage.

3.2. Methods of Checking Interlace

It is often stated that so long as the time base is triggered correctly, say by the sharp leading edge of a pulse, correct interlace will result. This, as will be shown later, is quite incorrect. One method of checking interlace often suggested is to turn up the brilliance until the flyback lines are visible and note whether there are two sets of flyback lines, starting one half line apart. This, of course, only checks that the flyback is interlaced and does *not* guarantee that the scan is correctly interlaced.

Figure 8 shows two photographs of a synchronized raster (without modulation) on a

cathode-ray oscillograph connected to the line and frame time-bases (X to frame and Y to line). (a) is a corrected interlaced raster and (b) a non-interlaced raster. It will be noted that in both cases the flybacks are identical and correctly interlaced, there being two flybacks spaced approximately half a line apart, but only in case (a) is the scan interlaced. In most cases it has been found that the time base interlaces correctly on flyback but not on scan.

One convenient method of checking interlace is to connect an oscillograph in the manner in which Fig. 8 was obtained and, by expanding the X trace, it is easy to see if the lines are equally spaced. This may also be seen on the screen of the set, particularly if the frame amplitude is increased so as to increase the line spacing. On experimental work on time bases it is not always convenient to have a line time-base in operation, and instead of connecting the Y plates to a line time-base they are connected to the video signal (or composite synchronizing pulses only). In this case interlace may easily be checked by noting whether there are two sets of line pulses and that these are equally spaced.

4. Synchronizing to Ideal Pulses

In order to find out the cause of incorrect interlace it was decided to see whether frame time-bases would interlace correctly if synchronized from ideal pulses, which are identical on odd and even frames. Such pulses were obtained from a pattern generator, being square and four lines long, corresponding to the eight half line pulses. Various types of blocking oscillator circuits, a thyatron, a transitron Miller integrator and a multivibrator time-base were tried. In all cases perfect interlace was obtained and it was impossible to obtain partial interlace, the time bases either interlacing correctly or pulling out of step.

It has been suggested^{2,3,4} that the lack of interlace is due to the amplitudes of alternate frame flyback strokes not being equal, but the author has not come across this phenomena when time bases are synchronized by ideal pulses. Since the time bases interlaced correctly on ideal pulses it would appear that the fault is not due to the time base itself but due to the method of synchronizing. Means of limiting the flyback as have been suggested³ do not therefore seem to be the correct solution.

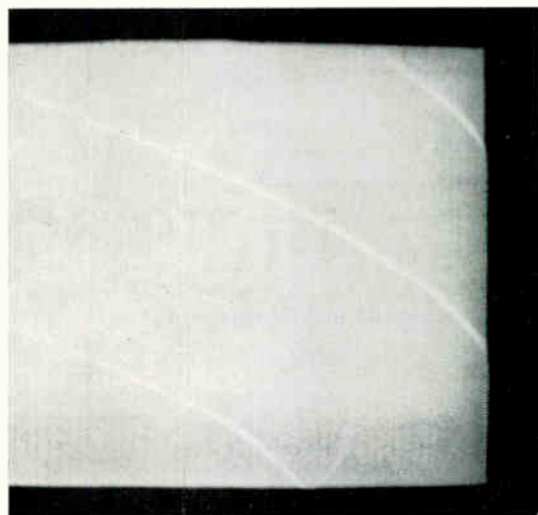

(a)

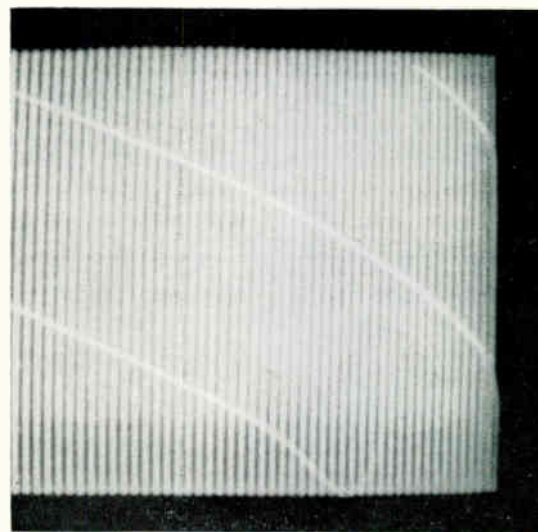

(b)

Fig. 8.—Photographs showing:—
(a) Interlaced scan and flyback. (b) Interlaced flyback but not scan.

The problem was, therefore, to determine why the time base fails to interlace when using a synchronizing separator. There are, of course, a large number of time-base and synchronizing separator circuits, and, in general, the experimental work in this paper has been limited to the thyatron and blocking oscillator types of

time base, although the general conclusions apply equally well to other types of time base. Where a certain combination of synchronizing separator and time base is stated to produce poor interlace it must be understood that the author does not imply that it is not possible to get this combination to interlace correctly. The component values and operating conditions are so variable that satisfactory results may be obtained under certain conditions.

5. Frame Synchronizing Separators

5.1. The Differentiating Circuit

The pulses are fed to a partial differentiating circuit having a time constant of about 40 μ sec; the effect is shown in Fig. 9, (a) being

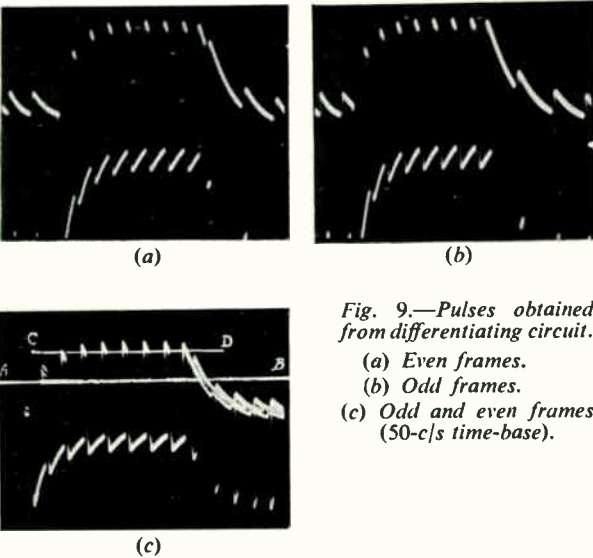

Fig. 9.—Pulses obtained from differentiating circuit.
 (a) Even frames.
 (b) Odd frames.
 (c) Odd and even frames (50-c/s time-base).

for even frames and (b) for odd frames. These oscillograms have been obtained on a special waveform display apparatus,⁵ the time-base repetition rate being 25 c/s. Fig. 9c shows the superimposition of the two sets of pulses using a special triggered time-base with a repetition rate of 50 c/s. Since large negative-going line pulses are present it is normally necessary to use a limiter to remove these line pulses by cutting off all below, say, a line AB.

There are three important points about the output of this circuit:—

- (a) Each pulse has a sharp leading edge which corresponds to the back edge of the frame synchronizing pulse and therefore occurs in both odd and even frames with a fixed time delay from the start of the first frame pulse.
- (b) There is a small difference in the height of the pulses on odd and even frames (see Fig. 9c) due to the different charge remaining on the capacitor at the start of the train of frame pulses. This is caused by the fact that on even frames there is 90 μ sec between the end of the last line pulse and the start of the frame pulses while on odd frames there is only 40 μ sec (see Fig. 6). This difference, although small, may cause trouble, as will be shown later.
- (c) The end of the train of pulses is different on odd and even frames, due to the differences which exist in the composite pulses as shown in Fig. 6c and f. Although this will not affect the triggering of the time base it may be vitally important to the correct interlacing during the scan, as will be seen later.

When this circuit was used to feed thyratron and blocking oscillator time-bases, proper interlace did not occur unless the limiter and time-base controls were adjusted very carefully. The problem was to find out why.

5.1.1. Blocking-Oscillator Type of Time Base

The circuit of the blocking oscillator used in these tests is shown in Fig. 10 and is fairly conventional. The differentiated waveform, as shown in Fig. 9, was fed to a limiter in order to remove the line pulses. The resultant train of frame pulses, being negative (due to phase reversal in the limiter), was fed into the anode circuit of the blocking oscillator time-base. It was found that nearly any degree of interlace could be obtained depending on the setting of the limiter, time-base frequency control, magnitude of pulses fed to the limiter and h.t. supply. When adjusted so that the interlace was poor the circuit appeared reasonably stable, the actual degree of interlace remaining practically constant.

To find out the cause of this, a special time-

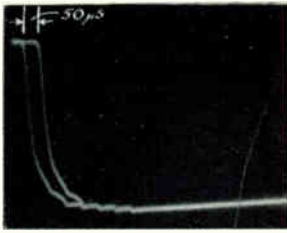

(a)

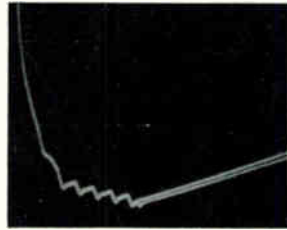

(b)

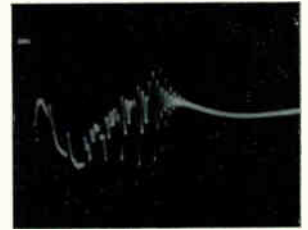

(c)

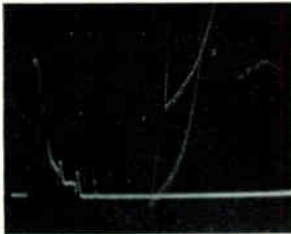

(d)

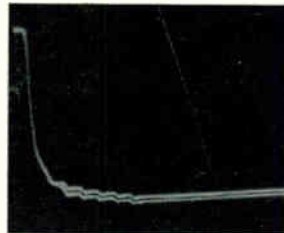

(e)

Fig. 11.—Oscillograms during flyback of blocking oscillator time-base.

- (a) and (b) Output voltage.
- (c) Anode voltage.
- (d) Cathode current.
- (e) Output voltage.

base⁵ was constructed which was accurately synchronized to 50-c/s pulses from the pattern generator feeding the synchronizing separator. The flyback and start of scan of the blocking oscillator time-base were examined on this apparatus, and, since the repetition rate was 50 c/s, the flybacks on odd and even frames were superimposed, and differences could easily be detected. When using this apparatus it was soon found that lack of interlace could occur for a number of reasons:—

Fig. 10.—Circuit of blocking oscillator time-base.

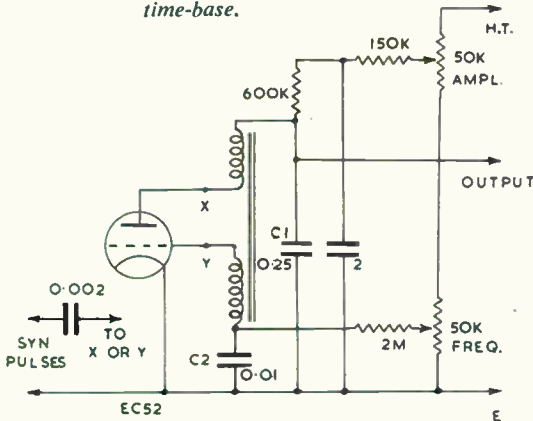

- (a) Due to the time base being triggered by different frame pulses on odd and even frames. It will be seen from Fig. 9 that the positive-going pulses are not exactly the same amplitude on odd and even frames. Fig. 11a shows the flyback of the time base when failure to interlace is due to this cause. It will be noted that there are two distinct flybacks (50 μsec apart) resulting in two different scans. It would appear that this would result in complete lack of interlace, but, in practice, this was often not found to be the case as partial correction occurs due to the second cause described below.
- (b) Due to the differences which are present at the end of the train of frame pulses. An oscillogram of the flyback under these conditions is shown in Fig. 11b, where the vertical scale is approximately double that of 11a, so that the end of the flyback period is more visible. It will now be noted that there is only one flyback, indicating that the time base is triggered at the same instant on odd and even frames. At the end of the train of frame pulses two traces are produced, meaning that the two scans are slightly displaced and the lines are not correctly interlaced. The "notches" in the waveform are

produced by the pulses from the differentiating circuit, and, since they are not identical on odd and even frames, cause the two traces on the scan.

The effect on the anode voltage of the time base is shown in Fig. 11c, where again it will be seen that two distinct traces are produced. The blocking oscillator only conducts for about four pulses (2 lines) as can be seen by the oscillogram of the cathode current shown in Fig. 11d. After this the blocking oscillator transformer is forced into damped oscillation by the synchronizing pulses. Correct interlace may be obtained by increasing the limiting (line CD on Fig. 9) so that the differences on odd and even frames do not pass the limiter. This setting is critical and of little use in practice. This appears to be the most common reason for failure to interlace.

(c) Due to the effect shown in Fig. 11e. In this case the flybacks are identical on both frames but it would appear that, due to the slight differences in the pulses fed to the anode, the valve ceases to conduct at a different instant.

5.1.2. Thyatron Type of Time Base

The circuit of the thyatron time-base used in these tests is shown in Fig. 12. This time base was fed with the same pulses from the differentiating circuit and limiter but a phase reverser, with unity gain, was added as positive pulses are required on the grid of the thyatron. It was found that failure to interlace was due to :—

- (a) Differences in the instant of triggering due to the slight differences in the heights of the pulses on odd and even frames. An oscillogram showing this is reproduced in Fig. 13a.
- (b) Differences at the ends of the trains of frame pulses. Two oscillograms showing the effect are reproduced in Fig. 13b and c where it will be noted that there is only one flyback but, at the end of the train of frame pulses, two scans are produced. In the case of the blocking oscillator it is easy to see how some of the synchronizing pulses are present on the output waveform as there is a direct connection (through the transformer) between the synchronizing point (the anode) and the output. With a thyatron there is no such connection and it is not easy to see how the

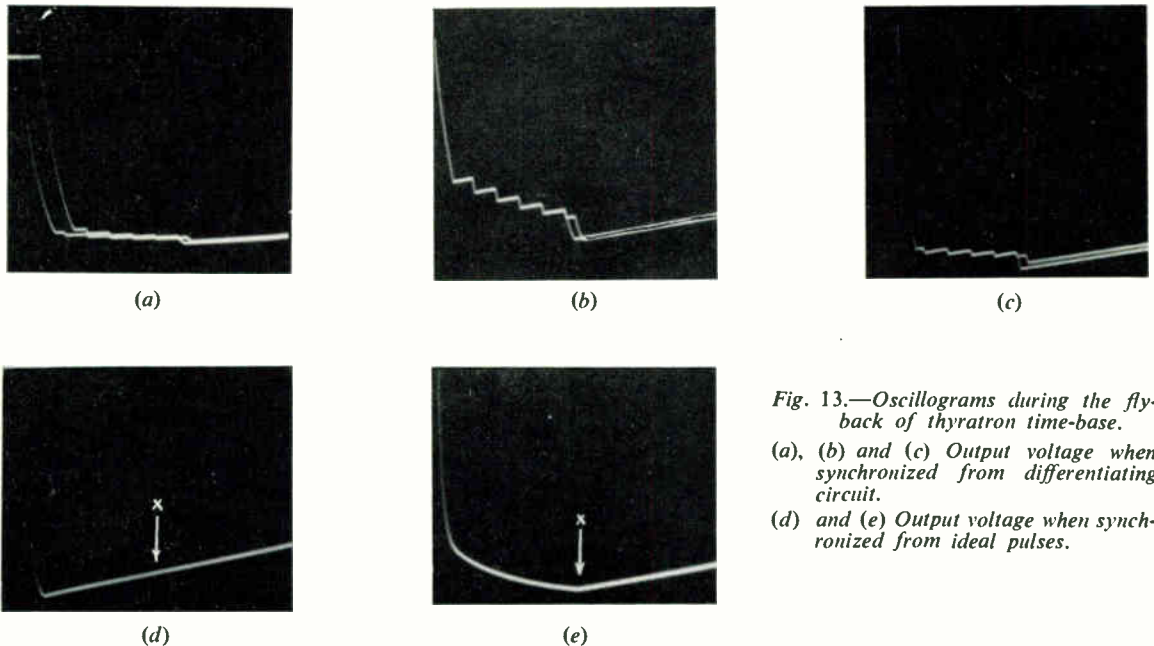

Fig. 13.—Oscillograms during the fly-back of thyatron time-base.
 (a), (b) and (c) Output voltage when synchronized from differentiating circuit.
 (d) and (e) Output voltage when synchronized from ideal pulses.

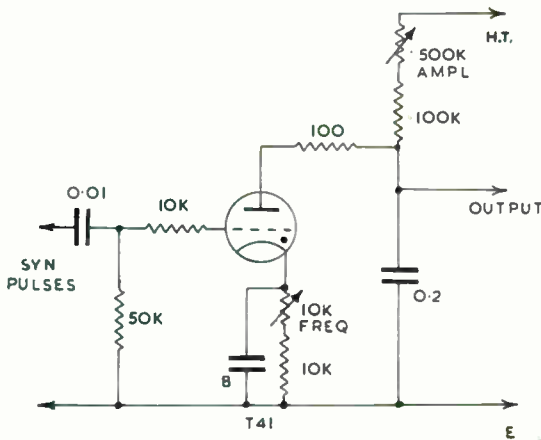

Fig. 12.—Circuit of thyatron time-base.

synchronizing pulse waveform is reproduced in the output waveform, particularly in view of the fact that, in this case, in the absence of synchronizing pulses the flyback was completed long before the end of the train of frame pulses. With a small ideal pulse of 20 V peak applied to the grid the output waveform was as shown in Fig. 13d, where it will be noted that the flyback is completed long before the end of the pulse, which occurs at point X. With a pulse of approximately 120 V peak the output waveform is as shown in Fig. 13e, where it will be noted that the valve is maintained in a conducting state, by a discharge between grid and cathode. Any variations in the pulse (as in the case of the differentiating circuit) will cause variations in the conditions at the anode, and therefore in the output. It will be noted that in the case of the large pulse the flyback is terminated by the end of the pulse. The effect of the differences in the train of frame pulses on odd and even frames may therefore be reduced by decreasing the magnitude of the pulses, but this makes the time base critical to frequency setting.

Although the differentiating circuit has the advantage of a sharp leading edge it is seen that it is no guarantee that correct interlace will result and, in general, the arrangement is not satisfactory.

5.2. Integrator Type of Synchronizing Separator

Probably the most common type of frame synchronizing separator is the integrator circuit, having a time constant of about 40 μ sec. In Fig. 14a and b are shown the effect of integrating the frame and line pulses around the frame pulse period. (a) shows the result on even frames and (b) on odd frames, these oscillograms being taken with a 25-c/s time-base. Fig. 14c shows the effect on a 50-c/s time-base; here pulses on odd and even frames are superimposed.

Three important factors should be noted about these waveforms:—

- (a) There is no sharp leading edge to the pulse, the curvature of the leading edge

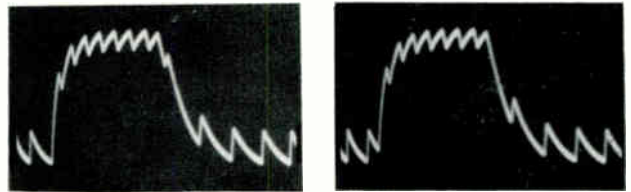

(a) (b)

Fig. 14.—Oscillograms showing the effect of integrating the line and frame pulses.

- (a) Even frames.
- (b) Odd frames.
- (c) Odd and even frames (50-c/s time-base).

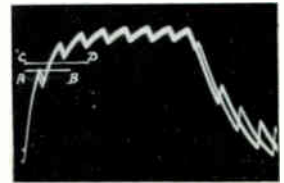

(c)

depending on the time constant of the integrating circuit.

- (b) The start of the pulse is not the same on odd and even frames. The reason for this difference is explained in section 5.1 and it can be seen in Fig. 14c that one waveform is lifted up relative to the other.
- (c) The end of the pulse is very different on odd and even frames due to the differences which occur at the end of the train of frame pulses (see Fig. 6). This will not, of course, alter the triggering of the time base which is controlled by the leading edge, but it is very important as regards interlacing on scan, as will be shown later.

When this circuit was used to synchronize a time base it was again found that, in general, correct interlace did not occur and careful setting of the frequency control of the time base was necessary to obtain correct interlace.

5.2.1. Blocking-Oscillator Type of Time Base

When a simple integrator circuit was used to feed the blocking oscillator time-base (on the grid) it was found that the degree of interlace could be varied by varying the setting of the frequency control. The partial interlace was found to be due to the differences at the start of the pulses. Variations of the frequency control cause the time base to trigger at different voltages on the rising portion of the frame synchronizing pulse. The differences between the two pulses vary at different points up the leading edge, being large on the line AB and small on line CD (Fig. 14c).

These variations can be reduced by obtaining a large pulse and using a small time constant so that the rate of rise is large. As this also increases the line pulses it is necessary to use a limiter to remove these unwanted pulses. The integrator circuit was now followed by a triode limiter. This reversed the phase and the negative output pulse was fed to the anode of the blocking oscillator. It was still found that partial interlace readily occurred, and the reason is shown in Fig. 15a and b. In 15a it is seen that the differences at the end of the odd and even frame pulses produce different scans, although the flyback is interlaced. In the case of 15b the difference is presumably caused due to slight differences in the height of the pulses causing the valve to cease conducting at different instants. This latter effect may be overcome by clipping the top portion of the pulse. By doing this it was found that much

better interlacing could be obtained. Circuits of this type have been published and are used in several commercial sets. In one of these circuits a single valve is used as a double clipper of large integrated pulses, so that a narrow "slice" is taken out of the waveform. The start of the pulse on a large time scale, using this type of circuit, is shown in Fig. 16a, and the end of the pulse in 16b. It will be seen that the start of the pulse is the same on odd and even frames, but the ends of the two pulses are different. The start of the pulse is reasonably sharp, the maximum rate of rise being of the order of $2V/\mu\text{sec}$. If the time constant of the integrating

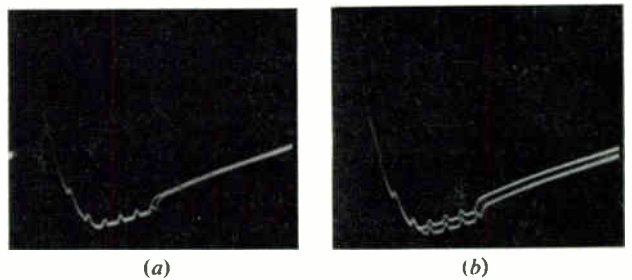
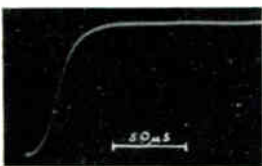

Fig. 15.—Oscillograms showing the flyback of the blocking oscillator time-base when synchronized from integrator circuit.

circuit is increased by a factor of three, the result is as shown in Fig. 16c and d. It will be seen that the maximum rate of rise of voltage is reduced to about $1V/\mu\text{sec}$ and that the start of the pulse is different on odd and even frames. The ends of



(a)

Fig. 16.—Oscillograms of the pulse from an integrator and double limiter.

- (a) Start of pulse.
 - (b) End of pulse.
 - (c) Start of pulse
 - (d) End of pulse.
 - (e) Output waveform from blocking oscillator when synchronized to anode.
- (c) and (d) are with time constant three times as great as (a) and (b).



(b)

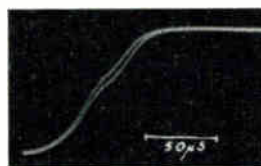

(c)



(d)

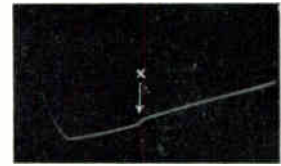

(e)

the pulses are now identical. This is due to the fact that the "slicing" takes place at a different point in the integrated waveform and shows that the time constant and position of the slicing is of some importance.

With this circuit it was found that interlacing was good when the pulses (positive) were fed to the grid of the blocking oscillator, but not as good when reversed in phase and fed to the anode. No trace of the pulse could be seen on the output when the synchronizing pulse was fed to the grid, but when fed to the anode a small "kink" was produced in the output as shown in Fig. 16e at point X. It is not possible to distinguish two traces as the interlace was not as bad as the other circuits. It is most likely that it is the small differences at the end of the pulses which cause failure to give correct interlace.

It will be noted that in Figs. 11e, 13c and 15b the difference between the scans on odd and even frames is large and more than the one half line, or 0.25 per cent., which is required to cause complete lack of interlace. It was found possible to get the time base to run with nearly perfect interlace, but with one frame displaced one and a half lines from the other, instead of the normal half line. This is shown in Fig. 17 which is the start of the white bar on a test pattern. It is seen that one of the frames is displaced approximately one line from its correct position, resulting in the absence of a white line at A. Although this may be considered as not normal it is possible to obtain this result with certain settings of the limiter and frequency settings of the time base and this condition is reasonably stable. The result is, of course, a reduction in the vertical definition.

Cocking⁶ has suggested that blocking oscillator circuits, such as that used in these tests, are more susceptible to trouble, due to differences in the synchronizing pulses on odd and even frames, than is the blocking oscillator circuit without a discharge capacitor in the anode circuit.

To test this theory a simple blocking oscillator circuit with a charging capacitor in the grid circuit only was fed from the differentiator circuit through a limiter, as used previously. It was found that in this case perfect interlace resulted, whatever the frequency setting of the time base and whatever the setting of the limiter. A 0.1- μ F capacitor and a 250-k Ω

resistor were now included in the anode circuit and interlacing was found to be bad, irrespective of whether the output was taken from the grid circuit or from the anode circuit. It would therefore appear that the simple blocking oscillator circuit using the voltage across the grid charging capacitor is satisfactory and produces good interlacing, provided that the valve is not conducting at the end of the frame pulse period or not conducting when any differences in the two pulses occur.⁶ It is interesting to note that out of a total of 38 modern television circuits using blocking oscillator frame time-bases only 19 consist of a single discharge circuit in the grid. (See Appendix.)

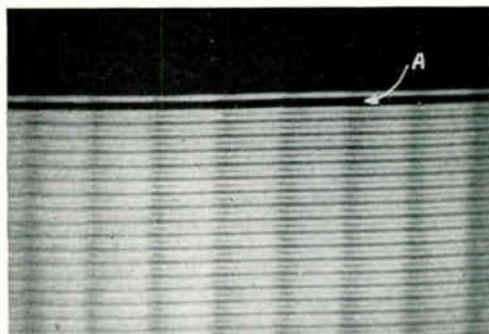

Fig. 17.—Photograph showing the displacement of one frame relative to the other frame.

5.2.2. Thyatron Type of Time Base

The thyatron time-base was used with the integrator circuit, and with double limiting good interlace resulted. When a simple integrator was used the interlace was found to be poor and to depend on the frequency setting of the time base, as in the case of the blocking oscillator time-base.

5.3. Modifications of the Integrator Circuit

There are a number of variations of the simple integrator circuit which may be used:—

- (a) Two—or more—section integrator. In this circuit two (or more) integrator circuits are connected in cascade.
- (b) An integrator circuit consisting of R and C in parallel in the anode or screen grid circuit of a valve. In this case the effective resistances during charge and discharge are different.

(c) Combination of integrator and differentiator circuits. The main idea of this arrangement is to obtain a sharp leading edge to the frame synchronizing pulse. The simplest arrangement is the direct addition of the outputs from an integrator and from a differentiator circuit, the latter having a short time constant of the order of 5-10 μ sec. A number of circuits of this type are described by Keen.⁷ These circuits give modified triggering pulses but do not remove the main defects which cause bad interlacing.

5.4. Use of Equalizing Pulses

It has been shown that a common reason for the failure to interlace is the differences at the start and end of the alternate synchronizing pulses. This difficulty can be overcome by the use of equalizing pulses before and after the frame synchronizing pulses, as shown in Fig. 18, which shows the Continental 625-line standard. By using equalizing pulses before the actual frame pulses, any slight difference caused by the odd half line will have disappeared by the time the frame pulses occur. Similarly, they will make the differences at the end of the pulses negligible. The idea is used in both the American 525- and Continental 625-line systems¹ but, unfortunately, not in the present B.B.C. system.

5.5. Requirements of a Synchronizing Separator to produce Correct Interlace

From the tests described it is seen that the design of a synchronizing separator is most important if correct interlace is to be obtained. The synchronizing pulses obtained from the separator should fulfil the following requirements:—

- (a) Have a sharp leading edge which has a fixed time delay to the first frame pulse, this time delay being identical on odd and even frames.
- (b) Be identical in all respects on odd and even frames, both as regards the start of the pulse and

the end of the pulse. The ideal frame pulse would be one of short duration, say 5 μ sec long, but, as will be shown later, this is not essential.

A number of published synchronizing separator circuits will now be reviewed to see how far they meet these conditions.

5.6. Interlace Filter

A circuit which produces identical pulses on odd and even frames is shown in Fig. 19a.⁷ The circuit is fed with negative-going pulses and, during the period between pulses, V1 conducts

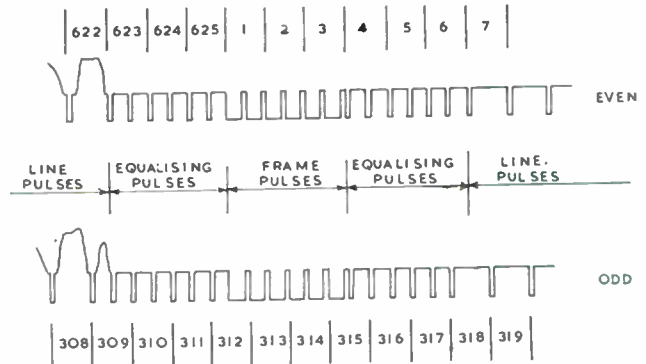

Fig. 18.—625-line standard showing equalizing pulses.

and charges C1 to the input voltage. During pulses V1 is cut off and C1 discharges through R1. On the line pulses the drop in voltage is small, but on frame pulses the decrease in voltage is approximately four times as great. Fig. 19b shows the waveform across C1 (50-c/s time base) during the frame synchronizing period. The anode of V2 is taken to a suitable positive potential so that during frame pulses

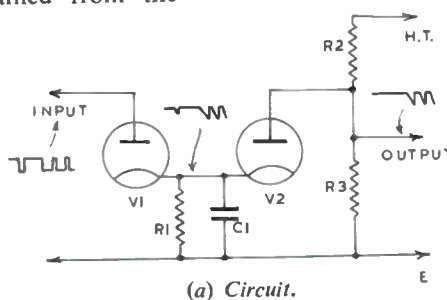
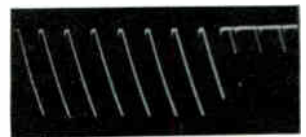
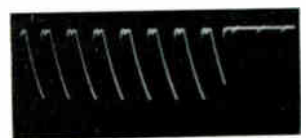

Fig. 19.—Interlace filter.



(b) Voltage across C1.



(c) Output voltage.

the cathode of V2 drops below its anode potential and, therefore, conducts and transmits the voltage across C1 to the output. The voltage output (on a 50-c/s time base) is shown in Fig. 19c, where it will be seen that there is only one trace, confirming that the output is the same on odd and even frames.

This circuit has the disadvantage that the leading edges of the pulses are not sharp, and synchronizing is not as precise as might be desired. Assuming a pulse input of 40 V, the rate of change of voltage on the leading edge is about 1 V/ μ sec. In general this circuit gave satisfactory interlace with both a thyatron time-base and a blocking oscillator time-base.

5.7. Pulse Width Discriminator

A circuit described by Hunter⁸ is shown in Fig. 20. Valve V1 is fed with negative-going pulses (picture signals being previously removed).

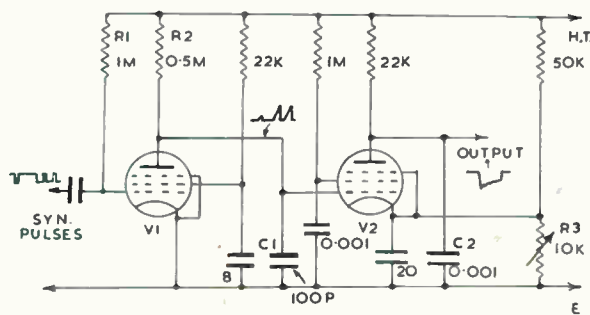

(a) Circuit.

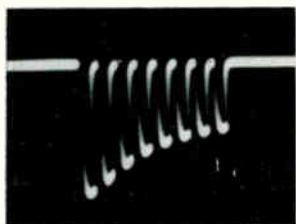

(b) Output waveform without C2.

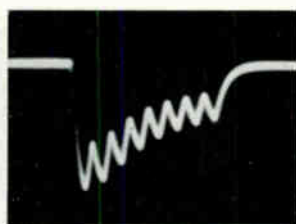

(c) Output waveform with C2.

Fig. 20.—Pulse width discriminator synchronizing separator.

Between pulses V1 is made to conduct heavily by returning g_1 to h.t. positive through R1. This maintains C1 substantially discharged. During the period of the pulse V1 is cut off and C1 charges through R2 and the rise of voltage on frame pulses will be approximately four

times that on line pulses. These pulses are then fed to the limiter valve V2, biased by R3 so that it only conducts on frame pulses. In the absence of C2 the output consists of eight negative-going pulses which start when the voltage across C1 makes V2 conducting and finish at the end of each frame pulse. In both cases the output is exactly the same of odd and even frames, as shown by Fig. 20b (C2 being omitted). The pulses decrease in amplitude due to the small decoupling capacitor used on g_2 of V2, which is probably an advantage. Fig. 20c shows the output with C2 connected which is added to reduce the rate of rise of voltage at the end of each frame pulse but also reduces the rate of decrease at the start of the pulse, which is undesirable.

In general, the operation of the circuit is similar to that of the interlace filter but with an amplifier limiter in place of the simple diode limiter. The circuit gave satisfactory interlace although the rate of rise of the leading edge is limited and not directly related to the frame synchronizing pulses, i.e., the output pulse is related to the frame pulses through the time constant of R1, C2 and the limiting action of V2.

5.8. Gating Circuit

A circuit described by Clements,⁹ which produces positive pulses with sharp leading edges is shown in Fig. 21a. The operation is briefly as follows:—

Positive pulses are applied to the grid of V1 which acts as a picture synchronizing separator in the orthodox manner. The line pulses are taken off the screen and fed to V2 where they are reversed in phase. Frame and line pulses would normally appear at the anode of V1, but are cut off by the negative bias on g_3 . Line and frame pulses appearing at the anode of V2 (positive pulses) are integrated by R1 and C1 and fed to g_3 of V1. As in a normal integrator circuit, the voltage across C1 rises more on frame pulses. This rise is arranged to be sufficient to allow V1 to conduct and frame pulses to appear in the anode circuit of V1. These are differentiated by R2 and C2, resulting in positive frame pulses. Clements shows the waveforms at the start of the frame period but does not make any reference to the end of the frame period. The circuit was connected exactly as described⁹ and

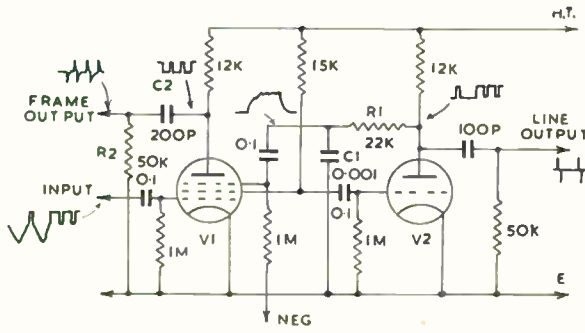

(a) Basic circuit.

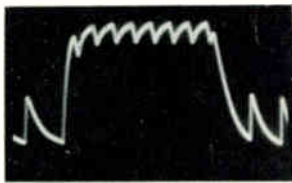

(b) Waveform on g_3 on V1 on even frames.

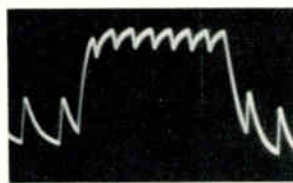

(c) Waveform on g_3 on V1 on odd frames.

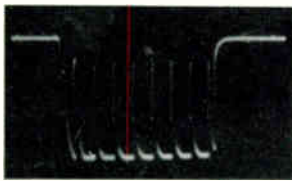

(d) Anode voltage of V1 on even frames.

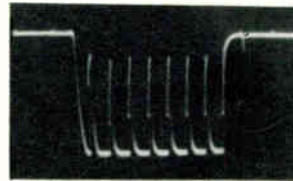

(e) Anode voltage of V1 on odd frames.

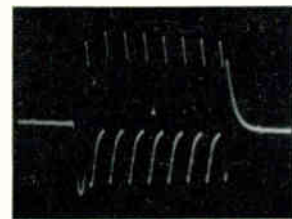

(f) Output voltage on even frames.

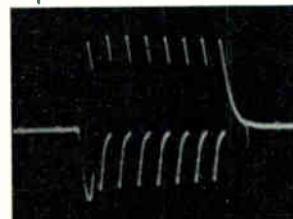

(g) Output voltage on odd frames.

Fig. 21.—Gating circuit synchronizing separator.

Fig. 21 shows the oscillograms obtained from various parts of the circuit. The voltage on g_3 of V1 is shown for even frames at (b) and odd frames at (c). (d) is an oscillogram of the voltage at the anode of V1 on even frames

and (e) on odd frames, and the corresponding output waveforms are shown at (f) and (g) respectively. It will be seen that the output waveforms are not identical due to the "gating" pulse from the integrator circuit being different on odd and even frames. This circuit was used to feed a thyratron time-base and it was found that interlace was not perfect. The interlace varied slightly with the setting of the time-base frequency control and it was not possible to obtain correct interlace.

5.9. Time Selection Circuit

A time selection circuit described by Luckett¹⁰ is shown in Fig. 22a and operates briefly as follows:—

Negative synchronizing pulses fed to A are differentiated by C1 and R1. Due to the bias the valve only conducts on the positive spike appearing at the back edge of each pulse. A line sawtooth waveform is fed to B, is differentiated by C2 and R2, the resulting negative pulse cutting off the valve for a short period after each line flyback. During the normal line pulses this negative pulse on g_3 prevents the input pulse on g_3 from appearing in the anode circuit, but, during the frame pulse period, positive spikes appear on g_1 , 40 μ sec after the start of the line flyback and are not cut off by the short negative pulse applied to g_3 .

The circuit was constructed, using 6F32 and D63 valves, in place of the 6F33 specified, to synchronize a thyratron time-base through a phase reverser. Good interlace could be obtained but component values are fairly critical for satisfactory results. The output pulses are not quite identical on odd and even frames, as can be seen from Fig. 22b and c. There are small humps which are differently placed on the two traces and appear to be due to capacity feed from the line waveform on g_3 . It will also be noted that the pulses are not all exactly the same height and are in a different order on odd and even frames. This is presumably due to the slightly different voltage on g_3 at the instant when these pulses are produced. The circuit appears to be good but suffers

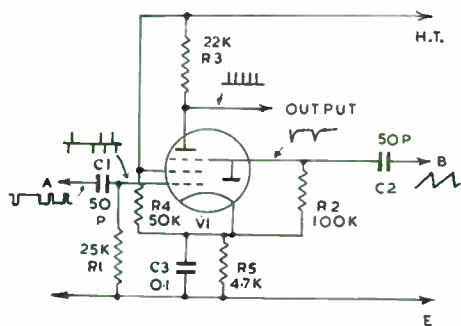

(a)

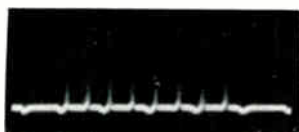

(b)



(c)

Fig. 22.
Time selection synchronizing separator.

- (a) Circuit.
- (b) Output on even frames.
- (c) Output on odd frames.

from the disadvantage that if the line time-base is triggered prematurely (say, by interference) the blocking pulse to g_3 is not present, and an output is produced from the anode circuit, which may trigger the frame time-base.

5.10. *Transitron Circuit*

A transitron circuit, described by Versey,¹¹ is shown in Fig. 23a. Positive pulses are applied to the grid so that the valve is cut off, except during pulses. On line pulses the valve conducts, anode and screen voltages fall, the latter being fed to g_3 , cutting off the anode current. The time constant in the g_3 circuit is long enough to prevent anode current flowing before the valve is cut off at the end of the line pulse. On a frame pulse g_3 allows anode current to flow, after a time depending on the time constant of C1 and R1, and a negative pulse occurs at the anode.

The author has tried the circuit with two types of valve but not been able to get the circuit to operate successfully. Using an EF50 valve, line pulses produce anode pulses of considerable magnitude, as shown in Fig. 23b. It was also found that the end of the train of pulses is different on odd and even frames. It is suggested by Versey that the line pulses may be removed by a low-pass filter or biased diode. The use of a low-pass filter to remove the line pulses reduces the rate of rise of the frame pulses considerably. The biased diode will, of course, remove the pulses but this does not overcome the differences which occur at the end of the train of pulses.

A 6F32 valve was also tried but this was found to oscillate during the period when the anode was allowed to conduct. Although the circuit has the advantage of simplicity of

components it does appear to be difficult to obtain satisfactory operation. Further, the start of the frame pulse in the anode circuit does not correspond directly with either side of the original frame pulses.

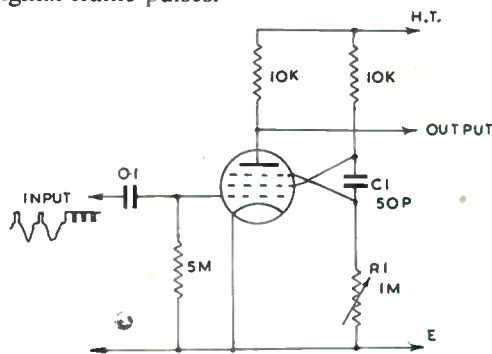

(a) Circuit.



(b) Output at end of the train of frame pulses.

Fig. 23.—Transitron synchronizing separator.

6. Synchronizing Separators Producing a Single Short Pulse

From the above review it would appear that most of the synchronizing separators described have some disadvantage and, in general, do not produce perfect interlace. The ideal pulse would appear to be a short pulse so that it could

not influence the time base during the critical flyback period, and circuits of this type will now be considered.

Since a pulse with a sharp leading edge which is delayed by exactly the same amount on odd and even frames is required, the integrator circuit is abandoned. The critical time-constant differentiating circuit would be satisfactory if the differences at the end of the train of pulses could be removed. This is the principle used in most of these synchronizing separators.

6.1. Use of Flip-flop to Produce a Short Synchronizing Pulse

The first part of the separator consists of a critical time-constant differentiating circuit followed by a limiter so that a train of negative-going pulses are available. The circuit of the flip-flop portion is shown in Fig. 24a, V2 being biased so that it is normally cut off and V1 is conducting. The first negative pulse cuts V1 off and makes V2 conducting. The resulting drop in anode potential of V2 is fed to g_3 of V1 and maintains it cut off until C1 discharges through R1. The resulting voltage on V2 anode is a negative pulse starting on the back edge of the first frame pulse and lasting for a period (depending on C1 and R1) which is made to exceed the frame pulse period. This pulse may be differentiated to produce a short negative pulse followed by a positive pulse, long after the flyback of the time base. When used to feed a blocking oscillator interlacing was found to be perfect, and it was found impossible to get pairing of the lines with any setting of the limiter, adjustment of the flip-flop, or time base.

As this arrangement appears good the circuit was redesigned as the cathode coupled flip-flop shown in Fig. 24b. Positive pulses from the limiter are required, VIA normally being cut off and VIB conducting. The first pulse causes VIA to conduct and its drop in anode potential is fed through C1 to VIB cutting off this half of the valve. A positive pulse is, therefore, produced at the anode of V1B lasting for a period depending on C1.R1, but normally made much longer than the frame pulse period. By differentiation a short positive pulse is obtained followed by a negative pulse. When used to trigger a thyatron time-base, interlace was found to be perfect and it was impossible to get partial interlace. The anode voltage of V1B is shown in Fig. 24c and the grid voltage of the thyatron in Fig. 24d.

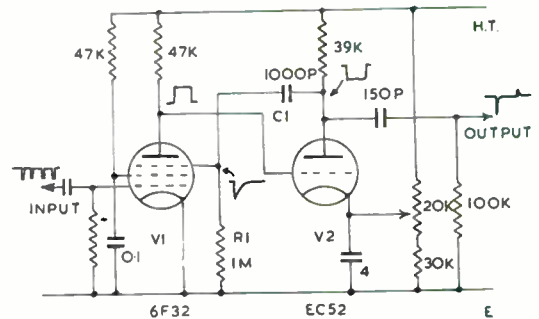

(a) Circuit.

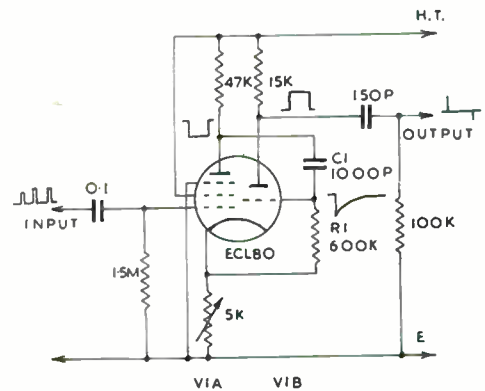

(b) Circuit of cathode coupled flip-flop.

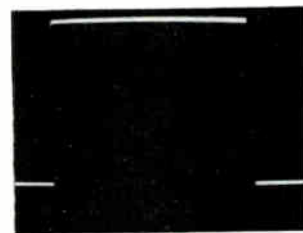

(c) Anode voltage of V1B.

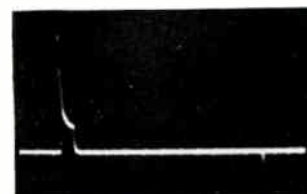

(d) Thyatron time-base grid voltage.

Fig. 24.—Flip-flop synchronizing separator.

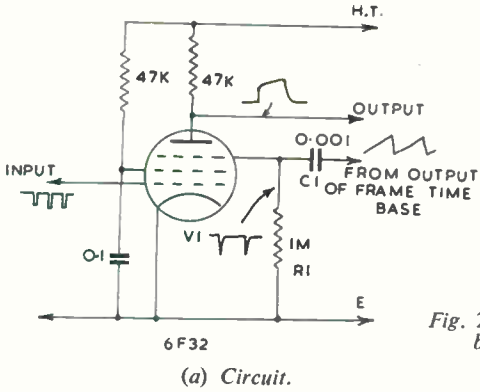
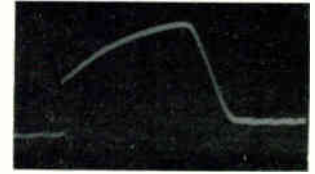

Fig. 25.—Use of time-base to suppress back portion of frame pulses.



(b) Voltage on g_3 .



(c) Anode voltage.

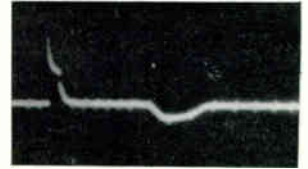

(d) Voltage on grid of thyatron time-base.

6.2. Use of Time Base to suppress back portion of Frame Pulse

In place of the second valve of the flip-flop used above it occurred to the author that the time-base output might be used for this purpose. A mixer valve was used, g_1 being fed with differentiated and limited pulses and g_3 being fed with a suppression pulse from the time base. The circuit is shown in Fig. 25a and was used first with a thyatron time-base, the output being of the correct polarity. The first negative pulse to g_1 cuts the valve off and the resulting positive pulse on the anode triggers the time base. The output (flyback) of the time base is differentiated by C1 and R1 and fed to g_3 producing the voltage shown in Fig. 25b. This cuts off the valve and prevents the remainder of the train of frame pulses from being fed to the time base. The resulting anode voltage is shown in Fig. 25c. The output was fed through a differentiating circuit so that the waveform on the grid of the thyatron was as shown in Fig. 25d. With this circuit it was found that perfect interlacing was obtained and it was impossible to get pairing of the lines.

The same arrangement using a blocking oscillator, synchronized through a phase reverser to the anode, gave perfect interlace and pairing could not be obtained.

Although this idea of pulse suppression has been used for a differentiating circuit, it is obvious that it may be used with other types of synchronizing separator and a circuit is described by Kerkhof and Werner¹² using the same general idea with an integrator circuit.

6.3. Other Methods of Suppressing the Back Portion of the Frame Pulse

6.3.1. Pulse-Reducing Circuit

An interesting circuit¹³ to reduce the back portion of the train of frame pulses is shown in Fig. 26a. The circuit is fed with negative pulses (with the picture signal removed) and C1, R1

Fig. 26.—Pulse-reducing circuit.

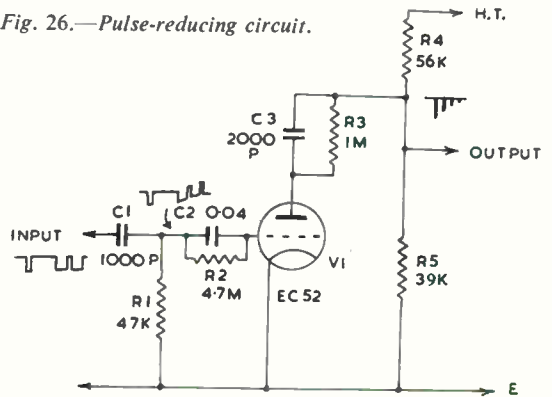

(a) Circuit.



(b) Output voltage on even frames.



(c) Output voltage on odd frames.

form the critical time-constant differentiating circuit. V1 acts as a limiter removing the line pulses, automatic bias being provided by C2, R2. In the normal way pulses of anode current would flow in V1 corresponding to the pulses on the grid. The first pulse of current, however, causes C3 to be charged and a pulse is produced across R4. Since the time constant of C3, R3 is large, C3 remains charged, and, on the next pulse, only a small charge is fed to C3 and a smaller pulse is produced across R4. In this way the first pulse is much larger than the remainder. Fig. 26b and c show voltage across R4 on odd and even frames respectively. In this case R3 was increased to 5 MΩ and C3 to 0.001 μF as this produces a greater decrease in the later pulses. It will be noted that the waveforms on odd and even frames are practically identical.

This synchronizing separator, when used to feed a thyratron time-base through a phase reverser, was found to give good interlace. The circuit has the advantage that it is simple, that the output pulse has a sharp leading edge which corresponds to the trailing edge of the first frame pulse and that it will give satisfactory interlace.

these two electrodes. The drop in the potential of g_2 is fed to g_3 by means of C2 and this drives g_3 negative and cuts off the anode current. Thus a sharp negative pulse is produced at the anode corresponding to the back edge of the first frame pulse. At the end of the pulse on g_1 the valve is cut off, but the potential of g_2 , and therefore g_3 , is prevented from rising by means of C3 so that by the time the next pulse arrives on g_1 (40 μsec later) no anode current flows and all other pulses are suppressed. An oscillogram of the output waveform is shown in Fig. 27b. The waveform on g_2 (g_3 being similar) is shown in Fig. 27c. It is seen that one sharp output pulse is produced, the other pulses being almost completely suppressed.

When used to synchronize a thyratron time-base (through a phase reverser), interlace was found to be perfect, it being impossible to produce pairing of the lines. The circuit has the advantage that it is simple, produces similar pulses on odd and even frames with a sharp leading edge corresponding to the trailing edge of the first frame pulse, and produces excellent interlace.

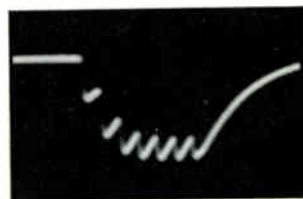
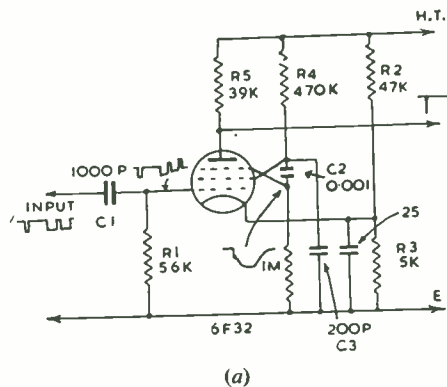

Fig. 27.—Transistron frame synchronizing separator.

- (a) Circuit.
- (b) Output voltage.
- (c) g_2 and g_3 voltage.

6.3.2. Transistron Frame Synchronizing Separator

A method of suppressing the back portion of the frame pulse trains is described by Haantjes and Kerkhof.¹⁴ Fig. 27a shows a modification of this synchronizing separator developed by the author. C1, R1 form a critical time-constant differentiating circuit. The control grid of the valve is cut off except during the frame pulse period by adjustment of R3. The first pulse causes a current to flow in the anode and g_2 circuits thus causing a drop in the potential of

6.3.3. Diode and Resonant Circuit Synchronizing Separator

An interesting new circuit¹⁵ is shown in Fig. 28a. Valve V1 is fed with negative-going pulses (with the picture signal removed) so that it is cut off during line and frame pulses. In the anode circuit is a resonant circuit composed of a "potted" choke L with a ferromagnetic core and capacitor C2. Between pulses anode current flows through L. When a line pulse occurs, V1 is cut off and the current therefore charges up C2 and the anode voltage rises. Before the

anode voltage has time to rise much, the valve is made conducting by the termination of the pulse and the anode voltage rapidly drops, the waveform being shown in Fig. 28b. The output voltage under these conditions is small as the top end of L is effectively connected to h.t. positive through V2.

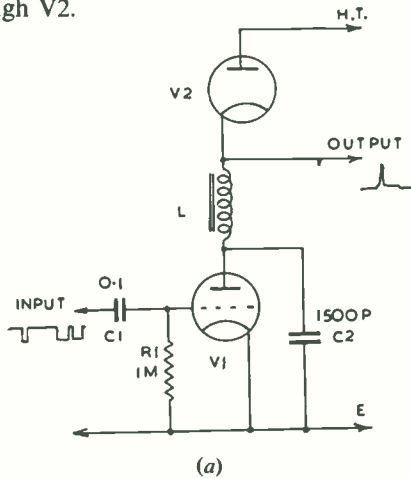

tend to reverse, but it cannot do so due to the diode V2, and hence the voltage across L must drop to zero. This causes the top end of L, the cathode of V2 and the output terminal to suddenly rise to the anode potential of V1. At the end of the pulse the valve conducts and rapidly discharges C2, but the current in L does not build up sufficiently in the time of 10 μ sec between pulses to cause the action to occur again. The result is, therefore, a single pulse at the output terminal. The voltage at the anode is shown for even and odd frames in Fig. 28c and d and the output voltage at e. It will be seen that there is some other output as well as the single pulse due to the impedance of the diode, but this may be removed by a limiter, or, since the pulse is large, the whole output may be attenuated by a resistance potential divider, so as to make the remaining small pulses negligible. Although at first sight one might expect the pulses to be identical on odd and even frames, this is not the case, as can be seen in Fig. 28f, which shows the pulse to an enlarged time scale

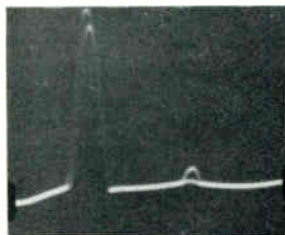
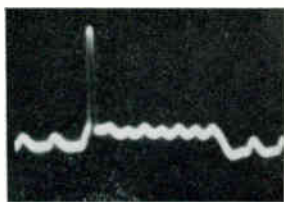
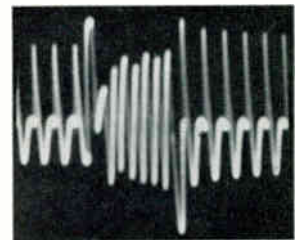
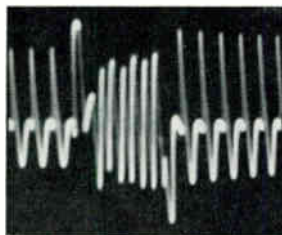
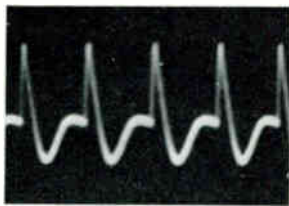

Fig. 28.—Diode and resonant circuit synchronizing separator.

- (a) Circuit.
 (b) Anode voltage of V1 during line pulses.
 (c) Anode voltage of V1 during even frames.
 (d) Anode voltage of V1 during odd frames.
 (e) Output voltage.
 (f) Output voltage on 50-c/s time-base.

During the first frame pulse the valve is cut off for 40 μ sec and the anode voltage rises to a larger value. The anode will rise above the h.t. potential since the voltage across L, produced by the decreasing current, will make the lower end positive with respect to the top end. Eventually the current in L will reach zero and

on a 50-c/s time base. The reason can be seen from Fig. 28c and d where it will be noted that the pulse starts from a different point due to the odd half line which occurs before the frame pulses on odd frames. When the circuit was used to synchronize a thyatron time-base, two distinct flybacks were obtained. This difference

in the pulses is quite small and only causes a slight error in the interlace. It was found necessary to remove the other minor oscillations in the output by a limiter or attenuator before satisfactory interlace could be obtained, as these oscillations are not the same on odd and even frames.

The circuit is reasonably simple and produces satisfactory interlace but it would appear that it could never be perfect. It should also be noted that the pulse does not correspond to a particular frame pulse, but occurs with a delay after the start of the first frame pulse which depends on the build-up of voltage in the resonant circuit and the "break away" from the cathode of V2.

Although the circuits which suppress the back portion of the train of frame pulses are perhaps ideal, so long as the train of pulses obtained from the synchronizing separator are *exactly* identical on odd and even frames, there is no need to suppress the pulses. A circuit will now be described which has been developed by the author using this idea.

6.4. Miller Integrator Synchronizing Separator

6.4.1. Circuit and Method of Operation

The circuit of this separator is shown in Fig. 29a.¹⁶ A negative-going video signal is fed to g_1 of V1, through capacitor C1. The signal is d.c.-restored by half of the double diode V2 and during the period between frame pulses the suppressor grid is driven sufficiently negative to cut off the anode current. The anode voltage therefore rises to full h.t., C2 being charged to the full h.t. voltage due to the flow of grid current. During the period of the pulse the suppressor grid is approximately at zero potential and the anode conducts. At the start of the pulse the anode drops in potential but this drop is communicated to g_1 through C2 (tending to reduce the anode current) and the anode potential only drops the amount necessary to give an equilibrium condition. This condition does not remain since C2 discharges through R2 and R4, and the anode potential falls linearly owing to the Miller-feedback action. As C2 discharges, the voltage across R2 must increase by the same amount. This action continues until the valve is cut off at the end of the pulse. On line pulses the drop in anode potential is small but on frame pulses the drop in potential

(neglecting the initial drop) will be four times as great. Fig. 29b shows the voltage at the anode (on a 50-c/s time base) during the frame synchronizing period.

The small anode pulses produced by the line pulses are removed by the diode V2b which is biased by R7 and R8. The resulting waveform is shown in Fig. 29c (on a 50-c/s time base). The resulting waveform has no sharp leading edge, but, by differentiating the waveform by C4, R5, the waveform shown in Fig. 29d is obtained. Fig. 29e shows the start of the train of pulses to a large time scale when it is seen that the rate of rise of voltage on the leading edge is extremely rapid. This is due to the fact that, at the end of the pulse, C2 is charged from the h.t. through R2 and the grid-cathode circuit of V1, which has a time constant of about 1 μ sec. It is impossible to measure the rate of rise from this figure but it is probably of the order of 20 V/ μ sec. This oscillogram is taken on a 50-c/s time base and it will be seen that there is only one trace, indicating that the pulses are identical on odd and even frames. The leading edge of the first pulse corresponds to the back edge of the first frame pulse and is therefore *rigidly* fixed in time to the start of the frame pulse train. Fig. 29f shows the back portion of the train of pulses, again showing that they are identical pulses on odd and even frames. The exposure for these oscillograms was 1 second on a 50-c/s time base. The output from the synchronizing separator is therefore seen to fulfill the conditions set out earlier.

Since the control grid is driven negative during the pulse periods a line output is available from g_2 across resistor R3. The output consists of positive pulses (Fig. 29g). Although this output may be used directly it will be noticed that there is about 10 per cent. picture content present, due to the capacitance feed from g_3 . This does cause slight pulling on whites, particularly with a large input on g_3 , and to overcome this a diode V3 (originally suggested by Attew¹⁷) is connected so that the diode does not conduct until the screen voltage rises above that determined by R9 and R10. The output from the diode is differentiated by R11 and C5 so that sharp positive pulses are produced, corresponding to the start of the line and frame pulses. Fig. 29h shows the output waveform on a 10-kc/s time base. This again shows an excellent positive synchronizing pulse.

Since the suppressor grid must be cut off between pulses, a short suppressor grid-base type of valve must be used, such as a 6F32 or 6F33. The latter has a diode connected to g_3 and therefore valve V2a is not required. Using a 6F32 and 250 V h.t., the minimum value of synchronizing pulse for correct operation is 6 V peak-to-peak. With 250 V h.t. the magnitude of the output available is approximately 20 V for the frame and approximately 25 V for the line.

6.4.2. Performance

Tests were conducted with the synchronizing separator on a thyatron time-base and it was found to interlace perfectly, it being impossible

to get the time base to cause pairing of the lines. Fig. 30a shows a photograph of the screen during a moving picture. This is a 3-minute exposure, so that no picture is visible, but it shows the excellent interlace and rigidity of the line structure. The photograph was taken on a commercial set with the synchronizing separator and time base replaced by this synchronizing separator and a thyatron time-base. Fig. 3c was taken under the same conditions and Fig. 3d with its normal synchronizing separator and time base (integrator, limiter and blocking oscillator). These two photographs show the reduction in line structure by correct interlace. Tests were made to determine whether syn-

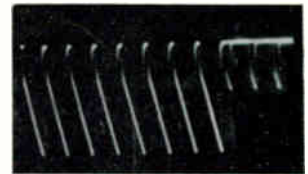
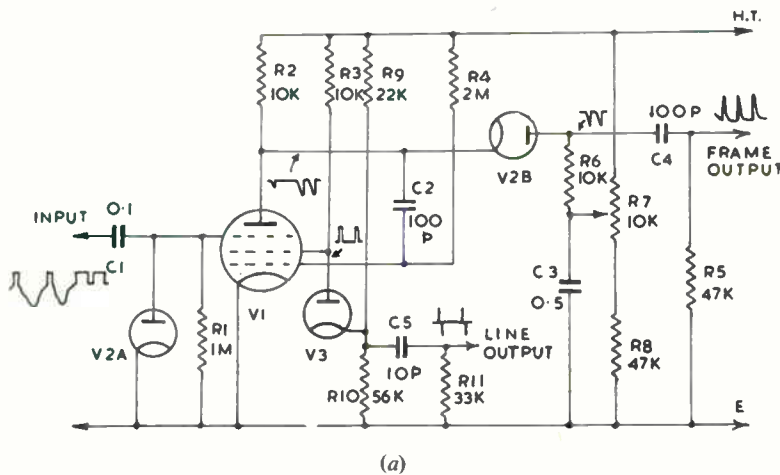

(b)

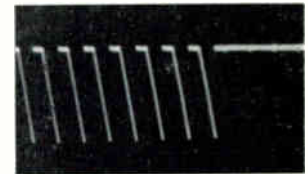

(c)

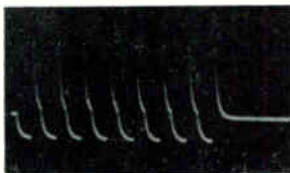

(d)



(e)



(f)

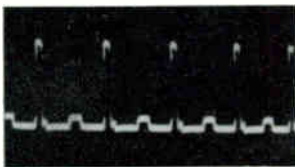

(g)

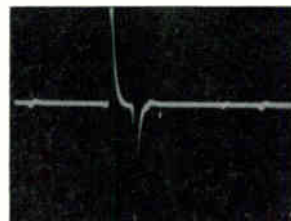

(h)

Fig. 29.—Miller integrator synchronizing separator.

- (a) Circuit.
- (b) Anode voltage of V1.
- (c) Voltage after diode V2B.
- (d) Frame output voltage.
- (e) Start of frame pulses.
- (f) End of frame pulses.
- (g) Screen voltage of V1.
- (h) Line output voltage:

chronizing pulses fed back from a line time-base would upset the interlace. With a blocking oscillator line time-base and a thyatron frame time-base, interlace was still found to be perfect under all conditions and Fig. 30b shows the result (on a cathode-ray oscillograph) under these conditions.

Similar results to the above have been obtained when using a blocking oscillator frame time-base.

A synchronizing separator of this type has been in use by the author for over 12 months, feeding two thyatron time-bases and at no time has it been possible to detect any failure in correct interlace. It is impossible to see the lines on the 12-in tube more than 2 ft from the screen. Synchronizing is good and it has not been necessary to touch the "hold" controls due to frame or line slipping.

Although the synchronizing separator produces such excellent interlace it is simple and uses few components. It not only separates the frame synchronizing pulses from the line pulses, but also the synchronizing pulses from the picture signal. It has no critical adjustments, the only adjustment being R7 which, once adjusted, needs no further attention and could be replaced by two suitable fixed resistors. None of the component values are at all critical. The circuit has been built several times and, in all cases, perfect interlace has been obtained, except where appreciable line pulses have been fed direct into the frame time-base circuit, but this, of course, is not a fault of the synchronizing separator, but of the circuit layout. The importance of this is now considered.

7. Effect of Line Pulses Injected into Frame Time-Base

Although the synchronizing separator may be perfect and produce identical pulses it must be remembered that line pulses injected into the frame time-base will also upset the interlace. In order to see the effect of line pulses a thyatron time-base was synchronized by ideal frame pulses and line pulses of varying magnitude were injected into the circuit. It might be expected that the introduction of line pulses would suddenly cause the time base to stop interlacing and produce a non-interlaced picture. This was not found to be the case. The addition of line pulses caused the interlace to change

gradually as the pulse magnitude was increased, from perfect interlace to no interlace. Any degree of interlace could be obtained in this manner.

Using frame pulses of four lines duration of sufficient magnitude to cause the grid to conduct for this period resulted in the time base being very sensitive to negative line pulses. Line pulses approximately 20 per cent. of the magnitude of the frame pulse caused noticeable pairing, 40 per cent. bad pairing and 60 per cent. to 120 per cent. no interlace.

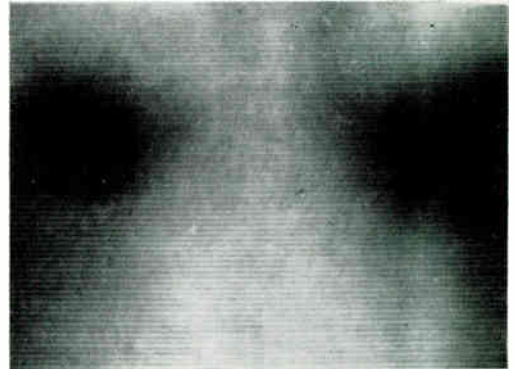

(a)

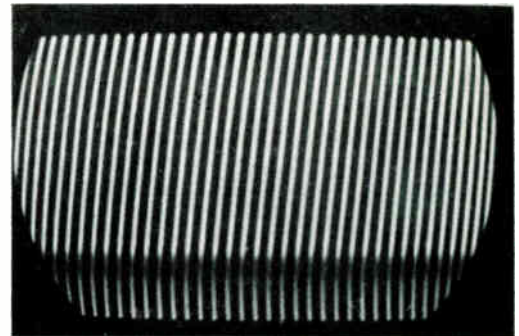

(b)

Fig. 30.—(a) Photograph of moving picture using Miller integrator synchronizing separator (3-minute exposure).

(b) Part of raster on c.r.o. using Miller integrator synchronizing separator.

Positive line pulses of 10 per cent. produced noticeable pairing, 20 per cent. bad pairing and 30 per cent. caused synchronizing to fail. When the time-base operation was changed so that the grid was not maintained conducting, the effect of

the line pulses was much smaller, the effect decreasing as the output of the line time-base was increased by reducing the charging resistor. When the frame pulse was differentiated before applying to the grid the effect of line pulses was found to be negligible, even when the magnitude of the line pulses was 20 per cent. negative or 20 per cent. positive (maximum amplitude without causing failure to synchronize). In this case the flyback was short and occurred in about 100 μ sec. When the flyback was increased to about 500 μ sec it was found that the line pulses were now important. Small negative line pulses of 20 per cent. caused considerable pairing but positive pulses had no effect until the time base pulled out of synchronism. The effect of negative line pulses was more pronounced with low output settings of the time base. The effect of line pulses has been considered by Tomlinson, Hosking and Schnetzler,¹⁸ who show that the line time-base is very critical to line pulses fed through the synchronizing separator, but no mention is made of the possible effect of the different frame pulses on odd and even frames, which has been shown to be equally, or even more, important.

It is not always appreciated how large a voltage can be induced from the line time-base and output stage into the frame circuits. On a typical commercial set it was found that a voltage of 20 V peak-to-peak could be picked up on a 6-in length of wire placed at the back of the set and this increased to 60 V peak-to-peak when placed along the side near the line output transformer. The wire was connected to an oscillograph for these measurements with an input resistance of 100,000 Ω and an input capacitance of 100pF. It is thus seen that it is quite easy to have an injected voltage of a few volts, which, under suitable conditions, will upset the interlace.

8. Conclusions

It is important to note that if a moving picture is viewed, the lines often *appear* to split as the eye follows the movement of an object. This is an optical illusion and is inherent in any interlaced picture and is *nothing* to do with failure of interlace. The effect is often attributed to interlace failure, but it can be shown to be otherwise by the use of an oscillograph. As a matter of fact, the better the interlace the more noticeable the effect, since, if the interlace is

poor, the change to an apparent non-interlaced picture is not so noticeable, as the lines are visible in both cases.

In this paper the author has not dealt with the more unusual synchronizing separators⁷ as these are rarely used. It is, of course, realized that there are other desirable properties in a synchronizing separator apart from interlace (e.g., freedom from effect of interference) which may decide the choice of circuit.

The Appendix gives an analysis of 57 modern television set circuits from the point of view of the synchronizing separator and time base. It is surprising how much the integrator circuit is used in view of its difficulties in connection with interlace.

It is the opinion of the author that if really correct interlace were present on a greater number of sets less would be said about the need for a greater number of lines, with the increased difficulties and cost. With a correctly interlaced picture it is quite impossible to see the lines on a 12-in tube from any normal viewing distance, which is far from true when incorrect or no interlace occurs.

9. References

1. "International television standards." *Wireless World*, 58, August 1952, p. 296.
2. W. T. Cocking. "Interlacing." *Wireless World*, 53, April 1947, p. 124.
3. G. B. Townsend. "On overcoming the non-interlace of television receivers which are accurately synchronized." *Proc. Instn Elect. Engrs*, 99, Part IIIA, 1952, p. 643.
4. W. T. Cocking. (Editorial.) "Saw-tooth generators." *Wireless Engineer*, 28, May 1951, p. 131.
5. G. N. Patchett. "A television waveform display apparatus." *Electronic Engineering*, 25, May and June 1953, p. 184 and p. 248.
6. W. T. Cocking. (Letter.) "Faulty interlacing." *Wireless World*, 58, November 1952, p. 457.
7. A. W. Keen. "Frame synchronizing signal separators." *Electronic Engineering*, 21, January 1949, p. 3, and *J. Television Soc.*, 5, June 1947, p. 49.
8. A. N. Hunter. "A pulse width discriminator for television frame synchronization."

Electronic Engineering, 23, March 1951, p. 104, and *J. Television Soc.*, 6, 1951, p. 209.

9. D. Clements. "Television synchronizing separator." *Wireless World*, 59, February 1953, p. 55.
10. W. R. Lockett. "A time selection circuit for frame sync-separation." *Electronic Engineering*, 23, September 1951, p. 343.
11. H. V. Versey. "Transitron sync separator." *Wireless World*, 55, July 1949, p. 249.
12. F. Kerkhof and W. Werner. "Television," p. 389. (Philips Technical Library, 1952.)
13. Originated by H. A. Fairhurst, Murphy Radio, Ltd.
14. J. Haantjes and F. Kerkhof. "Home projection television—Part III, Deflection circuits." *Proc. Inst. Radio Engrs*, 36, 1948, p. 407.
15. E. F. Wale, M. P. Beddoes and McMichael Radio, Ltd. Patent No. 22343/53.
16. G. N. Patchett. "Faulty interlacing." *Wireless World*, 58, July and August 1952, p. 250 and p. 315.
17. J. E. Attew. (Letter.) "Faulty interlacing." *Wireless World*, 58, October 1952, p. 420.
18. T. B. Tomlinson, J. Hosking and K. Schnetzler. "A problem of interlacing with thyratron time-bases." *J. Television Soc.*, 5, 1947, p. 95.

10. Appendix: Analysis of Television Receiver Time-Base and Synchronizing Circuits

Number of circuits considered: 57.

Frame Time-Bases

Blocking oscillators	38
Multivibrators	11
Thyratrons	5
Current generators	2
Transitrons	1

Types of Blocking Oscillator

Charging capacitor in grid circuit only ..	19
Charging capacitor in grid and anode circuits	19
Output from grid circuit	23
Output from anode circuit	15
Synchronizing to anode	23
Synchronizing to grid	12
Special synchronizing arrangement ..	3

Synchronizing Separators

Integrators without limiter	14
Integrators with limiter	19
Special integrators	4
Integrators with limiters and further integration	4
Differentiators without limiters	1
Differentiators with limiters	5
Special differentiator circuits	1
Interlace filters	3
Transitron	1
Special	4

NOTICES

1954 Edition of the Year Book

The 1954 edition of the Institution's Year Book will be published towards the end of June and copies will be sent, free of charge to all members whose names appear therein, that is to all grades with the exception of Student. Registered Students may obtain copies at a charge of 2s. 6d. post free. The charge to non-members is 7s. 6d. post free.

In addition to listing the Corporate Membership, Companions, Associates and Graduates, corrected up to December 31st, 1953, the Year Book also gives information on the terms of reference and constitution of all Standing Committees and Local Section Committees. Details of Institution premiums and examination awards are also given and the Memoranda and Articles of Association are printed in full for reference.

Visit to the Nuffield Organization

Among other visits being arranged for convention delegates is a tour of the assembly plant of Morris Motors at Cowley. The visit will take place on Monday, July 12th and the tour will include the Experimental Department which features some electronic equipment.

Convention delegates wishing to be included on this or other works visits are requested to register at the Registration Office in Christ Church immediately on arrival.

International Symposium on Chronometry

A Conference on the determination and transmission of time and frequencies and on the associated technical problems will be held in Paris from October 1st to 5th, 1954.

Aspects to be dealt with in addition to mechanical and electrical clocks will be the measurement of speed and acceleration, oscillations and stroboscopy. Methods of teaching and standardization will also be discussed.

The papers to be presented will be in either French, English or German and further details may be obtained from M. Jacques Viotte, Commissaire Général du Congrès International de Chronometrie, 34 avenue de Messine, Paris, 8.

Baghdad Trade Fair

A new venture on the part of the Federation of British Industries, through their organization British Overseas Fairs Ltd., is the British Trade Fair in Baghdad which is to take place on a site

just outside the city from October 25th to November 8th this year.

In the Engineering Section will be an extensive exhibit representing the Radio Industry in which 11 constituent firms of the British Radio Equipment Manufacturers' Association will take part.

It is understood that the closed circuit television link, which will be a prominent feature of this pavilion, is the first of such demonstrations in the Middle East. Telecommunication and industrial equipment will also be included in the display.

The British Broadcasting Corporation will also participate and will occupy an adjacent pavilion.

All communications regarding the Fair should be addressed to British Overseas Fairs Ltd., 20 Tothill Street, London, S.W.1.

Careers in Radio and Electronics

The Ministry of Labour has recently circulated to grammar and technical schools and youth employment offices, an illustrated booklet entitled "Careers in Radio and Electronics," issued by the Radio Industry Council.

The booklet, which is also to be circulated direct to public schools, shows diagrammatically the prospects open to the trainee after his initial training.

It states that in the professional engineering class alone the industry requires 1,000 recruits every year, and it defines professional engineers as being "able to undertake projects on their own initiative or with only general direction, and they supervise or lead groups of technicians and craftsmen. They are usually employed in research or development, or in posts of responsibility in the production, technical sales and administrative department."

In a diagram illustrating "the structure of the personnel in a production unit" an indication is given of the number of unskilled and skilled craftsmen required in relation to the number of technicians—obviously the demand for the latter is even greater than for the professional engineer.

The booklet is extremely well produced and will attract wide attention as an example of the way in which the industry is tackling the problem of the shortage of engineers.

Copies may be obtained from a local youth employment office or direct from the Secretary of the Radio Industry Council, 59 Russell Square, London, W.C.1.

APPLICANTS FOR MEMBERSHIP

New proposals were considered by the Membership Committee at a meeting held on May 11th, 1954, as follows: 19 proposals for direct election to Graduateship or higher grade of membership and 25 proposals for transfer to Graduateship or higher grade of membership. In addition, 68 applications for Studentship registration were considered. This list also contains the name of one applicant who has subsequently agreed to accept a lower grade than that for which he originally applied.

The following are the names of those who have been properly proposed and appear qualified. In accordance with a resolution of Council and in the absence of any objections being lodged, these elections will be confirmed 14 days from the date of the circulation of this list. Any objections received will be submitted to the next meeting of the Council with whom the final decision rests.

Direct Election to Full Member

BROWN, Air Vice-Marshal Colin Peter, C.B., C.B.E., D.F.C.
West Byfleet, Surrey.

Direct Election to Associate Member

KHARBANDA, Sant Raj Ram. *Cambridge.*
LANGRIDGE, Frederick Richard James. *Accra, Gold Coast.*
SWANSON, John William Moore. *North Shields.*

Transfer from Associate to Associate Member

FORREST, Robert Forrest. *London, W.C.2.*
PHIPPS-JONES, Aubrey Llewellyn. *Coventry, Warwickshire.*

Transfer from Graduate to Associate Member

BERTOYA, Hastings Charles Maxim. *Waltham Abbey, Essex.*
FLEURY, Edward Thomas. *Thornton Heath, Surrey.*
GULYANI, P. C., B.Sc. *Delhi.*
HODGSON, William Cliffe. *Alverstoke, Hants.*
MCMULLAN, Lieut.-Com. (L) Walter Joseph. *Fareham, Hants.*

Direct Election to Companion

ASH, William Thomas. *Kenton, Middlesex.*

Direct Election to Associate

BERNARD, Flt. Lt. David Harold. *Marlow, Buckinghamshire.*
BILLHAM, Robert Edward. *Nottingham.*
BOYACK, Gordon. *Pretoria, Union of South Africa.*
DENZEY, Trevor Waters. *West Drayton, Middlesex.*
GALLOP, William George. *Hayes, Middlesex.*
HUGGINS, John Hubert Gibson, B.Sc. *Ewell, Surrey.*
MCAULEY, Adam Henderson. *Newton Mearns, Renfrewshire.*
SMITH, John Frederick. *Otford, Kent.*

Transfer from Student to Associate

ANDREWS, William Gordon. *Liverpool.*
CHASTNEY, Peter. *Dagenham, Essex.*
VASSILAS, Vassas Charalambous. *Chelmsford, Essex.*

Transfer from Associate to Graduate

WHYTE, Ian. *Morden, Surrey.*

Direct Election to Graduate

BARKAWAY, Lieut. (L) Norman Ivo. *Gosport, Hants.*
GRAY, Donald Ernest. *Southampton.*
RAHMAN, Flt. Lt. Syed Azizur, B.Sc. *Karachi.*
TARNER, Henry Charles James. *London, N.8.*
ZAHEDY, Javad. *London, W.13.*

Transfer from Student to Graduate

CANDYLIS, Emmanuel. *Athens.*
ELLIS, Brian Norman. *Cambridge.*
JAISWAL, Hari Prasad, B.Sc. *Dehra Dun.*
KALYANA SUNDARAM, C. Raghava, B.Sc. *New Delhi.*
KULAHION, Kevork. *Beirut.*
MCLAREN, Robert Ian. *Edinburgh.*
SCHLOSS, Ralf. *Tel-Aviv.*
TIKARE, Narayan Dattatraya, M.Sc. *New Delhi.*
VIJAY, Ramesh Chand. *Agra.*
WEGER, Meir. *Tel-Aviv.*
WHITESIDE, Capt. Thomas. *Larkhill, Wiltshire.*

Studentship Registrations

AINSCOUGH, Kenneth. *London, W.5.*
ANTONY, O. A., B.Sc. *Trivandrum.*
BACON, Roy Harold. *Lowestoft, Suffolk.*
BALDWIN, John Richard. *Calne, Wiltshire.*
BAM, Sarel Andries. *Pretoria, Union of South Africa.*
BRYANT, William Cyril. *Sydney, New South Wales.*
CHAMPION, Allan Robert. *Preston.*
CHANDER PARKASH PURI. *Jalalabad, East Punjab.*
COX, John Edward. *Liverpool.*
CREEK, Paul Pallot. *Chelmsford, Essex.*
DE HAVILLAND, Douglas Grenville Rudyard. *Calne, Wiltshire.*
DHANJAL Gurdeep Singh, B.Sc. *Dehra Dun.*
DIEDERICH, Pierre. *London, S.E.26.*
ELLIOTT, Alan Tilbury. *Ilford, Essex.*
ETHIRAJULU, Govindarajulu, B.Sc.(Hons.). *Arkonam, India.*
FLOYD, John Thomas. *Hemel Hempstead, Hertfordshire.*
GOWARIKER, S. R., B.Sc. *Poona.*
GREEN, Kenneth Henry. *Hornchurch, Essex.*
GUNN, Douglas Arnold. *Rathgar, Dublin.*
HARBANS LAL SUD, B.A. *New Delhi.*
HENDERSON, Douglas Ross. *Codshall, Staffordshire.*
JAMES, Derek George. *Birmingham.*
JAMES, James Roderick. *Scarborough.*
JOFFREY, Hameed. *Lucknow.*
JONES, Cyril Thomas Robert. *Ruislip, Middlesex.*
KHAN, Capt. Mohd Afzal, B.A. *Rawalpindi.*
KHEMCHANDANI, Chetan Hiranand, B.Sc. *Kanpur.*
KRISHNAMOORTHY, T. Sundaresan. *Madras.*
LAKDAWALA, Homi Feroze. *Bombay.*
LEMONIAS, Gladstone Charles. *Davenry, Northants.*
LIMAYE, Laxman, Sidheshwar, B.Sc. *Gondia, India.*
LYALL, Andrew. *Ashington, Northumberland.*
MEHTA, T. Raj. *Jalahalli.*
MOHAMMED IBRAHIM, B.A. *Lahore.*
MUKHERJEE, Sitapati. *Calcutta.*
MURUGARAJ, Mylambadi Aradhanari. *Jalahalli.*
OAKES, Mervyn Brian. *Bristol.*
OSBORNE, John, B.Sc. *Ilford, Essex.*
OWEN, John. *Malvern, Worcestershire.*
PENDSE, Sahades Gajanan, B.Sc. *Poona.*
PISHARODY, Unni Krishna. *Bombay.*
RAMACHANDRA, H. L. *Bangalore.*
RAMACHANDRAN, Sundaram. *New Delhi.*
RUBIN, Moshe. *Haifa.*
SANKARA RAO, Nagaraja. *Madras.*
SAXENA, Anand Kumar, B.Sc. *Kanpur.*
SAXENA, Virendra Swarup, B.Sc. *Kanpur.*
SEAMAN, John Alan. *Croydon, Surrey.*
SEETHARAMAN, Mahakligudi Rajagopala. *Calcutta.*
SHELOLIKAR, Balkrishna Shripad, B.Sc.(Hons.). *Calcutta.*
SINGH, Chandra Vir, B.Sc. *Dehra Dun.*
SINGH, Joginder. *Jalahalli.*
SOFAT, Jagdish Chander. *Bangalore.*
SONI, Mangilal. *Nimar, India.*
SREEDHARA, Mijar Kanakabettu. *Agra.*
SRINIVASAN, Ramachandran, B.Sc. *Bangalore.*
SRINIVASAN, Rama Desikachari. *Madras.*
SRINIVASAN, V., M.A., B.Sc.(Hons.). *Allahabad.*
SUBRAMANIAM, Vadakancherri Lakshminarayan, B.Sc. *Madras.*
SUJAN, Chandur Sobhraj. *Jalahalli.*
TARLOK SINGH. *Jodhpur.*
THOMPSON, Stanley James. *Liverpool.*
VENKATACHALAM, A. *Madras.*
VENKATESULU, G. *Madras.*
WALLIS, Arthur Robert. *Sutton, Surrey.*
WHITE, Cyril. *Aylesbury, Buckinghamshire.*
ZIMELLI, John Egbert. *Tigne, Malta G.C.*

A SPECTRUM ANALYSER FOR THE RANGE 100 c/s to 100,000 c/s*

by

K. R. McLachlan†

SUMMARY

The specification is given of an analyser to measure the spectral distribution of the noise emanating from an air jet, and several methods of performing this analysis are discussed. The development of a practical instrument is described which uses a variable frequency selective amplifier with a Wien bridge as the frequency-dependent feedback network, and some details of its performance are given. Errors due to the short time available for analysis are derived and some of the less familiar aspects of the circuits used, such as a symmetrical-to-asymmetrical convertor, are analysed.

1. Introduction

In a recent investigation into the mechanism of noise production in air jets, it became necessary to correlate the aerodynamic conditions in such a jet with the acoustic disturbances thereby produced. Optical methods^{1,2} depending on the change of refractive index of air with density were used to investigate the conditions of the jet stream. Thus, the resulting changes of light intensity produced at a surface are converted by means of a photo-electron multiplier into an electrical signal. The acoustic disturbances in the neighbourhood of the jet were detected by a crystal sound cell (sensitivity — 95 db relative to 1 volt/dyne/cm²).

Practical considerations, such as air storage capacity, imposed a limitation on the size of the jets used and this in turn determined the frequency range of the noise produced. The size of the jet, made necessary by these considerations, produces noise with components in the range 100–100,000 c/s.

A knowledge of the total noise and energy distribution within this range was required for correlation with the measurements taken with the optical system.

The spectrum analyser needed to measure the energy distribution had to be specially developed, since no ready-made unit was available which conformed to the specification which this paper shows to be necessary.

*Manuscript first received February 19th, 1954, and in revised form April 6th, 1954. (Paper No. 263.)

†Engineering Laboratory, The University of Southampton.

U.D.C. No. 621.317.79.

2. Methods of Analysis

The spectrum produced by the air jet may contain discrete tones as well as distributed noise components, depending on such factors as blowing pressure, size and shape of nozzle, etc. A knowledge of the location of these discrete tones in the frequency range was required and influenced the method of analysis used.

The octave or sub-octave filter method is clearly impracticable since it allows of an uncertainty amounting to one filter bandwidth in the frequency location of a discrete tone. The alternative method was adopted in which a selective network may be adjusted to any frequency within the given range.

The desired adjustment of the selected frequency may be achieved by utilizing the heterodyne principle. Here a locally generated signal of variable frequency is mixed with the noise spectrum and the beat-frequency produced fed to a selective amplifier of fixed frequency response.

Alternatively, a variable frequency selective amplifier may be used, the selected frequency of which is capable of being adjusted over the specified range.

3. Practical Considerations

Since the aerodynamic conditions obtaining in the jet are constant for only short periods of time, in some cases only 30 seconds, manual operation and recording are precluded and an automatic method of tracing the spectrum becomes necessary. This involves sweeping the selected frequency through the range, whilst at

the same time plotting the output of the analyser to a base of frequency.

The resolution of such an analyser falls off as the rate of sweep is increased and hence for good resolution the analysis should be performed slowly and full use must be made of the maximum allowable interval of 30 seconds, to which reference has been made.^{3,4}

The loss of resolution and other errors resulting from these restrictions are considered in Appendix 1, which further shows that the appropriate corrections may, under certain conditions, be constant over the frequency range.

It may be shown that when the selective network has a finite response at frequencies remote from that to which it is tuned, serious error can arise in the indicated signal amplitude at the selected frequency. This error is due to the contribution of signal components located at these remote frequencies. This problem becomes more acute as the frequency range covered by the analyser is increased, and especially when a sloping spectrum is analysed. Calculations showed that this error could easily amount to 15 db over the range 100-100,000 c/s, hence the circuit arrangements finally adopted must reduce this error to negligible proportions.

In order to simplify the interpretation of the results when investigating random noise, it is desirable that the analysis should be performed by means of circuits, whose bandwidth is a constant percentage of the selected frequency. To permit spectra taken at different times to be usefully compared, the analyser must be stable in both frequency location and response.

4. Specification

These features may be summarized as follows, and form the specification for a practical instrument:—

Frequency range: 100-100,000 c/s.

Q of analysis: 10-20.

Maximum allowable analysis time: 30 sec.

Stability of response:

Amplitude $\pm \frac{1}{2}$ db

Frequency 1 per cent.

Automatic recording of spectra.

High input impedance for use with crystal or similar high-impedance microphone.

Built-in calibration facilities.

5. Discussion of the Merits of the Two Methods

5.1. Heterodyne

A review of the requirements outlined seemed in the first place to favour the adoption of the heterodyne method on account of its ability to sweep through the whole range without switching discontinuities. However, it is difficult with such a system to meet the stability requirements. For example, the local oscillator must be stable to one part in 100,000 if the frequency stability at the low-frequency end of the spectrum is to be no better than 1 per cent. In addition, the fixed frequency selective amplifier, whose pass band must be located above the analysis range, must have an extremely high Q if it is to provide a useful bandwidth at the low-frequency end of the analysis range. Thus, since in this method the bandwidth of the selective amplifier and hence that also of the analysis is constant, the effective Q of analysis is directly proportional to the frequency. For instance, a selective amplifier located at a frequency of 100,000 c/s would have to have a Q of 10,000 to provide an effective Q of analysis of only 10 at a frequency of 100 c/s.

The double heterodyne method could have been used to overcome this particular difficulty. In this method a beat frequency, obtained as described above, is mixed with the signal from the fixed frequency oscillator to produce a second beat frequency. This may be chosen at some convenient value such that the ratio of the Q of the selective amplifier to that of the analysis is not too large. If, in the example given above, the double heterodyne method had been considered, using a second beat frequency of 1,000 c/s, then the same analysis Q could have been achieved with a selective amplifier Q of only 100. However, the local oscillator stability must be as good here as in the single heterodyne method and both methods suffer from the disadvantage that spurious components of signal are produced in the mixing stage. Further, this method performs the analysis with constant bandwidth and not with the desired constant percentage bandwidth, although this could be overcome at the expense of additional circuit complication.

5.2. Variable Frequency Selective Amplifier

These difficulties led finally to the adoption of the alternative method of using a variable

frequency selective amplifier. Such an amplifier may be considered equivalent to a variable frequency tuned circuit of constant Q , and hence has, inherently, the desirable constant percentage bandwidth property.

Another advantage of this method is that the Q of the selective amplifier is also that of the analysis and hence is very much lower than is the case with the heterodyne analyser. As a result, the required degree of stability in the amplifier is much more easily achieved.

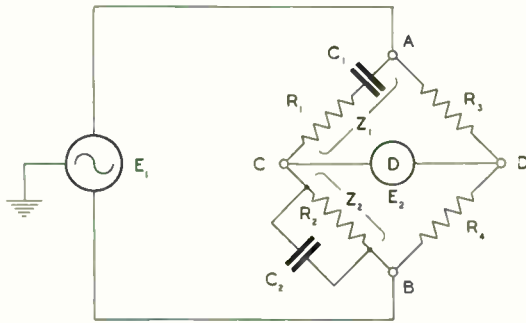

Fig. 1.—Basic Wien bridge circuit.

No local oscillator or mixer is required, hence the problems of stability and spurious signals associated with these units do not arise.

The principal disadvantage appeared to be that the analysis could not be performed in one range. This makes necessary range switching which would further limit the available operating time. This difficulty may be minimized, however, by making such switching operations automatic, and by reducing their number to a minimum. Preliminary calculations showed that it might be possible to do the analysis in only two ranges which further has the advantage of producing only one joint in the records, and hence simplifying the interpretation of the results.

Of the methods available for producing a variable frequency selective amplifier, that which employs a frequency-dependent feedback network was considered most suitable. The Wien bridge was chosen to form this feedback network since the selected frequency may be made to bear an inverse relationship to the change in circuit parameters. This property is shown in Appendix 1 to be desirable. In this way the gain

of the amplifier is reduced by negative feedback at all frequencies except the balance frequency of the Wien bridge. Then, providing the amplifier has a level frequency response, this arrangement produces frequency selection at constant Q and with a constant peak response.

6. Circuit Arrangements

6.1. Wien Bridge

Figure 1 shows the basic Wien bridge circuit. If a constant alternating voltage is applied to AB , and its frequency varied, there will be one frequency at which the voltage appearing at CD will be a minimum or zero. The ratio of R_3 to R_4 determines whether or not the zero is reached. If R_1 and R_2 or C_1 and C_2 be varied simultaneously then the frequency at which this zero occurs will bear the inverse relationship to the change in circuit parameters mentioned earlier.

These conditions are discussed in Appendix 2. It is appropriate here to mention that the complete Wien bridge was used in preference to the more usual arrangement employing only the two impedance arms. In this way greater flexibility of the feedback arrangements may be achieved.

6.2. Symmetrical - to - Asymmetrical Signal Converter

The use of the complete Wien bridge necessitates rather more complicated circuit

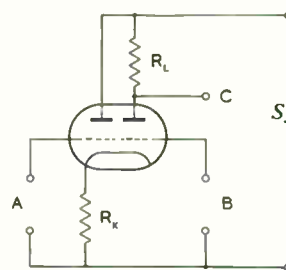
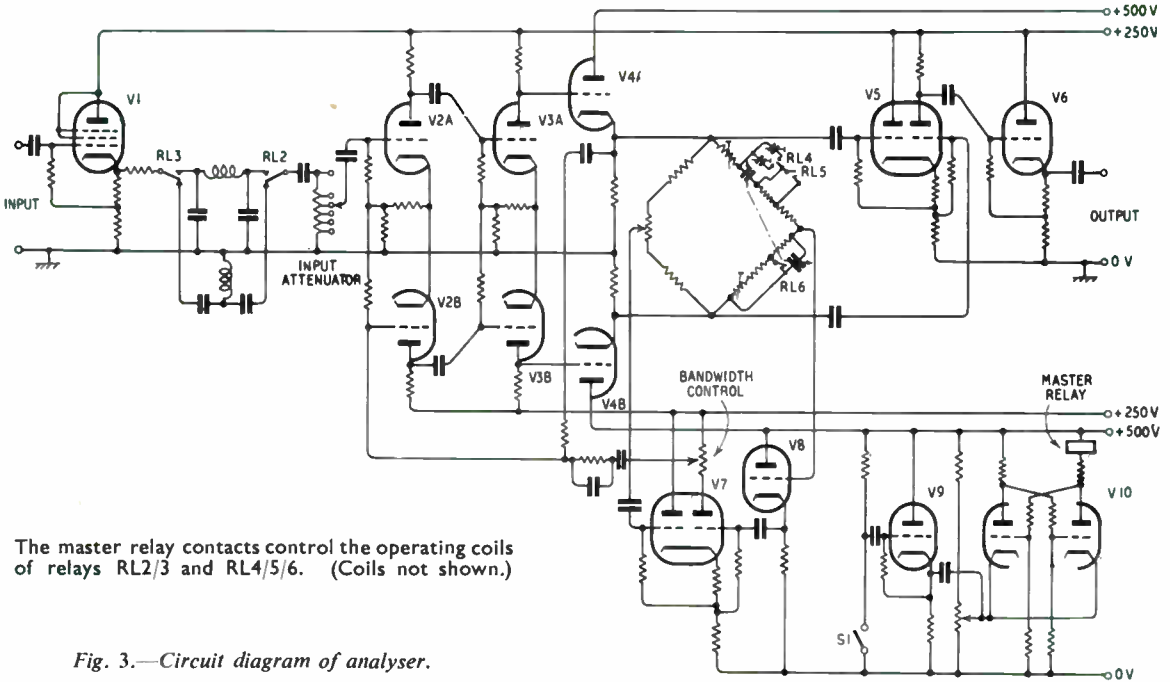

Fig. 2.—
Symmetrical-to-asymmetrical
signal converter.

arrangements in the amplifier than if the two impedance arms only had been used. This arises from the need to use a detector which is sensitive to the voltage between CD but not to that appearing between these two points and earth. Clearly, any detector, one side of which is earthed, is unsuitable unless isolated by a suitable matching transformer. In practice, however, it would be difficult to design a



The master relay contacts control the operating coils of relays RL2/3 and RL4/5/6. (Coils not shown.)

Fig. 3.—Circuit diagram of analyser.

transformer for this purpose because of the high impedance of the bridge circuit, and the wide frequency range to be covered. Hence a valve circuit was adopted which made the use of an isolating transformer unnecessary. The basic form of this circuit is shown in Fig. 2 from which it will be seen that anti-phase signals at A and B are additive at C whereas in-phase signals tend to cancel. The circuit is analysed in Appendix 3 which shows that cancellation is complete if the ratio of the two voltages differs slightly from unity.

When terminals A and B are fed from the Wien bridge the voltage appearing at C is a function of the out-of-balance voltage only and can be used as a feedback signal.

6.3. Main Amplifier

The output impedance of the amplifier should be low to minimize the effects of shunt capacitance and variation of loading associated with the Wien bridge. The use of a push-pull amplifier is desirable because of its inherent stability and flexibility, and since it allows the

Wien bridge to be isolated from earth. The equivalent Q of the amplifier and the Wien bridge combination depends not only on the inherent selectivity of the Wien bridge but also on the gain of the amplifier. Hence to keep the Q and peak response constant over long periods the amplifier gain must be stable. For the same reason the phase and frequency distortion in the amplifier must be negligible over a frequency range considerably in excess of that of the analysis. The relationship between the equivalent Q and the amplifier gain is given in Appendix 4.

7. Development of Prototype

7.1. Main Amplifier

The requirements outlined in the foregoing sections have been incorporated into a practical instrument, the circuit diagram of which is shown in Fig. 3. V2 and V3 form the voltage amplifying stages of the main amplifier and V4 the symmetrical cathode follower output stage to the bridge. The voltage amplification stages are connected as cathode-coupled pairs and hence a symmetrical output is obtained from an

asymmetrical input. This allows negative feedback to be applied via the normally quiescent grid of V2, which has the advantage of providing separate input circuits for the signal and feedback voltages. Two feedback voltages are applied to this grid, one from the appropriate cathode of V4, which is independent of frequency over the analysis range, and the other from the Wien bridge. The former improves the inherent stability and frequency response of the amplifier, the time constant of the coupling circuit having been chosen to prevent unwanted positive feedback at very low frequencies. The feedback voltage developed by the bridge is converted to an asymmetrical signal by V7. The capacitor shunting the coupling resistance between this valve and V2 is necessary to balance the effects of stray shunt capacitance. V8 serves as an impedance convertor.

At the input to the main amplifier two filters are included, these being driven by a cathode follower to ensure their correct termination for all possible input arrangements to the analyser. The low-pass filter has a cut-off frequency located just above the lower range and is switched into circuit when sweeping through this range. Hence any signal components occurring above the cut-off frequency will have negligible effect on the analyser response. The high-pass filter similarly isolates the upper range from low-frequency signal components.

In this way the error due to the finiteness of response at remote frequencies referred to in Section 3 is reduced to 0.5 db provided that the spectrum does not slope by more than 6 db per octave.

7.2. Wien Bridge

The bridge itself, connected across the output of the amplifier, utilizes ganged variable capacitors as the controlling elements. To allow them to be driven by a constant-speed motor and still produce the required variable rate of sweep they must have a linear capacitance law. The only suitable capacitors having this law which were immediately available had a smaller ratio of maximum to minimum capacitance than was required to cover the whole of the analysis in only two ranges. This resulted in the prototype analyser having a frequency range of only 150–75,000 c/s but this was considered adequate for development work. Ideally the capacitance/shaft-angle law of the variable capacitor should

be of saw-tooth shape, the change from one range to the other occurring at the step. However, the conventional variable capacitors fitted in the prototype have a triangular capacitance law, resulting in each range being swept with first positive and then negative rates of sweep. It was found in practice that when the capacitors were correctly aligned in the positive rate of sweep section, considerable errors appeared in the negative section. Hence, this part of the record has no value and represents a waste of analysis time.

To cover the upper range, part of the resistive components of the impedance arms are short-circuited by means of relay contacts RL5 and RL6. The contact RL4, operated simultaneously, selects the correct trimming capacitance for each range. In addition, there is a resistance trimmer in each of the impedance arms to balance exactly the resistance values for each of the two ranges.

To provide an easy means of balancing the bridge a 50,000-ohm potential divider forms the frequency-independent arms.

Since the values of the impedance arms are necessarily high, it is essential to keep stray capacitance to a minimum. In particular it was found necessary to employ a cathode follower to reduce the effects of loading and circuit strays on the high-impedance point of the bridge. The components in the impedance arms are so connected that those possessing the greatest stray capacitance are nearest the low-impedance points. In addition, the bridge circuits are screened from the effects of stray electrostatic and magnetic fields.

As mentioned above, frequency selection may also be achieved by varying the resistance in the impedance arms whilst keeping the capacitance constant. The use of fixed capacitors allows the impedance of the bridge to be set at a value low enough to avoid the effects of circuit loading and stray capacitance. However, it was found in practice that the electrical noise produced at the moving contacts of these variable resistors gave an unacceptably low signal-to-noise ratio. The noise arises from the change in resistance occurring in discrete steps corresponding to each turn on the toroidal winding of the resistors. These steps produce ringing of the selective amplifier at a frequency determined by the new value of resistance. The effect reaches a maximum at the high-frequency end

of each range, where the fractional change of resistance with each step is greatest.

A further difficulty experienced with the use of variable resistors was that of obtaining accurate tracking. For perfect tracking the two resistors must have the same value for any given shaft angle, which requires that they have not only the same resistance/shaft-angle law, but also identical maximum values. It was found impossible in practice to meet with sufficient accuracy both of these requirements.

7.3. Range Switching

The range-changing switches in the bridge circuit are operated automatically by a relay in one anode of V10. This valve together with V9 forms a trigger circuit controlled by the closing of the contacts S1 on the shaft of the variable capacitors. It will be seen that this circuit has two stable states, the change over from one to the other occurring at the instant of the impulse from S1. Thus the relay coils are energized during alternate revolutions of the capacitor shaft allowing the Wien bridge to sweep through first one range and then the other. The use of an electronic trigger circuit was considered simpler than the alternative of a geared contact drum driven from the capacitor shaft.

In this way no manual range switching is required, and the analyser once started completes the analysis automatically.

The action of the analyser, then, is to sweep from its lowest frequency of 150 c/s up to 4,000 c/s and back again. At this point the capacitor shafts have executed one complete revolution and the range-changing switches are operated, causing the selected frequency to jump from 150 c/s to 3,000 c/s. The capacitors continue to rotate and sweep the selected frequency from 3,000 c/s to its maximum value and back again, after which the range-changing switches return to their former position and another complete analysis may be started.

The overlap of the two ranges ensures that no information concerning the spectrum being recorded is lost due to the transient conditions obtaining when the change from the lower to the higher range is made.

7.4. Output Circuits

The unit used to record the noise spectra requires an asymmetrical input signal which is

obtained from the amplifier via V5. The cathode follower V6 provides a low output impedance and together with V5 eliminates any possibility of the recorder or indicator input impedance affecting the Wien bridge.

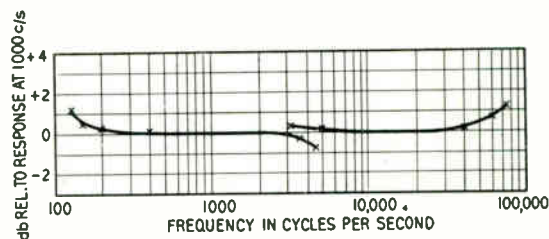

Fig. 4.—Frequency characteristics of complete analyser.

7.5. Pre-Amplifier

The analyser, as described, needs an input signal of about 100 mV to give full deflection of the recording pen. Hence, a separate amplifier having a gain of 60 db was provided to permit the use of low-output detectors. This amplifier is of conventional design and over the analysis range has a level frequency response within 0.2 db. A cathode follower input stage is employed to provide a high input impedance, the cathode circuit of this valve forming a low-impedance stepped attenuator. The connection between the amplifier and the microphone is made by means of double screened wire, so that the inner screen may be driven from the cathode of the cathode follower. In this way the effects of cable capacitance are greatly reduced. In addition a cathode follower output stage is used to provide a low-impedance supply to the analyser.

To reduce hum in the amplifier and to improve its input characteristics,⁵ the heaters of the input cathode follower and first amplifying stage are supplied with d.c. at reduced voltage. The resulting lowered cathode temperature reduces both the initial velocity of the electrons and hence the number reaching the grid, and also the number of positive ions formed. The grid current is thereby reduced and the effective grid input resistance improved. The lowered grid current permits a much higher value of grid leak to be used and reduces loss of signal voltage when the circuit is fed from a high impedance source.

7.6. Power Supply Unit

A single unit supplies power to both the pre-amplifier and analyser. Two h.t. voltages are provided, one at 500V d.c., unstabilized, and one at 250V d.c., stabilized. In addition, the heaters are supplied with a.c. at 6.3V, with the exception of those mentioned in Section 7.5. These are supplied from a copper oxide rectifier giving a smoothed output of 5V.

8. Recording the Spectrum

The output of the analyser is fed to a Bruel and Kjaer high-speed level recorder type 2301, which provides an instantaneous and permanent record of the noise spectrum. The record appears as a finely scribed line on waxed paper and hence no photographic or other processing is required. The paper is driven by a constant-speed motor giving the time axis, whilst the stylus indicates the signal amplitude along an axis perpendicular to that of the paper movement. The movement of the stylus is proportional to the logarithm of the input signal, the scale along this axis being calibrated 0-50 db. The drives to both the paper and the capacitors in the analyser are synchronous, so that the time scale may be interpreted in terms of frequency. The frequency scale may be expanded as required by the choice of paper speed. On this particular recorder 10 speeds are available, ranging from 0.003-100 mm/sec, and for use with the analyser the 3 and 10 mm/sec speeds have been found most satisfactory.

9. Calibration Equipment

To ensure that measurements are always made to the specified accuracy it is essential to have readily available means of checking the calibration of the instrument. Two additional units have been included in the equipment for this purpose. Firstly, a sine wave generator and attenuator with which the Q , overall gain, hum level, etc., may be checked. Secondly, an electrical white noise source and r.m.s. meter to check its performance on random noise. The second method is necessary since all noise measurements are required as true r.m.s. values, whereas the Bruel recorder indicates approximately the average value.

These units, together with the analyser, amplifier and power unit, are mounted together in one 19-in rack.

10. Performance

The transducers used to convert the acoustic pressure variations into an electrical signal are calibrated, and hence the relationship between these two quantities is known.

The characteristics of the amplifier and analyser, which follow these transducers, must also be known accurately if the final records are to be referred to an absolute value of sound intensity. Accordingly, the characteristics of the amplifier and analyser described have been determined and are presented in Figs. 4-7.

The measured maximum overall gain of the analyser together with its pre-amplifier is 105 db at 1,000 c/s, Fig. 4 showing the variation from this figure over the frequency range. These figures were obtained, using the built-in attenuator and oscillator, by the attenuator substitution method.

Referring to Section 3, it will be remembered that the analysis should be made at constant Q . To determine the performance of the analyser in this respect a number of measurements were made at spot frequencies within the range. The results of these measurements are plotted in Fig. 5.

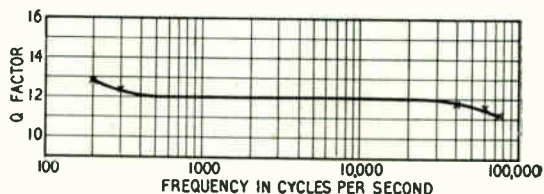

Fig. 5.—Variation of amplifier Q -factor over frequency range of analyser.

The residual hum and circuit noise arising within the equipment is, at worst, 55 db below the maximum output signal level of 10V, this occurring at the low-frequency end of the range.

Long-term stability tests, as such, have not been possible because the instrument was required for noise measurement as soon as completed. However, frequent checks with the built-in oscillator and attenuator during the six months the instrument has been in use have shown that its performance has been satisfactorily maintained.

When taking noise spectra, power is obtained from the normal mains supply, and hence is subject to the usual voltage variations.

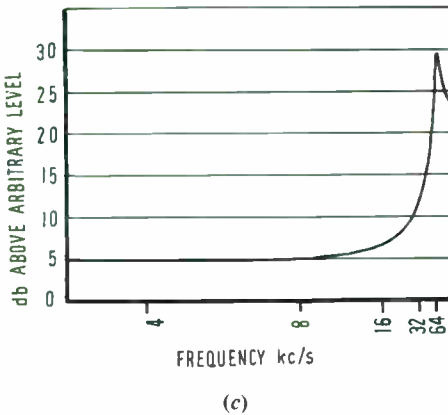
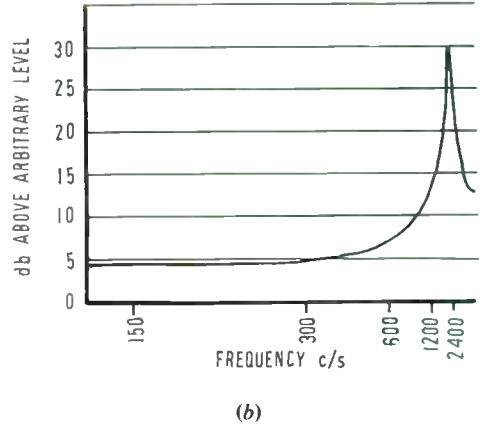
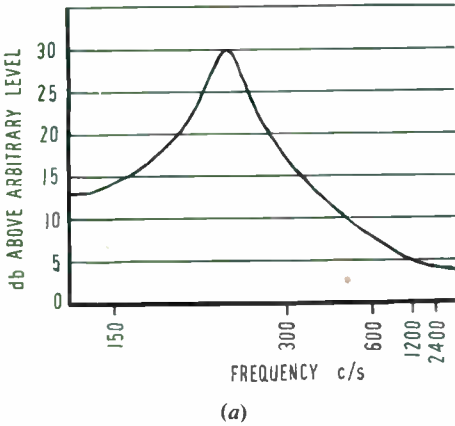

Fig. 6.—(a), (b) and (c) show variation in peak response due to rate of sweep. In each case the signal was set, statically, to the 30-db line.

Tests showed that a variation of $\pm 7\frac{1}{2}$ per cent. in the mains input voltage may occur without seriously affecting the accuracy of the instrument.

In Appendix 1, it is shown, theoretically, that the corrections to peak response and to frequency location, for a sine wave input, made necessary by the rate of sweep, are negligible for this analyser. This was verified experimentally by feeding into the analyser a sine wave signal of known frequency. With the analyser manually tuned to the frequency of this signal, its amplitude was adjusted until a predetermined output level was indicated on the recorder. Then a record was taken at the normal rate of sweep to show the difference between the known static response and the response when

sweeping through the frequency range. This procedure was repeated at a number of frequencies in both ranges of the analyser and confirmed experimentally the validity of the conclusions drawn from Appendix 2. The error in peak response due to rate of sweep at three different frequencies may be assessed from Fig. 6. When measuring the errors in bandwidth and frequency location a greatly expanded frequency scale was used, but these records could not be reproduced here due to the limited space available.

Finally, an example of the spectrum produced when analysing random noise with a superimposed tone is given in Fig. 7. This record is typical of those normally obtained, except for the length of the frequency scale. This has been greatly reduced to enable the satisfactory reproduction of the record in this paper.

11. Conclusions

The salient problems posed in developing the analyser described were concerned with the wide frequency range, the need for automatic operation and recording, and the stability requirements. Most of these problems have been

solved and the resulting prototype instrument has proved satisfactory in use.

The choice of the selective amplifier rather than the heterodyne method was made as the result of experimental as well as theoretical investigation. The experimental work showed that in the case of the heterodyne method the stability requirements would be difficult to meet. Further, to fulfil some of the other requirements of the specification, very considerable circuit complications would result.

These difficulties greatly outweighed the one limitation of the selective amplifier method, namely its inability to perform the analysis in one range.

The development of the prototype analyser has provided much valuable design information upon which may be based the building of an improved model. This would incorporate a number of features which experience gained in using the prototype has shown to be desirable.

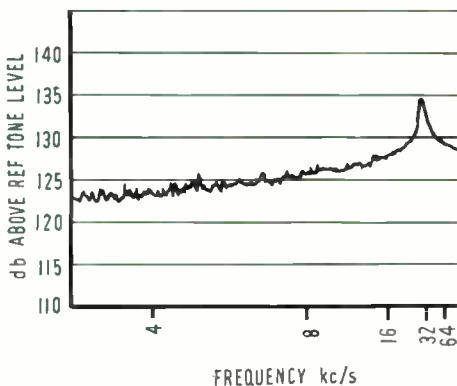

Fig. 7.—Typical noise spectrum with a superimposed tone at 30 kc/s.

The principal of these would be to provide two complete Wien bridges, one for each frequency range. The advantages resulting from this arrangement would be, firstly, that the wasted analysis time mentioned in Section 7.2 would be eliminated; secondly, that each bridge could be tuned separately for optimum performance. One important outcome of this development would be the reduction of the total analysis time.

A further reduction in analysis time could be effected by incorporating each Wien bridge into

separate analyser circuits. Two Bruel recorders could then be used to record the two ranges simultaneously. However, this has to be regarded as a refinement which could only be justified if the allowable analysis time were to be reduced below 30 seconds.

Turning now to the circuit details, some advantage might accrue from the substitution of reactance valve circuits for the variable Wien bridge capacitors. This would eliminate the necessity for the mechanical driving system and allow the capacitance/time law to be adjusted to any desired form. Further, instantaneous resetting of the capacitance values could be achieved, thus avoiding the difficulty associated with the mechanically driven capacitors.

However, considerable development work on such circuits would be necessary to make them conform to the requirements of accuracy and stability.

Although not all the possible improvements have been mentioned, those suggested indicate the lines upon which future development may take place.

12. Acknowledgments

The Author's thanks are due to the Ministry of Supply who have sponsored the work, and to Professor E. J. Richards, Professor of Aeronautical Engineering, who has directed the research programme of which the subject matter of this paper formed a part.

13. References

1. E. J. Richards. "Optical Methods of Measurement in Moving Air Streams." Paper read before the International Electro-Acoustics Congress, June, 1953.
2. A. Powell. "The mechanism and reduction of choked jet noise." *Proc. Phys. Soc.*, **B66**, 1953, p. 1034.
3. N. F. Barber and F. Ursell. "The response of a resonant system to a gliding tone." *Phil. Mag.*, **39**, May, 1948, p. 345.
4. N. F. Barber. "The optimum performance of a wave analyser." *Electronic Engineering*, **21**, May, 1949, p. 175.
5. P. Parker. "Electronics." Pp. 850 and 851. (Edward Arnold & Co., London, 1952.)

14. Appendix 1: Corrections Due to Rate of Sweep

When a simple resonant circuit is tuned through a signal of fixed frequency, the response curve differs from that which would be obtained under static conditions. This difference is due to the finite time taken for oscillations to build up and decay in the circuit, and increases with the rate of sweep and with the Q factor.

The practical effect of this form of response is to cause a reduction in the peak amplitude of the signal, a shift of its indicated frequency, and an apparent increase in the bandwidth of the circuit. Hence, it is necessary to be able to calculate the magnitude of the resulting errors if such an arrangement is to be the basis of a practical spectrum analyser.

A full theoretical discussion of this problem is given by Barber and Ursell³ and the following treatment is based on their results.

The three errors mentioned depend on the value of the parameter K defined as

$$K = \frac{f_0'}{\delta^2}$$

where f_0' = rate of change of f_0 , the resonant frequency of the tuned circuit,

$$\delta = \text{bandwidth} = \frac{f_0}{Q}$$

If the corrections are to be constant over the frequency range, then it is clear that the parameter K must also be constant. Substituting $\delta = f_0/Q$ in the above equation,

$$K = Q^2 \cdot \frac{f_0'}{f_0^2},$$

which shows that if K is to be constant for a constant Q circuit, f_0' must be proportional to f_0^2 . Solution of this equation gives the time necessary for analysis with given values of Q , K and frequency range.

$$\frac{K}{Q^2} = \frac{1}{f_0^2} \cdot \frac{df_0}{dt}$$

or $\frac{K}{Q^2} dt = \frac{1}{f_0^2} \cdot df_0$

Integrating

$$\int \frac{K}{Q^2} dt = \int \frac{1}{f_0^2} \cdot df_0 + C$$

or $\frac{K}{Q^2} \cdot t = -\frac{1}{f_0} + C \dots\dots\dots(1)$

If the analysis is started at the low-frequency end of the spectrum when $t = t_1$, f_0' is positive and the initial frequency is f_1 say,

then $\frac{1}{f_1} = C - \frac{K}{Q^2} \cdot t_1$

or $C = \frac{1}{f_1} + \frac{K}{Q^2} \cdot t_1$

and equation (1) reduces to

$$\frac{1}{f_0} = \frac{1}{f_1} - \frac{K}{Q^2} (t - t_1) \dots\dots\dots(2)$$

Now suppose the analysis is to extend over the range f_1 to f_2 in a time interval $(t_2 - t_1)$ seconds. Equation (2) gives

$$\frac{1}{f_2} = \frac{1}{f_1} - \frac{K}{Q^2} (t_2 - t_1)$$

or $(t_2 - t_1) = \frac{Q^2}{K} \left(\frac{1}{f_1} - \frac{1}{f_2} \right)$ seconds... (3)

The frequency range ($f_2 - f_1$), the value of Q , and the time interval $(t_2 - t_1)$ of the analyser described in the paper, are determined by factors other than those discussed in this appendix. Then the value of the parameter K may be obtained by numerical substitution in equation (3). Thus $(t_2 - t_1) = 30$ sec, $f_2 = 10^5$ c/s, $f_1 = 10^2$ c/s, and $Q = 20$, whence $K = 0.133$. From curves given in a paper by Barber⁴ the errors resulting from this value of K may be estimated and are:—

- Peak response error, less than 0.2 db.
- Frequency location error, less than 0.06 of the true bandwidth.
- Bandwidth error, less than 10 per cent.

It has been shown, therefore, that the errors due to rate of sweep are negligible and that they are constant throughout the frequency range provided that the frequency is the inverse function of time given in equation (1).

15. Appendix 2: Analysis of Wien Bridge Circuit

It is a well-known result, that in a four-arm impedance bridge, of which Fig. 1 is an example, balance is reached when the products of the impedances of the opposite arms are equal.

Applying this result to Fig. 1 gives:—

$$\left(R_1 + \frac{1}{j\omega C_1}\right) \left(\frac{1}{R_2} + j\omega C_2\right) = \frac{R_3}{R_4}$$

Equating separately the real and imaginary components

$$\frac{C_2}{C_1} = \frac{R_3}{R_4} - \frac{R_1}{R_2}$$

and $C_1 C_2 = \frac{1}{\omega^2 R_1 R_2}$

This second equation is dependent on frequency thus allowing the bridge to be used as a frequency-sensitive circuit. When so used it is convenient to let $C_1 = C_2 = C$ and $R_1 = R_2 = R$; these equations then reduce to:—

$$\frac{R_3}{R_4} = 2 \dots\dots\dots(1)$$

and $C = \frac{1}{\omega R}$ or $f = \frac{1}{2\pi CR} \dots\dots(2)$

Hence, the balance frequency will bear an inverse relationship to the value of C , and if C be varied uniformly with time, this frequency varies inversely with time. Clearly, the same holds for variations in R if C is maintained constant.

When the Wien bridge is used in a feedback network its frequency response must be known, and may be derived as follows:—

Let an alternating voltage of frequency $\omega/2\pi$, be applied to the input terminals. The output voltage will then be

$$E_2 = \frac{E_1 R_4}{R_3 + R_4} - \frac{E_1 Z_2}{Z_1 + Z_2}$$

hence $\frac{E_2}{E_1} = \frac{R_4}{R_3 + R_4} - \frac{Z_2}{Z_1 + Z_2}$

In the special case being considered

$\frac{R_3}{R_4} = 2$, then

$$\begin{aligned} \frac{E_2}{E_1} &= \frac{1}{3} - \frac{Z_2}{Z_1 + Z_2} \\ &= \frac{Z_1 - 2Z_2}{3(Z_1 + Z_2)} \\ &= \frac{\frac{Z_1}{Z_2} - 2}{3\left(1 + \frac{Z_1}{Z_2}\right)} \dots\dots\dots(3) \end{aligned}$$

To find the value of $\frac{Z_1}{Z_2}$ in the network,

$$Z_1 = \left(R_1 + \frac{1}{j\omega C_1}\right),$$

$$Z_2 = \left(\frac{1}{R_2} + j\omega C_2\right)$$

and remembering that

$$R_1 = R_2 = R \text{ and } C_1 = C_2 = C$$

$$\frac{Z_1}{Z_2} = 2 + j \left[\omega CR - \frac{1}{\omega CR} \right]$$

But $CR = \frac{1}{\omega_0}$, hence

$$\frac{Z_1}{Z_2} = 2 + j \left[\frac{\omega}{\omega_0} - \frac{\omega_0}{\omega} \right] = 2 + j\alpha \text{ say.}$$

Substituting this value in equation (3)

$$\frac{E_2}{E_1} = \frac{j\alpha}{3(3 + j\alpha)} = \frac{1}{3\left(1 + \frac{3}{j\alpha}\right)} \dots\dots(4)$$

Hence

$$\left| \frac{E_2}{E_1} \right| = \frac{1}{3} \sqrt{\frac{1}{1 + \frac{9}{\alpha^2}}} \dots\dots\dots(5)$$

and

$$\tan \phi = \frac{3}{\alpha} \dots\dots\dots(6)$$

These equations show that as α tends to infinity, $\left| \frac{E_2}{E_1} \right|$ tends to $\frac{1}{3}$ and ϕ tends to zero.

At the balance frequency when $\alpha = 0$, $\left| \frac{E_2}{E_1} \right| = 0$ and $\phi = \pm 90$ deg.

16. Appendix 3: Analysis of Signal Converter Stage

In this appendix the ratio E_1 to E_2 in the circuit of Fig. 2 necessary to give complete signal cancellation in the output is derived.

Referring to Fig. 2, let:—

E_1 and E_2 be the alternating voltages applied to terminals A and B respectively, and E_K be the alternating voltage developed across R_K .

Figure 8 shows the equivalent circuit of the signal converter upon which the analysis is based and the usual assumptions concerning the linearity of valve characteristics, etc., are made. In this diagram let:—

$$e_1 = \mu_1(E_1 - E_K) \text{ and } e_2 = \mu_2(E_2 - E_K)$$

- μ_1 and μ_2 be the amplification factors of the left- and right-hand triodes respectively.
- R_1 be the equivalent internal impedance of the left-hand valve.
- R_2 be the equivalent internal impedance of the right-hand valve together with its anode load resistance R_L .
- R_3 be the common cathode load resistance = R_K .

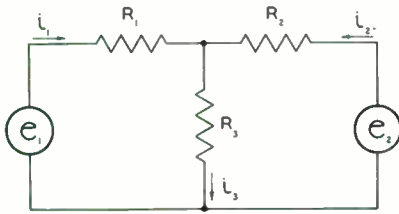

Fig. 8.—Equivalent circuit of signal convertor.

Let the currents i_1 , i_2 and i_3 flow as shown in the equivalent circuit diagram. Then

$$e_1 = i_1 R_1 + i_3 R_3$$

and $e_2 = i_2 R_2 + i_3 R_3$

or since $e_1 = \mu_1 (E_1 - E_K)$, and $i_3 R_3 = E_K$

$$\mu_1 (E_1 - E_K) = i_1 R_1 + E_K$$

Again, since $e_2 = \mu_2 (E_2 - E_K)$, and $i_3 R_3 = E_K$

$$\mu_2 (E_2 - E_K) = i_2 R_2 + E_K$$

These two equations may be rewritten as

$$\mu_1 E_1 - i_1 R_1 = E_K (1 + \mu_1) \dots \dots \dots (1)$$

$$\text{and } \mu_2 E_2 - i_2 R_2 = E_K (1 + \mu_2) \dots \dots \dots (2)$$

Also, since $i_1 = i_3 - i_2$, equation (1) may be rewritten

$$\mu_1 E_1 - R_1 (i_3 - i_2) = E_K (1 + \mu_1)$$

or $\mu_1 E_1 + i_2 R_1 - E_K \frac{R_1}{R_3} = E_K (1 + \mu_1)$

Setting $n = 1 + \frac{R_1}{R_3}$

$$\mu_1 E_1 + i_2 R_1 = E_K (n + \mu_1) \dots \dots \dots (3)$$

Multiplying equation (2) by $(n + \mu_1)$ and equation (3) by $(1 + \mu_2)$ and subtracting gives

$$\begin{aligned} & \mu_1 E_1 (1 + \mu_2) + i_2 R_1 (1 + \mu_2) \\ & = \mu_2 E_2 (n + \mu_1) - i_2 R_2 (n + \mu_1) \end{aligned}$$

$$\text{or } i_2 = \frac{\mu_2 E_2 (n + \mu_1) - \mu_1 E_1 (1 + \mu_2)}{R_1 (1 + \mu_2) + R_2 (n + \mu_1)} \dots \dots (4)$$

The product of this current and the load resistance R_L gives the output voltage of the convertor.

From equation (4) it can be seen that when E_1 and E_2 are of opposite sign, i.e., are in anti-phase, their effects are additive in i_2 . On the other hand, when these two voltages are in phase, i_2 can be zero, which represents the required condition of cancellation.

Since the denominator of equation (4) is always finite, i_2 will be zero when

$$\mu_2 E_2 (n + \mu_1) = \mu_1 E_1 (1 + \mu_2)$$

or when $\frac{E_1}{E_2} = \frac{\mu_2 (\mu_1 + n)}{\mu_1 (\mu_2 + 1)}$, which gives the ratio

of $\frac{E_1}{E_2}$ for complete cancellation in the output of the right-hand valve.

The values of μ_1 and μ_2 are not necessarily the same since, apart from manufacturing tolerances, the presence of R_L in the circuit affects unequally the working conditions of the two valves. However, the value of R_L may be made small, since voltage amplification is not the primary function of the convertor, thus reducing the disparity between μ_1 and μ_2 .

In addition, $n = \left(1 + \frac{R_1}{R_3}\right)$ will very closely approximate to unity since normally $R_3 \gg R_1$.

When these conditions are met, complete cancellation is obtained when $\frac{E_1}{E_2}$ differs from unity by only one or two per cent.

17. Appendix 4: Equivalent Q of the Selective Amplifier

It is necessary, in order to calculate errors due to rate of sweep, to define the bandwidth of the selective amplifier and it is convenient to express this in terms of an equivalent Q.

If M is the gain of the amplifier without feedback, and β the feedback factor, arranged to be negative, the resulting gain is

$$G = \frac{M}{1 + M\beta}$$

When the Wien bridge is used in the feedback

circuit, the factor β is frequency dependent and is given by

$$\beta = \frac{j\alpha}{3(3 + j\alpha)}$$

so that

$$G = \frac{M}{1 + M \left[\frac{j\alpha}{3(3 + j\alpha)} \right]}$$
 in this case.

To determine the equivalent Q of the feedback amplifier, the relative gain $\frac{G_{max}}{G}$ is used.

$$\frac{G_{max}}{G} = 1 + M \left[\frac{j\alpha}{3(3 + j\alpha)} \right] \dots \dots \dots (1)$$

Here the Q will be defined by the shift in frequency, from that at which maximum response occurs, necessary to reduce the response to $\frac{1}{\sqrt{2}}$ of its maximum value. Denoting the difference between these two values as $\frac{\Delta\omega}{2\pi}$, and the frequency at which maximum response occurs as $\frac{\omega_0}{2\pi}$, Q is given by,

$$Q = \frac{\omega_0}{\Delta\omega}$$

Then, by setting the absolute value of $\frac{G_{max}}{G}$ in equation (1) equal to $\sqrt{2}$, the relationship between α and M may be established. Further, since the relationship between Q and α is known, the value of Q in terms of M may be derived.

$$\begin{aligned} \frac{G_{max}}{G} &= 1 + \frac{M}{3 \left(1 - j \frac{3}{\alpha} \right)} \\ &= \frac{3 \left(1 - j \frac{3}{\alpha} \right) + M}{3 \left(1 - j \frac{3}{\alpha} \right)} \end{aligned}$$

Rationalizing

$$\frac{G_{max}}{G} = \frac{\left[3 \left(1 - j \frac{3}{\alpha} \right) + M \right] \left(1 + j \frac{3}{\alpha} \right)}{3 \left(1 + \frac{9}{\alpha^2} \right)}$$

$$= \frac{\left(3 + M + \frac{27}{\alpha^2} \right) + j \frac{3M}{\alpha}}{3 \left(1 + \frac{9}{\alpha^2} \right)}$$

Then

$$\left| \frac{G_{max}}{G} \right| = \frac{\sqrt{\left(3 + M + \frac{27}{\alpha^2} \right)^2 + \left(\frac{3M}{\alpha} \right)^2}}{3 \left(1 + \frac{9}{\alpha^2} \right)} \quad (1)$$

This may now be set equal to $\sqrt{2}$. Then squaring both sides and rearranging gives,

$$\left(3 + M + \frac{27}{\alpha^2} \right)^2 + \frac{9M^2}{\alpha^2} = 18 \left(1 + \frac{9}{\alpha^2} \right)^2$$

Separating the coefficients of α :

$$\alpha^4 (M^2 + 6M - 9) + \alpha^2 (9M^2 + 54M - 162) - 729 = 0$$

The solution of this gives

$$\alpha^2 = \frac{81}{M^2 + 6M - 9}$$

or $\alpha = \pm \frac{9}{\sqrt{M^2 + 6M - 9}} \dots \dots \dots (2)$

The relationship between α and Q must now be derived.

$$\begin{aligned} \text{As stated } Q &= \frac{\omega_0}{\Delta\omega} \\ &= \frac{\omega_0}{\omega_1 - \omega_2} \end{aligned}$$

where ω_1 is the upper angular frequency to give $1/\sqrt{2}$ of the maximum response and ω_2 is the lower angular frequency to give $1/\sqrt{2}$ of the maximum response.

The relationship between ω_0 , ω_1 and ω_2 is well known, and is

$$\omega_0^2 = \omega_1 \omega_2, \text{ giving } \omega_2 = \frac{\omega_0^2}{\omega_1}$$

$$\text{Then, } Q = \frac{\omega_0}{\omega_1 - \frac{\omega_0^2}{\omega_1}} = \frac{1}{\frac{\omega_1}{\omega_0} - \frac{\omega_0}{\omega_1}} = \frac{1}{\alpha}$$

Substitution into equation (2) gives:

$$Q = \frac{\sqrt{M^2 + 6M - 9}}{9},$$

that is, the effective Q factor of the selective amplifier having a gain, without feedback, of M .

1954 PHYSICAL SOCIETY EXHIBITION

This year's Physical Society Exhibition of scientific instruments and apparatus was held at Imperial College, London, from April 8th to 13th. The accommodation available this year was somewhat restricted and exhibitors numbered 103 as compared with 130 at the 1953 Exhibition.

Because of the limited accommodation, the Council of the Society has now decided that the increasing scope of the Exhibition makes it necessary to sever the long and successful connection with the College, and it has been announced that the 1955 Exhibition will be held at the Royal Horticultural Hall.

The considerations of space appear to have resulted in a greater accent on research exhibits rather than on production equipment—an appreciated return to the original purpose of the Exhibition.

The considerable impact of research on semi-conductors was seen in an interesting demonstration exhibited by the Research Laboratories of the General Electric Company, in which a complete radio link using only transistors and germanium diodes operated at a frequency of 40 Mc/s. The very low power requirement of transistors was shown by providing the power supply for the junction transistor oscillator from a simple cell consisting of one steel and one silver plate immersed in tap water. Members of the Institution who heard the paper on crystal valves, read by Mr. B. R. A. Bettridge,* had a further opportunity of seeing and discussing this interesting experimental arrangement.

The Services Electronics Research Laboratory showed some of the properties of semi-conductor compounds formed by combining elements such as aluminium, gallium or indium with phosphorus, arsenic or antimony. The properties of these compounds have a strong resemblance to the better known semi-conductors such as silicon and germanium and they are characterized by extremely high electron mobilities which may lead to important new uses in the future.

A new development in high-power transmitting valves, shown by the Edison Swan Electric Co. Ltd., and developed in France, showed the cooling of a valve by water vapour. The valve boils the water and heat transfer is by means of the latent heat of vaporization. It is claimed that this "vapodyne system" has a number of special advantages due to the greater efficiency of the

transfer of heat from the anode and that it achieves a marked saving in space and capital outlay.

A display of electronic writing by the Admiralty Signal and Radar Establishment demonstrated the possibility of simplifying a hitherto complex problem.

To form each character, the system makes use of up to three waveforms from a resistance/capitance waveform generator. In the case of the 10 Arabic numerals the generator comprises only 26 valves to produce 14 standard waveforms which are generally half-sine or -cosine waves. These standard waveforms add together to give 9 complex waveforms and 3 blackout pulses.

The method has considerable advantages over the scanning system because of its low frequency operation, 1,500 c/s and 3 kc/s compared with 2 Mc/s. There are no coils, special components, or pre-sets, and most components are of 10 per cent. tolerance. The circuits are nearly independent of valve characteristics, and hum pick-up has little effect. Picture definition in the absence of hum depends only on spot size, which on a 12-in tube may give legible symbols only 1/32 in high. The failure of blackout pulses—the equivalent of video in scanning—produces a slightly different picture but one which is still readable.

The display was arranged as the face of a clock in which each time the second hand reaches 12 o'clock, the minute number disappears and the subsequent number moves slowly from the appropriate hour number to take its place.

An unusual arrangement of two meters was shown by British Physical Laboratories, in which two independent movements are centred above the lower corners of the rectangular scale window. This enable voltages and currents, both direct and alternating, to be simultaneously displayed and in addition, output and resistance can be measured independently as each movement has its own multiplier.

The measurement of voltages from sources of extremely high impedance is a problem in many applications, particularly in industrial electronics. One solution was shown by Electronic Instruments, in a vibrating capacitor type of mechanical "chopper". This is incorporated in an octal-based container and can be handled like a conventional valve. Several associated d.c. amplifiers, making use of this converter were shown.

* A paper presented before the London Section on April 21st, 1954.

RADIO COMPONENT SHOW

The 11th Annual Radio Component Show, organized by the Radio and Electronic Component Manufacturers Federation, was held in Grosvenor House, London, from April 6th to 8th last. 130 firms exhibited—10 more than last year and over 20 more than in 1952.

The importance of this annual exhibition is rated very highly, not only in the British radio industry but overseas, since its exhibits are of prime importance to every radio and electronics manufacturer.

Within the span of one decade the show has increased nearly sevenfold in size, for to-day the annual output of British components, valves and accessories exceeds more than one thousand million items, half this number being directly, or indirectly, exported overseas.

Noteworthy among the trends to be seen at the Exhibition were those in the field of new materials, particularly for insulation. A number of manufacturers showed assemblies and individual components encased in synthetic polyester resin. These "potted" circuits give considerable advantage in many applications, since they ensure hermetic sealing and resistance to temperature, humidity and corrosion.

Insulation of wires and cables and special insulating applications also make increasing use of synthetic materials, as was noted last year in the use of polytetrafluorethylene (P.T.F.E.). New materials now being used include terylene and silicone enamel, which have their particular advantages in general and specialized applications.

The development of cold-rolled grain-oriented silicon steel for transformers and chokes is now finding increasing use in the production of these components, and a number of manufacturers exhibited cores, complete transformers and chokes in both the "C" form and toroidal form.

The increasing demand in many kinds of equipment for "special quality" valves* was to be seen in the display of these types of valves by several of the leading valve manufacturers. The ranges of valves are likely to be extended even further in the future.

Another development in the field of valve manufacture was the availability of transistors for experimental and development use, and also, to a lesser extent, for production purposes; both point contact and junction types were shown.

The trend of future development is always to be

seen in the combined exhibit by the Services research establishments, and the stand included a number of components and materials of various kinds which had been evolved by establishments in conjunction with industrial firms.

Although obviously intended for very special defence requirements, many of these items hold potential value for civilian use, particularly where either long-term or high stability is called for.

Among the resistor applications was a small-diameter glass tube or rod carrying a metallized film, chiefly of tin oxide, cut spirally and coated for protection. The temperature coefficient of a 4-kilohm resistor constructed in this way was 0.0003 ohm/°C, and it showed no change after 2,000 hours use. Metallized films of aluminium, coated with aluminium oxide, were used to produce capacitors having self-sealing properties and high capacitance per unit area.

The stand also contained an extremely small relay, requiring operating power of 700 mW and with the armature in the form of a partially rotating shaft; it occupies a $\frac{1}{2}$ -in cube and weighs only a quarter of an ounce.

In the field of audio frequency engineering tape recorders incorporated improvements in construction (for instance, the use of printed circuit technique in switch wiring) and in the facilities offered for use in a variety of applications. The elliptical loudspeaker is now widely accepted for use in television receivers where its shape gives advantages in cabinet, layout and types were shown with improved frequency response.

The imminence of alternative television programmes in the v.h.f. waveband influenced the exhibits of both aerial and tuner manufacturers, as well as the valve manufacturers who showed double triodes, cascode amplifiers and triode frequency changers suitable for operation at frequencies up to 220 Mc/s. This is only one example of the ability of the components industry to meet varying demands in an increasing field. It may not be generally known that, whilst domestic radio and television industry absorbs, in Great Britain alone, over a million components a day, those domestic appliances account for less than half the output of the British Radio Industry.

The catalogue which is issued at the opening of the Show forms an invaluable daily reference to the research, development and production engineer.

* "Special Quality" Valves, *J.Brit.I.R.E.*, May 1953, p. 274.

NEW BRITISH STANDARDS

The British Standards Institution has recently issued the following new and revised Standards, copies of which may be obtained from the British Standards Institution, Sales Branch, 2 Park Street, London, W.1.

B.S. 1568 : 1953. Magnetic Tape Sound-recording and Reproduction for Programme Interchange. Price 2s. 6d.

Specifies the features of recording on magnetic tape and of associated recording and reproducing equipment necessary to ensure the successful interchange of recordings for broadcasting or similar purposes. It applies only to single-track full-width recordings. The recording and reproducing characteristics are those adopted by the C.C.I.R.

B.S. 2042 : 1953. Artificial Ear for the Calibration of Earphones of the External Type. Price 2s. 6d.

The standard specifies the basic features of an artificial ear for use in the objective calibration of earphones of the external type over the approximate frequency range of 50—10,000 c/s. The primary function of the device is to provide means for comparing objectively the response characteristics of an earphone under test with those of a reference earphone of the same pattern, the performance of which has been evaluated by appropriate measurements or subjective tests. For example, in the case of audiometer earphones of a given pattern, the reference earphone of this pattern is envisaged as having been calibrated subjectively in terms of the threshold of hearing of normal subjects.

The standard seeks to ensure that objective comparisons between earphones of similar pattern carried out on the artificial ear shall reproduce the comparisons which would obtain on human ears with the same earphones. It should, however, be noted that the device as specified cannot necessarily be relied upon to provide equally valid comparisons between earphones of dissimilar pattern, unless the measurements are supported by evidence as to the comparative performance of the earphones on human ears.

B.S. 2045 : 1953. Preferred Numbers. Price 2s. 6d.

The series of standardized numbers known internationally as "Preferred Numbers" are finding increasing application in the preparation of standards and in the devising of ranges of products and processes. The technical features, advantages and practical applications of these numbers are discussed fully in B.S. 1638 : 1950, "Report on the Selection of Ranges of Types and Sizes (Preferred

Numbers)," by J. E. Sears, C.B.E. The present standard has been prepared with the objects (a) of giving authoritative status to these numbers for application, where appropriate, in British practice, and (b) of providing readily accessible information on the numbers themselves for those who may have occasion to use them.

B.S. 2067 : 1953. Determination of Power Factor and Permittivity of Insulating Materials by the Method of Hartshorn & Ward. Price 4s.

This standard describes in detail the theory and technique of the Hartshorn & Ward method for the determination of power-factor and permittivity of insulating materials at radio frequencies. The method has been adopted as a standard test in certain British Standards for insulating materials, and it is suitable for the measurement of power-factor and permittivity within a frequency range of 10 kc/s to 100 Mc/s at normal room temperatures. The method is essentially one of capacitance variation in a tuned circuit with a thermionic voltmeter as a detector or resonance. Details are given of the technique to be followed in testing moulded and sheet material, tubes and liquids, and drawings are included to illustrate the basic test circuit and some of the basic equipment involved. Appendices describe the theory of the method and detail the essential features of the main components forming the test assembly.

B.S. 2076 : 1954. Thermosetting Synthetic-resin Bonded-paper Insulating Sheets for use at Radio Frequencies. Price 2s. 6d.

This is a further standard in the series dealing with synthetic-resin bonded-paper materials for use as electrical insulation. It specifies the requirements for two types of natural-coloured thermosetting synthetic-resin bonded-paper sheets between $\frac{1}{8}$ in and $\frac{1}{4}$ in thick inclusive, intended for use at radio frequencies up to and including 30 Mc/s. In this respect it is complementary to B.S. 1314 (1946), B.S. 1885 (1952) and B.S. 1951 (1953). The electrical and physical properties specified include power factor and permittivity, insulation resistance, electric strength along laminae, water absorption, shear strength, as well as those relating to machining and punching (for piercing and blanking). Methods of test to check compliance with the specification are fully described in Appendices.

TWO PROBE-TYPE CAPACITANCE METERS*

by
L. Medina†

SUMMARY

Two types of instrument are described, suitable for the measurement of wiring and component earth capacitances in electronic apparatus. The instruments have a range of 50 pF and consist of a probe and an indicator unit. In the first instrument a substitution method is used. The unknown capacitance can be read on the dial of a small variable capacitor contained in the probe. The accuracy of the instrument depends only on the stability of this capacitor. An estimate of the parallel loss resistance of the unknown capacitance is possible. In the second instrument a moving coil meter gives a direct indication of capacitance and it is suitable for production purposes. The accuracy is ± 5 per cent or ± 1 pF, whichever is greater.

1. Introduction

The performance of many types of electronic apparatus is affected by the earth capacitances of its components and wiring. An instrument for the convenient measurement of these capacitances is not only useful for developmental work but is often essential for quality control in mass production. Wiring capacitances which form an integral part of a network can be checked and adjusted, variable trimmers can be preset to save alignment time and the capacitance between coupled coils can be compared with a standard sample.

With the first instrument to be described, capacitance is measured by a substitution method. The unknown capacitance detunes a parallel resonant circuit, and the capacitance change required to restore resonance is read from the dial of a small variable capacitor contained in the probe. This instrument is particularly suitable for developmental work, its stability of calibration being dependent on the stability of one capacitor only. Also, it makes possible an estimate of the parallel loss resistance of the unknown capacitance.

For production purposes, however, there is a need for another type of instrument with a direct indication of capacitance and with a smaller probe which does not require a variable capacitor. In this, the second instrument to be described,

the accuracy depends on the stability of several components.

2. Description of First Instrument

The circuit diagram is shown in Fig. 1. The components surrounded by dashed lines are in the probe. In the octode V1, grids 1 and 2 are used as an oscillator. C4 and L2 determine the frequency, which is approximately 2 Mc/s. When the resonant frequency of C1, L1 approaches the oscillator frequency, a voltage of this frequency appears on C1 L1 due to space charge and capacitance coupling. Grid rectification occurs and, due to the flow of current in R1, there is a drop in anode current which is indicated by M. This effect has been used by

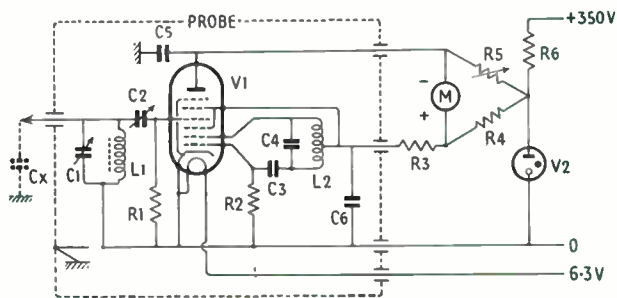

Fig. 1.—Circuit diagram of the first type of capacitance meter.

R1	3 M	C1	60 p (air-dielectric variable capacitor).
R2	0.1 M	C2	25 p
R3	10 k	C3, C4	50 p
R4	1 k	C5, C6	0.01 μ
R5	2 k		
R6	10 k		
V1	EK2 or EK32		
V2	VR150/30		
L1	Q > 100		
L2	tapped at 1/3		} to resonate at approx. 2 Mc/s.

* Reprinted from the *Proceedings of the Institution of Radio Engineers, Australia*, Vol. 14, August 1953. (Paper No. 264.)

† Division of Electrotechnology, Commonwealth Scientific and Industrial Research Organization, Chippendale, New South Wales.

U.D.C. No. 621.317.73: 621.3.011.4.

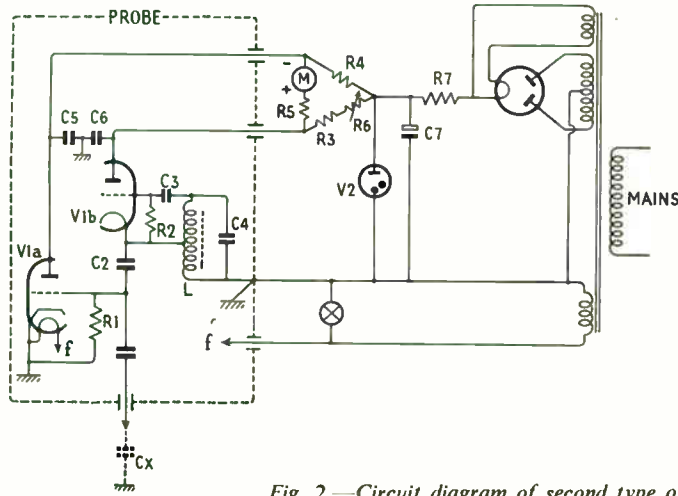

- C1 100 p
- C2 approx. 2 p (twisted pair of 26-s.w.g. enamelled wires)
- C3 10 p
- C4 50 p
- C5, C6 0.01 μ
- C7 8 μ
- R1 3 M
- R2 0.25 M
- R3 1,500 Ω
- R4 750 Ω
- R5 approx. 900 Ω (by trial)
- R6 500 Ω
- R7 7,500 Ω
- V1 12A U7
- V2 VR 150/30
- V3 5Z4
- L centre-tapped, to resonate at approx. 2 Mc/s
- M 0.1 mA

Fig. 2.—Circuit diagram of second type of capacitance meter.

Alexander.* The magnitude of the anode current change can be adjusted by means of C2 and it can be spread over the scale of a 0-1 mA moving coil instrument by means of the compensation circuit R4 R5. The unknown capacitance Cx is placed across C1, thus detuning C1 L1. The capacitance difference required to restore the anode current minimum equals Cx and can be read on the dial of C1. It is convenient to include in the probe a small variable trimmer so that the anode current minimum can be adjusted to occur with C1 near maximum. If the dial of C1 is marked zero when C1 is near maximum, this dial can be calibrated directly in Cx.

A capacitance change of 0.1 pF can be detected and this is less than the reading error of a small dial marked 0-50 pF.

The magnitude of the anode current drop diminishes with a decrease in the "Q" of L1 C1. Table 1 below gives the measured influence of parallel resistance added to L1 C1, the "Q" of which was 100. R5 was adjusted for 1000 μA deflection on M with L1 C1 completely detuned. C2 was set to 23 pF.

Table 1

Added Parallel Resistance, MΩ	∞	3	0.5	0.1	0.04	0.02
Indication of M, μA	120	200	500	620	800	870

* W. Alexander, "An electronic ultramicro-meter," *Electronic Engineering*, 23, December 1951, p. 479.

Before the advent of "Q" meters, the dependence of the anode current change on the parallel resistance of the control grid circuit as indicated in Table 1 was used by the author for the comparison of parallel-tuned circuits.†

A suitable probe for this instrument is a box 2¼ in × 2¼ in × 7½ in, made of brass. In the front portion are C1 C2, L1 and R1. The

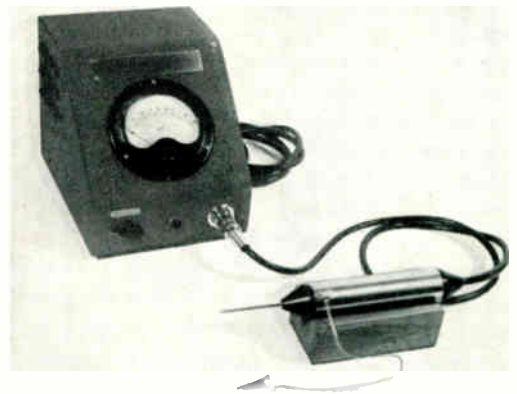

Fig. 3.—The second type of capacitance meter.

† L. Medina, "The use of the octode for measurement purposes," *OERA (Austrian Radio Amateur)*, 13, December 1936, p. 726.

octode is in the centre and the oscillator circuit and cable terminations are in the rear part. In order to eliminate hand capacitance the probe tip should be arranged so that the box acts as a screen between the knob of C1 and the probe tip.

Representative electrode currents for an EK2 tube are given in Table 2.

Table 2

Electrode	Electrode current in mA	
	At anode current minimum	L1, C1 completely detuned
anode	—	4.0
grid 3/5	2.85	2.7
grid 2	0.55	0.5
grid 1	0.10	0.08

The maximum current through M during the warming-up period was 1.2 mA.

3. Description of Second Instrument

The circuit diagram is shown in Fig. 2. The components surrounded by dashed lines are in the probe. V1 is a double-triode, the right half of which is used as an electron-coupled oscillator coupled by means of C2 to the left triode which serves as a grid-rectification type valve voltmeter. R3, R4 and zero control R6 are chosen in such a way that the anode potentials can be made equal. An unknown capacitance Cx forms, with C2, a voltage divider for the valve voltmeter grid voltage. The resulting change in anode current of V1 is indicated by M which can be calibrated in capacitance. C1 is in series with Cx and prevents overloading of M when the tip of the probe is shorted to ground. Also, by means of C1, the scale can be made open at low values of Cx and constricted at the higher values. Table 3 indicates the scale shape obtained in the instrument shown in Fig. 4.

Table 3

Capacitance pF	5	10	15	20	30	40	50
Per cent deflection of M ..	15	29	41	51	69	86	100

Because both anodes of V1 are at earth potential for r.f. the capacitance coupling between oscillator and valve voltmeter within the valve is negligibly small.

The instrument reading is influenced slightly by the power factor of Cx but the error resulting

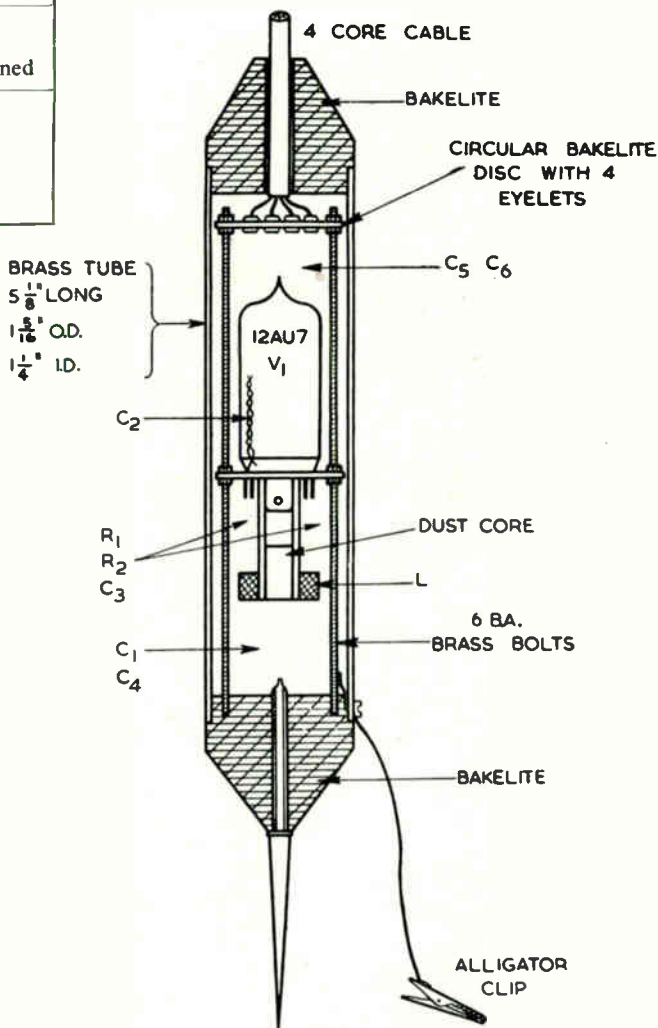

Fig. 4.—Construction of the probe of the second type of capacitance meter.

from this is small. For example, the error is $\frac{1}{2}$ per cent. for a power factor of 10 per cent. in Cx.

The stability of calibration depends on several components of the circuit and on V1. A conservative estimate of the accuracy, based on tests, is ± 5 per cent. or ± 1 pF, whichever is greater.

The construction of the instrument can be seen from Figs. 3 and 4. Typical operating currents are given in Table 4.

Changing V1 does not require a new scale, but merely adjustment of components, mainly C2 and R5.

4. Calibration and Range Extension

The calibration may be carried out by means

Table 4

Valve voltmeter anode current	4.3 mA
Oscillator anode current	2.1 mA
Reversed current during warming-up period			0.5 mA
Current through M with probe shorted	..		2.3 mA

of a variable standard capacitor or by series and parallel combinations of five mica capacitors of 10 pF.

The range of 50 pF was found to cover most requirements in practice. On the rare occasions when this was insufficient, a series capacitor of 100 or 70 pF was attached to the probe, thus extending the range to 100 or 200 pF.

Short papers and written comment on previously published work are welcomed by the Programme and Papers Committee, and members who are not in a position to contribute full-length papers to the *Journal* are invited to submit contributions of this nature.

The Committee would particularly welcome brief papers of a similar character to that published in the foregoing pages which describe the theory and construction of practical measuring equipment and the like.

Offers should be made in the first instance to the Committee and should be accompanied by a brief synopsis.