

PRACTICAL RADIO INSIDE OUT

By D.W. EASTERLING



**DETAILS OF ALL TYPES OF
COMPONENTS AND HOW TO
TEST THEM**

**ENTIRELY PRACTICAL CIRCUITS
BERNARDS RADIO MANUALS**

HR
9

or de Historie v/d Ra



PRACTICAL RADIO INSIDE OUT

BY D. W. EASTERLING

BERNARDS (PUBLISHERS) LTD LONDON W.6

General Editor:
CLIVE SINCLAIR

FIRST PUBLISHED APRIL, 1959

REPRINTED JULY, 1960

REPRINTED OCTOBER, 1961

REPRINTED MAY, 1963

REPRINTED APRIL, 1965

REPRINTED JULY, 1969

REPRINTED APRIL, 1972

© 1959

We invite all authors, whether new or well established, to submit manuscripts for publication. The manuscripts may deal with any facet of electronics but should always be practical. Any circuit diagrams that may be included should have been thoroughly checked by the author. If you are considering trying your hand at writing this type of book we suggest that you let us have a short summary of the subject you intend to cover. We will then be able to let you know the size of book required and perhaps give you some advice on presentation.

C. M. S.

Printed by Krişson Printing Limited, 184 Acton Lane, London N.W.10
for Bernards (Publishers) Ltd., The Grampians, Western Gate, London, W.6

CONTENTS

CHAPTER 1. RESISTANCE AND RESISTORS	5
CHAPTER 2. CAPACITANCE AND CAPACITORS	16
CHAPTER 3. INDUCTANCE, CHOKES AND TRANSFORMERS	28
CHAPTER 4. H.F. COMPONENTS	37
CHAPTER 5. MULTI-PURPOSE TEST GEAR	42

ILLUSTRATIONS

Fig. 1. Resistor Colour Code	6
Fig. 2. Resistor Silhouettes	7
Fig. 3. A Simple Heat Shunt	8
Fig. 4. Potentiometer Construction	9
Fig. 5. Potentiometer Resistance Gradings	9
Fig. 6. Using Ohm's Law to Determine Resistance	11
Fig. 7. A Medium and High Range Ohmmeter	11
Fig. 8. Output Voltage of a Dry Cell	13
Fig. 9. A Low Range Ohmmeter	13
Fig. 10. A Multi-Range Ohmmeter Circuit	18
Fig. 11. A Resistance Measuring Bridge Network	20
Fig. 12. Colour Codes for Capacitors	21
Fig. 13. A Direct Reading Capacitance Measure	22
Fig. 14. A Capacity Measuring Bridge Circuit	23
Fig. 15. A Magic Eye Null Indicator Circuit	24
Fig. 16. Layout for Capacitance Bridge	25
Fig. 17. Test Rig for Conditioning Electrolytic Capacitors	27
Fig. 18. Neon Leakage Tester	27
Fig. 19. A Buzzer Operated Supply for the Leakage Tester	28
Fig. 20. A Typical Mains Transformer	29
Fig. 21. A Test Rig for Measuring Impedance	30
Fig. 22. An Impedance Diagram	31
Fig. 23. Reactance: Inductance Chart	32
Fig. 24. Variable Resistance Network	36
Fig. 25. The Combined R.F. Probe and Amplifier Circuit	38
Fig. 26. One Method of Probe Construction	40
Fig. 27. Measuring Resonant Frequency	41
Fig. 28. The R.F. Test Rig	43
Fig. 29. Chart for Converting Frequency to Inductance	44
Fig. 30. The Response Curve of a Tuned Circuit	45
Fig. 31. A Suggested Layout for the R.F. Test Rig	45
Fig. 32. Combined Resistance and Capacitance Tester	46
Fig. 33. Multi-Meter Circuit	47
Fig. 34. Suggested Layout for the Combination Test Meter	48

RESISTANCE AND RESISTORS

Resistance in the electrical sense is the opposition to electron current flow in a conductor. A resistance of one ohm will cause the voltage to drop by one volt when a current of one ampere is flowing. This is related in Ohm's Law, where:

$$R \text{ (ohms)} = \frac{E \text{ (volts)}}{I \text{ (amperes)}}$$

Resistance may also be expressed in k.ohms (ohms x 10³), and M.ohms (ohms x 10⁶). In radio work, therefore, it is often more convenient to modify the above formula to:

$$R \text{ (k.ohms)} = \frac{E \text{ (volts)}}{I \text{ (milliamperes)}}$$

N.B.: milliamperes = amperes x 10⁻³.

Resistance in radio equipment may be considered from two viewpoints; first, incidental resistance which occurs in conductors, switch contacts, coil windings, and so on; secondly, resistance deliberately introduced by special components called resistors which are used to limit current, reduce voltage, and act as loads in valve circuits.

RESISTORS

Resistors may be divided into three main groups: moulded carbon, high stability carbon, and wire wound. Of the three, the first group is the most common and the cheapest.

Moulded carbon resistors have reasonably uniform characteristics and balanced performance, being useful in practically all applications where high power dissipation and stability better than ±5 per cent. are not required. They are manufactured in moulded rod form, usually protected by a lacquer coating or ceramic tube. The preferred resistance values rise approximately logarithmically to 12MΩ at tolerances of 20 per cent., 10 per cent. and 5 per cent. as follows:

PREFERRED VALUES OF RESISTANCE (OHMS)

± 5%	± 10%	± 20%
51		
56	56	
62		
68	68	68
75		
82	82	
91		
100	100	100
110		
120	120	
130		
150	150	150
160		
180	180	
200		
220	220	220
240		
270	270	
300		
330	330	330
360		
390	390	
430		
470	470	470
510		
560	560	
620		
680	680	680
750		
820	820	
910		
1000	1000	1000
1100		
1200	1200	

and in multiples of 10 up to 12,000,000 ohms

High stability carbon resistors are used where the specification of moulded types is not adequate. The construction consists of an element of carbon deposited on a ceramic rod by the cracking of gasses (often this type are called "cracked carbon") and then spiral cut to the required resistance value and tolerance. The resultant stability is often better than 0.5 per cent., while the temperature and voltage coefficients are substantially less than for moulded types. High stability carbon resistors are manufactured in values ranging from 10Ω to 12MΩ, although these may be in precise values as well as in preferred steps. Both moulded and high stability carbon resistors are in the low power dissipation class, and typical power ratings range from one tenth to 5.0 watts.

Wire wound resistors are available in many different types, and are generally used in circuits where heavy current is flowing, and consequently a high power rating is required. Wire wound resistors of extremely low value may be constructed more conveniently and with greater accuracy than is possible with carbon types. Sometimes advantage is taken of the different temperature coefficients of various resistance wire to balance out changes occurring in the circuit due to changes in temperature, or as a method of precision temperature control.

Nichrome wire is suitable for operation at high temperatures, but has a high temperature coefficient. It is suitable for the construction of resistance values with ± 5 per cent. and ± 10 per cent. tolerances. For precision resistors constantan or eureka is used, when tolerances of ± 1 per cent. are possible.

Wire wound resistors are usually grouped according to their finish or protective coating which may be paint, cotton, vitreous, or other materials bearing various trade names. Often the resistance wire is left bare, and wound on a former in a similar fashion to an electric fire bar. One advantage with this type of resistor is that it is possible to arrange tappings (often adjustable) between the end terminals.

THE COLOUR CODE

The resistance value of a resistor is identified by black characters or colour coding printed on the body; generally the first method is used for large resistors and the second method for small resistors including nearly all moulded types. The colour code arrangement is illustrated in Fig. 1.

N.B.: Band (A) double width indicates a wire wound resistor. A fifth band of salmon pink indicates a high stability type

Colour	(A) First Digit	(B) Second Digit	(C) Multiplier	(D) Tolerance
black	0	0	-	-
brown	1	1	10	$\pm 1\%$
red	2	2	100	$\pm 2\%$
orange	3	3	1000	-
yellow	4	4	10000	-
green	5	5	100000	-
blue	6	6	1000000	-
violet	7	7	10000000	-
white	8	8	-	-
grey	9	9	-	-
gold	-	-	0.1	$\pm 5\%$
silver	-	-	0.01	$\pm 10\%$
none	-	-	-	$\pm 20\%$

Fig. 1 Resistor Colour Code.

i.e. A 47k.ohm resistor would be coded as follows:

band (A) yellow.

band (B) violet.

band (C) orange.

Unless there was a fourth band brown, red, gold or silver, the tolerance would be 20 per cent. Incidentally, the manufacturer determines the tolerance after manufacture, and so it is unlikely that a 20 per cent. resistor is nearer than 10 per cent. or a 10 per cent. resistor nearer than 5 per cent.

POWER RATING

For most small resistors, size has no relation to the resistance value, but it often indicates the maximum power dissipation value. Fig. 2 gives the silhouettes of some typical carbon resistors drawn actual size, and may be used as a chart for determining the rating of these components. The values quoted are for conditions where the ambient temperature is 70°C. Operating the component at a higher rating is permissible when the ambient temperature is lower; for instance, the rating of moulded types can be increased by 100 per cent., and for high stability types by 50 per cent. when the ambient temperature is reduced to 40°C. In any case it is good practice not to let the power dissipated by a resistor exceed 60 per cent. of its rated value.

The power which is dissipated by a resistor may be calculated as follows:

$$P \text{ (watts)} = E \text{ (volts)} \times I \text{ (amperes)}$$

From the above may be derived:

$$P \text{ (watts)} = I \text{ (amperes)}^2 \times R \text{ (ohms)}$$

HIGH FREQUENCY OPERATION

The effect of capacitance and inductance becomes more noticeable as the frequency increases. With carbon resistors, the effect of inductance is negligible compared with capa-

capitance which may be from 0.1 to 1.00pF. This capacitance is spread along the entire length of the component and is difficult to tune out; in some cases it may produce an effective reduction of 90 per cent. of the resistance value at D.C.

Wire wound resistors are usually of solenoid construction, and, therefore, mainly inductive, but this does not matter when they are used in circuits where the frequency response is unimportant. Where frequency response is to be considered, and for some reason carbon resistors are undesirable, wire wound resistors adopting the Ayrton Perry method of winding may be used: this is two windings connected in parallel but wound in opposite direction along the former.

NOISE IN RESISTORS

All resistors have inherent noise due to thermal agitation ("Johnson noise"), and current or resistance noise; the latter caused by minute changes in resistance, proportional to the applied D.C. potential across the resistor. The noise due to the above effects are small, however, compared with that generated by a faulty component where the actual resistance element is broken, and consequently making an intermittent connection. This fault is not always obvious to visual inspection as it may be hidden by the protective coating, but it can often be traced by measuring the resistance value, and at the same time gently tapping the suspected component. The only cure is replacement.

Besides introducing current noise, there is a possibility that a breakdown will occur if excessive D.C. potential is applied across a resistor. Limiting values for typical carbon resistors are given as follows:

Type	Power Rating (at 70°C.)	Maximum D.C. PK Volts
Moulded carbon (lacquered)	2.5 watts	1500v
	1.0 watts	1000v
	0.1 watts	125v
Moulded carbon (ceramic insulated)	1.0 watts	1000v
	0.5 watts	1000v
	0.25 watts	700v
High stability carbon (ceramic insulated)	1.0 watts	750v
	0.5 watts	500v
	0.25 watts	350v

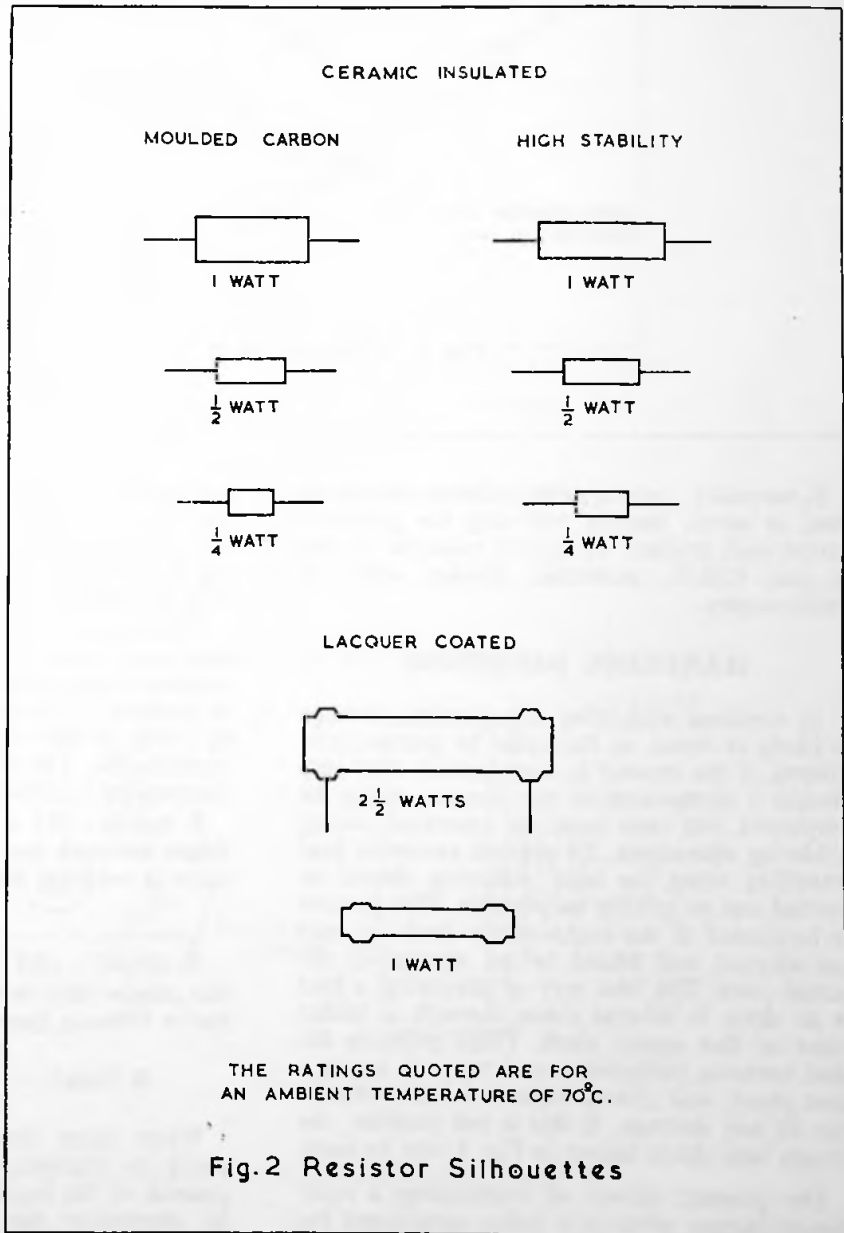

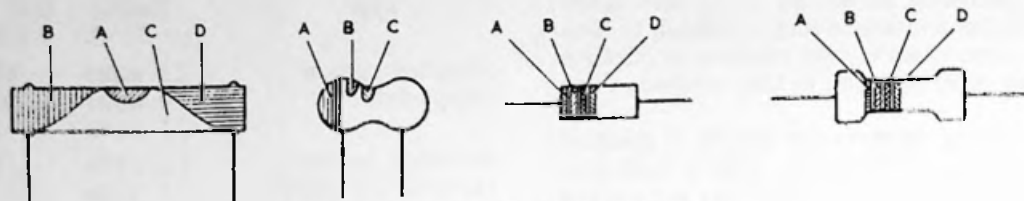

Fig. 1 The Resistor Colour Code

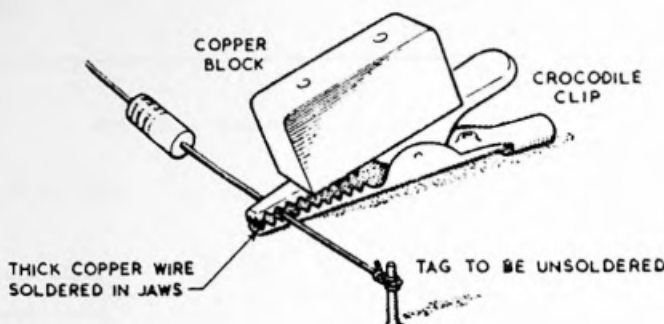

Fig. 3 A Simple Heat Shunt

If necessary, two or more resistors should be used in series, thereby reducing the potential across each resistor. A typical example of this is the C.R.T. potential divider used in oscilloscopes.

HANDLING RESISTORS

In common with other components, damage is likely to occur, or the value be permanently altered, if the resistor is over heated. Not only should a component of the correct rating be employed, but care must be exercised during soldering operations. To prevent excessive heat travelling along the lead, soldering should be carried out as quickly as possible. This process is facilitated if the component's leads or tags are cleaned and tinned before attempting the actual joint. The best way of preparing a lead is to draw it several times through a folded piece of fine emery cloth. Pliers gripping the lead between component and tag will act as a heat shunt, and absorb excessive heat before it can do any damage. If this is not possible, the simple heat shunt shown in Fig. 3 may be used.

The greatest chance of overheating a component occurs when it is being unsoldered for

test purposes. Again, the heat shunt should be used, but it is often safer to cut the component out of circuit rather than to attempt unsoldering it; making sure, however, to leave sufficient lead for reconnecting later.

When replacing a resistor, the correct value, type, and rating should be used. Sometimes a suitable component is not in stock, but it may be possible to obtain the correct value or rating by using several resistors in parallel or series combination. The total resistance of more than one resistor in series is found by:

$$R \text{ (total)} = R1 + R2 + R3 \text{ and etc.}$$

When resistors are in parallel, the total resistance is reduced, and the formula is:

$$\frac{1}{R \text{ (total)}} = \frac{1}{R1} + \frac{1}{R2} + \frac{1}{R3} \text{ and etc.}$$

But where only two resistors are involved, the above formula may be simplified to:

$$R \text{ (total)} = \frac{R1 \times R2}{R2 + R1}$$

When more than one resistor is used in series or parallel, the current paths are increased, or the applied potential reduced, thereby decreasing the power dissipated by each

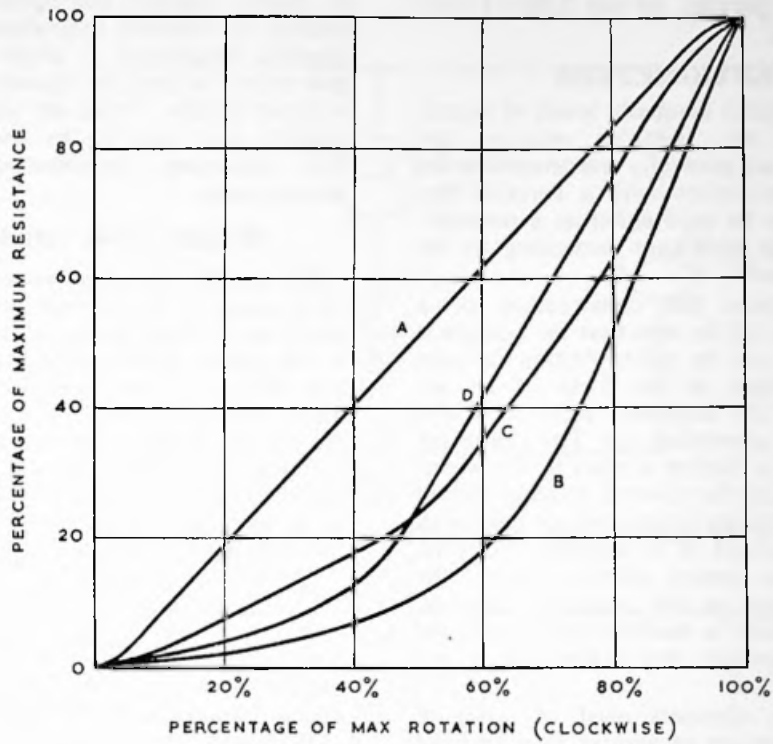

Fig. 5 Potentiometer Resistance Gradings

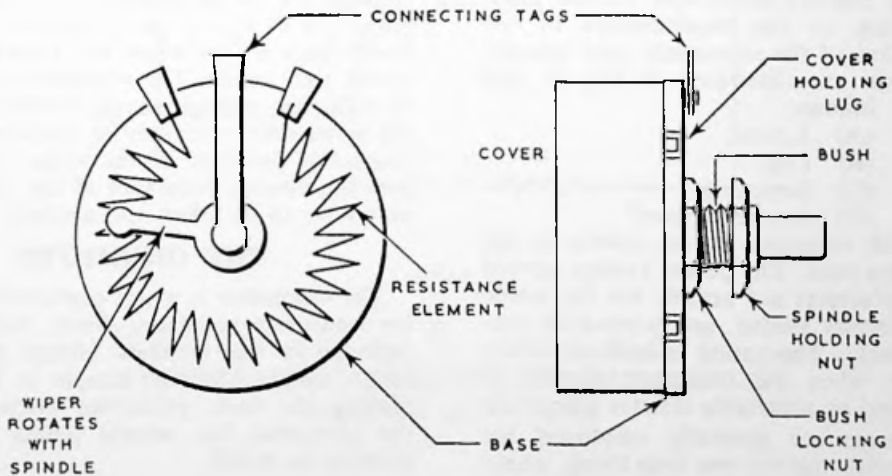

Fig. 4 Potentiometer Construction

resistor. For example, one $5k\Omega$ resistor rated at 1 watt could be replaced by two $10k\Omega$ $\frac{1}{2}$ watt resistors in parallel, or two $2.5k\Omega$ $\frac{1}{2}$ watt resistors in series.

POTENTIOMETERS

In order to control manually levels of sound, brightness, and etc., variable resistors are available. These are generally constructed in the form of a potentiometer with a variable tap, but can of course be used either as a potentiometer or variable resistance according to the circuit requirements.

Fig. 4 illustrates the construction of a potentiometer. It will be seen that the resistance element, which can be either carbon or wire wound, is arranged in the form of an arc (approximately 270 degrees), with each end terminated by a connecting tag. The centre tag is connected via a friction contact to the wiper, which rotates with the control spindle, but at the same time making continuous contact with the resistance element. It is possible, therefore, by adjusting the control spindle, to set the wiper at any point on the resistance element. Although the wiper is mechanically connected to the control spindle, this connection is not necessarily electrical.

The resistance elements used in potentiometer construction are as various as with fixed resistors. The values range from 10Ω to above $2M\Omega$, and from 1 to 30 watts. Wire wound elements are used for low resistance values and high power ratings, and carbon elements for high resistance values and low power ratings. The variation of resistance to spindle rotation is not necessarily linear as elements are manufactured with various gradings according to the requirements of the designer. A few of the commonly used element grading curves are illustrated in Fig. 5, and described as follows:

- (A) Linear;
- (B) Log;
- (C) Semi-Log;
- (D) Linear tapered.

Elements with resistance curves inverse to the above are also used. The power ratings quoted by the manufacturer are usually for the whole element uniformly loaded, and wound or constructed linearly. The rating is reduced, often considerably, when the resistance element is graded or used as a variable resistor (rheostat).

Two methods are generally employed for mounting potentiometers: one hole fixing, where the control is held by a nut fitted to a centrally mounted threaded bush inserted in a hole in the chassis approximately $\frac{3}{8}$ in. diameter; or two hole fixing, where the central bush is discarded, and the control held to the chassis by

two 6BA bolts one inch apart screwed into the base of the control. Several potentiometers may be ganged together and operated by the same spindle, or operated individually by concentric spindles. Sometimes a single pole or double pole switch is fitted to operate from the potentiometer spindle. These are usually moulded in bakelite, and fitted to the back of the control with connecting tags separate to those of the potentiometer.

MEASURING RESISTANCE

As already shown on page 1, the resistance of a circuit or component may be determined when the voltage across it, and the current in it, are known. Referring to Fig. 6 it will be seen that the circuit has been broken in order to insert a current meter. The voltage across R and the current meter is measured by connecting a voltmeter in parallel. From the current and voltage readings obtained, the combined resistance of R and the current meter in series may be found using Ohm's Law:

$$R \text{ (total)} = \frac{E \text{ (volts)}}{I \text{ (amperes)}}$$

The value of R only may be found by deducting the resistance of the current meter from the results obtained above.

If a single multi-meter is used to make both voltage and current readings (as is often the case) the measurements would have to be made separately. The results obtained will be accurate only if the internal resistance of the meter when measuring volts is considerably greater than the value of R, or the impedance of the supply source is low. Otherwise the increased current through the circuit caused by the voltmeter in parallel with R will make the indicated voltage lower than it was when the current measurements were made. The possibility of switching to a higher voltage range, thereby increasing the meter resistance, may be considered to overcome this problem. If the value of R is very low, the internal resistance of the current meter may have to be taken into account also.

THE OHMMETER

The ohmmeter is a self contained instrument for measuring resistance direct, and is usually included in the facilities offered by a multi-range meter. Although simple in design, employing the basic principles discussed above, the ohmmeter has several points worth considering in detail.

In its simplest form, the ohmmeter consists of a current meter in series with a dry battery and a resistor, this latter component being selected so that when the circuit is closed the meter reads exactly full scale deflection. If the

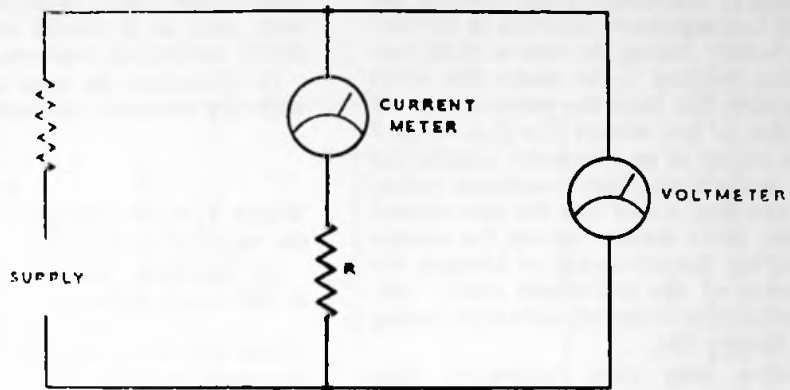

Fig. 6 Using Ohm's Law to Determine the Value of R

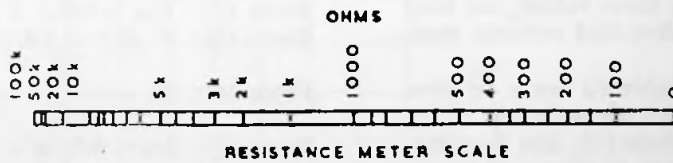
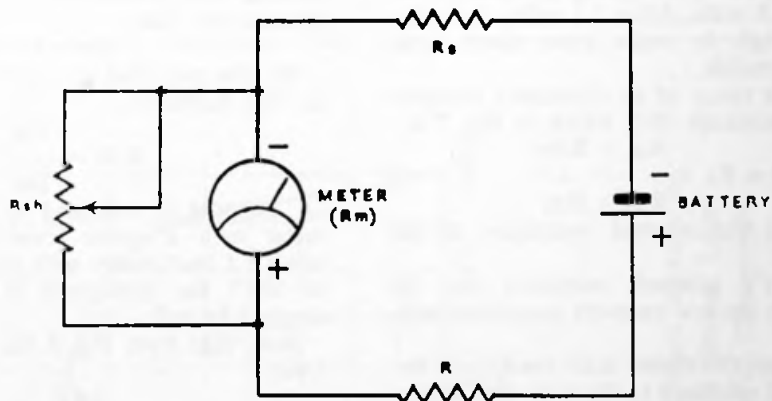

Fig. 7 A Medium and High Range Ohmmeter

circuit is broken and a unknown resistance inserted, the meter indication will be less than full scale by an amount depending on the value of the unknown resistance.

In a practical instrument some method has to be found to compensate variation in the output of the battery during the course of its useful life. One method is to make the series resistor variable, but from the point of view of accuracy, this is not always the best. Fig. 7 illustrates a circuit of an ohmmeter suitable for measuring medium and high resistance values. It will be seen that in this case the zero control is a variable shunt resistor across the current meter. This has the advantage of keeping the total resistance of the instrument nearly constant, so maintaining constant calibration during the useful battery life.

To improve long term calibration even further, component values and calibration should be set according to the average battery voltage. Fig. 8 illustrates a typical life curve for a battery used in an ohmmeter. It will be noticed that the voltage quickly drops from its maximum of 1.5 volts to just above 1.4 volts. The curve then flattens out for 60 to 80 per cent. of the life, and from 1.3 volts drops quickly to zero. It would seem, therefore, that the average value is 1.4 volts, and that the zero adjuster should be capable of permitting operation from 1.5 volts to 1.3 volts. After 1.3 volts, the drop is rapid enough to make even short term accuracy impossible.

The effective range of an ohmmeter depends on its total resistance (R_t), which in Fig. 7 is:

$$R_t = R_s + \frac{R_m \times R_{sh}}{R_{sh} + R_m}$$

Where R_m is the internal resistance of the current meter.

The battery's internal resistance can be ignored due to the low currents associated with this circuit.

R_t determines the centre scale reading of the ohmmeter, and reference to the scale also shown in Fig. 7 will show that the calibration is reasonably accurate from one tenth to ten times this value. Above these values, the scale closes up to such an extent that accurate reading is not possible.

The current meter suitable for use in an ohmmeter should have a full scale deflection of not more than 1.0mA and preferably less than this, otherwise it will be necessary to use an inconveniently high battery voltage to attain high resistance ranges. In practice the ohmmeter is often combined with a multi-meter which also measures voltage and current, and consequently it is these factors which determine the type and sensitivity of the actual meter movement.

It would be pointless to quote absolute component values for a practical ohmmeter as these will depend on the meter available and also the resistance range to be covered. The method of determining these values is given below, however, and so it should be an easy matter to satisfy individual requirements.

(1) Calculate the total current in the circuit with (R) terminals shorted:

$$I = \frac{V}{R_t}$$

Where V is the average battery output, and R_t the required centre scale reading.

(2) Calculate the potential across the meter at full scale deflection:

$$V_m = I_m \times R_m$$

Where I_m is the maximum current reading of the meter at full scale deflection.

(3) The voltage to be dropped by R_s , therefore, is:

$$V(R_s) = V - V_m$$

(4) The value of R_s may now be calculated by:

$$R_s = \frac{V(R_s)}{I}$$

(5) At full scale deflection the meter current is I_m , but the total current in the circuit (I) exceeds this amount by I_{sh} and has to be shunted by R_{sh} :

$$I_{sh} = I - I_m$$

(6) The potential across R_{sh} will be the same as V_m , therefore:

$$R_{sh} = \frac{V_m}{I_{sh}}$$

i.e., suppose it is desired to construct an ohmmeter with a centre scale reading of 1000 Ω using a 1.0mA meter with an internal resistance of 100 Ω , the instrument to be powered by a single 1.5v cell.

Note that from Fig. 8 the average voltage is 1.4v.

$$\text{From (1): } I = \frac{1.4}{1000} = 0.0014\text{A}$$

$$\text{From (2): } V_m = 0.001 \times 100 = 0.1\text{v}$$

$$\text{From (3): } V(R_s) = 1.4 - 0.1 = 1.3\text{v}$$

$$\text{From (4): } R_s = \frac{1.3}{0.0014} = 938.6\Omega$$

$$\text{From (5): } I_{sh} = 0.0014 - 0.001 = 0.0004\text{A}$$

$$\text{From (6): } R_{sh} = \frac{0.1}{0.0004} = 250\Omega$$

The value of R_{sh} is shown as 250 Ω , but this is only when the cell potential is 1.4v. The maximum and minimum values may be found as follows:

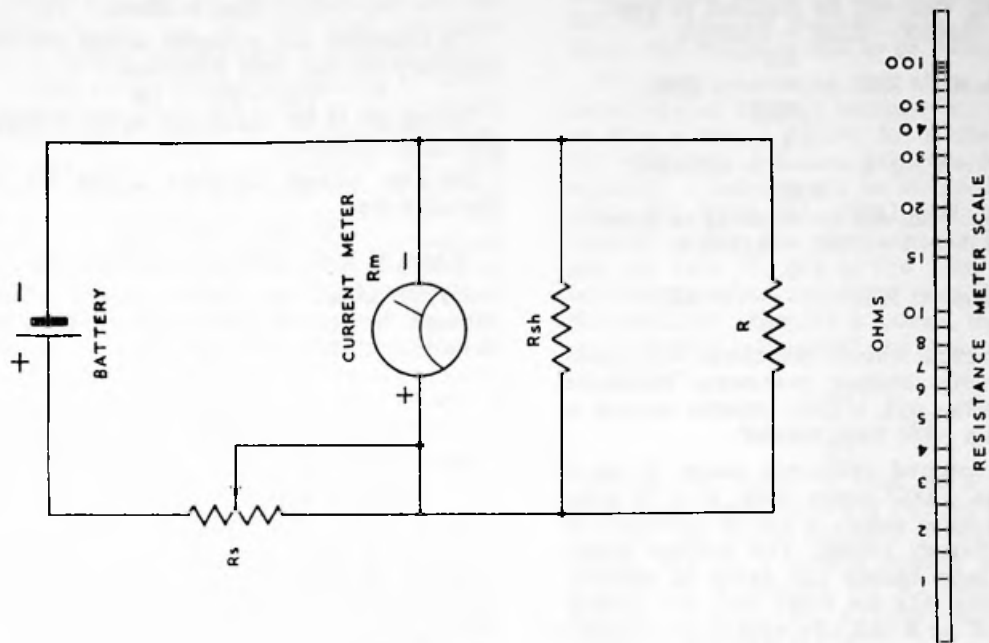

Fig. 9 A Low Range Ohmmeter

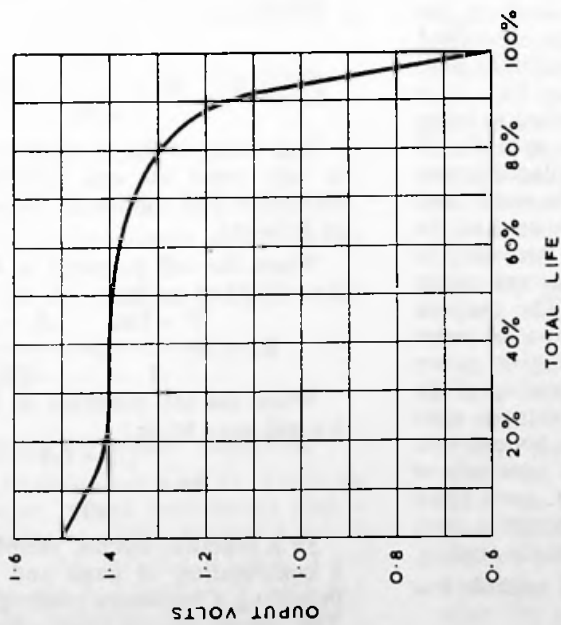

Fig. 8 Chart showing the Output Voltage of a Dry Cell during its Normal Life Period when used in an Ohmmeter.

$$\text{When } V = 1.5\text{v: } I = \frac{1.5}{1000} = 0.0015\text{A}$$

Therefore, Rsh will be required to pass:
 $0.0015 - 0.001 = 0.0005\text{A}$

$$\text{Consequently: } R_{sh} = \frac{0.1}{0.0005} = 200\Omega$$

$$\text{When } V = 1.3\text{v: } I = \frac{1.3}{1000} = 0.0013\text{A}$$

Therefore, Rsh will be required to pass:
 $0.0013 - 0.001 = 0.0003\text{A}$

$$\text{Consequently: } R_{sh} = \frac{0.1}{0.0003} = 333\Omega$$

In a practical circuit, therefore, Rsh could be a variable resistor maximum resistance 350Ω , or better still, a 250Ω variable resistor in series with a 100Ω fixed resistor.

If the required resistance range is much higher than 1000Ω centre scale, then in order to use the same meter, it will be necessary to raise the battery voltage. The average potential of a large battery can easily be deduced by deducting 0.1v for every cell; the average potential of an 8 cell 12v battery for instance will be 11.2v.

A LOW VALUE OHMMETER

The circuit in Fig. 7 is unsuitable for a low range ohmmeter (i.e., 10Ω centre scale say) because the total ohmmeter resistance would be low enough to cause a severe load on the battery, and the resistance values concerned with the circuit would be inconveniently low; consequently the circuit shown in Fig. 9 is preferred. In this circuit, Rs is adjusted to bring the meter to full scale deflection with the R terminals open circuit. When R is placed across the terminals, it effectively shunts the meter, and reduces the current indicated. Rs is used as the zero control, as in this circuit it is necessary to keep the resistance across the current meter constant to maintain calibration. The purpose of Rsh is to bring the resistance across the meter to a convenient value. This effective meter resistance is also the centre scale reading of the ohmmeter. A typical low value resistance scale is shown in Fig. 9, and it will be noticed that although the scale appears to run inversely to that of the other ohmmeter circuit, once again the most accurate readings are possible from one tenth to ten times the centre scale reading.

The calculations for designing a suitable low range ohmmeter are as follows:

(1) Decide the centre scale reading; this also determines the effective meter resistance (R_{em}).

(2) Calculate the value of Rsh:

$$R_{sh} = \frac{R_{em} \times R_m}{R_m - R_{em}}$$

(3) Calculate the potential across the meter necessary for full scale deflection:

$$V_m = R_m \times I_m$$

Where I_m is the maximum meter reading at full scale deflection.

(4) The voltage dropped across Rs must therefore be:

$$V(R_s) = V - V_m$$

Where V is the average cell potential.

(5) Calculate the total current flowing through the circuit when meter is at full scale deflection, and R terminals are open circuit.

$$I = \frac{V_m}{R_{em}}$$

(6) Calculate the value of Rs:

$$R_s = \frac{V - V_m}{I}$$

i.e., if it is desired to construct an ohmmeter with a centre scale reading of 10Ω using a 0.1mA meter with an internal resistance of 100Ω , the procedure would be as follows:

$$\text{From (2): } R_{sh} = \frac{10 \times 100}{100 - 10} = 11.1\Omega$$

$$\text{From (3): } V_m = 100 \times 0.001 = 0.1\text{v}$$

$$\text{From (4): } V(R_s) = 1.4 - 0.1 = 1.3\text{v}$$

$$\text{From (5): } I = \frac{0.1}{10} = 0.01\text{A}$$

$$\text{From (6): } R_s = \frac{1.3}{0.01} = 130\Omega$$

The value of Rs is shown as 130Ω , but this is only when the cell potential is 1.4v. The maximum and minimum values may be found as follows:

When the cell potential is 1.5v, the value of Rs will have to be:

$$R_s = \frac{V - V_m}{I} = \frac{1.5 - 0.1}{0.01} = 140\Omega$$

When the cell potential is 1.3v, the value of Rs will have to be:

$$R_s = \frac{1.3 - 0.1}{0.01} = 120\Omega$$

In a practical circuit, therefore, Rs could be a combination of fixed and variable resistors providing a resistance coverage of 120 to 150Ω . The circuit should also contain a switch to isolate the battery when the instrument is not in use.

A MULTI-RANGE OHMMETER

Fig. 10 illustrates a multi-range ohmmeter combining the two circuits discussed above. B1 is a single 1.5v cell which supplies the low and medium ranges, but for the high resistance range a further battery (B2) is also in circuit. For a high range centre scale reading of 100kΩ using a 1.0mA meter, B2 would be in the region of 120v. S1a, b, and c, is a single three pole, three way switch. The components VR1 and R1 are calculated in the same way as Rs and Rsh in the low range ohmmeter; VR2 and R2 in the same way as Rsh and Rs in the medium range ohmmeter; and VR3 and R3 the same as VR2 and R2, except that the higher range and battery voltage are taken into account. In order to conserve the battery the instrument should normally be left on either of the two higher resistance ranges, as no separate switch is provided to isolate the battery on the low resistance range.

CALIBRATING OHMMETERS

The easiest way to calibrate an ohmmeter is to apply a set of known resistance values to the R terminals, marking the scale accordingly. If possible a standard resistance box should be used, or a set of close tolerance, high stability resistors. A much less accurate method, but one suited to the constructor with limited facilities, is to apply as many ordinary wide tolerance resistors as possible, noting the reading for each value and from these drawing a set of average figures which will be used for final calibration. If desired, the instrument may be calibrated by a set of figures deduced mathematically as follows:

- (1) To calibrate the low range ohmmeters:

$$I \text{ (mA)} = \frac{V}{1 + \left\{ \frac{R_s \times R_{em} + R}{R_{em} \times R} \right\}} \times \frac{1000}{R_m}$$

Where I (mA) is the current meter reading in mA.

- (2) To calibrate the medium and high range ohmmeters:

$$I \text{ (mA)} = \frac{R}{R + R_t} \times \frac{I_m}{1}$$

THE WHEATSTONE BRIDGE

This circuit, illustrated in Fig. 11, forms the basis of a number of test instruments and so is worth considering in detail. Regard it as two potential dividers: R1:R2, and R3:R4. It will be seen that the top and bottom of each network is taken to opposite sides of a battery, while the centre taps are taken to opposite sides of a suitable indicator. It will be apparent that

if the potential dividers are identical, the voltage at point (C) will be the same as at (D), and consequently there will be no potential difference between points (C) and (D) with the result that the indicator registers zero. At this condition, the bridge is said to be balanced.

The most interesting part about the bridge circuit is that it is not necessary for the values of each potential divider to be the same for the bridge to balance, only the ratios. For example, a balance can be obtained if R1 is 100Ω, R2 400Ω, R3 1000Ω, and R4 4000Ω, because in this case the ratio R1:R2 is 1:4, and the ratio R3:R4 is 1:4 also. It will be realised, therefore, that if the ratio R1:R2 and the resistance value R4 is known, then providing the bridge is balanced, the value of R3 may be deduced.

$$R_3 = \frac{R_1}{R_2} \times R_4$$

When the bridge is used as a measuring instrument, the unknown is inserted in place of R3 and the bridge balanced by adjusting R4 (which can be a decade resistor box) while maintaining a constant R1:R2 ratio; or alternatively, making R4 a fixed standard, and adjusting the ratio R1:R2.

TESTING RESISTORS

The first step in any test is a visual examination, and this especially applies to resistor testing. Damaged leads or body are easily identified, unless the actual carbon resistance element is broken inside its ceramic housing. Signs of overheating should also be looked for as this may imply a large change in resistance value, thereby increasing the current through the component, or perhaps a fault elsewhere in the equipment. Overheating often effects the coding colours, making orange look brown, yellow like orange, and so on. If overheating is suspected, the correct value of the component is suspect, and should be ascertained by methods other than the colour code. In any case, severe overheating may seriously effect the reliability of the component, and so it may be better to scrap it now rather than waste time later.

Once the correct resistance value is known, it may be compared with a reading taken with an ohmmeter or bridge circuit. If the difference exceeds the tolerance the component is suspect. While the resistance measurements are being made, the component should be gently tapped. Wide fluctuations in resistance readings will indicate a faulty resistance element or resistance winding. This test is particularly necessary when the component under test is suspected of generating excessive noise of an intermittent nature. Care should be exercised to see that the

resistance being measured is not shunted by any incidental parallel circuit. This parallel path may be the operators body if the component or leads are being handled at the time.

TESTING POTENTIOMETERS

As well as the tests discussed in connection with fixed resistors, additional tests may be made with potentiometers. The wiper should make contact with the resistance element smoothly along its complete track. This is easily checked by connecting an ohmmeter between one side of the element and the wiper, and noticing whether the change in resistance is even compared with spindle rotation, bearing in mind the resistance gradings illustrated in Fig. 5.

A potentiometer with a resistance change which is erratic compared with its spindle rotation is said to be "noisy". This trouble may be due to loose carbon granules or other matter between the wiper and element. A cure is often possible by removing the cover and carefully wiping the track with a piece of fine toilet tissue; finishing with a faint smear of vaseline. If the control is fitted with a switch, re-assembly will be facilitated by turning the spindle almost fully clockwise before removing the cover.

When the control has a wiper which should be insulated from the spindle, this can be checked using an ohmmeter, but it is better to use the leakage tester described in Chapter Two in connection with capacitors. This tests up to about 250v which is suitable for most purposes although the factory often test at potentials exceeding 1000v.

When the control is fitted with a switch, insulation between switch connections should be checked similarly to the wiper/spindle test. Continuity tests across switch contacts should also be made, with resistances below 5Ω preferred.

CHAPTER 2

CAPACITANCE AND CAPACITORS

When there are two adjacent electrical conductors with different potentials, a force or strain exists between them rather in the same way that a magnetic force exists between magnetic poles. This force, measured in dynes, is calculated by:

$$F \text{ (dynes)} = \frac{Q_1 \times Q_2}{d^2}$$

Where Q_1 and Q_2 are the electrical charges on each conductor measured in coulombs, and d is the distance between them measured in centimetres.

As with magnets, the force either attracts or repels, so that when one conductor is positive, negative electrons will be attracted to the other conductor, building up a charge depending on the CAPACITY of the circuit.

$$\text{Capacity (farads)} = \frac{Q \text{ (charge in coulombs)}}{E \text{ (volts)}}$$

The farad, which is the basic unit of capacitance, is inconveniently large for radio work and so micro-farads (μF) which are farads $\times 10^{-6}$; or micro-micro-farads (μF) which are farads $\times 10^{-12}$; are preferred. Incidentally, micro-micro-farads are often referred to as picofarads (pF).

Besides the stray capacitance existing between conductors, screens, chassis and coil windings, capacitance is often deliberately introduced into a circuit by special components called capacitors. These are used to resonate inductors to specified frequencies, and in coupling or decoupling networks, especially where D.C. isolation is to be maintained.

CAPACITORS

In its simplest form, the capacitor consists of two metal plates separated by an insulator (dielectric). With this arrangement, the capacitance is approximately:

$$C \text{ (pF)} = \frac{A \times K}{11.31 \times d}$$

Where A is the useful area of each plate in square centimetres, d is the distance between them in centimetres, and K is the dielectric constant.

Although the reader is referred to practically any radio reference book for a comprehensive list of dielectric constants, a few are given below as a matter of interest:

Air (normal pressure)	1.0
Ebonite	2.8
Glass	6.5 to 8.5
Glass (Pyrex)	4.9
Mica	8.0
Paper (dry)	2.0 to 3.0
Paraffin Wax	2.3
Porcelain	6.5
Quartz	4.5
Resin	3.3

The dielectric constant of plastics vary with the type and formula from 2.5 to 20.

In order to attain large capacitances, plates may be stacked with alternate plates connected in parallel. When flexible plates and dielectric are used, they may be rolled into a tube. Some capacitors actually have the conductive plate etched on to the dielectric material, while with others the dielectric is a gas formed by electrolytic action.

Capacitors are usually grouped according to the dielectric and the style of manufacture, each type being particularly suited to certain jobs. Capacitors generally used in radio and television equipment are listed as follows:

1. **AIR DIELECTRIC.** Except for transmitting apparatus, not usual in fixed capacitors, but variable capacitors using air dielectric are used extensively.

2. **ELECTROLYTIC.** Uses gas formed by electrolytic action; electrolyte in paste or liquid form held by absorbent material between conductive plates made of aluminium foil. This method of construction enables high capacities to be obtained in small space. Typical capacitances are from $2\mu\text{F}$ to $1000\mu\text{F}$, with working voltages ranging from 1.5 to 600. Normally used for A.F. decoupling and h.t. filters. D.C. potential at correct polarity to be maintained during operation; not suitable for coupling circuits where high A.C. potentials are present.

3. **ELECTROLYTIC (ETCHED FOIL).** Etching foil permits greater capacitances to be achieved compared with plain foil types. Uses as above except where high ripple current is present. Not suitable as first h.t. filter capacitor in a smoothing circuit.

4. **ELECTROLYTIC (SUB MINIATURE).** Capacity range from 2.0 to $32\mu\text{F}$; working voltages from 1.5 to 25. Uses same techniques as other electrolytic capacitors, but specially suitable for transistor and other miniaturised low impedance circuits.

5. **PAPER TUBULAR.** Paper dielectric, wax impregnated; tropicalised or "rugged" types housed in plastic or metal cans. Capacities from .0005 to $1.0\mu\text{F}$; working voltages from 200 to 1000. Used as a general purpose capacitor at radio, video, and audio frequencies.

6. **PAPER TUBULAR (PLASTIC IMPREGNATED).** Capacities from .0005 to $1.0\mu\text{F}$; working voltages from 1,000 to 20,000. Used in e.h.t. circuits.

7. **PAPER CAPACITORS IN METAL RECTANGULAR CANS.** Capacities from 0.1 to $10\mu\text{F}$; working voltages from 250 to 2,000. Used where electrolytic capacitors are not suitable.

8. **MICA (STACKED FOIL).** Capacities from .00005 to $.01\mu\text{F}$; working voltages from 350 to 750. Used as a general purpose capacitor at radio frequencies.

9. **MICA (SILVERED).** Conductive plate is silver deposited on mica dielectric and etched to correct capacity. This method permits closer tolerances and better stability to be obtained. Capacities from 5pF to $.01\mu\text{F}$ at 350 volts working. Used as general purpose capacitor at high frequencies where a better specification than

that offered by stacked foil types is necessary, or where capacities below 50pF are required.

10. **CERAMIC (WITH SPECIFIED TEMPERATURE CO-EFFICIENTS).** Capacities from 0.5 to 1000pF at 500 volts working. Low loss capacitors with high insulation resistance and small dimension, suitable for use in equipment operating at very high frequencies. Types with large positive or negative temperature co-efficients used for temperature compensation.

11. **CERAMIC (Hi-K).** Capacities from 50 to $10,000\text{pF}$ at 500 volts working. These capacitors are manufactured to fairly wide tolerances and indeterminate temperature co-efficients. They are not suitable for compensation purposes, but are used for by-passing and other non-critical applications. The shape of these capacitors vary considerably depending on their application, from discs to lead-through bushes; the chief advantage being small size compared with capacity.

VARIABLE AND TRIMMER CAPACITORS

Variable capacitors permit the capacitance of a circuit to be varied manually (for tuning purposes for instance). The majority of variable capacitors are air dielectric, although some of the early types used mica or specially treated paper. Typical construction is such that the spindle, frame, and moving vanes are electrically connected, while the fixed vanes are mounted on small insulators made of ceramic, porcelain, or similar material. It is arranged that when the spindle is rotated, the moving vanes (approximately semi-circular in shape) move in or out of mesh with the fixed vanes. The normal amount of rotation is 180 degrees, but some specialised types have two sets of fixed and moving vanes the latter rotatable through 360 degrees and arranged to come fully into mesh every 90 degrees.

Capacities range from 10 to 1000pF ; the values quoted being the maximum capacitance with the plates fully in mesh. The shape of the plates may be designed to provide various capacitance characteristics detailed as follows:

1. **STRAIGHT LINE CAPACITANCE.** Each degree of rotation contributing an equal increment in capacity.

2. **STRAIGHT LINE FREQUENCY.** Each degree of rotation contributing an equal increment in frequency.

3. **LOGARITHMIC LAW.** Each degree of rotation contributing a constant percentage change of frequency.

4. **SQUARE LAW.** The variation in capacitance being proportional to the square of the angle of rotation.

FIG. 10 A Multi-Range Ohmmeter Circuit

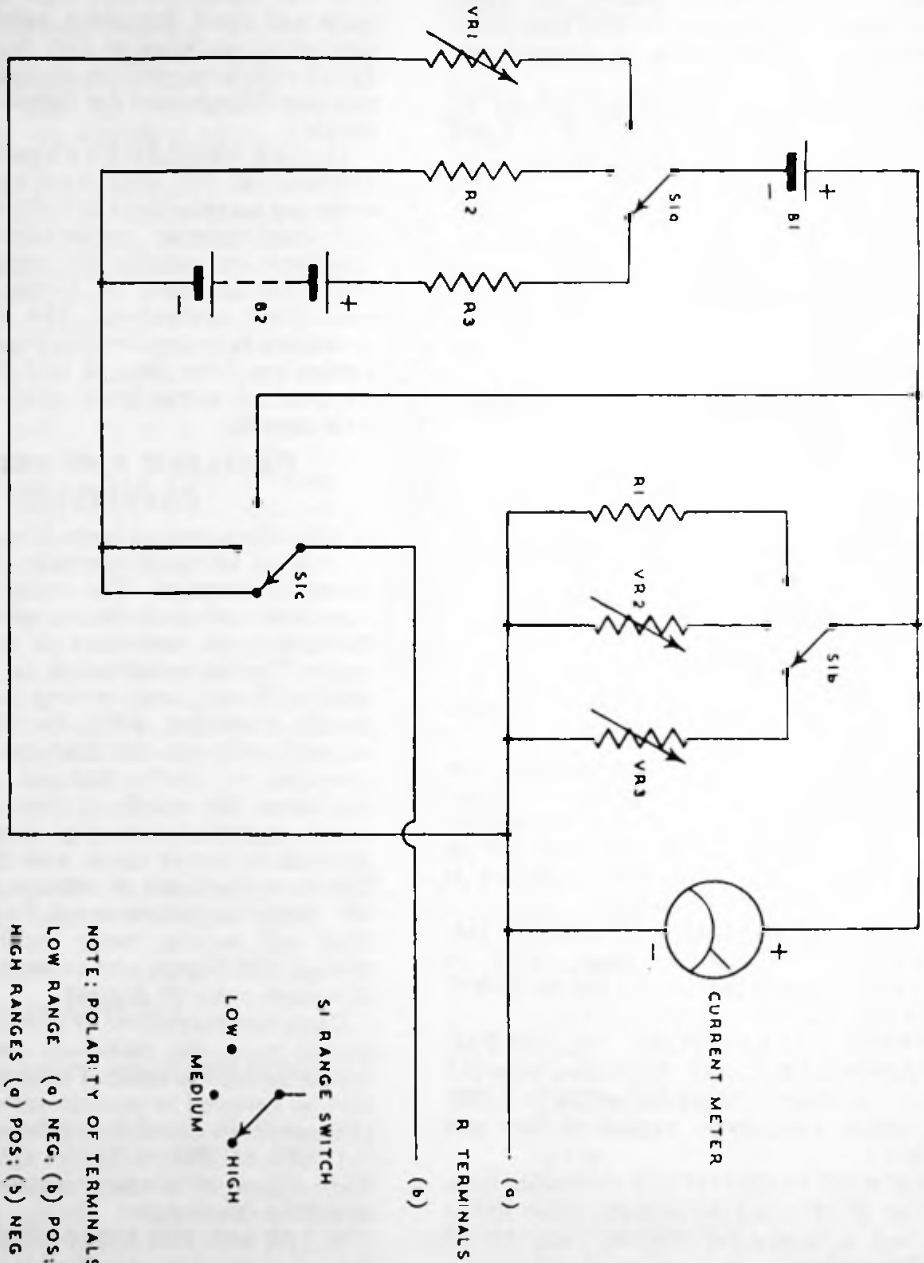

In order that the capacitance of more than one circuit may be varied simultaneously components consisting of more than one variable capacitor operated by the same spindle are available. These **GANGED CAPACITORS** are normally made in two or three units, although sometimes four gang capacitors are used. It is not always necessary for each unit (or gang) to be identical; sometimes, for instance, it is more convenient if the oscillator portion differs slightly so that correct tracking is achieved in superhetrodyne circuits.

The maximum working voltage of variable capacitors is not normally quoted, but the air gap is usually adequate for most purposes. Special transmitting type variable capacitors are used when high potentials are encountered.

Trimmer capacitors are used to pre-set the capacitance of a circuit, some constructed similarly to the variable capacitors just described, or consisting of two sets of plates which intermesh or come into close proximity with one another without actually touching.

CAPACITOR COLOUR CODES

Capacitors manufactured by British firms usually have the capacitance, and sometimes the working voltage and other information, marked on the body in printed characters. Occasionally colour codes are used, but the practice is not so widespread as with resistors. Unfortunately more than one code is used which tends to make matters a bit confusing. It is proposed to discuss the codes most likely to be encountered including some American ones.

Colours denote the following numerals, multipliers, tolerances, and temperature co-efficients:

Colour	Numeral	Multiplier	Tolerance	Temp Co-efficient
black	0	1	$\pm 20\%$	N90
brown	1	10	$\pm 1\%$	N030
red	2	100	$\pm 2\%$	N080
orange	3	1000	$\pm 3\%$	N150
yellow	4	10000	—	N220
green	5	100000	$\pm 5\%$	N330
blue	6	—	—	N470
violet	7	—	—	N750
grey	8	0.01	—	P030
white	9	0.1	$\pm 10\%$	P100
silver	—	0.1	—	—
gold	—	0.01	$\pm 10\%$	—

N.B. Colours gold and silver are not normally used in connection with ceramic capacitors; and colours grey and white do not indicate the multiplier and tolerance for mica capacitors. The temperature co-efficient for mica capacitors is not normally shown, and where it is, a code different to that shown above may be in use.

Reference to Fig. 12 will show some common methods of coding capacitors. First the codes for mica capacitors will be discussed.

(a) Six dot system. In all cases the multiplier is dot six, and the tolerance is dot five.

Should dot one be white or black, then the significant figures regarding the capacity are: dot two first figure; dot three second figure. If dot one is a colour other than black or white, the old R.M.A. code is probably in use, and so dot one is the first significant figure; dot two the second; and dot three the third. Dot four denotes the class, characteristic, or working voltage depending on the code in use.

(b) Three dot system. This applies only to capacitors with 500v ratings and ± 20 per cent. tolerance. Dot one is the first significant figure; dot two the second; and dot three is the multiplier.

(c) Four dot system. This is the same as the three dot system, but in this case the fourth corner dot indicates the tolerance.

The system used for coding ceramic capacitors is slightly different to that used for mica types in order to allow for the different shapes and characteristics encountered with these capacitors. Briefly, the code falls into two main groups; four colour or five colour; depending on whether the temperature co-efficient is shown.

(d, e and g) The five colour system. Band or dot A is the temperature co-efficient shown in parts per million per degree centigrade with N indicating negative and P positive. Sometimes black represents a zero co-efficient, and white indicates that the capacitor is a general purpose type. Bands or dots B and C are the first and second significant figures of capacitance, and band or dot D is the multiplier. Band or dot E is the tolerance given as the percentage of the nominal capacity, but where this is below 10pF the following code may be in use:

black	$\pm 2\text{pF}$
brown	$\pm 0.1\text{pF}$
green	$\pm 0.5\text{pF}$
grey	$\pm 0.25\text{pF}$
white	$\pm 1\text{pF}$

In all cases, colour identification is carried out reading from left to right. Where ambiguity exists, the makers name should be the correct way up, or an arrow points to the right.

HANDLING CAPACITORS

Much the same remarks apply as with resistors. Care should be taken to see that the component does not become overheated during soldering operations. It should be remembered that capacitors with large temperature co-efficients will vary considerably in capacitance

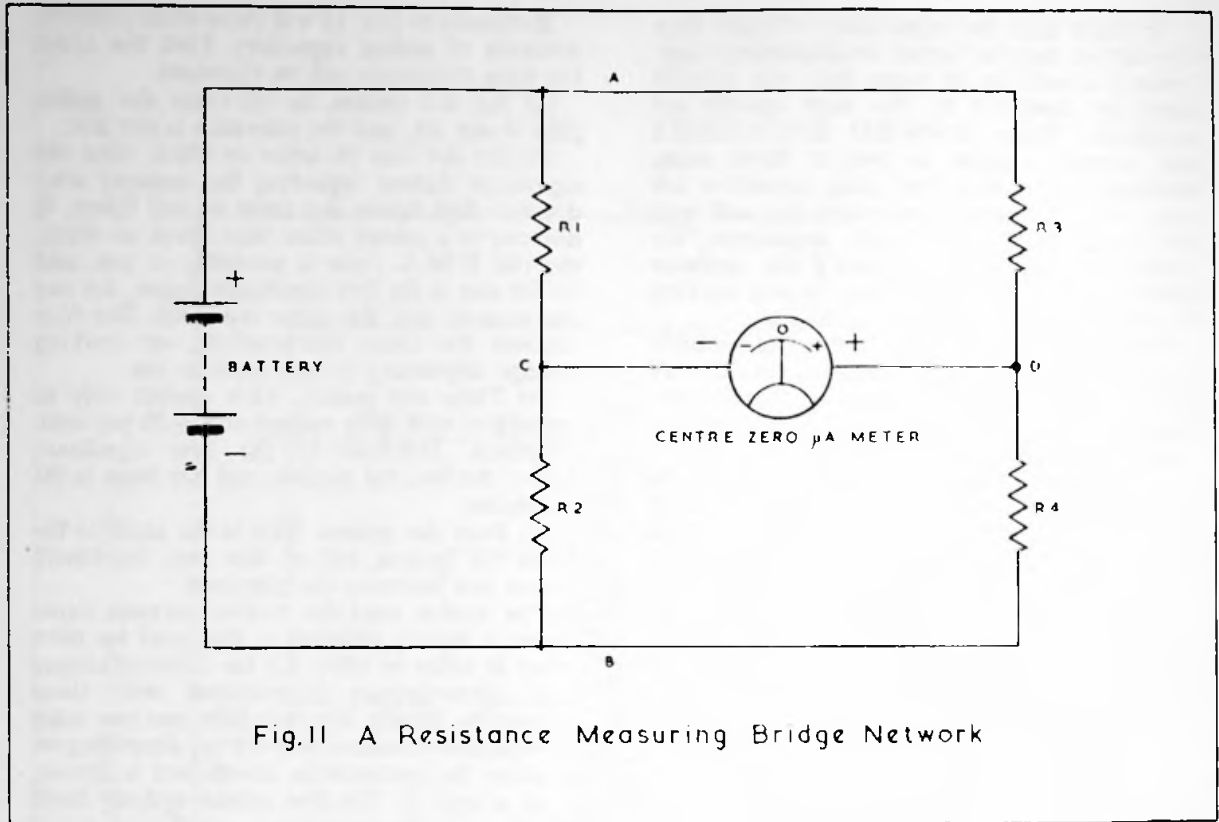

Fig. 11 A Resistance Measuring Bridge Network

immediately after soldering, consequently special notice should be taken of this when padding is being carried out. Leads of certain capacitors are extremely fragile, and if possible should not be bent within half inch of the component as they have a habit of breaking just where the lead enters the moulding. Should this trouble occur, it may be possible to remove sufficient of the moulding material to effect a repair, although to avoid heat damage to the component, soldering will have to be carried out quickly. Capacitors repaired in the way just described should be carefully tested afterwards in case further damage has resulted.

When capacitors are being replaced, care should be taken to see that one with the correct capacity and voltage rating is used. Other factors such as temperature co-efficients and ripple current may also have to be taken into account. If a component of the correct capacity is not available, it may be possible to use several capacitors in series or parallel arrangement to obtain the correct value.

Capacitors in parallel:

$$C \text{ (total)} = C1 + C2 + C3 \text{ and etc.}$$

Capacitors in series:

$$\frac{1}{C \text{ (total)}} = \frac{1}{C1} + \frac{1}{C2} + \frac{1}{C3} \text{ and etc.}$$

When only two capacitors are used in series it is often more convenient to convert the above formula to:

$$\text{Capacitors in series: } C \text{ (total)} = \frac{C1 \times C2}{C1 + C2}$$

Additional precautions are necessary when dealing with electrolytic capacitors, and this is dealt with later in the chapter. An important point, however, is that with the exception of non-polarised capacitors, electrolytics should always be connected the correct way round to observe polarity.

MEASURING CAPACITANCE

The most convenient method would be to have a direct reading instrument which would operate similarly to the ohmmeter except that the scale would be calibrated in capacitance instead of ohms. A possible arrangement is illustrated in Fig. 13. It will be seen that the capacitance to be measured is in series with an A.C. signal

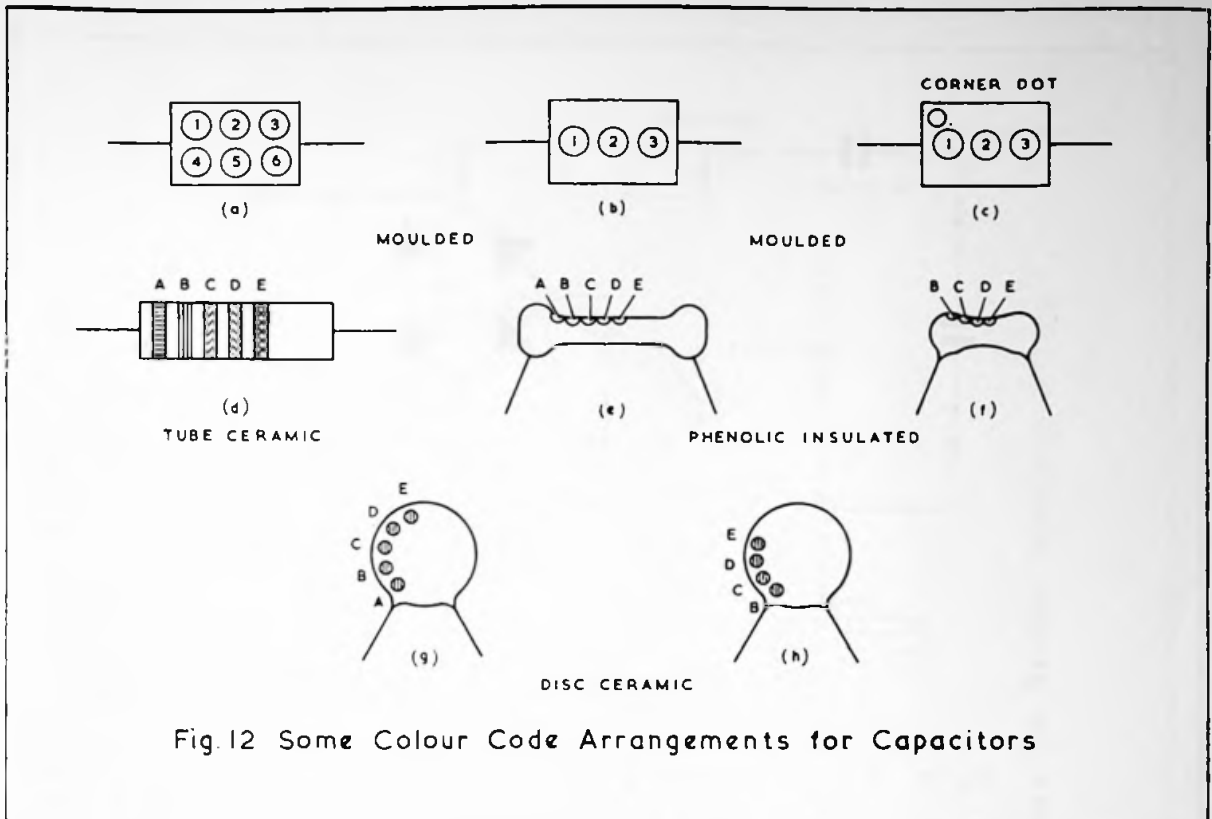

Fig. 12 Some Colour Code Arrangements for Capacitors

source, capacitor (C), potentiometer (VR), and a A.C. meter consisting of a bridge rectifier and current meter. The instrument is initially set by shorting the test leads, and adjusting VR until the meter reads exactly full scale deflection. When the capacitor to be measured is inserted, the meter reading will fall by an amount depending on the reactance of the capacitance at the applied frequency. A scale similar to the one shown in Fig. 13 will be obtained when the components specified are used. The level of the input signal should be approximately 5v peak. Calibration is carried out by first setting up the instrument, and then applying a set of known capacitance values.

A suitable signal source is the main problem regarding the circuit shown in Fig. 13. For a self contained instrument, a buzzer seems indicated. Unfortunately accuracy of calibration depends on the stability of the signal level, frequency, and waveform; these requirements being difficult to satisfy. A possible solution is to use the A.C. mains via a suitable step down transformer, but this reduces the range to about $0.001\mu\text{F}$ minimum, and the instrument ceases to be self contained.

As already mentioned in the previous chapter, the bridge circuit is probably the most convenient method of measuring capacitance, since the signal level and frequency does not tend to effect calibration. A suitable circuit is shown in Fig. 14, and it is interesting to compare it with the circuit shown in Fig. 11. In this case the bridge balances when the ratio of the two sections of potentiometer VR is equal to the ratio of the two capacitive reactances in the other arm. The bridge has to be supplied by an A.C. source, and consequently an A.C. null indicator must be used.

To measure capacitance, VR, which is calibrated in ratios similarly to the scale illustrated in Fig. 14, is adjusted until the bridge balances. The reading obtained from the calibration of VR is then multiplied by the capacitance of the standard (C1, C2, or C3) and the result is the value of the capacitance (C). The pointer on the scale illustrated in Fig. 14 indicates a ratio of approximately 0.33, and if the standard in circuit had been $1\mu\text{F}$ say, the value of C would be $0.33\mu\text{F}$. The calibration is most accurate from one tenth to ten times the value of the standard, consequently, for a wide range

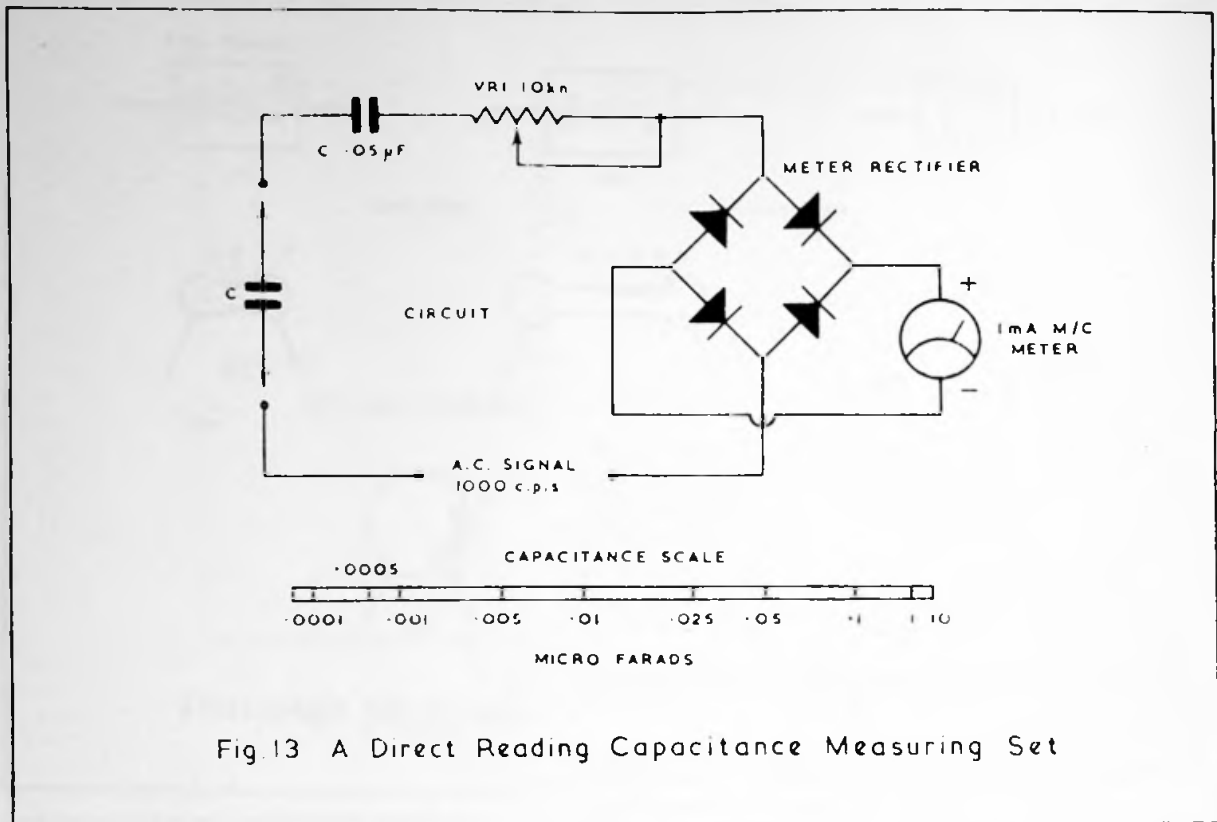

Fig. 13 A Direct Reading Capacitance Measuring Set

instrument, the standard should increase in multiples of 100. Suitable values for C1, C2, and C3, are 100pF, 0.01μF, and 1μF, which will permit measurements continuous from less than 10pF to above 10μF.

A useful A.C. source is the output from a heater transformer, which can possibly be installed in the same power unit feeding the indicating apparatus. The indicator can be a sensitive A.C. voltmeter, oscilloscope, or magic eye circuit similar to the one illustrated in Fig. 15. The magic eye indicates the null point when at maximum shadow. The heater supply to the magic eye must be separate from the bridge energising signal, since this signal must be related to chassis potential only through the slider of the ratio arm (VR in Fig. 14).

If the signal frequency is reasonably high; about 1000 c.p.s. say; head phones may be used as the null indicator, in which case, VR (in Fig. 14) is adjusted for minimum sound. A useful signal source at this frequency is the buzzer fed by a dry battery. This has the advantage of enabling the bridge to be self contained.

An interesting basis for a buzzer operated bridge is one of the ex-Government morse practice sets which are currently available on

the surplus market for a few shillings. These units include a buzzer, a switch (the morse key), battery, and battery clamps. A suggested form of construction using one of these sets is illustrated in Fig. 16. The wiring of the bridge is identical with that shown in Fig. 14 and is set behind the front panel. The connections to the signal source are taken to the phone terminals on the morse practice set, while the connections to the null indicator are taken to a telephone type socket or suitable terminals on the front panel. The actual wiring of the morse practice set is not altered in any way, but if desired, the PHONES label can be removed and fitted above the phones socket on the front panel. Adjustment (b) is set to obtain a satisfactory note from the buzzer, while adjustment (a) can be set to lock the key ON if required.

The potentiometer VR in Fig. 14 should be linear and approximately 5kΩ (the exact value is not important). Calibration can be carried out mathematically, but as the standards used by the average constructor will hardly be 100 per cent. accurate, the best method is to apply capacitances of a known value. This also has the advantage of balancing out stray capacities.

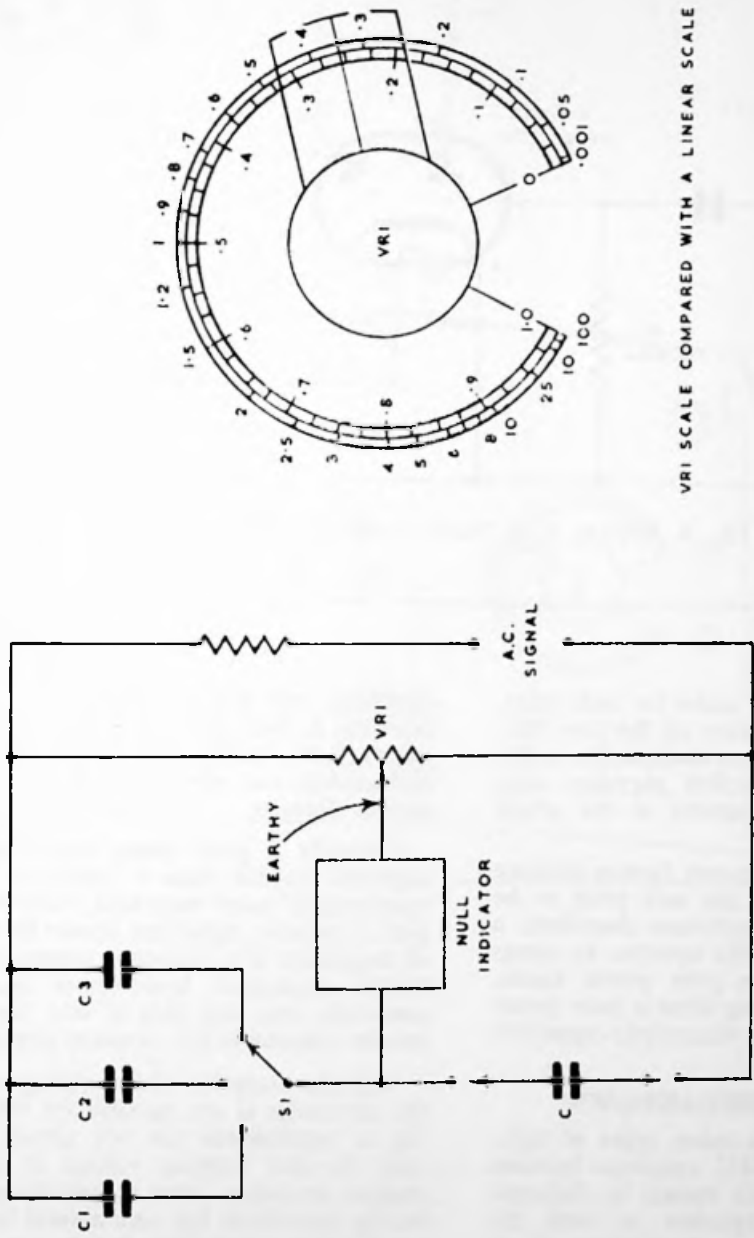

VRI SCALE COMPARED WITH A LINEAR SCALE

Fig.14 A Capacity Measuring Bridge Circuit

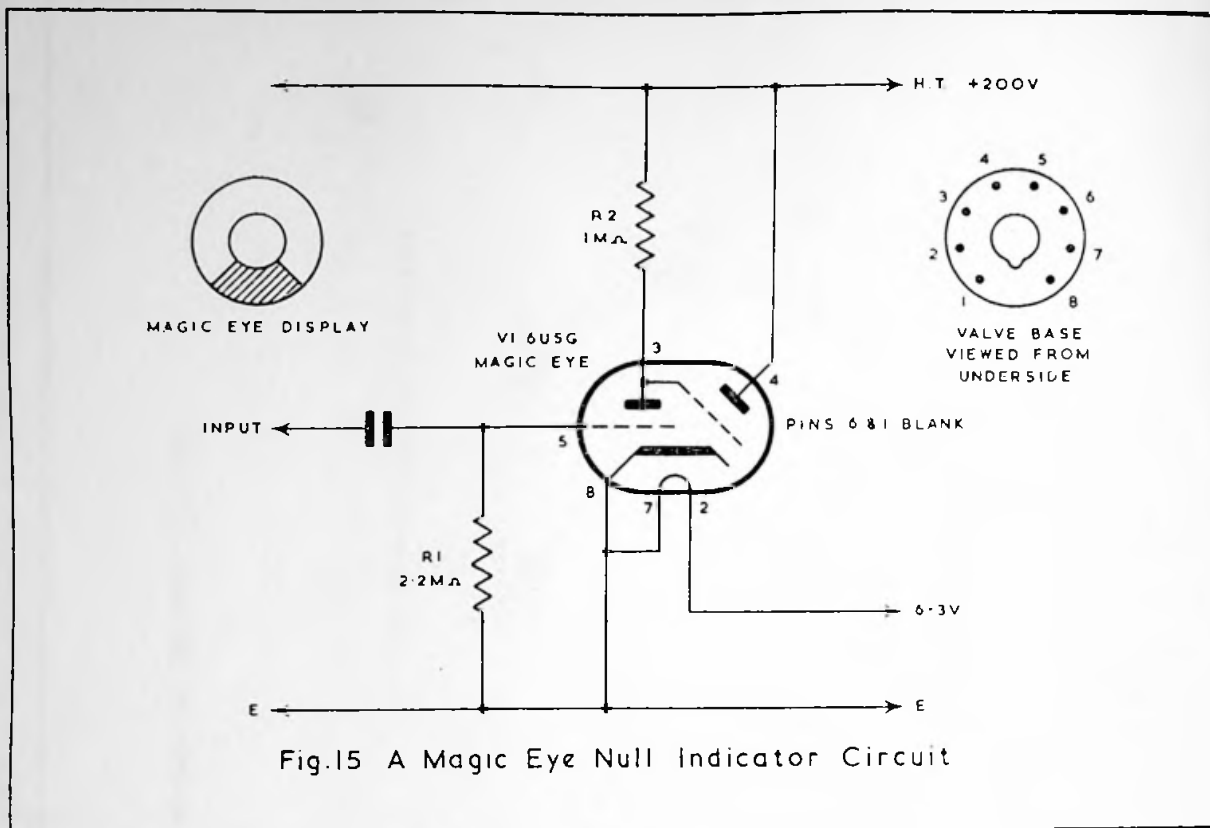

It is best to have separate scales for each range, and these will take the form of the one illustrated in Fig. 14. The linear scale shown in this illustration is for comparison purposes only, and need not be incorporated in the actual instrument.

Capacitors with poor power factors produce a phase change causing the null point to be less distinct. With the apparatus described, a little practice will enable the operator to recognise a capacitor with a poor power factor, and if it is below $1\mu\text{F}$ may show a poor power factor and still be usable; electrolytic capacitors come into this group.

DIELECTRIC BREAKDOWN

A common fault with many types of capacitor is leakage or low D.C. resistance between each set of plates, mainly caused by dielectric breakdown. If the capacitor is used for coupling purposes between two stages of an amplifier, the effect of D.C. leakage may well be serious as the h.t. potential will be fed to the grid circuit of the following stage and upset the bias arrangements. This will cause

distortion and possible damage to other components. A decoupling or smoothing capacitor which leaks badly may overload associated components and even the power unit, causing serious damage.

Normally a good paper capacitor or mica capacitor should have a dielectric insulation resistance of many megohms, while the insulation of ceramic capacitors should be thousands of megohms. The dielectric resistance of electrolytic capacitors, however, is usually comparatively low, and that is why they are usually unsuitable for coupling purposes.

With the exception of low voltage capacitors, the ohmmeter is not suitable for leakage testing as breakdowns are not always apparent until the full working voltage is applied. A megger insulation tester is sometimes used for testing capacitors, but care should be taken to see that the output from it does not exceed the safe working voltage of the capacitor otherwise permanent damage is likely to result. A megger should never be used for testing electrolytic capacitors.

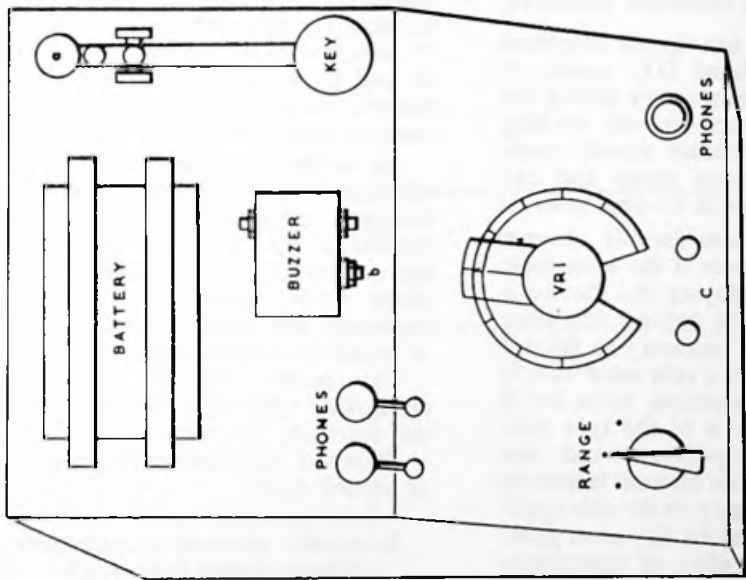

Fig.16 Suggested Layout Arrangement for the Capacitance Bridge

Ideally the leakage tester should contain a D.C. power supply which is adjustable over a wide range of voltages so that capacitors may be tested at correct working potentials. A current meter in series with a limiting resistance is connected in the output circuit and after the initial charging period will indicate if any D.C. current is being passed by the capacitor, and consequently if leakage is occurring. The limiting resistance will prevent damage to the meter during the initial charging period, or if the capacitor breaks down completely. A voltmeter across the power supply is necessary so that the voltage may be set accurately. A suitable test rig is shown in Fig. 17. The value of (R) the limiting resistor can be calculated by:

$$R \text{ (ohms)} = \frac{\text{Maximum Volts}}{\text{Meter reading at full scale deflection (amperes)}}$$

Meter reading at full scale deflection (amperes)

In practice the elaborate test rig just described is rarely necessary, as a fixed D.C. supply of about 250v will provide satisfactory testing for most capacitors, while capacitors with working voltages lower than this amount usually come into the low working voltage group and can be tested by the high range of an ohmmeter.

An indicator which is considerably cheaper than a sensitive current meter is the neon tube, and a suitable circuit employing this device is shown in Fig. 18. It will be noticed that once again a limiting resistor is necessary to prevent the tube current rising above a safe value usually in the region of 1mA. A nominal value for R is 470k Ω . A suitable neon is of the type used as indicators in mains equipment and fuse panels, preferably without an internal resistance which is usually on the high side for this application. Leakage is indicated by the neon glowing, but in some cases the effect of capacitance in parallel with the leakage resistance causes the circuit to function as a relaxation oscillator, and the neon blinks on and off instead of remaining steady. With a good capacitor, the neon should remain extinguished after the initial charging period.

A useful feature of the circuit in Fig. 18 is the provision of switch S1. This serves two purposes; first it isolates the test leads from the power supply while the capacitor is being connected, so preventing the possibility of shock; secondly, it discharges the capacitor through R and the neon when the test is completed, which again prevents the possibility of shock, and also damage to the capacitor should it be shorted, since the charge held by some large capacitors may be considerable.

The neon leakage tester may draw its power

supply from that supplying the indicating circuit such as the magic eye in a capacitance bridge. Suitable switching arrangements will facilitate rapid changeover from capacitance measurements to leakage testing. An alternative arrangement for the buzzer operated instrument, which also has the advantage of keeping itself contained is shown on Fig. 19. It will be seen that the output from the buzzer is taken to a transformer (T1), where the voltage is stepped up, rectified by the metal rectifier (MR) and smoothed by the network R.C. The remainder of the circuit can be as in Fig. 18.

A suitable transformer for T1 is one of the multi-ratio output transformers used for replacement purposes in receiver servicing, but any old output transformer from the junk box can be tried. The buzzer is connected across the low impedance (speech coil) winding, while the normal primary is in this case used as the secondary. MR is a low current metal rectifier suitable for operating at the output voltage of T1 which is in the region of 250v. The values of R and C are 2.7k Ω and 0.25 μ F respectively. Suitable switching will enable the circuit to be used in conjunction with that in Fig. 14.

As stated previously, one of the inherent characteristics of electrolytic capacitors is high leakage current. When a D.C. voltage is applied to a discharged capacitor, a high leakage current is passed initially, but this usually drops quite rapidly to a normal value and decreases still further when the component is in circuit for long periods.

The normal leakage current for typical electrolytic capacitors may be calculated from the following formulæ:

Polarised dry electrolytic capacitors (plain or etched foil).

$$\text{Leakage current (uA)} = 0.15 \times C \times V$$

Reversible electrolytic capacitors.

$$\text{Leakage current (uA)} = 0.3 \times C \times V$$

Wet electrolytic capacitors.

$$\text{Leakage current (uA)} = 0.35 \times C \times V$$

Where C is the capacity in μ F, and V is the working voltage.

If an electrolytic capacitor has been in store for a long period, the leakage current will take longer to drop to its normal steady value when first put into service. This is unimportant, however, providing precautions are taken to see that it does not overheat or cause other damage during this initial period. A capacitor with excessive leakage current, or showing signs of overheating should be reformed before being put into service. This reforming process should be routine if the component has been in store for some time, or if the capacitor has been removed from equipment laying idle (surplus equipment for instance).

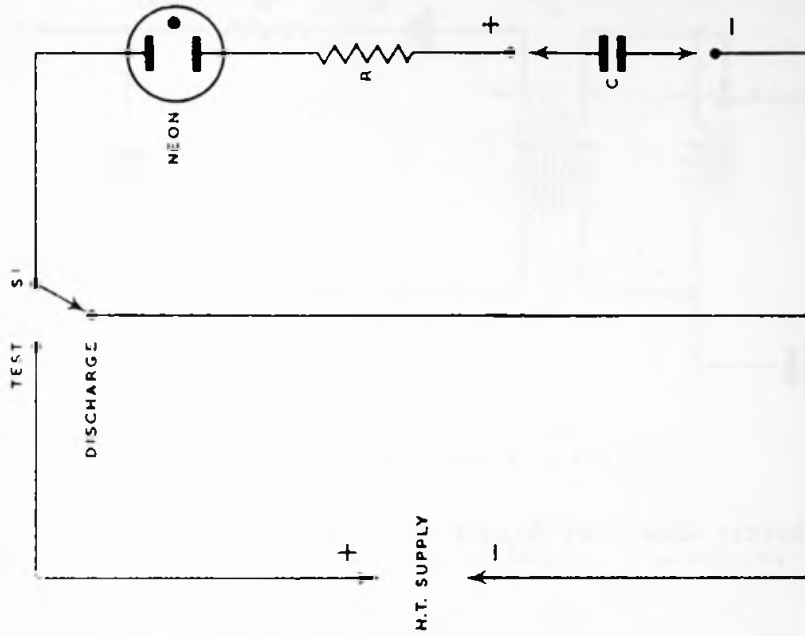

Fig.18 Neon Leakage Tester

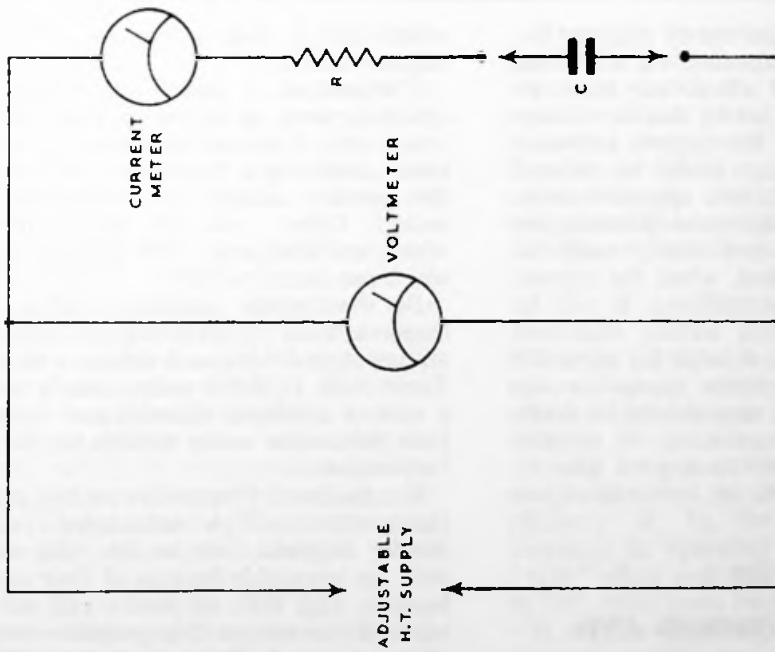

Fig.17 Test Rig for Conditioning Electrolytic Capacitors.

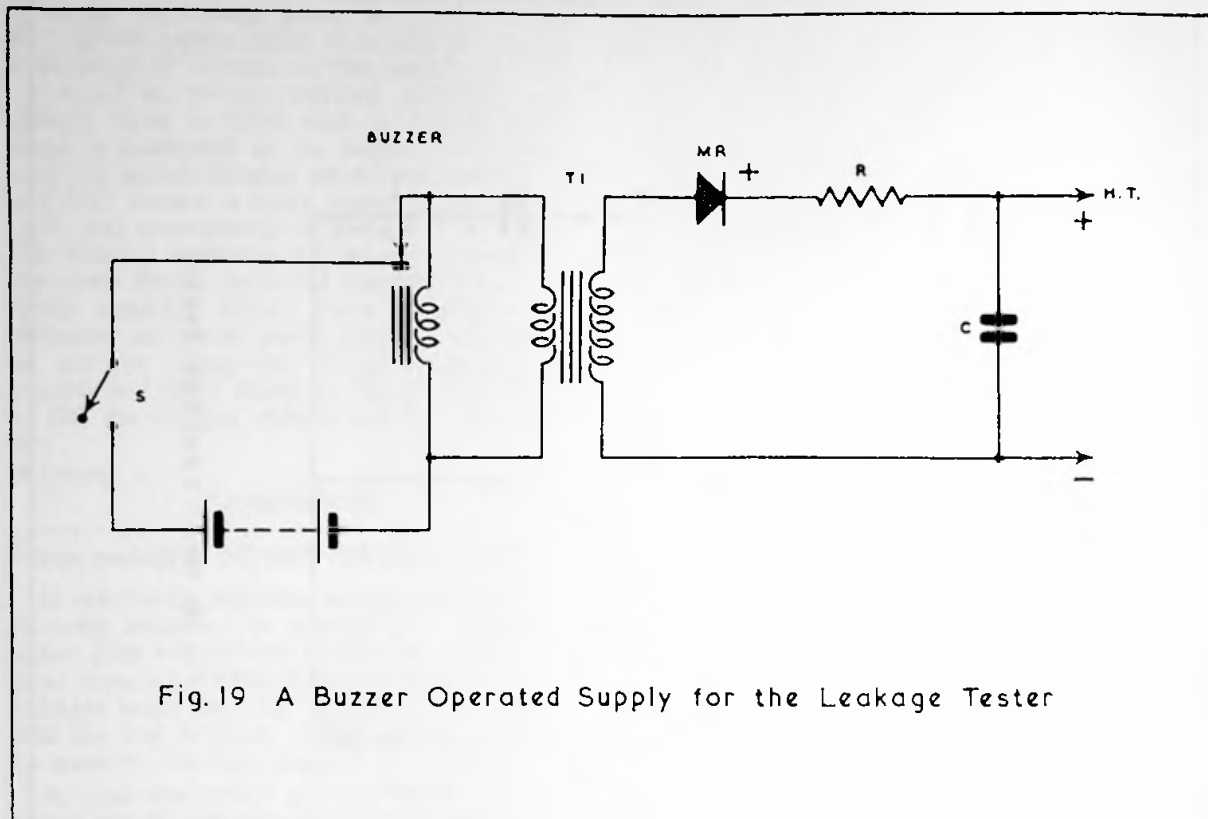

Fig. 19 A Buzzer Operated Supply for the Leakage Tester

Reforming is best carried out by applying the working voltage to the capacitor via a limiting resistor for a period of about one hour, or longer if the current has not by that time fallen to its normal value. If the current increases initially, the applied voltage should be reduced to a value where the current appears steady. After a short period at the lower potential the voltage should be increased slowly until the working voltage is reached, when the normal reforming process should continue. It will be realised that the apparatus already described for leakage testing is also suitable for capacitor reforming. When electrolytic capacitors are being tested or installed, care should be taken to see that they are connected to observe correct polarity, and so it is a good plan to mark the D.C. polarity on the terminals of test equipment.

CHAPTER 3

INDUCTANCE, CHOKES AND TRANSFORMERS

Current flowing through a conductor produces a magnetic field. If the value of the current changes, so also will the strength of the magnetic field. This change creates a back e.m.f.

which acts in such a way as to oppose the original current.

The amount of back e.m.f. produced by a circuit depends on its inductance, measured in henrys (H). This unit is defined as the inductance producing a back e.m.f. of 1 volt when the current changes by 1 ampere in one second. Other units are milli-henrys (mH), which are henrys $\times 10^{-3}$; and micro-henrys, which are henrys $\times 10^{-6}$.

By winding the conductor into a coil, the magnetic lines of force are concentrated permitting higher inductance values to be achieved. These AIR CORED coils, usually wound on a tube of insulated material such as paxaline, have inductance values suitable for use at radio frequencies.

For the lower frequencies used in power and audio circuits, high inductance values are usually required, but in this case air cored coils are unsuitable because of their size, which leads to high D.C. resistance and self capacitance. To overcome this problem cores made of iron are used. These concentrate still further the lines of magnetic force, thereby increasing the inductance values without increasing the number of turns in the winding. This type of core is said to have a greater permeability than air.

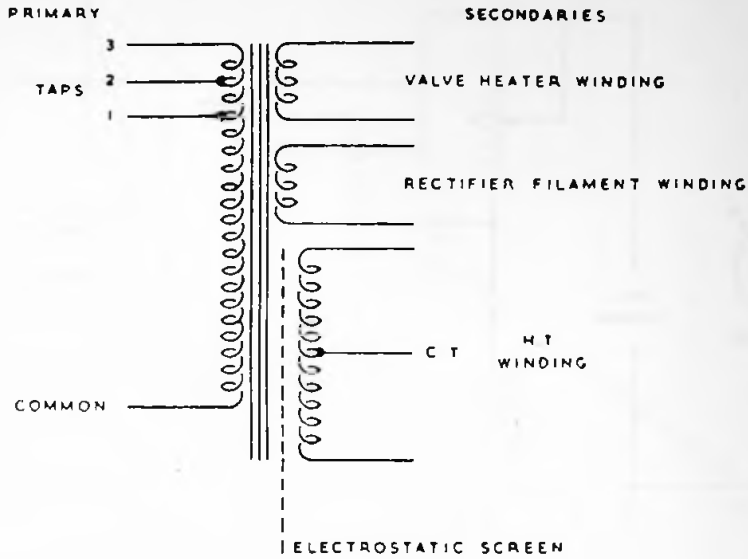

Fig. 20 A Typical Mains Transformer

As the iron core is an electrical conductor, e.m.f. is induced into this also, and produces eddy currents. These have to be limited to prevent the core overheating, and possibly damaging the winding. Resistance is introduced by constructing the core of thin plates, each one specially coated to insulate it from the other.

Coils of intermediate value inductance are often fitted with an iron dust core made of specially prepared granules compressed to a suitable shape. A special feature is that these cores are often threaded so that they screw in or out of the coil former enabling the inductance value to be adjusted to a precise value.

When A.C. is applied to an inductance, the back e.m.f. which is proportionate to the current change rate (frequency) sets up an opposition called reactance. The reactance of an inductor (X_L), measured in ohms, is calculated by:

$$X_L = 2 \pi f L \text{ ohms}$$

When f is the frequency in cycles per second, and L the inductance in henrys.

It will be seen that a coil may be constructed to present a high reactance at high frequencies, but permits lower frequencies to pass comparatively unopposed. Components which perform this function are referred to as chokes.

When the frequency of a signal which is applied to a circuit containing inductance and capacitance is such that the reactances of both are equal, the circuit is said to be at resonance. If the resonating components are in parallel (Rejector Circuit), the effective impedance is high compared with the normal impedance at non-resonance. The impedance at resonance, called the dynamic resistance, may be calculated by:

$$R_{\text{dyn}} = \frac{L}{C R}$$

When, on the other hand, the resonating components are in series (Acceptor Circuit) the effective impedance is low, being equal to the value of R .

It will be realised that if R is made as low as possible the circuit will attain maximum efficiency. R , by the way, is the effective resistance at operating frequency, and due to "skin" effect may be considerably higher than its D.C. value (zero frequency).

It will be seen from the above notes that resonant circuits may be used for filtering or selecting signals for the purposes of attenuation or amplification.

Changes of magnetic field in one circuit may also generate or induce e.m.f. in neighbouring circuits. This effect, called mutual inductance,

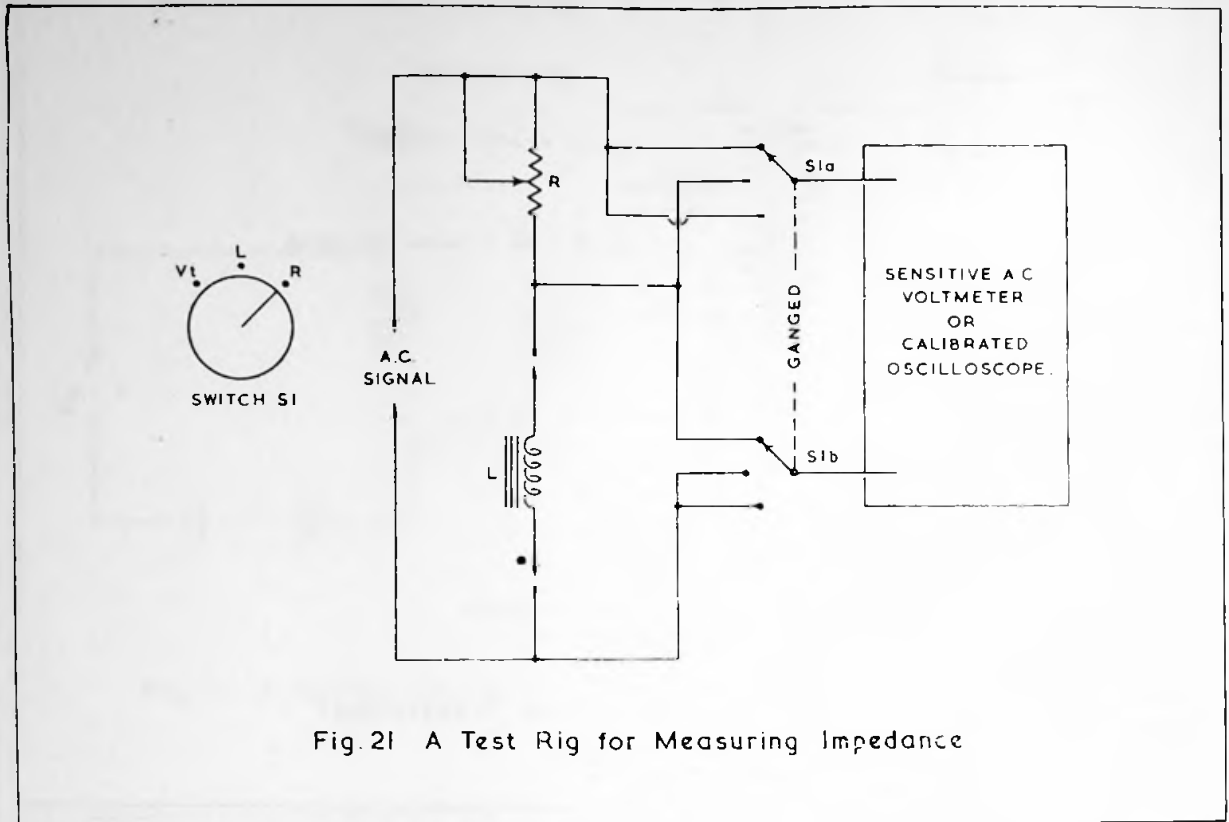

Fig. 21 A Test Rig for Measuring Impedance

is defined similarly to inductance. Circuits have a mutual inductance of 1H when current changing at one ampere per second in one circuit induces an e.m.f. of one volt in the other. Components making use of this effect may be constructed having more than one coil on the same former or core; these are called transformers.

Although the transformer cannot be regarded as a power amplifier, a good transformer has an efficiency not much less than unity. By careful choice of the turns ratio between primary and secondary windings, A.C. voltages may be stepped up or down; this is related by:

$$\frac{\text{Turns Primary}}{\text{Turns Secondary}} = \frac{\text{Volts Primary}}{\text{Volts Secondary}}$$

The transformer may be designed as an impedance changer enabling low impedance devices like moving coil loudspeakers to be efficiently matched to relatively high impedances such as valves.

Due to the wide range of inductive components generally used in radio equipment from smoothing chokes to I.F. transformers, it is difficult, as far as testing is concerned, to group them as one would resistors say. Techniques

vary considerably depending on the inductance and purpose of the component. Often it is desirable to simulate actual working conditions during test procedure, with the result that comprehensive test gear becomes complex. It is proposed therefore, to consider L.F. and H.F. components separately. This chapter will be concerned with the first group.

TYPICAL L.F. CHOKES AND TRANSFORMERS

The L.F. choke consists of a single winding on an iron core, with the inductance value chosen to present a high impedance at the required frequency without offering too much resistance to lower frequencies or D.C. A typical version is the smoothing choke which is used to filter out the A.C. ripple present in the output of a rectifier circuit, and is usually inserted in the h.t. line. A L.F. choke may also be used as a valve load in an audio amplifier where it presents a high impedance to the signal without limiting the applied h.t.

The mains transformer consists of several windings on the same core. A typical version is shown in Fig. 20 and detailed as follows:

PRIMARY WINDING. Usually tapped to

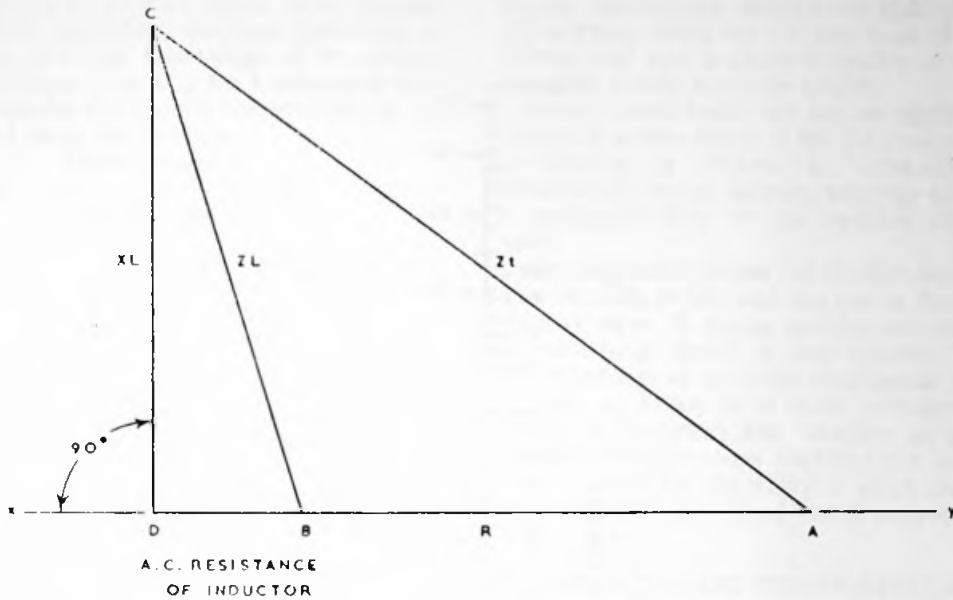

Fig.22 An Impedance Diagram

permit operation on common mains voltages; often in the following sequence:

Tap 1. 200v; Tap 2. 220v; Tap 3. 240v.

Sometimes, for intermediate values, an additional 10v tap is provided at the opposite end of the winding. Overseas versions may have provision for 110v operation when the primary is divided at the centre so that both halves may be fed in parallel. **SECONDARY WINDING (h.t.)**. Centre tapped for full wave rectification, each end is normally connected to the rectifier anodes, while the centre tap is earthy. Voltage (measured from the centre tap) from about 200-0-200 to 350-0-350 volts r.m.s. **SECONDARY WINDING (RECTIFIER FILAMENT)**. Usually four to five volts. The h.t. may be taken from a centre tap on this winding when a directly heated rectifier is used. **SECONDARY (L.T. OR HEATER WINDING)**. Supplies valve heaters usually at 6.3 volts, sometimes, but not always, fitted with a centre tap. **ELECTRO-STATIC SCREEN**. Fitted between primary and h.t. secondary windings to avoid capacitance coupling with certain types of transformer.

Some mains transformers may have more than one l.t. winding, while others have no h.t. windings (heater transformers). Transformers used to supply small low power apparatus may have single h.t. windings without a centre tap.

and are used with half wave or bridge rectifier systems.

Auto transformers are used when size and cost must be kept down. They have only one tapped winding, and the amount of winding across the output compared with the input determines the output:input ratio. Their chief disadvantage is that there is no isolation between the equipment and mains supply.

Output transformers permit output valves, which have optimum loads of some thousands of ohms, to be efficiently matched to low impedance moving coil loudspeakers. Normally they have single primary and secondary windings, but sometimes the primary is centre tapped for push-pull operation. In this case the ends of the winding are connected to the output valve anodes, and the tap to h.t. Other types may have double or tapped secondaries to facilitate matching of different or additional loudspeakers, or for use with special negative feedback circuits. Then there is the so called ultra-linear method of operation where the output valves screen grid is taken to a tap on the transformer primary instead of direct to h.t. This enables distortion figures similar to triode operation to be achieved while still maintaining high output. Single ended or push-pull ultra-linear stages are used.

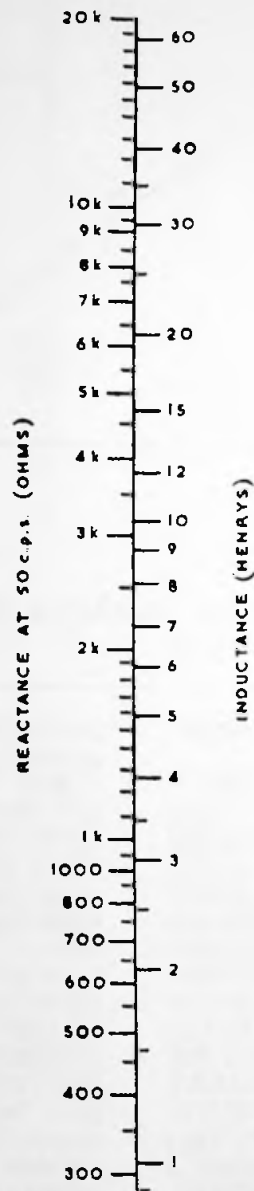

NOTE: SCALE MAY BE EXTENDED IN MULTIPLES
AND SUB-MULTIPLES OF 10.

Fig. 23 Reactance: Inductance Chart

Transformers specially designed for service replacement purposes often have tapped primary and secondary windings providing a wide range of ratios. Knowledge of the output valve's optimum load, and the loudspeaker impedance enables the nearest correct ratio to be determined using the formula:

$$\text{Ratio} = \frac{\text{Turns (primary)}}{\text{Turns (secondary)}} = \sqrt{\frac{\text{Valves optimum load (ohms)}}{\text{Speech coil impedance (ohms)}}$$

Intervalve transformers are used to couple the various stages of an amplifier. Usually the primary is connected in the anode circuit of the preceding stage, while the secondary is in the grid circuit of the succeeding stage. Sometimes D.C. current as well as the signal is allowed to flow through the windings. Intervalve transformers may also be used in oscillatory circuits.

Transformers similar to the above are specially designed for certain kinds of operation. Amongst this group are blocking oscillator, discriminator, and output transformers used in the timebase circuits of television receivers.

TRACING FAULTS

Faults in the components just discussed come into three main groups:

1. Windings open circuit;
2. Windings shorting to frame;
3. Shorting turns.

Faults in group one can usually be diagnosed by making continuity tests with an ohmmeter, although to avoid the shunting effect of other components, the winding under test should be disconnected first. In cases where the winding carries D.C. current it may be more convenient to check continuity by voltmeter tests. For instance, the primary of an output transformer can easily be checked by noting whether h.t. appears on the output valve's anode.

Tests to see whether shorting between frame and winding is likely to occur may be best carried out using the leakage tester already described in connection with capacitor testing. In this case the tests leads are connected between the frame and each end of the winding in turn.

Fault two may occur to a component causing heavy current to flow with the possibility of damaging other components in series with it and the power supply. An instance of this is in the case of a smoothing choke which is usually in series with the h.t. line. Breakdown between winding and frame would effectively short the h.t. causing the h.t. fuse to blow (if

there was one installed), or the mains transformer and rectifier would show signs of stress. By working along the h.t. line from the transformer end and isolating a section at a time, the fault should easily be traced.

Group three faults are not so easily traced except in severe cases. If the D.C. resistance of a winding is known, an ohmmeter will occasionally reveal shorting turns by indicating a noticeable drop in the specified resistance value.

Shorting turns causes the effective impedance of a winding to fall, and this can be detected in various ways. A mains transformer overheats, a smoothing choke is less efficient; or the characteristics of an audio transformer changes to such an extent as to cause considerable increase in distortion and reduction in gain. In all cases the symptoms described can be due to other causes, the possibility of which should be systematically eliminated before suspecting the inductance.

INDUCTANCE MEASUREMENTS

The impedance of an inductance may be measured using the simple arrangement illustrated in Fig. 21, where it is placed in series with a variable resistor (R), and fed by a suitable A.C. signal. Using a high impedance A.C. voltmeter or calibrated oscilloscope, R is adjusted until the reading obtained with switch S1 in position R is the same as when S1 is in position L. The resistance value of R is then identical with the impedance of the inductance (L).

It should be noted that the impedance of L depends on the frequency of the applied A.C. signal. Impedances normally quoted for audio components are for a frequency of 400 c.p.s. The audio note generally used for modulation purposes in signal generators is 400 c.p.s., and this may be used to drive the test rig illustrated in Fig. 21. Another convenient signal source is the A.C. mains obtained via a suitable step down transformer, but in this case the impedance value obtained is for a frequency of 50 c.p.s. For rough comparison purposes the impedance value at 50 c.p.s. may be multiplied

by $\frac{400}{50} = 8$ to give the approximate impedance at 400 c.p.s., but this ignores the effect of winding capacitance which becomes more significant at 400 c.p.s.

The effect of resistance and capacitance in the practical inductor is significant, consequently the design of a suitable bridge circuit becomes complicated. The circuit illustrated in Fig. 21 is, however, suitable for inductance and other measurements, by using the information

obtained with this test rig to construct an impedance diagram as shown in Fig. 22.

The procedure for constructing an impedance diagram is as follows:

1. Adjust R until reading obtained with S1 in position R is identical to that in position L; note the value of R, and also the voltmeter reading; call this reading VR.

2. Without altering R or the input signal, not reading with S1 in position Vt.

3. Draw a straight line xy as in Fig. 22; from the y end measure to any convenient scale line AB, representing the value of R (ohms).

4. Draw arc BC with radius the same as line AB, representing the impedance of L (ZL).

5. Calculate the total impedance of R and L in series by:

$$Z_t = \frac{R \times V_t}{V_R} \text{ ohms}$$

6. To the same scale as line AB (R), draw arc AC, representing Zt.

7. Where arcs AC and BC cross, draw perpendicular CD (at 90° to line xy).

8. The reactance of L (XL) may be determined by measuring line CD to the same scale as line AB.

9. The A.C. resistance of L may be determined by measuring line BD.

10. The inductance of L may be determined by:

$$L = \frac{X_L}{2\pi f} \text{ henrys}$$

Where the applied signal is 50 c.p.s. the chart shown in Fig. 23 may be used to determine the inductance from the reactance value.

In practice it is not always necessary to draw the impedance diagram as the specified impedance or inductance value of the component may be known. From this information the reactance value can be derived, and this compared with the measured impedance. Although the reactance is never identical to the impedance, large discrepancies point to a faulty component.

D.C. current flowing through an inductor raises the core magnetism, modifying the inductance value. When making measurements, therefore, it is advisable to simulate actual working conditions as much as possible by arranging for the component to pass the normal amount of current while the tests are in progress. This may usually be achieved by placing a suitable battery and current meter in series with L, R, and the signal source, the battery tapping being selected to obtain the required current.

To cover a useful impedance range at 50 c.p.s., the variable resistor (R) in Fig. 21 should

have a maximum value of about 20kΩ, and a power rating sufficient for the energising current discussed above. For practical purposes, it is unlikely that R will be required to pass the maximum current when set to maximum resistance, and so it is not necessary for the power rating to be constant over the entire resistance range.

A suitable arrangement for the variable resistor (R) is illustrated in Fig. 24. All resistors have a resistance rating of 1kΩ. Ra is a variable resistor used for fine adjustment; resistors Rb to Rk, and Rl to Rv are incrementally switched by S1 and S2, which are calibrated in 1kΩ steps. Resistors Ra to Rk are rated at 5 watts, permitting a maximum current of 70mA for resistance values up to 11kΩ; resistors Rl to Rv are rated at 1 watt, permitting a maximum current of 30mA for resistance values up to 23kΩ. The switching is so arranged that none of the 5 watt resistors are in circuit before all of the 1 watt resistors. Construction of the variable resistor network is quite simple, but it is recommended that the fixed resistors are mounted on a suitable tag strip to facilitate wiring.

IDENTIFICATION OF TRANSFORMER CONNECTIONS

Difficulty often arises in identifying the various transformer windings. When the component is already installed, knowledge of the circuit will enable the connections to be identified. It is a good plan, therefore, when removing a transformer for some reason (cannibalising surplus equipment for instance) to label the leads before disconnecting.

Comparison of the D.C. resistance in different transformer windings often enables them to be identified. In the case of the mains transformer for instance, the primary and secondary h.t. windings are of comparatively high resistance as many turns of fine gauge wire are used. The primary, however, probably has several taps near one end of the winding (this information obtained because of low resistance between taps and one end of winding), whereas the h.t. secondary has only one tap at the centre. The heater and filament windings, on the other hand, are low voltage, high current, consisting of a few turns of heavy gauge wire; the resistance in this case is very low. To differentiate between rectifier and valve heater windings (usually of slightly different voltages) it is probably the above method because the comparative necessary to measure their outputs with the component operational because the difference in D.C. resistance is very small.

The identification of output and intervalve transformer windings is often possible using

resistance of different windings usually bear some relation with their impedance: i.e., low resistance, low impedance; high resistance, high impedance. A further difficulty may arise because the phase relationship between different connections of a transformer is important. Often, however, this may be deduced experi-

mentally by switching the connections of one winding only and noting the results.

COLOUR CODES

The following colour codes are used by some, but not all, manufacturers:

MAINS TRANSFORMERS

1. Primary leads (no tap)	black
If tapped, Common:	black
Finish:	black and red 50/50 striped
Tap:	black and yellow 50/50 striped
2. h.t. Secondary, connections to rectifier anodes:	red
centre tap:	red and yellow 50/50 striped
3. Rectifier filament winding:	yellow
centre tap:	yellow and blue 50/50 striped
4. Heater winding No. 1:	green
centre tap:	green and yellow 50/50 striped
5. Heater winding No. 2:	brown
centre tap:	brown and yellow 50/50 striped
6. Heater winding No. 3:	slate
centre tap:	slate and yellow 50/50 striped

OUTPUT TRANSFORMERS

1. Primary leads (no tap)	
start, or h.t. end:	red, or brown
finish, or anode end:	blue
Primary leads with centre tap:	
centre tap, or h.t.:	red
start, or anode 1:	blue, or brown
finish, or anode 2:	blue
2. Secondary leads	
start:	black
finish:	green

A.F. TRANSFORMERS

1. Primary leads (no tap)	
start, or h.t. end:	red
finish, or anode end:	blue
Primary leads with centre tap:	
centre tap, or h.t.:	red
start, or anode 1:	blue, or brown
finish, or anode 2:	blue
2. Secondary leads (no tap)	
finish, or grid end:	green
start, or grid return (earthy)	black
Secondary leads with centre tap	
finish, or grid 1:	green
centre tap, or earthy end:	black
start, or grid 2:	green, or yellow

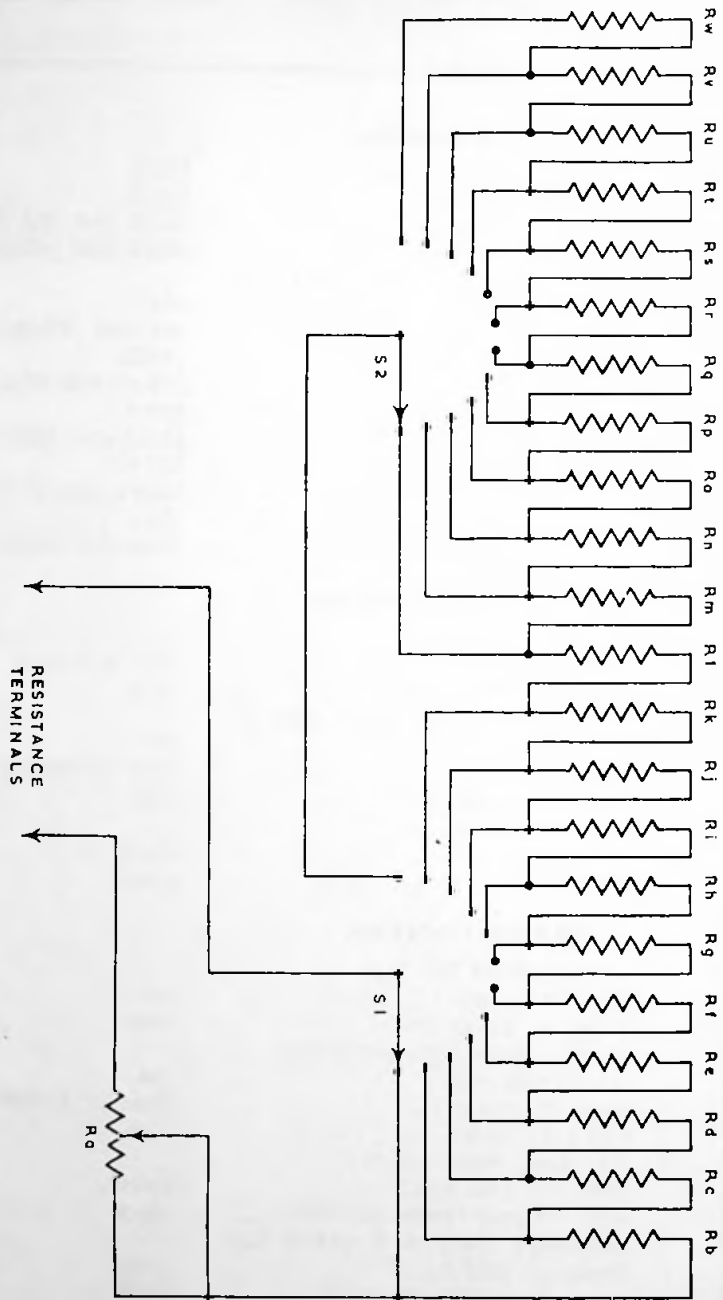

Fig. 24 Variable Resistance Network Suitable for the Impedance Measuring Rig.

CHAPTER 4

H.F. COMPONENTS

TYPICAL COMPONENTS

The tuning coil consists of an inductance which is resonated by capacitance, thus enabling signals to be either selected or rejected according to the circuit arrangement. Circuits may either use a parallel network, which presents a high impedance to signals at resonant frequency; or a series network, which presents a low impedance. Resonance occurs when the inductive and capacitive reactances are the same.

Because of stray capacitance and inductance, it is impractical to manufacture H.F. tuned networks to precise values, consequently provision is made for final adjustment of the circuit after installation. Two usual methods for adjustment after installation are; fitting the coils with adjustable cores made of ferrous or non-ferrous material which can be moved in or out of the formers so varying the inductance values; and making all or a part of the resonating capacitance variable by fitting a trimmer capacitor.

Circuits designed to be tuned manually by the operator of the equipment are usually equipped with variable capacitors which may be mechanically connected to the pointer of the frequency or wavelength scale. These circuits are also usually fitted with trimmer capacitors or adjustable cores so that coverage of the manual tuning arrangement can be pre-set to bring it in step with dial calibration or other tuned circuits.

The insertion of ferrous cores causes the coil's inductance value to increase, while non-ferrous cores have the opposite effect. Cores are usually threaded so that they screw into the coil former facilitating fine adjustment. Incidentally, screening cans effect the inductance of a coil similarly to cores, especially if they are in close proximity to the winding. This point should be borne in mind when measurements are being made to screened coils with their can temporarily removed.

Increasing the inductance and capacitance values of a tuned circuit cause the resonant frequency to drop. Decreasing the inductance and capacitance values cause the resonant frequency to rise.

H.F. transformers consist of two or more windings inductively coupled and usually wound on the same former. Just one or all windings may be tuned, depending on the components application. Winding impedances may be arranged to provide correct matching between different circuits. Tapped coils, using the same

principle as auto transformers mentioned in the previous chapter, may be used in place of the multi winding transformer.

A H.F. transformer is often used for the input coil of a receiver, the primary impedance being arranged to provide correct matching between the aerial system and tuned secondary. Generally speaking the primary impedance is high in low frequency receivers, where it is common practice to use a long wire aerial directly coupled to the receiver; and low in high frequency receivers such as televisions, where the aerial is coupled by low impedance feeder.

Transformers are often used to link the I.F. stages of a receiver, but in this case both primary and secondary windings are generally tuned to achieve the required band pass.

Oscillators, such as "tuned grid" or "tuned anode" types, use H.F. transformers with one winding in the anode circuit, and the other in the grid circuit.

H.F. chokes are coils wound to present a high impedance to specified frequencies without seriously attenuating lower frequencies and D.C. power supplies. Winding capacitance which shunts the inductive impedance must be kept to a minimum, and the choke's self resonant frequency must not be within its operating range.

FAULTS

As with L.F. components, faults may be due to windings becoming open circuited or turns shorting. Breakdowns between windings and frame are uncommon because insulated formers are mainly employed. Deterioration due to the effects of temperature and atmosphere may cause losses to be introduced, seriously lowering the stage sensitivity.

Open circuited windings are easily checked by continuity tests using an ohmmeter. Other types of fault, however, are more difficult to analyse. General symptoms, such as low sensitivity, apparent fall in impedance, and so on, may cause an inductor to be suspected; although in practice it may be easier to confirm this by process of elimination, checking the other types of component first.

Fortunately, H.F. coils are easily resonated, and resonance detected, using standard equipment, and this process forms the basis of tests to be described. The test equipment consists of a signal generator (which may be the usual type of servicing instrument), and a sensitive current meter or multi-meter used with the special R.F. probe to be described.

THE R.F. PROBE

Referring to Fig. 25, it will be seen that the R.F. signal is applied through C1 to a

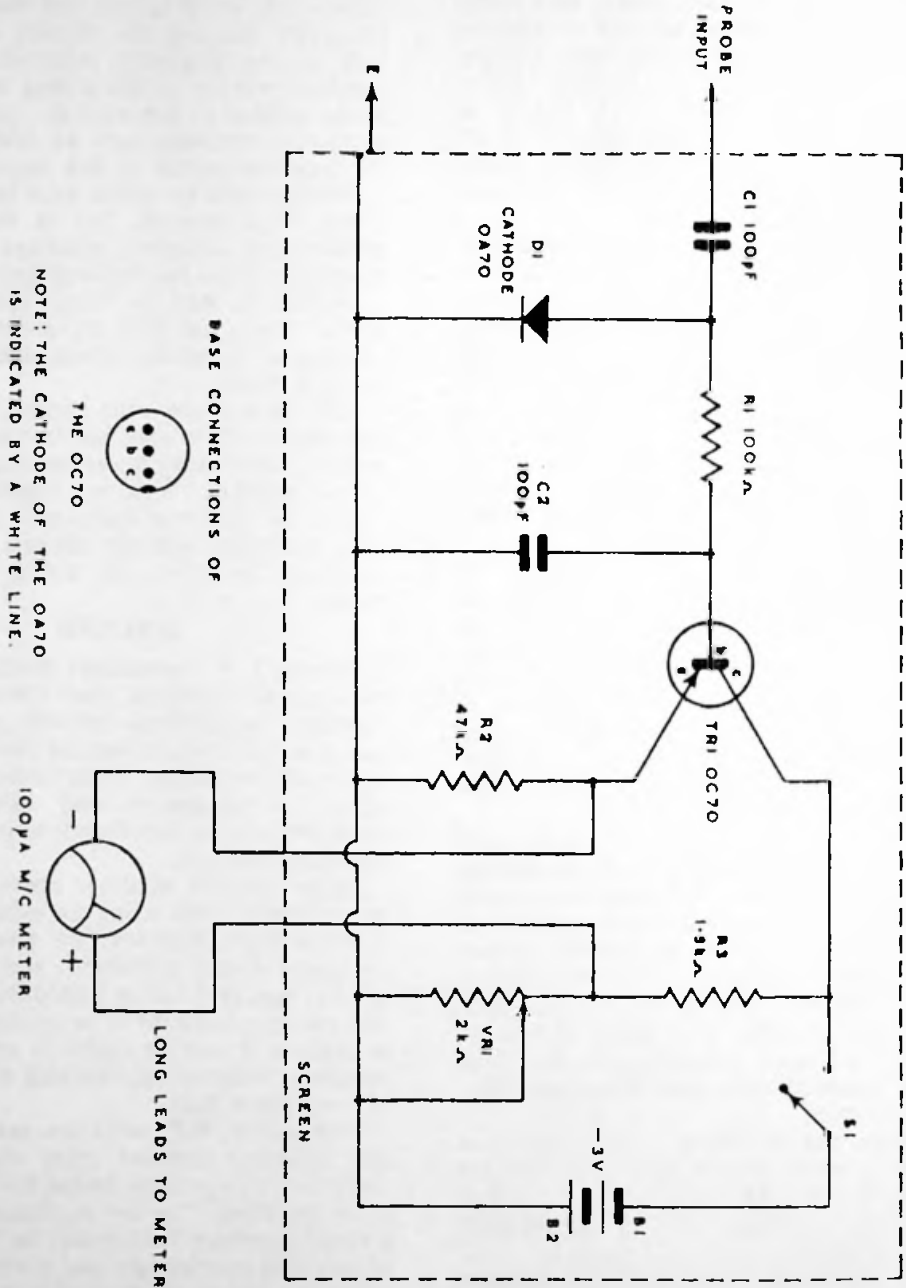

Fig. 25 The Combined R.F. Probe and Amplifier Circuit

germanium crystal diode which rectifies by shunting each positive half cycle. The negative half cycles are smoothed by the filter circuit R1 and C2, and appear at the base of TR1 as a negative D.C. potential.

The current meter is across a bridge circuit consisting of TR1 and R2 in one arm, and R3 and VR in the other. The circuit is initially balanced by adjusting VR so that the meter indicates zero. When the base of TR1 is supplied with a negative D.C. potential from the rectifier circuit, however, a small current flows between points b and e, and this causes a much larger current flow between e and c, which unbalancing the bridge circuit, results in current flowing through the current meter.

In a practical instrument, the probe housing will contain all the components shown in Fig. 25 enclosed by a dotted line. A twin flexible lead about 18 inches long will connect the probe to a suitable current meter or multi-meter. One possible arrangement is shown in Fig. 26. Here a torch case of the type normally taking three U2 type cells has been modified by the insertion of an insulated separator which divides it into two compartments; one for the battery; and the other for the rest of the components.

The battery consists of two U2 cells in series, but in this instance they are inserted so that the positive pole comes into contact with the metal case. This necessitates removing the contact spring from its usual place in the bottom cap, and mounting it on the separator after reducing the diameter to prevent it from touching the case. The spring is held by a 4BA bolt and washer secured by a nut on the other side of the separator. A solder tag under this nut enables the negative pole of the battery to be connected to switch S1. Four rubber gromets inserted in $\frac{1}{4}$ inch holes set round the case prevent the separator from moving forward. One of these holes may be used for **the meter leads, while the others are simply for ventilation.**

The forward compartment holds the remaining probe components including S1 and VR1 which are combined as a potentiometer and switch. If the torch lens is made of plastic, it may be easily drilled to take the input socket. The external and internal earthy leads are connected to a tag held to the metal torch case by a 6BA nut and bolt. Apart from the control and TR1, all components are supported by the wiring. TR1 is held by a rubber band to the potentiometer case. If the potentiometer is fitted with a double pole switch, the extra tags provide useful anchoring posts for the meter leads and emitter connection of TR1. The meter leads should be knotted inside the case to pre-

vent pulling on the other components. The connections to VR should be arranged so that when S1 is OFF, the slider is at the R3 end of the element.

Crystal diodes and transistors are quite rugged and give good service providing sensible precautions are taken. During installation connecting leads should not be bent within $\frac{1}{2}$ inch of the body, and soldering should be carried out quickly using a heat shunt to prevent excessive heat being absorbed by the component. The input signal should not be greater than will cause a meter deflection in excess of 250 μ A (a point to consider when a multi-meter is being used). Great care should be taken to see that the batteries are inserted the correct way round with the positive poles facing the end cap (opposite to the usual direction). Although a Mullard crystal diode and transistor are specified in Fig. 25, surplus types may be used. (The surplus "red spot" types make reasonable substitutes for OC70s).

Although not required in the tests to be described, the meter may be calibrated in R.F. volts. This is facilitated if the current meter is shunted by a 10k Ω variable resistance which may be adjusted to permit the range to be brought to a convenient level. The calibration is, however, affected by changes in ambient temperature, and this should be considered when working near equipment dissipating heat, or under a powerful bench light.

DETECTING RESONANT FREQUENCY

A simple method is shown in Fig. 27. It will be seen that the output of the signal generator is applied to one side of the network, and the probe (which has previously been connected to the current meter and zeroed) is connected to the other side of the network. The earth leads of the signal generator and probe are connected together. The tuned circuit is, therefore, in series with the test gear. If the signal generator is now tuned over the correct band, the meter reading will dip at the frequency where resonance occurs due to the impedance of the circuit increasing at this point. The resonant frequency of the circuit may then be taken from the tuning scale of the signal generator.

It is unusual for the output of a signal generator to be constant over the whole band, but this variation is normally gradual compared with the sharp dip obtained at resonance. The sharpness of the dip, by the way, is an indication of the circuits efficiency (Q) as will be seen later.

Before attempting to tune for resonance, the output level of the signal generator will have to be adjusted to a convenient reading on the

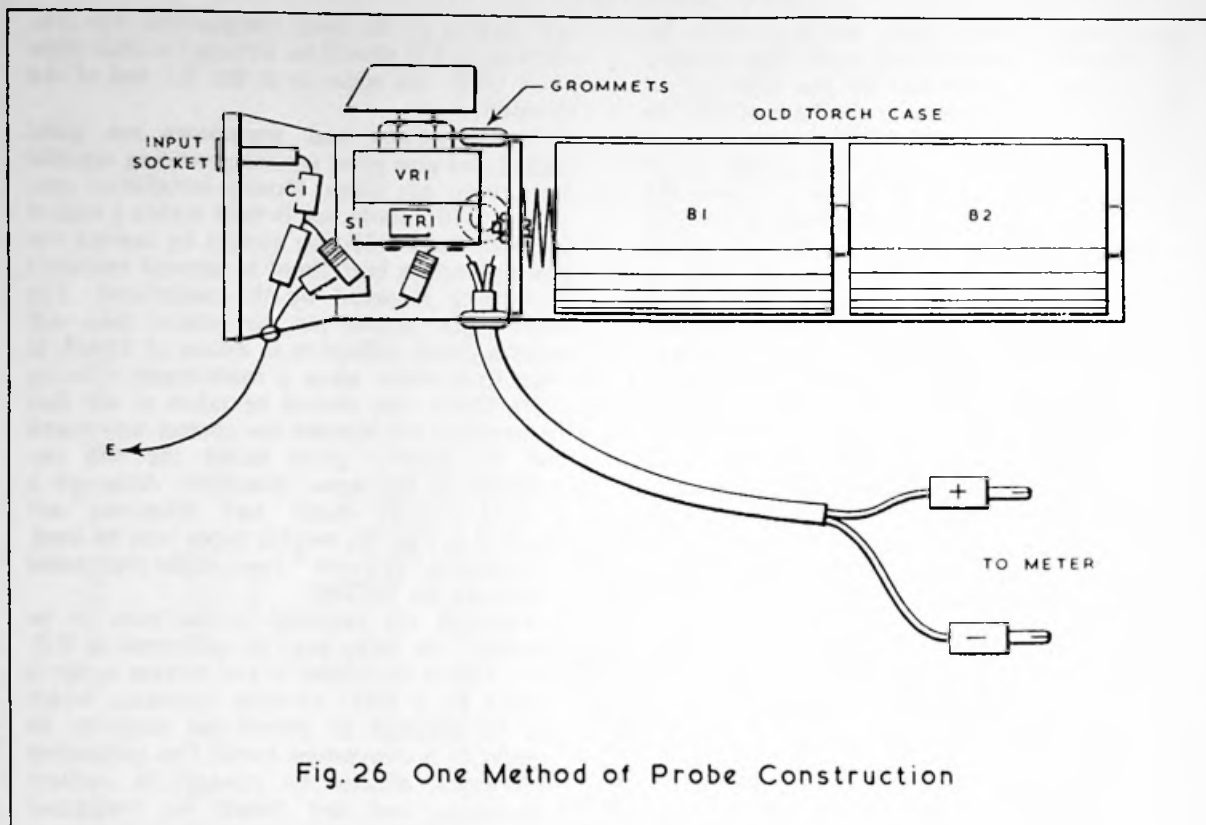

Fig. 26 One Method of Probe Construction

meter. This may necessitate switching the attenuator and matching pads out of circuit, or using the FULL R.F. or FORCE socket where one is provided.

It is often necessary to check the resonant frequency of a parallel tuned circuit which is mounted in equipment so that one side is taken to chassis. To avoid disconnecting or disarranging leads, and perhaps changing the conditions of the circuit, the test gear may be connected in parallel, with both earth leads connected to chassis, and the R.F. lead and probe input connected to the "hot" side of the circuit. Resonance will then show as a sharp rise in meter reading instead of a dip. Although this method is more easily applied, resonance is not so easily detected as with the series method.

Series tuned circuits may also be checked for resonance, but as the impedance of these circuits is at its lowest at this point, results opposite to those obtained from parallel circuits will apply.

Resonant frequency, capacitance, and inductance are coupled by the formula:

$$f = \frac{1}{2\pi\sqrt{LC}}$$

It will be appreciated that knowledge of two

of the above quantities will enable the third to be deduced. For instance:

$$L = \frac{10^6}{(2\pi f)^2 C}$$

and:

$$C = \frac{10^6}{(2\pi f)^2 L}$$

Where L is inductance in μH ; C capacitance in pF; and f is frequency in Mc/s.

When it is required to measure the value of an inductance, a tuned circuit is constructed using the unknown inductor and a known capacitance. The circuit may then be resonated by the methods previously discussed, and from the known frequency and capacitance values, the unknown inductance value determined. This system, however, does not take into account the stray capacitances associated with the coil and test gear.

To facilitate the tests described, the simple test rig illustrated in Fig. 28 may be used. It will be seen that it consists mainly of a calibrated variable capacitor (VC) and suitable terminals mounted in a metal case. The H.F. probe is connected across VC, and much of the stray capacitance associated with the test gear can be accounted for during calibration.

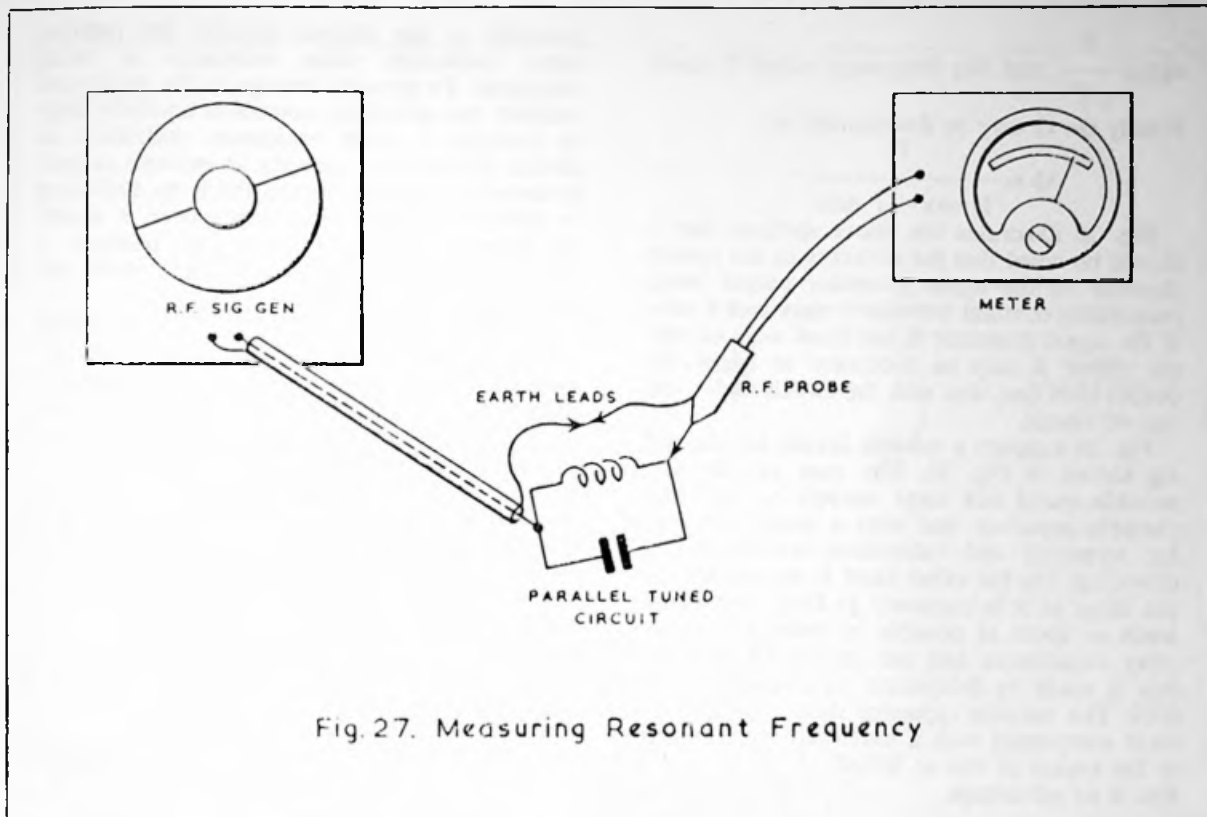

Fig. 27. Measuring Resonant Frequency

When calibrating, it is recommended that a coil of known inductance is connected across terminals a and b. The signal generator is then set to a frequency calculated to resonate the coil when tuned by a 100pF capacitor. VC can now be adjusted for resonance as indicated by the valve voltmeter, and the scale at that point marked 100pF. Other calculated frequencies may now be fed to the unit to permit calibration over the whole VC scale. Another scale on the same dial can be shown with 100pF marked as before but with the low capacitance end of the scale marked in minus quantities. This scale could also be calibrated from 100pF down by applying known capacitors to terminals b and c and noting the displacement of VC from 100pF necessary to keep the circuit at the same resonant frequency.

The most convenient way to measure inductance is to apply the coil across terminals a and b, and set the signal generator for resonance with VC at 100pF. The inductance may then be determined within reasonable limits of accuracy by using the chart shown in Fig. 29. For instance, a frequency reading of 5 Mc/s would indicate an inductance value of approximately 10 μ H.

To measure capacitance, a suitable inductor (the actual value is not important) is first

connected across a and b, and the signal generator adjusted for resonance with VC at 100pF. The unknown capacitance is now connected across b and c, and without altering the oscillator frequency VC is again adjusted for resonance. The amount of VC displacement (read from the minus 100pF scale) is the value of the unknown capacitance. If, for instance, it was necessary to displace VC by 50pF, then the unknown capacitance must be 50pF.

The above method can also be used to measure the self capacitance of coils, but it is important that the working frequency is substantially higher than the resonant frequency of VC and the coil under test.

The Q of a tuned circuit is a measurement of its efficiency and may be found as follows:

First adjust the signal generator to bring the circuit to resonance in the usual way, and note the resonant frequency. Now adjust the signal generator output so that the meter reading is of a convenient level; note this reading (V). Next lower the signal generator frequency to a

point where the meter reading is $\frac{V}{\sqrt{2}}$ (or $V \times 0.707$), and note this frequency (f min). The frequency should now be increased to a point above (f) where the meter reading is

again $\frac{V}{\sqrt{2}}$, and this frequency noted (f max).

Finally the Q may be determined by:

$$Q = \frac{f}{f \text{ max} - f \text{ min}}$$

Fig. 30 illustrates the above method, but it should be noted that the accuracy of the system depends on the signal generator output being reasonably constant between f max and f min. If the signal generator is not fitted with an output meter it may be necessary to check the output level first, and with the circuit under test out of circuit.

Fig. 31 suggests a suitable layout for the test rig shown in Fig. 28. The case can be any suitable metal box large enough to hold the variable capacitor, and with a panel sufficient for terminals and calibration without overcrowding. On the other hand it should not be too large as it is necessary to keep connecting leads as short as possible in order to reduce stray capacitance and inductance. (A suitable box is made by Eddystone, catalogue number 650). The variable capacitor should be a good class component with a maximum capacitance in the region of 140 to 200pF. A slow motion dial is an advantage.

CHAPTER 5

MULTI-PURPOSE TEST GEAR

The possibility of combination test equipment should be considered, as it is usually more convenient, and economises both in space and components. A typical example is the circuit shown in Fig. 32. This actually combines the resistance bridge illustrated in Fig. 11, the capacitance bridge in Fig. 14, and the leakage tester in Fig. 18. As the unit operates from a single 4.5v battery, it is completely self contained.

It is common practice in equipment of this type to energise the resistance bridge as well as the capacitance bridge with an A.C. signal. This means that where the measured resistance is inductive, an error occurs. Such a unit is unable to measure the resistance of a transformer winding or choke coil for instance. This is not the case with the circuit illustrated in Fig. 32, which employs a D.C. energising potential for the resistance bridge network.

A single indicator is used for both bridge circuits, consisting of a 100uA meter connected via a meter bridge rectifier, and the sensitivity control (S3). The rectifier is used for converting the A.C. signal to D.C. when capacitance is being measured, and for presenting the D.C.

potential at the correct polarity for positive meter deflection when resistance is being measured. To prevent damage to the meter and rectifier, the sensitivity control is normally kept in position 1, with maximum resistance in circuit. It may be necessary at extreme ranges, however, to increase the sensitivity by switching to position 2 while final adjustment is made. S3 should always be reset to position 1 immediately after adjustment, and before the component is disconnected.

In both bridge networks, potentiometer (VR1) is the variable ratio arm, and should, therefore, be calibrated for each resistance and capacitance range. It will be noticed that the resistance and capacitance calibrations are similar, except that they run in opposite directions to each other; one being a reciprocal of the other.

Switch S1 is the function switch consisting of three poles: a, b, and c. Pole (a) switches the battery direct to the bridge network for resistance measurements, or to the buzzer which generates an A.C. signal for capacitance tests. Pole (b) switches the resistance standards, capacitance standards, or leakage tester into circuit. Pole (c) isolates the indicating circuit when leakage tests are being made.

Switch 2 is the range switch consisting of two poles; pole (a) switching the resistance standards; and pole (b) switching the capacitance standards. The values quoted for the resistance and capacitance standards give an instrument range exceeding 10M Ω to 10 Ω and 10nF to 10pF.

For further information on the three test circuits, the reader is referred to Chapters 1 and 2.

Further reference to the indicator circuit of Fig. 32 will show that this is in fact a conventional A.C. voltmeter circuit using a moving coil meter. The constructor who possesses a sensitive A.C. voltmeter or multi-meter may prefer to use this, and consequently avoid the expense of installing a separate indicator in the test set.

To the constructor who is contemplating building his own multi-meter, the logical step is to incorporate the circuit of Fig. 32 as an integral part. This rules out the necessity of an ohmmeter circuit, and has the advantage that the basic meter scale, which normally suffices for the current and voltage ranges, does not have to be disturbed for the purpose of marking the ohms range.

A suitable multi-meter circuit which may be used with the circuit of Fig. 32 is illustrated in Fig. 33. It will be seen that all voltage and current measurements are made from one pair of terminals, while the capacitance and resis-

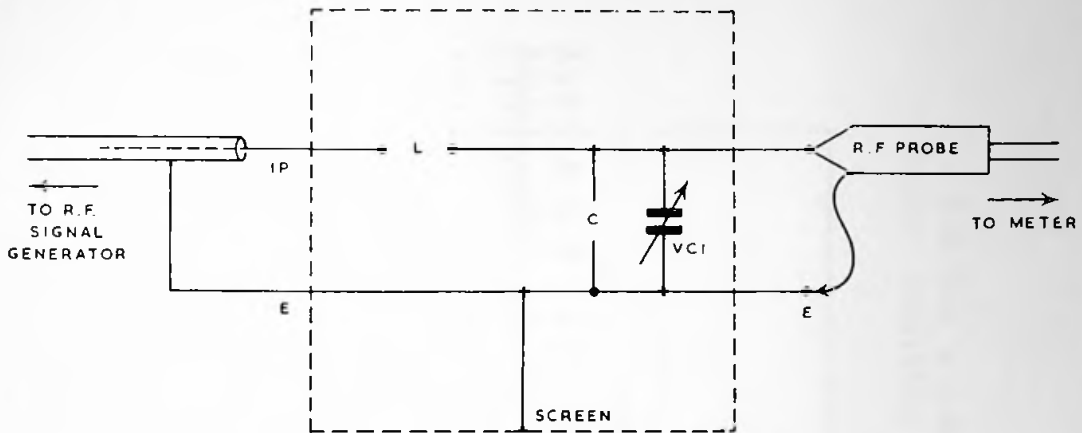

Fig.28 The R.F. Test Rig

tance tests use separate terminals. This introduces an element of safety, especially if the leakage tester is accidentally switched into circuit.

Switch S4 is the function switch consisting of three poles. Pole (a) switches the positive terminal of the 100µA meter; pole (b) switches the positive terminal; and pole (c) switches the negative terminal.

Switch S3 is the range switch consisting of three poles. Pole (a) selects the different shunt resistors for each current range; pole (b) selects the different series resistors for each D.C. voltage range; and pole (c) selects the different rectifier series resistors for each A.C. voltage range.

When S3a is in position 1, no shunt resistor is in circuit, and the meter passes the total current which is 100µA for full scale deflection. Other suggested current ranges are 1mA, 10mA, 100mA, and 1000mA. It is not practicable to quote actual values for the shunt resistors as they will depend on the internal resistance of the 100µA meter. Actual values may be determined, using the following formula:

$$R_{sh} = \frac{R_m}{n - 1} \text{ ohms}$$

Where Rsh is the shunt resistor, Rm the meter resistance, and n the range multiplier. In the case of the 1mA range for instance, n would be 10.

The shunt resistance values will be very low, and it will be necessary to wind them to the exact value using suitable resistance wire. Manganin is very satisfactory for this purpose.

Suitable D.C. voltage ranges are 0.1v, 1v, 10v, 100v, and 1000v. Using Ohm's Law the values of the series resistors may be determined by:

$$R_s = \frac{V}{I} \text{ ohms}$$

Where Rs is the series resistor, V the voltage range, and I the meter current (100µA). This gives the following values:

0.1v	1kΩ
1v	10kΩ
10v	100kΩ
100v	1000kΩ
1000v	10MΩ

From these values must be deducted the meter resistance.

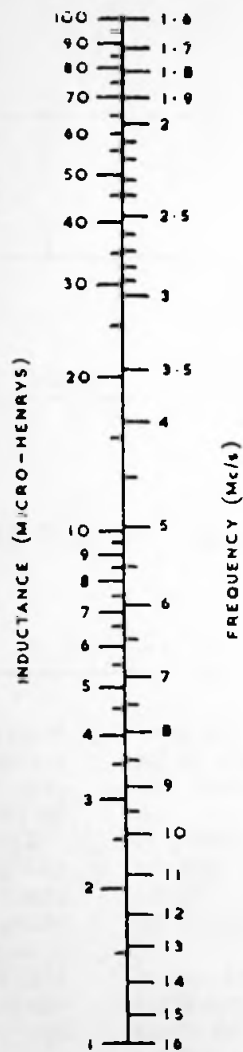

Fig. 29 Chart for Converting Frequency to Inductance when the Inductance is Resonated by 100pF.

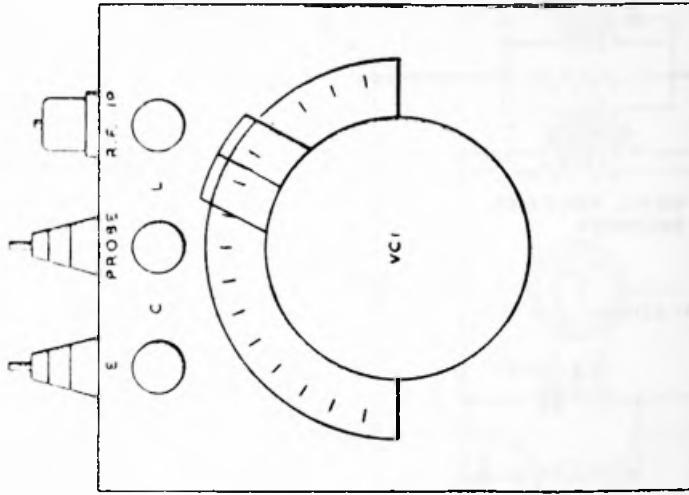

Fig 31 A Suggested Layout for the R.F. Test Rig.

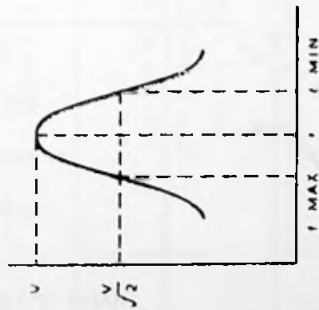

Fig.30 The Response Curve of a Tuned Circuit.

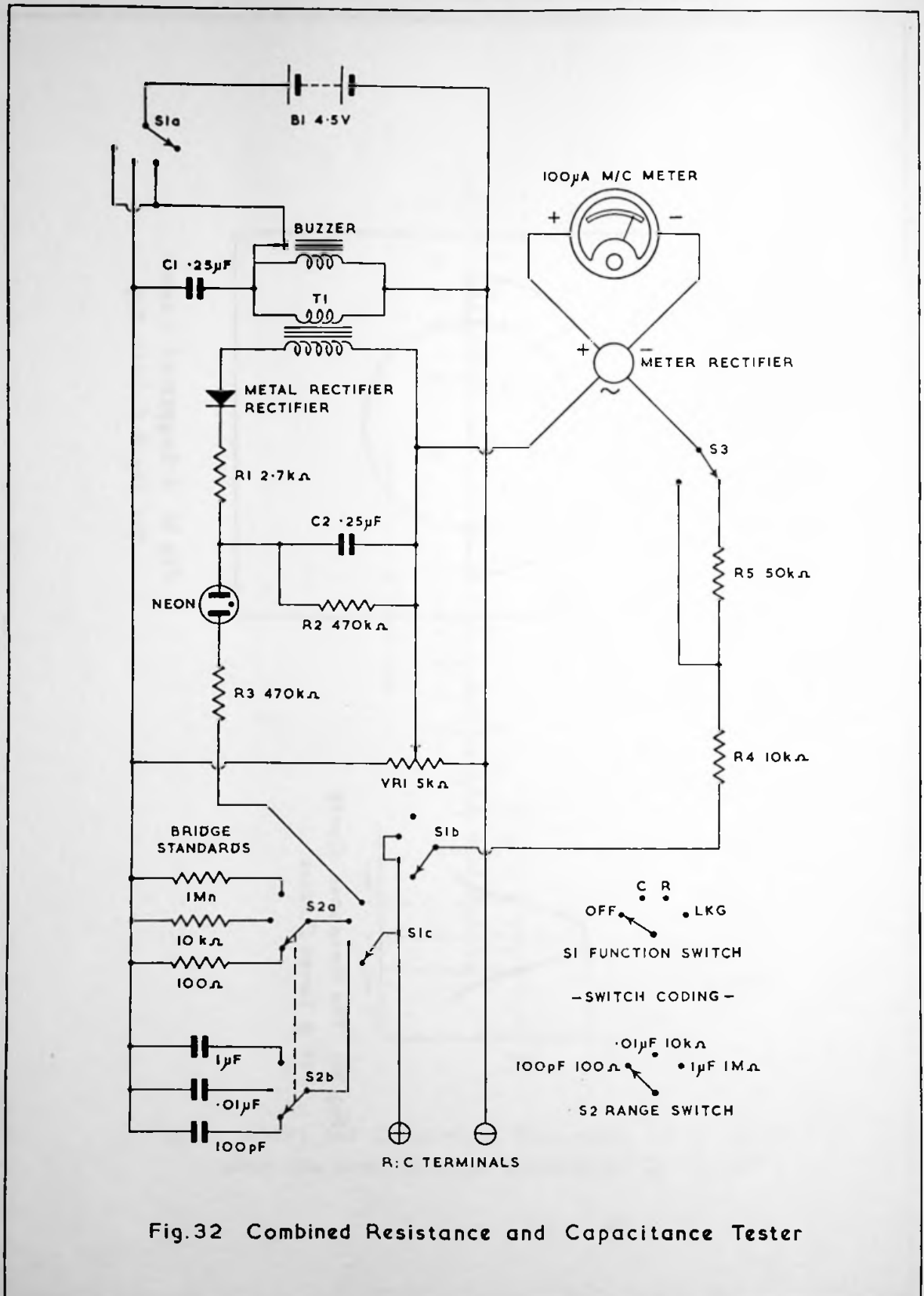

Fig.32 Combined Resistance and Capacitance Tester

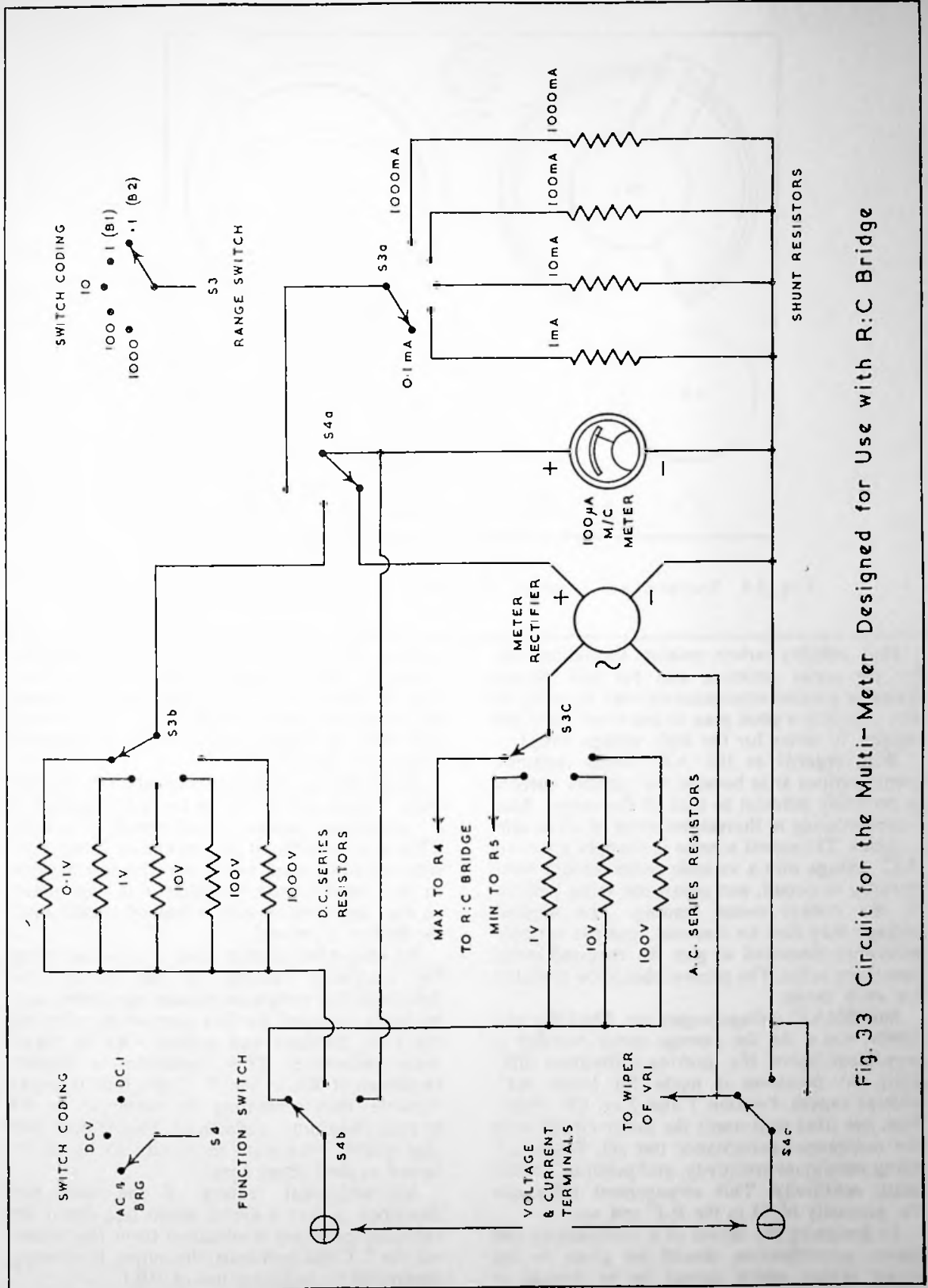

Fig. 33 Circuit for the Multi-Meter Designed for Use with R:C Bridge

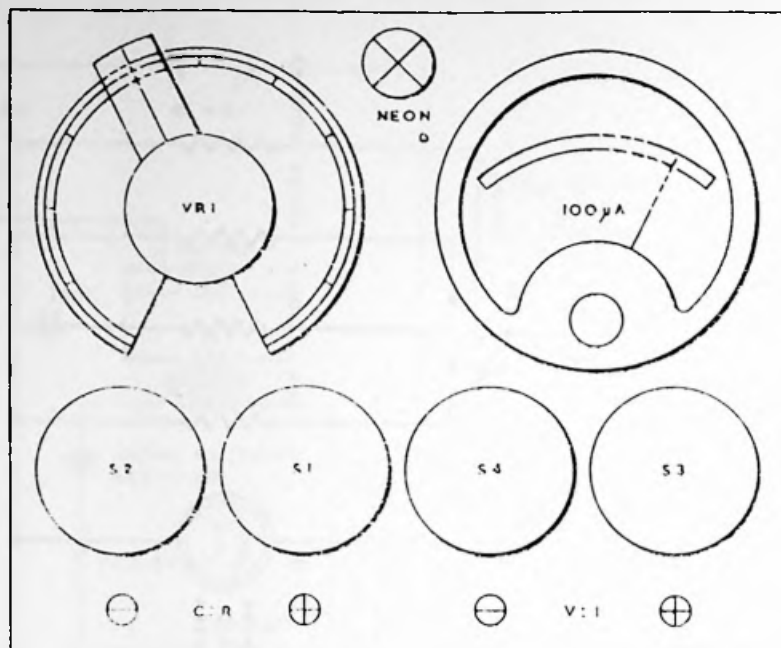

Fig. 34 Suggested Layout for the Combination Test Meter

High stability carbon resistors should be used for the series resistors, and for odd values, series or parallel arrangements may be used. In any case it is a good plan to use more than one resistor in series for the high voltage range.

With regards to the A.C. series resistors, complications arise because the rectifier current is probably different to that of the meter. Also losses occurring in the rectifier must be taken into account. The easiest scheme is to apply a known A.C. voltage with a variable series resistor temporarily in circuit, and adjust the series resistor to the correct meter reading. The applied voltage may then be removed, and the variable resistance measured to give the required series resistance value. The process should be repeated for each range.

Suitable A.C. voltage ranges are 10v, 100v, and 1000v, r.m.s. As the average meter rectifier is non-linear below 10v (making calibration difficult), no provision is made for lower A.C. voltage ranges. Position 1 and 2 on S3c, therefore, are used to connect the meter circuit with the resistance—capacitance test set. Position 1 being maximum sensitivity, and position 2 minimum sensitivity. This arrangement rules out the necessity of S3 in the R-C test set.

In designing the layout of a combination test meter, consideration should be given to the panel layout which should be logical to

prevent mistakes occurring due to incorrect switching. A suggested panel layout is shown in Fig. 34 where the meter on one side is balanced by the bridge potentiometer VR1 on the other, and with the respective switches and terminals positioned accordingly.

Instrument manufacturers usually install some form of patented device in the meter circuit as a protection against inadvertent overload. This is often difficult to arrange in home constructed equipment, but it may be worth while to fit a push-button in series with the meter, so that the moving coil is out of circuit until the button is pressed.

An ohmmeter is often used in radio servicing for continuity testing. In the meter just described, the resistance measuring circuit may be easily arranged for this purpose by selecting the 100n standard and setting VR1 to maximum resistance. This operation is further facilitated if R5 in the R-C test unit is made variable, thus permitting the meter to be set to zero (maximum deflection). This feature will also enable maximum sensitivity to be maintained as the battery ages.

An additional feature of the unit just described is that a useful audio test signal for servicing purposes is obtained from the buzzer via the R-C test terminals; the output level being controlled by judicious use of VR1.

BIBLIOTHEEK
N.V.H.R.

BERNARDS AND BABANI PRESS RADIO BOOKS

BP1	Handbook of Transistor Equiv. and Substitutes	40p
BP2	Handbook of Radio, T.V. & Industrial Tube & Valve Equiv.	40p
BP3	Handbook of Tested Transistor Circuits	40p
BP4	International Handbook of the Worlds Short Wave, Med and Long Wave Radio Stations & FM & TV Listings	35p
BP5	Boys Book of Simple Transistor Circuits	35p
BP6	Engineers & Machinists Reference Tables	20p
BP7	Radio & Electronic Colour Codes & Data Chart	15p
96	Crystal Set Construction	8p
100	A Comprehensive Radio Valve Guide, Book 1	30p
121	A Comprehensive Radio Valve Guide, Book 2	30p
126	Boys Book of Crystal Sets and Simple Circuits	18p
129	Universal Gram-Motor Speed Indicator	8p
138	How to Make F.M. and TV Aerials, Bands 1, 2, 3.	18p
141	Radio Servicing for Amateurs	20p
143	A Comprehensive Radio Valve Guide, Book 3	30p
146	High Fidelity Loudspeaker Enclosures	37½p
147	Practical Tape Recording Handbook	30p
149	Practical Stereo Handbook	30p
150	Practical Radio Inside Out	40p
156	Transistor Circuits Manual, No. 1	15p
157	A Comprehensive Radio Valve Guide, Book 4	30p
160	Coil Design and Construction Manual	30p
161	Radio, T.V. and Electronics Data Book	25p
163	Transistor Circuits Manual, No. 2	15p
165	Hartley on Hi-Fi, Book 1 - Radio Tuners	30p
168	Transistor Circuits Manual, No. 4	15p
170	Transistor Circuits for Radio Controlled Models	40p
171	Super Sensitive Transistor Pocket Radio	20p
173	Practical Transistor Audio Amplifiers, Book 1	20p
174	Transistor Subminiature Receivers	32½p
175	Transistor Test Equipment & Servicing Manual	25p
176	Manual Transistor Audio Amplifiers	40p
177	Modern Transistor Circuits for Beginners	40p
178	A Comprehensive Radio Valve Guide, Book 5	30p
181	22 Tested Circuits using Micro Alloy Transistors	25p
183	How to Receive Foreign TV Programmes on your set by simple Modifications	32½p
184	Tested Transistor Circuits Manual No. 3	20p
185	Tested Shortwave Receiver Circuits using MAT's	30p
187	The TSL Mark "4" Valved F.M. Tuner and its Construction	20p
191	Practical Car Radio Handbook	30p
501	ABC's of Magnetism	30p
502	ABC's of Missile Guidance	30p
RCC	Resistor Colour Code Disc Calculator	10p
FORTHCOMING TITLES		
BP8	Sound and Loudspeaker Manual	50p
BP9	38 Practical Tested Diode Circuits for the Home Constructor.	35p
BP10	Modern Crystal Set Circuits for Beginners	35p
BP11	Practical Transistor Novelty Circuits	40p
BP12	Hi-Fi, P.A. and Discotheque Amplifier Design Handbook	75p

BABANI PRESS AND BERNARDS (PUBLISHERS) LIMITED
 The Grampians, Western Gate, Shepherds Bush Road,
 London W6 7NF
 Tel: 01-603 2581/7296

Bibliotheek Ned. Ve