

THE LOUDSPEAKER MANUAL



PUBLICATION N° 70

PRICE 2'6

RADIO NEWS

foremost American Radio magazine, is obtainable direct by post from America ; the only sure way of receiving copies regularly.

RADIO NEWS unfolds, month by month, the complete story of radio research and development. Editorially and in presentation, printing and production, it maintains the highest American standards. Each issue contains from 136 to 160 pages of news, articles, pictures and advertisements, brilliantly written and illustrated.

Radio technicians, dealers, business and factory executives, radio specialists in the services, amateurs, "hams," officials, research specialists, constructors, all are fully catered for. The scope of RADIO NEWS, in all that matters, is complete.

For a modest sum, payable in advance, the postman will deliver a copy at the door every month.

Subscription orders may be placed through your Radio dealer or newsagent or, in case of difficulty, posted to us at the address below.

POPULAR PHOTOGRAPHY, FLYING, PLASTICS, and the new PHOTOGRAPHY

From the publishers of RADIO NEWS come these four superb magazines, each completely fulfilling, in its own sphere, the same essential purpose as RADIO NEWS. Informative to the highly skilled operator or technician, yet understandable and interesting to the amateur : intensely practical, yet never dry or stodgy. Brilliantly written, copiously illustrated and beautifully produced, each magazine maintains the highest standards for which American magazines are famous.

Particulars of subscription rates and facilities on request.

ZIFF DAVIS LIMITED,

GRAMPIANS BUILDING, WESTERN GATE, LONDON, W.6

Telephone : SHEPHERD'S BUSH 4794.

OPPORTUNITIES IN RADIO

Get this FREE Book !



“ENGINEERING OPPORTUNITIES” indicates clearly how all engaged in the wireless industry can equip themselves for safe and highly-paid posts despite the keener competition which will come with the return to normal conditions.

This modern guide contains 108 pages of highly interesting information. It gives full details of our very comprehensive series of modern **WIRELESS COURSES**, including **General Wireless, Short Wave, High Frequency, Sound-film Projection Engineering, Television and Radio Servicing, etc.**

TELEVISION and RADIO SERVICING

There is no doubt about it that there will shortly be an enormous boom in Television and unlimited opportunities for the trained man. Our special **TELEVISION and SERVICING Courses** are fully described in the handbook.

“ENGINEERING OPPORTUNITIES” also explains the most efficient way of preparing candidates for such recognised examinations as **A.M.I.E.E., A.M.Brit.I.R.E., City & Guilds, etc.**

We definitely guarantee

“NO PASS—NO FEE”

The wireless industry is alive with possibilities for the far-seeing man. In your own interests we advise you to investigate these possibilities by sending for your copy of “ENGINEERING OPPORTUNITIES” at once—FREE and without obligation.

**BRITISH INSTITUTE OF
ENGINEERING TECHNOLOGY**

514, Shakespeare House,
17-19, Stratford Place, London, W.1

—THESE ARE IN STOCK—

WIRELESS SERVICING MANUAL,
by W. T. Cocking, 10s. 6d. Postage
4d.

**TELEVISION RECEIVING EQUIP-
MENT**, by W. T. Cocking, 12s. 6d.
Postage 4d.

FOUNDATIONS OF WIRELESS,
by M. G. Scroggle, 7s. 6d. Postage
4d.

**RADIO RECEIVER SERVICING
AND MAINTENANCE**, by
E. J. G. Lewis, 8s. 6d. Postage 5d.

**A MODERN HOME-BUILT
TELEVISOR**, 2s. 6d. Postage 2d.

**WIRELESS COILS, CHOKES AND
TRANSFORMERS**, by F. J. Camm,
6s. Postage 4d.

**RADIO VALVE EQUIVALENTS'
MANUAL**, by B. B. Babani, 2s. 6d.
Postage 2d.

**NEWNES SHORT-WAVE
MANUAL**, by F. J. Camm, 6s.
Postage 4d.

FUNDAMENTALS OF RADAR, by
Stephen A. Knight, 10s. Postage 4d.

**THE CATHODE-RAY TUBE
HANDBOOK**, by S. K. Lewer, 6s.
Postage 4d.

RADIO UPKEEP AND REPAIRS,
by A. T. Witts, 7s. 6d. Postage 5d.

**WORKED RADIO CALCULA-
TIONS**, by A. T. Witts, 6s. 6d.
Postage 4d.

RADIO DATA CHARTS, by R. T.
Beatty, 7s. 6d. Postage 6d.

RADIO SERVICE TEST GEAR, by
W. H. Cazaly, 6s. Postage 4d.

THERMIONIC VALVE CIRCUITS,
by E. Williams, 12s. 6d. Postage 6d.

**RADIO ENGINEER'S POCKET
BOOK**, by F. J. Camm, 3s. 6d.
Postage 3d.

We have the finest stock of British
and American radio books.
Complete list on application.

THE MODERN BOOK CO.,

(Dept. B.)

19-23, Praed Street, London, W.2

Telegrams : Rodevco Lesquare
London

ROGERS DEVELOPMENTS CO.

Registered Office :
12 MACCLESFIELD STREET
SHAFTESBURY AVENUE
LONDON, W.1

HIGH FIDELITY

We can supply all components, baffles, bass reflex cabinets, gram-motors, loudspeakers, pick-ups, etc., for the construction of high fidelity equipment.

Price List available on receipt of S.A.E.

Telephone : GERrard 3057-8256

CHARLES AMPLIFIERS LTD.

1E PALACE GATE, KENSINGTON
LONDON, W.8

Phone : WESTERN 3350

For highest quality reproduction we offer two Amplifiers suitable for pick-up or Radio.

THE CONCERTO. 12 watts at under 2% distortion falling to below 1% at 6 watts. Incorporated pre-amplifier allows the use of any pick-up, including moving coil. Separate Bass and Treble control. with Double Bass Boost. 9 valves.

Price, £27 10s.

THE KI. 5 watts at under 1% distortion. Suitable for high fidelity pick-ups, including moving coil types. 7 valves, separate Bass and Treble controls.

Price, 17 Gns.

THE KI also available as a kit of parts. Price, including ready drilled chassis and valves, 13 Gns. Blueprint, 2s. 6d.

Send S.A.E. for complete lists of.
AMPLIFIERS, PICK-UPS, LOUDSPEAKERS

POST RADIO SUPPLIES

33 BOURNE GARDENS
LONDON, E.4

Offer from Stock

COPPER INSTRUMENT WIRES.
ENAMELLED, TINNED, COTTON
AND SILK COVERED. LITZ WIRES.
B.A. SCREWS, NUTS, WASHERS,
SOLDERING TAGS, EYELETS AND
RIVETS.

LAMINATED BAKELITE & EBONITE
PANELS. TUFNOL AND EBONITE
ROD. PAXOLIN type tubes and
coil formers. All diameters.

Permanent detectors, crystals, head-
phones, etc., etc.

Send S.A.E. for List. Trade Supplied

HENRY'S RADIO

OFFER

OUTSTANDING LINES
in a wide range of
RADIO COMPONENTS

Send S.A.E. for 1948 Price List

Cash with order or C.O.D.

WHOLESALE
and
RETAIL

5 HARROW ROAD
LONDON
PADDINGTON 2194

THE LOUDSPEAKER MANUAL

by

“RADIOTRICIAN”

1948

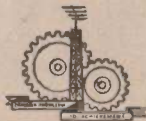

BERNARDS (PUBLISHERS) LTD.
LONDON

CONTENTS

	PAGE
CHAPTER 1. THE NATURE OF SOUND	5
CHAPTER 2. THE LOUDSPEAKER IN THEORY	9
CHAPTER 3. FEEDING THE LOUDSPEAKER	18
CHAPTER 4. MOUNTING THE LOUDSPEAKER	37
CHAPTER 5. THE LOUDSPEAKER IN USE	44
CHAPTER 6. EXTENSION LOUDSPEAKERS	46
CHAPTER 7. THE LOUDSPEAKER IN INDUSTRY	51
APPENDIX A. FEEDING THE SPEAKER FIELD	58
APPENDIX B. THE OUTPUT TRANSFORMER	60

WITH 26 DIAGRAMS

Chapter 1

THE NATURE OF SOUND

The task of a loudspeaker, whether it is connected to a receiver or amplifier or any other type of gear, is to convert fluctuations of electrical energy into sound. The sound may be a single tone, should the receiver be given over entirely to C.W. reception, but in general the sound will be either speech or music or noise, or a mixture of any or all of these things. It will be as well, therefore, to investigate the nature of these sounds before treating with the loudspeaker itself, so that its task may be more fully understood.

Sound is, of course, a mechanical movement of air caused by some disturbing factor, and it is worth while to remember that sound "occurs" as an effect of pressure and rarefactions of air on a perceiving organ, the ear. Most readers will know the old question—if a volcano blew up with nobody near it, would there be any sound? The correct answer, presumably, is that there would be sound in plenty, but that it would remain unperceived.

All sounds—vibrations within the audible range—have three main characteristics: pitch, loudness and phase, and to the conception of pitch must be added the conception of quality.

The pitch of a sound depends primarily upon the frequency of the vibrations, and is therefore expressed in cycles per second, and it is relatively rarely that a sound wave consists of a purely fundamental frequency. The vast majority of sounds consists of a number of components bearing harmonic relationships one to another, these components combining to give a complex wave-shape. The pitch of the resulting sound is the fundamental frequency of these harmonics, and the quality of the sound is given by the harmonics which are also called overtones. Consider, for example, a note played on the piano and the same note played on an organ. The qualities of the two sounds are remarkably different, although the pitch is the same in each case. It is the harmonics existing in a sound, therefore, that give the sound the indefinite "something" that allows the ear and brain together to say, "Organ," "Piano," "Harp," "Voice," even though the various sound sources are all giving the same pitch of sound. Changing the harmonic content of the sound changes the sound quality.

The loudness of a sound depends, naturally, upon the amplitude of the sound wave, and has some slight effect upon pitch so far as the response of the ear is concerned. Sound loudness is measured in bars, the bar being a unit of pressure representing 1 dyne per square centimetre of energy, or sound can also be measured as the ratio between the energy of the sound wave actually heard and the energy of a just audible wave at the same pitch.

The phase of a sound is related to the actual rarefactions and compressions of air. It is possible, for example, to produce a sound wave at a certain pitch—say, by striking a gong—where the first cycle was a compres-

sion cycle, but if the first cycle was a rarefaction cycle the sound reaching the ear would sound identically similar. The ear, therefore, is quite insensitive to phase, but this is not the case with mechanical devices where phase considerations must often be taken into account. Naturally, the ear is not insensitive to phase where sound travels by different paths to the ear from a single source so that the resultant sound level differs according to whether the sound waves are in or out of phase, in-phase waves adding in intensity and out-of-phase waves subtracting, but this is an effect extraneous to the ear, and is linked up with reverberation effects, etc.

Speech

The frequencies used in speech fall between the limits of 100 and 10,000 cycles with the fundamental frequency set by the vocal cords of the speaker. The vocal cords of men have a fundamental frequency of about 125 cycles per second, whilst the vocal cords of women have a fundamental frequency of perhaps twice this figure, the fundamental frequency rising in each case with a rise in sound intensity. The different sounds in speech are produced in a variety of ways. When a stream of air from the lungs is set flowing over the vocal cords, a fairly powerful sustained sound is set up, forming a vowel, and the tongue and lips are automatically shaped to provide, with the throat and mouth and nasal cavities, a resonant chamber which gives reinforcement to some of the harmonics contained in the basic sound whilst damping or suppressing other harmonics. Some sounds do not come from the vocal cords at all, whilst others are formed as beginnings and endings to a vowel sound, the beginnings and endings being produced in various ways with the mouth, tongue and lips.

The power used in speech is surprisingly small. More than once the suggestion has been put forward that microphones should be placed in noisy situations or in places where a considerable amount of talk goes on, such as the House of Commons, in order that the waste energy might be converted into electrical energy for heating and lighting! Since the very loudest sound connected with speech has a peak energy of perhaps one-two-hundredth of a watt, whilst the energy of ordinary conversation is, on the average, below 10 microwatts, any such scheme is due for failure. Nevertheless, the intensity range of the voice is very wide. A faint whisper is something like half a million times less powerful than a really loud shout.

Although speech frequencies range between 100 and 10,000 cycles, speech can be transmitted electrically by using a much more restricted frequency range, and whilst the "natural" quality of the speech is bound to suffer, intelligibility can be retained over a frequency band of only 250 to 3,000 cycles or so. This is fortunate, for in many cases it is desirable to attenuate the frequency range over which speech is transmitted or reproduced. The telephone, for example, has a restricted frequency range, and even the ordinary broadcast station must suppress frequencies above 5,000 cycles in order that its total bandwidth shall remain within the agreed limits.

Music

Music differs from speech in that the frequency range covered is much wider, being extended both at the low and high frequency ends, whilst the power involved is much greater. So far as frequency is concerned, many musical instruments produce sounds whose fundamental frequencies are as low as 50 cycles per second or less, and as high as 15,000 cycles. The power of a large orchestra can be as much as 100 watts on peaks, with an energy range of 10 million to one between the loudest and softest passages, and it is interesting to learn that the drums—or, more properly, the tympani—are among the most powerful orchestral instruments and have a frequency range of from below 50 to 3,000 cycles per second.

Comparing the peak energies of a normal voice and a large orchestra will enable the reader to realise one of the great difficulties always attending the reproduction of speech and music in the home. The voice can be presented greater than life-size—the microphone can be close to the speaker and its output subjected to great amplification, whilst at the receiving end practically any good set will provide an output so great that the speaker's voice will be louder than a normal voice in the same room. Now let an orchestra be broadcast—how should it be reproduced in the small living-room in which it could not play? If the voice of a speaker can be tolerated at greater-than-normal loudness levels, should the orchestra also be louder than life? It appears that the human ear is a very tolerant organ, and this in fact is so.

The Ear

The ear has a wide frequency range over which it is able to operate, the actual range appearing to vary with the age, health and general make-up of the person. An average frequency range would be from 20 cycles (below this sound is beginning to be "felt" rather than "heard") up to 20,000 cycles, though the upper limit varies considerably and is a low limit compared with some animals. Scientists are still discussing the possibility that some "dumb" animals actually make use of supersonic sound for communications, supersonic sound being sound at frequencies beyond the limit of human audibility. One well-known animal noise near the upper limit of the human ear's frequency range is the squeaking of bats.

The points at which sound is only just audible, in one direction of sensitivity, and at which sound is so loud that it produces the sensation of pain at the other extreme, are named respectively the Threshold of audibility and the Threshold of feeling. The ear is most sensitive between the frequencies of 1,000 and 3,000 cycles.

The important characteristics of the ear, however, related to sound reproduction and radio work, are the production of subjective tones and masking. Subjective tones are formed in the ear by relatively powerful sounds, and are harmonics and sum and difference frequencies which,

although not present in the original sound impinging on the ear, are passed on to the brain. For example, a sound might have its fundamental frequency removed or filtered out, leaving only the harmonics forming the sound quality, yet to the ear the pitch of the sound would not appear to change. The ear would form a subjective tone from the harmonic contents of the sound to take the place of the missing fundamental frequency, and the sound would thus be passed on to the brain. Subjective tones are the result of a non-linear response of the ear, and the ear is thus able to fill in for itself "gaps" in a transmitted frequency range. A loudspeaker, for example, may be a very bad performer on the low frequencies, as shown by tests with mechanical apparatus, yet give quite good results when judged by ear alone, the ear itself supplying the missing tones.

Masking is the progressive deafening of the ear to higher frequencies by lower frequencies. Subjective tones caused within the ear by low frequency sounds or notes make the ear less sensitive to higher frequency sounds, one example of the effect being the necessity of speaking more loudly in a noisy locality.

Noise may be described as random sound—sound existing or distributed over a wide frequency range without a fundamental frequency or pitch. Nevertheless, different noises have different distributions of energy, and a great number of noises have their main energy at high frequency levels. At the same time, music is often accompanied by noise set up as a by-product of the instrument being played. Most listeners will have heard key-clicks from pianos, air-hiss from organs and clarinets, plectrum-clicks from guitars, and similar instances, whilst surface and groove noise from gramophone records presents a problem concerning which much has been written and to alleviate which much work has been carried out.

The reproduction of music is also affected to some extent by the relationship existing between loudness and frequency. Reducing the volume of a record-player or radio receiver has the effect of reducing the loudness of the bass frequencies to a greater degree than is the case with the high frequencies, this being due to the fact that apparent loudness is reduced with a reduction in frequency. Some receivers are fitted with compensating volume controls which attenuate the high frequencies when the volume is reduced in order to maintain some degree of tonal balance.

With these various effects born in mind, it is interesting to speculate on the true meaning of "high quality" sound reproduction. The ear of the individual will place its own interpretation on the sound presented to it, and there is no doubt that a reproducing system set to give results very pleasing to one observer will totally fail to please another, even though both observers hear the original orchestra with pleasure. It would appear that the art of building a high quality amplifier or receiver is to construct the apparatus to distort the signal into a final and acceptable form for the particular user or observer—it is certain that a level response curve is very far from being the final desideratum.

Chapter 2

THE LOUDSPEAKER IN THEORY

In the early days of radio it is possible that more time was spent on loudspeaker development than any other single item of gear, but the multitudinous forms of loudspeaker have now all become standardised into three main kinds—the popular dynamic speaker, the horn speaker, and the magnetic speaker.

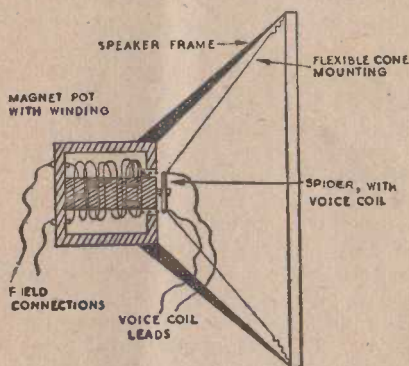

FIG. 1.—The Dynamic, or Moving-Coil, Loudspeaker.

Undoubtedly the reader will be most interested in the dynamic-loudspeaker; or moving-coil speaker, which is now so widely used. The horn loudspeaker is chiefly used for public address work and, in some forms, for cinema sound equipment, and the magnetic speaker can still be found in some battery sets and, in particular, in portable receivers, where its small size and light weight make it of use. The magnetic or armature speaker, however, has a poor performance when compared with a moving-coil speaker, and there are few cases where a moving-coil instrument could not be substituted beneficially for a magnetic movement.

The dynamic speaker, shown in cross-section in Fig. 1, essentially consists of a small coil, the voice coil, suspended in an intense magnetic field, this field being supplied either by a permanent or an electro-magnet. The coil is held in the field by a spider which positions the coil centrally in a narrow annular gap, the clearances being small so that the magnetic field is concentrated. The spider is made of springy material in the majority of cases, but a soft or yielding material is sometimes used. The voice coil is directly fastened to a cone made of stiff paper, which is thus centralised

with the coil by the spider, and the edges of the cone are fastened in some way to the framework of the loudspeaker for support. This fastening, of course, should be flexible, in order that the cone has a degree of forward and backward travel.

When alternating currents are passed through the voice coil they set up a magnetic field in and around the coil, the intensity of the field obviously depending on the instantaneous intensity of the current. An alternating or speech current thus gives an alternating field of varying intensity, and this field interacts with the field already cutting the turns of the voice coil, the steady magnetic field provided by the loudspeaker magnet. The interaction of the field results in forces playing upon the speaker magnet poles and the moving coil, and whilst the magnet poles are fixed the voice coil is free to move so that it trembles back and forth, carrying the paper cone with it through small excursions of travel. The cone therefore acts upon the air in contact with it and sends forth a series of rarefaction and compression waves—in other words, it causes sound.

When the magnet of the loudspeaker requires electrical energisation, it is generally used for another purpose as well, being pressed into service as a smoothing choke for the receiver into which the speaker is fitted. The receiver then draws current through the magnet coil, the current, flowing from the receiver's rectifier, is smoothed and the magnet is energised. There is a chance, of course, that the ripple on the speaker energising current will cause a hum in the loudspeaker, and to counteract this effect a hum-bucking coil is provided. The hum-bucking coil is wound round the magnet pole and consists of a few turns of heavy wire, unlike the magnet coil, which consists of many turns of fine wire. The speech currents to the moving coil are then passed through the hum-bucking coil, the connections being as shown in Fig. 2. Any hum in the magnetising current induces a hum voltage across the voice coil of the speaker and also across the hum-bucking coil, and if

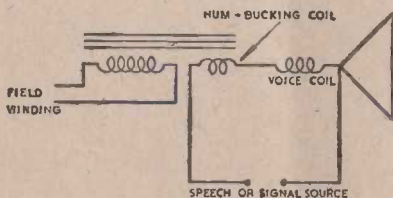

FIG. 2.—Speech or Signal Source.

the hum-bucking coil is connected into circuit in the right sense these two hum voltages tend to cancel each other out, the speaker thus being practically hum-free. The hum-bucking coil connections are generally brought out to a tag board and the connections are made experimentally, the hum increasing instead of decreasing if the coil is connected between the voice coil and output transformer in the wrong sense.

The voice coil is connected to the output valve or stage of the receiver or amplifier from which it is supplied with speech and signal currents through a step-down transformer.

The moving parts of the dynamic loudspeaker, the cone and voice coil, have a natural frequency which is generally arranged to fall at the low frequency end of the audible range. The cone and voice coil are thus resonant at this frequency.

It is most important that any dynamic loudspeaker shall be mounted on a baffle board or in a cabinet acting as a baffle board. Without a baffle board the low frequency sound waves radiating from the back of the cone can immediately flow round the cone to mingle with the sound waves radiating from the front of the cone. Since these sound waves are directly out of phase they will interfere unless a baffle is provided to keep them separated.

The voice coil and cone vibrate at a velocity which is proportional to the force applied divided by the mechanical impedance present. The mechanical impedance is made up of a mass, a compliance and a resistance, the mass consisting of the effective mass of the cone and voice coil with the mass caused by air in contact with the cone, the mass being taken at the particular frequency applying; the compliance involves the spider and enclosed air spaces and other factors which stiffen the movement; whilst the resistance is made up of eddy-current losses, friction, the radiation of sound, and similar factors:

Eddy-currents occur in the magnet's pole faces, and since it is moving in a magnetic field in the coil itself, these currents absorb energy from the circuit. Eddy-current losses may therefore be represented by a series resistance. In addition to causing eddy-currents, the movement of the coil produces a back E.M.F.; this reduces the current flowing in the coil, but absorbs no power and may be represented as an increase in the coil inductance.

In the same way the other mechanical losses can be likened to electrical losses, so that it is possible to draw an equivalent circuit of a dynamic loud-

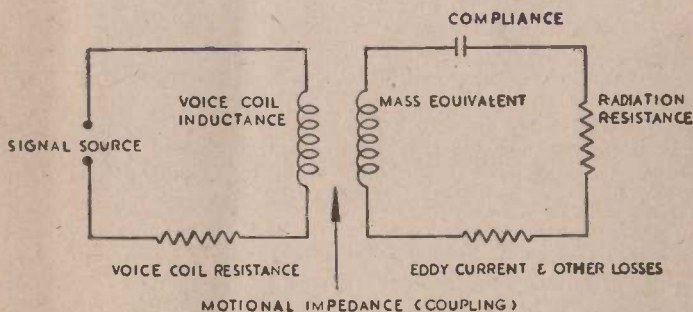

FIG. 3.—Equivalent Circuit of the Dynamic Loudspeaker.

speaker as in Fig. 3, where the voice coil resistance and inductance are shown coupled to the speaker's mechanical equivalents. The motional impedance appears in this figure as the coupling impedance between the two coils, and the mechanical equivalents obviously make up a tuned circuit complete with inductance, capacitance and resistance, and it is the energy spent in the resistance equivalent to the speaker's radiation resistance which corresponds to the actual sound energy given by the loudspeaker. At low frequencies the radiation resistance falls very rapidly until at the frequency to which the voice coil and cone are resonant the output tends to be large, since radiation resistance is governed by the ratio of the cone diameter to the wavelength of the sound produced (assuming that the cone may be taken as equivalent to a piston face or flat diaphragm which is only the case at low frequencies). At the same time, however, the motional impedance also rises rapidly, so that low frequency output is actually balanced against high frequency sound output, although it is still possible to modify the design of the loudspeaker to have accentuation or attenuation of the lower frequencies should this be desirable. As the frequency rises and the cone diameter—sound wavelength ratio rises, the radiation resistance eventually becomes independent of frequency and the sound output becomes inversely proportional to the square of the frequency, the output thus being theoretically reduced. In practice, however, this reduction in output at high frequencies is prevented in large measure by the behaviour of the cone. As the frequency rises, the cone behaves less and less like a flat diaphragm until at the highest frequencies practically the only part of the cone and voice coil radiating sound energy is the spider and the cone paper immediately surrounding it. The general effect is that the cone diameter is reduced with a rise in frequency, so that the mass is reduced and the sound energy retained at a higher output than might be expected. At the same time, the speaker gives a directional effect to high frequencies which are radiated from the very centre of the cone, and whilst there is some drop in the sound energy at the higher frequencies this is more apparent at the sides of the speaker than directly in front of it.

The load presented by a dynamic loudspeaker to an output valve varies very considerably with frequency by reason of the fact that the load is an impedance and not a pure resistance. Loudspeakers are rated for voice coil impedance at a frequency of 400 cycles, and at this frequency the impedance is usually at practically its lowest figure. At the bass resonant frequency the voice coil impedance rises to a value perhaps as much as six times the impedance at 400 cycles, whilst at only two frequencies is the voice coil load resistive, the load being inductive or capacitive at other frequencies, these effects being illustrated in Figs. 4 and 5.

In the equivalent circuit of Fig. 3 no details of the power source are shown, but in fact the behaviour of the loudspeaker depends to a considerable degree on the damping factor applied by the source to the voice coil. The loudspeaker has a natural damping factor due to the air on the cone, the stiffness of the spider and similar factors, but a further important source of damping is the impedance of the source of power shunted across the voice

coil. The damping factor given to a speaker by the output stage into which it is connected is $\frac{R1}{rp}$ where R1 is the anode load resistance of the output valve and rp is the valve's anode resistance, both of which values may be found from valve lists or tables. The damping when the impedance of the voice coil rises is greater than that given when the impedance of the voice coil is low, as at 400 cycles, so that for the great rise in impedance at the bass resonant frequency the damping also rises in proportion. Damping is especially important in the reproduction of transients, and since the damping

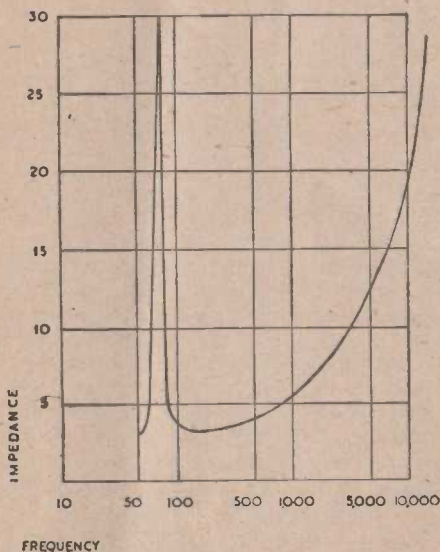

FIG. 4.—Voice coil Impedance with frequency.

factor improves as the anode resistance of the output valve is reduced, the highest damping factors are given by triodes. Output pentodes and beam power tetrodes have very poor damping factors for the reason that the anode resistances of these valves are high, the result being that an increase in the power input to the voice coil occurs at the resonant frequency when the sound output already tends to be higher than at other frequencies. The effect may be combated by applying negative feedback to pentode and tetrode output valves, this effectively reducing the anode resistance and improving the damping factor. A poor damping factor gives the effect of what may be termed "hangover" on transients—a transient is a sudden sound like a drum-beat.

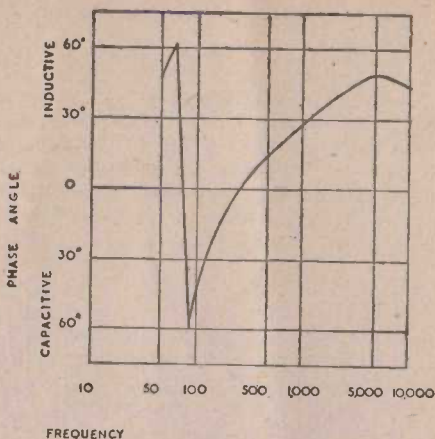

FIG. 5.—Impedance Characteristic with frequency.

The rise of damping with a rise of voice coil impedance is also of importance in reducing what is known as selective distortion. If the resonant frequency of the loudspeaker is 70 cycles, the voice coil impedance will rise for a frequency of 35 cycles since the second harmonic of this frequency falls at 70 cycles. Similarly, for a frequency of 23.3 cycles the voice coil impedance will rise since the third harmonic of this frequency is 70 cycles, whilst at frequencies above the middle audio frequencies—say, at above 1,000 cycles—the impedance of the voice coil will tend to rise higher for harmonics than for fundamental frequencies.

The mechanical proportions of a loudspeaker are allied to the type of output characteristic which is required. A large cone with a large voice coil will give good output on the low frequencies, whilst high frequencies will be best dealt with by a small cone and a light-weight voice coil. In some cases, therefore, two loudspeakers are used to deal with the output frequency range, the low frequency speaker sometimes being known as a "woofer" and the high frequency speaker as a "tweeter." The output arrangements coupling the output stage to the speakers must be so made that only the low frequencies are supplied to the woofer and only the high frequencies to the tweeter, the cross-over point being of the order of 1,000 cycles.

Speakers have been made which combine the two functions in one instrument, the whole voice coil and cone acting on low frequencies with a subsidiary voice coil acting with the spider on high frequencies, but such loudspeakers are not common.

The efficiency of an ordinary dynamic speaker is very low, since the driving force given by the cone is very inefficiently coupled to the air. An efficiency of 5 per cent., or even less, is normal.

Horn Loudspeakers

The low efficiency of the moving coil, i.e., the dynamic loudspeaker, whilst allowing it to be used successfully in the home, renders it unsatisfactory for work at long distances or in the open air. At the same time the poor coupling between the cone and the air which it drives means that a dynamic speaker has a relatively low overloading point. Any loudspeaker can be overloaded, and whilst the first consideration is perhaps the possibility of damage to the moving elements—for example, the voice coil former might “bottom” in the annular magnet gap and be buckled—overloading also causes distortion before the moving parts are in danger of harm. The moving coil, for example, might be swung out of a uniform magnetic field into a region where the field is not uniform, an effect more likely at the bass or resonant frequencies, or a wide amplitude of swing might cause non-linear action in the spider or other components.

A horn speaker overcomes the lack of efficiency of the cone, to some extent, and by loading the speaker diaphragm more effectively allows greater speaker drive.

A horn acts as a “sound wave transformer”—it transforms sound energy at high pressure and slow velocity to low pressure and high velocity sound energy. A horn therefore increases the air loading on the speaker cone, diaphragm or driving member, with the result that efficiency rises to perhaps 50 per cent., a notable gain. The chief design factors of a horn are the throat and mouth areas and the horn taper, the parts of a horn loudspeaker being shown diagrammatically in Fig. 6. The horn shape most commonly used is the “exponential” horn, where the area of the horn

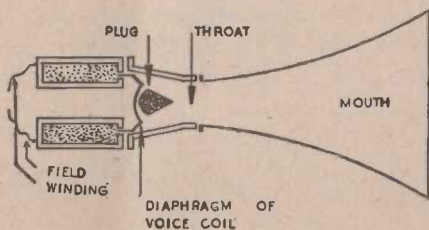

FIG. 6.—The Horn Loudspeaker.

aperture at any point along the horn bears a direct relationship to the throat area and the distance of the measured aperture from the throat. A horn of finite length of this form of taper has a cut-off frequency below which no sound is passed and above which all frequencies are passed without preference, so that the lowest frequency to be dealt with must also be brought into consideration. At the same time the mouth of the horn must be sufficiently large to pass to the outer air the lowest frequencies without

setting up beats or resonances in the enclosed air column, the mouth diameter being preferably at least a quarter wavelength in size of the lowest frequency sound wave.

The throat may be as large as the whole speaker diaphragm, or a good deal smaller, the loading on the diaphragm increasing, and the efficiency increasing, as the throat area diminishes. With reduction in the throat area, however, the horn length increases with consequent increases in losses such as frictional losses, and generally the throat area-diaphragm area ratio is a compromise to effect as high an efficiency as possible with as convenient a sized speaker as possible.

The high frequency limit of a horn loudspeaker is dependent, as in a dynamic speaker, upon the mass of the moving parts, but with the added complication that the distance from the diaphragm to the throat must be substantially equal no matter from which part of the diaphragm the measurement is taken, otherwise the sound waves from various points on the diaphragm will cancel out, rather than add together in the throat. (The greatest difficulty in path length must be below a half wavelength long of the highest frequency to be used.) A plug is thus often used between the diaphragm and throat to give equal path lengths, such a plug being shown in Fig. 6.

Whilst a horn loudspeaker is directional, and is often used, as in the open air, where the directional effect is advantageous, the directivity becomes more apparent as the frequency rises. Accordingly, the mouths of some horn speakers are fitted with vanes, which divide the mouth up into a series of mouths, the vanes bending as the horn opening flares out to direct the higher frequencies over a wider area.

The majority of horn loudspeakers have moving elements which are driven by moving coils, as in the dynamic loudspeaker.

Directional Baffles

Directional baffles are actually short horns which may be fitted to dynamic speakers to give them an increase in efficiency and a directional character, as when such speakers are used for theatre and cinema work. The throat, corresponding to the throat of a true horn speaker, is obtained by bolting a plate over the speaker frame, the plate having a circular aperture rather smaller in diameter than the speaker cone—one plate size used by a well-known firm has a 6" aperture to cover an 8" cone. The pierced plate thus acts as a throat with a small coupling chamber behind it, and a short horn can in turn be bolted on to the plate to give directional output, greater efficiency and a higher loading on the speaker cone.

The speaker used in this manner should be totally enclosed in a stout case with a packing of sound absorbent material at the rear of the case. At low frequencies when the case dimensions are appreciably smaller than the length of the soundwaves the case then acts as a "stiffening chamber,"

giving greater resistance through the enclosed air to the speaker cone and voice coil. At the higher frequencies the sound absorbent material at the rear of the case prevents the setting up of resonances within the case. An absorbent such as heavy felt may be used. All sound absorbent materials increase in absorbing efficiency as the frequency rises.

Little need be said concerning the magnetic speaker, the most popular form of this type being shown sectionally in Fig. 7. The speaker cone is attached via a rod coupling to a vibrating reed, which is mounted stiffly in the field of a permanent magnet. Speech or signal currents are passed through a pair of coils which are mounted on the magnet poles, so that the

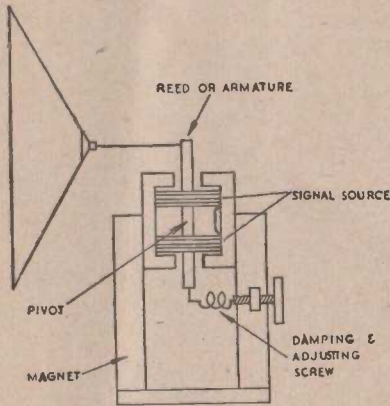

FIG. 7.—The Magnetic or Reed Loudspeaker.

field strength in and around the reed varies with the field set up by the coils, the fields adding and subtracting as the current varies. With anything more than a low amplitude of reed movement the characteristic of such a speaker becomes non-linear—the effect can easily be observed by driving such a loudspeaker from a good amplifier—and with the wide range of moving coil speakers now obtainable (dynamic speakers for use even with peanut output valves are now being made), there is little point in using the inefficient magnetic speaker. Perhaps the one advantage of the reed or magnetic speaker is that it requires no matching transformer, unlike the dynamic and horn speakers, where the matching transformer is of vast importance and must be well designed and made if the full benefit of a good loudspeaker is to be obtained.

The matching transformer is dealt with in the following chapter.

Chapter 3

FEEDING THE LOUDSPEAKER

The loudspeaker, whether it is of the dynamic or horn type, is coupled to its receiver, amplifier or other supply source via a transformer, the output transformer, and a perfect speaker used with a perfect supply source will still give poor results if the coupling is not correct. Such a mass of theory has been developed concerning the output transformer that a book of this size and nature offers far too little space for a discussion on the behaviour of the output stage, transformer and speaker in full—this chapter must be limited to the practical considerations arising from the theory.

All valves have optimum output loads, the loads into which they will deliver the maximum possible power with the minimum possible distortion, and in the case of output valves, it is the task of the transformer to make the low impedance of the voice coil, measured at 400 cycles, to appear as the optimum load. To one or two younger readers the idea of a transformer as an impedance changing device, rather than as a voltage or current changing device, may be a new conception, so that a simple example may be of help. Consider a step-down transformer with a primary to secondary ratio of 10 : 1, the primary being connected into a 200 volt 1 amp circuit. From the secondary may be drawn 10 amps at 20 volts.

Using Ohm's law and neglecting any phase shifts which may be present—in other words, calculating for D.C. rather than A.C. for the sake of simplicity—the apparent resistance of the input circuit is

$$R = \frac{V}{I} = \frac{200}{1} \text{ or } 200 \text{ ohms.}$$

The apparent resistance of the secondary circuit, however, must be

$$R = \frac{V}{I} = \frac{20}{10} \text{ or } 2 \text{ ohms.}$$

In stepping down the voltage the transformer has also stepped down the apparent circuit resistances; we may now say that the transformer is matching a 2 ohm circuit into a 200 ohm circuit.

The step down ratio is 10 : 1, but the ratio between the resistances is 100 : 1. Further examples, if worked out, will confirm that this effect is an actual law, and to discover the ratio between the windings of a transformer which is required to match two resistances (or, rather, impedances)

It is necessary only to take the square root of the ratio between the impedances themselves. As a formula this becomes

$$\text{Ratio} = \frac{\text{Imp. 1}}{\text{Imp. 2}}$$

As an example, suppose that a loudspeaker whose voice coil impedance is 3 ohms is to be matched into an output stage using a PX4 triode. Reference to valve tables shows that the PX4 requires a load impedance of 4,000 ohms, so that the transformer ratio may be calculated from

$$\begin{aligned}\text{Ratio} &= \frac{4,000}{3} \\ &= 1,333 \\ &= 36.51\end{aligned}$$

and the ratio between the windings is 36.5:1.

This form of the formula is the simplest which can be used and does not take into account the various losses occurring in the transformer, nor even the D.C. resistance of the transformer windings. So long as the resistance is no more than 5 per cent., for either winding, of the impedance connected with the winding, no serious error will arise, however, and since the windings of any good transformer should be made with stout wire, the secondary winding being of 18 or 16 S.W.G., the allowance of 5 per cent. should be ample.

The required ratio of the windings is only the first consideration. The output transformer consists of windings on a laminated core, so that inductance must enter into the picture, and the inductance of the primary has a close connection with the bass response obtained whilst the high frequency response improves with a reduction in the leakage inductance of the output transformer. Increasing the primary inductance is possible, of course, by increasing the number of turns of wire forming the primary winding, and the leakage inductance is reduced in a good output transformer by winding both the primary and secondary in a series of coils, sandwiching the secondary coils between primary coils. There is little point in dividing the primary into more than eight parts, with the secondary in seven parts, since practically the full available benefit will then be obtained.

The primary inductance is also affected by the D.C. flowing in the primary winding. It is well known that the inductance of a choke decreases rapidly if D.C. as well as A.C. flows through the windings for the steady magnetising effect of the direct current has the effect of decreasing the permeability of the magnetic core. The trouble may be overcome to some extent by leaving an air-gap at one point in the core, which means that the laminations must all be stacked the same way with no overlapped joints. Using E and I laminations and stacking them all the same way will result in three gaps, a gap between each arm of the E and the I, and in such a

case the laminations should be butted tightly together, for butt joints act in the same way as air gaps in reducing the effect of D.C. in the windings.

The same effect is found in the output transformer and the core of a transformer used for a single ended—that is, a single valve—output stage should be butt jointed or air gapped. In push-pull operation, however, the D.C. flow from the H.T. line to the anodes of the two valves is divided at the centre of the primary winding and the magnetising effect due to one-half of the winding is cancelled by that due to the other half, so that in this case no butt joints or air gaps are necessary. A transformer used as a universal component for either single ended or push-pull output stages should be butt-jointed or gapped, of course.

The minimum permissible inductance of the primary winding depends on several factors, and may be obtained from the formula given below.

$$L = \frac{1}{W \sqrt{\left(\frac{1}{a^2} - 1\right)}} \cdot \left(\frac{R(s+v)}{b^2.R + s + v}\right)$$

where L is the inductance of the primary winding in Henrys, w is $2\pi f$ with f as the lowest frequency to be transmitted (2π may be taken as 6.28),

a is the ratio of the response at the lowest frequency to the response at the highest frequency, expressed as a decimal,

R is the valve's anode resistance (not load resistance),

s is the resistance of the transformer secondary,

v is the voice coil impedance, and

b is the ratio of the transformer expressed as a fraction.

It will be seen that the formula is not simple to apply. The term a , for example, is difficult to evaluate. If we endeavour to make the response at the lowest frequency equal to the response at the highest frequency a becomes 1 and the first part of the equation becomes equal to infinity. The low frequency response, therefore, must be down on the high frequency response for a practical transformer. It will, perhaps, be of greater value to say that for the average triode valve the primary inductance of the transformer should not fall below, say, 10 Henrys at working conditions, whilst for the average pentode or tetrode the primary inductance should not fall below 25 Henrys.

Remember that these figures are minimum figures, based on the provision of a fairly good response down to 50 cycles. The inductance of the transformer primary winding can, with benefit, be made a good deal higher, especially in the case of a transformer for matching into a triode valve. An inductance of 100 Henrys would not be too high for coupling a pair of output tetrodes to a loudspeaker. The required minimum inductance rises

with a rise in the anode resistance, in the case of a triode, or the load resistance in the case of pentodes and tetrodes.

The output transformer must also be capable of handling the full output given by the receiver or amplifier, the core and wire size having a bearing on this as well as on the primary inductance. It appears to the writer that there is little point in building an output transformer when excellent components are on the market at reasonable prices, at least where the required ratio is one easily obtained. Messrs. Premier's Universal output transformer, sold in a range of types to suit various output powers, can be highly recommended, as also can Messrs. Coulphone's Extra Heavy Duty Universal output transformer.

The transformer ratio used to couple a loudspeaker into an output stage should be as exact as possible, but if a ratio other than the exact ratio has to be used, choose a ratio higher than the correct figure in order that the load presented to the valve or valves is higher than normal. For example, should a speaker require a transformer ratio of 45 : 1 for a certain application, and the transformer in use has ratios of 40 : 1 and 50 : 1 the speaker should be fed from the 50 : 1 tapping.

So far we have dealt with a single loudspeaker coupled into the output stage through the transformer, but it is often necessary to couple more than one loudspeaker to the receiver or amplifier. Music for dancing, cinema sound equipment, public address work, school or factory or office relays all are examples of conditions under which a number of speakers are to be used together, and the problem of coupling all the speakers to the load will naturally be affected by the speaker types involved and how they are to be fed.

In the first place all the speakers may be of similar types and the available output might be divided equally amongst them. Alternatively, the speakers might all be identically similar yet have different proportions of the available output power—a speaker in a hall might, say, have 10 watts out of a total of 12 watts output power, the other 2 watts being fed to a small monitor speaker in a sound or relay room. Lastly, the speakers might be of different types and have unequal distributions of load.

By similar types of speaker is meant, primarily, that the speakers all have the same voice coil impedance which is the only factor affecting the matching of speaker to speaker, dissimilar types meaning that speakers with different voice coil impedances are being used together. It is assumed that each speaker can handle the proportion of the output power which is to be fed to it.

When loudspeakers are used together all working from the one output stage and all operating in one room, hall or location, the speakers must be phased so that, in effect, the cones all move forwards and backwards together. If the speakers are not phased, there will almost certainly be queer distributions of sound and interference patterns. Loudspeakers used in separate rooms, such as extension loudspeakers in the home, do not need to be phased, of course.

Speakers are most easily phased by connecting a small battery across the voice coil with the fingers resting lightly on the cone. As the battery is connected the cone will move. Arrange the battery so that the cone of each loudspeaker being phased moves outward, marking the voice coil leads red and black or plus and minus to correspond with the battery polarity which gives this effect. Then all the red voice coil leads must be connected together and all the black voice coil leads must be connected together.

If separate transformers, one for each speaker, are used then the phasing potential must be connected across the transformer primary leads, and these coded instead of the voice coil leads.

Similar Loudspeakers With Equal Loads

To match similar speakers into an output stage when each speaker is to have an equal proportion of the output power is a simple matter. In the first place the voice coil impedances are treated, for calculations, as though they were ordinary D.C. resistances, and they can be added in series or joined in parallel to give a final total impedance by following the normal rules. For example, three 15 ohm voice coil speakers connected in series would give a final load impedance of 45 ohms, whilst the same three loudspeakers connected in parallel would give a final load of 5 ohms.

Remember that resistances in parallel are added by the formula

$$\frac{1}{R} = \frac{1}{r_1} + \frac{1}{r_2} + \frac{1}{r_3} \text{ etc.}$$

where R is the final resistance and r1, r2, r3, etc., are the resistances which are connected in the network.

Whether the speakers are connected in series or parallel is a matter to be decided purely by convenience and depends on the ratios obtainable from the output transformer in use.

Presuming that the speakers were to be operated from an output stage requiring a 10,000 ohm anode load, the transformer ratio required for the three speakers in series would be

$$\sqrt{\frac{10,000}{45}} = \sqrt{222.2} = 14.9 : 1$$

whilst the ratio required for the three speakers in parallel would be

$$\sqrt{\frac{10,000}{5}} = \sqrt{2,000} = 44.7 : 1.$$

The loudspeakers will be connected in a manner which therefore must depend on the output transformer. They will automatically share the available output between them.

Similar and Dissimilar Speakers with Unequal Loads

When the speakers are to share the available output in pre-arranged proportions, a different method of approach is necessary. Each speaker may have its own output transformer, or the speakers may be fed from separate secondaries of a single output transformer, and the ratio of the windings in either case determines how the power is fed to the loudspeakers, the voice coil impedances in their turn affecting the ratios used.

To understand how the ratios may be calculated, imagine first of all an output stage which requires an anode load of 10,000 ohms, and that the output from this stage is to be split into 100 equal parts. One simple way of splitting the output would be to use 100 anode resistances in parallel when one-hundredth of the output would be dissipated in each resistance. To obtain the correct anode loading it would be necessary only to apply the rules for parallel connection, when it would immediately be found that each resistance must be $10,000 \times 100$ ohms. The hundred resistances, each of value 1 megohm, when connected in parallel would then have a total value of 10,000 ohms, and since there are 100 resistances it is obvious that in each resistance must be dissipated 1% of the whole output power.

Now suppose that it is no longer desired to obtain the output power split up into 100 equal parts, but that three unequal parts are required, 50% of the whole, 35% of the whole, and 15% of the whole. It is only necessary to group the resistances together, 50 in one group, 35 in the second group, and 15 in the third group, when each group of resistances will be dissipating the appropriate power.

Alternatively, three resistances could be substituted for the groups of resistances. The resistance to dissipate 50% of the power would have a resistance equal, obviously, to the total resistance of fifty 1 megohm resistances in parallel — that is, a resistance of 20,000 ohms. The second resistance must be equal to thirty-five 1 megohm resistances in parallel, or 28,571.4 ohms, whilst the third resistance must be equal to fifteen 1 megohm resistances in parallel, or 66,666.6 ohms. These three resistances in parallel will still equal 10,000 ohms, the required load.

To summarise, the three resistances may be expressed as

$$r_1 = \frac{100R}{50}, \quad r_2 = \frac{100R}{35}, \quad \text{and} \quad r_3 = \frac{100R}{15}$$

where R is the required final anode load, in this imaginary case 10,000 ohms. However the load is split, the various proportions must, of course, add up to the full load of 100%.

Now, using separate transformers to drive the various loudspeakers which are to be supplied from the output stage, let us suppose that three loudspeakers, each of voice coil impedance 3 ohms, are to have the above proportions of the available output from the stage supplied to them. The primary windings of the loudspeaker transformers must present a total load of 10,000 ohms to the stage, and the equations given above will still refer to them. The transformer ratios, therefore, may be calculated in the usual manner by using the above formulæ adapted to the new purpose, and the

ratio of the transformer which is supplying 50% of the whole output power to the first loudspeaker will be

$$\text{Ratio} = \sqrt{\frac{100R}{50 \times V}}$$

where V is the voice coil impedance. Thus

$$\begin{aligned} \text{Ratio} &= \sqrt{\frac{100 \times 10,000}{50 \times 3}} \\ &= \sqrt{6,666.6} \end{aligned}$$

so that the ratio of this transformer is 81.65 : 1.

The ratio of the transformer supplying 35% of the output to the second loudspeaker is, similarly,

$$\begin{aligned} \text{Ratio} &= \sqrt{\frac{100 \times 10,000}{35 \times 3}} \\ &= \sqrt{9,523.8} \end{aligned}$$

so that the ratio of this transformer is 97.59 : 1.

Finally, the ratio of the third transformer which is to supply the third loudspeaker with 15% of the available output is

$$\begin{aligned} \text{Ratio} &= \sqrt{\frac{100 \times 10,000}{15 \times 3}} \\ &= \sqrt{22,222.2} \end{aligned}$$

so that the ratio of this transformer is 149 : 1.

Naturally, the same method still works when the voice coil impedances of the loudspeakers are dissimilar, and the method can be used to solve a problem such as:—

A Pen 45 output tetrode gives an output of 4.5 watts into an optimum anode load of 5,200 ohms. What will be the transformer ratios required to supply 4 watts to a 15 ohm speaker, the other 0.5 watt being supplied to a 3 ohm speaker?

Using the same equations as before, the ratio of the transformer used with the 15 ohm speaker will be

$$\text{Ratio} = \sqrt{\frac{100 \times 5,200}{88.8 \times 15}}$$

(since 4 watts in a total of 4.5 watts is 88.8%)

$$= \sqrt{390.3} \text{ or a ratio of } 19.75 : 1.$$

The ratio of the transformer supplying the 3 ohm speaker will be

$$\text{Ratio} = \sqrt{\frac{100 \times 5,200}{11.2 \times 3}}$$

taking 11.2 as the remaining percentage of power to be passed to the 3 ohm speaker. Therefore

$$\text{Ratio} = \sqrt{15,476.1} \text{ or a ratio of } 124.4.$$

The Pen 45 output stage will be correctly loaded when these two transformers have their primary windings connected in parallel in the anode line of the valve.

However many speakers are used, whatever valve or pair of valves is used, and however the output power available is split up, the optimum anode load of the stage must remain at a given figure. Instead of using a separate transformer for each loudspeaker, therefore, a single transformer with one primary winding can be used, the secondaries being calculated to give the required percentages of output power into the different (or similar) voice coil impedances. Exactly the same working is used, the only difference being that the various ratios obtained all refer to one common primary. Thus, in the last example, a single transformer with two secondaries, one having a ratio of 19.75 : 1 and the other having a ratio of 124.4 : 1 to the primary would give the same correct matching of the two speakers and the same distribution of output power.

Such a transformer must of necessity have very close coupling between the primary and all the secondaries, and the secondary windings must be suitable for their particular powers; but, even so, a good commercial transformer, having the correct winding ratios, will give perfectly satisfactory results. It is this type of output transformer, however, which might require home or workshop construction since the necessary ratios are often uncommon.

Probably the best form of construction is to use the core of an old mains transformer, thus obtaining a large winding window and plenty of iron in the output transformer. The primary winding is then split up into as many sections as there are secondaries, plus one—that is, for three secondaries the primary would be split into four equal parts, for four secondaries the primary would be split into five equal parts, etc.—and the secondaries are then wound between the primary sections, using on all windings as heavy a gauge of wire as the available space will allow.

It is difficult to give winding details, wire gauge details and the like, since these factors will all depend on the number of secondaries and the output power to be handled, and the constructor will have to determine such details for himself to suit his own case. (See Appendix B.)

Volume Control

When a single loudspeaker is in use the volume is controlled automatically from the receiver or amplifier which is feeding the speaker, but when a chain of speakers, or a main speaker and a monitor, are coupled together it may be desirable or necessary to have individual control over loudspeaker volume.

A chain of loudspeakers will be connected in one of the ways shown in Fig. 8. All the voice coils can be in series, or all the voice coils can be in parallel, or all the speakers can have their own output transformers, the transformer primary windings all being in parallel; or, finally, all the voice coils can be supplied from separate secondaries on one output transformer. In any case, the obvious control point is in the low impedance voice coil circuit.

Control could be easily effected by placing in series with the voice coil to be controlled a low resistance rheostat—say, of 10 ohms resistance for use with a 3 ohms voice coil. It is perfectly clear, however, that as the rheostat arm is advanced the voice coil circuit suffers a rise in resistance and immediately all the trouble which has been taken over the matching of the circuit and the correct loading of the output stage is wasted. A method

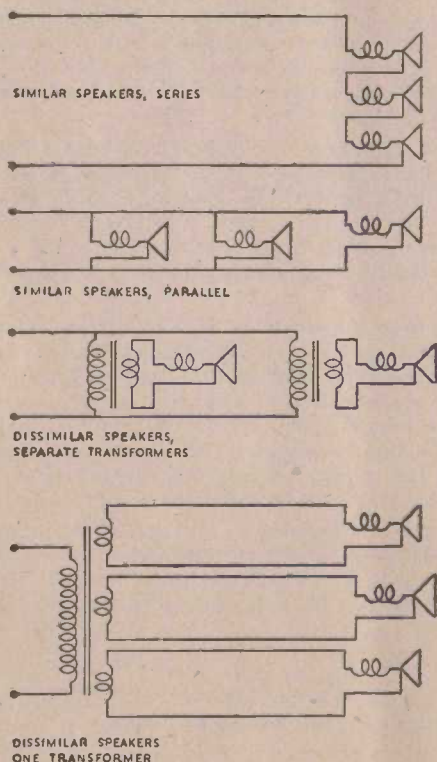

FIG. 8.—Loudspeaker Chains.

must be found whereby the power to the controlled voice coil is attenuated without any change in circuit resistance or impedance, and whilst a transformer can be made to perform the operation through a series of tapping points, it is easier to obtain or construct an "L Pad" control.

This type of individual volume control is shown in Fig. 9, and it can be seen that advancing the control causes two arms to advance along two resistances. The impedance, looking into the circuit, remains constant, but progressively more and more power is wasted in the L pad than is passed into the voice coil until, with the moving arm at the bottom of its travel, all the supplied power is being dissipated in one arm of the pad. Each resis

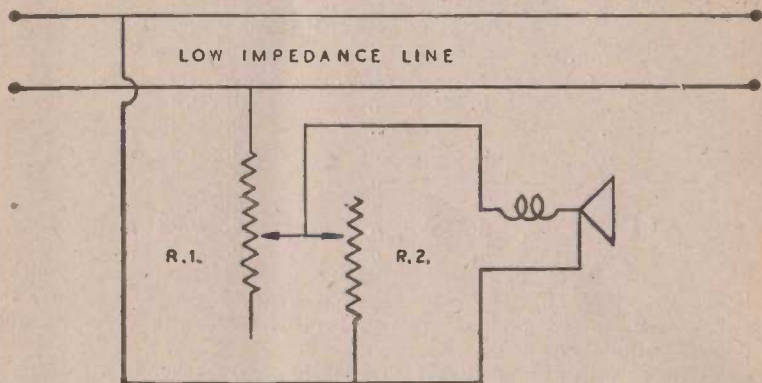

FIG. 9.—The "L Pad" Attenuator.

tance winding, therefore, must be able to deal with the maximum power the voice coil circuit will be called upon to handle.

The two resistances, unfortunately, must be tapered to give a constant input impedance, the degree of tapering being shown by the following specimen figures. These represent the resistances of R1 and R2 of Fig. 9, which will give input and output impedances over the pad of 15 ohms to suit a 15 ohms voice coil, taken at intervals of 6 dbs. attenuation.

dbs. Down:	R1.	R2.
6 dbs.	7.5 ohms.	15 ohms.
12 "	10.75 "	6.9 "
18 "	12.9 "	2.1 "
24 "	14.2 "	1.0 "

It will be seen in each case that the maximum resistance required is equal to the voice coil impedance, 15 ohms, but that a correct match cannot be obtained by ganging two 15 ohm rheostats together since then R1 would be at zero when R2 is set at 15 ohms, whereas R1 actually requires to be at 7.5 ohms. The degree of mismatch would become far more tolerable at lower settings—that is, for greater reductions of volume—and if a proper pad cannot be obtained, two rheostats could be ganged together in opposition in this way and would give better control with much better matching than

a straightforward rheostat in series with the voice coil. Even better matching would be obtained if the volume were reduced in steps, using a two-pole switch, and below is given a table of resistances which can be used to build up such a stepped pad, the steps of attenuation being in units of 3 decibels over 9 steps, the first step, of course, giving no attenuation.

NOTE PARTICULARLY.—The resistances given are for use with a 2 ohms voice coil. For use with other voice coil impedances, multiply by the appropriate factor each resistance; thus, for a 3 ohms voice coil multiply each resistance by 1.5, for an 8 ohms voice coil multiply each resistance by 4, for a 15 ohms voice coil multiply by 7.5, and so on.

For Impedance of 2 Ohms.

db's. Down.	Group 1.	Group 2.
3 db's.	a. 0.6 ohms.	i. 2.6 ohms.
6 "	b. 0.4 "	j. 0.9 "
9 "	c. 0.28 "	k. 0.43 "
12 "	d. 0.2 "	l. 0.24 "
15 "	e. 0.16 "	m. 0.14 "
18 "	f. 0.07 "	n. 0.1 "
21 "	g. 0.09 "	o. 0.02 "
24 "	h. 0.08 "	p. 0.17 "

The arrangement of these resistances around their two group switches is shown in Fig. 10. The switches, of course, are ganged together, the switch positions giving attenuations as per the table, with 0 db's. attenuation at position 1.

With an attenuator of this type fitted to each speaker in a chain, the control being mounted on the speaker baffle or in a suitable place near the speaker, every speaker in a large chain could be reduced to very low volume simultaneously without any change in the loading presented to the amplifier output stage. At the same time, this attenuator is not perfect for every purpose. It suffers from the defect that the input to the voice coil is halved with the attenuator switch arms on the second contact at the three decibels position (halving the power is equivalent to a 3 db's. drop), and whilst the attenuator would be excellent for recording and other similar uses, a simpler circuit might prove of greater value to some workers.

This simpler attenuator is shown in Fig. 11, and is based on the circuit of Fig. 10. In this case, however, the greatest attenuation is 6 db's. obtained in 4 steps from 0 db's.—that is, the switch is a two-pole four-way switch giving 0, 2, 4, 6 db's. attenuation. In terms of power to the voice coil this corresponds roughly with full power, 77% of full power, 40% of full power, and 25% of full power. Once again the resistance values are given for a 2 ohms voice coil, and must be multiplied by the appropriate factors for use with voice coils of other impedances.

For Impedance of 2 Ohms. Fig. 11.

db's. Down.	Group 1.	Group 2.
2 db's.	a. 0.43 ohms.	d. 3.8 ohms.
4 "	b. 0.31 "	e. 1.4 "
6 "	c. 0.26 "	f. 2.0 "

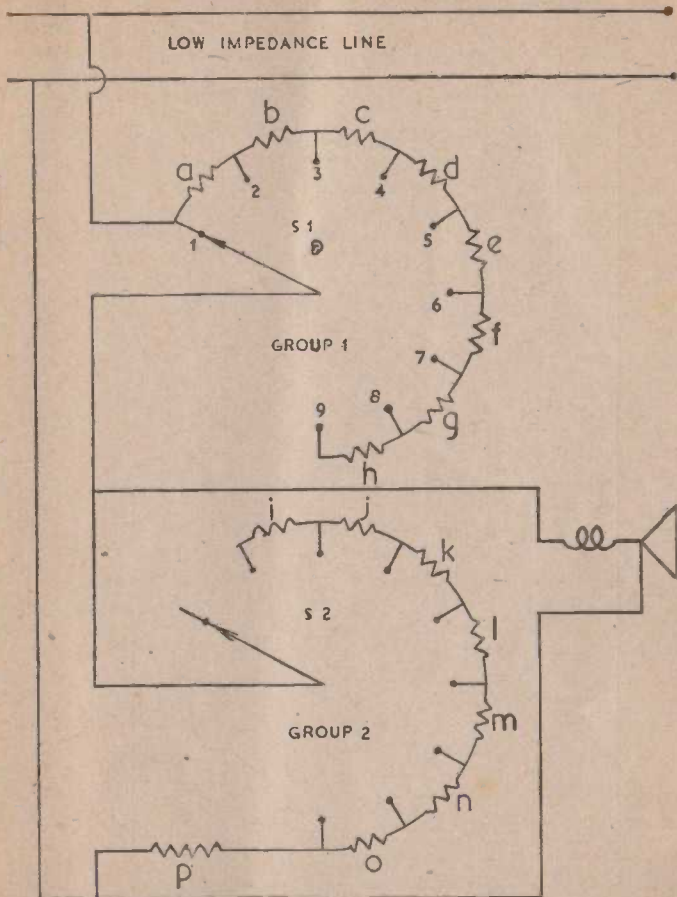

FIG. 10.—A practical "L Pad" attenuator, 0-24dbs.

In either attenuator the resistances should ideally be non-inductive, and since the resistances will have to be made up using a Wheatstone's bridge for anything like accuracy, they can be wound in bililar fashion. It will be seen that making the resistances for a high impedance voice coil attenuator is simpler than for a low impedance voice coil, since then the individual resistance values will be higher; but, given a bridge, all the resistances can be made from ordinary Manganin or Constantan using, say, 18 S.W.G. wire, without too much trouble.

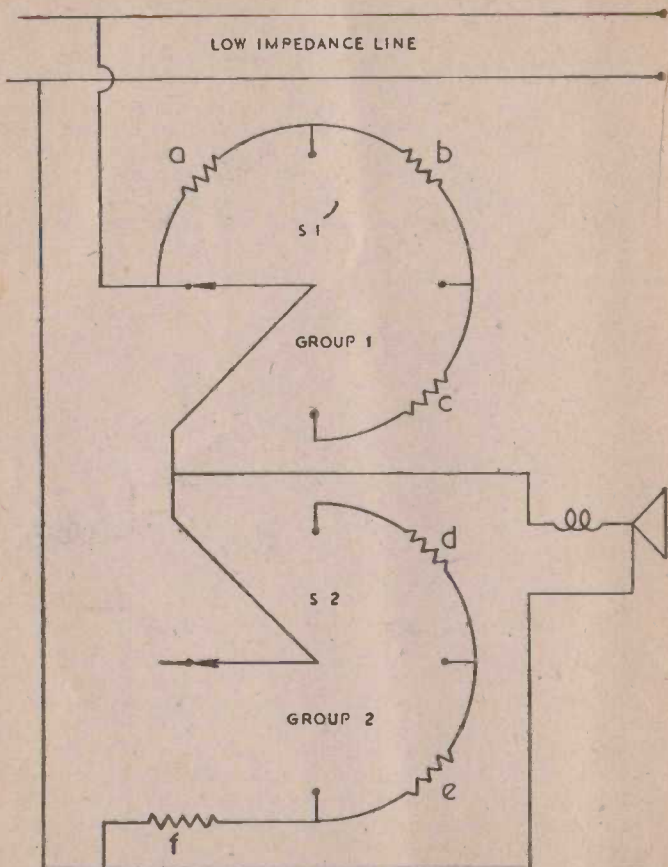

FIG. 11.—Simplified "L" Attenuator.

The keen experimenter could wind a double rheostat on the base of an old potentiometer with a double moving arm, calculating the desirable tapering of each resistance element from the attenuator tables and thus obtaining stepless volume control, but the preservation of the correct input impedance would be difficult.

When choosing or making the attenuator, it must always be remembered that a 50% reduction in input power to the voice coil of a loudspeaker does not necessarily mean a 50% reduction in sound as judged by the ear. The drop in sound output will be appreciable, but will not appear as great as might be expected. A 6 db. reduction will be as much as is required for

practically all purposes, however, unless fine graduations of output right down to silence are required. The larger attenuator of Fig. 10 will then be useful.

Loudspeaker Lines

So far the arrangements of a number of loudspeakers connected to a single output stage have been considered, and it is now time to pay attention to the connecting lines themselves. As with any other transmission of power by lines, the use of a pair of wires to carry power to distant loudspeakers means sustaining a loss along the line, the loss being related both to power and to frequency.

Lines carrying audio power may be known either as "low" or "high" impedance lines, but these terms must not be confused with the characteristic impedances of lines or feeders working at radio frequencies where the line itself has an impedance. The impedance of audio lines refers to the impedance into which the line is feeding—a 15 ohms line, for example, would be a line connected into a 15 ohms voice coil—and the terms "low" and "high" impedance are rather elastic. In general, lines feeding into impedances below, say, 50 ohms are termed low impedance lines; lines feeding into impedances above 50 ohms up to about 500 ohms are termed high impedance lines.

The lines shown in Figs. 9, 10 and 11 are therefore low impedance or voice coil lines.

Line losses are greatest when the terminating impedance is low, since then the line has to carry a relatively heavy current. To avoid this, when a long line is to be used it is general practice to make the line impedance of the order of 200 to 500 ohms. This entails using two transformers, one at the output stage to match, say, a 200 ohms line into the optimum anode load, with a further transformer matching the 200 ohms line into the voice coil impedance at the far end. The transformers themselves introduce losses since transformer efficiency will probably not be above 85%, so that the line loss must be reduced to as small a value as possible.

For a low impedance line, or a line where only one transformer is used, a tolerable line loss is 15%. Where two transformers are used, one at either end of the line, the line loss should be reduced to 5%.

The power loss in a line is obviously due to the line's own impedance which dissipates a proportion of the energy carried by the line. At the same time, however, the line has capacitance and this results in a disproportionate loss of the higher frequencies. A low impedance or voice coil line has the advantage of reducing the capacitive loss to a very small figure whilst increasing the power loss (unless very heavy conductors are used), whilst with the high impedance line the power losses fall as the capacitive losses rise.

For a two-wire line of 20 S.W.G. copper wire, the wires being run together, the maximum length of line to be used at voice coil impedances is shown by the table below, where the line length appears beneath the appropriate voice coil impedance.

Impedance (ohms)	2	4	6	8	10	15	30	50
Line length (feet)	25	48	70	100	120	180	375	590

Thus, not more than 25 feet of line should be used to couple a 2 ohms voice coil to its output transformer secondary winding, given that the output transformer is situated at the amplifier, although 180 feet of line would give only the same losses using a 15 ohms voice coil speaker coupled to a correct 15 ohms secondary on the output transformer.

The line length may be increased by increasing the wire size. As a rough guide the line may be half as long again if 18 S.W.G. copper wire is used, or slightly more than twice as long if 16 S.W.G. copper wire is used.

When 20 S.W.G. copper wire is used for a high impedance line, the maximum frequency to be transmitted must be allowed for in the calculations. Allowing for a frequency of 10,000 cycles, however, the maximum line length for a 100 ohms line is about 1,200 feet; for a 200 ohms line, 2,000 feet; for a 300 ohms line, 1,000 feet; for a 400 ohms line, 700 feet; and for a 500 ohms line, 600 feet. It is not often that loudspeakers must be separated from their amplifier by distances greater than these and, indeed, in the majority of cases the permissible lengths of line to work at voice coil impedances will be quite sufficiently long. All these figures relate, of course, to the maximum line length for tolerable losses—the losses will be correspondingly less if shorter lines are used.

To match a line of, say, 200 ohms impedance into an output stage, the line is treated just as if it were a voice coil of 200 ohms impedance, whether the transformer is to be used for this one line alone or whether the line is being fed along with a number of other speakers. The formulæ already given apply to such a line just as they do to voice coil impedances. To match the line at its far end to a speaker once again the ordinary ratio equation is used. As a last example, suppose that a 2 ohm speaker is to be supplied from a PX4 valve whose optimum output load is 4,000 ohms. The speaker is required to be at a distance of 750 feet from the amplifier.

From the details given above, a 200 ohm line of 20 S.W.G. will be satisfactory over this distance, allowance having already been made for transformer losses at either end. The circuit is as shown in Fig. 12, and the ratio of the first transformer coupling the line with the output stage, transformer T1, is

$$\begin{aligned} \text{Ratio} &= \sqrt{\frac{4,000}{200}} \\ &= \sqrt{20} \text{ so that the ratio of T1 is 4.47.} \end{aligned}$$

At the far end of the line T2 is coupling the 200 ohms line to the 2 ohms voice coil. The ratio of T2 is therefore

$$\begin{aligned} \text{Ratio} &= \sqrt{\frac{200}{2}} \\ &= \sqrt{100} \text{ so that the ratio of T2 is 10 : 1.} \end{aligned}$$

It is of interest to examine the losses over the whole system, presuming

transformer efficiencies of 80% with a line loss of 5%. The PX4 will supply 3.5 watts to a properly matched load, so that to the line will be supplied

$$3.5 \times \frac{80}{100} \text{ watts, or } 2.8 \text{ watts.}$$

Quite a large drop is caused by the first transformer. The line will reduce this further to 2.66 watts, and the second transformer, also with an efficiency

of 80%, will supply $2.66 \times \frac{80}{100}$ or 2.13 watts to the loudspeaker

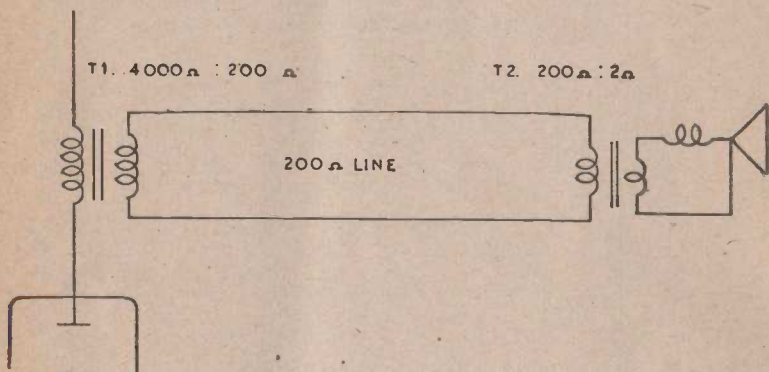

FIG. 12.—Simple Line and Two Transformer Circuit.

This example, of course, uses an arrangement—a single output valve, a single loudspeaker and a long line—which would hardly ever be used, but it illustrates the calculation of losses. Where long lines are being used the installation is generally a fixture, and the power required for the loudspeakers would first be decided, the losses then calculated, and finally the amplifier designed to have a power output which would provide a margin of safety.

Woofers-Tweeter Cross-over Circuits

Finally, under the heading of "feeding the loudspeaker," it is necessary to investigate the type of circuit which is used when a bass and a treble speaker are working together. In the first place, the two speakers must be mounted close to each other so that all the sound appears to come from one point. The cross-over frequency must be decided, the point where, as the frequency rises, the tweeter takes over from the woofer, and the circuit to divide the frequencies must be designed.

The cross-over frequency depends on the speaker characteristics, but providing that the woofer response is good up to about 1,500 cycles it is

wise to make the cross-over frequency in the region of 1,000 cycles. Most orchestral music has the greatest power peaks below about 600 cycles, and it is desirable that the woofer should handle these power peaks especially when the tweeter is a very small speaker. A typical woofer-tweeter combination would be a 12" speaker as the woofer with a 3" or 5" tweeter. Crystal speakers act well as tweeters, but then the problem of matching one speaker to the other and to the output stage becomes involved, and the figures given below are based on the assumption that the two speakers used have equal voice coil impedances.

The cross-over filter used for the calculations is shown in Fig. 13, and it will be seen that the real purpose of the filter is to act in one section as a bass attenuator and in the other section as a treble attenuator. Other circuits are available, but this filter is both simple and effective.

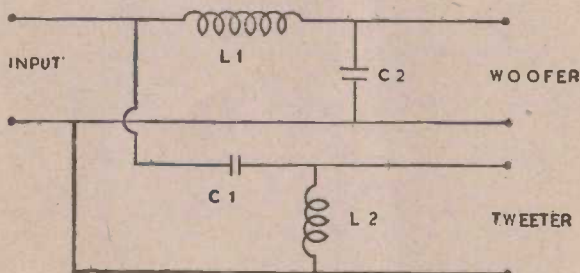

FIG. 13.—Basic Crossover Filter.

The filter can be used in either of two ways—either between the output transformer and the voice coils of the two loudspeakers, when the terminating impedance is low, or between the output stage and the two loudspeaker transformers. In this case it is wise to connect the filter network to the output stage through a 1 : 1 transformer when the filter will be terminated by a high impedance equal to the optimum load impedance of the output stage which is being used.

The two methods of connection are shown in Figs. 14 and 15.

It would appear at first sight that the most economical way of using the filter would be to include it in the low impedance side of the output transformer, as in Fig. 14. Only one output transformer is then necessary, whilst using the circuit of Fig. 15 means that 3 transformers must be used, with losses at each transformer.

In fact, however, the circuit rapidly becomes impractical as the terminating impedance is reduced. Using the circuit of Fig. 14 and feeding into voice coils of 3 ohms impedance, C1 requires a capacitance of 33 mfd., with C2 requiring a capacitance of 54 mfd. These high capacitances are

reduced by increasing the terminating impedance, so that when voice coils of 15 ohms impedance are used for the woofer and tweeter, the capacitances become of the orders of 6 and 10 mfd.

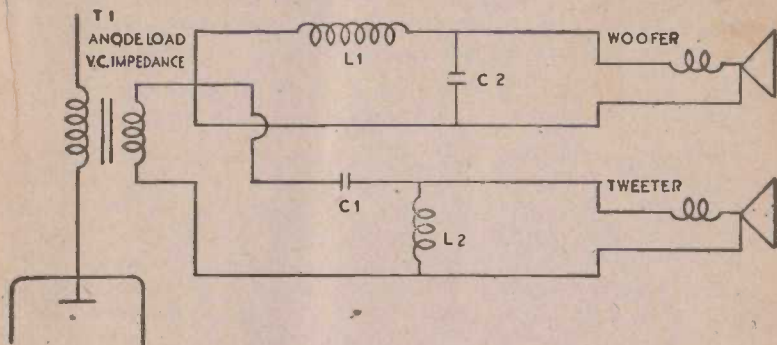

FIG. 14.—Filter with Low Terminating Impedances.

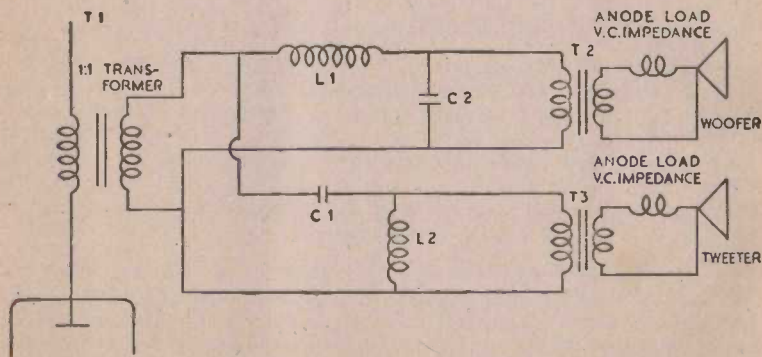

FIG. 15.—Filter with High Terminating Impedances.

It is suggested, therefore, that the arrangement shown in Fig. 14 be used only for speakers whose voice coil impedances are 15 ohms. A 15 ohm to optimum anode load transformer is then used for T1 and the filter values are

L1,	3.8 millihenrys.
L2,	2.38 millihenrys.
C1,	6.6 mfd.
C2,	10.5 mfd.

Should it be desired to use the circuit of Fig. 14 with other voice coil impedances, however, the new values of the filter components may be found as follows. For a reduction in voice coil impedance, divide the inductances and multiply the capacitances by the reduction factor. Thus, to find the values necessary for 3 ohms voice coils, the reduction factor is 5 ($15 \div 3 = 5$), so that the inductances for 3 ohms voice coils become

L1,	0.76 millihenrys (760 microhenrys).
L2,	0.476 millihenrys (476 microhenrys).
C1,	33 mfd.
C2,	52.5 mfd.

The method is not quite exact, but gives results quite sufficiently accurate. If voice coils with impedances higher than 15 ohms are to be operated from the filter, the process is reversed, the inductances being multiplied and the capacitances being divided by the increase factor. Thus, for 30 ohms voice coils the filter component values would become .

L1,	7.6 millihenrys.
L2,	4.76 millihenrys.
C1,	3.3 mfd.
C2,	5.25 mfd.

since the increase factor clearly is 2.

When the circuit of Fig. 15 is used the circuit becomes simpler to construct since the inductances are higher, and of values more easily obtainable in iron-cored choke ranges, whilst the capacitances become fractional parts of mfd. The filter would work without the 1 : 1 isolating transformer, but in any case it is desirable to keep the anode current to the output stage out of the filter and the transformer provides for this, whilst with a push-pull output stage the filter would need the provision of a centre-tap were not the 1 : 1 transformer in circuit.

The filter therefore works with terminating impedances of the same value as the optimum load impedance, which will be of the order of some thousands of ohms. Accordingly, the filter component values for a terminating impedance of 1,000 ohms are given, and can be corrected within tolerance limits for any higher impedance.

For working into 1,000 ohms the filter values are

L1,	250 millihenrys.
L2,	160 millihenrys.
C1,	0.1 mfd.
C2,	0.16 mfd.

For higher impedances, multiply the inductance and divide the capacitance by the impedance increase factor. Thus, to use the filter with a PX4 valve using the circuit of Fig. 15, the increase factor is 4, since the PX4 requires to work into a load of 4,000 ohms. T1 thus becomes a 1 : 1

transformer to handle 5 watts, T2 and T3 match the voice coil impedances used into 4,000 ohms (the tweeter transformer can be a midget type without introducing losses since no D.C. is flowing in its primary), and the filter values become

L1,	1,000 millihenrys (1 Henry).
L2,	640 millihenrys.
C1,	0.025 mfd.
C2,	0.04 mfd.

It is also possible to use this type of filter before the output stage of an amplifier, feeding from the filter into two output stages, one of which handles the low and the other the high frequencies, so that each output stage can have its own volume control. Taking the required input impedance to the following valves as the terminating impedance, the filter component values can then be calculated by multiplying and dividing the 1,000 ohms values by the correct factor.

Since the bass or low frequencies have individual treatment when this filter is used, the output stage should always have as high a damping factor as possible.

Chapter 4

MOUNTING THE LOUDSPEAKER

In the majority of table radio receivers the cabinet cannot afford a good speaker mounting by its very nature. It is full of equipment, much of which is metal, and may resonate undesirably and which may, with age, start to "tizz"—a term which requires no explanation—whilst the cabinet material itself may be thin wood or plastic, neither of which provides a good baffle material.

It has already been said that the chief function of the speaker baffle, which may either take the form of a flat baffle board or a box baffle, is to prevent the out-of-phase low frequencies from the rear of the cone mingling and interfering with the in-phase or wanted low frequencies from the front of the cone. Naturally, if the low frequencies from the cone's rear could be added, in phase, with those from the front of the cone, the bass output of the speaker would be enhanced. Some various methods for providing such an effect have been devised.

Theoretically, the flat baffle board should have a diameter or width of half a wavelength at the lowest frequency required, the baffle, moreover, having an irregular shape to prevent the chance of interference between in and out of phase waves at any point in the frequency range.

The wavelength corresponding to a frequency is easily calculated since the velocity of the wave is equal to the product of the frequency and the wavelength. The velocity of sound in air is approximately 1,130 feet per

second, so that if $V=f.L$, where f is the frequency and L the wavelength of a sound,

$$L = \frac{V}{f}$$

The wavelength of a sound whose fundamental frequency is 50 cycles is therefore

$$L = \frac{1130}{50} = 22.6 \text{ feet,}$$

so that a suitable baffle for this frequency is 11 feet in diameter. In practice, of course, it would be difficult to provide and mount such a size of baffle.

It is easier to prevent the mingling of the out-of-phase high frequencies from the rear of the cone with the high frequencies from the front of the cone since the unwanted high frequencies at the rear of the speaker are more easily absorbed than are the low frequencies, whilst the high frequencies originating at the front of the speaker are far more directive than the low frequencies. At the same time, it must always be remembered that it is as important that high frequencies from the cone's rear do not mix with those from the front of the cone as it is for the low frequencies.

The speaker baffle, then, in its most beneficial form, can have three main functions:—

- (1) To prevent out-of-phase sound from the cone's rear mixing with the sound from the front of the cone;
- (2) To lead the low frequencies to the front of the baffle in such a way that they will add, in phase, with the low frequencies from the front of the cone; and
- (3) To absorb the high frequency sounds from the rear of the cone.

The flat baffle will perform the first of these tasks well or indifferently well according to its size, and the better the performance of the baffle is in task 1 the less will be the importance of task 3. A straightforward box baffle of adequate size will perform tasks 1 and 3 well and do nothing at all about task 2. The cutting of an opening below the speaker aperture in a box baffle will, however, convert the box baffle into a bass reflex cabinet, and all three tasks will be performed.

A bass reflex cabinet must reflect the rear of the cone low frequencies out through the port to add with the existing low frequencies, whilst the high frequencies from the rear of the cone are absorbed in a pad of material behind the loudspeaker. Thus, the cabinet really requires to be individually designed for the speaker and conditions under which it is to be used, but the details given below will serve for the majority of cases.

The bass reflex cabinet must be built of heavy wood, preferably an inch in thickness and certainly not below a half-inch thick. Five or seven-ply wood can be used with good results. The cabinet must be clear inside with no other equipment mounted within apart from the loudspeaker itself, and the loudspeaker should be mounted first on a pad of fibrous material such as building board which is then mounted on the cabinet front wall.

Behind and in line with the speaker there should be glued right across the rear of the cabinet a strip of heavy felt to act as the high frequency absorbent. Below the speaker opening is cut the bass frequency port.

The bass reflex cabinet is shown in section in Fig. 16, and suitable dimensions are as follows, the measurements being for 1" wood taken externally:—

Speaker

diam.	a	b	c	d	e	f	g	h	i
6"	18½	8	5	3½	3	3½	8½	7	15
8"	22	10	7	4	3½	3¼	9½	9	18
10"	26	12	9	4½	4	4¼	11	11	20
12"	31	14	11	5½	4½	5	12	12	22
15"	33	17	14	6	5	4	13	14	25

(All measurements in inches.)

The largest bass reflex cabinet could also be used for a really comprehensive woofer-tweeter combination, using either a large 12" or 15" woofer speaker or two 8" woofers mounted side by side. The tweeters are then mounted in the top of the cabinet, a slotted port being cut for them, at

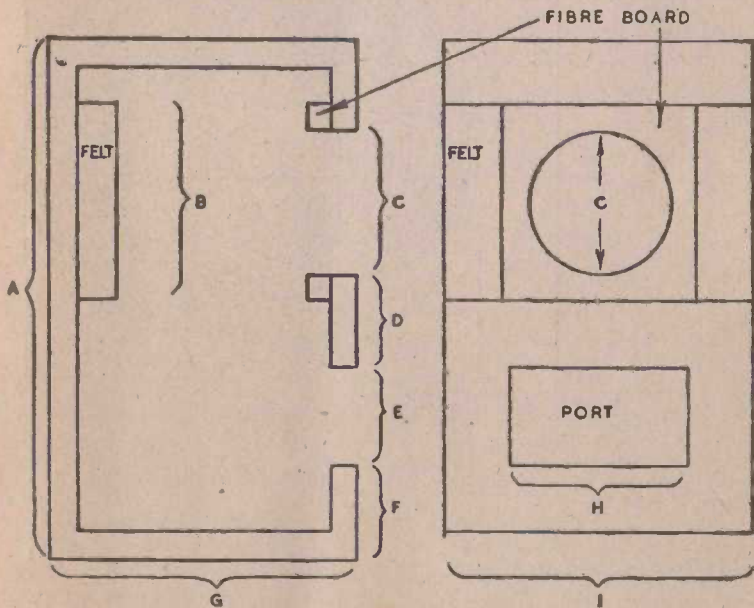

FIG. 16.—The Bass Reflex Cabinet.

least four tweeters mounted along a semi-circle behind the tweeter port being used to counteract the directional effect. For ease of matching into the cross-over filter the tweeters could be increased to five in number when five 15 ohms voice coils in parallel to give a final impedance of 3 ohms could be balanced against a 3 ohms woofer.

If the bass reflex cabinets with sizes as above for various speaker diameters are used without the reflex ports they become straightforward box baffles, and can give quite good results when heavy wood is used for their construction. A layer of felt all over the inside of the box baffle is of assistance in absorption of the high frequencies.

The ordinary thin wood cabinet, such as is fitted to an extension speaker, can often be improved by a considerable degree by the addition of damping material. Rectangles of felt or fibrous building board may be cut to fit inside the speaker cabinet, the felt or board having its centre cut away to give a widening conical aperture behind the speaker, shown sectionally in Fig. 17. This will absorb the high frequencies from the rear of the cone to a good

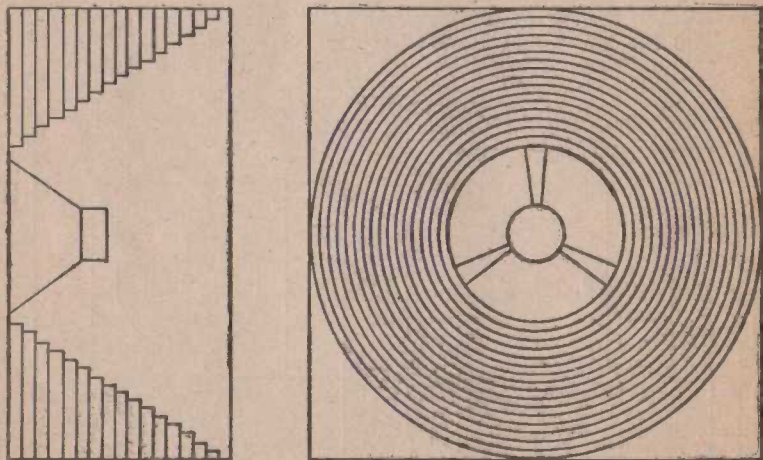

FIG. 17.—Improving the Cabinet Loudspeaker.

degree and direct the out-of-phase bass frequencies to the rear of the speaker and cabinet.

A further method of obtaining the effect of large baffle area is to enclose the rear of a loudspeaker and provide a path to the open air for the sound waves from the rear of the cone through an acoustical labyrinth. The method is now not often used and the construction of the labyrinth, although a simple matter, consumes both time and material. The labyrinth may be arranged in several ways, and has the effect of passing the low frequencies

whilst absorbing to a considerable extent the high frequencies. One possible arrangement of the labyrinth is shown sectionally in Fig. 18.

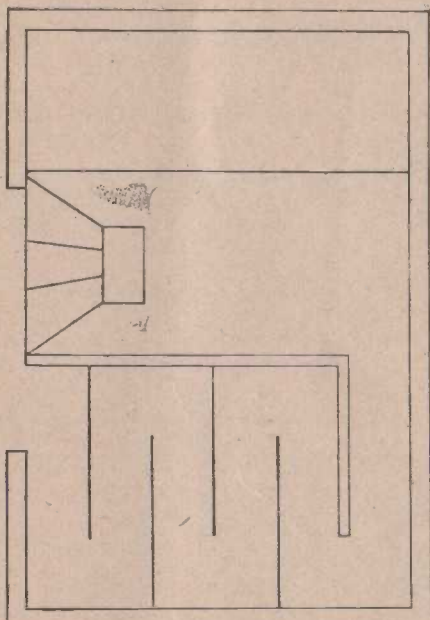

FIG. 18.—The Basic Acoustic Labyrinth.

Horn Loudspeakers

It is not often that an exponential horn must be made in the home workshop, but provided that a horn of square cross-section is used, the sides of the horn can be designed for shape and cut from sheet metal using some rather complicated formulæ. The derivation of the equations is not shown since this would entail an excursion into calculus for which there is neither need nor space. Some values must be taken for granted, such as the flare constant of the horn. The formulæ are used to give points to which a template can be drawn and cut, the four sides of the horn then being cut to the template and assembled.

A typical template is shown in Fig. 19, and the shape is obtained by taking a series of points along the X, X axis and finding the distance of the

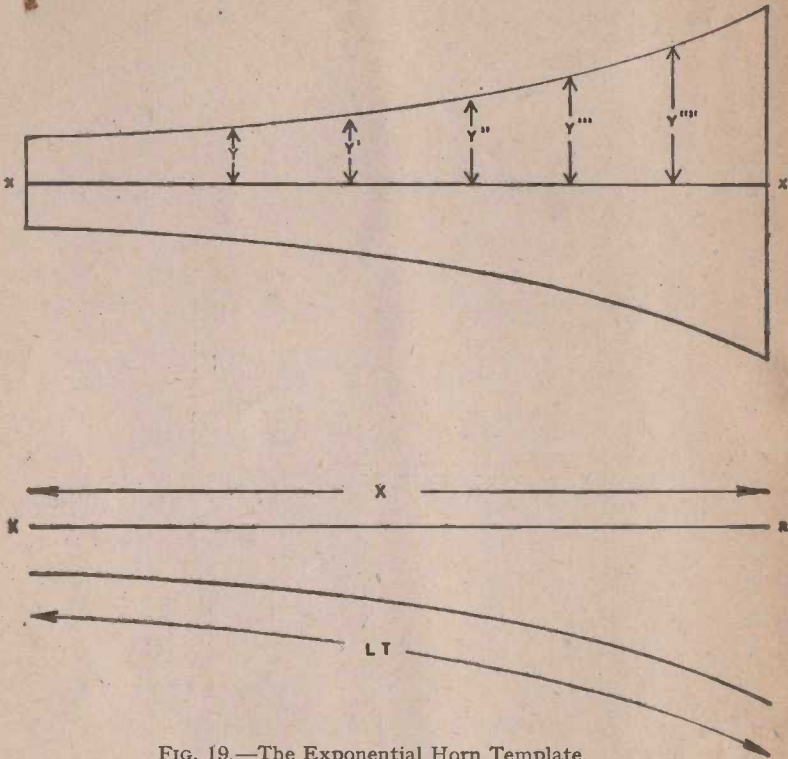

FIG. 19.—The Exponential Horn Template.

points Y , Y' , Y'' , Y''' , Y'''' , etc., from the axis. A curve is thus obtained by connecting the Y points, this curve forming the shape of the horn.

Since the side of the horn follows a curve the overall length of the horn will be shorter than the true length of the side, this point being illustrated in Fig. 19. The design data therefore must also give the uncurved length of the template which, when curved, will give the correct horn length.

To commence the calculations, it is necessary to know the area of the throat of the driving unit, A (square inches), the desired overall length of the horn (i.e., the axial length) x , in inches, and B , the flare constant of the horn. The cut-off frequency of the horn is connected with B , and it may be said that frequencies below $4,000B$ have a falling-off characteristic. B therefore depends on the lowest frequency to be transmitted.

As an example, the reader may follow the working to give template points for a horn 40 inches in axial length where the throat area of the driving unit is 49 square inches and B is chosen to be 0.05.

The distance at any point along the axis between the axis and the side of the horn is given by the equation

$$Y = keb^x$$

where $k = \frac{\sqrt{A}}{2}$, $b = \frac{B}{2}$, $e = 2.718$, and $x =$ distance in inches.

$$\text{Therefore } k = \frac{\sqrt{49}}{2} = 3.5 \text{ and } b = 0.025.$$

Finding first the width of the mouth of the horn, and remembering that the equation gives only the half width, so that the answer must be doubled for the full width, we have

$$Y = 3.5 \times 2.718^{0.025 \times 40}$$

which is simply evaluated by the use of logarithms. To obtain the value of $2.718^{0.025 \times 40}$ multiply the common log. of 2.718 by 0.025×40 —that is, by 1.0. In other cases, of course, the power will not be so obliging! Evaluating by logs, then, we have

$$\begin{array}{r} Y = \text{antilog}_{10} \quad 0 + .5441 \\ \quad \quad \quad \quad \quad + 0 + .4343 \\ \hline \quad \quad \quad \quad \quad 0 + .9784 \end{array}$$

and $Y = 9.514$. Double this figure for the full mouth width, and the width of the horn at its mouth becomes

$$19.03 \text{ inches.}$$

The full width of the horn at the throat is, presumably, 7 inches since the throat area is 49 square inches. We thus have the width of the template at its two extremities.

We now have to find out how long the flat template must be to give a horn length of 40 inches when the template is bent into the true curve of the horn. The equation in this case is derived through the use of calculus and, in as simple a form as possible, is still rather involved. The template length Lt for an axial length of 40" is given by

$$Lt = \frac{1}{b} \left[M + 1.1513 \log_{10} \left(\frac{M-1}{M+1} \right) \right] - \frac{1}{b} \left[m + 1.1513 \log_{10} \left(\frac{m-1}{m+1} \right) \right]$$

where $M = \sqrt{1 + b^2 k^2 e^{2bx}}$

and $m = \sqrt{1 + b^2 k^2}$

and b, k, e , have their values as before and x is the axial length of the horn, in this instance the full length of 40 inches.

Evaluating M and m we find that

$$M = 1.028 \text{ and}$$

$m = 1.004$, so that these values may be substituted into the main equation. If this is then evaluated, however, it will be found that with the present values of b, k, M and m the answer is very slightly below 40 inches,

which is obviously incorrect—in other words, the necessary simplifications in the derivation of the equation have introduced working errors which, for a short horn with a small flare are greater than the corrected length of the template. Experimental measuring of the required template shows that the extra length necessary to allow for curvature is of the order of $\frac{1}{2}$ " , and if the template length were made the axial length, the error, in this case, would be negligible.

For longer horns, or for horns with a greater flare constant or where the horn was larger by virtue of the fact that the throat area was larger, Lt would be calculated as a larger figure than the axial length.

For each point down the curving side of the template, therefore, two calculations must be made, the first for Y, showing the distance between the axis and the horn side, and the second for Lt. In the present case we may take Lt as being equal to the axial length x of 40 inches, and so it would be sufficient to work out the points for the value of Y when x = 40, 35, 30, 25, and so on. In a horn where Lt is longer than x, a new Lt would also be worked out for each Y point so that the Y value could be put not at its nominal place on the template but at the place indicated by Lt, a fraction of the horn length further from the end of the horn.

Chapter 5

THE LOUDSPEAKER IN USE

With the loudspeaker matched into its receiver or amplifier and mounted on a baffle or in a suitable cabinet to the best advantage, it is time for a word on the loudspeaker in use in the home and also in halls and the open air. We have already seen that the loudspeaker can transmit sound in two ways—either non-directionally, the manner mostly required, or directionally.

The loudspeaker sends sound into space; and the limits and bounds of that space have a great effect on the sound quality as heard by the ear. Apart from the nature of sound itself, a fundamental frequency accompanied by harmonics or overtones and, on occasion, by subjective frequencies introduced by the observing ear, the quality of sound depends to a great extent on the room or hall or space in which the sound originates. An orchestra in a felt-lined hall would appear dead and uninteresting—reverberation plays a great part in the presentation of all sound and especially in so far as music is concerned.

The reverberation characteristics depend on the shape of the space in which the sound originates, the materials with which the space is enclosed, the size of the enclosure and upon objects within the space. A concert hall empty of an audience gives a different quality to that heard in the same hall with every seat filled. The amateur actor, too, if he knows his job, will find that he is subconsciously adjusting his voice, during his first few words, to suit the reverberation time of the auditorium. The loudspeaker cannot adjust

itself, and so must be placed and fed with power in a manner which allows it to give the best quality possible under the conditions in which it is being used.

Once again the writer must state that in his opinion the term "quality" can only be taken as subjective. Quality is observed by the ear and translated into ideas or thought in the mind, and neither the ear nor the mind is interested to any great extent in a straight line response curve. True, an amplifier with a straight line response is the best starting point—there are then no deficiencies in the bass and no peaks in the treble—but the theoretically excellent curve must be the starting point in the search for quality sound, not the finish. The quality enthusiast presumably knows what he means by high quality music, and must satisfy his own ear. If, to him, quality requires good bass response he must lift his bass response curve accordingly until what he hears is truly satisfying, and the engineer who then says that he is upsetting balance or that his ear is playing him false must be disregarded. In other words, the only possible course open to the quality enthusiast is to be perfectly selfish and please only himself—in very many cases this will finally lead to pleasing the majority of other listeners.

The author therefore recommends the use of a good amplifier, for sound reproduction, with the best pick-up and loudspeaker that the pocket can afford, with a low frequency and high frequency pair of controls on the amplifier which, together with the volume control and the loudspeaker positioning are varied exhaustively until the results are really pleasing.

Here, however, we are chiefly concerned with the loudspeaker positioning. In the home a single speaker will generally be used—a woofer-tweeter combination must be mounted on the same baffle or in the same cabinet and so may be treated as a single speaker—and the placing of this speaker in the listening room must be experimental. In any case, the experimenter is working under difficulties simply because he is trying to make a large orchestra sound natural in a small room, and it is well to bear these points in mind:—

The small room cannot possibly have the same acoustic pattern as a concert hall.

The room will almost certainly possess resonant characteristics which will apparently "amplify" certain frequencies or harmonics in complex tones.

The most serious resonances, in a room, are grouped in the low frequencies, thus making accurate bass note reproduction almost impossible.

In contrast with the last point it may be said that the serious resonant points in most concert halls and similar places are at frequencies so low that they may be considered as sub-audible.

All that can be done, then, in a room, is to find the best place for the loudspeaker and, if possible, to experiment with a few heavy rugs on the floor and heavy curtains at the windows, since this is the only way in which the reverberation time of the room can be adjusted by some small degree. A high position for the loudspeaker should not be overlooked, a corner baffle suspended from the picture rails in an angle of the room often gives good results.

Where sound is to be distributed in a hall, as for entertainments or dancing, experiment with the placing of speakers is once again the only real way of obtaining satisfactory results. If a microphone is in use, then not only must the speakers be positioned for good and equable distribution but feedback also must be prevented. In general, however, it seems preferable to group the loudspeakers below or on a level with the stage for hall work, possibly directing sound into odd-shaped corners of the hall, if these exist, by turning one of the speakers at the right angle. An ordinary straight hall with no alcoves can often be covered adequately by a single large diameter speaker, preferably on a big flat baffle, but a hall with a number of side alcoves or with side aisles under galleries will generally need a series of small speakers, phased in with the main speaker, to give good audibility in the irregularities of the hall layout.

The distribution of sound in the open air generally calls for directional loudspeakers, using exponential horns or directional horns with no mouth flares. There are many examples which can be studied, ranging from the P.A. systems of railway stations to those of sports arenas. Highly directional loudspeakers, may be bought, at the time of writing, from Army surplus stores, since such equipment was used extensively for beach landings and battle orders. At least one loudspeaker was designed to have such a narrow angle of sound distribution that a modified form of sights was mounted on the horn to ensure that orders reached their correct destination!

For open air sound over small distances, however, such as for low-level music at garden parties, dynamic speakers in box baffles are excellent, and two speakers set together at an angle of about 45° are generally sufficient to give perfectly adequate coverage for music and announcements.

Chapter 6

EXTENSION LOUDSPEAKERS

It is often desirable to run extension speaker wiring from the ordinary domestic receiver throughout the house, feeding one or two or perhaps all rooms so that the programme to which the set is tuned is available over the house. The details so far given can be applied both to the arrangement of the feed system if a number of loudspeakers are to be in use at one time, but some amplification on the use of lines is needed.

The number of speakers required to run at one time will affect the volume obtained from each speaker, and a limit will be set by the power output of the receiver. Most receivers have provision for plugging-in extension speakers, and it should first be ascertained whether the extension requires its own output transformer, and if so, the anode load into which the transformer must be matched, or whether a low impedance output line is provided, in which case the extension speaker must have the correct voice coil impedance. All these details depend upon the receiver.

If more than one extension speaker is to be used at once, especially if there is no provision for switching off the receiver speaker, it will be wise

to provide a new output transformer with ratios and windings calculated to the details previously given in order both that the available power may be fairly distributed and, perhaps more important, to ensure that the correct anode load impedance is given to the output stage. Adding speakers in parallel without adjusting the overall matching arrangements will reduce the loading into the stage.

If a battery set is in use the extension speakers can be connected to the receiver by a single wire line, the circuit being completed through an earth connection. This method of connection is definitely unsafe when mains receivers are in use, even when an isolating transformer is used.

A simple single line extension circuit is shown in Fig. 20, the speaker line being supplied from the set by connecting a low resistance high inductance choke in the anode line of the output valve and taking the audio signals from the anode via a capacitance. With this type of line each speaker will need its own output transformer. It is not suitable for use with a low impedance line since the circuitous route of continuity through the earth connections will cause serious losses in a low voltage - high current line.

Generally, a two-wire line will be used, and when this line is of the high impedance type it will be necessary to guard against high frequency losses, especially since the impedance will be, not of the order of 200 to 500 ohms, but 2,000 to 5,000 ohms, unless a special transformer is used at the line terminals with special transformers at the speakers.

To reduce the line capacity is reasonably simple, however, for one wire of the line can be taken along skirting boards whilst the other wire can be taken along picture rails, the wires only approaching at the speaker socket connections.

A low impedance line can have the wires both in one cover since the high frequency loss is small, and ordinary twin cable of good quality may be used, the wire diameter being as large as possible to prevent losses. See Chapter 3 for details of wire sizes, line lengths and losses.

Several different types of plugs and sockets are available commercially, and the neatest method of extension wiring is to fit permanent sockets in all the rooms where the programme will be required, having one or two speakers with plugs so that they can be taken from room to room and plugged in.

Extension speakers should naturally be of the permanent magnet type, since under no circumstances is it possible to energise an external speaker from the receiver. Connecting the field winding of an external speaker in with the field of the receiver's speaker would result in under-energisation if the fields were in parallel and a great drop in anode potential if the fields were in series, not to mention the complication of the extension wiring. With the present advances and technique in high fluxdensity permanent magnets, there seems to be no good reason why permanent magnet speakers should not be used for all speaker positions remote from a receiver or amplifier whether for house extensions or sound in halls and theatres. Energised field speakers used in this way require their own power packs to supply the field current, and it is problematical whether the energised field speaker has any advantage over the permanent magnet speaker except in the case of special types and large-size speakers.

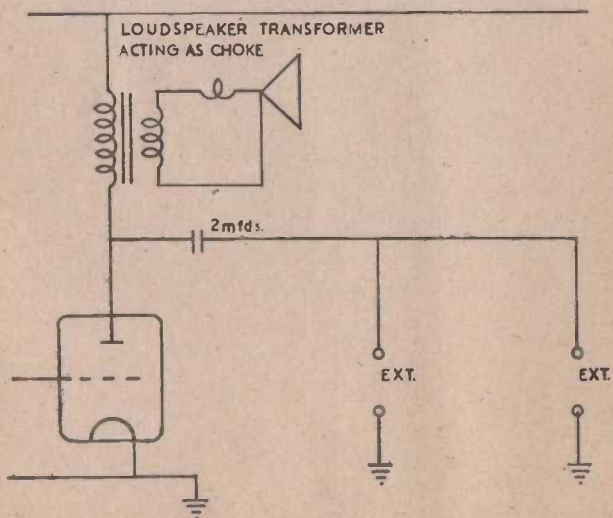
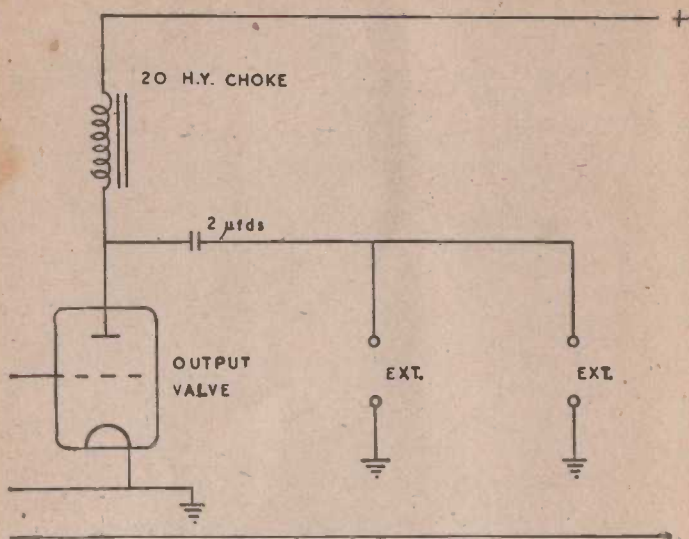

FIG. 20.—Single Line Extensions for Battery Sets.

All extension point sockets must obviously be wired in parallel so that a single speaker can be plugged into any one of a number of points. Points in series would require to have a speaker in each position or else a shorted plug in each position, the shorted plug being removed and the speaker being plugged in when needed.

Loaded plugs rather than shorted plugs can be of use, however. If a special output transformer were designed and fitted to the receiver to supply, say, four extension loudspeakers, the removal of one loudspeaker would upset the matching of the extension line into the receiver. This defect could be overcome by wiring a plug with a small resistance across the plug legs, the resistance having the same value as the voice coil impedance of the removed speaker. The speaker can then be removed and the plug inserted into the socket so that the correct load is still on the output transformer and the primary still presents the correct load to the output stage.

When an extension speaker is connected to a receiver by the receiver's "extension speaker" sockets, and no special provision has been made to correct the matching of the new composite load into the output stage, a straightforward volume control can be used wired in series with the extension speaker and mounted in the extension speaker cabinet. When the speaker has its own output transformer, the extension line then being of high impedance, a 10,000 or 50,000 ohms potentiometer, connected as a rheostat, will be suitable, whilst where the line is of the low impedance type with the extension speaker voice coil connected directly across it, a 30 ohm wire-wound rheostat will prove satisfactory.

When the extension speakers are matched into the receiver or amplifier by a special transformer, an L pad should be provided to maintain the correct matching.

Remote Control

One disadvantage of a simple extension speaker system is that there is no control over the set from the extension positions. When the desired programme is finished, or when it is required to switch off the receiver, it is necessary to perform this at the receiver itself. The benefit of extension speakers, especially in bedrooms or distant parts of the house, is thus to some extent annulled. By the use of a remote control system incorporated with the extension speaker wiring, the difficulty is overcome and the receiver can be switched off and on from any of the extension speaker stations. A really comprehensive remote control system can also operate the receiver tuning, but the installation of such a system is so expensive and there are so many relays and controls to go out of order that in the writer's opinion a simple On-Off remote control is more satisfactory in the long run. The engineer can easily devise his own remote controlling devices, but for those who require ready-made gear, the Bulgin Remote Control is recommended, with Bulgin Control Pushes. The Remote Control unit is No. R.C.10, and the On-Off Control Pushes are No. R.C. 8 on Messrs. Bulgin's list.

Control is effected through a pair of interlocking relays which must be supplied with a high current low voltage impulse to operate them into either

the Off or On position. The current is only momentary, and can be supplied from a battery or the receiver's L.T. cell for D.C. mains and battery receivers, or from a small 4-volt transformer for A.C. mains operation. The use of a small battery to provide the relay driving current would seem preferable, however, since a transformer would need to be connected permanently to the mains, and whilst the current drain should be extremely

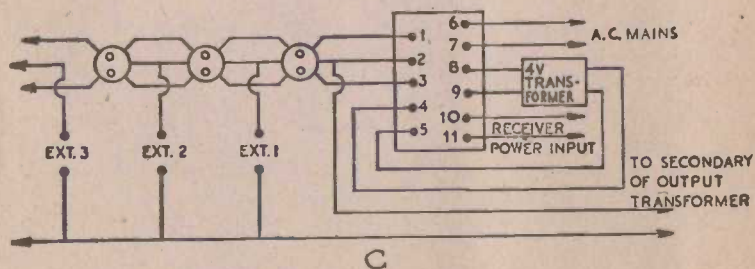
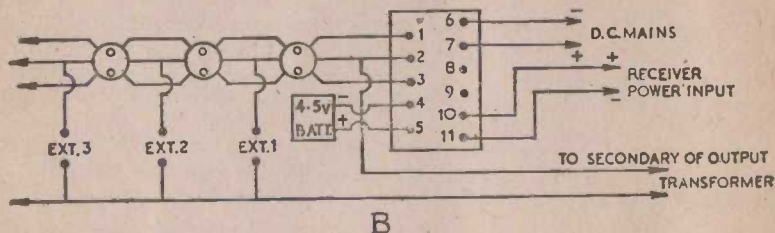
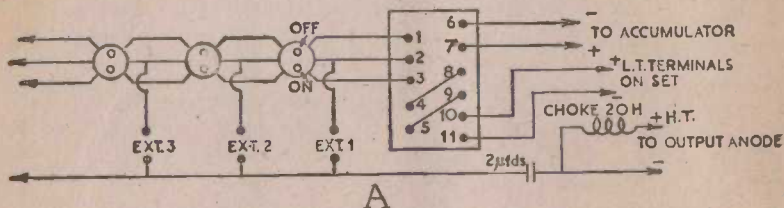

FIG. 21.—Remote Control Wiring.

(A) For Battery Receivers.

(B) For D.C. Mains Receivers,

(C) For A.C. Mains.

(A Battery may be connected to 4 and 5 in place of the 4V Transformer.)

small with no secondary current flowing, small transformers are often not what they might be in this respect.

The remote control cable running from point to point requires three fairly heavy conductors of 18 S.W.G. wire or equivalent, one wire being common and the other two linking the On and Off buttons of each push respectively. The common line can also be used as one wire of the extension speaker line, so that a four-wire cable can provide for both speakers and control current.

The control unit, with its energising battery or transformer, is situated beside the receiver. The loudspeakers must be coupled to the output stage either through an output transformer or a choke-capacitance filter, and since the common control line is connected to the chassis of the receiver when a choke-capacitance filter is used, or to one side of the output transformer when a low impedance line is being used, care must be exercised when the system is used with D.C. receivers or Universal sets where one side of the mains is also directly connected to the chassis.

In Fig. 21 are shown the various ways in which the Bulgin Remote Control Unit may be used. There is, of course, no limit to the number of push buttons and speaker extensions which may be wired into the circuit. It is only necessary to ensure that no more than the maximum permissible number of speakers are working at once—as is the case with any extension system—and that the length of the control cable is not so great that a serious voltage drop is caused when the energising current will be insufficient to trip the relays. The latter trouble, if it arises, can be overcome by using a slightly larger battery.

Chapter 7

THE LOUDSPEAKER IN INDUSTRY

One of the minor results of the late war was the appearance in factories, workshops and offices of batteries of loudspeakers engaged in announcing imminent danger from bombs or, in calmer moments, in dispensing "Music While You Work," and despite some argument as to which was the more harrowing to the nerves, music and the loudspeaker have come to stay in the factory. Long before the war the British man in the street was introduced, via the American films, to the office inter-communication set, which uses a loudspeaker both in the ordinary way and also as a microphone.

This chapter shows specimen circuits of such an intercommunication system and a small factory or workshop Alarm-Call-Music amplifier system. It is not possible to give circuits to cover every requirement, for the power output of the amplifier itself must needs vary according to the number of speakers which are to be operated, but the circuits shown will at least act as an outline for the constructor which he may adapt to his own particular needs.

Loudspeakers as Microphones

In Fig. 22 is shown a circuit for two-way communications using a central amplifier and the loudspeaker at each end of the circuit as the microphone.

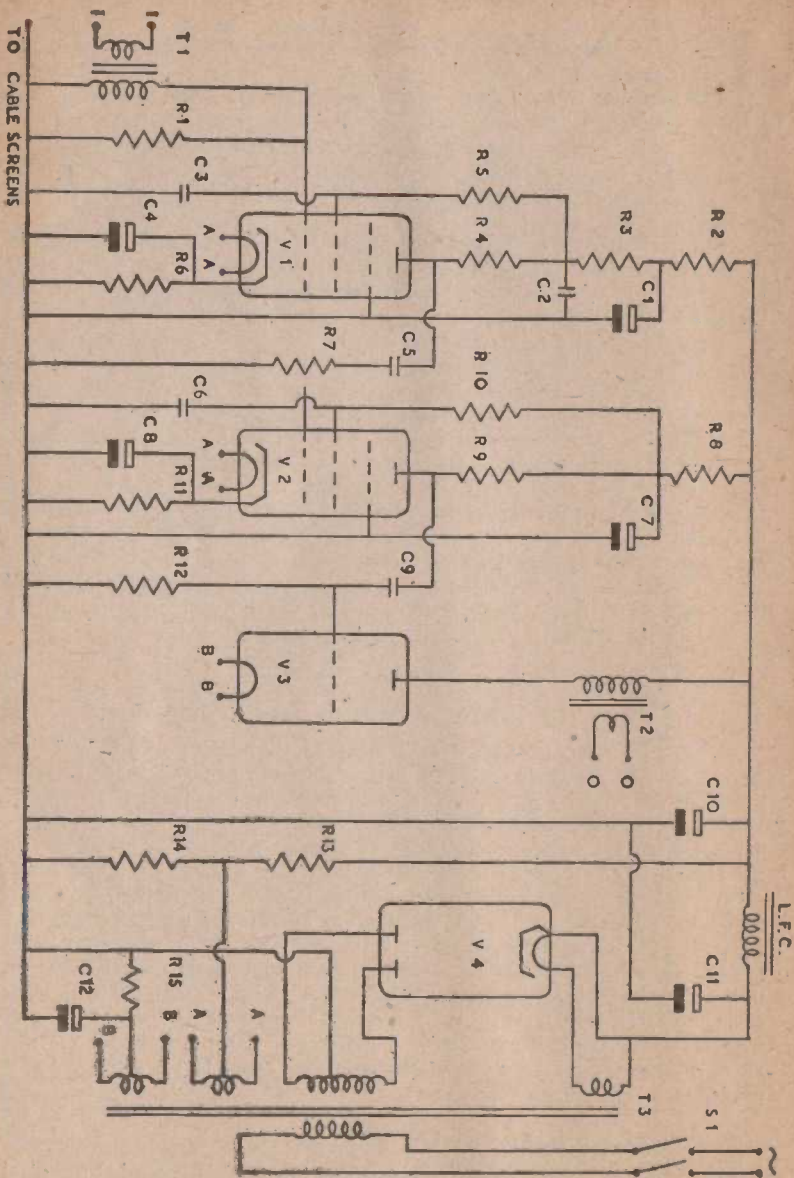

FIG. 22.—Office Intercom. Amplifier.

Loudspeakers operate quite well in this way, and tone can be excellent despite the large diaphragm and the low resonant frequency of the loudspeaker. A small loudspeaker, such as a 5" diameter permanent magnet model, should be used at each end of the line, and experiment shows that the speaker cone should be fairly open—that is, a close mesh fret material should not be used. A metal grille or mesh is more suitable, and copper gauze gives excellent protection, has a pleasing appearance and gives good results.

An amplifier using a loudspeaker as a microphone must have a high gain for the microphone output will be very small. In a system of this type, speech will be at several inches distance from the microphone, whilst the matching between the microphone and first stage of the amplifier will be only approximately correct.

The switching of even a two-way intercom. set requires some thought, for both stations of the system must be at the "Receive" position so that either can be switched to "Transmit" and messages sent immediately. At the same time, this provides for privacy, for there can then be no eavesdropping until a station actually switches to the "Transmit" position. The amplifier does not need a high output so long as the output stage is fully loaded, so that a single-ended triode output stage is shown.

A single output transformer and a single input transformer is used. The output transformer matches the output stage, using a PX4, to the two speakers in parallel, so that the available power is shared between them. Allowing for transformer and low impedance line losses, this means that a little more than one watt is available to each speaker which, for 5" units, should be ample. Switching one station to "Transmit" does not change the output stage loading and does not give extra power to the other loudspeaker, which is still switched to "Receive," for in order to maintain the correct matching a ballast resistor of 3 ohms resistance is switched into circuit in place of the voice coil which is now acting as a microphone. It is assumed that 3 ohm voice coils are being used.

In the same way the input lines are loaded even when both loudspeakers are switched to "Receive," although here the situation is rather different. As much input power as possible must be transmitted to the amplifier via the input transformer, and as little as possible must be wasted in the shunting resistor of the station switched to "Receive." For this reason, 50 ohms resistances are used to terminate the microphone lines until the 3 ohms voice coils are switched into circuit, since the real job of these resistances is to close the line ends and prevent hum when both stations are at the "Receive" position.

The output transformer must therefore be capable of handling, say, 5 watts and have a ratio which will match 1.5 ohms into 4,000 ohms. The ratio of this transformer is thus 50 : 1 approximately, and a 100 : 1 input microphone transformer is used. The output transformer may be mounted without trouble on the amplifier chassis, but the input transformer should, ideally, be mounted at some little distance from the amplifier, since not only

will there be the chance of hum pick-up from the mains transformer and choke, but there is also a possibility of feedback from the output transformer field. The input transformer should have excellent shielding and be mounted experimentally in a suitable position.

The intercom. system requires four wires to each station, and whilst a four-wire cable could be used, it is strongly advised that a pair of two-way cables be used, each pair of cables being shielded. The increase in cable capacitance will be of little importance since both lines are low impedance lines and in any case a top frequency limit of 5,000 cycles is adequate. The shield on both cables should be earthed at each end of the cable.

The amplifier itself can form the body of the station at one end of the system, a small cabinet containing the second loudspeaker and "Transmit-Receive" switch forming the second station.

The high gain of the amplifier is obtained by using as the first two stages R.F. pentodes of the SP41 type. Since it is possible to obtain a gain of 200 per stage with these valves, every precaution must be taken to avoid hum in the amplifier circuit, and the layout must be clean and tidy to prevent feedback. The volume control, which may be set and then left without further adjustment, is in the second stage, where it reduces noise due to the first stage as well as the signal. It is virtually impossible to overload the first stage using the loudspeaker as a microphone.

The grid leads to both the first stages must be screened, and the input circuit as a whole should have a small screen fitted over the sockets. It is easy to make such a screen from copper gauze and to bolt it to the chassis. The switches and resistors at each station should also be screened, the resistors having individual screening.

The station wiring and switching is shown separately in Fig. 23, both stations being identically similar.

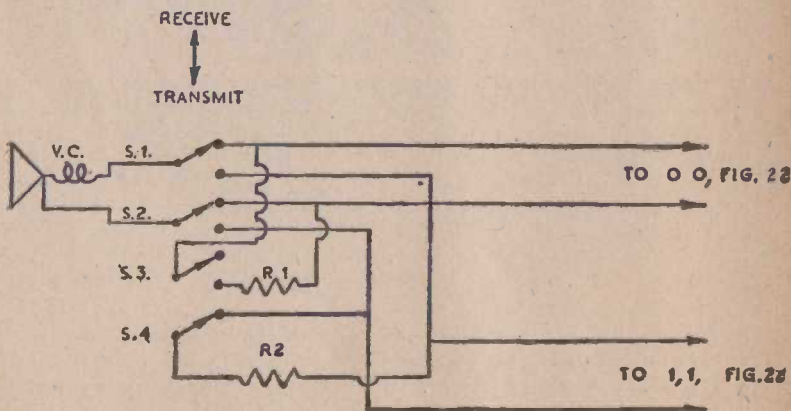

FIG. 23.—The Office Intercom. Station.

COMPONENTS LIST FOR THE OFFICE INTERCOM. AMPLIFIER.

(Fig. 22.)

R1, R12,	330,000 ohms, 1 watt.
R2, R3, R8,	33,000 " $\frac{1}{2}$ "
R4, R9,	100,000 " 1 "
R5, R10,	470,000 " $\frac{1}{2}$ "
R6, R11,	1,000 " $\frac{1}{2}$ "
R7,	0.25 meg. Volume Control.
R13,	33,000 ohms, 3 watts.
R14,	470 " $\frac{1}{2}$ "
R15,	910 " 3 "
C1, C7, C11,	8 mfd. 500 v.w. Electrolytic.
C2,	1 mfd. 350 v.w. Non-inductive.
C3, C6,	0.5 mfd. 350 v.w. Non-inductive.
C4, C8,	50 mfd. 25 v.w. Electrolytic.
C5, C9,	0.1 mfd. 350 v.w. Non-inductive.
C10,	16 mfd. 350 v.w. Electrolytic.
C12,	50 mfd. 50 v.w. Electrolytic.
T1,	100 : 1 Microphone transformer.
T2,	50 : 1 5 watts Output transformer.
T3,	300-0-300 v. 100 mAs. Secondary.
L.F.C.,	4v. 2a. 4v. 2a. C.T. 4v. 2a. C.T.
S1,	20 Henrys, 100 mAs.
V1, V2,	D.P.S.T. On-Off mains switch.
V3,	SP41.
V4,	PX4.
	UU6.
	3 Mazda octal chassis mounting valveholders.
	1 British 4-pin chassis mounting valveholder.
	Chassis, aluminium, 10" x 8" x 2 $\frac{1}{2}$ " with screening cover.
	Shielded grid clips, output and input sockets, control knob, etc.

COMPONENTS LIST FOR INTERCOM. STATION. (Fig. 23.)

(Two stations required.)

Loudspeaker, V.C. with 3 ohms voice coil.

S1, S2, S3, S4, 4-pole 2-way Yaxley type switch,
"Receive-Transmit."

R1, 3 ohms, 2 watts.

R2, 47 " $\frac{1}{2}$ "

The amplifier shown in Fig. 24 has provision for microphone and gramophone pick-up inputs, connected into the main amplifier via a mixing stage. As well as a pick-up, the output from a simple radio tuner can be fed into the pick-up sockets.

The output from the amplifier is 15 watts, sufficient to feed two or three speakers in workshops where the noise level is not too high.

Between the mixing stage and the phase splitter is a double tone control working on bass and treble, with the main gain control.

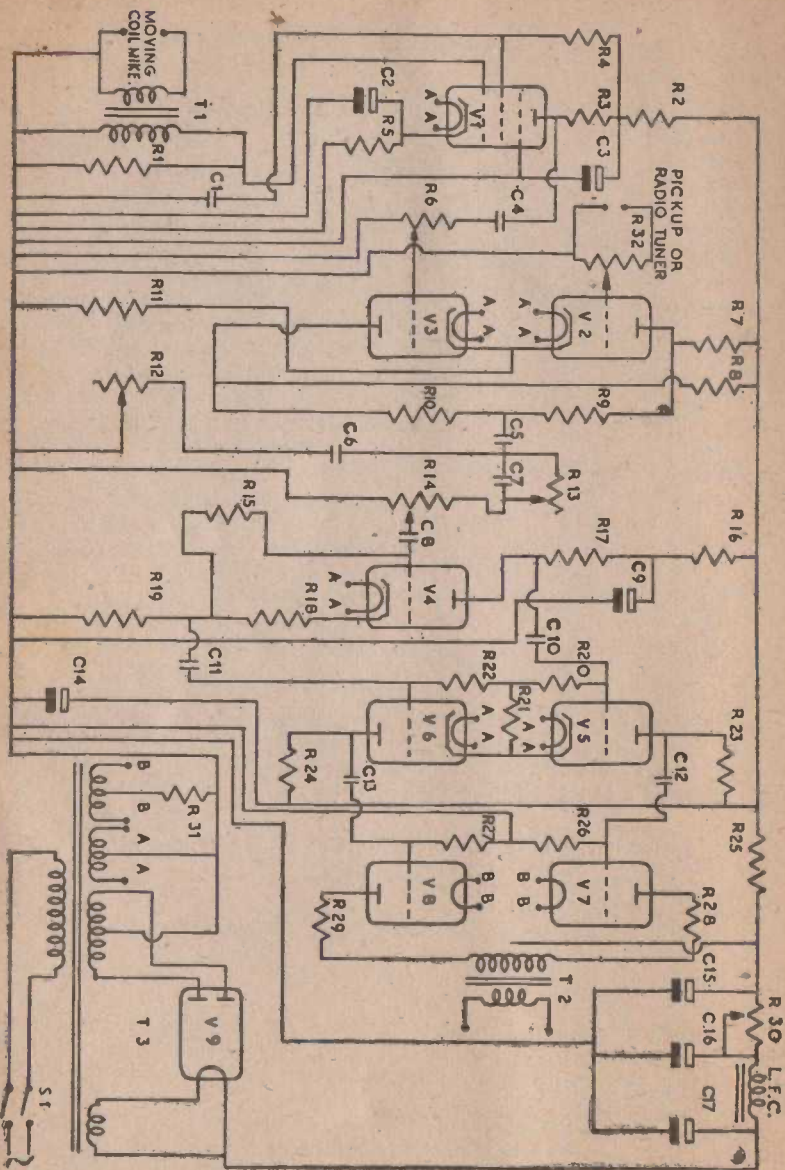

FIG. 24.—Alarm-Call-Music Amplifier.

A fairly high anode voltage is necessary on the output PX25's, the H.T. line being dropped and decoupled for the preceding stages by R25. The H.T. line is set to 450 volts by adjusting R30, an 0.2 amp. 1,000 ohms voltage dropping resistance as used for the heater resistor in Universal sets.

This amplifier must also be built with care, the layout being made to prevent any chance of hum pick-up through the stages, whilst the microphone transformer must be very well screened and mounted separately from the amplifier chassis. If a crystal microphone is used, R1 will become of the order of 2 megohms, so that once again there will be the chance of hum if the resistor and grid lead are not well shielded.

The loudspeakers used with the amplifier must be matched into an anode-to-anode load of 6,000 ohms.

COMPONENTS LIST FOR THE 15-WATT AMPLIFIER.

(Fig. 24.)

R1,	100,000 ohms 1 watt, or as specified for the microphone used.
R2, R7, R8, R17, R19, R23, R24,	47,000 ohms, $\frac{1}{2}$ watt.
R3,	100,000 " $\frac{1}{2}$ "
R4, R9, R10, R20, R22,	470,000 " $\frac{1}{2}$ "
R5,	1,000 " $\frac{1}{2}$ "
R6,	0.25 meg. Mike mixer input.
R11, R21,	330 ohms, $\frac{1}{2}$ watt.
R12,	0.25 meg. Treble control.
R13,	0.25 meg. Bass control.
R14,	0.5 meg. Main gain control.
R15,	1 megohm, $\frac{1}{2}$ watt.
R16,	33,000 ohms, $\frac{1}{2}$ "
R18,	2,200 " $\frac{1}{2}$ "
R25,	7,500 " 3 "
R26, R27,	330,000 " $\frac{1}{2}$ "
R28, R29,	47 " $\frac{1}{2}$ "
R30,	1,000 ohms 0.2 amp. dropping resistor.
R31,	100 ohms 2 watts plus 150 ohms 3 watts in series.
R32,	0.25 meg. Pick-up mixer control.
C1,	0.5 mfd. 350 v.w. Non-inductive.
C2,	50 mfd. 25 v.w. Electrolytic.
C3, C9, C14, C15, C4, C5, C10,	8 mfd. 500 v.w. Electrolytic.
C11, C12, C13,	0.1 mfd. 500 v.w. Non-inductive.
C6,	0.005 mfd. 500 v.w. Non-inductive.
C7,	0.001 mfd. Mica.
C8,	0.02 mfd. 500 v.w. Non-inductive.
C16, C17,	8 mfd. 750 v.w. Electrolytic.
L.F.C.,	20 Henrys, 200 mAs.

- T1, Microphone transformer, to suit microphone used.
- T2, Output transformer; 15 watts, to match load to 6,000 ohms.
- T3, 200-250 volt primary.
500-0-500 volts 200 mAs. secondary.
4v. 3a. 4v. 5a. C.T. 4v. 4a. C.T.
- S1, D.P.S.T. On-Off mains switch.
- V1, SP41.
- V2, V3, V4, V5, V6, 354V.
- V7, V8, PX25.
- V9, FW4/500.
- 1 Mazda octal chassis mounting valveholder.
- 5 British 5-pin chassis mounting valveholders.
- 3 British 4-pin chassis mounting valveholders.
- Chassis, aluminium, 16" x 8" x 2½", with screening cover.
- Grid clip, output and input sockets, control knobs, screened cable for pick-up and microphone leads, etc.

Appendix A

FEEDING THE SPEAKER FIELD

Where an energised loudspeaker is to be used directly with a receiver or amplifier, the energising current is obtained automatically by using the speaker field as a smoothing choke and passing the whole H.T. current drain through the winding. All that is necessary is to calculate the permissible voltage drop—for example, if the power pack has an output of 350 volts and 250 volts are required to operate the receiver or amplifier, the permissible voltage drop is 100 volts—and to choose a speaker with a field resistance which, at the rated current for the receiver or amplifier, will drop the correct voltage. To expand the above example, imagine that the receiver or amplifier requires 100 mAs. Then to drop 100 volts at 100 mAs. the field

resistance must be $\frac{100}{0.1}$ ohms, or 1,000 ohms. Remember, when using

Ohm's Law, that current in mAs. must always be expressed as current in amperes. Thus, 100 mAs. is expressed as 0.1 ampere. The speaker field will be dissipating 10 watts.

When using energised speakers as extension speakers it is both inconvenient and unwise to run a power line from the amplifier to energise the field, however, whilst where a number of speakers with energised fields are in use it is practically essential to provide each speaker with its own power pack. The power pack circuit is simple since the speaker field acts as its own smoothing choke, whilst a single capacitance only is required. When the apparatus is being used with D.C. mains, the power pack is so simple

as to require no illustration. A speaker with a high resistance field is chosen and connected directly across the mains, or a speaker with a lower resistance field is connected to the mains in series with a suitable resistance. In either case, a 4 mfd. capacitance is connected across the field winding and if an electrolytic capacitor is used care must be taken to observe the correct polarity.

The series resistance used must, of course, depend on the speaker resistance and its rating either in current or watts, which should be stamped on any good speaker. A 1,000 ohm speaker field with a rating of 10 watts obviously requires 100 mAs. flowing through the winding. D.C. mains with a voltage of 250 volts will cause 100 mAs. to flow through a 2,500 ohms resistance. Accordingly, a resistance of 1,500 ohms must be connected in series with the speaker field to make a total resistance of 2,500 ohms, and the watts rating of this resistor must be 150 (the voltage dropped across the resistance) multiplied by the current, 0.1 ampere—that is, 15 watts.

When the speaker field is to be energised from the A.C. mains, a rectifier must be used. Half-wave rectification is perfectly suitable, so that a metal rectifier will perform the operation satisfactorily, dispensing with a heater transformer and rectifying valve.

The circuit is shown in Fig. 25, and in many cases can be used without the provision of further dropping resistances. Speakers with fields whose resistances lie between 2,000 and 7,500 ohms can be energised from 200-230 volt A.C. mains, using the Westinghouse HT15 rectifier with field excitations of between 6 and 9 watts. If the mains voltage is above 230 volts up to 250 volts, a 2,000 ohms field should be supplied from an HT17 rectifier, although fields of higher resistance can still have the HT15 rectifier.

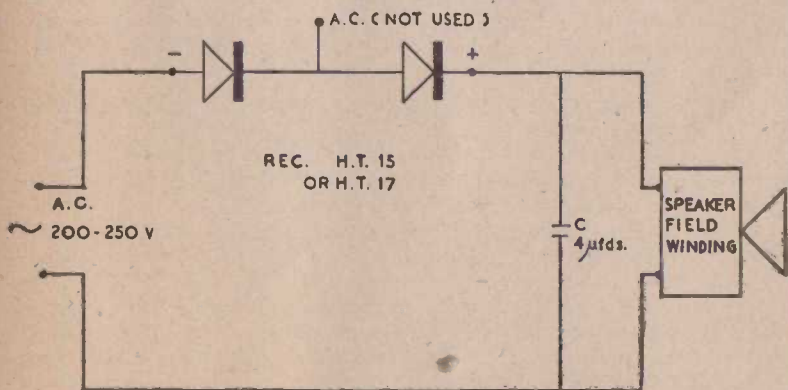

FIG. 25.—Energising the Field Winding.

The field excitation will naturally rise a little, to perhaps 10 or 11 watts. 1,000 ohms fields can be fed from the HT17 rectifier when the excitation will be between 10 and 15 watts for mains voltages of between 200 and 250 volts. In all cases the value of C in the diagram should be 4 mfd., a paper type condenser with a working voltage of 500 volts being preferred, although an electrolytic condenser connected with the correct polarity can be used.

If the excitation values are too high for the speaker it is desired to use, a variable resistance of the heater dropper 0.2 amp. type should be inserted in series with the speaker and the current adjusted to a calculated correct value by variation of the resistance slider.

Appendix B

THE OUTPUT TRANSFORMER

Whilst it is impossible to give a design for an output transformer which will cover all applications, loads and powers, it is possible to give a skeleton design which will form the basis of an output transformer with a high primary inductance, a high power handling capacity, and which can be wound with secondaries as calculated to suit the load.

In this appendix, therefore, are given details for a sectionalised primary winding on a standard lamination core, the winding having a round number of turns. Between the primary sections should be wound the secondaries required with ratios to the primary winding as calculated. If only one secondary winding is required this should be put on in sections sandwiched between the primary sections, using as large a wire gauge as the former and core and winding area can accommodate, whilst several secondaries can be put on as separate windings each sandwiched between a pair of primary sections. Again, the wire gauge must be as heavy as can be accommodated.

A good many of the details of the transformer are still left to the builder to fill in, therefore, but this cannot be avoided.

Obtain an old mains transformer with E and I laminations, and strip the laminations from the former, then clear the former of the old wire. In the centre of the former build up a central cheek so that the former is now divided into two equal parts, using for the purpose stout card and good cement. The former will now look like Fig. 26.

The primary and secondary windings are put on the former in two halves, 2,000 turns of 30 S.W.G. enamelled copper wire being used on each half former to make a total primary of 4,000 turns of wire. On each half former the primary is put on in 5 sections, 400 turns to a section, the secondary windings or part windings being placed between the primary sections, so that 4 secondary sections can be accommodated on each half former making 8 secondary windings or sections in all. Between each layer of wire in both primary and secondary should be placed a turn of waxed paper, such as can be obtained by stripping down an old Mansbridge type condenser, whilst

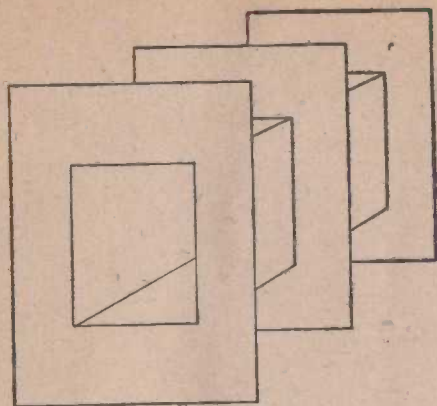

FIG. 26.—The Former, with an extra cheek.

between the primary and secondary sections the insulation should consist of 2 or preferably 3 layers of 5 thou. Empire tape.

The secondary wire size should be about 18 S.W.G. enamelled wire, but it may be possible to use thicker wire, all depending on the number of turns to be used.

A mains transformer with a 1 inch cross-sectional core area or more should take this size of primary and leave adequate room for the secondary windings. If a small core only is at hand it will be necessary to put on a smaller primary winding, adjusting the secondary windings to maintain the correct ratios. The sectional method of winding should still be used, of course.

The primary leads should be brought out at one side of the former, the secondary leads at the other. Only two or three primary leads should be brought out (three if the primary is centre-tapped), the connections between sections being made internally and carefully insulated. A centre tap, when required, gives no trouble since it occurs between the two half-windings at their junction. The secondary sections, if they are parts of one secondary winding, may also be connected together internally. Remember, when winding the two halves of the former, that the windings must all be in the same sense so that the fields assist.

30 S.W.G. copper wire will carry 120 mAs. with ease.

The secondary ratios are calculated against a 4,000 turn primary—a ratio of 100 : 1 will require a secondary of 40 turns, and so on.

When the transformer is to be used with a push-pull output stage the laminations should be crossed, stacked with an E, an I, an E, an I, etc., but when the transformer is to be used with a single-ended output stage all the E's and all the I's should be stacked together to give 3 butt joints, the core being bolted into a frame for strength and rigidity.

NOTES

NOTES

NOTES

BERNARD'S RADIO BOOKS

FOR THE HOME & AMATEUR CONSTRUCTOR

3.	SERVICES SIGNALLING MANUAL	1/-
4.	RADIO POCKET BOOK	1/-
6.	ELECTRICAL ENGINEERS HANDBOOK	1/-
22.	MANUAL OF RADIO CIRCUITS	2/-
30.	RADIO VALVE MANUAL	3/6
37.	MANUAL OF DIRECT DISC RECORDING	2/-
41.	WIRELESS AMPLIFIER MANUAL	2/-
42.	SHORTWAVE RADIO HANDBOOK	2/-
43.	MODERN RADIO TEST GEAR CONSTRUCTION	1/6
44.	RADIO SERVICE MANUAL	2/6
45.	RADIO REFERENCE HANDBOOK	12/6
48.	RADIO COIL AND TRANSFORMER MANUAL	2/-
50.	INTERNATIONAL SHORTWAVE RADIO STATION LIST	1/-
51.	CATHODE RAY OSCILLOSCOPE MANUAL	2/-
52.	RADIO TUNER UNIT MANUAL	2/6
53.	RADIO CONSTRUCTORS' MANUAL	3/-
54.	RADIO RESISTOR CHART	1/-
55.	HANDBOOK OF RADIO CIRCUITS No. 2	2/6
56.	RADIO AERIAL HANDBOOK	2/6
57.	ULTRA SHORTWAVE HANDBOOK	2/6
58.	RADIO HINTS MANUAL	2/6
59.	TELEVISION CONSTRUCTION MANUAL	3/6
60.	RADIO REPAIRS MANUAL	2/6
61.	AMATEUR TRANSMITTERS' CONSTRUCTION MANUAL	2/6
62.	CAR AND PORTABLE RADIO CONSTRUCTORS' MANUAL	2/6
63.	RADIO CALCULATIONS MANUAL	3/6
64.	SOUND EQUIPMENT MANUAL	2/6
65.	RADIO DESIGNS MANUAL	2/6
66.	COMMUNICATIONS RECEIVERS' MANUAL	2/6
67.	RADIO VALVE EQUIVALENTS MANUAL	2/6
68.	FREQUENCY MODULATION RECEIVERS' MANUAL	2/6
70.	LOUDSPEAKER MANUAL	2/6

Other Titles in Preparation

- | | |
|-----|--|
| 69. | RADIO INDUCTANCE MANUAL (<i>Coil and Transformer Construction</i>) |
| 71. | MODERN BATTERY RECEIVERS' MANUAL |
| 72. | EXPERIMENTAL CIRCUITS MANUAL |
| 73. | RADIO TEST EQUIPMENT MANUAL |
| 74. | RADIO VALVE APPLICATIONS MANUAL |
| 75. | RADIO ANTI-INTERFERENCE MANUAL |

"TECHNI-GEN" CONSTRUCTORS' ENVELOPES

Correspondence with many thousands of purchasers of our well-known Radio books has revealed a considerable demand for Radio designs in sheet form, and has indicated the types of sets desired.

The new "TECHNI-GEN" series of Radio Constructors' Envelopes is based upon this information.

Each envelope has an attractive cover design in two colours and contains a broadsheet, size 22½ in. by 17½ in., giving a chassis blueprint, a picture of the set which, in each case, has been built and fully tested, circuit diagrams and explicit instructions.

Lewis George, the well-known Radio designer and author, is responsible for the production of the Series and British component manufacturers have co-operated in developing the designs.

No. 1. HOW TO MAKE A 3-VALVE PLUS RECTIFIER AC/DC TRF RECEIVER. For medium waves (200-557 M. only). This receiver is provided with a tone control and a method of using an energised loudspeaker is illustrated and described.

No. 2. HOW TO MAKE AN "ECONOMY" 4-VALVE PLUS RECTIFIER AC/DC SUPER-HET. RECEIVER. For medium waves (200-557 M. only). A.V.C. and Tone Control is incorporated.

No. 3. HOW TO MAKE "ALL-DRY" 4-VALVE BATTERY SUPER-HET. PORTABLE RECEIVER. For medium waves (200-557 M. only). A.V.C., Tone Control and a Frame Aerial are incorporated. Provision is also made for the use of an outside aerial.

No. 4. HOW TO MAKE AN AC/DC "QUALITY" RECEIVER. For medium and long waves. This receiver is suitable for both local station reception and for the more powerful Continental stations. Approximately 8-watts push-pull output is provided.

No. 5. HOW TO MAKE A 20-WATT "QUALITY" AMPLIFIER. Separate treble and bass tone controls are incorporated and the output stage comprises two tetrodes in push-pull with negative feedback.

No. 6. HOW TO MAKE A PORTABLE AC/DC PUBLIC ADDRESS AMPLIFIER. 10-watts output with provision for mixing two microphone inputs and a gramophone pick-up. A suitable carrying case is illustrated.

No. 7. HOW TO MAKE A DE LUXE TUNING UNIT FOR THE 20-WATT "QUALITY" AMPLIFIER. Both straight and super-het circuits are incorporated allowing wide-band local station as well as all-wave reception. Continuously variable tone control circuits are included.

Retail price 2s. each

Obtainable from your dealer or, in case of difficulty, write direct

BERNARDS (PUBLISHERS) LIMITED,
GRAMPIANS BUILDING, WESTERN GATE,
LONDON, W.6.

Telephone : SHEPHERDS BUSH 2581