

RADIO

COIL

AND

TRANSFORMER

MANUAL



No. 48
Copyright



BY "RADIOTRICIAN"

RADIO, COIL and TRANSFORMER Manual

by

“Radiotrician”

Copyright 1944

BERNARDS (Publishers) LTD.

London, W. 6

CONTENTS.

Section 1.	PAGE
Radio Frequency Coil Types and Characteristics ...	3
 Section 2.	
The Design and Construction of Radio Frequency Coils	11
The Calculation of Inductance	15
Bank Wound Coils	17
Oscillator Coils	18
Aerial and Reaction Couplings	18
Reaction Windings	20
Ultra Short Waves	20
Medium and Long Wave Coils	21
Band Pass Units	23
I.F. Transformers	24
Variable Selectivity	25
Coil Construction	27
Screening	28
Testing Coils	29
 Section 3.	
H.F. Chokes	29
 Section 4.	
Power Transformers	30
The Primary	35
The H.T. Secondary	35
Heater Secondaries	36
Testing	38
High Voltage Transformers	41
 Section 5.	
Low Frequency Chokes	42
Chokes for Alternating Current Only	42
Chokes for Mixed Currents	44
 Section 6.	
Output Transformers	45
 Section 7.	
Copper Wire Tables	48

SECTION 1.

Radio Frequency Coil Types and Characteristics.

Whatever the final function of the apparatus there is no radio and almost no electronic device which does not rely to a great extent on coils. In broadcast receiver design the radio frequency coil with its associated condenser forms the heart of the circuit and the whole excellence of the final output depends upon its working whilst such gear as audio amplifiers, cathode ray oscillographs, relay operators, sound heads and photo-electric devices all depend on coils in the shape of transformers for power supply and coupling, smoothing chokes and audio or radio resonant circuits.

Whether the coil is designed for high frequency working and is a simple helix supported in air or whether it is for power transformation at a low audio frequency, consisting of thousands of turns of wire on an iron core, its basic operation is the same.

All coils exhibit the same qualities, the most important being:—

(1) Inductance.

The inductance of a coil (coils are often known as inductances) is the measure of its electrical inertia. To generate a current in a wire and thus develop a voltage across the wire's ends it is merely necessary to move the wire through a magnetic field so that it cuts the lines of force, when the current will depend on the rate of cutting and the number of lines cut, this being the well known principle of the generator. Moreover, moving the wire one way through the field and then reversing its direction of travel will cause the current to reverse its direction of flow—it will commence at zero and grow to a maximum, fall back to zero as the movement slows and stops and on the return of the wire through the field will grow to a maximum again but in the opposite direction of flow.

This current, of course, is A.C. or Alternating Current, whilst current which always maintains one direction of flow is D.C. or Direct Current.

Current may also be generated in the wire, however, by arranging it in a fixed position and allowing the magnetic field to vary around it, the lines of force growing and collapsing and so cutting the wire as before. Obviously any current so obtained must be A.C. and the frequency will depend on the rate at which the magnetic field grows and collapses or, in the same way, on the rate at which the wire in the earlier examples reverses its direction of travel. One complete alternation from zero to maximum in one direction, back to zero and on to maximum in the other direction and finally back to zero is known as one "CYCLE" (the number of cycles per second being known as the frequency) and corresponds with one complete revolution of the rotor of a simple alternating generator. Thus we can say that such a cycle takes place over 360 degrees, and if it is desired to inspect only a part of a cycle we can measure any part of a whole cycle along the zero line and give it an angular measurement of, say, 90 degrees or one quarter of the cycle, whilst if we desired to compare two alternating voltages of the same frequency where one grew to its maximum one quarter of a cycle after the other we would say that there was a "PHASE DIFFERENCE" of 90 degrees between them or that they were "90 degrees out of phase."

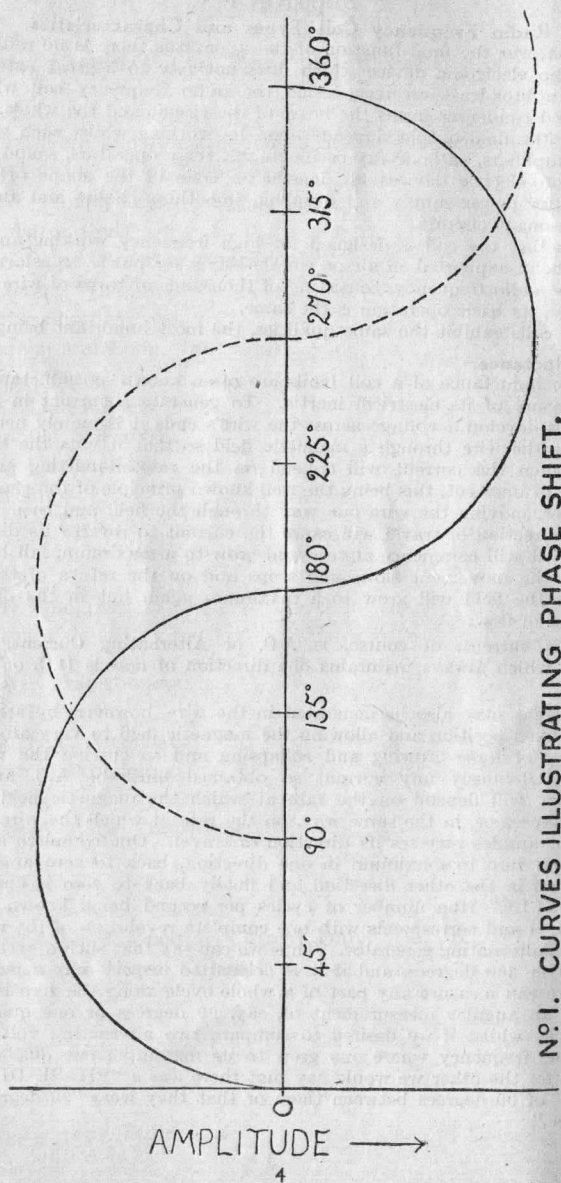

No. 1. CURVES ILLUSTRATING PHASE SHIFT.

In Fig. 1 the continuous line shows one cycle of voltage, the time of the cycle being measured along the zero line in degrees while the broken line shows a similar cycle of the same frequency 90 degrees out of phase. Moreover the crest or maximum point of the broken line is after that of the continuous line cycle, so that it " $\frac{1}{4}$ LAGS" behind the continuous line by 90 degrees or the continuous line cycle is "LEADING" by 90 degrees.

It may be said here that the usual frequency of the A.C. mains in this country is 50 cycles per second (c.p.s.) while audio waves extend from roughly 20 to 20,000 c.p.s. and radio waves are arbitrarily divided into bands between roughly 100,000 to 300,000,000 c.p.s. 1,000 cycles are known as a KILOCYCLE and 1,000,000 are a MEGACYCLE.

A coil or inductance, then, may be fed with any of these frequencies depending on the task it is to perform, but to understand what happens suppose a simple coil, a solenoid of a few turns of wire on a simple former, connected to a battery through a switch. When current flows through a coil it causes a magnetic field to form, the axis of the field being down the centre of the coil, so that if the switch of the above circuit is closed current will flow through the coil and the magnetic field will suddenly grow. As it grows, however, the lines of force, extending outwards, cut the wires of the coil which is the necessary condition for generating a current in those wires. The growing field of a coil always generates this current in opposition to the current from the supply and so it is plain that the full battery voltage will not at first appear across the coil for it will be reduced by the voltage due to the current generated in the coil itself. Obviously this will affect the battery current, making it a smaller flow than it would otherwise be, and not till the whole system is in equilibrium will the current rise to its maximum value. When the circuit is broken the magnetic field collapses and once more the lines of force cut the wires inducing a voltage which this time endeavours to assist the falling voltage and thus endeavours also to bolster up the falling current, these effects, of course, occurring in the fraction of a second. These voltages, generated to oppose any change of condition of the coil, are sometimes known as "BACK E.M.F.'s" and may be quite high, depending on the inductance of the coil. In an electric bell, for instance, it is the self-induced voltage which gives the spark at the contacts and experiment will show that the Back E.M.F. is sufficient to give a smart shock.

This, then, is the effect of the coil's inductance, and obviously it will be of great importance when the coil is fed with A.C. The current is always rising and falling in value so that there will always be a voltage induced by the coil's own field and affecting the current flow in the coil. In a pure inductance the current would lag behind the voltage by 90 degrees, thus in Fig. 1 the continuous line curve could now represent the A.C. voltage across a coil with the broken curve representing the lagging current, so that at full voltage the current is only just beginning to flow.

The unit of inertia, or inductance, is the HENRY and as it is proportional to the rate of change of the current a coil is said to have an inductance of 1 Henry when the current, changing at the rate of 1 ampere per second causes a pressure of 1 volt to be induced across the coil.

The Henry is too large a unit for use with radio frequency coils and they are measured in Milli-henrys (one thousandth of a henry) or in Micro-henrys (one millionth of a henry). The symbol for inductance is L.

(2) Reactance.

A coil has its own ordinary resistance to a steady current, measured as usual in ohms, but as it opposes the sudden changing of currents and voltages it obviously has a secondary effect on A.C. Alternating currents will have to overcome not only the ordinary resistance but also this "Reactance" and the opposition to A.C. of the coil is given by the formula:—

$$Xl = 2\pi fL$$

where Xl is the Reactance of the coil in ohms, f is the frequency of the A.C. applied. L is the inductance of the coil in Henrys and π equals 3.14.

R.F. coils are usually coupled with condensers, and the capacity has an effect on A.C. exactly opposite to that of the inductance. It causes the current to lead the voltage, and so the effect of placing inductance and condenser together in a circuit is largely to cancel out their reactances. For a condenser:—

$$Xc = -\frac{1}{2\pi fC}$$

where Xc is the reactance in ohms and C is the capacity in Farads. It must be noted that the result is expressed as a negative quantity. Reactances may be added together.

(3) Impedance.

Impedance is denoted by the term Z and when Ohm's Law is applied to A.C. Z takes the place of R, the term for D.C. resistance. When a circuit contains resistance and reactance although both terms are in ohms they cannot simply be added. The formula:—

$$Z = \sqrt{R^2 + X^2} \text{ ohms}$$

must be applied, and where a circuit contains a resistance R ohms, an inductance L henrys and a capacity of C farads in series, the Impedance will be:—

$$Z = \sqrt{R^2 + \left(2\pi fL - \frac{1}{2\pi fC}\right)^2}$$

An inductance and capacity together have

(4) Resonance.

that is they respond to a resonant frequency with their lowest impedance if they are in the series or with their highest impedance if the inductance and capacity are in parallel. Thus inductance and capacity in parallel and tuned to their resonant frequency develop their highest voltages in phase opposition at that frequency and are the most usual form of tuning circuit as shown in Fig. 2.

The formula for the resonant frequency for either series or parallel circuits is:—

$$f = \frac{1}{2\pi\sqrt{LC}} \times 1,000,000$$

and it must be noted that here the values have been reduced to working practical values f is in kilocycles, L is in microhenrys, and C is in Micro-microfarads.

(500 micro-microfarads = .0005 microfarads, a common size for a variable condenser.)

(5) Dynamic Resistance. RD.

As a coil and condenser in parallel present a high impedance to their resonant frequency, as is generally desirable so that they may develop a good voltage, the ratio L/C is important and the impedance of such a circuit at resonance may be given as L/CR, this often being known as the Dynamic Resistance. It is plain, therefore, that R, the coil's H.F. resistance, has a large bearing on the dynamic resistance RD and affects the efficiency of the whole circuit. This efficiency is known as the

(6) "Q".
of the circuit and may be shown as

$$Q = \frac{2\pi fL}{R}$$

where f is in c.p.s., L is in henrys and R is in ohms. For example a coil of 100 microhenrys inductance with a resistance at 800 kilocycles of 8 ohms: would have a "Q" of

$$Q = \frac{2 \times 3.14 \times 800,000 \times 100 \times \frac{1}{1,000,000}}{8} = 62.8$$

It must be realised that the coil resistance R grows higher with a rise in frequency due to losses and the skin effects of the wire, and cannot be taken as the resistance to D.C. Also a coil can never displace current and voltage by the full phase shift of 90 degrees because a pure inductance is impossible—the turns of wire have resistance and a self-capacity one to the other while a condenser, on the other hand, sometimes displays quite a large inductive effect.

As "Q" is a measure of efficiency it is also known as the magnification factor of the coil. Clearly if the coil and condenser system has a resonant frequency a charge induced in such a system will not die away rapidly. The condenser will become charged, will discharge through the coil and so reverse its charge, the coil endeavouring to maintain the current flow, will discharge again and so produce a train of waves each of slightly less amplitude until they finally disappear. The circuit is heavily damped and has a low "Q" if these oscillations die away rapidly and vice versa.

The desirable features of a coil may now be summed up.

It should be as "pure" an inductance as possible—that is, its self-capacity due to humped turns of wire, heavy former and the design generally must be small, the resistance to high frequencies must be kept low, it must be rigid and of strong construction, for obviously any misplaced or disturbed turns of wire will change the inductance, it must not be susceptible to humidity changes in the atmosphere—dampness might cause leakages from turn to turn—and as the coil has a varying magnetic field it must not be brought too close to any mass of metal for

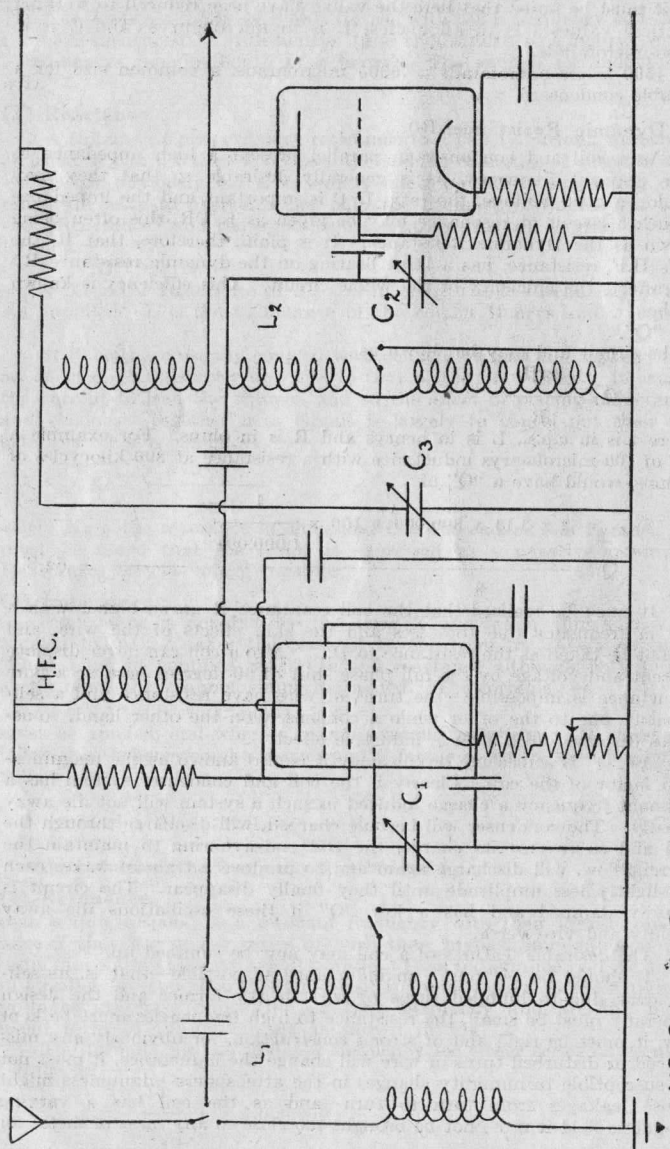

No. 2. BASIC CIRCUIT OF H.F. AND TRIODE DETECTOR STAGES.

eddy currents would be induced by the field and the efficiency of the coil reduced. For that reason screening cans must be of a correct size which, as shown later, may be calculated.

(7), Mutual Inductance.

The coil has a varying magnetic field in and around it and this will induce a voltage across any other coil in the vicinity if the lines of force are able to cut the wires of the second coil, the wave-form of the induced voltage being a pattern of that on the original coil. This linking of two coils by the magnetic fields around them is known as mutual inductance, and its symbol is *M*.

Mutual inductance may be either desirable or not, depending on the circuit. For example in Fig. 2 the second valve, a detector triode, has a reaction coil connected to its anode whose function is to feed back energy into the grid coil. Here mutual inductance is very necessary, but the whole coil set of the detector valve must be screened completely from the coils of the first valve or energy will be fed back into the first stage with consequent uncontrollable instability.

Again, in Fig. 3, the I.F. Transformers have their windings coupled by mutual inductance but each transformer is carefully screened from all other coils.

The types of R.F. coils used in receivers vary according to the circuits, but Figs. 2 and 3 give some idea of what is needed. Fig. 2 is of a basic circuit for a "straight" receiver, the first being a high frequency amplifier followed by the second stage, a triode detector. Obviously it will be very desirable to make *C*₁ and *C*₂ a ganged two-section condenser but before this can be done the two sets of coils must be similar in all respects so far as the actual tuning windings are concerned. The other windings will put varying loads on these tuning coils in each case, causing damping to some degree but these effects can be balanced in practice. In the first stage the aerial will impose its load on the grid coil via the aerial coil and in the detector stage the anode coil will be coupled to the grid coil as well as the inter-stage coupling, but if the two grid coils are made identically similar these loads will be balanced by keeping couplings low and, finally, by trimming out stray capacities with the trimming sections of the ganged condenser.

It will be seen that the grid coil is in two parts in each coil set, one winding being short-circuited by a switch. This winding is the long-wave coil, the unswitched coil in both cases being the medium wave coil, and these switches must also be ganged. If further wave-bands are required their coils may be wound on the same former with extra switching but for good results on short waves it is advisable to isolate each winding and make it a separate coil with grid and aerial and grid and anode windings as desired. These coils are then mounted round a rotary Yaxley type switch so designed (with an earthing ring) that all coils not in use are short-circuited and earthed to prevent pick-up and other losses, and each set of coils is screened in its own box built round the switch.

For a superhet (Fig. 3) the coil systems are rather more complex. The first stage is a mixing circuit where incoming signals are tuned by *L*₁ and *C*₁ and fed to a triode-hexode. The triode portion of the valve is a local oscillator with its own set of coils arranged to tune to a frequency which, no matter what the position of the ganged condenser,

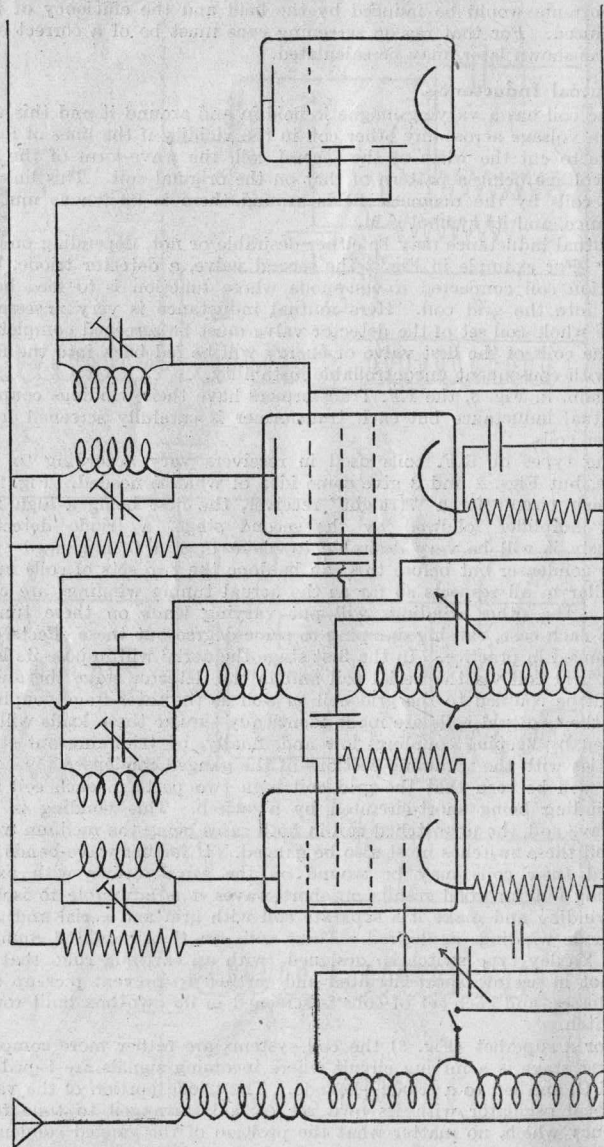

No. 3. BASIC CIRCUIT OF R. F. PORTION OF SUPERHET.

's always a constant number of kilocycles different from the incoming signal. This difference is known as the Intermediate Frequency and the oscillator is usually tuned above, rather than below, the frequency being received. These two frequencies are mixed in the valve and the result is a modulated signal composed of the Intermediate Frequency and the sound signals from the transmitter.

The coil in the anode circuit is tuned by a small trimmer type condenser to this frequency so that a modulated high frequency voltage is set up across this coil and a similar voltage is induced in an adjacent similar coil, the two coils together forming an Intermediate Frequency Transformer. The induced voltage is fed to the grid of an I.F. amplifying valve and again passes through an I.F. Transformer before reaching the de-modulator.

The aerial and oscillator coils are similar to those as used in a straight receiver but the I.F. Transformers tune to a lower frequency (about 465 kcs) and thus need more turns of wire and a greater inductance. An I.F. Transformer is, in effect, a Band Pass Filter and as will be shown in Section 2 this greatly assists selectivity in tuning.

There are several methods of improving the selectivity of a receiver. In the straight set reaction can be used in the detector stage to give greater selectivity and volume with a slight drop in tonal quality or several tuned stages may be employed, each consisting of a grid coil and tuning condenser coupled through an H.F. amplifying valve to the next stage. It is plain, however, that instability would soon be caused by the multiplication of valves and generally it is better to reduce the number of stages by using Band Pass Filters instead of single coils. Each Filter requires two tuning condensers instead of one so that a ganged condenser for more than one stage becomes an unwieldy affair, but with a straight receiver good results are obtained by using a Band Pass Filter with the H.F. stage coupled to a single coil in the detector grid circuit.

Band Pass Filters of different types are shown in Fig. 4 and their action may briefly be explained as follows. Where two coils have identical resonant frequencies these frequencies are slightly changed by coupling the coils, one moving higher and one lower. Thus two coils coupled to the correct degree spread a single tuning point over a band although the limits of this band are far more sharply defined than the limits of a tuning point on a single coil. Not only are the coils more selective, therefore, but a station on the band of frequencies has a more even response accorded to its sidebands with a consequent improvement in quality.

Details of calculating the wave ranges of coils, self inductances, couplings for B.P.F.'s and methods of construction follow in Section 2.

SECTION 2.

The Design and Construction of Radio Frequency Coils.

For home construction R.F. coils on open air-cored formers need only be considered for there is no really satisfactory method for the construction of powdered iron cores.

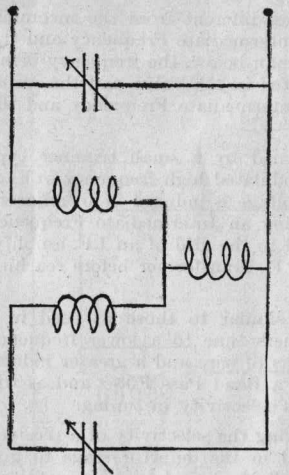

b

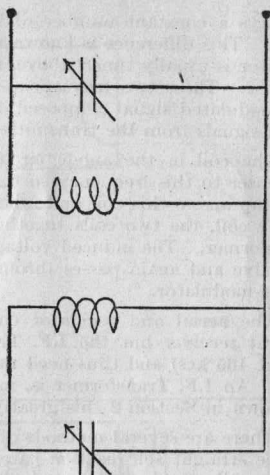

d

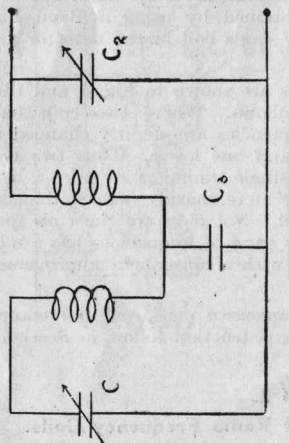

a

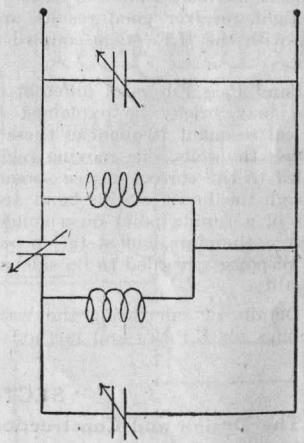

c

BANDPASS CIRCUITS.

No. 4.

The steps to be described are:—

1. Design of the coil and determination of inductance.
2. Choice of former and type of wire.
3. Construction.
4. Testing.

(1) Design.

Obviously the whole design of the coil will depend upon the work it is expected to perform. A medium wave tuning coil will consist of a single layer solenoid with or without reaction and aerial coupling coils, multi-range coils will contain both single layer solenoids and bank wound coils for the higher inductances, I.F.T.'s will, generally speaking, be bank wound coils made to fit on a dowel former and so on.

For tuning coils it is first necessary to consider the wave range the coil is to cover with due regard to the variable condenser to be used, and here it is advisable to use the formula

$$W = 1885 \sqrt{LC}$$

where W is the wavelength, L is the inductance in microhenrys and C is the capacity in microfarads. Wavelength has a fixed relationship to frequency, the product of the two being 300,000,000 or $W \times F = 3 \times 10^8$.

E. H. Chapman (*Popular Wireless*) has described one method for discovering the required inductance from the above formula. Variable condensers have a minimum and a maximum capacity, the stated value being the maximum. The minimum depends on good design and the amount of insulating material used in the construction, and there is a further stray capacity in a tuning circuit due to the wiring of the coil, shields, etc. If, however, the minimum capacity of the condenser is assumed to be zero then the stray capacities of the tuning circuit can be called S. and the formula can be written:—

$$W = 1885 \sqrt{L(C+S)}$$

This is the value for maximum capacity; obviously the wave-length for minimum capacity is:—

$$W1 = 1885 \sqrt{LS}$$

Square both equations:—

$$\dagger W^2 = 1885^2 L(C+S) = 1885^2 LC + 1885^2 LS.$$

$$* W1^2 = 1885^2 LS.$$

and by subtracting * from †

$$W^2 - W1^2 = 1885^2 LC.$$

This form of the formula is very useful for it enables any maximum and minimum wavelength to be referred to the coil and condenser and by transposition L is easily found.

EXAMPLE 1.

It is required to tune from 200 to 500 metres using a .0003 variable condenser. Then:—

$$500^2 - 200^2 = 1885^2 \times .0003 \times L.$$

$$\text{and } 210,000 = 1,066L.$$

$$\text{so that } L = 210,000/1,066.$$

$$= 197 \text{ microhenrys.}$$

It should be borne in mind that a tuning system is more efficient so far as range average is concerned the higher the L/C ratio can be made, that is by using a low capacity condenser with a high inductance, but clearly this is limited in the higher waveranges. At low wavelengths the band covered reduces, and adequate coverage is obtained by using several coils with the condenser to cover the bands. As the wavelength falls so will the capacity of the condenser as may be seen by considering a high frequency tuning system with a range of 5 to 8 metres which would have covered the B.B.C. Television service and the 56 megacycle amateur band.

EXAMPLE 2.

A suitable condenser would be of .00005 mfd. capacity (generally styled a 50 micro-microfarad condenser).

$$\text{Then } 8^2 - 5^2 = 1885^2 \times .00005 \times L$$

$$\text{and } 39 = 177.7L$$

$$\text{or } L = .22 \text{ microhenrys.}$$

The stray capacities in such a circuit would obviously have to be reduced to the smallest degree and the coil would be self-supporting, no former would be used. As the inductance is so low the connecting wires to the condenser must be as short as possible—usually the coil is mounted directly on the condenser terminals—for any loops of wire would add seriously to the inductance, perhaps even doubling its value.

This, then, demonstrates the differences between various types of coils, so far as structural methods are concerned, and a series of general suggestions may be given here.

(1) Ultra Short Wave Coils. 4 to 10 metres.

These may be wound on formers or be self-supporting. If the main desired waveband is about 5 metres self-supporting coils are advisable although if the coil is one of several, as in a superhet, where ganging is necessary a former must be used for the sake of rigidity.

Formers may be of ceramic materials such as are advertised, these formers often being chased with a very shallow spiral so that the wire is more firmly held. It is sometimes stated that copper or silvered copper tubing should be used for Ultra Short Wave work, but this is unnecessary even in small transmitters, let alone receivers. No. 16 or 18 S.W.G. copper wire is perfectly suitable and this may or may not be silvered. The spacing between turns need not be greater than the diameter of the wire used; some spacing is desirable to cut down the self capacity of the coil but greater spacing than one diameter merely has the effect of reducing the inductance disproportionately.

Spaced coils, therefore, are best wound by taking two lengths of the wire to be used and winding them side by side on the former, the spacing wire being stripped away after varnishing (if done) to leave the actual winding spaced out by the wire's diameter. Spacings of smaller size may be made in the same way using various sizes of wire alongside the turns of the coil.

The leads of Ultra Short Wave coils should be made by merely leaving sufficient of the winding wire for connecting up at each end,

this being cut down to the smallest length possible when the coil can be tried out in position.

(2) Short Wave Coils. 10 to 180 metres.

These coils may be made on the formers already suggested, on paxolin formers or on ribbed ebonite tubes, the wire sizes being graded down in diameter as the wavelength rises. Above 100 metres spacing will probably be dispensed with, the turns being wound to touch and here insulated wire will be needed. For all general purposes enamelled wire is suitable, the insulation being thin yet strong; the wire must be handled with care, however, for the enamel can be cracked or scratched especially if the wire be allowed to kink. Keep coils of wire wrapped and boxed so that sharp edges cannot rub the insulation.

Once again connections should be made by leaving sufficient of the winding wire at each end of the coil for that purpose.

(3) Medium Wave Coils. 200 to 600 metres.

These coils are usually single layer solenoids wound with the turns side by side and touching. They are made on paxolin formers using enamel, cotton or silk insulated wire, and the ends of the windings should terminate in soldering tags so that connections may easily be made with no risk of poor joints.

(4) Long Wave Coils. 900 to 2,000 metres. (And I.F.T.'s.)

These coils are most often bank wound, that is they are made of several layers of wire one layer on top of the other. Small paxolin bobbins may be made for the purpose or paxolin cheeks fitted over a cylindrical former, particularly where both Medium and Long wave coils are being wound together. Cardboard or paxolin cheeks might be fitted over $\frac{1}{2}$ " dowel rod and the turns laid between them, the cheeks in this case being removed when the winding has been impregnated with paraffin wax.

Examination of commercially made coils will give ideas and examples.

The Calculation of Inductance.

When the desired inductance has been found by the wavelength formula it is necessary to work out the size of former and number of turns of wire to use to make such an inductance. The writer compared several formulae and tables and found surprisingly wide discrepancies existed between some of them so that finally only two formulae for single layer coils were chosen. Both formulae are adapted from Wheeler's Formula, but whilst the first form uses the total length of the winding the second uses the number of turns per inch (the winding "pitch"), this being far more convenient for spaced coils.

Wheeler's Formula, adaptation 1.

$$L = \frac{r^2 \times N^2}{9r + 10l}$$

where L is the inductance in microhenrys, r is the outside radius of the coil in inches and l the length of the winding in inches. N is the number of turns.

EXAMPLE 3.

The medium wave coil of Example 1, of 197 microhenrys is to be wound on a paxolin former two inches in diameter and three inches

long, so that allowing a $\frac{1}{4}$ " overlap at each end l may be taken as $2\frac{1}{2}$ ". As it refers to the outside radius r should include the wire diameter but only a small error will result if it is made l " for calculation.

$$\text{Then } 197 = \frac{l^2 \times N^2}{9 \times l + 10 \times 2.5} = \frac{N^2}{34}$$

$$\text{or } N^2 = 197 \times 34 = 6698$$

and $N = 81$ turns.

This means a pitch of $\frac{81}{2.5} = 32.4$ turns per inch and from the

Wire Tables in Section 7 it is seen that S.W.G. 22 Double Silk covered wire wound with turns touching has almost exactly this pitch.

Formula 2. (Wheeler's Formula adapted by Hayman.)

$$N = Lx \left[1 + \sqrt{1 + \frac{9}{aLx^2}} \right]$$

where N is the number of turns, L is the inductance, a is the outside radius of the coil and X is $\frac{20}{nd^2}$, n being the number of turns per inch and d the diameter of the coil.

EXAMPLE 4.

It is required to wind a coil with an inductance of 250 microhenrys on a two inch diameter former using 20 turns per inch.

Then

$$N = 250X \left[1 + \sqrt{1 + \frac{9}{1 \times 250 \times X^2}} \right]$$

$$\text{and } X = \frac{20}{20 \times 4} = \frac{20}{80} = .25.$$

$$\text{So } N = 250 \times .25 \left[1 + \sqrt{1 + \frac{9}{1 \times 250 \times .0625}} \right]$$

$$= 62.5 \left[1 + \sqrt{1 + \frac{9}{15.63}} \right]$$

$$= 62.5 \times 2.253$$

$$= 140 \text{ turns and the winding length will be } \frac{140}{20} \text{ or } 7".$$

An efficient shape for a coil is one where the diameter is two or three times the winding length but this would be bulky and incon-

venient for most purposes and the diameter is reduced. Similarly, formulae exist for calculating the optimum gauge of wire to use on a particular coil but this calculation is so intricate that it is omitted. In any case modern valves are so efficient and have such large amplification factors that the efficiency of coils is sometimes reduced to prevent feedback and instability so that the gain in efficiency due to the use of such formulae can be dispensed with.

Nº 5. DIMENSIONS OF BANK WOUND COIL.

a . IS THE MEAN DIAMETER.

c . IS THE
RADIAL DEPTH OF THE WINDING.

l . IS THE WINDING LENGTH.

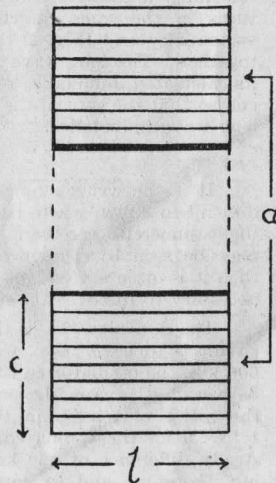

Bank Wound Coils.

Where coils are to have such high inductances that they are bank wound a formula given by R. E. Blakey in *Radio and Telecommunication Engineer's Design Manual* (Pitman) may be used. For a coil such as is shown in Fig. 5 where a is the mean diameter, l is the winding length and c is the radial depth of the winding all in inches, and N is the number of turns and L is the inductance in microhenrys:—

$$L = \frac{.2a^2 N^2}{3a + 9l + 10c}$$

EXAMPLE 5.

A coil of 1,000 microhenrys inductance is to be bank wound on a $\frac{1}{2}$ " paxolin tube, c and l both measuring $\frac{1}{2}$ ".

$$\text{Then } a \text{ will measure } \frac{1}{2}" + \frac{1}{4}" + \frac{1}{4}" \text{ or } 1".$$

$$\text{Thus } 1,000 = \frac{.2 \times 1^2 \times N^2}{(3 \times 1) + (9 \times .5) + (10 \times .5)}$$

$$= \frac{.2N^2}{2N^2}$$

$$= \frac{12.5}{125}$$

So $1,000 \times 125 = 2N^2$

and $N^2 = 62,500$ and $N = 250$ turns.

The cross section area of the coil is $c \times l$ square inches or $\frac{1}{4}$ square inch so that wire must be chosen that will wind 250 turns to the $\frac{1}{4}$ square inch or 1,000 turns per square inch. Reference to the Wire Table shows that S.W.G. 24 D.C.C. is sufficiently close to this value.

When more than one coil is to be wound on a former—for example as in the case of the usual medium and long wave coil—it must be remembered that the two windings are connected in series with all the turns in the same direction of rotation so that when the shorting switch is opened (Fig. 2) the inductances are in series and will be added together. The long wave winding of such a coil, therefore, should have its calculated inductance reduced by the inductance of the medium wave coil so that the sum of the two inductances together equals the required long wave inductance.

Oscillator Coils.

It is the writer's opinion that oscillator coils for superhets are too difficult to design where the tuning arrangements are to be ganged as in the commercial receiver. The complexity of the various calculations may be seen by reference to various designer's handbooks, and even then it is often stated that experimental work on the proposed circuit is necessary to discover the adaptations and changes needed.

The difficulty lies in the tuning arrangements. If the main tuning circuit is to cover, say, from 200 to 500 metres—a range of 1,500 to 600 kcs. the oscillator coil for an intermediate frequency of 460 kcs. will be working between the points 1,960 to 1,060 kcs. It will be seen that the ratios of maximum to minimum frequencies are different, being 1 to 2.5 for the tuning coil and 1 to 1.84 for the oscillator coil. The steady difference of 460 kcs. will not be maintained by straight ganging, therefore, and to correct this a system of padding and tracking condensers is arranged in the oscillator circuit.

In American amateur practice, however, it is becoming usual to tune the oscillator quite independently of the aerial or H.F. circuits with a separate variable condenser, and this is probably the best way out of the difficulty for tracking can then be made 100% accurate over the whole dial. Using this method the oscillator coils can be calculated in the ordinary way.

Aerial and Reaction Couplings.

The signals from the aerial may be fed into the first tuned circuit in a variety of ways which can be reduced to three main methods.

1. Aperiodic Coil Coupling.
2. Condenser Coupling.
3. Tap Coupling.

Almost all tuning coils are connected with one end earthed and the other feeding the grid of the valve and for convenience these are termed the "earthy" and "H.F." ends respectively.

For aperiodic coil coupling a small aerial coil is wound on the same former which holds the tuning or grid coil, the winding being near the H.F. end of the grid coil. The number of turns depends on local conditions but 30 turns in either a single layer or bank wound should be satisfactory for medium and long wave coils, or one quarter of the grid

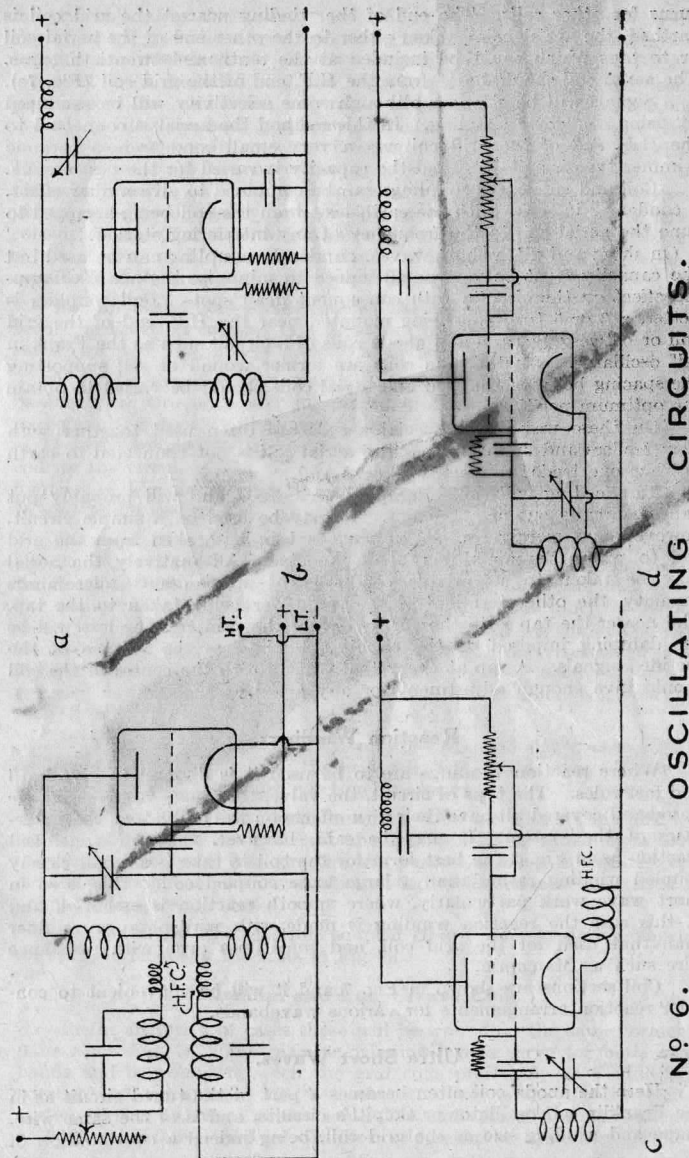

turns for other coils. The end of the winding nearest the grid coil is earthed, the aerial being taken either to the other end of the aerial coil or to taps which could be included at the tenth and twentieth turns. The aerial coil should be $\frac{1}{4}$ " from the H.F. end of the grid coil (Fig. 7e).

Signals will be stronger although some selectivity will be sacrificed by using condenser coupling. In this method the aerial is connected to the H.F. end of the grid coil via a very small condenser—a ceramic trimmer type is suitable—and the capacity is varied for the best results.

Coil and condenser couplings can be combined to give a filter effect, a condenser in series with the earth lead from the coil being arranged to tune the aerial coil to the frequency of any interfering station.

On short and ultra short waves, condenser coupling can be used but the capacity must be very small indeed to minimise the aerial's damping effect on the circuits with consequent dead spots. Coil coupling is better, a 5 turn coil being mounted near the H.F. end of the grid coil or between the grid and anode coils of a circuit such as the Franklin self oscillator. Whether the coils are former wound or self supporting the spacing between the grid and aerial coils should be varied to obtain the optimum position.

On these wavebands special aerials are often used together with twin feeders and in the latter case the aerial coil is not connected to earth but has one feeder connected to each end.

Tap feeding will cause damping of the coil and will probably put ganged circuits out of alignment. It may be used on a simple circuit, however, and merely consists of various tappings taken from the grid coil to which the aerial may be connected. Alternatively the aerial may be taken to a variable condenser of up to .0003 microfarads capacity, the other terminal of the condenser being taken to the tap. The nearer the tap is to the earthy end of the grid coil the less will be the damping imposed on the circuit and the less the volume of the rectified signals. A tap at every tenth turn up to the centre of the coil should give enough adjustment for any aerial.

Reaction Windings.

Where reaction windings are to be used it is difficult to give hard and fast rules. The type of circuit, the valve, the anode voltage and the waveband covered all have their own effects on the oscillatory characteristics of the system. It may be said, however, that for controlled reaction as in Fig. 2 the best form for the coil to take is a small closely coupled winding rather than a large loose coupled coil. This is so in short wave work particularly, where smooth reaction is essential, and in this case the reaction winding is made with wire of a gauge finer than that used for the grid coil, and sometimes even with resistance wire such as Manganin.

Coil sections are shown in Fig. 7 and it will be convenient to consider reaction arrangements for various wavebands.

Ultra Short Waves.

Here the anode coil often becomes a part of the tuned circuit as in the Franklin self oscillator or Colpitt's circuits, and is of the same wire, shape and winding size as the grid coil, being indeed a continuation of

the grid coil. Fig. 6a shows a very efficient ultra short wave receiving circuit where grid and anode coils are exactly similar and regeneration depends on inter-electrode capacity coupling inside the valve. Super-regeneration is included and the two larger coils or the feed leads superimpose an oscillation of much lower frequency (20 to 30,000 cycles) on the ultra high frequency oscillation, thus bringing the circuit to the threshold condition where it is most sensitive and least selective. The net result is a hiss over the whole tuning range which reduces to silence or nearly so when a signal is received. Naturally the system cannot give good quality but for this type of work that is the least consideration. The super regeneration coils are tuned with condensers of about .006 mfd. capacity so that the inductance for bank wound coils to give the frequencies mentioned above can be calculated.

For an ultra short wave superhet the oscillator section might well be of the Electron coupled type as shown in Fig. 6a, though the more usual circuit of Fig. 2 or Fig. 6b is sometimes used.

For reference it may be said that 6 turns of No. 24 gauge S.W.G. bare copper wire as a self supporting grid coil tuned with a .00005 microfarad condenser will serve for the 5 metres band with an aerial coil of $1\frac{1}{2}$ turns coupled to feeders and screened from the aerial coil. A reaction coil for the circuit of Fig. 6b would be 4 turns of the same wire; for that of Fig. 6a it would be 2 turns with the grid coil. See Figs. 7a and 7b for sections.

Between 10 and 180 metres the range is covered in bands as of 10—25, 18—60, and 50—180 metres or corresponding overlapping bands and reaction is usually applied by the throttle control circuit of Fig. 6b. For mains valves, however, the circuit of Fig. 6c was much to recommend it for reaction is controlled by the potential on the screen of a tetrode and by feedback in the cathode coil which may conveniently be a short wave choke. There is of course no coupling between the grid coil and cathode inductance so that the grid and aerial coils may be simple, efficient windings on a small former.

When an anode coil is used it may be arranged either as in Fig. 7c or 7d, being interwound with the grid coil in the latter case. The wires must be insulated but must not touch in any case.

It is suggested that anode reaction coils are given one third the number of turns of the grid coil, the grid coil being tuned by a .0001 microfarad condenser and the throttle control a .0003 microfarad condenser, although as already mentioned individual circuits may need an adaptation to these figures.

Fig. 6d shows the electron coupled circuit where reaction depends on cathode feedback much as in Fig. 6c.

Medium and Long Wave Coils.

In the majority of cases these will be wound on the same former in pairs as in Fig. 7e. The reaction winding has to serve for both wavebands and is wound between the grid coils preferably as a multilayer winding to save space. The best circuit to use is the throttle control system of Fig. 6b, usual values being .0005 microfarad tuning condenser, a .0005 microfarad solid or air dielectric reaction condenser, .0001 to

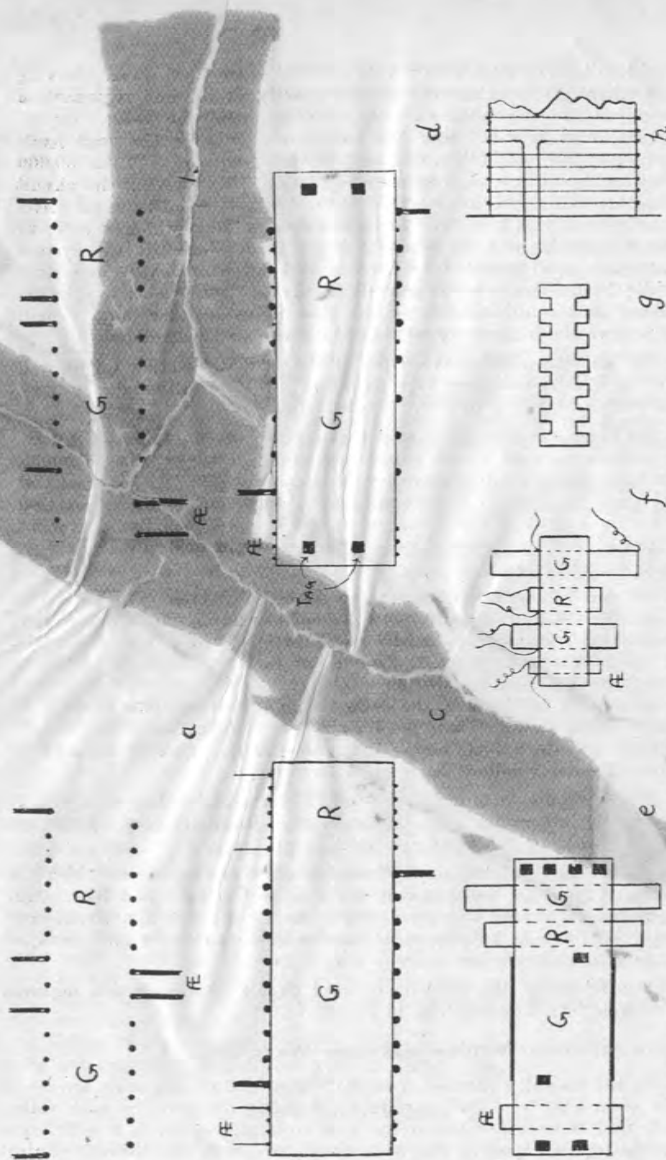

NO. 7. LONGITUDINAL SECTIONS THROUGH COILS.
 AERIAL COIL - FE. GRID COIL - G. REACTION COIL - R.

.0003 microfarad grid condenser and a grid leak which, with modern practice has reduced its value from 5 megohms to 1 megohm or even less.

As a general rule the reaction winding can have a quarter to a third of the total number of turns on the medium and longwave grid coils.

Fig. 7f shows a medium and longwave coil such as may be used for a midget or portable set. All the windings are multilayer on 1/2" paxolin tubing.

Reaction coils must always be connected in their correct phase. If a circuit fails to oscillate reversing the reaction coil leads generally corrects the fault.

Band Pass Units.

Where two identical tuning circuits are coupled together the resonant frequency of each circuit changes slightly, one to either side of the original frequency, and if the original frequency was f then the new resonant frequencies are:—

$$f_1 = \frac{f}{\sqrt{1-K}} \text{ and } f_2 = \frac{f}{\sqrt{1+K}}$$

where K is the coupling factor. Thus a band of frequencies between f_1 and f_2 is passed, signals within the band being received strongly and those outside the band being cut off more sharply than with other forms of tuning.

A good band-width for normal conditions is 10,000 cycles and for "Bottom Capacity Coupling," the most simple system to arrange is as in (Fig. 4a).

$$K = \frac{\sqrt{C_1 C_2}}{C_3}$$

and band-width is given by $B_n = fK$.

EXAMPLE 6.

Two matched coils are tuned by a ganged condenser of .0005 microfarad capacity to 500 metres (500,000 cycles) when the sections are fully meshed. The bandwidth at this point is to be 10,000 cycles, therefore as

$$B_n = fK, \\ 10,000 = 500,000K \\ \text{and } K = .02$$

$$\text{But } K = \frac{\sqrt{C_1 C_2}}{C_3} \\ \text{so } .02 = \frac{\sqrt{.0005 \times .0005}}{C_3} \\ = \frac{.0005}{C_3}$$

$$\text{and } C_3^2 = \frac{.0005}{.02} = .025 \text{ microfarads.} \\ .02$$

Supposing, however, that when the value of the condensers is reduced to .0001 the circuit now tunes to 300 metres (1,000,000 cycles) then

10,000 = 1,000,000 K or K is now only .01 and

$$K = \frac{\sqrt{C^3 C^2}}{C^2} \text{ becomes}$$

$$.01 = \frac{.0001}{C^3}$$

and $C^3 = .01$ microfarad.

The band-width, therefore, will change over the tuning range with consequent varying selectivity. In commercial practice C^3 may range from .01 to .5 microfarad.

The coils used for a Band Pass Unit must be similar in all respects so that perfect ganging is obtained, and should be in separate screening cans so that no magnetic coupling is possible between them, when capacity coupling is to be used.

I.F. Transformers.

It will be seen that the I.F. Transformer is no more than a Band Pass Unit so arranged that the Intermediate Frequency is at the centre of the band. In this case, however, the coils are coupled generally by mutual inductance although there is also a capacity coupling due to the capacity between the bank wound coils. R. E. Blakey (*Radio and Telecommunications Engineer's Design Manual*) points out that commercial practice makes the magnetic coupling oppose the capacity coupling by winding both coils in the same direction and connecting either the two starting or two finishing leads to anode and grid of the respective valves.

Particular attention should be paid to making I.F. coils efficient with a high "Q", low loss tuning condensers being used with adequately sized circular screening cans. The main trouble in the construction of I.F. Transformers lies in the adjustment of the coupling between the coils which controls the bandwidth and thus the selectivity, and as these calculations depend on the value of the mutual inductance which is difficult to arrive at it is suggested that experimental methods will give quicker results.

EXAMPLE 7.

An I.F. Transformer for 465 kcs. is required, both primary and secondary being tuned and identical.

First consider the tuning. The coil will have a self-capacity adding its effect to the capacity of the small tuning condenser so that if .0001 microfarad is considered a satisfactory condenser to use the calculations for resonant frequency should be based on almost the maximum value of this condenser, say, .000075 microfarad. Then the capacity of coil and condenser will come well above this in practice, giving room for trimming adjustment either way. The condensers ideally would be of the ceramic mounted air-dielectric rotating type for these are more simple to build in and adjust than the screw operated

trimmers, which have an additional drawback in the liability of the screw threads to slip.

The inductance required is discovered from:—

$$f = \frac{1,000,000}{2\pi \sqrt{LC}}$$

where f is the frequency in cycles, π is 3.14, L is the inductance in microhenrys and C is the capacity in microfarads.

For 465 kcs., then,

$$465,000 = \frac{1,000,000}{6.28 \sqrt{.000075L}}$$

$$\text{and } \sqrt{.000075L} = \frac{465,000 \times 6.28}{1,000,000}$$

$$\text{and } .000075L = .342^2$$

$$\text{or } L = \frac{.342 \times .342}{.000075} = 1,560 \text{ microhenrys.}$$

This inductance may be made as already described in the example of a bank wound inductance, and mounted on $\frac{1}{2}$ " paxolin tubing. The transformer will require two such inductances.

Variable Selectivity.

As already explained the band width passed by the I.F. Transformer will depend on the coupling factor—in this case the mutual inductance between the coils—and Fig. 8a shows the coils mounted on a wooden dowel with a push fit so that the coupling between them can be varied till the optimum position is found and then left, an increase in coupling (coils closer together) causing the band width to widen and vice versa.

For constantly variable selectivity, however, either a moving coil or tertiary winding can be employed. Fig. 8b shows one transformer coil arranged to rotate about a central axis about 1" from the other, the spindle being pivoted in the wall of the screening or on an internal framework. By using this method it is of course possible to gang a number of transformers by mounting them with the spindles in line and connected together by insulating tubing or rods.

Fig. 8c shows how the coupling and selectivity can be varied by a third coil mounted between the secondary and primary and possessing about one third of the number of turns on one of the main coils. Control is effected by a variable resistor of 5,000 ohms which is connected across this winding with its moving arm earthed. As the resistance is reduced so coupling is reduced and the selectivity becomes greater.

When using these methods it is advised that one coil of the transformer is still mounted on a dowel with a push fit. The variable selectivity device is then arranged and clamped to give half of the total effect possible and the transformer response brought to its optimum setting by adjusting the coil on the dowel. The variable device will then give good control on either side of the mean position.

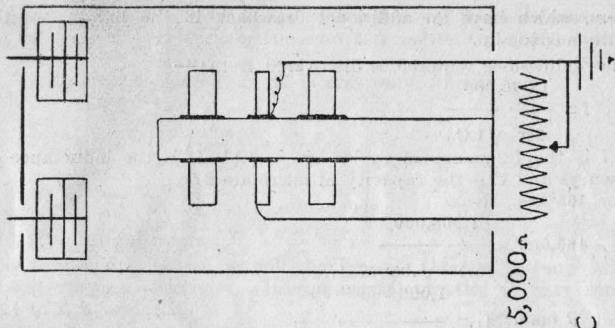

5,000 Ω

C

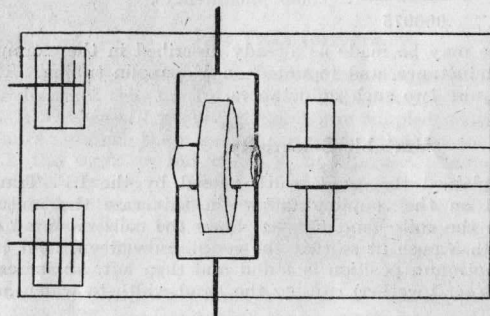

B

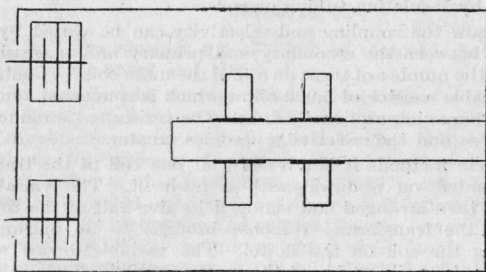

A

N^o 8. METHODS OF COUPLING IN I. F. TRANSFORMERS.

The condensers shown in the figures must be insulated from the screen or any other support, and have any earth leads returned directly to the chassis.

Coil Construction.

When the inductance, method of winding and details of associated coils and condensers have been calculated and decided upon the type of former as already discussed is chosen and the coil wound upon it. Where bank wound coils are to be made it is suggested that a few commercial types should be inspected, they often have the wire laid on spirally in a wave winding which makes a very strong, self supporting coil and reduces the self capacity. This is machine wound, however, and for hand winding it will probably be found sufficiently difficult to keep each layer even, tightly packed without lumping or crossovers and with no break in the insulation. If a coil is to be tapped and is bank wound on no account bare the wire and solder the tapping lead so that the joint comes in the centre of the layers. Instead draw out six inches or so of wire, fold the length into a long loop which is taken out through the cheek of the former, if used, and carry the wire back to continue the winding, anchoring the loop in place with the continuing turns, Fig. 7h. The wire can then be bared and connected outside the coil with no risk of a break down in the insulation.

Only where wires are completely substantial, as in Ultra Short wave coils should they be used as the coil leads. Thinner wires should be taken to soldering tags and the simplest method of making and fixing these paxolin formers is to drill two small holes at the desired point $\frac{1}{4}$ " apart, and to run a double loop of 18 S.W.G. tinned copper wire through them. The winding wire is then soldered to the loop inside the former and carried to the starting point of the winding by the most direct route, being brought to the surface of the former through a third drill hole. This will give adequate anchorage and prevent slipping turns of wire.

When baring the ends of wire for soldering, silk and cotton coverings should be stripped off, not scraped, and enamelled wire should be cleaned by dipping its end into methylated spirit and wiping with a rag. For soldering use resin flux and resin cored solder, avoiding killed acid fluxes which might cause corrosion; there should be no chance of a dry or poor soldered joint at any place for bad joints make fault finding doubly difficult.

When the coils are wound it is very desirable to protect them from the effects of humidity and a method which will give them further strength and rigidity as well is to varnish or wax them. There will be a slight rise in self-capacity but this should by no means be troublesome.

The best varnish is polystyrene, if it is obtainable, but thin shellac varnish may be tried. Either immerse the coil in the varnish and allow it to drain very thoroughly or brush the varnish on with a soft brush, working it well into the layers of a bank wound coil. When the varnish is dry spacing turns can be stripped off and bobbin cheeks removed if desired. Coils wound between paxolin washers, as in Fig. 7e may be left untreated or protected by a layer of cellophane tape.

If the coils are given a protecting layer of wax instead of varnish it is more simple to be assured of thorough impregnation especially in

the case of bank wound coils. Beeswax or paraffin wax is melted down and then boiled, to make sure that any water contained in it is expelled, and then the coil is dipped in the molten wax and allowed to remain until all the air bubbles are driven off and cease to rise.

Wooden formers or the dowels suggested for the I.F. Transformers should be boiled in the wax before use, once again remaining until air bubbles cease to rise.

When the wax has set the coil will be very firm but all surplus wax must be well drained away.

Screening.

Enclosing a coil in a screening can always result in some drop in efficiency together with a drop in inductance, these losses being very serious if the can is not of an adequate size. It is possible, however, to calculate the inductance drop due to a can so that when the coil is designed this loss can be allowed for by adding it to the correct inductance value of the coil.

A rough rule for keeping the Q of the coil high is to make the diameter of the can at least twice that of the coil; greater spacing would be beneficial but would make the apparatus bulky in most cases.

A. G. Bogle (Journ. I.E.E. Vol. 87) gives, that for a coil mounted coaxially in a can of reasonably thick non-magnetic metal, where coil and can are cylindrical and the gap between the ends of the winding and the ends of the can is equal to or greater than the gap between the sides of the coil and the sides of the can,

$$L_0 = L \left[1 - \frac{1/g \cdot b^2}{1/g + 1.55 \cdot a^2} \right]$$

where L_0 is the inductance screened, L is the inductance unscreened, I is the length of the coil winding, g is the gap between the side of the coil and the side of the can (equal all round), a is the diameter of the can and b is the diameter of the coil, all measurements in inches, and the formula to hold for frequencies of or over 100 kcs.

EXAMPLE 8.

The coil of examples 1 and 3 is to be screened. $L = 197$ microhenrys, $l = 2.5"$, $b = 2"$ and if the can is $4"$ in diameter $g = 1"$ and $a = 4"$.

Then

$$L_0 = 197 \left[1 - \frac{\frac{2.5}{1} \cdot \frac{2^2}{4^2}}{\frac{2.5}{1} + 1.55} \right]$$

$$= 197 \left[1 - \frac{.625}{4.05} \right]$$

$$= 197 \times .846$$

$$= 166.66 \text{ microhenrys, the new inductance.}$$

Thus if the screened inductance is still required to be 197 microhenrys the percentage difference due to the screening effect must be added to the original inductance of the coil.

Testing Coils.

Coils when wound may have several tests applied to them but for home construction it will be sufficient to make a simple continuity check with a battery and lamp or instrument and to measure inductance if a bridge is available or can be made. Where coils are to be matched, however, it is necessary to use a signal generator and valve voltmeter (as described in Radio Test Gear Construction, Bernards No. 43) although the method is easy and gives good results. Each coil is connected in turn across a small condenser and the output from the signal generator fed into the tuned circuit thus formed by connecting its leads across the coil. The voltage across the coil is measured by the valve voltmeter and when the signal generator is tuned through the resonant frequency the voltage rises sharply through a peak. Each coil is tested in this way and if the peak voltages occur at different settings of the generator that coil with the highest frequency setting has the lowest inductance and the other coils must be reduced to the same value. This is done by removing from them one turn of wire at a time until the resonant point of each coil falls on the same setting of the signal generator.

Naturally this method of adjustment should not be carried beyond narrow limits and two or three turns should be the maximum number removed. If a greater discrepancy between the coils the low inductance coil should be inspected for faulty winding or shorting turns.

SECTION 3.

H.F. Chokes.

In the ordinary receiver the H.F. Choke can never be better than a compromise—even for one waveband a properly designed choke can have its maximum efficiency at only one frequency although the drop in response is gradual enough for working all over the band and one choke will suffice for the medium and long wave bands—and the cause of this is easily seen when the theory of the choke is understood.

The purpose of the H.F. choke is to allow low frequency signals to pass on to further circuits after separation from their H.F. carrier whilst blocking the H.F. and by-passing it to earth (as in the case of the ordinary triode detector); to prevent H.F. from entering the high tension supply; to pass H.F. from radio frequency amplifiers to following circuits with as little loss as possible, as in Fig. 2, together with other less frequently used applications. A high resistance will oppose a flow of H.F. and is sometimes used in the anode circuits of radio frequency amplifiers and detectors, but an H.F. choke will perform the same function without the high voltage drop which must of necessity appear across such a resistance.

The action of the choke depends upon the fact that if a radio frequency signal is applied to a long wire whose electrical length is $\frac{1}{4}$ of the wavelength of the signal applied a standing voltage wave is set up on the wire or, in other words, the wire behaves as if it had very high impedance at one end and very low impedance at the other. If one

end of the wire is earthed (via a condenser) therefore, the other end of the wire opposes the passage of H.F. currents of the resonant frequency.

Thus all that is required is to wrap the length of wire into a more convenient form, and it will be realised that a high number of turns will be necessary for the lower frequencies. The characteristics of the choke are not greatly changed by coiling the wire.

For the medium and long wave bands it is not very economical to construct H.F. chokes but should it be desired to do so a convenient method is to slot an ebonite top 1" in diameter with six equally spaced rings each $\frac{1}{4}$ " deep and $\frac{1}{4}$ " wide, winding 500 turns of No. 34 S.W.G. enamelled copper wire in each slot (Fig. 7g). The windings, of course, are carried from slot to slot and are all in the same direction of rotation. This gives 3,000 turns of wire, the two ends being anchored to soldering tags or terminals threaded into the ebonite former.

When a set is to receive medium, long and short waves a short wave choke should be wired into circuit before each medium and long wave choke—that is nearer the valve in question—the chokes being in series. Short wave chokes are simple to calculate by using the $\frac{1}{4}$ wave-length ruling; for example a choke for wavelengths around 50 metres would have 12.5 metres (41 feet) of No. 34 S.W.G. enamelled or silk covered wire wound on to a narrow paxlin former in three or four small banks, the banks being spaced to cut down the self-capacity. For Ultra Short Wave work the wire becomes very short and is then best wound onto a glass tube of suitable diameter in a single spaced winding. For 5 metres a suitable choke would consist of 4 feet of wire on a $\frac{1}{4}$ " tube, the ends being held by a turn of cellophane tape. Such a choke would be wired directly into the circuit and supported by its leads clear of the chassis or baseboard.

Transmitter and oscillator chokes for amateur equipment may be made in the same way with any necessary allowance in the wire gauge to suit the probably heavier currents flowing.

Chokes are better unimpregnated, and if protection is thought to be necessary for the 3,000 turn choke it is best provided by winding cellophane tape round the former or by cementing a sheet of celluloid over the wire.

The only test necessary for the choke is a simple continuity check.

In all circuits the choke should not be allowed to approach other wiring in the same valve circuit, particularly if it is an anode choke as is usually the case. The bypass condenser lead should go directly to earth by the shortest route, and in Ultra Short Wave equipment it is beneficial to run all bypass leads to one main connecting point on the chassis.

Medium and long wave chokes can be screened if desired if the precautions observed in screening coils are noted.

SECTION 4.

Power Transformers.

Transformers may be regarded either as impedance or voltage matching devices, and when designing power transformers it is more convenient to consider the voltage ratios.

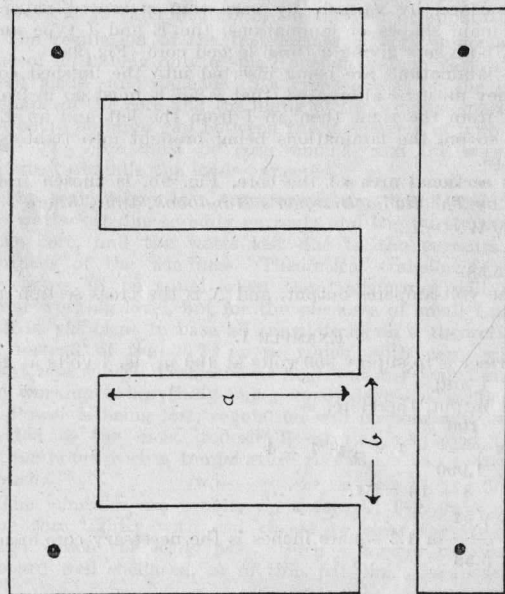
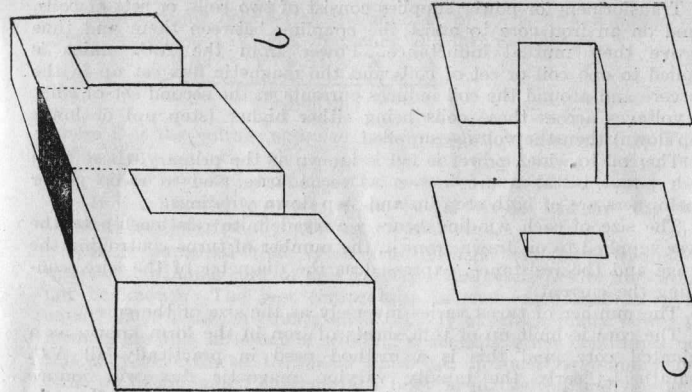

Transformers for power supplies consist of two coils, or sets of coils, wound on an iron core to assist the coupling between them and thus improve their mutual inductance. Power from the A.C. mains is supplied to one coil or set of coils and the magnetic flux set up in the iron core and around the coil induces currents in the second set of coils, the voltages across these coils being either higher (step up) or lower (step down) than the voltage supplied.

The coil to which power is fed is known as the primary, those from which power is taken are known as secondaries, and in radio power transformers are of both step up and step down windings.

The size of each winding bears a very definite relationship to the power supplied to or drawn from it, the number of turns controlling the voltage and the resistance, expressed as the diameter of the wire, controlling the current.

The number of turns varies inversely as the size of the core.

The core is built up of thin sheets of iron in the form known as a laminated core, and this is a method used in practically all A.C. apparatus. Clearly the rapidly varying magnetic flux will induce currents in the core as well as in the windings around it and if the core were one mass of metal with a very low resistance the current so induced would be exceedingly high. It is necessary therefore to increase the electrical resistance of the core which can only be done as described, by splitting it into thin sheets and insulating each sheet from the next. Eddy currents will still flow but the total loss of power so caused will be far less than it would otherwise have been.

Laminations are insulated in several ways—by chemical treatment of the metal surface, by varnish, by very thin cemented paper—and there are two main shapes of laminations, the E and I type and the T and U type, both sets giving a three legged core (Fig. 9a).

When the laminations are being inserted into the finished coils on their former they must be alternated, that is an E must go in from the left with an I from the right then an I from the left and an E from the right and so on, the laminations being brought into tight contact with no air gaps.

The cross sectional area of the core, Fig. 9b, is chosen from the formula given by *The Radio Designer's Handbook*, Iliffe, where

$$A = \frac{\sqrt{W}}{5.58}$$

where W is the volt-amperes output, and A is the cross section area in square inches.

EXAMPLE 1.

A transformer is to supply 300 volts at 100 m/as. 4 volts at 2 amps. and 4 volts at 4 amps.

The total output, therefore, is

$$\begin{aligned} & \frac{100}{300} + 4 \times 2 + 4 \times 4 \\ & \frac{1,000}{= 30 + 8 + 16 = 54.} \\ & \sqrt{54} \end{aligned}$$

Therefore $A = \frac{\sqrt{54}}{5.58}$ or 1.3 square inches is the necessary core area.

The formula connecting the number of turns in a winding with a given voltage, size of core, frequency and flux density is

$$E = \frac{4.44 \times F \times H \times N \times A}{100,000,000}$$

where E is the voltage supplied to or supplied by the winding, F is the mains frequency, H is the number of lines of magnetic flux per square inch in the iron and A is the cross sectional area of the core.

If E is allowed to equal 1 then the calculation will give the number of turns per volt for any winding on that core.

It is supposed that often transformers will be rewound using materials to hand, and in this case the characteristics of the iron will not be known. The best compromise in such conditions is to let H equal 60,000 lines per square inch, a figure at which many power transformers are run, although if winding space and other conditions permit this may be reduced to 50,000 lines. A, it must be remembered, is built up of laminated sheets which have insulation on one side at least so that the actual magnetic area will be only 90% or so of the geometrical area. This measured area, then, should be reduced by 10% for the calculation. The shape of the core must be well proportioned, each outer limb having half the width of the middle limb on which all the windings are placed in layers, thus occupying the window space "a x b" of Fig. 9a. The general order of the windings is primary inside, nearest the limb, the H.T. secondary and the heater windings outside, of which there are usually at least two, one to supply the rectifier heater and one for the valve heaters of the receiver or apparatus.

The regulation of the transformer is very important—that is the virtue of its having only a small output voltage variation with varying current loads—depends to a great extent on the iron of the core, the shape of the core and the filling of the window space with windings, there being no large gap between the last layers of wire and the outside limbs. The core must be large enough and the wire diameter fully adequate to handle the loads expected.

The main losses in a transformer are "iron" and "copper" losses; those watts lost due to eddy currents and the purely magnetizing effect on the core, and the watts lost due to the currents flowing in the resistances of the windings. Theoretical transformer design requires these losses to be equal when the transformer will be at its most efficient working level, but for the purposes of small transformer design it will be sufficient to base all calculations on a theoretical efficiency of 80% instead of the 90% or so which, with care, will be obtained. These losses will be dissipated as heat and any transformer which heats up in working to anything but a small degree is inefficient and wasteful. Power is being lost, regulation will be poor and insulation will be subjected to the most undesirable strains. A good transformer will work for hours with a temperature rise which can scarcely be observed by touch.

The windings are usually on a former, Fig. 9c, a tube which will fit the core tightly with end cheeks to clear the window space, and through which the leads pass. Such a former can be made of stiff cardboard well shellaced, or of thin paxolin. Cardboard is quite suit-

able for ordinary voltages; the tube is first made to fit the core and the end cheeks are fitted, then the whole is well varnished and allowed to set hard. It will perhaps be best to follow the design and construction of a specimen transformer throughout.

EXAMPLE 2.

A transformer is to be made with the specification: Primary to be tapped to 210, 230, 250 volts, H.T. Secondary to give 350-0-350 volts, 120 m/as, Valve heater secondary to give 6.3 volts 3 amps. and Rectifier heater secondary to give 5 volts 2 amps.

The watts ratings, therefore, are:—

350 x 120 m/as (only half the H.T. winding supplies current at one time) =	42	watts.
6.3 x 3 =	18.9	watts.
5 x 2 =	10	watts.

giving an *output* total wattage of 70.9 watts.
or, say, 71 watts.

The cross sectional area of the core should be at least $A = \frac{\sqrt{71}}{5.58}$
or 1.5 square inches, and assuming an efficiency of 80%, which should certainly be bettered in practice, the input wattage is therefore $71 \times \frac{100}{80}$
or 88.7 watts.

At a working voltage of 230, therefore (the usual mains voltage) the primary will take $\frac{88.7}{230}$ amps. or .4 amps. nearly, and the wire must be chosen to carry this current safely. The question of insulation enters here.

Commercial transformers, as inspection will show, are most often wound with enamelled wire, but conditions are different from those obtaining for home construction. The commercial transformer is machine wound so that the wire can be, and generally is slightly spaced between turns so that there is no rubbing of the enamel, whilst the wire tension can be more accurately controlled. For amateur construction enamelled wire can be used but on no account should it be wire taken from old coils or transformers. It must be new and every precaution must be taken to ensure the covering is not cracked, kinked or rubbed for a breakdown in insulation in any winding renders the whole transformer useless.

Probably the best plan is to use enamelled wire with the added protection of a single silk covering for the heavier primary winding.

A suitable core is now chosen, one with an area of 2 square inches (reducing to an electrical area of 1.8 sq. ins.) being before the writer.

The turns per volt formula becomes, then,

$$1 = \frac{4.44 \times 50 \times 60,000 \times N \times 1.8}{100,000,000}$$

but if desired a factor can be produced relating to all transformers where H is taken as 60,000 by leaving out the terms N and A.

This factor, obviously, for 50 cycle mains, is

$$1 = \frac{4.44 \times 50 \times 60,000}{100,000,000} \times AN$$

$$= .1332 AN$$

so that the formula for this transformer becomes

$$1 = .1332 \times 1.8 \times N$$

$$= .24N$$

$$\text{and } N = \frac{1}{.24} \text{ or } 4.2 \text{ turns per volt.}$$

The windings can all be calculated, then, the primary having $250 \times 4.2 = 1,050$ turns tapped at 966 and 882 turns, the secondary has $700 \times 4.2 = 2,940$ turns, centre tapped, the valve heater secondary has $6.3 \times 4.2 = 26.5$ turns and the rectifier secondary has $5 \times 4.2 = 21$ turns.

The size of wire, as already shown, affects the current flowing in the winding, and for this type of transformer the gauge may be chosen on the basis of a current flow of 2,000 amps. per square inch.

The primary draws .4 amps. so from the wire table it will be seen that S.W.G. 26 S.S. & E copper wire will be suitable; for the H.T. secondary enamelled wire with an interleaving of thin waxed paper between each layer will be used, and to carry the 129 m/as S.W.G. 34 copper wire will be suitable.

S.W.G. 18 copper wire, enamelled, will suit both heater windings, and to make up losses one extra turn is usually added to the calculated figures for these two coils.

It is now necessary to pay some attention to mechanical details and to check over the dimensions of the former. The size of the window space, a x b, as shown in Fig. 9a, is $1\frac{1}{8}'' \times 1\frac{1}{8}''$ and the former may be supposed to be made of one-eighth material, card or paxolin. This will reduce the available space in three directions, leaving the depth of the window one inch and the length one and five-eighths inches. The space taken by each winding must now be calculated.

The Primary.

S.W.G. 26 S.S. & E. winds 48 turns to the inch, so that the former will take $48 \times 1\frac{1}{8}$ turns per layer, or 78 turns. The number of layers will be $\frac{1,050}{78}$ or 14 layers and the height will therefore be $\frac{1}{8}''$.

The H.T. Secondary.

S.W.G. 34 E. wire winds 100 turns per inch so that each layer will contain $100 \times 1\frac{1}{8}$ or 162 turns. The number of layers will be $\frac{2,940}{162}$ or 19 layers, and these will be one-fifth inch high.

Heater Secondaries.

S.W.G. 18 E. wire winds 19.7 turns per inch so that one layer will contain $19.7 \times 1\frac{1}{2}$ or 32 turns so that each heater winding will fit into a layer comfortably, and the whole wire height of the two windings together will be under $\frac{1}{8}$ ".

The total height of the wire alone, then, is $\frac{1}{2} + 1/5\text{th} + \frac{1}{8}$ or $2/3\text{rd}$ inch, leaving $\frac{1}{8}$ inch space for insulation.

When the former is made, shellaced and perfectly hard the cheeks may be drilled for the leads using the figures above as guides or the holes may be made as the work progresses providing there is no chance whatever of damaging the wire insulation in any way. The primary is wound first, the wire being cleaned properly with spirit, not by scraping, and having a flexible lead soldered to it. The soldered joint must be perfectly smooth with no sharp points or projecting wire ends, and it is then covered with insulating sleeving which carries the flex lead through the cheek. The wire is then wound either by hand or by a simple winder, which is much to be preferred. All that is needed is a spindle turning in end plates or bearings, a handle at one end. Two adjustable cheeks are then mounted on the spindle to grip the former tightly, the spindle (which might well be a long screw threaded rod) passing through the centre hole of the former. The former is then rotated with the right hand, the wire being fed off its reel and tensioned evenly with the left. The turns should be laid evenly side by side and counted as they are put on, in the absence, as is likely, of a mechanical counter it is convenient to mark every twenty turns on a sheet of paper.

It is fatal to lose count!

The primary winding is not interleaved so that when the end of one layer is reached the wire is wound straight back on itself and tension must not be over tight for each corner of the former presents a sharp right angle bend to the wire whilst the lower turns have to sustain the considerable strain of all those windings above them.

It is necessary to understand the effect of one short-circuiting turn in any winding. It would consist of a very low resistance loop in which, therefore, a very high current would be induced, this causing heating and consequent burning of the insulation on adjoining turns of wire, whilst the extra load reflected into the primary might cause that winding to be overloaded to the fusing point. It must be realised that the current flowing in the primary depends entirely on the load being drawn from the secondaries; with the secondaries disconnected the only current flowing in the primary is the small core magnetizing current and the winding acts as a choke.

The taps for the various primary voltages can be taken out in the same manner as the taps on coils, by drawing out a loop of wire and returning the wire to the next turn without any breaks or joins, or a flex lead may be soldered to the winding at the correct turn and well insulated. Whenever possible taps should be arranged to fall at the end of a layer so that they may be passed straight through the former cheek. If, however, they have to pass over several turns the insulation

must be perfect and on no account must unevenness of winding be allowed in the next layers. Any bump in the centre of the coil will be magnified in the later layers with a corresponding strain on wire and insulation.

When the primary is finished, and a flex lead soldered to the last turn, the winding must be insulated from the following coils. The best material is Empire Cloth interwoven with glass fibres and known under such names as Glassite, but plain Empire Cloth may be used. Every part of the primary must be covered, the insulation being carried up snugly to the former cheeks.

Many transformers have an electrostatic screen wound over the primary to prevent interference from the mains being induced into the secondaries. It consists simply of one layer of fine insulated wire—S.W.G. 34 enamelled, for example, one end of the wire being anchored internally and the other brought out through insulating sleeving. The end brought out is earthed to the receiver or other apparatus worked from the transformer. Naturally just as much attention must be paid to the insulation of the screen as of any other winding; no load is taken from it as only one end has a connection but shorting turns would give rise to the same heavy overloads mentioned above.

If the screen is included another layer of Empire Cloth is wound over it, giving a smooth, even base for the H.T. winding. Again a flex lead is soldered to the start of the coil and insulated but in this winding a sheet of thin paper is interleaved between each layer of wire. Excellent paper for this purpose can be obtained by stripping down an old paper condenser of the Mansbridge type, any punctured parts of the paper being discarded. On each wire layer one turn of paper is wound, fitting tight up the cheeks, and the wire is wound back over it to form the next layer.

At the centre tap a flex lead is soldered to the wire and anchored firmly in the coil, the flex being taken through the cheek and the joint, as before, being perfectly smooth and insulated. When the H.T. winding is finished another layer of Empire Cloth or Glassite is laid over it and the valve heater winding made, the commencing lead through one cheek and the finishing lead through the other. A layer of Empire Cloth or Glassite separates it from the last winding, that for the rectifier heater which is put on in the same way.

Study of any power pack will show that the full H.T. voltage is established between the H.T. and rectifier heater windings and the insulation between them must be perfect. Any breakdown here will immediately ruin both transformer and rectifier valve.

When the former is wound it is given a last covering of cloth and the laminations are inserted into the centre aperture in order as already explained. The stampings must be inserted carefully for it may be possible to run a sharp edge or corner into and through the former material, cutting or scraping the primary winding.

The laminations must be clamped into a solid mass with wooden or metal clamps which can also be drilled to provide fixing holes for bolting the transformer to its chassis.

Testing.

The first tests to be given the transformer are continuity and insulation checks, these being performed with a neon lamp worked from the A.C. mains. One mains lead is taken to the metal core of the transformer and the other, through the neon lamp, to each lead from the windings in turn. Any lighting of the lamp indicates a short circuit from a winding to the core which must be rectified. The next test is to check the insulation between the windings; transfer the lead from the core to the common primary wire and test the screen and secondary leads in turn with the neon lamp, transferring the mains lead from the primary to each secondary in turn as the test progresses.

Again, any lighting of the lamp indicates a short circuit, but actually any short circuits so discovered would be due to very careless workmanship and are unlikely.

Finally the continuity of each winding is checked with the neon lamp, connecting it across each coil in turn, not forgetting the tappings, when the lamp should light.

If a small megger set is available really valuable insulation tests can be made but care must be used to choose a voltage below any break-down voltage calculated for the insulation used. However, as the peak voltage across the H.T. secondary of the transformer described would be almost 1,000 volts the transformer should certainly show a resistance of many megohms at 2,000 volts between windings.

When the transformer has been checked for insulation and continuity, its voltage ratios can be checked. The primary is connected through the suitable tapping to the A.C. mains, with all the secondary leads well separated so that no two can short-circuit together.

Never check secondaries by touching the leads together to produce a spark—results are spectacular but impose an unnatural strain on the primary and should the transformer have been wound to close limits the high currents flowing will probably fuse a winding.

Switch on with the primary only in circuit. After a slight thump or click there should be very little hum from the core, and any appreciable noise indicates loose laminations which must be tightened. Let the primary run alone for ten minutes and check for warming up. Any temperature rise indicates either a totally incorrect winding size or shorting turns in any one of the windings.

In either case connect an A.C. voltmeter across each secondary in turn, and note the voltages obtained from each. If they are all somewhat low and the transformer is heating up it is likely that there are shorting turns in the primary. If one voltage is low and the transformer is heating up there are probably shorting turns in that secondary alone. Any winding with shorting turns must be rewound but if the work has been done properly and good wire used there is very little reason for this fault to occur.

Check the voltage on the H.T. secondary from the centre tap to either end of the winding—there should be no difference in the readings,

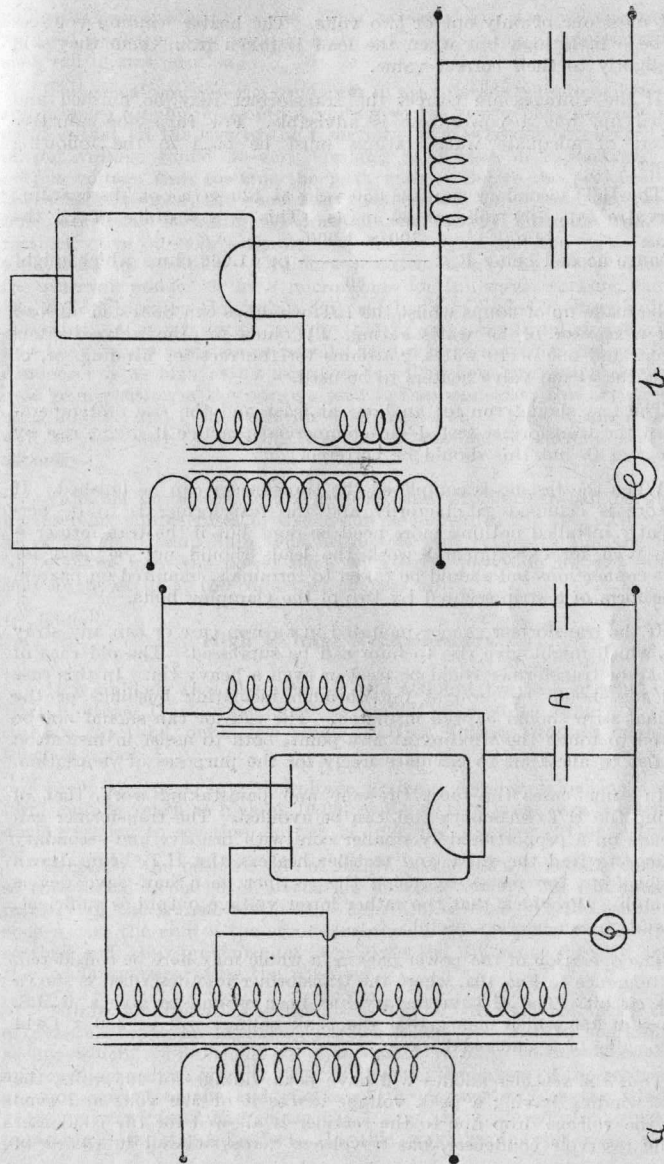

or at most one of only one or two volts. The heater winding voltages will be a little high but when the load is taken from them they will fall slightly to their correct value.

If the voltages are correct the transformer may be finished and coupled up, but a power test is advisable. For this, non-inductive resistors of adequate watts ratings must be used in the following manner.

The H.T. secondary supplies 350 volts at 120 m/as, or, disregarding the centre tap, 700 volts at 60 m/as. This is a wattage of 42, the resistance needed being $R = \frac{700 \times 1,000}{60}$ or 11,666 ohms which might

well be made up of lamps whilst the L.T. windings can be tested on load using a resistor of 20 watts rating, 2.1 ohms for the valve heaters winding and one of 10 watts, 2.5 ohms for the rectifier winding, or, of course, the actual valve heaters to be used.

The test should run for an hour at least and the rise of temperature of the transformer tested—in commercial practice it might rise by 40 degrees C. but this should be bettered.

When the testing is completed the transformer can be finished. If the core is clamped satisfactorily and the transformer is to be permanently installed nothing more need be done but if the transformer is to be used for experimental work the leads should not be used for direct connections but should be taken to terminals, mounted on paxolin in the form of a strip secured by two of the clamping bolts.

If the transformer can be mounted in an iron case or can any stray fields which might give rise to hum can be suppressed. The old case of a choke or transformer could be used or even a heavy tin. In this case the leads should be brought out through insulating bushings or the terminal strip should be well insulated. The case or can should not be allowed to touch the winding at any point, both to assist in insulation and also to allow air to circulate freely for the purposes of ventilation.

In some cases the most tiresome and painstaking work, that of winding the H.T. secondary coil, can be avoided. The transformer can be made on a proportionately smaller core with primary and secondary windings to feed the valve and rectifier heaters, the H.T. being drawn straight from the mains by using the rectifier as a half-wave device (Fig. 10b). Provided that the rather lower voltage output is sufficient, this system can be very useful.

The operation of the power pack as a whole may here be considered, with reference to Fig. 10a, where the transformer just described is shown in its circuit. The H.T. secondary has been wound to give a R.M.S. voltage of 350 which means that the peak voltage will be 350×1.414 (peak value of a sinusoidal wave).

Thus the rectifier anodes will have peak voltages of 495 volts, the whole winding having a peak voltage across it of 990 volts and even after the voltage drop due to the rectifier is allowed for the condenser A, the reservoir condenser, has a voltage across it well in excess of

350 volts—probably 450 volts. This explains why the voltage rating for this condenser is necessarily high; a 350 volt rating condenser would soon fail in this position.

The actual value of the condenser in microfarads is more or less of a compromise for the final output voltage of the power pack depends to a great extent on the size of the reservoir. If it were to be omitted the output voltage would be very low and as it rises in capacity so the output voltage rises towards the peak value. Before the peak voltage is reached, however, the condenser is excessively large (and expensive), but, moreover, it would be drawing very heavy currents from the rectifier valve on each surge or peak of the cycle and the valve would soon loose its emission. Ordinary practice usually fixes the value of the reservoir condenser at 8 microfarads for full-wave working, but in the writer's opinion this value may safely be exceeded if extra voltage is needed. It is interesting to note that in one commercial circuit where two heavy duty rectifiers in parallel feed a large amplifier the reservoir condenser is as high as 25 microfarads. The only protecting device is a 50 ohm resistor in the positive lead to the condenser, this acting as a surge limiter, and if the reservoir condenser is to be large it might be as well to use such a limiting resistor of reasonable current carrying capacity.

Valuable protection to the rectifier and transformer can be given by inserting simple fuses in the circuit as shown in Fig. 10. They can be of the flash lamp bulb type, with a current rating to suit the load to be taken from the power pack with extra provision for any surges that might occur as the condenser charges up.

High Voltage Transformers.

It is unlikely that the amateur will attempt the task of winding a High Voltage Transformer such as would be used to supply a large cathode ray tube, but a few points of High Voltage practice might be touched upon.

First, the peak inverse voltage across a typical television transformer might reach as high as 10,000 volts, so that great care is essential during testing to see that no risk of touching any live circuit is taken.

Secondly, the positive side of such a power pack is usually earthed, so that strain is placed on insulation in many ways. For example the primary of the transformer might easily be earthed via the mains; in such a case the end of the secondary nearest the primary would be the earthed end, thus preventing a large potential difference directly across the insulation separating the windings.

Thirdly air insulation is often relied upon. At high voltages a trace of moisture upon an insulating surface might give rise to sparking or arcing which, while slight at first would rapidly become something approaching a short circuit. For this reason the layers of the secondary are not carried to the end cheeks of the former and as the winding grows outward from the centre the layers are made shorter, giving a pyramidal or stepped effect. In this way, as the potential above

earth rises through the winding so does the distance between any earthed object and the winding increase.

Fourthly, the potential difference between the rectifier heater winding and the H.T. winding makes it necessary to have perfect insulation between the windings, a separate heater transformer helping in this respect. Metal rectifiers give very good results for cathode ray tube power supplies.

SECTION 5.

Low Frequency Chokes.

The Low Frequency Choke is used in the power pack to filter out hum from the current supply, for intervalve coupling and in various forms of input and output circuits. Slightly different methods of construction are used dependent upon whether the choke is to carry direct current in the winding as well as A.C.; in a power pack for example, D.C. is flowing whilst in a parallel fed intervalve coupling D.C. would be excluded by a blocking condenser.

The effect of D.C. in the winding is to decrease the incremental permeability of the core material—in practice a laminated core is used as in the transformer—so that the iron saturates more rapidly and the inductance of the choke is lowered. This inductance loss can only be partially countered by arranging to have a small air gap between the sets of laminations in the assembled core.

For chokes carrying A.C. alone, therefore, the laminations are interleaved as are those in a transformer, but for a choke carrying D.C. and A.C. the laminations are assembled with the two sets of stampings one on each side—that is all the E's on one side and all the I's opposite (or all T's together opposite all U's, whichever type of stamping is used), and it will be seen that in the core assembled in this manner there will be three air gaps, one at the end of each limb (Fig. 11). So far as the magnetic circuit is concerned even a tightly clamped butt joint acts as a small air gap, and for correspondingly larger air gaps a piece of thin tissue paper may be inserted between the end of each limb and the opposite laminations. The calculation of the correct air gap for any single case is rather involved, however, and it is recommended that for mixed A.C. and D.C. operation the gap should be decided upon by experiment. As a rough guide it may be said that the close butt joint will do for currents of 5 or even 10 milliamps but for higher currents the gap must be widened by inserting a "5 thou" sheet of tissue or more.

Chokes for Alternating Current Only.

These are chokes as used for intervalve coupling, tone control, bass boosting, resonant circuits and audio oscillators wherever the current feed to the valve is "shunted." The inductance of the choke is given by:—

$$L = \frac{3.2 \times N^2 \times \mu \times A}{1 \times 100,000,000}$$

where L is the inductance in henrys, N is the number of turns of wire, μ is the incremental A.C. permeability of the iron core material, A is

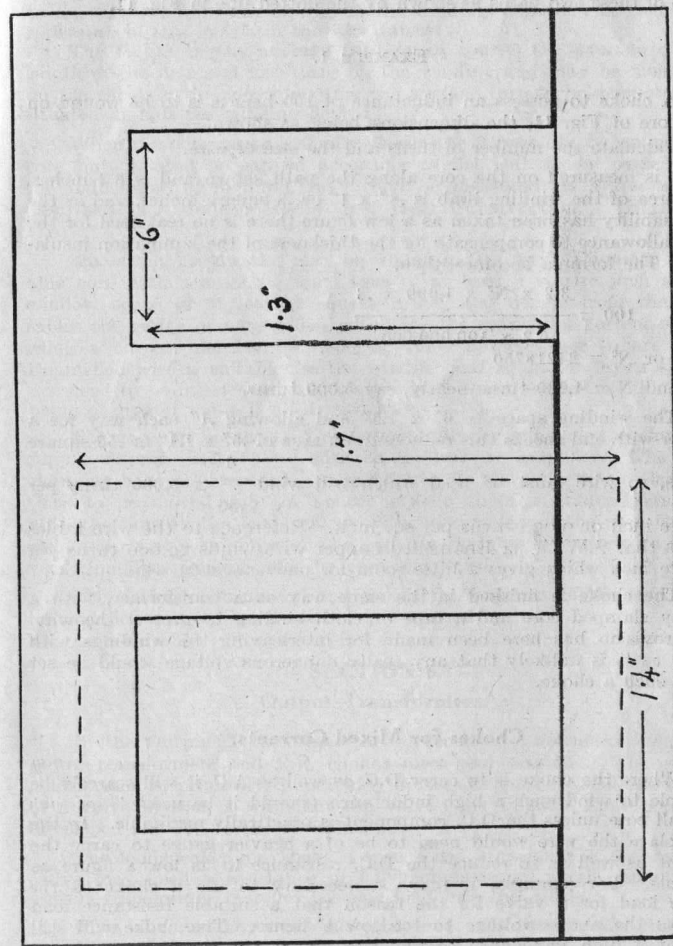

the cross sectional area of the winding limb in square inches and l is the length of the magnetic path in inches.

A safe figure to use for μ is 1,000 unless greater information about the core material is available, and l is measured directly from the laminations. A well-shaped core has the two outer legs only half the width of the inner or winding leg so that the magnetic path is split equally into two, and the length, l , to be measured is the centre line of ONE of these two paths as shown by the dotted line in Fig. 11.

EXAMPLE 1.

A choke to possess an inductance of 100 henrys is to be wound on the core of Fig. 11, the dimensions being as shown.

Calculate the number of turns and the size of wire.

l is measured on the core along the path shown and is 6.2 inches. The area of the winding limb is .8" x 1" or .8 square inches, and as the permeability has been taken as a low figure there is no real need for the 10% allowance to compensate for the thickness of the lamination insulation. The formula becomes, then,

$$100 = \frac{3.2 \times N^2 \times 1,000 \times .8}{6.2 \times 100,000,000}$$

$$\text{or } N^2 = 24218750$$

and $N = 4,920$ turns nearly, say 5,000 turns.

The winding space is .6" x 1.3" and allowing .1" each way for a former with end cheeks this reduces to an area of .5" x 1.1" or .55 square inches, so wire must be used which will wind $\frac{1}{.55} \times 5,000$ turns per

square inch or 9,090 turns per sq. inch. Reference to the wire tables shows that S.W.G. 34 Enamelled copper wire winds 10,000 turns per square inch which gives a little room for unevenness in winding.

The choke is finished in the same way as a transformer, with a tightly clamped core and a tape or cloth binding to protect the wire. No provision has here been made for interleaving the windings with paper as it is unlikely that any really dangerous voltage would be set up in such a choke.

Chokes for Mixed Currents.

Where the choke is to carry D.C. as well as A.C. it will scarcely be possible to wind such a high inductance (should it be needed) on such a small core unless the D.C. component is practically negligible. In the first place the wire would need to be of a heavier gauge to carry the current as well as to reduce the D.C. resistance to as low a figure as possible. For example, it may be necessary to use a choke as the anode load for a valve for the reason that a suitable resistance load reduces the anode voltage to too low a figure. The choke will still present a high impedance to the A.C. signal but the D.C. resistance must be low or otherwise the whole purpose of the choke will be

defeated. This means a thicker gauge of wire and therefore a larger core, for the number of turns must still be high to maintain the inductance and therefore the impedance to the signal. The simplest way out of the difficulty is to measure the winding space of the core to be used and choose a gauge of wire which when wound to fill the space will give a D.C. resistance suitable for the permitted voltage drop. This may be done by taking the length of an average turn on the winding limb, multiplying the number of turns given by the wire table by this length to find the whole length of wire in the winding, and then to check the resistance of this length in the wire tables.

The length of the average turn is, of course, the average of the length of the first and last turns on the winding and may be measured on the cheek of the core supposing the average turn to be geometrically situated at half the winding depth.

When the wire gauge is finally chosen the former can be wound, the core butt jointed or gapped according to the D.C. to be passed and the inductance, if required, may then be measured on a test set as described in "Modern Radio Test Gear Construction." (Bernard's 1/6).

Smoothing chokes also may be wound in this way. Choose a suitable core with a cross sectional area of at least 1 square inch and a window space of at least 2 square inches and decide from the wire tables the gauge of wire which will carry the maximum current safely, using a current density of 1,500 or 2,000 amperes per square inch. Enamelled wire is suitable for the winding and again the layers should not need to be interleaved, the space which would be used by the paper being of greater value if filled with wire.

The gap can be adjusted experimentally by allowing the choke to supply filtered D.C. to a sensitive receiver or amplifier. The core clamping bolts are loosened just sufficiently to allow the sets of laminations to be moved and the space between them is gradually opened until the hum in the loudspeaker, with no signals and the gain control right out, is at a minimum. The gap can then be set with a paper or very thin fibre packing and the core reclamped.

The testing of insulation and general performance of the choke can be modelled on the lines described in Section 4.

SECTION 6. Output Transformers.

In the Output Transformer the methods of construction used for power transformers and L.F. chokes meet and combine. The output transformer is, primarily, a matching device designed to load the anode of a valve in such a way that the valve's maximum output power is developed and fed to the reproducer.

The loudspeaker may have a speech coil impedance of 5 ohms, the valve may need a resistance of 5,000 ohms in its anode circuit; the output transformer matches the one load into the other.

It is obvious, however, that the load will change with the frequency for the reactance of an inductance is given by

$$X = 2\pi fL \text{ ohms,}$$

so that as the frequency rises so does the apparent resistance of the inductance. As audio frequencies range between 20 and 20,000 cycles this means that measurements and calculations must be made at a reference point, and for this purpose 400 cycles is generally taken as the standard frequency.

The first consideration is the transformer ratio necessary to match a given speaker to a given valve.

The optimum valve load is given in a maker's tables—for example a Pen. 45 requires 5,200 ohms in the anode circuit—and the speech coil impedance should be marked on the speaker. If not the dealer should be able to supply it or the speaker type number can be quoted to the makers who will supply information. It is not sufficient to measure the D.C. resistance of the speech coil, for the impedance at 400 cycles will probably be a very different value.

Supposing the above valve is to be matched to a speaker of 3 ohms impedance the formula is

$$\text{Ratio} = \sqrt{\frac{\text{Optimum anode load}}{\text{Speech coil impedance}}}$$

or

$$\begin{aligned} \text{Ratio} &= \sqrt{\frac{5,200}{3}} \\ &= \sqrt{1,700} \end{aligned}$$

which is 41.6 so that the ratio of the transformer must be 41.6:1 and thus the primary, the winding connected in the valve anode circuit, must have 41.6 times the number of turns in the secondary which is coupled to the speech coil.

This is only the first point of consideration, however, and presupposes that the resistance of the windings themselves is negligible. If the resistances of the windings can be made low then they may be ignored, but if not they will clearly affect the matching and must have due allowance made for them. It is generally accepted, for example, that if the secondary winding has a resistance of more than 5% of the speech coil impedance the formula must be amended to read

$$\text{Ratio} = \sqrt{\frac{\text{Optimum anode load}}{\text{Speech coil impedance} + \text{secondary resistance}}}$$

Moreover the response of the transformer as a whole to the various frequencies with which it will have to cope depends on its method of construction, bass response relying on a high primary inductance and treble response relying upon a low leakage inductance between the windings, the treble falling off as the leakage inductance rises.

It will be seen, then, that some types of commercial transformers rather fall down on some, at least, of these points. The core is not really large enough to allow a heavy gauge of wire to be used for the primary winding, for many turns of wire are needed to give an adequate inductance. The D.C. resistance therefore rises and while this can be allowed for in a calculation it would be better to use a larger core with larger wire to give as good, or better, an inductance with less

resistance. To improve the value of the leakage inductance, especially on the proposed larger core, the primary should be split into four sections or even more, the secondary being split into a corresponding number of sections which are then wound between the primary sections, while at the same time the leads from the sections can be isolated and brought out to separate terminals to give a multi ratio transformer, different sections being connected in series or parallel.

The primary winding of the output transformer is usually passing D.C. so that the core is gapped to compensate for this, the gap size being adjusted by experiment as in the case of the choke.

The main points of design, then, may be summed up as follows:—

(1) Large core. The writer has used power transformer cores with considerable success.

(2) Low resistance windings. The resistance of the primary should be no more than 5% of the optimum valve load and that of the secondary no more than 5% of the speech coil impedance. Higher values of resistance will need corresponding correction in the formula.

(3) The primary winding to have a suitably large inductance. This inductance cannot be pushed up to an unlimited degree, however. All loudspeakers have a bass resonant note at which point the impedance of the speech coil suddenly rises to a high figure, and too great an inductance in the primary winding would set up too high a voltage across the speech coil at this and neighbouring frequencies, causing boominess. Suitable primary inductances for output transformers for the average valve are about 15 henrys for a triode output stage and about 25 henrys for a pentode output stage.

(4) Sectionalising of the coils and interwinding.

(5) Gapping the core where D.C. feeding the valve flows through the primary. The gapping can quite well be done by experiment, relying on the ear to judge results.

An output transformer for a push-pull stage will not require gapping so long as the valves are accurately matched. Transformers for all push-pull and paraphase output systems need a centre tap on the primary winding, of course.

Enamelled wire for both primary and secondary windings will be sufficiently well insulated and windings need not be interleaved with paper. The turns must be wound in neat layers as in power transformers and each section, when finished, must be covered with Empire Cloth or a similar insulating medium. Insulation between primary and secondary must be excellent as an earth connection to the secondary is often useful to stabilise the circuit.

When constructing a multi-ratio transformer it must be remembered that the primary centre tap should be usable for several different ratios. All sections of the primary, therefore, should be of equal sizes on either side of the centre tap.

No examples of design are given for the reason that so many different ratios are required for different circuits and apparatus.

The testing of the finished transformer may be modelled on the lines described in Section 4.

SECTION 7.
COPPER WIRE TABLES

SWG No	WORKING CURRENT @ 2,000A	LENGTH OF ONE SHOLE OF COPPER YARDS	E NAMEL TURNS PER INCH	DOUBLE SILK TURNS PER INCH	SINGLE SILK TURNS PER INCH	DOUBLE COTTON TURNS PER INCH	E.E.S.C. TURNS PER INCH
16	6.434	134	14.81	219.4	14.93	13.16	14.2
18	3.62	75.3	19.72	388.9	20	16.95	19
20	2.036	42.4	25.97	674.4	26.32	21.28	24.7
22	1.232	25.6	33.33	1111	33.33	25.64	31.2
24	.76	15.8	42.37	1794	40	31.25	39.5
26	.508	10.6	51.55	2655	48.78	35.71	48.1
28	.344	7.18	62.50	3906	57.8	40.32	57.8
30	.24	5.03	74.63	5569	67.11	44.64	67
32	.182	3.82	85.47	7308	75.19	48.08	76.3
34	.132	2.77	100	10000	85.47	52.08	87.7
36	.090	1.89	120.5	14520	99.01	60.24	102
38	.06	1.18	151.5	22950	117.6	66.67	125
40	.036	.755	188.7	35620	137	72.46	151

BERNARDS' TECHNICAL BOOKS.

No.	1	Amalgamated Engineering Ref. Tables ...	1/-
"	2	"Little Marvel" Vegetable Ref. Book ...	1/-
"	3	Services Signalling Manual	1/-
"	4	Radio Manual	1/-
"	5	Elements of Mathematics	1/-
"	6	Electrical Engineers Handbook	1/-
"	7	Manual of Metals and Alloys	1/-
"	8	Manual of Modern Automatic Guns ...	1/-
"	9	Manual of Photography	1/-
"	10	Manual of Mathematical Tables	1/-
"	11	Manual of Cycle Maintenance and Hints ...	1/-
"	12	Manual of Commando and Guerilla Tactics: Unarmed Combat	1/-
"	13	Manual of Commando and Guerilla Tactics: House to House Fighting	1/-
"	14	Manual of Small Arms and Special Weapons	1/-
"	15	Manual of Wartime Household Repairs ...	1/-
"	16	Illustrated Engineering Practice Machine tools and productive processes	2/-
"	17	Manual of Rifles, usual series	1/-
"	18	Weapons and Armaments of the Modern German Army	2/-
"	19	Manual of Map and Compass Reading ...	2/-
"	20	Manual of Gliding and Motorless Flight ...	2/-
"	21	Manual of Science. Mechanics, Physics, etc.	2/-
"	22	Manual of Radio Circuits. How to build your own receivers and transmitters	2/-
"	23	Manual of Hand Grenades, Mines and Bombs	2/-
"	24	Uniform, Rank Badges and Intelligence Data on the Modern German Armed Forces	2/-

No.	25	Strategy and Tactics of the German Army	2/6
"	26	Tanks at War—Friend or Foe?	2/-
"	28	Income Tax for the Working Man ...	1/-
"	30	Manual of Radio Valves, British and American with Characteristics and Data equivalents and alternatives	3/6
"	31	Explosives.—Nature, variety and uses as Projectile Fillings, Propellents, Mines, Demolition Charges, etc., etc.	2/-
"	32	You can Fly. Flying made easy, fully illustrated ...	2/-
"	33	Invasion Tactics. Here and on the Continent ...	2/-
"	34	Guerillas v Tanks	2/-
"	35	Mathematical Dictionary	2/-
"	36	Defence against Gas	2/-
"	37	Manual of Direct Disc Recording	2/-
"	33	Aeronautics Illustrated	2/-
"	39	Tool Makers' and Engineers' Manual ...	1/-
"	40	Carpenter's Handbook	1/6
"	41	Wireless Amplifier Manual	2/-
"	42	Short-Wave Radio Handbook	2/-
"	43	Modern Radio Test-Gear Construction	1/6
"	44	Rapid Radio Repairs	2/6
"	45	Radio Reference Handbook	5/-
"	46	Motor Car Queries	2/6
"	47	Pay As You Earn	1/-
"	48	Radio Coil and Transformer Manual ...	2/-

BERNARDS' FICTION SERIES.

No.	27	Fighter Controller by S/L J.D.V. Holmes, R.A.F.V.R. A tale of the R.A.F. based on Fact	2/-
No.	29	Did this Really Happen? by S. Gainsley Short Stories at their best ...	1/6