

BBC ENGINEERING TRAINING MANUAL

MICROPHONES

**By the Staff of the
Engineering Training Department
British Broadcasting Corporation**

A "WIRELESS WORLD" PUBLICATION

About this book

This book, originally written as a textbook for use in training BBC engineers, has now been made available by the BBC for general publication. It will prove to be of great interest and value to all concerned with microphones in sound engineering, in which field the Corporation's engineering division has, of course, gained an almost unique experience over many years.

The requirements for microphones in a broadcasting studio are set out in an introductory chapter, and this is followed by chapters covering the laws relating to sound waves and their behaviour. The design and characteristics of various types of microphone are then described, and full details given of the ribbon, moving-coil, crystal and condenser instruments that have been used in British broadcasting studios during recent years.

The book should be of particular value to students, but its specialized nature assumes that the reader already has a basic knowledge of electrical engineering and, in particular, of alternating current theory.

15s. net

The journal for all radio technicians

WIRELESS WORLD, founded over 40 years ago, is Britain's leading technical journal in the general field of radio, television and electronics. It provides a complete and accurate survey of the newest technique in design and manufacture and, with up-to-date reviews of commercial equipment, broadcast receivers and components, covers every phase of the radio and allied industries.

Keep in touch with the very latest developments . . . read WIRELESS WORLD regularly.
2s. Monthly. £1 7s. 0d. per annum.

Wireless World

The journal for advanced workers

WIRELESS ENGINEER is produced for research engineers, designers and students in the advanced fields of radio, television and electronics. The journal publishes only original work and is the accepted source of information for advanced workers everywhere. Its Editorial Advisory Board includes representatives of the National Physical Laboratory, the BBC, and the British Post Office. Regular features include abstracts and references compiled by the Radio Research Organization of the Department of Scientific and Industrial Research.
3s. 6d. Monthly. £2 4s. 6d. per annum.

WIRELESS ENGINEER

*Subscriptions may be placed with
your newsagent or sent direct to:*

DORSET HOUSE, STAMFORD STREET, LONDON, S.E.1

MICROPHONES

IN THIS SERIES

SOUND RECORDING AND REPRODUCTION

**By the BBC Engineering
Training Department
(In preparation)**

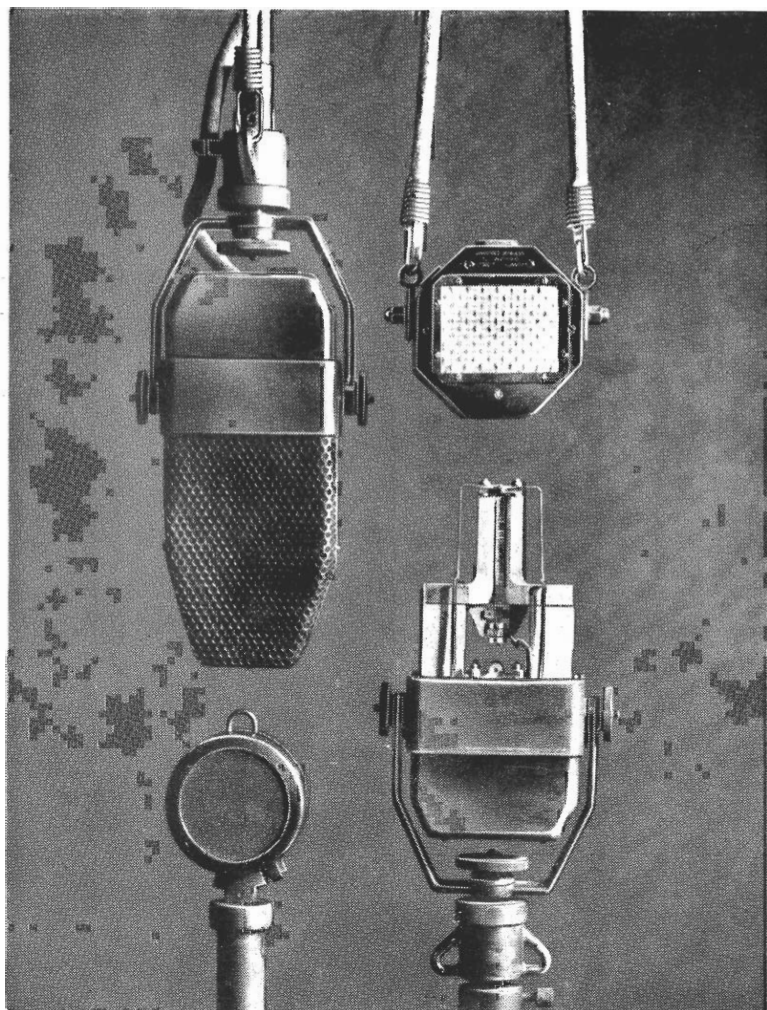

[Frontispiece]

SOME BBC MICROPHONES

(Top left) BBC-MARCONI RIBBON; (top right) MARCONI-REISZ, AN EARLY CARBON TYPE NOW OBSOLETE; (bottom left) S. T. & C. MOVING-COIL; and (bottom right) BBC-MARCONI RIBBON, WITH CASING REMOVED

BBC ENGINEERING TRAINING MANUALS

MICROPHONES

By the Staff of the
Engineering Training Department
BRITISH BROADCASTING CORPORATION

With 78 illustrations



Published for
" WIRELESS WORLD "

LONDON : ILIFFE & SONS, LTD.

First published 1951

*Published, by arrangement with the British Broadcasting Corporation, for
"Wireless World" by Iliffe & Sons, Ltd., Dorset House, Stamford
Street, London, S.E.1*

*Printed in England at The Chapel River Press, Andover, Hants
(BKS. 1073)*

CONTENTS

<i>Chapter</i>	<i>Page</i>
LIST OF SYMBOLS	7
PREFACE AND ACKNOWLEDGMENTS	9
1. MICROPHONES IN A BROADCASTING SERVICE	11
Introduction—Requirements of Broadcasting Microphones—Constant-velocity and Constant-amplitude Microphones—Relationship between Velocity and Amplitude.	
2. SOUND WAVES IN AIR	17
Sound Pressure—Nature of Sound Waves—Variation of Sound Energy and Pressure with Distance.	
3. OPERATIONAL FORCES	25
Pressure Operation—Differential-pressure Operation—Differential Pressure with Sound at an Angular Incidence—Increase of Force with Low-frequency Spherical Waves.	
4. ELECTRO-ACOUSTICS	33
Introduction—Electromechanical Analogies—Dynamic Conditions in a Mechanical System—Mechanical Impedance of a Simple System—Mechanical Impedance of a Complicated System—Equivalent Circuits for Composite Mechanical-acoustical Systems—Resonance in Mechanical Systems.	
5. DIAPHRAGM OPERATION	47
Introduction—Diaphragm Dimensions—Diffraction—Phase Difference Across a Diaphragm—Cavity Resonance—Dimensions of High-quality Pressure-operated Microphones—Polar Diagrams—Cardioid Characteristics—Directional Efficiency.	

CONTENTS

<i>Chapter</i>	<i>Page</i>
6. STUDIO MICROPHONES	66
BBC-Marconi Ribbon Microphone—S. T. & C. Moving-coil Microphone 4017—S. T. & C. Moving-coil Microphone 4021A—E.M.I. Moving-coil Microphone — Brush Crystal Microphone — Condenser Microphones—BBC-Marconi Lip Microphone.	
<i>Appendix</i>	
1. PROOF OF THE RELATIONSHIP $v = +j\omega x$, FOR SIMPLE HARMONIC MOTION	94
2. ANALYSIS OF THE FORCE ON A COMPLETELY EXPOSED DIAPHRAGM	97
3. DERIVATION OF ELECTRICAL-ACOUSTICAL ANALOGIES FROM THE EQUATION FOR SIMPLE HARMONIC MOTION	99
4. ACOUSTICAL UNITS ; FORMULÆ FOR ACOUSTICAL IMPEDANCES; EQUIVALENT MECHANICAL VALUES	101
5. EFFECT OF DIFFRACTION VARIATIONS ON DIFFERENTIAL-PRESSURE OPERATION	106
BIBLIOGRAPHY	112
INDEX	113

LIST OF SYMBOLS

<i>Symbol</i>	<i>Term</i>
A	Area
B	Magnetic flux density
C	Capacitance (electrical)
C_a	Capacitance (acoustical)
C_m	Compliance
c	Velocity of sound propagation
D	Diameter
d	Effective path-length (front to rear of microphone)
F	Force
f	Frequency
f_r	Frequency of resonance
I	Current
I_o	Sound intensity
L	Inductance
l	Length
λ	Wavelength
M	Inertance
m	Mass
m_a	Acoustical mass
P	Power (electrical)
P_a	Power (acoustical)
p	Pressure
p_o	Free-wave pressure
ρ	Density of medium
Φ	Magnetic flux
Q	Quantity
R	Resistance (electrical)
R_a	Resistance (acoustical)
R_m	Resistance (mechanical)
r	Radius
S	Stiffness
t	Time
θ	Angle

LIST OF SYMBOLS

<i>Symbol</i>	<i>Term</i>
φ	Angle of phase difference
U	Volume current
V	Voltage
v	Velocity
W	Energy (electrical)
W_a	Energy (acoustical)
W_m	Energy (mechanical)
x	Displacement amplitude
X	Reactance (electrical)
X_a	Reactance (acoustical)
X_m	Reactance (mechanical)
ω	$2\pi f$

PREFACE AND ACKNOWLEDGMENTS

THIS BOOK HAS been written by members of the staff of the BBC Engineering Training Department, and is intended to serve as a text-book for students and operational engineers employed at studio centres.

It is anticipated that this book will be followed by others dealing with the various specialised branches of broadcast engineering, and although special emphasis will be given to BBC practice, it is felt that the subject matter will be of interest to many readers outside the BBC who are actively engaged in sound engineering. This view is emphasised by the fact that although methods of application may differ, broadcasting apparatus used by organisations throughout the world has much in common.

The specialised nature of this book assumes that readers already have a basic knowledge of electrical engineering in general and of alternating-current theory in particular.

Some of the illustrations used originally appeared in other publications, as follows: Figs. 44, 54, 55, 56, 57 and 59 in *Electronic Engineering*; Fig. 46 in the *Journal of the Society of Motion Picture Engineers*; and Figs. 47 and 53 in "A Handbook of Telecommunications", by B. S. Cohen (Sir Isaac Pitman & Sons, Ltd., 1947). The Engineering Training Department wishes to acknowledge its indebtedness to the publishers concerned, also to the D. Van Nostrand Co., Inc., New York, publishers of "Elements of Acoustical Engineering", by H. Olsen (1948), which work has proved invaluable in the preparation of the present book.

CHAPTER 1

MICROPHONES IN A BROADCASTING SERVICE

1.1 INTRODUCTION

THE MAIN PURPOSE of this book is to explain the elementary principles of microphones in general, to examine some of the features which distinguish one type of microphone from another and to give engineers a better understanding of the problems associated with the design and operation of microphones used in a broadcasting service.

The design of an efficient microphone suitable for broadcasting purposes presents many problems which do not arise with other equipment used in the broadcasting chain. This is because the function of the microphone is the translation of sound into equivalent electrical signals; the design must therefore take into account acoustical as well as electrical principles. It is important that, from the outset, we should understand how general acoustical conditions affect the electrical performance of the microphone.

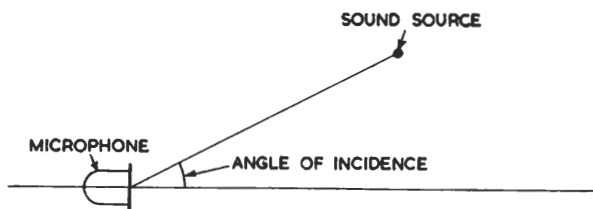

Fig. 1—ILLUSTRATING ANGLE OF INCIDENCE

The first point to be considered is the obstruction to the passage of sound waves caused by the microphone when placed in the sound field. This at once affects the pressure exerted on the microphone diaphragm, and consequently modifies the electrical output; this effect varies considerably as the frequency of sound varies and as the angle of incidence changes: by angle of incidence we mean the angle formed by an imaginary extended line passing through the microphone from front to back and another line joining the centre of the diaphragm to the sound source (Fig. 1). The degree to which obstruction and angle of incidence affect the frequency response can be controlled to a large extent by careful choice in size and shape of the microphone.

MICROPHONES

Secondly, the pressure on the diaphragm is affected if resonances occur in the air adjacent to the diaphragm. Such resonances may be caused by a cavity immediately in front of the diaphragm, formed by the clamping ring; the cavity may be very shallow, but even so, the resonance produced may considerably affect the frequency response of the microphone. It can be minimised by careful design, and in certain circumstances may be utilised to compensate for losses introduced by other parts of the system at the same frequency.

Thirdly, the relationship between the effective pressure on the diaphragm and the output voltage may vary as the frequency varies because of the mechanical and electrical impedance characteristics of the microphone.

These are some of the main problems to be encountered and the methods by which they are solved vary with different types of microphone. It is well known, however, that there are large differences in the performance of commercial microphones of different types, and a knowledge of the capabilities and limitations of all the types suitable for broadcasting is essential to engineers at studio and recording centres.

1.2 REQUIREMENTS OF BROADCASTING MICROPHONES

1.2.1 GENERAL REQUIREMENTS

Before considering the principles involved in microphone design, we must give some thought to what is required of a microphone by a broadcasting service. The first requirement is fidelity of performance, which implies that a constant level of acoustical input produces a constant level in electrical output over the required audio-frequency range, i.e., the response of the microphone should be independent of frequency.

Secondly, it is desirable that the frequency response should be reasonably independent of the angle of incidence; this calls for discrimination in the size and shape of the microphone, which should be such that the body of the microphone presents minimum obstruction to the sound wave; this is particularly important at high audio frequencies when the wavelengths may approach the physical dimensions of the microphone.

In addition to these fundamental requirements, the performance of the microphone should conform to the high standards expected from other apparatus in the broadcasting chain. In particular, the microphone should be free from harmonic generation; it should respond to transients; its normal output level should be high in relation to self-generated and thermal noise; it should be unaffected by adjacent electrostatic or electromagnetic fields; its mechanical

construction should be sufficiently robust to withstand handling in service use.

1.2.2 DIRECTIONAL REQUIREMENTS

The directional requirements of a microphone vary considerably with broadcasting conditions. Sometimes it is desirable that the response should be omni-directional; at other times, local conditions may call for discrimination between sounds reaching the microphone from different directions. This is particularly important when sound waves from a given source reach the microphone by different paths.

In an enclosed area such as a broadcasting studio, sound waves reach the microphone by a direct path from the source and also by numerous indirect paths because of reflections from floors, walls and ceilings; the reflected sound may form an appreciable part of the total sound reaching the microphone.

For a given ratio of direct to indirect sound the effect may be to add atmosphere or colour to musical sounds but this same ratio may be quite unsatisfactory for speech, robbing it of its natural quality.

In practice, the indirect sound consists of repeated reflections from a number of different surfaces, the cumulative effect of which is called reverberation. At each reflection, a certain amount of sound energy is absorbed by the reflecting surfaces; the amount of absorption is dependent upon the physical properties of the surfaces, and varies with frequency. Because the absorption of reflected sound varies when the frequency varies, the strengths of individual tones forming the indirect sound may be different from those of the direct sound. The direct/indirect sound ratio is thus of great importance and its proper control is one of the fundamental problems confronting designers of microphones and designers of broadcasting studios.

In the early days of broadcasting, the sensitivity of the microphone was comparatively low and a "close" technique was employed, i.e., the microphone was placed close to the performers. An incidental result of this technique was a high ratio of direct/indirect sound; because of this, studio acoustics were relatively unimportant. In later years improvement of microphones and amplifiers made it possible to increase the distance between microphone and performers; this use of a "distant" technique not only produced a good psychological effect on the performers, but increased the relative level of the indirect sound, giving colour to the broadcast. With the use of distant technique, however, it was found essential to control the acoustics of studios by suitable choice of reflecting

MICROPHONES

and absorbing surfaces. If satisfactory acoustical conditions can be obtained in this way, the distant technique may be applied with advantage and a low ratio of direct/indirect sound maintained; given these conditions the microphone should have no directional discrimination.

Where acoustic conditions are poor, it is necessary to revert to a close technique or, if this is impracticable, a microphone having directional properties may be used, with a distant technique. Working under these conditions, the directional discrimination of the microphone results in a high ratio of direct/indirect energy in its output although the ratio may be relatively low at the acoustical input.

1.2.3 SPECIAL REQUIREMENTS

All microphones give a reduced output when the distance from the sound source is increased, but for some broadcasting purposes it is almost essential to use microphones with special discrimination against sound from remote sources.

Broadcasts from industrial plants, race or sports meetings and boxing matches are examples where unwanted sounds from remote sources may be many and powerful, so that the noise reaching the microphone may drown the voice of the commentator.

To meet the requirements of such operating conditions, microphones have been developed for which the response/frequency characteristic is dependent on the distance from the sound source. An equaliser is required with a microphone of this type, because the low-frequency response of the microphone alone is excessive for sound sources which are very close (page 93).

The equaliser introduces large attenuation at low frequencies, hence the response/frequency characteristic becomes reasonably flat for the commentator's voice, but there is very little response to low-frequency sounds from the remote sources.

1.3 CONSTANT-VELOCITY AND CONSTANT-AMPLITUDE MICROPHONES

We have seen that a broadcasting service may use omni-directional microphones for one purpose and directional microphones for another; selection is largely a matter of operational requirements dictated by acoustical conditions. We must now consider the working principles of different types of microphone, paying particular attention to the nature of the voltage-generating device.

With almost all types of microphone, the generation of voltages is dependent upon sound waves setting up mechanical vibrations

in a moving element. The voltage generated by the vibration of the moving element may be proportional either to the velocity or to the amplitude of oscillatory displacement. Microphones can therefore be classified broadly, as follows:—(a) Constant Velocity; (b) Constant Amplitude. (The Thermal or Hot-wire microphone is in neither classification, having no moving element.)

1.3.1 CONSTANT-VELOCITY MICROPHONES

A constant-velocity microphone is one in which the output is proportional to the velocity of vibration of the moving element. If the sound intensity is constant and independent of frequency, the velocity must be constant over the whole of the frequency range in order to give a constant value of electrical output.

Moving-coil and ribbon microphones are examples of the constant-velocity type and the open-circuit voltage V is given by $V = Blv \times 10^{-8}$ volts,

where B is the density of magnetic flux (gauss), l the length of conductor (cms), and v the velocity (cms per sec).

B and l are constants, and the output voltage is therefore proportional to the velocity. The physical characteristics of the moving system are so chosen that, for a constant level of input, the velocity is substantially constant throughout the frequency range.

1.3.2 CONSTANT-AMPLITUDE MICROPHONES

A microphone in this classification is one in which the output is proportional to the displacement amplitude of the moving element, and care is taken in the design to ensure that, for a constant value of acoustical input, the displacement amplitude is the same at all frequencies within the working range. The crystal microphone (Fig. 2) is an example of this type. When a sound wave impinges on the crystal surface, a deformation or deflection of the crystal is caused, which is proportional to the sound pressure.

This causes an e.m.f. V to be generated, owing to the so-called "piezo-electric activity"

and the output voltage is proportional to the product kx , where k is a constant depending on the crystal system, and x is the effective displacement of the plate from its neutral condition.

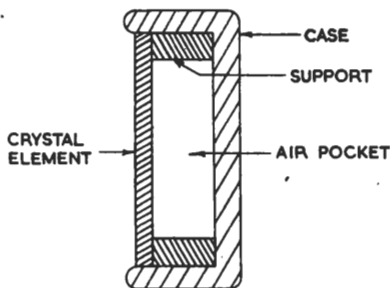

Fig. 2 — CROSS-SECTIONAL REPRESENTATION OF A DIRECT-ACTUATED CRYSTAL MICROPHONE

MICROPHONES

Since k is constant, the output voltage is proportional to displacement.

In the following table, the various types of microphone are classified into appropriate groups.

CONSTANT VELOCITY	CONSTANT AMPLITUDE
Moving-coil	Carbon
Ribbon	Piezo-electric Crystal
Inductor	Capacitor (Condenser)
Moving-iron	Electronic
Magneto-striction	

1.4 RELATIONSHIP BETWEEN VELOCITY AND AMPLITUDE

The relationship between velocity, v , and amplitude x , in a vibrating mechanical system if phase effects are neglected is expressed by

$$v = \omega \cdot x$$

where $\omega = 2\pi f$ and $x =$ maximum displacement value. (See Appendix 1.)

If, as with a constant-amplitude microphone, x is constant, the maximum velocity, v , is clearly proportional to the frequency f .

With a constant-velocity microphone, it can be shown that the maximum displacement value, or amplitude, x , is inversely proportional to frequency.

The graph in Fig. 3b represents a cycle of sinusoidal displacement, of maximum value x . Such a graph can be traced out by rotation of the vector OP, of length x , Fig. 3a.

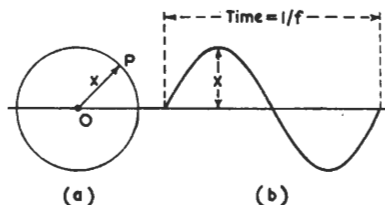

Fig. 3—GRAPHICAL REPRESENTATION OF SINUSOIDAL DISPLACEMENT

The distance travelled by the point P in one revolution $= 2\pi \cdot x$ and the time taken for one revolution $= 1/f$ where $f =$ number of revolutions per unit time. We have then

$$\begin{aligned} \text{Distance} &= 2\pi \cdot x \\ \text{and Time} &= 1/f \end{aligned}$$

$$\text{Now velocity} = \frac{\text{Distance}}{\text{Time}} = \frac{2\pi \cdot x}{1/f} = 2\pi f \cdot x$$

If velocity is constant, $x \propto 1/f$.

CHAPTER 2

SOUND WAVES IN AIR

IN ORDER TO UNDERSTAND the functioning of microphones, we must have some knowledge of the nature of sound and of its propagation through the atmosphere. It is still more important that we should know how sound energy from a point source, spreading out uniformly through an ideal medium, is reduced in intensity and how the intensity is dependent on the distance from the sound source.

2.1 SOUND PRESSURE

The normal human ear registers a sensation of sound when periodic variations, in the form of sound waves, are superimposed on the steady atmospheric pressure, provided that the periodicity of these variations lies within what is usually termed the audio-frequency range. The precise limits of this range depend to some extent on the age of the hearer; normally the high-frequency limit decreases as age increases. The range also varies with different individuals of similar age. The extreme limits are about 15 c/s for the lower and 20,000 c/s for the upper end of the range.

The magnitude of pressure variation which must be reached before sound becomes perceptible is not the same for all audio-frequencies, but whatever the frequency, it is an extremely small fraction of the steady barometric pressure. For example, the normal atmospheric pressure is approximately 1,000,000 dynes per sq cm, yet the alternating pressures produced by speech are round about 0.25 dyne per sq cm. There is, however, a very wide range of possible sound pressures: the lower limit of the range, at which sound is just audible, is referred to as the *threshold of hearing*; the upper limit at which sound becomes painfully loud is referred to as the *threshold of feeling*. For frequencies in the middle part of the audio range, the r.m.s. value of pressure variation approximates 0.0002 dyne per sq cm, at the threshold of hearing and 1,000 dynes per sq cm, at the threshold of feeling.

2.2 NATURE OF SOUND WAVES

Sound is propagated through the atmosphere by a wave motion which is longitudinal in character, the air particles having an

MICROPHONES

oscillatory displacement along the axis of propagation. When we speak of particles, we imply elementary air masses each being very small, but containing millions of molecules. The displacement of the particles may be represented graphically, with the convention that displacements in the direction of wave propagation are plotted as distances above a zero axis, and backward displacements as distances below the axis. Fig. 4 is drawn to this convention; the line AB may be taken to represent a very small portion of the

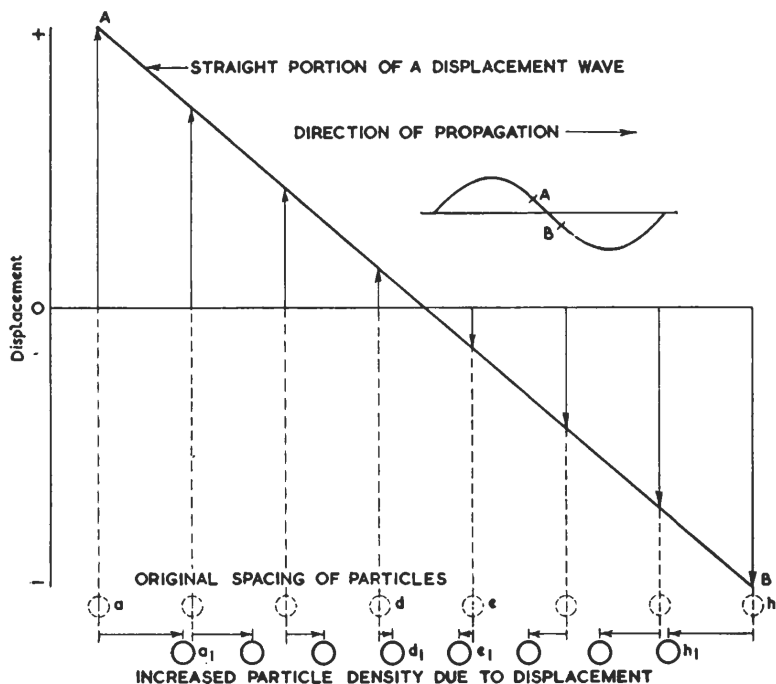

Fig. 4—INCREASED PARTICLE DENSITY (COMPRESSION)

straight part of a sinusoidal displacement wave (shown inset), in the region of zero displacement and negative slope, i.e., when the direction of displacement is changing from forward to backward. The particle density increases when the slope of the displacement wave is negative.

It can be seen from the diagram how particle density is increased in regions where forward displacement decreases with distance or where backward displacement increases with distance thus, particle *a* is displaced by an amount corresponding to the distance $a-a_1$, whereas particle *d* is only displaced by an amount corresponding to the distance $d-d_1$. Similarly there is a corresponding difference

between the backward displacements of particles *e* and *h*. This increase in particle density with negative slope of the displacement wave is usually called *compression*.

Fig. 5 illustrates another region where the displacement wave passes through zero with a positive slope. It can be seen that, in regions where the backward displacement decreases and forward displacement increases, the particle density decreases. This decrease in particle density is known as *rarefaction*.

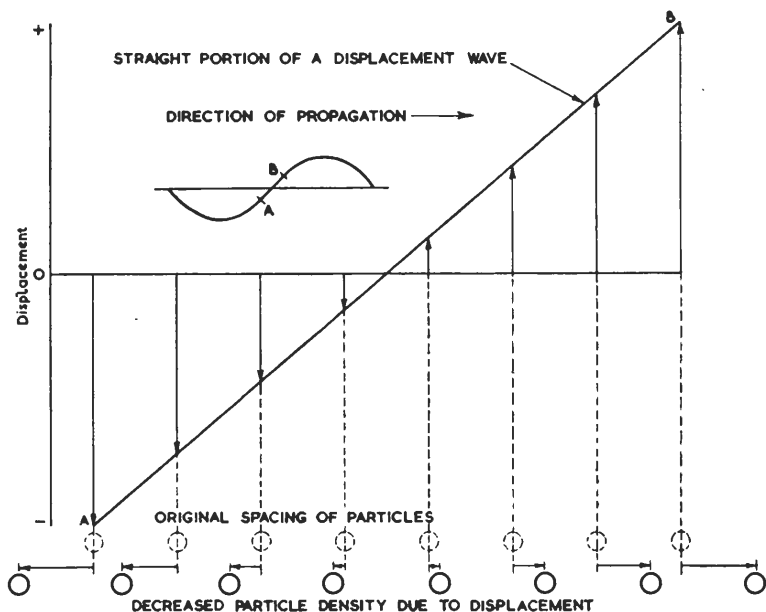

Fig. 5—DECREASED PARTICLE DENSITY (RAREFACTION)

Having established that particle density is increased in proportion to the negative slope of a displacement wave and decreased in proportion to the positive slope, we may proceed to draw a diagram of particle distribution along the axis of propagation of a sinusoidal displacement wave. In practice, the passage of sound causes a disturbance to a whole mass of particles in its path and not merely to a single string of particles; we should, therefore, refer to particle layers, as represented in Fig. 6.

The density of the particle layer distribution has been made to correspond to the slope of the displacement wave at each point in the propagation path; thus there is compression at C and G, which are points of maximum negative slope, and rarefaction at A and E, which are points of maximum positive slope. At points such as

MICROPHONES

B, D and F, where the displacement is either a positive or negative maximum, the slope is zero and the density of particle layer distribution has a normal value corresponding to the steady atmospheric

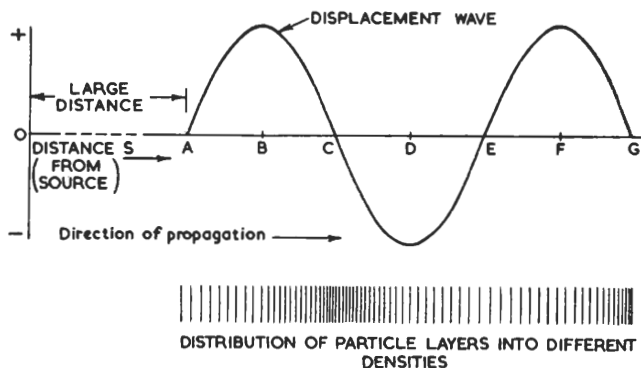

Fig. 6—DISPLACEMENT WAVE AND PARTICLE LAYER DISTRIBUTION

pressure. The conditions represented in Fig. 6 are those of so-called “plane-wave” propagation, i.e., the particle layers are flat.

From our knowledge of the particle layer distribution we are able to draw a diagram showing the sinusoidal pressure wave, because pressure is proportional to the number of particles per unit of volume; the sound pressure wave therefore has positive

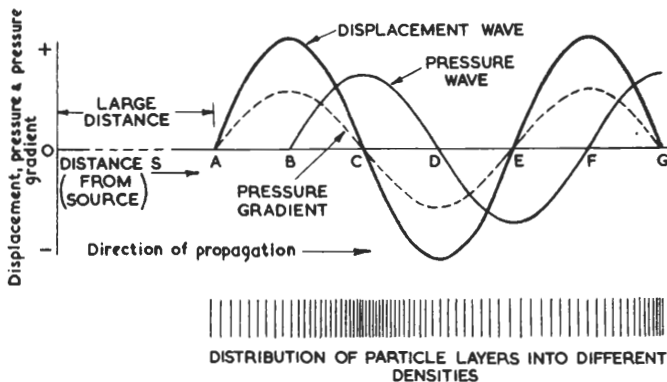

Fig. 7—DISPLACEMENT, PRESSURE AND PRESSURE-GRADIENT WAVES

Pressure and displacement waves are shown separated by $1/4\lambda$

values in regions of compression and negative values in regions of rarefaction. This is shown in Fig. 7, which illustrates the spacing of $\frac{1}{4}$ wavelength between the pressure and displacement waves and

shows the curve of another important quantity called the *pressure gradient* (rate-of-change of pressure with distance, dp/ds).

The pressure-gradient curve may be drawn without reference to the particle layers, since pressure gradient is given by the slope of the pressure wave. The slope of the pressure curve can be altered by varying either the pressure or the frequency. It is important to realise that although the pressure may be constant the pressure gradient will vary if the frequency is altered, for pressure gradient is proportional to frequency. With a sinusoidal pressure wave, the pressure-gradient wave is sinusoidal and displaced from the pressure wave by $\frac{1}{4}$ wavelength, as shown. From the examination which we have made of conditions in the medium at a particular instant, we are able to deduce the nature of the variations of pressure and other quantities, which occur with time at a point in the propagation path; that is to say, we see the phase relationships of the various quantities in a plane sound wave.

If we consider a point such as G, Fig. 7, we can see that continued propagation of the wave from left to right will immediately cause the

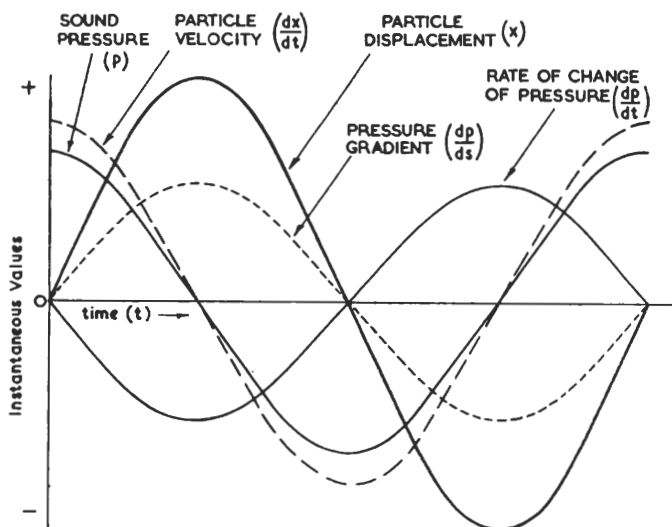

Fig. 8—PHASE RELATIONSHIP BETWEEN SINUSOIDAL QUANTITIES IN A PLANE WAVE

pressure at G to decrease, and the displacement and pressure gradient to increase. The various quantities will alternate in a manner which is sinusoidal with respect to time, as shown in Fig. 8. The zero point of the time scale in Fig. 8 corresponds to the instant for which conditions are depicted in Fig. 7.

MICROPHONES

Now that we have the waves plotted against time we can see that the pressure wave leads the displacement and pressure-gradient waves by an amount of time equal to $\frac{1}{4}f$ seconds, where f is the frequency of the sound (this corresponds to a phase difference of 90 degrees). We are also able to show the phase relationships of two other important quantities by drawing in the waves for rate-of-change of displacement x with time t (*particle velocity* dx/dt) and rate-of-change of pressure with time dp/dt . The slopes of the displacement and pressure curves increase with increase in frequency; consequently the rate-of-change of displacement (i.e., velocity) and rate-of-change of pressure are both proportional to frequency. The difference in height of the various curves has no particular significance, but has been arranged to make them more easily distinguishable.

2.3 VARIATION OF SOUND ENERGY AND PRESSURE WITH DISTANCE

If sound from a perfect point source is propagated equally in all directions, the wave-front has the form of a rapidly expanding spherical envelope. The term *spherical wave* is applied to this type of propagation, and since the total energy in the wave is almost constant, the energy per unit area of the sphere decreases as the wave expands.

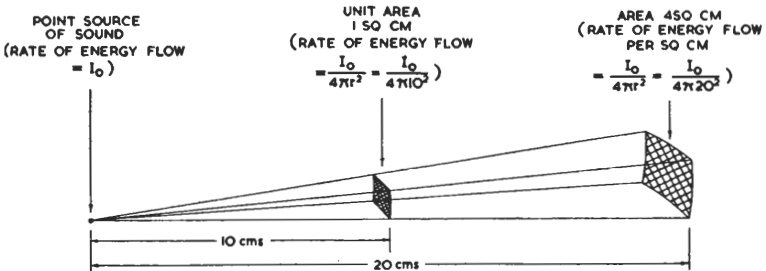

Fig. 9—ILLUSTRATING DECREASE IN SOUND ENERGY AS DISTANCE INCREASES

Assuming negligible absorption of the sound energy by the atmosphere, the rate of energy flow (or sound intensity I_0) per unit area is given by:—

$$I_0 = \frac{P_a}{4\pi r^2}$$

where P_a is the rate of production of sound energy at the point source (the acoustic power) and r is the distance from the point source (the radius of the spherical envelope).

Thus, even in conditions of zero absorption, the sound energy

per unit area decreases as the distance increases, in the manner illustrated in Fig. 9.

Practical sound sources do not produce perfect spherical waves, but a section of the wave-front may be similar in form to a portion of a sphere, and the energy is distributed in a uniform manner over an appreciable angle. (At large distances from the sound source, the curvature of the wave-front is so slight that for most purposes the wave is assumed to be plane.)

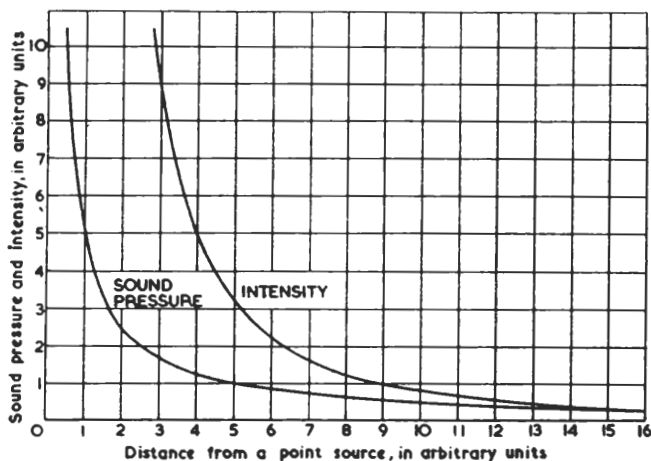

Fig. 10—ILLUSTRATING DECAY OF SOUND PRESSURE AND INTENSITY AS DISTANCE INCREASES

$$\text{Sound pressure} \propto \frac{1}{\text{distance}}$$

$$\text{Intensity} \propto \frac{1}{\text{distance}^2}$$

The rate of flow of energy, per unit area normal to the direction of propagation, is referred to as the *Sound Intensity*, the unit being one erg per second per square centimetre. The intensity represents the power in the wave, and is given by the formula:—

$$I_0 = \frac{p^2}{R_a}$$

where I_0 is Intensity Units (ergs per second per sq cm)
 p is the Sound Pressure in Bars (dynes per sq cm)
 R_a is the Specific Acoustical Resistance.

The Specific Acoustical Resistance is given by:—

$$R_a = \rho c$$

where ρ is the density of the medium (grammes per cubic cm)
and c is the velocity of propagation of the wave (cm per sec).

MICROPHONES

With atmospheric pressure corresponding to 760 mm of mercury, and a temperature of 20° C, the values of ρ and c are 0.0012 and 34,400 respectively. The product is generally taken as 42, and the formula for intensity then becomes:—

$$\text{Intensity Units} = \frac{(\text{Bars})^2}{42}$$

As the intensity is inversely proportional to the square of the distance r from the source, the pressure p is inversely proportional to r .

Thus:

$$I_o = \frac{P^2}{R_a}$$

$$\therefore \frac{P_a}{4\pi r^2} = \frac{p^2}{R_a}$$

$$\text{and } p = \frac{1}{r} \sqrt{\left(\frac{P_o R_a}{4\pi}\right)}$$

Fig. 10 shows graphically the decay of sound pressure and intensity with increase in distance. Sound pressure change over a given distance is much less when the distance to the sound source is great.

CHAPTER 3

OPERATIONAL FORCES

HAVING STUDIED THE PROPERTIES of a sound wave, we must now examine possible methods of obtaining force from the wave, to drive the moving system of a microphone.

There are two possible methods, which we will term *pressure operation* and *differential-pressure operation*. The appropriate method for a particular type of microphone depends upon whether it is of the constant-velocity or constant-amplitude class and the manner in which the mechanical impedance of the moving system varies with frequency. The subject of mechanical impedance and its variation with frequency is dealt with in a later section on electro-acoustics (page 37).

3.1 PRESSURE OPERATION

We have seen that the sound pressure due to a sound source of constant energy is constant for all frequencies, and, if absorption by the atmosphere is negligible and the wave is virtually unobstructed, the pressure at any point depends only on the distance from the source. A force which is substantially independent of frequency can therefore be produced by the difference between the sound pressure and the steady atmospheric pressure. A microphone designed to utilise this force has one side of the diaphragm exposed to the sound waves and the other in contact with an enclosed volume of air at steady atmospheric pressure. A small breather hole may be provided to ensure that the internal pressure is always equal to atmospheric pressure. This type of instrument is referred to as *pressure-operated*, and is very widely used; the direct-actuated crystal microphone of Fig. 2 is an example of pressure operation.

The r.m.s. force on the diaphragm (dynes) is equal to the product of the r.m.s. sound pressure (dynes per sq cm) and the area of the diaphragm (sq cm). The force is independent of frequency, provided that the diameter of the diaphragm is very small compared with the wavelength at all frequencies in the working range. If this condition is not fulfilled the force is changed at the higher frequencies.

3.2 DIFFERENTIAL-PRESSURE OPERATION

We have said that particle velocity, pressure gradient and rate-of-change of pressure in a wave are all proportional to frequency as well as to sound pressure. Because particle velocity and pressure gradient are proportional to frequency, the terms *velocity-operated* and *gradient-operated* are sometimes loosely applied to microphones which have both sides of the diaphragm exposed to the sound waves and thus derive an operating force which, within certain limits, is almost proportional to frequency.

When both sides of a diaphragm or ribbon are exposed to a sound wave, the pressures on the two sides do not coincide exactly in time. This is because of the time taken for the wave to travel from one surface of the diaphragm to the other. The difference of timing

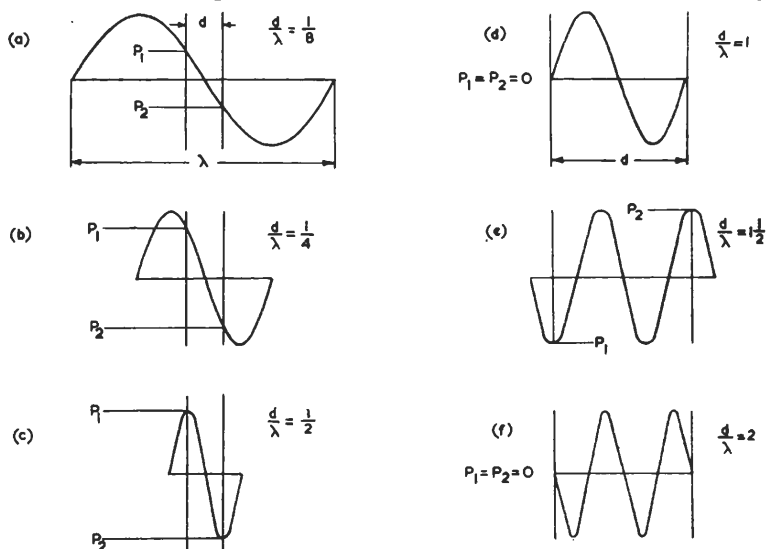

Fig. 11—DIFFERENTIAL-PRESSURE OPERATION: PATH-LENGTHS OF SOUND WAVES OF DIFFERENT LENGTHS

between the two pressures, which is referred to as a difference of phase or *phase-shift*, causes a force to be exerted on the diaphragm, corresponding at every instant to the difference between the instantaneous pressures on the two sides of the diaphragm. This difference of pressure, which may be termed the *differential pressure*, varies with frequency and depends on the ratio d/λ where d is the effective "path length" for the wave from front to rear of the diaphragm, and λ is the wavelength of the sound.

Fig. 11 represents sound-pressure waves of various lengths, the direction of propagation being from left to right. The path length,

corresponding to the propagation time from front to rear of the diaphragm, is constant throughout and is represented by the distance d between the vertical lines. (The scale for d and λ is enlarged in the diagrams (d), (e) and (f), just as the timebase of an oscilloscope is altered for the proper examination of waveforms with widely different frequencies.)

The maximum instantaneous force corresponds to the difference of pressure $p_1 - p_2$ caused by the steepest part of the pressure wave, as shown in diagram (a).

Diagram (b) represents the condition when the sound has a pitch one octave higher than for (a), i.e., when the frequency is doubled and the wavelength is halved. It will be seen that the force has almost doubled and is thus nearly proportional to frequency. At (c), another octave higher, the force is maximum, but has not increased in proportion to the frequency. Diagram (d) shows that the force is zero when the frequency is doubled again to produce the condition $d/\lambda = 1$.

Subsequent conditions of maximum force occur when higher values of d/λ are odd multiples of 0.5; the force is zero for whole numbers. These conditions are depicted in (e) and (f) for $d/\lambda = 1\frac{1}{2}$ and $d/\lambda = 2$.

It should be noted from the diagrams (a), (b) and (c) that the force is in the direction of propagation when the pressure gradient is negative (rate-of-change of pressure with time is positive); also that the force is proportional to the *average* slope of the pressure wave between the extremes of the path length, and therefore cannot correspond precisely to the magnitude of the pressure gradient (slope at a single point). Neither can the force correspond precisely to the particle velocity, which is proportional to pressure gradient, but of reversed phase (Fig. 8).

Expressions for the r.m.s. force on a completely exposed diaphragm are derived in Appendix 2. It is shown that the force is given by the following equation:—

$$\text{Force in Dynes (r.m.s.)} = 2Ap_{max} \sin \pi d/\lambda$$

where A is the area of one side of the diaphragm, in cms,
and p_{max} is the sound pressure, in bars.

The equation shows that if the frequency is low (λ large) and the path length d is small, the force on the diaphragm is practically proportional to d/λ , i.e., to the phase shift $2\pi d/\lambda$. This is because $\sin \pi d/\lambda$ is almost equal to $\pi d/\lambda$ for small values of the latter. At very low frequencies the force may be almost proportional to frequency, but the path length d (and consequently the force on the diaphragm) must be extremely small if the force is to be proportional to frequency over an appreciable frequency range.

MICROPHONES

The variation of force with ratio d/λ is shown graphically in Fig. 12. The dotted line has the same slope as the initial part of the force characteristic and shows the departure from proportionality between force and frequency.

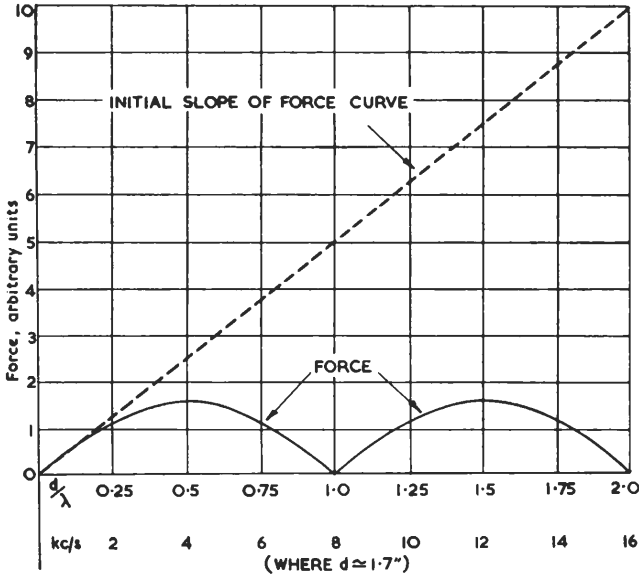

Fig. 12—DIFFERENTIAL-PRESSURE OPERATION WITH FREE PROGRESSIVE PLANE WAVES
Force plotted against d/λ (where $d = 1.7$ in)

There is a point of interest regarding the second hump of the force characteristic. It may be noted by reference to the equation for the force that, for values of d/λ between 1 and 2, the force is a negative quantity. Since we are concerned with the magnitude of an alternating quantity the negative sign merely indicates a reversal of phase with respect to the sound wave. The reversed phase is indicated for the condition $d/\lambda = 1\frac{1}{2}$ in diagram (e) of Fig. 11, where the instantaneous difference of pressure is such as to produce force in a direction opposite to that of the propagation. The alternating force due to differential pressure undergoes repeated reversals of phase as the value of d/λ passes through successive whole numbers.

It has been assumed so far that throughout the audio-frequency range the diaphragm is very small in relation to the wavelength, so that there is no appreciable obstruction of the wave. If the wave is obstructed, either by the diaphragm or an adjacent surface, the effective pressures on the diaphragm are changed owing to diffraction effects (page 48).

3.3 DIFFERENTIAL PRESSURE WITH SOUND AT AN ANGULAR INCIDENCE

The force due to differential pressure is dependent on the angle of incidence of the sound wave.

In Fig. 13, the path length between the two surfaces of the diaphragm is represented by a distance d between two points A and B. If the angle of incidence is θ , the acoustic separation or phase shift corresponds not to d but to the distance AC, equal to $d \cos \theta$.

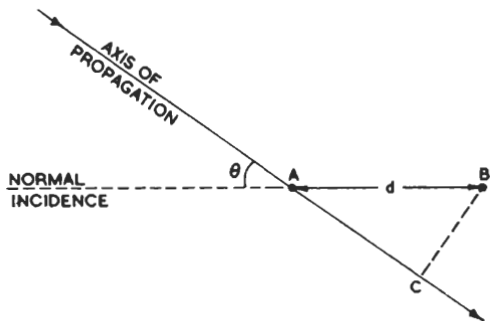

Fig. 13—ILLUSTRATING HOW RESPONSE DEPENDS ON $\cos \theta$

The phase shift from front to back of the diaphragm is therefore equal to $2\pi d/\lambda \cdot \cos \theta$ and, for plane waves at frequencies so low that diffraction effects are negligible, the complete expression for the force due to differential pressure is as follows:—

$$\text{Force in Dynes (r.m.s.)} = 2A p_{r.m.s.} \sin (\pi d/\lambda \cdot \cos \theta)$$

If θ is 90° , $\cos \theta$ is 0 and there is then no pressure difference on either side of the diaphragm and no force to set it in motion. At this angle of incidence the microphone is "dead."

3.4 INCREASE OF FORCE WITH LOW-FREQUENCY SPHERICAL WAVES

The frequency characteristic of the force due to differential pressure (shown for plane waves in Fig. 12) depends on the shape of the wave-front, which is virtually spherical if the microphone is operated close to a sound source having small dimensions.

For spherical waves, the force is increased considerably at very low frequencies. The increase depends not only on the distance r of the microphone from the sound source but also on the frequency; for frequencies corresponding to $r/\lambda=0.1$ or less, the increase of force is almost inversely proportional to frequency.

To understand the effect, it is best to consider the differential

MICROPHONES

pressure on the diaphragm, first for a plane-wave sound field and second, for a spherical wave.

3.4.1 PLANE WAVE CONDITION

For the plane-wave condition the pressure at the front of the diaphragm or ribbon is represented by the vector p_1 in Fig. 14 (a).

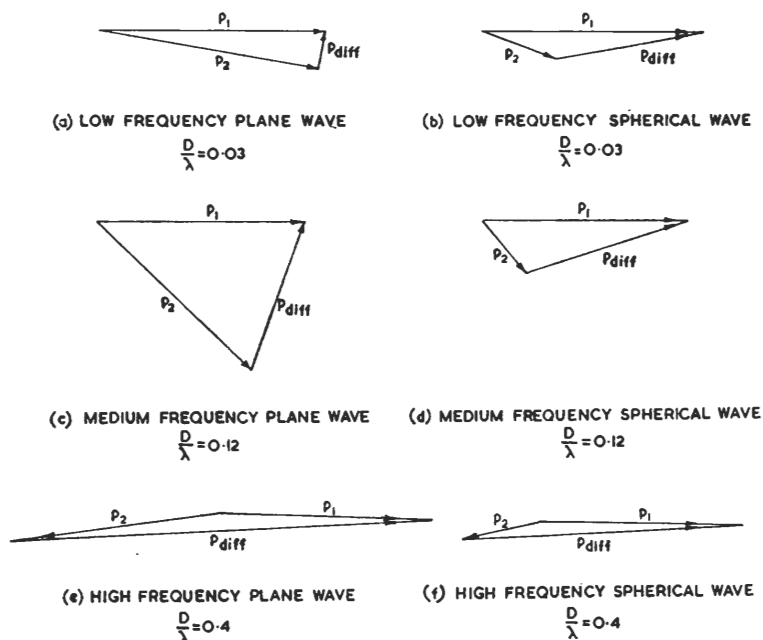

Fig. 14—DIFFERENTIAL PRESSURE WITH PLANE AND SPHERICAL WAVES: VECTOR COMPARISON

The pressure at the back of the diaphragm p_2 , lags on p_1 by an angle $\theta = kd$ where $k = 2\pi/\lambda$ and d the path length. At low frequencies the wavelength is large hence $\theta = 2\pi/\lambda d$ is small. This is the condition represented by Fig. 14 (a).

3.4.2 SPHERICAL WAVE

If now a point source of sound is situated at a distance r from the microphone and produces spherical waves the pressure p_1 (Fig. 14 (b)) on the front will be inversely proportional to r (see page 24) but the pressure p_2 on the back of the diaphragm will not only lag by angle $\theta = kd$ but will be smaller in magnitude since the back of the diaphragm is at a greater distance from the sound source than

the front $\left(p_1 \propto \frac{1}{r}; p_2 \propto \frac{1}{r+d} \right)$.

OPERATIONAL FORCES

At low frequencies θ is small; the difference in magnitude of the forces causes a large increase in the differential pressure and consequently a large output from the microphone actuated by the spherical wave. This can easily be seen if p_{diff} is compared for cases (a) and (b) in Fig. 14. At medium frequencies where the phase difference is appreciable the increase of the differential pressure is only slight (c) and (d). As the frequency is raised the pressure difference for the spherical wave becomes less than for the plane wave (e) and (f), and the output of the microphone falls.

The response of a differential-pressure microphone to spherical waves, expressed in terms of the response to plane waves, is given approximately for low frequencies by the ratio of the particle velocities in spherical and plane waves.

We have the two following equations:—*

$$(i) \text{ Ratio } \frac{\text{Particle Velocity}}{\text{Pressure}} = \sqrt{\frac{(1+k^2r^2)}{\rho ckr}} \text{ for a spherical wave}$$

where r = radius of curvature of the wave-front (the distance between the source and the microphone).

$$k = 2\pi/\lambda$$

$$\lambda = c/f$$

ρc = Specific Acoustical Resistance (page 23).

$$(ii) \text{ Ratio } \frac{\text{Particle Velocity}}{\text{Pressure}} = \frac{1}{\rho c} \text{ for a plane wave.}$$

From these equations we have:—

$$\begin{aligned} \text{Ratio } \frac{\text{Particle Velocity (Spherical Wave)}}{\text{Particle Velocity (Plane Wave)}} &= \sqrt{\frac{(1+k^2r^2)}{kr}} \\ &= \sqrt{\left\{1 + \left(\frac{1}{kr}\right)^2\right\}} \end{aligned}$$

For a differential-pressure microphone:—

Spherical-wave L.F. Response (in decibels relative to plane-wave

$$\text{L.F. response) } \quad 20 \log_{10} \sqrt{\left\{1 + \left(\frac{\lambda}{2\pi r}\right)^2\right\}}$$

$$\text{or } 20 \log_{10} \sqrt{\left\{1 + \left(\frac{c}{2\pi fr}\right)^2\right\}}$$

The so-called ribbon microphone is an example of a type which is operated by differential pressure. The ribbon is a very thin and flexible strip of metal, which is supported in a magnetic field and exposed to the sound waves on both sides.

To produce a strong magnetic flux in the plane of the ribbon, it is necessary to have two magnetic pole-pieces in close proximity

* Olsen: Elements of Acoustical Engineering (Equations 1.18, 1.22, 1.45).

MICROPHONES

to the edges of the ribbon (Fig. 15). The effective path for the sound waves, from front to rear of the ribbon, is around the pole-pieces; for very low frequencies it is equal to the shortest air distance between the ribbon surface centres, shown as the dimension d in Fig. 15. As can be seen, the path length depends on the cross-section of the pole-piece, which is relatively large in order to carry the magnetic flux.

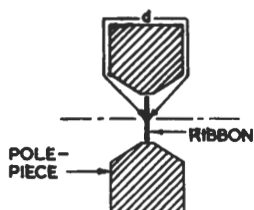

Fig. 15—CROSS-SECTIONAL REPRESENTATION OF RIBBON MICROPHONE : SHOWING EFFECTIVE PATH LENGTH, d , FOR VERY LOW FREQUENCIES

The BBC-Marconi ribbon microphone (described later) has an effective low-frequency path length of approximately 1.5 inches, and the force/frequency characteristic would be somewhat similar to that shown in Fig. 12, if it were not for the effects of diffraction and cavity resonance. For sinusoidal waves at the lowest frequencies, the force on the ribbon corresponds closely in magnitude and phase to the rate of change of pressure dp/dt , leading the

pressure and particle velocity in a plane wave by 90° (Fig. 9). With this type of microphone, the velocity of the conductor lags the applied force by approximately 90° , so that for low frequencies the generated e.m.f. has much the same phase as the particle velocity, besides being practically proportional to it.

CHAPTER 4

ELECTRO-ACOUSTICS

4.1 INTRODUCTION

IN THE DESIGN of a microphone, whether for constant velocity or for constant amplitude, the choice of pressure operation or differential-pressure operation depends on certain physical quantities which influence the velocity/frequency characteristic of the moving system. The velocity of the moving system for a given driving force depends on mass, compliance and friction, which are present in any mechanical or acoustical system. The study of the effects of mass, compliance and friction is facilitated if the system is represented by an equivalent electrical circuit, based on analogies between electrical and mechanical quantities.

4.2 ELECTROMECHANICAL ANALOGIES

Force acting on a mechanical system is analogous to *Voltage* (*Electromotive-Force*) in an electrical system. Force exerted on a movable body or system causes motion, which is analogous to the movement of electrons in a conductor due to the application of a voltage; hence the *Velocity* of a mechanical system is analogous to *Current* in a circuit.

The mass of a body is the amount of matter contained therein, and determines the weight of the body. *Mass* in a mechanical system is analogous to *Inductance* in an electrical circuit; the inertia of the mass opposes changes of velocity in a mechanical system, just as inductance opposes changes of current in an electrical circuit.

If the mass m has attained a velocity v under the action of a force the energy stored is $\frac{1}{2} mv^2$.

When a current has been established in an inductance, the energy in the circuit is $\frac{1}{2} LI^2$.

The compliance of a mechanical system may be defined as the amount of deflection or displacement, caused by a unit value of applied force. It is the reciprocal of stiffness, and a large value of compliance indicates that the system is easily flexed. *Compliance* in a mechanical system is analogous to *Capacitance* in an electrical circuit; it has the property of accepting and storing the energy expended in the process of deflection. If the deflecting force is

MICROPHONES

withdrawn, the stored energy is released, in a manner similar to the discharge of a capacitor.

Resistance (or "damping") in a mechanical system is analogous to resistance in an electrical circuit. Mechanical resistance is generally caused by friction, but in microphones of the moving-coil type it can be produced by eddy-current damping.

To maintain a mechanical system in a state of vibration, there must always be an applied force sufficient to overcome mechanical resistance. The force required is proportional to the product of the velocity and the resistance, just as the voltage applied to an electrical resistance is proportional to the product of current and resistance.

Let us now consider the relationship between these analogies and certain fundamental laws of linear motion, and see how this relationship can be applied to determine the velocities and amplitudes of simple harmonic motion which occurs in the moving systems of microphones. (A derivation of the analogies from the equations for simple harmonic motion is given in Appendix 3.)

4.2.1 MASS AND INDUCTANCE

If we have a mass m , free from friction, and accelerating because of an applied force F , the law of motion, by Newton's second law, is $F=ma$, where a is the acceleration. The acceleration is the rate of change of velocity, and we may write:

$$F=m \times \text{rate of change of velocity}$$

$$F=m \frac{dv}{dt} \quad \dots \dots \dots \quad (1)$$

If a voltage V is applied to an inductance L , the relationship between voltage V and current i is given by the expression:

$$V=L \times \text{rate of change of current}$$

$$V=L \cdot \frac{di}{dt} \quad \dots \dots \dots \quad (2)$$

The equations (1) and (2) are of identical form, and we may conclude that:

Force is analogous to Voltage.

Mass is analogous to Inductance.

Velocity is analogous to Current.

4.2.2 COMPLIANCE AND CAPACITANCE

If a spring, having a coefficient of stiffness S , has one end fixed and its length is compressed by application of a force to the free end, the amount of movement of the latter point may be termed the

ELECTRICAL			MECHANICAL			ACOUSTICAL		
<i>Quantity</i>	<i>Symbol</i>	<i>Unit</i>	<i>Quantity</i>	<i>Symbol</i>	<i>Unit</i>	<i>Quantity</i>	<i>Symbol</i>	<i>Unit</i>
Pressure	V	Volt	Force	F	Dyne	Pressure	p	Dyne per sq cm
Current	I	Ampere	Velocity	v	cm per second	Volume current	U	cu cm per second
Power	P	Watt	Power	P_m	Erg per second	Power	P_a	Erg per second
Charge	Q	Coulomb	Displacement	x	cm	Volume Displacement	X	cu cm
Resistance	R	Ohm	Resistance	R_m	Dyne-sec per cm (Mech. ohm)	Resistance	R_a	Dyne-sec per cm ⁵ (Acous. ohm)
Capacitance	C	Farad	Compliance	C_m	cm per dyne	Capacitance	C_a	cm ⁵ per dyne
Inductance	L	Henry	Mass	m	Gram	Inertance	M	gram per cm ⁴
Reactance	X	Ohm	Reactance	X_m	Mechanical ohm	Reactance	X_a	Acoustical ohm
Impedance	Z	Ohm	Impedance	Z_m	Mechanical ohm	Impedance	Z_a	Acoustical ohm
Electromagnetic Energy	W	Joule	Kinetic Energy	W_m	Erg	Kinetic Energy	W_a	Erg
Electrostatic Energy	W	Joule	Elastic Energy	W_m	Erg	Potential Energy	W_a	Erg

TABLE OF ANALOGIES

plotting the reciprocal of the impedance. If required, the frequency characteristic of amplitude can be obtained from that of velocity, by means of the relationship $x = V/\omega$.

4.4 MECHANICAL IMPEDANCE OF A SIMPLE SYSTEM

A simple mechanical system is represented in Fig. 16 (a). A cylindrical mass m is capable of movement along the axis of a tube. It is subject to mechanical resistance R_m , due to contact with the surface of the tube, and is connected by a spring, of compliance C_m , to a fixed outer bracket.

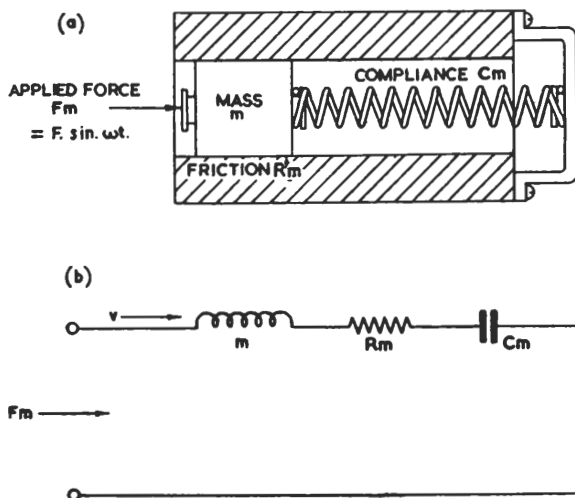

Fig. 16—(a) SIMPLE MECHANICAL SYSTEM
(b) EQUIVALENT ELECTRICAL CIRCUIT

An alternating force $F_m = F \sin \omega t$ is applied to the system and a reciprocating movement is produced, which is a simple harmonic motion because F_m is sinusoidal. The compliance C_m is subjected to a velocity equal to that of the mass m , since one end of the spring is attached to the mass and the other is in a fixed position. The mechanical resistance R_m must be associated with the same velocity as the mass because it is due to friction between the mass and the wall of the tube.

Since there is a common velocity for the three elements of the system, we must represent them by elements connected in series, when drawing the equivalent circuit (Fig. 16 (b)).

For an electrical circuit, with inductance, capacitance, and resistance, all in series, we have:

MICROPHONES

$$I = \frac{V}{Z} = \frac{V}{R + j \left(\omega L - \frac{1}{\omega C} \right)}$$

where $\omega = 2\pi f$, and V and I are r.m.s. values.

For the series equivalent circuit of a mechanical system, we may write:

$$v = \frac{F_m}{Z_m} = \frac{F_m}{R_m + j \left(\omega m - \frac{1}{\omega C_m} \right)}$$

or

$$v = \frac{F_m}{\sqrt{\left\{ R_m^2 + \left(\omega m - \frac{1}{\omega C_m} \right)^2 \right\}}}$$

where F_m and v are r.m.s. values, and all quantities are in the units given in the table of analogies.

We can see that, for a constant value of the force F_m , the velocity v is proportional to the reciprocal of the impedance Z_m .

Example

A moving-coil microphone has a magnetic flux density B of 15,000 lines per square centimetre, and the effective length l of the moving conductor is 100 centimetres. At 1,000 c/s, the moving system has the following effective series values of mass, compliance and resistance: $m = 0.2$ gram, $C_m = 0.000023$ centimetres per dyne, $R_m = 50$ dyne seconds per centimetre = 50 mechanical ohms.

Find the r.m.s. velocity and amplitude of vibration, and the open-circuit voltage generated in the coil, when the diaphragm is subjected to a sinusoidal alternating force of 25 dynes (r.m.s.) at 1,000 c/s.

$$\text{Velocity} = \frac{F_m}{Z_m} = \frac{F_m}{\sqrt{\left\{ R_m^2 + \left(\omega m - \frac{1}{\omega C_m} \right)^2 \right\}}}$$

$$\text{We have } F_m = 25; R_m = 50$$

$$\omega = 2\pi \times 1000 = 6280$$

$$\omega m = 6280 \times 0.2 = 1256;$$

$$\frac{1}{\omega C_m} = \frac{1}{6280 \times 0.000023} = 7$$

$$\therefore v_{r.m.s.} = \frac{25}{\sqrt{\left\{ 50^2 + (1256 - 7)^2 \right\}}} = \frac{25}{1250}$$

$$= 0.02 \text{ cms per second}$$

ELECTRO-ACOUSTICS

$$\text{Amplitude, } x, = \frac{v}{\omega}$$

$$\text{We have: } v=0.02; \omega=6280$$

$$\therefore x_{r.m.s.} = \frac{0.02}{6280} = 0.00000318 \text{ cm}$$

$$\text{Generated voltage } V = Blv \times 10^{-8}$$

$$\text{We have: } B=15,000; l=100;$$

$$v=0.02$$

$$\therefore V_{r.m.s.} = 15,000 \times 100 \times 0.02 \times 10^{-8} =$$

$$0.0003 \text{ volts}$$

4.5 MECHANICAL IMPEDANCE OF A COMPLICATED SYSTEM

The moving system of a microphone may be much more complicated than the system shown in Fig. 16 and the equivalent circuit may therefore differ considerably from the simple series circuit.

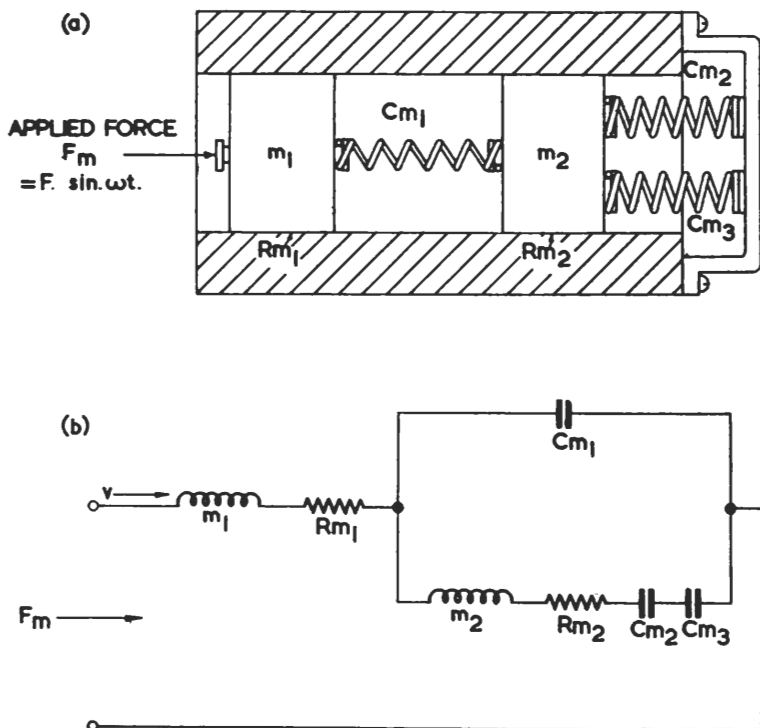

Fig. 17—(a) COMPLICATED MECHANICAL SYSTEM
 (b) EQUIVALENT ELECTRICAL CIRCUIT

When drawing the equivalent circuit for a complicated system, we must be careful to observe the following cardinal principle:—

Only those elements having a common velocity in the mechanical system may be represented by elements connected in series in the equivalent circuit.

It follows that for a mechanical system with several elements subjected to difference velocities, the equivalent circuit must have a number of parallel branches; the total current through the circuit represents the velocity at the point of application of the force.

Fig. 17 represents a complicated mechanical system. Two cylindrical masses, m_1 and m_2 , are located within a tube and coupled by a spring C_{m_1} . This assembly is connected by two springs C_{m_2} and C_{m_3} to a fixed outer bracket. Friction between the wall of the tube and the masses m_1 and m_2 causes mechanical resistance, represented by R_{m_1} and R_{m_2} respectively.

The total velocity of the system (velocity at the point of application of the alternating force) is the velocity of the mass m_1 , with associated resistance R_{m_1} ; in the equivalent diagram m_1 and R_{m_1} are shown in series with the remainder of the circuit.

The velocity of the spring C_{m_1} , at any instant, is the difference between the velocities of m_1 and m_2 ; consequently C_{m_1} and m_2 are shown in two separate branches of the equivalent circuit, together making up the total velocity corresponding to the velocity of m_1 and R_{m_1} .

The springs C_{m_2} and C_{m_3} have a common velocity with the mass m_2 and its frictional resistance R_{m_2} ; all four elements are shown in series in the equivalent diagram. The effective compliance for the lower branch of the circuit is equal to $(C_{m_2} \times C_{m_3}) / (C_{m_2} + C_{m_3})$.

The equivalent diagram makes it clear that there are not only different magnitudes of velocity in the various parts of a complicated system, but, to an extent depending on the frequency, there are differences of phase between the motions of the various elements.

4.6 EQUIVALENT CIRCUITS FOR COMPOSITE MECHANICAL-ACOUSTICAL SYSTEMS

When drawing an equivalent circuit for a composite mechanical-acoustical system, the principles governing the series or parallel connections are the same as those for the mechanical system.

For the purpose of calculations based on the equivalent diagram, it is necessary to convert the acoustical quantities into equivalent mechanical values, as described in Appendix 4. If, for example, the force acting on a system is due to a sound wave, we have $F_m = pA$.

where p is the effective sound pressure

and A is the area of application of pressure.

Fig. 18 (a) represents a composite system, with mechanical properties of mass, compliance, and friction and a large additional stiffness due to the small compliance of an enclosed volume of air. The application of the alternating force F_m causes the mass m to have a velocity which is not only common to C_m and R_m , but also to the acoustical compliance, C_a , whose value in equivalent mechanical units we will call C_{ma} . In the equivalent circuit (Fig. 18 (b)), we show all four elements in series, because of their common velocity.

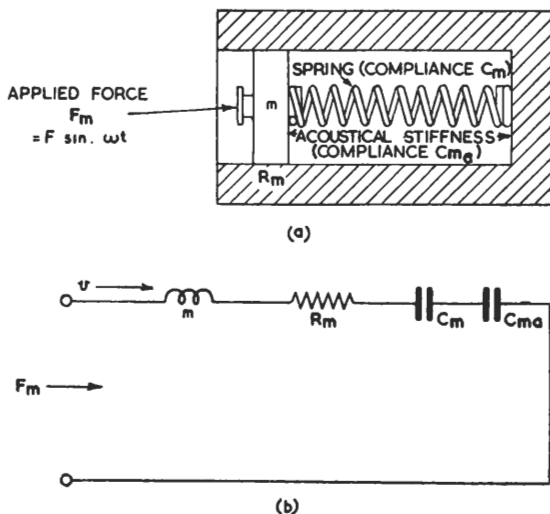

Fig. 18—(a) SIMPLE MECHANICAL-ACOUSTICAL SYSTEM
(b) EQUIVALENT ELECTRICAL CIRCUIT

The effective compliance is given by $(C_m \times C_{ma}) / (C_m + C_{ma})$ and, if C_{ma} is very small, the effective compliance is very small. By placing the mechanical and acoustical compliances in series, the frequency of resonance of the mechanical system is raised; with condenser microphones this principle is sometimes used to raise the frequency of resonance to a point above audibility.

The moving parts of a microphone may have mass, compliance and friction in such proportion as to have a serious effect on the response/frequency characteristic, unless some correction of the mechanical impedance/frequency characteristic is arranged. For this purpose, it is usual to employ acoustical impedances coupled to the moving system, and the composite mechanical-acoustical system so formed may be very complicated; as, for example, that of the S. T. & C. microphone Type 4017A, represented by the equivalent circuit of Fig. 19.

MICROPHONES

The quantities m_d , C_{m_d} and R_{m_d} are due to actual mechanical elements; all others are due to acoustical elements.

This system has a fairly constant mechanical impedance over a large part of the audio-frequency range. The only purely mechanical elements in the system are represented by m_d , C_{m_d} and R_{m_d} , the constants for the diaphragm and moving-coil assembly; the rest of the network is due to various acoustical impedances.

In such equivalent circuits, it is usual for the constants which are due to acoustical elements to be represented by the ordinary mechanical symbols m , C_m and R_m ; but the values, if shown, must be mechanical equivalents of the actual acoustical values (see Appendix 4).

4.7 RESONANCE IN MECHANICAL SYSTEMS

4.7.1 ANALOGY BETWEEN MECHANICAL AND ELECTRICAL RESONANCE

Resonance in a series electrical circuit occurs when the effective reactance $\omega L - 1/\omega C$ is zero. The current is then limited only by the resistance R , and is equal to V/R . The precise frequency of resonance is given by $f_r = 1/2\pi\sqrt{LC}$ but the peak in the current/frequency characteristic is not sharp if, at frequencies on either side of resonance, the resistance R is large compared with the reactance $\omega L - 1/\omega C$.

Resonance in a simple mechanical system such as that of Fig. 16 occurs when the series mechanical reactance $\omega m - 1/\omega C$ is zero. The velocity is then limited only by the mechanical resistance R_m and is equal to F_m/R_m . The precise frequency of resonance is given by $f = 1/2\pi\sqrt{mC_m}$ but the peak in the velocity/frequency characteristic is not sharp if, at frequencies on either side of resonance, the resistance R_m is large compared with the series mechanical reactance $\omega m - 1/\omega C_m$.

Resonance in the moving system of a microphone is, in general, undesirable. Since, at any given frequency, amplitude is proportional to velocity, a peak in the velocity/frequency characteristic is accompanied by a peak in the amplitude/frequency characteristic. Thus with any microphone, whether of the constant-velocity or constant-amplitude class, the excessive velocity due to resonance causes a peak in the response/frequency characteristic.

It is not entirely satisfactory to compensate electrically for the effects of mechanical resonance, because the relatively large amplitude of motion in the moving system is likely to cause harmonic generation, or transient distortion. Electrical circuit arrangements are sometimes introduced to compensate for minor imperfections

in the motional characteristic, but it is a prerequisite that the latter is reasonably free from the effects of resonance.

The effects of resonance may be made negligible by one of three methods. The method used depends on whether the microphone is in the constant-velocity or the constant-amplitude class and whether pressure operated or differential-pressure operated. The three possible methods are as follows:—

1. *Resistance control* (Resonance within the working range, but heavily damped).
2. *Mass control* (Resonance at a frequency much lower than the lower limit of the working frequency range).
3. *Compliance control; sometimes called stiffness control* (Resonance at a frequency much higher than the upper limit of the working frequency range).

4.7.2 RESISTANCE CONTROL (and constant-impedance systems)

The aim of this arrangement is to keep the mechanical impedance Z_m at an almost constant value throughout the frequency range. It is impossible to do this when there is only the one condition of resonance due to m and C_m , unless R_m is very large compared to the net reactance $\omega m - 1/\omega C_m$ even at the extremes of the range.

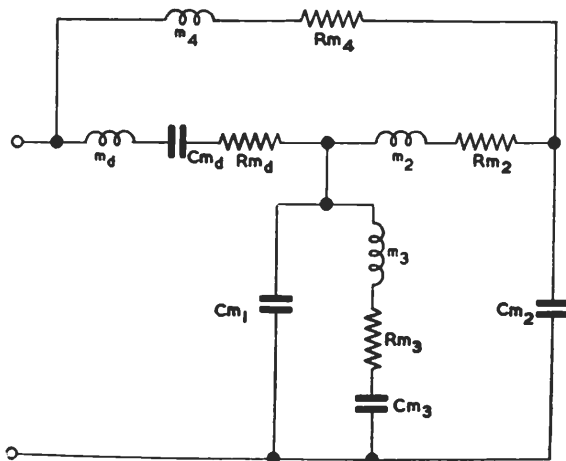

Fig. 19—EQUIVALENT CIRCUIT FOR MECHANICAL-ACOUSTICAL SYSTEM: S. T. & C. MICROPHONE 4017A

A very large value of R_m results in low sensitivity of the microphone, and, to avoid the use of a large amount of damping, acoustic reactances and resistances may be coupled to the moving element.

By such means, the mechanical impedance is kept substantially

constant throughout the frequency range and the velocity produced by a constant driving force is then fairly independent of frequency.

If the microphone is the constant-velocity type (e.g., moving-coil), the driving force must be constant, and is therefore obtained by pressure operation. An example is the S. T. & C. microphone Type 4017A, with pressure operation of the composite system of Fig. 19.

For a constant driving force, the velocity of a resistance-controlled system is constant and the displacement amplitude is inversely proportional to frequency. The combination of pressure operation and constant mechanical impedance is not therefore suitable for microphones of the constant-amplitude class. If a microphone of this class (such as condenser or crystal microphone) has a mechanical impedance substantially independent of frequency, then differential-pressure operation must be arranged, so that driving force is proportional to frequency and the displacement amplitude therefore constant.

4.7.3 MASS CONTROL

If the product mC_m is made large enough, the frequency of resonance, given by $f_r = 1/2\pi\sqrt{mC_m}$ is much lower than the lowest frequency of the working range. At frequencies greater than about three times the frequency of resonance, the net reactance $\omega m - 1/\omega C_m$ is not very different from the mass reactance ωm . If, at the lowest frequency of the range, R_m is small compared with ωm , the mechanical impedance Z_m is almost entirely reactive, and is practically proportional to frequency over the working range. Thus the velocity is given fairly accurately by $v = F_m/\omega m$, and because ωm is a mass reactance, we say that the system is *mass controlled*.

Since the velocity is inversely proportional to frequency, for a constant driving force, such a system is not suitable for pressure operation. The driving force must be proportional to frequency to maintain constant velocity; consequently differential-pressure operation is necessary. An example is the BBC-Marconi ribbon microphone (page 66).

4.7.4 COMPLIANCE CONTROL

By arranging for the effective value of the product mC_m to be very small, we can ensure that the frequency of resonance is well above the highest frequency of the working range. We cannot achieve this solely by choice of materials and dimensions for the moving element, because the requirements of extremely small mass and compliance are, to some extent, in conflict. We can, however, arrange for the mass to be very small, and a low value of the effective compliance C_m can be obtained by coupling an acoustical capacitance

MODE OF CONTROL	PRESSURE OPERATED Pressure independent of frequency				PRESSURE-GRADIENT OPERATED Pressure proportional to frequency			
	<i>Velocity</i>	<i>Amplitude</i>	<i>Type of Microphone</i>	<i>Polar Diagram</i>	<i>Velocity</i>	<i>Amplitude</i>	<i>Type of Microphone</i>	<i>Polar Diagram</i>
Resistance Controlled	Constant	$\propto \frac{1}{f}$	Moving Coil	Omni-Directional	$\propto f$	Constant	Double sided Condenser	Bi-directional
Mass Controlled	$\propto \frac{1}{f}$	$\propto \frac{1}{f^2}$	—	—	Constant	$\frac{1}{f}$	Ribbon	Bi-directional
Compliance Controlled	f	Constant	Crystal Carbon Condenser	Omni-Directional	$\propto f$	$\propto f^2$	—	—

TABLE SHOWING MODE OF CONTROL FOR DIFFERENT CLASSES OF MICROPHONES

MICROPHONES

in series with the actual compliance of the moving element, in the manner represented in Fig. 18.

At frequencies below that of resonance, the net reactance of a series circuit is negative, i.e., the capacitive reactance predominates. For the mechanical system, we should say that the compliance reactance predominates. If the frequency of resonance is much higher than the highest frequency of the working range, the net reactance $\omega m - 1/\omega C$ at the latter frequency is almost equal to the compliance reactance $1/\omega C_m$; if R_m is relatively small, the impedance through the working range is given, fairly accurately, by $Z_m = 1/\omega C_m$, and we say that the system is *compliance controlled*.

The velocity, for a constant driving force, is then practically proportional to frequency, as for a perfect constant-amplitude system. Therefore the amplitude due to a constant driving force is substantially constant and the system is suitable for a pressure-operated, constant-amplitude microphone.

The direct-actuated crystal microphone (Fig. 2) is an example of pressure operation of a compliance-controlled system. The complete enclosure of the back of the crystal element causes the effective compliance to be very small, due to the stiffness of the pocket of trapped air.

In the table on page 45 the more important information given under the three previous sub-headings is summarised, and examples are given of common microphones that employ the principles outlined therein. There are other microphones which combine pressure operation and pressure-gradient operation; the mechanical system of these is usually complex and their inclusion in this table would lead to confusion.

CHAPTER 5

DIAPHRAGM OPERATION

5.1 INTRODUCTION

IN THIS CHAPTER we shall try to show how the physical dimensions of the diaphragm and the shape of the microphone housing affect the mean pressure acting on the diaphragm; these factors have an important bearing on the frequency response and directional characteristics of the microphone.

5.2 DIAPHRAGM DIMENSIONS

Most types of microphones are fitted with a diaphragm to provide a coupling between the moving element and the acoustic pressure. The force exerted on the diaphragm is proportional to the product of sound pressure and diaphragm area; it acts upon the moving system as a whole including the additional mass, compliance and mechanical resistance due to the diaphragm itself. The mechanical impedance of the diaphragm should be as low as possible for a given area, because the main consideration is to produce a velocity as high as possible for a given sound pressure. The diaphragm must be sufficiently rigid to ensure a piston-like movement; there must be flexibility at the junction of the diaphragm and casing. Little advantage is gained by using a large diaphragm, with its proportionately large mass, for the increase in force thus obtained is not accompanied by a proportionate increase in velocity, because of the greater mass reactance of the diaphragm; if the latter is large enough to be responsible for most of the mechanical impedance, the velocity cannot be increased to any appreciable extent by further increase in diaphragm area.

There are, moreover, very serious objections to the use of a large diaphragm, and the choice of dimensions must take into account the three following acoustical effects:—

- (i) Diffraction
- (ii) Phase difference across the diaphragm
- (iii) Cavity resonance.

5.3 DIFFRACTION

5.3.1 EFFECTS OF DIFFRACTION

Diffraction is the term applied to the distortion of the wave-front when an obstacle is present in the sound field; this distortion is most marked when the obstacle is large compared with the wavelength of the sound, for the distribution of pressure on the diaphragm will be very different from that of free space.

When a sound impinges on an obstacle in its path, the normal free-field conditions are disturbed, for a secondary wave is produced and is scattered from the surface of the obstacle. If the obstacle is large compared with the wavelength, it acts as a reflecting surface, and a portion of the scattered wave is reflected or returned against the original wave. The magnitude of the reflected wave is approximately equal to the incident wave; these two waves produce a standing wave in front of the obstacle, the maximum amplitude of the standing wave being twice that of the original plane wave. This is the phenomena of *pressure doubling*.

That portion of the scattered wave which is produced behind the obstacle is concentrated in such a way as to interfere destructively with the original sound field there, reducing the sensitivity in that region and producing a sharp-edged shadow.

It often happens in sound problems that the object is small compared with the wavelength; pressure doubling and the sharp-edged shadow are then absent because the scattered wave is not concentrated in front of, or behind the object, but is sent out uniformly in all directions. In intermediate cases, where the size of the object and the wavelength are comparable, a variety of interesting phenomena occur; these will be discussed later.

The diffraction will be negligible at the lower audio frequencies for a microphone whose dimensions are of the order of two or three inches; when the frequency is increased, diffraction becomes important, and if the diaphragm faces the sound source, the pressure on it will be greater than that in free space, whilst those portions of the microphone remote from the sound source will be in the region of shadow or reduced pressure.

So far, our argument has been confined to sound at normal incidence, the front of the object being the surface nearest to the source of sound. If the microphone housing is not spherical, diffraction will vary also with the angle of incidence. Diffraction, therefore, not only affects the response/frequency characteristics of a microphone, but has an important bearing on its directive properties; furthermore, both response/frequency characteristic and directional property are influenced by the physical shape of the object.

DIAPHRAGM OPERATION

When studying the effects of diffraction, it is customary to consider the pressure p at a particular point of interest on the surface of an object, in relation to the pressure p_0 of the sound wave, at the same point, when unobstructed by an obstacle; we will call p_0 the *free-space pressure*.

We can now examine the effects of diffraction for objects of different shapes, bearing in mind that for any given shape, the effects vary as D/λ varies (D =frontal dimensions of the object and λ =the wavelength of the sound) and also as the angle of incidence varies.

The effects may be shown graphically for several angles of incidence, with the pressure ratio p/p_0 plotted as a function of D/λ . The graphs shown in the following sections are based on data for plane-wave conditions, but the effects are very much the same whether the waves are plane or spherical.

5.3.2 DIFFRACTION CAUSED BY A SPHERICAL OBJECT

The calculated diffraction by a sphere for various values of D/λ at different angles of incidence is indicated in Fig. 20. In this figure, the pressure ratio p/p_0 is given for a single point, A, on the surface of the sphere, A being the point which, at normal incidence, is nearest to the sound source.

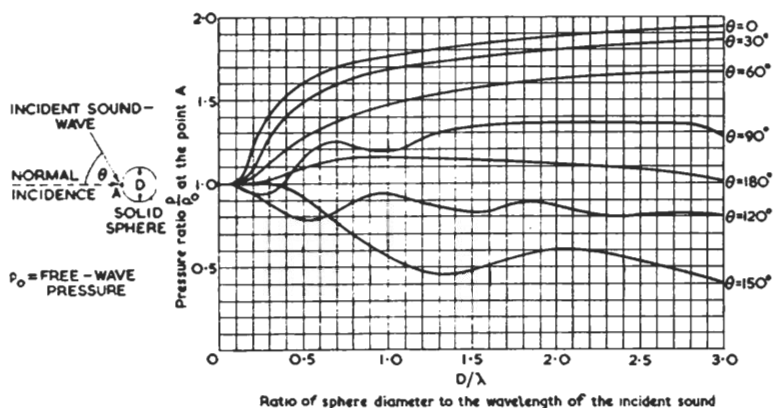

Fig. 20—DATA OF DIFFRACTION BY A SPHERE

It will be seen that, for the smaller angles of incidence ($0-60^\circ$) p/p_0 increases rapidly as D/λ attains a measurable value; it continues to rise, but more steadily, after $D/\lambda=1$, until when D/λ reaches 3.0, the pressure attains almost double the free-wave value. This is what is meant by the term *pressure-doubling*; it is an important consideration, for we shall see later that, when the surface is flat

instead of spherical, the pressure may increase to more than twice the free-wave pressure for the same variations in D/λ .

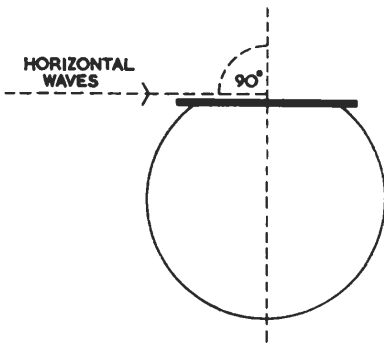

Fig. 21—MICROPHONE WITH DIAPHRAGM IN PLANE OF HORIZONTAL WAVES

The curve for $\theta=90^\circ$ is particularly interesting, for at this incidence the pressure remains reasonably uniform for values of D/λ above 1.5 but without pressure-doubling effect. This feature has considerable practicable significance: the most important components in a sound field are usually the horizontal waves; if a microphone is placed so that its diaphragm is always in the plane of the horizontal waves (Fig. 21), the effective value of θ

will be 90° for these waves, whatever the direction of the sound source. Such a microphone, therefore, would have the same diffraction for all angles of incidence; a practical example is discussed on page 80.

The values of p/p_0 for incidence greater than 90° are also of interest. The ratio falls as low as 0.4 for $\theta=150^\circ$ and $D/\lambda=3.0$, but the curve for $\theta=180^\circ$ shows that when A is the point most remote from the sound source, the pressure at A is not less than the free-wave pressure for all values of D/λ between 0-3.0; indeed over most of this range the ratio p/p_0 is greater than 1.0.

So far we have been concerned with the pressure at a given point on the surface of the spherical object. We must now turn our attention to the distribution of pressure over the surface of the object, for it is this distribution which determines the most suitable size for a microphone diaphragm.

Because of the circular symmetry of the sphere, pressure distribution over the surface can be shown by means of a polar diagram based on the data supplied in Fig. 20. Such a diagram is drawn in Fig. 22 in which values of p/p_0 are plotted as concentric circles and radial lines are drawn at angles varying from 0- 180° ; these diagonal lines form polar angles over the surface of the sphere, and are correlated to the angles of incidence shown in Fig. 20. We may therefore use the data from Fig. 20 to plot pressure values at different points on the surface of the sphere where the polar angles intercept the circles representing p/p_0 values. A smooth curve drawn through these points gives us a pictorial representation of the pressure distribution over the surface; in Fig. 22 three such curves are shown for three different values of D/λ .

MICROPHONES

uniform for a wide range of incidence, the value of p/p_0 remaining above unity for angles up to 90° ; the peak pressure around 180° will be flattened, so that the mean pressure on the diaphragm will be less than unity. If, however, the diameter of the diaphragm is less than about one-third the diameter of the sphere, the mean pressure at angles of incidence in the region of 180° will be above unity.

5.3.3 DIFFRACTION CAUSED BY A CYLINDRICAL OBJECT

The pressure ratio for the centre of the end surface of a cylinder is shown in Fig. 23 as a function of the ratio D/λ , for various angles of incidence.

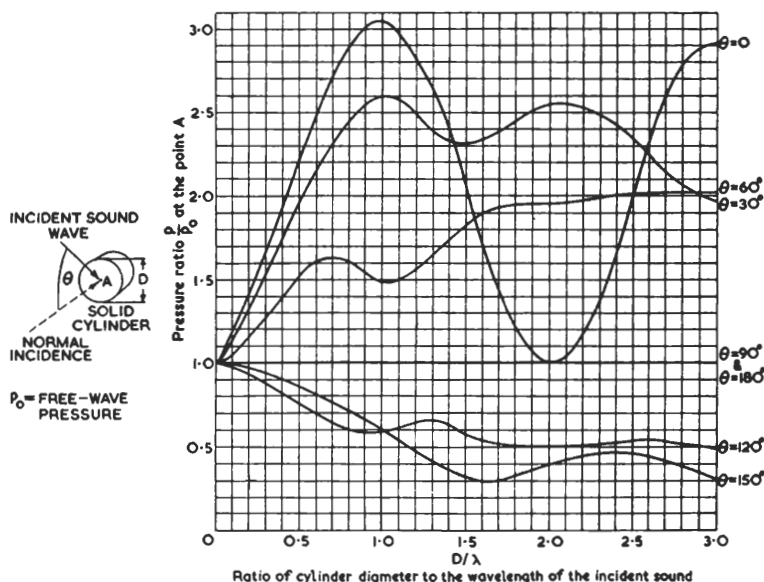

Fig. 23—DATA FOR DIFFRACTION BY A CYLINDER

It should be noted first, that at a frequency where $D/\lambda=1$, the pressure ratio is approximately 3.0 for normal incidence compared with 1.0 at frequencies where $D < \lambda$; this corresponds to a difference of approximately 10 db in microphone output for different frequencies at normal incidence. Secondly, when $D/\lambda=1$, and the angle of incidence $\theta=120^\circ$ to 150° , the pressure ratio is as low as 0.6, compared with 3.0 for the same D/λ when $\theta=0$; this represents a difference in pressure ratio of 5 : 1, or approximately 14 db in microphone output for one frequency at different angles of incidence.

DIAPHRAGM OPERATION

Thus, for a relatively small diaphragm at the centre of the end surface of a cylindrical microphone, the response/frequency characteristic may vary by as much as 10 db; for the same diaphragm, when $D/\lambda=1$, the response/direction characteristic may vary by 14 db. If these figures are compared with Fig. 22, it will be seen that the pressure distribution on a sphere is much more uniform as D/λ varies, and for a given frequency where $D/\lambda=1$, the maximum difference in pressure ratio between $\theta=0$ and $\theta=180^\circ$ is approximately 3.0, which is equivalent to a variation in response/direction characteristic of 10 db.

Experimental investigations of pressure distribution indicate that the diameter of the diaphragm of a cylindrical microphone should be a large fraction of the outer diameter (unless the latter is too small to cause appreciable obstruction of sound waves).

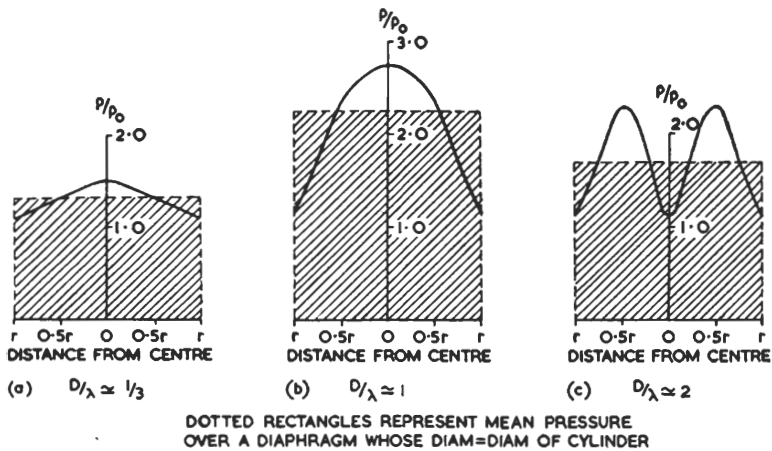

Fig. 24—APPROXIMATE REPRESENTATION OF PRESSURE DISTRIBUTION ON THE FLAT END SURFACE OF A CYLINDER OF RADIUS r , WITH SOUND AT NORMAL INCIDENCE

The pressure distribution across the front surface of a cylinder, with sound at normal incidence, is represented approximately in Fig. 24, for various values of D/λ .

In the range of D/λ from 0 to 1 the pressure distribution is fairly even over a central circular area, of diameter half that of the cylinder; beyond this limit the pressure falls away to approximately free-wave value at the outer edge. The use of a diaphragm covering most of the front surface will therefore minimise the effect of the rise of pressure up to $D/\lambda=1$. In the range D/λ from 1 to 3 the centre point of the front surface is, so to speak, in a crater of low pressure, with the pressure rising sharply to a ring-like crest, at a

distance from the centre equal to half the radius of the cylinder; then falling again towards free-wave pressure at the edge. In this range of D/λ the advantage of a relatively large diaphragm is quite definite, since the average pressure on a large diaphragm will be much more independent of frequency than is the pressure at the centre point.

The horizontal straight line shown in Fig. 23 for 90° and 180° incidence is indicative of two important features:—

(a) 90° incidence

The diffraction caused by a surface at right angles to the wave-front is, theoretically, zero. Because of this, at normal incidence the magnitudes of the pressures at front and rear surfaces are fairly independent of the thickness of the obstacle; in fact, the pressure ratios for a thin rigid disk are taken as similar to those of a cylinder of the same diameter, but having considerable length.

(b) 180° incidence

As has been shown for the sphere, there is a central area at the rear surface of the obstacle where the pressure is of the same order as the free-wave value. The diameter of this area decreases with increase of frequency, and at large values of D/λ it is roughly equal to the wavelength, the pressure ratio at the centre point being constant at unity for all frequencies.

Secondary Radiation

The central area of the rear surface where the pressure is approximately that of free space has been termed the acoustic *bright spot* (Fig. 25); the existence of a similar effect in the shadow of a disk obstructing light rays was predicted by Poisson and later observed by Arago. The area of the acoustic bright spot varies with frequency and although its diameter is of the order of a wavelength immediately behind the disk it increases in diameter as the distance from the disk is increased until it eventually terminates the sound shadow.

It has been suggested that this bright spot is due to the secondary radiation from the edge of the obstacle. It is assumed that the radiation is similar to that which would be obtained from a series of point sources situated along the edge; and for the disk, sphere or cylinder the radiation directed towards the centre arrives in phase in that region producing the bright spot. Obviously an interference pattern results from the combination of the original sound field and the edge radiation. Thus the sound shadow behind the disk is not uniform in intensity but varies in a regular manner giving rise to "bright" and "dark" rings. The length of the shadow is proportional to the frequency and the square of the diameter, i.e.,

DIAPHRAGM OPERATION

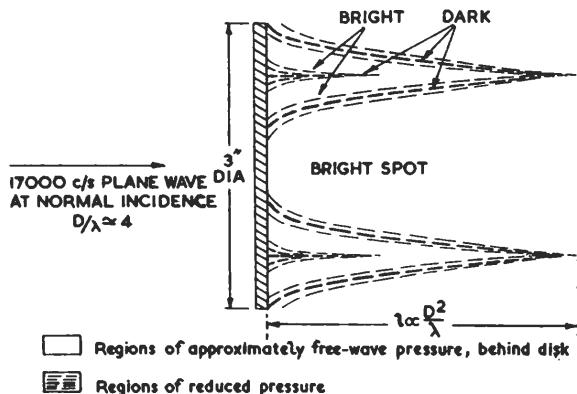

Fig. 25—APPROXIMATE CROSS-SECTIONAL REPRESENTATION OF SOUND SHADOW BEHIND A RIGID DISK

proportional to D^2/λ . The nature of the sound-shadow, in the space at the rear of a cylindrical obstacle, may be assumed similar to that of the disk (Fig. 25). The special diffraction properties of the disk are discussed in Appendix 5.

5.3.4 DIFFRACTION CAUSED BY RECTANGULAR OBJECT

The data shown for the cube (Fig. 26) may be taken as representative for other rectangular obstacles, the dimension W being the lesser of the two frontal dimensions, if different. The thickness dimension has little effect on the pressure ratios at the centres of front and rear surfaces, and the data shown for normal incidence may be assumed to apply to a rigid rectangular baffle, however thin. The thickness dimension does of course introduce an equivalent phase angle, corresponding to the propagation time for the distance from front to rear (as also for the cylinder and other shapes).

Fig. 26 shows that the pressure for normal incidence is approximately trebled at $W/\lambda=1$, and this may be taken as characteristic of an obstacle with a flat surface at the front. In the diagrams for both cylinder and cube it is noticeable that the undulations of the curves show a tendency to decrease in amplitude as D/λ or W/λ becomes greater than 3.0. It is reasonable to assume that the undulations of the curves are further reduced as λ decreases, the ratio p/p_0 tending to an ultimate steady value of 2.0 at very high frequencies.

In general the curves of Figs. 23 and 26 show that there is little to choose between the cube and the cylinder for the shape of a

MICROPHONES

microphone. The curve for 180° incidence (Fig. 26) shows that up to $W/\lambda=1$ there is a definite "bright" area in the central part of the rear surface, although the pressure in that region decreases steadily with further increase of W/λ . This brightness is explained by the symmetry of the rectangular boundary, various distances from the centre being common to various groups of points on the outer edge; so that the secondary radiation from the edges has some cumulative effect at the centre.

The magnitude of the pressure in the central region of the rear surface is an important factor in the functioning of a ribbon

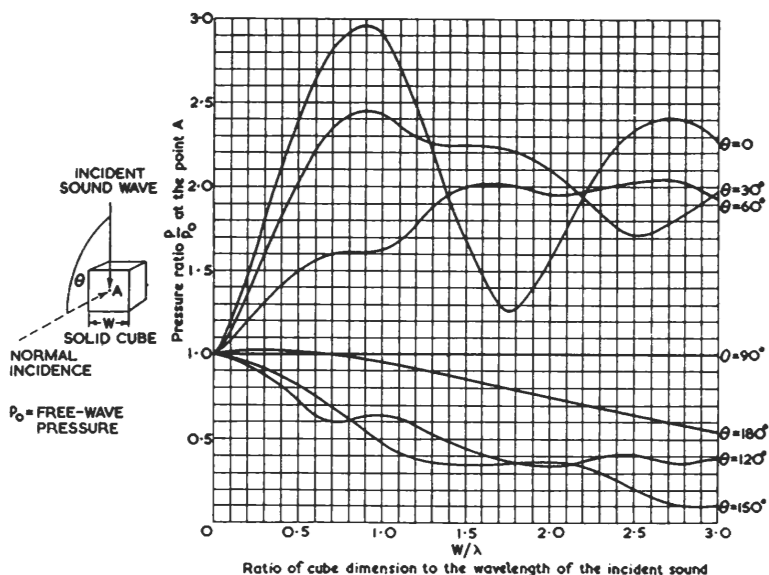

Fig. 26—DATA FOR DIFFRACTION BY A CUBE

microphone, where the front and rear surfaces of the ribbon occupy small central areas of what is in effect a rectangular baffle, formed by the pole-pieces and ribbon. The large frontal pressure, rising to thrice free-space value at $W/\lambda=1$, in conjunction with unity pressure at the rear and the incidental conditions of phase, has a profound influence on the frequency range of response. For values of W/λ greater than 1 the frontal pressure does not decrease sufficiently to equal the pressure at the rear: for example, in Fig. 26, at $W/\lambda=1.65$, the pressure ratio at the front is as 1 : 1.3, and at the back as 1 : 0.8; so that whatever the conditions of phase, the differential pressure cannot fall to zero; consequently there is no "extinction frequency" at which output is zero.

DIAPHRAGM OPERATION

5.3.5 DIFFRACTION AND MICROPHONE DIMENSIONS

In concluding the subject of diffraction, the following points must be emphasised:—

1. The frontal dimension of the microphone is of great importance and must be kept as small as possible, if the effective pressure on the diaphragm is to be approximately equal to the free-wave pressure throughout the audio-frequency range.

2. The front surface of a pressure-operated microphone should be rounded as far as possible, to avoid the larger increase of pressure which occurs with a flat surface. The sphere is the best

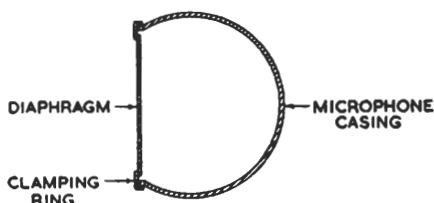

Fig. 27—SPHERICAL MICROPHONE WITH LARGE FLAT DIAPHRAGM

shape for a microphone, as far as diffraction effects are concerned, the variation of effective pressure with variation of sound incidence being less than for other shapes. If the diaphragm diameter is made a large fraction of the spherical casing diameter (in order to minimise the effects of sound incidence variation), then the diaphragm should be of a spherical shape; with a large flat diaphragm, such as represented in Fig. 27, much of the advantage of a spherical shape would be lost, the diffraction effects corresponding more closely to those of the cylinder.

3. The shape of the outer rim, edge, or boundary, is of less importance, but it does influence the pressure distribution on the rear surface. This frequently results in a greater microphone output for an incidence of 180° than for, say, 150° .
4. The graphs for the various shapes show that the pressure ratio at 90° incidence is unity for the cylinder and cube and little greater than unity for the sphere. Because of this, a microphone of almost any shape with the diaphragm facing vertically upward (Fig. 21), will preserve the free-space pressure of horizontal waves (usually the most important components of the sound field). This arrangement is satisfactory if the diaphragm is fairly small, but with a large diaphragm the high-frequency response to the horizontal waves may be seriously reduced by the effect of phase difference across the diaphragm, which will now be discussed.

5.4 PHASE DIFFERENCE ACROSS A DIAPHRAGM

When a flat diaphragm is subjected to a plane wave at normal incidence, the effective pressure on the diaphragm is equal to the

MICROPHONES

sound pressure if diffraction is ignored. With angles of incidence other than zero or 180° the effective diaphragm pressure is less than the sound pressure, because there are differences of phase across the diaphragm surface.

The phase-difference effect with a flat diaphragm and plane-wave propagation is illustrated in Fig. 28, which represents instantaneous conditions of maximum pressure at the centre of the diaphragm.

In Fig. 28 (a) the wavelength is several times the diaphragm diameter, and the pressure at the outer edges is approximately equal to the pressure at the centre, as indicated by the ordinates drawn as arrows in the sinusoidal wave diagram. For these conditions of frequency and incidence, the loss of effective pressure is very

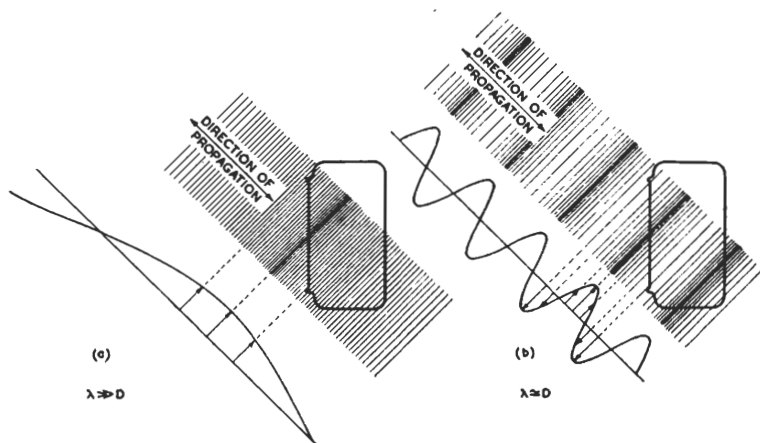

Fig. 28—EFFECT OF PHASE DIFFERENCE ACROSS DIAPHRAGM

- (a) Wavelength \geq Diaphragm diameter
 (b) Wavelength \leq Diaphragm diameter

slight, but at a higher frequency, where the wavelength may be comparable with the diaphragm diameter, the loss of driving force on the diaphragm becomes considerable. This is shown in diagram (b) where the centre of the diaphragm is at maximum positive pressure, and the outer regions of its surface are at maximum negative pressure. The effect grows more severe as the wavelength becomes small relative to the diaphragm dimension.

The loss of effective pressure caused in this way is the same for any two opposite directions of propagation, as indicated by the double-headed arrows drawn for the axes of propagation in the figure; thus, for instance, it is the same at incidence -135° and $+135^\circ$, as at incidence $+45^\circ$ and -45° . The loss increases from zero at normal and 180° incidence to a maximum at 90°

DIAPHRAGM OPERATION

incidence, the phase difference across the diaphragm, at a given frequency, being proportional to the projection of the diaphragm dimension on to the axis of propagation, i.e., proportional to the sine of the angle of incidence, as well as to frequency and diaphragm dimension.

The nature of the effect is similar for a diaphragm which is other than circular, although its magnitude may be slightly different. With a very narrow and relatively long diaphragm, such as that of a ribbon microphone, the phase-difference effect is different for different planes. If a ribbon microphone is mounted in the conventional manner, with the length of the ribbon vertical, the phase-difference effect is quite negligible throughout the audio range for any angle of horizontal wave, but is appreciable for waves having a frequency of say 6,000 c/s or more (λ less than ribbon length) and whose direction of propagation is approximately along the length of the ribbon (e.g., waves reflected from the ceiling or floor of a studio). For planes intermediate between horizontal and vertical, there is some phase-difference effect, depending on angle of incidence and frequency.

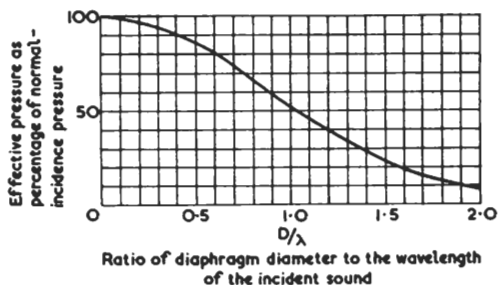

Fig. 29—PHASE-DIFFERENCE DATA FOR INCIDENCE OF 90°

The effective pressure on a circular diaphragm, expressed as a percentage of the normal incidence pressure, is shown for the condition of 90° incidence, as a function of the ratio D/λ (Fig. 29).

The graph shows how serious is the reduction of operating force for transverse sounds having a wavelength comparable with the diameter of the diaphragm; for example, with a two-inch diaphragm there is a 6-db discrimination against a 7,000-c/s signal ($D/\lambda = 1$) at 90° incidence.

The effects of diffraction variation and phase difference across the diaphragm combine to make the high-frequency response of a microphone greater for normal incidence than for 90° incidence. The diffraction variation increases the response to sound sources in front of the microphone and phase difference reduces the response to sound from the side, although in this sense their effects are

cumulative; for some microphones there are intermediate angles of incidence at which the increase of pressure due to diffraction variation just compensates for the reducing effect of phase difference, making the operating force almost independent of frequency. This provides an explanation for the "oblique" technique practised by radio announcers using the earlier types of microphone.

With almost any pressure-operated microphone the reproduction of unpleasant sibilants in a speaker's voice may be reduced by positioning the microphone so that the angle of incidence is approximately 90° .

5.5 CAVITY RESONANCE

A common arrangement for clamping the edge of a diaphragm is shown in Fig. 30. The clamping-ring serves to locate the diaphragm in its correct position and also prevents access of sound to the rear surface.

The presence of the clamping ring in front of the diaphragm causes a cylindrical cavity, the air of which has inertance, compliance, and resistance. With usual diaphragm dimensions, the frequency of the main resonance of the cavity is within the audio range and

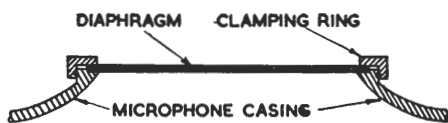

Fig. 30—DIAPHRAGM CLAMPED BY ANNULAR RING

there is a pronounced increase in pressure on the diaphragm at this frequency; there are also other frequencies of resonance, as with waves in a pipe, but their effects are slight and may be ignored.

Resonance occurs when the wavelength is approximately equal to the circumference of the cavity, i.e., when the wavelength is from 2 to 3 times the diameter.

The rise of effective pressure at the diaphragm, in proportion to the acoustical Q , depends on the depth d of the cavity (Fig. 31), and if the cavity resonance effect is to be negligible the depth must be a very small fraction of the diameter ($1/10$ or less), as shown in Fig. 30. This type of resonance was a most potent cause of bad performance from early microphones with deep cavities.

The cavity resonance effect is largely independent of the angle of incidence of the sound, and may therefore be put to advantage in the design of some microphones to extend the range of response at the higher frequencies.

The output of a constant-velocity type pressure-operated microphone decreases beyond some upper frequency limit; because

DIAPHRAGM OPERATION

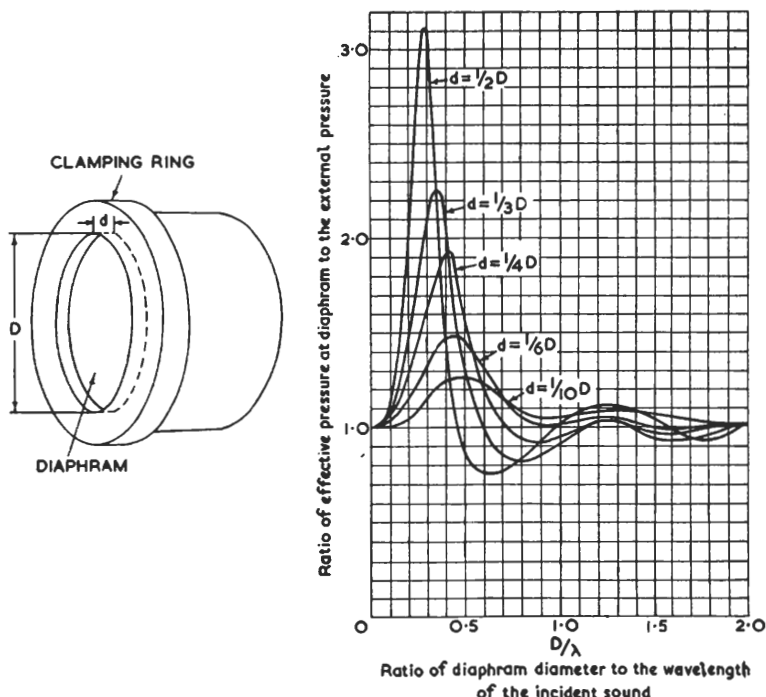

Fig. 31—RESONANCE DATA FOR CYLINDRICAL CAVITIES OF MODERATE DEPTH

whatever arrangements are made to secure constant mechanical impedance, the mass reactance of the moving system eventually predominates, reducing velocity and output at the high frequencies. The diaphragm may however have an appreciable cavity at the front, depth and diameter being carefully chosen so that the effect of mass reactance is offset, up to a very high frequency, by the increase of pressure due to cavity resonance. Any arrangement of this nature requires a particularly small diaphragm, for Fig. 31 shows that the effective pressure will only increase up to $D/\lambda=0.5$ (or less, according to depth). The diameter must therefore be from $1/3$ to $1/2$ of λ at the highest frequency required.

5.6 DIMENSIONS OF HIGH-QUALITY PRESSURE-OPERATED MICROPHONES

In designing a microphone to have a response/frequency characteristic independent of the angle of sound incidence, it is necessary to exercise a strict control over the dimensions of the outer casing, the diaphragm and the diaphragm cavity. To limit the phase-difference effect to 6 db at 15 kc/s (50 per cent loss of the pressure

MICROPHONES

occurs at $D/\lambda=1$) the diameter of the diaphragm must be less than one inch, and for diffraction effects to be moderate the dimension of the outer casing (preferably spherical) should be less than two inches. The depth of the frontal cavity should be very small for a constant-amplitude type, of the order of .05 inch or less; for some constant-velocity types making use of cavity resonance effects, the depth of cavity may be much greater.

For acoustical research work requiring sound pressure detectors which are completely omni-directional and cause negligible obstruction of sound waves, small crystal microphones made from a block of lithium salt have been developed with frontal dimensions of an eighth to one-quarter of an inch.

5.7 POLAR DIAGRAMS

The directional characteristics of a microphone are usually represented by means of a polar diagram. The output levels for various angles of incidence are plotted at distances from a central

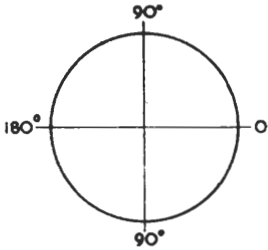

Fig. 32 — POLAR DIAGRAM FOR PERFECT OMNI-DIRECTIONAL MICROPHONE

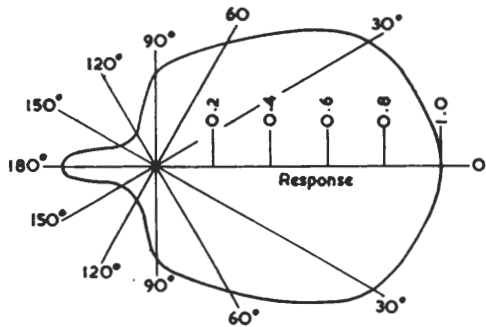

Fig. 33 — POLAR DIAGRAM FOR CYLINDRICAL MICROPHONE WITH SMALL DIAPHRAGM CONCENTRIC ON AXIS

origin which is at the point of intersection of the axes. Thus for a perfect omni-directional microphone the diagram is a circle, as shown in Fig. 32.

The variations of output are usually represented by means of a percentage or fractional scale, the reference level being some convenient arbitrary value for normal incidence. For certain purposes a decibel scale may be used.

For a cylindrical-shaped microphone with a small central diaphragm the polar diagram for the higher frequencies is approximately as shown in Fig. 33. This is the polar representation of the data given in Fig. 23 for the diffraction of the cylinder at $D/\lambda=1$.

In the explanation of differential-pressure operation it was shown how the difference of phase between the pressures at front

DIAPHRAGM OPERATION

and rear of the diaphragm is proportional to the cosine of the angle of incidence of the sound. The response at low frequencies is therefore proportional to $\cos \theta$ and if the latter is plotted for all angles of θ up to 90° on each side of normal incidence, a circle is produced which passes through the origin. Continued plotting for all angles greater than 90° on each side gives another circle occupying the remainder of the diagram (Fig. 34).

The positive and negative signs indicate that the output of a differential-pressure operated microphone undergoes a phase change of 180° when the microphone is turned from a position facing the sound source to a position facing away. The output falls to zero as the incidence becomes 90° , and with continued rotation grows again rapidly with the phase reversed.

The diagram is usually called a "figure-of-eight" diagram and the difference of phase for the two halves is important. The polar diagram for the higher frequencies differs slightly from Fig. 34 and at the highest audio frequencies the shape of the directional characteristic is influenced by diffraction and phase-difference effects.

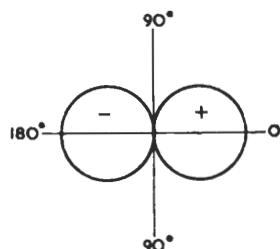

Fig. 34—POLAR DIAGRAM FOR DIFFERENTIAL-PRESSURE MICROPHONE AT LOW FREQUENCY

5.8 CARDIOID CHARACTERISTICS

Combination of pressure operated and differential-pressure operated units in one microphone, enables a cardioid characteristic to be obtained, which sometimes has useful application. The two units act in series, and acoustical or electrical arrangements ensure that the voltages are in phase for sound sources in front of the microphone; for sound from the rear the voltages are in anti-phase, and cancellation occurs according to their magnitudes. This is illustrated in Fig. 35, in which the polar diagram for the pressure-operated unit is represented by a circle, and that for the differential unit by the figure-of-eight. Since, in the diagram, the circle has been assigned a positive phase, the resultant cardioid characteristic is positive. In practice, the sense of the cardioid may be made positive or negative, by making the sense of the pressure-operated unit positive or negative.

Fig. 35 is representative of a microphone having two units with equal sensitivity to sound at normal incidence. With most cardioid microphones there is some arrangement by which the relative magnitudes of the two individual voltages can be altered. The adjustment may be acoustical, involving the alteration

DIAPHRAGM OPERATION

(a) SENSITIVITY OF PRESSURE
UNIT REDUCED 6db

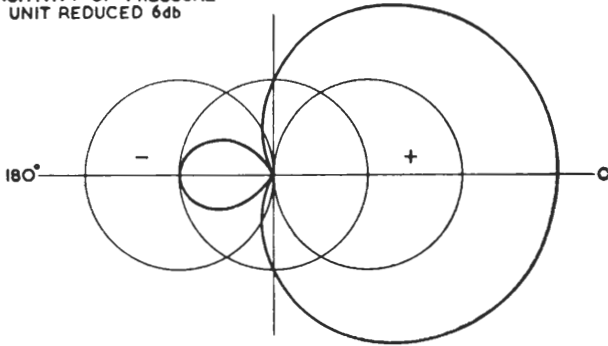

(b) SENSITIVITY OF DIFFERENTIAL
PRESSURE UNIT REDUCED 6db

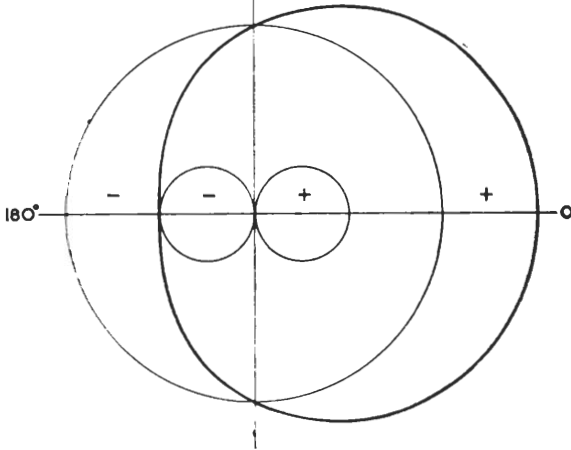

Fig. 36—TWO POSSIBLE POLAR DIAGRAMS FOR AN ADJUST-
ABLE CARDIOID MICROPHONE

For example, a microphone with a pure cardioid characteristic has a directional efficiency of $1\cdot3$ and the voltage response to indirect sound is $1/\sqrt{3}$ of that given by an omni-directional microphone. In general, a cardioid microphone can, for the same ratio of direct/indirect pick-up, be used at a distance from the sound source $\sqrt{3}$ times as great as with an omni-directional microphone.

The use of a microphone which facilitates a more distant technique may be more convenient for some kinds of broadcast production, but for the purpose of a high-quality broadcast the polar diagram of the microphone must be substantially independent of frequency; this requirement is not generally fulfilled by cardioid microphones.

CHAPTER 6

STUDIO MICROPHONES

6.1 BBC-MARCONI RIBBON MICROPHONE

6.1.1 GENERAL DESCRIPTION

THIS IS A HIGH-GRADE MICROPHONE with a wide frequency range, designed for high-quality broadcasting from a studio; it is an example of differential-pressure operation of a mass-controlled system.

An extremely thin ribbon of beaten aluminium foil (approximately $\cdot 00003$ in thick) supported at its ends is suspended in a strong field of a permanent magnet system, and is exposed to sound waves at both sides. The length of the ribbon is approximately $2\frac{1}{2}$ in. and there are very shallow corrugations (concertina-fashion) at right angles to the length. The corrugations facilitate a smooth adjustment of the tension of the ribbon. The clamping and tensioning arrangements at the ends of the ribbon can be seen in Fig. 37, together with the pole-pieces which distribute the magnetic flux uniformly in the plane of the ribbon and at right angles to its length.

Since the length of the ribbon and the magnetic flux-density are constants, the generated e.m.f. is proportional to velocity. Though the generated e.m.f. is independent of the ribbon material, the electrical resistance of the ribbon determines the necessary turns ratio for the matching transformer. The voltage delivered to the output load is proportional to the transformer turns ratio and therefore:—

Output Voltage $\propto \sqrt{\left(\frac{Z_2}{Z_1}\right)}$ where Z_2 is the output circuit impedance and Z_1 is the ribbon impedance.

It follows that, for a given value of the impedance Z_2 , the sensitivity is proportional to $1/\sqrt{Z_1}$ and it is an advantage to have the ribbon impedance as low as possible.

Aluminium is used for the ribbon because its resistance for a given mass is lower than that of any other suitable material. The latest type of ribbon, which is termed *x-foil*, has an impedance which is virtually a pure resistance of approximately 0.6 ohm.

The corrugations of the ribbon give it freedom to vibrate in the manner of a piano string, in a plane at right angles to the surface. There is thus a possibility of harmonic modes of vibration at multiples of the fundamental ribbon resonance, but this is of little

STUDIO MICROPHONES

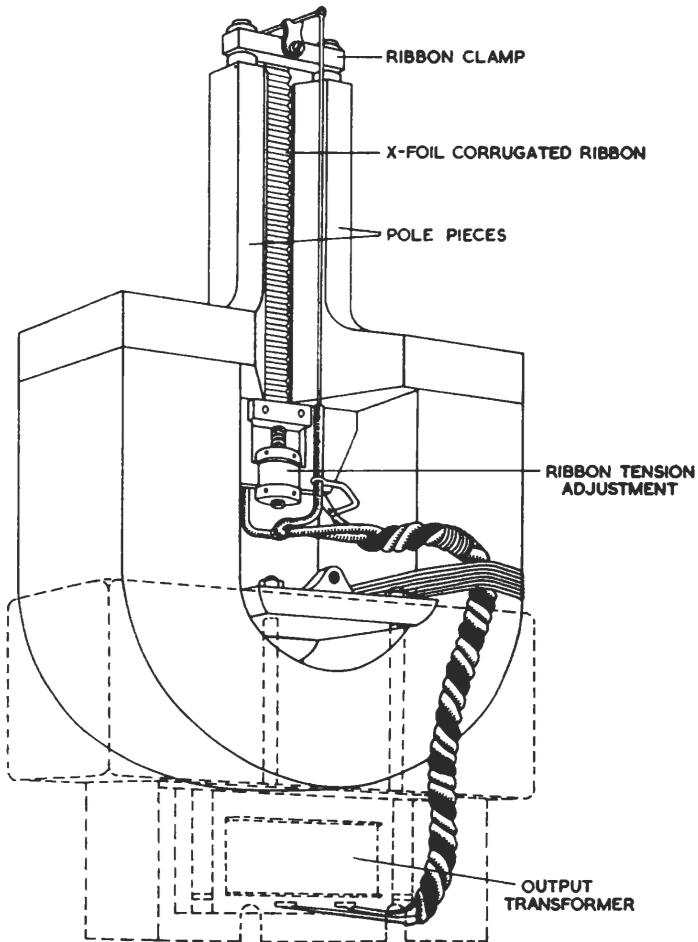

Fig. 37.—BBC-MARCONI RIBBON MICROPHONE

consequence because the resonance occurs at a very low frequency and is heavily damped.*

6.1.2 MECHANICAL IMPEDANCE

The mass of the ribbon together with that of the air load upon it (mass of air driven by the ribbon) is of the order of 0.0025 gram. Because the tension of the ribbon is so very small, compliance is

* With some ribbon microphones that have been made in America, the ribbon has a different form, the corrugation being confined to the end portions and the centre portion stiffened to ensure a more piston-like motion, free from harmonic modes.

MICROPHONES

large and compliance reactance at frequencies higher than a few cycles per second is negligible. The fundamental resonance occurs at approximately 2 c/s, but the effect is inappreciable because of mechanical resistance caused by friction and electromagnetic damping. Resistance forms an appreciable part of the mechanical impedance at frequencies up to approximately 100 c/s, but for higher frequencies the movement is essentially mass-controlled. It is usually assumed that the system is mass-controlled throughout the audio-frequency range.

6.1.3 DRIVING FORCE

With a mass-controlled system (impedance ωm) the driving force is required to be proportional to frequency if the output is to be independent of frequency. The force acting on the ribbon is proportional to the area of the ribbon and to the differential pressure, which is the vector difference of the alternating pressures at the front and rear surfaces. Apart from differences of phase between the front and rear pressures, large differences in their magnitude are also produced at high frequencies due to diffraction.

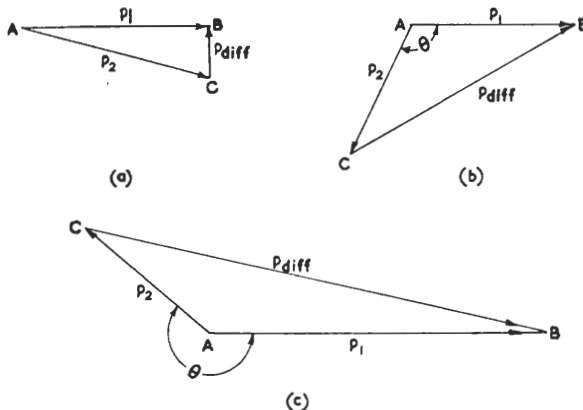

Fig. 38—BBC-MARCONI RIBBON MICROPHONE : DRIVING-FORCE VECTORS

(a) Low frequency ; (b) Medium frequency ; (c) High frequency

p_1 = Front pressure

p_2 = Rear pressure

Fig. 38 (a) shows the conditions at low frequency. The pressure at the front of the ribbon is represented by p_1 and the pressure on the rear face by p_2 . These pressures are equal in magnitude and differ only in phase for diffraction effects are negligible. At medium frequencies there is little change in the value of p_1 , and p_2 now lags

STUDIO MICROPHONES

by a much larger angle as shown in Fig. 38 (b). The driving force p_{diff} has increased considerably, the increase being approximately proportional to frequency. At high frequencies the angle of lag (Fig. 38 (c)) is large and the driving force p_{diff} would be smaller than at medium frequencies if it were not for diffraction which increases the frontal pressure p_1 to two or even three times free-space pressure. Thus the driving force remains substantially proportional to frequency over the working range of the microphone.

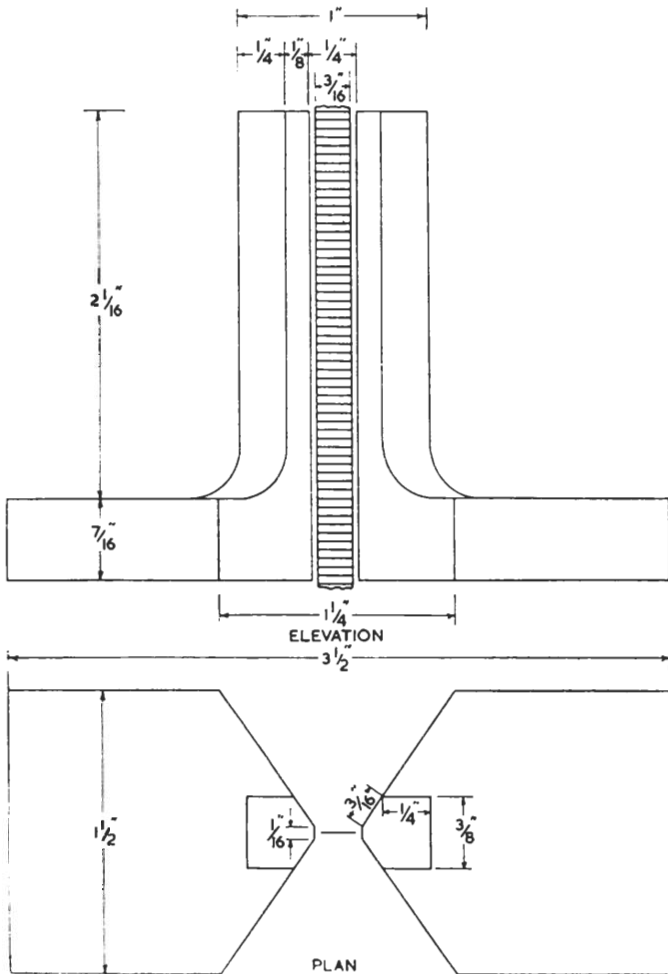

Fig. 39 -BBC-MARCONI RIBBON MICROPHONE: POLE-PIECES AND RIBBON

MICROPHONES

The differential pressure for any condition is given by solution of the triangle ABC, thus:—

$$\text{Differential Pressure} = p_{diff} = \sqrt{A^2 + B^2 - 2AB \cos \theta} \quad \dots \quad (1)$$

6.1.4 CALCULATED RESPONSE

The pole-pieces and ribbon are represented in full scale, with approximate dimensions in Fig. 39. The differential pressure on the ribbon and the performance of the microphone may be computed for plane waves at normal incidence.

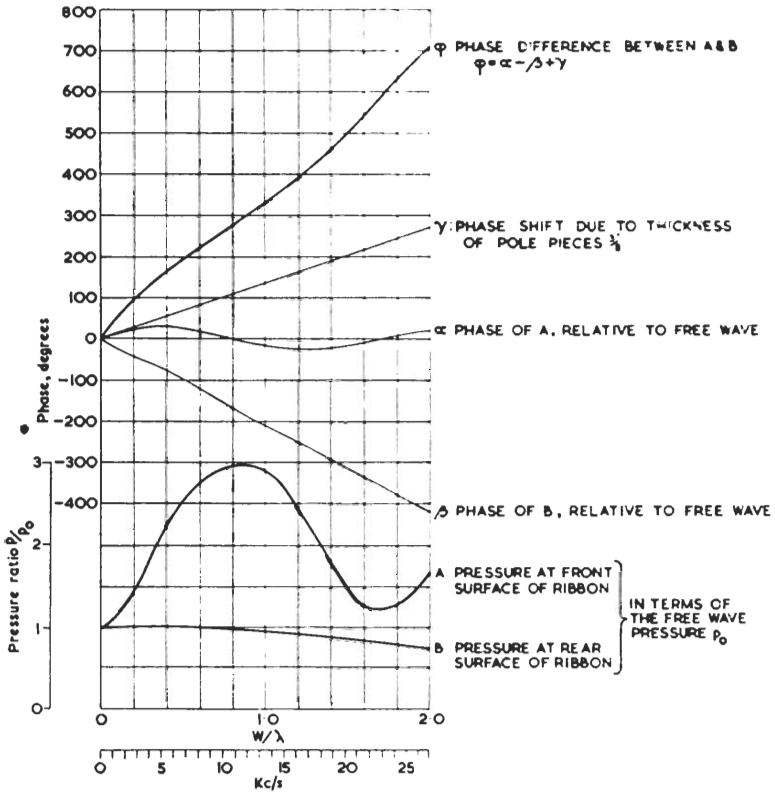

Fig. 40—MAGNITUDE AND PHASE OF PRESSURES

To illustrate the method of calculation we will assume that the diffraction effects around the rectangular frontal area of the microphone are the same as those produced by a solid square obstruction one inch wide. This conveniently neglects the effect of the cavities at front and rear, and other complications, but gives reasonable results which indicate the steps in computing the output voltage.

STUDIO MICROPHONES

The shortest distance from the centre of one ribbon surface around the pole-piece to the other centre is 1.5 in.; at the lowest frequencies the phase difference corresponds to this dimension and is given by $2\pi d/\lambda$ radians, where $d=1.5$ in.

The computed diffraction data are shown in Fig. 40, with a frequency scale included corresponding to a width W of 1 in. It should be noted that the front and rear pressures are only equal at frequencies approaching zero; although the pressure at the front

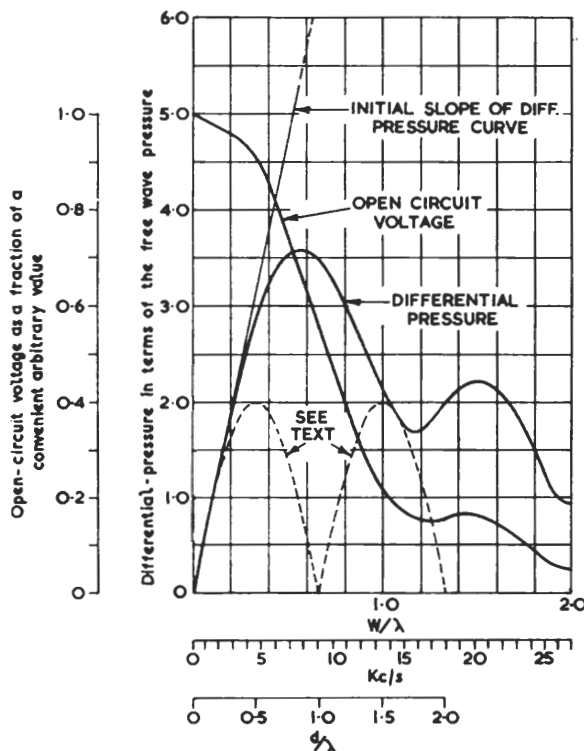

Fig. 41—COMPUTED CHARACTERISTICS OF DIFFERENTIAL PRESSURE AND OPEN-CIRCUIT VOLTAGE

decreases above $W/\lambda=1$, the minimum value which occurs at $W/\lambda=1.7$ is not as low as the pressure at the rear. The phase difference at $W/\lambda=1.7$ is approximately 600 degrees, so that the differential pressure would not be zero even if the front and rear pressures were equal.

At $W/\lambda=1.1$ the phase difference is 360 degrees but the pressures are very dissimilar: the combined effect of the pressure and phase characteristics is such that there is no "extinction frequency."

MICROPHONES

To obtain the differential pressure characteristic, the data of Fig. 40 for various values of W/λ are substituted for A, B and θ in the expression $p_{diff} = \sqrt{A^2 + B^2 - 2AB \cos \theta}$. The resulting characteristic is shown in Fig. 41, together with a dotted characteristic and scale of d/λ , included to show how much smaller and more erratic the differential pressure would be if it were not for the diffraction effects.

For frequencies near to zero, the front and rear pressures are both equal to p_o , while the phase difference is equal to $2\pi d/\lambda$. Substituting accordingly in Equation 1 gives $p_{diff} = 2p_o \sin \pi d/\lambda$ and the slope of the curve at low frequencies, obtained by differentiating with respect of d/λ , is given by $2\pi p_o \cos \pi d/\lambda$. Thus at zero

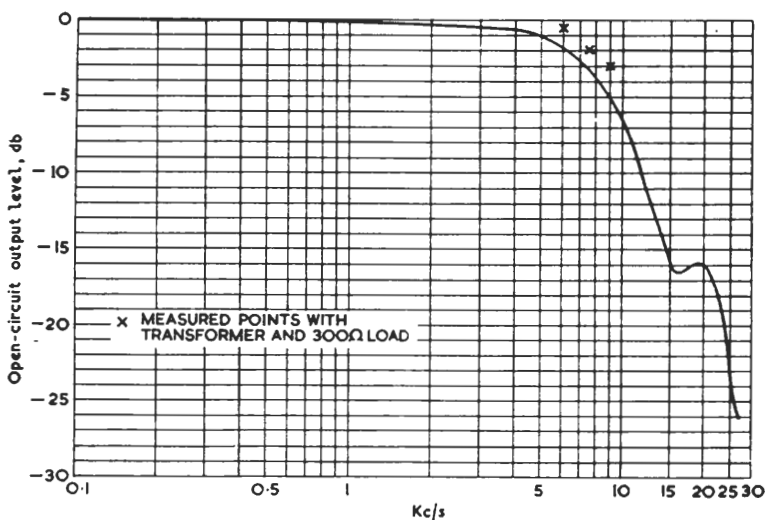

Fig. 42—COMPUTED RESPONSE/FREQUENCY CHARACTERISTICS FOR PLANE-WAVE CONDITIONS

frequency the slope is $2\pi p_o$; the straight line in Fig. 41 is drawn with this slope and shows how the differential pressure should increase with frequency to maintain a constant output voltage (on the assumption of a purely mass-controlled system).

The divergence of the differential pressure curve away from the straight line, expressed in a fractional manner, gives the fractional divergence of the open-circuit voltage away from the low-frequency reference level. Thus, for example, at the condition $W/\lambda = 0.6$ an ordinate drawn to the straight line has a height of 5.7, but the differential pressure is only 3.6, giving a ratio of 0.63 for the relative output voltage. It is not necessary to use this graphical method of obtaining the response characteristic, because the height of any

ordinate to the straight-line curve is equal to $2\pi p_o d/\lambda$ and the relative output voltage may therefore be calculated from the expression:—

$$\text{Open-circuit Voltage} = \frac{\sqrt{(A^2 + B^2 - 2AB \cos \theta)}}{2\pi d/\lambda} \quad \dots \quad (2)$$

Since W is 1 in and d is 1.5 in, the ratio d/λ may be replaced by $1.5W/\lambda$ and the expression becomes:—

$$\text{Open-circuit Voltage} = \frac{\sqrt{(A^2 + B^2 - 2AB \cos \theta)}}{3\pi W/\lambda} \quad \dots \quad (3)$$

The open-circuit voltage characteristic, calculated in this way, is shown in Fig. 41, and is represented with the more usual decibel and logarithmic frequency scales in Fig. 42.

In practice, it is found that the measured response differs very little from the computed curve for frequencies between 1,000 c/s and 10,000 c/s, and it is reasonable to assume that this holds for higher frequencies.

Below 100 c/s there is an appreciable reduction of output with reduction of frequency and this may be explained by the fact that the mechanical impedance does not decrease quite in proportion to the reduction of frequency, owing to the friction and magnetic damping; there is also the effect of the reduced shunt reactance of the coupling transformer. At frequencies below approximately 10 c/s there may be some recovery of the output because of the approach towards the frequency of resonance of the ribbon.

6.1.5 CALCULATION OF OUTPUT VOLTAGE

The actual value of the output voltage may be calculated from the knowledge of the differential pressure and the constants of the system.

Thus, for the open-circuit ribbon voltage,

$$V = Blv \times 10^{-8} \text{ volts}$$

where B is the flux-density in the air-gap, stated to be approximately 3,200 lines per sq cm:

l is the effective length of the ribbon, approximately 6.35 cm; and v is the velocity, in cms sec.

The velocity is given by:—

$$v = \frac{\text{force}}{\text{impedance}} = \frac{A \cdot p_{diff}}{\omega m}$$

where A is the area of the ribbon, approximately 3 sq cm;

p_{diff} is the differential pressure;

and ωm is the impedance of the mass-controlled movement.

At a frequency of 2,700 c/s the ratio W/λ is 0.2 and the differential pressure (Fig. 41) is equal to $1.8p_o$. Assuming the total effective

mass to be 0.0025 gramme, the ribbon velocity for a sound wave of r.m.s. pressure 1 dyne per sq cm may be written:—

$$v = \frac{3 \times 1.8}{2\pi \times 2700 \times 0.0025}$$

$$= \frac{1}{2.5\pi} \text{ cms per sec}$$

$$\text{Then } Blv = \frac{3200 \times 6.35}{2.5\pi} \times 10^{-8} \text{ volts}$$

$$= 26 \text{ microvolts}$$

The coupling of the ribbon to the 300-ohm output circuit terminates the ribbon with an impedance equal to its own (0.6 ohm) and the voltage into the transformer becomes 13 μ V. The voltage delivered from the secondary winding to the load is given by:—

$$v_{sec} = \frac{300}{0.6} \times 13 \mu\text{V}$$

$$= 290 \mu\text{V}$$

This output voltage of 0.000290 corresponds closely to a level of -70 db with respect to 1 volt; this is in close agreement with the reputed output level of the microphone of approximately -68 db for a sound wave of r.m.s. pressure 1 dyne per sq cm.

6.1.6 WORKING DISTANCE AND POLAR DIAGRAM

As has been explained, for all differential-pressure operated microphones the response to sounds of low frequency is much greater if the waves are spherical than if they are plane. Most of the sound sources in a studio are of sufficiently small dimensions to produce sound waves which at short distances are not plane. It is therefore necessary to have a reasonably large distance separating the ribbon microphone from the nearest sound source, in order to avoid an excessive bass response. The microphone should never be used at a distance less than approximately two feet.

The polar diagram for the horizontal plane is a figure-of-eight loop, almost identical with that of Fig. 34 throughout the major part of the audio-frequency range. At the highest frequencies diffraction variations cause some distortion of the shape of the loop.

The polar diagram for the vertical plane is also a loop similar to that of Fig. 34, but distortion occurs at a somewhat lower frequency than for the horizontal plane because, owing to the length of the ribbon, the phase-difference effect becomes appreciable at frequencies of 6,000 c/s and over.

The response/frequency characteristic of this microphone is sufficiently independent of the angle of incidence to ensure reasonable preservation of the tone relationships in a sound field.

6.2 S. T. & C. MOVING-COIL MICROPHONE 4017

6.2.1 GENERAL DESCRIPTION

This microphone has been used extensively by the BBC for a number of years, particularly on outside broadcasts. It incorporates the principle of pressure operation of a constant-impedance system discussed on page 43. The microphone was designed to produce a uniform response over a wide frequency range and the velocity of the moving system for a constant driving force is substantially independent of frequency over a range of 35–10,000 c/s.

The construction is shown in Fig. 43; the general shape of the microphone is cylindrical with an overall diameter of approximately

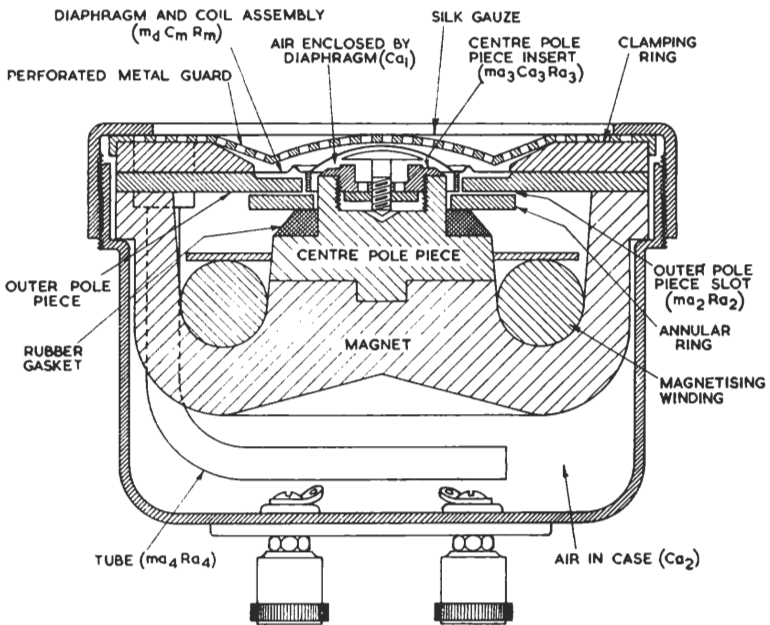

Fig. 43—S. T. & C. MICROPHONE 4017C: CONSTRUCTION

$3\frac{1}{4}$ inches. The diaphragm is of thin duralumin, for lightness, domed for rigidity to ensure a piston-like motion, free from harmonic modes. The domed centre portion, which is the active part of the diaphragm, has a diameter of approximately one inch; the outer portion of the diaphragm has concentric circular corrugations which form a flexible mounting.

The moving coil, which is attached to the underside of the dome, is of aluminium ribbon, wound on edge and secured and insulated with phenol varnish. The diameter of the coil is approximately

MICROPHONES

equal to that of the domed portion of the diaphragm, to which it is bonded with varnish by a high-temperature baking process.

A perforated steel guard protects the diaphragm from accidental damage in handling and prevents objects attracted by the strong magnetic flux from impinging on the diaphragm; the steel guard is covered by a silk screen which serves to exclude dust, iron particles and other foreign matter.

The centre pole-piece of the magnet system is welded to the permanent magnet, which is of cobalt steel and has a large flux with a high degree of permanence; the magnetising winding is left in position as shown in Fig. 43.

A recessed insert is screwed into the centre pole-piece, the recess being immediately under the large round head of an adjusting screw; the head is suitably domed to correspond with the inner surface of the diaphragm. By movement of the screw, an adjustment can be made to the narrow annular passage between the rim of the insert and the head of the screw; this passage connects the cylindrical cavity below the screw head with the small enclosure between diaphragm and pole-pieces.

There is a restricted passage for air particles from the front of the pole-pieces to the rear, via the magnetic air-gap and a much narrower annular slot; this slot is formed between the underside of the outer pole-piece and an annular ring, spaced from the pole-piece by a shim. The space between the ring and the centre

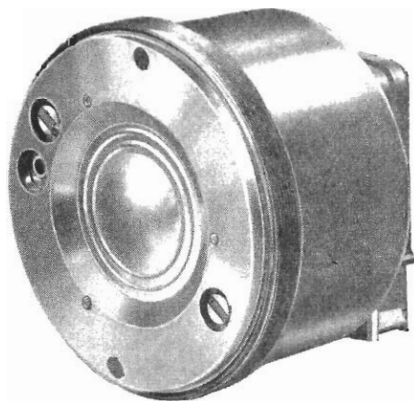
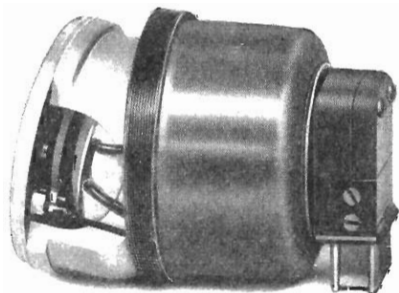

Fig. 44—S. T. & C. MICROPHONE 4017A

(Above) With front screen and guard removed. (Right) Casing removed to show cut-away shape of magnet



STUDIO MICROPHONES

pole-piece is sealed by a rubber gasket (shown cross-hatched in Fig. 43).

The clamping ring, which holds the diaphragm against the outer pole-piece, is chamfered to minimise cavity resonance. This is shown in the photograph taken with silk screen and guard removed (Fig. 44). The lower picture, with the internal assembly partially withdrawn from the casing, shows the cut-away magnet shape, which ensures that the air behind the outer pole-piece is part of the total air volume within the casing.

The plug and socket at the rear of the 4017A microphone was found unsatisfactory in service. Later microphones, designated 4017C, are provided with terminals, as shown in Fig. 43.

Two of the terminals at the rear of the casing are connected to the moving coil, which is insulated from the rest of the microphone. A third terminal is connected to the casing which, together with the perforated guard at the front, functions as an electrical shield when the terminal is earthed.

6.2.2 OPERATION

The diaphragm and coil assembly has mass m_d , compliance $C_{m d}$ and resistance $R_{m d}$, such that if no other elements were present

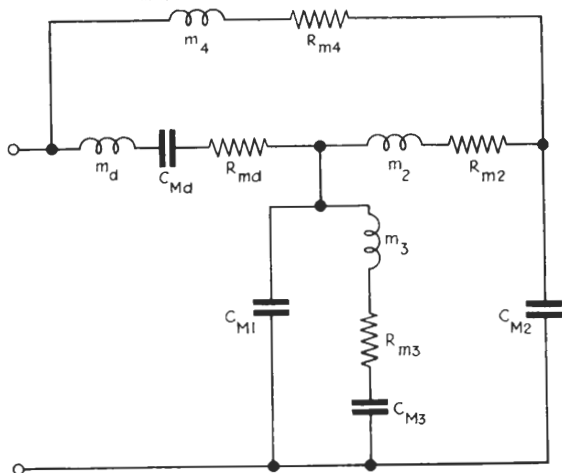

Fig. 45—S. T. & C. MICROPHONE 4017: EQUIVALENT CIRCUIT, SHOWING MECHANICAL EQUIVALENTS FOR ACOUSTICAL ELEMENTS

the velocity frequency characteristic would have a sharp peak below 2,000 c/s. This resonance is avoided by the provision of slots and cavities behind the diaphragm; because of the acoustical impedances introduced, the velocity for a constant applied force is

MICROPHONES

reasonably uniform through the frequency range. The equivalent diagram for the composite system of acoustical and mechanical elements is shown in Fig. 45.

The main resonance of the diaphragm is smoothed out by the effect of m_2 , R_{m2} and C_{m2} , which are the mechanical equivalents of the acoustical elements m_{a2} , R_{a2} and C_{a2} associated with the outer pole-piece slot and the air in the microphone casing. In the absence of the other acoustical devices, the velocity would decrease below 200 c/s, with sharp irregularities above 2,000 c/s caused by m_2 , R_{m2} and C_{m2} . These deviations from a constant-velocity characteristic are shown by the dotted curves of Fig. 46 which is a

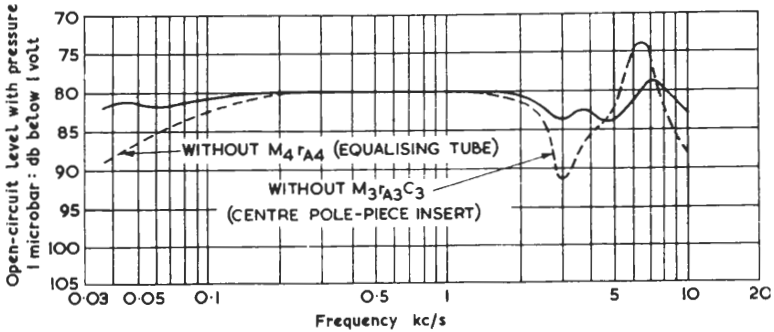

Fig. 46—S. T. & C. MICROPHONE 4017: PRESSURE/FREQUENCY CALIBRATION

graph of output for a constant applied pressure, plotted against frequency. The effect of m_3 , R_{m3} and C_{m3} , due to the centre pole-piece insert, is to reduce the variations above 2,000 c/s, leaving only minor undulations as shown by the full-line curve.

The function of the tube, m_{a4} , R_{a4} , is to offset the effect of the low-frequency capacitive reactance of the air in the casing, thus preventing a sharp decrease of diaphragm velocity at the lowest audio frequencies. The inertance and resistance of the tubular path are such that at frequencies above 200 c/s the volume displacement is negligible and the response of the microphone is not affected. At frequencies lower than 200 c/s there is a partial resonance between the positive reactance of the tube and the negative reactance of the casing. The acoustical resistance is comparatively small and an appreciable pressure is produced in the casing, the phase being such that the velocity of the diaphragm is augmented and the low-frequency response maintained, as shown in Fig. 46.

6.2.3 PERFORMANCE

It must be emphasised that the graph of Fig. 46 represents a "pressure" calibration, which is obtained by a laboratory process involving

STUDIO MICROPHONES

the application of a known pressure to the diaphragm. Information of this kind is of value in the development of a satisfactory moving system, but is not a complete indication of microphone performance because no account is taken of the diffraction and phase-difference effects.

The proper representation of microphone performance is by means of a graph showing the "field" calibration. This is obtained by measuring the output of the microphone when subjected to a sound field of constant intensity at various frequencies and angles of incidence. A field calibration for the S. T. & C. 4017 microphone is given in Fig. 47.

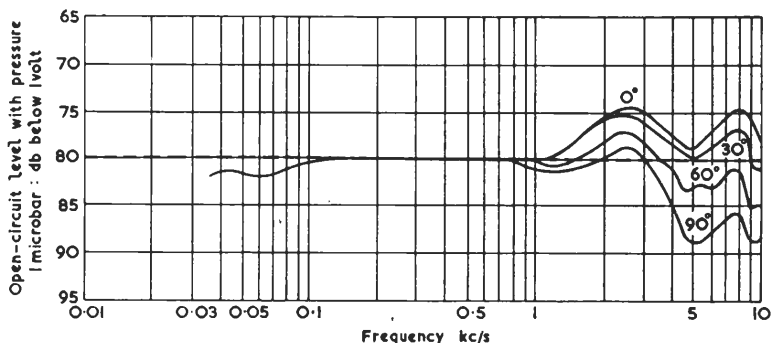

Fig. 47—S. T. & C. MICROPHONE 4017: FIELD CALIBRATION

Comparison of the field and pressure calibrations shows that although they are very similar for all frequencies below 1,000 c/s the shapes of the various field response curves for the higher frequencies differ considerably from that of the pressure response. For sound at normal incidence, the field response at frequencies between 1,000 c/s and 5,000 c/s is much greater than the pressure response. The difference is almost 10 db at 3,000 c/s, the rise in response in this part of the range being quite consistent with the microphone frontal dimension of $3\frac{1}{4}$ in. ($D/\lambda=1$ at approximately 4,000 c/s, page 51).

The electrical impedance of the microphone is almost constant at 30 ohms, from very low frequencies up to 1,000 c/s, increasing to approximately 37 ohms at 10,000 c/s.

The levels shown in Fig. 47 are the open-circuit levels of the moving-coil output. When the microphone is matched by a transformer to a 300-ohm line, there is a 6-db loss of level due to termination and a 10-db gain due to the step-up ratio of the transformer. The general level of output due to a sound field of pressure 1 bar, will, therefore, be -76 db with respect to 1 volt into 300 ohms.

6.3 S. T. & C. MOVING-COIL MICROPHONE 4021A

6.3.1 GENERAL DESCRIPTION

This microphone was developed about 1935, some years after the introduction of the 4017A microphone. The internal acoustical arrangements of this microphone are less elaborate and the external shape and size is chosen with due regard to diffraction effects. The frequency range is similar to that of the 4017 microphone, i.e., 35–10,000 c/s, but the response at the upper part of the range is much less dependent on the angle of incidence of the sound.

The microphone is designed for use with the diaphragm uppermost, as shown in Fig. 48.* This arrangement results in an equal angle of incidence for all sound in the horizontal plane (page 50) ensuring that the frequency characteristic is common for all horizontal components of the sound field. Within the frequency range there is no appreciable loss of response due to phase difference across the diaphragm, the diameter of which is less than the wavelength at all frequencies below 17,000 c/s.



Fig. 48—S. T. & C.
MICROPHONE
4021A

6.3.2 CONSTRUCTION

The general construction is shown in Fig. 49. At the top of the microphone there is a disk-like screen, mounted on three small pillars so that its centre is approximately $\frac{1}{8}$ in. from perforations in the casing above the diaphragm. The screen is of silk gauze, enclosed within layers of fine wire mesh and bounded by a rigid metal rim. Its function is to equalise the response at all angles in the vertical plane; without the screen the directivity is sufficient to be objectionable, even though it is minimised by the spherical shape. The diameter of the casing is $2\frac{1}{2}$ inches.

The diaphragm is somewhat similar in construction to that of the 4017 microphone, but is much lighter because of decreased thickness and diameter. The domed central portion or diaphragm proper has a diameter of approximately $\frac{3}{8}$ in. and rigidity such that, for all frequencies below 15,000 c/s, the motion is piston-like with no tendency for harmonic modes of vibration. Surrounding the central dome there are tangential corrugations on an annular portion $\frac{1}{8}$ in. wide. This arrangement provides a flexible mounting with low mechanical resistance. The diaphragm is protected by

* From its shape it is known colloquially as the *apple and biscuit* microphone.

STUDIO MICROPHONES

the perforated part of the casing, covered with a fine gauze to exclude dust and iron particles.

Below the air-gap between the pole-pieces, there is an annular gauze strip which provides acoustical resistance to the movement of air particles in the gap. The space below the gauze is filled with cotton-wool, as are the small holes in the side wall of the Alnico magnet and the outer spaces between magnet and casing. A threaded ring below the magnet clamps the diaphragm and magnet assembly firmly against a rubber gasket in the top part of the casing.

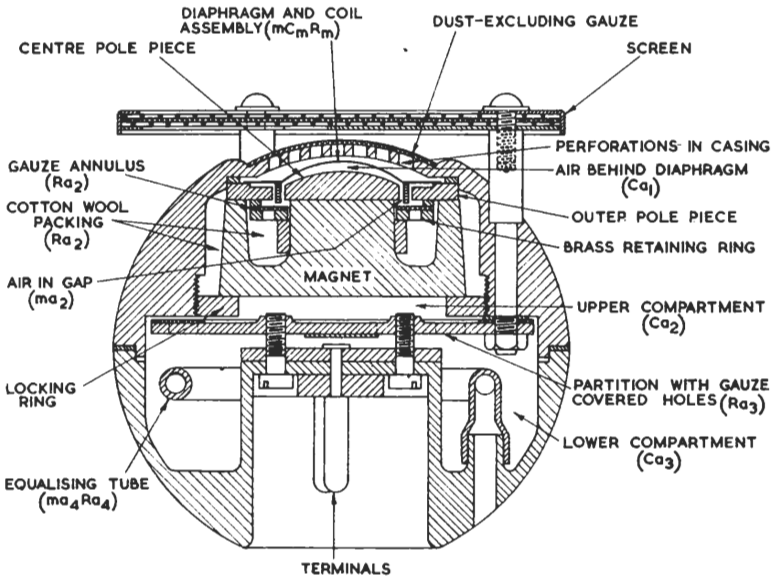

Fig. 49--S. T. & C. MICROPHONE 4021A: CONSTRUCTION

The lower part of the casing is separated from the upper part by a brass partition, with six holes covered by gauze. This functions as an acoustical resistance, damping resonances in the volume of air below the magnet.

The tube in the lower compartment serves not only to equalise internal and external pressures, but also to maintain the low-frequency response (as described for microphone S. T. & C. 4017). For the latter purpose an appreciable inertance is necessary, and this is provided by using a rubber tube, curled into the available space, and thick enough to maintain its tubular shape.

At the bottom of the microphone there is a recess with connecting pins and a securing clip, provided for the insertion of the tubular microphone stand.

MICROPHONES

6.3.3 OPERATION

Because of the extreme lightness of the diaphragm, the frequency of the diaphragm resonance is quite high in the audio range and its effect is made negligible by comparatively simple means. There is no resonant cavity in the centre pole-piece and no special slot below the outer pole-piece. The mechanical impedance is sufficiently uniform due to the combined effects of (i) the capacitance of air behind the diaphragm, (ii) the mass of air in the magnetic air-gap, and (iii) acoustical resistance, provided by the gauze ring below the coil and by cotton-wool in the upper part of the casing. The reactance of the equalising tube opposes that of the lower part of the casing, preventing loss at low frequencies.

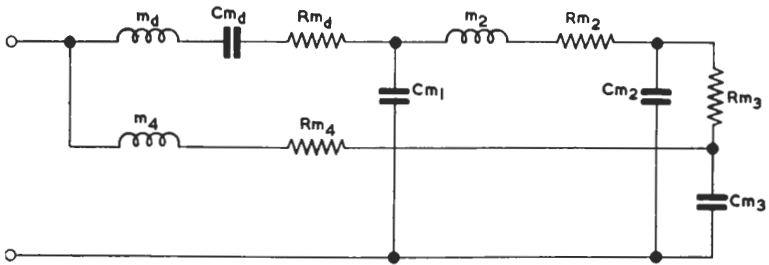

Fig. 50—S. T. & C. MICROPHONE 4021A: EQUIVALENT CIRCUIT

The equivalent circuit for the microphone is shown in Fig. 50. The branch m_4 , R_{m_4} , corresponding to the inertance and resistance of the tube, is shown connected between C_{m_3} and the input terminal. Although the outlet of the tube is at the back of the microphone, the phase of the pressure applied to it at low frequencies is virtually the same as the phase at the diaphragm.

6.3.4 PERFORMANCE

The field response is represented in Fig. 51. For horizontal waves the maximum variation of output with frequency is approximately 6 db. The variation of output with various angles of incidence in the vertical plane is approximately 6 db at 10,000 c/s and 4 db at 5,000 c/s, decreasing to zero for frequencies below 1,000 c/s. Although the shape of the response/frequency characteristic is reasonably independent of the angle of incidence, there is a slight loss of high-frequency response to sound at an oblique angle from below the microphone, as shown by the curves for -30° and -60° .

The screen on the top of the microphone is largely responsible for the good omni-directional characteristics. Without the screen, the divergence between the curves is some 6 db greater at 5,000 c/s and 10 db more at 10,000 c/s. The equalising effect of the screen

STUDIO MICROPHONES

is due to its properties of diffraction and attenuation. At frequencies below 1,000 c/s, sound at any angle has free access to the diaphragm. At the higher audio frequencies, sound impinging on the microphone from above is obstructed by the screen and there is an acoustical flow through it due to high pressure at the top surface. This controlled flow contributes to the effective diaphragm pressure, which otherwise would be rather less than the free-wave value (as for an appreciable central region at the rear of a rigid disk).

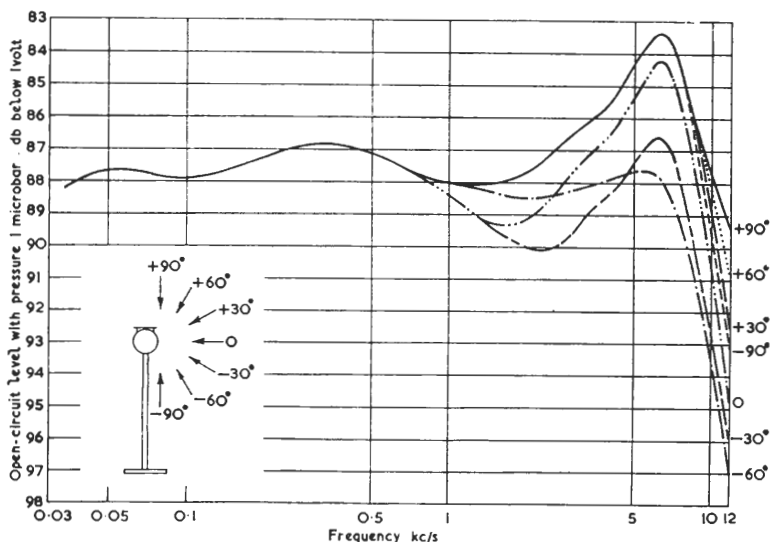

Fig. 51—S. T. & C. MICROPHONE 4021A: FIELD CALIBRATION

High-frequency sound impinging on the microphone from below is partially reflected from the screen on to the diaphragm, thus maintaining the effective diaphragm pressure despite obstruction of the direct wave by the microphone casing.

All the curves have a definite peak between 5,000 c/s and 8,000 c/s; this may be attributed to cavity resonance, the effective diameter of the cavity in front of the diaphragm being approximately 0.8 in. (circumference equal to wavelength at 5,500 c/s, page 60).

6.4 E.M.I. MOVING-COIL MICROPHONE

6.4.1 GENERAL DESCRIPTION

This microphone is a pressure-operated moving-coil instrument and its general construction is shown in the cross-section drawing (Fig. 52).

MICROPHONES

The diaphragm is of balsa wood 2.5 mm thick, enclosed between two thin sheets of aluminium foil. Enamelled aluminium wire is used for the coil, which is wound on a thin aluminium former, riveted to the diaphragm. The complete assembly is waxed and combines high rigidity with lightness, the total mass being 0.75 gramme. An outer surround is formed by the aluminium foil.

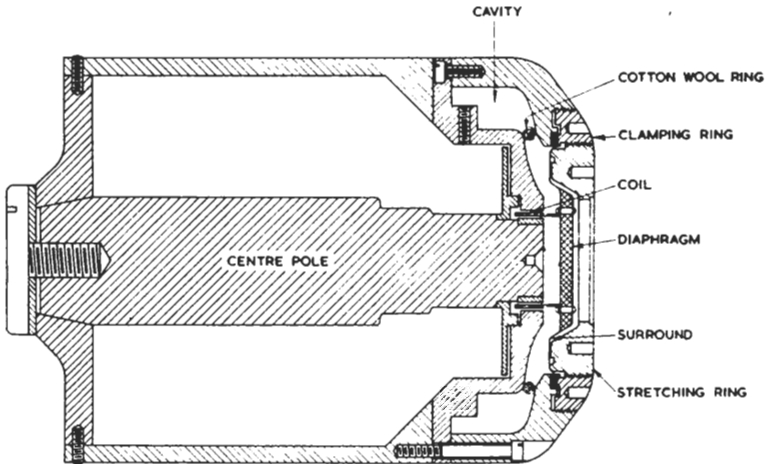

Fig. 52—E.M.I. MOVING-COIL MICROPHONE

This is clamped at its edge, and the diaphragm is mounted in a stretched condition by the action of the two rings shown in the diagram. The microphone illustrated is provided with a winding for energising the magnet system, but some types have cobalt permanent magnets.

6.4.2 OPERATION

The effect of the main diaphragm resonance is minimised by the considerable eddy-current damping due to the aluminium coil former and the acoustic resistance associated with the cotton-wool in the resonator neck. Because of the comparatively large frontal dimension (7 cm) and cylindrical shape, the diffraction effects are considerable within the audio-frequency range ($D/\lambda=1$ at 5,000 c/s). There is also an appreciable cavity, of diameter 2 cm, in front of the diaphragm and a cavity resonance of some magnitude must occur at approximately 5,500 c/s ($\pi D/\lambda=1$). It is probable that increased operating pressures due to cavity resonance and diffraction effects are of such magnitude as to compensate approximately for increased mechanical impedance at the higher frequencies.

An equalising circuit is included in the three-stage amplifier,

which is provided to work with this microphone. The output from the amplifier, for a normal-incidence field strength of 1 bar, is approximately 25 db below 1 volt and is flat within ± 2 db throughout the range 40–10,000 c/s.

6.4.3 PERFORMANCE

Phase-difference effects are negligible because of the small diameter of the diaphragm, but diffraction by the casing is such that this microphone in common with other moving-coil types is not omni-directional for frequencies above 1,000 c/s. For the higher frequencies, the variation of response with angle of incidence is considerable; it may be assumed that the shape of the polar diagram at 5,000 c/s approximates to that of Fig. 33, which shows in polar form the diffraction of a cylinder at $D/\lambda=1$.

Since the polar diagram for this microphone is very dependent on frequency, the tone relationships of a sound field are not fully preserved in the electrical output and the instrument is therefore less suitable when high quality is a major consideration.

6.5 BRUSH CRYSTAL MICROPHONES

6.5.1 GENERAL DESCRIPTION

Plates cut from Rochelle salt crystals are the most suitable elements for crystal microphones, the piezo-electric activity being approximately 1,000 times greater than that of quartz.

A typical crystal of Rochelle salt is represented in Fig. 53 (a) which shows the angle of cut of the crystal plate in relation to the main axes. For clarity, the plate is shown thicker than normal. The upper and lower surfaces of the plate are cut parallel with the base of the crystal, and the edges are cut at an angle of 45° to both the B and C axes. A conductive coating is applied to the two main surfaces, between which an e.m.f. can be produced by subjecting the crystal to mechanical stress. The application of an alternating force causes an alternating e.m.f. to be generated by the plate, which is therefore suitable as a microphone element.

Two such crystal plates are cemented together to form what is called a "Bimorph" element Fig. 53 (b). One terminal of the element is connected to the inner surfaces, and the other to the outer surfaces, so that the two plates are in parallel. The Bimorph may be a "bender" type, with plates cut as in Fig. 53 (a) and requiring a bending stress along its length or width for generation of e.m.f.; or it may be a "twister" type as used in some microphones, the orientation with respect to the B and C axes being different by 45° from that of the bender type. The twister Bimorph,

MICROPHONES

which is usual in a diaphragm-actuated microphone, requires a bending stress along one of the diagonals.

The Bimorph construction has definite advantages, combining high sensitivity with small size and neat efficient shape, and minimising the effect of crystal variations caused by changes in ambient temperature.

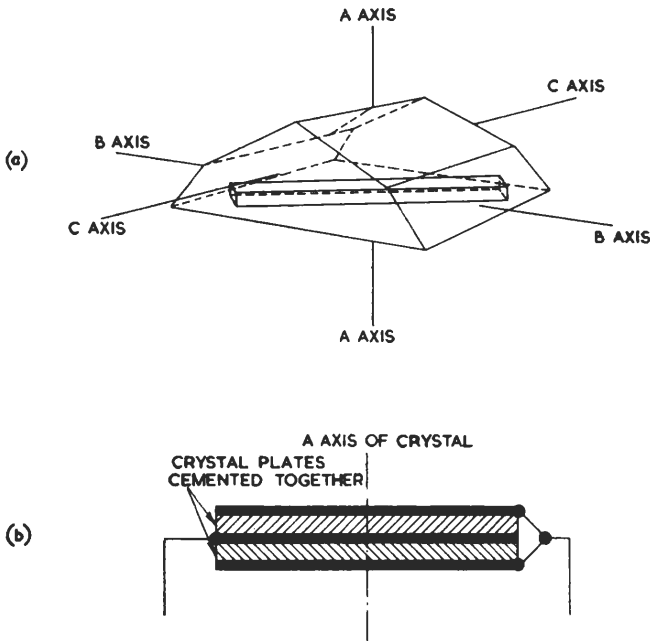

Fig. 53—(a) ROCHELLE SALT CRYSTAL AND CUT PLATE
(b) BIMORPH

The Brush Development Company produce a small unit called a “sound cell,” which consists of two bender Bimorphs mounted parallel in a close-fitting frame and enclosing a small volume of air (Fig. 54). The variations of external pressure due to a sound wave cause equal and opposite deformations of the Bimorphs, the connections being such that the voltages are additive. The arrangement gives a measure of freedom from pick-up due to mechanical shock,

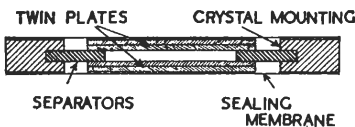

Fig. 54—BRUSH SOUND CELL

deformation of the Bimorphs in a common direction producing equal and opposite voltages.

6.5.2 OPERATION

The frequency of mechanical

STUDIO MICROPHONES

resonance of the sound cell is above the audio range, largely due to the stiffness of the enclosed air, and the unit is therefore compliance controlled throughout the audio range, i.e., impedance is inversely proportional to frequency. The e.m.f. generated in the crystal is proportional to kx , where k is a constant for the crystal and x is the displacement from the neutral condition. The output voltage of the crystal is therefore proportional to the displacement amplitude, which is constant for a constant driving force because velocity is proportional to frequency. In consequence the response/frequency characteristic is very flat, although a slight increase of response is usual at the highest audio frequencies.

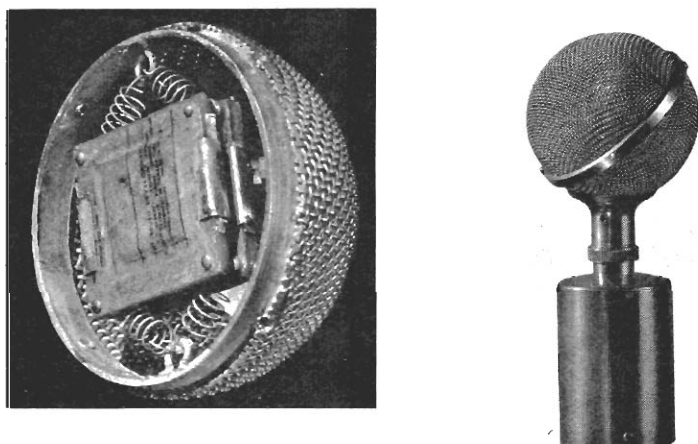

Fig. 55—BRUSH SINGLE-CELL CRYSTAL MICROPHONE
(Left) Spring-mounted sound cell; (Right) Microphone and amplifier

The sensitivity of a single sound cell is such that a sound pressure of 1 bar produces an open-circuit level of approximately -90 db with respect to 1 volt. When using a single cell, the output impedance of the crystal is large and the impedance remains high over the audio range. For these reasons, a pre-amplifier placed in close proximity to the microphone is necessary, and an example is shown in Fig. 55, the amplifier being housed, in this case, in a cylindrical casing.

Multi-cell microphones, having increased sensitivity and a lower output impedance, have been made with as many as 24 cells, the output level being approximately -65 db and the capacitance of the order of $0.01 \mu\text{F}$. The cells may be arranged in various series and parallel groups to meet particular requirements of sensitivity and impedance.

6.5.3 PERFORMANCE

The sound cells are quite small, not more than $\frac{1}{2}$ in. square and about 0.05 in. thick. Consequently diffraction and phase-difference effects are negligible and the response at all audio frequencies is practically independent of the angle of incidence. These omnidirectional qualities are not of course shared by the diaphragm-operated twister type crystal, represented in Fig. 56.

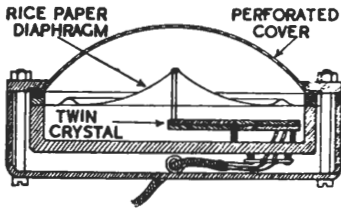

Fig. 56—CROSS-SECTION OF DIAPHRAGM-ACTUATED CRYSTAL MICROPHONE

The sensitivity of a microphone incorporating Rochelle-salt crystals varies with temperature. This is mainly due to variation of the electrical capacitance, but also to variation of the piezo-electric activity. The working temperature range is from -40° F to 130° F, and if the latter temperature is exceeded the crystal loses activity permanently.

6.6 CONDENSER MICROPHONES

A condenser microphone depends for its action on the variation of capacitance between two electrodes. A thin flexible metal diaphragm is mounted in a stretched condition in very close proximity to a rigid back plate, supported by mica insulation (Fig. 57).

The diaphragm is usually of duralumin and may be as thin as 0.001 inch. The separation between diaphragm and back plate is generally between 0.001 in. and 0.002 in. and the capacitance, which varies according to the separation, is approximately 300 pF, for a diaphragm of 1.5 in. diameter.

The microphone is connected to a circuit as shown in Fig. 58. Between the electrodes there is a potential difference of approximately 150 volts, applied from a battery via a resistor. The impact of a sound wave on the diaphragm causes an oscillatory variation of the capacitance; as the capacitance increases a charging current flows and a decrease of capacitance causes a discharge current. These oscillatory currents produce an alternating voltage across

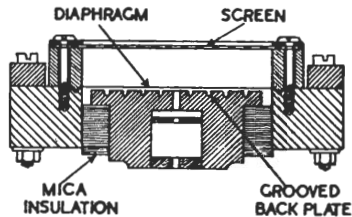

Fig. 57—CROSS-SECTION OF CONDENSER MICROPHONE

the resistor R , proportional to the amplitude of displacement of the diaphragm. This alternating voltage is applied to the amplifier via the blocking capacitor C_2 , which prevents the battery voltage from reaching the amplifier.

The amplitudes of displacement of the diaphragm, due to sound waves, are so minute (about 1×10^{-11} cm) that despite the small separation of the electrodes there is no possibility of contact between them in normal operation of the microphone.

To obtain a wide frequency range, the moving system of a pressure-operated condenser microphone must be substantially compliance-controlled so that velocity is proportional to frequency, and displacement amplitude therefore independent of frequency. To meet these requirements the constants of the moving system must be such that the mechanical resonance occurs at a high frequency, preferably above the audio range.

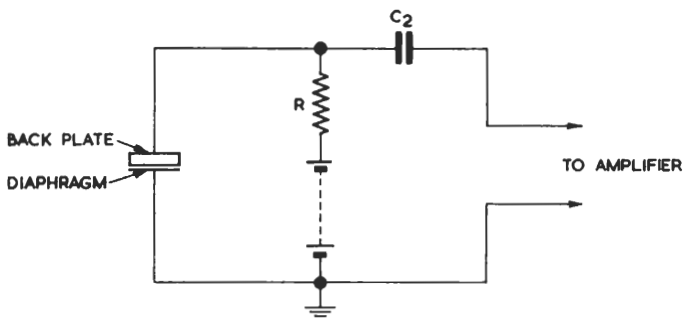

Fig. 58—CONDENSER MICROPHONE: CIRCUIT

Mechanical resonance at a high frequency is made possible by a compliance reactance due to the small volume of air enclosed between the electrodes (page 46). But if the back plate has a smooth unbroken surface the volume of the enclosed air is extremely small, making the frequency of resonance unnecessarily high and causing serious loss of sensitivity due to excessive compliance reactance in the audio range.

To obtain good sensitivity, the volume of enclosed air must be increased without sacrificing the close spacing of the electrodes; this is achieved in various microphones by the introduction of grooves and cavities in the back plate, as shown in Fig. 57.

The mass of the diaphragm should be small otherwise the excessive tension necessary to obtain a high frequency of resonance will result in its fracture. If a stronger diaphragm material is employed, although the increased stiffness will contribute to the provision of a high resonant frequency, it does so only at the expense of sensitivity.

MICROPHONES

The output impedance of the condenser microphone is high and capacitive, being approximately equal to that of the capacitance between diaphragm and back plate. It is therefore necessary to have the first stage of amplification located in close proximity to the microphone. The amplifier should be of small bulk to minimise diffraction effects, a good example being that of the Marconi condenser microphone (Fig. 59), with amplifier enclosed in the lower tubular portion.

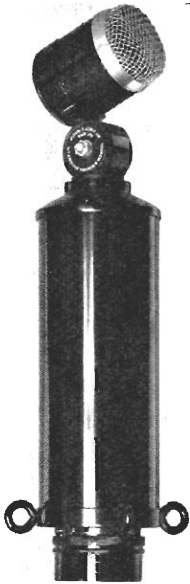

Fig. 59 — MARCONI
CONDENSER
MICROPHONE
WITH BUILT-IN
AMPLIFIER

6.7 BBC-MARCONI LIP MICROPHONE

6.7.1 GENERAL DESCRIPTION

This microphone was developed to suit the conditions of certain outside broadcasts such as sports commentaries, where the interference effects of noise from spectators and other unwanted sources is considerable.

A small electrodynamic unit of the ribbon type is held in close proximity to the mouth of the commentator, the frame or mouth-guard at the front of the microphone being in contact with the jaws, to ensure a correct and constant

distance between the mouth and the ribbon. Sponge-rubber covering on the handle serves to lessen noise caused by handling.

Removal of the mouth-guard portion of the case reveals the ribbon unit, mounted so that the ribbon is away from the mouth and shielded from the commentator's breath by the permanent magnet (Fig. 60). This arrangement is necessary, because direct draughts from a speaker's mouth might, at short operating distances, cause pressures far in excess of those due to sound waves.

Fig. 61 shows clearly the spring suspension, which is necessary to minimise jarring effects caused by the handling of the microphone. Fig. 62 shows the ribbon (a piece of corrugated X-foil approximately 1 in \times 0.1 in), just visible through an adjacent screen of silk gauze.

The electrical resistance of the ribbon is so low that it is necessary to minimise the length of connecting wires to the ribbon by inserting the line transformer in the handle. The transformer is of long and narrow construction to fit in the available space, and the turns ratio is such as to match the ribbon impedance to an output circuit impedance of 300 ohms.

STUDIO MICROPHONES

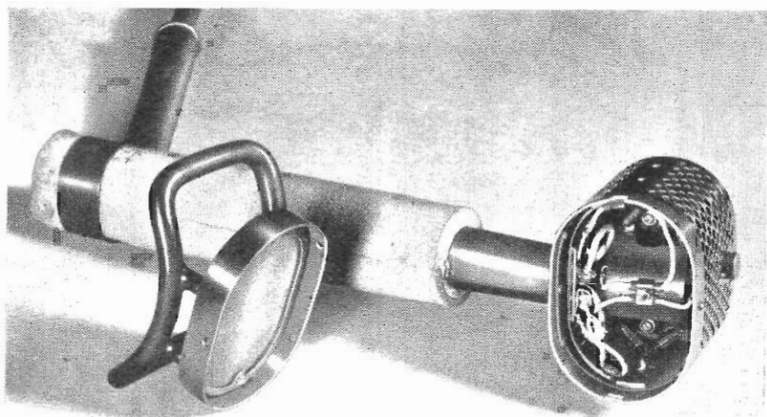

Fig. 60—BBC-MARCONI LIP RIBBON MICROPHONE: MOUTH-GUARD REMOVED

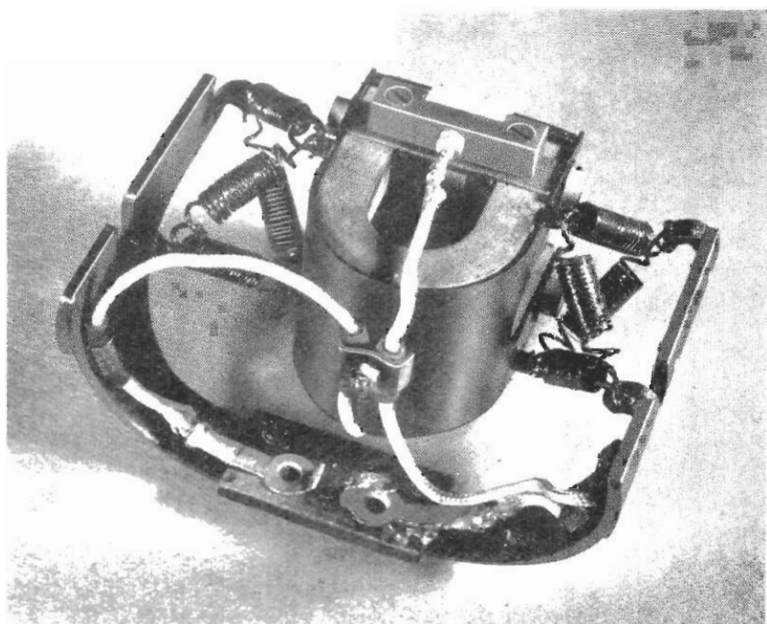

Fig. 61—LIP RIBBON MICROPHONE: FRONT VIEW
The magnet screens ribbon from diffraction effects

MICROPHONES

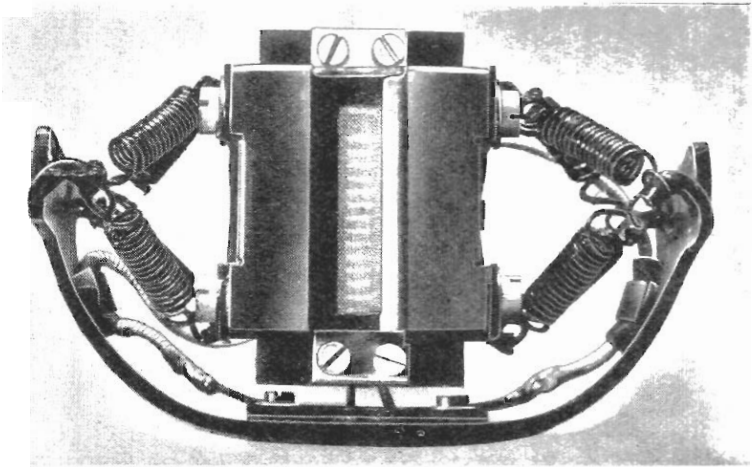

Fig. 62—LIP RIBBON MICROPHONE: BACK VIEW
The corrugated ribbon is just visible behind the silk screen

6.7.2 OPERATION

The operation of the ribbon unit differs somewhat from that of the BBC-Marconi ribbon microphone. The distance from mouth to ribbon is approximately 2.5 in. and the waves actuating the ribbon are practically spherical. The differential pressure on the unit is therefore accentuated for low-frequency sounds from the mouth, and would cause an excessive low-frequency response if no equalisation arrangements were made. The equalisation characteristic necessary for a uniform response to the speech input corresponds to the ratio of the particle velocities in spherical and plane waves. The loss introduced at the lower frequencies is approximately 18.5 db at 100 c/s, 11 db at 250 c/s, 5.5 db at 500 c/s and 2.5 db at 1,000 c/s.

This equalisation of the response to close speech causes a corresponding reduction of the low-frequency response to plane waves. Sound waves from the interfering sources of noise are almost plane, due to distance, and low-frequency components of noise which usually cause greatest interference, are practically eliminated from the microphone output.

Part of the equalisation is acoustical, due to the presence of silk gauze screens on either side of the ribbon. These introduce acoustical resistance, which tends to govern the motional impedance at the lower frequencies, where mass reactance is small. The low-frequency response is therefore reduced, because although a

STUDIO MICROPHONES

decrease in frequency causes a proportionate decrease in differential pressure, the motional impedance is relatively constant. The use of silk gauze also serves to protect the ribbon against draughts from the mouth and from the effects of wind.

The remainder of the equalisation is effected by an electrical network in the carrying case; it can be varied by means of a 3-position key to suit the timbre of a commentator's voice.

The response is decreased at frequencies above 6,000 c/s owing to the obstruction to high-frequency waves by the magnet. The frequency range of the microphone is, however, adequate for speech transmission.

APPENDIX I

PROOF OF THE RELATIONSHIP $v = + j\omega x$, FOR SIMPLE HARMONIC MOTION

IF WE HAVE SIMPLE HARMONIC MOTION in a mechanical system, and the maximum amplitude of the displacement is x_{max} centimetres, the displacement at any instant is given by:—

Displacement $x = x_{max} \sin \omega t$ centimetres

where $\omega = 2\pi f$,

f = Number of complete cycles of vibration per second,

t = Time, in seconds, from a zero datum.

The motion is represented in Fig. 1.1.

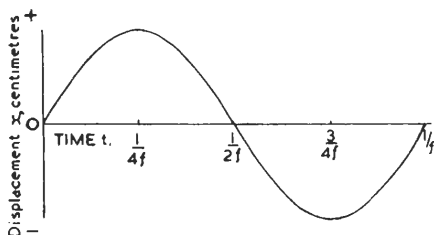

Fig. 1.1—SINE CURVE FOR SIMPLE
HARMONIC MOTION

The velocity v , at any instant, is the rate of change of displacement at that instant, and is given by dx/dt centimetres per second.

Velocity, $v = dx/dt = \omega x_{max} \cos \omega t$ centimetres per second.

If we make a second differentiation and equate to zero, we obtain the values of t which give the conditions of positive or negative maximum velocity:—

Slope of the velocity curve $dv/dt = -\omega^2 x_{max} \sin \omega t = 0$

$\sin \omega t = 0$ when $\omega t = 0, \pi, 2\pi$, etc.

$\therefore \frac{dv}{dt} = 0$ when $t = 0, \frac{1}{2f}, \frac{1}{f}$, etc.

The instantaneous velocity has positive or negative maximum at the instants when $t = 0, 1/2f, 1/f$, etc.

We can distinguish between the positive and negative maxima by making a further differentiation and then substituting the above values for t . A substitution which gives a negative quantity for the rate of change of slope, corresponds to a positive maximum

velocity; the negative maximum velocity has a positive rate of change of slope.

$$\frac{d^2v}{dt^2} = -\omega^3 x_{max} \cos \omega t$$

When $t=0$, $\frac{d^2v}{dt^2} = -\omega^3 x_{max} \cos 0$
 $= -\omega^3 x_{max}$; the velocity is a positive maximum

When $t = \frac{1}{2f}$, $\frac{d^2v}{dt^2} = -\omega^3 x_{max} \cos \pi$
 $= \omega^3 x_{max}$; the velocity is a negative maximum

When $t = \frac{1}{f}$, $\frac{d^2v}{dt^2} = -\omega^3 x_{max} \cos 2\pi$
 $= -\omega^3 x_{max}$; the velocity is a positive maximum

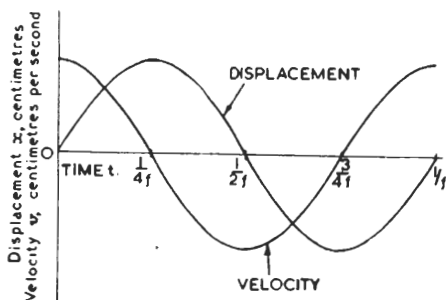

Fig. 1.2—VELOCITY AND DISPLACEMENT CURVES: SIMPLE HARMONIC MOTION

In Fig. 1.2 the velocity and displacement curves are represented together. The maximum velocity, at the instants when $t=0$, $1/2f$, $1/f$, etc., is given by $v_{max} = \omega x_{max}$.

For a sine wave we have the constant relationship $r.m.s. = \frac{\text{Maximum Value}}{\sqrt{2}}$. Because the velocity and displacement waves are

both sinusoidal we may write $v_{r.m.s.} = \omega x_{r.m.s.}$

Fig. 1.2 shows that the positive maximum of the velocity curve occurs earlier than the positive maximum of the displacement, by an amount of time $1/4f$, corresponding to a quarter of a wavelength, or an angular displacement of $\pi/2$ radians, i.e., 90° . Therefore to describe completely the relationship between v and x we must use the j notation:—

$$v = +j\omega x$$

where v and x are both r.m.s. values, or both maximum (peak) values.

MICROPHONES

Other applications of the proof

The proof given above is exactly similar to the proof of the rate of change of current or voltage in an electrical circuit; in fact, it may be applied to any sinusoidal function.

If we have a quantity which is a sinusoidal function of distance, then $\omega = 2\pi f'$, where f' is cycles per unit distance (i.e., reciprocal of the wavelength λ). Thus $\omega = 2\pi/\lambda$.

APPENDIX 2

ANALYSIS OF THE FORCE ON A COMPLETELY EXPOSED DIAPHRAGM

ASSUME THAT THE DIAPHRAGM is exposed in a uniform sound field, causing no appreciable obstruction to the free propagation of a plane sinusoidal wave. The pressure at a point in the propagation path is given by:—

$$\begin{aligned}
 p &= p_{max} \sin \omega t \\
 &= p_{max} \sin 2\pi f t \quad \dots \quad \dots \quad \dots \quad \dots \quad \dots \quad \dots \quad (1)
 \end{aligned}$$

where p_{max} is the peak pressure in the sound field, f is c/s, and t is time.

We have also $f=c/\lambda$, where c is velocity of propagation and λ is the wavelength.

Thus we may write:—

$$\begin{aligned}
 p &= p_{max} \sin 2\pi ct/\lambda \\
 \text{and } p &= p_{max} \sin kct \quad \dots \quad \dots \quad \dots \quad \dots \quad \dots \quad \dots \quad (2) \\
 \text{where } k &= 2\pi/\lambda
 \end{aligned}$$

The product ct represents distance, being the product of velocity and time.

For a wave at normal incidence to the diaphragm, we may represent the extremes of the path length d , and its centre point, by three points on the axis of propagation, x_1 , x_0 and x_2 .

We have,* for an instantaneous distribution of pressure along the axis of propagation:—

$$\begin{aligned}
 p &= p_{max} \sin k(ct-x) \quad \dots \quad \dots \quad \dots \quad \dots \quad \dots \quad \dots \quad (3) \\
 \text{where } x &\text{ is the distance, in the direction of propagation, from a reference point.}
 \end{aligned}$$

With plane wave propagation, we may take as our reference point, the position x_0 midway along the path length about the diaphragm. The pressure at this point, where $x=0$, is given by equation (2).

The position of the front surface of the diaphragm is indicated by the point x_1 , Fig. 2.1, at a distance $x=-d/2$ from x_0 . The pressure at x_1 is given by equation (3):—

$$p_1 = p_{max} \sin k \left\{ ct - \left(-\frac{d}{2} \right) \right\} = p_{max} \sin k \left(ct + \frac{d}{2} \right)$$

The position of the rear surface of the diaphragm is indicated by the point x_2 , at a distance $x=+d/2$ from x_0 .

* Olsen: Elements of Acoustical Engineering (Equations 1.17, 1.22, 8.39).

MICROPHONES

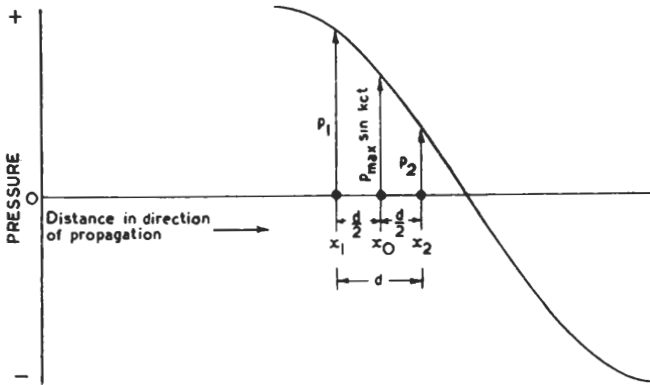

Fig. 2.1—PRESSURE CURVE, PLANE-WAVE PROPAGATION

The pressure at x_2 is given by:—

$$p_2 = p_{max} \sin k\left(ct - \frac{d}{2}\right)$$

The net pressure on the diaphragm is $p_1 - p_2$.

$$\begin{aligned} p_1 - p_2 &= \left\{ p_{max} \sin k\left(ct + \frac{d}{2}\right) \right\} - \left\{ p_{max} \sin k\left(ct - \frac{d}{2}\right) \right\} \\ &= p_{max} \left\{ \left[\sin k\left(ct + \frac{d}{2}\right) \right] - \left[\sin k\left(ct - \frac{d}{2}\right) \right] \right\} \end{aligned}$$

Because $\sin A - \sin B = 2 \cos \frac{A+B}{2} \sin \frac{A-B}{2}$

$$p_1 - p_2 = 2p_{max} \cos kct \sin k \frac{d}{2} \quad \dots \quad \dots \quad \dots \quad (4)$$

The force on the diaphragm is given by the product of the net pressure and the surface area of one side:—

$$\text{Force} = 2Ap_{max} \cos kct \sin k \frac{d}{2} \quad \dots \quad \dots \quad \dots \quad (5)$$

where A is the diaphragm area.

Since $k = 2\pi/\lambda$ and $c = f\lambda$, we may write $\cos 2\pi ft$ instead of $\cos kct$.
 Force = $2Ap_{max} \cos 2\pi ft \sin k d/2$.

We can see that $\cos 2\pi ft$ has a maximum positive value of 1.0 when t is any integral multiple of $1/f$. At such instants the force has a positive maximum value:—

$$\text{Force}_{(max)} = 2Ap_{max} \sin k \frac{d}{2} \quad \dots \quad \dots \quad \dots \quad (6)$$

When t is any integral odd multiple of $1/2f$, $\cos 2\pi ft$ has the maximum negative value of -1.0 and the force is negative.

APPENDIX 3

DERIVATION OF ELECTRICAL-ACOUSTICAL ANALOGIES FROM THE EQUATION FOR SIMPLE HARMONIC MOTION

A SIMPLE MECHANICAL SYSTEM having mass, compliance, and friction is represented in Fig. 3.1 (a).

The mass m is a cylindrical body capable of movement along the axis of a tube. It is subject to damping R_m , due to contact with the cylindrical wall of the tube, and is coupled by a spring (compliance C_m) to a fixed outer bracket; the stiffness of the spring is S dynes per centimetre displacement (of the point of junction with the mass m).

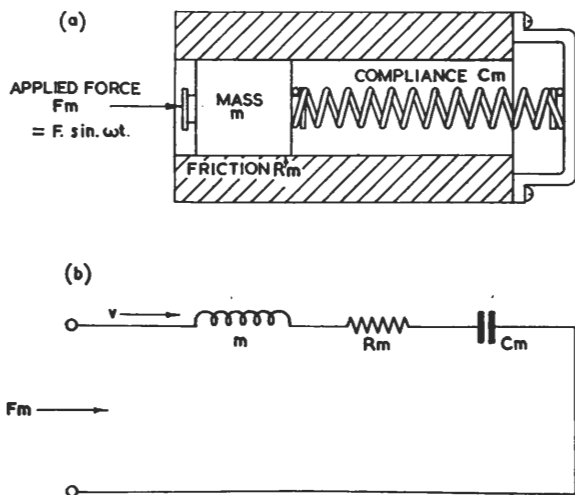

Fig. 3.1—(a) SIMPLE MECHANICAL SYSTEM
(b) EQUIVALENT CIRCUIT

When the system is subjected to a sinusoidal force F_m dynes, a reciprocating motion is caused which may be expressed by the differential equation:—

$$F_m = m \frac{d^2x}{dt^2} + R_m \frac{dx}{dt} + Sx = F \sin \omega t$$

where x is the displacement in centimetres.

MICROPHONES

This may be re-written:—

$$F_m = m \frac{dv}{dt} + R_m \cdot v + S \int v \cdot dt = F \sin \omega t \quad \dots \quad (1)$$

where v is the velocity in centimetres per second.

For an electrical circuit which has resistance, inductance, and capacitance in series, and is subjected to a sinusoidal voltage, we have:—

$$V = L \frac{di}{dt} + Ri + \frac{1}{C} \int i \cdot dt = V_{max} \sin \omega t \quad \dots \quad (2)$$

The steady-state solutions of (1) and (2) are of similar form.

Substituting $\frac{1}{C_m}$ for S :—

$$v = \frac{F_m}{r + j \left(\omega m - \frac{1}{\omega C_m} \right)} \text{ for the mechanical system,}$$

and

$$I = \frac{V}{R + j \left(\omega L - \frac{1}{\omega C} \right)} \text{ for the electrical circuit}$$

where v and F_m , and I and V are r.m.s. values.

By comparing equations (1) and (2) we may draw the following conclusions:—

- Force is analogous to Voltage
- Mass is analogous to Inductance
- Damping is analogous to Resistance

Displacement ($\int v \cdot dt$) is analogous to Charge ($\int i \cdot dt$). Comparison of the two final equations shows that:—

- Velocity is analogous to Current
- Compliance is analogous to Capacitance
- Mechanical Impedance is analogous to Electrical Impedance.

The analogies show that the mechanical system of Fig. 3.1 (a) may be represented by the equivalent circuit of Fig. 3.1 (b).

APPENDIX 4

ACOUSTICAL UNITS; FORMULÆ FOR ACOUSTICAL IMPEDANCES; EQUIVALENT MECHANICAL VALUES

Acoustical Units

With reference to the table of analogies, it should be noted that the acoustical units apply to an acoustical path, which has volume.

The *volume current* U in a plane wave represents the total of all the identical rates of displacement of particles in a plane normal to the axis of propagation, bounded by the depth and width dimensions of the acoustical path, i.e., $U = vA$

where v = the particle velocity, in centimetres per second

A = the cross-sectional area of the acoustical path, in square centimetres.

The volume current is expressed in cubic centimetres per second, and is given by:—

$$U = \frac{p}{R_a}$$

where p is the sound pressure and R_a is the acoustical resistance.

The acoustical resistance R_a is, in general, partly due to radiation resistance, and partly due to frictional resistance. The relative proportion of the two components depends on the nature of the acoustical path. The unit of acoustical resistance is explained by the relationship:—

$$R_a = \frac{p}{U} = \frac{\text{Dynes per sq cm}}{\text{Cu cms per sec}}$$

$$\begin{aligned} R_a &= \frac{\text{Dynes}}{\text{cm}^2} \times \frac{\text{Secs}}{\text{cm}^3} \\ &= \text{Dyne-secs per cm}^5 \end{aligned}$$

The power P_a is the total rate of flow of energy through the cross-sectional area of the acoustical path. The intensity, in ergs per second per square centimetre, is given by P_a/A .

The inittance M is equal to the sound pressure divided by the rate of change of volume current (from the law: Force = Mass \times Acceleration).

$$M = p / \frac{du}{dt} = \frac{\text{Dynes per sq cm}}{\text{Cu cms per sec per sec}}$$

MICROPHONES

$$= \frac{\text{Dynes}}{\text{cm}^2} \times \frac{\text{secs}^2}{\text{cm}^3} = \frac{\text{Dyne (secs)}^2}{\text{cm}^5}$$

1 dyne is the force required to produce an acceleration of 1 centimetre per second per second in a mass of 1 gramme.

$$\therefore \frac{1 \text{ dyne (secs)}^2}{\text{cm}} = 1 \text{ gramme}$$

and $M = \text{grammes per cm}^4$

The capacitance C_a is equal to the volume displacement x_a divided by the sound pressure:—

$$\begin{aligned} C_a &= \frac{x_a}{p} = \frac{\text{Cu cms}}{\text{Dynes per sq cm}} \\ &= \frac{\text{cm}^3}{\text{dyne}} \times \text{cm}^2 \end{aligned}$$

$$\therefore C_a = \text{cm}^5 \text{ per dyne}$$

Formulae for Acoustical Impedances

The inertance M of a column of air is given by:—

$$M = \frac{m_a}{A^2}$$

where $m_a = \text{the total mass of the air}$

$A = \text{the area subjected to the acoustical pressure}$

A circular tube has an inertance given by:—

$$M = \frac{m_a}{A^2} = \frac{\rho l}{\pi r^2}$$

where $r = \text{radius of tube in centimetres}$

$l = \text{length of tube in centimetres (including end correction)}$

$\rho = \text{density of air in tube, } 0.0012 \text{ gramme per cubic centimetre.}$

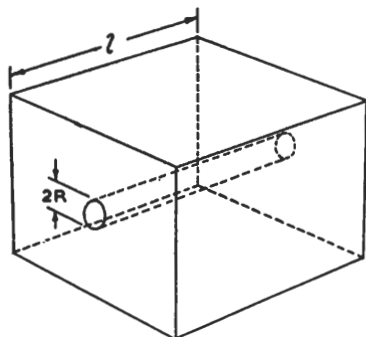

Fig. 4.1—NARROW TUBULAR PATH

The narrow tube has an acoustical impedance which is partly due to inertance, and partly due to acoustical resistance. If the diameter is small compared with the length, the end correction for the external air load may be neglected; the acoustical resistance is due to viscous friction between air particles.

The impedance of a tubular path (Fig. 4.1), with diameter small compared with length,

and length small compared with the wavelength of the pressure wave, is given by:—

$$Z_a = \frac{l}{\pi r^2} \left(\frac{8\mu}{r^2} + j\omega \frac{4\rho}{3} \right)$$

where r = radius of tube in centimetres

l = length of tube in centimetres

$\omega = 2\pi \times c/s$

μ = viscosity coefficient; 1.83×10^{-4} grammes per cm/sec, for air.

A narrow slot (Fig. 4.2) presents an acoustical impedance of the same type as that of a narrow tube. The end corrections may be neglected if the thickness of the slot is small compared with the length.

The impedance of a slot, with thickness small compared with length, and length small compared with the wavelength of the pressure wave, is given by:—

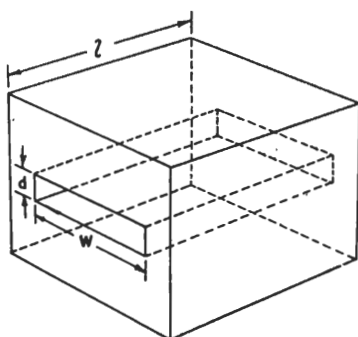

Fig. 4.2—NARROW SLOT HAVING SIMILAR ACOUSTICAL IMPEDANCE TO NARROW TUBE

$$Z_a = \frac{12\mu l}{d^3 W} + j\omega^2 \frac{\rho l}{5dW}$$

where l = length of slot in the direction of flow, in centimetres

d = thickness of slot normal to direction of flow, in centimetres

W = width of slot normal to direction of flow in centimetres.

The resistive part of the impedance is inversely proportional to the cube of the thickness d of the slot. The inertance is inversely proportional to d . By a suitable choice of d the ratio of inertance to resistance may be made to have almost any desired value. The magnitude of the impedance is determined by choice of the ratio of length to width, l/W . The slot is a most useful form of acoustical impedance, and is of particular value in microphone design technique.

Silk screens are commonly used in microphones, to provide acoustical resistance. The smallness of the interstices in the material causes the ratio of acoustical resistance/inertance to be very high. Other materials such as hair and cotton-wool are very widely used to increase the resistance of tubes and slots, in which the material is inserted.

MICROPHONES

A simple cavity (Fig. 4.3) has a capacitive impedance, but generally has small amounts of resistance and inertance, associated with the oscillatory movement of air particles at the mouth of the cavity.

The acoustical capacitance C_a is given by:—

$$C_a = \frac{\text{Volume of cavity (cubic cms)}}{\rho c^2}$$

where c is the velocity of sound in air (34,400 cms/sec).

Because there is always some inertance associated with a cavity, a condition of resonance is caused at a particular frequency.

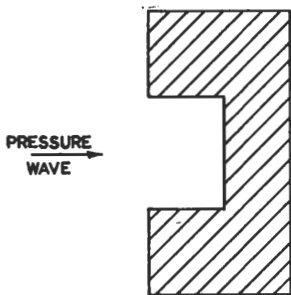

Fig. 4.3—SIMPLE CAVITY

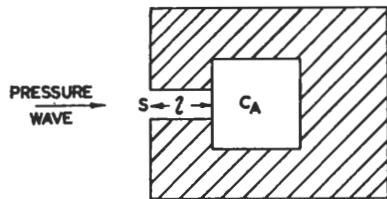

Fig. 4.4 — ACOUSTICAL SYSTEM
SIMILAR TO HELMHOLTZ
RESONATOR

Fig. 4.4 shows an acoustical system similar to a Helmholtz resonator. The frequency of resonance f_r is given by:—

$$f_r = \frac{c}{2\pi} \cdot \sqrt{\left(\frac{A}{V_a l}\right)}$$

where l = length of the entrance passage in centimetres

A = cross-sectional area of the entrance passage in square centimetres

V_a = volume of the cavity C_a in cubic centimetres.

Equivalent Mechanical Values

Fig. 4.5 represents the coupling of a mechanical system to an acoustical system, by means of a rod and diaphragm (both assumed

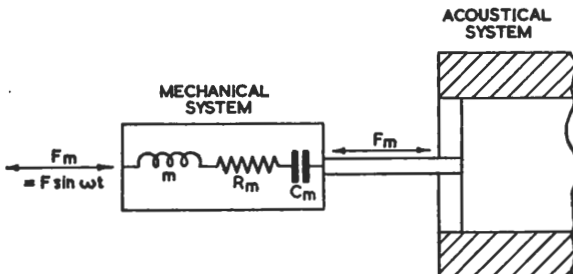

Fig. 4.5—COUPLING OF MECHANICAL SYSTEM TO
ACOUSTICAL SYSTEM

to have negligible mass and compliance). The acoustical system is represented by a simple tubular passage, but the acoustical impedance may be of any kind, depending on whether there are sudden changes of diameter along the length of the tube, the nature of the termination of the tube, and the frequency of the applied sinusoidal force. The cross-sectional area of the diaphragm in square centimetres is denoted by A . The sinusoidal force F_m applied to the diaphragm is the resultant of F'_m applied to the mechanical system.

The various possible types of acoustical impedance are reflected into the mechanical system. Equivalent mechanical values of the acoustical quantities may be obtained from the relationships:—

$$(1) \text{ Force} = \text{Pressure} \times \text{Area}$$

$$F_m = pA$$

$$(2) \text{ Velocity} = \frac{\text{Volume Current}}{\text{Area}}$$

$$v = \frac{U}{A}$$

$$(3) \text{ Displacement} = \frac{\text{Volume Displacement}}{\text{Area}}$$

$$x = \frac{x_v}{A}$$

$$(4) \text{ Resistance} = \text{Acoustical Resistance} \times \text{Area squared}$$

$$R_m = R_a A^2$$

$$(5) \text{ Mass} = \text{Inertance} \times \text{Area squared}$$

$$m = M A^2$$

$$(6) \text{ Compliance} = \frac{\text{Acoustical Capacitance}}{\text{Area squared}}$$

$$C_m = \frac{C_a}{A^2}$$

A microphone may have several slots, tubes, and cavities, as in Fig. 4.6, in order that the mechanical impedance shall have the desired frequency characteristic. For any particular slot, tube, or cavity, the effective area A may be only a very small fraction of the total effective diaphragm area.

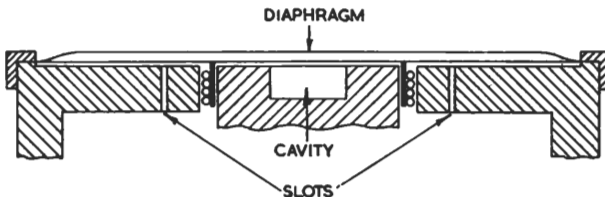

Fig. 4.6—CAVITIES AND SLOTS IN A MICROPHONE

APPENDIX 5

EFFECT OF DIFFRACTION VARIATIONS ON DIFFERENTIAL-PRESSURE OPERATION

THE EXTENT TO WHICH differential-pressure operation is affected by diffraction variations is best illustrated by a comparison of the response/frequency characteristics of two different microphone systems, as follows:—

Narrow Cylinder (Fig. 5.1 (a))

A ribbon microphone, actuated by the instantaneous difference of pressures at the two ends of a cylinder of appreciable length; the

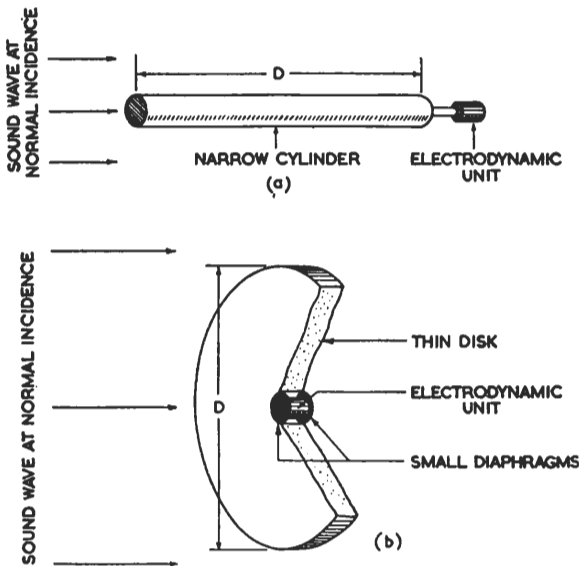

Fig. 5.1—TWO DIFFERENTIAL-PRESSURE-OPERATED SYSTEMS

(a) No diffraction variation: operation due to phase difference only; (b) Diffraction variation causes the pressure on the diaphragms to differ in both magnitude and phase

diameter is small compared with the wavelengths at the frequencies considered, and the effective pressures at the ends of the cylinder are assumed to be equal to the free-wave pressure. The differential

pressure is therefore entirely due to the difference of phase between the two ends.

Thin Disk (Fig. 5.1 (b))

A ribbon microphone located in a central hole in a disk of appreciable diameter, and actuated by the difference of pressures at the central areas of the disk*; the thickness of the disk is small compared with the wavelengths, and it is assumed that phase-shift due to the thickness is negligible.

The comparison made is for plane-wave conditions and normal incidence.

Differential pressure may be defined as the vector difference of two pressures separated by a phase angle. The magnitude of the differential pressure is given by the solution of the triangle:—

$$p_{diff} = \sqrt{A^2 + B^2 - 2AB \cos \phi} \quad \dots \dots \dots (1)$$

where A and B are the individual pressures and ϕ is their phase difference (Fig. 5.2).

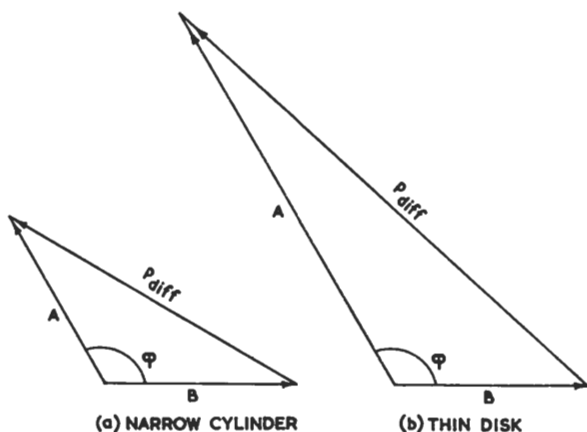

Fig. 5.2—DIFFERENTIAL-PRESSURE VECTORS

For the narrow cylinder the pressures A and B are both equal to the free-wave pressure p_0 and the phase difference is given by $2\pi D/\lambda$ for ϕ in Equation (1), the expression reduces to:—

$$p_{diff} = 2p_0 \sin \pi D/\lambda \quad \dots \dots \dots (2)$$

This corresponds to the equation in Appendix 2 for the force on a completely exposed diaphragm. The differential pressure for the narrow cylinder, calculated from Equation (2), is represented as a function of D/λ by the dotted curve of Fig. 5.4.

* The mass-controlled microphone at the centre could consist of two pressure-operated units, back-to-back, with outputs connected in series opposition.

difference $\alpha-\beta$ corresponds approximately to the distance $2r$ (the shortest air distance between the centres). At higher frequencies, where the angle α is only a very small fraction of the total phase difference, the latter corresponds approximately to the radius r .

The values of A , B and ϕ , taken from Fig. 5.3, are substituted in Equation (1) to obtain the differential pressure acting on the unit at the centre of the thin disk. The resulting characteristic, shown

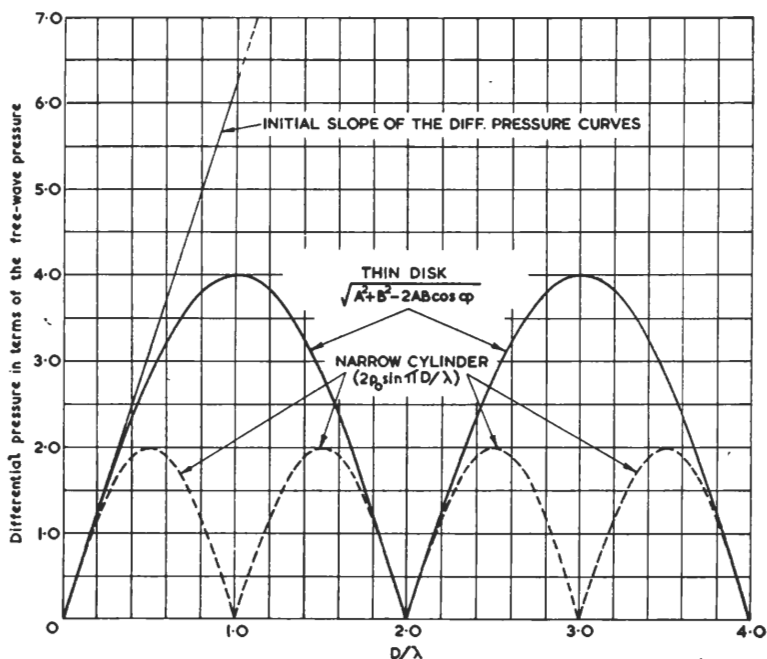

Fig. 5.4—DIFFERENTIAL-PRESSURE CHARACTERISTICS, SHOWING SLOPE AT ZERO FREQUENCY

in Fig. 5.4, rises to twice the height of the curve for the narrow cylinder; also the first extinction frequency, at which the differential pressure is zero, is twice as high as for the cylinder.

The two curves are of similar shape for values of D/λ less than approximately 0.1; for such low frequencies the pressures on the diaphragms at the front and rear of the thin disk are both equal to p_0 , the phase difference ϕ is equal to $2\pi D/\lambda$, and the differential pressure is given by $2p_0 \sin \pi D/\lambda$, just as for the narrow cylinder.

The initial slope at $D/\lambda=0$ is the same for both curves and is obtained by differentiating $2p_0 \sin \pi D/\lambda$ with respect to D/λ . Differentiation gives $2\pi p_0 \cos \pi D/\lambda$ for the slope, and at $D/\lambda=0$

MICROPHONES

the slope is equal to $2\pi p_0$. The straight line in Fig. 5.4 is drawn with a slope of 2π , and indicates the manner in which the differential pressures of the two systems should increase with frequency in order to maintain constant output (based on the assumption of perfect mass control at all frequencies, even at or near zero frequency).

The fractional divergence of each differential-pressure curve away from the straight line gives the fractional divergence of each microphone output from the reference level (output voltage at the lowest frequencies). The height of any ordinate drawn to the straight line is equal to $2\pi D/\lambda$, and the response of the narrow cylinder system is given by $(2p_0 \sin \pi D/\lambda)/(2\pi D/\lambda)$; similarly the response of the thin disk system is given by $\sqrt{(A^2+B^2-2AB \cos \phi)}/(2\pi D/\lambda)$. The range of response of the two systems calculated in this way, is shown in Fig. 5.5 with a logarithmic scale for the

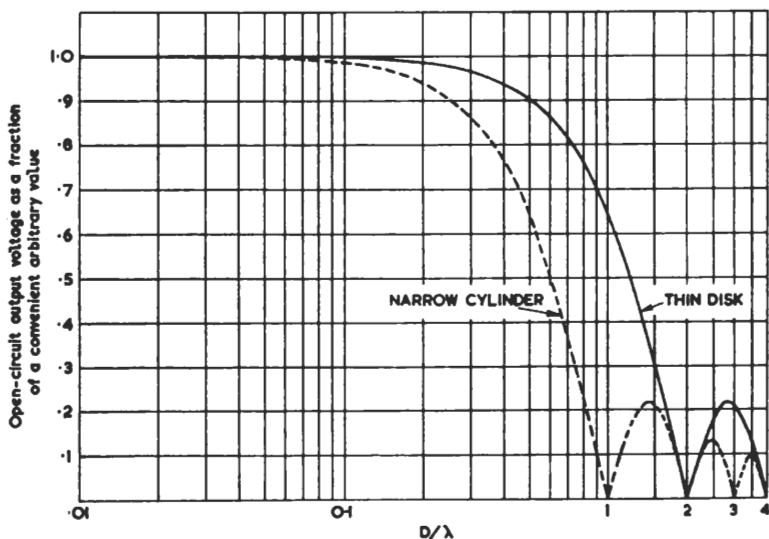

Fig. 5.5—COMPARISON BETWEEN RESPONSE/FREQUENCY CHARACTERISTICS OF DISK AND CYLINDER SYSTEMS

ratio D/λ . It is apparent that diffraction by the disk causes the response/frequency range of the thin disk system to be twice as great as that of the narrow cylinder system.

The first extinction frequency for the thin disk system occurs at $D/\lambda=2$, i.e., when the wavelength is equal to the radius of the disk. This suggests that with a differential-pressure operated microphone having an air separation between the diaphragm surfaces which is mainly due to the transverse dimension, a first

APPENDIX 5

extinction frequency is to be expected with wavelength equal to half of the lesser frontal dimension.

With practical microphones there is only a semblance of a cut-off because the diffraction variations are somewhat different from those of the thin disk, whose diffraction properties are peculiar to it. A computed response/frequency characteristic for the BBC-Marconi ribbon microphone shows a kink, of lowest level approximately -16 db, occurring at about 16 kc/s, at which frequency the wavelength is about 15 per cent less than the overall width (1 in.) of the obstruction formed by the pole-pieces and ribbon.

ERRATA

Page 24, line 12. For P_0 read P_a .

Page 74, line 11. Read $v_{ac} = \sqrt{\left(\frac{300}{0.6}\right)} \times 13 \mu V$

Figures 46, 47, 51, legends. For microbar read bar.

BIBLIOGRAPHY

BOOKS

- “Acoustic Measurements”, by Leo. L. Beranek. Chapman & Hall, 1949.
- “Acoustics” (Students’ Physics Series, Vol. 2), by Alexander Wood. Blackie, 1940.
- “Electro-acoustics”, by E. Meyer. Bell, 1939.
- “Elements of Acoustical Engineering”, by H. Olson. Van Nostrand, 1948.
- “Glossary of Acoustical Terms and Definitions”, British Standard 661: 1936.
- “The Physics of Music”, by Alexander Wood. 4th edn. Methuen, 1947.
- “Speech and Hearing”, by H. Fletcher. Macmillan, 1936.
- “Textbook of Sound”, by A. B. Wood. 2nd edn. Bell, 1942.
- “Theory of Sound”, by J. W. S. Rayleigh. 2 vols. 2nd edn. Macmillan, 1937.

JOURNALS

- Bell System Technical Journal*, 15, 405–423, 1936. “A Non-directional Microphone”, by R. N. Marshall and F. F. Romanow.
- BBC Quarterly*, 1, 4, 1947. “Acoustical Planning of Broadcasting Studios”, by John McLaren.
- BBC Quarterly*, 3, 4, 1949. “Listeners’ Sound Level Preferences”, by T. Somerville and S. F. Brownless.
- Electronic Engineering*, April–August, 1946. “Microphones”, by S. W. Amos and F. C. Brooker.
- Philips Technical Review*, 9, 330–338, 1947–8. “A Condenser Microphone for Stereophony”, by A. Rademakers.
- Philips Technical Review*, 9, 357–363, 194, –8. “Circuit for Condenser Microphone with Low Noise Levels”, by I. J. Zaalberg Van Zelst.

INDEX

- Acceleration, 34
Acoustic bright spot, 54
 power, 22
Acoustical - electrical - mechanical analogies, 36
Acoustical impedances, formulæ, 101
 units, 101
Analogy between mechanical and electrical resonance, 42
Analysis of force on exposed diaphragm, 97
Angle of incidence, 11
"Apple and biscuit" microphone, 80

Bimorph, 85
Bright spot, acoustic, 54
 calculation of output voltage, 73
 calculation of response, 70
 driving force, 68
 mechanical impedance, 67
 polar diagram, 75
 working distance, 75
BBC-Marconi lip microphone, 90
BBC-Marconi ribbon microphone, 66
Brush crystal microphones, 85
 "Sound Cell," 86

Cardioid characteristics, 63
Cavities and slots in microphones, 105
Cavity resonance, 60
Compliance, 33
 and capacitance, 34
 control, 44
Compression, 18
Condenser microphones, 88
Constant-amplitude microphones, 15
Constant-impedance systems, 43
Constant-velocity microphones, 15
Crystal microphones, 15, 86
 plates, 86

Damping in mechanical system, 34
Datum of diffraction by a cube, 56
 of diffraction by a cylinder, 52
 of diffraction by a sphere, 49
Decay of sound pressure with distance, 23
Derivation of electrical-acoustical analogies, 99
Diaphragm dimensions, 47
 operation, 47
Differential pressure with sound at angular incidence, 29
Differential-pressure operation, 26
Diffraction, 48
 and microphone dimensions, 57
 by cylindrical dimensions, 52
 by rectangular object, 55
 by spherical object, 49
Dimensions of diaphragm, 47
 of microphones, 57, 61
Directional efficiency, 64
 requirements of microphones, 13
Directivity index, 64
Displacement wave, 20
Distance, variation of energy and pressure with, 22
Dynamic condition in a mechanical system, 35

Effects of diffraction, 48
 of diffraction variations on differential-pressure operation, 106
Electro-acoustical analogies, 33, 99
Electro-acoustics, 33
Electromechanical analogies, 23
E.M.I. moving-coil microphone, 83
Equivalent circuit, mechanical-acoustical system, 41
 circuits, 37

Figure-of-eight diagram, 63
Force, 34
 on exposed diaphragm, 27, 97
Formulæ, acoustic impedance, 101
Free-space pressure, 49

INDEX

- Gradient-operated microphones, 26
 Impedance of BBC-Marconi ribbon microphone, 67
 of complicated mechanical system, 39
 of simple mechanical system, 37
 Inertance, 101
 Intensity, sound, 22
 Mass and inductance, 34
 control, 44
 Mechanical and electrical resistance, 35
 impedance of complicated system, 39
 impedance of simple system, 37
 Microphones, studio, 66
 BBC-Marconi lip, 90
 BBC-Marconi ribbon, 66
 Brush crystal, 85
 E.M.I. moving-coil, 83
 Marconi condenser, 89
 S.T. & C. moving-coil 4017A, 75
 S.T. & C. moving-coil 4021A, 80
 Multi-cell crystal microphones, 87
 Nature of sound waves, 17
 Operational forces, 25
 Particle density, 18
 velocity, 22
 Path length, 26
 length ribbon microphone, 32
 Phase difference across a diaphragm, 57
 relationship between sinusoidal quantities in plane wave, 21
 shift, differential-pressure microphones, 26
 Plane wave propagation, 20
 Polar diagrams, 62
 Pressure distribution over a sphere, 51
 doubling, 48
 operation, 25
 Pressure wave, 20
 Pressure-gradient wave, 20
 Propagation of sound waves, 17
 Random efficiency, 64
 Rarefaction, 19
 Reisz microphone, *Frontispiece*
 Relationship between velocity and amplitude, 16
 Requirements of broadcasting microphones, 12
 Resistance control, 43
 Resonance in mechanical systems, 42
 Ribbon microphone BBC-Marconi, 66
 microphone, differential pressure of, 31
 microphone, effective path length at low frequencies, 32
 Scattered wave, 48
 Secondary radiation, 54
 Sibilants, prevention of, 60
 Simple harmonic motion, 94
 Single-cell crystal microphones, 86
 Sound intensity, 23
 pressure, 17, 22
 shadow behind a disk, 54
 waves in air, 17
 Specific acoustic resistance, 23
 Spherical wave, 22
 waves, increase of force with, 29
 S.T. & C. moving-coil microphone 4017A, 43, 75
 moving-coil microphone 4021A, 80
 Standing wave, 48
 Stiffness, 35
 Studio microphones, 66
 Table of analogies (accoustical, electrical, mechanical), 36
 of modes of control (resistance, mass, compliance), 45
 Threshold of feeling, 17
 of hearing, 17
 Variation of sound energy and pressure with distance, 22
 Velocity and amplitude, relationship between, 16
 Velocity-operated microphones, 26

TELEVISION RECEIVING EQUIPMENT

3rd Edition. By W. T. Cocking, M.I.E.E. First explains the fundamental principles of television reception and then describes each stage of a normal receiver. The text includes notes on special circuits and gives practical details of receiver design. Other chapters are devoted to faults and their remedies, servicing of modern sets and the problems of obtaining selectivity. Mathematical data of particular value to the designer has been collated and appears in appendixes. **18s. net. By post 18s. 8d.**

RADIO LABORATORY HANDBOOK

5th Edition. By M. G. Scroggie, B.S.C., M.I.E.E. This handbook shows the methods available for carrying out tests and measurements, using either commercial instruments or improvised equipment. The fifth edition has been revised and new material added—in particular details of the more recent developments in valve oscillator design. **15s. net. By post 15s. 5d.**

WIRELESS SERVICING MANUAL

8th Edition. By W. T. Cocking, M.I.E.E. Deals with the location and cure of the innumerable faults which can develop in broadcast receivers and their associated equipment. Apart from domestic sets, short-wave receivers and converters are covered, and there is a special chapter devoted to servicing with the cathode-ray oscilloscope.

12s. 6d. net. By post 12s. 11d.

FOUNDATIONS OF WIRELESS

5th Edition. By M. G. Scroggie, B.S.C., M.I.E.E. Explains the whole basic theory of radio from the most elementary principles. Subjects covered include: fundamental laws of electricity and radio, theory of valves, simple transmitters, all types of modern receivers, aerials, power supplies, transmission lines and an introduction to television and radar. No previous technical knowledge whatever on the reader's part is assumed and mathematics are avoided except where essential.

12s. 6d. net. By post 13s.

RADIO VALVE DATA

Characteristics of 2,000 Receiving Valves and C.R. Tubes. 2nd Edition. Compiled by the Staff of WIRELESS WORLD. Gives the main characteristics and base connections of over 2,000 types of British and American radio valves, and over 100 cathode-ray tubes. These are further classified into obsolete, replacement or current types as recommended by the makers.

3s. 6d. net. By post 3s. 9d.

SOUND RECORDING AND REPRODUCTION

Second in a series of textbooks originally written for BBC engineers, this book covers the theory and practice of disc, magnetic and film recording, with special reference to the equipment used by the BBC. It includes over 170 photographs and drawings. **In preparation.**

Obtainable at all booksellers or direct from :

DORSET HOUSE • STAMFORD STREET • LONDON • S.E.1