

W. J. G. Beynon

BBC

ENGINEERING DIVISION

MONOGRAPH

NUMBER 61: MARCH 1966

Sporadic E ionization and
television interference

by

W. J. G. BEYNON, C.B.E., Ph.D., D.Sc.

(Professor of Physics, University College of Wales, Aberystwyth)

BRITISH BROADCASTING CORPORATION

PRICE FIVE SHILLINGS



BBC ENGINEERING MONOGRAPH

No. 61

SPORADIC E IONIZATION AND
TELEVISION INTERFERENCE

by

W. J. G. Beynon, C.B.E., Ph.D., D.Sc.

(Professor of Physics, University College of Wales, Aberystwyth)

MARCH 1966

BRITISH BROADCASTING CORPORATION

FOREWORD

THIS is one of a series of Engineering Monographs published by the British Broadcasting Corporation. About six are produced every year, each dealing with a technical subject within the field of television and sound broadcasting. Each Monograph describes work that has been done by the Engineering Division of the BBC and includes, where appropriate, a survey of earlier work on the same subject. From time to time the series may include selected reprints of articles by BBC authors that have appeared in technical journals. Papers dealing with general engineering developments in broadcasting may also be included occasionally.

This series should be of interest and value to engineers engaged in the fields of broadcasting and of telecommunications generally.

Individual copies cost 5s. post free, while the annual subscription is £1 post free. Orders can be placed with newsagents and booksellers, or BBC PUBLICATIONS, 35 MARYLEBONE HIGH STREET, LONDON, W.1.

FOREWORD TO MONOGRAPH NUMBER 61

By the Director of Engineering, British Broadcasting Corporation

Professor Beynon has kindly consented to write this monograph at the request of the BBC. The commissioning of a monograph on Sporadic E interference is one of a number of steps which the BBC and the Post Office are taking in an effort to find out whether there is anything that can be done to reduce the increasingly serious interference in Band I television due to this mode of propagation.

Among the possibilities which are being considered is the use of a directional receiving aerial, which may be effective in some cases where the interference comes from a single source, or from two or more sources on approximately the same bearing. A horizontal polar diagram with a low minimum pick-up can be obtained from a comparatively simple aerial, and in these cases a suitably aligned aerial of this type should reduce Sporadic E interference.

Another possibility, which the Post Office are investigating, is the use of a switchable notch filter in receivers to cut down the patterning in certain known cases of interference.

CONTENTS

| <i>Section</i> | <i>Title</i> | <i>Page</i> |
|----------------|---|-------------|
| | FOREWORD TO MONOGRAPH NO. 61 BY THE DIRECTOR OF ENGINEERING, BRITISH BROADCASTING CORPORATION . . . | 2 |
| | PREVIOUS ISSUES IN THIS SERIES | 4 |
| | SUMMARY | 5 |
| 1. | INTRODUCTION | 5 |
| 2. | EXPERIMENTAL DATA ON SPORADIC E | 5 |
| 2.1 | The Observation of E _s Echoes | 5 |
| 2.2 | E _s at Different Latitudes | 6 |
| 3. | SPORADIC E AND RADIO WAVE PROPAGATION | 8 |
| 3.1 | The E _s m.u.f. Factor | 8 |
| 3.2 | Theory and Experiment | 8 |
| 4. | THE INCIDENCE OF SPORADIC E IONIZATION | 9 |
| 4.1 | Diurnal Variation | 9 |
| 4.2 | Seasonal Variation | 9 |
| 4.3 | Sunspot Cycle Variation | 10 |
| 5. | BBC OBSERVATIONS ON SPORADIC E TELEVISION INTERFERENCE | 10 |
| 6. | INFLUENCE OF THE TROPOSPHERE; F ₂ LAYER PROPAGATION | 11 |
| 7. | CONCLUSIONS | 12 |
| 8. | BIBLIOGRAPHY | 13 |

PREVIOUS ISSUES IN THIS SERIES

| No. | Title | Date |
|-----|---|----------------|
| 1. | <i>The Suppressed Frame System of Telerecording</i> | JUNE 1955 |
| 2. | <i>Absolute Measurements in Magnetic Recording</i> | SEPTEMBER 1955 |
| 3. | <i>The Visibility of Noise in Television</i> | OCTOBER 1955 |
| 4. | <i>The Design of a Ribbon Type Pressure-gradient Microphone for Broadcast Transmission</i> | DECEMBER 1955 |
| 5. | <i>Reproducing Equipment for Fine-groove Records</i> | FEBRUARY 1956 |
| 6. | <i>A V.H.F./U.H.F. Field-strength Recording Receiver using Post-detector Selectivity</i> | APRIL 1956 |
| 7. | <i>The Design of a High Quality Commentator's Microphone Insensitive to Ambient Noise</i> | JUNE 1956 |
| 8. | <i>An Automatic Integrator for Determining the Mean Spherical Response of Loudspeakers and Microphones</i> | AUGUST 1956 |
| 9. | <i>The Application of Phase-coherent Detection and Correlation Methods to Room Acoustics</i> | NOVEMBER 1956 |
| 10. | <i>An Automatic System for Synchronizing Sound on Quarter-inch Magnetic Tape with Action on 35-mm Cinematograph Film</i> | JANUARY 1957 |
| 11. | <i>Engineering Training in the BBC</i> | MARCH 1957 |
| 12. | <i>An Improved 'Roving Eye'</i> | APRIL 1957 |
| 13. | <i>The BBC Riverside Television Studios: The Architectural Aspects</i> | JULY 1957 |
| 14. | <i>The BBC Riverside Television Studios: Some Aspects of Technical Planning and Equipment</i> | OCTOBER 1957 |
| 15. | <i>New Equipment and Methods for the Evaluation of the Performance of Lenses of Television</i> | DECEMBER 1957 |
| 16. | <i>Analysis and Measurement of Programme Levels</i> | MARCH 1958 |
| 17. | <i>The Design of a Linear Phase-shift Low-pass Filter</i> | APRIL 1958 |
| 18. | <i>The BBC Colour Television Tests: An Appraisal of Results</i> | MAY 1958 |
| 19. | <i>A U.H.F. Television Link for Outside Broadcasts</i> | JUNE 1958 |
| 20. | <i>The BBC's Mark II Mobile Studio and Control Room for the Sound Broadcasting Service</i> | AUGUST 1958 |
| 21. | <i>Two New BBC Transparencies for Testing Television Camera Channels (Out of Print)</i> | NOVEMBER 1958 |
| 22. | <i>The Engineering Facilities of the BBC Monitoring Service</i> | JANUARY 1959 |
| 23. | <i>The Crystal Palace Band I Television Transmitting Aerial</i> | FEBRUARY 1959 |
| 24. | <i>The Measurement of Random Noise in the presence of a Television Signal</i> | MARCH 1959 |
| 25. | <i>A Quality-checking Receiver for V.H.F. F.M. Sound Broadcasting</i> | JUNE 1959 |
| 26. | <i>Transistor Amplifiers for Sound Broadcasting</i> | AUGUST 1959 |
| 27. | <i>The Equipment of the BBC Television Film Studios at Ealing</i> | JANUARY 1960 |
| 28. | <i>Programme Switching, Control, and Monitoring in Sound Broadcasting</i> | FEBRUARY 1960 |
| 29. | <i>A Summary of the Present Position of Stereophonic Broadcasting</i> | APRIL 1960 |
| 30. | <i>Film Processing and After-processing Treatment of 16-mm Films</i> | MAY 1960 |
| 31. | <i>The Power Gain of Multi-tiered V.H.F. Transmitting Aerials</i> | JULY 1960 |
| 32. | <i>A New Survey of the BBC Experimental Colour Transmissions</i> | OCTOBER 1960 |
| 33. | <i>Sensitometric Control in Film Making</i> | DECEMBER 1960 |
| 34. | <i>A Mobile Laboratory for UHF and VHF Television Surveys</i> | FEBRUARY 1961 |
| 35. | <i>Tables of Horizontal Radiation Patterns of Dipoles Mounted on Cylinders</i> | FEBRUARY 1961 |
| 36. | <i>Some Aspects of Optical Lens Performance</i> | APRIL 1961 |
| 37. | <i>An Instrument for Measuring Television Signal-to-noise Ratio</i> | JUNE 1961 |
| 38. | <i>Operational Research on Microphone and Studio Techniques in Stereophony</i> | SEPTEMBER 1961 |
| 39. | <i>Twenty-five Years of BBC Television</i> | OCTOBER 1961 |
| 40. | <i>The Broadcasting of Music in Television</i> | FEBRUARY 1962 |
| 41. | <i>The Design of a Group of Plug-in Television Studio Amplifiers</i> | APRIL 1962 |
| 42. | <i>Apparatus for Television and Sound Relay Stations</i> | JULY 1962 |
| 43. | <i>Propagational Factors in Short-wave Broadcasting</i> | AUGUST 1962 |
| 44. | <i>A Band V Signal-frequency Unit and a Correlation Detector for a VHF/UHF Field-strength Recording Receiver</i> | OCTOBER 1962 |
| 45. | <i>Vertical Resolution and Line Broadcasting</i> | DECEMBER 1962 |
| 46. | <i>The Application of Transistors to Sound Broadcasting</i> | FEBRUARY 1963 |
| 47. | <i>Vertical Aperture Correction using Continuously Variable Ultrasonic Delay Lines</i> | MAY 1963 |
| 48. | <i>The Development of BBC Internal Telecommunications</i> | MAY 1963 |
| 49. | <i>Apparatus for Measurement of Non-linear Distortion as a Continuous Function of Frequency</i> | JULY 1963 |
| 50. | <i>New Methods of Lens Testing and Measurement</i> | SEPTEMBER 1963 |
| 51. | <i>Radiophonics in the BBC</i> | NOVEMBER 1963 |
| 52. | <i>Stereophony: the effect of cross-talk between left and right channels</i> | MARCH 1964 |
| 53. | <i>Aerial distribution systems for receiving stations in the l.f., m.f., and h.f. bands</i> | JULY 1964 |
| 54. | <i>An Analysis of Film Granularity in Television Reproduction</i> | AUGUST 1964 |
| 55. | <i>A Review of Television Standards Conversion</i> | DECEMBER 1964 |
| 56. | <i>Stereophony: the effect of interchannel differences in the phase/frequency and amplitude/frequency characteristics</i> | DECEMBER 1964 |
| 57. | <i>Drop-out in Video-tape Recording</i> | JUNE 1965 |
| 58. | <i>Sine-squared pulse and bar testing in colour television</i> | AUGUST 1965 |
| 59. | <i>The acoustic design and performance of a new free-field sound measurement room</i> | SEPTEMBER 1965 |
| 60. | <i>Colorimetric Analysis of Interference in Colour Television</i> | FEBRUARY 1966 |

SPORADIC E IONIZATION AND TELEVISION INTERFERENCE

SUMMARY

It is well known that many examples of television interference between widely separated stations, especially during local summer, arise from propagation by way of sporadic E ionization. A brief survey is made of the incidence of E_s ionization, its causes, and the part it plays in the propagation of long-range interference with television reception in Band I.

1. Introduction

'Sporadic E' is the term applied to thin strata of ionization which appear from time to time at E-layer heights (100–120 km). Under typical 'normal' conditions the electron density/height profile (or $N(h)$ profile) would be of the form indicated by the solid line curve in Fig. 1. Under sporadic E (or ' E_s ') conditions the profile would have an additional thin ledge of ionization as shown by the dotted curve. This ionization has been given the name 'sporadic' because of its irregular behaviour—irregular both temporally and in its spatial distribution in the horizontal plane. It is perhaps important to add that this ionization is not sporadic in the sense that it occurs infrequently—during the daytime, at least, it is more likely to be present than absent although fortunately its intensity, as measured by its peak electron density, is only occasionally large enough to give rise to oblique transmission of television signals.

Of all ionospheric phenomena the problem of sporadic E ionization has proved one of the most difficult to solve although it has now been clear for some time that this abnormal ionization near the 100 km level probably results from more than one cause. This fact in itself makes the problem complex, but the situation is made still more difficult by the fact that we do not yet know the relative importance of the different possible causes and often we do not have anything like full experimental data concerning these basic generating forces.

2. Experimental Data on Sporadic E

2.1 The Observation of E_s Echoes

The incidence of E_s ionization is readily seen on the conventional ionogram obtained in vertical incidence sounding of the ionosphere. Fig. 2 shows some typical ionograms which illustrate clearly the appearance of E_s echoes. Fig. 2 (a) shows a record free of E_s echoes in which the transition from the normal E layer to the F layer can be clearly observed, and in which the critical frequency of the normal E layer (fE) at 2.85 Mc/s can be accurately measured. Fig. 2 (b) shows conditions under which some E_s ionization is present. It will be seen that there is a range of frequencies (approximately 3.7 to 4.8 Mc/s) over which echoes are simultaneously received from the E_s layer and the F layer. This means that the E_s ionization is partly reflecting and partly transmitting the energy of the incident signals. This suggests that the E_s ionization is not of great thickness and may well also be 'patchy', i.e. in the nature of 'clouds' or 'blobs' of ionization with considerable variability in the horizontal plane. It will be noted, too, that

when penetration of the E_s ionization finally occurs (near 4.85 Mc/s) the transition takes place suddenly without any gradual bending upwards of the echo trace as occurs during gradual penetration of a thick layer. This absence of any 'cusp' during penetration again indicates that the ionization is 'thin' in the vertical direction. Fig. 2 (c) shows a case of really intense E_s in which the ionization is so intense that it completely obscures or 'blankets' the upper F region. The echo traces at ranges of 200, 300, and 400 km are due to multiple reflections between the layer and the ground and emphasize the fact that intense E_s of this sort necessarily has a very sharp vertical gradient of ionization with a correspondingly high reflection coefficient. Such ionization would consist of a thin dense sheet having considerable horizontal extent (up to many tens of thousands of square kilometres). Interference between television broadcasts could certainly be expected under such conditions.

In tabulating data from ionograms the penetration of the E_s layer as indicated in Figs. 2 (b) and 2 (c) would be taken to be the 'ordinary ray penetration frequency' of the E_s layer. This frequency is usually written ' f_oE_s ' but in this monograph we shall use ' fE_s '—it being understood that this refers to the ordinary ray component. However, it has long been recognized that quite apart from its variability from one hour to the next and from one site to another, fE_s does not have the reliable physical significance that other 'normal' critical frequencies have. Thus because of its 'thinness' and/or irregular cloudlike structure the E_s layer is a partially, rather than a completely reflecting stratum and consequently the upper frequency limit of signals which it will appreciably reflect depends to some extent on the strength of the incident signals, i.e. on the power of the sender. Hence fE_s is to some extent dependent on equipment characteristics and this fact introduces yet another uncertainty. Not only does it become

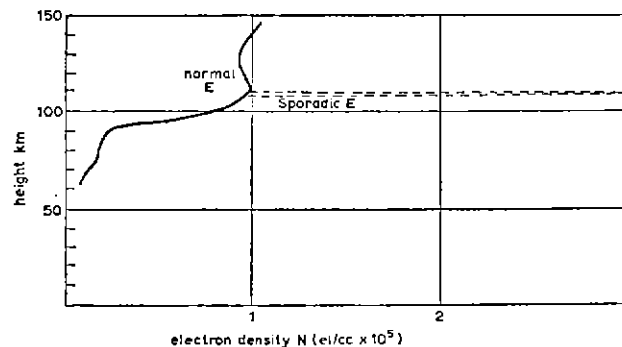
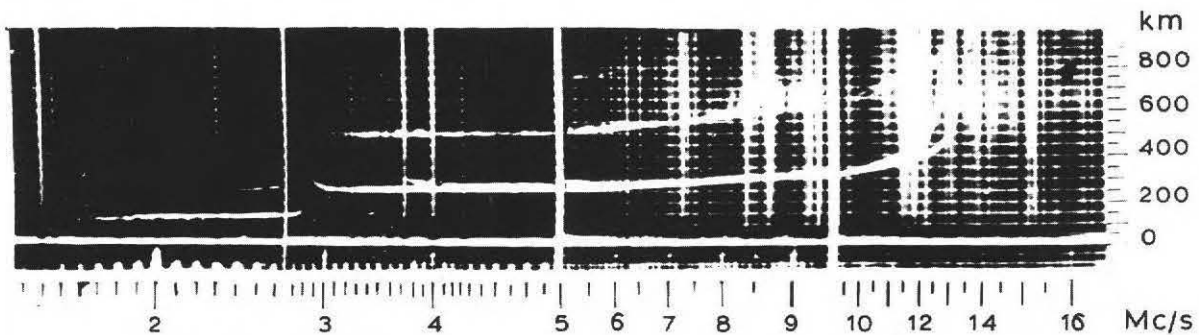
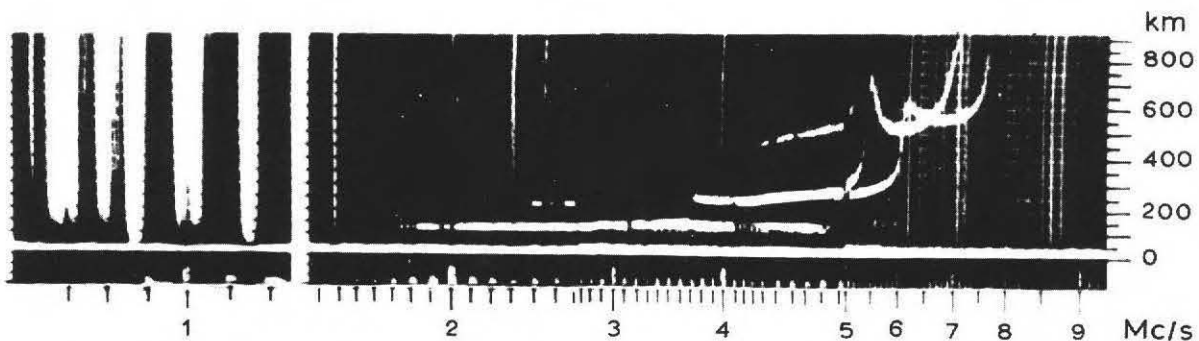

Fig. 1 — Variation of electron density with height



(a) No Sporadic E echoes



(b) Patchy Sporadic E ionization, with partial penetration between 3.7 Mc/s and 4.8 Mc/s

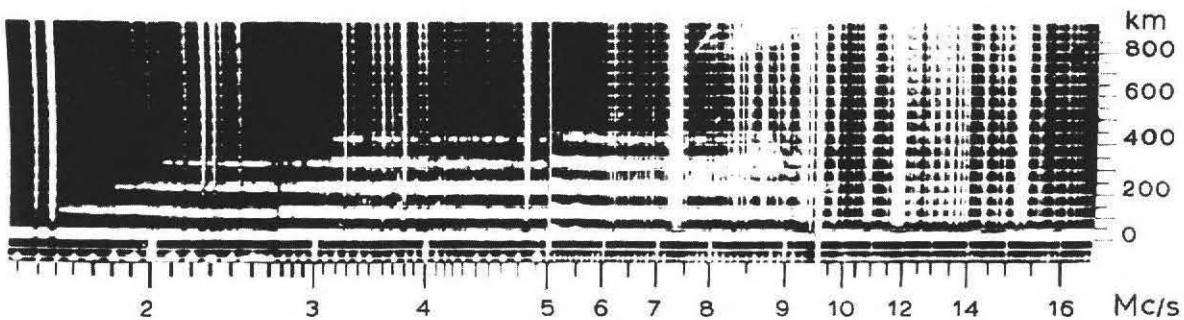

(c) Intense Sporadic E ionization, causing blanketing of F region and multiple reflections

Fig. 2 — Ionograms for latitude 51° N without and with Sporadic E echoes

a little more difficult to compare values of fE_s obtained with different equipment but it also becomes more difficult to apply these vertical-incidence data, obtained with comparatively low-power radio senders, to oblique-incidence practical problems in which very high-power senders are generally employed.

2.2 E_s at Different Latitudes

The incidence and 'type' of E_s varies with latitude and although in the present instance we are mainly concerned

with E_s in temperate latitudes, the latitude division is not rigorously defined and it is worth summarizing briefly the experimental facts concerning the variation of E_s with latitude.

Because of its variability, studies of fE_s are generally made on a statistical basis, i.e. consideration is given to the percentage of time that fE_s exceeds some selected threshold value. World maps of the incidence of E_s based on cases in which $fE_s \geq 5$ Mc/s have been constructed for the IGY network of stations by Taguchi and Shibata (1961). With

an inadequate network of stations and the consequent need for interpolation, and with different reduction procedures at different stations, the construction of world maps is not a straightforward task and care must be exercised in drawing conclusions from such maps. However, certain general features of the world distribution of E_s are clear. A month-by-month examination of the variation of the incidence of E_s shows that at midnight throughout the year there is always a clear preponderance in auroral latitudes. On the other hand, at midday in every month the greatest incidence of E_s always occurs at the magnetic equator. An examination of the diurnal variation for high- and low-latitude stations shows that at equatorial stations there is an obvious solar influence with maximum E_s in the daytime and centred roughly on noon. At high-latitude stations there is a preponderance of E_s in the evening and night when, in fact, auroral activity is greatest.

At middle latitudes there are both diurnal and seasonal variations with maximum incidence near noon and in mid-summer. These variations suggest a measure of solar control but attempts made over a period of more than twenty years to detect a solar cycle variation in E_s type ionization have been inconclusive. This uncertainty about a solar cycle effect in E_s can be illustrated by reference to three recent publications.

Chadwick (1962) studied the count of occasions when fE_s exceeded 5 Mc/s over the eleven-year period 1949–59. Three stations were selected, Fairbanks, Washington, and Huancayo, as typical of auroral, temperate, and equatorial conditions. These three stations were believed not to have suffered any major changes in operation, etc., over the eleven years considered, and in analysis of the data consideration was given to, and allowance made for, the possible effect of factors such as changes in equipment and scaling practice. The correlation coefficients, for the three stations, between the yearly count of fE_s and yearly sunspot numbers are -0.68 for Fairbanks, -0.52 for Washington, and -0.42 for Huancayo. These negative correlation coefficients are mean values for all hours of the day. A more detailed analysis, in which the correlation coefficients hour by hour have been examined, shows again a very large measure of negative correlation at all hours, but there are some interesting systematic variations from hour to hour. For example, at Huancayo between 18 and 19 LMT the correlation coefficients jump from 0 to -0.91 and remain above -0.9 until 2300 hrs.

An independent simpler analysis by Leighton, Shapley, and Smith (1962) in which counts were made of the number of stations where E_s was more abundant in 1958 than in 1954 (years of high and low activity) indicated that in the daytime there were slightly more stations with more E_s in 1958 than in 1954 (slight positive correlation). It must be emphasized that this approach was much cruder than that carried out by Chadwick, but at least it does bring out the point that all the correlation can hardly be negative.

The third analysis of this kind was made by Das Gupta and Mitra (1962) who took IGY data for thirty-three stations in auroral, temperate, and equatorial latitudes

and calculated the percentage occurrence of $fE_s \geq 5$ Mc/s. These percentages were plotted month by month for the sunspot maximum year 1957–8 and for the sunspot minimum year 1954. The authors state that twenty-four out of the thirty-three stations show that the percentage occurrences were much larger in the sunspot maximum year than in the minimum year, while four stations show the opposite effect. Two of the stations, viz. Fairbanks and Huancayo, are the same pair as were selected by Chadwick and the results agree with those of Chadwick in showing clear negative correlation for Fairbanks and a much reduced and doubtfully significant negative correlation for Huancayo. For Slough and Inverness the results quoted by Das Gupta and Mitra show an unmistakable positive correlation with sunspot activity which is quite contrary to the results of Chadwick for Washington. (The geomagnetic latitudes of these stations are: Slough 54° , Inverness 62° , Washington 50° .)

This apparently completely contrary conclusion from statistical studies of temperate latitude E_s may perhaps be again underlining our ignorance of its causes. Of course, the fact that we have to resort to correlation methods to look for a possible solar cycle variation in E_s is, in itself, an admission that we are uncertain about the causes of E_s .

The E region (between about 90 and 120 km) is an extremely complicated part of the whole ionosphere in that a number of quite important and significant phenomena are located in this height range. Thus it is a region in which we find a very large temperature gradient. It is a region of high wind velocities with rapid variations in wind speed and direction with height so that very marked wind shears occur. The E-region is also the level of the main dynamo electric or Sq^* current system which is responsible for the well-known regular variations in the geomagnetic field. At the equator the exceptionally intense current system known as the electrojet also flows in this height range. It is also at E-region levels that meteor particles entering the earth's atmosphere are disintegrated, dissipating their energy as heat and producing trails which can be seen visually or by radar means. There can be little doubt that the occurrence of E_s ionization in this same height range is not unrelated to these other phenomena.

Thus a close relationship has long been established between a certain type of equatorial E_s ionization and the equatorial electrojet referred to above (Matsushita 1951). It is now believed that the electrojet is one of the actual causes of E_s near the equator. At temperate latitudes the intensity of the current system is much less than in the electrojet but evidence of an association between the current system and E_s ionization has been given (Beynon 1959). At high latitudes there can be little doubt that the auroral E_s is largely produced by particle radiation from the sun. The intense electric currents known to flow near the auroral zone (the auroral electrojet) may also be a

* S is the usual geomagnetic symbol for the amplitude of the daily or Solar variation in the earth's magnetic field. Sq denotes the variation on a 'quiet' magnetic day. Sq currents are the 'quiet-day' values of the currents in the ionosphere which give rise to these magnetic variations, and which are induced by the movements of the ionosphere in the earth's magnetic field.

contributory factor. The cause of E_s at temperate latitudes is still an open question. The relative contributions of meteors, wind shear effects, solar radiation effects, and possibly of other factors are still to be resolved. Recent work (Whitehead 1961) has shown that in temperate latitudes wind shear can be an important factor in redistributing ionization so as to produce thin intense sheets of the E_s type. Thus a wind directed towards the East on the lower side combined with one towards the West at a little greater height will move ionization across the earth's magnetic field in such a way that it is compressed in between into a thin E_s type layer. These winds are partly of tidal origin but there are also large random wind components which can produce the same effect. This mechanism, coupled with other wave motions in the ionosphere, has been suggested to explain the apparent downward movement of certain types of E_s layers. It might be anticipated that these downward moving E_s layers would also exhibit horizontal tilts. Such tilts, even when comparatively small, would probably be of considerable importance in facilitating oblique propagation on frequencies well in excess of those predicted for horizontal layers having the same electron density.

3. Sporadic E and Radio Wave Propagation

3.1 The E_s m.u.f. Factor

As stated above it is now generally accepted that the E_s layer consists of a thin stratum of ionization embedded in the normal E region. The actual height of the ionization may vary between 100 and 120 km. Now the factor by which the vertical-incidence 'critical frequency' of an ionospheric layer, must be multiplied to give the 'maximum usable frequency' (m.u.f.) over any selected distance of transmission varies both with the height of the reflecting layer and with its thickness. The analysis of this problem was given by Appleton and Beynon in two papers published in 1940 and 1947 and from this work we deduce that the m.u.f. factor increases as the thickness of the region decreases. Thus other things being equal the thin E_s layer will reflect higher frequencies over any given distance of transmission than, say, the thicker normal E layer. If, in addition, allowance is made for the fact that the electron density in the E_s layer is always larger than that on the normal E layer (sometimes ten times or more as large) then its profound influence on oblique propagation can readily be understood.

3.2 Theory and Experiment

In theory it might appear to be a simple matter to use ionospheric data on E_s obtained from vertical soundings to predict the conditions under which television interference might be expected. Thus for a thin totally reflecting E_s layer the simple secant law might be expected to give a reasonably accurate answer. Vertical incidence soundings show that E_s ionization occurs over a range of equivalent heights from 100 to 125 km and for the purposes of calculation we could assume an average value of about 110 km. In practice we might expect the average *true* height

to be a few km less than this—say 105 km. For a transmission distance of 1,500 km simple geometrical considerations then suggest that the m.u.f. factor would be about 5·1, the angle of elevation of the signal being about 4·5°.* This would mean that over this 1,500-km path a 50 Mc/s signal would be specularly reflected by the E_s layer whenever fE_s exceeded 9·8 Mc/s. The m.u.f. factor for normal E-layer ionization at the same height would be about 4·3.

Over the years considerable effort has been directed to a comparison between calculated and observed values of the m.u.f. and in the present review it may be particularly appropriate to mention that some twenty years ago the author and the late Sir Edward Appleton had occasion to make a special study of the evidence then available for satisfactory radio propagation on frequencies substantially higher than those calculated theoretically. To quote from the published paper: 'During the war many examples of this phenomenon were brought to our attention by the British Broadcasting Engineering Division who cited to us cases of satisfactory long-distance broadcasting on frequencies which considerably exceeded the maximum usable frequency predicted in the normal way.' The experimental data showed that the discrepancies occurred most frequently in daytime and in summer and our general conclusion was 'that the BBC results could be explained partly by reflection from the normal E and F_2 layers and especially by the intervention of abnormal E-layer ionization which provides copious reflection in summer daytime'. At that time we were mainly concerned to establish the prime cause of this summertime anomaly but in the same paper we went on to consider some quantitative data on 44 Mc/s propagation over a distance of 1,428 km supplied to us by the Engineering Department of the Federal Communications Commission, USA. We estimated that the equivalent vertical incidence value of fE_s would be 8·9 Mc/s and so made a comparison between FCC data and vertical incidence data on the number of occasions when fE_s exceeded 9 Mc/s. The result is reprinted as Fig. 3 and it will be seen that very good agreement appeared to exist between theory and experiment.

However, despite this conclusion of twenty years ago, clear evidence of oblique E_s transmissions at frequencies well in excess of those expected from vertical soundings has continued to accumulate. As an example we may quote a recent series of measurements in Japan (Miya and Sasaki, 1966) and which are very pertinent to the present discussion. These workers have studied 50 Mc/s propagation over a 1,480-km path and found that a signal with less than 45 dB ionospheric attenuation was observed whenever fE_s at the mid-point of the path exceeded 7·5 Mc/s. This corresponds to an m.u.f. factor of 6·7 rather than 5·1. In the same set of experiments the median value of the measured angle of elevation of the received signal was about 4° as calculated, and values within $\pm 1^\circ$ of the median were observed for about 80 per cent of the time, but the effective height of the reflecting E_s layer was deduced to be 92 km rather than the 105 km assumed above. The substantially

* The m.u.f. factor referred to here is the secant of the angle of incidence at the reflecting layer.

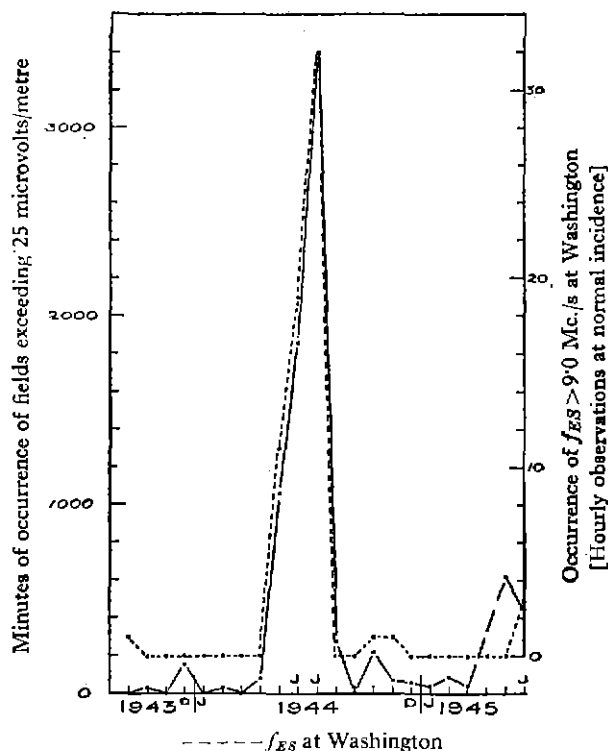

Fig. 3 — Propagation of 44 Mc/s over distance of 1,428 km

From Appleton & Beynon, *The Application of Ionospheric Data to Radio Communication Problems*: Part II. Proc. Phys. Soc., 1947. Reproduced by permission of the Institute of Physics and the Physical Society.

lower effective reflection height may be related to the lower latitude of the transmission path and would partly, though not entirely, account for the great difference between the calculated and experimentally deduced m.u.f. factor.

From these results it would appear that simple theory grossly underestimates the effectiveness of E_s ionization in the oblique transmission of VHF signals. Possible reasons for this discrepancy are:

- (i) The higher power of the transmitters used in the oblique experiments compared with that of the vertical incidence ionosonde. As mentioned in Section 2.1 above, the upper frequency limit of a thin reflecting layer shows a degree of dependence on the transmitter power and receiver sensitivity.
- (ii) Signals can be transmitted on paths off the true bearing. In fact, the Japanese experiments just quoted showed that both the bearing and the angle of elevation of E_s signals were irregularly distributed over a wide range (up to $\pm 15^\circ$ for bearing, but occurring within $\pm 10^\circ$ for 88 per cent of the time).
- (iii) Horizontal tilts in the E_s reflecting layer could greatly enhance oblique transmission.
- (iv) In addition to specularly reflected E_s signals, some contribution from signals scattered by E_s irregularities could be present.

If factor (i) above is of practical importance then we would expect that the vertical incidence equivalent frequency (i.e. the value of fE_s to be used in predicting oblique

transmission) would not be fixed by a simple secant law calculation but would depend on the field strength of the received signal. The weaker the received signal the smaller the equivalent vertical-incidence equivalent fE_s . This is just what was observed in the experiments of Miya and Sasaki—a 28 dB increase in the received field strength at 50 Mc/s was found to correspond with an increase in fE_s from 6 Mc/s to 7.5 Mc/s.

The practical consequence of (ii) is that transmission via E_s ionization is going to depend on the characteristics of the antennae. Narrow-beam systems would be expected to reduce the overall time for which E_s signals are received. This was also found to be the case in the Japanese experiments. (Of course the high gain associated with a narrow beam would mean stronger signals on the occasions when they are received.)

The effect of (iv) would be especially noticeable at great obliquity (i.e. at large distances) and in these experiments a significant enhancement of the signal intensity at the larger ranges was in fact observed.

From the above one can conclude that, in general, calculations based on vertical-incidence measurements of fE_s combined with a simple secant law tend to underestimate the effectiveness of E_s ionization in oblique propagation.

4. The Incidence of Sporadic E Ionization

Because of its irregular behaviour, the presentation of information on the incidence of E_s ionization is not quite as straightforward as is the case for the other principal ionospheric layers. E_s data can be expressed in terms of fE_s , which is a measure of the maximum electron density in the layer, but from the point of view of the role of E_s in propagating television signals a more useful index is the percentage of time for which fE_s exceeds some selected threshold value. For the present discussion a convenient threshold value is 5 Mc/s.

The following then briefly summarizes present information on the diurnal, seasonal, and sunspot cycle variations in the incidence of E_s in temperate latitudes based on this 5 Mc/s criterion. It is to be remembered that for a higher arbitrary threshold value all the percentages shown below would, of course, be reduced. It is also to be expected that other methods of representing the incidence of E_s would give different percentage figures.

4.1 Diurnal Variation

In Fig. 4 curves (a) and (b) refer respectively to the summer (May, June, July) and winter (November, December, January) of 1964. In this case we have plotted the percentage of two-hour observations on which fE_s exceeded 5 Mc/s at Slough. Features of both curves are the double maxima—one just before noon and the other in the evening. In most years the noon maxima are considerably larger than the evening maxima and the magnitudes of the noon maxima also vary quite a lot from year to year.

4.2 Seasonal Variation

This is shown in Fig. 5, again for Slough in 1964, and

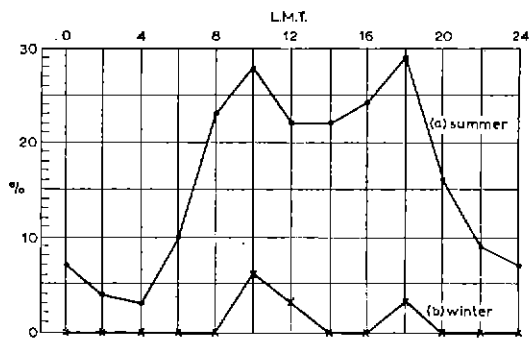

Fig. 4 — Diurnal variation in incidence of $fE_s \geq 5$ Mc/s. Slough 1964

here the variation in the incidence from month to month for observations at 11, 12, and 13 L.M.T. is shown. This curve is typical of all years in that the main incidence of E_s occurs, generally with an abrupt start, in the months of May to August inclusive although in individual years the magnitude of the summer peak varies between the 20 and 50 per cent levels.

4.3 Sunspot Cycle Variation

As stated in Section 2.2 several workers have endeavoured to detect a sunspot cycle variation in the incidence of E_s at temperate latitude stations, but some of the published conclusions on this are completely contradictory and for the present at least we must conclude that no obvious and well-defined correlation one way or the other exists. However it should be added that these statistical approaches to the problem are often not very precise and it is not altogether surprising that they sometimes yield results contrary to one another. When we have a proper understand-

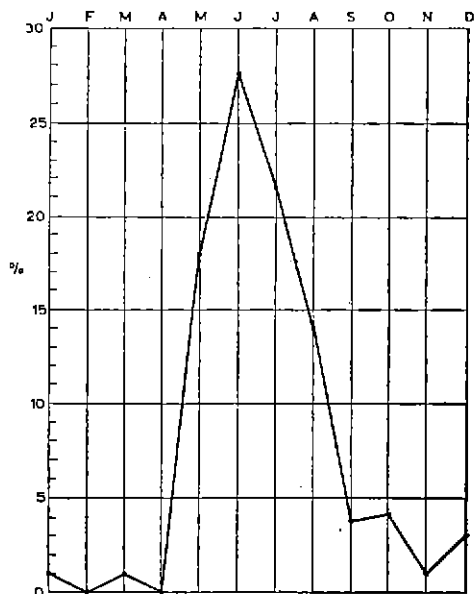

Fig. 5 — Seasonal variation in incidence of $fE_s \geq 5$ Mc/s. Slough 1964

ing of the causes of E_s ionization it will be possible to state confidently whether or not a solar cycle variation is to be expected and resort to statistical searches for correlation will not be necessary.

Further consideration of the long-term incidence of E_s is given in Section 5 below.

5. BBC Observations on Sporadic E Television Interference

A short BBC internal report of 7 October 1964 contained data on 'sporadic E conditions' based on observations, made at their Tatsfield receiving and measuring station, on the reception of Band I European stations. These data show a steady increase in the numbers of days per month when E_s conditions were observed from about twelve in June 1957 to thirty in June 1964. These data are plotted in Fig. 6 together with the sunspot number and might be taken to show a clear inverse variation of E_s with solar activity. However, as the report rightly points out, there may be other factors influencing this tendency for increased interference in recent years, such as the increase in the number and power of European television stations in Band I. It is clearly important to investigate the extent, if any, to which the increased interference is due to changed E_s conditions.

For comparing with vertical-incidence ionospheric measurements ideally it would be desirable to have data on fE_s for the mid-points of the oblique trajectories, i.e. for sites some 800–1,100 km to the south and east of Tatsfield. However, for the present first approach it will be sufficient to use data from Slough, bearing in mind that improved correlation might be expected for data on fE_s at the mid-point.

For Band I frequencies, theory would indicate that for extreme distance propagation the equivalent vertical-incidence frequency should be about 7 Mc/s. However, for reasons discussed in Section 3.2 this figure is certainly too large and for this analysis we shall take the vertical incidence equivalent frequency to be 5 Mc/s. The Tatsfield data also refer to a range of transmitter distances but again for this empirical approach we shall regard them as being all at the extreme distance for which single-hop E_s propagation is possible.

If now we count the number of days per month for which fE_s exceeded 5 Mc/s at any time between 06 and 22 G.M.T. (assuming this was roughly the daily observing period at Tatsfield) then for the years 1961 to 1964 we get the result shown in Fig. 7. It will be seen that there is quite a remarkable degree of agreement between the Slough data on fE_s and the Tatsfield observations. (Only the months April to December of each year are shown since tabulated figures for these months are given in the report.) Fig. 7 would indicate that interference on Band I television signals from Europe may be expected whenever $fE_s \geq 5$ Mc/s at Slough.

The period June 1961–June 1964 covered only the tail-end of the sunspot cycle (see Fig. 6) and to test for any clear solar-cycle influence we should consider the other years for which Tatsfield observations are available. Fig. 8 shows

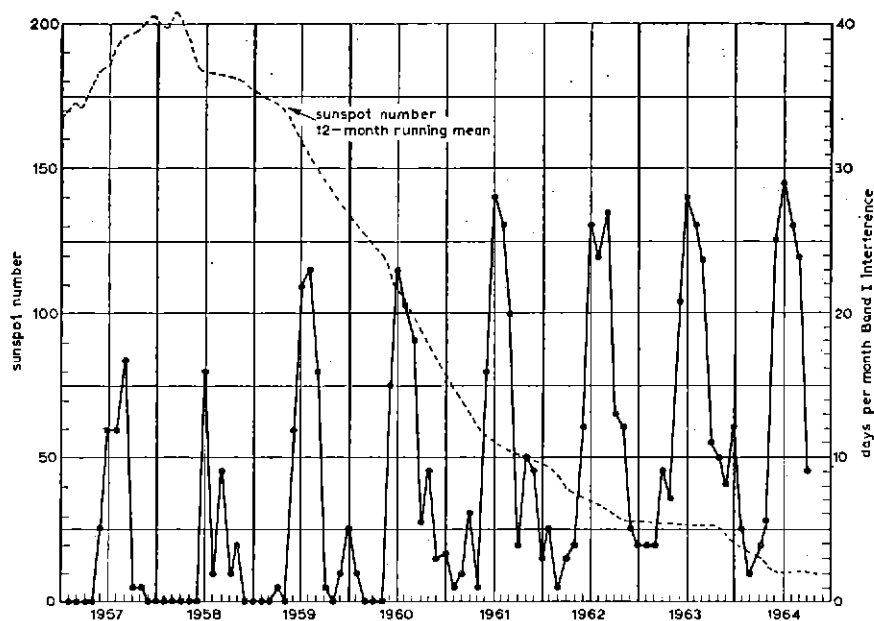

Fig. 6 — Sunspot activity and Tatsfield observations on Band I interference

corresponding results for 1957–60 when the sunspot number (twelve monthly running mean) changed from about 200 to 80. It will be seen that over this period the incidence of $fE_s \geq 5$ Mc/s at Slough certainly did not appear to increase and if anything it actually decreased from 1957 to 1960. For some reason the correlation between the Tatsfield observations and the Slough fE_s data is not so good for the first three years of the period concerned but for the five years 1960 to 1964 inclusive there is very good agreement indeed between the two sets of data. It would appear from this analysis that the observed increase in interference on Band I television between 1957 and 1959 was not linked with an increased incidence in E_s ionization. It might be suggested that a solar cycle effect in the D region could perhaps influence the field strength of signals reflected from E_s ionization and thus give rise to an apparent solar cycle change in E_s , but for various reasons this possibility can almost certainly be ruled out for both the vertical and oblique incidence observations.

6. Influence of the Troposphere; F_2 Layer Propagation

Although the main purpose of this survey is to consider the propagation of television signals by way of E_s ionization some brief references to tropospheric and F_2 layer propagation may be appropriate.

Simple calculation shows that for frequencies of 40 Mc/s and above in temperate latitudes, significant propagation via E_s ionization is only likely to occur at distances greater than 800–1,000 km from the transmitting station. Beginning at this distance the percentage of time for which 40 Mc/s signals would be propagated increases from zero to about 5 per cent at 1,600 km, and to about 10 per cent at the theoretical maximum range for one-hop propaga-

tion (about 2,250 km). The discussion in Section 3 indicates that these simple calculations of the percentage time are, without doubt, an underestimate but the main conclusion that E_s propagation of 40 Mc/s television signals is important only at distances beyond about 800 km remains essentially correct. At higher frequencies the lower limiting distance is rather larger and the percentage times for which E_s propagation can occur are considerably less. Thus at 50 Mc/s the lower limit would generally be expected to be about 1,100 km and the percentage time of propagation over the extreme distances reduced to 3 or 4 per cent.*

It is well known of course that abnormal tropospheric propagation can occur under suitable meteorological conditions, and can result in television signals being received at distances as great as 800 km, i.e. within the E_s 'skip zone', but well beyond the optical horizon. Empirical studies indicate that, in this latitude, at 150 km, abnormally strong VHF signals may be received for as much as 15 per cent of the time and this percentage steadily falls to zero at 800 to 1,000 km.

Although tropospheric refraction and E_s propagation refer to different ranges, it is probable that on some occasions abnormal propagation in the longer-distance range (1,000–2,250 km) is the net result of the combined influence of abnormal conditions in the troposphere and of E_s ionization.

During periods of high sunspot activity long-distance

* The percentage of time for which E_s propagation may be expected on frequencies near 40 Mc/s is of course larger than for higher frequencies and it might be expected that E_s interference would be most troublesome at the lower or Channel 1 end of Band I. However, in the United Kingdom it is in Channel 2 (Sound 48.25 Mc/s; Vision 51.75 Mc/s) that E_s interference occurs most often in practice since there are fortunately very few transmissions in Europe which can cause this interference in Channel 1 (Sound 41.5 Mc/s; Vision 45 Mc/s).—ED.

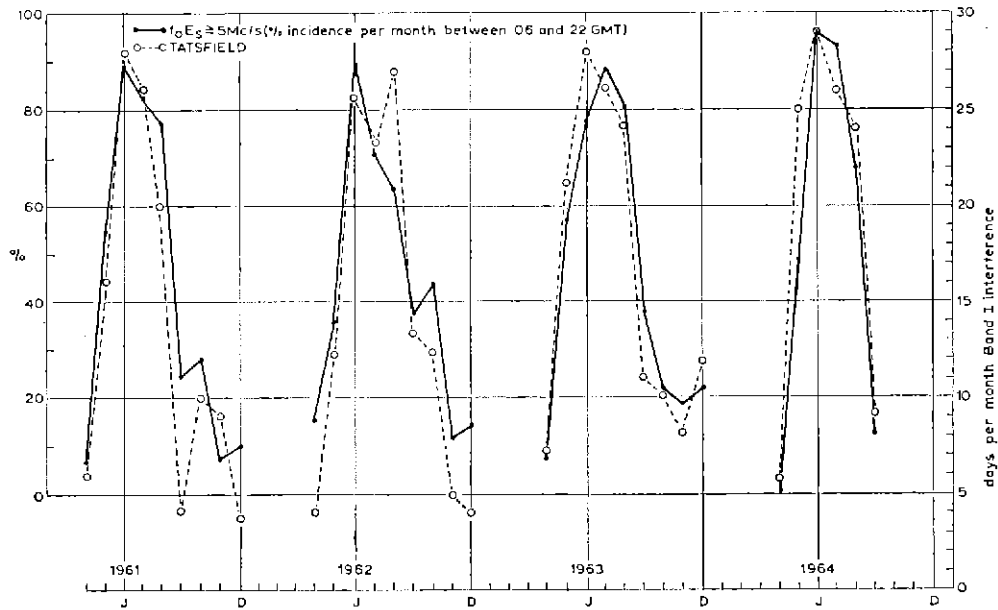

Fig. 7 — Tatsfield observations on Band I interference and incidence of $fE_s \geq 5Mc/s$ at Slough (1961-4)

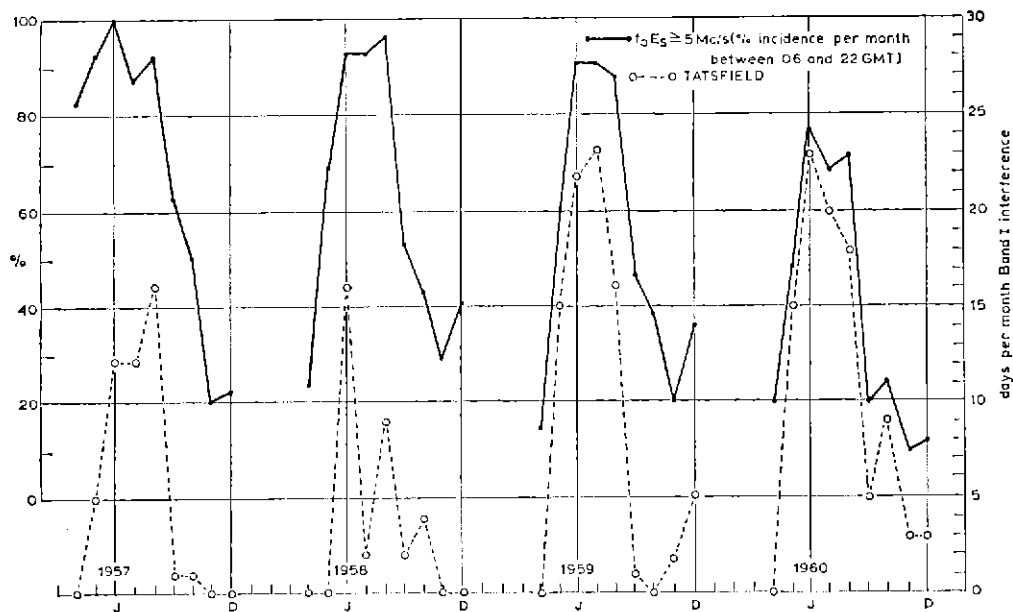

Fig. 8 — Tatsfield observations on Band I interference and incidence of $fE_s \geq 5Mc/s$ at Slough (1957-60)

propagation of VHF signals can occur by way of the F_2 layer. Under such conditions 40 Mc/s or even 50 Mc/s signals can be transmitted over several thousand kilometres, and during the last two maxima this mode of propagation gave rise to interference with the lower Band I channels in the UK from transmissions in the USA. If sunspot activity should be high enough during the next maximum period

(about 1968) there might well be more interference with these channels from new transmissions on these frequencies in other parts of the world.

7. Conclusions

1. The fact that reflections from E_s ionization are a major

cause of television interference at distances beyond about 800–1,000 km is, without doubt, established.

2. In the case of Band I signals received in the United Kingdom from European television stations for the five years 1960–4, the number of days per month on which such interference occurred has correlated closely with the number of days on which fE_s exceeds 5 Mc/s.

In the present brief study only a simple count of number of days per month has been possible and it would be interesting to examine the data in more detail to see whether there is agreement on a daily or even an hourly basis. Such a study would best be undertaken using vertical-incidence data from a site near the mid-point of the trajectory of the interfering signal, but even then perfect correlation might not be found, because the signals can be propagated from E_s ionization with bearing deviations of up to $\pm 15^\circ$ from the great circle path.

3. Observations at Tatsfield since 1957 on Band I interference have shown a significant increase in the number of days each summer on which the interference occurs. The increase was particularly marked between 1957 and 1961. The sunspot number has decreased over the same period but it is very doubtful whether the two facts are related. The increased interference between 1957 and 1961 cannot be ascribed to an increase in the incidence of E_s , but it could have arisen from increased numbers of European Band I stations or/and increased power of such stations.

4. Signals propagated over distances of about 1,600 km via E_s ionization have a mean elevation of about 4° with a spread of about $\pm 1^\circ$. As stated above the bearings of the signals are distributed over angles of up to as much as $\pm 15^\circ$ of the true bearing but lie within $\pm 10^\circ$ for nearly 90 per cent of the time. At extreme distance the spread of bearing is somewhat reduced. These experimental facts are relevant to possible consideration of ways of minimizing the effect of the interfering signal at the receiving site.

5. The causes of temperate-latitude E_s are not, by any means, fully understood yet but it appears that wind shear effects may be an important factor. The influence of the Sq current system in this mechanism may also be significant.

If, and when, these causes are identified it may be possible to attempt some well-founded short- and long-term

prediction of E_s ionization. At the present time it is not possible to do much better than forecast the probable number of days per month on which pronounced E_s is likely to occur. As far as the reception of Band I signals from European stations is concerned, the significant threshold value of fE_s would appear to be about 5 Mc/s. A careful study of past European data might possibly improve our ability to predict the percentage of time when this threshold is likely to be exceeded. From tabulated data on hourly values of fE_s at one station it does not appear possible to predict a few hours ahead that fE_s will exceed a certain threshold value. However, from a detailed study of data from a group of stations, or alternatively from a special study undertaken for the purpose, it might be possible to observe a Sporadic E cloud grow and give some short-term warning of imminent E_s interference. (Since there is not much that the viewer can do about it such warnings may, of course, not be very useful.)

6. The percentage of time during which Sporadic E conditions exist is about three times as great at 40 Mc/s as it is at 50 Mc/s.*

8. Bibliography

- Appleton, E. V., and Beynon, W. J. G., Proc. Phys. Soc., Vol. 52, No. 518, 1940; Vol. 59, No. 58, 1947. Proc. I.E.E., Vol. 100, Pt 111, No. 192, 1953.
Beynon, W. J. G., J. Atmos. Terr. Phys., Vol. 15, No. 13, 1959.
Chadwick, W. B., *Ionospheric Sporadic E*, Pergamon, p. 182, 1962.
Das Gupta, M. K., and Mitra, R. K., J. Atmos. Terr. Phys., Vol. 24, No. 408, 1962.
Leighton, H. I., Shapley, A. H., and Smith, E. K., *Ionospheric Sporadic E*, Pergamon, p. 166, 1962.
Matsushita, S., J. Geomag. Geoelec., Japan, Vol. 3, No. 44, 1951.
Miya, K., and Sasaki, T., *Characteristics of Ionospheric E_s Propagation and Calculation of E_s Signal Strength*, Radio Science, Vol. 1 (new series), No. 1, Jan. 1966.
Taguchi, S., and Shibata, H., J. Rad. Res. Lab., Japan, Vol. 8, No. 355, 1961.
Interference from Continental Stations with Television Reception in Band I due to Sporadic E Propagation. BBC report, October 1964. (unpublished).

* In practice, the comparative absence of interfering transmissions in Channel 1 means that Channel 2 (Sound 48·25 Mc/s; Vision 51·75 Mc/s) is the one in which sporadic E interference is most troublesome in the United Kingdom.—ED.

A Recent BBC Technical Suggestion

A TWO-WIRE LOUDSPEAKING TELEPHONE SYSTEM

In a high-gain communication circuit employing loudspeakers at both terminals it is necessary to introduce precautionary measures to prevent 'howl-round'.

A system has been developed in which 'howl-round' is prevented by sequentially gating the circuit in each direction so that simultaneous transmission from both terminals is impossible. Due to reverberation effects the gating

must be performed at a low frequency, and would therefore cause mutilation of speech signals if continued during an actual speech transmission. For these reasons the gating is made to cease and the circuit become effectively mono-directional whenever speech signals are detected on the line between the terminals.

General Arrangement of Equipment

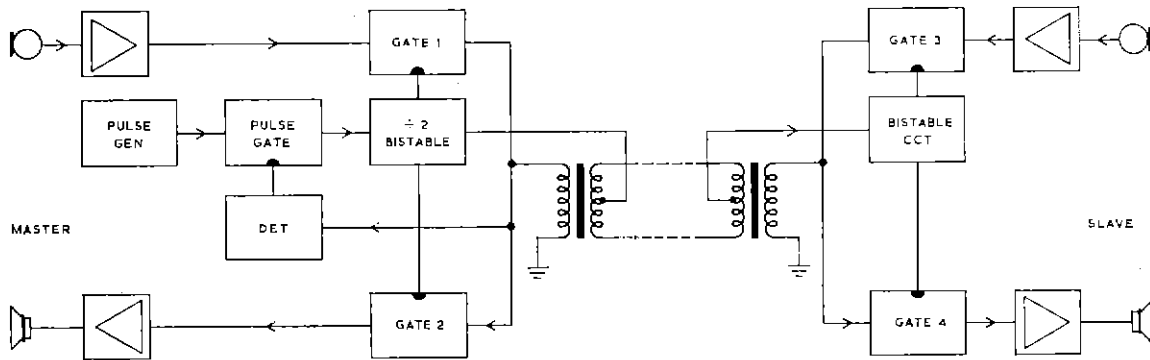

In the absence of speech signals the Pulse Gate is open and the divide-by-two circuit changes state with each pulse from the Pulse Generator. This causes Gates 1 and 2 to open and close alternately—i.e. the Master Station switches between the 'Send' state (when Gate 1 is open) and the 'Receive' state (when Gate 2 is open).

Every time a change of state takes place at the Master Station a synchronizing pulse is transmitted to the Slave Station along the earth phantom line between the two. The polarity of this pulse is dependent upon the direction of the change; the Bistable Circuit at the Slave Station is thus

always set to the 'Receive' state when the Master Station changes to the 'Send' state, and vice versa.

If any speech signal starts to be transmitted along the line (in either direction) the Detector circuit in the Master Station immediately causes the Pulse Gate to close. Switching is thus inhibited and the state of the system will not change again until the speech finishes. The method of operation is referred to as 'Voice-inhibited sequential sampling' (VISS) since during quiescent periods the equipment continually samples the output from both sending amplifiers, only stopping when it detects a voice signal.

M. J. MILLER

BBC ENGINEERING TRAINING MANUALS

The following manuals by members of the Engineering Division of the BBC have been prepared primarily for the Corporation's operating and maintenance staff. They have been made available to a wider public so that the specialized knowledge and experience contained in them may be open to all interested in the engineering side of sound and television broadcasting.

Sound and Television Broadcasting: General Principles—K. R. Sturley, Ph.D., B.Sc., M.I.E.E. 45s. net, by post 46s. 4d. 378 pp.

This manual explains the basic principles of sound and television broadcast engineering and operations.

Studio Engineering for Sound Broadcasting—General Editor: J. W. Godfrey. 25s. net, by post 26s. 208 pp.

Explains the principles underlying current operational procedures at BBC studio centres. Covers the whole range of equipment used and the problems arising in the studio.

Television Engineering: Principles and Practice—S. W. Amos, B.Sc.(Hons.), A.M.I.E.E., and D. C. Birkinshaw, M.B.E., M.A., M.I.E.E.

Vol. I: Fundamentals, camera tubes, television optics, electron optics. 45s. net in U.K. only. 301 pp.

Vol. II: Video-frequency amplification. 35s. net, by post 36s. 2d. 270 pp.

Vol. III: Waveform Generation. (Out of Print.)

Vol. IV: General circuit techniques. 35s. net, by post 36s. 2d. 277 pp.

These manuals are published by ILIFFE BOOKS LTD, DORSET HOUSE, STAMFORD STREET, LONDON, S.E.1, for the British Broadcasting Corporation, and are available from the publishers or from BBC PUBLICATIONS, 35 MARYLEBONE HIGH STREET, LONDON, W.1.

ENGINEERING TRAINING SUPPLEMENTS

| | <i>s. d.</i> |
|---|--------------|
| No. 1 Some Transmitter Problems | 2 6 |
| No. 3 Harmonic Distortion and Negative Feedback in Audio-frequency Amplifiers | 7 0 |
| No. 4 Some Fundamental Problems in Radio Engineering | 4 0 |
| No. 5 An Introduction to Wideband Aerials | 3 0 |
| No. 6 Programme Meters | 3 0 |
| No. 7 Basic Principles of Television Lighting | 5 6 |
| No. 9 Frequency Modulation | 6 6 |
| No. 10 Long-wave and Medium-wave Propagation | 4 0 |
| No. 11 Lighting for Television Outside Broadcasts | 6 0 |
| No. 12 Transistors | 3 0 |
| No. 14 Colorimetry | 4 6 |

These Engineering Training Supplements are available from BBC TECHNICAL PUBLICATIONS SECTION, HAREWOOD HOUSE, HANOVER SQUARE, LONDON, W.1.

© The British Broadcasting Corporation 1966

*Published by the British Broadcasting Corporation, 35 Marylebone High Street, London, W.1. Printed in England
by The Broadwater Press Ltd, Welwyn Garden City, Herts.*

No. 6634