

BBC

ENGINEERING DIVISION

MONOGRAPH

NUMBER 16: MARCH 1958

Analysis and Measurement of Programme Levels:

Investigation of Extreme Values of Sound Pressure

by

D. E. L. SHORTER, B.Sc.(Eng.), A.M.I.E.E.

and

W. I. MANSON, B.Sc.(Eng.)

(Research Department, BBC Engineering Division)

A Description of an Optical Instrument for Monitoring Sound Signals

by

E. R. WIGAN, B.Sc., A.M.I.E.E.

(Research Department, BBC Engineering Division)

BRITISH BROADCASTING CORPORATION

PRICE FIVE SHILLINGS



BBC ENGINEERING MONOGRAPH

No. 16

ANALYSIS AND MEASUREMENT OF PROGRAMME LEVELS:

Part I

INVESTIGATION OF EXTREME VALUES OF SOUND PRESSURE

by

D. E. L. Shorter, B.Sc.(Eng.), A.M.I.E.E.

and

W. I. Manson, B.Sc.(Eng.)

(RESEARCH DEPARTMENT, BBC ENGINEERING DIVISION)

Part II

A DESCRIPTION OF AN OPTICAL INSTRUMENT FOR
MONITORING SOUND SIGNALS

by

E. R. Wigan, B.Sc., A.M.I.E.E.

(RESEARCH DEPARTMENT, BBC ENGINEERING DIVISION)

MARCH 1958

BRITISH BROADCASTING CORPORATION

FOREWORD

THIS is one of a series of Engineering Monographs published by the British Broadcasting Corporation. About six are produced every year, each dealing with a technical subject within the field of television and sound broadcasting. Each Monograph describes work that has been done by the Engineering Division of the BBC and includes, where appropriate, a survey of earlier work on the same subject. From time to time the series may include selected reprints of articles by BBC authors that have appeared in technical journals. Papers dealing with general engineering developments in broadcasting may also be included occasionally.

This series should be of interest and value to engineers engaged in the fields of broadcasting and of telecommunications generally.

Individual copies cost 5s. post free, while the annual subscription is £1 post free. Orders can be placed with newsagents and booksellers, or BBC PUBLICATIONS, 35 MARYLEBONE HIGH STREET, LONDON, W.1.

CONTENTS

<i>Section</i>	<i>Title</i>	<i>Page</i>
	PREVIOUS ISSUES IN THIS SERIES	4
PART I INVESTIGATION OF EXTREME VALUES OF SOUND PRESSURE		
	SUMMARY	5
1.	INTRODUCTION	5
2.	GENERAL	5
3.	MEASUREMENT OF MAXIMUM LEVELS	5
4.	MEASUREMENT OF MINIMUM LEVELS	6
5.	TEST MATERIAL	7
6.	RESULTS	7
	6.1. General	7
	6.2. High- and low-level tests	10
	6.3. Dynamic range	10
7.	EFFECT OF POLAR CHARACTERISTICS OF MICROPHONE	11
8.	COMPARISON WITH PUBLISHED DATA	11
9.	CONCLUSION	11
10.	APPENDIX	12
11.	REFERENCES	12
PART II A DESCRIPTION OF AN OPTICAL INSTRUMENT FOR MONITORING SOUND SIGNALS		
	SUMMARY	15
1.	INTRODUCTION	15
2.	FACTORS WHICH DETERMINE THE dB RANGE OF A PROGRAMME METER	16
3.	GENERAL DESCRIPTION OF THE NEW PROGRAMME METER	19
4.	THE RANGE OF THE INSTRUMENT	19
5.	THE OPTICAL SYSTEM	19
	5.1 Ray geometry	19
	5.2 The focal plane	22
	5.3 Cylindrical mirror	24
	5.4 Edge-lit subsidiary scale	24
	5.5 The moving mirror and its influence upon mechanical perfor- mance	24
6.	THE USERS' OPINION OF THE OPTICAL METER	25
7.	CONCLUSION	26
8.	ACKNOWLEDGMENTS	26
	APPENDIX A	27
	APPENDIX B	28
	APPENDIX C	29
	APPENDIX D	31

PREVIOUS ISSUES IN THIS SERIES

No.	Title	Date
1.	<i>The Suppressed Frame System of Telerecording</i>	JUNE 1955
2.	<i>Absolute Measurements in Magnetic Recording</i>	SEPTEMBER 1955
3.	<i>The Visibility of Noise in Television</i>	OCTOBER 1955
4.	<i>The Design of a Ribbon Type Pressure-gradient Microphone for Broadcast Transmission</i>	DECEMBER 1955
5.	<i>Reproducing Equipment for Fine-groove Records</i>	FEBRUARY 1956
6.	<i>A V.H.F./U.H.F. Field-strength Recording Receiver using Post-detector Selectivity</i>	APRIL 1956
7.	<i>The Design of a High Quality Commentator's Microphone Insensitive to Ambient Noise</i>	JUNE 1956
8.	<i>An Automatic Integrator for Determining the Mean Spherical Response of Loudspeakers and Microphones</i>	AUGUST 1956
9.	<i>The Application of Phase-coherent Detection and Correlation Methods to Room Acoustics</i>	NOVEMBER 1956
10.	<i>An Automatic System for Synchronizing Sound on Quarter-inch Magnetic Tape with Action on 35-mm Cinematograph Film</i>	JANUARY 1957
11.	<i>Engineering Training in the BBC</i>	MARCH 1957
12.	<i>An Improved 'Roving Eye'</i>	APRIL 1957
13.	<i>The BBC Riverside Television Studios: The Architectural Aspects</i>	JULY 1957
14.	<i>The BBC Riverside Television Studios: Some Aspects of Technical Planning and Equipment</i>	OCTOBER 1957
15.	<i>New Equipment and Methods for the Evaluation of the Performance of Lenses for Television</i>	DECEMBER 1957

PART I

INVESTIGATION OF EXTREME VALUES OF SOUND PRESSURE

by

D. E. L. SHORTER, B.Sc.(Eng.), A.M.I.E.E.

and

W. I. MANSON, B.Sc.(Eng.)

SUMMARY

In a broadcasting system intended to provide radio signals capable of reception and reproduction as high-quality sound, it is essential that the possibility of non-linear distortion occurring in the amplifiers employed in the chain be reduced to a minimum.

In order to avoid the risk of non-linear distortion during loud passages of programme material, it is necessary to pay careful attention to amplifier design and also to have available accurate information as to the maximum and minimum levels of signal produced by the microphone, dependent upon the maximum and minimum sound levels to which it is likely to be exposed.

Part I of this monograph describes a survey undertaken by the Research Department of the BBC's Engineering Division in 1954 to obtain, for design purposes, up-to-date information on the microphone levels and dynamic range encountered in current broadcasting practice.

1. Introduction

In designing amplifier equipment for sound transmission systems it is necessary to provide adequate gain and signal-to-noise ratio without risk of non-linear distortion during loud passages. It is therefore essential to know the maximum and minimum signal generated by the microphone and hence the maximum and minimum sound level to which it is subjected. A certain amount of data on maximum sound levels has long been available in the literature, but this relates mainly to symphonic music and does not cover the case, quite common at the present time, of microphones placed among the performers in a light orchestra or dance band to pick up sound at very close range. There is, moreover, little published data relating to the minimum sound level for which provision must be made.

The first part of this monograph describes a survey undertaken in 1954 to obtain, for design purposes, up-to-date information on the microphone levels and dynamic range encountered in current broadcasting practice.

2. General

Throughout the investigation, the level of signal generated by the microphone was measured by means of a standard BBC peak programme meter,* which is actuated by a full-wave signal rectifier having charge and discharge time constants of 2.5 ms and 1 sec respectively. The rectified voltage is applied negatively to the grid of a 'variable- μ ' valve giving a change of anode current approximately proportional to the logarithm of the signal amplitude. The indicating instrument, placed in the anode circuit of the valve, is a quick-acting milliammeter which, for a suddenly applied signal, has an overshoot of less than 5 per cent (equivalent to $\frac{3}{4}$ dB at mid scale).

* See footnote to Section 1, Part II, p. 15.

All measurements were carried out by means of a calibrated BBC type PGS/1 pressure-gradient microphone, the open-circuit sensitivity of which was checked between groups of tests. Some of the measurements were made during rehearsals and others on transmission; in each case, the calibrated microphone was placed in a typical position indicated by the studio manager, who is responsible for the balance of the transmissions. Two high-gain amplifiers separated by an attenuator were interposed between microphone and programme meter and the complete equipment was calibrated on site by injecting a known voltage into the input circuit.

3. Measurement of Maximum Levels

In the measurement of maximum sound levels, it is desirable to keep the transmission chain between the microphone and the point at which the voltage is measured as short and direct as possible to minimize phase distortion and non-linear effects which would be likely to reduce the crest value of the signal waveform. For this reason, only live programme material was used and the maximum levels were read on the studio premises by a peak programme meter connected to the output of the microphone amplifier. Fig. 1 shows the frequency response of the microphone, amplifier, and peak programme meter for sound incident on the microphone axis. The variation in frequency response with angle of incidence is a function of the microphone geometry and is described elsewhere.⁽¹⁾

To present the results in proper perspective, it is necessary to give the frequency of occurrence of the various peak levels measured. In the absence of portable equipment for automatically registering the maximum programme meter readings, the latter were called aloud by an observer, whose voice was recorded on a tape recorder; the tape was

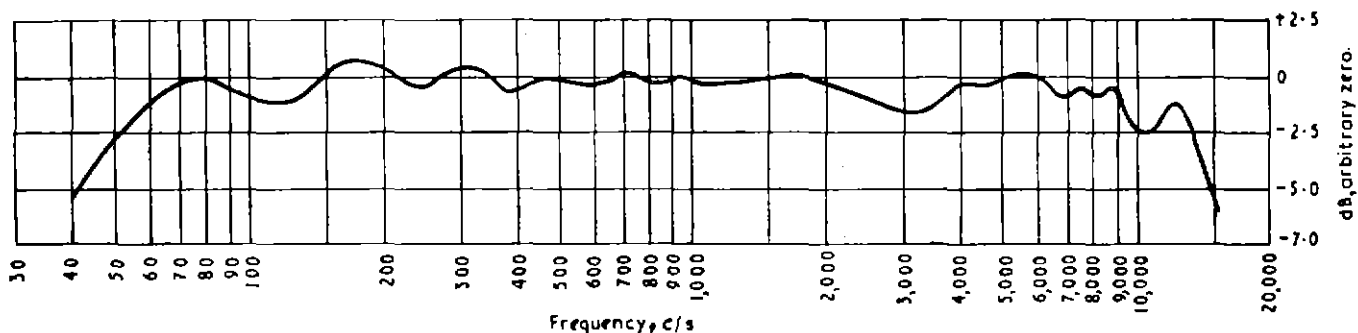

Fig. 1 — Overall frequency response of microphone, amplifier, and programme meter for sound source on microphone axis

later replayed at reduced speed and the results committed to paper for subsequent analysis.

4. Measurement of Minimum Levels

The programme meter readings observed during quiet passages of music do not always consist of a series of well-defined 'peaks' which can be counted without ambiguity; indeed, the indicated level frequently hovers about some value for several seconds at a time. For this reason, the minimum levels were not assessed in terms of the number of peaks exceeding a certain value, but rather by the proportion of the test period during which the programme meter indication remained below a stated figure. The programme material was recorded on a portable tape recorder running at $7\frac{1}{2}$ in./sec of which the frequency characteristic is shown in Fig. 2. The statistical distribution of levels in selected passages was subsequently analysed by means of the integrating circuit described in the next paragraph. The intervention of the recording medium was considered to be permissible in this case, since any resulting degradation of the signal by phase distortion or by attenuation at the extremes of the frequency band would be likely to reduce the crest value of the programme wave-

form, so that from the point of view of the amplifier designer, the error would be in the safe direction. The separation between noise level and overload point in the recording was only about 50 dB but, as will be seen later, the range of levels covered in individual tests was well within this figure.

Fig. 3 shows the integrating circuit used. A voltage E_1 , derived from the peak programme meter circuit (not shown) and proportional to the current passing through the indicating meter, is applied, in the positive sense, to a cathode-follower valve V_1 . The signal from the cathode-follower is applied to the grids of the gas discharge tubes V_2 to V_n , the anode currents of which actuate counters A to E. Each of the gas discharge tubes is so biased as to strike whenever E_1 attains or exceeds a particular value. The anodes of V_2 to V_n are supplied with alternating voltage at 50 c/s; as long as the value of E_1 is sufficient to cause any of these tubes to strike, rectified current will flow through the corresponding counters. The positive signal from the cathode of V_1 is interrupted approximately five times per second by a vibrating contact S_1 , so that the rectified current is broken up into a series of pulses; the number of pulses, which is proportional to the time during which a particular discharge tube is operative, is recorded

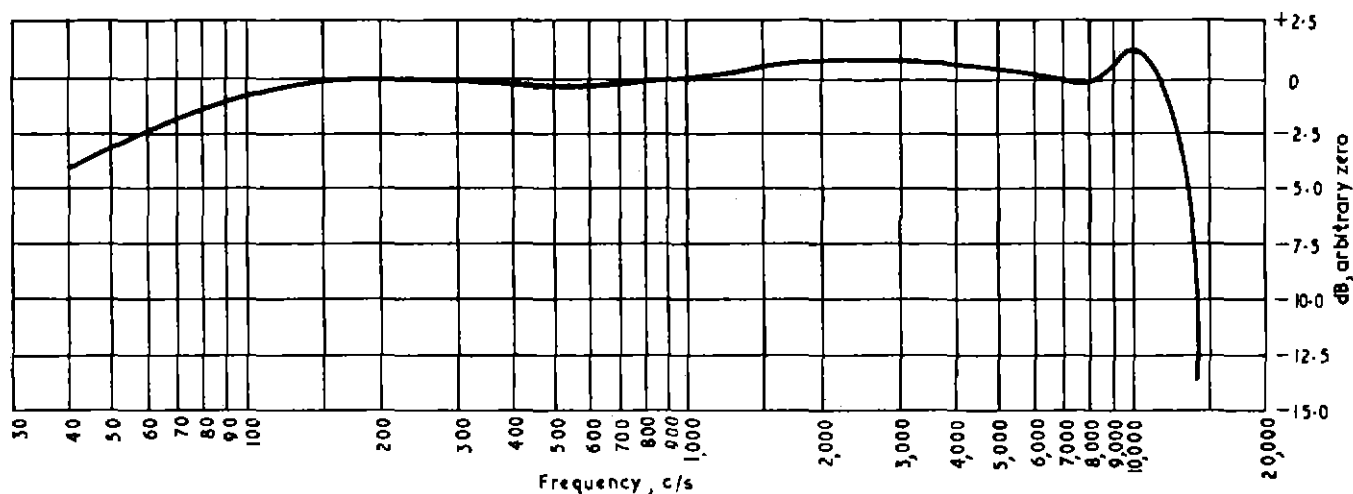

Fig. 2 — Frequency response of tape recorder used for low-level tests

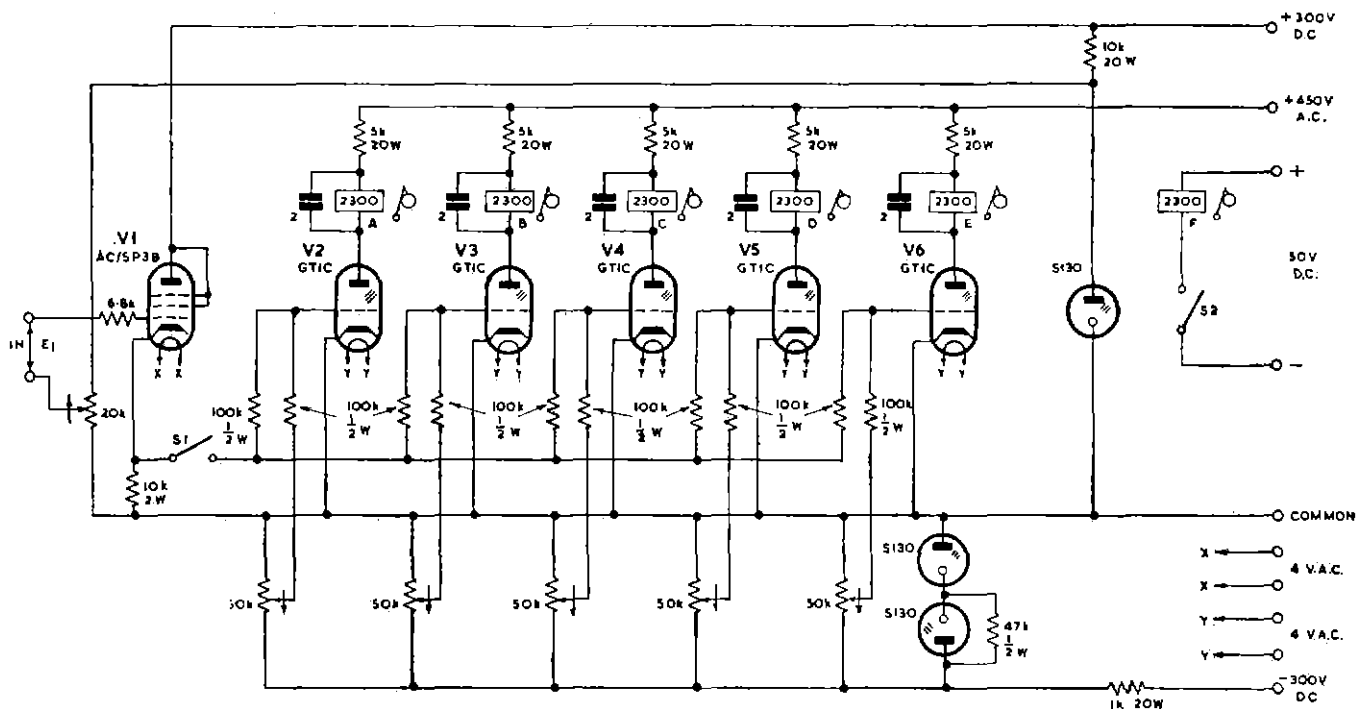

Fig. 3 — Integrating circuit for statistical analysis of programme levels

by the appropriate counter. An additional counter F, energized from a separate d.c. source through a contact S_2 vibrating in synchronism with S_1 , registers a number of pulses proportional to the duration of the test. The fraction of the test time during which E_1 remained above a given figure is obtained by dividing the reading of the corresponding counter by the reading of counter F.

5. Test Material

The test material consisted of a number of passages of speech or music, selected to represent the highest and lowest sound levels encountered in programmes; the selection was made on the basis of operational experience and no attempt was made to include every kind of musical instrument or effect. Passages of orchestral and operatic music, dance music, and dramatic speech were chosen with the help of the senior studio managers in the music, variety, and drama departments respectively. Unfortunately it was impossible in a dramatic production to collect sufficient material to give a statistically significant result. For the present purpose, therefore, the figures obtained with solo singing voices were taken to represent the maximum sound levels produced by a voice and the minimum levels were obtained from tests made with selected BBC Research Department personnel, the level of whose speaking voices was below the average. The fact that untrained voices were used for the latter tests makes the results directly applicable to the case, frequently occurring in practice, of a talk delivered by an inexperienced speaker.

A list of the test material used is given in the Appendix; in the case of orchestral and operatic music, the approximate location of the test passage in the score is given where possible, though it was not always practicable to obtain this information at rehearsals.

6. Results

6.1 General

The results of the measurements are shown in Figs. 4 and 5. All the figures relate to the crest value of programme waveform as indicated by the peak programme meter; they are in each case 3 dB above the r.m.s. value of the sinusoidal sound pressure which would produce the same meter reading.

As the results of the high- and low-level tests are required for different purposes, the two sets of data are presented in different ways.

The data on maximum sound levels will be used to decide the highest circuit gain which can be allowed without danger of amplifier overloading. For this purpose, the relevant quantities are the maximum and near-maximum values of sound level and their approximate rate of occurrence; the mean level of the peaks observed during the tests is of little interest. The results of these high-level tests are therefore presented by plotting the number of peaks per minute against sound level.

The data on low sound levels will be used to decide the circuit gain required to keep the modulation depth of a transmitter within prescribed limits and to enable the signal-to-noise ratio of the transmission system to be

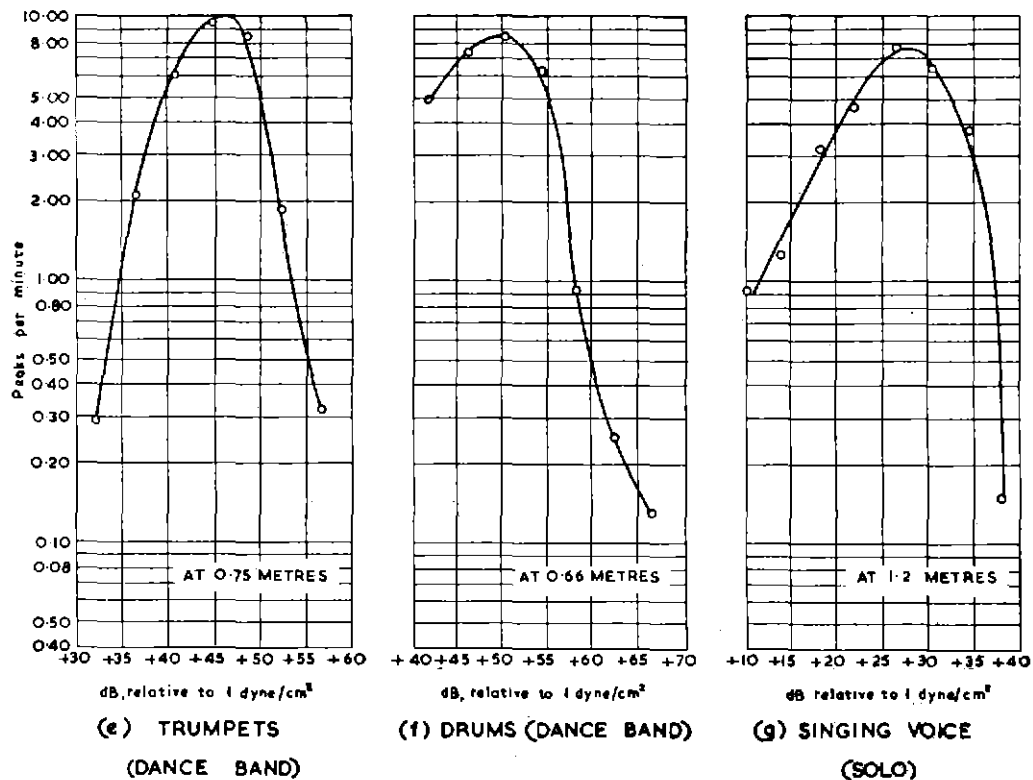
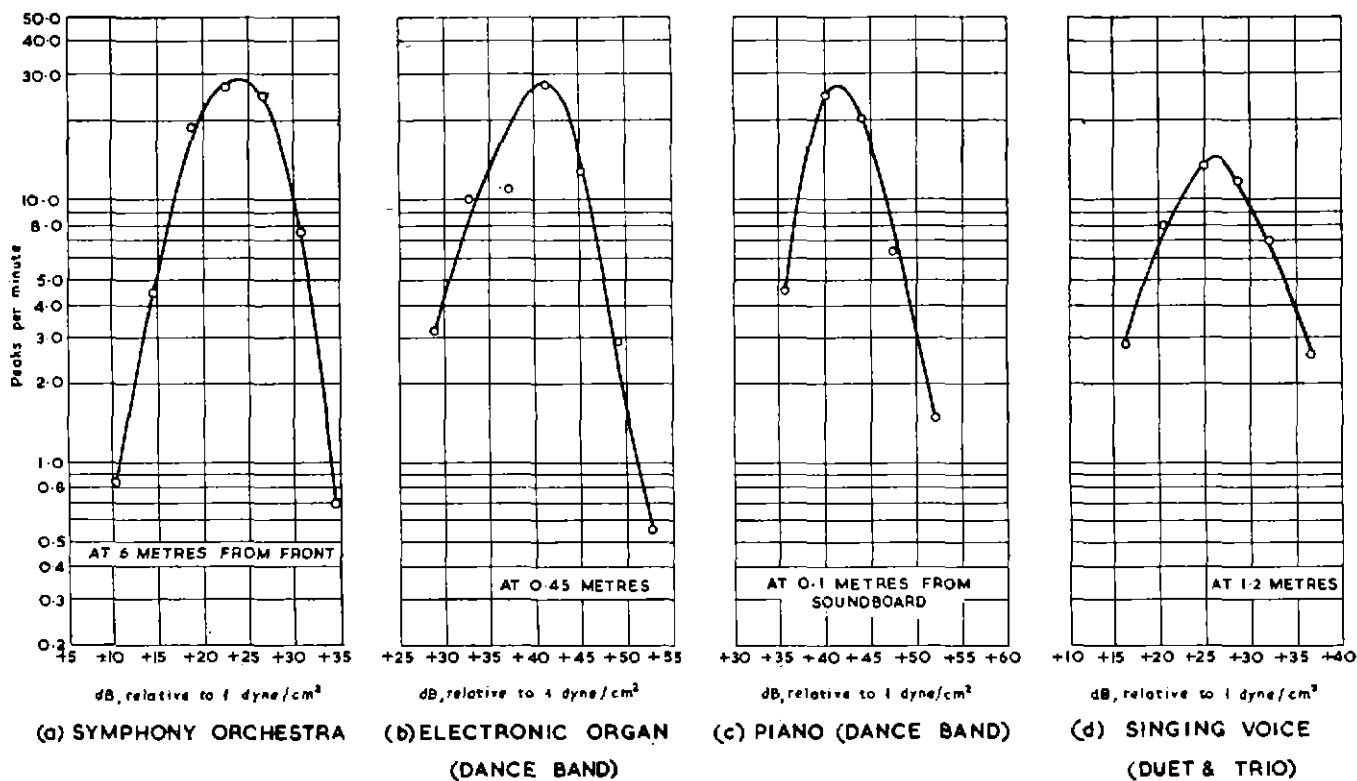
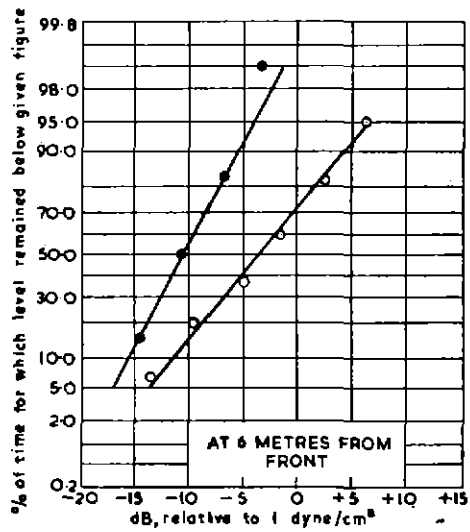
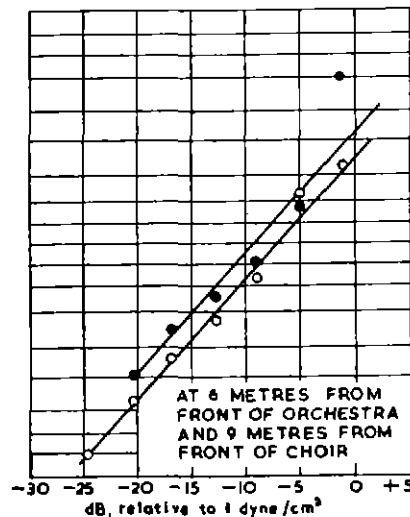

Fig. 4 — Peak sound levels produced by various types of programme. High-level tests



(a) SYMPHONY ORCHESTRA



(b) SYMPHONY ORCHESTRA & CHOIR

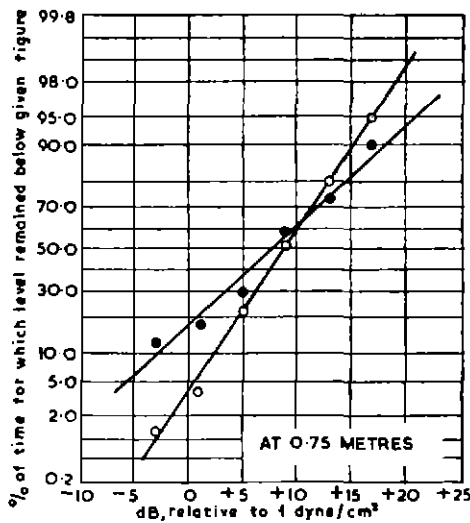

(c) MUTED TRUMPET (DANCE BAND)

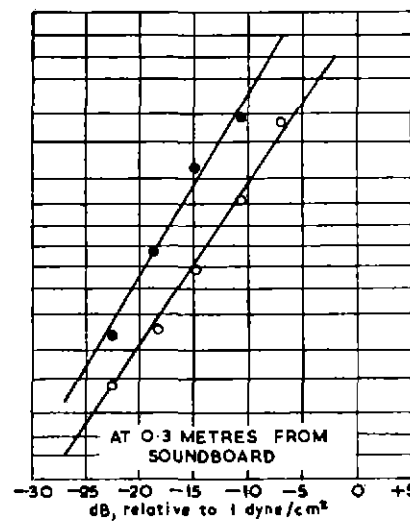

(d) CLAVICORD

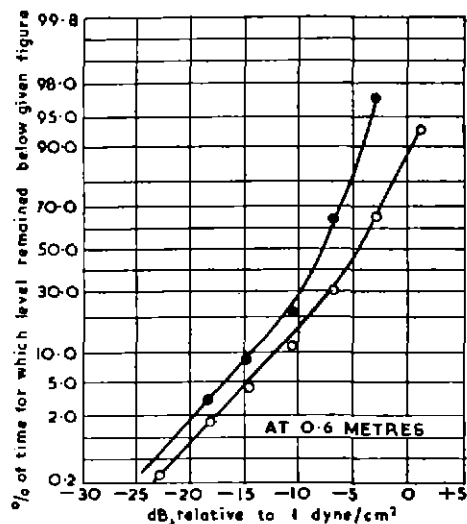

(e) QUIET SPEECH

Fig. 5—Peak sound levels produced by various types of Programme. Low-level tests

- TEST PASSAGE WITH LOWEST AVERAGE LEVEL.
- ALL TEST PASSAGES.

assessed. Since, however, no well-defined minimum value can be assigned to the sound intensity at the microphone, any deductions made must necessarily be of an arbitrary character based on the statistical distribution of levels during quiet passages of programme. The results of the low-level tests are therefore presented in the form of percentage time plotted against sound level on a probability scale; the data is found in most cases to follow a normal distribution law.

For each class of test material, a curve derived from all the test passages is given. In the high-level tests the greatest sound pressure reached is shown by this curve; in the low-level tests the extreme condition is shown by a supplementary curve for the test passage having the lowest average level.

In the quiet speech tests, the time lost in pauses between sentences and paragraphs, amounting to some 25 per cent of the test period, has been included in the total time given.

6.2 High- and Low-level Tests

The principal conclusions to be drawn from the curves

are summarized in Tables 1 and 2, which relate to the maximum and minimum levels respectively.

It should be noted that the levels given in Table 2 under the 100 per cent heading, which represent the maximum for the test passage concerned, cannot be shown on the probability scale used in Fig. 5.

6.3 Dynamic Range

For each type of programme material, the same microphone position was used in both the maximum and the minimum level measurements, so that the difference between the two results obtained gives the dynamic range. The figure thus derived must, of course, involve an arbitrary decision as to the frequency of occurrence of high-level peaks and the duration of low-level passages which are to be regarded as significant. The order of values obtained is illustrated in Table 3 for the symphony orchestra, trumpet, and voice. Two figures are given in each case; the first of these is obtained by considering the ten-per-cent-of-time figure of the average low-level passage together with the once-per-ten seconds peak value of

TABLE 1
High-level Tests

Programme	Microphone distance	Sound level indicated by peak programme meter dB relative to 1 dyne/cm ²	
		Level attained on average once per 10 seconds (all test passages)	Maximum level attained
Symphony orchestra	6 metres from front	+31	+35
Singing voice	1.2 metres	+33	+36
		for duets and trios	
		+31	+38
		for soloists	
Piano (dance band)	10 centimetres from soundboard	+48	+51
Trumpets (dance band)	0.75 metre	+50	+56
Drums (dance band)	0.66 metre	+54	+65
Electronic organ (dance band)	0.45 metre	+47	+52

TABLE 2
Low-level Tests

Programme	Microphone distance	Upper limit of sound level indicated by peak programme meter for stated percentage of time. dB relative to 1 dyne/cm ²					
		All test passages			Lowest-level test passage		
		10%	50%	100%	10%	50%	100%
Symphony orchestra	6 metres from front	-12	-3	+6	-16	-11	+1
Symphony orchestra and choir	6 metres from front of orchestra and 9 metres from front of choir	-16	-7	+3	-18	-9	+1
Muted trumpet (dance band)	0.75 metre	+2	+9	+21	-3	+8	+21
Clavichord	0.3 metre from soundboard	-20	-14	-2	-24	-18	-5
Quiet speech	0.6 metre	-12	-4	+5	-14	-8	0

the average loud passage; the second represents the more extreme case of the ten-per-cent figure of the lowest-level passage taken in conjunction with the maximum observed level. In combining the data on quiet speech with that obtained with the operatic singers, allowance was necessary for the fact that the microphone distance in the latter case was double that in the former. At very short range, the effect of reverberant sound is small; for the present purpose, the sound pressure reaching the microphone has been assumed to vary inversely as the distance, and a correction of 6 dB therefore applied.

TABLE 3

Type of programme	Dynamic range
Symphony orchestra	43 to 51 dB
Trumpet (dance band)	48 to 59 dB
Solo voice (singing and speaking)	49 to 58 dB

7. Effect of Polar Characteristics of Microphone

The data given above was obtained with a pressure-gradient microphone, having a figure-of-eight polar characteristic, calibrated in terms of its axial response. In estimating the probable output from microphones having other forms of polar characteristic some allowance may be necessary for the different amounts of reverberant sound picked up. The most extreme case likely to be encountered in practice is that of an omnidirectional microphone used at such long range that the effect of reverberant sound is predominant; the output of such a microphone could be as much as 5 dB greater than that of a pressure-gradient microphone having the same axial sensitivity. In theory, some allowance should also be made for the variation in sensitivity of a pressure-gradient microphone over the angle subtended by a large orchestra. This correction, however, amounts to less than 3 dB for instruments located on the extreme right or left of the orchestra and, as it applies only to the direct sound, may be neglected for the present purpose.

8. Comparison with Published Data

It is of interest to compare the figures given above with some corresponding data taken from the literature and reproduced in Table 4.

Comprehensive data on the maximum instantaneous sound pressures produced by various musical instruments and combinations were given in a paper published in 1931 by Sivian, Dunn, and White.⁽²⁾ The tests were carried out indoors but the data were corrected, on the basis of previous experiments made with a loudspeaker as sound source, with the intention of eliminating the effect of reflections from the walls; the correction was based on measurements of average amplitudes but was assumed to apply also to peaks. Gas discharge tubes were used as peak indicators, the signal from the microphone being sampled in alternate one-eighth second intervals. The gas discharge

tubes were set to operate at a series of levels separated by intervals of 6 dB and the results were given in terms of the proportion of observations lying within each 6 dB zone. The two figures given in Table 4 for the 15-piece, 18-piece, and 75-piece orchestras represent the limits of the highest level range shown in the paper.

More recent data on maximum sound levels were published by Schlechtweg⁽³⁾ in 1950; the method of measurement was not described. The peak sound levels obtained are also given in Table 4.

TABLE 4

Authority	Programme	Maximum level relative to 1 dyne/cm ²
Sivian, Dunn, and White	15-piece orchestra in laboratory (microphone approximately 2 m from nearest instrument)	+39 to +45 dB
	18-piece orchestra in laboratory (microphone approximately 2 m from nearest instrument)	+33 to +39 dB
	75-piece orchestra in motion picture theatre (microphone attached to conductor's stand). Three test passages	+31 to +37 dB +33 to +39 dB +40 to +46 dB
Schlechtweg	45-piece orchestra (microphone position unspecified)	+32 dB
	Symphony orchestra (at 5 m from front)	+40 dB
	Dance bands	+50 dB
	Dance bands with soloists at intentionally close range	+58 dB

The highest figure given in Table 1 for orchestra is considerably below the maximum given by Sivian, Dunn, and White. Part of this difference may be attributed to the greater distances between microphone and orchestra in present-day practice and part to the fact that the gas discharge tubes used would indicate peaks too short in duration to be fully registered by the peak programme meter, though these factors may be to some extent offset by the exclusion, in the earlier work, of the effects of reverberation. There is reasonable agreement with the work of Schlechtweg on the sound level from a symphony orchestra and good agreement on the results obtained for dance band soloists.

9. Conclusion

The results obtained in this study are necessarily incomplete; it is, however, doubtful whether the expense of a

more comprehensive survey, involving the employment of musicians for special tests, would be justified by the practical utility of the additional data obtained.

With some of the higher sound levels measured, the output from a microphone of average sensitivity (say -75 dB with reference to 1 volt/dyne/cm² open-circuit on 300 ohms) may be sufficient to overload a microphone amplifier operating at maximum gain, and attenuation may sometimes have to be introduced.

The significance of the lower sound levels in programme lies partly in their relationship to the noise level in the transmission system. In this connection it should be noted that the self-generated electrical noise from high-quality studio microphones and their associated amplifiers, when weighted⁽¹⁾ for aural sensitivity, is equivalent to a mid-band sound pressure in the studio of -45 dB to -50 dB with reference to 1 dyne/cm².

The conclusions to be drawn from an assessment of the dynamic range depend on the range of levels which it is considered practicable to transmit, a subject which is outside the scope of this work.

10. Appendix

The following tables describe the test material on which are based the figures given in Section 6 of Part I of this monograph; the items are grouped according to the type of programme. The low-level test passages marked with an asterisk are those which gave the lowest results in their group; the data on these passages is also included in the total for each group. It may be noted that in some cases the time assigned to a given passage of music is obviously greater than that required for a single playing; this is due to the unavoidable repetitions and overlapping which occur in rehearsals.

11. References

1. BBC Engineering Monograph No. 4, *The Design of a Ribbon Type Pressure-Gradient Microphone for Broadcast Transmission*.
2. Sivian, L. J., Dunn, H. K., and White, S.D., *Absolute Amplitudes and Spectra of Certain Musical Instruments and Orchestras*, J.A.S.A., Vol. 2, No. 3, January 1931, pp. 330-71.
3. Schlechtweg, W., *Eine Kritik an neuen Rundfunkverstärkern*, Mitteilungen des Rundfunk-Technischen Instituts (RTI), No. 7, October-November 1950, pp. 23-5.
4. XV Plenary Assembly of the C.C.I.F., July 1949. (Weighting for the measurement of noise on programme circuits.)

High-level Tests — Singers

<i>Fig. No.</i>	<i>Type of programme</i>	<i>Title of work played</i>	<i>Location of test passages</i>	<i>Duration of test passages (sec.)</i>
4(g)	Male and female soloists	Dvořák, <i>Rusalka</i>	Act 1, bars 520/601 630/672 575/700 770/837 900/954	496
4(g)	Male and female soloists	Dvořák, <i>Rusalka</i>	Act 2, bars 1010/1111 1200/1294	312
4(g)	Male and female soloists	Dvořák, <i>Rusalka</i>	Act 3, bars 286/414 1053/1070	330
				1138
4(d)	Male and female, duets and trios	Dvořák, <i>Rusalka</i>	Act 2, bars 420/440	74
4(d)	Male and female, duets and trios	Dvořák, <i>Rusalka</i>	Act 3, bars 867/892 900/978 930/995	242
				316

High-level Tests — Individual Instruments or Groups

<i>Fig. No.</i>	<i>Instrument</i>	<i>Duration of test passages (sec.)</i>
3(f)	Dance band drums (Ted Heath's Band)	97
3(c)	Dance band piano (Tito Burns' Band)	704
3(e)	Dance band trumpets (Ted Heath's Band and Show Band)	568
3(b)	Electronic organ (Show Band)	219

High-level Tests — Orchestral

<i>Fig. No.</i>	<i>Type of programme</i>	<i>Title of work played</i>	<i>Location of test passages</i>	<i>Duration of test passages (sec.)</i>
4(a)	BBC Symphony Orchestra	Mahler, Symphony No. 1	1st movement bars 338/450	173
4(a)	BBC Symphony Orchestra	Mahler, Symphony No. 1	3rd movement bar 168 to 4th movement bar 90	157
4(a)	BBC Symphony Orchestra	Mahler, Symphony No. 1	4th movement bars 120/154 267/300 328/387 612/640	276
4(a)	BBC Symphony Orchestra	Beethoven, Overture Egmont	bars 69/108 169/250 286/338	247
4(a)	BBC Symphony Orchestra	Elgar, Symphony No. 1	1st movement	202
4(a)	BBC Symphony Orchestra	Elgar, Symphony No. 1	4th movement	436
4(a)	BBC Symphony Orchestra	Sibelius, Symphony No. 5	1st movement	237
4(a)	BBC Symphony Orchestra	Sibelius, Symphony No. 5	4th movement	64
4(a)	BBC Symphony Orchestra	Berlioz, Overture Benvenuto Cellini	—	205
4(a)	BBC Symphony Orchestra	Wagner, Mastersingers	—	130
				2127

Low-level Tests — Individual Instruments

<i>Fig. No.</i>	<i>Instrument</i>	<i>Duration of test passages (sec.)</i>
4(c)	Single muted trumpet (BBC Show Band)	61
4(c)	Single muted trumpet (BBC Show Band)*	8
4(d)	Clavichord	870
4(d)	Clavichord*	170

Low-level Tests — Speech

<i>Fig. No.</i>	<i>Type of voice</i>	<i>Duration of test passages (sec.)</i>
4(e)	Male and female	504
4(e)	Male*	120

Low-level Tests — Orchestral

<i>Fig. No.</i>	<i>Type of programme</i>	<i>Title of work played</i>	<i>Location of test passages</i>	<i>Duration of test passages (sec.)</i>
5(a)	BBC Symphony Orchestra	Elgar, Symphony No. 1	1st movement	142
5(a)	BBC Symphony Orchestra	Sibelius, Symphony No. 5	4th movement	185
5(a)	BBC Symphony Orchestra	Berlioz, Overture Benvenuto Cellini	—	62
5(a)	BBC Symphony Orchestra	Wagner, Mastersingers	—	80
5(a)	BBC Symphony Orchestra	Wagner, Lohengrin	Prelude, Act 1	330
5(a)	BBC Symphony Orchestra	Berlioz, Symphonie Fantastique	1st movement bars 1/12	80
5(a)	BBC Symphony Orchestra	Kodály, Concerto for Orchestra	bars 132/160	145
				1024
5(a)	BBC Symphony Orchestra	Kodály, Concerto for Orchestra*	bars 132/142	45
5(b)	London Symphony Orchestra and Choir	Vaughan-Williams, Sancta Civitas	—	298
5(b)	London Symphony Orchestra and Choir	Vaughan-Williams, Sancta Civitas*	—	30

PART II

A DESCRIPTION OF AN OPTICAL INSTRUMENT FOR MONITORING SOUND SIGNALS

by
E. R. WIGAN, B.Sc., A.M.I.E.E.

SUMMARY

In order that transmitters shall not be overmodulated, whilst a satisfactory signal-to-noise ratio is maintained, it is necessary for the programme to be 'controlled', i.e. for the dynamic range to be deliberately restricted. For this purpose apparatus must be provided at convenient points in the broadcasting chain to enable studio managers, control room staff, transmitter engineers, and others to observe the signal voltages produced by the programme. It should be noted that it is the quasi-peak voltages that are of interest in this connection, and that they are not directly related to the loudness of the programme when reproduced by a loudspeaker.

Part II of this Monograph describes a new type of programme meter instrument, having a moving bar of light in place of a pointer, which has been designed to take the place of the conventional pointer-type instrument with which the signal voltages on BBC sound circuits are usually measured.

The optical system, which is novel, is highly efficient and leads to a compact and simple assembly.

In the course of its design the statistical parameters of typical programme material had to be assessed. Predictions made from this analysis were confirmed in field trials of the instrument, which is now going into service.

1. Introduction

A 'programme meter',* i.e. the instrument together with the associated amplifier, acts as a peak-voltmeter, designed specifically for measuring the signal voltages at convenient points along a programme chain. Such meters are used by transmitter engineers, control room staff, and others concerned with the monitoring of the signal, as well as by the studio manager who has to 'control' the programme level.

The optical instrument which is the subject of Part II of this monograph has been designed as a replacement for the conventional pointer-type instrument of Fig. 1, which is in general use throughout the BBC. Both these meters are calibrated to read on a decibel scale, each division corresponding to 4 dB, and are associated with a combination of linear and logarithmic amplifiers. When connected across a circuit carrying programme signals, the meters respond to the local crest value of the signal voltage, any sudden increase being indicated as a rapid upward swing, after which the reading falls quite slowly until the next peak occurs. The circuit controlling the rise time has a time constant of 2.5 ms and the rate of decay is controlled by a circuit of 1.0 sec time constant; this leads to the meter reading falling at about 8 dB/sec.

* A programme meter instrument is a quick-acting milliammeter, see Section 2, Part I, p. 5. It is this instrument which forms the subject of Part II of the monograph. The term is also loosely applied to the complete programme meter amplifier and instrument which acts as a peak-voltmeter for measuring signal voltage.

In this way the meter reading provides information about the local crest values, irrespective of whether the general signal level is high or low.

Some information will, of course, be lost while the meter reading is falling, but experience has proved that the observer is confused by too much detail, and that the information provided is adequate.

However, in quiet passages of music the crest may be too small to be readable on the pointer instrument. It is for this reason that the range of the optical instrument has been made 10 dB more than that of its predecessor.

An instrument which can be read in the dark has obvious advantages for use in television studios. To be readable at some distance the physical length of the scale must be adequate, and to this the optical principle sets no rigid limit. The 6-in. (15.2-cm) scale was adopted as a compromise suitable for either close or distant viewing, although in practice the meter is usually mounted near the picture monitor so that sound and vision can be monitored simultaneously.

The optical system which has been chosen is quite unconventional* and will be discussed in detail. Besides leading to a compact assembly, the layout adopted uses the light very efficiently, relying little upon the 'frosting' of the scale to scatter the light to the observer's eye; high-performance light sources are therefore not required.

* British Patent No. 740,150.

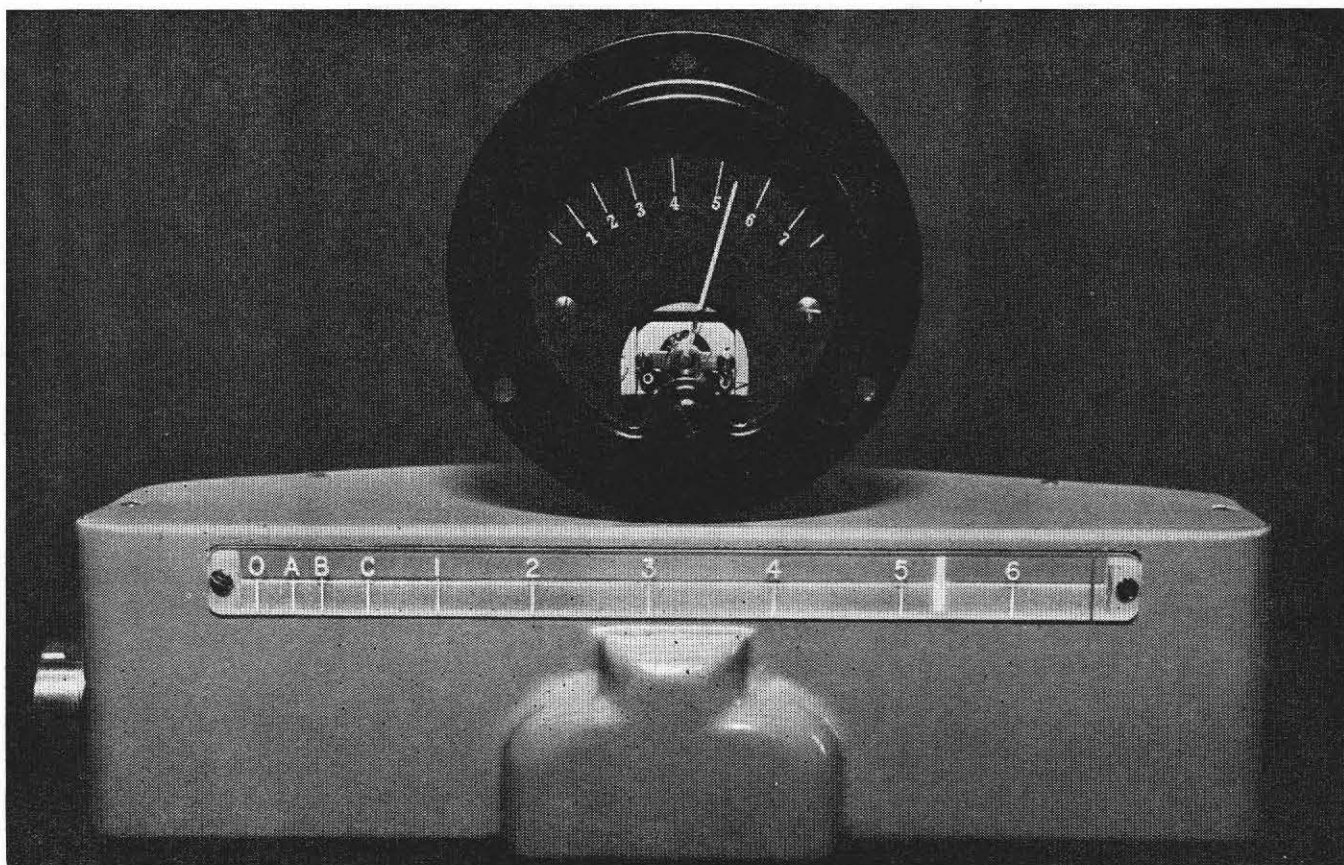

Fig. 1 — Pointer and Optical Programme Meters

The addition of extra marks to the scale of the new instrument confers advantages which will be explained by a statistical analysis of the programme signal. When the prototype instruments were given a field trial this analysis was proved to be reliable, the increased reading range being found adequate for all types of programme.

2. Factors which determine the dB Range of a Programme Meter

The range in decibels over which a programme meter has to be calibrated is relatively small. The 'dynamic range' of programme may be as great as 60 or even 80 dB, but, partly because the meter under discussion takes note only of the local crest value of the signal, and partly for other reasons, rather less than half this range has to be allowed for.

If all the local crest values had to be taken into account, the range could not be reduced very much, but, in fact, some of the extremely low- and some of the extremely high-level signals can be ignored because they occur so rarely. In this way the scale of the programme meter can be compressed to about 30 dB; a 'calculated risk' being taken that the information which is lost in the process may be

important. It is clear that in certain programmes, e.g. symphonic music, this risk must be significant. In order to estimate it properly an analysis had to be made on a statistical basis taking into account all kinds of programmes.*

Investigation of a wide range of typical programme material yielded data exemplified by the graphs of Fig. 7. It should be clearly understood that these are based not on the average signal level but on the crest values of the signal registered, as just described, by a BBC programme meter. The ordinate of each graph represents the number of times the meter reading fell in the part of the meter scale extending for 2 dB on either side of the ordinate. For example, in Fig. 7a the ordinate (50) at 10 dB indicates that on 50 out

* In Part I of this monograph a survey of programme sound levels has been made on a rather different basis, and it is important that the reader should not be confused by the apparent inconsistencies between this and the present analysis. The former deals in absolute sound levels, the latter in relative signal levels only (the origin of the dB scales in Fig. 7 is quite arbitrary). The former is concerned with individual instruments and combinations, the latter with all kinds of programme taken in a body.

It is interesting that in spite of the wide divergences in aim and methods of analysis the two sections yield figures for the effective dynamic range which do not seriously conflict: >42 dB in the present case and between 43 and 59 in the other.

of 400 occasions the crest value lay between 8 and 12 dB above the datum level.*

It will be seen from Fig. 7c that purely didactic, undramatized speech is described by a narrow histogram, dramatic speech, Figs. 7a, 7d, by a wider one, and symphonic music, Fig. 7g, by the widest of all. Moreover, in each case the histogram can be fairly represented by two normal Gaussian distributions, D_1 and D_2 , the sum of whose ordinates equals the histogram ordinate.

After making a large number of histograms of this kind, it was possible to abstract two quantities from which the 'calculated risk' could be computed, namely: (i) the chance that the signal would exceed a fixed maximum value, and (ii) the chance that it would fall below a fixed minimum. The upper limit was computed from the parameters of the D_2 distribution and the lower limit from the D_1 distribution.

For example, if Fig. 7a were representative of all dramatic speech (which in fact it is not) it could at once be deduced that there was a 2 per cent chance of a fortissimo passage (D_2 distribution) yielding a meter reading in excess of 32 dB, and, similarly, that the chance of a pianissimo passage (D_1 distribution) yielding a meter reading below 2 dB was also 2 per cent. These two quantities could be combined in the statement that the '2 per cent to 2 per cent range' of this programme material was 30 dB.

The single examples illustrated in the figure were of course insufficient to establish the '2 per cent to 2 per cent range' of all drama, all didactic or conversational speech, and, least of all, of all music. To get a reliable estimate of the range representative of each class of programme material the range of a number of samples was measured and its mean and standard deviation computed.

From this somewhat tedious but necessary statistical procedure it was possible to arrive at a crude estimate of the minimum dB-range of a programme meter, it being understood that a certain risk of missing some information had to be accepted. It will have been noticed that a first-order risk of 2 per cent had already been taken in defining the programme in terms of the 2 per cent to 2 per cent range. A second and larger risk was now involved in the statistical variation of the range itself.

The relationship of the data to practical conditions is made clearer if we assume that the technique of programme 'control' is such that, taking all programme sources together, the risk of exceeding 100 per cent modulation at the transmitter (i.e. a reading of '6' on the programme meter), lies between 1 and 2 per cent.†

It is therefore not unrepresentative of practical conditions to place the upper limit of the 2 per cent to 2 per cent

* The number 400 is a normalizing factor and does not mean that there were in fact 400 crest readings in the three-minute scene; 100 to 150 is more likely, the rate for speech varying between 35 and 45 per minute. In symphonic music it may fall to 25.

† In symphonic music, peaks occur at an average rate of 25 to 30 per minute, so on this basis there will be, as a long-term average, a risk of 1 or 2 peaks in excess of '6' on the meter per four minutes of programme.

range of programme at '6' on the scale and to consider the lower end of the range as variable.

Proceeding in this way, it was found that speech in any European language could be dealt with by a programme meter with a range of 22 dB; the existing pointer instrument was therefore perfectly adequate. However the dynamic range of music is much greater and, between one composition and another, it is much more variable. To extract the necessary statistics some twenty-five separate compositions were analysed, taking sections of three to five minutes at a time. Each analysis therefore contained about 100 meter readings, which, in music, occur at about 25 to 30 per minute. From histograms such as those set out in Fig. 12, the D_1 and D_2 distributions were abstracted and the 2 per cent to 2 per cent range estimated.

It was found that the average value of the 2 per cent to 2 per cent range was about 30 dB with a standard deviation exceeding 6 dB. From this it was clear that the length of a programme meter scale should exceed 42 dB to accommodate 98 per cent of all the ranges. Since the logarithmic law of the amplifier supplying the programme meter could not be extended much beyond 32 dB, it followed that some pianissimo passages would not register on the meter.

The risk involved in using a scale limited to 32 dB can be expressed if the statistics are recomputed on the basis of the 10 per cent to 2 per cent range of the programme material, that is to say, accepting the risk of losing all the lowest 10 per cent of the meter readings during pianissimo passages, together with the already accepted 2 per cent of the fortissimo. The mean value of this narrower 10 per cent to 2 per cent range was found to be 25.2 dB and the standard deviation 6.1 dB, which can be interpreted to mean that if the meter scale were only 32 dB long, about 15 per cent of the quietest passages in symphonic music would be on such a low level that during 10 per cent of the period of these passages no meter reading would pass the first scale mark.

A 4-dB extension of the scale would about halve the first percentage and a 4-dB contraction would about double it. From this it was clear that a 32-dB scale was near the optimum, the 7.5 per cent advantage to be gained by lengthening it being scarcely justified. On the other hand a scale 4 dB shorter would be less than adequate, the loss of quiet passages in symphonic music now being increased to 30 per cent.

The still shorter, 22-dB, scale of the standard pointer instrument was unquestionably too small, pianissimo passages on many occasions registering no reading greater than '1' on the scale for twenty seconds at a time; this meant that for about 90 per cent of the period of the passage the observer had no information to guide him.

All these factors had been established before the optical programme meter was designed. In casting about for means to extend the range of the pointer instrument by 10 dB or so it was noted that the logarithmic law of the associated amplifier was sufficiently well maintained to allow extra scale marks to be inserted at the lower end of

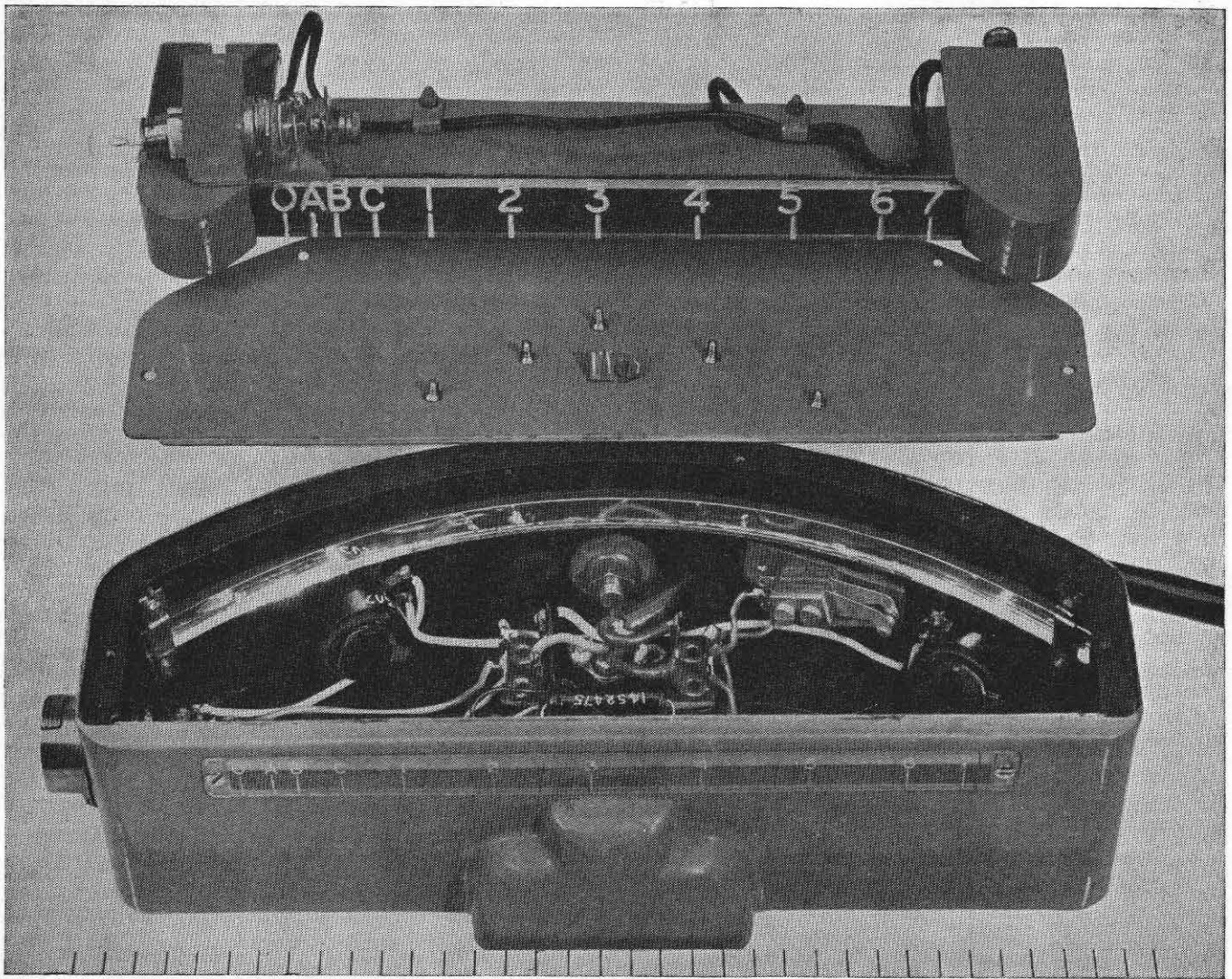

Fig. 2a — Optical Meter with edge-lit Scale for T.V. installations

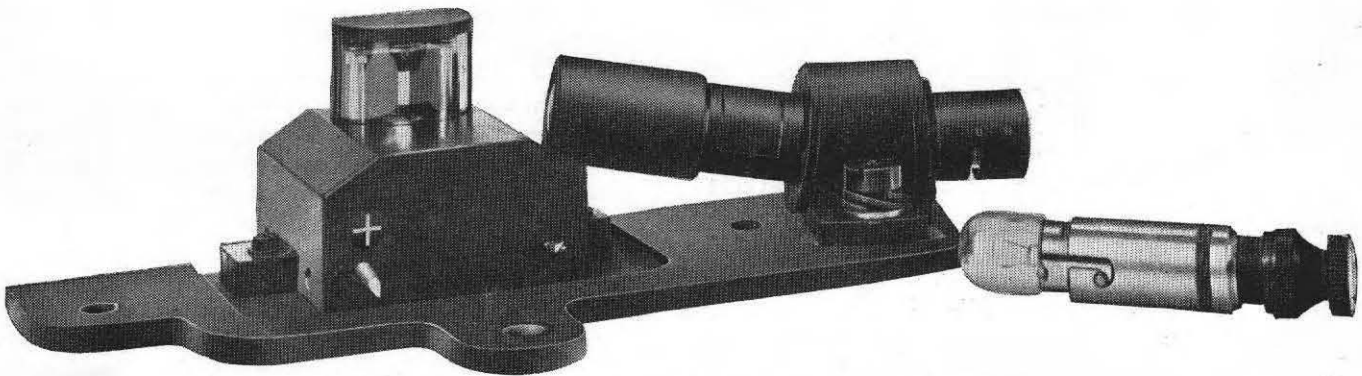

Fig. 2b — Projection-Lamp and totally enclosed Meter Assembly

the scale, but a physically larger scale was needed to separate them clearly. From this requirement the optical system with a 6-in. (15.2-cm) scale evolved.

3. General Description of the New Programme Meter

A prototype optical instrument and a standard pointer instrument are compared in Fig. 1. The optical system is exposed in Figs. 2a and 2b and explained diagrammatically in Fig. 8. Fig. 2a differs from Fig. 1 in including the extra edge-lit scale which is required for television sound control; in the dark, the scale numbers appear above the moving light-bar as shown in Fig. 3. The corresponding view, Fig. 4, taken with the lights on, shows the meter supported about an inch above the picture monitor by an arm attached to a wall bracket (rear, right). A much shorter arm is used in Fig. 5 to secure the instrument to the roof of an outside broadcast van.

The extra illuminated scale is unnecessary in sound broadcasting, the deflection being read in this case from the numbers engraved on the surface of the translucent scale. From Fig. 6 it can be seen that the bar of light is clearly visible in spite of the ambient lighting.

The essential difference between this instrument and normal optical projection systems is the use of a concave-cylindrical mirror to 'fold' the light beam (see Fig. 8). It is common practice to obtain a large linear scale deflection from a small rotation of a moving mirror by 'folding' the light beam by a plane mirror mounted at the rear of the housing. This has the disadvantage of throwing the reflected ray out of the line of sight as the ends of the scale are approached. To make sure that the light spot remains visible, by light scattered from the 'frosted' surface of the scale, a powerful light source is needed.

The advantage of the concave mirror is that the beam is returned to the translucent scale at roughly normal incidence; which ensures that it is directed towards the eye of the observer and gives a brilliant image with little reliance upon scattered light.

By adjusting the position of the moving mirror, (2) in Fig. 8, in relation to the centre of the curvature of the mirror (3), the reflected rays can be given an inward bias. This preserves the brilliance of the image formed on the scale (4) as seen by an observer standing on the centre line of the instrument; he has the impression that the light-source moves across the scale behind the light-bar (see Fig. 9). Since the optical efficiency of the system described is so high, no special 'projection'-type lamps are required, a cheap, low-power, straight-filament, M.B.C. bulb being sufficient. The image can be viewed obliquely by the light scattered from the frosted surface of the scale, and, in the plane at right-angles to the scale length, the angle of view is made unusually large by using refraction of the image through the triangular-section scale. These points are discussed more fully in Section 5.

The mirror (2) is attached to a moving-coil system which is virtually a replica of the assembly used in the standard

programme meter (the pointer instrument in Fig. 1), except that the shaft is extended to carry a 2×5 -mm mirror.

To protect the moving system from dust and magnetic particles, the moving-coil unit is totally enclosed, a very thin window being provided in front of the mirror (see Fig. 2b). This makes a dust-seal on the main casing of the instrument unnecessary, and allows lamps to be replaced without damage to the meter movement. The small cylindrical cap to the left of the instrument housing in Fig. 1 turns on a hinge to expose the lamp housing for this purpose.

Since the mirror is long and narrow, it is necessary to align the straight lamp filament to coincide with the long axis of the mirror by turning the lamp in its housing and by swinging the assembly slightly in a horizontal plane. The latter motion is locked by a set-screw reached through a hole in the bottom of the case.

It is not always desirable, particularly in television studios, to have the programme meter lamps too bright; adjusting knobs for this, and for the brightness of the subsidiary scale, are provided at the rear of the casing. At the rear there is also a push-switch which disconnects the meter circuit to allow 'mechanical zero' (right-hand end mark) to be set.

The whole assembly is supported by a lug at the back which is attached to a suitable arm or bracket of which a variety can be seen in the illustrations.

The instrument, excluding the bracket, connecting cable, or any extra edge-lit scale assembly, is designated PRM/1A. The weight is 1 lb. 14 oz. (850 g.). Exposed surfaces have a glossy grey finish; internally a matt black surface is necessary to remove causal reflections.

4. The Range of the Instrument

All the prototype meters illustrated here provided the 32-dB range demanded by the analysis of Section 2, the marks 'A, B, C' being added at 4-dB intervals between the '0' and '1' of the original scale used for the pointer instrument. To find room for the new graduations the scale numbering was shifted one unit to the right (4 dB), as will be seen in Fig. 1.*

An instrument scaled in this way cannot be used in series with, or as a direct replacement for, the pointer instrument. Unfortunately both these arrangements are, at present, quite common service requirements, and so, on meters going into service a shorter, compatible, scale is being provided. It has a range of 28 dB and is marked 'O, B, C, 1 . . . 7'; this represents the shorter of the two scales discussed at the end of Section 2.

5. The Optical System

5.1 Ray Geometry

The essential optical components are shown in plan in Fig. 8a, which illustrates the path of a pencil of rays

* In this photograph the '7'-mark is missing from the optical scale, but it appears in other illustrations.

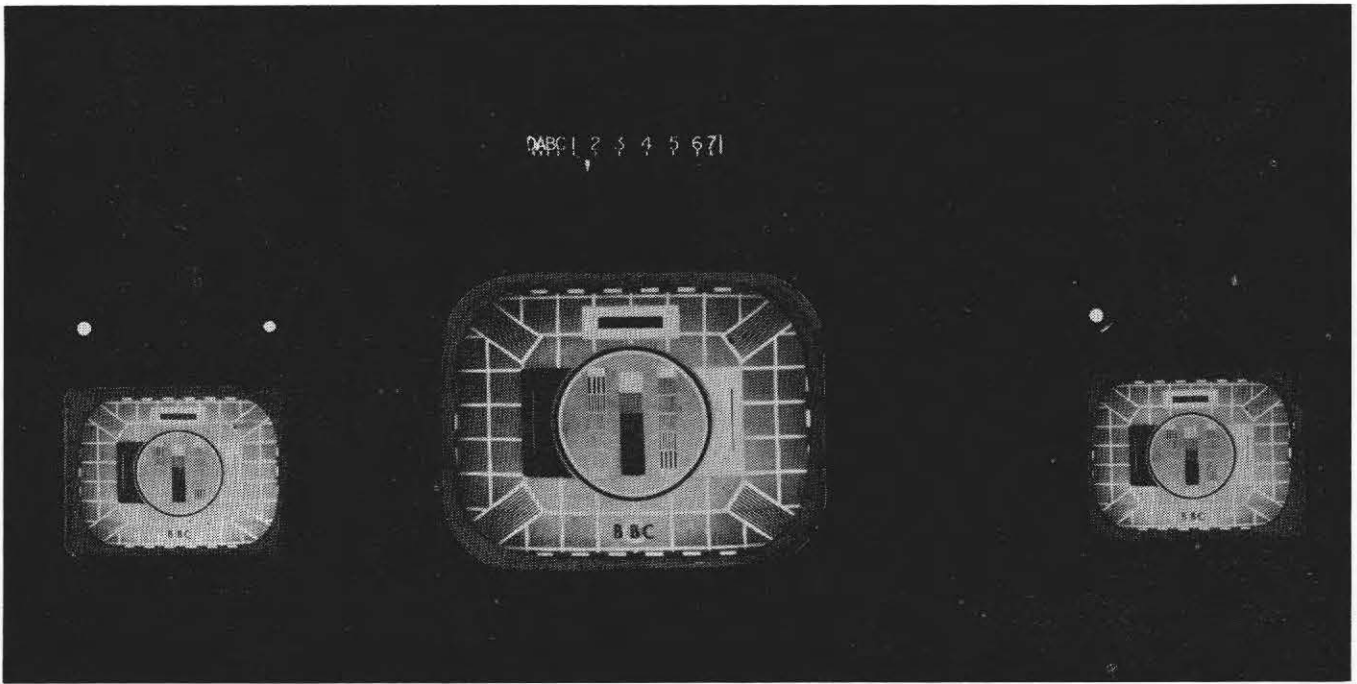

Fig. 3 — Television Theatre; lights out

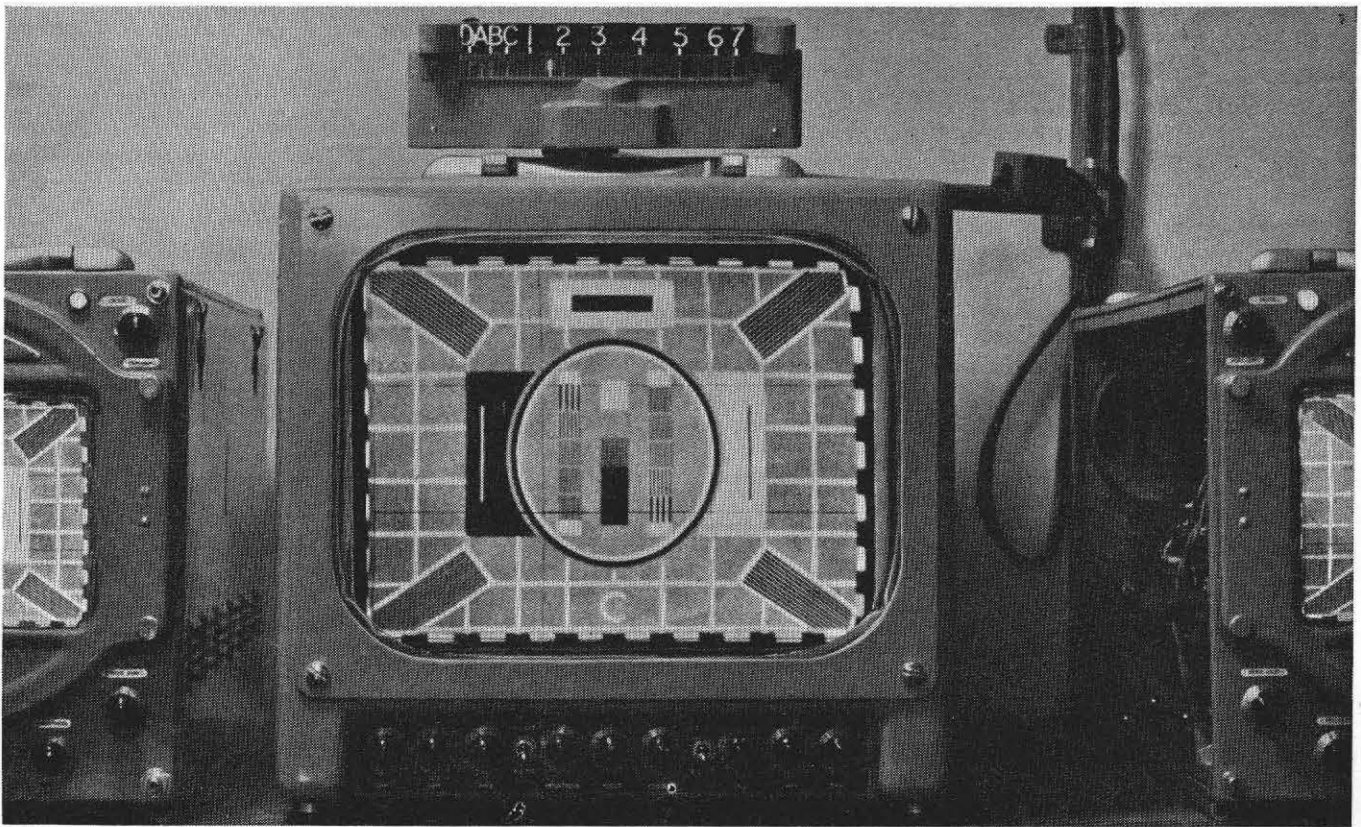

Fig. 4 — Television Theatre; lights on

passing through the centre of the image. We shall confine attention to the central ray of the pencil. At this stage we ignore the focusing of the image; this is formed at or near the translucent scale (4) by the lenses in the lamp housing (1), with the assistance of the concave mirror (3). The moving mirror (2) is plane, and is shown at slightly more than half-scale deflection.

Fig. 8b is limited to half the structure since this is symmetrical. The line AD represents the ray reflected from (2), and DE the reflection from (3) which passes through the scale (4) at E, where the image is formed. The deflection H is measured from the centre of the scale, and the ray rotation, Φ (due to the mirror (2) moving by $\Phi/2$), is also measured from the line symmetry. Positive values of H correspond to deflections to the right of the observer.

As H varies from one extreme to the other (-2.8 in. to $+2.8$ in.), (-7.1 cm to $+7.1$ cm), Φ varies from $-56^\circ.1$ to $+56^\circ.1$.

In the final design the scale lies about $\frac{1}{4}$ in. (6.33 mm) nearer to O (Fig. 8b) than to C. For geometrical analysis,

however, it is simpler to deal with the scale located, as in the figure, at a distance from the concave mirror exactly equal to half its radius of curvature R. In the prototype meter, R is 6 in. (15.2 cm), and to avoid generalities, all numerical statements of deflection, H, given here will be based on this value.

The relationship between H, R, and Φ is derived in Appendix A. Since H is very nearly proportional to Φ , the ratio H/Φ has been extracted to illustrate the minor deviations from linearity, and has been plotted in Fig. B1a. It is particularly to be noted that the large variations of H/Φ shown in that figure are no direct measure of the lack of linearity of the scale, which can be arranged to be linear to $\pm 5 \times 10^{-3}$ in. in a 5.60-in. (14.2 -cm) scale, a deviation of about ± 0.10 per cent of full-scale deflection. This apparent anomaly is discussed in Appendix B.

If the construction of Fig. 8b is carried out for a variety of values of Φ the ray diagram of Fig. 9 results. From this it is clear that there is what may be called a 'ray focus', i.e. a bringing together of the central rays of the image into a

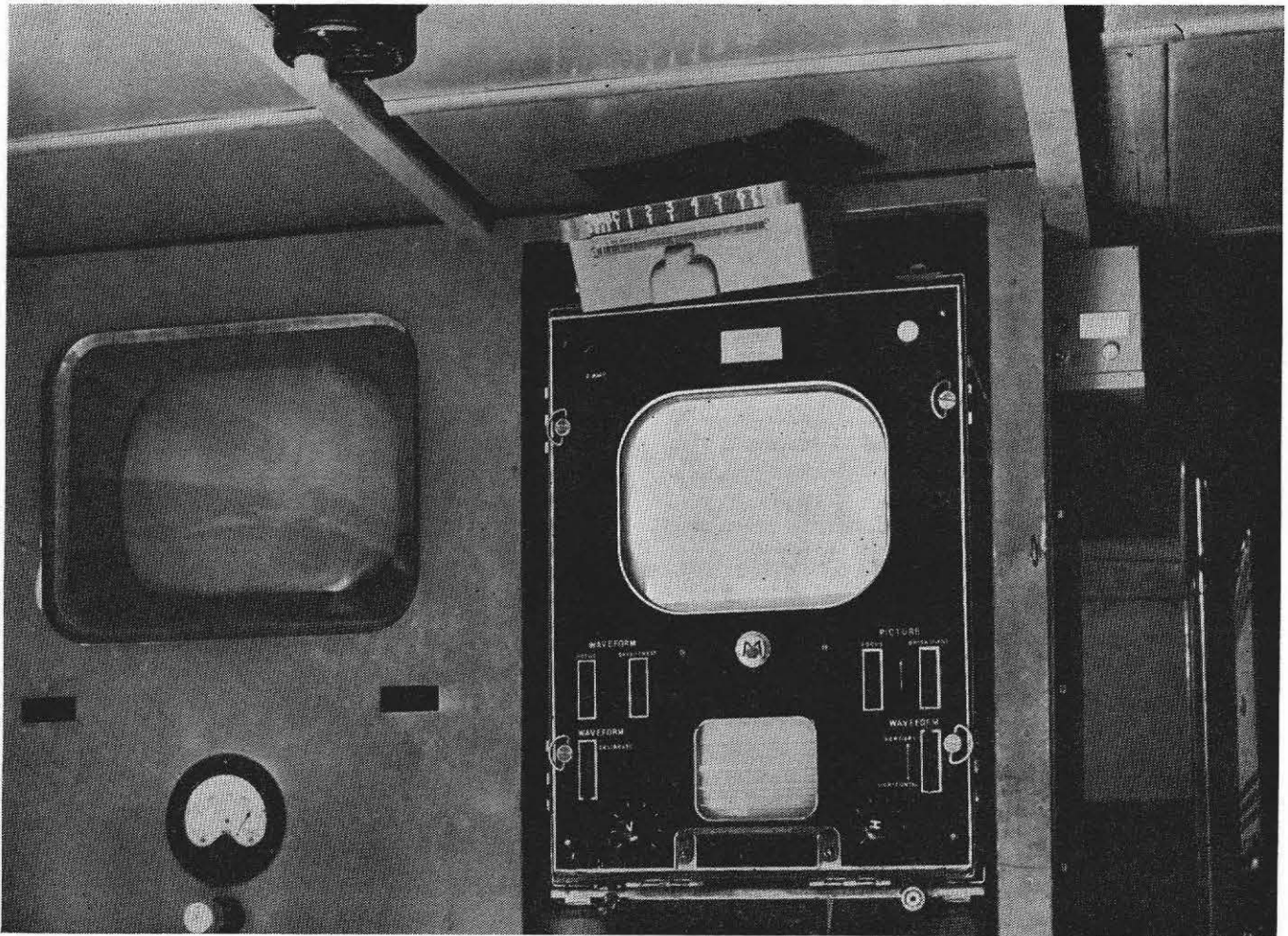

Fig. 5 — Installation in Outside-broadcast Van



Fig. 6 — Installation in Drama Studio

corridor, located some 20 to 30 in. (50 cm to 75 cm) from the scale. In this region one or other of an observer's eyes will receive a ray which has passed through or very near the centre of the image.

The image is of course 'real' and is focused on the scale, but, because the scale is translucent, it appears most brilliant when viewed by direct unscattered light.

In practice the observer will rarely place himself in this narrow corridor, but, as explained in Appendix C, the polar diagram of the light scattered from the scale is broad enough to ensure that the image brilliance is adequately maintained over a large area. For example, variations no greater than 3 dB in light intensity will occur in a triangular area which has its apex at the scale centre and a semi-angle of about 10 degrees. The variation of brightness over this area is scarcely noticeable.

The previous remarks apply to the plan view; in the vertical plane a wide angle of view is obtained by quite a different technique, as shown in Fig. 10. The image of the slit in the lens housing is formed on the inner surface of the triangular-section, perspex scale, which is slightly rough-

ened. Half of the light is bent upwards and half downwards in passing through the scale, so that looking from above at the scale, the lower half is brilliantly illuminated and the upper half is dark; and vice versa from below. Very little brilliance is lost when the scale is viewed from straight ahead; owing to the wide polar diagram of the scattered light, both the upper and lower halves of the image appear equally bright.

Although there is no immediate demand for the facility, the instrument can be used with the scale vertical where horizontal space is limited. An objection to this arrangement is that the eyes of the observer at close range have to follow the light spot over a large vertical angle. This seems to cause strain, although horizontal movement does not. At 4 ft to 5 ft (1.2 m to 1.5 m) range however, there is no difficulty.

5.2 The Focal Plane

The image of the slit in the lens-housing (1) has been described as focused on the scale; this is not strictly true, but since the departure from ideal focus can scarcely be

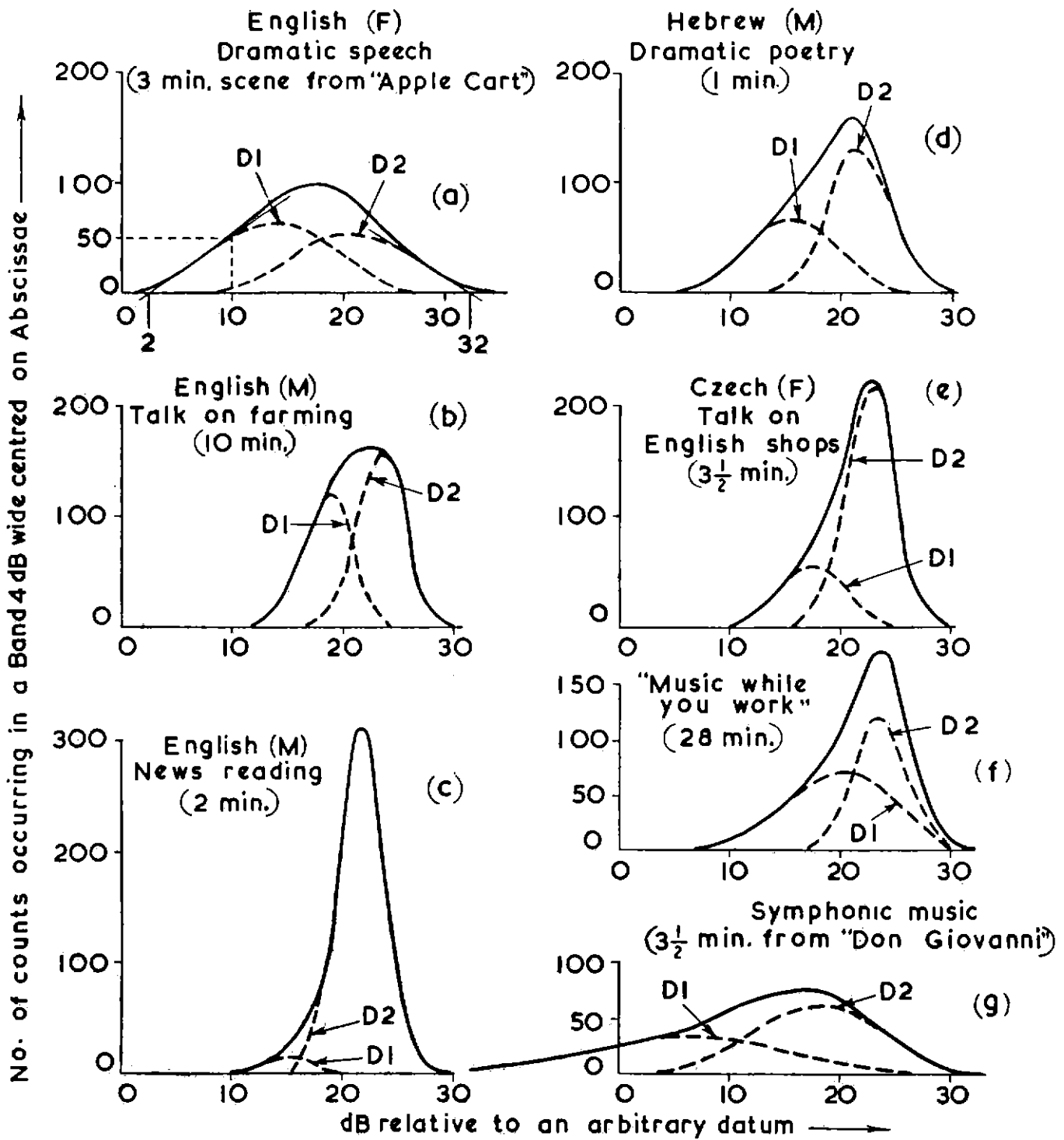

Fig. 7 — Typical Histograms ('normalized' to 400 counts so that all have equal area)

(F) :— Female voice (M) :— Male voice

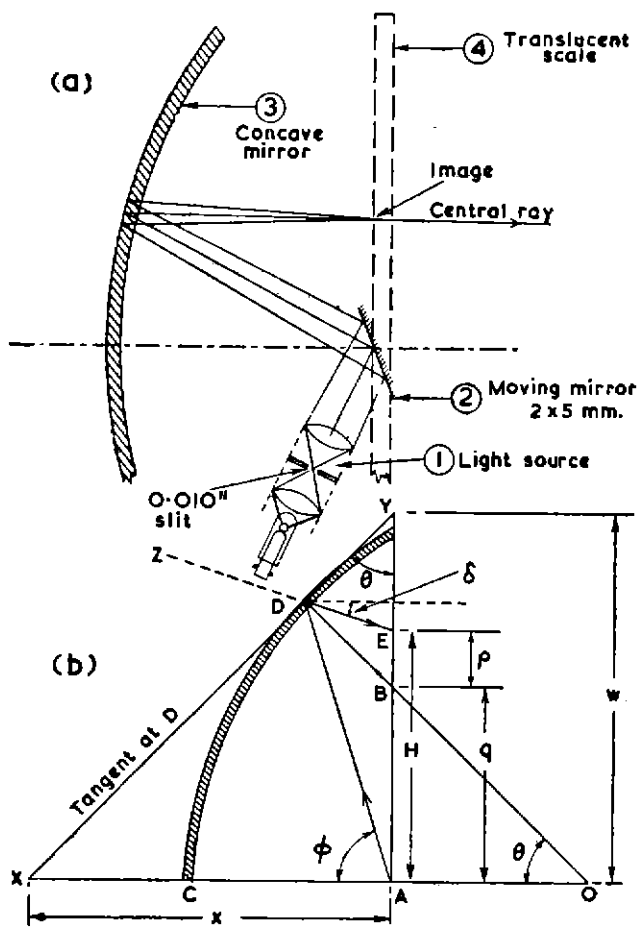

Fig. 8 — Ray Path

appreciated by casual inspection, the system behaves as if the focus were perfect.

The focal plane of the prototype meter is illustrated in Appendix D.

5.3 Cylindrical Mirror

Cylindrical mirrors can be made by shaping plate glass to a pattern when hot. The mirrors for the prototype meters were cut from a sheet which had been shaped in this way and cost much less than precision-ground and polished mirrors.

A high degree of precision in the mirror shape is of little importance because the beam of light which builds up the 1.5-mm wide image on the scale covers such a small surface area of the mirror, that, provided the departures from a true cylindrical shape are smooth and systematic and not sudden or irregular, the sharpness of the image does not suffer. This is exemplified by an experiment in which a strip of plated and polished spring steel, bent to shape against a backing piece, successfully replaced the mirror. This simple structure was abandoned only because the reflecting surface was exposed and liable to tarnish. The glass mirror is, of course, silvered on the rear surface and is affected only by dust on the front surface. So far dust has caused no trouble, but inspection every six months may be advisable.

5.4 Edge-lit Subsidiary Scale

The subsidiary edge-lit scale has no unconventional features, the perspex strip, on which the scale marks and designations are engraved, being illuminated from both ends by small 6-volt lamps of the same type as the main projection lamp. To make the scale marks visible many feet away, it was found necessary to use a specially-ground engraving tool for cutting a sharp triangular groove to nearly half the depth of the strip. All six surfaces of the strip have to be polished; the ends to admit the light, and the edges and flat faces to prevent light from escaping except at the engraved marks.

5.5 The Moving Mirror and its Influence upon Mechanical Performance

Optical glass has about the same density as aluminium and mirrors made from it can be very light. Glass cannot, however, be used in very thin sheets if the figure of the surface is important. Although the surface of a thin mirror can be made flat, it can be distorted seriously by the cement used to fix it in position and will slowly change its shape as the cement hardens. The risk of distortion is greatly reduced if the mirror is small. Microscope 'cover glass' can safely be used in the form of a 2 x 5-mm mirror.

Such a mirror, mounted on the shaft of the programme meter moving-coil system so as to rotate on its long axis, will have a moment of inertia considerably less than that of the aluminium pointer in Fig. 1; but allowance must be made also for the duralumin shaft on which the mirror is

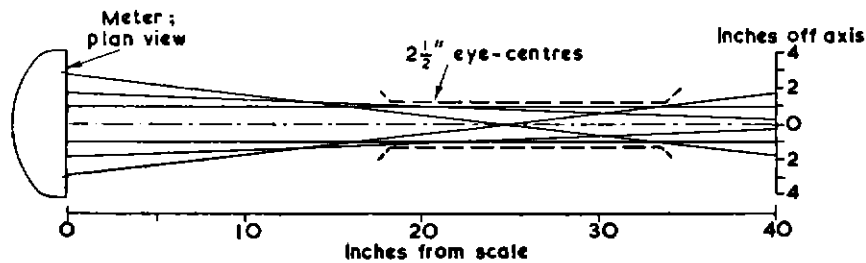

Fig. 9 — Ray Focus Effect

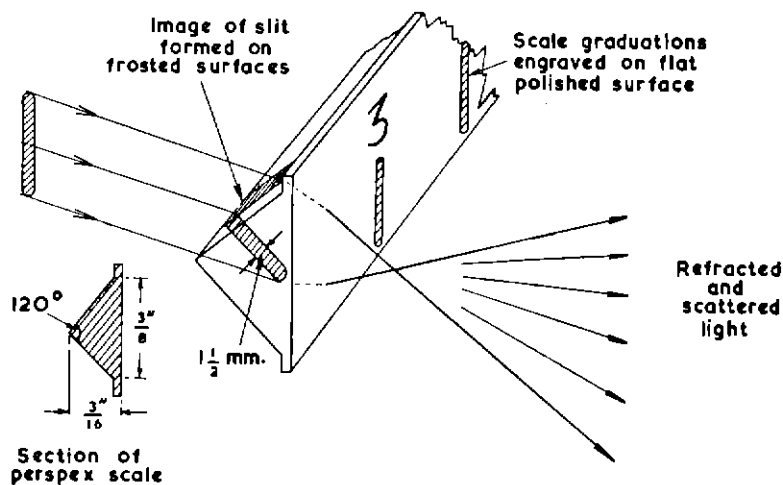

Fig. 10 — Refraction through Scale

carried. In the final models it was found that the total inertia of the mirror assembly was so much less than that of the pointer that the optical meter passed with ease the mechanical performance specification laid down for the pointer instrument. In particular, the percentage 'overshoot' was roughly halved, while the speed of response was more rapid. If necessary, the overshoot could be still further reduced by magnetic and electrical redesign of the driving system.

6. The Users' Opinion of the Optical Meter

The advantages of the instrument for television purposes were immediately evident when it was installed for operational trials, because the instrument could be used in darkness. During the trials of the instrument in sound broadcasting the most important conclusion was that the arguments set out in Section 2, above, were vindicated; the full 32-dB scale was adequate for the control of symphonic music, and no further extension was called for. For the control of speech, including dramatic material, there appeared to be, as expected, no advantage.

It remained to be proved, however, that the instrument would be acceptable in other respects. For example, the change from a conventional meter needle to a luminous pointer distracted many users, and the increased physical length of the scale upset some observers. In particular, where the instrument was viewed at close range the commonest complaint was that the spot moved too fast. Since the scale lengths were roughly in the proportion of three to one, the light-bar moved three times as fast as the tip of the pointer of the standard instrument. It appears that in reading a fast-moving pointer the eye is guided not by the tip but by a point lower down where the velocity is lower. The moving light-bar did not permit of this compromise and this apparently accounted for the complaint.

In all there were almost as many favourable as unfavourable comments, but not enough to justify the general use of

the optical meter for the control of sound broadcasting (as distinct from the sound channel of a television programme). A significant fact was that nearly all opinions expressed were either strongly in favour or equally strongly against, which suggest that the optical instrument may in due course find a limited field of application in sound broadcasting, particularly for the control of material of wide dynamic range.

Unfortunately the users' reports throughout the trials were strongly biased by factors which might have been eliminated if the instrument and the associated studio equipment had been tailored to fit each other. For a trial of this kind no such arrangements could be made. For example, all operators were used to having the programme meter centrally disposed on the control desk; the optical meter had to be placed above the desk or to one side. This was considered to be distracting.

The conditions in a television studio or outside broadcast van were radically different; here the luminous pointer appeared to best advantage, and because the meter could be read at long range, it could be placed in the proper position, immediately adjacent to the picture monitor. This was a great improvement, since a dimly-lit pointer instrument had previously to be viewed at a range of 20 in. to 30 in. (50 cm to 75 cm), which meant that attention had to be diverted from the picture monitor several feet away, requiring a change of accommodation for both viewing distance and the change of brightness.

In the outside broadcast van the wide angle of view was fully exploited by mounting the meter in the roof (Fig. 5) where it was readable by observers in the line of sight, below, and to one side. The observer's view in a more normal installation is illustrated in Figs. 3 and 4, which show an early arrangement of the apparatus associated with the Television Theatre at Shepherd's Bush, which has since been remodelled. The picture on the monitor tubes was set up so that its brightness could be compared with the illuminated meter scale and spot. The row of numerals

above the central monitor tube come from the edge-lit scale of the meter; the bar of light beneath them is the 'light pointer' of the instrument, held at rest for the photograph to be taken. The halation around the upper half of the light bar was visible only to the camera.

7. Conclusion

It has been shown that by using a projection-type meter in place of a pointer instrument it is possible to extend the useful range of indication of the standard BBC programme meter equipment. When full advantage is taken of the new instrument, the range is wide enough to cope with even the most difficult programme material.

For the control of television sound-channels the luminous pointer has proved to have such obvious advantages

that a number of installations are projected and several are in service. In sound broadcasting the new instrument is considered to have a limited field of application, and so far no use has been made of it.

8. Acknowledgments

The housings and all accessories of the instruments illustrated, with the exception of the meter assemblies, were constructed at the BBC Research Department, Kingswood Warren. Messrs Ernest Turner, High Wycombe, built the totally enclosed meter units. Lenses for the optical system were supplied from stock by Messrs Hilger and Watts, and the concave mirrors were made to specification by Messrs Robinson, King and Co.

APPENDIX A

The Relationship between the Linear Deflection H, and the Angular Deflection of the Reflected Ray

In Fig. 8b the cylindrical mirror CD has its centre at O . The scale YA is placed so that $CA=AO=R/2$. The moving mirror ((2) of Fig. 8a) lies at A and is set at such an angle to the light incident from the lens-system (1) that the reflected ray AD is at an angle Φ to the line of symmetry CAO . In practice the scale will be placed slightly to the right of the mirror (2) instead of coincident as shown, but it is simpler to compute the effect of this later.

For analysis w , p , q , and x are written for the distances YA , EB , BA , and AX respectively. Also $OD=OC=R$.

The deflection H can be expressed in terms of R and $\tan \theta$ by starting from the triangle XYA where XY is the tangent at D . Since $\angle ODA=\angle ODE$, DO is a median of the triangle ADE . But by construction XY is also a median, bisecting in this case, the external angle $\angle ZDA$. Noting that $\angle AYZ=\angle DOX=\theta$, H is first obtained in terms of w :

$$\frac{p}{q} = \frac{w-H}{w} \quad (\text{since } DB \text{ is a median of the triangle } ADE)$$

$$= 1 - \frac{H}{w}$$

$$\text{Also } \frac{p}{q} = \frac{H-q}{q} = \frac{H}{q} - 1; \text{ whence } q = \frac{Hw}{2w-H}$$

$$\text{But since } AO=R/2; \frac{2q}{R} = \tan \theta$$

$$\text{Hence } \frac{R}{2} \tan \theta = \frac{Hw}{2w-H} \dots\dots\dots (\text{A.1})$$

To obtain w in terms of R , it should be noted that

$$\frac{R}{x+R/2} = \cos \theta$$

$$\text{and } \frac{x}{w} = \tan \theta$$

Whence, writing 't' for $\tan \theta$ for brevity:

$$\frac{w}{R} = \frac{1}{t} (\sqrt{1+t^2} - \frac{1}{2}) \dots\dots\dots (\text{A.2})$$

Substituting (A.2) in (A.1):

$$\frac{H}{R} = t \left(\frac{2\sqrt{1+t^2}-1}{t^2+2\sqrt{1+t^2}-1} \right) \dots\dots\dots (\text{A.3})$$

It is easy to show that

$$\cot \Phi = \left(1 - \frac{\sqrt{1+t^2}}{2} \right) / t \dots\dots\dots (\text{A.4})$$

$$\text{Later } \tan \delta \text{ is needed} = \tan (2\theta - \Phi) \dots\dots\dots (\text{A.5})$$

The following table is now drawn up, derived for values of t from 0.0 to 0.8:

TABLE I

$t = \tan \theta$	θ (deg.)	Φ (deg.)	H/R	Based on $R=6$ in.		Tan δ
				H in.	H/Φ (in./deg.)	
0.0	0	0	0	0	0.052,361	0
0.1	5.7091	11.365	0.099,019 ₆	0.594,117	0.052,262	0.000,872,7
0.15	8.5310	16.878	0.146,770	0.880,620	0.052,176	0.003,200
0.20	11.308 ₀	22.199 ₆	0.192,590	1.155,542	0.052,053	0.007,270
0.30	16.683	32.116 ₄	0.277,081	1.662,486	0.051,764	0.021,796
0.40	21.801 ₇	40.917 ₈	0.351,296	2.107,777	0.051,512	0.046,935
0.50	26.565	48.590	0.415,885	2.495,313	0.051,354	0.079,523
0.60	30.966 ₃	55.208	0.472,369	2.834,214	0.051,337	0.117,927
0.70	34.991 ₆	60.896 ₇	0.522,400	3.134,402	0.051,471	0.159,920
0.80	38.659 ₇	65.787	0.567,405	3.404,429	0.051,749	0.204,06

The value of H/Φ in Table 1 decreases to a minimum when Φ is about 53° (see also Fig. B.1 of Appendix B), at which point the change in H/Φ , reference to $\Phi=0$, is about 2 per cent. It is shown in Appendix B that this does not indicate a 2 per cent departure from linearity of the scale marking.

The maximum value of Φ chosen for the optical programme meter was made $56^\circ.1$, i.e. the ray moves from $-56^\circ.1$ to $+56^\circ.1$ as the deflection changes from -2.8 in. to $+2.8$ in. The mirror (2) therefore rotates through

$56^\circ.1$; this is considerably less than the angle of full-scale deflection of the pointer instrument of Fig. 1 (about $80^\circ.0$). If the same coil construction is used for the two instruments, it follows that the optical meter is the more 'sensitive'. In practice, advantage is taken of the increased sensitivity to modify the coil construction and damping shunt; this, with the reduction in the moment of inertia of the movement, leads to improved speed of response and reduction of overshoot.

APPENDIX B

Relationship between Scale Deflection and Meter Current

Because of the imperfections of the associated logarizing amplifier the scale marks of the programme meter are not equally spaced, as can be seen from the photographs. The scale is clearly non-linear in this sense. What is discussed here is the ratio between the displacement of the light-bar

rotation Φ . This has already been computed in Table 1 (Appendix A) for the case in which the scale and moving mirror coincide. The data is plotted in Fig. B.1(a) on the curve marked ' $\Delta S = \text{zero}$ '. Fig. B.1(b) explains the meaning and sign of ΔS . It can be seen that the deflection H is reduced to $(H - \Delta H)$ when the scale is moved a distance ΔS to the right and

$$\Delta H = \Delta S \tan \delta$$

Using the values of δ from Table 1 the curves of Fig. B.1(a) have been computed.

The maximum values of Φ are $\pm 56 \cdot 1$ and the two ends of the scale will therefore be $56 \cdot 1 (H/\Phi)_{56 \cdot 1}$ inches from the scale centre. Intermediate values of Φ will give deflections which are not quite in proportion; in general they will be too large. Fig. B.2 shows, grossly exaggerated, the case of $\Delta S = \text{zero}$. The slope of the dotted line is $H_{\text{max}}/\Phi_{\text{max}}$. The departure from linearity, E , is given by $(H_a - H_b)$, so:

$$E = \left\{ \frac{H}{\Phi} \right\}_a - \frac{H_{\text{max}}}{\Phi_{\text{max}}} \cdot \Phi_a \dots \text{(inches)} \quad \text{Equation B.1}$$

Positive values of E therefore correspond to a deflection greater than the linear law demands. Notice that this statement is true for a deflection measured away from the scale centre in either direction.

In Fig. B.3 the value of E has been graphed for several positions of the scale. When ΔS is $+\frac{1}{4}$ in. (6.3 mm) (the scale shifted towards the concave mirror) the linear error does not exceed $\pm 5 \times 10^{-3}$ in., which, on a scale nearly 6 in. long, means a precision of ± 0.1 per cent of full scale. However, this nearly perfect arrangement made the mounting of the meter movement a little difficult and had to be abandoned. In fact in the prototype instrument the scale was moved outwards by $\frac{3}{16}$ in. (4.8 mm) (ΔS negative). The linearity error then rose to 25×10^{-3} in. which could not be ignored when placing scale marks to correspond with current values.

The necessary correction is easily applied using the current scale in Fig. B.3, and the 'reference line', as illustrated by the dotted lines and arrows. For example, if the position of a scale mark corresponding to 1.2 mA has to be found, the figure shows that its position calculated by simple proportion has to be adjusted by moving it away from the scale centre by 21.3×10^{-3} in. So also at 0.32 mA.

It has to be remembered that the value of H_{max} is different for each of the scale positions chosen, in fact $\pm \frac{1}{4}$ in. (6.3 mm) shift of the scale alters H_{max} by $\pm 30 \times 10^{-3}$ in. (0.76 mm). From this it might be concluded that special care must be taken in building the meter housing and locating the scale, moving mirror, and concave mirror. In practice, however, there is no difficulty, the BBC programme meter amplifier having a 'zero adjustment' with which the maximum current and deflection can be adjusted; this removes any error at H_{max} .

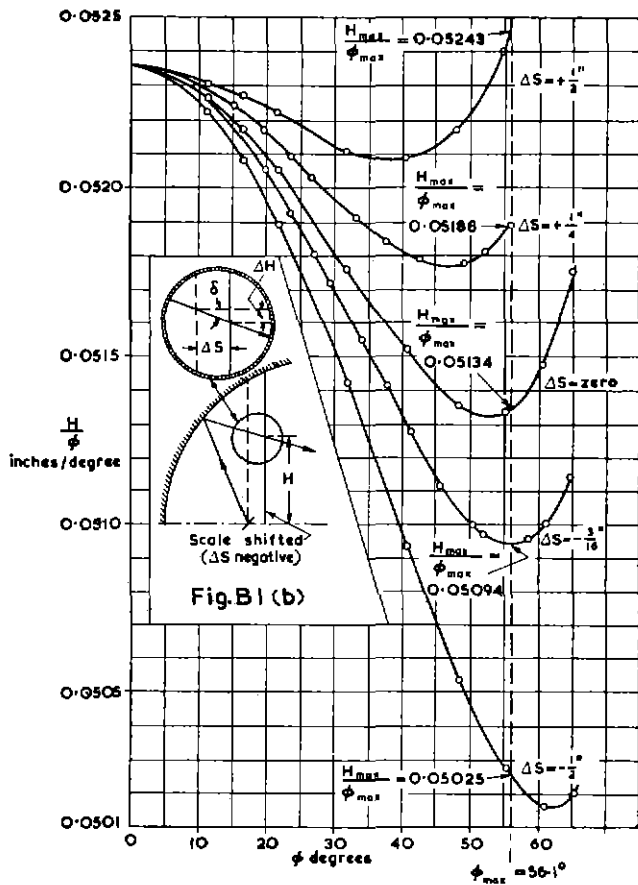

Fig. B.1(a) and B.1(b) — Scale Linearity

and the current fed to the moving coil system; this can be made very closely constant, and in this sense the scale is nearly linear.

In what follows it is assumed that the rotation of the meter mirror is strictly proportional to the current flowing, and the examples will be calculated for the prototype instrument in which the movement rotates $56 \cdot 1$ when the total current to the shunted meter is 1.52 mA. The radius of the concave mirror is six inches.

The present argument is concerned only with the relationship between the linear deflection H and the mirror

Even so, placing the scale in the wrong position will alter the value of E . But from Fig. B.3 it is clear that quite large errors in position will have very little effect on E , and then only in the region of $E = \pm 0.025$ in. In the prototype meter, with $\Delta S = \frac{3}{16}$ in. (4.8 mm), errors of $\pm \frac{1}{16}$ in. (1.6 mm) in scale location alter E by $\pm 5 \times 10^{-3}$ in. (0.075 mm) and this is confined to a small part of the scale only.

It follows that mass-produced meter scales engraved from a computed calibration can give reliable readings in spite of quite large errors of assembly.

It should be noticed that all the examples quoted are based ultimately on the data of Table 1. In order to deduce the linearity error of a system in which the moving mirror

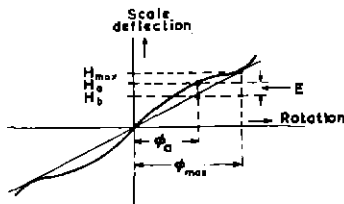

Fig. B.2 — Definition of error 'E'

was not placed at $R/2$ from the concave mirror, new data would be required (formulae A, 1, 2, 3, would not apply).

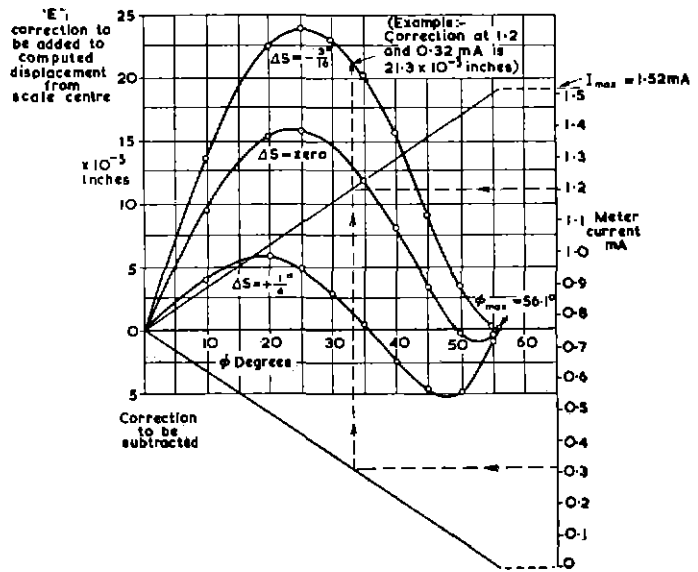

Fig. B.3 — Variation of error 'E'

APPENDIX C

The 'Ray-Focus' Effect

The simplified diagram of Fig. 9 suggests that the area in which the observer can see a brilliant image is very limited. The ray paths chosen are those which pass through the centre of the scale image and will certainly be the brightest, but the scattering effect of the roughened perspex scale will broaden the working area considerably.

The polar diagrams in Fig. C.1(a) show the brightness-distribution for three typical meter readings. The central ray (used in Fig. 9) is shown chain-dotted and it can be seen that the scattered light at large deflections has a polar diagram which is biased outwards from the central, brightest, ray. This greatly widens the viewing area at extreme distances.

In Fig. C.1(b) two rays have been taken from each polar diagram, each of half the brightness of the central ray, so that the brightness measured in the region enclosed between the rays will vary over a 3-dB range. The pairs of

rays from the extreme and central deflections overlap in the shaded area extending from the right of the diagram. This region includes the half-brightness area of the polar diagrams corresponding to any deflection whatever and is a triangle of apex angle 20° , the apex lying 16 in. (40 cm) from the scale centre.

It follows that to an observer 4 ft (1.2 m) from the screen the spot will not vary its brightness by more than 3 dB whatever the deflection, provided he is not more than about 8 in. off the axis; while at a range of 6 ft (1.8 m) he has latitude to move about 12 in. (30 cm) off the axis. There is in practice a still larger latitude, for 3-dB brightness variation is not easily noticed. If the brightness tolerance is increased to 6 dB the area of view is greatly increased, as may be seen in Fig. C.1(c); the apex of the triangle moves to within 10 in. of the scale, and the apex angle increases to $27^\circ.0$. This allows the observer a latitude

of over 16 in. (40 cm) on either side of the axis at 6 ft (1.8 m) range.

The shortest likely range is 20 in. (50 cm) where the 3-dB area is 2 in. wide. The 'effective' 3-dB area is 5 in. (7.5 cm) wider than this (twice the eye-centre distance of 2½ in.), since the observer will be satisfied with a bright

image in one eye only, the one nearest the axis. The width of the 6-dB area is effectively* 9 in. (23 cm) at this range.

* The position tolerances given in the previous paragraph have been adjusted in the same way, the 'effective' width of the viewing area being taken as 5 in. greater than the ray diagram suggests.

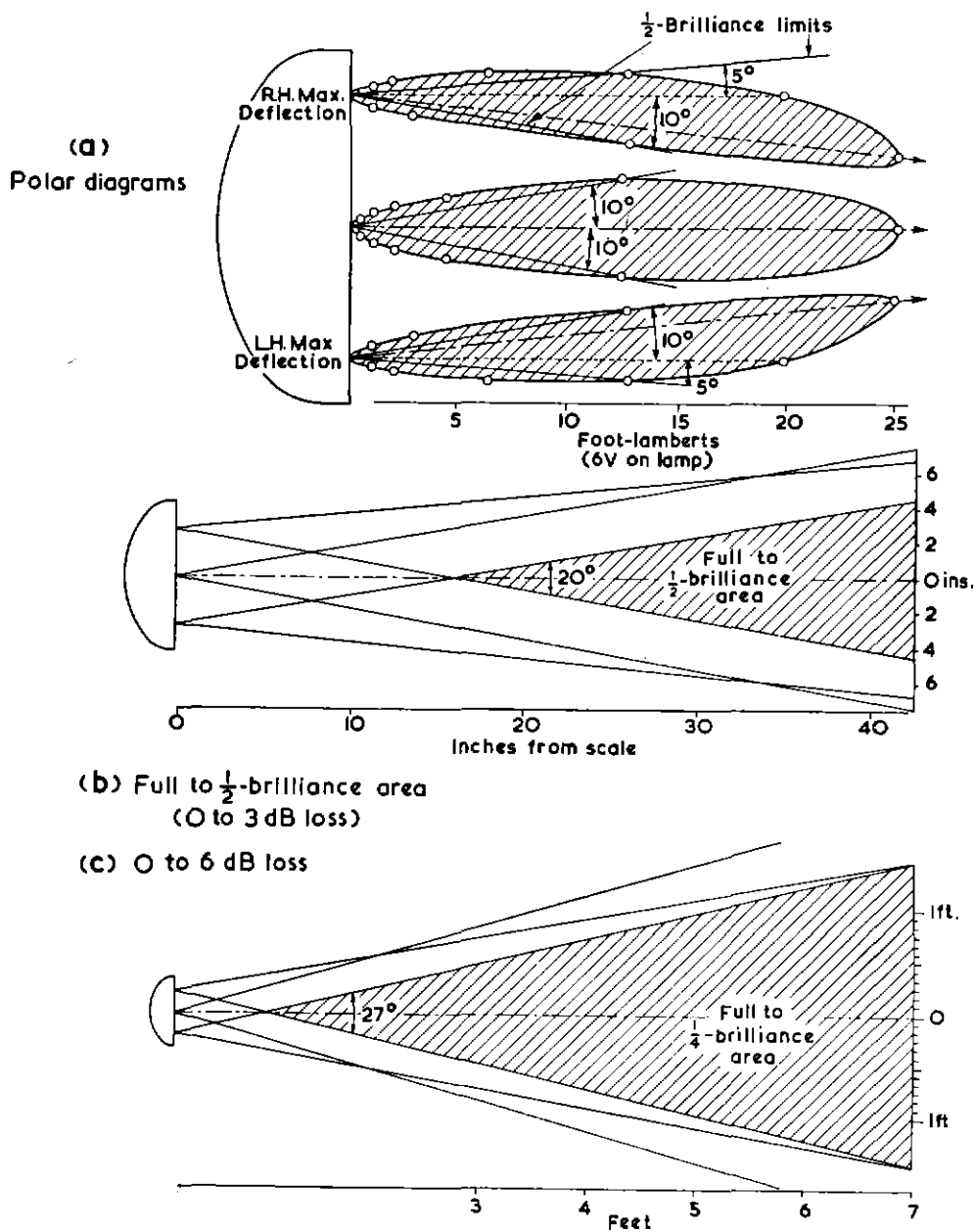

Fig. C.1 — Viewing Area

APPENDIX D

The Focal Locus

The direction of the central ray of the image has been established by the geometry of Fig. 8. The final real image will lie on this ray, but its position will depend upon the disposition of the lenses in the projection system. The ideal arrangement would be to bring the image to a focus on the rear face of the translucent scale, but this is not feasible and the best compromise is the 'preferred locus' of Fig. D.1, the focal point lying outside the outer surface of the scale when the deflection is a maximum, and about $\frac{1}{8}$ in. behind the scale at the minimum deflection.

The various focal loci shown in Fig. D.1 correspond to different values of the distance 'L' between the mirror (2) and the first image I_1 . This is the image which the projection system would produce if the concave mirror (3) were absent. The quantity L can be adjusted by moving one of the projection lenses relative to the illuminated slit (Fig. 8a). The preferred focal locus is obtained when L is about 20 in.

When the mirror (3) is interposed a real image I_2 is formed, which will be very near the surface if I_1 lies only

slightly outside the mirror. The diagram shows the formation of the image when L is 4.5 in. and the deflection of mirror (2) is a maximum ($56^\circ - 1$).

It will be seen that, by reducing L , the curvature of the locus can be reduced, which suggests that the scale should ideally be set very near to the concave mirror. Unfortunately this is not practicable since the light-rays, shown in plan in the diagram are, in fact, tilted upwards after leaving the mirror surface in order to pass through the scale. To get adequate clearance for the beam the scale had to be much further away. Although it enforced a curved focal locus, the placing of the scale somewhere near the mirror (2) had obvious mechanical advantages; in addition, it made it possible, as explained in Appendix B, to obtain a very nearly perfect linear relationship between the deflection of the image on the scale and the angle of deflection of mirror (2).

In practice, it is found that the curvature of the preferred locus has negligible effect upon the clarity of the image.

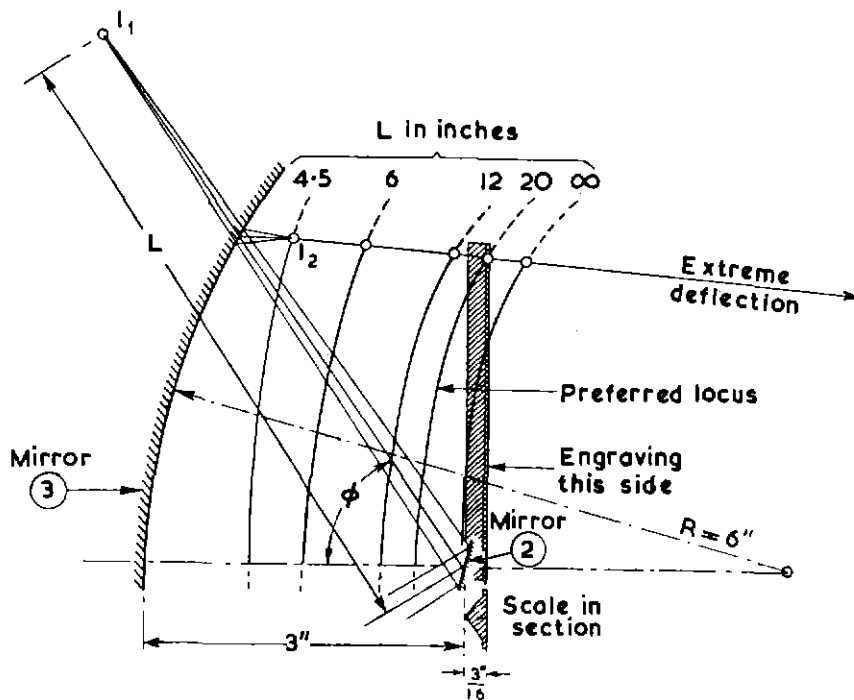

Fig. D.1 — Focal Loci of Prototype Instrument

