



BBC

ENGINEERING DIVISION

MONOGRAPH

BRITISH BROADCASTING CORPORATION

Library Copy

NOV 1956 No. 9

THE APPLICATION OF
PHASE-COHERENT DETECTION AND
CORRELATION METHODS TO ROOM
ACOUSTICS

by C. L. S. GILFORD, M.Sc., F.Inst.P., A.M.I.E.E.
M. W. GREENWAY, M.Sc. (Eng.), D.I.C., A.C.G.I.,
Grad.I.E.E.

(Research Department, BBC Engineering Division)



BBC ENGINEERING MONOGRAPH

No. 9

THE APPLICATION OF PHASE-COHERENT DETECTION AND
CORRELATION METHODS TO ROOM ACOUSTICS

by

C. L. S. Gilford, M.Sc., F.Inst.P., A.M.I.E.E.
M. W. Greenway, M.Sc. (Eng.), D.I.C., A.C.G.I., Grad.I.E.E.

(RESEARCH DEPARTMENT, BBC ENGINEERING DIVISION)

NOVEMBER 1956

BRITISH BROADCASTING CORPORATION

FOREWORD

THIS is one of a series of Engineering Monographs published by the British Broadcasting Corporation. About six will be produced every year, each dealing with a technical subject within the field of television and sound broadcasting. Each Monograph will describe work that has been done by the Engineering Division of the BBC and will include, where appropriate, a survey of earlier work on the same subject. From time to time the series will include selected reprints of articles by BBC authors that have appeared in technical journals. Papers dealing with general engineering developments in broadcasting may also be included occasionally.

This series should be of interest and value to engineers engaged in the fields of broadcasting and of telecommunications generally.

Individual copies will cost 5s. post free, while the annual subscription is £1 post free. Orders can be placed with newsagents and booksellers, or BBC PUBLICATIONS, 35 MARYLEBONE HIGH STREET, LONDON, W.1.

CONTENTS

<i>Section</i>	<i>Title</i>	<i>Page</i>
	SUMMARY	5
1	INTRODUCTION	5
2	THE DEVELOPMENT OF THE PHASE-COHERENT PULSED GLIDE .	5
	2.1. Experimental Chain	6
	2.2. Description of the Instrument	6
	2.3. Details of the Experimental Method	6
3	EXPERIMENTAL WORK AND RESULTS	8
	3.1. Investigations in Rooms	8
	3.2. Some Theoretical Considerations in Connection with Small Rooms	9
	3.3. Coherent Glides of Electrical Networks	9
	3.4. Phase-reversal counting	12
4	METHODS INVOLVING AUTO- AND CROSS-CORRELATION	12
	4.1. Cross-correlation Methods	13
	4.2. Coherent Glide between two Points in a Studio	13
	4.3. Other applications of correlation methods	14
5	CONCLUSIONS	14
6	REFERENCES	14

PREVIOUS ISSUES IN THIS SERIES

No.	Title	Date
1.	<i>The Suppressed Frame System of Telerecording</i>	JUNE 1955
2.	<i>Absolute Measurements in Magnetic Recording</i>	SEPTEMBER 1955
3.	<i>The Visibility of Noise in Television</i>	OCTOBER 1955
4.	<i>The Design of a Ribbon Type Pressure-gradient Microphone for Broadcast Transmission</i>	DECEMBER 1955
5.	<i>Reproducing Equipment for Fine-groove Records</i>	FEBRUARY 1956
6.	<i>A V.H.F./U.H.F. Field-strength Recording Receiver using Post-detector Selectivity</i>	APRIL 1956
7.	<i>The Design of a High Quality Commentators' Microphone Insensitive to Ambient Noise</i>	JUNE 1956
8.	<i>An Automatic Integrator for Determining the Mean Spherical Response of Loudspeakers and Microphones</i>	AUGUST 1956

THE APPLICATION OF PHASE-COHERENT DETECTION AND CORRELATION METHODS TO ROOM ACOUSTICS

SUMMARY

In an attempt to produce an improved method of displaying the acoustic behaviour of a room, an investigation has been made into some phase-sensitive and correlation methods. In particular, a phase-coherent modification of the pulsed glide type of display has been developed, in which the microphone output is modulated by the original frequency of excitation before being applied to the cathode-ray oscillograph. Tests made using this new instrument are described, and the results discussed. Correlation methods are also discussed, and the results of some tests involving cross-correlation are given. Finally, modifications of the phase-coherent pulsed glide, making use of cross-correlation and phase-reversal counting are described.

1. Introduction

In the investigation of the acoustics of a studio, it is very desirable to obtain a record of its behaviour which shows clearly the 'singularities' in its response to sounds of different frequencies. These singularities may take the form of long 'rings' at certain frequencies, or of greater or lesser degrees of colouration of the programme, i.e. the undue prominence of certain sharply defined frequencies. Such effects, which are noticed more commonly in small speech studios than in larger ones, often appear to be due to simple isolated natural modes of vibration of the air mass in the studio and hence vary greatly in their audibility with the position of the microphone or hearer. This feature renders quantitative study more difficult and instrumental means of evaluation more attractive.

In order to obtain a permanent record of the transient frequency response, the 'Pulsed Glide' type of display was developed, as previously described in the *BBC Quarterly*.⁽¹⁾ The basic element of this display is a photographically recorded time-graph of the decay of the sound pressure in the studio after the cessation of a tone emitted by a loudspeaker. The time axis is along the length of a 35 mm. film and the pressure axis, normally giving a range of 50 dB, is at right-angles.

The photographic film is moved continuously, and a succession of traces with slowly increasing tone frequency is recorded, giving a composite display such as that shown later in Fig. 3. The example given is unusually simple in form, being the display for a small room at comparatively low frequencies.

In such displays, colourations due to isolated modes are usually shown as a straightening of the individual traces as at (a), owing to the absence of beats with neighbouring modes; the room behaves, in effect, as a simple resonant system with only one mode of vibration. Unfortunately, this feature is not always apparent in the display, particularly when there is no accompanying lengthening of the reverberation time, since it may be obscured by irrelevant detail. Moreover at any particular microphone position, the amplitude of a mode which is subjectively important in the room as a whole may be insufficient to give a recognizable feature of the display. It is true that if the display is obtained from several different points the important modes will be revealed but such repetition is too

lengthy to be practicable in many cases. Because of these difficulties it was decided to investigate a phase-sensitive method of display which would be less dependent upon the respective amplitudes of the modes.

Changes of pitch always occur during the decay of sound of frequencies on either side of a modal frequency, and pitch changes are also associated with structural resonances. These pitch changes may be recognized by the ear as colourations, if sufficiently prominent, and probably constitute an undesirable subjective feature. In the type of display to be described first, the product of the amplitudes of the decaying sound and of the exciting frequency is shown on a logarithmic scale, and this method clearly indicates pitch changes whether these are due to structural resonances or isolated modes.

As with the normal pulsed glide, small studios give more comprehensible patterns than large ones; difficulties arise with large studios mainly because of the extremely rapid variation of response with frequency.

A second possible method of reducing the influence of individual microphone positions and revealing those features which are most generally encountered in the room would be to combine or correlate the outputs of two or more microphones distributed about the room. In Section 4, methods involving cross-correlation are considered and a variation of the phase-coherent display described earlier in the monograph is shown to have some useful features.

2. The Development of the Phase-coherent Pulsed Glide

The principle of the method to be described may be illustrated by considering the simple case of the sound decay taking place at a single frequency close to the original exciting frequency.

Here the sound decay may be represented by

$$Ae^{-at} \cos \{(\omega + \delta)t + \phi\}$$

where A , a , δ , and ϕ are constants, $\omega/2\pi$ is the frequency of the tone, and t is the time. If this is multiplied by the time function of the original tone, $\cos \omega t$, we obtain the expression:

$$\frac{1}{2}Ae^{-at} [\cos \{(2\omega + \delta)t + \phi\} + \cos(\delta t + \phi)]$$

The second term in the above expression may be selected by a low-pass filter arranged to remove frequencies greater than, say, 10 c/s. The output then takes the form of an exponentially decaying sine-wave of a frequency equal to the pitch change in the room. When there is no pitch change a true exponential is obtained, whose magnitude and sign depend on the phase of the voltage produced by the microphone.

A conventional ring modulator has been used to achieve the multiplication, and the instrument accordingly responds to odd harmonics of the original frequency in addition to the desired fundamental. It is not possible to remove harmonics by the use of filters in the microphone circuit because of the phase shifts which would be introduced, but no trouble has been experienced in practice.

It is convenient to convert the decays from a linear to a decibel scale, and this logarithmic conversion may be carried out either before or after the multiplication by the original tone. It is very much simpler from an instrumental point of view to pass the returning sound through a logarithmic amplifier before multiplication, but there are theoretical objections, and it has been found in practice that clearer displays more in accordance with prediction are obtained by reversing the order. Another disadvantage of logarithmic conversion before mixing is that this causes the instrument to respond also to odd subharmonics of the original frequency, if these are present in the returning sound. It will be appreciated that, apart from the above considerations, the instrument is virtually insensitive to noise, having an extremely small effective bandwidth.

2.1 Experimental Chain

A block schematic diagram showing the normal interconnection of apparatus is given in Fig. 1. An audio frequency signal is obtained from an oscillator and fed simultaneously to the coherent detector and to a 'Tone Pulser', the function of which is to convert the signal into

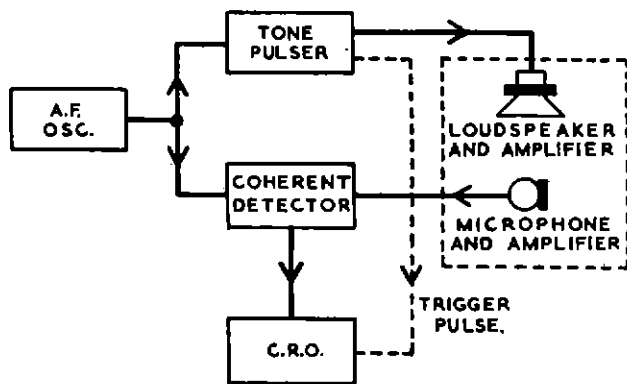

Fig. 1 — Block schematic diagram of coherent detector chain

short bursts which are then applied to a loudspeaker in the room under test. The pulses or bursts of tone are long enough to allow steady-state conditions to be reached. The sound picked up by a microphone is amplified and applied to the coherent detector, the output from which is displayed on a cathode-ray oscillograph. The time-base is triggered at the end of the pulse of tone so that only the decaying sound is shown.

2.2 Description of the Instrument

A simplified circuit diagram of the instrument is given in Fig. 2. It will be seen that two inputs are provided, one for the microphone signal and one for the reference voltage from the oscillator. The reference voltage is limited by the crystal rectifiers X_1 and X_2 and applied to an amplifying stage driving the first ring modulator X_{3-6} .

The microphone output, after amplification by a microphone amplifier (not shown) is applied to the grid of V_2 and thence to the ring modulator X_{3-6} for multiplication by the reference voltage.

The difference frequency is selected from the multiplication products by the low-pass filter L_1, C_1, C_2 and is then superimposed on a 1 kc/s carrier by means of the circuit shown (X_{7-10}) before being applied to a logarithmic amplifying stage V_3 . Anti-phase outputs from a multi-vibrator (not shown) are clipped by the high resistances R_1 and R_2 and the rectifiers X_{7-10} , the resulting square waves being applied to the grid of V_3 through the equal resistances R_3 and R_4 . Under conditions of zero output from the low-pass filter the system is symmetrical and no voltage is applied to V_3 . However, the presence of a signal unbalances the system, producing a 1 kc/s square wave of amplitude proportional to the output from the filter, and of phase determined by its sign. GEX.66 crystal rectifiers are used as logarithmic elements (X_{11} and X_{12}) and these provide a useful range of at least 50 dB. However, the operating range of the complete instrument is limited by various other effects to about 40 dB.

V_4 drives a second ring modulator X_{13-16} , the switching waveform for which is also derived from the multi-vibrator. This ring modulator thus functions as a phase-sensitive detector of the output from the logarithmic amplifier. An output of $\pm 5v$. is obtained.

2.3 Details of the Experimental Method

It was found quite early in the experimental work that it was essential to interchange the X and Y plates in the oscillograph so that the time base sweep was perpendicular to the direction of motion of the film. If this was not done the patterns obtained were virtually unintelligible. Investigations were also made into the possibilities of normal pulsed glides with the oscillograph plates interchanged in this manner, but here the disadvantages appeared to outweigh the advantages and the idea was not pursued further.

It was also found that an optimum gain exists for the microphone amplifier driving the coherent detector. With excessive gain extraneous detail is liable to be recorded, while useful information may be lost if the gain is too low.

In general, it is desirable to include the maximum number of individual decays in the display, as this enables small formations to be identified more easily. A frequency range of 50 c/s to 500 c/s has been used in the investigations, as above 500 c/s the change in frequency of the

oscillator during the period of a decay becomes significant. A glide rate of 8 minutes per octave was found to be suitable for most purposes. Oscillator stability becomes a serious problem for slower glides than this and the time required becomes excessive.

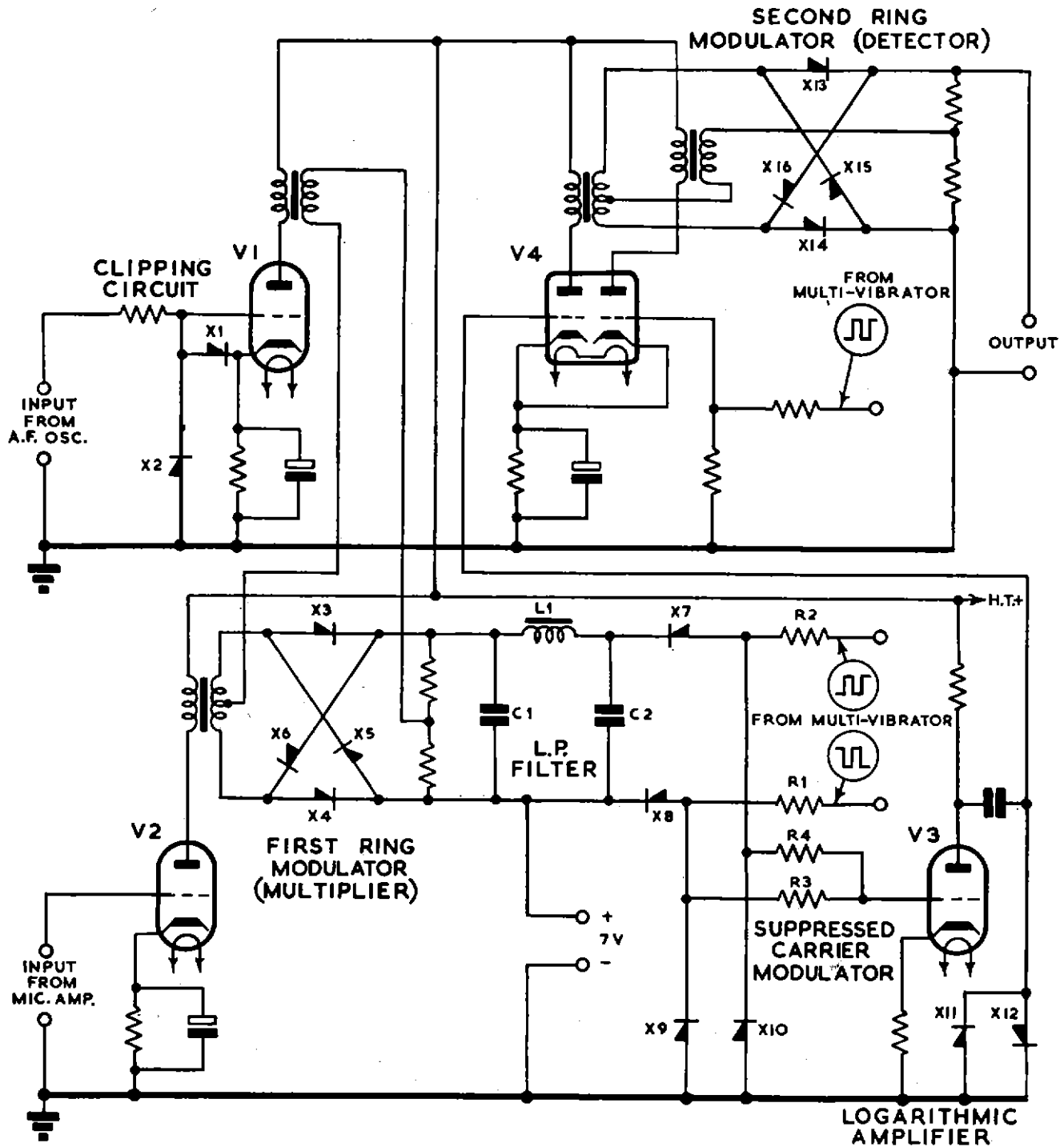

Fig. 2 — Simplified circuit diagram of phase-coherent detector

3. Experimental Work and Results

The experimental work undertaken was divided into three main groups:

- Coherent glides of rooms.
- Coherent glides of electrical networks. This was undertaken to investigate the extent to which room behaviour can be simulated by electrical networks.
- Investigations in rooms using phase-reversal counting.

3.1 Investigations in Rooms

Most of the experimental work was done in a small experimental talks studio in the Research Department. It has dimensions 15 ft 7½ in. × 12 ft 8 in. × 9 ft 6 in. (4.77 × 3.86 × 2.90m) and a volume of 1 880 cu. ft (54m³). Table I gives a list of the frequencies of the axial modes for this studio.

TABLE I

Table of Axial Modes up to 500 c/s for Experimental Talks Studio

c/s	c/s	c/s	c/s
36.2	144.6	267.5	397.7
44.6	178.3	289.2	401.2
59.5	178.3	297.3	416.3
72.2	180.8	312.0	433.9
89.1	216.9	325.3	445.8
108.4	223.0	356.7	470.0
118.9	237.8	356.8	475.9
133.7	253.1	361.6	490.5

A series of tests was undertaken to compare the coherent glide with the normal pulsed glide as a means of indicating the frequencies of the principal subjective colourations. Listening tests with speech showed the latter to lie at 90, 140, 175, and 220 c/s, and it will be seen from the table that these correspond to axial room modes or groups of modes.

Early in the tests it was established that no satisfactory correlation was obtained between pulsed glide displays and colourations unless the loudspeaker used for producing tone for the displays was comparable in size with the source used for the subjective tests, i.e. the human head. An '8-inch' loudspeaker unit was therefore used in a cabinet of only 25 cm. square frontal area. Six coherent displays, from different microphone positions, and five

normal pulsed glide displays were examined by three observers and the frequencies of indicated singularities were listed. Corresponding formations of the types associated with strong isolated modes are visible in Figs. 3 and 4. The straight line formation of the normal pulsed glide appears at (a) in Fig. 3, while at (b) in Fig. 4 is the corresponding pattern obtained by the coherent detection method. The general slope of the decays in the latter is the cause of the noticeable asymmetry of the pattern, and this would be reversed if the microphone leads were interchanged.

The results of these tests may be summarized as follows:

(i) Normal Pulsed Glide

This showed severe colourations at 137, 160, and 225 c/s with a minor group at 150 c/s.

(ii) Coherent Display

The most severe formations shown were in the range 215–225 c/s, other sharply localized groups being at 88–98 c/s, 140–150 c/s and 320 c/s. There was also a diffuse group ranging from 180 c/s to 200 c/s.

Thus the normal display showed two of the subjectively important colourations and two spurious frequencies; the coherent display showed three of the known colourations with two spurious groups. It may be remarked that the coherent display showed the very important colourations at nearly all microphone positions, whereas the conventional display was less uniform in this respect.

The coherent display, therefore, appears to be slightly better as a means of diagnosis, although it shares the disadvantages that several microphone positions are necessary and that spurious indications are normally present as well as correct ones.

An examination of a typical coherent glide shows that simple, clear patterns are only rarely obtained. Most of the formations present are of a random nature, probably due to reflections taking place before standing wave systems can be built up. These effects tend to obscure any regular patterns in the display.

It will be noticed from Fig. 4 that compression or bunching of the commencement of the traces, i.e. at the bottom, occurs at intervals along the display. This is due to the progressive phase advancement with frequency which takes place with a fixed microphone and loudspeaker spacing. (See Section 3.3 below.) Patterns char-

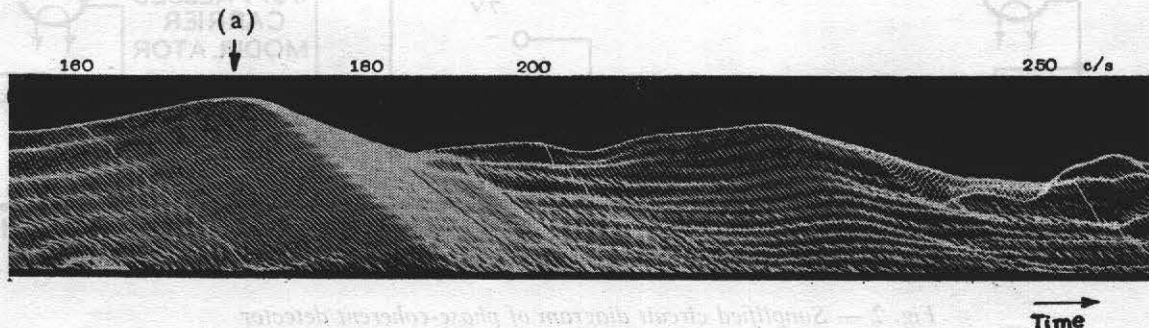

Fig. 3—Part of a normal pulsed glide of a small room

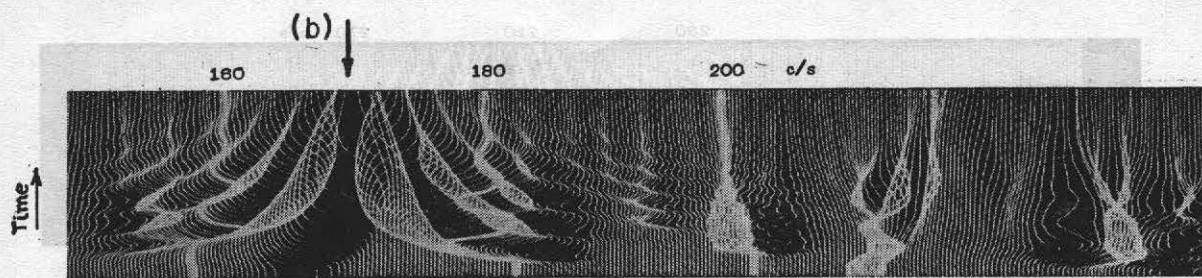

Fig. 4 — Part of the phase-coherent pulsed glide corresponding to Fig. 3

acterized by a beat frequency which is constant and independent of the oscillator frequency over a region of several cycles may also be observed occasionally in the display. These beats probably take place in the room itself between adjacent modes, and are not a result of the modulation process in the coherent detector.

Fig. 5 is part of a coherent glide taken in a large orchestral studio (Maida Vale Studio No. 1). It will be seen that successive decays differ too much for any patterns to be visible. This is because the response of the studio changes very rapidly with frequency. In addition the longer reverberation time of the studio makes it necessary to allow a greater interval between successive pulses and therefore for a given rate of frequency glide differences between the frequencies of consecutive pulses are greater than for small studios. To avoid this effect, an impracticably slow rate of frequency glide would be necessary.

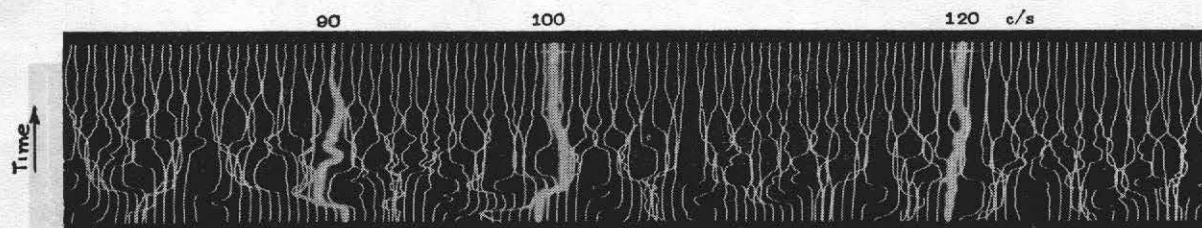

Fig. 5 — Part of a phase-coherent pulsed glide taken in a large studio (Maida Vale 1)

3.2 Some Theoretical Considerations in Connection with Small Rooms

Compared with the conventional pulsed glide, the coherent type of display possesses a slightly superior resolving power. This is illustrated by one particular case in which a region only a few cycles wide was shown by the coherent display to contain two very closely spaced modes. The region appeared on a conventional pulsed glide simply as a series of smoothly rounded decays.

The improved resolution is largely due to the fact that there is a visible change of phase as a room mode is passed through. If we consider two modes 2 c/s apart in frequency, it will be appreciated that they will not come into anti-phase until 0.25 second has elapsed. Therefore in a display sensitive only to amplitude there will be no clear indication of beats unless the time of sweep across the oscillograph exceeds this time, that is unless the reverberation time of the room exceeds 0.30 second. Even when

this condition is satisfied, it is necessary to ensure that the frequency change between pulses is not greater than 1 c/s if it is desired to preserve this detailed information. This remark applies, of course, equally to both types of display. It should be noted that since data concerning normal modes are, in general, most useful in connection with colourations in small talks studios, and as these rarely have reverberation times in excess of 0.4 second, the coherent type of display possesses an intrinsic advantage in this application.

3.3 Coherent Glides of Electrical Networks

In order to obtain a better understanding of coherent glide displays, from rooms, it was decided to investigate the displays obtained from certain simple networks, such as tuned circuits. The essentially resonant nature of room modes suggested that patterns similar to those obtained

from strong isolated modes might be obtained from tuned circuits. This was in fact shown to be the case.

Coherent pulsed glides were taken of the following networks:

- (a) Single tuned circuit. $Q=50$, $f_r=250$ c/s approx.
- (b) Two tuned circuits, uncoupled and with various spacings between their frequencies of resonance. $Q=50$, $f_r=250$ c/s approx.
- (c) All-pass network.

The response of the coherent detector to a single tuned circuit was also calculated and the results compared with those obtained in practice. To facilitate the comparison of individual decays, the spacing between the decays was increased in two of the glides. The glides of the single tuned circuit are shown in Figs. 6, 7, and 8, and some of the computed curves are given in Fig. 9.

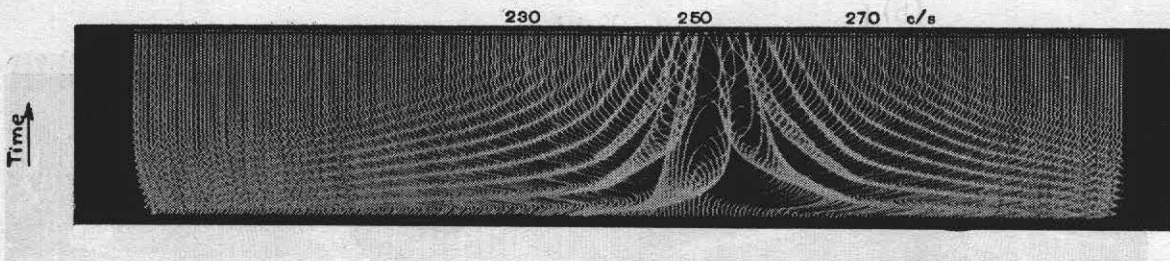

Fig. 6 — The pattern produced by a phase-coherent pulsed glide of a tuned circuit

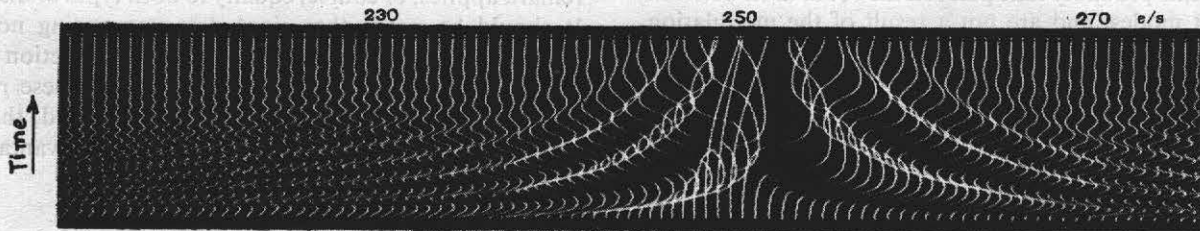

Fig. 7 — The pattern produced by the tuned circuit of Fig. 6, with the frequency scale expanded

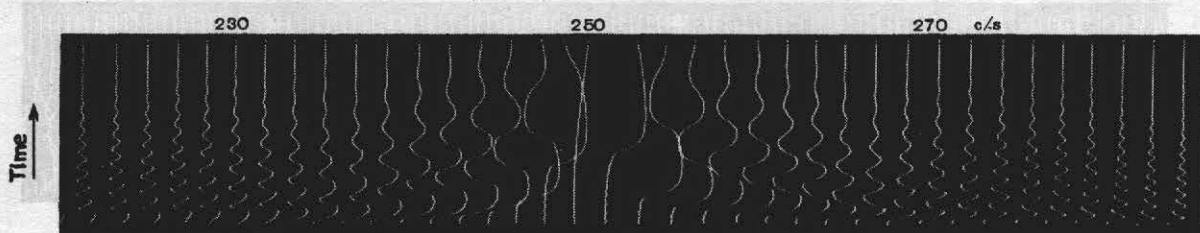

Fig. 8 — As Fig. 7, but with the pulsing rate reduced to enable individual traces to be seen

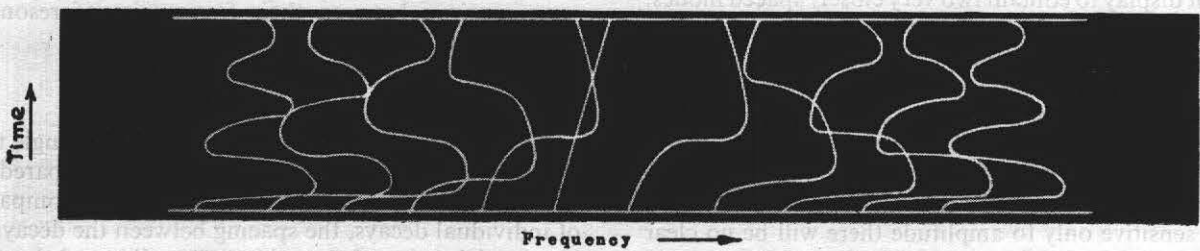

Fig. 9 — Computed curves for the single tuned circuit, for comparison with Fig. 8

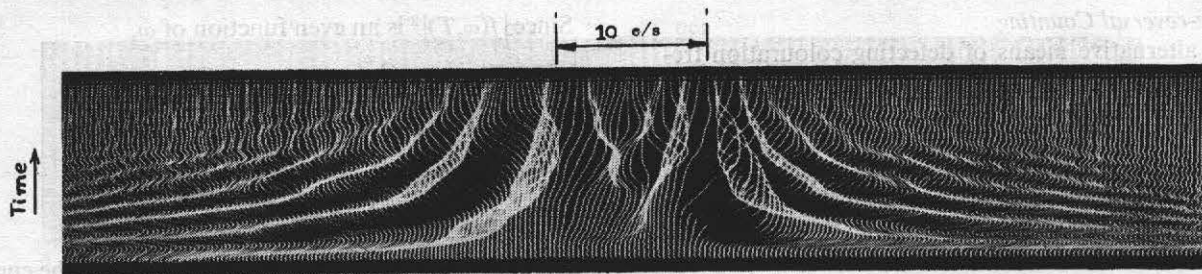

Fig. 10 — Part of a phase-coherent pulsed glide of two tuned circuits, uncoupled, and with a resonance frequency separation of 10 c/s

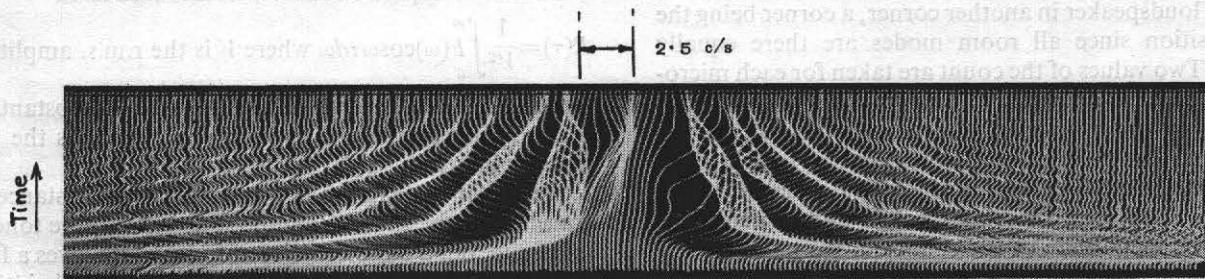

Fig. 11 — Part of a phase-coherent pulsed glide of two tuned circuits, uncoupled, and with a resonance frequency separation of 2.5 c/s

Figs. 10 and 11 show the response of the coherent detector to the two tuned circuits (see (b) above), with resonance separations of 10 c/s and 2.5 c/s. The glide rate of the oscillator was specially reduced in this case, to lessen the complexity of the patterns produced. It will be seen by comparison with Fig. 6 that resonance separations of 2-3 c/s are resolvable.

Part of a 'glide' of the all-pass network shown in Fig. 12 is given in Fig. 13. It illustrates the bunching and expansion of the decays which result from a phase characteristic $\phi(\omega)$ of the form

$$\phi(\omega) = 2N \tan^{-1} k \frac{\omega}{\omega_r} \left(1 - \frac{\omega^2}{\omega_r^2} \right)^{-1}$$

where N is the number of sections of the network

k is a circuit parameter

ω_r is the frequency at which $\phi = N\pi$

A similar effect of dispersion is observable in all coherent glides of rooms; it appears as a background to the more striking patterns due to eigentones and strong early reflections.

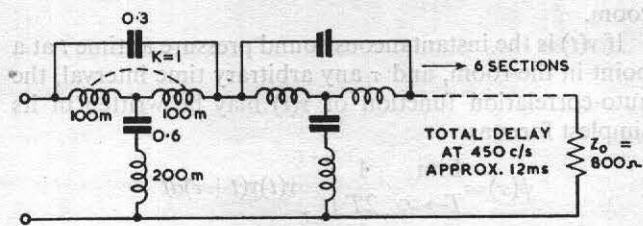

Fig. 12 — Circuit diagram of all-pass network

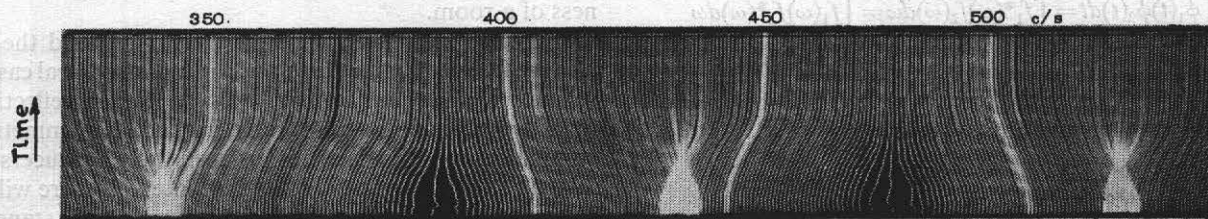

Fig. 13 — Part of the phase-coherent display of the network illustrated in Fig. 12, showing effects of periodic phase reversal

3.4 Phase-reversal Counting

As an alternative means of detecting colouration frequencies, slight modifications have been made to the output stage of the coherent detector so that it can be used to operate a counter which indicates the number of phase reversals during the decay of the sound.

When the frequency of the exciting tone is equal to the frequency of a normal mode of the room, there is no pitch change and no count is obtained. As the frequency of the exciting tone is moved away from that of the normal mode, the count for each pulse gradually increases until the normal mode is no longer excited and the count suddenly ceases.

The microphone is placed in one corner of the room, with the loudspeaker in another corner, a corner being the best position since all room modes are there equally excited. Two values of the count are taken for each microphone position, one with the microphone connections reversed in order to eliminate any asymmetry in the apparatus. The colouration frequencies, as indicated by the counter, were found to be almost independent of the corners chosen for the loudspeaker and microphone though the magnitude of the count did vary.

4. Methods Involving Auto- and Cross-correlation

A study of methods involving correlation was made in an attempt to measure properties that are characteristic of the studio as a whole, rather than of particular microphone positions. As mentioned in the previous section, this is one of the fundamental difficulties in acoustical measurement, and correlation methods would appear to be very advantageous in this respect.

Gershman⁽²⁾ has used correlation methods in an attempt to measure a quantity corresponding to the liveness of a room.

If $v(t)$ is the instantaneous sound pressure at time t at a point in the room, and τ any arbitrary time interval, the auto-correlation function of $v(t)$ may be written in its simplest form as

$$\psi(\tau) = \lim_{T \rightarrow \infty} \frac{1}{2T} \int_{-T}^{+T} v(t)v(t+\tau)dt$$

Parseval's theorem⁽³⁾ states that if $f_1(\omega)$, $f_2(\omega)$ are the Fourier transforms of $\phi_1(t)$, $\phi_2(t)$, and if * indicates the conjugate of a function of a complex variable,

$$\frac{1}{2\pi} \int_{-\infty}^{+\infty} \phi_1(t)\phi_2^*(t)dt = \int_{-\infty}^{+\infty} f_1^*(\omega)f_2(\omega)d\omega = \int_{-\infty}^{+\infty} f_1(\omega)f_2^*(\omega)d\omega$$

Writing $f(\omega, t)$ as the Fourier transform of $v(t)$ we see that $f(\omega, t)e^{i\omega\tau}$ is the transform of $v(t+\tau)$ and hence the auto-correlation function may be written

$$\int_{-\infty}^{+\infty} \lim_{T \rightarrow \infty} \frac{\pi}{2T} |f(\omega, T)|^2 e^{i\omega\tau} d\omega,$$

since the function $f(\omega, T)$ is real and equal therefore to its conjugate.

Since $|f(\omega, T)|^2$ is an even function of ω ,

$$\psi(\tau) = \int_0^{\infty} \lim_{T \rightarrow \infty} \frac{2\pi}{T} |f(\omega, T)|^2 \cos\omega\tau d\omega$$

We may write

$$F(\omega) = \lim_{T \rightarrow \infty} \frac{2\pi}{T} |f(\omega, T)|^2$$

where $F(\omega)$ is the spectrum power function, i.e. the energy density at frequency $\omega/2\pi$ and hence $\psi(\tau)$ is given by

$$\int_0^{\infty} F(\omega) \cos\omega\tau d\omega$$

Gershman expresses this in a normalized form

$$R(\tau) = \frac{1}{V^2} \int_0^{\infty} F(\omega) \cos\omega\tau d\omega$$
 where V is the r.m.s. amplitude,

and shows that in general, the function falls substantially to zero after an interval τ_0 which he defines as the 'Coherence interval'.

He prefers to express this interval as the distance $c\tau_0$ travelled by the sound from the source. For pure tone $c\tau_0$ is infinite, but a band of noise of finite width gives a finite correlation interval which decreases as the bandwidth increases. Thus, an octave band of noise from 800 c/s to 1 600 c/s has a coherence interval of about 70 cm, and the band from 3 200 c/s to 5 400 c/s only about 18 cm. Outside these distances any observed correlation between the signal from a microphone and the exciting signal from the loudspeaker must be due to standing wave effects, and any cross-correlation observed between two microphones at a similar distance apart must be due to standing wave effects or symmetry with respect to the source.

If $v(t)$, $u(t)$ are the two microphone signals in the latter case, the cross-correlation between them may be expressed most generally as

$$\lim_{T \rightarrow \infty} \frac{1}{2T} \int_{-T}^{+T} v(t)u(t+\tau)dt$$

The effect of varying τ is not significant for the present purpose and therefore Gershman makes $\tau=0$, giving

$$\lim_{T \rightarrow \infty} \frac{1}{2T} \int_{-T}^{+T} v(t)u(t)dt$$

which is simply the time-averaged product of the two instantaneous signals. He shows that in the case of two microphones placed symmetrically about the axis of a loudspeaker, this function is a useful measure of the liveness of a room.

It will be seen from this that Gershman used the departure from complete correlation in a symmetrical case to indicate a phenomenon, viz. liveness, due to reflections from the walls of the enclosure. If, instead, the symmetry is eliminated and the distances between the transducers are all made greater than the coherence interval, there will be zero correlation unless there are appreciable standing wave effects at both positions, since standing wave systems have only two (opposite) values of phase throughout the room.

4.1 Cross-correlation Methods

This approach has been followed in some investigations in two experimental talks studios. The circuit used for performing the cross-correlation consisted of a ring modulator fed with the two microphone signals, each of which was adjusted independently to a known fixed value. This adjustment having been made, the output from the modulator gave the correlation coefficient. A diagram of the circuit is given in Fig. 14. Uncorrelated inputs from two noise generators give a coefficient of less than 0.1 by this method, and this figure was taken as the threshold of accuracy of the method. Microphones were placed at two

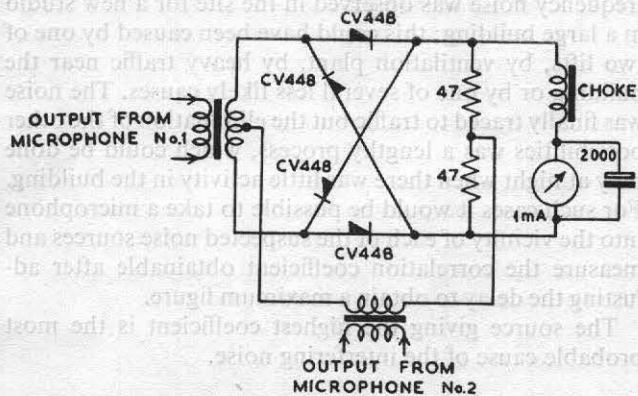

Fig. 14 — Circuit diagram of arrangement for cross-correlation experiment

points in the room, and a loudspeaker was fed with a band of noise wide enough to put both microphones outside the coherence interval with respect to each other and the loudspeaker. A difficulty arises here, however, since the coherence interval for a talks studio of normal size may be greater than the room dimensions except for bands of noise wide enough to excite many modes. Each standing wave system will give either +1 or -1 correlation between two microphones, and hence the coefficient for the band may have any value between -1 and +1, depending upon the number and sense of the separate correlations within the band. In the actual experiments two pressure microphones were placed in each of the twelve pairs of corners having diagonal relationships to each other (i.e. two or three co-ordinates different), the loudspeaker being

in another corner. For each pair the correlation coefficients were read for octave bands of noise with central frequencies ranging from 120 c/s to 1 700 c/s. The mean of the moduli of the twelve figures for each band would be a measure of the importance of the standing wave effects in the band.

The results were as follows:

TABLE II

Mean Cross-correlation Coefficients between Pairs of Microphones in a Studio

Mid-frequency	120	240	480	950	1700 c/s
Studio No. 1	0.26	0.21	0.12	0.11	0.05
Studio No. 2	0.27	0.25	0.10	0.10	0.08

The differences between the two studios are thus quite insignificant, and it is concluded that the figures obtained are a function more of the method than of the studio. No useful information as to the characteristics of the studio could therefore be obtained in this way.

4.2 Coherent Glide between two Points in a Studio

Another possible method of obtaining a synthesis of two microphone positions is to use a modified form of the coherent detection display described in Section 2. The normal coherent detection equipment is used but the tone input to the modulator is replaced by a signal from a second microphone, the output of which has been amplified and limited. This method gives a simpler display than the single-microphone method previously described, because the beats of continuously varying frequency, which form a prominent feature of the latter, are absent.

Fig. 15 shows part of one such display, using microphones in two corners of a small room. It will be seen that the display consists mainly of comparatively unmodulated decays interspersed with regions where the decays show beats of constant frequency over an appreciable range of exciting frequency. Each of the two microphones, being in a corner of the room, will be excited at all modal frequencies, and at any particular exciting frequency the modes most strongly excited will be those adjacent in frequency above and below. Hence the display will tend to consist of straight lines at or around the modal frequencies,

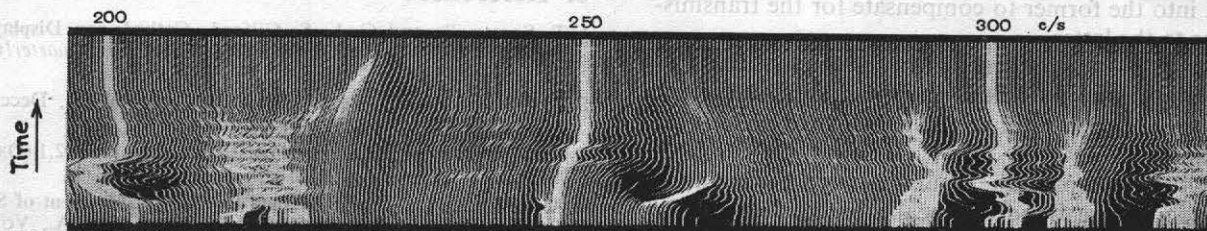

Fig. 15 — Part of a cross-correlated coherent pulsed glide taken in a small room

while at frequencies approximately midway between them, there will be strong beats. The substitution of a signal from the room for the tone used in the ordinary coherent display causes the disappearance of the beats of continuously varying frequency which are a feature of the frequency region surrounding isolated eigentones in the ordinary display. This method therefore has possibilities as a means of exploring the distribution of particular room modes but the possibilities have not yet been exploited.

4.3 Cross-correlation Methods in the Measurement of Sound Insulation

Two further applications of auto-correlation and cross-correlation may be of interest here, although they are not directly related to the work described above.

It is often desirable to estimate the sound insulation between two adjacent rooms of a building which is in course of construction or alteration. It often occurs in these cases that owing to the incomplete state of the building, there are indirect paths by which sound can be transmitted between the two rooms without traversing the partition wall which in the final state will be the easiest path. Similar problems occur also in finished buildings. The usual method of sound transmission measurement is to place in one room a loudspeaker radiating a suitable test sound and to measure the intensities in the two rooms in turn. The transmission loss figure thus obtained represents the total effect of all possible paths.

The contributions of individual paths may be measured if their times of transmission can be taken into account. Raes⁽⁴⁾ has proposed the use of short pulses of tone as the test sound, the transmitted signal being displayed on a cathode-ray oscilloscope with a rapidly moving time-base. The sound transmitted by the several paths will then be indicated by a series of deflections, the amplitudes of which represent the relative contributions.

This method is rather better suited to high frequencies than low since the minimum length of pulse of which the frequency can be accurately enough determined is about 3 cycles, and at, say, 100 c/s the corresponding time discrimination would therefore be limited to about 30 milliseconds, i.e. 33 ft of path. In broadcasting studios, the frequency range in which adequate sound insulation is difficult to obtain is mainly below 100 c/s.

A method described by Goff⁽⁵⁾ has therefore been put into use, in which the cross-correlation coefficient is derived between a microphone in the loudspeaker room and one in the receiving room, an adjustable delay being inserted into the former to compensate for the transmission time to the latter.

The cross-correlation coefficient is calculated automatically by electronic multiplying circuits and its current average value over a short period is indicated on a direct reading meter.

If we thus compare the sound at two microphone positions, one close to the loudspeaker and the other a few feet away, the instrument will show a very high cross-correlation coefficient, provided that a delay equivalent to the path difference between them is introduced into the

signal from the nearer microphone. If the two microphones are on opposite sides of a wall, the correlation coefficient is again high, though the signal from the remote microphone is greatly reduced. The increase of amplifier gain in this chain required to restore the product of the two signals to the 'no-wall' value is a fairly accurate indication of the attenuation of the sound along the direct path through the wall. If there is an alternative path, the delay may be increased to correspond to this transit time, and the attenuation again measured.

Another application suggested by the same author is to the identification of a source of disturbing noise from a number of possibilities. For instance, intermittent low-frequency noise was observed in the site for a new studio in a large building; this could have been caused by one of two lifts, by ventilation plant, by heavy traffic near the building or by one of several less likely causes. The noise was finally traced to traffic but the elimination of the other possibilities was a lengthy process, which could be done only at night when there was little activity in the building. For such cases it would be possible to take a microphone into the vicinity of each of the suspected noise sources and measure the correlation coefficient obtainable after adjusting the delay to obtain a maximum figure.

The source giving the highest coefficient is the most probable cause of the interfering noise.

5. Conclusions

The work which is described in the first part of this monograph is an attempt to improve upon the Pulsed Glide display as a method of diagnosis of colourations in small studios. It has been shown that the addition of information about the relative phases of the input and reverberant sounds enables the important room modes to be identified with greater certainty, and the addition of a phase-reversal counter has increased the effectiveness of the method. A further advantage of the introduction of phase information is that it is possible to resolve modes separated by smaller frequency intervals than hitherto.

Auto- and cross-correlation methods of diagnosis have also been examined, but show less promise. Applications to sound insulation measurement are, however, being tested with some success.

6. References

1. T. Somerville and C. L. S. Gilford. *Cathode-ray Displays of Acoustic Phenomena and their Interpretation*, *BBC Quarterly*, VII (Spring 1952), pp. 1-13.
2. S. G. Gershman. *J. Tech. Phys. U.S.S.R.*, Vol. 21, December 1951, pp. 1492-6.
3. E. C. Titchmarsh. *Theory of Fourier Integrals*, Para. 2.1 (Oxford, 1937).
4. A. C. Raes. *A Tentative Method for the Measurement of Sound Transmission Losses in Unfinished Buildings*, *J.A.S.A.*, Vol. 27, No. 1, pp. 98-102, January 1955.
5. K. W. Goff. *An Analog Electronic Correlator for Acoustic Measurements*, *J.A.S.A.*, Vol. 27, March 1955, p. 223.

*Published by the British Broadcasting Corporation, 35 Marylebone High Street, London, W.1.
Printed on Basingwerk Parchment in Times New Roman by The Broadwater Press Ltd, Welwyn
Garden City, Herts.*

No. 3540