

BBC ENGINEERING

D.B. PHILLIPS

~~JCE~~
at

BSS

~~RSC~~
Phil

GJP

Number 111

December 1978



BBC Engineering

including Engineering Division Monographs

A record of BBC technical experience and developments
in radio and television broadcasting

Published approximately four times per year by
BBC Publications,
35 Marylebone High Street,
London W1M 4AA.
ISSN 0308-2369
ISBN 0 563 17721 7

Edited by
BBC Engineering Information Department,
Broadcasting House,
London W1A 1AA.

Printed by
The Yale Press Ltd,
London SE25 5LY.

Price
80p or \$2.00 per issue post free.
Annual Subscription
£3.00 or \$8.00 for 4 issues post free.

Articles are copyright © 1978 by the
British Broadcasting Corporation
and may not be reproduced in whole
or part without written permission.

Contents

Retirement of James Redmond	2
Engineering Directorate changes	3
Notebook	4
Principal articles	
CEEFAX Progress J. Redmond	7
Perceptible Levels of Audio-frequency Tones in the Presence of Programme D. J. Whythe	13
BBC Radio Facilities in the United States of America S. Christie	18
A UHF Talkback System for Television Studios A. H. B. Bower T. J. Wade	25
Contributors to this issue	30

In the cover picture a floor manager on the set
of "A Horseman Riding By" is using the UHF
talkback system described in the article
beginning on page 25.

Retirement of James Redmond



James Redmond, F.Eng, F.IEE, the BBC's Director of Engineering for the past ten years, retired on 6 November. His first job, after education at Graeme High School, Falkirk and the Caledonian Wireless College at Edinburgh, was as a Marine Radio Officer. He joined the BBC in 1937 and after a short time as a sound engineer in Edinburgh he joined the Television Service in London in 1938.

During the war James Redmond served again in the Merchant Navy and he returned to the BBC in 1945, to work for some years as a Planning and Installation engineer. Since 1954 he occupied a number of senior posts in television until his appointment as Assistant Director of Engineering in 1967 and Director in 1968.

The BBC's Director-General, Ian Trethowan, writes:

"When Jim Redmond joined the BBC in 1937, the Corporation was only eleven years old, it had only one domestic radio network, and television was still an experimental infant. When he retired in November, after exactly forty-one years of service, he left behind a Corporation now over fifty, with four domestic radio networks, two television networks, a multiplicity of regional and local broadcasting activities and the most admired external service in the world. His own very distinguished career has thus spanned, and increasingly contributed to, the most important period of expansion in broadcasting in this country.

His own career began in his native Scotland, when he joined the BBC in Edinburgh as a junior maintenance

engineer. A year later, when he was just twenty, he joined the original London television station. After War Service in the Merchant Navy, he went back to television and moved steadily up the ladder of television engineering to become the Senior Superintendent Engineer in 1963. He was deeply involved in the early technical developments at Alexandra Palace, the move to Wood Lane, and the switch into colour. In 1967 Jim moved to Henry Wood House as Assistant Director of Engineering, and then succeeded Francis McLean as Director a year later. During his years as Director, he had to contend with the financial difficulties forced on the Corporation by the wider problems facing the country as a whole. This caused particular difficulty in the area of capital projects, where the BBC was first forced to make substantial cuts for financial reasons, and then latterly, due to the Government's pay policy, found itself short of skilled staff. Another problem he faced has been the reorganisation of the radio frequencies. But alongside the problems were the achievements of BBC engineering bringing two Queen's Awards in his time — and I suspect nothing has given him greater pleasure than to see his infant CEEFAX grow to the maturity of a permanent service.

During his years in television, Jim Redmond acquired an enviable respect among both professional engineering colleagues and production staff. He was recognised as a man of high standards, and of invention, but also a man who understood the practical needs of programme-making. My own knowledge of him comes largely from our nine years as colleagues on the Board of Management. As Director of Engineering he has in the past nine years seen his role as that of upholding the BBC's traditionally high technical standards, but of working within an increasingly stringent financial climate to sustain the BBC's programme output. One of the most difficult responsibilities he carried was that of advising the BBC on its capital priorities at a time of shortage. He was always particularly insistent that we must never be tempted by the lure of new developments into allowing too little for the refurbishment of our existing plant.

I am sure that all Jim's fellow Directors would agree that we could not have asked for a more agreeable engineering colleague. Where he felt strongly on an issue, he fought his corner tenaciously, and this would not only be on technical questions. He has always taken a sharp interest in BBC policy as a whole and has been particularly concerned about problems for staff. More widely, we have come to value his shrewd judgement on some of the problems we have faced in our relations with Government and other institutions outside. Not least, he has been to all of us not only an important colleague, but a very good friend."

The Queen's Awards to Industry mentioned by Ian Trethowan were received by the BBC's Engineering

Research and Designs Departments in 1969, for the Advanced Field-store Television Standards Converter and in 1974, for the Sound-in-Sync system. It is gratifying that CEEFAX, also mentioned by Ian Trethowan, is the subject of an article by James Redmond in this issue of *BBC Engineering* — see page 7.

Shortly before his retirement from the BBC James Redmond took office for 1978-79 as President of the Institution of Electrical Engineers, of which he has been a Fellow for many years and was Vice-President from 1973 to 1976. He was elected to the Fellowship of Engineering earlier this year and is also a Fellow of the Institution of Electrical and Electronic Technician Engineers, a Fellow and Past President of the Society of Electronic and Radio Technicians and a Fellow of the British Institute of Management.

BBC Engineering wishes James Redmond a long and happy retirement.



Despite having spent the war years in the Merchant Navy, James Redmond was, it seems always happy to get back on the water. The photograph shows him (arrowed) when he was on duty as an outside broadcasts engineer at the 1950 Oxford and Cambridge Boat Race.

Engineering Directorate Changes



T. Bryce McCrerrick



Peter Rainger



George Cook

T. Bryce McCrerrick, FIEE, has succeeded James Redmond as Director of Engineering.

Bryce McCrerrick joined the BBC in 1943, following education at Galashiels Academy and Heriot Watt College, Edinburgh, and soon afterwards moved to London. After National Service in the Royal Air Force he returned to the BBC in 1949. He joined the Television Service and began a progression to senior posts becoming, in turn, a Technical Operations Manager, Engineer-in-Charge Television Studios and Head of Engineering, Television Recording. He left the Television Service in 1969 to become Head of Studio Capital Projects Department. A year later he was appointed Chief Engineer Radio Broadcasting and soon afterwards became Assistant Director of Engineering. He became Deputy Director in May 1976.

Bryce McCrerrick is a Fellow of the Institution of Electrical Engineers and a Fellow of the Institution of Electronic and Radio Engineers.

Peter Rainger, CBE, B.Sc (Eng), FIEE succeeds Bryce McCrerrick as Deputy Director of Engineering. After graduating at London University, Peter Rainger joined the Designs Department of the BBC in 1951 and there he became a specialist in signal processing. He was appointed Head of

the Department in 1969, Head of Research Department in 1971 and Assistant Director of Engineering in 1976.

Peter Rainger has been the author of a number of papers presented to the Institution of Electrical Engineers and was awarded the Franklin Premium in 1966. He has also been very active in professional and international committees of the Institution and the European Broad Broadcasting Union. In 1964 he received the Royal Television Society's Geoffrey Parr Award for work on television standards conversion and in 1973 he was made a Fellow of the Royal Television Society. In 1967 the Society of Motion Picture and Television Engineers presented him with an Emmy Award and in 1972 he was awarded the David Sarnoff Gold Medal. His CBE was awarded in the 1978 New Year Honours.

The new Assistant Director of Engineering is George Cook, FIEE. Since 1974 George Cook has been Chief Engineer Transmitters and for seven years before that he was Assistant Chief Engineer, Television Operations. He joined the BBC in 1947 and for several years was concerned with transmitter installation. In 1955 he became Assistant Superintendent Engineer (Regions and Outside Broadcasts) and he also held the posts of Engineer-in-Charge (Television) at Manchester and Head of Engineering (Wales).

Notebook

CCD field store in television noise reducer

A CCD digital television field store on a board 250 mm by 152 mm has been designed and built at BBC Research Department. The 2-Mbit store takes 8-bit words at 13.3 Mwords/sec (3 times PAL subcarrier frequency). The accompanying photograph shows a complete field store, with 32 CCD stores and associated driving circuitry. Two such stores constitute a full television picture store which may be used for any application where a digital television picture delay is required.

The store was designed for immediate application in the television noise-reduction system developed by BBC Research Department (*BBC Engineering* 107 August 1977 page 34). It is used as the delay element in a recursive filter to integrate successive pictures in parts of the scene in which there is no movement. In this way, the equipment reduces noise in stationary areas, where it is most visible, without movement blur. The reliable detection of movement in the presence of noise was one of the many problems which had to be overcome in the course of development.

The noise reducer adjusts itself automatically to cope with both varying noise level and the various noise characteristics

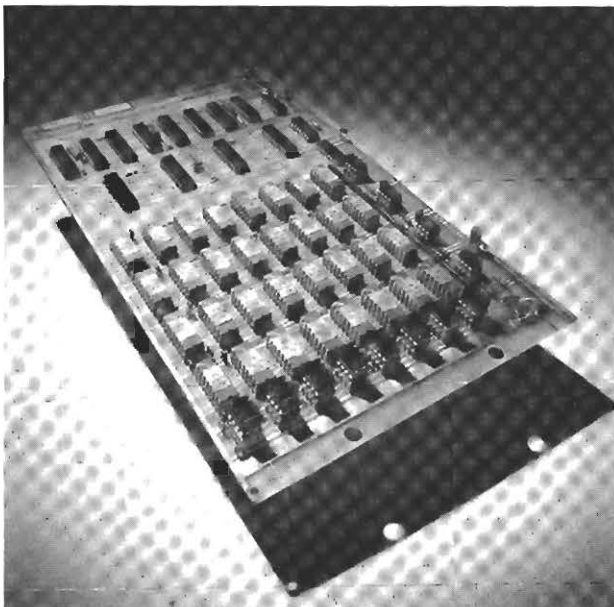

of different picture sources — cameras, telecine and videotape. Thus it causes no degradation to good pictures and may be connected permanently on a broadcasting network output. The equipment can operate on 625-line PAL and 525-line NTSC signals.

The BBC has licensed Pye TVT Limited to manufacture the noise reducer for commercial sale.

IBC 78



The seventh International Broadcasting Convention was held at the Wembley Conference Centre, London from 25 to 29 September. The numbers of delegates, papers and exhibitors all broke records. Of the 82 papers presented in the 14 technical sessions, 12 were by BBC authors and the chairmen of two of the sessions were Peter Rainger (Assistant Director of Engineering) and Darrell Maurice (retired Chief Assistant to Director of Engineering).

The BBC stand in the IBC exhibition attracted great interest throughout the Convention. The major exhibits were a working video noise reducer (see previous item) and a demonstration of CARFAX, the BBC's proposal for an improved service of road traffic information broadcasting. Also featured were a few of the many items of BBC-designed equipment which are the subject of commercial manufacturing licences or are available for licensing.

The BBC also co-operated in a comprehensive display of working teletext receivers throughout the Convention areas, including two sets which displayed teletext pages in the English, French, German, Swedish, Finnish and Greek alphabets.

Television Centre Development

The BBC Board of Governors have approved in principle the plans for further development of BBC Television Centre in West London. This, the fifth stage of development, opens an exciting prospect for the architects and engineers to research and plan a building in keeping with the latest technical advances. It is intended that the new building will provide improved facilities for existing operations and also enable some staff in peripheral premises to be moved to Television Centre.

A major part of the new complex will be a Videotape Area with accommodation for about 100 broadcast-quality machines, production facilities and all the related ancillary functions.

The plans include an additional production studio, to facilitate the transfer of current affairs programmes from Lime Grove, and the possible re-commissioning of the existing Studio 2. This is the only one of the existing eight main production studios at Television Centre not to have been converted for colour. It has not been used for programme service for some years and is at present used as a store. Also included in the plans is a new studio for light entertainment production. It has been acknowledged for some time that the limited facilities at the Television Theatre have restricted the scope of production and it is planned to replace the Theatre by a new studio which would also have general purpose uses. The studio would have an area of 743 m² and would have a theatre-type foyer of about 280 m² with seating for 400 to 500, an orchestral enclosure and all the necessary store-rooms, make-up and wardrobe areas, etc. It is also suggested that there should be a small recording studio for backing groups in addition to a band room for 30 to 40 players.

Associated with the new development is a new multi-storey car park on an adjoining site.

Research Department Reports

BBC Research Department has recently published the following reports.

- 1978/17 Digital video: bit-rate reduction by removal of the line-blanking portion of the waveform
- 1978/18 CEEFAX: microprocessor-based clock
- 1978/19 A digital television error-protection scheme based on waveform estimates
- 1978/20 Narrow-band f.m. system for television links: a feasibility study
- 1978/21 Narrow-band f.m. system for television links: interference between f.m. and a.m. television signals
- 1978/22 Narrow-band f.m. system for television links: tests for performance under conditions of multipath propagation
- 1978/23 The zone plate as a television test pattern
- 1978/24 Television re-broadcast links: alleviation of off-set co-channel interference by means of simple video notch filters

1978/25 Probability levels of sound interference between programme areas

A subscription to BBC Research Department Reports, of which about 35 are published each year, costs £25.00. Further information and subscription forms are available from: *Research Executive, BBC Research Department, Kingswood Warren, Tadworth, Surrey, England.*

CEEFAX hard-copy printer

The positive value of CEEFAX is well established, making available a continuous display of frequently updated news and information on some 100 different pages on each BBC television network. The value will be further enhanced by a device recently developed by BBC Designs Department to provide a hard-copy printout. The device provides a method of permanently recording CEEFAX information using a special decoder and printing machine to provide a facsimile of any CEEFAX page selected by the user.

The combination of standard-format characters and contiguous graphics, used in teletext and viewdata, makes it extremely difficult to print an accurate facsimile using standard dot-matrix printers. The guard spaces provided between characters and rows break up large graphic areas and result in a print which is not easy to interpret.

The new printer overcomes this deficiency entirely. The monochrome video output from the decoder is used directly as the data source to produce the print. The basic principle of operation is as follows.

The first block of seven data-bits from each line during a field are stored in a read/write memory. At the end of the field the memory contains the 240 x 7 bit bytes which form the left-hand column of the data page. The contents of the memory are then sequentially read into a 40-column 7-dot matrix printer which prints the page rotated through 90° from the conventional display. These data thus occupy the top row of print. The next seven data-bits which form the column to the immediate right of the previously scanned column are copied in a similar fashion and printed directly under the previous row without spacing (i.e. the top dot of the second row links with the bottom dot of the previous row to form a continuous vertical dot pattern). This process continues until the complete data page has been printed.

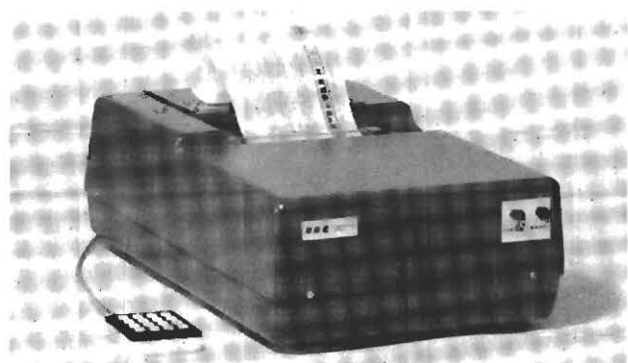

New high-voltage vacuum switchgear at Television Centre

Prior to 1974, high-voltage switchgear installed at the BBC's studio centres and main transmitting stations was based universally on oil circuit breaker equipment. For many applications, particularly at transmitting stations, the duty cycle of circuit breakers used to switch high-voltage rectifier supplies is extremely onerous and has led to high maintenance costs and a significant number of circuit breaker failures caused by rapid contact wear and mechanical fatigue in the operating mechanisms.

In the early nineteen-seventies, vacuum switchgear technology had reached the stage at which switching devices for high levels of power (in excess of 10,000 amps at 11,000 volts) were becoming available. Initially the equipment incorporated switches mounted on open frames but by 1973 manufacturers had started to build complete circuit breakers and to incorporate these into fully-enclosed metal-clad switchgear with full capability to withstand short-circuit conditions.

One of the first multi-panel 6·6 kV vacuum switchboards to be manufactured in the United Kingdom was commissioned at the BBC's Manchester Network Production Centre in 1974 and the success of this installation led to the phased introduction of vacuum switchgear at many other BBC premises. The photograph shows the latest installation at Television Centre.

Developments leading to this major advance in switchgear technology and the advantages for broadcasting applications will be the subject-matter of an article in a forthcoming issue of *BBC Engineering*.

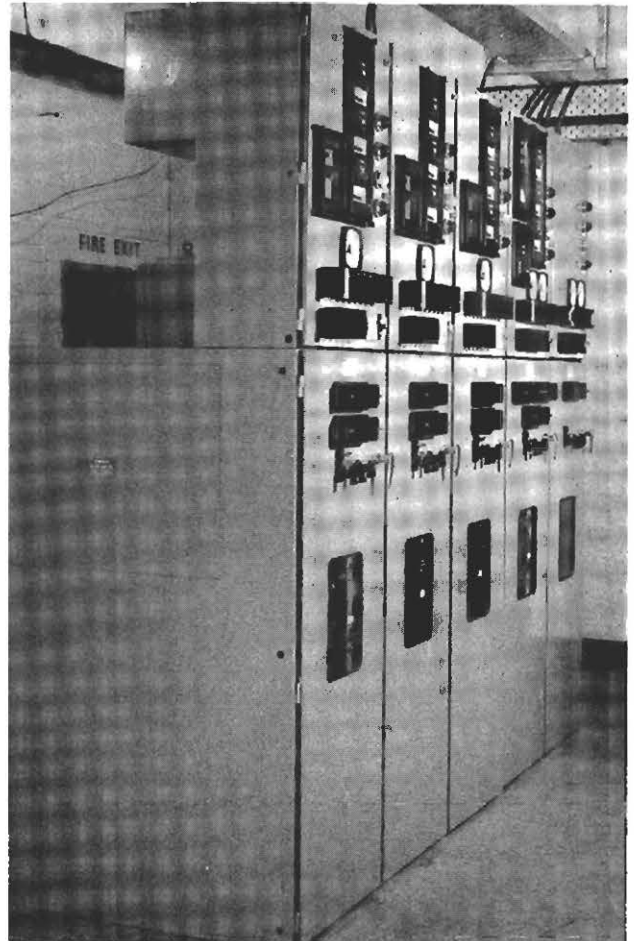

CEEFAX Progress

J. Redmond, F Eng.

Director of Engineering 1968-1978

Much has been written about CEEFAX, on both the technical and editorial aspects, in many different publications but, strangely, this is the first full-length article to be published in *BBC Engineering*. Much of the article is based on the text of an address given by Mr. Redmond to the Electronic Industries Association of Japan toward the end of 1977. CEEFAX progress is rapid and the text has had to be altered in many places to take account of developments during the past year.

It is particularly appropriate that this general survey of the present state of CEEFAX should appear shortly after the author's retirement after ten years as the BBC's Director of Engineering. He was greatly and directly interested in CEEFAX from the start and, through his contacts in industry and the broadcasting world gave great encouragement to its development and its general acceptance as a valuable new service.

- 1 Introduction
- 2 The broadcasting of CEEFAX
- 3 Teletext and viewdata
- 4 Availability of teletext receivers
- 5 Teletext abroad
- 6 Future development
- 7 Subtitling for the deaf
- 8 Conclusion

1 Introduction

We have come to expect a lot from television. We have entertaining programmes, educational programmes, news and current affairs broadcasts, and so on. We have come to take international television for granted and we expect it to show us important events anywhere in the world.

The British television viewer has a new, extra facility. He can demand the latest news whenever he wants it — the latest sports news, weather forecasts, financial news and many other sorts of information — at any time when BBC Television is on the air. He can turn to CEEFAX. All he has to do is to pick up a remote-control box, push a few buttons and in a few seconds his television set will display whichever of the 200 or so available CEEFAX pages he has chosen.

CEEFAX is transmitted by digital signals using two lines in the field-blanking period — two lines that would not otherwise be used to carry information. It is a broadcasting engineer's delight — a communication channel that requires no extra space in the frequency spectrum. It is easily added to the television signal and travels at no extra cost through the conventional transmission network to the viewer's home. A decoder in the receiver selects information from the digital signals, stores it and then produces the video output to write the text on the television screen.





2 The broadcasting of CEEFAX

One of the big advantages of CEEFAX is that the publishing process can be very fast. The CEEFAX editorial office, which at first glance is very much like other newsrooms, is at BBC Television Centre in West London — the heart of the BBC television networks. News material is received continuously from agencies, the BBC's own news departments, etc. A sub-editor can see a good story as it arrives on a teleprinter, step across to a visual display unit (VDU), edit it and type it into the magazine in less than two minutes. If it is only a matter of updating an existing page the delay may be only seconds.

The VDUs in the editorial office are of the type described by computer people as 'intelligent' VDUs. This means that many of the operations of preparing a CEEFAX page can be carried out on the VDU, independently of the main computer. The output from the VDUs goes to a mini-computer which also collects and organises the data from VDUs used by specialist editors for sport and finance located in their own areas of our news operation. Main storage is on disc with a capacity of 1.23 million words and the main computer and disc store are backed by a second unit operating in parallel. The computer installation can accept eight inputs. In addition to the VDUs in the CEEFAX newsroom there is a modem link to other VDUs in Broadcasting House, for example one in the finance newsroom.

Most broadcasting organisations have extensive news-gathering operations but are able to use, in their regular broadcast bulletins, only a small fraction of the news they collect. CEEFAX can make good use of more of this news for transmission.

The cost to the broadcaster of a CEEFAX operation is small. Our capital expenditure on the equipment now in service is less than the cost of three colour television camera channels; our annual running costs are also low.

Soon we shall extend our operations by introducing local pages. At the moment CEEFAX pages are prepared only in London, although we do have a contribution system through which anyone with access to a telex machine can send in material on punched tape. The stories are sent in a format requiring the minimum amount of work from the sub-editor in London to put them into the current CEEFAX magazine.

Local news and information is attractive to our audiences. There is no reason why each of our local newsrooms should not compile its own CEEFAX magazine, which would be interleaved with the national version. The additional cost would not be high.

The key factor in the amount of information we can broadcast is the maximum waiting time that the viewer will accept. We think it should be not more than 25 seconds, and preferably less. The pages are transmitted in sequence, each page taking about a quarter second and so we would not expect to extend the capacity of the current magazine beyond about 100 numbered pages on each of the BBC's two television services. For more magazines, each with a similar access time, we would transmit CEEFAX data on more than two lines of the field-blanking interval. If we were to use 16 lines we could have up to eight magazines on each service,

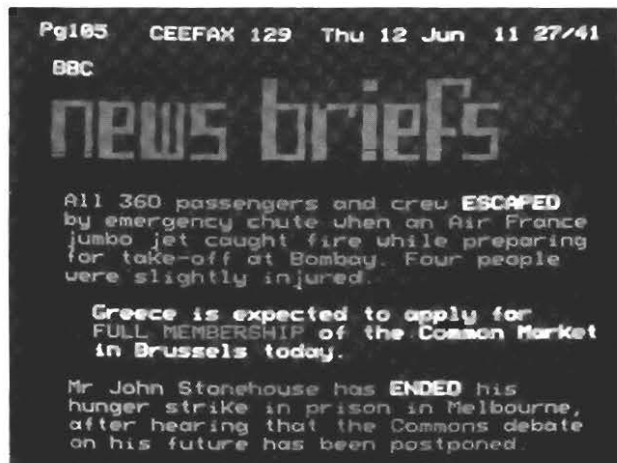

BBC Research Department started work on CEEFAX in 1970 and one of the first things that had to be built was a decoder to drive a receiver. It was built from standard components and was rather large — in fact it was about as large as a standard television set. Soon, however, the semiconductor industry became interested in decoder design. The usual miracles of miniaturisation were performed and the complete decoder was produced on a board about 6 inches by 4 inches which could easily be integrated into the television set.

but it will be some time before we would wish to use so many data lines. Nevertheless we may extend our existing use of two data lines to three or four in the not-too-distant future.

One way we can increase the size of the magazine without increasing the access time is by using self-changing pages. We simply transmit several versions of a particular page number, in a slow sequence. When the viewer has had time to read a given version of the page we can provide a different version.

CEEFAX also provides a newsflash service. A viewer who wishes to be sure that he will not miss important news announcements selects the newsflash 'page' and continues to watch the ordinary television picture. If a very important news story should break, the CEEFAX editor announces it in newsflash form and it appears within a moment, inset into the television picture. Once the viewer has read the newsflash he can erase it and carry on watching television, or perhaps call up more information about the story in the magazine proper.

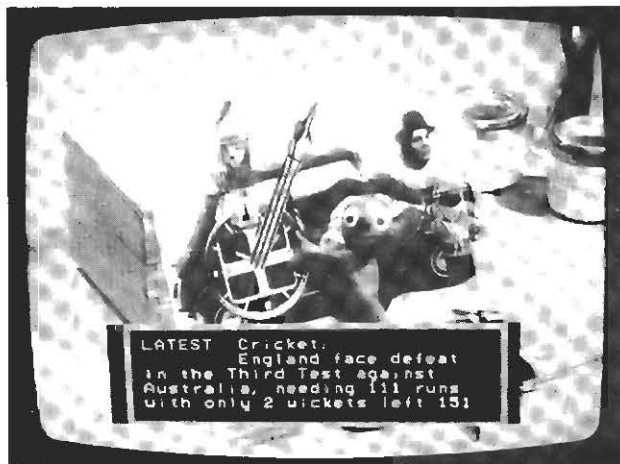

3 Teletext and viewdata

In Britain the commercial television network operates a news and information service, called Oracle, which has exactly the same technical standards as CEEFAX and the word teletext is used to describe the techniques developed for broadcasting both CEEFAX and Oracle. Both services are provided nationwide and operate throughout the television day from 8.30 in the morning until after midnight.

A related development whose future is closely linked with teletext is the British Post Office's viewdata system, Prestel. Instead of a broadcast signal, viewdata uses the ordinary telephone line to carry information to the television receiver. Viewdata uses the same display standard as teletext and so the number of extra circuits needed in the television set is few. The main extra circuits for decoding viewdata are an interface to connect between the telephone line and the television set and a microprocessor to assemble the asynchronous data signal into a form acceptable to the decoder.

When it gets into full swing Prestel may have a data base of some 100,000 pages. It may offer the business world easy access to detailed catalogue information which could be right up-to-date. It could eventually replace the printed telephone directory. It can offer two-way communication because it uses a personal telephone line and the British Post Office has also successfully interconnected Prestel and the public telex network.

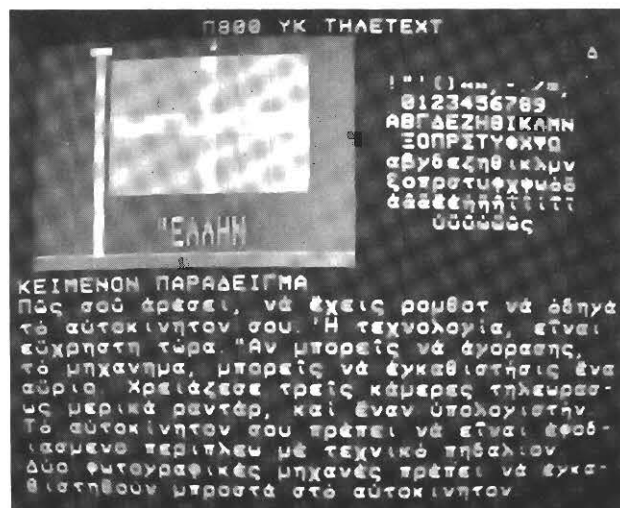

4 Availability of teletext receivers

We have now had a lot of experience of broadcasting CEEFAX — we have been providing up-to-date information seven days a week since September 1974. Until recently, however, there were not many teletext receivers available to the public. But now that the receiver industry has completed its market research and development work, teletext receivers designed for mass production are on the market.

In Britain the renting of television sets is very popular and rental customers can now have teletext for a small additional charge.

5 Teletext abroad

We are, of course, very interested in teletext developments in other countries and are gratified that so many overseas broadcasters have visited us to see and discuss CEEFAX. Also we have been pleased to help with advice and the loan of equipment for experimental CEEFAX-type services.

Sweden and Germany are showing great interest in CEEFAX — in Germany the interest includes viewdata — and in the southern hemisphere Australia is very active. There is great interest in the United States and work to adapt teletext to their 525-line system is in hand. Japan and some of the Arab states would like to have teletext but some problems associated with displaying their written languages have to be solved.

We have already established that CEEFAX travels well over the Eurovision network and all that is needed for regular transmissions between European countries is the provision of appropriate routing equipment.

One of the most important aspects of international teletext is, of course, the ability of the system to cope with foreign alphabets. Doubts were expressed about this ability in many quarters but they should have been resolved by recent work and demonstrations of how simple it is to extend the UK teletext code to accommodate the accented

characters used in many non-English alphabets*. On the occasion of the International Broadcasting Convention in London last September we displayed teletext pages in English and four other European languages.

6 Future development

Our first objective was to make full use of the opportunity to transmit data. The CEEFAX codes were chosen to give the highest data rate consistent with Europe's 625-line 50-field television system. The signals are rugged. There is built-in error correction and the teletext signal can be received by all who can receive television.

The system is designed to permit development of new facilities without out-dating existing decoders. Many attractive new ideas may be added by receiver designers to take advantage of the control information which is broadcast along with the CEEFAX messages. Simple receivers need not attempt to display every possibility and so there is already a choice of receiver options and this choice will grow.

On the editorial front, many developments are possible and one of these, CEEFAX subtitling for the deaf, is so important that I deal with it separately later. We have still to exploit fully the use of texts for teaching purposes. CEEFAX can be used as a supplement to educational television programmes on the same channel. It can be used to reveal the answers to problems. It could also play a part in programmed text methods of teaching.

CEEFAX has so far been used mainly for information and we have not seriously tried it for entertainment. Jokes, drawings and puzzles could provide light-hearted distraction. We have used crossword puzzles, with small prizes for the first correct solutions opened, as a means of studying the spread of CEEFAX throughout Britain.

It would be possible to offer serialised fiction or poetry on sequential pages for more serious entertainment. In this case the sequence would begin at a fixed time, say at the beginning of each hour.

CEEFAX 118 Tue 21 Jun 10:32/28

BBC SPORT **rugby** UNION

FINAL INTERNATIONAL CHAMPIONSHIP TABLE

	P	W	L	F	A	Pts
FRANCE	4	4	0	58	21	8
WALES	4	3	1	66	43	6
ENGLAND	4	2	2	42	24	4
SCOTLAND	4	1	3	39	65	2
IRELAND	4	0	4	33	65	0

France completed the Grand Slam and Wales won the Triple Crown for the second year running.

Every CEEFAX page displays the correct time and already there are receivers on the market which extract the

*BBC Engineering 108, December 1977, page 2

time information from the CEEFAX data and display it superimposed on the top right-hand corner of the television picture.

A viewer can also arrange for any page to be stored at any minute of the day. If we change the information on a page of a particular number every minute, the viewer can pre-select the page containing information that he knows will be sent out at that time. We can use this technique to supply information that does not need to be updated very often.

So far, receivers can store only one page, but the option could be used in conjunction with stores capable of holding many pages. We could thus expand a single CEEFAX magazine to thousands of pages without making any changes in the technical system we have today and without affecting the speed of delivery of the main part of our present service. With a suitable interface, the storage might even be on a data cassette recorder. One simple step forward is already on its way. A manufacturer of decoders has in hand the development of a decoder with additional one-page stores so that the viewer could preselect and be gaining access to one page while he is reading another.

There is a category of developments which will use the CEEFAX data stream to control electronic processes associated with the receiver. The simplest example is the sending of data to redefine the character set to be employed in the receiver display. This would permit new applications such as broadcasts in unusual languages and the display of mathematical symbols. We can anticipate using the CEEFAX data stream to program a microprocessor in the receiver to give computing facilities, for example to calculate tax returns, play television 'games' — or help with the children's homework! In effect we can use the CEEFAX data stream to temporarily convert the receiver into a small and versatile home computer.

All these things are possible without disturbing conventional CEEFAX transmissions and without making today's CEEFAX receivers redundant.

There will be those who will want a 'hard copy' print-out and we have developed a machine to provide one. Possibly the business world will find this particularly valuable and it seems likely that one of the first applications will be in a business terminal for teletext and viewdata.

The CEEFAX editorial team is eager to continue the development and improvement of the contents of the magazines and some of the improvements will require additional engineering support, which we hope to provide soon. In addition to the local services I have mentioned, we have already fed some pages directly into the CEEFAX magazine from outside broadcast locations. For the future, we may need a special CEEFAX outside broadcast vehicle, with a VDU and facilities for connection to the CEEFAX computer along telephone lines or by radio link. We could also have briefcase-size VDUs which our reporters could operate from a telephone box or from a commentary position.

7 Subtitling for the deaf

With the aid of CEEFAX, deaf people could be helped to get much greater enjoyment from television programmes, because the CEEFAX computer could be used to make available a much more comprehensive subtitling service than



125 CEEFAX 125 Wed 6 Sep 14:46/27 1/4

CEEFAX 124 Wed 6 Sep 14:44/17 1/2

WORLD OIL NEWS

QUEENSLAND WELL FLOWS 1,000 BARRELS PD

Bridge Oil say that their Boggo Creek No 2 well in southern Queensland flowed 45.5 degree API gravity oil at the rate of 1,000 barrels a day through a 3/8-inch surface choke during a two-hour open hole test last Friday.

The well has been drilled to a depth of 6,330ft and 5.5-inch production casing run in.

Once the well is ready for production, further tests will be needed to measure the commercial significance of the discovery.

International News 124

FINANCIAL NEWS

Japanese Growth Seen Rising To 6.3pc
Japan's real growth will average 5.8pc in the 1977-85 period and rise to 6.3pc in 1986-90, according to the National Institute for Economic Research in Tokyo.

US Export Mission For Japan
US Secretary of Commerce, Mrs Juanita Kreps, is to head a US export mission to Japan on October 1.

National To Discuss PanAm Terms
The National Airlines Board is to meet in New York tomorrow to consider terms for the proposed merger with PanAm.

In a moment More International News



is possible at present. The provision of subtitles was very much in mind when we designed CEEFAX. The system allows the superimposition of subtitles on the programme picture at any time, that is, without waiting their turn in the sequence in which the CEEFAX rows and pages are transmitted. The deaf viewer would call up the appropriate CEEFAX page and the subtitles would automatically appear on his screen; they would not be mixed with the programme video signal and so would be available at the viewer's option.

That part is relatively simple and the real difficulty lies in preparing the subtitle information. If the programme is scripted in advance, as in drama, it is easy enough to write succinct subtitles, although the process is slow and therefore expensive. But a lot of television is not scripted, or is not prepared sufficiently far in advance to give time for the editorial process of composing subtitles. We are therefore

looking at a method of immediate subtitling through the CEEFAX system, using the long-established Palantype shorthand writing machine. The BBC has designed an electric Palantype machine and is collaborating with Leicester Polytechnic in experiments in which the Palantype operator, transcribing programme speech into shorthand, makes a direct entry to a computer which in turn translates the shorthand back to English and feeds it through CEEFAX to the subtitle page. What the Leicester Polytechnic mathematicians have done is to devise a computer program which in effect provides a computer dictionary in which the Palantype symbols are 'looked up' to derive the equivalent English word. Remarkable results have already been achieved, with good protection against errors and phonetic ambiguity and we are optimistic about the process. There are, of course, problems of staffing and finance but it is clear that we are well on the way to a workable system.

8 Conclusion

CEEFAX has now been on the air for more than five years and interest in it is growing rapidly. We have acquired a lot of engineering and editorial experience. The CEEFAX signal is rugged and can be decoded satisfactorily under conditions when the television picture signal is badly degraded. Our editorial colleagues have become expert at producing attractive pages which exploit all the available characters and graphics facilities and in colour — which, unfortunately, cannot be reproduced in the accompanying illustrations. There is no doubt that CEEFAX is providing a valuable additional service and has a very bright future.

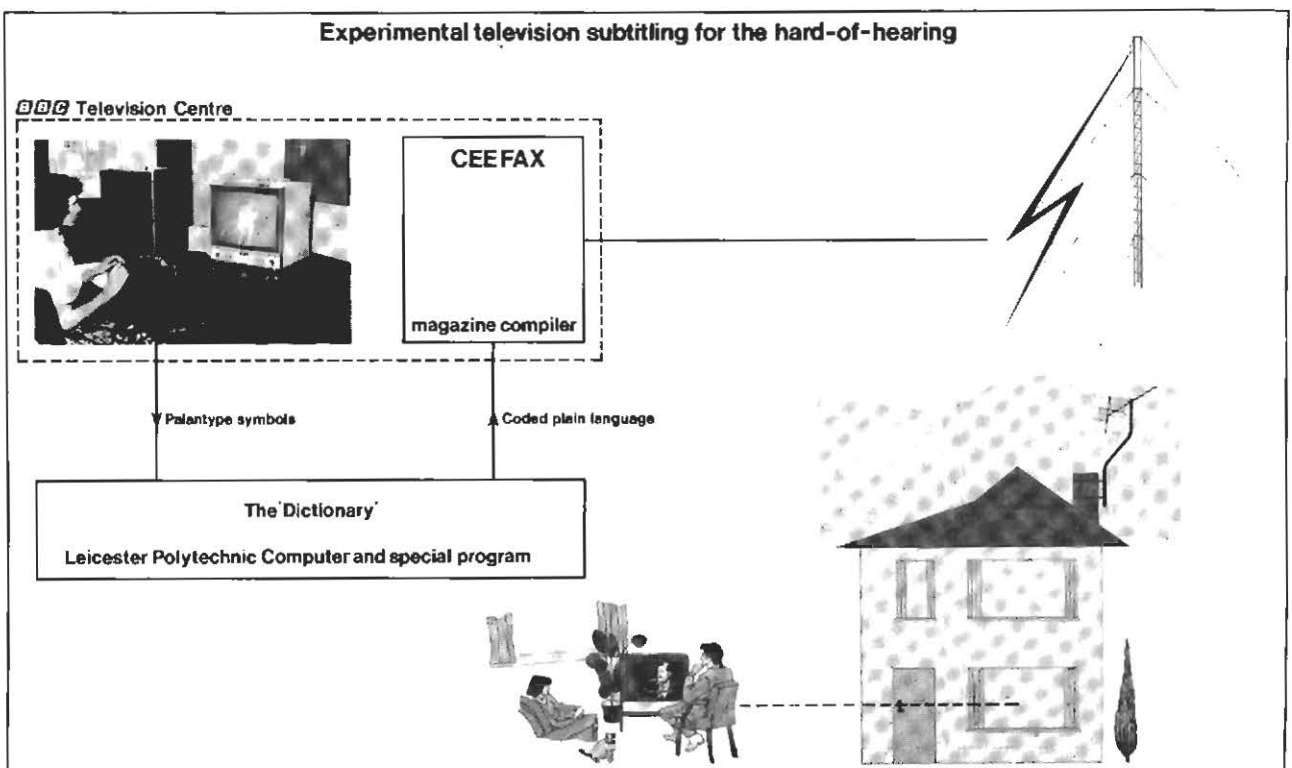

Perceptible Levels of Audio-frequency Tones in the Presence of Programme

D. J. Whythe, B Sc., MIEE, ACGI

Research Department

Summary: Subjective tests have been carried out to assess the relationship between the level and the frequency of interrupted tones that would cause 'perceptible' and 'just perceptible' interference when added to programme signals. One set of tests was conducted entirely at baseband frequencies, using a high-quality monitoring loudspeaker, while other sets used modulated signals reproduced by a stereo tuner with a high-quality loudspeaker and by battery-operated portable receivers.

Tests so far have been on a small scale but tentative recommendations are made for the maximum levels at which such tones could be added to programmes broadcast from AM and FM transmitters.

- 1 Introduction
- 2 Method of test
 - 2.1 General
 - 2.2 Tests at baseband frequencies
 - 2.3 Tests using modulated carriers
 - 2.3.1 Speech programme
 - 2.3.2 Tone programme
- 3 Discussion of results
- 4 Conclusions
- 5 References

1 Introduction

The possibility of adding data signals imperceptibly to AM and FM sound-broadcast transmissions is currently being considered by broadcasting authorities in various parts of the world.^{1,2,3,4}

Such data signals could provide broadcast programmes with an identification or 'data label' that could be decoded in receivers and used in various ways. Simple receivers may merely affirm, by means of a visual display, the station or programme that has been selected. More sophisticated receivers, on the other hand, may tune automatically to some chosen station or programme material, perhaps even according to some preset plan determined by the listener.

Data signals could also provide a means for transmitting simple messages for visual display on receivers. Supplementary information broadcast in this way could include news flashes or the time: there are many possibilities.

Various methods have been described by which the data signals may be added to the broadcast programmes.^{4,5} One method, which has the advantage of being the same for both AM and FM broadcasts, is to add the data to the broadcast programme signals at a level low enough to be subliminal relative to normal programme volume. The experiments described in this article were performed to discover what that level should be.

2 Method of test

2.1 General

The form of the data signals has not yet been decided but the most stringent form could probably be represented by using interrupted tones at various frequencies. Accordingly the arrangement shown in figure 1 was adopted for adding the tone to the programme. The tone was interrupted for one second at two-second intervals but, in order to remove switching transients, the interrupted tone was fed through a tunable bandpass filter, tuned to the frequency of the tone being used and having the response shown in figure 2. It may readily be shown that the amplitude of each tone burst at the output of such a filter increases exponentially, reaching α times its steady-state value after n cycles of the tone burst where

$$n = (Q/\pi) \log_e 1/(1-\alpha)$$

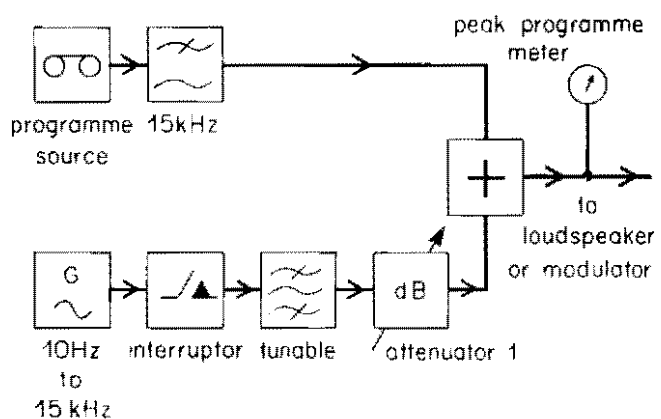

Fig. 1 Method of combining interrupted tone with programme.

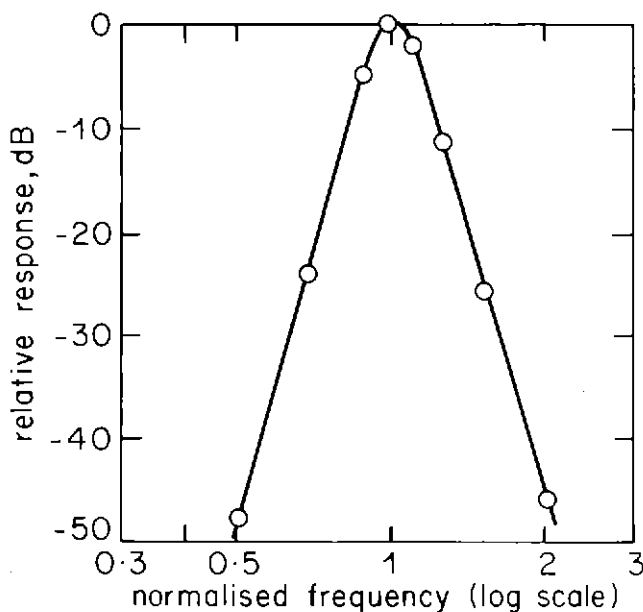

Fig. 2 Normalised amplitude/frequency response of tunable bandpass filter.

and Q is the ratio of the centre frequency of the filter to its 3 dB bandwidth. For the filter shown in figure 2, the value of Q was about 10. Thus the amplitude of each tone burst increases to about 90% of its steady-state value during the first seven cycles of each burst, independently of the frequency of the tone. In the case of the lowest-frequency tone used the amplitude will reach more than 95% of the steady-state value in the one second available.

The added tone would probably be most perceptible during the syllabic pauses of speech. The programme chosen for the tests was therefore a passage with normal syllabic pauses read by a selection of male and female announcers. Subjective tests were performed first at baseband frequencies and, later, with the combined programme-plus-interrupted-tone modulating either the amplitude or the frequency of a carrier which was fed to a selection of receivers.

All the tests were performed in a quiet listening room about 7 m x 4 m x 3 m high.

2.2 Tests at baseband frequencies

For the tests at baseband frequencies, the combined programme-plus-interrupted-tone (see figure 1) was fed directly to a high-quality monitoring loudspeaker type LS5/5A. Five experienced listeners took part in the tests, each of whom in turn sat, first, directly in front of the loudspeaker and 1.5 m from it and second, near to one wall of the room and about 3.6 m (diagonally) from the loudspeaker. These two positions (described as position 1 and position 2 respectively) were chosen in order to assess the degree to which acoustic standing-wave patterns in the room might affect the results. At each position, the listener was able to move his head in order to obtain the most stringent result.

Peak programme level was taken to correspond to a reading of 6 on the peak programme meter (PPM) shown in

TABLE 1

Perceptibility of added tone for two listening positions

Frequency of tone	Levels of interrupted tone (averages for either 2 or 5 listeners, see text) dB relative to peak programme volume, for subjective grading			
	'Just perceptible'		'Perceptible'	
	Position 1	Position 2	Position 1	Position 2
10 Hz	>0	>0	>0	>0
20 Hz	-9.8	-8.2	-5.4	-5.8
30 Hz	-15.0	-14.4	-11.8	-11.4
40 Hz	-25.2	-25.4	-20.2	-20.6
50 Hz	-38.6	-41.0	-34.8	-36.4
100 Hz	-48.6	-47.6	-43.4	-43.6
200 Hz	-49.8	-52.8	-45.6	-47.6
1 kHz	-69.6	-70.4	-61.0	-65.4
2 kHz	-70.8	-67.8	-66.6	-62.2
10 kHz	-70.5	-74.0	-66.5	-65.5
12 kHz	-72.5	-69.5	-65.0	-60.5
14 kHz	-68.5	-64.5	-65.0	-59.5

figure 1 and the level of the programme was set to peak to 5 (in accordance with normal practice for speech). The level of the interrupted tone was set so that, when attenuator 1 was set to 0 dB, the presence of the tone caused the PPM to read 6 in the absence of programme. Thus the level of the speech programme was set so as to peak 4 dB below peak programme level and the setting of attenuator 1 indicated the level of the interrupted tone relative to peak programme level, i.e. to the peaks which would occur with a music programme.

Each listener in turn set the loudspeaker volume as required (in the absence of the interrupted tone) and then, with the interrupted tone set to a chosen frequency, was asked to adjust attenuator 1 until he judged the disturbance to be, first, 'just perceptible' and then, 'perceptible but not disturbing'. The settings of attenuator 1 were noted in each case.

The spread of results between the five listeners was small when the frequency of the interrupted tone was 2 kHz or lower but, at frequencies of 10 kHz or above, the two younger listeners (22-25 years) made judgments which were similar to each other but very much more demanding than those of the other three. The results presented are therefore the average for five listeners for frequencies of 2 kHz or lower, and the average for the two younger listeners for frequencies of 10 kHz or higher. These averages are given, for the two listening positions, in table 1.

Table 1 shows that the differences between the individual results at the two listening positions were small and evenly scattered, with no obvious trends over particular ranges of frequency and, in particular, very small indeed when averaged over all frequencies. The result at each frequency was therefore taken to be the average for the two positions and this is plotted as a function of frequency in figure 3. For comparison purposes, the normal equal-loudness contour⁶ for a frontally-incident free field* is also shown, adjusted in absolute level to agree with the subjective result for 'just perceptible' at 1 kHz. Agreement is reasonably good at all other frequencies, particularly at those below 1 kHz.

*The correction for a diffuse field of equal loudness⁷, is considered negligible in the present context.

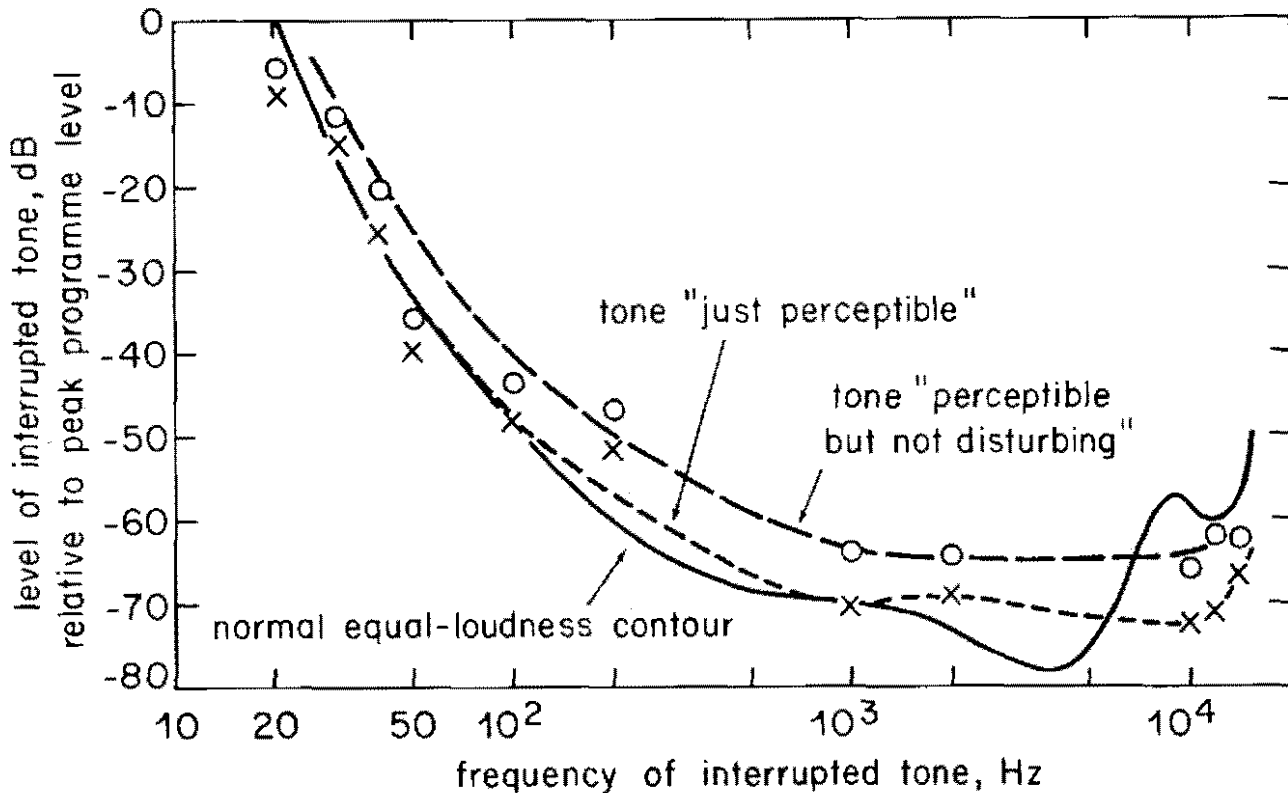

Fig. 3 Perceptibility of interrupted tone: baseband tests.

2.3 Tests using modulated carriers

2.3.1 Speech programme

Tests similar to those described in section 2.2 were performed for which the programme-plus-interrupted-tone (see figure 1) was used to modulate either the amplitude or the frequency of a carrier which was then fed to a suitable receiver. The tests involving frequency modulation were monophonic using $50 \mu\text{s}$ pre-emphasis in accordance with standard UK broadcast procedure. Because the speech programme had been limited before recording no further limiter was required for either type of modulation. Peak programme level (i.e. PPM reading 6) was set to produce 90% modulation depth when using amplitude modulation, or $\pm 34.16 \text{ kHz}$ deviation at 400 Hz (i.e. 90% of $\pm 37.96 \text{ kHz}$, the normal peak deviation of monophonic programme) when using frequency modulation. In the same way as for the tests described in section 2.2, the level of the speech programme was set to peak to 5 on the PPM and the level of the interrupted tone was set so that, when attenuator 1 was set to 0 dB, the presence of the tone caused the PPM to read 6 in the absence of programme. Thus the setting of attenuator 1 indicated the level of the interrupted tone relative to peak programme level and, after modulating, the peak modulation corresponding to peak-programme-level-plus-interrupted-tone would not exceed 100% provided attenuator 1 was set to 19 dB or more. Just as in section 2.2 this, too, refers to the peaks which would occur with a music programme.

For the tests, three receivers were used in turn. For amplitude modulation a battery-operated portable (receiver

1) with its built-in loudspeaker, and an AM/FM tuner (receiver 2) feeding a BBC loudspeaker type LS5/5A, were used. For frequency modulation a low-cost battery-operated portable (receiver 3) was used. The results obtained with this small selection of receivers are regarded as sufficiently reliable for the present purpose but further tests using a larger selection might be necessary before firm decisions are taken about the addition of data signals to broadcast programmes.

The tests were conducted in the same way as those described in section 2.2, but with each listener in turn sitting only in position 1. Furthermore, each listener was asked to assess only the 'just perceptible' level of interrupted tone during the speech programme. Four experienced listeners took part in the tests involving the portable receivers but only one in the tests involving the AM/FM tuner. The judgments of this single listener, however, had previously been found to accord well with those of the other four. The results, shown in figure 4, are the averages for the four listeners or the assessments of the single listener as appropriate. When using AM the highest frequency for the interrupted tone was 2 kHz but, when using FM, frequencies up to 14 kHz were used. At frequencies of 10 kHz and above, the results shown in figure 4 are the assessments of only one listener, namely one of the two mentioned in section 2.2 whose judgments were particularly stringent at those frequencies.

2.3.2 Tone programme

Figure 4 shows that very high levels of low-frequency tones can be added imperceptibly to a speech programme. When

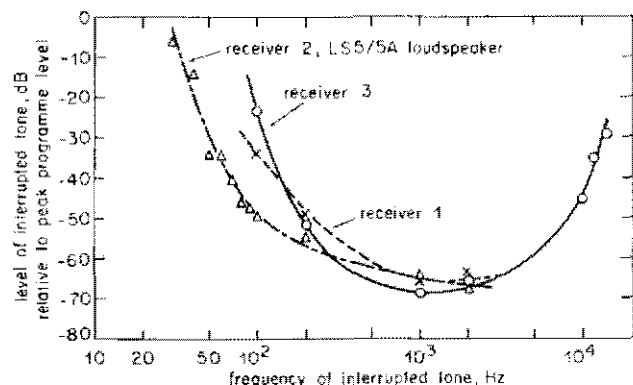

Fig. 4 Perceptibility of interrupted tone: AM and FM tests (tone 'just perceptible').

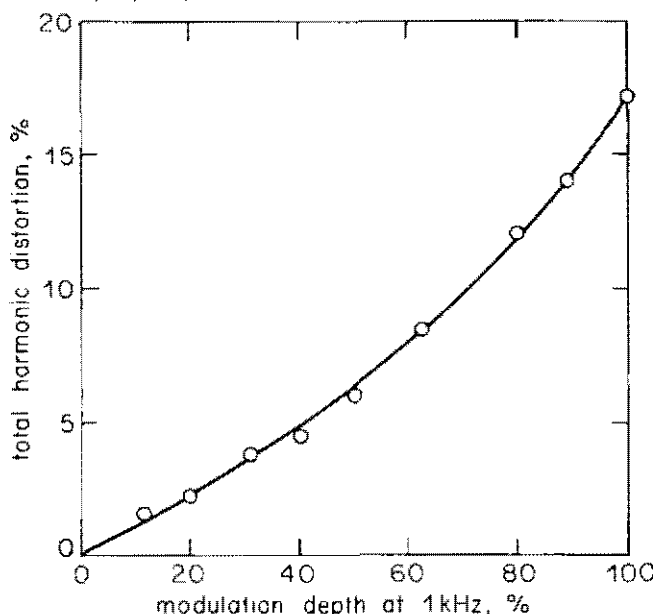

Fig. 5 Harmonic distortion of Receiver 2 as a function of modulation depth.

such high levels are used the tones may modulate the programme as a result of non-linearity and hence cause a 'warbling' effect which would probably be most perceptible on programmes containing sustained chords. Such a programme could reasonably be simulated by continuous tone.

Accordingly, a brief experiment was performed by two experienced listeners to assess the 'just perceptible' levels of the low-frequency interrupted tone against a background of 400 Hz steady tone at 90% modulation depth. Three receivers were used, receivers 2 and 3 which had been used for the tests described in section 2.3.1 and a BBC high-quality medium-wave check-receiver (receiver 4). The average results for the two listeners are given in table 2. They show not only that the frequency of the interrupted tone was of little consequence but also that, for receivers 3 and 4, the interrupted tone became noticeable only when the peak modulation depth of the steady tone and the interrupted tone together exceeded 100%. The performance of receiver 2 was markedly inferior but subsequent tests showed that particular receiver to cause the rather high levels of harmonic distortion shown in figure 5. This could account

TABLE 2

Perceptibility of interrupted tone in the presence of a steady tone

Receiver No	Type of loudspeaker	Type of modulation	Frequency of interrupted tone (Hz)	Levels of interrupted tone relative to level of 400 Hz steady tone (dB) for 'just perceptible' effect*
No. 2	LS5/5A	AM	10	-25.5
			20	-25
			30	-25.5
			40	-24.5
No. 3	LS5/5A	FM	10	-19
			20	-14.5
			30	-14.5
			40	-14
No. 3	Own in-built	FM	10	-17
			20	-17
			30	-15.5
			40	-16.5
No. 4	LS5/5A	AM	10	-14
			20	-15
			30	-15
			40	-17.5

*The level of the steady tone was set to correspond to 90% modulation depth. Thus the addition of the interrupted tone at relative levels greater than -19 dB would cause modulation depths greater than 100%.

for its inferior performance in this respect although the distortion was not such as to cause marked impairment to normal programme reproduction.

3 Discussion of results

The measured variation with frequency of the perceptible level of interrupted tone is in good agreement with the normal equal-loudness contour (see figure 3). These levels were established at baseband frequencies on the basis of perceptibility during a speech programme. This is likely to correspond to the most stringent case under practical modulation conditions over the great majority of the tone-frequency range but, at very low frequencies where the results given in figure 3 would permit high levels of interrupted tone a lower limit may, on certain programmes, be determined by intermodulation between the tone and the programme. In this regime, the most critical programme is likely to be music involving sustained chords. This lower limit would be determined by intermodulation within receivers and, so far, too few receivers have been tested to provide a reliable result. Nevertheless, the effect appears to be small in that it did not occur at all on two of the three receivers tested (i.e. it was not perceptible until the peak modulation depth exceeded 100%). Receiver 2, on which it was noticeable, was found to have a rather poor distortion characteristic and hence may not be typical from this point of view. Furthermore, the effect was noticeable only on tone modulation, simulating sustained chords at 90% modulation depth, and not on speech (see figure 4), even on this rather poor receiver.

It therefore appears reasonable, if data signals are to be added to AM broadcasts, to add them at levels derived from figure 3 but with the additional restriction that the level should not exceed -20 dB relative to peak programme level, even for low-frequency data. For FM broadcasts (both mono and stereo) a similar constraint may be necessary in order both to prevent over-deviation and as a precaution against possible similar intermodulation effects in FM receivers.

4 Conclusions

Most of the work described in this article was based on the assumption that data signals added to a broadcast programme would be most perceptible during silent periods of the programme. Provided this assumption is valid the results shown in figure 3 are appropriate when deciding upon the permissible levels of added tones. Intermodulation with the programme may dominate, however, if low-frequency signals are added at the levels shown in figure 3, particularly on programmes involving sustained chords. For this reason it is recommended that, if signals are to be added to either AM or FM broadcast programmes, their levels should not exceed the levels shown in figure 3, with the further restriction that no signals should exceed a level of

-20 dB, relative to peak programme level, even for very low-frequency data. Since only a few receivers have so far been tested, however, this should be regarded as a tentative recommendation, subject to re-examination if the proposals to add data signals to broadcast programmes are to be pursued. It would also be necessary, of course, to make the appropriate reduction in either peak modulation depth at AM transmitters or peak deviation at FM transmitters, due to the programme. This reduction would be small and could best be done by slightly reducing the maximum output level from the programme limiter at some point in the programme chain prior to the addition of the data signals.

5 References

1. Radio in the 80s. Ottawa Symposium, 5th-11th June 1976.
2. MAKITALO, O. Utilization of the FM-broadcasting network for transmission of supplementary information. International Broadcasting Convention, Wembley, September 1978.
3. PEEK, J.B.H. and SCHMIDT, J.M. A Station Programme Identification (SPI) system for FM sound broadcasting. *ibid*
4. WHYTHER, D.J. and ELY, S.R. Data and identification signalling for future radio receivers. *ibid*
5. HILL, P.C.J. Simultaneous subliminal signalling in conventional sound circuits: a feasibility study. BBC Research Department Report No. 1971/1.
6. ISO Recommendation R226, Appendix A, Table A-1, 1961.
7. ISO Recommendation R454, 1965.

BBC Radio Facilities in the United States of America

S. Christie

Lately Senior Engineer, New York Office

Summary: The BBC has taken advantage of the wide range of facilities of the Bell System and of the keen competition of other organisations to establish a communications system in the USA (chiefly in New York) and between New York and London to provide valuable services at a modest cost.

A studio and control room at the BBC's New York headquarters are linked permanently to small studios at the United Nations building, to the BBC's Washington office, to London, and to the homes of the New York and Washington correspondents, as well as being open to temporary access from telephone lines all over the USA. Many of the facilities can be set up in the absence of staff at the New York headquarters by using simple remote control equipment in Washington or London.

- 1 Introduction
- 2 Background
 - 2.1 FCC Regulations
 - 2.2 Bell System facilities
 - 2.3 Special telephone equipment
 - 2.3.1 Touch-tone switching
 - 2.3.2 Telephone coupler
 - 2.3.3 New York office telephone installation
- 3 Installations and facilities
 - 3.1 Main sites
 - 3.2 Leased circuits
 - 3.2.1 New York/London
 - 3.2.2 New York/Washington
 - 3.3 Remote switching
 - 3.4 Washington Telecommunications Equipment
 - 3.5 Outside Broadcasts
- 4 Further developments
 - 4.1 Washington studio
 - 4.2 New York studio
 - 4.3 New York/Washington leased circuit

BBC uses a system of communications and programme circuits linking Washington, New York, and London. There is also a well-equipped studio at the New York office premises, as well as simple studio facilities elsewhere.

2 Background

In order to appreciate the nature of the facilities used by the BBC it is necessary to understand some of the characteristics of the communications services available in the USA.

2.1 FCC Regulations

The FCC (Federal Communications Commission) Regulations permit private communications companies to compete with the huge national Bell System in providing specific services between major cities (often at substantially lower cost) and in allowing interconnection of Bell telephone equipment with a varied range of customer-supplied interfaces. The BBC makes use of this situation in, for example, the leasing of the microwave channels between New York and Washington and the Western Union International satellite circuit between New York and London.

2.2 Bell System facilities

The success of the BBC undertaking lies in combining the utilisation of such cheaper facilities with the exploitation of other services provided by Bell. The Bell System has invested extensively in rapid touch-tone computer-switched signalling systems and in high-quality satellite links. As a result, it is normally possible to dial direct to most parts of the world in a fraction of the time taken to place a call from Europe and this is used to good advantage by Radio News since the call

1 Introduction

News from North America is often of interest to British audiences and frequent contributions to news bulletins and current affairs programmes are made by correspondents on the other side of the Atlantic. Regular features, such as Alistair Cooke's popular 'Letter from America', are also required. Items not wanted for broadcasting within the UK are handled for the BBC's overseas broadcasts to all parts of the world.

To satisfy these requirements for rapid access to news and for facilities for the production of radio programmes, the

can be recorded in New York and replayed over the permanent circuit to London. In addition, it is possible to carry out an OB using a telephone coupler (see section 2.3.2) on the public telephone network with only slightly lower quality than that available from a specially provided line, but at a very much lower cost. For instance, the line costs 32 cents per hour for each mile: a 2,500-mile line would therefore cost \$800 per hour. A peak-rate telephone call over the same distance costs \$25 per hour.

2.3 Special telephone equipment

Several facilities of the Bell System play an important part in the overall operation.

2.3.1 Touch-tone switching

Switching in the Bell System is commonly carried out by two-tone voice-frequency signalling using a twelve-key matrix in place of the traditional dial. The touch-tone encoder, shown in figure 1, is basically a keyboard that switches the frequencies of two oscillators feeding a combined zero-level output. Each row of keys corresponds to one of four frequencies for the low-frequency oscillator (between 697 Hz and 941 Hz) and each column corresponds to one of three frequencies for the high-frequency oscillator (between 1209 Hz and 1477 Hz).

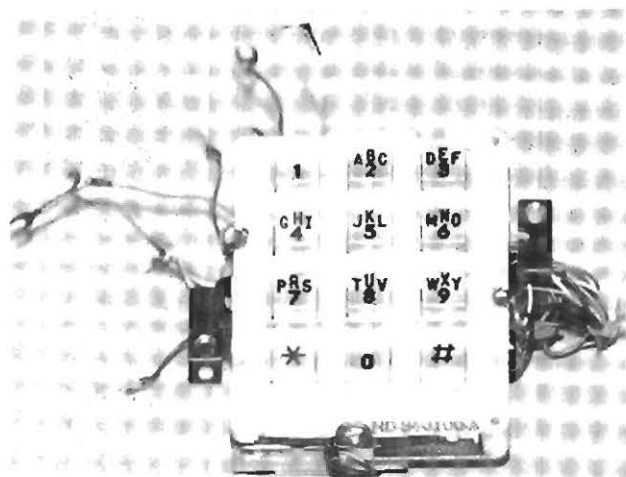

Fig. 1 A touch-tone encoder.

2.3.2 Telephone coupler

Loudspeaking telephones used on conference calls require a high degree of separation between incoming and outgoing signals on the two-wire local end and the Bell System has a unit for this purpose, the 50A Conference Set, illustrated in figure 2.

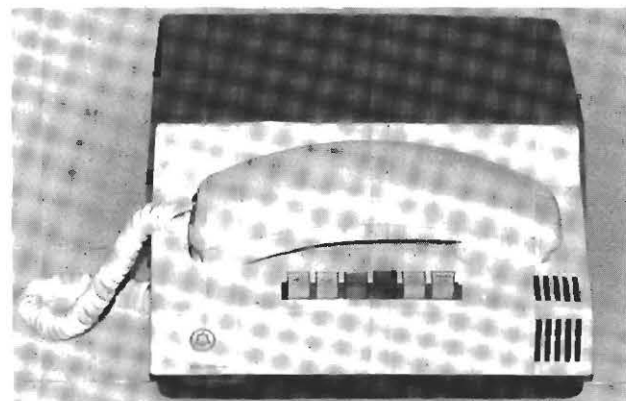

Fig. 2 The 50A conference set, a high-performance self balancing telephone coupler. One of these sets can be seen installed on the middle equipment bay in figure 4.

This is a sophisticated telephone coupler providing a high-level line output and two switchable microphone-level inputs controlled by AGC. It balances automatically, usually to an effective separation of 30-35 dB, and is reasonably portable. It requires a mains supply but will work into a standard telephone socket anywhere in the United States or Canada.

2.3.3 New York office telephone installation

The telephone installation in the New York office is a Tele/Resources System 32 which is connected to 14 Bell System trunk lines (via an approved interface), three lease lines, and two off-premises extensions. The system is quite unusual in design and its ability to operate on pre-programmed logic (both ROM and manual strapping) is an important feature.

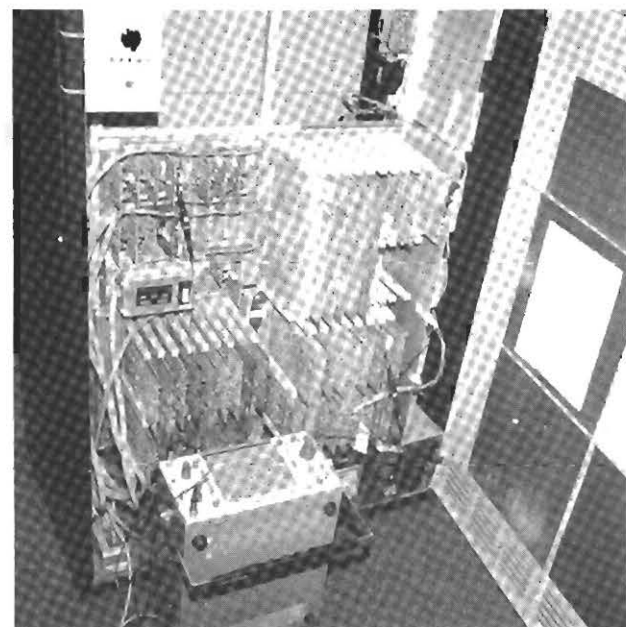

Fig. 3 The Tele/Resources System 32 telephone installation in the New York office

Connections between input and output ports are made by a time-division-multiplex switch, sampling each source at a 12.5 kHz rate. Each source and destination is controlled by logic gates driven by the decoded output of one or more of three synchronously stepped shift registers — 'originate', 'conference', and 'terminate'. The equipment is shown in figure 3.



Fig. 4 The main control room at the New York studio.



Fig. 5 Inside the New York studio



Fig. 6 New York studio - Cubicle B.

3 Installations and facilities

3.1 Main sites

The chief installation is a small studio in the New York office. The main control room includes a telephone-equipment and line-termination cubicle. A Neve four-group desk can be seen in front of the studio window (figure 4) and the racks to the left of the desk house remote switching equipment. Figure 5 shows the inside of the studio.

The Cubicle B (figure 6) can duplicate many of the facilities of the main control room but the Neve two-group desk is used mostly for longer recording sessions and the editing and compilation of feature packages. Alistair Cooke's world-famous 'Letter from America' is recorded here.

The installation has permanent links to the six remote locations listed below.

- The New York Radio Correspondent's home 'studio'.
- The New York Radio Producer's home 'studio'.
- The National Public Radio (NPR) Network in Washington via its office in New York.
- The Washington Radio Correspondent's home 'studio'. This is fed through the studio at the Washington office.
- The BBC's Washington office (figure 7).
- The BBC's United Nations office (figure 8).

The installations at the New York home 'studios' and at the United Nations office are essentially similar and consist of a simple mixer and two tape decks, and feed a wide-band line (with a narrow-band return cue line) to the New York office. A combined MF, VHF/FM, and television band tuner is used as a source for recording broadcasts from the American networks.



Fig. 7 The studio at the BBC's Washington office.



Fig. 8 A studio at the BBC's United Nations office. This studio overlooks the Security Council — a smaller studio overlooks the General Assembly.

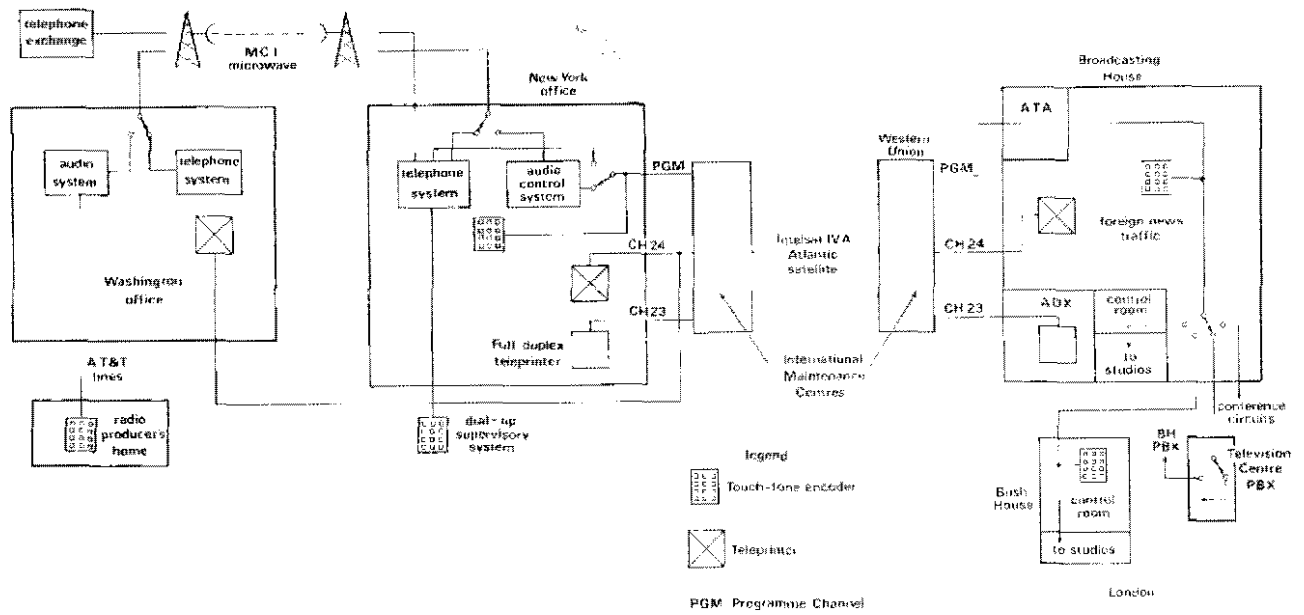

Fig. 9 The permanently leased New York/Washington and New York/London circuits and their principal applications.

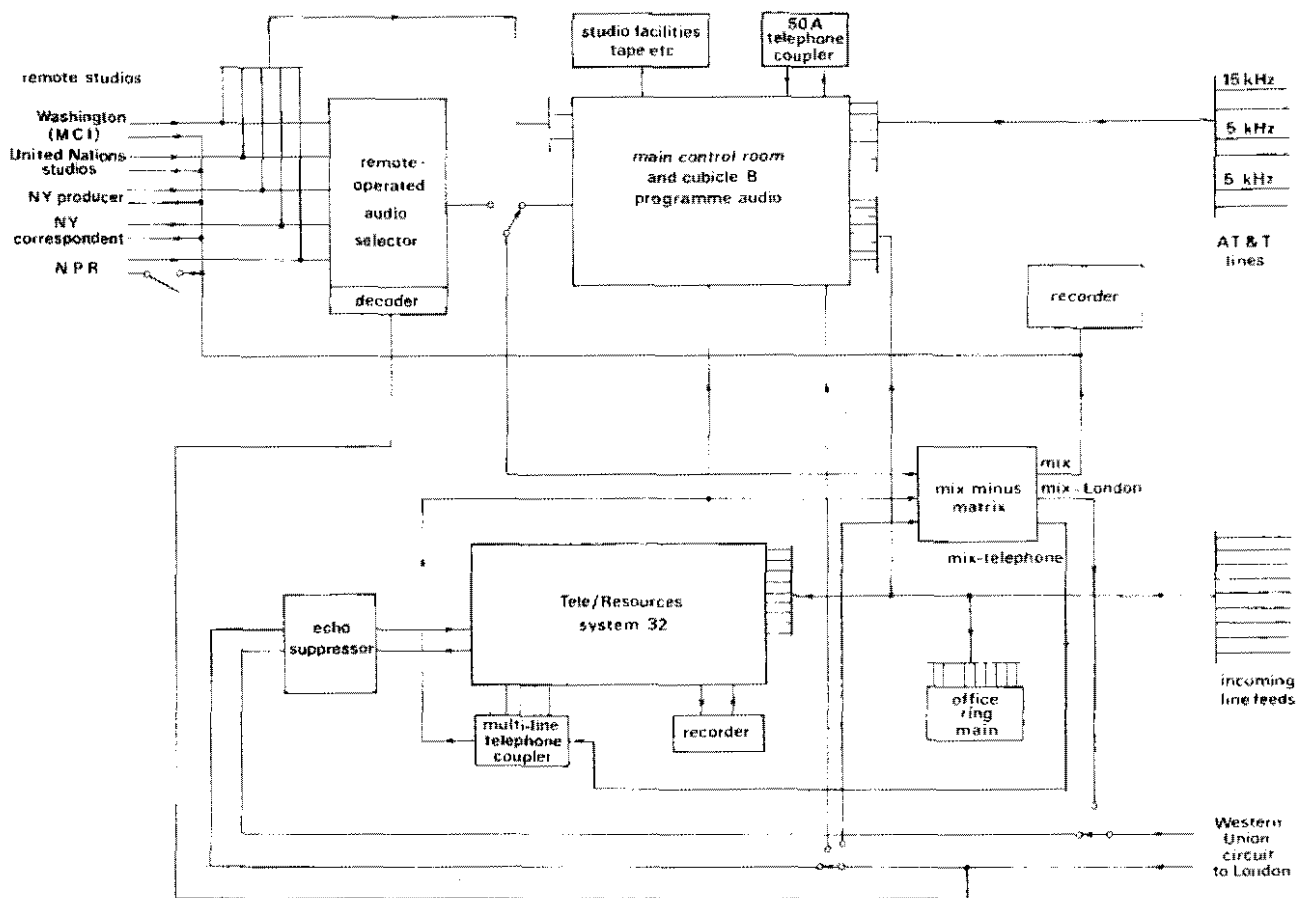

Fig. 10 The main programme and communications connections in the New York office.

3.2 Leased circuits

Permanent circuits are leased between New York and London and between New York and Washington. Figure 9 illustrates their use.

3.2.1 New York/London

A 4 kHz satellite circuit is leased from Western Union International. The 4 kHz is divided into a 2.6 kHz speech band and two teleprinter channels. The speech channel is used in four-wire form for broadcasting, but can be switched via four-to-two-wire converters at each end for telephone use. The circuit then terminates at Television Centre PBX in London and as an extension of the Tele/Resources telephone system in New York. Precise control of transmitted levels is essential because the average signal-to-noise ratio of the speech channel is only 32 dB with very little headroom.

3.2.2 New York/Washington

Two circuits are leased on a microwave system owned and operated by Microwave Communications Incorporated (MCI). One operates as an extension of the Tele/Resources system terminating at the Washington end as a local telephone number. Thus, an office call between New York and the Washington area (a distance of 220 miles) using this circuit is charged as a local call.

The second circuit provides a straightforward speech channel (350 Hz-4 kHz) between the New York and Washington offices.

3.3 Remote switching

Touch-tone encoders are used in a number of locations for remote control of operating conditions in London and New York as described below.

London: When the New York installation is switched to the automatic (unstaffed) mode switching can be controlled either from Foreign News Traffic in Broadcasting House or the control room in Bush House. The transatlantic circuit can be switched either to the Tele/Resources system which provides a number of feeds (for example, extension 470 is a line feed of CBS 88, a twenty-four-hour news service) or via the remote line source selector to any of the remote studios.

New York: The London end of the transatlantic circuit can be switched between the PBX at the Television Centre and Foreign News Traffic at Broadcasting House (see figure 9) and this switching can be controlled from the control room at the New York office. Access to the Tele/Resources system can be obtained from a standard Bell System telephone equipped with touch-tone facilities anywhere in the United States: this provides a remote engineering supervisory facility. An outline of the principal connections at the New York office is given in figure 10.

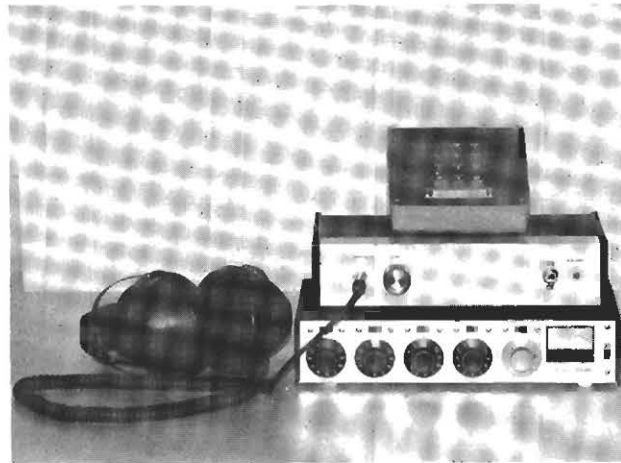

Fig. 11 The Washington Correspondent's home terminal for the New York microwave circuit

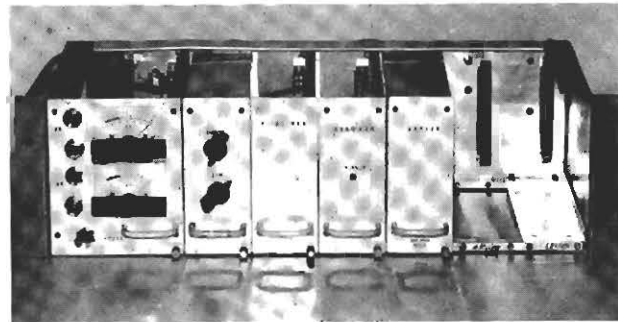

Fig. 12 The Washington studio terminal for the New York microwave circuit

3.4 Washington Telecommunications Equipment

The Washington Correspondent's home terminal uses touch-tone codes to switch the MCI circuit to New York into the programme mode. Once this is achieved, he can exercise full control of the transatlantic system. The equipment concerned at his home is shown in figure 11 and the corresponding equipment at the Washington studio in figure 12.

3.5 Outside Broadcasts

Mobility is important, so OB operations are based on small Shure mixers. In a typical case, two or more of these are used to provide a particular mix, often after being flown as luggage 2,000 miles or more across the United States. At a recent radio sports OB in Las Vegas, two of these four-channel units were used as the programme mixer feeding New York via a 50A telephone coupler and telephone line. Another coupler installed in the New York Control Room fed standard narrow-band circuits across the Atlantic.

4 Further developments

Three main projects are in progress or have recently been completed.



Fig. 13 The new console in the Washington studio.

4.1 Washington studio

A modified 5402 Neve console mounted in a specially made desk has been installed and has improved the facilities available (see figure 13).

4.2 New York studio

Stereo dubbing and listening equipment is being installed in Cubicle B.

4.3 New York/Washington leased circuit

Various methods of improving the low-frequency response of the MCI channel (including replacement by alternative facilities) have been under consideration for some time. One possible method is to use a double modulation process that raises the audio spectrum by 250 Hz at the transmit end and a corresponding process to restore it to normal at the receive end. The necessary equipment is currently undergoing trials on the circuit.

A UHF Talkback System for Television Studios

A. H. B. Bower, MA, C Eng., MIEE
T. J. Wade, MA, C Eng., MIEE

Designs Department

Summary: A short-range two-way radio link has been designed for use in television studios to provide communication between floor managers and producers. The portable transceiver has low power consumption even though the system operates continuously. Widely spaced frequencies are used for the two directions of transmission so that filtering is simple and as many as possible of the circuit functions are carried out in the base equipment to minimise the size and weight of the portable transceiver.

Additional channels are available so that similar equipment may be used simultaneously by, say, sound and lighting supervisors.

- 1 Introduction
- 2 Requirements for a new system
- 3 The portable transceiver
- 4 The base station
- 5 Operational experience
- 6 Reference

1 Introduction

Television production is controlled from a room completely separate from the studio so that the producer's voice is not picked up in the programme sound. The producer's requirements are conveyed (silently) to the performers by a floor manager who can hear his (the producer's) voice on headphones. Initially the headphones were on a long lead but this was cumbersome and a natural development was to replace the lead by a radio link.

This was tried in the early nineteen-fifties¹ with an amplitude-modulated transmitter on about 60 MHz together with a self-quenching super-regenerative receiver employing battery valves. The system worked satisfactorily and a further advance was the introduction of a solid-state receiver in 1961. A transmitter using transistors followed some years later.

The system gave many years of service but had certain drawbacks. Super-regenerative receivers have poor selectivity and so lead to wasteful use of the frequency spectrum and liability to interference from other Band I signals e.g. radio microphones. In addition, radiation from one receiver to another made it difficult to use more than one in the same studio simultaneously.

2 Requirements for a new system

By 1971 the receivers were becoming unreliable and difficult to maintain and the need for replacement was apparent. The requirements for a talkback system were re-examined with the following results.

- Several channels should be available simultaneously in the same studio without mutual interference, so that similar systems could be used by lighting and sound supervisors.
- Reverse talkback should be possible from floor manager to producer, i.e. a two-way link is required.
- The portable transceiver should operate all day on one battery, which should be of a readily available type.
- The portable unit should be compact and light but it need not be waterproof because it will only be used indoors.
- The speech quality should be good because poor communication quality is tiring when listened to over long periods.

Various systems, including inductive loops, were considered but a UHF FM radio link system seemed the most promising. Commercial equipment performed well but had two drawbacks for talkback use. The first was concerned with battery life: the portable receivers were expected to operate intermittently and were designed for minimum power consumption in the absence of a received signal. For talkback purposes, however, the producer's transmitter is in continuous use so that the transceiver's batteries run down quickly, a two-hour life being typical. To overcome this difficulty an external battery pack was required which was bulky and unacceptable to the user. The second drawback of commercial equipment was that it operated in the congested 450-470 MHz band, where the

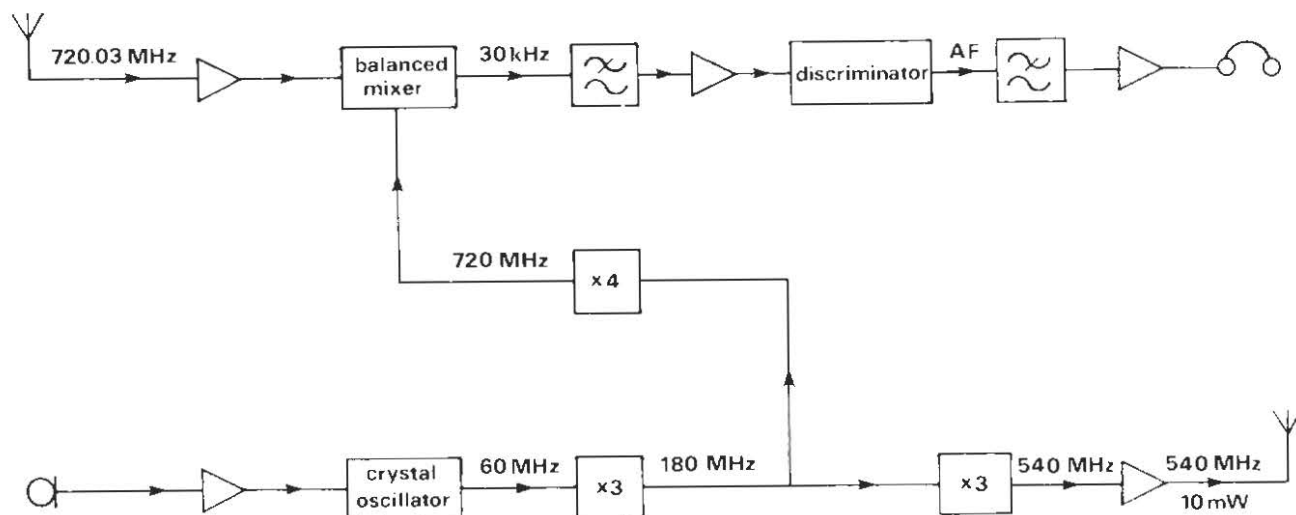

Fig. 1 Transceiver block diagram.

number of channels required would not be available. A fresh design was therefore needed to meet the requirements specified.

An allocation of three or four channels for each studio in the London area makes a requirement of some forty to fifty channels. With the modulation bandwidth used, these can be fitted comfortably into parts of television channels not used in the vicinity. The base-to-portable link operates at about 720 MHz and the reverse at about 540 MHz. This wide separation allows duplex operation without complex filtering.

The frequencies were chosen with great care to avoid interference and intermodulation between channels and, because of the limited range of the equipment, the capacity of the system can be increased by re-using frequencies in non-adjacent studios.

3 The portable transceiver

Clearly a very important design requirement was to

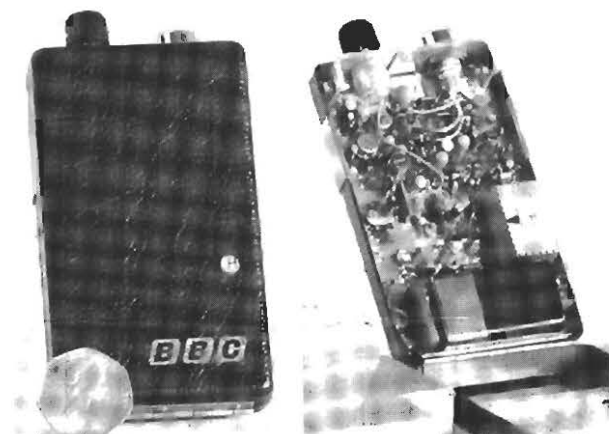

Fig. 2 (left) A letter shows through a window in the transceiver case to indicate the channel used

Fig. 3 (right) The transceiver with the case opened and the screening cover removed to show most of the components.

minimise battery consumption. The receiving section could be relatively simple because it would be operating in a screened environment with a maximum range of about 100 m; it would not be used on outside broadcasts.

Figure 1 shows how the principal parts are related to each other. The output of a crystal oscillator at about 60 MHz is multiplied to 720 MHz to provide local-oscillator injection for the receiver which is a single-conversion superhet with a very low IF — 30 kHz. To save power, pairs of stages in the multiplier are operated in series across the supply but in cascade as far as the multiplying process is concerned. Initially, single-ended diode and transistor mixers were tried, but local-oscillator noise sidebands proved troublesome and a balanced arrangement was adopted. The IF amplifier is RC-coupled and needs no alignment. It is followed by a pulse-counting discriminator, low-pass filter, and audio amplifier. Muting is not required because the receiver always has an input signal.

In the transmitter, the output of the crystal oscillator is multiplied to 540 MHz and amplified to 10 mW. The oscillator is phase-modulated, with high-frequency response restriction in the audio amplifier and ALC to prevent over-deviation. The transmitter is operated on a push-to-talk basis; the receiver remains operational all the time to allow duplex working. The receiver local oscillator is of course also phase-modulated so that the operator hears his own voice in his earphone. This might appear to be a drawback but is actually an advantage, the side-tone effect giving an indication that the transmitter is working.

The photographs (figures 2, 3, and 4) show the transceiver, which is contained in a moulded case fitted with a clip for attaching it to the user's belt or pocket; a carrying pouch is also available. The receiving aerial is part of the printed-circuit board and the case hinge is used as the transmitting aerial. This hinge is rather small and close to other metal parts and is thus a less effective radiator than it might be. A more effective aerial built into the microphone/earphone harness is currently undergoing trials. Unplugging the microphone/earphone lead disconnects the battery.

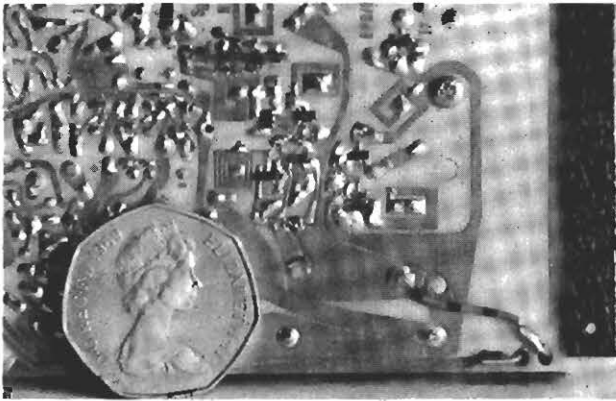

Fig. 4 Part of the printed side of the circuit board showing printed inductors and miniature transistors in the RF section.

4 The base station

Figure 5 is a simplified block diagram of the base station. The equipment consists of two transmitters and two receivers all powered by one supply. Each transmitter has an associated aerial in the studio, but one common receiving aerial is used for both channels. The aerials are folded

dipoles mounted on the studio wall, located as near to the equipment rack as possible to minimise cable losses. Figure 6 is a photograph of a studio aerial installation. The incoming signal is filtered before being split between the two receivers, so that only one UHF filter is required. A single-channel version is also available for use in studios requiring an odd number of channels.

The base transmitter and receiver are fairly conventional but incorporate a number of features to make possible the simplicity of the transceiver.

The base transmitter produces $1\frac{1}{2}$ watts (approximately $\frac{1}{2}$ watt at the studio aerial) to allow the transceiver to have low sensitivity, and is continuously powered, thus avoiding the need for a receiver mute circuit. The unit incorporates all the audio pre-correction necessary to give an overall flat response in conjunction with the simplest possible form of receiver.

In order to give good carrier-frequency stability, the basic oscillator is controlled by a crystal which is kept in an oven, and phase-modulation is used. The oscillator output is at approximately 6.66 MHz.

The modulator circuit is novel in that it requires no alignment and uses integrated circuits normally associated with digital techniques. The audio input is used to produce pulse-width

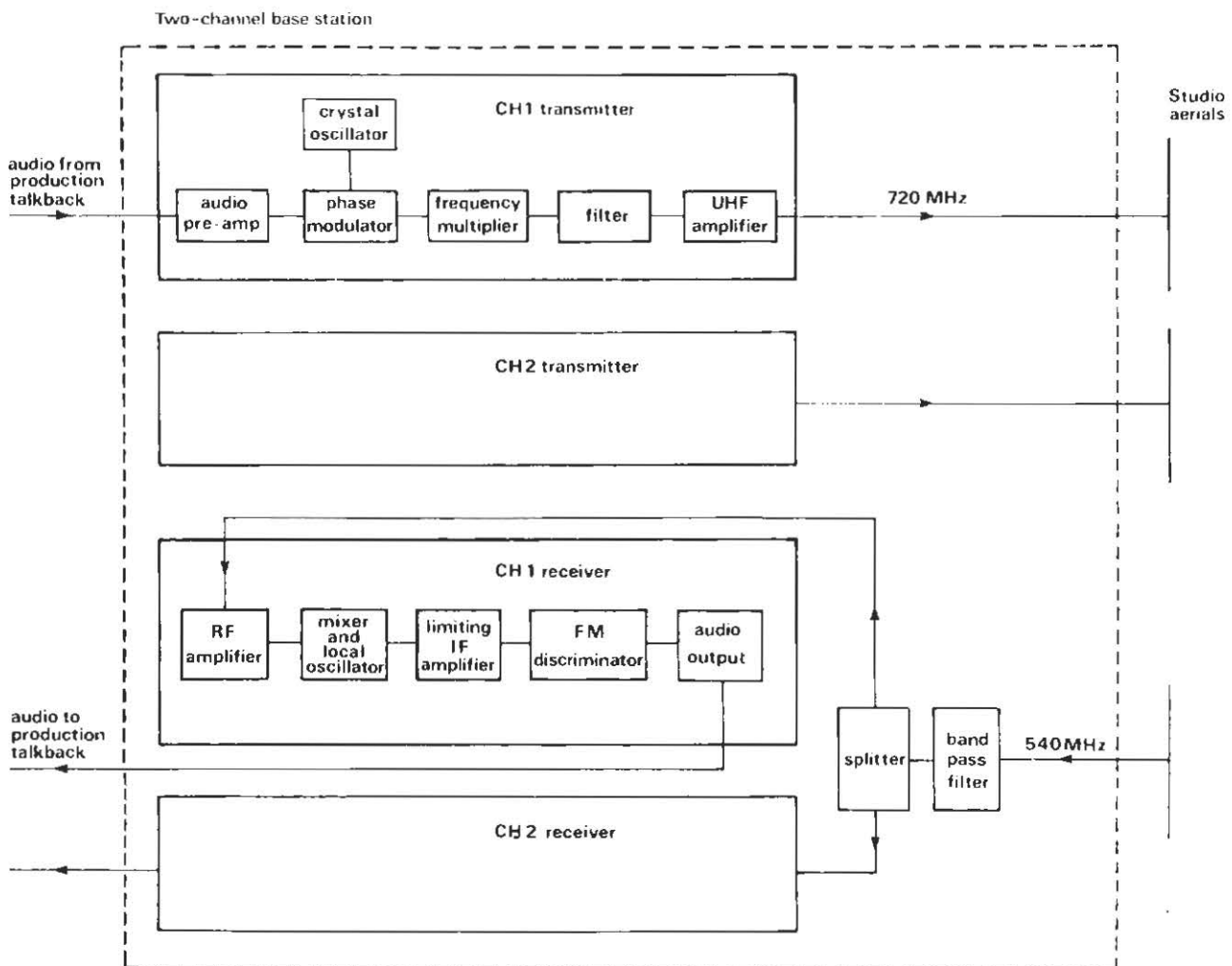

Fig. 5 Base station block diagram.

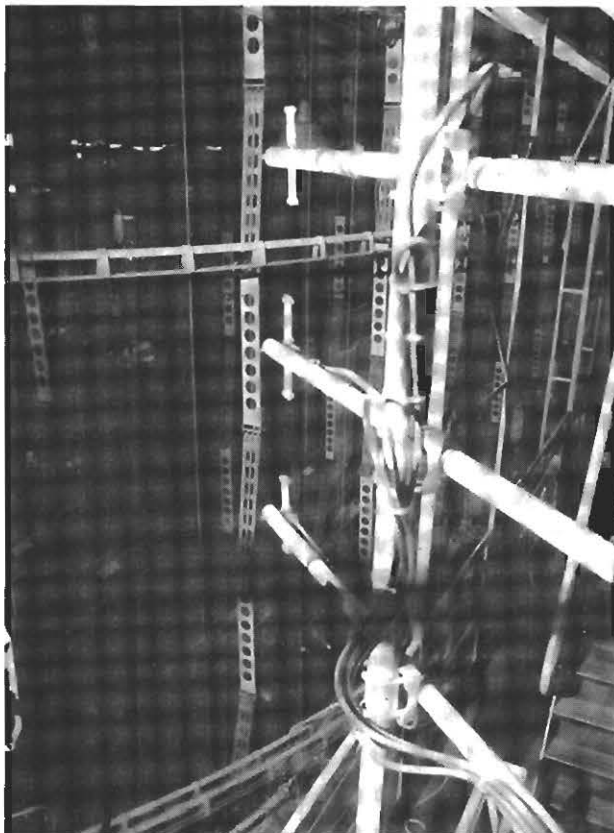

Fig. 6 The talkback aerial installation in a corner of a studio at the Television Centre. The two separate transmitting aerials and, between them, the common receiving aerial, are clearly visible. The photograph was taken while lighting was being rigged and the hoists had been lowered; the extended cable support trays can be seen beyond the aerials. Even when the studio is encumbered with so much distributed metalwork the talkback system gives reliable communication.

modulation of the 6.66 MHz square-wave, and a divider, triggered by the trailing or modulated edges, converts the signal to a phase-modulated 3.33 MHz square-wave (see figure 7). Audio and mean-level DC feedback, derived by integrating the PWM square-wave, eliminate the need for adjustment.

The final output frequency is obtained by multiplying the phase-modulated square-wave frequency by 216. The first stage of multiplication consists simply of selecting a high harmonic of the square-wave by means of a filter. The multiplication sequence was chosen to avoid producing spurious outputs at 540 MHz which would interfere with the receiver. The final 1½ watts of UHF is produced by filtering and amplifying the output of the last multiplier stage. Figure 8 shows a typical base station with two receivers, two transmitters, and a power supply. Figure 9 shows one of the transmitters pulled forward and hinged open.

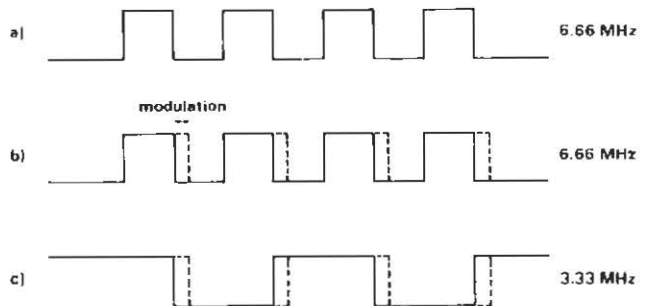

Fig. 7 Producing phase modulation from pulse-width modulation. The square-wave derived from the crystal oscillator is shown at *a*) and the effect of pulse-width modulation at *b*). The divider is triggered only on the modulated edges of *b*) and this delivers an output at an average frequency of 3.33 MHz with *both* transitions modulated. This corresponds to phase modulation, as shown in *c*).

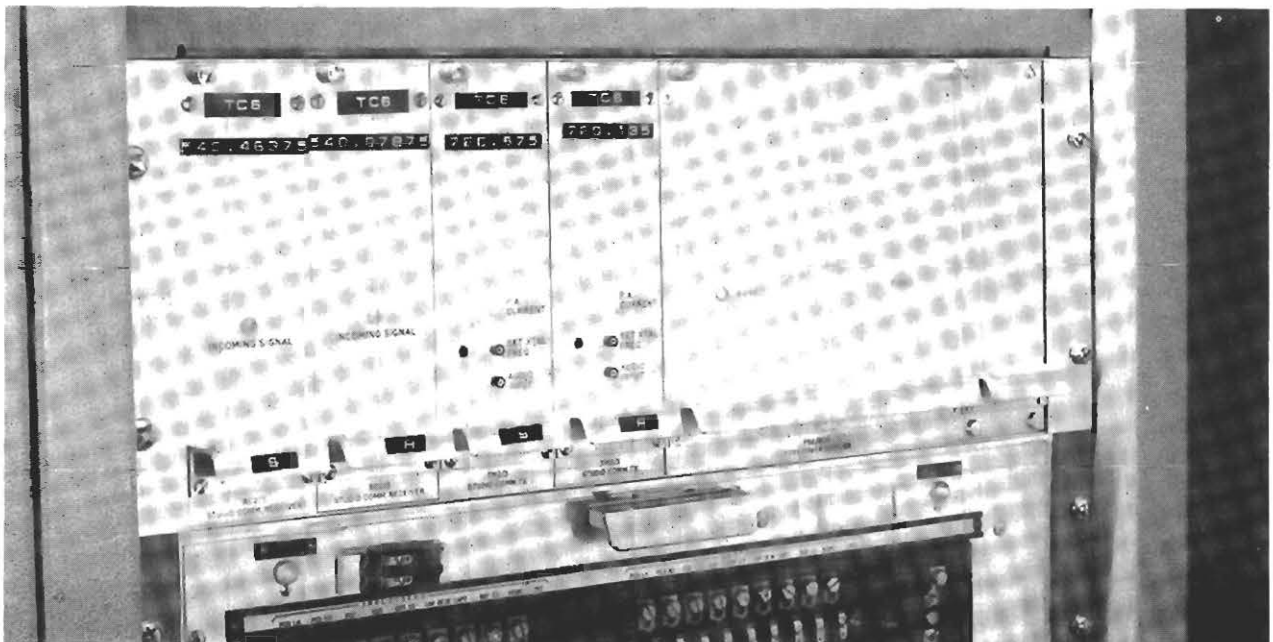

Fig. 8 A bay-mounted base station installation

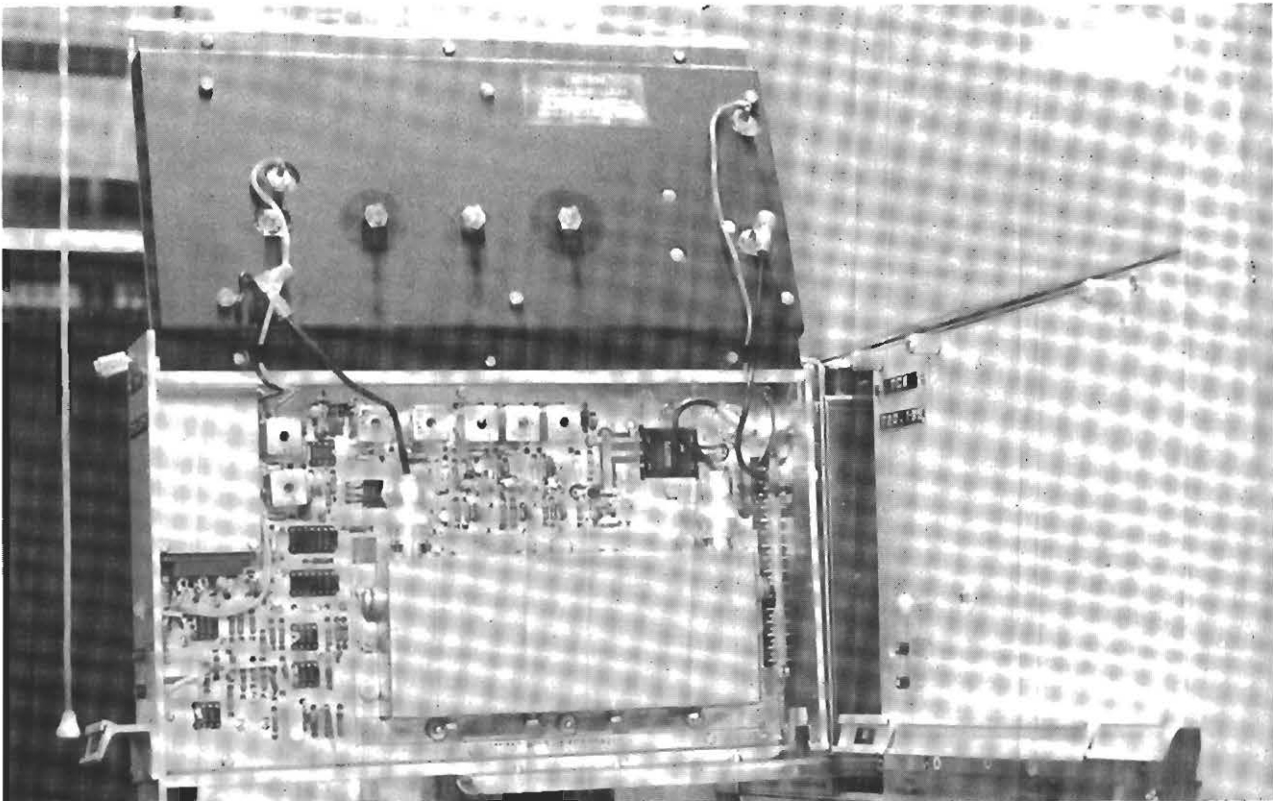

Fig. 9 One of the base station transmitters supported clear of the pay on an extender, and with the output amplifier raised

The base receiver is a conventional superhet. After RF amplification, the incoming signal is converted to a standard IF of 10.7 MHz where channel selectivity is provided by a crystal filter. Because of the small deviation, however, a high discriminator slope (V/kHz) is required to obtain a reasonable audio signal-to-noise ratio. This is achieved by using a high-Q coil and counteracting temperature and mechanical drift by means of AFC. This has the additional advantage of steering the discriminator accurately on to the incoming signal, automatically minimising the distortion and eliminating DC 'bumps' when the receiver is muted. Just as the transmitter includes pre-correction to permit the use of a simple form of portable receiver, so the base receiver contains the necessary equalisation in its audio stages to provide an overall flat response from signals radiated by the portable transmitter.

5 Operational experience

A wide variety of head-set combinations is required to cover the needs of various users. The most popular arrangement is a hidden (hearing-aid type) earpiece together with a lavalier microphone; such a set is being worn by the floor manager in the cover picture. For different situations the hidden earpiece can be replaced by conventional or protective headphones.

Battery life is several days with normal use. The batteries are tested for remaining life before each session to avoid failure in operation.

Rechargeable batteries were considered unsuitable for this application. The voltage of a rechargeable cell remains virtually constant until sudden failure, giving no warning to the operator, or indication of remaining charge. The capacity is lower than that of primary cells and the charging rate slow, so that several batteries might be required for every working transceiver, calling for a complicated storage and charging procedure. Relatively fast charging of a fully discharged battery is possible with an automatic time switch preventing damage from over-charging, but the need to replace the battery before it is fully discharged makes it difficult to exploit this possibility. In the long run, therefore, rechargeable batteries would be likely to prove more expensive than ordinary primary cells.

Rechargeable cells may be worthwhile where the equipment use is intermittent, for example, in lighting or sound rigging.

6 Reference

1. Toombs, R. Use of the radio talkback unit in television productions. *British Kinematography*, Vol. 21, No. 5, November 1952.

Contributors to this issue



Brian Bower took his degree in Electrical Engineering at Cambridge in 1950. After National Service in REME and a period with British Telecommunications Ltd., Taplow, he joined the BBC Designs Department in 1955. At first he worked on experimental colour television equipment and then on the development of new video equipment for the Television Centre, which opened in 1960. After this he transferred to radio-frequency work where he was mainly concerned with the design of VHF/FM transmitters, receivers, and transposers. Recently his chief responsibilities have been in the field of television studio apparatus.

He is an active radio amateur with special interests in long-distance VHF and UHF propagation and communication through artificial satellites.



Stephen Christie joined the BBC as a Technical Assistant with Television Outside Broadcasts in 1959. He moved to Television News as a Vision Control Supervisor in 1964 before participating in a number of major overseas projects, including the construction of the Libyan Television Network in 1967-1968, and the expansion and conversion to colour of the Malaysian Broadcasting Service from 1972-1974. He was resident in the United States as the BBC's Senior Engineer, New York, from 1975 to 1978.

James Redmond: see page 2.



Terry Wade took his degree at Cambridge in 1963 and joined the BBC in Transmitter Capital Projects Department in the same year. For five years he worked on the planning and installation of low-power Band I and Band II relay stations. He then transferred to the External Services Section of the same department where he worked on HF aerials and automatic control systems for the short-wave transmitting stations at Skelton, Cumberland, and Tebrau in Malaysia.

In 1973 he joined the Transmission Section of Designs Department where he has worked on vision carrier equipment, the NICAM PCM equipment, and, more recently, various UHF equipments.

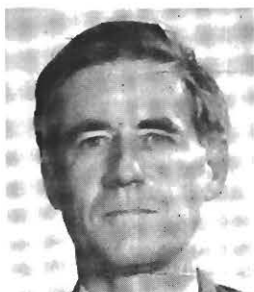

David Whyte studied electrical engineering at Imperial College, London, after wartime service in the RAF. He took his degree in 1949 and in the same year joined the BBC Research Department, where he has worked ever since. The projects on which he has been engaged cover a wide range of aspects of both sound and television broadcasting. Three of his published articles have won premium awards.

He represents the BBC on one of the BSI's Technical Committees and has also been concerned with overseas meetings of the IEC and EBU.