

# ENGINEERING

Autumn 1988 No.34

## IBC 88 — THE YEAR OF HDTV!

The 12th International Broadcasting Convention - IBC 88 - was held in Brighton at the end of September. This year, the exhibition occupied not only the same venues as IBC 86 (the Metropole, the Brighton Centre and the Grand Hotel) but two new areas as well - the West Pier Pavilion and the new Eureka Pavilion, both flanking the outdoor exhibit area on the lower esplanade. With this extended capacity, the number of exhibitors passed the 200 mark for the first time.

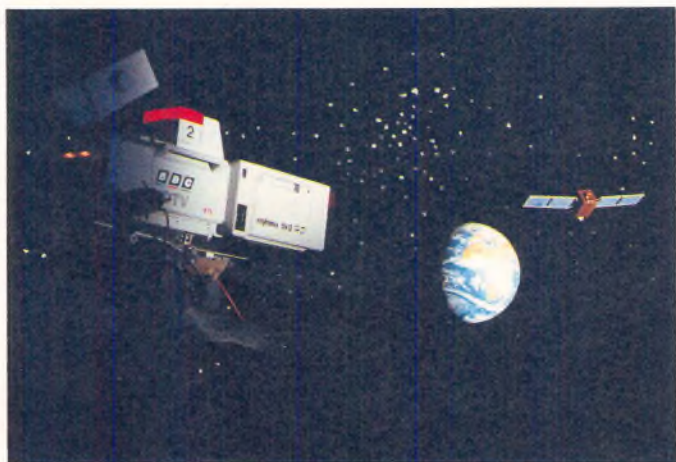

*Opening caption for the first commissioned programme in the 1250-line format, made at BBC Milton Keynes*

Bill Denny, Director of Engineering, had this to say about IBC 88:

"My own overall impression of IBC 88 was based on three elements. In the display areas, the developing of 625-line PAL production equipment - seen in its 525-line NTSC mode at previous exhibitions - was obvious. Small formats for television; digital developments in audio and video equipment; more sophistication in such areas as video effects and much improved CCD cameras, were all very evident. This gave the impression of an industry consolidating an established product base."

"In the presentation of papers we saw much more of the high technology of the future, both immediate

and more distant. Many papers on enhanced television were presented whilst in the exhibition areas, with two major exceptions, such developments were presented in fairly low key. The two exceptions were of course, the Eureka Pavilion and the Hi-Vision display at the University. Both were impressive but in totally different ways, as befits totally different messages being delivered."

"Eureka, with pride, was announcing a mid-term report showing it to be on course to meet its 1990 objectives. It represents a major success of international collaboration and collective technical innovation, whilst at the same time showing how much work needs to be done and what hurdles have to be cleared before the initiative becomes a broadcasting reality."

"The Hi-Vision display was what was to be expected from a system over eight years old in operation; the images, both visual and aural, were therefore suitably impressive. Eureka and Hi-Vision indicate the difficulties facing major broadcasters as we move towards enhanced television standards; my over-riding impression of IBC 88, from a personal view point, was the highlighting of these difficulties in an industry which is clearly in a robustly healthy condition."

A special feature on BBC Engineering at IBC 88 begins on page 4.

### RDS TAKES OFF

RDS was launched as a new service on 20 September at a special presentation in the Queen Elizabeth II Conference Centre in Westminster, London. It was hosted by Mr Marmaduke Hussey, Chairman of the BBC, in the presence of HRH Prince Michael Of Kent, who has many links with the motoring and radio industries.

See page 3 for a report on the launching ceremony.

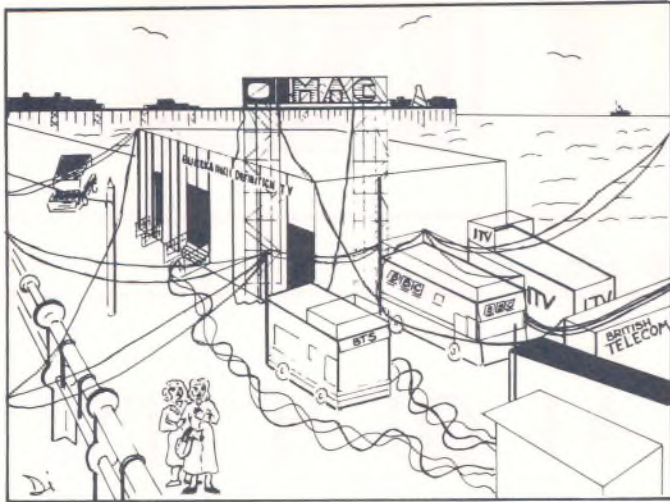

"So that's what they mean by 1250 lines!"

## FM Radio

Black Hill replaced Kirk o' Shotts as Central Scotland's main FM station, on 1 September. At the same time, Radios 2,3 and Scotland were joined by Radios 1 and 4 - the first time the latter two services have been broadcast on FM in Scotland.

Other main stations to commence a stereo FM Radio 1 service were Sutton Coldfield (West Midlands) and Holme Moss (near Huddersfield) on 1 September and Wenvoe (near Cardiff) on 29 September.

On 29 August, Radio Bedfordshire transferred its FM service from Luton Town to Zouches Farm, near Dunstable, which improves FM coverage in South Bedfordshire and extends it to parts of Hertfordshire and Buckinghamshire.

## LICENCE AGREEMENTS

A licence has been granted to ABL Engineering Inc. of Ohio, USA, which will assist them in developing a range of equipment using composite digital video signals. The original work was carried out by a small team at Research Department; the results of their studies formed the basis of - among other things - a digital video link between Pebble Mill and Television Centre.

The licence, which covers both know-how and a BBC Patent (British Patent Application number 86 12133), will allow ABL Engineering Inc. to design equipment and market it worldwide. The know-how being transferred covers such subjects as comb filters, DPCM predictors, error correction and conditional access, and applies to both 34Mbit/sec and 45Mbit/sec transmission data rates.

For further information on this, or any aspect of licensing, please contact the D&ED Liaison Engineer, Peter Jefferson, at Avenue House on telephone, AH 375.

## TRANSMITTER NEWS

The following stations/services have opened since 1 July:

### Television

Cumbernauld	Cumbernauld, Strathclyde
Duffryn	Maesteg, W. Glamorgan
Eston Nab	Middlesbrough, Cleveland
Strontian	Lochaber, Highland
Wall	Hexham, Northumberland

### World Service

On 25 September, World Service improved its coverage in East Africa, when the Seychelles HF relay entered service.

## D&ED's OPEN DAYS

Following the EsIC Meeting, D&ED held Open Days at Avenue House on 5-7 October.

The emphasis this time was on specific exhibits and work in progress, including:

- Implementation of RDS Travel Service
- Stereo Line-up Ident. Generator
- TFM modem for over-video transmission of NICAM signals
- Colour Phasing and Delay unit
- The new one-line, field-alternate ITS signal
- Cinetrace presentation of wide-screen films on television
- HF automatic test equipment
- Software engineering methods and tools
- Digital Audio Monitor
- Digital Limiter for AES/EBU audio bitstreams
- Band III Music-Quality Link equipment
- Development of a CSO facility for the Digital Video Mixer
- 'Leopard' patching system to interface with the new QII lighting controller
- Television Downloading

Also on show was Research Department's HDTV OB vehicle (which is described in an article beginning on page 14).

# RDS TAKES OFF

On 20 September, RDS was launched as an official BBC service at a special ceremony in London, hosted by BBC Chairman, Marmaduke Hussey, in the presence of His Royal Highness, Prince Michael of Kent.

Also present were: Tim Renton, MP, Minister of State at the Home Office with special responsibilities for broadcasting; Peter Bottomley, MP, Minister for Roads and Traffic and an avid campaigner for improved road safety, and Johnny Beerling, Controller Radio 1, who is chairman of both the BBC and EBU Steering Committees for RDS.

Before the presentation began, His Royal Highness was introduced by Johnny Beerling and Marmaduke Hussey to various staff involved in the realisation of RDS, including Bev Marks (the RDS Technical Project Manager), Dr Bob Ely (RD), Graham Snaith (TED), Simon Parnall (D&ED), Robert Amine (Enterprises Plc - the PR company handling the RDS launch) and Mark Saunders (the RDS Business Development Manager).



*HRH Prince Michael of Kent meets the RDS team, watched by Marmaduke Hussey and Johnny Beerling*

Radio personalities Simon Bates and Debbie Thrower introduced the guest speakers - Marmaduke Hussey, Tim Renton, Peter Bottomley and Johnny Beerling - to an audience of around 150 invited journalists, manufacturers, EBU representatives and senior members of staff. With the aid of two short videos and a demonstration of the new RDS Exhibition Model, the whole presentation took just over half an hour.

Guests were then invited to put their questions to a panel comprising Peter

Bottomley, Tim Renton, Bev Marks and Johnny Beerling. After fifteen minutes of lively questioning, refreshments were served in the adjacent St James Suite where guests were able to view current RDS equipment - both car radios and domestic tuners - which invited companies had put on display.

Those attending this small exhibition included Alpine, Blaupunkt (Robert Bosch Ltd.), Clarion, the Ford Motor Company, Grundig, Panasonic, Philips, Pioneer, Revox (FWO Bauch Ltd.), Sharp and Volvo. A version of Research Department's new RDS Reference Receiver was also on display.

## ENGINEERING SAFETY

The Engineering Management Safety Committee has just issued the fifth set of amendments to Engineering Safety Regulations (ESRs). These have been distributed by now to all holders of the little red binder which should be every engineer's constant companion. If by any chance you have been missed out in the distribution, please ask for a copy via your line manager.

Those with direct responsibility for other staff, eg managers, senior engineers and supervisors, should also have the Supplementary ESRs for Managers; amendments to these have also been issued.

The items mentioned above are obtainable from Ware Stores, under the following reference numbers:

- ESRs 9th Edition, reprinted with amendments 1-4 (Nov 85)...Ref 9367
- Amendment 5 to above (Feb 88)...Ref 9368
- Red binder.....Ref 9313
- Supplementary ESRs for Managers 2nd Edition (Jan 87).....Ref 9311
- Amendment 1 to above (Feb 88)...Ref 9310

Note that ESRs are printed on green paper while Supplementary ESRs for Managers are on pink paper.

(Note from Martin Nutt, Sec. to EMSC)

# BBC ENGINEERING AT IBC 88

BBC Engineering occupied Stand L12 in the Metropole Hotel but was also involved in Eureka Project EU95, based in the Eureka Pavilion. Additionally, the new Type B and Type C Radio OB vehicles were on display on the lower esplanade.



*BBC Radio OB vehicles on the esplanade*

In this special feature, we look at the wide range of BBC exhibits on show at Brighton, many of them in support of conference papers.

## INTERNATIONAL PROJECTS

Research Department is involved in two international projects - Eureka EU95 and RACE - which are supported financially by the EEC and National Governments and involve broadcasters, telecom providers, manufacturers and educational/research establishments throughout Europe. BBC work on these two projects was represented in Brighton as follows:

### EUREKA EU95 (HDTV)

This project aims to produce by the 1990s, a 1250-line HDTV system for production, transmission and reception - based on the MAC system with multichannel sound. The system will be compatible with 625-line MAC services but dedicated HDTV MAC receivers will have wide screens with an aspect ratio of 16:9. RD leads the project covering Display Standards and Up-Conversions and is involved in six of the other nine projects.

The ten Project Groups have been working towards a number of demonstrations to show

the progress of their studies and hardware implementation, in the period up to 1990. IBC 88 provided an ideal opportunity to demonstrate both hardware and system performance at the halfway stage. On display in the Eureka Pavilion was a fully compatible HDTV chain, including programme material - a significant advance on IFA Berlin 87 where only individual items of hardware were displayed.

Research Departments's mobile HDTV laboratory was parked outside the Pavilion. It houses 1250-line camera and vision equipment and has four 625-line VTRs configured to operate as an HDTV digital VTR, including editing. It is fully described in Geoff Key's article which starts on page 14.

On the BBC stand, HDTV exhibits included the showing of a TFS film entitled 'Kew Gardens' which was shot on 35mm film at 50fps. A Rank Cintel Mark IIIC flying-spot telecine, modified by Rank Cintel to operate at 50fps and with a 1250/50/2:1 raster, was used to replay the film (which



*The busy HDTV display*



*The optical WDM display*

is of considerable arboricultural interest as it shows views of The Royal Botanic Gardens at Kew before they were greatly altered by last October's severe storms). The aperture corrector was designed by RD in a collaborative venture with Rank Cintel.

Another exhibit showed the input and output monitors on a Line Rate Up-Converter which RD has developed to convert 625-line tv signals to the 1250-line format of HDTV.

Some thirty conference papers were presented on HDTV - mainly by Eureka participants - including two on Digitally-Assisted Television (DATV) by Dick Storey, one on HDTV displays by Mike Stone and Nick Tanton and one on up-conversion techniques by Martin Weston and Dave Ackroyd, all from Research Department.

#### **RACE**

This project was described in some detail in 'Eng Inf' No32. It stands for Research and development in Advanced Communications technologies in Europe and its objective is to make technology available for the building of a Europe-wide digital communications network using optical fibres.

The BBC leads one of the forty-three projects - to develop a Broadband Customer Premises Network (BCPN) that can carry digital video, sound and control signals, with a wide range of bit-rates, including HDTV. A BCPN is the type of signal distribution and routing system that is used in a television studio centre, as well as in industry, commerce, education and public services.

The network relies on optical fibres to

carry sixteen separate waveforms and uses a combination of optical wavelength-division multiplexing (WDM) and electrical time-division multiplexing (TDM) - the combination being known in abbreviated form as 'WTDM' (Wavelength and Time Division Multiplexing).

The principle of operation of optical WDM was demonstrated on the BBC stand, in support of a conference paper 'Development of a digital optical routing system for television studio centres', presented by Andrew Oliphant of Research Department.

## **STUDIO SYSTEMS**

### **DIGITAL AUDIO EDITING**

Research Department first demonstrated a prototype digital audio editor at IBC in 1984. Further development has since been carried out and a completed system was installed last year in Broadcasting House, London, and has been used to edit a variety of speech and music programmes. Studio Managers have found the digital system very rapid and simple to use, achieving very high quality edits with ease.



*RD's Digital Audio Editor*

Based on high-capacity magnetic storage (Winchester discs), editing is performed by compiling a list of extracts from the recorded material and replaying it in sequence to form the edited programme. Locating the required edit-point (performed on analogue tape by physically 'rocking' the tape back and fore) is achieved by means of a large knob, in conjunction with signal processing, which electronically simulates the analogue technique.

**Continued on next page**

**Continued from previous page**

The BBC recently entered a collaborative research agreement with Real World Research (RWR), so that many of the editor's features can be incorporated in commercially available equipment. BBC Radio has already taken delivery of two RWR 'Tablet' editors and a further four are due shortly. An enhanced version of the 'Tablet' editor, bearing the fruits of the RD/RWR research agreement, is expected to become available in the near future.

This exhibit supported the paper 'The realisation and exploitation of a digital audio editor' presented by David Kirby of RD and Simon Shute of Radio Engineering.

**RADIO OB VEHICLES, TYPES B & C**

The new Type B and Type C Radio OB vehicles have already been described in 'Eng Inf' (No 32). The two vehicles on display at Brighton are destined for Manchester (the Type B) and Glasgow (the Type C).

ETD has produced leaflets on the two vehicle types and copies can be obtained from RCP at Woodlands (Keith Harte on TVC x7026).



*Keith Harte (RCP) in the Type B vehicle*

**VIDEO WATERMARKING**

Research Department has developed a system for 'watermarking' a video signal: it is invisible during normal viewing and cannot be detected by normal video test equipment. The system enables a video source to be positively identified and has been in experimental use on all BBC1 and BBC2 networked programmes passing through Television Centre over the last three years.

The watermark identifies the network which

carried the programme, together with the date and time (to the nearest ten minutes) of the original recording. It has been shown in tests to be very rugged and is not rendered unusable by any processing included in the television distribution chain. The watermark is extremely difficult to remove and hence offers considerable security.

At the exhibition, off-air BBC1 and BBC2 signals as well as VHS recordings were decoded, with the help of a BBC Micro, and the resultant watermark information displayed on a monitor.

**COMMUNICATIONS SYSTEMS**

**BAND I RADIO MICROPHONE**

D&ED's new Band I system operates in the two post-Merriman sub-bands allocated for radio-mic use: 53.75 - 55.75 MHz and 60.75 to 62.75 MHz. By using low-deviation FM for spectral efficiency, nineteen 100 kHz-spaced channels can be accommodated in either sub-band - with no compromise on audio quality. However, having the channels so closely spaced can lead to intermodulation problems between nearby transmitters. The new equipment addresses this problem by using circulators in the aerial feed.

Full details of the system are given in D&ED's leaflet, EDI 10552(1).

**BAND III MUSIC LINK**

This new D&ED system operates in the post-Merriman sub-bands at 141, 213 and 224 MHz, where channel spacing of only 75 kHz is employed. Like the Band I radio-mic, the music link uses several novel design features to allow efficient use of the



*The Music Link in the Type B vehicle*

narrow channel spacing, with no compromise on audio performance.

The system has been designed for point-to-point OB link use, carrying both programme material and communications. With a power output of 10 watts, the transmission range is in excess of 40 km, in open countryside.

Further information on the music link is given in D&ED's leaflet, EDI 10561(1).

### SOUND MULTIPLEX TRANSCIEVER

This unit, designed for OB use, will simultaneously multiplex and demultiplex up to five narrow-band signals, for transmission over a single bearer of bandwidth 15 kHz. The five signals are combined using FDM techniques and one of three operating modes can be selected.



*Graham Whitehead (D&ED) with the Sound Multiplex Transceiver*

Mode 1 simply provides five narrow-band control channels while Mode 2 allows a single music channel of bandwidth 5 kHz to be combined with three control channels. Mode 3 sacrifices a further control channel in order to expand the bandwidth of the music channel to 8 kHz. Music channels always occupy the 1f end of the multiplex configuration while the top two channels (numbered 4 and 5) incorporate audio companders which may be switched into circuit - to improve audibility when the bearer is subject to excessive amounts of hf noise.

The system is based on digital techniques and will be fully compatible with future digital bearers - allowing a direct digital transfer without the need for DA/AD conversion.

Further information on the transceiver is given in D&ED's leaflet, EDI 10558(1).

## TRANSMISSION SYSTEMS



### RDS

RDS generated a great deal of interest on the BBC stand - second only to HDTV. On display were:

- An RDS Encoder as used at BBC FM stations
- A Travel Control Unit for use with the future travel service
- An RDS Monitoring Receiver with built in display of decoded data
- An RDS Reference Receiver

The encoder was fed with taped programme material, typical of Radio Sussex, to provide a 'BBC Local' service. A second encoder was used to provide a 'BBC Network' source, this signal being derived from an off-air programme feed, mixed with locally-generated Radio Data. These two signals were available to the receivers on the stand, along with a conventional off-air feed.

Using this set-up, two RDS facilities were demonstrated - Auto-tuning and Travel Service. (The latter is not yet available but five BBC LR stations in central and southern England are due to participate in a Travel Service experiment next year.)

An RDS radio will select and tune to the strongest available signal, automatically; the listener only has to select the wanted service by pressing a button. In order to do this, the receiver has to identify the transmission which has been tuned and this is achieved by means of the Programme Identification (PI) code which has been allocated to national, regional and local services throughout Europe.

However, a second code - Alternative Frequencies (AF) - is required to inform the receiver of all the alternative transmitters in the area which carry the same programme service. An RDS receiver constantly compares the signal strength of the current transmission with those in its AF list - retuning instantaneously to an alternative if it finds a better signal.

**Continued on next page**

## IBC 88

### Continued from previous page

This facility is more useful to the motorist, whose RDS radio will be supplied with a new AF list whenever it retunes to an alternative frequency during the journey.

A third code - Other Networks (ON) - is also monitored continuously by an RDS receiver. This code keeps the radio informed of the preferred frequencies for the other network and local stations in the area. Thus, if the listener decides to change channels, say from Radio 1 to Radio 4, the new station is instantly heard when its button is pressed.

The Travel Service relies on two RDS codes - Travel Programme (TP) and Travel Announcement (TA). The TP code indicates which stations broadcast travel announcements as part of their programme output. The TA code, on the other hand, identifies that a particular station is currently broadcasting a travel message.

The TP code is primarily of benefit to listeners with basic RDS receivers; it enables them to select a station which broadcasts travel messages. The TA code,



*John Riley (RD) with Johnny Beerling (CR1) at the RDS display*

however, is intended for listeners with more sophisticated RDS receivers, who do not necessarily wish to tune to the station carrying the travel messages. Whenever a TA 'flag' is raised, the radio will tune to the station carrying the travel announcement, for the duration of the message only, then return to the original station selected (or to cassette if selected, or even to silence if that is what the motorist wants).

BBC staff presented two papers on RDS: 'The technical realisation of a new broadcast service', by Rhys Lewis, Simon Parnall and John Robinson of D&ED, and 'The planning and implementation of a new broadcast service ( using high reliability systems)' by Bev Marks of RCP.



### MARK II NICAM-3

At present, the digital distribution of audio signals and transmitter control data is by means of 6-channel NICAM-3 equipment (designed in 1980), in conjunction with the 13-channel linear pcm network, which entered service in the early 1970s. The latter is due to be phased out over the next few years and the 8.448 Mbit/s data bearers might be re-engineered to carry a total of twenty-four NICAM-3 channels. With this in mind, D&ED has developed a mark II version of NICAM-3.

The original version was based on 2-channel audio circuits on a 676 kbit/s bearer; three of these could be multiplexed to provide the BT-standard 2.048 Mbit/s data stream. However, being totally hardware-based, it resulted in fairly bulky equipment - 12U of racking space for the coder and a further 12U for the decoder (ie 2U per channel, coder or decoder).

Experience gained in developing the more recent 2-channel, sound-in-sync (SIS) system for television has led to a much trimmer (and cheaper) version of NICAM-3. The new coders and decoders are based on the LSI gate array which was developed for 2-channel SIS - in conjunction with a single Z80 microprocessor and a separate sequencer, based on hardware, to control coding or decoding as appropriate. Each coder/decoder pair will handle six audio



channels along with control and other data (eg RDS) at an overall bit-rate of 2.048 Mbit/s. A single 6U rack can accommodate either two coders or two decoders (ie 0.5U per channel, coder or decoder), thus yielding a 4:1 space saving over the original version - and a 50% saving in costs!

Further information on Mark II NICAM-3 is given in D&ED's leaflet, EDI 10559(P).

### CONDITIONAL ACCESS TELEVISION

Conditional Access (CA) is the term given to a tv system which has been encrypted or 'scrambled' for restricted use by subscribers who have the appropriate descrambler. No international standard exist for CA television but a new generation of digital techniques has been developed, primarily for use with the proposed DBS services. The BBC is no longer involved in DBS but has become involved with the application of CA techniques to the existing UHF networks, as part of the current Downloading experiment. In this, special medical broadcasts are scrambled and transmitted outside normal programme hours to be automatically recorded, via a descrambler, on a domestic VCR.

An adapted commercial CA system is used for this experiment but it does not offer a particularly high level of security. In the longer term, many other applications of CA are foreseen - some of them requiring much higher security and a business management system. Thus the search is on for a second generation system for terrestrial broadcasting, which will offer a degree of commonality with systems designed for DBS. It will of course need to be compatible with the existing UHF network so that no degradation to existing viewers is caused by its use.

Active line rotation (ALR) scrambling of a PAL signal is similar to the component rotation scrambling method used in the MAC/packet system. It comprises cutting and rotating the active line video information so that the portion extending beyond the end of the line is transferred to the space at the beginning of the line.

As the cut-points can be positioned at many different points throughout the active line period and can be changed from line to line, the security is high and the picture content is unrecognisable.

Although ALR is one of the more complicated methods of picture scrambling, it requires only small amounts of storage in the decoder. Further development is needed, however, to produce decoders with sufficient ruggedness to operate satisfactorily when subjected to the kind of distortions that may be encountered in terrestrial broadcasting.



*Bob Ely of RD (centre) demonstrates CA with Peter Jefferson of D&ED (left) looking on*

In the longer term, the BBC's choice of a CA system is likely to be based upon ALR techniques, combined with a scrambled version of the NICAM 728 stereo sound with television system. It will also need a business management system using a detachable CA sub-system, preferably compatible with those being developed with MAC/packet services. Encrypted data signals for the CA control would probably be accommodated in or near the vertical blanking interval.

A paper on this topic was presented by Chris Clarke of Research Department.

### A STEERABLE FLAT-PLATE ANTENNA for DBS

On the stand was a display giving the design features of a Steerable Flat-plate Antenna for DBS use. This type of antenna can be less obstrusive, and easier to point and support in high winds, than a traditional parabolic dish - and it offers electronic beam steering. However, a practical design needs to be relatively cheap and capable of being mass produced.

In its simplest form, it would be mounted flat on the most favourable wall (or roof slope) and would 'look' permanently at one satellite - using a cheap passive microwave lens to achieve the correct beam alignment. The RD antenna uses a polar

**Continued on next page**

Continued from previous page

method of beam steering where the beam is slewed in one plane and the antenna is mechanically rotated in its own plane to achieve the required alignment.



Mark Maddocks (RD) discusses the Flat Plate Antenna design

Operating in the satellite sub-band, 11.7 - 12.1 GHz, a gain in excess of 30dBi could be expected from a production version of the antenna. Anyone requiring further information on the design should read RD Report 1988/6 'A flat-plate antenna for DBS reception'.

## TEST EQUIPMENT

### ITS GENERATOR and INSERTER

Making considerable use of EPROMs, this ITS Generator/Inserter can be programmed to provide a range of insertion test signals, including the current two-line national and international ITSS and the new one-line field-alternate ITS (occupying lines 21 and 334). It can also accept data and monitoring signals for multiplexing into the new one-line signal.

An internal cross-point pin matrix is used

to 'program' the unit. In addition to selecting the required output, it enables lines in the range 6 (319) to 22 (335) to be erased or another signal to be inserted; this signal may be generated internally or externally. The applied waveform is inserted on the same line of the outgoing video as that on which it was sited previously and thus, any external signal must be synchronised to the generator.

The conditions for signal insertion are set up from the front panel by means of a three-position switch; the ITS may be OFF, ON permanently, or it may ALLOW the signal to be inserted into the video feed conditionally - depending on whether the incoming feed already has ITS present.

The unit can also generate up to sixteen full-field test waveforms and is capable of being controlled remotely.

Further information on the generator/inserter is given in D&ED's leaflet EDI 10560 (1) while leaflet EDI 10562 (1) covers the new one-line ITS.

A conference paper on the one-line ITS was presented by Colin Spicer and Richard Hubbard of D&ED.

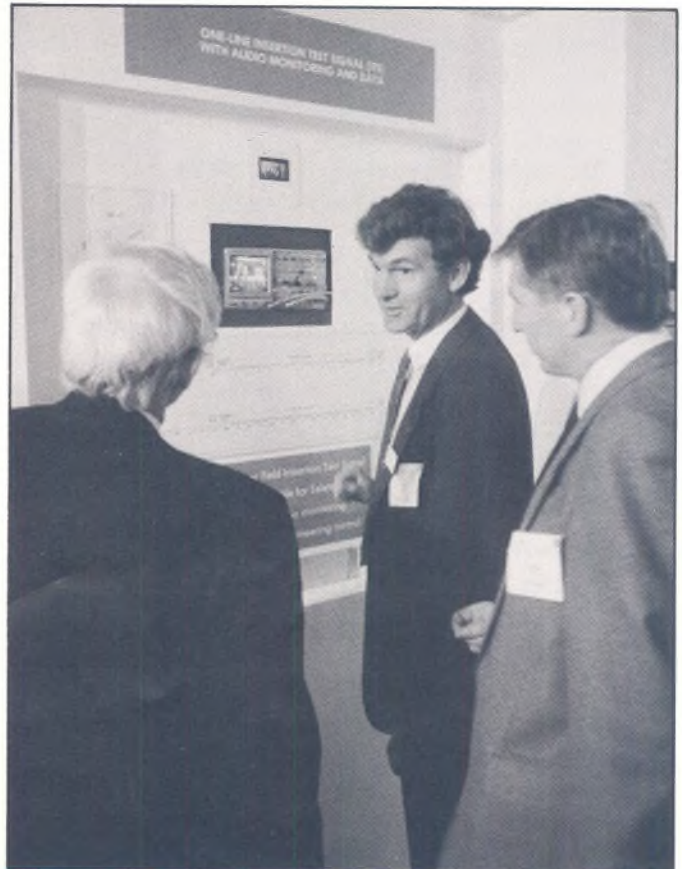

Colin Spicer of D&ED (centre) discusses the One-line ITS, with David Bradshaw of D&ED looking on (right)

## DIGITAL AUDIO WAVEFORM GENERATOR (DAWG)

This generator provides a dual-channel source of digital test waveforms in the standard AES/EBU serial format, ie a transformer-coupled, bi-phase mark encoded RS422 bitstream. The waveforms for each channel are reproduced at a resolution of up to 20 bits per sample at sixteen spot-frequencies and forty-four output levels, according to data held in internal EPROMs. However, the unit may be reprogrammed to provide any required frequency from 12Hz up to around 24kHz (limited by aliasing products).

Separate controls for the A and B channels of the stereo signal are provided to allow maximum flexibility; however, these may be locked together electronically from the front panel so that one knob adjusts both channels simultaneously. Sinusoidal and ramp waveform representations are available and full control has been provided - both static and dynamic, as required - over the V, U and C bits.

The unit which was demonstrated at IBC 88 is one of three examples of this equipment that have been produced by the BBC. A non-exclusive licence agreement has been struck with Pro-Bel Ltd., from whom essentially identical items may be acquired.

The AES/EBU serial format for digital audio signals is defined in EBU Document Tech.3250-E, 'Specification of the Digital Audio Interface', while D&ED's leaflet EDI 10555 (1) gives further information on DAWG.

## DIGITAL AUDIO MONITOR

This portable monitor - a companion unit to DAWG - accepts an input of serial bitstream, within a sampling frequency range of 32-48 kHz. The input is transformer-balanced and equalisation for varying cable lengths may be adjusted internally by means of a link. A four-position switch allows different audio de-emphasis characteristics to be selected from the front panel, as follows:

- 1 Flat (no de-emphasis)
- 2 50/15 microseconds
- 3 CCIR Rec. J17
- 4 Automatic

The audio, which is derived from a 16-bit DAC employing 4x over-sampling, is band-limited to 15kHz. A miniature PPM

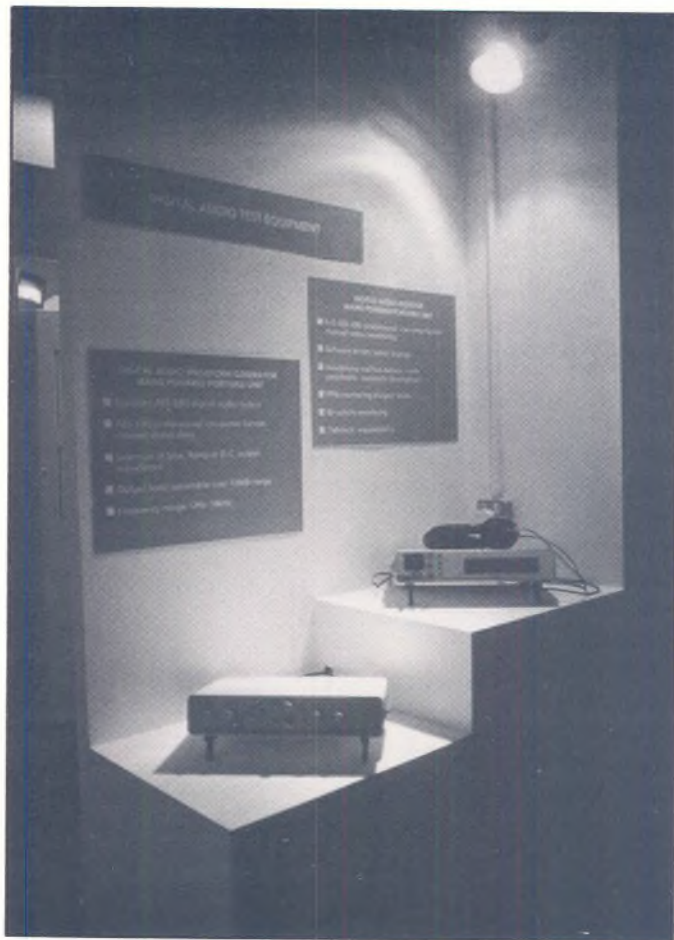

*DAWG and the Digital Audio Monitor*

indicates the audio output level, and can be switch-selected to measure either 'A', 'B', 'M' or 'S'.

The front panel includes a four line by forty character liquid-crystal display, onto which a number of 'pages' of information can be selected by use of four menu-driven 'soft-keys'. It is anticipated that most of these displayed pages will be set up to show the following:

- 1 Incoming data format
- 2 Routing and timecode
- 3 Signal data, including parity and validity errors
- 4 Channel status (Hex)
- 5 User bits status (Hex)
- 6 'A' and 'B' channel bitstream activity

Further information on the monitor is given in D&ED's leaflet, EDI 10557 (1).

## MEASURING the PERFORMANCE of DVTRS

New digital recording formats offer the possibility of recording and editing many generations, without significant loss. Continued on next page

## IBC 88

### Continued from previous page

However, the new digital formats are complex and it is not always clear whether a recording operation has been successfully achieved and that the recorded tape will replay satisfactorily on other machines using nominally the same format.

There are many different factors which contribute to the ability of a recorder to replay a recording successfully. Failure to do so with a DVTR causes errors in the replayed signal. The presence of such errors could be used to indicate the state of the recording but it is an objective of the present work to establish the margin of performance, without having to wait until a recording is lost.

It is a characteristic of digital recording that the recording channel can still provide low error rates whilst working close to the point of complete failure. Beyond that there is a sudden onset of errors when they occur at a greater rate than the error handling system can manage.



*Richard Salmon (RD) checks the performance of a DVTR*

Equipment has been constructed by Research Department which allows the signals being recorded and replayed in a digital recorder to be intercepted. Signals from the replay heads may be applied to a high speed ADC and stored temporarily in memory at rates of up to 162MHz. A desktop computer is programmed to process the stored signals to analyse their spectral

characteristics. They can also be processed using software which simulates the operation of idealised data recovery circuits. Other software has been developed to identify the effects of tape defects so that these can be separately analysed. The affected periods of captured waveforms can be ignored in measuring the general record/replay characteristic of the recorder under test.

The demonstrations on the BBC stand showed the analysis of signals replayed from the heads of a D1 digital video recorder. Software has been prepared to separate the effects of tape defects from variations in the performance of machines. The equipment has also been used to provide statistical data on media and the relationship between the different portions of a complex helical format like the D1 format. In this case, the relative positions of the audio and video sectors recorded on the same helical scan have been accurately measured.

A paper 'The Measurement and Monitoring of the Performance of DVTRs' was presented at Brighton by Alan Bellis and Chris Williams of Research Department.

## TRAINING

### TELEVISION TRAINING

Television Training Department mainly caters for BBC staff but recently there has been a move to widen the department's catchment area to include long-term unemployed people who have an interest in television, thus enabling them to apply for jobs in the industry. The department also runs annual refresher courses for overseas broadcasters and programme makers, who have been sponsored by their parent company, and short courses (often at weekends) for non-BBC individuals who are prepared to pay their own costs.

Several training manuals and video training tapes have now been prepared (or are in preparation); some of these were on display at the BBC stand. They are also available at a modest cost to outside organisations.

For further information, contact:

Publications and Marketing,  
Room N327,  
Elstree Centre.

## ENGINEERING TRAINING

Some books produced and used at the Engineering Training Centre were also on display at the BBC stand. Further information on these can be obtained from Manager, Planning and Resources, ETD, Woodnorton.



*A potential recruit at the BBC Training display!*

## TECHNICAL SESSIONS

Many of the BBC exhibits were in support of conference papers which have already been mentioned in the preceding pages. However, a number of papers were presented in addition to these:

### Studio and OB Facilities

'A helicopter tracking receiver for television outside broadcast links' by Chris Gandy (RD).

### Transmitters and Antennas

'Health and safety with RF broadcast radiation' by Pete Shelswell, Bob Thoday and Sue Wakeling of RD.

'HF antenna radiation patterns over real terrain' by Dick Manton and Karina Beeke of TED.

'The planning and construction of an HF relay station in Hong Kong: a design for automatic and unattended operation' by Gordon Harold (TED).

### TV Graphics etc

'Distorting the time axis: motion compensated image processing in the studio' by Graham Thomas (RD).

'Using the 8 bit CCIR recommendation 601 digital interface' by Mike Croll, Vic Devereux and Martin Weston of RD.

### Sound Systems and Radio Broadcasting

'Proposals for high quality digital sound broadcasting for mobile and fixed radio receivers' by Paul Ratliff, Jonathan Stott and Bill Williams of RD.

'Digital audio in the BBC's radio network operations' by Richard Lawrence and Viv Weeks of D&ED, Simon Shute of Radio Engineering and Tim Shelton of RD.

\* \* \* \* \*

Further information on the RD exhibits can be obtained from Res. Ex. at Kingswood Warren (x224) and on the D&ED exhibits from Peter Jefferson at Avenue House (x375). Information on RDS can be obtained from Mark Saunders in Room 104 Duchess Street, (LBH x4024/4457) while Brendan Slamin, Special Assistant to DE, can supply more information on Eureka EU 95 and RACE (LBH x5784/7826).



*Terry Leyland (RD) with a visitor to the BBC Stand*

# THE HDTV OB VEHICLE

CMCR 13 (Ex-Wales) has died of old age! It was built by Pye TVT in 1971/2 as a speculative venture and, following a sales tour of Africa, was bought by the BBC to augment the fleet of Type 2 CMCRs which had just gone into service.

Research Department recently completed what amounts to a reincarnation within the resprayed vehicle shell. All the original equipment, and most of the racking structure, has been replaced with a purpose built framework to house two HDTV cameras, with monitoring, mixing and distribution, and a digital HDTV recorder which has been built using four Sony D1 digital video recorders. The rear part of the vehicle is now dedicated to a demonstration and editing area, which has been acoustically treated and isolated from the rather noisy machine area.

The vehicle will be used to introduce HDTV

to programme making at normal television venues; previously HDTV has been restricted to experimental and demonstration roles and to film scanners and synthesised pictures.

Shortly before IBC 88, the unit was driven to the OUPC at Milton Keynes where it recorded the first commissioned programme in the Eureka standard. This programme was used to explain the principles of Eureka HDTV to the delegates at IBC 88. An HDTV recording of the Changing of the Guards, at Buckingham Palace, was also shown at Brighton. The producers concerned are most enthusiastic about the potential of the new system.

One high definition camera, a BTS (Bosch-Philips) KCH 1000, has been bought. It is fitted with three Saticon tubes with a special high resolution layer, and can resolve 27 MHz at the 12-line standard.



*HDTV editing and conforming in the HDTV vehicle*

*L to R: Alastair Bruce (RD), Graham Pearson (OUPC) and Phil Ashby (OUPC)*

This is in excess of the recording capability, and implies focussing problems for the cameraman. A second camera has been loaned by BTS as part of their Eureka contribution, as was an analogue recorder which was used as a back-up to the BBC digital one. As a consequence of the development nature of this equipment, delivery in time for the Milton Keynes programme was on a very tight schedule - only achieved with the cooperation and advice of the BBC Shipping Section at Heathrow and with BTS who sent over four specialist engineers.

The camera produces RGB signals, and these are distributed to the vision mixer and throughout the vehicle for monitoring. Four D1 digital video recorders have been arranged with a cleverly conceived multiplexing system to record and replay together under the control of a specially programmed edit controller. The RGB signals are converted to YUV signals (with bandwidths of 23, 11.5, and 11.5 MHz respectively) prior to conversion to four interleaved 625-line pictures, which are separately recorded; conversely, on replay, the four machines run together with their outputs combined into one 1250:50 signal.

One of the 625-line signals is made available for distribution to any 625-line monitors, used for example as a commentator's monitor.

Because only one set of four such recorders is available, editing is carried out using just two machines at a time, then working through the four sets of tapes repetitively. This operation is carried out while the signal remains in digital form so that there is no general deterioration in picture quality with successive generations of recording.

The interleaved format has the advantage that every recorder carries a full picture. An alternative method divides the picture into four quadrants and allocates one quadrant to each machine. There are advantages to both methods and the multiplexer can be set to work in either mode.

The recorders each have the capability of recording four high quality sound channels, so sixteen are available in all. However, the vehicle has been configured with only a simple sound mixer since it will be used with stereo sound mixing equipment, currently in operation.



*The HDTV vehicle at IBC 88*

Two LS5/9 loudspeakers have been provided in the demonstration area to show the full potential of the system.

A simplified version of the standard OB communications system has been included.

Research Department resources were stretched to the limit to complete the work in time to make the recordings for IBC. While their ideas had previously been proved to work (using hand-built circuits, processing parts of a static picture), it was a big leap to the manufacture of complete units and unforeseen problems arose, right up to the last minute, which had to be resolved.

Further, the recorders operate within very fine mechanical tolerances and special arrangements have been made for them to travel separately, in a vehicle with soft suspension, and to be carefully loaded into the operating racks at each site.

It is intended to use the vehicle as a mobile laboratory so that alternative equipment proposals can be tested out in a real-life environment.

Geoff Keys,  
HDTV Vehicle Co-ordinator

# BIRMINGHAM INITIATIVE....

When a new studio set and programme format were introduced at Pebble Mill for 'Midlands Today', the acquisition of a Rank Cintel Artfile gave the production team the opportunity to use wholly electronic graphic sources. Graphic Designers, Marcus McGuinness and Andrew Turley, asked: "Would it be possible to generate transparent 'boxes' into which Aston captions could be placed?". "Probably" was the answer provided by the local projects team, John Macavoy and Ian Sykes, ".....but when do you want it?". The reply came: "In two weeks time!".

The new programme format required Aston text to be inserted into one of two transparent blue boxes, one of which incorporated a logo. The composite (ie Aston + box) would provide an infill feed for the downstream keyer (DSK). Simultaneously, the new format might require an inset picture or logo to be inserted over the presenter's left or right shoulder, using the effects bank.



*The transparent blue boxes and inset picture on 'Midlands Today'*

It would have been possible to store these various insets on a slidefile along with the corresponding mattes, using the preview feeds to provide the key for the mixer. However, with only one slidefile available and a live programme to produce, it would not have been practicable to lose the preview facility in this way. The inset had previously been achieved using box wipes, which required setup time during rehearsal.

The projects team set about designing and making a unit that would meet the require-

ments of the new format - without any extensions to the vision mixer or additional operational complications, such as multiple simultaneous cutting or an extra slide-file. The unit also had to recognise the type of slide content, in order to provide the correct key mattes for the two boxes and the left- or right-hand insets.

Despite the large data-handling capabilities of the slidefile, and the large amount of spare data moved with each picture, this data is not readily accessible so an 'in picture' method of identification was developed. This consists of a train of red dots, at the top left-hand corner of the frame, carrying binary code and error protection.

As time restraint was the major problem, the matte frame store and AD-DA convertors were laid out using our EE Designer 2.5 CAD software. The analogue RGB Aston insertion, the red dot separation and the system control cards were produced by manual pcb artwork and/or wirewrap. The matte storage employs 64K by 4 bit or, in the later version, 1 Mbyte dynamic ram SIL modules. The remainder of the digital circuitry exploits the extremely low power requirements of high speed CMOS.

The only production overhead is that a series of pre-made pictures with blank insets and boxes are used by the graphics area as a base on which to build up pictures for programme insets. These pre-made pictures include their unique red dot code.

In order to provide the required key mattes simultaneously, with partial transparency, a four level (2 bit binary) frame store was made with two frame capacity. Key switching - in three zones (top left, top right and bottom) in any combination under automatic red dot control - provides the correct matte segments to the two key outputs (DSK and Bank). The mattes are automatically loaded from the slidefile, having red dot codes themselves, and are retained in memory during the programme.

If commanded to do so by the red dot control system, the unit will inlay Aston text into the slidefile blue box and add the Aston key to the matte for the mixer



DSK. This single composite picture - slidefile plus Aston - provides the infill for both the DSK and bank keyers. The RGB addition of the Aston and slidefile outputs also provides a cleaner composite for the graphics area to make up pictures, being available as a grab source within the electronic graphics area.

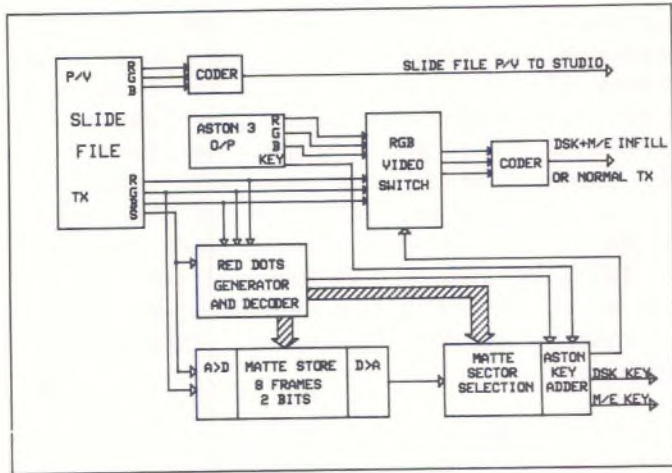

Block diagram of the red dots system

The use of linear keyers in the studio mixer and soft-edged mattes throughout the system (except the Aston 3 key) has also reduced aliasing on the mixer output. This was particularly noticeable around inset pictures, supposedly on the wall

behind the presenter's shoulder. Three of the units have been made, two of which are resident in the graphics apparatus room. The third has capacity for eight frames of storage and multiple RGB overlay facilities, and has been used to generate or modify complex on-site graphics for the RAC Rally. This unit is capable of being driven by a micro-computer.

The basic unit consists of four 100 x 160mm cards, plus power supply, in a 3U-19 inch rack and is connected between a slidefile and its transmission output coder. This means that the unit takes little space and does not need to be routed separately, as it appears as an ordinary slidefile when a picture without red dots is displayed.

The units have made the use of picture and text composites, particularly on "Midlands Today", much more manageable as well as providing useful graphics facilities. Most noticeable has been the improvement in the text overlay and picture inset quality.

John Macavoy and Ian Sykes  
Project Engineers, Pebble Mill

## ....SOUTHAMPTON INITIATIVE

In an effort to improve the control of tapes being used for the Portable Single Camera Unit, a bar code system has been developed and introduced in Southampton.

Unlike film stock, PSC tapes are re-used up to five times and at any given time, a particular tape might be: held in stock, with the cameraman, in for editing, held in the library or in to be wiped for re-issue. It was found desirable to develop a control system which could identify a specific tape and then keep track of its progress through these various cycles.

The system had to identify when tapes had been used five times, store information on an individual cameraman's stock and be able to trace batches of tape in case of a manufacturer's fault. Simple operation was important, especially as stock control would not involve the recruitment of extra staff.

At an early stage, it was decided that a

bar code system was the best solution with each tape being allocated a unique number. Also, because quantities of PSC tapes are not easily portable, a Psion Organiser with bar-code facility was chosen, to enable tapes to be logged in and out easily. As well as identifying the tapes, the bar codes are used to input instructions, making the system very easy to operate.

MPSE, MPF and OM guided the development, while the detailed planning and programming was carried out by Technical Operator, Steven Cole. A fourth generation language was used - Clipper, which is similar to dB3 but faster. The computer used was an Epson PCAT 40 while labels were printed on a high quality dot-matrix printer.

Anyone requiring further information on the system should contact MPSE South (Mike Cox) in Room 322, Southampton (Tel: 225).

# NEW CEEFAX COMPUTER

On Sunday 10th July, a new Ceefax computer system entered service. Viewing at home, you may have seen little improvement although, looking more closely, you should have noticed that the waiting time has been reduced by 10-15% and that all pages now carry 'Fastex' prompts.

The new system has been installed to provide a springboard to the future and will enable Ceefax to offer a better, quicker service through the use of:

- 1) More TV data lines - tests are already taking place.
- 2) An option for allocating more capacity to the fast changing pages, eg Football or Election results.
- 3) A system capable of transmitting Level 2 - the next phase of teletext development which will give better graphics, more colours, more characters and scrolling. To receive this at home, a different decoder will be required but the effect can be seen on Ceefax-in-Vision now.
- 4) Computer-to-computer links with outside data sources, like the Stock Exchange or Prestel, thus giving up-to-the-second information on screen.

- 5) A more reliable service with comprehensive standby facilities - the old system had become very unreliable.

The new system, built by Softel Ltd of Pangbourne, utilises five DEC PDP-11 computers, interconnected by a local area network (LAN). As shown on the diagram, three of these are used for Editorial Master, Standby and Information Provider (IP) Master, while the remaining two are used as Transmission (TX) units for BBC1 and BBC2. The system can support thirty-two Edit terminals, either in the News Room or at remote sites, and sixteen lines to other computer systems (Information Providers).

Specification for the system was completed in early 1987 by Project Leader, David Crawford of Central Systems Section (CSS), P&ID Tel, who managed the testing and installation with the assistance of David Clarkson, John Wynne and Chris Przeslak, also of CSS.

Now the system is settling down, a start is being made in implementing some of the benefits which are outlined above.

Gaeron Davies,  
Central Systems Section, P&ID Tel

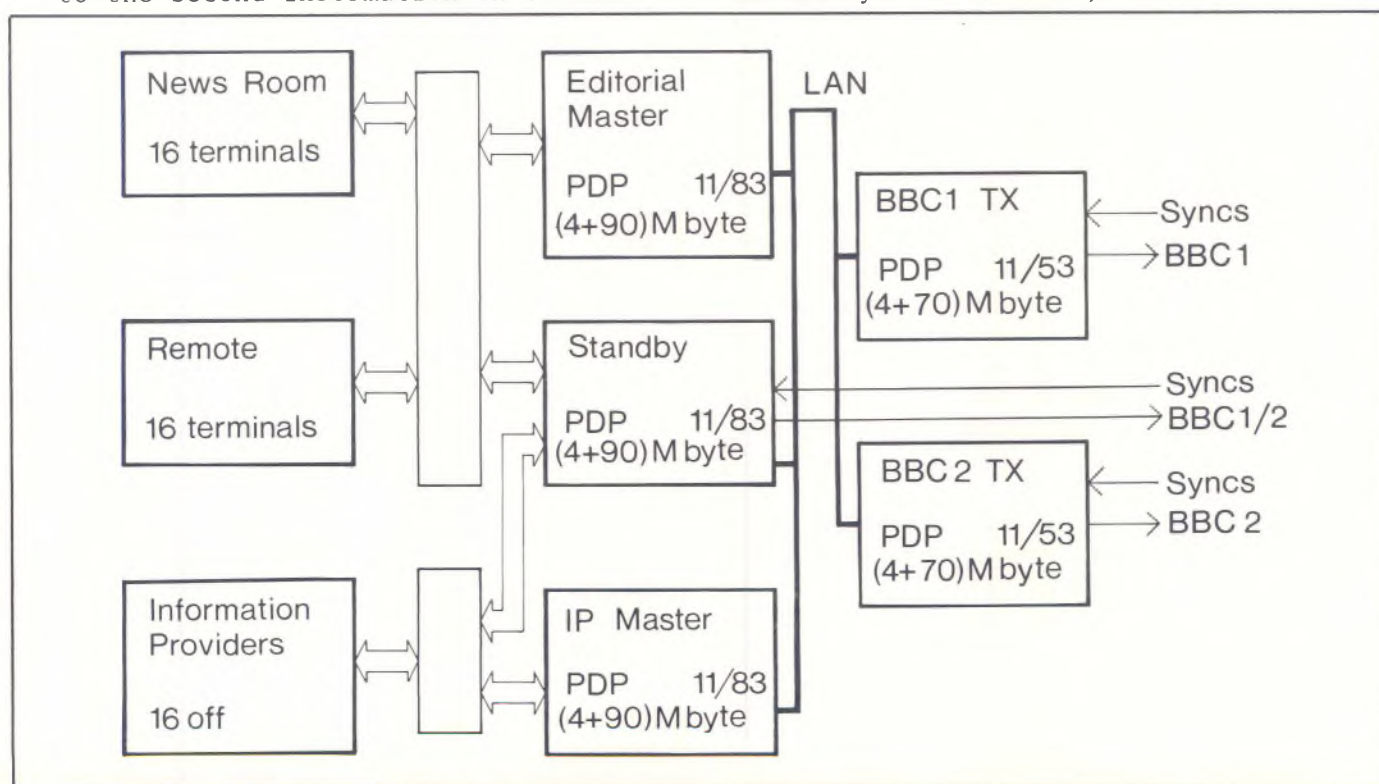

Block diagram of the new Ceefax computer

# RADIO-CAMERAS

At an OB, it is often desirable to have a camera operator close to the action and this can be achieved by three means:

- The obvious way is to have a long cable attached to a portable camera. Usually this is not a practical solution as the cable will often get in the way of both the camera operator and the event being covered.
- The operator can carry a portable video recorder. This makes events such as news gathering easier but makes live broadcasts impossible.
- A radio link can be provided between the operator and a base station and this would carry the video from the camera and possibly a sound channel as well.

The latter arrangement is known as a 'radio-camera' and is potentially the most versatile of the three methods.

## What frequency should be used?

Radio-cameras have been used in Band V and constructing a small, powerful transmitter at these frequencies is relatively easy. However, the antennas tend to be quite large and finding a free channel can be difficult, especially in areas where there are a lot of television repeaters. At the other end of the scale is the 12 GHz band. Antennas at these frequencies can be very small and light but the transmitters tend to be low power and quite inefficient.

In between these two extremes is the 2.5 GHz band which is very popular for OB links, as both the antennas and transmitters can be quite small and efficient.

## What is needed for a radio-camera?

The system comprises a camera, a battery, a transmitter and an antenna, which can be either directional or omni-directional. A directional antenna needs to be pointed towards the receive site, which has usually meant having a second operator, whereas an omni-directional antenna does not need to be aligned but may cause multipath propagation effects, as described later.

## What are the problems?

In the past, two people have been needed for radio-camera operation, partly because

of the size of the link equipment but mainly because the directional antenna has had to be pointed at the receiver. The main problem with using two operators is the cable which connects the camera to the transmitter. Imagine the camera operator running forwards (away from the receive dish) and the link operator running backwards while trying to point the antenna at the receiver. Now sprinkle a few spectators around for good measure and consider the effect of the connecting cable. The result could be catastrophic for the two operators, the spectators and/or the equipment. For this reason, two person operation is not allowed in certain circumstances - for instance, while the winning team is running around the pitch holding the FA cup.

## One man radio-cameras

Recently, small lightweight transmitters have become available. Attaching one of these to the back of the camera and mounting a small omni-directional antenna on the top allows single person operation and improved freedom of movement.

The main problem with an omni-directional antenna is multipath propagation. The camera operator will often be working in an area where there are lots of metal reflectors, such as the support struts of the stadium, BBC vans, corrugated iron roofs etc. If the receiver picks up significant signal from these indirect paths, the received picture suffers from effects such as differential gain and loss of line syncs. There are two ways to combat multipath propagation. One is to make the transmit antenna directional and the other is to use circular polarisation: increasing the power is not effective.

The Italian broadcaster, RAI, has developed a one man radio-camera system which was used during the 1987 World Athletics Championships. A set was borrowed for evaluation and found to work very well, mainly because the transmitting antenna is circularly polarised.

## Circular Polarisation

If the omni-directional antenna emits circular polarisation (say clockwise), then a single reflection from a plane metal surface will have the opposite sense of polarisation (ie anti-clockwise).

Continued on back page

## RADIO-CAMERAS

Continued from previous page

Thus, if the polarisation discrimination of the receive antenna is good, there will be a significant attenuation of these reflected signals.

An omni-directional, circularly polarised, 2.5 GHz antenna was built at Research Department and used in tests at the Crystal Palace and Wembley stadia, confirming that circular polarisation offers an improvement over linear polarisation. A one man radio-camera system using this antenna has since been used to cover many sporting events including Wimbledon and the FA Cup Final.

The Research Department antenna is a Lindenblad array, which consists of a ring of slanted dipoles around a central feed point. The dipoles approximate to a ring of current about a central, vertical dipole which will radiate circular polarisation if the slant angle is correct.

For the Seoul Olympics, the BBC has been allocated a radio-camera channel at 12 GHz. At this frequency, a Lindenblad array would be smaller than a postage stamp, so an alternative antenna has been designed, with the help of British Aerospace. This uses a ring of crossed slots to produce the required omni-directional, circularly polarised pattern.

### Directional antennas

As mentioned previously, the main problem with a directional antenna is that it must point towards the receiver and, for one man operation, there must be some kind of automatic tracking system. Many methods have been tried, including the use of gyroscopes and compasses. A Japanese company has built a radio camera system where the receive dish transmits an shf beacon signal. The portable transmit antenna locks onto this and transmits the video signal in the same direction, hence tracking the location of the receiver.

At Research Department, a novel radio-camera system is currently being developed for use at 12 GHz. The camera operator carries an antenna which comprises a cluster of 6 horns, arranged around a central pole, and some video and rf circuitry. Each of these horns has a 3dB beamwidth of about 60 degrees which gives

some directivity and ensures there are no nulls between horns. During field blanking, one television line is transmitted through each horn. At the receiver, the horn with the best combination of signal-to-noise ratio and minimum multipath degradation is chosen. A radio link carries data from the receiver to the portable equipment, selecting the horn to transmit the next television field. This system has the advantage that it 'sounds out' the best transmission path and should still work when the direct route is not the optimum one.

### Conclusion

Reliable radio-camera operation is becoming easier with the introduction of smaller transmit equipment. Once multipath propagation problems have been solved, it should be possible to use radio-cameras in virtually any sports stadium, thus allowing production teams to get very close to the action when required.

Bruce Devlin,  
Research Department

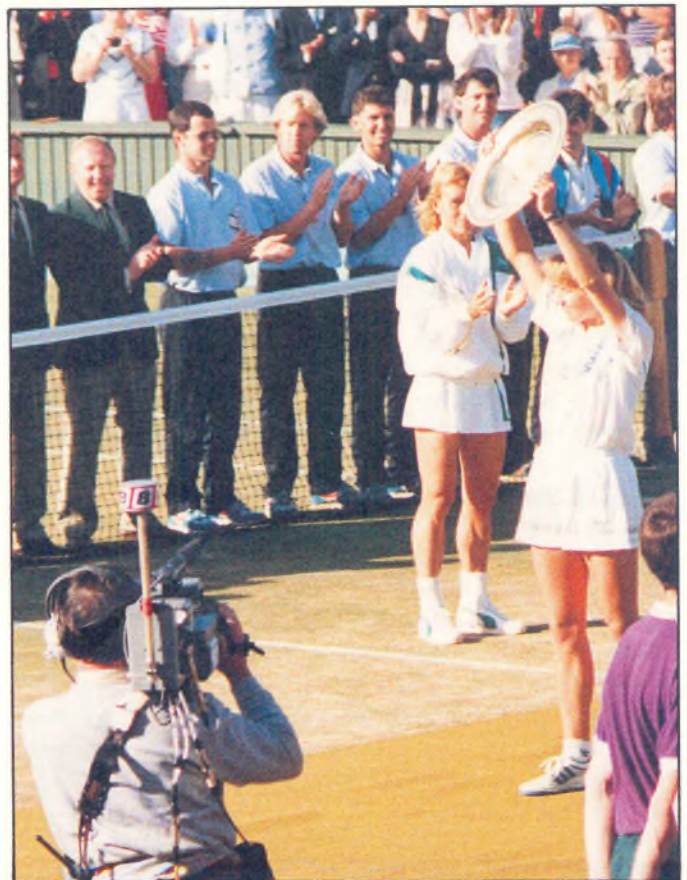

*2.5 GHz one man radio-camera in use at the Ladies Final, Wimbledon*