



The B·B·C Year Book 1931



	<i>January</i>	<i>February</i>	<i>March</i>	<i>April</i>
S	4 11 18 25	1 8 15 22	1 8 15 22 29	5 12 19 26
M	5 12 19 26	2 9 16 23	2 9 16 23 30	6 13 20 27
T	6 13 20 27	3 10 17 24	3 10 17 24 31	7 14 21 28
W	7 14 21 28	4 11 18 25	4 11 18 25	1 8 15 22 29
T	1 8 15 22 29	5 12 19 26	5 12 19 26	2 9 16 23 30
F	2 9 16 23 30	6 13 20 27	6 13 20 27	3 10 17 24
S	3 10 17 24 31	7 14 21 28	7 14 21 28	4 11 18 25
	<i>May</i>	<i>June</i>	<i>July</i>	<i>August</i>
S	31 3 10 17 24	7 14 21 28	5 12 19 26	30 2 9 16 23
M	4 11 18 25	1 8 15 22 29	6 13 20 27	31 3 10 17 24
T	5 12 19 26	2 9 16 23 30	7 14 21 28	4 11 18 25
W	6 13 20 27	3 10 17 24	1 8 15 22 29	5 12 19 26
T	7 14 21 28	4 11 18 25	2 9 16 23 30	6 13 20 27
F	1 8 15 22 29	5 12 19 26	3 10 17 24 31	7 14 21 28
S	2 9 16 23 30	6 13 20 27	4 11 18 25	1 8 15 22 29
	<i>September</i>	<i>October</i>	<i>November</i>	<i>December</i>
S	6 13 20 27	4 11 18 25	1 8 15 22 29	6 13 20 27
M	7 14 21 28	5 12 19 26	2 9 16 23 30	7 14 21 28
T	1 8 15 22 29	6 13 20 27	3 10 17 24	1 8 15 22 29
W	2 9 16 23 30	7 14 21 28	4 11 18 25	2 9 16 23 30
T	3 10 17 24	1 8 15 22 29	5 12 19 26	3 10 17 24 31
F	4 11 18 25	2 9 16 23 30	6 13 20 27	4 11 18 25
S	5 12 19 26	3 10 17 24 31	7 14 21 28	5 12 19 26



on FRIDAYS

and on

look for

WEDNESDAYS

“The Radio Times”

look carefully

and “World-Radio”

for “The Listener”

THE
RADIO
TIMES

THE JOURNAL
OF THE
BRITISH BROADCASTING CORPORATION

One and a half million copies of the Radio Times are sold every week.—————

Why?

The Radio Times is designed to assist all listeners. It gives in full the broadcast programmes for a whole week—from Sunday to Saturday. But more important than this, it annotates these programmes: it explains, where explanation is necessary: it supplies biographical details—photographs—diagrams. It enables you to plan your listening ahead. It makes listening more than worth while—a pleasure and a joy!

OF ALL BOOKSELLERS NEWSAGENTS BOOKSTALLS

TWOPENCE

EVERY FRIDAY



WORLD-RADIO

WORLD-RADIO is designed for those listeners who listen regularly to foreign broadcasts, and select their programmes with the same care as they select British programmes from the Radio Times.

Further—————

WORLD-RADIO is the official technical journal of the B.B.C.—it is abreast of every worth-while development in the technique of both reception and transmission.

W·R·

THE OFFICIAL FOREIGN &
TECHNICAL JOURNAL OF
THE B·B·C



WORLD. RADIO

PRICE 2D. EVERY FRIDAY

The Listener

Six times in the year THE LISTENER issues special supplements, fully and comprehensively illustrated, designed to meet the practical needs of readers who wish to study some particular subject or period. They are intended to be workmanlike and complete, with advice on reading, and suggestions as to practical steps to be adopted for further study and experiment. These should on no account be missed. Announcements giving the dates of issue are made through the microphone and printed in THE RADIO TIMES.

What is The Listener?

THE LISTENER is a B.B.C. publication, on sale at all bookstalls, newsagents, and booksellers every Wednesday. It is intended for the intelligent man and woman who is interested in all that the modern world evolves—literature and science, art and æsthetics, travel, philosophy, administration, psychology, economics, world-politics. It prints, each week, the best of nearly everything of



permanent value in the spoken word broadcast during the previous week. Important series of talks which need to be studied in print are printed in *THE LISTENER*, with information to assist further study. In addition, the finest critics of the day contribute regularly to its pages—for instance, Herbert Read writes every week on Art, Harvey Grace on Music, and Dr. A. S. Russell on Science. No other weekly covers so wide a range, and with such authority.

The format of *THE LISTENER* is graceful and pleasing. It is very well printed on good white paper. It is beautifully illustrated. And it costs only 3d. It is really worth reading!

The Listener



BROADCAST TO SCHOOLS PAMPHLETS

Since the demand for pamphlets published in connection with Schools Transmissions comes from a wide public—apart even from the Schools themselves—a subscription scheme has been inaugurated whereby any listener may for an annual subscription—at present only four shillings—be supplied with these pamphlets as they are published {approx. 24 each year.} They form an admirable complement to the broadcasts: they are well illustrated, and contain notes and suggested questions and follow-ups to the lessons.

Full details from the B.B.C. Bookshop, Savoy Hill, London, W.C.2

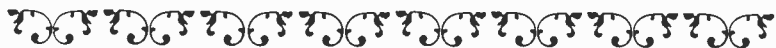



Talks Pamphlets

Every day B.B.C. talks are increasing in popularity. More and more listeners are being attracted to them—a fact which is not very surprising when the quality and importance of these talks is considered, and the authority of the speakers. Practically every series of talks is preceded by the publication of an illustrated and documented pamphlet, which enables listeners to familiarise themselves with the general outline of the subject, and to refer to other sources of information. Full details and rates of subscription may be had of the B.B.C. Bookshop, Savoy Hill, London, W.C.2.

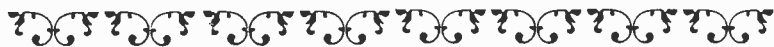

A MAP

The B.B.C. has prepared, under the advice of Rear-Admiral H. P. Douglas, C.M.G., Hydrographer to the Royal Navy, an important MAP, designed especially to assist in the reception of European broadcasts. It is, firstly, accurate. Secondly, it is serviceable: it is meant to stand up to hard wear. It is mounted on linen; its size is 36 ins. × 46 ins. It is printed in colours, and shows all important stations.

It should be kept at the side of any set provided with a frame-aerial. It is invaluable—and a necessity!—to the long distance set. It costs 3s. post free, of the B.B.C. Bookshop.

*World Radio Broadcasting Map
of Europe*

a log book

It is called the WORLD-RADIO STATION IDENTIFICATION PANELS BOOKLET. It is the best and the ideal log-book because it contains information which enables you to identify accurately more than 130 foreign broadcast stations, on the Continent, for the most part, a few American.

THESE DETAILS

are given for each station: Frequency in kc/s. Wavelength. Aerial power. Approximate distance from London. Opening call, interval signal, closing signal. Space is allotted for dial readings, and generous white margins for any special remarks. In addition a small map is provided showing practically all European stations.

IT COSTS

only one shilling post free! The B.B.C. bookshop, Savoy Hill, W.C.2, will supply you!

World-Radio
Station Identification Panels
Booklet

THE B.B.C. *issues from time to time free technical pamphlets to help listeners to obtain good reception. Two such pamphlets, for instance, were published at the opening of the new London dual programme Station at Brookmans Park. Similar pamphlets will be available for the opening of the North Regional Station at Moorside Edge, Huddersfield. These and other pamphlets can be had on application to _____*

*The B.B.C. Bookshop,
Savoy Hill, London, W.C.2.*

T A B L E O F C O N T E N T S

	PAGE		PAGE
Introduction	25	Balance Sheet	39
Notes of the Year	29	Programme Developments	43
Finance	35		

THE YEAR

CALENDAR OF IMPORTANT EVENTS 51

Public Ceremonials	99	Some Variety Artists	106
Speeches	100	Some Musicians	109
Sporting Events	102	Religious Services	110
Light Entertainment	105	Some Prominent Speakers	112

GENERAL SECTION

B.B.C. Time Signals	117	Scotland's New Headquarters	137
The King Speaks to the World	121	The Children's Hour	140
Broadcasting House	125	Co-operation in Ireland	146
The Story of a Licn	128	Wireless and the Blind	149
The American Listener	131		

MUSIC

My Experiences as B.B.C. Critic	153
A Beloved Musician	157
The New B.B.C. Orchestra	159
The National Chorus	164
The Church Cantatas of Bach	169
National Orchestra of Wales	172
"The Northern Proms"	178
Military Band Music	181

DRAMA

Future of Broadcast Drama	185
Lesson's from the Year's Plays	191
Use of Sound Effects	194
Producing Plays for Broadcasting	198
Diversions	202
Vaudeville Programmes	207

THE SPOKEN WORD

Personality in Speakers	211	School Broadcasting	233
Are Talks too Highbrow?	215	Development of Organized Listening	236
The Important Symposiums	219	The News Bulletins	242
Broadcasting of Poetry	222	How the S.O.S. Service Works	246
Two Poet Laureates	225		
Religious Broadcasting	229		

T A B L E O F C O N T E N T S

TECHNICAL SECTION

	PAGE		PAGE
Technical Progress	251	How to Identify Stations	324
The North Regional Trans-		Designs of Crystal Sets	348
mitting Station	254	Power Supply for Receivers	354
Sidebands and Heterodynes	259	Volume Control	361
The London Regional Station	269	Properties of Frame Aerials	367
		Aerial Systems	375
		The Beginning of a New	
		Service	387
<i>STUDIO AND LINES</i>			
Piano Balance	281		
Studio Acoustics	284		
Gramophone Pick-up Devices	290		
Simultaneous Broadcasting	293		
		<i>INTERNATIONAL</i>	
		International Relays	397
		Summary of Distribution of	
		Wavelengths under the	
		Prague Plan	403
		Tatsfield Receiving Station	404

RECEPTION

High Quality Receivers	299
Wave Ranges of Receivers	319

REFERENCE SECTION

B.B.C. Addresses	410	<i>STANDARD SYMBOLS</i>	415
Wireless Societies and Associ-		<i>TECHNICAL TABLES</i>	
ations	411	<i>AND FORMULÆ</i>	420
Radio Circle Rules	412	<i>TECHNICAL DICTION-</i>	
S.O.S. Rules, Weather Fore-		<i>ARY</i>	435
casts, Market Bulletins, etc.	413	Buyer's Guide	460
Time Signal Chart	414	Index	463

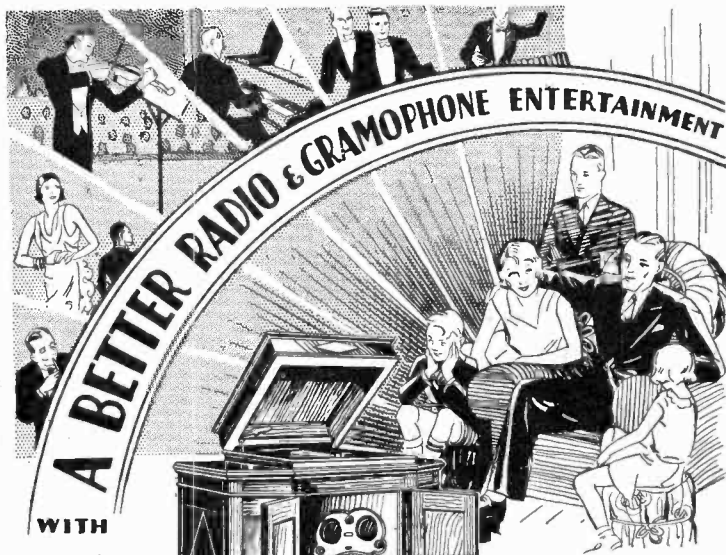

A BETTER RADIO & GRAMOPHONE ENTERTAINMENT

WITH
LISSEN
 VALVES
LISSEN
 BATTERIES
LISSEN
 COMPONENTS
LISSEN
 RECEIVERS

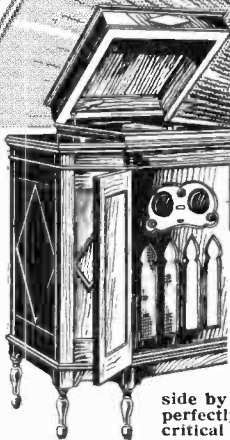

THERE is new distance-getting power in the Lissen radio of to-day—new realism in the reproduction of broadcast and recorded music—new simplicity in the operation of both sets and gramophones. Because Lissen have developed radio reception, amplification and reproduction side by side; so that a Lissen Receiver is a perfectly balanced instrument, with all the critical values carefully co-related, and operation reduced almost to a mechanical switching from station to station or from broadcast to recorded items.

Sets built even one short year ago are now noticeably surpassed by these new Lissen Receivers. But old sets may well be brought up to the new standard by replacing the important components with the latest Lissen parts. Replace old valves with Lissen—the valves that employ the new Extended Grid construction—you'll get new and mighty volume from the same battery power.

Get the Lissen Catalogue and ask your radio dealer for advice.

ALL
LISSEN
 for HOME ENTERTAINMENT

LISSEN LIMITED
 Worples Road
 Isleworth, Middlesex

*There are two
things essential
to Perfect Radio
Performance*

Marconiphone Radio

BECAUSE every Marconiphone product is designed by the world famous Marconiphone engineers led by that master genius, the Marchese Marconi himself, and because behind Marconiphone are the greatest research and manufacturing resources of the radio industry.

Marconi Valves

BECAUSE their efficiency and lasting reliability have been proved throughout the history of radio and are definitely established by the fact that these famous Valves are used by the B.B.C., Imperial Airways, the great Shipping Companies, Trinity House Lightships and Beacon Stations, Empiradio Beam Wireless, Metropolitan Police, etc., etc.



Catalogues from any appointed dealer or direct from

The Marconiphone Company Ltd.
Radio House
210-212, Tottenham Court Road
London, W.1

*Buy your Radio
where you
see this sign*



LIST OF ILLUSTRATIONS

	PAGE	PAGE
Mr. J. H. Whitley	24	Shooting for the King's Prize at
"A Race Against Time"	27	Bisley 84
The Main Transmitter Hall at		Athletics: Oxford and Cam-
Brookmans Park	28	bridge v. Princeton and Cor-
Professor Einstein	34	nell 85
The Prince of Wales leaving St.		Miss Amy Johnson 86
Paul's after the service in		The Refectory at Buckfast
memory of the dead of the		Abbey 88
Airship R 101	45	The Return of R 100 from
Buglers Sounding the Last Post		Canada 89
at the Menin Gate	47	Hereford Cathedral 91
The King Opening the London		The R 101 Memorial Service at
Naval Conference	48	St. Paul's 92
Delius at the Queen's Hall	50	The Don Cossack Choir 93
"Journey's End"	52	Scene from "Eldorado" 94
General View of Cologne	53	Scene from "Charlot's Mas-
Generals von Lettow-Vorbeck		querade" 94
and Jan Smuts at the Recon-		Ethel Bartlett and Rae Robertson 96
ciliation Dinner	54	Bristol from the Air 97
The Memorial to Queen Alex-		The Opening of India House
andra at Copenhagen	55	by H.M. the King 98
The Chapel of King's College,		The Prince of Wales launches
Cambridge	57	"The Empress of Britain" 101
Gracie Fields	58	Dulepsinhji's Great Debut 103
Sir George Henschel	61	The Palladium at Night 104
Rugger: England v. France	62	Gillie Potter 107
R.M.S. "Majestic"	63	Arthur Catterall 108
The Grand National	64	Durham Cathedral 111
The Presentation of the Free-		Paul Robeson 114
dom of Manchester to Mr.		The Transit Instrument at
C. P. Scott	66	Greenwich 116
St. George's Chapel, Windsor		President Hoover 120
Castle	67	Broadcasting House 124
The F.A. Cup Final	69	Broadcasting House 127
The King and Queen and		"I take it that it would be pos-
the Duke of Gloucester at		sible to get the lion upstairs
the Palladium	71	to the studio" 129
The Prince of Wales at Cardiff	72	The "Braw Lads" Gathering at
Broadcasting the Nightingale	73	Selkirk 139
The Memorial to General Wolfe	74	The Stage Coach leaving Toy
Trooping the Colour	75	Town 141
Sir James Barrie at Kirriemuir	76	Leslie Mainland 143
The Senior Tourist Trophy		Scene from "The Mikado" 144
Races in the Isle of Man	77	The First Broadcast from the
The Royal Ulster Yacht Club		Abbey Theatre, Dublin—a
Regatta	78	scene from "Cathleen ni
Helen Wills-Moody	79	Houlihan" 147
The King and Queen leaving		The Annual Tynwald Cere-
St. Paul's Cathedral after the		mony, Isle of Man 150
Thanksgiving Service	80	Suggia, by Augustus John 152
Act II of "Aida"	82	Sir Walford Davies 156
The Millenary Celebrations in		The Queen's Hall 158
Iceland	83	No. 10 Studio 167

LIST OF ILLUSTRATIONS

	PAGE		PAGE
The Thomaskirche, Leipsig	168	The Battery Room at Brook-	
Violet Gordon Woodhouse	171	mans Park	258
Broadcasting Four Pianos	173	The Vault at Brookmans Park	
The B.B.C. Symphony Or-		showing the Cable Ducts	258
chestra	176	The London Regional Trans-	
Sir Hamilton Harty and the		mitter	272
Hallé Orchestra	180	The Power House Switchboard	
Sound Effects Studio	195	at Brookmans Park	275
Examining a Record of Noises		Detail of the Switchboard	277
of the Underground	197	The Music Control Panel	280
At Wembley Speedway	203	One of the B.B.C.'s Exhibits at	
The Pool of London by Night	205	the National Radio Exhibi-	
The Post Office Parcels Railway	206	tion at Olympia	283
Clapham and Dwyer	208	The Smaller Talks Studio at	
Harold Nicolson	210	Savoy Hill	285
"The Bridge-hand interrupted		An Electrical Pick-up Device	292
to listen to a broadcast talk"	213	Big Valves used in the Brook-	
Sir Rabindranath Tagore	218	mans Park Transmitters	297
Sir John Simon	220	The Fly-Wheel of a Diesel En-	
John Masfield	226	gine at Brookmans Park	318
Norwich Cathedral	228	The River Broadcast	323
Fixing the Microphone on St.		Latticework of a Brookmans	
Paul's for Broadcasting the		Park Aerial	347
Bells	231	The Larger Talks Studio	365
Impromptu "Group Listening"	238	Negro Boys Listening	372
News tape machines	245	B.B.C. Amplifier used at the	
One of the four Aerial Masts at		National Radio Exhibition	395
Brookmans Park	250	Castle of the Prince-Bishops,	
The Masonry of the Building		Salzburg	396
housing the Transmitters at		The Dutch Short-wave Station	
Brookmans Park	253	at Kootwijk	399
Moorside Edge, showing the		Cologne Broadcasting House	401
Laying of the Foundations	255	Tatsfield Receiving Station	404

MAPS, DISPLAYS, ETC.

Graph of Monthly Increases of Licences	30	Isle of Man Week	148
Percentages of Licences to Population (shaded map)	32	Some B.B.C. Publications	151
Ditto (table)	33	Map showing whereabouts of No. 10 Studio	163
Analysis of the London Alternative Programmes	42	The Foundations of Music Broadcast Plays	175 184
Bristol Radio Week	97	Grouping of Studios on the Dramatic Control Panel	199
Apportionment of the Licence Revenue of 1929	123	Making Work Worth While	240
Comparison of British and American Programmes	133	Map of Areas alluded to in the Daily Shipping Forecasts	243
What the B.B.C. is doing for Scotland	136	S.O.S. Results	248
		Good Reception	298
		How to Earth Your Set	394

THE CRIPPLED CHILDREN'S CRY!

“**HELP US TO HELP OURSELVES**”

The greatest assistance humanity can give to crippled children is to fit them for useful life with every chance of becoming physically normal citizens. 406 crippled children from all parts of the country are undergoing treatment and training at the Lord Mayor Treloar Cripples Hospital and College. Funds are urgently needed to maintain this national work.

LORD MAYOR TRELOAR CRIPPLES HOSPITAL AND COLLEGE,

ALTON and HAYLING ISLAND.

Trustees:

The Rt. Hon. and Rt. Rev. The
Lord Bishop of London, D.D., K.C.V.O.
The Rt. Hon. Viscount Burnham, G.C.M.G.,
Miss Florence Treloar

{C.H.

The Rt. Hon. The Lord Mayor of London
Lt.-Col. Frederick Lawson, D.S.O., M.C.
T. J. Harrowing, Esq., C.C.

Secretary: H. B. Harper, J.P.

To THE SECRETARY,
25 ELY PLACE, LONDON, E.C.1.

I enclose a Cheque for £.....
Postal Order
as a contribution to the Lord Mayor Treloar
Cripples Hospital and College.

Signature

Address

B B.C

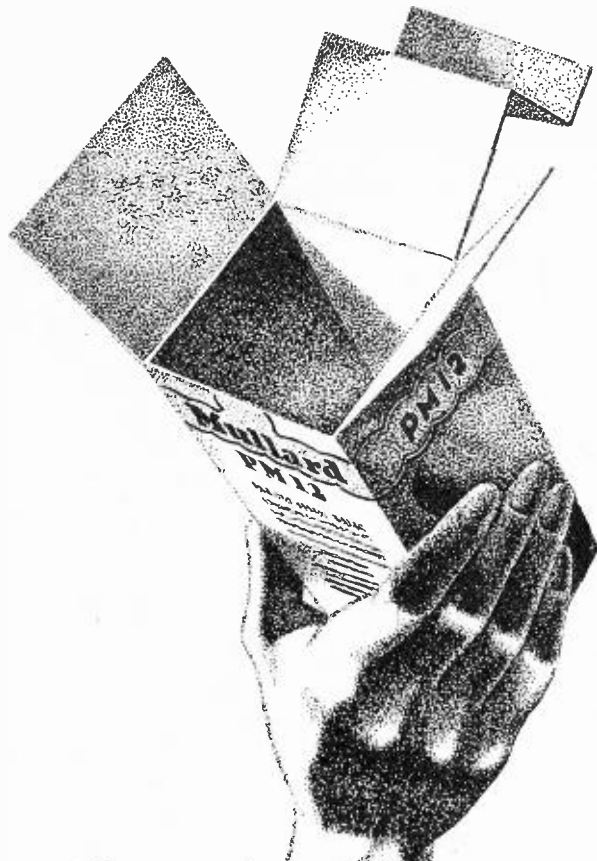

Somebody's got
better radio!

Mullard

THE · MASTER · VALVE

*Advert. The Mullard Wireless Service Co., Ltd., Mullard House, Charing
Cross Road, London, W.C.2.*

[20]

THE
B. B. C.
YEAR-BOOK
1931

THE PROGRAMME YEAR COVERED
BY THIS BOOK IS FROM NOVEMBER 1,
1929, TO OCTOBER 31, 1930

THE BRITISH BROADCASTING CORPORATION
SAVOY HILL, LONDON, W.C.2

THE B.B.C. is fortunate in having the support of honorary advisory councils and committees in almost every branch of its work. Among them are the following:—

THE CENTRAL COUNCIL FOR BROADCAST ADULT
EDUCATION

THE CENTRAL COUNCIL FOR SCHOOL BROADCASTING

THE ADVISORY COMMITTEE ON SPOKEN ENGLISH

THE ADVISORY PANEL FOR NATIONAL LECTURES

THE MUSIC ADVISORY COMMITTEE

THE CENTRAL RELIGIOUS ADVISORY COMMITTEE

THE APPEALS ADVISORY COMMITTEE

Sub-councils and local Committees exist in Scotland, Wales, Northern Ireland, and the Northern and Midland Regions of England, and do valuable work in connection with local programmes. The B.B.C. takes this opportunity of recording its indebtedness to the above Councils and Committees and its gratitude for the services of busy public men and women which have been so freely given in the interests of the public.

THE BRITISH BROADCASTING
CORPORATION



Chairman

The Rt. Hon. J. H. Whitley

Vice-Chairman

The Rt. Hon. Lord Gainford

Governors

Sir John Gordon Nairne, Bart.
Dr. Montague John Rendall
Mrs. Philip Snowden

Director-General

Sir J. C. W. Reith

Head Office

SAVOY HILL, LONDON, W.C.2



Vandyk

MR. J. H. WHITLEY

late Speaker of the House of Commons, the new Chairman of the B.B.C.

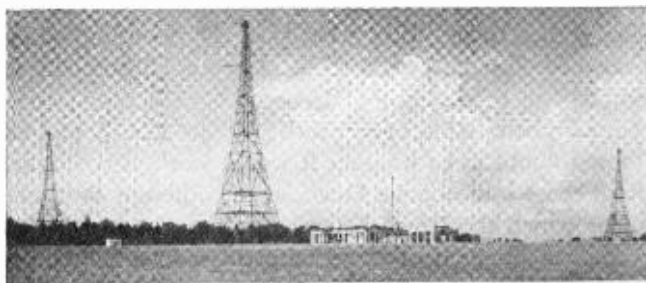

I N T R O D U C T I O N

THE year 1931 will see the inauguration of the new alternative services for the North of England through the twin-wave Regional transmitter at Slaithwaite, near Huddersfield. A start will be made also on the new transmitters for Scotland, and preparations completed for the construction of the West Regional station in the following year. Thus the B.B.C. is about half-way through the formidable task of changing its system of distribution. The South and the Midlands have had their broadcasting under practically "Regional" conditions for a period long enough to estimate the nature of the public reception. The alternatives have been warmly welcomed, there being evidence of much more selection in listening, with correspondingly greater profit and enjoyment.

Licences increased steadily during 1930. During the summer period, normally regarded as an "off season," the average number of new licences taken out each month, apart from renewals and after subtracting non-renewals, was in excess of 20,000. Statisticians will continue to argue about "saturation points." So far as the B.B.C. is concerned there is no saturation point short of "wireless in

every home." The number of licences in force on September 30th, 1930, was 3,195,553, representing about 12,000,000 listeners, or roughly every second home in the country.

Some critics of the constitution of the B.B.C. had expressed doubt as to whether it would work as well when there came into office a Government different from that under which the Royal Charter had been granted. The event has disposed of these misgivings. The B.B.C. has continued its work as happily and as independently during a Labour administration as it did during a Conservative administration.

A notable development, the benefits of which should be felt generally this year, is the improvement and cheapening of the apparatus of wireless reception. The British wireless industry has achieved some "rationalising" of itself; sets and components have been well standardised, efficient mass-production has been introduced, and a vigorous forward policy adopted. Although the B.B.C. has no financial interest in the wireless trade, it is naturally concerned that the programmes should be accessible as cheaply and as efficiently as possible. This desirable state of affairs seems a good deal nearer now than ever before.

After a year of careful preparation the new orchestra appears in its complete form. The purpose is to make this orchestra not only a source of enjoyment and pride to the millions of British listeners, but also a worthy example to the world of British artistic and organising achievement. The practical obstacles in the way of the exchange of programmes internationally are being steadily surmounted. Before long it will not be unusual or eccentric for the music-lover of Vancouver, San Francisco, or Tokyo so to plan his listening diary as to include the best of the world's effort. The B.B.C. hopes that when this time comes the B.B.C. Symphony Orchestra will be pre-eminent.

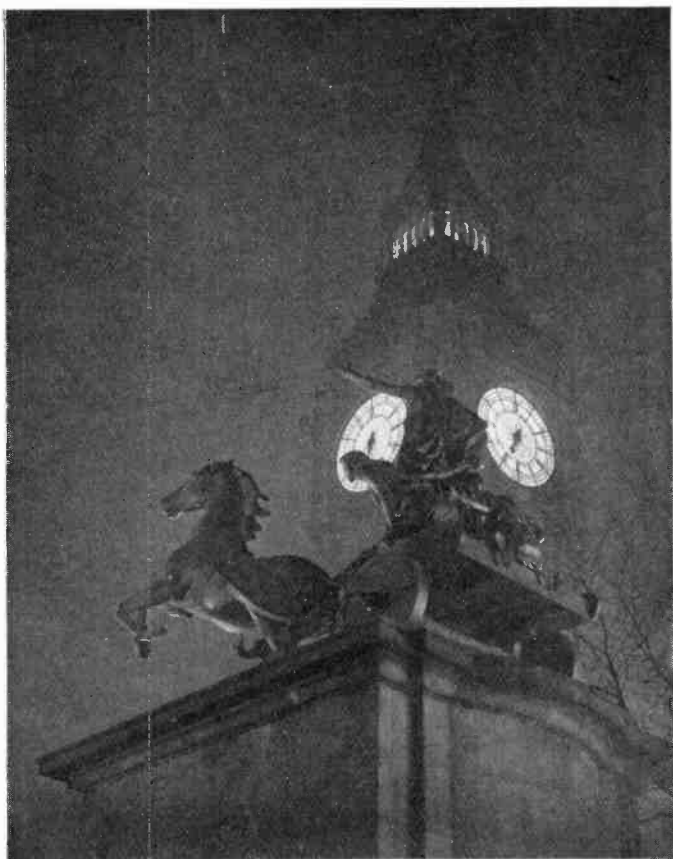

"A RACE AGAINST TIME"

A magnificent photo of Big Ben, still one of the most impressive broadcasts

Reproduced by permission of Harold B. Burdekin, Hythe, Kent

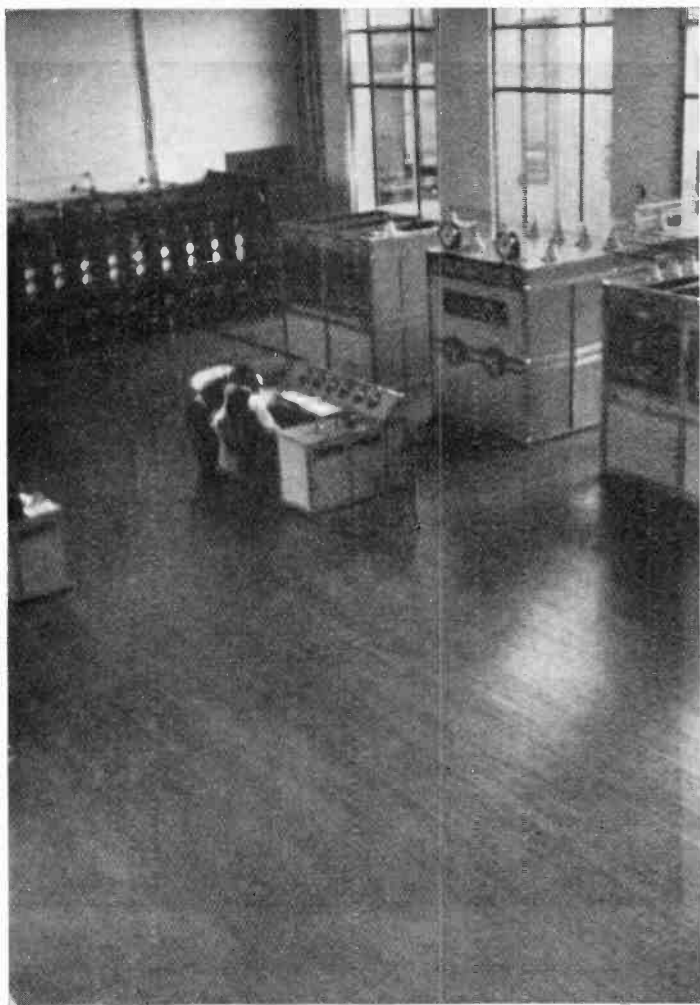

A VIEW OF THE MAIN TRANSMITTER HALL AT BROOKMANS PARK

NOTES OF THE YEAR

THE year saw two full meetings of the International Broadcasting Union: the General Assembly at Lausanne, where Vice-Admiral C. D. Carpendale, C.B., of the B.B.C. was re-elected to the Presidency and had the pleasure of welcoming three new members; and an autumn conference at Budapest. A special committee, in addition, met in Paris to discuss constitutional points. It has been an important year for the Union, and current business, in the Council as in the four Committees, has been heavy, while the frequency-checking station at Brussels, now under official auspices, has been working full time. The great task of the near future must be that of the preparing to present the broadcasting viewpoint at the quinquennial International Radiotelegraphic Convention, which takes place at Madrid in 1932, but for which the agenda must be drawn up early in 1931. It is this Convention that decides upon the allocation of appropriate bands of wavelengths to the various public and commercial radio services, and it is the Union's earnest hope that the outcome of this Convention will be a serious extension of the facilities available for broadcasting, which must now be ranked high among the public services.



The exchange of programmes internationally has developed steadily during the year. Those who heard relays of concerts from the Continent, the speeches at the Boston (U.S.A.) tercentenary, and some of the running commentaries on the America's Cup races, will realise the marked improvement made possible by recent experience and technical development. There is still a good deal to be done to improve quality and dependability features, but 1931 may see a further and perhaps decisive advance.



Definite progress has been made with the plans for transforming the experimental transmissions of 5SW into a permanent service for the Empire. The Colonial Conference in July endorsed with enthusiasm the proposals of the B.B.C., which undertook to provide a service on reimbursement only of the actual additional expenditure

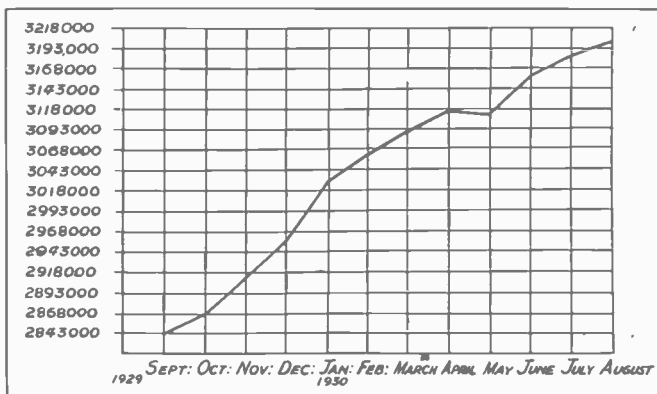

GRAPH OF THE MONTHLY INCREASES OF LICENCES IN THE YEAR
SEPTEMBER 1, 1929-AUGUST 31, 1930

involved. It is understood that the Treasury is now considering the matter. The B.B.C. plan is to substitute for the present temporary 5SW a new permanent short-wave station at Daventry with programmes adapted to the needs of the Empire overseas.



Sir John Simon's impressive broadcasts explaining the Report of the Royal Commission on India emphasised once again the enormous value of the microphone for political education. Millions of citizens, who in the absence of broadcasting would have known little and cared less about the position in India, were given a first-hand account in the simple, clear, attractive style of which Sir John Simon is master, and which only broadcasting can make fully effective.



The new B.B.C. Orchestra has come into being, absorbing the Wireless Orchestra and the Queen's Hall Orchestra. The best available players have been secured for the principal positions, and the choice of rank and file players has been most carefully considered. There is to be no deputising except in the case of illness, and the contracts are full-time. The creation of the new orchestra was the main programme development of the year.



The Central Council for Broadcast Adult Education recently recommended that a statistical survey should be made of listeners' tastes, habits, and requirements, with regard to education. It is obvious that the task of building an educational programme would be greatly simplified if the views of different sections of the public could be obtained. It would, for instance, make it far easier to determine the most generally acceptable method of presentation and the most suitable timing of educational talks. Ways and means of making an inquiry on these lines are now under discussion between the Executive Committee of the Central Council, the B.B.C., and statistical experts. The B.B.C. is also considering the possibility of extending the investigation to cover all broadcast programmes.



Comparative licence figures are shown on pp. 32-3 in tabular form and on a map of England shaded to represent the percentage of licences to population in each county. Perhaps the most striking feature of the map is the density in the area that lies roughly between the Daventry and London transmitters. This area contains the four leading counties—Oxfordshire, Hertfordshire, London, and Northants—and the next four counties, viz. Surrey, Cambridgeshire, Berkshire, and Bedfordshire, are on the fringe of it, and two of the next three counties on the list are Warwickshire and Leicestershire, which really belong to the area. Round this nucleus is a fringe of residential and agricultural counties, where the percentage ranges from seven to nine, a curious exception being Essex, for which, owing to its character as a residential area for London and its proximity to the London transmitters, a higher percentage would have been expected. A still more inexplicable oasis in this area of maximum licences is provided by the county of Middlesex. It will be noticed that the percentage is low in the thickly populated industrial counties, the figures for Yorkshire being relatively low, and those for Cheshire, Staffordshire, Derbyshire, Durham, and Glamorgan still lower. This result may, no doubt, be attributed to industrial depression and the consequent relative poverty of listeners in those thickly populated areas. The low percentage of licences in Cornwall is possibly explained by its distance from centres of distribution, and

similar considerations of service may account for low figures in Ireland and in the mountainous parts of Wales. It must be remembered, of course, that each licence may represent three or four listeners, and that, therefore, the actual percentage of listeners to total population in a county like Oxfordshire is something over 50 per cent. The possibility also of there still being a number of unlicensed listeners must not be forgotten.

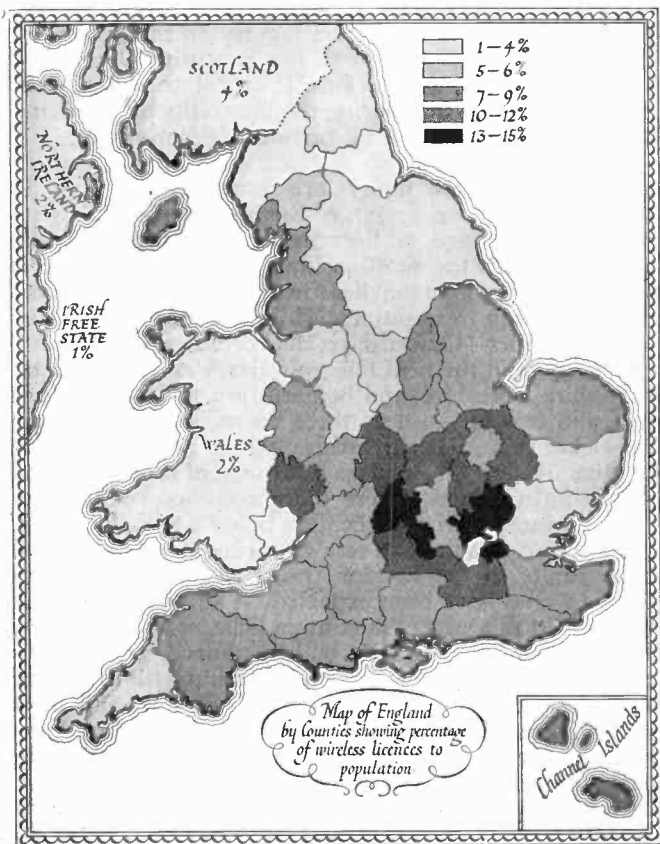

PERCENTAGES OF LICENCES TO POPULATION

COUNTY.	No. of Licences, 31 July 1930.	% to Population (approx.).
Bedfordshire	21,481	10
Buckingham	20,827	9
Berkshire	35,313	12
Cambridgeshire	22,807	11
Cheshire	48,148	5
Cornwall	15,354	5
Cumberland	10,491	4
Derbyshire	33,980	5
Devon	56,107	8
Dorset	18,174	8
Durham	35,395	2
Essex	87,884	6
Gloucester	64,751	9
Hampshire	86,048	9
Herefordshire	10,840	10
Hertfordshire	44,639	13
Huntingdon	4,911	9
Kent	101,649	9
Lancashire	319,424	7
Leicestershire	46,690	9
Lincolnshire	48,982	8
Middlesex	49,987	4
Monmouthshire	19,031	4
Norfolk	34,032	7
Northampton	42,585	12
Northumberland	44,925	6
Nottinghamshire	50,806	8
Oxfordshire	25,708	14
Rutland	1,203	7
Shropshire	18,424	8
Somerset	30,973	7
Staffordshire	66,337	5
Suffolk	24,629	6
Surrey	111,657	12
Sussex	60,217	8
Warwick	131,514	10
Westmorland	2,842	5
Wiltshire	24,917	9
Worcestershire	32,148	8
Yorkshire	265,115	6
London Area	564,201	13
Wales (Glamorgan 5%)	98,987	2
Scotland	202,437	4
Northern Ireland	30,343	3
Irish Free State	25,454	1
Isle of Man	3,503	7
Channel Islands	6,042	7

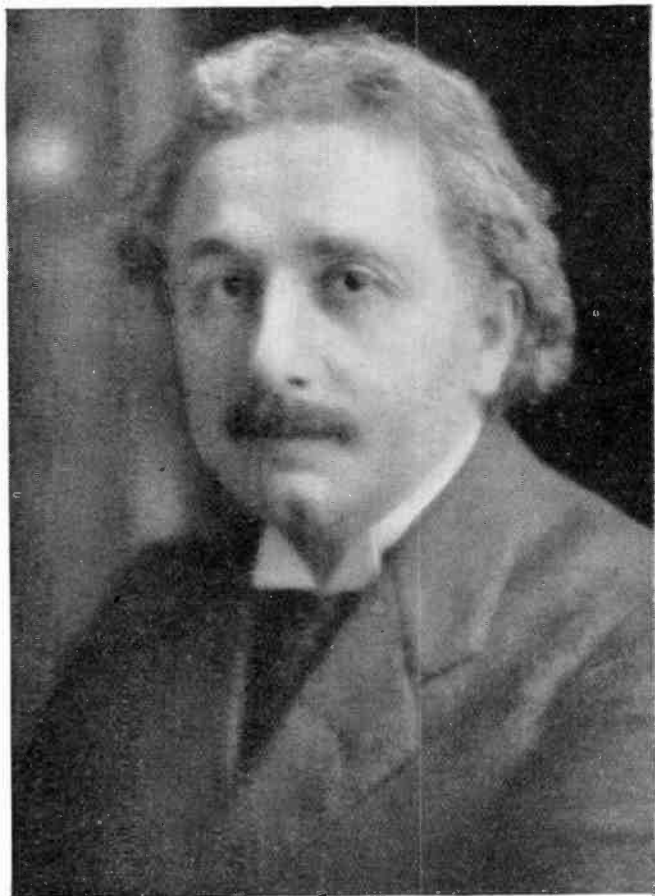

PROFESSOR EINSTEIN
(October 28, 1930)

F I N A N C E

THE latest published Accounts, those for 1929, which are reproduced on pp. 39-41, will be used in illustration of the outstanding features of the year's finance. The main tendencies affecting the Corporation's finances are, however, not so readily discernible from the Accounts as in previous years, owing partly to the interaction of what are from the financial point of view opposing factors, and partly to the introduction of new factors. A certain amount of general explanation is necessary.

Many of the chief features of the year have been evident in previous years. Amongst these are :—the steady increase of public interest in and support of broadcasting—the continuous development of the service—the work on the Regional Scheme—and the overlapping between the old and the new scheme of things. (This last feature will of course persist until the Regional Scheme is completely established.) Some features, on the other hand, are becoming apparent for the first time. A certain degree of centralisation of programmes (one of the elements of the Regional Scheme) is now being carried out, with considerable saving in programme expenditure. A less desirable new feature is that it has been decided that the Corporation is liable to income tax on the excess of Income over Revenue Expenditure. This decision affects the Corporation seriously, for this "excess" is the Corporation's only resource for meeting capital expenditure, and taxation is therefore simply depriving the B.B.C. of money essential for capital developments.

The rate of expansion of the service, considered in terms of public support, is being more than maintained. The net number of licences issued during the year to 31st March, 1930, was 3,091,345 (including 16,496 free licences issued to the blind), an increase of 360,364 over the net issues for the year to 31st March, 1929, as against an increase then of 248,981 over the previous year's issues. The system under which the Corporation's revenue from licences is determined (and which has been explained on previous occasions) debars the Corporation from benefiting

proportionately or immediately by this increase; but previous expansion has resulted in the licence income for 1929, £944,300 15s. 6d., exceeding that of 1928 by £72,536 18s. 9d. The following table gives an approximate analysis of the division of the revenue from licence fees.

	1927.	1928.	1929
Approximate gross income from licences .	£ 1,192,000	£ 1,307,000	£ 1,470,000
Post Office 12½ per cent.	149,000	163,375	183,750
Treasury	242,041	271,861	341,949
B.B.C. Income from Licences	£800,959	£871,764	£944,301

The amounts received by the B.B.C. represent approximately:—in 1927, 67·2 per cent. or 6s. 8½d. per licence; in 1928, 66·7 per cent. or 6s. 8d. per licence; and in 1929, 64·2 per cent. or 6s. 5d. per licence.

The Net Revenue from Publications is also an indication of the support being given to broadcasting by the public. The tendency so far has been for the revenue to rise steadily, and at £138,852 11s. 1d. the total for 1929 had risen to more than £18,000 above the 1928 figure. It may be noted in passing that the gap between Licence Income and Revenue Expenditure has grown wider, the income from that source falling short in 1929 by over £12,000. The Net Revenue from Publications and Interest, etc., have to be looked to to an increasing extent to cover Revenue Expenditure as well as, in effect, to provide the whole of Capital Expenditure and Reserves.

Most of the main features mentioned at the beginning appear in Revenue Expenditure, although not in every case obviously. The percentage statement on the opposite page gives a basis of comparison between the years 1927, 1928 and 1929 and illustrates the general effect of the various tendencies.

Programme Expenditure in 1929 was only £9,685 6s. above the previous year's figure and represents actually a decrease in percentage to total Revenue Expenditure. While the amount of increase in expenditure is not of course a criterion of the extent of development, it is

	1927.	1928.	1929.
Expenditure on Programmes .	63·07	61·30	57·37
Maintenance of Plant, etc. .	16·95	18·25	18·71
	80·02	79·55	76·08
Rent, Rates, etc.	5·59	6·60	6·17
Administration Expenses .	6·58	6·39	5·82
Provident Fund Contributions .	1·02	0·96	0·99
Governors' Fees	0·79	0·69	0·64
Provision for Depreciation .	3·41	3·54	4·03
Provision for Income Tax .	2·59	2·27	6·27
	100·00	100·00	100·00

(NOTE.—This statement differs from that given in the 1930 Year-Book for the years 1927 and 1928 in that Provision for Income Tax was then included under the heading Rents, Rates, etc.)

inevitable at the present stage of broadcasting that development should be reflected more or less directly in increasing costs. The fact that in this case the actual increase is inconsiderable, however, does not indicate that the rate of development is slackening; the real extent of programme development in 1929 is not reflected in the Accounts because against the increased expenditure are off-set the considerable economies effected by the degree of centralisation so far introduced. Maintenance of Plant, etc., shows a percentage as well as an actual increase in 1929 over the previous years. This is one of the results of the gradual establishment of new high-power stations under the Regional Scheme; another will be seen in the greater provision needed for Depreciation, in accordance with the basis imposed by the B.B.C. Charter, as new assets are acquired. In both cases further increases will be called for until the new system of stations is complete. The temporary over-lapping between the old and the new systems commented on last year is still making itself felt under the heading of Rent, Rates, Taxes, etc., although the percentage is slightly lower than in 1928. Administration Expenses are again lower in percentage than in preceding years. The new burden of income tax was particularly heavy in 1929, as the bulk of the liability from the Corporation's inception had to be provided for in that

year. This was due to the uncertainty existing until then as to whether the Corporation was liable at all, and if so, on what basis. To the end of 1929 a total sum of £100,000 had to be withdrawn for this purpose from projected use in financing capital development.

The general effect of the various factors mentioned is to alter slightly the ratio between the "Prime Cost" of the service (Programmes and Engineering Expenditure) and "Overheads" as compared with former years. This tendency is exaggerated in 1929 by the exceptionally heavy income tax provision. The ratio should readjust itself when the Regional Scheme is completely in operation. It has to be borne in mind, however, that provision for Depreciation and for income tax are both included in "Overheads"; both are beyond the Corporation's direct control; and both must continue to be considerably greater than in the years with which 1929 is being compared.

The Capital Expenditure on the Regional Scheme is not obvious in the Balance Sheet and Accounts. The position is that during 1927 and 1928 a reserve of £200,000 was built up for this purpose; to the end of 1928, £30,854 15s. 8d. of this sum had been spent; during 1929 expenditure increased rapidly, and in this year the amount spent was £114,747 2s. 2d. By the appropriation of £110,000 at 31st December, 1929, the balance of the Reserve was brought up to £164,398 2s. 2d., but as the cost of the Scheme will fall much more heavily on the next few years' finances, it is apparent that it will be impossible to meet it out of income. The Capital Account, which amounted to £565,639 5s. 5d. at the end of 1929, represents expenditure on Permanent Assets (both general and of the Regional Scheme) shown under appropriate headings in the Balance Sheet, and also the balance of the Regional Scheme Reserve.

It will be seen from these explanations that the Corporation is entering on a phase of its development in which its needs in the way of Revenue and Capital Expenditure are bound to exceed greatly its present financial resources, and it is obvious that some of the existing limitations of its resources will have to be overcome very shortly if its progress is not to be unduly impeded.

REVENUE ACCOUNT for the Year ended 31st December, 1929.

EXPENDITURE.

To Expenditure on Programmes (including payment of Artists, Orchestras, News Royalties, Performing Rights and Simultaneous Broadcast Telephone System, Salaries and Expenses of Programme Staff)	548,676	2	8
„ Maintenance of Plant, Power, Salaries and Expenses of Engineering Staff, Development and Research, etc.	178,942	2	8
„ Rent, Rates, Taxes, Insurance, Heating and Lighting, Upkeep of Premises, Telephones, etc.	59,025	18	8
„ Administration Salaries and Expenses	55,682	6	10
„ Contributions to Staff Provident Fund	9,416	18	4
„ Governors' Fees	6,100	0	0
„ Provision for Depreciation and Renewal of Premises, Plant, Furniture and Fittings, etc.	38,500	0	0
„ Provision for Income Tax	60,000	0	0
„ Balance carried down, being Net Revenue for year	140,993	18	1
	£1,997,337	7	3

[39]

INCOME.

By Licence Income	£ 944,300	15	6
„ Net Revenue from Publications	138,852	11	1
„ Interest and Sundry Receipts (Net)	14,184	0	0

£1,997,337 7 3

REVENUE APPROPRIATION ACCOUNT.

To Transfer to Capital Account to cover—	£ 36,425	8	6
Capital Expenditure incurred by the Corporation during the year (other than upon Regional Stations)	110,000	0	0
Capital Expenditure to be incurred in the construction and equipment of Regional Stations	1,810	14	3
„ Balance carried forward as per Balance Sheet	£148,236	2	9
To Balance brought from 31st December, 1928	£ 7,242	4	8
„ Balance brought down, being Net Revenue for year	140,993	18	1

£148,236 2 9

BALANCE SHEET

LIABILITIES.

	£	s.	d.	£	s.	d.
CAPITAL ACCOUNT—						
Value placed upon Premises and Plant, Furniture and Fittings, Musical Instruments, Music, Stores, etc., taken over (without payment) from the British Broadcasting Co., Ltd.	174,938	0	0			
Appropriated from Revenue to cover Capital Expenditure incurred by the Corporation to date, and to be incurred on the construction and equipment of Regional Stations—						
Appropriated at 31st December, 1928 (per last Balance Sheet)	244,275	16	11			
Appropriated at 31st December, 1929	146,425	8	6			
				565,639	5	5
RESERVE FOR DEPRECIATION AND RENEWAL OF PREMISES, PLANT, FURNITURE AND FITTINGS, ETC.—						
Balance at 31st December, 1928, per last Balance Sheet	55,907	18	4			
Add: Further provision during 1929, per Revenue Account	38,500	0	0			
				94,407	18	4
Less: Book value (net) of Plant and Furniture discarded during 1929	1,803	9	7			
				92,604	8	9
CREDITORS AND INCOME TAX RESERVE—						
Sundry Creditors	97,030	18	7			
Income Tax Reserve	100,000	0	0			
Provident Fund Trustees	4,158	2	7			
				201,189	1	2
REVENUE ACCOUNT—						
Balance at credit at 31st December, 1929, carried forward as per Account					1,810	14 3

CLARENDON }
 GAINFORD } Governors.
 J. C. W. REITH, Director-General.

£861,243 9 7

REPORT OF THE AUDITORS TO THE MEMBERS

We have examined the above Balance Sheet dated 31st December, 1929, obtained all the information and explanations we have required.

The above Balance Sheet is, in our opinion, properly drawn up so as to to the best of our information and the explanations given to us and as shown

5, LONDON WALL BUILDINGS, LONDON, E.C.2.

1st May, 1930.

as at 31st December, 1929.

ASSETS.

	£	s.	d.	£	s.	d.
FREEHOLD AND LEASEHOLD PREMISES—						
Acquired from the British Broadcasting Co., Ltd., as valued by the Corporation's Officials, plus additions made by the Corporation to 31st December, 1928, at cost, per last Balance Sheet	60,481	14	10			
Additions during 1929, at cost	53,013	3	3			
	<hr/>			113,494	18	1
PLANT—						
Acquired from the British Broadcasting Co., Ltd., as valued by the Corporation's Officials, plus additions made by the Corporation to 31st December, 1928, at cost, per last Balance Sheet	118,585	15	5			
Additions during 1929, at cost (<i>less</i> book value of Plant discarded during the year)	88,684	13	6			
	<hr/>			207,270	8	11
FURNITURE AND FITTINGS—						
Acquired from the British Broadcasting Co., Ltd., as valued by the Corporation's Officials, plus additions made by the Corporation to 31st December, 1928, at cost, per last Balance Sheet	50,890	14	7			
Additions during 1929, at cost (<i>less</i> book value of Furniture discarded during the year)	4,978	12	3			
	<hr/>			55,869	6	11
MUSICAL INSTRUMENTS, MUSIC AND BOOKS—						
Acquired from the British Broadcasting Co., Ltd., as valued by the Corporation's Officials, plus additions made by the Corporation to 31st December, 1928, at cost, per last Balance Sheet	20,110	7	9			
Additions during 1929, at cost	4,496	1	8			
	<hr/>			24,606	9	5
	<hr/>			401,241	3	3
STORES ON HAND AND WORK IN PROGRESS, at cost or under				4,500	9	0
DEBTORS AND UNEXPIRED CHARGES—						
Sundry Debtors	73,462	19	3			
Unexpired Charges	9,364	10	6			
	<hr/>			82,827	9	9
INVESTMENTS—						
£305,000 5% War Loan, 1929-47, at cost (Market Value at 31st December, 1929, <i>less</i> accrued interest—£304,308 3s. 9d.)				307,250	16	3
CASH AT BANK AND IN HAND				65,423	11	4
	<hr/>			£861,243	9	7
	<hr/>					

OF THE BRITISH BROADCASTING CORPORATION.

with the books and vouchers of the British Broadcasting Corporation, and have exhibit a true and correct view of the state of the Corporation's affairs according to the books of the Corporation.

DELOITTE, PLENDER, GRIFFITHS & CO., Auditors,
Chartered Accountants.

ANALYSIS OF THE LONDON ALTERNATIVE PROGRAMMES

	National.		London Regional.	
	%.	%.	%.	%.
MUSIC				
Serious	21·393		22·234	
Light	18·330		34·820	
Variety	4·062		4·735	
Dance Bands	10·502		19·671	
Gramophone Records	4·455		2·047	
	58·742		83·507	
DRAMA	1·889		1·673	
	1·889		1·673	
TALKS				
Talks and Readings .	9·178		1·567	
Schools Education .	2·799		—	
Adult „	2·154		3·113	
News & Runn. Coms.	9·193		8·604	
	23·324		13·284	
RELIGIOUS SERVICES .	5·504		1·076	
	5·504		1·076	
APPEALS		·164		·192
CHILDREN'S HOUR .		5·569		—
SPECIAL TRANSMISSIONS .		·433		·101
PICTURES		4·375		·167
		100·000		100·000
		100·000		100·000

PROGRAMME DEVELOPMENTS

IT is not the primary purpose of this article to take stock of the outstanding programmes broadcast during 1929-30. This can be better done by each individual listener, in accordance with his personal tastes, when he has refreshed his memory by glancing at the list of the main events of the year published on pages 51-113. Its aim is rather to trace the main trend of development in programme achievement and policy during the year under review, and to give an indication of the probable course of events in the immediate future. Growth and development in this type of activity are too gradual to show particularly clean-cut changes taking place in so short a space of time as one year, but the analysis repays the effort it costs to make it. One's memories of broadcast programmes are often so fleeting, and so jumbled up together, that it is fatally easy to accept this programme and reject that as they tumble out of the loud-speaker, and to lose all consciousness of broadcasting as an organic whole with exciting possibilities for good or ill. Such a state of passive acquiescence is bad both for the listener and for broadcasting.

The first main development to be considered is the increase in listening facilities provided by the first steps in what is called the Regional Scheme. For the past year the majority of listeners in London, the Home Counties, and the area served by the Midland Regional Station, have had two programmes to choose from throughout the most important listening hours. Perhaps it is worth repeating here that this is only the first step in a scheme which has been designed to include a second wavelength service from Manchester, from Glasgow and from Cardiff. Obviously, therefore, it is too soon to estimate the success of the scheme with any finality, but experience of its working in London does show that it has been of the utmost value to most listeners. There are some listeners, of course, who have not made use of the increased facilities, and, unfortunately, there are some who find it difficult to hear the shorter wavelength programme in the neighbourhood in which they live. For their benefit it has been arranged that on those occasions when, for one reason or another, only one programme is to be broadcast, it will be given on the 356 wavelength as well as on Daven-

try 1554, instead of on 261 and 1554. Moreover, every outstanding programme will, if possible, be given a repeat performance on a different day, at a different time in the evening, and on a different wavelength. This arrangement not only gives listeners who can only use the 356 wavelength a chance of hearing programmes which they would otherwise have missed; it also gives the general listener a second chance of hearing a programme which other engagements made him miss on its first broadcast, and even an opportunity to hear a favourite programme twice if he wishes to do so.

The greatly improved quality of continental relays may also be described as an increase in listening facilities. Some of the relays from Ostend, Cologne, Brussels, Berlin, and particularly from Salzburg, have been of admirable quality. Reception has been so good that the day is clearly passing, if it has not already gone, when one need be surprised by good reception from such far-away places. Boundaries have been pushed back again, and we may expect that in the course of the next five years practically all the important broadcast activities in Europe will be available for listeners in Great Britain. In a different category there have been successful relays from America, from Australia when Miss Amy Johnson arrived there, and from Canada when R 100 crossed the Atlantic for the first time. But these were in the nature of astonishing feats or romantic experiments, like Harold Nicolson's conversation with a friend on board the liner "Homerick" at sea. The fact that European relays must obviously be placed nowadays in a different category from these experiments is itself a record of progress.

At home there have been great events in plenty—the concert at Queen's Hall by Toscanini conducting the Philharmonic Orchestra of New York, a series of Points of View talks by some of the most distinguished living Englishmen, the Command Performance in aid of the Variety Artists' Benevolent Fund, a season of Grand Opera at Covent Garden, Sir John Simon on "The Problem of India," a season of Symphony Concerts, running commentaries on all the big sporting events of the year. There is an imposing list of plays performed during the year, which include "Journey's End," and an equally imposing list of talks and talkers, but in 1930 one has almost come to expect



THE PRINCE OF WALES LEAVING ST. PAUL'S
after the service in memory of the dead of the airship R 101
(Broadcast Friday, October 10, 1930)

to find solid achievements of this kind in one's diary of programmes, though they would surely startle a new-comer to broadcasting.

The new departures in the world of music deserve a special note in this introductory and general article, though they are dealt with more fully elsewhere. In the early summer of 1930 the experiment was made of giving a season of Promenade Concerts in the North of England. The experiment proved successful, and this addition to the musical life of the North was eagerly welcomed and well supported from the first to the last night of the season. Close on the heels of this new venture came the season of "Proms" at Queen's Hall. The popularity of these concerts is a matter of history. They are old friends, but the 1930 season has had the added distinction of being the occasion of the first appearance in public of the greater part of the B.B.C. permanent orchestra. The trial orchestra which played in the October to April series of Symphony concerts was highly praised by all the critics, and it does not seem unduly optimistic to hope that the complete orchestra, based as it is on experience gained last year, will surpass the achievements of its predecessor, and rival the visiting orchestras of America, Germany, and Holland which have been so warmly received in this country. This is an event of the utmost importance both to the general musical life of the country and to broadcasting in particular. All sides of broadcasting will benefit, since various sections of the full orchestra will perform in the studio concerts, and the orchestra as a whole will give a series of symphony concerts in Queen's Hall.

This brief outline of some of the more important programme activities in the year 1929-30 may serve to give a bird's-eye view of what is happening in broadcasting and of what steps are being taken to get nearer in 1931 to an ideal state of affairs. Fortunately there is no point at which the growth of broadcasting must stop. It is a process of continual growth, a living organism, and not a progression along any one definite path to a definite and final goal.

So long as broadcasting is to be alive and sensitive to the informed needs of the community as a whole it must continue to improve in one direction or another.

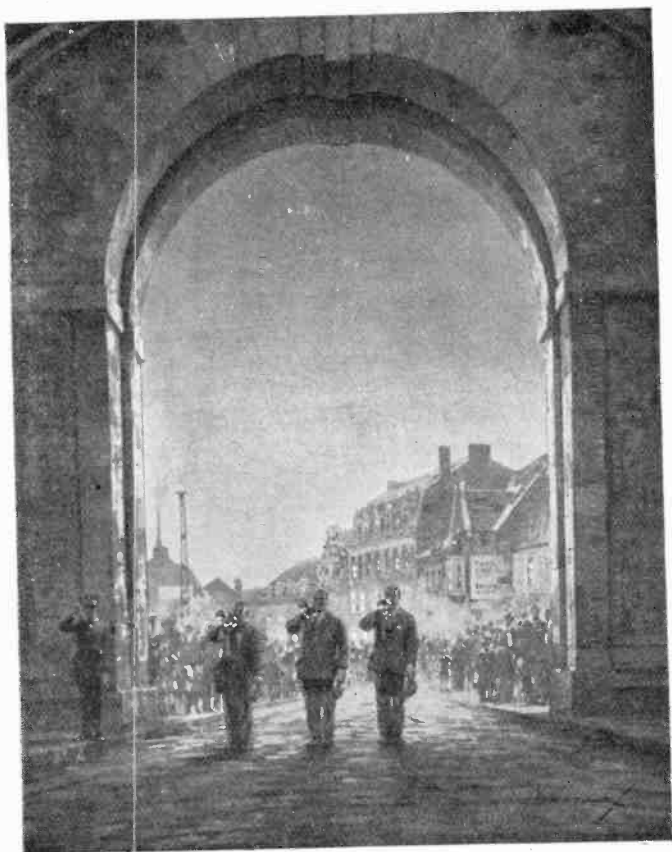

BUGLERS SOUNDING THE LAST POST AT THE MENIN GATE
(Broadcast on Armistice Day, November 11, 1929)



THE KING OPENING THE LONDON NAVAL CONFERENCE
His Majesty's speech was broadcast by radio.
(See the article on page 47.)



L CONFERENCE, JANUARY 21, 1930
as broadcast to the world
(see on p. 121)

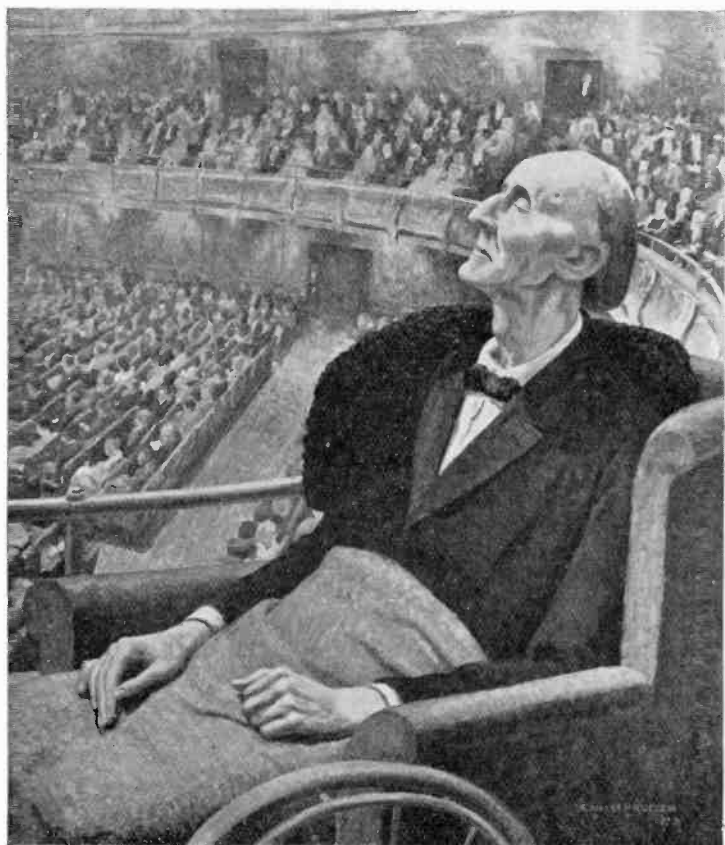

Ernest Proctor

DELIUS AT THE QUEEN'S HALL
(November 1, 1929)

EVENTS OF THE YEAR

(Nov. 1st 1929—Oct. 31st 1930)

NOVEMBER

1. Delius's "Mass of Life." Part of the Delius Festival at Queen's Hall.
Borough Election Results.
Symphony Concert conducted by Sir Henry Wood in the Ulster Hall.
2. Sir Oliver Lodge's "Point of View."
3. Broadcast by Lord Sankey, Lord Chancellor of England.
4. Mr. G. Lowes Dickinson sums up the "Points of View."
5. Liverpool Philharmonic Society Concert, conducted by Abendrodt.
6. "Carnival" adapted by Holt Marvell from the novel by Compton Mackenzie.
7. First of the season's B.B.C.'s Popular Symphony Concerts from the People's Palace, E.1.
Running Commentary on a Wembley Speedway meeting, from the Empire Stadium.
A Russian Cabaret relayed from the Kasbek Restaurant.
8. B.B.C. Symphony Concert, conducted by Sir Landon Ronald. Soloists: Jelly d'Aranyi and Adila Fachiri.
9. Speech by Prime Minister, Mr. Ramsay MacDonald, at the Lord Mayor's Banquet at the Guildhall.
10. Piano Recital by Pouishnoff.
Reid Orchestral Concert from Edinburgh.
11. Armistice Day Service relayed from the Cenotaph in Whitehall. Broadcast of "Journey's End," the play by R. C. Sherriff.
12. The Entente String Quartet.
13. B.B.C. Symphony Concert, conducted by Sir Thomas Beecham.
14. Peace Commemoration Dinner from the Guildhall. Speakers: Viscount Cecil, Mr. William Graham, General Smuts, Sir John Power, and Sir Herbert Morgan, who auctioneered the MS. of "Journey's End."
Birthday Programme by members of the B.B.C. Staff.
"Empire Builders," the Story of Bristol Merchant Venturers, from the Salon of the Royal Empire Society, Bristol.
15. Recital by Myra Hess.
Music from "The Beggar's Opera" with Sylvia Nelis and Frederick Ranalow.
Elgar's "The Kingdom," performed by the Belfast Philharmonic Society.
16. Oddfellows' Concert, including the Wireless Military Band, from Queen's Hall.
Brahms' "Requiem" from St. Anne's Church, Soho.
"Mary's John," a play by Harold Brighouse.
17. Barbirolli conducting the Wireless Symphony Orchestra.
Albert Sandler and the Park Lane Hotel Orchestra.
Congregational Service relayed from Albert Hall, Nottingham.
18. National Lecture by Professor G. M. Trevelyan, O.M.
Programme of Music by Arne.
Eye-witness Account of the fight between Carnera and Stribling at the Royal Albert Hall.
19. Conrad's "Typhoon" adapted by John Watt.
"Cavalleria Rusticana," by the Newport Choral Society, from the Central Hall.
Concert by the Newcastle Philharmonic Orchestra conducted by Alfred Wall.

20. A. J. Alan: "A Joy Ride."
A Concert by Victors at the National Eisteddfod of Wales, Liverpool, 1929.
21. "The Republic of Austria: a Poster in Sound."
City of Birmingham Orchestral Concert. Soloist: Fanny Davies. Speeches at the Scottish National Lifeboat Assembly at Glasgow by the Prince of Wales and the Duke of Montrose.
22. B.B.C. Symphony Concert conducted by Sir Henry Wood. Soloist: Paul Hindemith. "Intimate Snapshots" by Lance Sieveking.
Speech by Mr. F. B. Kellogg at the Pilgrims' dinner in his honour.
23. Vaudeville including George Graves and Nora Blaney.
24. Studio Service with an address by the Rev. Alfred Sharp, D.D., President of the National Council of Evangelical Free Churches.
25. Appreciation of M. Clemenceau by Viscount Cecil.
The Virtuoso String Quartet.
26. Lady Tree, Henry Ainley, and Leslie Henson, in aid of the League of Mercy.
Recital by Maggie Teyte.
27. "Louise," an opera by Charpentier.
A Reading from Robert Bridges' "Testament of Beauty."
B.B.C. Symphony Concert conducted by Sir Thomas Beecham.
28. Hallé Concert from Manchester. Speeches at the Dinner of the National Institute of Industrial Psychology, including the Duke of York, the Prime Minister, Viscount d'Abernon, and Sir Josiah Stamp.
29. Richard Strauss's Opera "Salome" relayed from Cologne.
30. A St. Andrew's Night Programme, from Edinburgh.
Sonata Recital by Szigeti and Harriet Cohen.



"JOURNEY'S END"
(November 11, 1929)



E.N.A.

A GENERAL VIEW OF COLOGNE

(November 29, 1929, and January 3, 1930)

The Cathedral, which figures largely in this as in any other general view of the city, celebrated on October 15 the Jubilee of its consecration in its completed form, the celebrations being broadcast in Germany

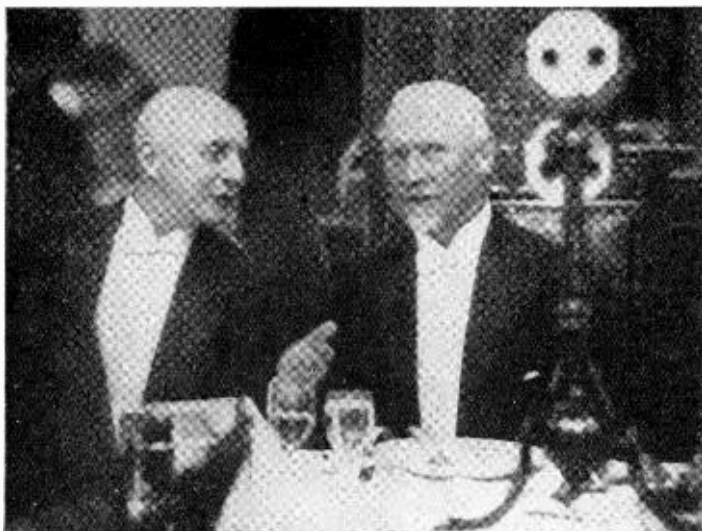

World Wide

GENERALS VON LETTOW-VORBECK AND JAN SMUTS AT THE
RECONCILIATION DINNER

(December 2, 1929)

DECEMBER

1. Annual Scottish Festival Service from St. Columba's, Pont Street. The Pro Arte String Quartet and Anne Thursfield. First Concert of the Cardiff Musical Society, "A Sea Symphony," from the Park Hall, Cardiff. Sea Pictures in Music, presented by Lawrence Haward, with the Northern Wireless Orchestra. Service from Bangor Cathedral.
2. Speeches at the Reconciliation Dinner of the Comrades of the East African Campaign by General Smuts and General von Lettow-Vorbeck. B.B.C. Concert of Contemporary Music, conducted by Anton Webern.
3. The Berlin Philharmonic Orchestra, conducted by Furtwangler, from Queen's Hall.
4. Concert by the Glasgow Orpheus Choir, conducted by Hugh S. Robertson. Concert of modern French music, conducted by Percy Pitt. Broadcast of the trial for the Dunmow Flitch.
5. B.B.C. Concert from the People's Palace, conducted by Sir Landon Ronald. Soloist: Solomon. Vaudeville including the Houston Sisters and Wish Wynne. "Heredity and Environment": a discussion between Professor H. Laski and Dr. F. A. E. Crew.

6. B.B.C. Symphony Concert, conducted by Franz von Hoesslin.
7. "Weir of Hermiston," by R. L. Stevenson, adapted by Halbert Tatlock.
8. Piano Recital by Orloff.
The London Chamber Orchestra, conducted by Anthony Bernard.
League of Nations Service from the Fisherwick Presbyterian Church, Belfast.
9. Concert by the Choir of St. George's Chapel, Windsor, under the direction of Sir Walford Davies, from the Albert Institute.
"The Tales of Hoffmann" by the Carl Rosa Opera Company, conducted by Richard Austin, from the Lewisham Hippodrome.
10. "The Death of Tintagiles" by Maeterlinck.
Running Commentary on the 'Varsity Rugby Football Match at Twickenham.
- International String Quartet.
"What's Bred in the Bone," a play by Harold Brighouse.
11. B.B.C. Symphony Concert; The National Chorus in Sir Granville Bantock's "Omar Khayyam," conducted by Sir Thomas Beecham.
Speeches at the Annual Banquet of the United Associations of Great Britain and France, by Lord Derby, Mr. Arthur Henderson, the French Ambassador, and the Marquis of Vogue.
Programme of Butterworth's Music.
13. Songs and Choruses by Students of the University of Bristol.
14. Broadcast of the Unveiling of the Memorial to Queen Alexandra at Copenhagen.
Replica of a Covent Garden Promenade Concert of Oct. 29th, 1883.
"The Messiah" by the Belfast Philharmonic Society.

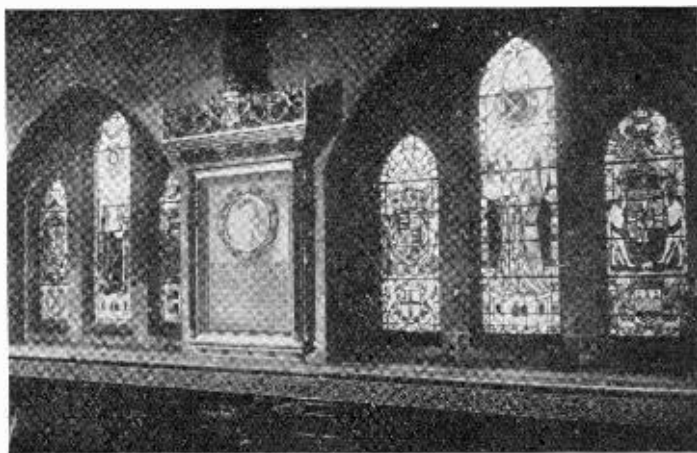

THE MEMORIAL TO QUEEN ALEXANDRA AT COPENHAGEN

(December 14, 1929)

- Running Commentary by Mr. W. Harland on the Rugby Match—Ulster v. Leinster.
Speech by Mr. Winston Churchill in reply to an address of welcome by students of Bristol University.
15. Concert by the Hastings Municipal Orchestra, conducted by Basil Cameron.
The Catterall String Quartet.
 16. Commemoration Service relayed from King's College, London.
Recital by Jelly d'Aranyi and Myra Hess.
Tour of a newspaper office at night relayed from the offices of the "Daily Express."
Beethoven Anniversary Concert by Northern Wireless Orchestra.
 17. Music by Montague Phillips.
Concert by the Scottish Orchestra, from St. Andrew's Hall, Glasgow.
 18. Humperdinck's "Königskinder," conducted by Percy Pitt.
 19. German National Programme arranged by Lance Sieveking and Rolf Gardiner.
Sonatas played by Albert Sammons and Leslie Heward.
"The Messiah" by the Leeds Choral Union and Symphony Orchestra conducted by Sir Thomas Beecham.
A Concert by Bristol University Madrigal Singers from University Union, Bristol.
 20. "The Prisoner of Zenda," Anthony Hope's novel adapted for broadcasting by Holt Marvell.
Concert of Russian Music, conducted by Malko.
 21. Relay of part of "The Student Prince" from the Piccadilly Theatre.
A Historical Manx Programme by Manx artists.
"Gruach," a Verse Play by Gordon Bottomley, presented by the Scottish National Players.
 22. The Vienna String Quartet.
"The People's Service" from Liverpool Cathedral.
A Mendelssohn Programme.
 23. "Bethlehem": a Nativity Play relayed from St. Hilary's, Marazion, Cornwall.
"Carols on 'Change" from the Exchange, Cardiff.
 24. Carol Service from King's College, Cambridge.
Ghost Stories by E. F. Benson, W. W. Jacobs, and Desmond MacCarthy.
The Wireless Choir in Carols from St. Mary's Church, Whitechapel.
 25. Service from York Minster.
Address by the Archbishop of York.
Mabel Constanduros in "The Buggins's Christmas Party."
Mr. Winston Churchill appealing on behalf of the Wireless Fund for the Blind.
"Cox and Box" by Arthur Sullivan.
"Scrooge" adapted and played by Bransby Williams.
 26. "Cinderella": a Pantomime by Ernest Longstaffe.
A Programme of Military Marches arranged by Walter Wood.
"The Messiah" from the Town Hall, Birmingham.
 27. The London String Players.
 28. "Rupert of Hentzau," adapted by Holt Marvell from the novel by Anthony Hope.
The Marquis and Marchioness of Aberdeen's Reminiscences.
 29. Service from Canterbury Cathedral.
 30. A Concert of settings by the Duchess of Atholl of R. L. Stevenson's Songs, with the Duchess of Atholl at the piano.
 31. Piano Recital by Moiseiwitsch.
"The Birth of the Year," including relays of New Year Celebrations from the Continent.

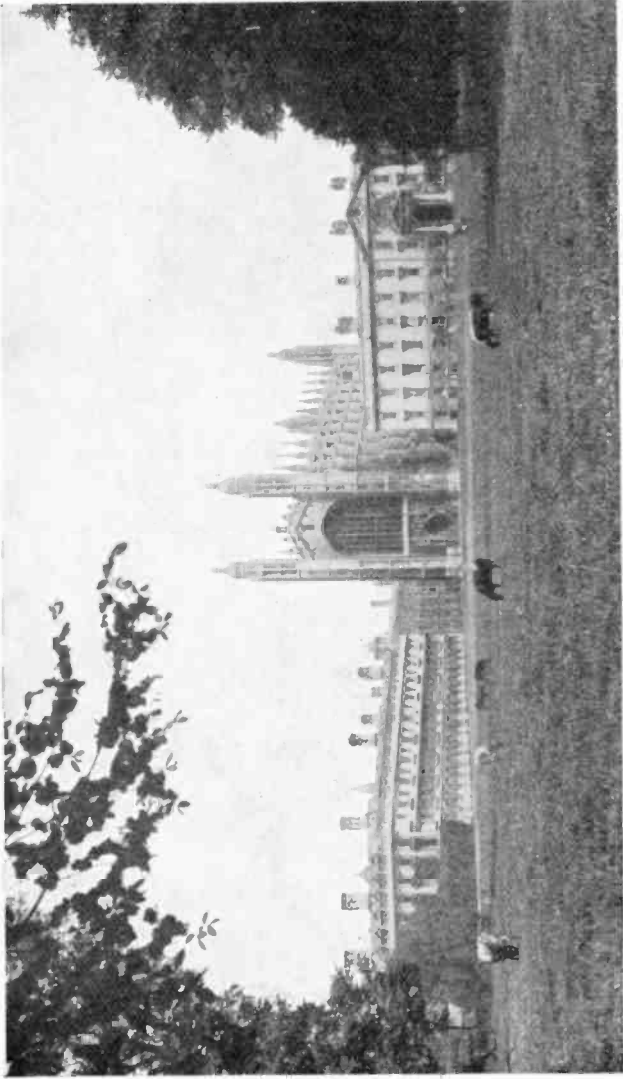

Stearn

THE CHAPEL OF KING'S COLLEGE, CAMBRIDGE
(December 24, 1929)



GRACIE FIELDS
(January 15, 1930)

JANUARY 1930

1. "Les Cloches de Corneville," conducted by John Ansell.
2. "Milestones," adapted from the play by Arnold Bennett and Edward Knoblock.
Concert by the Orchestra of the N.B.C. of America, conducted by Adrian Boult, re-broadcast from New York.
3. An International Concert with items contributed by Germany, Belgium, and Great Britain.
"Clothes Props," a production by Gordon McConnel.
First of the Weekly Talks on "People and Things" by the Hon. Harold Nicolson.
4. Part of Act I of "Dear Love" from the Palace Theatre.
5. Piano Recital by Bela Bartok.
6. Lady Emmott in the first broadcast of a series on "The Future of Domestic Service."
7. The Scottish Orchestra, conducted by Golschmann.
9. Recital by Sir George Henschel. Humperdinck's "Hansel and Gretel" from the People's Palace.
10. Speeches at the Hague Conference by Mr. Philip Snowden and others.
Oskar Fried conducting a Berlioz Concert.
13. Recital by Lionel Tertis.
14. Sir Alfred Yarrow's reminiscences.
Edward German Programme.
Will Hay, Fred Duprez, Mabel Constanduros, Tommy Handley, and Flotsam and Jetsam.
15. Gracie Fields in an extract from "The Show's the Thing" at the Winter Garden Theatre.
"The Wrecker" by R. L. Stevenson.
16. Vaudeville with Jack Hulbert and Cicely Courtneidge.
Toast by Mr. Stanley Baldwin at the Dinner of the Edinburgh Sir Walter Scott Club.
17. Sir Landon Ronald conducting the B.B.C. Symphony Orchestra at Queen's Hall..
18. Commentary on Rugby Match, England v. Wales, from Cardiff. Extract from the Pantomime "Mother Goose" from Theatre Royal, Leeds.
20. A Sketch by P. G. Wodehouse. Chamber Music by Ethel Smyth.
21. Speech by H.M. the King at the Opening of the London Naval Conference in the Royal Gallery of the House of Lords.
"Ceremony of the Keys" relayed from the Tower of London described by H. V. Morton.
22. B.B.C. Symphony Concert, conducted by Basil Cameron. Soloist: Moiseiwitsch.
23. Speeches from the Guildhall Banquet to the Delegates attending the London Naval Conference, including M. Tardieu and the Prime Minister.
City of Birmingham Orchestral Concert. Soloist: Sir Walford Davies.
24. Extracts from "The Mikado" relayed from the Savoy Theatre.
25. Burns Night Celebrations.
26. Service from Chester Cathedral. The Hungarian String Quartet.
27. National Lecture by Sir J. J. Thomson, O.M.
28. Broadcast to America on the Naval Conference by Mr. H. L. Stimson.
Speech by Lord Grey at the Dinner of the Pilgrims' Society to the Delegates of the London Naval Conference.
29. Puccini's "La Bohème," conducted by Percy Pitt.
30. Royal Philharmonic Concert of Music by Sir Edward Elgar, conducted by the Composer.
31. B.B.C. Symphony Concert, conducted by Ernest Ansermet.
A Speech by G. Bernard Shaw on behalf of the National Theatre, from Kingsway Hall.

FEBRUARY

1. Lady Trevelyan in the first of a series of talks on "Saving the Countryside."
Vaudeville including Gracie Fields, Albert Whelan, and Dora Maughan.
Running Commentary on the International Rugby Match, Scotland *v.* Wales, from Edinburgh.
2. Mozart and Haydn Concert.
3. 5th Symphony of Beethoven, conducted by Weingartner, relayed from Frankfurt.
B.B.C. Concert of Contemporary Chamber Music, conducted by Ernest Ansermet (including "Les Noces" of Stravinsky).
5. B.B.C. Symphony Concert, conducted by Leslie Heward.
6. A French National Programme introduced by H.E. the French Ambassador.
7. "The Tragedy of Pompey the Great": a Play by John Masefield.
'Cello Recital by Suggia.
Symphony Concert in aid of the Belfast Branch of the Musicians' Union Benevolent Fund.
8. Programme of Leslie Stuart's Music.
Running Commentary on the Rugby International, Ireland *v.* England, relayed from Dublin.
9. 'Cello Recital by Paul Hermann.
Fishermen's Service from the Priory Church, Bridlington.
Berlioz's "The Childhood of Christ," by the Birmingham Studio Chorus and Orchestra.
"For the Children," by E. R. Appleton, a series of dramatised Bible stories, from Cardiff.
10. "Points of View," Second Series, I. The Archbishop of York.
Steuart Wilson, Antoni Sala, and John Ireland, in Chamber Music.
Speeches at the Annual Dinner of the Society of Somerset Folk from the Berkeley, Bristol.
Speech by George Birmingham (Canon Hannay).
11. Augustine Birrell's reminiscences.
Tom Webster, the famous Cartoonist.
The Lancashire Cotton Fair. Speeches by the Rt. Hon. J. R. Clynes, M.P., Home Secretary, a Kaleidophonic programme, "Cotton," and a play, "Progress and the Builder," by Edwin Lewis, presented from the Manchester Studios.
13. Wagner Anniversary Concert from the People's Palace.
"Love in Greenwich Village": a modernised version of the opera by Arne.
14. B.B.C. Symphony Concert, conducted by Sir Henry Wood.
Soloist: Béla Bartók.
Concert by the Belfast Philharmonic Society.
15. Student Songs by the Wireless Male Voice Chorus.
16. Piano Recital by Franz Osborn.
17. Vaudeville including Claude Hulbert.
"Points of View": II. Viscount Grey of Fallodon.
First broadcast by the Abbey Players in "The White-Headed Boy" by Lennox Robinson.
18. Birthday Greetings to Sir George Henschel, in the form of one of his songs sung by his daughter, Helen Henschel.
"The Mock Doctor" by Henry Fielding, from Molière's "Le Médecin Malgré Lui."
Eye-witness Account of the Boxing Match between Callaghan and Kid Berg.
Swansea Orpheus Society in scenes from "Hiawatha."
19. A talk by Miss Megan Lloyd George, M.P.
A Discussion on Unemployment

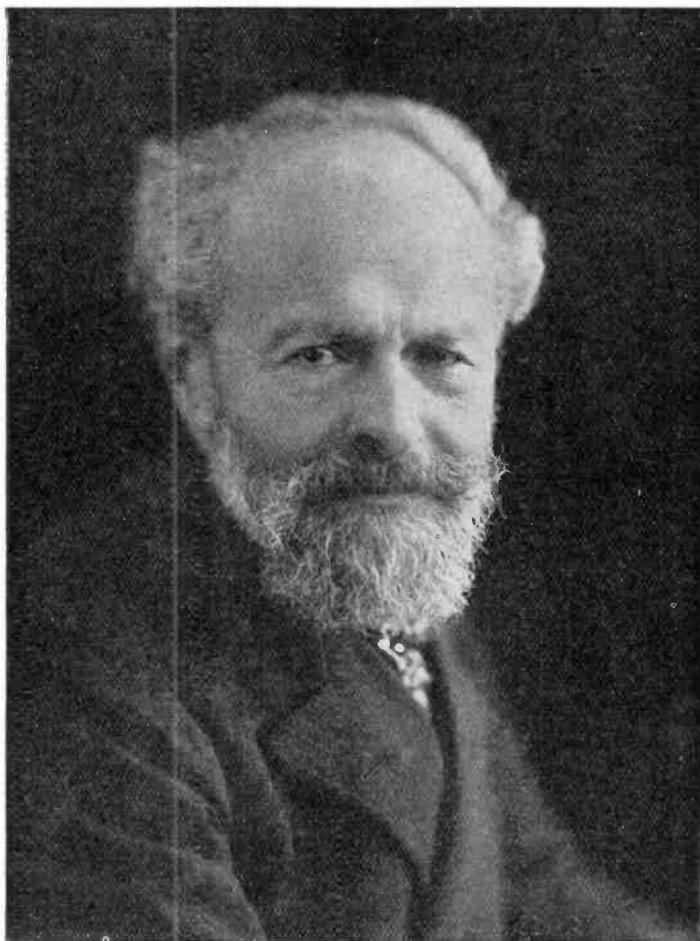

SIR GEORGE HENSCHEL

(February 18, 1930)

[61]



ENGLAND V. FRANCE

(February 22, 1930)

[62]

- between Sir Josiah Stamp and Mr. J. M. Keynes.
 "The Princess who lost a Tune": a Ballet Mime by Alec Rowley.
20. Concert by the Gloucester Orpheus Society and Muriel Brunskill from the Saire Hall. Berlioz's Faust, by the Hallé Chorus and Orchestra. Fraser-Simson's Songs sung by Dale Smith.
 21. B.B.C. Symphony Concert from Queen's Hall, conducted by Scherchen. Soloist: W. Frey.
 22. Running Commentary on England v. France Rugby Match at Twickenham. Extracts from "Iolanthe" at the Savoy Theatre. "The Devil a Saint," by K. R. Gregson, performed by the Leeds Civic Players.
 23. Recital by Elena Gerhardt. Margaret Balfour in Bantock's "Aphrodite."
 24. "Points of View": III. Sir James Jeans.
 25. Broadcast from R.M.S. "Majestic" in mid-ocean by Captain Vaughan. Vaudeville inc. Sybil Thorndike, from the Coliseum, Norman Long, and Bransby Williams.
 26. Lalo's Opera "Le Roi d'Ys."
 27. Hallé Concert from Manchester.
 28. "The Piccadilly Dally," compiled by Gordon McConnel. "Sea Shanties" from the Dinner of the Seven Seas Club. "Exiles": a Play for Broadcasting produced by Lance Sieveking. Handel's "Solomon," conducted by Sir Thomas Beecham.

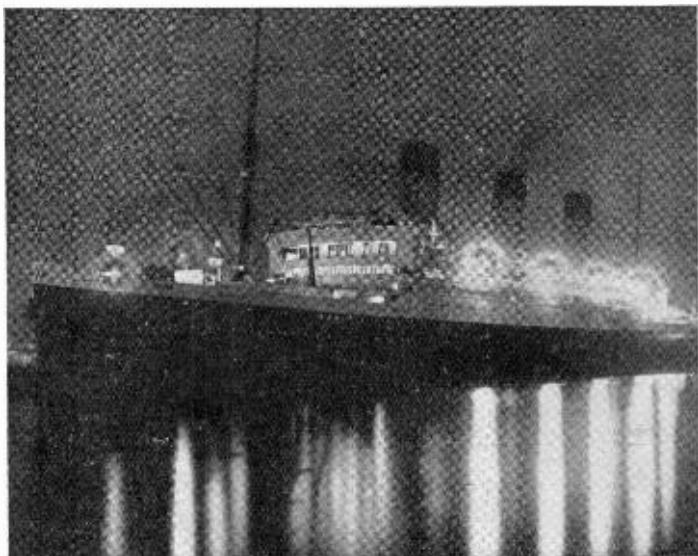

R.M.S. "MAJESTIC"

(February 25, 1930)



Central News

THE GRAND NATIONAL

(March 28, 1930)

Note the jockey crouching in the ditch and the horse upturned with its forelegs in the air

[64]

M A P C H

1. Leicester Brass Band Festival from the De Montfort Hall. St. David's Day Concert. Speeches at the Banquet of the Cardiff Cymodoriion Society from the City Hall.
2. Symphony Concert, conducted by Sir Henry Wood. Service from Manchester Cathedral with a sermon by the Bishop of Birmingham.
3. B.B.C. Concert of Contemporary English Music, including "Facade," a setting of Edith Sitwell's poems by William Walton. "Points of View": IV. Dame Ethel Smyth.
5. Czecho-Slovakian National Programme.
6. Ceremony of the Unveiling of Mrs. Pankhurst's Statue by Mr. Baldwin from the Victoria Tower Gardens, Westminster. "Salving a Derelict" by Cutcliffe-Hyne.
7. B.B.C. Symphony Concert, conducted by Frank Bridge.
9. The Prague Siring Quartet.
10. "Points of View": V. Sir Josiah Stamp. Sea Shanties sung by the Birkenhead Dock Gatemmen.
12. Piano Recital by Harold Samuel.
13. Hallé Concert from Manchester.
14. "Fulk of the Forest," adapted from the novel "The King behind the Kirg" by Warwick Deeping. The first of a series of "Diversions," including a tour round the new London Broadcasting Station at Brookmans Park. B.B.C. Symphony Concert, conducted by Sir Henry Wood. Soloist: Backhaus.
15. Commentary on the Rugby Football Match between England and Scotland at Twickenham.
16. Religious Service arranged by the National Brotherhood Movement, conducted by Charles G. Ammon, M.P., from Whitefield's Central Mission.
17. "Points of View": VI. Sir Henry Newbolt. St. Patrick's Day. Yeats's "Cathleen ni Houlihan" relayed from the Abbey Theatre, Dublin. Broadcast of the winning play in the Annual Festival organised by the Scottish Community Drama Association.
18. International Concert from Berlin Funk-Stunde, Radio Belgique, and London, Studios. Revival of the Masque in "The History of Timon of Athens, the Man-Hater," music by Henry Purcell (first performance since 1740), and "Alceste" by Handel, performed by the Northern Wireless Orchestra and Lewis's Staff Choir.
19. Harpsichord Recital by Violet Gordon Woodhouse. "There is no Fool like a Young Fool," an Operetta by Mehul. Military Band Concert by the No. 1 Free State Army Band, conducted by Colonel Fritz Brase, relayed from Dublin.
20. Mr. Stanley Baldwin: "A Tribute to Lord Balfour." Piano Recital by Fanny Davies. Hallé Pensions Fund Concert.
21. B.B.C. Symphony Concert, conducted by Sir Thomas Beecham and Sir Edward Elgar. New viola arrangement of Elgar's cello concerto, played by Lionel Tertis.
22. Eye-witness Account of the Semi-Final of the F.A. Cup, Arsenal v. Hull City. "Diversion No. 2," including the first broadcast of a Talkie. Final Scenes of the Gilbert and Sullivan Season from the Savoy Theatre.

- Bantock Programme by the Midland Regional Orchestra, conducted by Sir Granville Bantock.
- Concert by the first and second Prizewinners in B.B.C. Brass Band Contest at Newcastle.
23. Wireless for the Blind Fund Concert from the Albert Hall.
 24. National Lecture by Rt. Hon. Lord Hewart of Bury, Lord Chief Justice of England. Recital by Conchita Supervia and Amparo Iturbi.
 25. Sir Ian Hamilton's reminiscences. "Brigade Exchange": a Sound picture by Ernst Johannsen. "King Charles I in Newcastle 1646-7," a Dramatic Episode performed by the Newcastle-on-Tyne Repertory Company.
 26. "The Bartered Bride," an opera by Smetana.
 27. "A Café in Vienna," including an operetta, "Zara." Recital by Gunther Ramin. Welsh Singing Festival from Corwen.
 28. Running Commentary on the Grand National Steeplechase from Aintree. B.B.C. Symphony Concert: a programme of Spanish music conducted by Perez Casas.
 29. Recital by John Coates and Arthur Catterall.
 30. Salvation Army Service conducted by General Higgins, from Queen's Hall.
 31. Mrs. Philip Snowden on "Why Women want Peace." British Women's Symphony Orchestra from Queen's Hall.

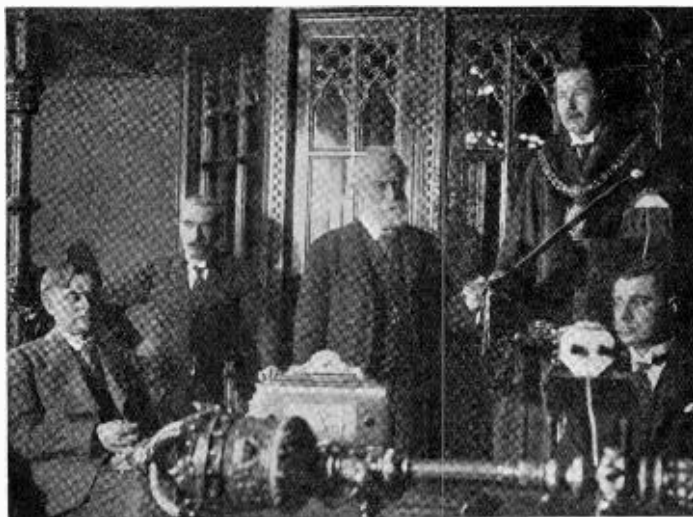

Manchester Guardian

THE PRESENTATION OF THE FREEDOM OF MANCHESTER TO MR.

C. P. SCOTT

(April 8, 1930)

[66]

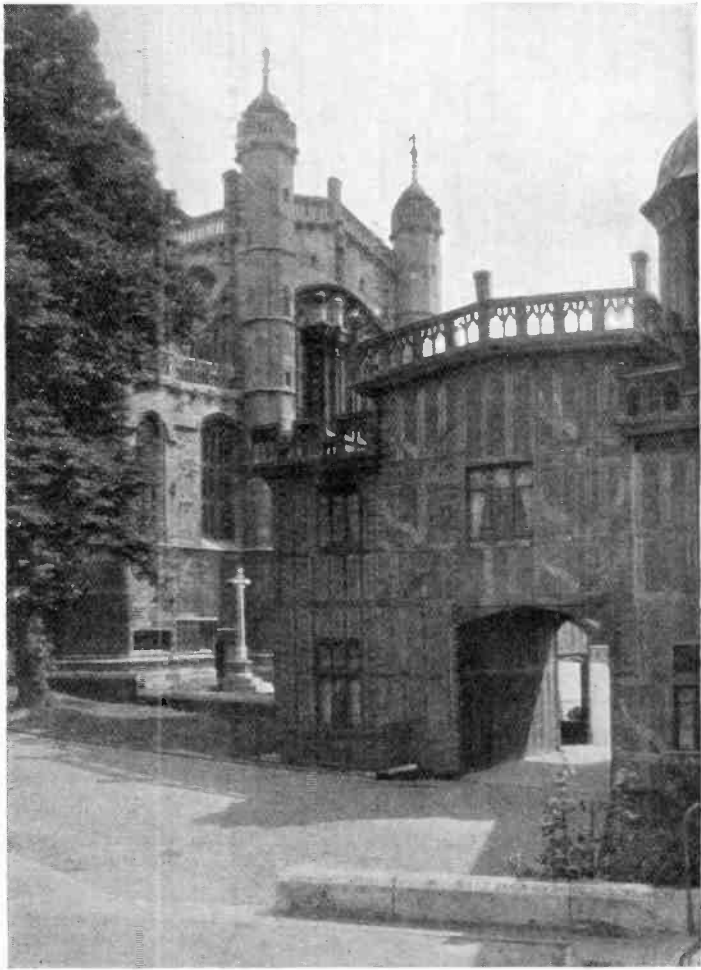

Will F. Taylor

ST. GEORGE'S CHAPEL, WINDSOR CASTLE

(April 18, 1930)

The chapel, which is the home of the Order of the Garter, was re-opened on November 4, after being partially closed for ten years for repairs.

[67]

A P R I L

2. "Philip the King" by John Masefield.
3. An Alfred Reynolds Programme.
Royal Philharmonic Concert conducted by Oskar Fried.
"Everyman," a Cantata by Sir Walford Davies, from Swansea.
4. B.B.C. Symphony Concert from Queen's Hall. Soloist: Wanda Landowska.
Concert performance of "Tannhauser" by the Belfast Philharmonic Society.
5. Extract from "The House that Jack Built" from the Adelphi Theatre.
Recital by Marcel Dupré.
6. The Kolisch String Quartet and Steuermann.
The London Symphony Orchestra, conducted by Reginald Stewart.
7. Concert of Schonberg's music, inc. Pierrrot Lunaire, conducted by Erwin Stein.
8. Conferring of the Freedom of the City of Manchester on Mr. C. P. Scott, Governing Director of the *Manchester Guardian*.
Worcester Festival Choral Society, in Part II of "The Apostles" by Elgar.
Verdi's "Requiem," by the Newport Choral Society.
11. "The Flowers are not for you to Pick": a play by Tyrone Guthrie.
Opening of the Cartwright Memorial Hall, Bradford, by the Countess of Oxford and Asquith.
12. Running Commentary on the Varsity Boat Race.
14. "Diversions," including a description of the P.O. Automatic Tube Trains.
Bach's St. John Passion by the Newcastle Bach Choir.
15. The Chancellor of the Ex-
- chequer, Mr. Philip Snowden, on the Budget.
Last B.B.C. Symphony Concert at Queen's Hall; Mahler's Eighth Symphony, conducted by Sir Henry Wood.
E. M. Forster on D. H. Lawrence.
16. Paul Robeson singing Negro Spirituals.
"The Prophetic Camera" and "The Seven Ages of Mechanical Music" arranged by Lance Sieveking.
17. "The Son of Man" by Lois Mary Shiner.
18. Service from St. George's Chapel, Windsor.
B.B.C. "Parsifal" Concert from Queen's Hall.
Bach's "St. Matthew Passion" relayed from the Thomas Kirche, Leipzig.
"The Messiah," by the Cardiff Musical Society.
22. Prime Minister on the Results of the Naval Conference.
23. Speeches at the Shakespeare Birthday Celebration from the Town Hall, Stratford-on-Avon.
Shakespeare's "King Henry V."
24. Dr. Rudolph Eckener on the Airship of the Future.
25. Chamber Music, including Sextets by Brahms and Schonberg.
26. Commentary by G. F. Allison on the F.A. Cup Final, Arsenal v. Huddersfield Town.
Professor George Gordon on Robert Bridges.
Speeches at the Reunion Dinner of the Survivors of the Siege of Kut-el-Amara.
28. Act III of "The Mastersingers" from the opening of the Covent Garden Opera Season.
30. Two Operas, "Cavalleria Rusticana" and "Gianni Schicchi," from the Studio.
Opening of the London-Australia Telephone Service with a conversation between Mr. Ramsay MacDonald and Mr. Scullin.



THE F.A. CUP FINAL
(April 26, 1930)

M A Y

1. "Robin Hood," a drama derived from the ballad "The Little Geste of Robin Hood and his Meiny," first printed by Wynkyn de Worde about 1510. Recital by Elena Gerhardt. Opening of the New Stranmillis Training College, Belfast, by the Duchess of Atholl.
2. Symphony Concert conducted by Sir George Henschel.
3. Commentary on Rugby League Cup Final, St. Helens *v.* Widnes. Speeches, following the Royal Academy Dinner, by H.R.H. the Duke of York, Lord Parmoor, Lord Macmillan, Sir Wm. Llewellyn, the late Lord Thomson, and Lord Moynihan. Diversions No. 8, including a Hyde Park orator.
4. Military Service from York Minster. Beethoven's Mass in D by the Huddersfield Choral Society and the Northern Wireless Orchestra, conducted by Sir Henry Coward. Service from Newcastle Cathedral.
5. T. E. Brown Centenary Concert, and Talk by Sir Henry Newbolt. Contemporary Music, conducted by Hermann Scherchen.
6. Talk by Sir Herbert Samuel. Copenhagen Palestrina Choir, from the Park Lane Hotel. Band of H.M. Welsh Guards, relayed from the Exhibition of Industries at Bath.
7. Violet Loraine in a revue, "Red Pepper!" The Duchess of Bedford on "Cape Town and back by Air." The Inauguration of the Bangor Electricity Scheme, Co. Down. Speeches by the Mayor and Lord Craigavon, Prime Minister of Northern Ireland.
8. "The Four Feathers," by A. E. W. Mason, dramatised by Cecil Lewis. The Home Secretary (Mr. J. R. Clynes) on "The Electoral Register."
9. Chamber Music by the Philharmonic Trio. "Diversions," including S. C. H. Davies giving an Eye-Witness Account of the Brooklands Double-12 Race, the Budapest Male Voice Choir from the Savoy Hotel, the Lagoon Scene from "Peter Pan" and "The Pool of London by Night," described by J. C. Squire. "Die Gotterdammerung," Act III, from Covent Garden.
10. Concert by the Society of Symphonic Players from Brighton. "The Conquering Hero," a Play by Allan Monkhouse, from the Sheffield Repertory Theatre. First Relay of Variety from the Capitol, Dublin.
11. Piano Recital by Marguerite de Pachmann.
12. "Stars and Stripes"—a symposium on America: I. The Marquess of Lothian on "What is the United States?" "Intimate Snapshots," by Lance Sieveking. "Das Rheingold," from Covent Garden.
13. Symphony Concert conducted by Sir Henry Wood, including Mahler's First Symphony. A Discussion between Mr. St. John Ervine and Mr. Lloyd James on "What is Good English?" Broadcast from the London Zoo during the Children's Hour.
14. Recital by Miriam Licette. Vaudeville, including Ann Penn, Sandy Rowan and Betty Chester.
15. "The Man of Destiny," by George B. Shaw. "Diversions," including a Commentary on the Speedway meeting at the Empire Stadium,

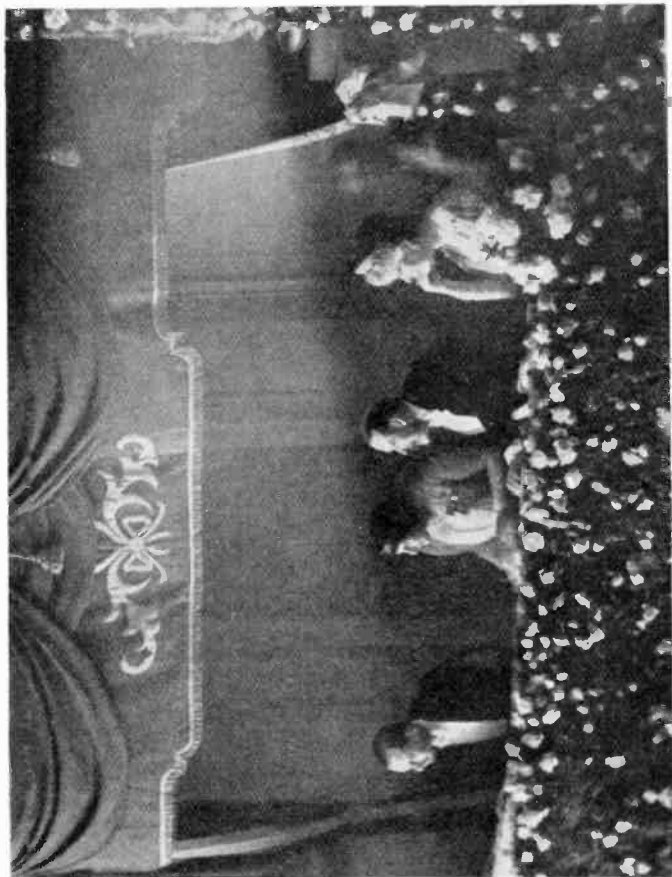

THE KING AND QUEEN AND THE DUKE OF GLOUCESTER AT THE PALLADIUM

(May 22, 1930)



THE PRINCE OF WALES AT CARDIFF
(May 21, 1930)

South Wales Echo

- Wembley, John Gielgud in "Hamlet," and a relay from the Willesden Junction Signal Box.
16. Act II of "Parsifal," from Covent Garden.
Scottish Chamber Music, including a quintet by Ian Whyte.
 17. Fridtjof Nansen: a tribute by Gilbert Murray.
 18. Elizabeth Schumann in an Orchestral Concert.
Religious Service from the City Temple.
Octets played by the Brosa and International String Quartets.
 19. International Concert, including the Stuttgart Philharmonic Orchestra, the Radio Belgique Orchestra, and the Wireless Military Band.
 20. Samuel Pepys Commemoration Service from St. Olave's Church, Hart Street, Mark Lane.
Opening of the General Assembly of the Church of Scotland at Edinburgh.
Vaudeville, including Albert Sandler and Madge Saunders.
Act III of "Siegfried," from Covent Garden.
 21. Opening of the Physics Laboratories by H.R.H. the Prince of Wales, from University College, Cardiff.
Act II of "Fledermaus," from Covent Garden.
 22. Royal Command Performance in aid of Variety Artists' Benevolent Fund, from Palladium.
Josiah Wedgwood Industrial Day Luncheon Speech by Sir Oliver Lodge, from the Town Hall, Stoke-on-Trent.

23. Mendelssohn's "Elijah," sung in the Queen's Hall by the National Chorus conducted by Stanford Robinson.
Manchester University Jubilee Celebrations.
24. Empire Day programme, including a speech by the Prime Minister from the palace of Holyrood House, Edinburgh.
25. Address by Sir Rabindranath Tagore, from Manchester College, Oxford.
Recital by Maria Olszewska.
Service from Southwark Cathedral.
26. Viscount Cecil of Chelwood: an appreciation of Archbishop Lord Davidson.
Broadcast of the song of the nightingale from a wood in Berkshire.
Inaugural Northern Promenade Concert (Wagner Programme), from the Free Trade Hall, Manchester.
27. "Nowt Wrang," a Yorkshire play by F. A. Carter, performed by members of the Huddersfield Theatians.
28. "La Basoche," an Opera by Andre Messager.
29. Act I of Bellini's "Norma," from Covent Garden Opera House.
Miss Amy Johnson speaking from Australia on her Flight.
30. Act I, "Madame Butterfly," from Covent Garden.
Vaudeville, including Dorothy Dickson, Flotsam and Jetsam, and Ronald Frankau.
31. International Air Pageant on the occasion of the official opening of Bristol Municipal Airport by Prince George, from Whitchurch, Bristol.



BROADCASTING THE NIGHTINGALE

(May 26, 1930)

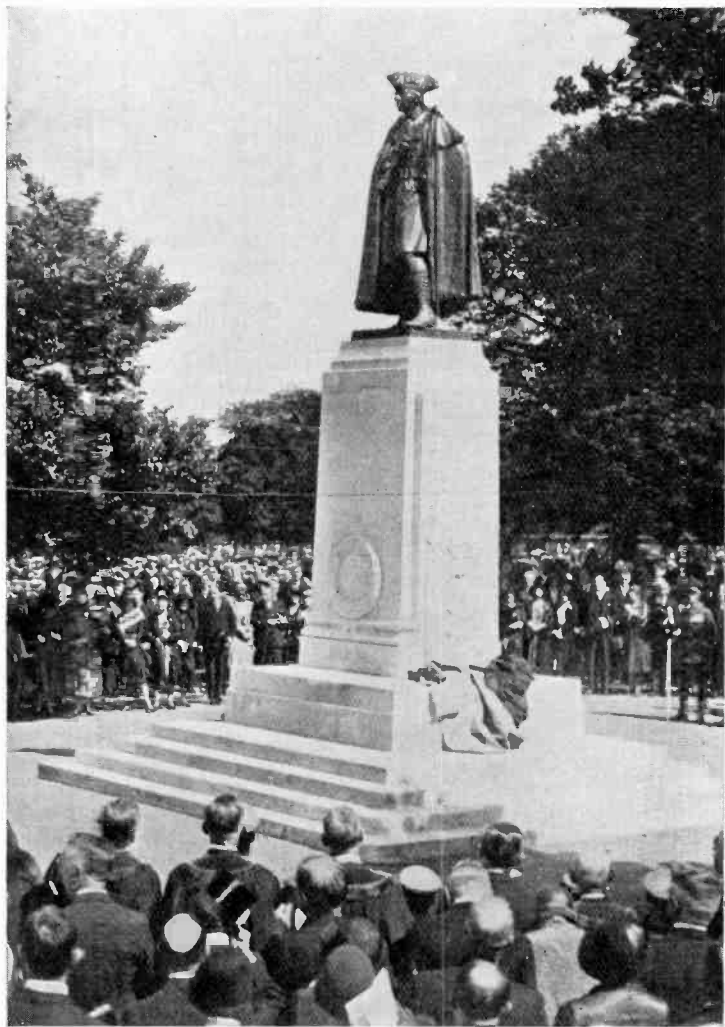

Sport and General

THE MEMORIAL TO GENERAL WOLFE

(June 5, 1930)

[74]



Sport and General

TROOPING THE COLOUR

(June 3, 1930)

JUNE

1. Recital by Rheingold Gerhardt.
2. Speech by Major the Hon. J. J. Astor, at the Guildhall Banquet to the Delegates of the 4th Imperial Press Conference.
Dramatic Recital by Henry Ainley and Alexander Moissi.
3. Commentary on the Trooping of the Colour from the Horse Guards Parade, Whitehall.
Birthday Greetings to H.M. the King.
"Irish Bulbuls," by Gordon McConnell.
Special Service from Birmingham Cathedral.
4. Running Commentary on the Derby by R. C. Lyle.
The Kneller Hall Band from Twickenham.
The Philharmonic Orchestra of New York, conducted by Toscanini, from Queen's Hall.
5. Unveiling of the Monument in memory of General Wolfe at Greenwich Park by the Marquis of Montcalm, and speeches following the Canada Club Dinner.
Concert by the Rouen Municipal Band relayed from the British-French Week Exhibition at Bristol.
6. "'Tis o Aucassin and Nicolette," translated from the French by Eugène Mason.
Act I. of Verdi's "Otello" from Covent Garden.
Eye-Witness Account of the Open Golf Championship of Ireland, by Major C. O. Hezlet.
Broadcast Conversation between Mr. Harold Nicolson in the London Studio and Mr. Cyril Carmichael on the White Star Liner *Homeric* in Mid-Atlantic.
7. Chamber Music by the Virtuoso String Quartet.
Brig.-Gen. C. G. Bruce on "Kanchenjunga."
Opening of the Sports Pavilion at Kirriemuir by the donor, Sir James Barrie.
8. The British Legion Memorial Service at the Cenotaph.
Bournemouth Municipal Orchestra conducted by Sir Dan Godfrey.
9. Northern Promenade Concert from Liverpool.
Mr. Walter Lippman on "The Press and Public Opinion in America" (re-broadcast from America).
11. Speech by H.R.H. the Prince of Wales at the Luncheon follow-



SIR JAMES BARRIE AT KIRRIEMUIR

George Outram

(June 7, 1930)

ing the Launching of the S.S. *Empress of Britain* at Clyde Bank. Col. the Master of Sempill and Herr Kromfeld on British Gliding.

First of a series of talks by Mr. Leonard Woolley on "Digging up the Past."

Heckmondwike Lecture from the Upper Independent Chapel, Heckmondwike, Yorks.

12. Celebration of the Fortieth Anniversary of the Election of Mr. Lloyd George as Member of Parliament for Caernarvon Boroughs.

Act III of Verdi's "Aida" from Covent Garden.

13. Presentation of the Freedom of Inverness to Mr. Ramsay MacDonald, Mr. Stanley Baldwin, and Sir Murdoch Macdonald. Eye-Witness Account of the First Test Match at Nottingham, by M. K. Foster.

"The Rumour," a play by C. K. Munro.

Miss Margaret Bondfield, Minister of Labour, on "Labour and International Affairs," relayed from Geneva.

14. Extract from "Hiawatha" performed by the Royal Choral Society, in the Albert Hall.

The First Instalment (by Hugh Walpole) of "Behind the Screen," a serial Detective Story.

15. Piano Recital by Irene Scharrer. Religious Service from Spurgeon's Tabernacle.

Chamber Music by the English Singers, Gabrielle Fleury, and Rene de Roy.

Religious Service from Oldnacher Cathedral, Aberdeen.

16. Vaudeville, including Jose Collins and Geoffrey Gwyther.

"He Went to China," by V. W. Purcell and Lance Sieveking.



THE SENIOR TOURIST TROPHY RACES IN THE ISLE OF MAN

(June 20, 1930)

[77]

- A. J. Alan: "The Dream."
17. Aldershot Command Searchlight Tattoo.
 18. Sir John Simon on "The Problem of India."
The Swansea Players in a One-Act Play, "Home," by Betty Eynon Davies.
 20. Eye-Witness Account of the Open Golf Championship at Hoylake.
"Baghdad on the Subway," a phantasmagoria of New York, by John Watt.
Speech by the late Lord Thomson at the National Savings Assembly Dinner at Llandrindod Wells.
Commentary on the Senior Tourist Trophy Motor-Cycle Races in the Isle of Man.
 21. Final Performance of the Northern Promenade Concert Season relayed from the Theatre Royal, Leeds.
Running Commentary on the Royal Ulster Yacht Club Regatta at Bangor, Co. Down.
 22. Recital of the songs of Montague Phillips, by Clara Butterworth.
Religious Service from Bangor Cathedral.
Concert by the London String Players conducted by Herbert Menges.
 25. Thanksgiving Service for the Preservation of St. Paul's Cathedral, attended by H.M. the King, relayed from St. Paul's.
Stanford's "Shamus O'Brien," performed in the studio.
Running Commentary on the Irish Derby at the Curragh, relayed from Dublin.
Sir John Simon on "The Future of Indian Government."
 26. Shakespeare's "Midsummer Night's Dream."
Act II of Gounod's "Romeo and Juliet" from Covent Garden.
 27. Eye-Witness Account of the

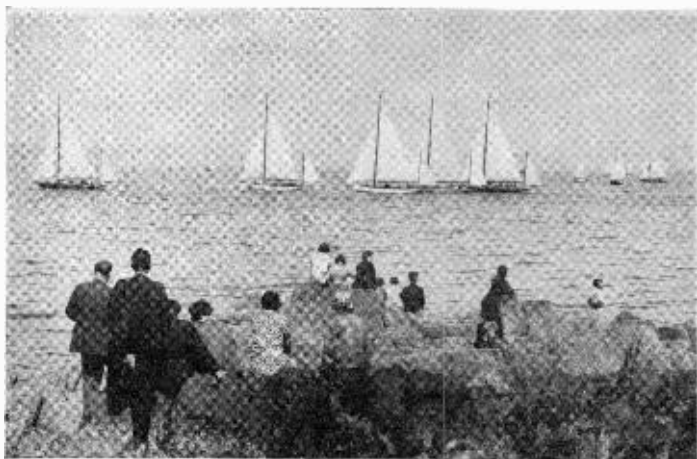

Belfast Newsletter

THE ROYAL ULSTER YACHT CLUB REGATTA

(June 21, 1930)



HELEN WILLS-MOODY

The Woman Lawn Tennis Champion of England

(June 28, 1930)

Second Test Match at Lord's,
by A. C. Maclaren.

Festival of English Church
Music directed by Dr. Sydney
H. Nicholson.

Act III of Verdi's "Rigoletto,"
from Covent Garden.

Speeches by Viscount Hailsham
and Viscount Craigavon at the
Dinner of the Ulster Association
in London.

Speech by the Rt. Hon. J. H.
Thomas, Secretary of State for
the Dominions, at the Forfeit
Feast, Cutlers' Hall, Sheffield.
The Galashiels Braw Lads'

Gathering Concert and Official
Ceremony at Galashiels.

28. Running Commentary on the
Departure of the White Star
Liner *Britannic* on her maiden
voyage from Liverpool.
Running Commentary on the
R.A.F. Display at Hendon.
Running Commentary on the
All-England Lawn Tennis
Championship at Wimbledon.
29. St. Peter's Service from York
Minster: Address by the Arch-
bishop.
30. The Archbishop of Canterbury
on the Lambeth Conference



[80]

THE KING AND QUEEN LEAVING ST. PAUL
(June 2)



S CATHEDRAL AFTER THE THANKSGIVING SERVICE
1930

[81]

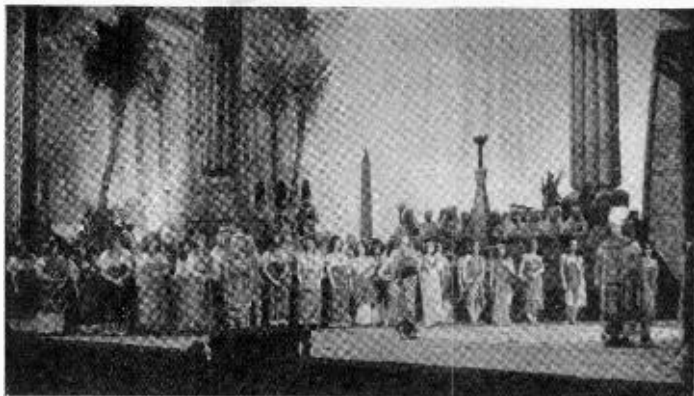

ACT II OF "AIDA" (JULY 1, 1930)

(A photograph of the actual scene at Covent Garden)

JULY

1. "The Proposal," a Comedy by Anton Chekov.
Act II of Verdi's "Aida" from Covent Garden.
2. Vaudeville, including Nellie Wallace.
Sir Francis Newbolt on The Royal Academy.
3. London Gaelic Choir.
A Swedish National Programme devised by Lance Sieveking, inc. an excerpt in Swedish from "Ett Drompsel," by Strindberg.
4. The Aero-Optimists in "Jolly Old Jail," produced by Austin Melford and Melville Gideon.
Act III of "The Love of the Three Kings" (Montemezzi) from Covent Garden.
5. The Annual Tynwald Ceremony of the Isle of Man.
Mr. Leonard Birch: "The Disaster at the Chemical Works, Castleford," on July 4th.
Running Commentary on the Finals of the Lawn Tennis Championships at Wimbledon.
Extract from "Badger's Green," by R. C. Sheriff.
6. Drumhead Service from the Castle Park, Colchester.
7. An Eye-Witness Account of the Millenary Celebrations of the Icelandic Parliament.
Speech by H.R.H. the Prince of Wales at the Dinner of the National Union of Students.
8. The ceremony of the opening of India House by H.M. the King.
9. "A Limehouse Night," an Anglo-Chinese Puzzle solved by Harry S. Pepper.
Sir E. Hilton Young on "Irak."
10. "The Brass Bottle," a Farcical play by F. Anstey.
11. Eye-Witness Account by A. C. Maclaren of the Third Test Match at Leeds.
Programme of Liza Lehmann's music.
12. Running Commentary on the Oxford & Cambridge v. Princeton & Cornell Sports at Stamford Bridge.
Chamber Music by the English Ensemble.
13. The Jubilee Service of the Diocese of Liverpool relayed from the Cathedral.

14. Recital by the English Singers. Broadcast of the first play by television, Pizzandello's "The Man with the Flower in his Mouth."
Programme commemorating the French Revolution.
Sir Henry Hadow on "Universities and Industry."
Mr. Stanley Baldwin speaking on "Democracy" in the Clifford Lectures of the Brotherhood Movement at Coventry.
15. An Evening at Blackpool.
16. Vaudeville, including Gillie Potter and Claude Hulbert & Enid Trevor.
Mr. Vilhjalmur Stephansson on "The Arctic Highway."
Shakespeare's "Antony and Cleopatra," produced by Cecil Lewis.

- Concert of British Music by the Frankfurt Wireless Symphony Orchestra, conducted by Constant Lambert, relayed from Homburg.
17. "Midsummer Madness," a play by Clifford Bax, music by Armstrong Gibbs.
The Houston Sisters from the London Palladium.
18. Symphony Concert by the Northern Wireless Orchestra conducted by T. H. Morrison.
19. Running Commentary on the Shooting for the King's Prize at Bisley, including a broadcast by the winner, Miss Foster.
Eye-witness Account of the Second Irish International Grand Prix Motor Race at Phoenix Park, relayed from Dublin.



The Times

THE MILLENNARY CELEBRATIONS IN ICELAND

(July 7, 1930)

20. Concert by the B.B.C. Orchestra conducted by Frank Bridge, soloist Felix Salmond.
21. Sir Francis Goodenough on "Foreign Languages and Foreign Trade." Recital by Olga Haley and Isolde Menges.
22. Scenes from Shakespeare's "Macbeth." Dramatic Recital by the Jewish artist Miriam Elias on the theme "By the Waters of Babylon." Mrs. Sidney Webb on "The Reform of British Parliamentary Government."
23. Recital by the Northern Singers.
24. Songs from Schubert's "The Maid of the Mill," sung by Steuart Wilson.
A Folk Song Concert in connection with the Celtic Congress at University College, London.
Flotow's "Martha," performed in the Belfast Studio.
25. "Twelve Thousand," a play by Bruno Frank adapted by John Watt.
26. Vaudeville, including Ann Penn and Mabel Marks.
Music from the Musical Comedies of H. Fraser-Simson.
Dublin Artists in the Belfast Studio.
27. Evensong from St. Paul's Cathedral.
Piano Recital by Solomon.
28. "Sob Stuff," a light programme by Gordon McConnel.
Chamber Music by the Catterall String Quartet and Gabriel Joachim.
29. Miss Sara Allgood's "Reminiscences of the Abbey Theatre."
30. A Sketch by Lord Dunsany.
31. Vaudeville, including Will Hay, Melville Gideon, Clapham & Dwyer, and Harold French & Vera Lennox.
Programme by Londonderry Artists in the Belfast Studio.



SHOOTING FOR THE KING'S PRIZE AT BISLEY

, (July 19, 1930)

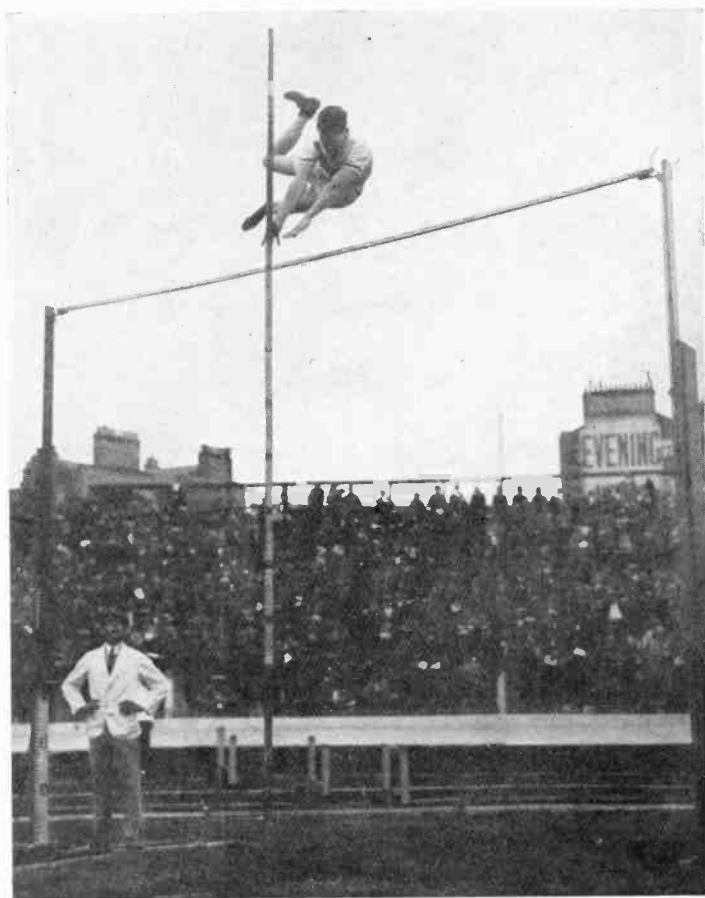

Sport and General

OXFORD AND CAMBRIDGE *v.* PRINCETON AND CORNELL

(July 12, 1930)

[85]

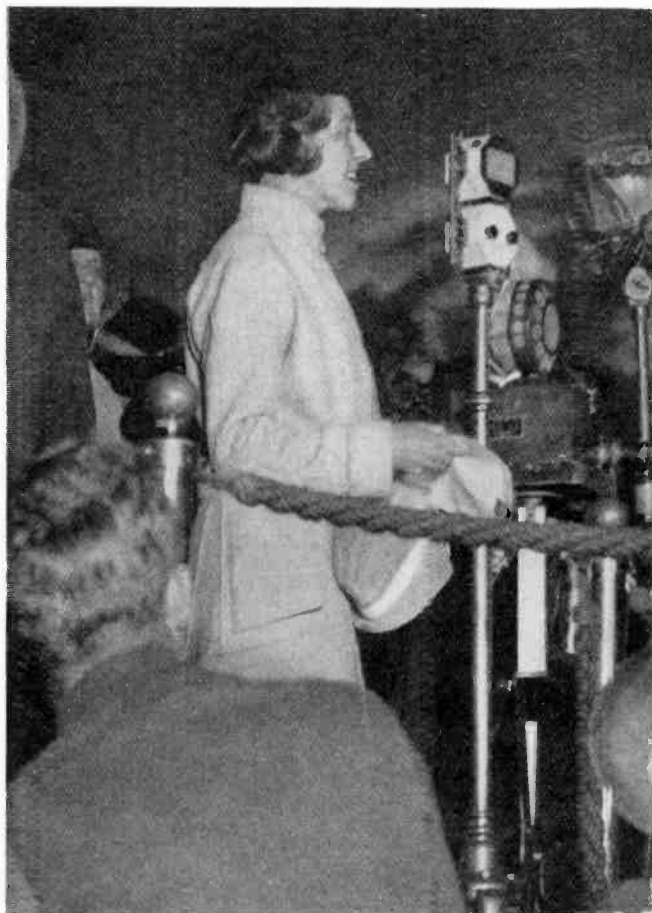

MISS AMY JOHNSON
facing a battery of microphones on her arrival at Croydon
(August 4, 1930)

PROMENADE CONCERTS

During the season of eight weeks August 9th-October 4th, a Promenade Concert has been broadcast on one of the London wave lengths almost every night. The broadcasts are not mentioned individually in the accompanying list.

AUGUST

1. "Obsession," a Radio Play by Dulcima Glasby.
2. Eye-Witness Account of the Athletics, England v. France, at Stamford Bridge.
3. Concert by the Band of H.M. Coldstream Guards from the Palace Pier, Brighton.
Religious Service from the Parish Church, Great Yarmouth.
4. Miss Amy Johnson welcomed by the late Lord Thomson, Secretary of State for Air, on her arrival at Croydon.
5. Tidworth Tatoo from the Grounds of Tidworth House, Tidworth.
Chamber Music by the Harp Ensemble.
6. Concert at the National Eisteddfod of Wales from the Eisteddfod Pavilion, Llanelly.
Miss Amy Johnson and Captain C. D. Barnard on "Long-Distance Flying."
The Rev. Kenneth Macleod and Hugh Mackay, "Songs and Stories of the Western Isles."
7. Speech by the Rt. Hon. David Lloyd George, M.P., and Chairing of the Bard Ceremony, from the Royal National Eisteddfod of Wales, Llanelly.
The Vienna Philharmonic Society Orchestra conducted by Dr. Bernhard Paumgartner, from Salzburg.
9. "Stop Press," a Miniature Revue produced by John Watt. First of a Series of Talks on "Country Life." I. The Country Postman, by Mr. Simon Evans.
The Opening Night of the Promenade Concerts at Queen's Hall.
10. Viola Recital by Lionel Tertis.
11. Mr. Victor Peers on "Photographing Sound"—How a Talkie is recorded in the studio.
12. "Salt Water Ballads." A Mascfield programme devised in collaboration with the Author, presented by the Bath Citizen House Players.
Massed Choirs Musical Festival in aid of the Mayor of Oldham's Distress Fund.
13. Festival Service from Norwich Cathedral on the 1300th Anniversary of the Founding of the Cathedral.
Sir George Dunbar, Bart., "The North-West Frontier."
"Fireside," a play by L. du Garde Peach, produced by Peter Creswell.
14. Broadcast from the Fête in aid of the Queen Alexandra Memorial Hospital, from Weston-super-Mare.
15. The Bishop of Chichester on "The Message of the Lambeth Conference."
A Border programme, introduced by Walter Barrie, of Yarrow.

16. Commentary on the Arrival of the R 100 at Cardington by Squadron-Leader Helmore. Eye-Witness Account of the Final Test Match at the Oval.
17. Religious Service in Welsh from St. Mary's Welsh Church, Dowlais. Symphony Concert from the Kursaal, Ostend.
18. "Ile," a play by Eugene O'Neill.
20. "Iphigenia in Aulis," an Opera by Gluck, from Salzburg. The Lansdowne Singers in Nursery Rhymes by Sir Walford Davies.
21. Lecture Recital on the Art of Irish Bardic Minstrelsy by Dr. Annie Patterson.
22. "Do we need an International Language?" A Discussion between Prof. W. F. Collinson, Mr. L. N. Newell, and Mr. A. Lloyd James.
23. Running Commentary on the R.A.C. International Tourist Trophy Motor Race over the Ards Circuit, Belfast.
24. Service from Buckfast Abbey.
25. "Beggar on Horseback," a play by George Kaufmann and Marc Connelly.
28. Mr. R. H. Wright, President of the Motor-Cycle Union of Ireland, on "Ulster's New Sport"—Cross Track Motor-Cycle Championships.
30. Mozart Concert at the Salzburg Festival performed by the Vienna Philharmonic Orchestra, conducted by Bruno Walter. Northumbrian Folk Songs and Dances by the Newcastle Bach Choir Society.



THE REFECTORY AT BUCKFAST ABBEY (August 24, 1930)
The painting of it was done by one of the monks and took fifteen years to complete

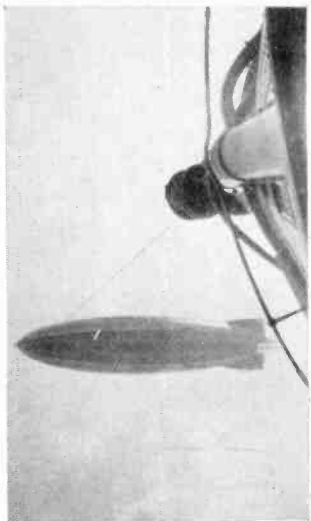

THE RETURN OF R 100 FROM CANADA

Pictures of the last stages of the return and mooring, showing the commentator, Squadron-Leader Helmore (left), at his post by the microphones
August 16, 1930

S E P T E M B E R

1. "Yes and Back Again," adapted for broadcasting by K. B. Indoe from "The Story of This Book," by Walter de la Mare.
2. Vaudeville, including Norman Long and Florence Marks.
3. Northern Diversions, including broadcasts from a woollen mill and a colliery.
A Recital of Songs of the Hebrides by Marjory and Patuffa Kennedy-Fraser and Margaret Kennedy.
5. Vaudeville, including Clapham and Dwyer and the Kentucky Singers.
"Hyacinth Halvey," an Irish Comedy in One Act, by Lady Gregory.
6. Students' Choruses, the Wireless Male Chorus and Stuart Robertson.
Captain Harry Graham on "Humorous Verse."
Concert of Sir Frederick Cowen's Music.
Ulster Grand Prix Motor-cycle Race on Carnaughlis Course, Ulster.
7. Boys' Brigade Special Service from St. George's Hall, Liverpool.
A String Orchestral Programme conducted by Percy Pitt.
British Association Service from Bristol Cathedral.
Preacher: Bishop of Oxford.
8. Speeches by President Hoover, Colonel Lindbergh, and Read-Admiral Byrd, at the reception to the French Aviators, Major Costes and Lt. Bellonte, relayed from America.
"Ingredient X," a play written for broadcasting by L. du Garde Peach.
9. Recital by Clive Carey.
"The Constant Lover," a Comedy in One Act by St. John Hankin.
Diversions—the Underworld of the West, including a broadcast from Pwllgwaum Colliery and Wookey Hole.
10. Broadcast of Music reproduced by electrically played violin and piano.
Running Commentary on the St. Leger by Mr. R. C. Lyle, from Doncaster.
"The Cries of London" as arranged by Herbert Oliver for Soprano Chorus and Orchestra.
An Organ Recital by Marce Dupré.
Orchestral Concert from the Three Choirs Festival at Hereford.
Relays from Harry Gordon's Entertainment, the Beach Pavilion, Aberdeen.
11. M. Briand addressing the Assembly of the League in the Assembly Hall, on "The Federation of Europe," from Geneva.
Mr. Arthur Henderson replying to M. Briand.
Evensong from Westminster Abbey.
Recital by the Wireless Singers.
Mr. P. J. Noel Baker, M.P., on "The Week in Geneva," relayed from Geneva.
"Martha," an Opera by Flotow, performed in the Belfast studio.
12. "Gala," an Open-Air Diversion, by Tyrone Guthrie.
"The Rising of the Moon," produced by William J. Rea.
Buxton Musical Festival, Concert by the Northern Wireless Orchestra conducted by T. H. Morrison, and Roy Henderson.



Robinson

HEREFORD CATHEDRAL

from which the Three Choirs Festival was broadcast on September 10, 1930

13. Commentary on the Race for the America Cup between "Shanrock V" and "Enterprise," relayed from America.
The Ridgeway Parade, a revue by Philip Ridgeway.
Harp Recital by Mildred Dilling.
Manchester and Liverpool Railway Centenary Celebrations. Speeches by the Lord Mayor of Liverpool and the American Ambassador, from St. George's Hall, Liverpool.
Concert by Victors at the Royal National Eisteddfod of Wales, Llanely, 1930.
14. The Liverpool Tudor Singers in an Old English Programme arranged by Dr. J. E. Wallace.
15. A Piano Recital by Arthur Benjamin.
"Through the Looking-Glass," adapted by Cecil Lewis from the book by Lewis Carroll.
16. Vaudeville, including Leslie Henson, Cicely Courtneidge and a Sketch by P. G. Wodehouse.
17. Belgian National programme relayed from Brussels.
18. An All-Welsh Concert from the Pavilion, Caernarvon.
"St. Patrick's Day" (or "The Scheming Lieutenant"), a play by Richard Brinsley Sheridan.
19. Concert by the Wireless Military Band conducted by B. W. O'Donnell.
Chamber Music by the Kitcher String Quartet and Norah Gruhn.
20. Vaudeville, including Teddy Brown, Jack Smith, and Stainless Stephen.
The Band of H.M. Welsh Guards relayed from Bristol's Annual Exhibition, Colston Hall.
21. A Welsh Religious Service relayed from Capel Gomer, Abertawe.

- Service from St. James's Parish Church, Belfast.
Harvest Festival Service from Gt. Mells Parish Church, Frome.
The International String Quartet and Sumner Austin.
22. "R.U.R.," the Play by Karel Capek adapted by Cecil Lewis.
 23. Mr. Hugh de Selincourt on "Poetry,"
Vaudeville, including Gillie Potter.
Recital by Samuel Dushkin.
 24. Concert of Russian Folk Music.
 25. Recital by Arthur Cranmer.
 26. A Chaminade Programme by the Gershom Parkington Quintet.
 27. Cyril Scott's Music performed by Isobel Baillie and the composer.
 28. Concert by the Winning Band from the Crystal Palace Festival—Foden's Motor Works Band.
First of a series of talks on "Science and Religion." I. Professor Julian Huxley.
 30. Violin Recital by Isolde Menges.
Bradford Triennial Festival of Chamber Music. Concert by the Brosa String Quartet.

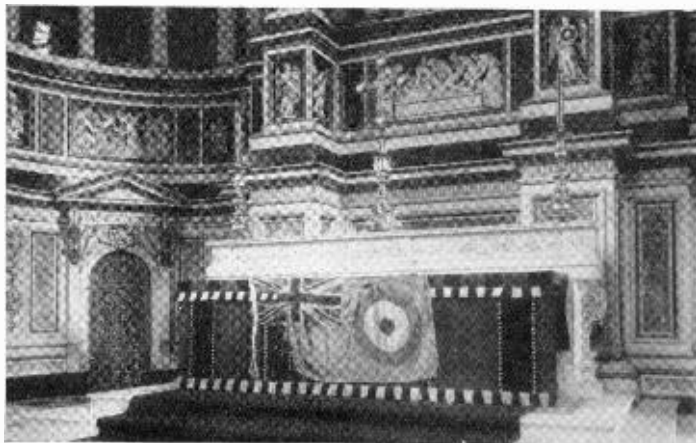

THE MEMORIAL SERVICE AT ST. PAUL'S
Showing the R 101's flag on the High Altar
(October 10, 1930)

The Times



THE DON COSSACK CHOIR

(October 12, 1930)

OCTOBER

1. The Prime Minister on the Imperial Conference.
2. "Red Tabs," a Radio War Play by Val Gielgud.
3. The first of a series of talks on "The Dark Continent". I. Major Walter Elliot, M.P.; "Downing Street and Africa."
4. Last Night of the Promenade Concerts at Queen's Hall.
5. A Religious Service in connection with the Church Congress, from St. Mark's Church, Newport.
6. Sir Walford Davies: first of a new series on "Music and the Ordinary Listener."
7. Concert by the Liverpool Philharmonic Society conducted by Albert Coates. "New Lamps for Old," a series of talks on contemporary problems in Scotland. I. Mr. George Blake on "Scottish Letters."
8. Speech at the Opening of the Manchester Radio Exhibition by Sir John Reith. Debate on the Federation of Manchester and Salford, arranged by the Manchester Athenæum Debating Society.
9. Concert in Aid of the Wireless for the Blind Fund. Symphony Concert conducted by Leslie Heward, from the Town Hall, Birmingham. Robb Wilton from the Palladium.
10. The Memorial Service for the dead in the R 101 disaster, relayed from St. Paul's Cathedral. "Romance," adapted for broadcasting by Peter Creswell from the novel by Joseph Conrad and Ford Maddox Hueffer.
12. Concert by the Don Cossack Choir from the Royal Albert Hall. Chamber Music by the Catterall String Quartet and the Wireless Singers.
13. Vaudeville from Manchester Radio Exhibition.
14. Concert arranged by Lady Tree and Henry Ainley in aid of the League of Mercy, including Sophie Tucker.

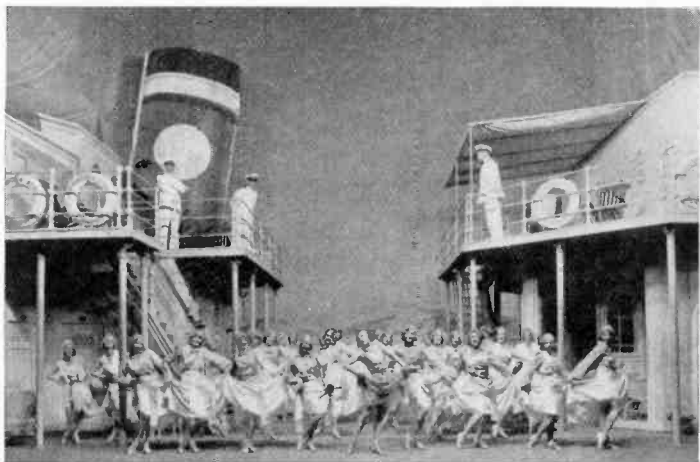

A SCENE FROM ELDORADO
(October 18, 1930)



CHARLOT'S MASQUEFADE
(October 25, 1930)

15. "Strife," a play by John Galsworthy.
Rt. Hon. R. B. Bennett, Prime Minister of Canada, on the Imperial Conference. Opening of the Belfast Wireless Exhibition by Professor R. W. Livingstone, Principal of Queen's University.
The Virgil Bi-millenary—Mr. G. S. Gordon, President of Magdalen, on "Virgil in English Poetry," relayed from the British Academy.
16. Mendelssohn's "Elijah" from the Town Hall, Birmingham.
17. Puccini's "Madam Butterfly" broadcast from the studio.
A Chamber Music Concert by the Unity Quartet, from the Society of Artists' Gallery, Birmingham.
18. Extract from Act II of "Eldorado," from the Palace Theatre.
Bransby Williams in "The Incredible Adventures of Rowland Herne."
Acts I and II of Puccini's "Turandot," performed by the Covent Garden Opera Co. at the Theatre Royal, Glasgow.
19. Recital of Lieder by Elena Gerhardt.
Roman Catholic Service from St. Sebastian's Priory Church, Pendleton, Manchester.
Scottish Brotherhood Union Mass Meeting, from Edinburgh.
20. First of a series of talks on "The Future of Medicine."
I. Sir George Newman, "Medicine and the State."
Guitar Recital by Louise Walker.
21. Speeches by Mr. Lloyd George, Mr. J. R. Clynes, and Sir Henry Lytton, at the Luncheon in honour of Sir Henry Lytton.
Opening of the new London office of the Ontario Government by the Hon. G. Howard Ferguson, Prime Minister of Ontario.
"Talkie Town," a revue by John Watt.
Variety relayed from the Belfast Wireless Exhibition.
22. First of the B.B.C.'s New Season's Symphony Concerts at Queen's Hall, B.B.C. Symphony Orchestra conducted by Adrian Boult.
Solo Cello: Suggia.
23. Sir Basil P. Blackett on "Trade Within the Empire." Recital by Ethel Bartlett and Rae Robertson.
Inter-Varsity Debate between Leeds, Sheffield, Manchester, and Liverpool Universities, from Leeds University.
24. "Nurse Henrietta," a Drama for broadcasting by Hermann Kesser.
The Belfast Philharmonic Society's First Subscription Concert, from the Ulster Hall.
25. Running Commentary on the Association Football Match, Arsenal v. West Ham. Extracts from "Charlot's Masquerade," from the Cambridge Theatre.
"Carmen" (Bizet), Acts III and IV, by the Carl Rosa Opera Co., from Princes Theatre, Bristol.
Leoncavallo's Opera "Pagliacci," in the Belfast Studio. Address by Sir James Barrie, O.M., on his installation as Chancellor of the University of Edinburgh.
"Mary Queen of Scots," a programme including "Mary of Delight," by Naomi Jacobs, presented by the Masque Theatre, Edinburgh.
26. Religious Service from Durham Cathedral.

27. Addresses by President Hoover, Mr. Ramsay MacDonald, and the Japanese Prime Minister on the occasion of the ceremony of Depositing the Ratification of the London Naval Treaty, relayed from America, England, and Japan.
 "The Western Land," a dramatic narrative of work in Cornwall, presented by Bernard Walke, from St. Hilary, Cornwall.
28. Speeches by Mr. Bernard Shaw and Professor Einstein from a Dinner at the Savoy Hotel.
 "The Partners," a play by Vincent Douglas.
29. Symphony Concert at the Queen's Hall with the B.B.C. Symphony Orchestra, conducted by Adrian Boult. Solo Pianist: Rubinstein.
 Rt. Hon. J. W. Scullin, Prime Minister of Australia, on the Imperial Conference.
30. Speeches by H.R.H. the Prince of Wales and Viscount Grey of Fallodon following the Banquet of the League of Nations Union at the Guildhall.
 A Symphony Concert relayed from the Dublin Broadcasting Station, the Symphony Orchestra of the Dublin Station, conducted by E. Godfrey Brown, B.B.C. Music Director, Belfast.
31. "The Importance of Being Earnest," a Trivial Comedy by Oscar Wilde.
 First of a new monthly series of "Diversions."



ETHEL BARTLETT AND RAE ROBERTSON
 (October 23, 1930)

BRISTOL RADIO WEEK



- Oct. 26. Religious Service from St. Mary Redcliffe Church.
Concert by the City of Bristol Police Band.
27. Broadcast from the H.M.S. "Flying Fox" Training Ship of the R.N.C.R. stationed at Bristol.
28. Children's Hour. Broadcast from the Zoological Gardens, Clifton, Bristol.
29. Concert arranged by the Bristol Children's Concert Society, relayed from the Central Hall, Bristol.
"The Purple Bedroom," by Eden Phillpotts, performed by Bristol's Little Theatre Repertory Players.
30. Variety Programme from the Bristol Musical Club, including the Lockier String Orchestra, and the Bristol Drama Club in a revue sketch, "French as She is Learnt," by E. F. Watling.
31. Mr. H. A. Downes Shaw on "Civil Aviation in Bristol," from the University of Bristol Union, Clifton.
Chamber Music Concert by the Bristol Women's Music Club.
A Discussion, Somerset *v.* Gloucester, between Mr. W. Irving Gass and Mr. Fred A. Wilshire.
- Nov. 1. Popular Concert from the Central Hall, Bristol, including Norman Allin, Roy Taylor, and Mira Johnson.
Dr. F. W. Rixon, "Bristol in A.D. 2000," from the University of Bristol Union.



THE OPENING OF INDIA HOUSE BY H.M. THE KING
(July 8, 1930)

PUBLIC CEREMONIALS

Broadcasting kept listeners in touch with the following important public ceremonials during the year:—

- Nov. 11th. Armistice Day Ceremony at the Cenotaph.
Dec. 14th. The Unveiling of the Memorial to Queen Alexandra at Copenhagen.

1930

- Jan. 21st. The Opening of the Naval Conference by H.M. the King in the House of Lords.
Ceremony of the Keys at the Tower of London.
Mar. 6th. The Unveiling of the Statue of Mrs. Pankhurst in the Victoria Tower Gardens.
Apr. 8th. Conferring of the Freedom of Manchester on Mr. C. P. Scott.
11th. Opening of the Cartwright Hall, Bradford, by the Countess of Oxford and Asquith.
23rd. Shakespeare Birthday Celebrations at Stratford-on-Avon.
May 20th. Opening of the General Assembly of the Church of Scotland in Edinburgh.
21st. Opening of the Physics Laboratories at University College, Cardiff, by H.R.H. the Prince of Wales.
23rd. Manchester University Jubilee Celebrations.
31st. Opening of Bristol Air Port by H.R.H. Prince George.
June 3rd. Trooping the Colour on Horse Guards Parade.
5th. Unveiling by the Marquis of Montcalm of the Monument to General Wolfe at Greenwich.
12th. Celebration of the Fortieth Anniversary of the Election of Mr. Lloyd George as M.P. for Caernarvon Boroughs.
13th. Conferring of the Freedom of Inverness on Mr. Ramsay Macdonald and Mr. S. Baldwin.
July 8th. Opening of India House by H.M. the King.
Aug. 4th. The Arrival of Miss Amy Johnson at Croydon.
7th. The Chaining of the Bard at the Royal Welsh Eisteddfod.
16th. The Arrival of the R 100 at Cardington from Canada.
Oct. 21st. Opening of the new London office of the Ontario Government by the Hon. G. Howard Ferguson, Prime Minister of Ontario.
25th. Installation of Sir James Barrie as Chancellor of Edinburgh University.
27th. Speeches by President Hoover, Mr. Ramsay Macdonald, and the Japanese Premier on the occasion of the ceremony of depositing the ratifications of the London Naval Treaty.

S P E E C H E S

The following are some of the chief speeches broadcast during the year:—

- Nov. 9th. The Prime Minister at the Guildhall Banquet on Lord Mayor's Day.
14th. General Smuts at the Peace Commemoration Dinner.
22nd. Mr. F. B. Kellogg at the Pilgrims' Society's Dinner.
- Dec. 2nd. General von Lettow-Vorbeck and General Smuts at the East African Campaign Reconciliation Dinner.
11th. The French Ambassador at the Banquet of the United Associations of G. B. and France.
- 1930
- Jan. 10th. Mr. Philip Snowden from The Hague.
16th. Mr. Baldwin at the Sir Walter Scott Club.
23rd. Mr. Ramsay Macdonald at the Guildhall Banquet to the Naval Conference Delegates.
28th. Lord Grey at the Pilgrims' Society's Dinner.
- Feb. 11th. Mr. J. R. Clynes at the opening of the Lancashire Cotton Fair.
26th. The Reunion Dinner of the Survivors of the Siege of Kut.
- May 3rd. H.R.H. the Duke of York at the Royal Academy Dinner.
22nd. Sir Oliver Lodge at the Wedgwood Centenary Luncheon.
- June 2nd. Major J. J. Astor at the Guildhall Banquet to the Imperial Press Conference Delegates.
5th. Speeches at the Canada Club Dinner.
11th. H.R.H. the Prince of Wales at the Launching of S.S. "Empress of Britain."
20th. The late Lord Thomson at the National Savings Movement Dinner.
25th. H.R.H. The Duke of Gloucester at the Scottish Association of Boy Scouts.
27th. Lord Craigavon at the Dinner of the Ulster Association in London.
Mr. J. H. Thomas at the Cutlers' Forfeit Feast, Sheffield.
- Oct. 21st. Mr. Lloyd George, Mr. J. R. Clynes, and Sir Henry Lytton at a lunch in honour of the latter.
28th. Mr. G. B. Shaw and Professor Einstein from a dinner at the Savoy Hotel.
30th. H.R.H. the Prince of Wales and Lord Grey at the dinner of the League of Nations Union.

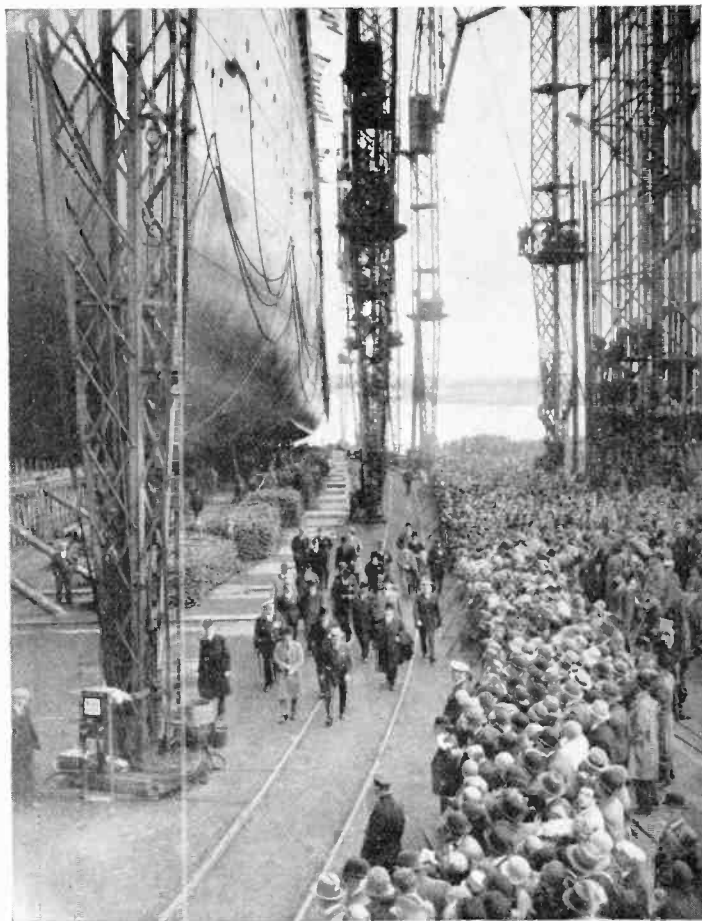

THE PRINCE OF WALES LAUNCHES "THE EMPRESS OF BRITAIN"
(June 11, 1930)

CHIEF SPORTING EVENTS OF THE YEAR

FOOTBALL

Rugby.

Oxford *v.* Cambridge.
Ulster *v.* Leinster.
England *v.* Wales.
Scotland *v.* Wales.
England *v.* Ireland.
England *v.* France.
Wales *v.* Ireland.
England *v.* Scotland.
Rugby League Final—St.
Helens *v.* Widnes.

Association.

Arsenal *v.* Chelsea.
Arsenal *v.* Birmingham.
Arsenal *v.* Everton.
Arsenal *v.* Hull City.
Arsenal *v.* West Ham.
F.A. Cup Final—Arsenal *v.*
Huddersfield Town.

BOXING

Carnera *v.* Stribling.
Callagher *v.* Kid Berg.

ATHLETICS

Oxford and Cambridge *v.*
Princeton and Cornell.
England *v.* France.

ROWING

Oxford *v.* Cambridge.

The above events were dealt with either by commentaries broadcast while the event was taking place, or by accounts by eye-witnesses broadcast after the event or in an interval.

RACING

Horse.

The Grand National.
The Derby.
The St. Leger.
Irish Derby.

Motor.

Senior T.T. Races, Isle of
Man.
R. A. C. T. T. Races, Belfast.
Irish Grand Prix, Dublin.
Wembley Speedway Meet-
ings.

CRICKET

Frequent Eye-Witness Ac-
counts of every Test
Match.

GOLF

Open Championship of
Great Britain.
Open Championship of
Ireland.

TENNIS

All England Champion-
ships.

SHOOTING

The King's Prize at Bisley.

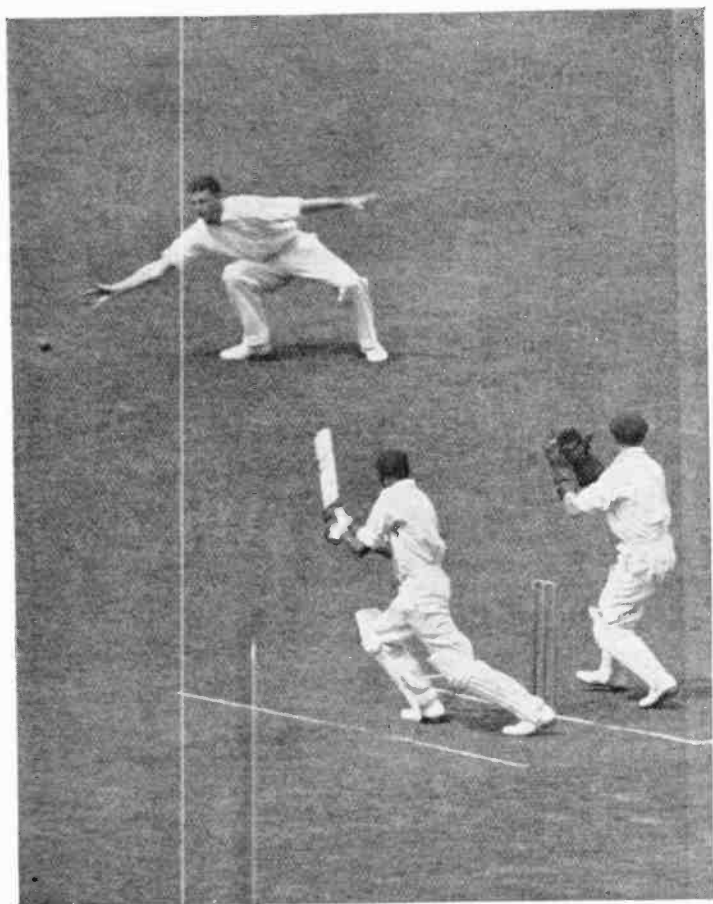

DULEEPSINHJI'S GREAT DEBUT

*at the Lord's Test Match on June 27, descriptions of which were broadcast by
Mr. A. C. Maclaren*

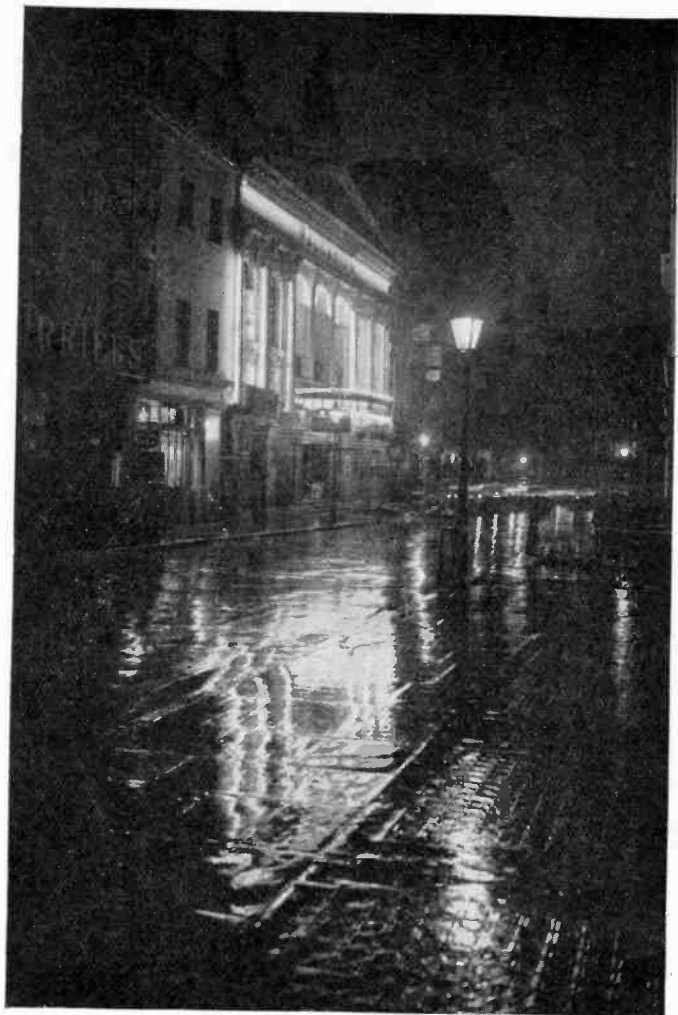

THE PALLADIUM AT NIGHT

[104]

The following are among the year's most important outside relays of light entertainments:—

THEATRES

Dec. 21st.	Piccadilly Theatre.	"The Student Prince."
Jan. 4th.	Palace Theatre.	"Dear Love."
18th.	Leeds Theatre Royal.	"Mother Goose."
24th.	Savoy Theatre.	"Mikado."
Feb. 22nd.	Savoy Theatre.	"Iolanthe."
Mar. 15th.	Savoy Theatre.	"Yeomen of the Guard."
22nd.	Savoy Theatre.	Final Scenes of the Gilbert and Sullivan Opera Season.
Apr. 5th.	Adelphi Theatre.	"The House that Jack Built."
10th.	Hippodrome.	"Co-Optimists."
May 3rd.	Savoy Theatre.	"Damask Rose."
Oct. 18th.	Daly's Theatre.	"Eldorado."
25th.	Cambridge Theatre.	"Charlot's Masquerade."

MUSIC HALLS

May 22nd.	Palladium.	Variety Artists' Benevolent Fund Royal Command Performance.
-----------	------------	---

There were also about a dozen shorter broadcasts during the year.

Jan. 14th	} Coliseum.	Broadcasts of single acts.
Feb. 25th.		

DANCE MUSIC

Ambassador Club.
 Café de Paris.
 Ciro's Club.
 Covent Garden Dances.
 Gleneagles' Hotel.
 Grosvenor House.
 Hotel Splendide.
 Kit-Cat.
 May Fair Hotel.
 Midland Hotel, Manchester.
 Piccadilly Hotel.
 Winter Gardens, Blackpool.

LIGHT MUSIC

Beaufort Cinema, B'ham.
 Brixton Astoria.
 Commodore Theatre.
 Grosvenor House.
 Kit-Cat Restaurant.
 May Fair Hotel.
 Piccadilly Hotel.
 Prince of Wales' Playhouse, Lewisham.
 Restaurant Frascati.
 Shepherd's Bush Pavilion.
 Tussaud's Cinema.

SOME VARIETY ARTISTS

who have broadcast during the year.

Teddy Brown	Angela Baddeley
Tom Clare	Norah Blaney
George Clarke	Marie Burke
Chick Farr	José Collins'
Ronald Frankau	Elsie Carlisle
Melville Gideon	Betty Chester
Ronald Gourley	Cecily Courtneidge
Geoffrey Gwyther	Yvette Darnac
Tommy Handley	Dorothy Dickson
Morris Harvey	Desirée Ellinger
Will Hay	Gracie Fields
Harry Hemsley	Florrie Forde
Leonard Henry	Norah Howard
Leslie Henson	Hetty King
Bobby Howes	Beatrice Lillie
Horace Kenney	Nancy Lovat
Jack Hulbert	Violet Loraine
Lupino Lane	Dorothy McBlain
Norman Long	Clarice Mayne
Billy Mayerl	Phyllis Monkman
Mario de Pietro	Florence Oldham
Gillie Potter	Kathleen O'Regan
Julian Rose	Ann Penn
Sandy Rowan	Elizabeth Pollock
Jack Smith	Irene Russell
Rudy Starita	Madge Saunders
"Stainless Stephen"	Ivy St. Helier
Bransby Williams	Sophie Tucker
Robb Wilton	Nellie Wallace
Wee Georgie Wood	Wish Wynne
Burns and Allen	Layton and Johnstone
Clapham and Dwyer	Vera Lennox and Harold
Mabel Constanduros and	French
Michael Hogan	Winnie Melville and Derek
Fairchild and Lindholm	Oldham
Flotsam and Jetsam	Rosie Moran and Peter
Muriel George and Ernest	Haddon
Butcher	The Roosters
Rupert Hazel and Elsie	Ross and Sargent
Day	Scott and Whaley
The Houston Sisters	"Those Four Chaps"
Claude Hulbert and Enid	Doris and Elsie Waters
Trevor	That Certain Trio

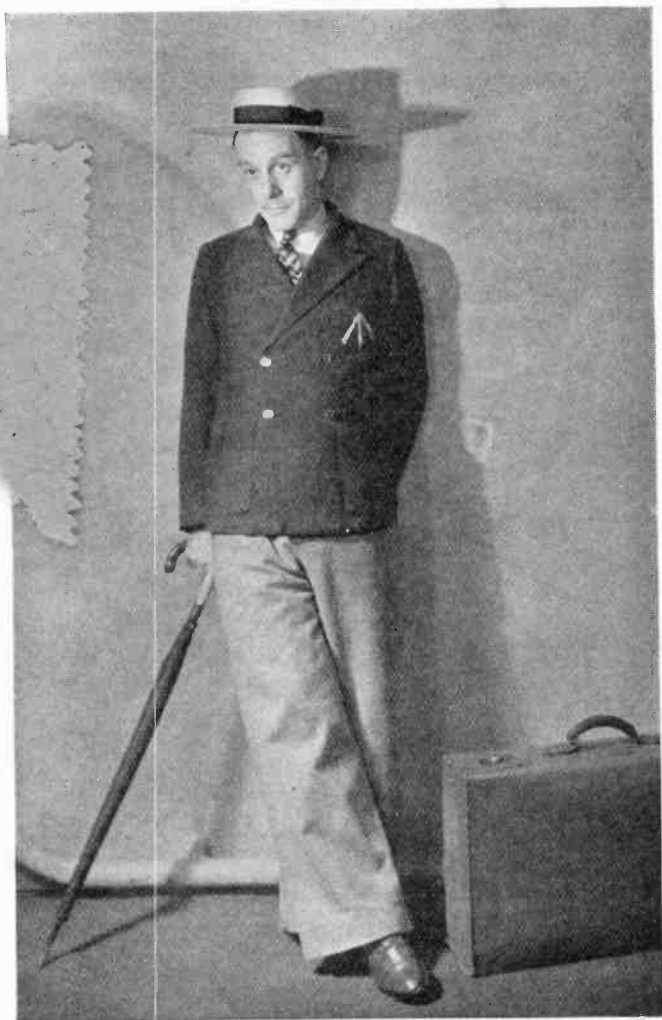

GILLIE POTTER ARRIVES IN THE STUDIO

[107]



ARTHUR CATTERALL
Leader of the B.B.C. Symphony Orchestra

SOME MUSICIANS OF THE YEAR

CONDUCTORS

Ernest Ansermet	Sir Edward Elgar	Percy Pitt
Sir Granville Bantock	Oskar Fried	Sir Landon Ronald
John Barbiroli	Furtwängler	Hermann Scherchen
Sir Thomas Beecham	Eugene Goossens	Malcolm Sargent
Adrian Boult	Sir Hamilton Harty	Stravinsky
Frank Bridge	Leslie Heward	Toscanini
Basil Cameron	Franz von Hoesslin	Bruno Walter
Albert Coates	Nicolai Malko	Sir Henry Wood

SINGERS

Stiles Allen	Maria Olszewska	John Coates
Marian Anderson	Rosa Ponselle	Keith Falkner
Margaret Balfour	Elisabeth Schumann	Roy Henderson
Maria Basildes	Clara Serena	Sir George Henschel
Hilda Blake	Dorothy Silk	Marcel Journet
Muriel Brunskill	Oda Slobodskaya	Lauritz Melchior
Elena Gerhardt	Elsie Suddaby	George Parker
Olga Haley	Conchita Supervia	Paul Robeson
Lotte Lehmann	Maggie Teyte	Friedrich Schorr
Miriam Licette	Anne Thursfield	Mariano Stabile
Toti dal Mortè	Eva Turner	Walter Widdop
Rachel Mortøn	Norman Allin	Steuart Wilson
Maria Nemeth	Ivan Andresen	Fritz Wolff

PIANISTS

Backhaus	Myra Hess	Pouishnoff
Béla Bartók	Lamond	Rubinstein
Harriet Cohen	Moiseiwitsch	Harold Samuel
Fanny Davies	Nicolas Orloff	Irene Scharrer
Gieseking	Egon Petri	Solomon
Arthur de Greef	Ethel Bartlett and Rae Robertson	

VIOLINISTS

Arthur Catterall
 Jelly d'Aranyi
 Adila Fachiri
 Daisy Kennedy
 Eda Kersey
 Isolde Menges
 Albert Sammons
 Joseph Szigeti

CELLO

Arturo Bonucci
 Beatrice Harrison
 Paul Hermann
 Lauri Kennedy
 Felix Salmond
 W. H. Squire
 Suggia

VIOLA

Paul Hindemith
 Bernard Shore
 Lionel Tertis

ORGANISTS

Dr. Alcock
 Joseph Bonnet
 Marcel Dupre
 Gunther Ramin

HARPSICHORD

Rudolph Dolmetsch
 Wanda Landowska
 V. Gordon Woodhouse

OBOE

Leon Goossens

HORN

Aubrey Brain

PART SINGERS

The English Singers
 The Wireless Singers

THE YEAR'S CHIEF RELIGIOUS SERVICES

CATHEDRALS

Canterbury	Norwich	Chester
Westminster Abbey	Birmingham	York
St. Paul's	B'ham St. Chad's	Durham
Chichester	Coventry	Newcastle
Southwark	Manchester	Edinburgh
Bristol	Liverpool	Glasgow
Buckfast Abbey	Bangor	Paisley Abbey

CHURCHES

Birmingham:	London:
Carr's Lane Chapel	King's College
Parish Church	Muswell Hill Wesleyan
Bournemouth:	St. Anne's Soho
All Saints, Southbourne	St. Anne's (R.C.) Vaux-
Brighton:	hall
Union Church	St. Columba's, Pont St.
Bridlington:	St. Martin-in-the-Fields
Priory Church	St. Olave's, Hart Street
Cambridge:	St. Sepulchre's, Holborn
Great St. Mary's	City Temple
King's College	Spurgeon's Tabernacle
Cransley Church, nr. Ket-	Westminster Congre-
tering	gational
Eastbourne:	Whitefield's Tabernacle
Eastbourne Presbyterian	Manchester:
Church	St. Ann's
Great Mells Church, nr.	Southend:
Frome	Crowstone Congrega-
Isle of Man:	tional
St. George's, Douglas	St. Leonards:
Leeds:	St. Mary Magdalene's
Parish Church	Windsor:
Brunswick Chapel	St. George's Chapel
The Cenotaph, Whitehall	

STUDIO

Among the preachers in the studio have been Bishop Gore, Archdeacon Holmes, Father Martindale, and Dr. H. T. Hodgkin of the Society of Friends. The Salvation Army, the Brotherhood Movement and the Student Christian Movement have also conducted services.

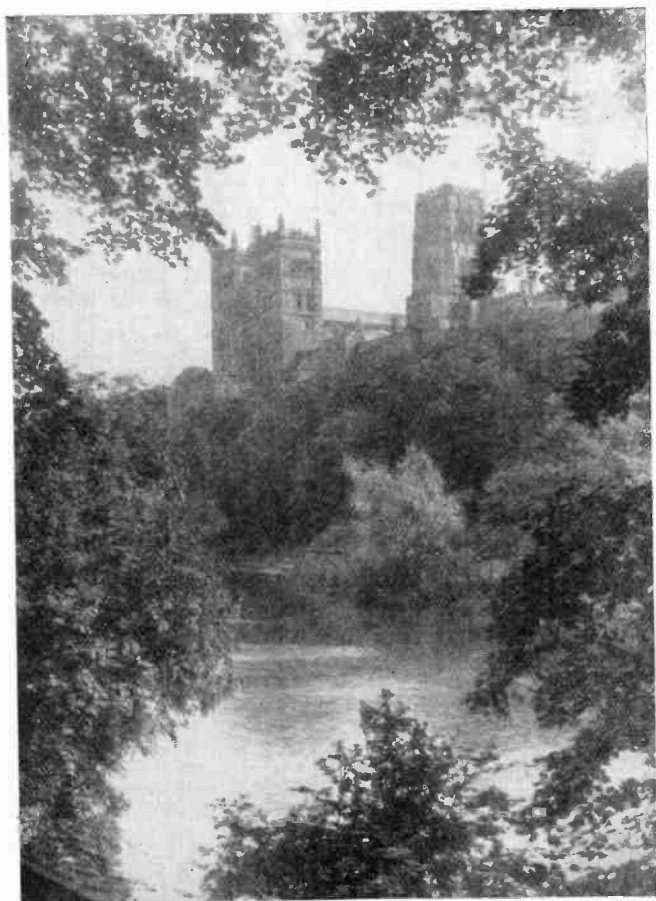

Will F. Taylor

DURHAM CATHEDRAL

(October 26, 1930)

[111]

SOME OF THE MOST PROMI

H.M. the King
 H.R.H. the Prince of Wales
 H.R.H. the Duke of York
 H.R.H. the Duke of Gloucester
 H.R.H. Prince George

Viscount D'Abernon
 H. M. Abrahams
 Prof. Samuel Alexander, O.M.
 Sir Hugh Allen
 Lord Amulree
 Viscountess Astor
 Major J. J. Astor
 Duchess of Atholl

Professor P. J. Noel Baker
 Rt. Hon. Stanley Baldwin
 Captain C. D. Barnard
 Sir James Barrie, O.M.
 Vernon Bartlett
 "Beachcomber"
 Lord Beaverbrook
 Duchess of Bedford
 Sir Hugh Bell
 Rt. Hon. R. B. Bennett.
 E. F. Benson
 The Bishop of Birmingham
 Rt. Hon. Augustine Birrell
 Count Gottfried Bismarck
 Sir Basil Blackett
 R. D. Blumenfeld
 Rt. Hon. Margaret Bondfield
 F. Yeats Brown
 Brig.-General C. G. Bruce
 Sir Dennis Burney
 Professor C. Delisle Burns
 Dr. Cyril Burt

Sir John Cadman
 Signor Carlo Camagna
 The Archbishop of Canterbury
 Professor A. M. Carr-Saunders
 Viscount Cecil of Chelwood
 The Bishop of Chichester
 Agatha Christie
 Rt. Hon. Winston Churchill
 Walter M. Citrine
 Rt. Hon. J. R. Clynes
 A. Duff Cooper

Viscount Craigavon
 Professor F. A. E. Crew
 Sir Edward Crowe
 Professor Winifred Cullis

Bernard Darwin
 Major Leonard Darwin
 Sir Walford Davies
 General Dawes
 Earl of Derby
 G. Lowes Dickinson
 J. W. Dunne
 Sir Francis Dyke-Acland

Dr. Rudolph Eckener
 Sir Arthur Eddington
 Professor Einstein
 T. S. Eliot
 Major Walter Elliot
 St. John Ervine

E. M. Forster
 "Fougasse"
 H.E. the French Ambassador
 Roger Fry
 Dame Katharine Furse

Rt. Hon. D. Lloyd George,
 O.M.
 Miss Megan Lloyd George
 Captain Harry Graham
 Stephen Graham
 Rt. Hon. William Graham
 Rt. Hon. Arthur Greenwood
 Sir Wilfred Grenfell
 Viscount Grey of Fallodon
 Capt. The Rt. Hon. F. E.
 Guest

Dr. J. S. Haldane
 J. B. S. Haldane
 Sir Daniel Hall
 Sir Ian Hamilton
 Mrs. Mary Hamilton
 Rt. Hon. Arthur Henderson
 General Hertzog
 Lord Hewart
 J. B. Hobbs
 Frank Hodges

NT SPEAKERS OF THE YEAR

Professor Julian Huxley

Dean Inge
Countess of Iveagh

Dr. L. P. Jacks
Sir Barry Jackson
Sir James Jeans
Earl Jellicoe, O.M.
Miss Amy Johnson

F. B. Kellogg
J. Maynard Keynes
Stephen King-Hall
Edward Knoblock
E. V. Knox
Rev. Father Ronald Knox

Colonel Lindbergh
Walter Lippman
Sir Oliver Lodge
Marquis of Lothian
Sir Henry Lytton

Desmond MacCarthy
Rt. Hon. J. Ramsay Mac-
Donald

F. L. McDougall
Rt. Hon. Reginald McKenna
Compton Mackenzie
A. C. Maclaren
Professor J. Macmurray
Professor B. Malinowski
H. J. Massingham
André Maurois
Rt. Hon. Herbert Morrison
Lady Cynthia Mosley
Professor Gilbert Murray

Sir Henry Newbolt
Ernest Newman
Sir George Newman
Hon. Harold Nicolson
Dr. Cyril Norwood

Countess of Oxford and As-
quith

Sir Nigel Playfair

Sir John Reith
Sir Humphrey Rolleston
Professor Russ

Miss V. Sackville West
Michael Sadleir
Sir Arthur Salter
Sir Herbert Samuel
Lord Sankey
Dorothy Sayers
C. P. Scott
Rt. Hon. J. H. Scullin
G. Bernard Shaw
R. C. Sherriff
Rt. Hon. Sir John Simon
Osbert Sitwell
General Jan Smuts
Dame Ethel Smyth
Rt. Hon. Philip Snowden
Mrs. Philip Snowden
J. C. Squire
Sir Josiah Stamp
Wickham Steed
Vilhjalmur Stefansson
H. L. Stimson
Canon B. H. Streeter
H.E. the Swedish Ambassador

Rt. Hon. J. H. Thomas
Sir J. Arthur Thomson
Sir J. J. Thomson, O.M.
Francis Toyne
Professor Arnold Toynbee
Prof. G. M. Trevelyan, O.M.

Hugh Walpole
Sir Fabian Ware
Mrs. Sidney Webb
E. F. Wise
Rebecca West
Miss Ellen Wilkinson
Virginia Woolf
Leonard Woolley
Evelyn Wrench

Sir Alfred Yarrow
The Archbishop of York
Rt. Hon. Sir E. Hilton Young
Geoffrey Winthrop Young

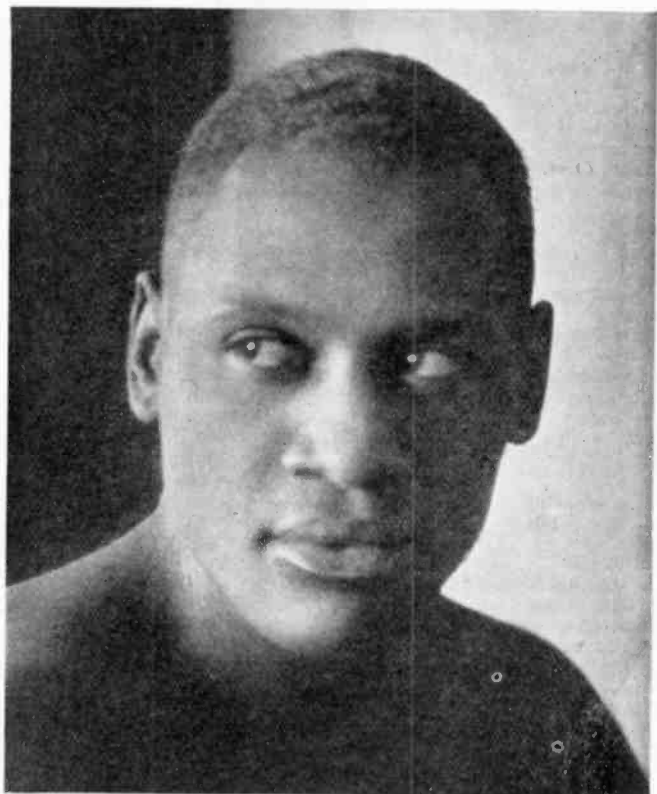

PAUL ROBESON
(April 16, 1930)



GENERAL
SECTION

MISCELLANEOUS
MUSIC
DRAMA
THE SPOKEN WORD

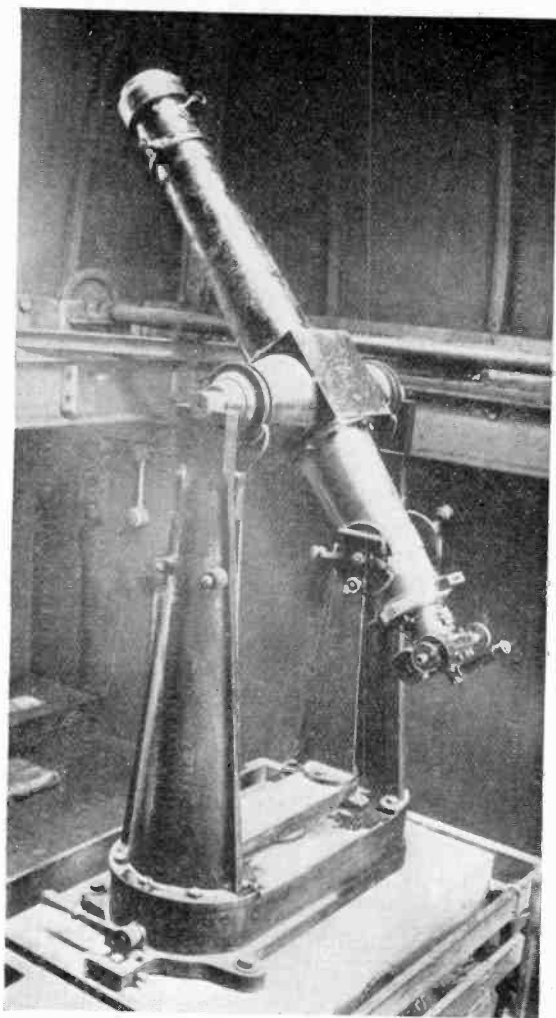

THE TRANSIT INSTRUMENT AT GREENWICH
by which Greenwich Mean Time is ultimately determined.

[116]

THE B. B. C. TIME SIGNALS

By SIR FRANE DYSON, K.B.E., F.R.S., Astronomer-Royal

LONG before the existence of any records the human race used the Sun, Moon, and stars to measure time. It is, therefore, quite natural that astronomers should be the time-keepers of the modern world. They have made very careful and extended studies of the three natural divisions of time—the day, the month and the year. They find that the day, *i.e.* the interval between instants when the Sun is due south on successive days, varies by three-quarters of a minute in the course of the year; that the interval from New Moon to New Moon varies more than twelve hours; and even the year varies slightly. When freed from certain calculable irregularities they have found three nearly uniform units of time:—

The period of the Earth's rotation on its axis.

The period of the Moon's revolution about the Earth.

The period of the Earth's revolution about the Sun.

The friction of the tides causes a lengthening of the day by about $\frac{1}{10000}$ th of a second in a hundred years, and there may be other slight variations in the length of the day in the course of years. But within this limit the daily rotation of the Earth provides a uniform measure of time.

The astronomer makes the rotating Earth his standard clock. The stars are the dial and are brought successively across his meridian, *i.e.* the vertical plane stretching north and south through his place of observation. By building a wall truly north and south and looking along it he can tell the moment at which stars cross his meridian, and the same star may be watched night after night. This crude method was improved by the astronomer Römer, who devised the transit instrument, by which a telescope is mounted on an axis perpendicular to its length. The axis ends in accurately turned pivots which rest in bearings placed truly east and west. In the focal plane of the object-glass a fine wire, usually a spider's thread, is placed in a direction at right angles to the horizontal. When the telescope is turned on its axis to the right elevation, the star is seen as a bright dot which moves across the field of view and in due course

crosses the thread. The observer in this way can tell the exact moment at which the star crosses the meridian.

To note this and keep a record of it he needs something terrestrial which will move uniformly. Hour-glasses, the rate at which candles burn, water clocks, might all be used. But nothing of the requisite accuracy was discovered till the pendulum was applied by Huyghens to regulate the motion of a train of wheels. The dead-beat escapement invented by Graham made the astronomical clock a worthy partner of the transit instrument. By the co-operation of these two valued servants the astronomer not only determines the time but also measures the intervals at which different stars follow one another across his meridian. It is convenient to use a clock which keeps "Sidereal Time," *i.e.* should show 24 hours between consecutive passages of the same star across the meridian. Let us suppose that on one night his clock shows exactly 4 h. 30 m. 0 s. when Aldebaran crossed the wire of his telescope, and the next night this occurred at 4 h. 30 m. 1 s. Then he would say that the clock was gaining 1 second in 24 hours. If on the first night Sirius was noted as crossing the meridian at 6 h. 40 m. 11.2 s. by his clock, he would make allowance for the amount the clock had gained in 2 h. 10 m., and thus find exactly how much Sirius was behind Aldebaran. By the co-operation of transit-instruments and clocks the accurate positions of a large number of stars have been found, and any of these are available for determining the time when required.

Clocks have gradually become very perfect time-keepers. The Shortt clocks at Greenwich seldom change their rate by more than one hundredth of a second in a day. But this may accumulate and in ten days the clock be one-tenth of a second in error. So it must be constantly controlled by astronomical observations. A good observer in a couple of hours from ten stars can be relied on to tell the error of the clock to one-fiftieth of a second. So the clock is checked every four or five days when weather permits. Its errors are booked regularly but the clock itself is not touched.

Sidereal Time is only used by astronomers and is unsuitable for ordinary domestic purposes. Owing to its revolution round the Sun, the Earth makes one more turn on its axis with reference to the stars in a year than with

reference to the Sun. So there are $366\frac{1}{4}$ sidereal days to $365\frac{1}{4}$ mean solar days in the year. The Sidereal and Mean Solar Clocks start level on March 21, but the Sidereal Clock gains about 4 minutes a day. After a fortnight the clocks are one hour apart, after a month two hours, and so on. We must keep solar time if we want the clock always to show 12 hours about midday, unless we are prepared at some part of the year to lunch in the middle of the night.

So the astronomer keeps a Mean Solar Clock and makes a little calculation to tell the Mean Solar Time from the Sidereal Time. He makes the necessary allowance for the amount his Sidereal Clock is in error, and so finds the error of his Mean Solar Clock. He has to set this clock right before time signals are sent out. The error is generally very small, but how is he to correct the clock for a small fraction of a second? A simple plan is to put a bar magnet on the pendulum of the clock and fix a solenoid a little below the pendulum. An electric current sent in one direction causes the solenoid to attract the magnet and so slightly increases gravity and quickens the swing of the pendulum, and the reverse effect is produced when the current is reversed. By keeping the current on for a short time, perhaps half a minute, the clock is quickened up or slowed down the necessary fraction of a second.

When the clock has been corrected its signals are all sent out automatically. These consist of hourly telegraphic signals to the G.P.O., which are transmitted to all parts of the country. Six signals are sent every quarter of an hour to the B.B.C. by a special wheel on the clock, and distributed as required. These give the seconds 55, 56, 57, 58, 59 and the 0 of the exact quarter. Finally, at 10 h. and 18 h. G.M.T., a series of signals are transmitted from Rugby which can be received in most parts of the world under good atmospheric conditions. It is seldom that the signals are one-tenth of a second in error, and our aim at Greenwich, though not always achieved, is to keep the error less than one-twentieth of a second.

Note—A table of time signals broadcast by the B.B.C. will be found on page 414, in the Reference Section.



Wilfred Jenkins

PRESIDENT HOOVER

speeches by whom were rebroadcast in this country several times in the course of the year

[120]

THE KING SPEAKS TO THE WORLD

AT 11 a.m. on Tuesday, January 21st, His Majesty the King officially opened the London Naval Conference of 1930 in the House of Lords (a photograph will be found on pp. 48-9). The B.B.C. was able to make arrangements which resulted in what may be truly described as a broadcast to the world. The B.B.C. received from all parts of the world reports on the reception of the speech, which make it clear that the broadcast was almost a complete success. The area covered was some seventeen hours of longitude, and conditions of reception were, therefore, necessarily very varied.

In Europe all the more important countries reported participation in the broadcast with the exception of Spain and Russia. In some countries interpreters were used for the speeches in foreign languages. In Italy the King's speech was taken down in shorthand both in Rome and in the Vatican City. Reports from Iceland show that many inhabitants listened to Daventry (5XX) direct.

Five different channels were arranged for reception outside Europe:—

1. G5SW, the B.B.C.'s Chelmsford experimental short-wave station;
2. the Rugby Transatlantic telephone service to New York;
3. the experimental Beam. telephone service to Canada;
4. the experimental Beam telephone service to Australia;
5. the Beam telephone link with Japan, which is still in an early experimental stage.

No other previous arrangements were made, but it is a remarkable proof of the world-wide interest of the event that a number of short-wave stations joined in spontaneously. In Holland, for instance, Noordwijk picked up the speeches from 5XX Daventry and PCK (Kootwijk) passed them on to Java, where they were again radiated by PMP and PLE. It is believed that both the Dutch station PHI and the German station Zeesen were also listened to in various parts of the world, and the B.B.C.

listening post at Tatsfield overheard rebroadcasts by Manila and two short-wave stations in the United States.

CANADA

The Canadian National Railways' chain of twenty-five broadcasting stations received the speeches from the terminal of the England-Canada Beam, and rebroadcast them, with excellent results, from coast to coast.

UNITED STATES OF AMERICA

Arrangements had been made with the two "chains" of the National Broadcasting Company and the Columbia broadcasting system for rebroadcast in all parts of the United States. The N.B.C. used fifty-five stations and the Columbia thirty-eight. Of the two channels to the United States available, the N.B.C. used G5SW (B.B.C.) and also occasionally Rugby, while the Columbia system used the Rugby telephone with full success. From correspondence received from individuals, it is clear that public interest throughout the States was very great in spite of the fact that the broadcast took place at 6 a.m. New York time (which was 5 a.m. in Chicago and as early as 3 a.m. on the Pacific Coast). No reports of reception in Central and South America were received except from the Falkland Islands, where apparently the Government broadcasting service received the speeches satisfactorily from G5SW.

AFRICA

Arrangements were made by the three stations of the South African Broadcasting Company to attempt rebroadcast of a pick-up from G5SW. It appears that the attempt was unsuccessful, though Johannesburg reported a period of good reception. Subsequent evening talks on the Conference were well received and rebroadcast. The British East African Broadcasting Company reported good reception of the rebroadcast from Java, but no relay was attempted.

ASIA AND AUSTRALIA

In Australia preparations for rebroadcast were made, but little or no success was achieved, while in New Zealand, on the contrary, several stations (G5SW in England, 2XAF in America, and PLE or PMP in Java) were well received and rebroadcast from the four stations of the Radio Broad-

casting Company. In the Philippines the Manila station KZRM received and relayed the speeches, and its transmission was picked up at widely different points of the globe, including Tatsfield, the B.B.C.'s receiving station near London; the source of Manila's reception being probably Java. As regards Japan, the intention had been to rely upon the experimental beam service from Dorchester, and on G5SW, but in actual fact the rebroadcast, which was carried out fairly successfully, seems to have been based on reception of KGO, Oakland, California. Hong-Kong reported excellent reception of the King's speech, which was picked up from a short-wave station in Holland and rebroadcast from the local station. In parts of India there was fairly satisfactory reception of G5SW by amateurs, but no rebroadcast, while in Ceylon reception appears to have been wholly impossible. It is interesting to note that the B.B.C.'s regular correspondent in Malaya listened to Manila KZRM, which itself picked up PLE Java, this in turn receiving from PCK in Holland the output of Daventry 5XX.

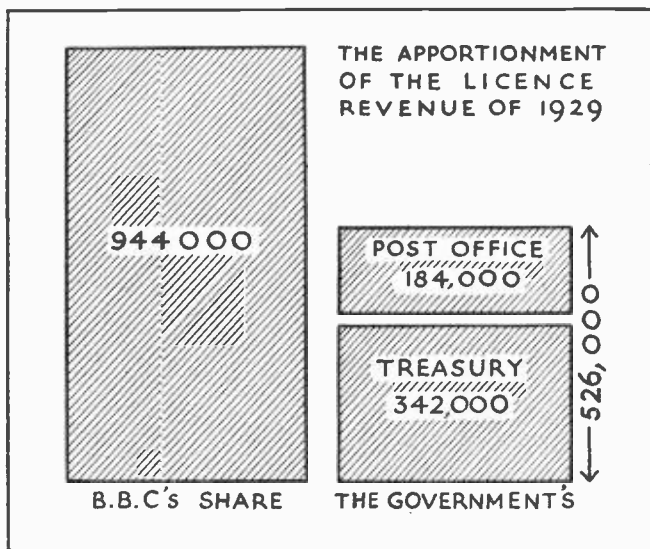

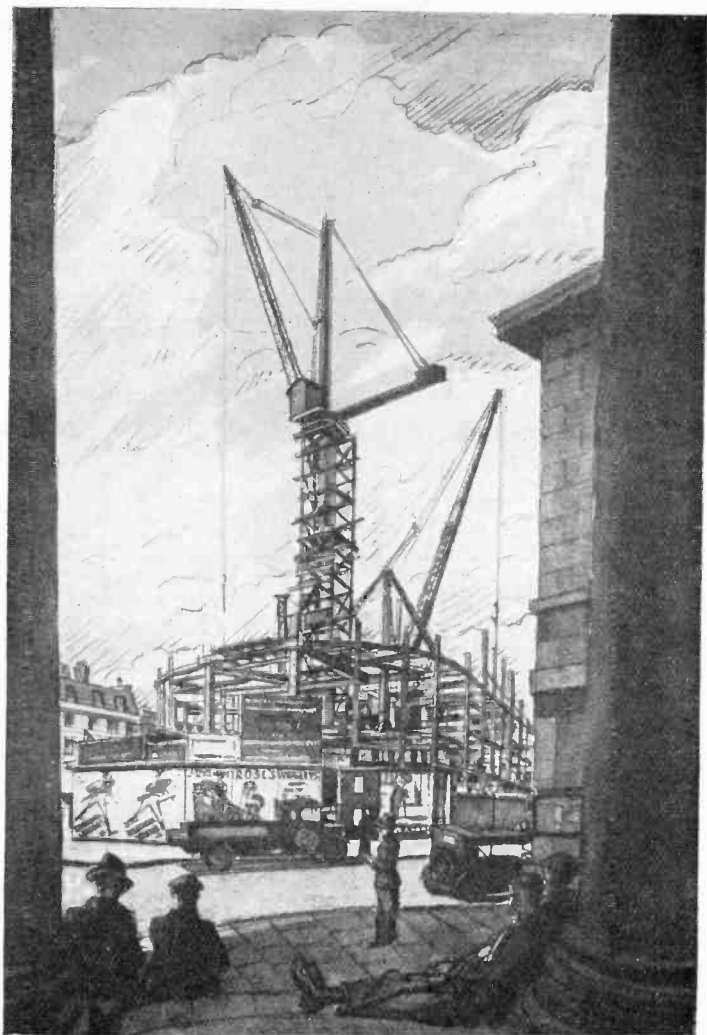

BROADCASTING HOUSE

*A view of the construction in July 1930
From a water-colour painting by Karl Hagedorn*

[124]

B R O A D C A S T I N G H O U S E

IN the autumn of 1928 the B.B.C., after long and deliberate investigation, completed arrangements for the building of a new headquarters in London, to take the place of their Savoy Hill premises that were becoming quite inadequate for the service that they had in prospect.

More numerous and better-proportioned studios, perfectly isolated from one another and immune as far as possible from the invasion of sounds from the City, with more perfect acoustical regulation and affording a proper degree of comfort to artists in their interpretive work, was the ideal that the B.B.C. had set for itself. All this finds expression in the planning of the building to be known as Broadcasting House, now in course of construction in Portland Place, W.1.

The building will make full and practical use of the whole of the space afforded by the site. There will be twelve floors, three of which will be below street level. There will be twenty studios, ranging in size from the small apartment necessary for "news," to a studio large enough to accommodate a full orchestra and an audience of about 1000 people.

The shape of the site has enabled the B.B.C. to ensure the isolation of the studios from external noises by a simple but at the same time ingenious expedient. The studios will be separated from the streets that bound the site on all but the north side by a "buffer building." They will, in fact, be contained within a vast brick tower that will occupy that portion of the site that is, in the ordinary building, devoted to a light well.

The building outside the central tower follows the usual modern lines of construction. It is steel framed and will, for the most part, house the administrative and executive departments, which thus will be close to, but sufficiently separated from, the studios and their suites to admit of efficient working.

To render the studios immune from sound transmitted through the steel of the outer structure, the central tower is constructed in brick, without vertical steelwork. The lower walls are four feet thick, to carry the enormous load

of the upper walls and their floors. For the most part the studios are separated vertically by rooms intended for use as Music Libraries, Stationery Stores, Publication Offices, and the like, which are approached from corridors outside the tower; hence the studios are unaffected by sound interference with one another.

On the lower ground floor will be the super studio, or Concert Hall, which is three storeys in height, and will be provided with all necessary waiting rooms, etc., for the convenience of artists; also a lounge for the comfort of the public.

On the sub-basement floor, and on the eighth floor, there will be large studios, each one-and-a-half times the size of the largest studio at Savoy Hill. There will also be suites of dramatic studios; a debate studio, talks studios, and studios devoted to other special requirements. All these studios will be well served with waiting-rooms and band-rooms.

Space is provided in a well-lighted situation on the eighth floor for a large Control Room that will be equipped with apparatus of most up-to-date design, and sufficient to deal effectively with this large range of studios.

It will be obvious that the accommodation in so confined a space of so large a number of studios variously, and often simultaneously, used presents a unique problem in ventilation and temperature regulation. The precautions for ensuring inter-studio silence, already mentioned, must not be jeopardised, and artists must enjoy a suitable degree of comfort within their windowless prisons. The B.B.C. has spared no pains to ensure that the ventilation of the studios shall be on the most up-to-date lines. It is, without doubt, the most complicated of the many problems associated with Broadcasting House, and upon its satisfactory solution depends in a large measure the success of the building. The air supply will be "conditioned" both as regards temperature and humidity, and these will be automatically controlled to suit the number and activities of the persons present at any time in individual studios. When one speaks of "automatic" control of such conditions, it must be understood that the term is in a certain degree relative and that intelligent oversight of apparatus applied to these purposes is essential to its proper functioning.

This is no less true of many other essential features of the building, which are usually taken for granted by most of

those who enjoy their benefits. Such matters as the water-supply, the drainage, the lighting, the lifts, the internal communication by telephones and bells are all on an extensive scale, and the break-down of any of these elements would be felt immediately as a serious blow to the amenities of the premises.

Every precaution has been taken to ensure installations of a perfect kind, and to reduce to the narrowest limit dependence on the personal element in the organisation of these features of the building. Further than this one cannot go, any more than the provision and assembly of "wireless" apparatus can of itself ensure successful broadcasting.

That part of the building that is below street-level is far advanced, and the B.B.C. has reason to believe that it will be in occupation of its new headquarters by the autumn of 1931. In spite of the exceptional methods of construction, the contemplated rate of progress has been maintained, and all engineering and other difficulties, so far met with, anticipated and successfully overcome.

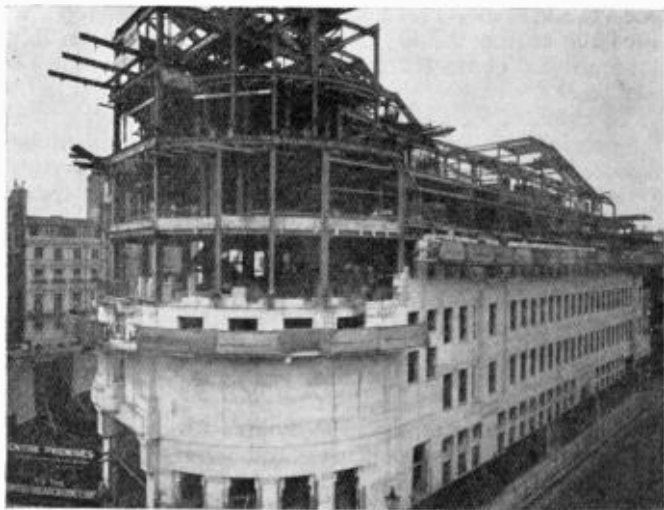

BROADCASTING HOUSE

A photograph showing progress in October, 1930

THE STORY OF A LION

THE files of the B.B.C. contain many thousands of letters, the signatures to some of which would turn autograph hunters green with envy. The variety of names in this correspondence is rivalled by the variety of subjects; in seven and a half years broadcasting has come into touch with practically every aspect of contemporary affairs.

Recent research among the correspondence of early days has revealed the story of one Poilu, "the lion who nearly broadcast." What is not revealed by the letters in the Poilu case is whether the two protagonists in the correspondence appreciated the humour of the situation. It would be kinder to assume that they did.

This Poilu, pride of a menagerie in Kent, was born in Paris in 1916 and sold in aid of Red Cross funds. The purchaser presented him to a general, who installed him at Divisional Headquarters and on occasions took him on a visit to the line. As his subsequent owner proudly claims in a letter to the B.B.C., "He is naturally the only lion that can lay claim to having been in the front line of trenches."

The demand for Poilu's services as a broadcaster came about as follows:—an Empire Day programme was under consideration, and some one had suggested that the Imperial spirit would be suitably symbolised by the roaring of a lion. In those days they were sticklers for veracity; they must have a genuine lion; no gramophone record or roaring synthetically produced by "Effects" would suffice. In reply to a tentative letter from Savoy Hill, the owner of the menagerie replied that he could supply "a suitable lion, and I feel certain that he can be made to *growl*, but I do not think to *roar*, as lions only roar when the mood takes them."

Despite the uncertainty as to Poilu's roaring capacity, he was accepted as a broadcaster and arrangements made to move him to Wembley. The owner was still cautious. "It is also clearly understood," he writes, "that should we, through no fault of ours, be unable to move this lion from his wagon cage into the den, that you have no claim of



"I TAKE IT THAT IT WOULD BE POSSIBLE TO GET THE LION UPSTAIRS TO THE STUDIO"

E

[129]

any sort against me. It is very difficult to move such an animal *against his will*." He was also a proud owner, for he made the additional condition that "a note be sent to the Press that the lion used was my lion."

All seemed set for the lion's microphone debut, when, a few days later, the B.B.C. wrote that "it is now considered better to broadcast the lion from our offices here rather than from Wembley. . . . I take it that it would be possible to get the lion upstairs to the studio, as it cannot be more difficult to move him than to move a grand piano!" However, the situation was quickly cleared by the decision to instal Poilu in the yard and let him growl (or roar) from there. He was to arrive at 9.15 on the evening of the programme and "be ready to leave at 10.30 p.m. or thereabouts."

Yet another letter from the lion-owner, enclosing "photograph of myself and lion," disclosed further details of Poilu's sensational career. Returning from France in a torpedo boat destroyer, "the animal was almost washed overboard by rough seas, the force of the waves dashing in the sides of its cage." After such experiences in the trenches and on the high seas, the mere business of being "eased" upstairs like a grand piano can have held no terrors for Poilu.

Alas, poor Poilu, noble exile from the forest, terror of the trenches, your hopes of fame were too soon dashed to deep despair. A few days after the conclusion of arrangements for your debut, almost as the travelling cage ("some 6 ft. by 3 ft. 6 in.") which was to take you famewards stood waiting your desire, a telegraphist in London was tapping out the fearful words, "Please cancel all arrangements in connection with lion. Writing." Next morning a letter confirmed in detail the cancellation of his appearance. The B.B.C. had been "reluctantly forced to this decision on account of various considerations, both with regard to the uncertainty about the lion performing and also for policy reasons which had not been fully envisaged when the suggestion was first made." What were the reasons of policy does not transpire in this momentous correspondence. Perhaps the B.B.C. was afraid that Poilu would eat an announcer and awkward questions be asked in the House.

THE AMERICAN LISTENER

A BRITISH IMPRESSION

IT is the proud boast of American broadcasting to-day that approximately 43 per cent. of all families in the United States now possess wireless receiving sets. If this estimate is correct, Americans are in the van of the world's listening population; yet this vast audience and the industry which caters for it have been built up on a very different plan from that which prevails in the Old World. In Europe, broadcasting is a new and virile force; but the resources of the community, even for the development of this new necessity of life, have to be carefully husbanded. Hence the tendency to monopoly. But in America, with its apparently limitless prosperity during the past ten years, there has been no need of husbanding resources; and almost unlimited competition in broadcasting, whilst it has produced some confusion, has also achieved results which must be put down to the credit of competitive enterprise. The American listener pays no licence, but he is expected to buy the products of the firms which sponsor the finest programmes on the ether. To what extent does he do so? The latest edition of the *Starch Survey*, made for the National Broadcasting Company, declares that "approximately 26 per cent. of the families interviewed stated that they have purchased products mentioned over the radio." Presumably the cost of American broadcasting therefore really comes out of the products which this 26 per cent. purchase.

The American listener is extraordinarily well catered for on the technical side. Two out of every three receiving sets are five- or six-valve sets, and this indicates that the listeners have preference for variety in the choice of programme. The American listener expects to be able to tune in easily to a dozen or more stations, some of which will be the local links in the two or three great national chains of broadcasting stations which form, as it were, the central backbone of American broadcasting; and the rest, stations of local range under independent ownership, or one or two more distant but more powerful stations. With all this desire for variety, however, the American listener is

not nearly so keen as the British listener upon constructing his own set, or improving it when made. It is an American characteristic not to think it worth while spending time on home-made articles when they can be purchased cheap and good ready-made. And in spite of the variety of stations which he can get with his five-valve set (which will, by the way, be usually an all-main set—battery sets are now coming to be the exception), the different programmes which he can receive will be of very similar type. The commercially sponsored programme in American broadcasting is successful because American business is enterprising, adaptable, and ever seeking new ideas and new ways of advertising. Nevertheless, when it comes to framing a wireless programme, the advertiser is apt to restrict himself to the beaten track of successful features. Music forms the basis of almost all programmes, and those kinds of music which make the loudest noise head the list in popularity—that is, orchestras and dance bands. Grand opera is not so much in favour as it is with English listeners, while chamber music is not palatable to American listeners at all. Still, there is the same tendency in America as here, for the taste of the public to rise as the field of its musical knowledge widens; classical and semi-classical music are gaining ground. And from the executant point of view the best American orchestras and dance bands are indeed hard to beat. Among single features which are not musical, popular entertainers easily hold the favourite place. The household words of American broadcasting are the comedians Amos 'n' Andy. The appeal here is something comparable with certain serial cartoon features in English newspapers; something which supplies a snappy little commentary of five or ten minutes' duration every evening, concerning the ordinary experiences of the ordinary man. Typical figures in American life are the enterprising partners who are making their way "from Log Cabin to White House," and so Amos 'n' Andy have their "Fresh Air Taxicab Corporation" to form the basis of their own comic enterprise.

Now good music and good popular turns are the two mainstays of the American advertiser's programme. When he strays outside this well-trodden track, he feels less certain of success and accordingly more cautious. The

A COMPARISON OF BRITISH AND AMERICAN PROGRAMMES

The following programmes were broadcast on October 1st, 1930, the alternative services being printed in italics.

LONDON ALTERNATIVE PROGRAMMES

- p.m.
- 7.45. Roy Henderson—Baritone.
- 8.0. Promenade Concert—Olga Haley, Arthur Catterall, Lauri Kennedy, The B.B.C. Symphony Orchestra, Conductor Sir Henry Wood.
- 8.0. *German Language Talk.*
- 8.30. *Jack Payne and his B.B.C. Dance Orchestra.*
- 9.20. "*Red Tabs*"—*A Radio War Play by Val Gielgud.*
- 9.40. Weather Forecast, Second General News Bulletin.
- 9.55. "The Imperial Conference," by the Prime Minister.
- 10.5. *Jack Payne and his B.B.C. Dance Orchestra.*
- 10.10. London and New York Stock Exchange Reports; Shipping Forecast and Fat Stock Prices.
- 10.20. The B.B.C. Orchestra conducted by Joseph Lewis.
- 10.30. *Henry R. Hall's Gleneagles Hotel Band from the Midland Hotel, Manchester.*

THE N.B.C. ALTERNATIVE PROGRAMMES

- 7.45. *Dic-a-Doo Entertainers—piano duo—girls trio—mixed octet—Sax Smith and his cavaliers.*
- 8.0. East of Cairo—Dramatic sketch. Oriental music.
- 8.0. *The Yeast Foamers male quartet; and orchestra.*
- 8.30. Mobiloil Concert—Beatrice Belkin, soprano; Yascha Zayce, violinist; H. M. Neely, master of ceremonies.
- 8.30. *Sylvania Foresters male quartet, direction Roy Close.*
- 9.0. Halsey Stuart Program—the "Old Counsellor"; Chicago Little Symphony Orchestra.
- 9.0. *Wadsworth Program, musical drama—Sir Walter Scott—string quartet direction Leo Kempinski.*
- 9.15. *O'Cedar Time—mixed quartet.*
- 9.30. Palmolive Hour. Olive Palmer, soprano; Elizabeth Lennox, contralto; Paul Oliver, tenor; the Revelers; Lewis James and James Melton, tenors; Elliott Shaw, baritone; Wilfred Glenn, bass.
- 9.30. *Cameo Pleasure Hour. Mary McCoy, soprano; Reinald Werrenrath and Billy Hughes, baritones; Willard Robinson and his Deep River Orchestra; Hayton and Schutt, piano duo; male chorus of eighteen voices; and orchestra.*
- 10.30. Coca Cola Program. Sports interview with Grantland Rice; C. Gayliso, vocalist; string orchestra.
- 10.30. *Wayside Inn—male quartet.*

drama, for instance, finds a comparatively modest place in American broadcasting. It is not easy to develop the right technique for radio drama. It is a subject that only yields gradually to persistent experiment, and to be effective it requires a good deal of elaborate preparation and rehearsal. So far American advertisers have hardly found it worth while to give the attention which is required to this side of broadcasting. Talks figure still less in the advertiser's repertoire. This has not always been so. In the early days the advertiser frequently used the time which he bought on the ether for a straight talk advertising his product. Now that there has been a strong reaction against this, the direct advertising talk has been eliminated, and the pendulum has not yet swung back to a comprehension of the part that the spoken word might play in sponsored programmes, not for direct advertising purposes, but in order to give contrast and tone to programmes.

In one or two rare cases, American advertisers do put on programmes containing talks, but such talks are very short and carefully swathed in a kind of musical cotton wool in the form of short snatches or parts of popular tunes. This habit of giving the public a bit of a tune only is common in America. It corresponds to the deeply-ingrained American taste for quick change and "pep" and variety. The American listener probably listens in short snatches. His life is already so full of varied activities that he can hardly do otherwise. So whatever he hears should be satisfying and self-contained within, say, a period of five or ten minutes. For this reason, the American listener does not care much for relays or speeches from public dinners and such-like ceremonies. A word much heard in American broadcasting circles is "continuity," which means the filling in of every little gap in the programme with trifles of some sort or another, so that the listener is induced by the attraction of perpetual novelty to go on listening.

Besides the "sponsored" programmes put on by advertisers, usually during the best hours of the evening, the listener will also hear "sustaining" programmes, originated by the broadcasting authorities themselves to fill in the periods when there are no sponsored programmes. Naturally the broadcasting authorities look at the problem of programmes from rather a different angle from adver-

tisers. "The Listener makes the Programme" is a slogan of American broadcasting. As far as advertisers are concerned, this means that it will not pay the advertiser to put on programmes which are unpopular from the point of view of helping to sell their products; but from the broadcasting authorities' point of view it means putting on programmes which must be acceptable to the community of listeners as a whole. There is a growing sense of social responsibility here, which reflects itself in the readiness shown by the larger broadcasting concerns in the United States to take up the educational side of broadcasting, if and when the educational forces of the country give them a clear lead. At present talks of various kinds, such as on Farming, Home and Health, work of Government Departments, and Foreign Affairs, find their place in the sustaining programmes (though not at the best times); and of course if the President wishes to come to the microphone, or some distinguished visitor or traveller arrives opportunely, there is the same keenness on topical events in America as over here. But broadcasting does not set out, as in Britain, to advise listeners regularly on such matters as the theatre, the cinema, choice of books, appreciation of music, and so forth. The American listener, for the most part, has not yet developed any expectation of getting his intellectual interests satisfied through the wireless. That day is still to come. But many Americans are impressed with the different line which broadcasting has taken in Europe, and would like to incorporate the best European features in their own system. A sign of this is the increasing popularity of relays of talks and addresses from Britain across the Atlantic. The insistent demand of the American listener for variety and novelty will, in the end, almost certainly lead to more weight being given to the features at present neglected in American broadcast programmes—that is, drama, opera, chamber music, and talks.



SUGGESTIONS



The Editor welcomes any suggestions for improving the *B.B.C. Year-Book* in any way or increasing its usefulness to readers.



WHAT THE B.B.C. IS DOING FOR SCOTLAND

Scottish Music

Outside Concerts by the Scottish and the Reid Orchestras

Studio Concerts of Scottish Chamber Music

Studio and Outside Concerts by Scottish Choirs

Broadcasts of Gaelic Song arranged in collaboration with the Highland Association

Lecture-Recitals of Scottish Folk Song arranged by Thomas Henderson, with the co-operation of Robert Burnett and others.

Talks

Broadcasts for Scottish Schools arranged under the auspices of the Scottish Sub-Council for School Broadcasting.

Special Scottish Talks on farming, health, and matters of national interest.

A Scottish News Bulletin and a regular Bulletin of Scottish juvenile organisations.

Scottish Herring Fishery Bulletins.

Appeals for Scottish Charities.

The encouragement of young Scottish authors.

Religion

Services from Scottish Cathedrals and Churches representative of all phases of Scottish religious life, arranged in consultation with a Scottish Religious Advisory Committee.

SCOTLAND'S NEW HEADQUARTERS

THE progress of centralisation, leading up to the full functioning of the Regional Scheme, has brought many changes to Scottish broadcasting during the last two years. The latest—and the biggest—has been the transfer of the Regional headquarters from Glasgow to Edinburgh. It was fitting that, with control exercised from one centre over the entire country, that centre should be the capital. Hence the change—and hence Scottish Broadcasting House.

As soon as the decision to “flit,” as they say in Scotland, was taken, the long and somewhat difficult search for premises in Edinburgh began. Something very near the ideal was at length found in the old Queen’s Hall, towards the east end of Queen Street. The building consisted of the large hall, which, with its galleries, seated approximately one thousand, and which had a fully fitted stage of considerable capacity; a smaller hall seating about two hundred; and a large suite of offices and other rooms. The acoustics were particularly good, and Mark Twain, after the last lecture which he delivered in Edinburgh, said that it was one of the finest halls he had ever spoken in.

It was the Queen’s Hall itself which principally attracted the B.B.C. to the building. Visions of a wonderful “No. 1” studio, complete with stage and audience galleries, began to be formed whenever the empty, cheerless-looking building was visited last February. Now, these visions are well on the way to fulfilment, and by the time this *Year-Book* is published Scottish Broadcasting House should boast the possession of the largest and best equipped audience studio in Britain. A very considerable amount of alteration has, of course, had to be done, and those who knew the Hall in its earlier form will find it very different when they return to it as a broadcasting studio. The stage is still there, but it has a new equipment fitted for the needs of the microphone. The walls are almost entirely covered with fabric, and the high-domed roof has undergone a new acoustic treatment. The hall is just a little smaller, too, for a partition has been built under the north gallery, to make room for a large and handsome waiting-room lounge. Extensive acoustic tests have been carried out by B.B.C. engineers,

and, as a result, the treatment of the walls with a thick layer of felt covered with a special fabric for decorative purposes has been evolved. The colour scheme is carried out in tones of deep gold, and the appearance of the finished studio is most imposing. The three galleries have been fitted with seating for audiences, and the floor of the studio and the stage will be used for performers. Needless to say, the equipment of this studio is right up-to-date in every department. Until the B.B.C. has had more experience of actual working it cannot be said definitely what programmes will be given in this studio, but it is likely that every performance of importance will be broadcast from it.

No. 2 studio is being constructed in what was formerly the small meeting hall. In size this is slightly larger than either the Glasgow or the former Edinburgh studios. It, too, has the felt and fabric treatment on the walls. In this studio, however, it is not a single colour wool fabric which has been used, but a damask patterned in green and silver. This is relieved by a dado carried out in a heavier fabric of a deeper green. No. 2 studio will probably be used largely for small concerts, Children's Hour, and dramatic work. A feature of it is the built-in silence cabinet, which is sunk into the wall so as not to disturb the line of the room.

The No. 3—or Talks—studio is a small room which has been specially constructed for the purpose. It, too, has the felt treatment on the walls, but instead of fabric the decorative element is supplied by a modern Scottish tapestry of a distinctively national character based on a mediæval design. The aim here has been to make the room as thoroughly suggestive of a small Scottish study as is possible under the technical limitations imposed. In order to obviate any "closed-in" feeling, the recess of the heavily-silenced window—which, of course, can never be open during a broadcast—is veiled by drawn curtains. To be in keeping with the decorative scheme, these are of a subdued shade, and each one bears a small heraldic shield. The furniture, specially designed for the room, consists of a reading desk, a gramophone, and a small bookcase.

The decorative schemes for these three studios and for the waiting-room have been evolved by Mr. J. R. Mackay, a well-known Edinburgh architect who has been responsible for many important schemes of decoration in Scot-

land. It may be interesting to note that the wall fabrics, which are quite unique, are the work of the Edinburgh Weavers, and were all woven especially for the B.B.C.

In the basement there is an echo room—an adjunct to good broadcasting which Edinburgh has not hitherto possessed. The entire top floor is devoted to engineering requirements. Facing north there is a very large and light room which will eventually house the best-equipped control-room outside London. From its windows there is a glorious view across the Forth to the shores of Fife and to the hills far to the north. To the south there is an equally large room for the storage of batteries, and other rooms on this floor are to be adapted as machine-rooms and as elaborately equipped listening-rooms for checking the quality of transmissions. Here, too, will be the dramatic control panel, which will enable producers to use all three studios at once. Scotland has not yet enjoyed the use of such a panel, and dramatic enthusiasts are looking forward to it with eagerness.



Clapperton, Selkirk

THE "BRAW LADS" GATHERING AT SELKIRK
A description of the Ceremony was broadcast on June 27

THE CHILDREN'S HOUR

THE progress or otherwise of the Children's Hour may be roughly estimated in terms of Radio Circle membership. This has shown a rapid increase over the last two years, an increase which is being well maintained during the current year. At the end of 1928 the membership stood at 22,000: in December 1929 it was 39,000, and this year, despite certain modifications in the rules of membership, the total promises to be well over 40,000.

The modifications referred to were made necessary by the fact that, at one time, practically 25 per cent. of the total time allotted to the Children's Hour was devoted to reading birthdays. This resulted either in a definite cramping of the actual programme, or, where the programme could not be cut, in an undignified scramble to finish the birthdays by six o'clock. In consequence of this, the age limit at which birthday greetings may be given was reduced from 18 to 15, and at the other end of the scale, the age at which congratulations to adults can be broadcast was raised from 90 to 100.

It would be well for adults who find listening to the reading of birthdays a bore, to remember that birthday greetings are only broadcast to members of the Radio Circle, and that the funds raised from subscriptions, after deducting the sums spent on badges and membership cards, are devoted to charitable objects, notably the Children's Hospital Wireless Fund. This year in London alone three cots have been endowed in three different hospitals at a total cost of £1500.

There is another method by which the success or otherwise of the Children's Hour can be gauged, and that is by means of Request Weeks. Twice each year, in January and June, a Request Week is held, and children are asked to send in a list of the six best items broadcast during the previous six months. Interest in Request Weeks is increasing, and with its aid it is possible to obtain a very fair estimate of the popularity of individual items and artists. For the Request Week held in June 1930 there was not one item broadcast during the previous six months, or one



THE STAGE COACH LEAVING TOY TOWN

An incident from Mr. Hugh Beaman's successful Toy Town stories broadcast in the Children's Hour

artist who had appeared during the same period, which failed to obtain at least one vote.

In addition to the foregoing there is, of course, a continual daily correspondence between children of all ages and the staff of the Children's Hour. In this, questions are asked and answered, and views frankly expressed. The modern child is not slow to appreciate, nor is he shy if he feels that criticism is justified.

For the programmes themselves there are two facts to be borne in mind; first, that nothing which is not good enough for adults is good enough for children, and second, that really first-rate children's material is as hard to come by as it is difficult to write. This is not to say that the material broadcast to children must appeal to adults, but that it must be of an equally high literary and artistic standard and performed and presented with as much care as is given to any other part of the programme. Nor does it mean that children's material of the highest class is unobtainable. There is a considerable amount of published material suitable for children which can be, and is being, adapted for broadcasting, and for the rest, established

authors, as well as new authors, are being encouraged to write stories and plays for the microphone. Only by these means can children be given the best: there is no doubt they are entitled to it.

The most difficult problem which confronts those connected with the Children's Hour is the problem of presentation. The success or failure of a programme depends largely on the atmosphere created in the studio. This atmosphere should be friendly, simple, and intimate, without being on the one hand heavily avuncular or, on the other, childishly facetious. Only those who have tried, or at least have been present in the studio, can imagine how difficult it is to steer a confident course between these two admittedly objectionable extremes. It must be remembered that the B.B.C. is trying to entertain children between the ages of eight and fifteen, and at the same time not to exclude the ones below the age of eight or alienate those over fifteen. The slightest false step, the most minute jar in the atmosphere, may completely wreck a programme and rob it of its appeal. How often those false steps are made only the children themselves can judge.

There is one fact which should always be borne in mind, namely, that the Children's Hour is designed and intended for children. This may sound dangerously like a truism, but there have been cases where people of riper years have admitted that they listen to the Children's Hour, and even enjoy it. To all such are due the grateful thanks of the Children's Hour staff, both for their appreciation and their understanding of the difficulties which have to be surmounted, but it may well be pointed out to them, as well as to those adults who have listened and failed to enjoy, that the Children's Hour is not primarily designed for them, but for the amusement of their younger brothers and sisters, who are the final court of appeal.



THE RADIO CIRCLE

Information as to membership of the Radio Circle, its rules, and the distribution of its funds, will be found in the Reference Section at the end of the book.



LESLIE MAINLAND

It is difficult to put into words the feelings of his colleagues in the B.B.C. and of all the members of the London and Daventry Children's Hour at the death of Leslie Mainland (L. G. M. of the *Daily Mail*) which occurred on June 3rd, 1930. The faculty of endearing hundreds of thousands of people—children and adults alike—by sheer microphone personality is the privilege of only the very few, and this faculty Leslie Mainland possessed in the highest degree. Certain phrases which he invariably used are as much part of broadcasting as they were typical of the man himself. His "Zoo Stories are true Stories," his "Well, it's a hard life, children. Good-bye, and good luck to you," are indelibly impressed on the minds of all who have ever listened to him.

No one who has heard him or who has had the privilege of working with him could ever doubt his sincerity, his love of children, and his knowledge and love of animals of every sort.



A SCENE FROM THE GILBERT AND SULLIVAN OPERA, "THE MIKÉ"

The illustration shows the very effective



¹³ BROADCAST FROM THE SAVOY THEATRE ON JANUARY 24TH, 1930
costumes designed by Charles Ricketts

CO-OPERATION IN IRELAND

FROM the earliest days of broadcasting there has been a frequent interchange of programmes between Dublin and Belfast, but the most important feature of activities in Ireland in the year under review has been the increasing co-operation between the B.B.C. and the Irish Free State Post Office, which directly administers the Free State Broadcasting Stations. The result can be seen in the many interesting broadcasts which have passed between the two centres. Seamus Clandillon, the energetic Dublin Station Director, has given invaluable practical advice on all matters, especially as to artists resident in the South, with the happy result that many of them have found a place in the Belfast programmes. In this connection three of the most important visits were those of Colonel Fritz Brase (Director of the Irish Free State Army School of Music), Vincent O'Brien (Conductor of the Dublin Broadcasting Orchestra), and Terry O'Connor (Leader of the Dublin Broadcasting Orchestra). The first conducted a memorable Wagner programme, Mr. O'Brien conducted an orchestral concert, and Miss O'Connor played a concerto. Such visits mean more than the mere introduction of new personalities into the Belfast programmes. The Abbey Players visited the studio and presented the three-act play "The White-Headed Boy" by Lennox Robinson on February 17, but the dramatic side of this liaison really created history on March 17—St. Patrick's Day—when the play "Cathleen ni Houlihan" (W. B. Yeats) was relayed from the stage of the Abbey Theatre, Dublin, and broadcast nationally. A word of thanks is due to the authorities and players of this world-famous theatre for the trouble and care they took in numerous rehearsals and tests before the actual broadcast.

Sport has also entered the programme field and given many thrilling moments to listeners in Northern Ireland. Chief in point of interest have been the running commentaries on the Rugby Internationals from the fine park at Lansdowne Road, given by the ex-Irish International Rugby player, W. P. Collopy; the Irish Derby at the Curragh; and the Eye-Witness Account of the second Irish



Abbey Theatre, Dublin

THE FIRST BROADCAST FROM THE ABBEY THEATRE, DUBLIN
A scene from Yeats' "Cathleen ni Houlihan" which was chosen for the relay on St. Patrick's Day, March 17, 1930

International Grand Prix Motor Race over the Phoenix Park Circuit by F. M. Summerfield.

Many artists, too, who contribute regularly to the lighter side of the Dublin programmes have taken part in variety, vaudeville, sketches, etc. from our own studio.

The most important relays in the realm of music have been the concerts by the No. 1 Free State Army Band, under the baton of the distinguished conductor, Colonel Fritz Brase. Since taking up his present appointment as Director of the Irish Free State Army School of Music, Colonel Brase has shed lustre on Irish music and has in a great measure restored that musical culture which was at one time one of Ireland's most treasured assets. His popular Irish fantasies for Military Band have done much to increase public interest, and his work in reviving and maintaining the Dublin Philharmonic Society still further increases the debt Irish music-lovers owe to him.

ISLE OF MAN WEEK

June 29th-July 5th, 1930.

In 1930 for the first time a telephone cable was installed between the Isle of Man and the mainland. This made it possible to broadcast from the Island and arrangements were accordingly made for a commentary on the Tourist Trophy Races and for a special Isle of Man Week.

- 29th. Religious Service in Manx from St. George's Church, Douglas. Address by the Bishop of Sodor and Man.
- 30th. "Castle-Rushen," a Historical Play by Mr. Ramsey Moore and Prof. Hamby Hay.
- 1st. Mr. Ramsey Moore, Attorney-General of the Isle of Man, on "The House of Keys."
Sir Claude Hill, K.C.S.I., the Lieut.-Governor, on "The Isle of Man, Past and Present."
- 4th. A Concert of Manx Music, including choral singing, from Groudle Glen, by the Northern Wireless Orchestra and the Douglas Festival Choir.
- 5th. Commentary on the annual Tynwald Ceremony, including the promulgation (in Manx and English), from Tynwald Hill, of laws passed during the preceding 12 months by the House of Keys.

WIRELESS AND THE BLIND

THIRTY or forty years ago, one of the most familiar sights in the streets of any big city was the blind beggar. He was a pitiful object, sometimes tapping along the pavement with his stick, with a mournful little mongrel beside him, sometimes crouched on a stool in the fog and drizzle, reading or pretending to read from a Braille Bible. Most of us gave the poor fellow a coin and forgot him, as too abjectly miserable, too much an alien from life as we knew it, for comprehension.

Since those days, however, enormous progress has been made in the amelioration of the blind. The blind beggar has almost disappeared. Braille publications are issued in millions; there are Braille magazines and newspapers; the progressive blind have distinguished themselves in many professions; thousands of the rank and file are excellent handicraftsmen; and the cheerfulness of the blind has become proverbial.

Yet in spite of this wonderful advance, the lot of the average blind man or woman was, until quite recently, dull and monotonous, as colourless as extreme poverty, as wearisome as an eternal Monday morning. The cheerfulness was there, but it was the result of will-power, courage and self-respect. It must have been, for although most of us are dependent for work on others, how terrible to be dependent on others for pleasure!

But to-day, every minute of a blind person's leisure hours can be a minute of life lived to the full, throbbing with vitality and interest—provided that the blind person possesses a wireless set. Master of a wireless set, a blind man has at his bidding concerts and plays, variety shows and learned lectures, church services and State pageants, Lord Mayor's dinners and political receptions. The best speakers, the best brains of the nations of the world are at his service. If he wants to see a football or cricket match, the tennis championships or the Derby, his faithful servant, the wireless set, takes him. It is his newspaper, his encyclopædia, his entertainer, his teacher—and the cost is but a few pounds down.

If listeners can only conceive the marvellous manner in which wireless has transformed the outlook of the blind,

their first thought will be to help this magical process of creating light in darkness by subscribing what they can to the British Wireless for the Blind Fund, 226 Great Portland Street, London, W.1.

The object of this Fund is to provide, as far as is practicable, every blind person in Great Britain and Northern Ireland with a wireless set. Its President is the Prince of Wales, and all societies for the Blind in this country, as well as the B.B.C., are represented on its Committee.

On Christmas Day, 1929, Mr. Winston Churchill made a splendid appeal for the Fund, and the result exceeded all expectations. The wireless trade is providing most generous assistance by giving sets; the B.B.C. is helping the Fund in every possible way. And if every listener who can see gives even a shilling towards the Fund, every man or woman who is blind will become a listener too, one with you all, one of us, partakers in the fascinating movement and the vivid life of this our present-day world.

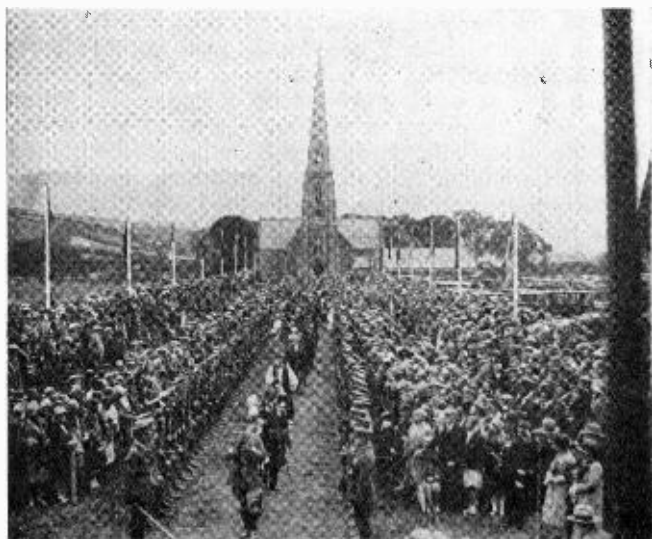

THE ANNUAL TYNWALD CEREMONY, ISLE OF MAN

(July 5, 1930)

[150]

SOME B.B.C. PUBLICATIONS

The Radio Times

The B.B.C.'s official programme, published on Fridays, price 2d., containing the programmes for the following week, with notes, illustrations, and special articles.

The Listener

The B.B.C.'s illustrated Literary Weekly, reprinting the best of the past week's broadcast talks. Published on Wednesdays, price 3d.

World-Radio

Published on Fridays, price 2d., with full summaries of the programmes of all important foreign stations, and technical articles issued with the authority of the B.B.C.

Talks Pamphlets

Some twelve pamphlets a year are published two or three weeks in advance of the broadcast talks. They are usually illustrated and contain notes, synopses, questions for discussion, and lists of books. Price 2d., postage 1d.

School Pamphlets

These number about 30 a year and contain illustrations, notes, questions, etc., preparatory to the School Broadcasts. Price 1d. or 2d. according to size, postage 1d.

Miscellaneous Books

Religious Services for Broadcasting, price, Paper 1s.
Cloth 2s.

New Ventures in Broadcasting, A Study in Adult Education, price, Paper 1s., Cloth, 2s.

National Lectures, price 1s. post free. Five Lectures (by Robert Bridges, Sir A. S. Eddington, Prof. G. M. Trevelyan, Sir J. J. Thomson, and Lord Hewart) have so far been issued. The first is out of print.

Broadcast English I. A List of Pronunciations for Announcers, price 3d. post free.

Broadcast English II. A Dictionary of the pronunciation of English Place Names, price 1s., postage 2d.

Technical Books and Pamphlets

World-Radio Broadcasting Map of Europe, price 3s., post free.

World-Radio Identification Panels, price 1s., post free.
The Service Area of Broadcasting Stations, price 5s., postage 4d.



National Gallery

SUGGIA

*A reproduction of the great portrait by Augustus John
(Recital, February 7; Concerto, October 22, 1930)*



M U S I C



MY EXPERIENCES AS B.B.C. CRITIC

By ERNEST NEWMAN

LET me begin by saying that I have never quite understood what my duties were intended to be, or precisely what is meant by "the B.B.C. Music Critic"—or even by the term "music critic"! Anyone who interests himself in the literary side of music in the present day knows that the old notion of a music critic, as a man who was exceptionally qualified to tell the public what is good and what is bad in music, is on its last legs. The etymological meaning of the word "critic" is "a judge." In practical matters, a judge is a person specially qualified by nature and by training to sift out the few essential from the many inessential facts bearing on a case, and then to deliver judgment upon those facts in accordance with certain rules of right and wrong that have been agreed upon by the particular community in which he lives. It is evident at once that there is nothing corresponding to this in the "criticism" of music. The critic has not necessarily the slightest natural aptitude for criticism; he goes through no special training for his job, but learns what he can about it in the act of practising it; and there is no agreement whatever either among the judges or the litigants or the public as to the "laws" of the game.

Nobody seems to have noticed that the game itself has been transformed beyond recognition since it began some two thousand odd years ago in literature. There was some sense in certain ancient Greeks setting up as critics, that is to say, judges. They had no literature but their own to deal with, and not very much of that; and the Greek mind of the time was a relatively homogeneous thing. There was

some sense, then, in some Greek or other of especially fine sensibilities trying to work out standards of Greek literary taste; and in relation to the limited material they had to deal with it was possible to argue that certain things were in themselves better than others.

There is no need for me to tell the reader that things have altered very much since then, especially in music. There are no rules, no standards; everyone is firmly convinced that his own reactions to a given work are right and all other reactions wrong; and the wider the area over which the game of taste is played, the more farcical does a game become in which every player makes his own rules as he goes along.

Now my gifted colleagues Sir Walford Davies and Dr. Dyson find themselves in no such difficulties as daily beset me. *They* deal with accepted standards and established reputations; no one now doubts that Mozart is a great composer, or that the Beethoven No. 5 is a model symphony. These two lucky fellows have nothing to do with criticism in the general sense of that dreadful term. Their business is appreciation—showing just *why* something that everyone accepts as beautiful *is* beautiful. They address people who, from long working together along the same lines, have come to agree on the rules of the game. Moreover, they can make their points clear on the piano—in the first place because the points are beyond dispute, and in the second place because that sort of music lends itself to skeletonisation on the piano even if it was not written for the piano.

Compare now the Elysian ease of these gentlemen's situation with the Tartarean discomforts and difficulties of mine. My public and myself listen to all sorts of new works. Some of these works are very hard to understand even after long study, and almost impenetrable at a first hearing. There is no accepted standard of what constitutes goodness or badness in this music. It is impossible for me to make my points clear by piano illustration, for the piano cannot reproduce the essence of most of this music; moreover, to analyse a particular work in detail would mean my devoting my whole talk to it, to the neglect of all the other events of the fortnight.

So here I am, trying, without established rules to help me, to guide the listener through the mazes of modern

music, which is of every conceivable order and sets up every possible variety of reaction in the listener, according to his temperament and his experience. I try not to force my own opinion down his throat, but to put certain considerations before him that may help him to clarify his own opinions. And I have learned more from my listeners than they have learned from me. I get a great number of letters, and the majority show me how much hard and good thinking there is going on all over the country about music. Thanks to broadcasting, everyone can now hear the newest music for himself and form his own opinion of it; and unless I am greatly mistaken, one of the results of broadcasting will be to make an automatic end, within a few years, of musical criticism as that term has hitherto been understood. So long as the plain man could not hear new music for himself he necessarily listened to what was said about it by someone who *had* heard it; but now that he can hear it for himself he prefers to do his own thinking about it—especially when he finds that not only do “the critics” say something that appears to him to be untrue, but are not even consistent with each other. Everyman is well on the way to becoming his own musical critic, so far as “criticism” means the expression of personal liking or disliking. All this means the doom of musical criticism of the present newspaper type. But there are compensations ahead. To-day it is almost impossible to write for the general public about music in the way a musician would like to write about it, because the general public lacks the necessary width and depth of knowledge. But now that millions of people are hearing music that in the old days would have been heard by only a few hundreds in some large town or other, it is becoming possible to talk to them about it not from the point of view of mere taste, but with regard to the principles that underlie it. Broadcasting will, I believe and hope, make an end of the “critic” as “judge,”—for Everyman will be his own judge—and will make it possible for the writer on music to talk to Everyman about things that really matter.



SIR WALFORD DAVIES
from an etching by Rosa Hope

L O V E D M U S I C I A N

ES, Sir (Henry) Walford, Kt., Mus. Doc., etc., is a very great man. His attainments, his professorships, the organs and choirs over which he presided, his publications: oratorio, cantata, symphony, anthem, suite, song, sonata, church service,—all these things were written in the book of *Who's Who?* Sir Walford is not as the Great Man or the Royal Organist that Sir Walford is now known to the world. It is as the broadcaster to listeners ordinary and extraordinary, great and small, far and near; as the most genial of friends, the most patient of instructors, the man with the mellow voice and the light dancing fingers; that he has won the love of all. After a well-deserved rest, at his own desire, he returned to the evening programme this autumn.

He was one of the few men of vision who perceived in the infant days of broadcasting the infinite possibilities of this new medium, first and foremost in the direction of musical education. He is one of those who believe that there is no such thing as an "unmusical nation," although there may be a nation whose education in music is so perverse, so wrong-headed, that the majority of children leave school without any passion for this noblest of arts; indeed often with a kind of dull resentment towards it. He was determined to alter all this. He was certain that children could be taught to make their own tunes, and so to love the craft of music in the only way that craftsmanship is ever taught, that is by actual practice. Sir Walford had preached this gospel in the teaching world long before broadcasting was invented. Some of the pundits of the Board of Education doubted its validity. They said that the astonishing results which he occasionally brought from Aberystwyth to town were due to the genius of the Welsh. Sir Walford pooh-poohed the notion that it was due to any particular national characteristic. Melody was the child's birthright. And so he was a veritable pioneer of school broadcasting, and became the spearhead of its forward movement in the early days of 1923 and 1924. He has been teaching schools by wireless for six years, and their number has steadily grown. So has the excellence of the results. Anybody who cares to look at his *Scholars' Manuals* containing the text of

his teaching will find included therein numbers of compositions by Public, Elementary, and Secondary school-children, which will some day be put together and form the subject of a chapter in the history of Education. The circulation of the last Scholars' Manual about which figures are available amounted to 40,000 copies, and as it is notorious that only a small proportion of mankind succeed in making the necessary effort to acquire the documentary accompaniment of wireless lessons, it is pretty safe to say that on Tuesday afternoons he is teaching 80,000 children to enjoy music in a new way; that is, to make it. It is little short of a new miracle, this releasing of old dormant faculties, enabling the young people of England to enter into an inheritance which is theirs by right, to acquire a gift which will be their joy for ever.



THE QUEEN'S HALL

The scene of the "Proms." and the B.B.C. Symphony Concerts. From a water-colour by Karl Hagedorn



THE NEW B.B.C. ORCHESTRA

IN the early days of broadcasting the B.B.C. formed the London Wireless Orchestra, and in 1927, on taking over the management of the Promenade Concerts at Queen's Hall, the B.B.C. employed the former Queen's Hall Orchestra for three successive Promenade Seasons. As the work of the B.B.C. expanded, it was found desirable to make plans for the formation of a permanent first-class symphony Orchestra, contracted under the "no deputy" system. As a preliminary the B.B.C. in the winter season of 1929-30 formed an interim orchestra, certain outstanding contracts making it impossible to secure a permanent personnel until the next season.

The new permanent B.B.C. Symphony Orchestra, which began to take its final shape in the summer of 1930, absorbed both the Queen's Hall Orchestra and the London Wireless Orchestra. An advance guard of ninety players, led by Charles Woodhouse, undertook the Promenade Concerts of 1930, and the full new Orchestra of 114 players made its debut in the first of the B.B.C. Symphony Concerts at Queen's Hall on October 22nd, under the leadership of Arthur Catterall.

In catering for the orchestral needs of its programmes, the B.B.C. is faced with a problem of unique complexity. Every week shows examples of the following different types of work, each of which requires a different combination of players.

1. Symphony Concerts requiring full modern orchestra (at least 100 players).
2. Symphony Concerts requiring medium-sized orchestra (say 80 players).
3. Theatrical programmes (*e.g.* musical comedy, etc.) requiring an orchestra of between 30 and 40 players.
4. Light Orchestral and Light Symphony Concerts. The numbers needed for this type of programme may vary between about 40 and 70 players.
5. Miscellaneous work (*e.g.* incidental music for plays), the combination required for which varies in each case.

It is therefore clear that the B.B.C.'s orchestral organisation has to fulfil the function not of one, but of at least five orchestras of different calibre and duties.

The new Orchestra is designed to fulfil all these requirements, either as a whole or by subdivision where necessary. As the scheme is unprecedented in its scope and variety, experience will naturally modify the minor details of subdivision; but the main idea is this.

The full Orchestra (A) will consist of 114 players, and will undertake concerts under heading (1) above. This body of players will be divisible for other programmes into the following two independent orchestras.

(B) An orchestra of 78 players, suitable for programmes under heading (2).

(C) An orchestra of 36 players, for theatrical programmes (heading 3).

The full Orchestra will also be subdivisible into these other two following organisations:

(D) An orchestra for light symphony concerts of 67 players.

(E) An orchestra for "Popular Orchestral" Concerts and similar programmes of 47 players.

Both orchestras (D) and (E) will be used for programmes under heading (4). Programmes under heading (5), being quite variable in their requirements, will be dealt with by an *ad hoc* allocation of players in each case.

The particular kind of music which these various orchestras will undertake may now be very shortly typified, starting from the smallest combination.

Orchestra (C) will perform operettas, musical comedies, and similar work, as well as the Bach Cantatas on Sundays.

Orchestra (E) will undertake the lighter concert works of such composers as Edward German and Eric Coates.

Orchestra (D) will perform Haydn, Mozart, and early Beethoven Symphonies, and all works in which there is a slender complement of wind instruments, and which consequently do not require many strings.

Orchestra (B) will undertake such works as extracts from Tristan, Brahms symphonies, and modern works of the type of Scheherazade, Cesar Franck's Symphony, etc.

The type of work that the full Orchestra will be able to perform is indicated by Strauss' Symphonic Poems, extracts from Wagner's Ring, and Mahler's Symphonies. This is not to say that the full Orchestra will never undertake works noted above under some of the other headings; the point is that whereas the former works can only be undertaken by the full Orchestra, the latter can be dealt with by its sectional organisations.

A noteworthy feature of the organisation as a whole is the status of what may be called the "accessory" wind instruments. In most orchestras the Piccolo, Cor Anglais, Bass Clarinet and Double Bassoon are regarded as subordinate members of the Flute, Oboe, Clarinet and Bassoon departments respectively. The first Piccolo will actually be played by the third Flute player; but when playing Piccolo he will rank equally with the first Flute. Similarly, the fourth and fifth Trumpets will play cornets when required; and when doing so they will be of equal importance in the orchestral scheme with the first, second and third Trumpets.

These "accessory" instruments, though not used with such constant regularity as the main wind instruments, have often conspicuous and important parts. A famous example is the Cor Anglais solo in Dvorak's New World Symphony, where an unsympathetic soloist can mar the effect of the entire work.

It is the aim of the B.B.C. that this Orchestra should set a standard for English orchestral playing, and should bear comparison with the finest orchestras in the world. With this object in view, not only have the best players obtainable been secured for the principal positions, but the choice of every rank and file player has been most carefully considered. They have all been engaged on a full-

time contract ; deputising, except in case of illness, will not be permitted. The experience of the players engaged, the regularity and frequency with which they will play together, and the eminence of the conductors under whom they will play, give every ground for confidence that the B.B.C.'s ambition will be realised.*

COMPOSITION OF THE ORCHESTRA

- 20 First Violins.
 - 16 Second Violins.
 - 14 Violas.
 - 12 Cellos.
 - 10 Double Basses.
 - 4 Flutes (including Piccolos).
 - 4 Oboes (including Cor Anglais, Hecklephone, Bass Oboe, Oboe d'Amore, Oboe da Caccia).
 - 5 Clarinets (including E flat Clarinet, Bass Clarinet, Saxophone).
 - 4 Bassoons (including Double Bassoon).
 - 6 Horns (including Wagner Tubas).
 - 5 Trumpets (including Trumpet in D, Bass Trumpet, Cornets).
 - 5 Trombones (including Contrabass Trombone).
 - 2 Tubas (including Euphonium, Tenor Tuba).
 - 2 Harps.
 - 5 Percussion players.
-
- 114 Players altogether.

FULL ORCHESTRA AND SUBDIVISIONS

INSTRUMENTS.	A.	B.	C.	D.	E.
First Violin	20	14	6	12	8
Second Violins	16	12	4	10	6
Violas	14	10	4	8	6
Cellos	12	8	4	7	5
Double Basses	10	7	3	6	4
Flutes	4	3	1	2	2
Oboes	4	3	1	2	2
Clarinets	5	3	2	3	2
Bassoons	4	3	1	2	2
Horns	6	4	2	4	2
Trumpets	5	3	2	3	2
Trombones	5	3	2	3	2
Tubas	2	1	1	1	1
Harps	2	1	1	1	1
Percussion	5	3	2	3	2
	114	78	36	67	47
		114		114	

* A photograph of the orchestra and their names appear on pages 176-7.

THE NATIONAL CHORUS

Chorus Master: STANFORD ROBINSON *Hon. Secretary:* ERNEST WOOD

Sopranos:

Ballam, A. J. G.	Drury, E.	Kemp, A. J.	Page, B.
Beeby, D. M.	Fellingham, G. E.	Kemp, M.	Page, D.
Bennett, D. M.	Fricke, L.	Lance, F. M.	Palmer, M. H.
Best, H.	Garnsey, G. M.	Lander, E. D.	Pearson, H. M.
Bignell, J. P.	Geen, E. V.	Lawrence, E.	Pendlebury, E.
Blareau, M.	Goddard, F. M.	Leach, F. H.	Percival, A. C.
Booth, K.	Goodey, E. M.	Lodge, A.	Price, N.
Buckle, V. M.	Hall, H.	Longden, M.	Prior, H. M. T.
Bultz, Z. M.	Hayman, W.	Lubman, H.	Shaw, M.
Burke, D. M.	Hayward, L. M.	Mason, D. E.	Smith, E. H.
Calow, D. C.	Heard, V. A.	Measday, A. D.	Smith, G. M.
Carter, A. M.	Heffer, E.	Mew, L. G.	Taylor, C. E.
Carter, P. V.	Henderson, I.	Miles, E. J. H.	Thake, M.
Chibnall, C.	Hewson, D.	Morley-Taylor, J. M.	Thompson, K.
Clarke, C. E.	Hodges, G.	Nash, G.	Wade, I. M.
Clements, R.	Holgate, J.	Newall, F.	Wallbank, G. M.
Collen, D. M.	Hooper, M. B.	North, D.	Warner, E. M.
Corlette, H.	Jackson, E. I.	Oliver, M.	Williams, J. E.
Cox, F. M.	Jackson, J.	Oram, L. O.	Wood, K. B.
Dean, O. A.	Jones, O.	Orgles, E. C.	Woodin, V. G.
Dickens, P. E.			

Contraltos:

Adams, W.	Fredericks, E.	Leigh Hunt, B. R.	Smith, E. G.
Arran, F.	French, G. I. A.	Lewis, E.	Stewart, N. E.
Bailey, L. M.	Godale, W. J.	Lovibond, J.	Stone, N.
Billson, L.	Gordon-Ruggins, W.	Newby, F. E.	Swain, R. G.
Bowden, V. B.	Gwynne-Jones, D.	Nicholas, K. M.	Theed, P. E.
Brough, G. T.	Hammond, L.	O'Connor, M.	Tingley, C.
Butler, V.	Hay, D. M.	Perry, C. E.	Veale, C.
Collins, M.	Hodder, M. P.	Pope, B. G.	Waggett, W.
Conquest, C. A.	Hopson-Hill, H.	Price, A.	Warn, C. M.
Dale, L. M.	Innes, M. M.	Price, A. E.	Waterer, D.
Dorée, P. B.	Jackson, E.	Rodway, E.	Western, M. K.
Downer, W.	James, D. M. T.	Salthouse, B.	White, M. M.
Eagles, A.	Jarrett, W. E.	Shale, N.	Williams, E. M.
Franklin, D.	Kirk, D. E.	Shier, M. A.	

Tenors:

Becket, F. H.	Eburne, C. H. G.	Isaacson, F.	Scopes, A. T.
Bergen, F. v.	Everitt, W.	Inskip, J. M.	Smith, P. E.
Birkett, S. J.	Foster, A.	Labdon, R. M.	Thompson, F.
Bourne, W. H.	Fowler, B. H. C.	Latham, B. S.	Toms, A.
Bray, E. M.	Gibbon, J. W.	Lenthall, T. A.	Watson, H. W.
Cable, C. J. C.	Gibson, S. V.	McAthy, A.	Witts, H. L.
Carpenter, S.	Grundy, F.	Miles, T. F.	Whitmore, C. A.
Carroll, W. H.	Hale, H. L.	Neville, L. R.	Williams, A.
Cozens, J.	Hale, T. J.	Perkins, A. F.	Willson, A. O.
Dacre, R.	Hannan, F. D.	Ratcliffe, W. H.	
Dunn, H. H.	Hubbard, F. A.	Rowland, G. H.	

Basses:

Baker, S. O.	Harrison, H. C.	Mascall, P.	Syrett, H. G.
Bell, C. J.	Helin, J. P. H.	Masters, F.	Taylor, G. J.
Bowyer, C. T.	Hill, G. F.	Oliver, W. C.	Taylor, J. A. G.
Brigden, J. H.	Hilton, J. D.	Pedley, S. A.	Thomas, C.
Cole, C.	Hixson, W. H.	Pepper, W. E.	Thorpe, F. W.
Cooper, A. A.	Holland, A.	Powley, T.	Thorpe, W.
Cory, H. E.	Holland, R. H.	Ramsey, G. A.	Williams, B. B.
Cullen, W. F.	Hughes, J. L.	Rolton, E. H.	Willson, F. G.
Debonnaire, E.	Humphrey, W. J.	Sack, T. J.	Winslade, G. O.
Dolby, E. V.	Jenkin, C. V.	Salmon, A. T.	Woodington, J. C.
Eaton, E. C.	Keyte, C. F.	Sharpe, H. E.	Woods, C. R.
Eaton, W.	Lewis, A. T. D.	Sherriff, H. B.	Wood, R. C.
Edwards, O. J.	Littler, W.	Simpson, J. W.	Wright, H. F.
Ellis, C. J.	Lloyd, J.	Smart, E.	Young, W. J.
Fletcher, W. W.	Lorn, H. E.	Stevens, P. A. S.	
Flindall, W. G.	Marvin, R. G.	Stevens, W. J.	

THE NATIONAL CHORUS

THE National Chorus is the standing choral organisation of the B.B.C. for concert hall—as distinct from studio—performance. It was formed in 1928, is 250 strong, and is composed only of amateurs. Before its formation the B.B.C. had to get together a fresh chorus whenever a big choral work was undertaken; and thus all the trouble of achieving a good ensemble for one concert had to be gone through again with a fresh body of singers for the next. The National Chorus was formed on a permanent basis to obviate this waste of time and trouble, and as it has a constant personnel, the benefit derived from rehearsal does not end with the particular concert in view, but is perpetual and increasing.

Every member of the National Chorus is a picked and experienced choral singer, and it has been the urgent wish of the B.B.C. that membership of it should not result in singers resigning from any choral society to which they may have belonged previously. The National Chorus as a body seeks not to compete, but to collaborate, with its contemporaries.

Although it has only been in existence for two years, the Chorus has to its credit a repertoire of great and varied musical interest. It opened its first season (1928-9) with Bantock's "Pilgrim's Progress," a work specially commissioned by the B.B.C. for the tercentenary of Bunyan's birth, and the other works performed in this season were Verdi's "Requiem," Eric Fogg's "Song of the Hillside," Debussy's "Martyrdom of St. Sebastian," Beethoven's Choral Symphony and Berlioz' "Faust." In the 1929-30 season the following works were performed: Bantock's "Omar Khayyám," Handel's "Solomon," Mahler's Eighth Symphony (a colossal undertaking), and Mendelssohn's "Elijah." The last of these is (with the exception of Beethoven's Choral Symphony) the only work among those mentioned which is a "tried favourite" among choral societies; the others are mostly works which through one cause or another have not had the recognition in England to which their musical value entitles them, and which the National Chorus has been able conveniently to present. It is right that both types of work should be

found in its programmes; for it is the aim of the National Chorus to take all choral music for its province, and to frequent both its highways and its byways. In accordance with this principle, the works put down for performance in the current season (1930-31) include Beethoven's Mass in D, Handel's "Israel in Egypt" (the most predominantly choral of all oratorios), and a new work by Arthur Bliss. The season will also include a performance of Beethoven's Choral Symphony.

THE WIRELESS CHORUS

The National Chorus' "opposite number" in the studio is the Wireless Chorus. All choral work in the studio—concerts, operas, Bach Cantatas, etc.—is undertaken by these singers, and their numbers vary in accordance with the requirements of the programme in question. Their normal strength for operatic performance is 26. It is not possible to give here even a summary of their varied activities; but it is enough to say that they can tackle with success anything from plantation songs to oratorios.

<i>Sopranos</i>	<i>Contraltos</i>	<i>Tenors</i>	<i>Basses</i>
Doris Watkins	Ruby Boughton	John Collett	Graham Smart
Elsie Otley	Jean Roper	Tom Purvis	Radley Gove
Hilda Robinson	Muriel Wilson	Mountford Scott	Victor Utting
Eileen Tunbridge	Elsie Hay	Lloyd Saxton	Michael Henry
Rose Green	Elsie Wynn	Felix Baker	Walter Montgomery
Olive Evers	Frances Bowen	Frederick Hayes	Charles Wingrove
		Joseph Congdon	James Bond
		Harold Wilde	Joseph McLean
			Frederick Masters
			Charles Sapsed

THE WIRELESS SINGERS

The nucleus of the Wireless Chorus is the body of eight soloists known as the Wireless Singers. These singers are at the heart of the B.B.C.'s choral activities, and stand in the same relation to the Wireless Chorus as a chamber music combination does to an orchestra. They are perhaps best known to the listening public by their work in studio services and the Epilogue, but their duties embrace all kinds of singing, both ensemble, choral, and solo.

Mary Hamlin	Gladys Winmill	Edward Reach	Stanley Riley
Rosalind Rowsell	Doris Owens	Bradbridge White	Samuel Dyson

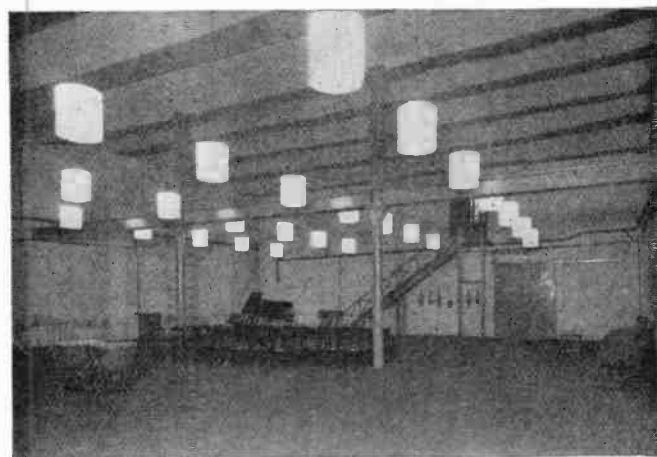

BEFORE AND AFTER

The B.B.C.'s large new orchestral studio on the South bank of the River almost opposite Savoy Hill. An old warehouse, roughly 67 X 70 feet, was secured and converted into the largest broadcasting studio in this country, for use by the new E.B.C. Symphony Orchestra until such time as the Concert Hall in Broadcasting House is ready.

[167]



THE THOMASKIRCHE, LEIPSIG,

the church at which Bach was organist and cantor, and where many of the cantatas were originally performed. A performance of Bach's St. Matthew Passion was relayed from there on April 18, 1930

THE CHURCH CANTATAS OF BACH

By FILSON YOUNG

ON Sunday, May 20th, 1928, the B.B.C. quietly inaugurated what is undoubtedly one of the most important series of musical performances that has ever been given in this or any other country. On that day was performed the Church Cantata of Bach No. 44, entitled "Sie werden Euch in den Bann thun" ("They shall put you under Ban"), that being the cantata for the Sunday after Ascension. Mr. Stanford Robinson was the conductor; the soloists were Caroline Hatchard (soprano), Elsie Black (contralto), Hughes Macklin (tenor), and Keith Falkner (baritone); and the Wireless Chorus and Orchestra furnished the accompaniment and choruses. Every Sunday since then, the same chorus and orchestra (or the chorus and orchestra of some other B.B.C. station), and a selection of soloists drawn from what may be described as a repertory group of specially-trained singers have performed one of the cantatas. Two out of about every five performances are repetitions of a cantata that has already been performed, and three are entirely new ones. For every minute that these cantatas take to perform you may count an hour of study, preparation, and rehearsal. The performance varies from 20 to 45 minutes in length; the extent of the study and preparation involved in the whole series may be estimated from that.

After a few performances in the studio, the absence of an organ and the very unsatisfactory results obtained from ordinary substitutes came to be acutely felt. I should say that at this time the performance of the cantatas was distributed between four stations—London, Birmingham, Glasgow and Manchester—the cantata on alternate Sundays being given at the provincial stations. Efforts were then made to find suitable churches, the choice in Manchester and Birmingham ultimately settling down to St. Ann's Church in Manchester and the Church of the Messiah for the Midland Station. Mr. Morrison in Manchester and Mr. Joseph Lewis in Birmingham entered enthusiastically into the work, and their performances were attended by large audiences.

The listener might think that it would be an easy matter to find a church in which to perform these magnificent works, themselves designed for performance in a church. But it is not so. The acoustic requirements are very exacting. An empty church is entirely different acoustically from a church filled with a large congregation. Moreover, the balancing of volumes of tone between an organ, an orchestra in which almost every instrument is playing what is practically a solo part, three or four obbligato instruments, a chorus, and solo voices, has proved to be one of the most exacting problems set before the B.B.C. officials concerned. One of the troubles is that the organs in most churches are not tuned to the same pitch as are the instruments of a modern orchestra. This, for the difficult passages in the brass and wood-wind parts of Bach's works, has proved an almost insurmountable obstacle.

In London the problem was partially solved by the expensive method of hiring an outside hall and draping it with the necessary hangings to deaden the echo. The Principal of the Guildhall School of Music, Sir Landon Ronald, and his colleagues, came to the B.B.C.'s assistance in this matter by letting their concert-hall and having the pitch of the organ corrected to the true orchestral pitch. After that it was felt that the interests of the cantatas themselves demanded the conditions that had been attained at the Guildhall School of Music as a minimum of efficiency; and the performances at Manchester and Birmingham (with the exception of an occasional relief performance) were gradually, but reluctantly, given up in favour of the London performances with their specialised repertoire and favourable acoustic conditions.

On the 10th of November, 1929, the cantata was conducted by Mr. Percy Pitt, who, although in this country his great work has been in connection with opera, received his musical training in Germany and in his youth absorbed the very atmosphere in which these cantatas are steeped. Since then he has shared with Mr. Stanford Robinson the fascinating but exacting task of preparing and conducting the cantatas, and it is hoped that other conductors of distinction who have specialised in Bach (among them the present Music Director, Mr. Adrian Boult) may occasionally take part in this great enterprise.

There is still to be considered one essential characteristic of these works—that they were intended to be performed in the presence of a congregation, which itself would sometimes take part in the concluding chorale. Space at the Guildhall School of Music being limited, this has so far only been attainable there by the admission (by free ticket) of a limited audience of fifty; but at Birmingham and Manchester, where the performances were given in churches open to the public, a large and regular attendance testified to the interest taken in these by the public. If and when the B.B.C. finds in London the right church, in the right locality, with the right acoustical properties, with an organ suitably situated and of the right pitch, and with an incumbent who will throw open his church for these weekly performances, the B.B.C. shall attain its aim of presenting these works in a church and with the right religious and musical atmosphere.



Elliott and Fry

VIOLET GORDON WOODHOUSE
who gave a harpsichord recital on March 19, 1930

THE NATIONAL ORCHESTRA OF WALES

SINCE October 1929 the National Orchestra of Wales (popularly designated the N.O.W.) has enhanced in many ways the reputation which it so quickly acquired. A policy of touring the orchestra round the important towns in South Wales has contributed largely to this success. Swansea, as the principal centre apart from Cardiff, has, of course, received the greatest number of visits. A definite series of Swansea concerts was established in October, and concerts were continued at intervals of approximately a fortnight throughout the season. The hall used for the concerts was the Patti Pavilion, which was given to the town by Madame Patti "for the purpose of music and recreation." It was formerly the conservatory of Madame Patti's house at Craig-y-nos, near Swansea, and on being handed over to the Swansea Corporation it was taken down and rebuilt in Victoria Park. It is a happy coincidence that this building, a personal link with the musical genius of Madame Patti, should house the National Orchestra of Wales, the present-day evidence of a new movement in the musical development of Wales.

Up to the end of 1929 concerts at the City Hall, Cardiff, were continued on the original basis of two per week. The demand for the orchestra in other towns was growing so much, however, that it was decided to make a complete rearrangement in the New Year. Already a regular series of Sunday night concerts at the Park Hall, Cardiff, had been added to the original scheme for Cardiff, and accordingly it was decided to reduce the City Hall concerts to one per week. Thereafter the activities of the orchestra embraced a wide field. In addition to the regular Swansea series, the Orchestra visited Newport, Port Talbot, Barry, Aberdare, Tonypany, Maesteg, Cwmaman, Aberaman, Pwllgwaun, Briton Ferry, and Mountain Ash. The enthusiasm displayed in some of the Welsh valley towns was remarkable. Many people in these towns had never previously had an opportunity of hearing a first-class symphony orchestra, and on more than one occasion



Challen

BROADCASTING FOUR PIANOS

A photograph taken during the Concert of Contemporary Music at the Central Hall, Westminster, on February 3

people declared that the visit of the N.O.W. had been the revelation of a lifetime to them.

The programmes have been diverse in character—popular programmes, operatic programmes and symphony programmes, classical and modern. All the Beethoven symphonies, including the Choral Symphony, all the important Mozart and Haydn symphonies and the four Brahms symphonies have been performed. Big modern works have included the “Divine Poem” of Scriabine. Mahler’s fourth symphony was given two of its earliest performances in this country.

Eminent guest conductors have included Sir Thomas Beecham, Sir Henry Wood, Sir Edward Elgar, and Dr. Malcolm Sargent. The concert conducted by Sir Edward Elgar

was given in Swansea and formed a highly appreciated climax to the series of Swansea concerts.

During the summer months, when the normal concert season is closed, the orchestra continued to give concerts in surroundings suited to fair-weather conditions. Many Sunday concerts were given at Llandaff Fields Pavilion, Cardiff, and at the request of the Cardiff Corporation a week's performances were given in the Cardiff parks. These concerts took on the character of informal promenade concerts, and the venture proved very popular.

The most important summer engagement, however, was the Royal National Eisteddfod at Llanelly. For the first time a Welsh National Orchestra, with standards unknown in Wales a few years before, took its place in the great Welsh festival.

At the moment the future of the orchestra is uncertain. Its artistic achievements receive the highest praise on all sides, but the problem of handing it over to Wales, so that it may be financed and managed by the nation, is difficult. In April 1930 the orchestra entered upon the third year of its existence. For the first two years it was financed entirely by the B.B.C., and for the third year the B.B.C. again covered the greater part of the cost, the Welsh nation providing £2000 through a general Appeal Fund. The task of financing an orchestra is a heavy one at any time, and in Wales at the present time it is particularly difficult, as the country has been severely affected by the prevalent industrial depression. Nevertheless, the outlook is not unhopeful if the Welsh nation will make an organised effort to secure the orchestra permanently. The B.B.C. has offered to continue the subsidy to the orchestra (though not, of course, to the full extent of the first three years) and, provided Wales itself will make a big effort to overcome the financial difficulties, the National Orchestra can be secured on a permanent basis, to pass from strength to strength, as a vital asset to a musical nation.

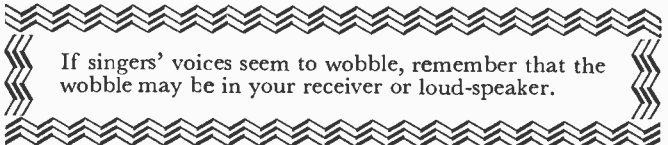

If singers' voices seem to wobble, remember that the wobble may be in your receiver or loud-speaker.

THE FOUNDATIONS OF MUSIC

These broadcasts take place daily at a fixed time in the early evening, usually 6.40 p.m., and last about 20 minutes. The B.B.C.'s intention is to give lovers of music an opportunity for the synoptic study of standard works under the conditions of a sound performance by a first-class artist. The following series were broadcast during the year:—

Songs

Handel's Arias (2)
 Schubert's "Winterreise"
 Wolf's Goethe Lieder
 Bach's Motets
 Parry's Songs of Farewell
 Russian
 Brahms
 Schubert
 Schumann
 Liszt
 Old French

Violin Music

Brahms' Sonatas
 Haydn's Sonatas
 Corelli's

'Cello Sonatas

Old Italian
 Bach
 Mendelssohn

String Quartets

Haydn
 Mozart
 Beethoven (Rasoumowsky)
 Miscellaneous works for
 Wind instruments

Piano Music

Bach's French Suites
 „ English Suites
 „ Miscellaneous (2)
 Handel's Suites
 Beethoven's Sonatas (3)
 „ Miscellaneous
 Mozart's Duets
 „ Miscellaneous
 Schubert's Sonatas (2)
 Chopin's Studies
 Scarlatti
 Mendelssohn (2)
 Schumann
 Brahms
 Liszt
 Debussy
 Old English
 Modern British
 Transcriptions

Organ Music

Bach's Preludes (2)

Piano Trios

Mozart
 Beethoven
 Brahms

Note.—Each of the above series was broadcast for one week (six performances) with the exception of those followed by the number (2) which denotes performance in two separate weeks.

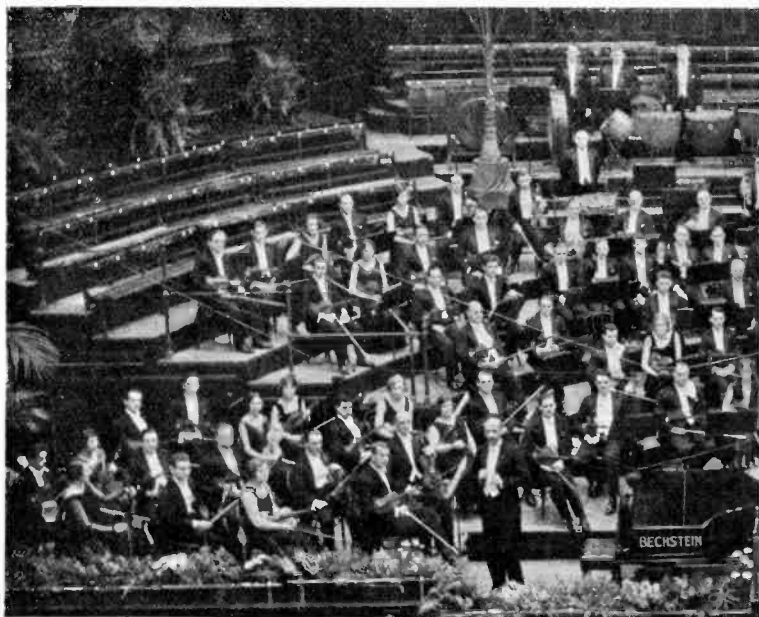

THE B.B.C. SYM

First Violins

Catterall, Arthur (*Leader*)
 Woodhouse, Charles
 Turner, L.
 Wilson, Marie
 Kelly, S. Kneale
 Hill, F. W.
 O'Donnell, M.
 Bates, Doris
 Rutledge, E.
 Fairless, Margaret
 Cass, W. J.
 Braham, Editha
 Kostall, J.
 Hinchliffe, Jessie
 Dunn, F. V.
 Washbourne, Kathleen
 Blech, H.
 Bailey, Enid
 Bor, S. H.
 Mason, Lena

Second Violins

Squire, Barry
 Ungerson, J.
 Caprara, E. G.
 Hamilton, J.
 Sherman, A.
 Thornton, Evelyn
 Wyatt, E.
 Stratford, E.
 Stein, J.
 Browne, L.
 Lones, Gwen
 Meachem, J.
 Malcolm, S.
 Hepton, A.
 Ellingford, Constance
 Young, J.

Violas

Shore, Bernard
 Sinton, P.
 Bray, E.
 Wolfe, Anne
 Harding, K.
 Gladden, Mary
 Carrell, N.
 Hart, Muriel
 Southworth, L.
 Copperwheat, Winifred
 Wyand, H. B.
 Lucas, Patience
 Owen, J. W.
 Milne, Helen

'Cellos

Kennedy, Lauri
 Gauntlett, A.
 Shinebourne, J.
 Clark, Raymond
 Muscant, P.
 Beers, B.
 Nifosi, A. P.
 Beattie, C. D.
 Ford, A.
 Revell, H. A.
 Blackford, G.
 Briggs, R.

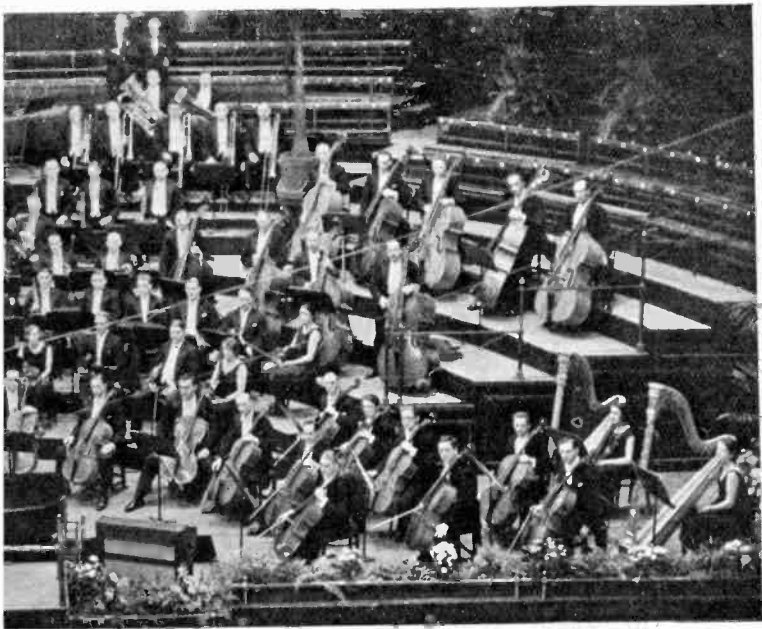

IONY ORCHESTRA

Double Basses

Cruft, Eugene
 Hobday, C.
 Sutton, S.
 Powell, F. G.
 Chesterman, E. D.
 Burton, D.
 Murray, G. T.
 Conhoff, C.
 Cockerill, A. E.
 Robinson, R. E.

Flutes

Murchie, Robert
 Almgill, F.
 Walker, E.
 Stainer, C.

Oboes

Whittaker, Alec
 Pantling, J. C.
 Field, J.
 MacDonagh, T.

Clarinets

Thurston, Frederick
 Clarke, Ralph
 Lear, W.
 Tschaikov, A.
 Whelan, P.

Bassoons

Newton, Richard
 Wilson, A. E.
 Hinchliff, E.
 Dickie, T. J.

Horns

Brain, Aubrey
 Probyn, F.
 Cursue, A. J.
 Jackson, H.
 Burrows, V.
 Thornton, H. F.

Trumpets

Hall, Ernest
 Pritchard, E.
 Barr, H.
 Mackintosh, J.
 Hamilton, H.

Trombones

Stamp, Jesse
 Falkner, A.
 Taylor, F.
 Garvin, S.
 Risdon, J.

Tuba

Barlow, Harry
 Smith, H. R.

Harps

Goossens, Sidonie
 Chevreau, Jeanne

Tympani

Bender, Charles
 Lees, J. B.

Percussion

Gillegin, E.
 Wheelhouse, F. H.
 Franklin, R. G.

“ THE NORTHERN PROMS ”

MUSICAL history has been made in the Provinces during the year under review by the season of Northern Promenade Concerts from May 26th to June 21st of this year. The concerts were financed by the B.B.C. and organised in conjunction with Manchester's famous Hallé Orchestra and Sir Hamilton Harty, its conductor.

It was inevitable that the hall which has stood for so much in the musical and political life of Lancashire—the Free Trade Hall at Manchester—should have been chosen as the rendezvous for music lovers during the first fortnight of the season. This hall has seen audiences in many moods, but it is doubtful whether any audience, even when moved by the political oratory of the past, has been stirred to such depths as were some of the audiences during the fortnight of orchestral music at Manchester. Before the start of the Wagner Concert on the opening night, Alderman W. Davy, appearing on behalf of the Lord Mayor of Manchester, commended the effort to Manchester citizens. In the famous Liverpool Philharmonic Hall, which was built in 1848, and whose proportions and acoustics make it probably the finest temple for orchestral music in the whole country, the concerts were introduced on June 9th by Mr. Sydney Jones, ex-High Sheriff of Lancashire, who deputised for the Lord Mayor of Liverpool. In Leeds, the site chosen for the “Northern Proms” was the Town Hall, and here the Lord Mayor of Leeds, Mr. N. G. Morrison, made a moving appeal from the platform on the opening night to the citizens of Leeds to take the opportunity of hearing first-class music at prices never hitherto practicable.

Looking back on this season, certain impressions stand out vividly and definitely. There was the first night at Manchester, where a packed audience, consisting largely of men and women who had never hitherto attended an orchestral concert, gradually began to realise that a new experience had come to them, with the result that, when Sir Hamilton Harty concluded the concert and the Prelude to Act III of “Lohengrin” by a final sweep of his baton, the whole audience rose as one man and applauded vociferously. The largest audience of the whole season was

that which came to the concert in Liverpool on Thursday, June 12th, to listen, among many other outstanding items, to the orchestra performing Schubert's "Unfinished" Symphony, and Max Bruch's Violin Concerto, in which Albert Sammons played the solo violin part. Then there was the final Saturday night at Liverpool, which was a bright and joyous evening given over to lighter moods in music, in which the orchestra, with Dr. Wallace and Harold Dawber at the piano, created merriment by a brilliant performance of Saint-Saëns' "Carneval des Animaux." At the end of this concert, the huge audience clapped, cheered, and even stamped on the floor with enthusiasm. The concert which brought the largest attendance at Leeds was that on Tuesday, June 17th, in which Myra Hess performed Beethoven's fourth Pianoforte Concerto with the Orchestra. This was a well-varied programme which included music by such widely differing personalities as Mozart, Strauss, Walford Davies, Delius, and Rimsky-Korsakov. Perhaps the most unusual experience of concert-goers that week befell those who attended the performance of Elgar's "Dream of Gerontius" on the Wednesday night, June 18th. Owing to the sudden indisposition of Miss Margaret Balfour, a brilliant *tour de force* was executed by Harold Williams, who doubled the part of the Angel with his own part, that of the Priest. On this occasion, too, the Leeds Choral Union showed that Yorkshire choirs still remain, from the point of view of volume, power, and rugged strength, in the very first flight of choral combinations in the whole country. The last concert at Leeds, on June 21st, and the final concert of the whole season, was given over to the performance of items chosen by concert-goers and wireless listeners, who had been invited to send in suggestions from which the programme would be made up. The fact that the whole concert was on a very high level of musical composition, including as it did Bach's Concerto for two violins, and Schubert's Symphony in C Major, was a tribute to the musical appreciation of Northern listeners and concert-goers.

In spite of fine weather and warm nights throughout the season approximately 35,000 persons attended the Northern Promenade Concerts. In round numbers, 18,000 came to the two weeks in Manchester, 9,500 to the week in

Liverpool, and just over 7,000 to the week in Leeds. The habit of "Promenading" caught on most easily at Liverpool. At Manchester the balcony was the most popular part of the hall, but both at Manchester and Leeds there was a noticeable increase in the number of "Promenaders" as the concerts began to get under way and to attract a new kind of audience. Although regular concert subscribers and concert-goers supported the effort, there is no doubt that the bulk of the audience each night was of a new type. In fact the audiences consisted very largely of young men and women under the age of twenty-five, many of whom came to the concerts attired in plus-fours, flannels, tennis clothes, or summer frocks. It was they really who made the chief contribution to the informality, the enthusiasm, and the intimacy between the conductor and his audience, which marked the concerts. Business men in bowler hats, who had obviously walked into the concerts at the end of office hours, were also prominent among the "Promenaders," while in general it may be said that every class of the community was attracted.



SIR HAMILTON HARTY AND THE HALLÉ ORCHESTRA
on the opening night at Manchester

MILITARY BAND MUSIC

By Colonel J. C. SOMERVILLE, C.M.G., C.B.E.

THE present century has seen a notable spurt in the evolution of the Military Band. On the technical side, its organisation has been definitely stabilised, its pitch brought down to that of the Philharmonic, and many improvements made in the construction of the instruments, producing increased beauty of tone and ease in manipulation. On the artistic side, however, its upward progress has been, comparatively speaking, disappointingly slow. A relatively small amount of really first-rate music has been written for it, and, *vis-à-vis* the orchestra, it is still to some extent suffering under an inferiority complex, the result of a long and persistent tradition of incapacity to play any but second or third-rate music. That this should have been so was more or less inevitable. The class of audience for which it formerly had to cater was, to an overwhelming extent, intolerant of any but the most banal and obvious type of music. I remember, shortly after joining my regiment in 1892, squeezing out of my exiguous pay as a 2nd Lieutenant the price of a newly published Wagner arrangement, and presenting it to the Band. It was duly practised and performed on a guest night by a flattered, though slightly apprehensive Bandmaster, with the result that he was subsequently sent for by an incensed Commanding Officer and told that if it was ever played again, he'd try him by Court Martial!

Those days are past. There is now quite a considerable amount of genuine music available for the Military Band to play; but most Bandmasters—who I firmly believe would personally prefer to play it—continue to let “I dare not” wait upon “I would,” and to fill their programmes with what are euphemistically called “popular numbers.” A vicious circle is thus solidly established: the Bandmaster postulates that, with the exception of a few well-worn classics, such as the “Unfinished” symphony, Handel’s “Largo,” and the Tannhauser Overture, little but cheap and meretricious music will find favour with his audiences; the publishers have to supply him with what he wants, and, not being altruists but business men, decline to pro-

duce much else; and composers—those, at least, of the first rank—are naturally shy of writing works for an unfamiliar, wood-wind-brass medium for which they are unlikely to find a publisher or, if published, much public performance or recognition.

There is only one way of breaking this unfortunate sequence of cause and effect, and that is by stimulating the public demand for better things, and thus inducing the supply to meet it. The sole agency capable of bringing this about within measurable time is broadcasting, whereby public interest in and taste for a higher class of music can be, and is being, generated and encouraged. It was a fortunate day for the B.B.C. when Mr. Walton O'Donnell gave up his Directorship of Music in the Royal Marines and assumed the conductorship of the Wireless Military Band. Fortunate, too, for the public, as the ideal towards which he has immutably set his face appears to be that described. Not only has he, in the Wireless Military Band, forged an instrument of the very finest temper, of which it is doubtful that the equal anywhere exists, but he is consistently using it for the performance of the best type of music, classical and modern. He has two very able and enthusiastic co-adjutors in Messrs. Gerrard Williams and R. J. F. Howgill, who like himself thoroughly realise the musical potentialities of the Military Band, and are continually working on arrangements of orchestral works for it. Listeners may remember some of the following, which are amongst the most effective and successful:—

By Mr. Williams: The No. 3. Brandenburg Concerto; Liszt's Rhapsody No. 13; the Overture to Borodin's "Prince Igor," and the Brahms Variations on a Theme by Haydn.

By Mr. Howgill: Moussorgsky's Suite "Pictures from an Exhibition"; 2nd and 3rd Movements from Vaughan Williams' "London" Symphony; Richard Strauss' "Dance of the Seven Veils," from "Salome," and "Islamey," by Balakirev. (The last named is an arrangement of the brilliant pianoforte piece, and in the nature of a free transcription.)

All the above, and many others of a like character which they have arranged, are works that "the Ordinary Listener" ought to know: thoroughly eclectic, and at the same time containing none of the monstrosities of

“modern music,” which would, in any case, be quite untranslatable into the Military Band idiom. How unfortunate it is, by the bye, that a new expression cannot be coined for the combination of brass, wood-wind, and percussion that is known as the “Military Band.” Whatever its origin, it is now in no way essentially “military”—*i.e.*, primarily intended for troops to march to. Its musical objective should now be as high and as serious as that of its indoor counterpart, the orchestra; and some new nomenclature, *e.g.*, “Wind Orchestra,” is wanted, more nearly to express its true nature. Thanks very largely to the finished and artistic playing of the Wireless Military Band, it is becoming generally realised that here is a worthy vehicle for fine music, which fact the younger generation of composers is beginning to recognise, more particularly on the Continent, whence appreciation of the tone, technique, and interpretations heard from Savoy Hill have frequently been expressed. The Gramophone Companies, who appear still to be obsessed by the traditional view of the musical limitations of the Military Band—as a glance at their lists of records will show—might do much to hasten the day which must inevitably come, when it will take its rightful place in music.

It is an undisputed fact that the influence of broadcasting has been to increase the general interest in music, and to open the eyes—the ears, rather—of many who had never imagined that they could care for anything more exalted than musical comedy selections and the vulgarities of jazz, to the deep and abiding pleasure to be derived from the works of the great masters of music. This is a taste that seems certain to grow and to spread, and hence an increased demand for opportunities of hearing them, in which the “Wind Orchestra”—the combination heard by far the greatest number of people—is bound to have the lion’s share. The provident publisher will take note of this betimes, and be in a position to meet the demand when it arises by maintaining a cache of the scores of original compositions and effectively arranged orchestral works. A treasure house of the kind is now being formed by the B.B.C., from which Mr. O’Donnell purveys to the public things new and old. Long may he continue to do so!

BROADCAST PLAYS

The following are the most important plays broadcast during the past year:—

PLAYS WRITTEN FOR BROADCASTING

- "The Flowers are not for You to Pick" and "Squirrel's Cage" (W. T. Guthrie)
- "Exiles" and "Red Tabs" (Val Gielgud)
- "The Son of Man" (Shiner)
- "Nurse Henrietta" (Kesser)
- "Obsession" (D. Glasby)
- "Brigade Exchange" (Johansen)
- "Roland" (E. A. F. Harding)

ADAPTATIONS OF NOVELS

- "Carnival" (Compton Mackenzie and Holt Marvell)
- "The Wrecker" (R. L. Stevenson and Talbot)
- "Romance" (Joseph Conrad and P. Creswell)
- "Yes and Back Again" (De la Mare and K. B. Indoe)
- "Through the Looking Glass" (Lewis Carroll and C. A. Lewis)

ADAPTED STAGE PLAYS

- "Twelfth Night," "A Midsummer Night's Dream," "Henry V," "Macbeth," and "Antony and Cleopatra" (Shakespeare)
- "The Mock Doctor" (Molière)
- "The Proposal" (Chekov)
- "Pompey the Great" (Masefield)
- "Strife" (Galsworthy)
- "The Importance of Being Earnest" (Wilde)
- "Milestones" (Bennett)
- "The Rumour" (Munro)
- "Twelve Thousand" (Bruno Frank)
- "Journey's End" (Sherriff)
- "The Brass Bottle" (Anstey)
- "Deirdre of the Sorrows" (Synge)
- "The Man of Destiny" and "St. Joan" (G. B. Shaw)



D R A M A



FUTURE OF BROADCAST DRAMA

By TYRONE GUTHRIE

MICROPHONE drama is beginning to develop differently from that of both films and theatre. Broadcast drama is, in the first place, invisible, and in the second is heard at home privately, and not in a public building.

First, then, let us consider this question of invisibility. The listener is dependent upon one sense only for his impression—the hearing—and in this lies both the strength and the weakness of the broadcast plays: weakness inasmuch as the effort of concentration required by the listener is considerable and is more than many people can consistently achieve; strength inasmuch as the impression, if it reaches the listener at all, will reach him in a highly concentrated form. Now since such strict attention is demanded of the listener it becomes necessary for the author to say what he has to say *briefly*—an hour, in my opinion, is quite long enough for a broadcast play under present conditions. And this brevity must be combined with wit—with the audience dependent solely upon dialogue, the dialogue must be good.

On the other hand, if the author is deprived of the aid of visual effect he is also freed from the cumbersome mechanics of theatrical scenery. He can change the scene at will; and the audience, deprived of their eyes, must use their imaginations instead. And how much more satisfactory that is. An imaginative writer can build up a scene by subtle and ingenious word pictures, and for an imaginative listener he will create illusions infinitely more romantic than the tawdry grottos of the stage.

[185]

One further result of the highly concentrated nature of wireless drama is that it must be simple—the number of voices must be limited and the audience must be able to follow easily which of the characters is speaking. But along with this simplicity and economy of treatment there must go a subtlety of method—because the author's treatment of a play is simple, it does not necessarily follow that it is silly—and the highly concentrated nature of the medium shows up with relentless candour a crudeness and naïveté which can often pass muster on the stage by broadly-sweeping theatrical treatment—the sort of treatment Sarah Bernhardt gave to *Fedora* and *La Tosca*—the sort of method Pola Negri uses for her glamorous and highly incredible impersonations on the screen.

Now, not only is the broadcast play invisible, and therefore highly concentrated, it is also played to an audience who are not clumped together in one mass in an auditorium, but who are scattered over an area of hundreds of square miles and who are listening to plays under the most diverse circumstances.

This means that the actors cannot rely for help on that elusive psychical elixir which is generated by a crowd of people all concentrated on the one thing. This hits the comedians hardest. In a theatre the majority of the people are “on the spree”—they have come in search of entertainment—more than that, they have *paid* to be *amused*. No wonder that the comedian has only to mention Wigan or kippers to provoke piercing yells of mirth. Also mirth is infectious : dozens of people laugh in the theatre not because they are amused at what is happening on the stage, but because others are laughing, because the atmosphere is festive and jolly.

But your poor funny man at the microphone is deprived by invisibility of his funny appearance, his props, and his business ; his audience is in workaday, not holiday, mood, and instead of being stimulated to jollity by their surroundings, they find the atmosphere utterly at variance with the entertainment.

But there is another side to the picture. The broadcast actor does not have to declaim into an auditorium ; he does not have to speak so that those in the remotest confines of the pit and gallery can hear him. When he addresses the

microphone he speaks, as it were, into the ear of each single member of the audience.

This intimacy is very hard to achieve—from the author's point of view it is difficult to make a scene significant without allowing artifice to peep out and betray itself. A faithful transcript of real life is almost inevitably dull, and similarly it is almost impossible to get actors to resist the temptation of making "effects"—there is nothing so hard as to play a scene in the key of ordinary speech. So long as the dialogue is casual, it is easy enough—"How do you do. . . . pass the mustard"—any competent artist can do that perfectly naturally and realistically—but when it comes to the really juicy and effective bits, when the parlourmaid says, "I have broken the entire set of Crown Derby," or the man says, "Clarissa, I love you, I love you, I love you". . . then it is that the temptation to be effective is irresistible, the performance oversteps the bounds of realism, and the audience begins at once to realise that they are not eavesdropping, but that somewhere, in some far-away "studio," actors, with their parts in their hands, are clustered round a strange-looking instrument, conscientiously trying to entertain the public in exchange for thirty pieces of silver.

Then there is a technique of listening, just as there is a technique of looking at moving pictures. Do you remember in the early days of films what difficulty one had in telling one character from another, in following devices like fading and flash-back, in quickly adjusting one's mind to the location and time of the various "shots"? Now all that has, by use, become almost an unconscious mental process. Similarly with listening: experienced listeners have infinitely less trouble in following a broadcast play than those who are new to the game; not only are their ears more acute to catch differences of timbre and accent in the voices, their minds are accustomed to the conventions of the medium and they can take much for granted that is puzzling and strange to the inexperienced. But the most important and the most badly needed improvement in the technique of listening is the realisation that hearing a play demands concentrated attention, and that, therefore, the surroundings must offer the minimum of distractions to eye and ear—in other words, broadcast plays should be heard in silence and in darkness.

Up till now writers for the wireless have been principally occupied in surmounting the difficulty of invisibility, in trying various methods of creating "mind-pictures" for their audience. Considerable progress has been made, but though in this respect the general level is immensely higher than it was five years ago, I doubt whether Richard Hughes' mine play (a very early B.B.C. production) has ever been surpassed. "Squirrel's Cage" set a fashion in the abolition of "narration," but the value of this has been over-estimated. Narration properly used can be a useful short cut, saving much time that would otherwise have been spent in verbal *décor* and conveying information through the dialogue as to the whereabouts, appearance, costume, and so on, of the characters. No one who has not attempted to write a broadcast play can realise how difficult it is to convey such information economically and yet delicately—for it must never be obvious that a scene has been written merely to convey certain information to the audience. Much faith is placed in the use of "effects" to convey impressions vividly and tersely to an audience; but in my experience they are not always satisfactory. In the first place, they are apt to become confused with the dialogue. It may be argued that such confusion could be remedied by more adequate rehearsal, but experience has proved that few effects are capable of "striking into" a scene effectively without putting the dialogue out of focus. Next comes the difficulty of selecting "effects"—what noises to reproduce and what to omit. In most cases this problem is solved by reproducing in a given scene as many noises as can be effectively transmitted, and omitting only those which prove either impossible to interpret or ineffectual in the scene. Take, for example, a dance scene. (Dances frequently occur in broadcast plays because they are so easy to suggest.) The usual method is to reproduce in addition to the dialogue a background of music, of sliding feet and a hum of conversation. This gives quite a convincing picture of a ballroom, but is an unsatisfactory artistic compromise; since the dialogue is minutely realistic and the effects impressionistic, omitting, as they do, the innumerable tiny sounds of actuality that are untranslatable when detached from their visual complement.

But this is a digression. To return to the previous point:

writers for broadcasting have up to the present concentrated most of their energies on conveying to the audience a series of mind-pictures; but it is doubtful whether the future of broadcast drama lies in this direction or whether it would not be more profitable to explore the purely symphonic possibilities of the medium; to make more use of rhythm in the writing and speaking; more use of choral speaking; more deliberate use of contrasting vocal colour, changing tempo, varying pitch. One feels that only by attacking the subject from a symphonic angle is it possible to rid the mind of unwanted literary and theatrical conventions; and, furthermore, that, in the inevitable and fast-approaching fusion with the talking films, the contribution of broadcasting to the new art-form will be a symphonic one and that, therefore, it would be wise to approach the problem symphonically at the outset.

There can be little doubt that it is merely a matter of time before the films and the wireless join hands. In the meantime technical changes are taking place with bewildering rapidity in both mediums. The most striking instance of this, of course, was when the hitherto silent films suddenly began to talk.

As yet broadcast drama has suffered no such violent revolution at this; but all the time minor changes are taking place. To-day's methods are obsolete to-morrow—yesterday's methods are dead as the dodo. Naturally this perpetual seethe and surge of technical novelty does not make for the creation of masterpieces. Nothing has yet emerged that could possibly be regarded as a broadcast classic; and nothing classical can, one feels, possibly be achieved until the technique of this new art becomes a little more stabilised, and that will only happen when the present impetus of mechanical invention is exhausted—when and if the literary and philosophical side of human nature develops proportionately to the mechanical and practical. For my part I feel convinced that the future lies along the lines of television . . . of co-ordination with other arts—a vista of ever-growing elaboration, mechanisation, centralisation, most depressing to contemplate but quite inevitable. In this fusion with the visual arts I believe the broadcast-drama will lose most of its individuality and its virtue, but will only then for the first time come into its

own in popular esteem : will only then take its place as the most popular method of entertainment, and consequently as the most forceful medium of propaganda in the history of the world.

In the meantime, more profitable than prediction, one can contemplate the phenomena before us, the broadcast plays, the talking films ; one can analyse their composition, criticise their merits, deplore their vulgarity, but above all realise that they are the drama of the day. More and more is economic pressure going to relegate the theatre proper to select corners of the wealthiest metropolitan cities, more and more is mechanical perfection of reproduction going to strengthen the position of the broadcasters and the film people. The films we recognise ; we have at last after thirty years admitted them to be a force. But it is only beginning to dawn on us that broadcasting must now be reckoned with as well. A few of the more go-ahead weekly papers are beginning to publish condescending, ill-informed, little snippets of discussion and criticism. A few cranks and freaks perceive and are interested in the possibilities of this new medium. But the world at large is blind and deaf.

But broadcasting is bigger than the public, bigger than the B.B.C. . . . it is a spontaneous expression of present-day civilisation that, like Topsy, has just growed.



PLAYS FOR BROADCASTING

The B.B.C. is always glad to consider plays specially written or adapted for the microphone. MSS. should in all cases be typewritten, and, as a general rule, the time of playing should be calculated so as not to exceed an hour and a half. Address: The Productions Dept., B.B.C., Savoy Hill, London, W.C. 2.

LESSONS FROM THE YEAR'S PLAYS

THE B.B.C. broadcasts something like fifty plays in the course of a year. Of this year's fifty, perhaps a dozen can be reckoned as definite failures, but from the failures no less than from the successes a good many valuable lessons have been learnt. Broadcast drama has not yet emerged from its experimental stages; a satisfactory theory of its technique has not even yet been evolved, and therefore it would be dangerous to suppose that the generalisations here drawn from its present achievement have any finality about them.

Nevertheless, this year has seen the production of a microphone play which sets a definite standard for the future. "Brigade-Exchange," a German war play, derived by its author, Ernst Johannsen, from his own novel, "Four Infantrymen on the Western Front," marks the peak of dramatic accomplishment so far. To analyse its success—the theme of the play is tremendous; the construction of a scene in which the characters speak to each other from locations as far apart as the German front line, divisional headquarters and base hospitals, demands sound as its medium: "Brigade-Exchange" would gain nothing and lose much by visual presentation; the writing is austere simple; the acting was natural and the entire production very dignified. It ran for less than an hour. Its brevity and simplicity and its stark tragedy achieved a greater effect than the very fine production of "Journey's End" on Armistice Day.

"Exiles," another specially-written microphone play, rather more complex in the construction of its scenes than "Brigade-Exchange," was so far elaborated in production by the use of effects and mass voices as to disguise the emotional simplicity of the author's dialogue and story.

The nearest English equivalent to "Brigade-Exchange" is Mr. Tyrone Guthrie's work, "Squirrel's Cage," which was produced twice last year, and his recent "The Flowers are not for You to Pick." Mr. Guthrie's unmistakable sincerity and his economy of writing give his play a very important place in the year's productions, because it is always the writing that matters most in wireless plays. He is probably the most promising pure radio dramatist yet dis-

covered. He understands the medium thoroughly, and his work therefore to some extent indicates the future trend of broadcast drama. Perhaps it is rather to be regretted that he chooses morbid themes and handles them brutally, but none the less his next play is awaited with great interest by those who take their broadcast drama seriously. The production of "The Flowers are not for You to Pick" was slightly marred by the prolonged use of sea and wind effects, a temptation hard to avoid when a good effect has been discovered. "The First Second" succumbed to it.

Sound effects have still to be set in their proper perspective. The present tendency is still towards a naturalistic rather than a symbolic use of them, but with increasing economy. The production of Conrad's "Typhoon" was a failure because it was made to depend almost wholly upon sea effects which could not be got across the microphone. "The Wrecker" was successful because effects were used throughout with admirable discretion.

"Roland" and "Robin Hood" broke new ground both in form and production. These dramatised romances of the Middle Ages depended altogether for their success upon the felicitous use of words beautifully spoken, but there was felt to be a certain incongruity in the modern incidental music which was so skilfully balanced against the voices. The same criticism applies in some degree to "Aucassin and Nicolette." There is now a tendency to discount the value of incidental music used merely as a background or decoration of what might otherwise sound dull and monotonous. Plays which depend on beauty of language should be able to dispense with music which is not an integral part of their conception.

Two examples of modern poetic drama—"Deirdre of the Sorrows" and "Pompey the Great"—proved once more the great value of the microphone as a vehicle for this type of play, and also the danger of misusing sound effects and music in their production.

Broadcasts of stage plays have been on the whole very successful. Apart from "Brigade-Exchange," last year's performance of "St. Joan" remains the high-water mark of dramatic achievement. The literary excellence of "Captain Brassbound's Conversion," "The Man of Destiny," "Journey's End," "Milestones," "The Mock Doctor," "The

Proposal," "The Rumour," "The Brass Bottle," "Twelve Thousand," would distinguish them in any medium, and they have made popular broadcasts in spite of the disadvantage of their length.

The ideal length for a microphone play tends to grow shorter every year. When "Carnival" was first produced over eighteen months ago and ran for about two hours, it was thought to be acceptable timing. Its more recent revival was considered far too long, and "Brigade-Exchange" and "The Flowers are not for You to Pick," which ran for fifty-five minutes each, set an ideal limit for broadcast plays, though it is a limit to which there must, of necessity, be wide exceptions. In spite of their length, four of Shakespeare's plays—"Twelfth Night," "Henry the Fifth," "A Midsummer Night's Dream," and "Antony and Cleopatra"—have provided popular entertainment this year. "Henry the Fifth" drew the criticism which is fired at Shakespeare in modern dress, but there was felt to be a justifiable novelty in its broad interpretation.

"The Prophetic Camera," "Matinée," "Copy," and "Obsession" were all original microphone plays which made good entertainment without being experimental.

This year's adaptations from novels—"Rupert of Hentzau," "The Wrecker," "Typhoon," "Huntingtower," "The Four Feathers"—did not reach the standard previously set by "Carnival" and "Lord Jim," although none of them were as long.

One of the greatest difficulties of drawing any conclusions at all from a broadcast play is its evanescence. It is broadcast once, or sometimes twice, and is gone. The tendency to revive successful productions is, however, growing, and it has even been suggested that a week's performance of a good play should be given. But even while the suggestion is being made, a new factor has come into existence. "The Man with the Flower in his Mouth" was chosen for the first television broadcast of a play in July, but the experiment is still too recent for its implications to be grasped. It is possible that all the lessons learnt since the first play was broadcast will only need to be forgotten.

THE USE OF SOUND EFFECTS

IT is interesting to reflect that of everything which goes to make up the daily broadcast programmes, those things predominate which existed before broadcasting was invented, and are now being transmitted very much as the water which existed before Water Companies is now being transmitted to the Water Companies' subscribers. Music is the most obvious example of something which has been made use of just as it stands.

But there is a part of the programmes that is essentially and peculiarly the stuff of broadcasting, and that is (in its widest possible interpretation) the Sound Effect. And in its widest interpretation the name Sound Effect covers a large field. In fact, it covers everything which comes out of a loud-speaker, except what is usually classed as "Music" or "Speech." Even these have been forced by imaginatively enterprising producers to do jobs as Sound Effects. Further, oscillation, Morse, and crackling have occasionally been chained to an oar in the strange galley of some fantastic programme, and been forced to masquerade as honest intentional noises!

Just before its temporary death, the silent film had begun to realise that it must aim for what was proper and peculiar to its medium; that it must not allow itself to be bound within the limits of the old theatre; that, in fact, there were a thousand new things which it alone could explore and exploit. And this is just beginning to be true of talking films.

In the same way, those people who deal with a certain side of broadcasting are realising that they must not only use things created for other mediums in the past, but must constantly endeavour to develop and use that which can only be attempted in the medium in which they are working, namely, the Sound Effect, *in its widest sense* (the essential stuff of broadcasting).

This is not to suggest that Sound Effects have not as their main duty to be adjuncts to other matters; but it would be a great mistake to think of them as analogous to punctuation marks and accents in print. They should never be *inserted* into a programme already existing. The author of a broadcast play or broadcast construction ought to have

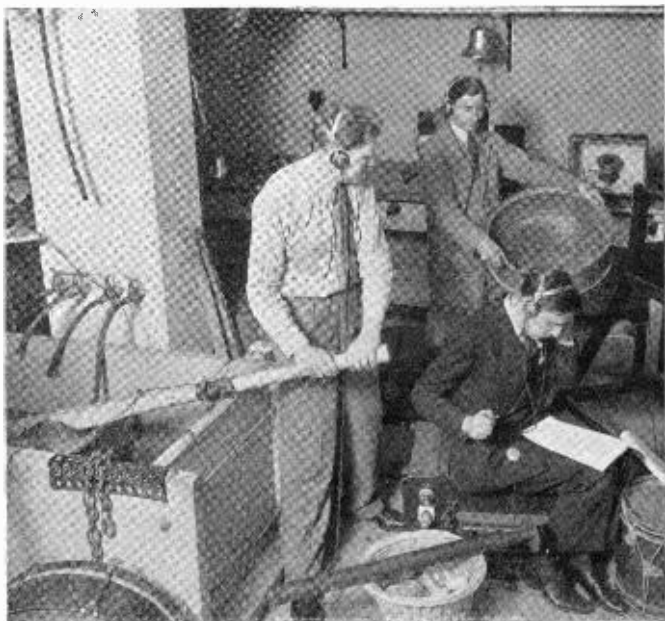

ILLUSIONS DISPELLED

used Sound Effects as bricks with which to build, treating them as of equal value with speech and music.

There are six totally different primary genres of Sound Effect, which might appear on the first casual glance to approximate one to another, but which, on closer examination, turn out to be quite individual and separate, both in quality and function. They are as follows:—

- (1) *The Realistic, Confirmatory Effect*, which amplifies without adding to the dialogue; e.g. the ship sounds and storm in “Ingredient X” (*storm referred to in dialogue*), and the sound of a bath running in “A Taste of Life” (*bath referred to*).
- (2) *The Realistic, Evocative Effect*; e.g. the use of Morse in the Empire Day Programme, to suggest a mental conception of ships a great distance away out at sea (*Morse not actually mentioned in dialogue*); church

bells in the Empire Day Programme, giving effect of movement from Drake's wars to the peaceful haven of Plymouth.

- (3) *The Symbolic, Evocative Effect*; e.g. the churning rhythm record used to express the confusion of a charwoman's mind in "Intimate Snapshots"; the use of sea sounds between all scenes in "The Flowers are not for You to Pick," expressing the inevitability of disaster.
- (4) *The Conventionalised Effect*; e.g. the train rhythm record used in "Exiles"; the horses' hoofs in "Carnival."
- (5) *The Impressionistic Effect*; e.g. the fanfare used for entry and exit of servant in "Matinée"; the use of echo imposed on the speech in "The First Second" to indicate that the speaker has died; and the choral shouting of the starving revolutionaries in "Exiles."
- (6) *Music as an Effect*; e.g. Beethoven Symphony faded against jazz, symbolic of the sacred and profane love forces in the characters of "Kaleidoscopes I and II."

One programme's excellently suitable Effects may be another programme's poison; and if broadcast authors and producers thought only in terms of one genre of Effect, and either were unaware of the others or scorned to use them, it would follow that a number of plays and programmes would be sent out like an army in a job-lot of makeshift uniforms.

It is axiomatic that every Sound Effect, to whatever category it belongs, *must* register in the listener's mind instantaneously. If it fails to do so its presence could not be justified. That is one of the primary considerations on which authors, adapters, and producers, have continually to use their judgment when employing Sound Effects in broadcasting. This article has not set out to treat of the intriguing methods of creating all the funny noises you hear, but of the considerations which weigh with authors and producers as to which sort of Effect shall be used, how much of it, where put, and so on and so on. Grant that the Effect has "registered" instantaneously; it is essential

that the author and the producer should have remembered that the words which come all round an Effect are capable of altering its character entirely! When one is told what a sound is intended to be, an immediate difference is made to that sound. If, for instance, the noise is a piece of realism which *hasn't* quite come off, the reaction is, "Oh, *that's* what they're trying to make a noise like, is it?" Or if it is a piece of successful realism rather unnecessarily amplifying the dialogue, the listener exclaims, "Yes, I *know!* Don't dot all your i's for me—I'm not a half-wit!" In the case of a piece of realistic sound which wholly achieves its object, something very odd occurs. The dialogue can give a Sound Effect further particular *specific* character which it alone could not possess. For example: the sound of running water—excellent realism. The character says, "I am going to have a hot bath"—and behold, the sound *becomes* the sound of *hot* water.

From this brief sketch the interested reader will be able to imagine how much experience and judgment is required in the use of Sound Effects in broadcasting.



EXAMINING A RECORD OF NOISES OF THE UNDERGROUND

The record was specially made for broadcasting

PRODUCING PLAYS FOR BROADCASTING

SO much ink appears to have been spilt on the above subject that the Productions Department of the B.B.C. might almost be accused of emulating the very youthful gardening enthusiast, who, having planted certain choice bulbs, dug them up at increasingly short intervals "just to see how they were getting on." The obvious defence against such a charge, if defence were needed, is that broadcasting itself being in its infancy, broadcast drama is only just born. Indeed the severe critic may reply rather tartly that it isn't; but for the present purpose it can be assumed that it is a very lusty child whose rapid development cannot fail to be a matter of interest.

One imagines, then, that few listeners to-day who are interested in wireless plays can be entirely ignorant of the general procedure involved, but for those few it may be as well to describe it briefly.

Some six or seven weeks before the day appointed for the broadcast, the play is selected and the producer is notified. Unless the work in question happens to be specially written for the microphone, it may have to be adapted, either by the producer himself, or one of the official play doctors, or by the two working in concert. It will be obvious, of course, that any stage-play will require alteration in dialogue before it is ready for broadcasting; bits of "business" must be made clear, gesture must give place to words, characters may have to be addressed by name to aid identification or to mark arrival and departure. All this has to be very carefully considered before the producer can embark on the preliminaries of his scheme of production. Next he must decide what musical accompaniment, if any, he will use, whether symphony orchestra, string quartet, gramophone records or military band; also shall he have music specially composed, or is the association of ideas conjured up by some standard work going to be of more value to him; will he require any singers, either solo or choral?

These questions and others being settled to his own satisfaction, he must now get into touch with the Music Department and do his provisional requisitioning before someone

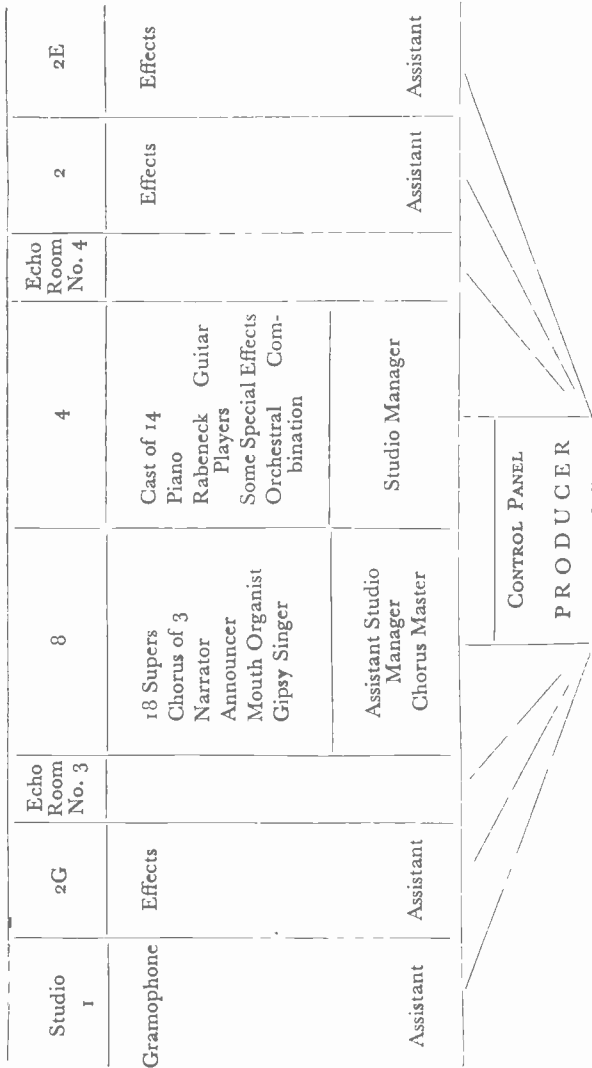

THE GROUPING OF STUDIOS ON THE DRAMATIC CONTROL PANEL FOR "EXILES,"
A PLAY BROADCAST IN FEBRUARY 1930

else steps in and books up everything in sight for a mammoth production about the same date! Next he must decide how many studios he will require, how he will group them on the Dramatic Control Panel, which studio's acoustic properties will best achieve the effect he is aiming at; will echo be of any help to him, and—a most important and much discussed point—what Sound Effects he will ask the head of the Effects Section to devise for him.

Then comes the brain-racking, soul-searching, business of casting, difficult enough in the theatre, but bewilderingly hard in the studio. Every artist's idiosyncrasies, magnified by that uncompromising fellow the microphone, have to be realised and remembered. Voice balance, by which is meant the respective weight and force of two or more contrasting voices, has to be considered; accent, diction, pitch, all must play their part in conveying the right impression to thousands of unseen listeners. Much concentration and the keenest of ears are necessary when summing up judgment on the voices that are the pigments wherewith the producer of wireless plays sets out to paint his mental picture. There are, of course, the main differences between bass, baritone, tenor, and their feminine counterparts, but also, be it remembered, there are a thousand and one other differentiations; there are plaintive voices, happy voices, hard compelling voices, soft beguiling voices, voices that are old and worn with grief, voices that are as young as laughter itself, voices that suggest fat old men, and voices that suggest thin young ones—though it is always possible that the owners may be in themselves the exact antithesis of what their microphone personality conveys. All this, then, has got to be weighed and pondered, but at last the cast is complete—until, of course, someone desires to be released and then the whole thing has to be reshuffled, as the “balance” of personality has been completely upset.

Now it will be readily understandable from the foregoing that not the least of the difficulties confronting the producer is the fact of having to work ahead. No one can decide questions such as the above on a mere cursory reading through of a play manuscript. Yet, having studied and absorbed it sufficiently to have made up his mind, he must then dismiss it from his thought for the time being in order

to give all his attention to some other Production, the preliminaries of which had been attended to six weeks before in their turn.

Another point mentioned above which presents a tremendous problem to the producer is that of Effects, not so much in the inventing and devising of Effects as in what capacity to employ them. Generalisations are notoriously both dangerous and untrustworthy, but there seems to be a growing feeling—to which the writer certainly subscribes—that Effects should be used emotionally rather than graphically; more, that is to say, to underline a mood or a dramatic situation than to paint a scene. Thus, if there is a passage of dialogue as follows: “Have another glass of port?” “Thanks,” “Good stuff this!” it is on the face of it unnecessary and probably rather ridiculous to illustrate the fact that your characters are drinking port by giving the noise of tinkling glass and pouring liquid. On the other hand, noise effects can themselves be more eloquent and more dramatically useful than speech, and it is conceivably right to drown speech with abstract noise on certain occasions. In fact, the successful production of a play for broadcasting must be conceived in symphonic form, where speech is merely one thread in the woven fabric of sound, and not inevitably the most important, but one which it is permissible to swamp with some other theme, as the conductor of an orchestra will occasionally swamp his strings with his brass, or his wood-wind with his percussion.

Well, problems have been weighed, difficulties coped with, successfully or not as the case may be, and the fateful hour arrives. Arrives, and goes ticking on, for there has been a slight delay or over-running of another programme. Suspense and nervous excitement quicken the pulse of the producer seated before the Control Panel with his fixed and anxious gaze on the red light signal. At last it winks its message—all ready? Flick! he sends his signal to the Announcer—“This is the National programme . . .” Flick again on a switch at his side and a green bulb lights in the orchestral studio. The opening chords of the overture crash out, and the result of his labour steals out to penetrate a million homes.

D I V E R S I O N S

AFTER the underlying idea of *Diversions* had been simmering on the third floor at Savoy Hill for some time, number one burst suddenly upon the ether in March, with shattering effect on the well-bred tradition of studio microphones, and the gentle and sophisticated methods of the B.B.C. announcers. The first stentorian introduction shook the building to its foundations, tested the safety factor of the Brookmans Park transmitters, and brought the unfortunate victim of the experiment to the verge of nervous prostration. Subsequent "issues" (as they were called, to preserve their topical and "news reel" character) continued with an individual style in general presentation but with modified announcements; those for the tenth (and last) being perhaps the best. A second series was started on a monthly basis in October, after each of the B.B.C.'s Regional Stations had broadcast a *Diversions* compiled from local sources.

Diversions was essentially an experiment, born of practical difficulties in fitting in last-minute programmes of uncertain timing, such as music-hall and theatre relays (one of which had already caused a minor disaster), brief topical events, surprise items, and a host of short turns. These, though entertaining in themselves, seldom justify the cutting up of the two main evening periods into short unrelated "snippets." For if it can be said that listeners are ever unanimous, they would appear to be so in a widespread distaste for "bitty" programmes. It did seem possible, however, that if an hour could be set aside in each week for a programme made up entirely of contrasting and irrelevant items, welded together in a special setting, and with the contrasts emphasised, considerable entertainment might be derived from it by listeners rendered intellectually uncritical by a frivolous and disarming title.

The guiding principle settled, and a slogan manufactured (this, by the way, referred to the programme as a whole and not to individual items, and was followed to the bitter end—it was "an entertainment made possible only by broadcasting"), the B.B.C. set about devising details of presentation on the lines of a topical budget film, among which was the "scal" of a fanfare, and a playing-in-and-



AT WEMBLEY SPEEDWAY
(*Diversions*, May 15, 1930)

out number composed by Jack Payne. A good title proved elusive at first, but was eventually found in the word *Diversions*. It is interesting to note incidentally, that its adequacy as a description has since not been overlooked by certain skilled purveyors of light entertainment not a thousand miles from Savoy Hill! The sub-titling method was a brain-wave on the part of the ever-scintillating "Broadcaster" of the *Radio Times*, who, in addition, took on the production and linking-up of the programme as a whole.

Now that the first series is over, it is of interest to survey critically in retrospect the field covered. Apart from the initial difficulty of obtaining fresh material within the time limits, a serious obstacle was the impossibility of rehearsal. Nine-tenths of the programme items could not be rehearsed at all, and not a single *Diversions* could be rehearsed as a complete programme. This resulted in much "blind" working, and occasional "nerves," inevitably reflected in the programmes themselves. Consequently their arrival began to be awaited in a cold sweat of apprehension; scarcely a good augury for the gaiety the producers were trying to infuse into the material!

This was chiefly the case with the Outside Broadcasts

which were relied upon as the backbone of the entertainment. Miscalculations and over-runs of a minute or so could, and indeed did on one occasion, lead to a disaster which had to be "covered up" at the last moment. Few listeners spotted it, but many must have been aware of grit in the machinery.

Possibly the most amusing aspect of *Diversions* were the letters of criticism slung at the B.B.C. on the days following. Occasional want of finesse was made up for by that solid and devastating attitude represented roughly by the statement, "I know what I am talking about, and that's that." This is perhaps typical of our race in moments of irritation, when their natural delicacy may be somewhat atrophied by the anonymity of their target. For sometimes listeners forget that the B.B.C. is made up of human entities, and think they are addressing an object as inanimate as a loud-speaker. Not that there was no encouragement and sympathy, but . . .

One correspondent, referring to the Hyde Park orator (note the psychological effect of the blessed words "Hyde Park"), accused the B.B.C. of being suborned by the Bolsheviks to contaminate the ether with "the most violent anarchist propaganda"! Now, our orator is a man of sensibility and honour, and with a great sense of humour. For fifteen solid minutes he held forth without a subject and without once indulging in propaganda or controversy of any sort; truly a remarkable feat for one holding strong private views! Another correspondent became mixed up between a cricket talk by Mr. A. C. McLaren, which preceded *Diversions*, and the orator who spoke within it.

The "talkie" broadcast was well received by the public, but led to some bitterness on the part of other picture people. The broadcast critic of one of our most influential and discerning daily papers suggested that the B.B.C. had had its corporate leg pulled by the film magnates. Actually the B.B.C. had not even been approached by the owners, though naturally they provided every facility and help, and did not interfere in any way either with the methods of presentation or the excerpts selected. The fact is that, of the many musical films viewed, not one was as suitable for the purpose in character, quality, idea, or production. In this first broadcast of a talking film the aim was to give the

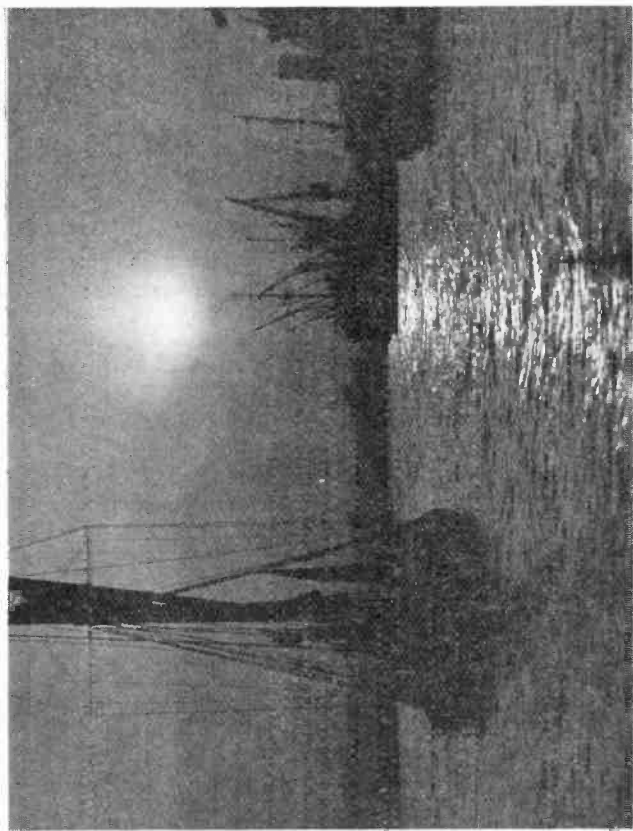

THE POOL OF LONDON BY NIGHT
(*Disturbances, May 9, 1930*)

public who had not heard one an opportunity of judging what had been achieved.

Judging by appreciations, the Chief Engineer's tour of Brookmans Park and the "trailer" of "Journey's End" and "Brigade Exchange" (No. 1), the "Love Parade" excerpts, "The Love Parade a Hundred Years Ago" (read with great gusto and perfect understanding by Mr. J. C. Stobart) (No. 2), the sketches from Jack Hulbert's Revue, "The House That Jack Built" (No. 4), The Royal Mail (No. 6), Layton and Johnstone from the Palladium (No. 7), the Pool of London at Night (not an unqualified success), the Telephone Exchange, and the Hungarian Choir at the Savoy Hotel (No. 9), the Willesden Signal Box (No. 10), and the musical backing up by Jack Payne and the Gershom Parkington Orchestra appear to have been among the more popular items.

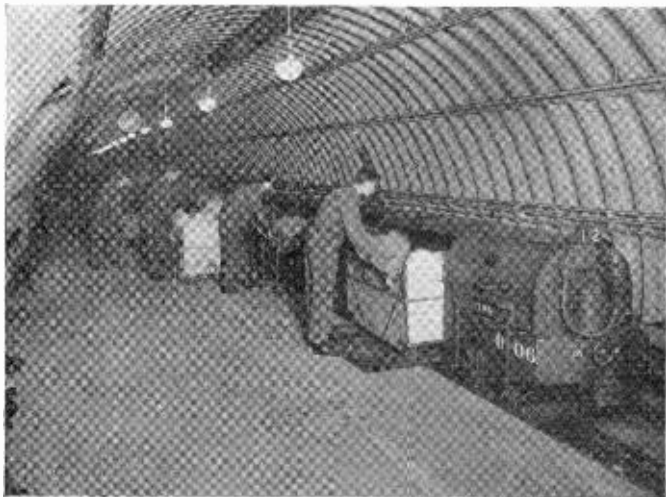

THE POST OFFICE PARCELS RAILWAY

Diversions, April 14, 1930

VAUDEVILLE PROGRAMMES

VAUDEVILLE is practically another name for Variety, and the word "Variety" speaks for itself—change and yet more change. With 150 vaudeville programmes to be made up per annum this presents no easy task. Added to this, experience has proved the backbone of vaudeville to be humour, and *good* humour is very rare.

In fairness to variety artists, and in particular comedians, they should not be allowed to appear too frequently; but with the existing serious shortage of performers a nicely balanced programme of appearances has unfortunately not always been possible, with the result that listeners have asked, and not always in the politest terms, why the B.B.C. does not put on fresh talent. The answer is simply that it does not exist. Another difficulty lies in the fact that but few comedians are capable of writing their own material, and the dearth of clever humorous writers is even greater. In these days, when songs are only written in the first instances as dance music, with the lyrics added after, the so-called humour that these songs contain is often pitiful. Comedians scour the whole country for comedy material but without result.

The slap-stick, red-nosed comedian is dead. He has served his time, but the public to-day demand something more worthy of their intelligence. Gillie Potter, Ronald Frankau, and A. J. Alan (although not actually to be classed as a comedian, yet definitely a clever and subtle humourist), provide the type of comedy that deserves and gets success, the type that will become more and more prevalent.

The difficulty is to find the type of comedy mentioned. If sufficient is not available, then surely it is better to hear a first-class comedian three times than hear the bad comedian once. The public are in no way absolved from responsibility in this matter, as long as they remain content to listen to rubbishy songs and remain satisfied with the poor standard of material offered by comedians.

TWO TYPES OF VAUDEVILLE

To enable listeners to have changes in their vaudeville two types of programmes are arranged. First, the broader



Press Portrait Bureau

CLAPHAM AND DWYER
apparently solving one of their famous conundrums

type of performance, supported by dance music, and secondly, a much quieter type which might contain songs sung in French or German, a well-written dramatic monologue or sketch, an operetta, a good standard instrumental, and generally one comedian very carefully selected, who will blend in with the rest of the programme and make a harmonious whole. The method of presentation, too, is entirely different, and is so arranged as to make for smooth, almost soothing, running of the programme.

It is realised that broadcast vaudeville has attracted a large public which does not in the ordinary course patronise the music-halls. It is for those listeners as well as the others that the quieter type of vaudeville is broadcast.

A DIFFICULTY

In compiling the vaudeville programmes there is one difficulty which is unfortunately distressingly prominent, viz. the unlikelihood of all artists asked to participate in a programme being able to accept the date offered. Thus, out of six artists approached, only two may be able to accept. This means, therefore, that round those two must be built a well-balanced and varied programme. On the face of it this may not appear difficult, but taking into consideration the shortage of "acts," and the endeavour made by the B.B.C. not to engage artists so frequently as to tire the listener, it presents a great problem, sometimes necessitating making up the same programme twice or even three times. Perhaps this can be made clearer if it is realised that some 900 artists are booked yearly for vaudeville, and the number of first-class comedians is very limited.

No artist, amateur or professional, is refused an audition, and some 1500 to 2000 aspirants are heard yearly: but less than 1 per cent. reach the standard required.

Vaudeville ranks amongst the most favoured programmes, and whilst the possibility of cutting down the number per week has received careful attention, so far it has not been considered a wise policy. More first-class "acts" must be discovered, however, or such a policy may be forced on the B.B.C.



HAROLD NICOLSON

whose weekly talks on "People and Things" have been a new feature in the programmes



THE SPOKEN WORD



PERSONALITY IN SPEAKERS

THE leisure hours of members of the B.B.C. staff are constantly embittered by the necessity of watching other people listen, or fail to listen, to talks. Certain reactions may be unhappily observed in any group of people sitting in any room in which the loud-speaker has just switched from music to the speaking voice. Bateman has yet to depict the bridegroom which was interrupted to listen to a broadcast talk, or the Mothers' Meeting which silenced its gossip to hear a wireless discussion.

Inattention is not, of course, the general rule; there is a constant and intelligent audience for all talks; yet in the indifference with which a good talk may often be received by an average group of people there is something inexplicable and disheartening to those who have dealt with the several, and sometimes difficult, steps of its arrangement and presentation. Although the B.B.C. cannot govern the relative power or lack of concentration of its listeners, it must shoulder the responsibility for the ability or disability of broadcast speakers to catch and hold the wandering attention of the average listener. And think for a moment how that attention does wander! In the theatre or concert-hall, people sit quietly in an attentive mood; to the loud-speaker they seldom give more than a half of their attention. An audience engaged in eating, knitting, gossiping, playing games, or even motoring about the country, would be a severe test for the most popular actor or singer. Yet this is the type of audience to which the wireless speaker must plead for silence. The interest of his subject, the greatness of his name, may draw this strange and vast audience together for the first sentences of his talk; but only his

personality will decide whether their attention is held until the end.

And there's the rub. For personality, that rare and indefinable quality which alone can always be counted upon to bridge the gap between loud-speaker and listener, is even more elusive in the broadcasting studio than elsewhere. The charm that is apparent at the dinner-table or on the platform is apt—as the staff at Savoy Hill have learned by bitter experience—to “softly and suddenly vanish away” from its owner's voice when that voice travels alone through the ether. The very best Snarks are horribly apt to become Boojums at Savoy Hill. The famous author may stammer through his manuscript in a cockney voice; the well-known actress, radiating personality and perfume through the Studio, may sound on the loud-speaker like a tired school-marm; the famous explorer, with those name the world is ringing, very possibly can't put two sensible words together before the microphone; and, by way of contrast, the unexpected nobody delivering a talk on slugs or dustbins reaps a thousand appreciative letters.

Problems, these, which the listener cannot be expected to appreciate; he merely knows that a talk is good or bad—so far as he is concerned—and does not trouble to analyse the why and wherefore of its success or failure.

The trouble is that the technique of broadcasting, as distinct from that of journalism or public speaking, is not yet sufficiently appreciated. The post-bag at Savoy Hill shows clearly enough that everyone who has written an article or delivered a speech is an immediate candidate for the microphone, and that each mother's son who has recited the “Charge of the Light Brigade” to an appreciative family circle is considered to have qualified as a poetry-reader for Savoy Hill. On the other hand, public opinion and the Press force the celebrities of the day towards the microphone, regardless of their broadcasting abilities, while science and the skilled trades demand that only the academic voice of authority shall deliver talks upon any aspect of their work. The matron of a hospital may be able to talk convincingly of the work which is being done and the reason why support is needed: yet the hospital committee, when it is a question of a broadcast appeal, may



"THE BRIDGE-HAND INTERRUPTED TO LISTEN TO A BROADCAST TALK"

prefer to select Lord X., who in a few badly-chosen words effectively ruins all hope of a satisfactory response. Such instances can be multiplied *ad infinitum*. The moral is that broadcast speakers are broadcast speakers and not "eminent authorities": it is personality at the microphone that counts, far more than names or deeds or elocutionary attainments. Yet each year as the power and uses of broadcasting are more fully realised, the harassed members of the B.B.C. staff are more and more bombarded by those who sit in high places and upon committees, and who claim that Lord This or Professor That must alone represent their views at the microphone. It is a dangerous tendency, for the whole fabric of broadcast talks may crumble under the continued assault of speakers who do not possess sufficient personality to interest the public and whose aim is always to instruct and never to entertain. On the other hand, personality by itself clearly won't do: the speaker who puts rubbish and inaccuracies over the microphone with conviction and charm is an even greater menace than the dull and careful statistician. Somewhere between the two, between the dull authorities and the racy liars, the ideal race of broadcasters has to be discovered. In some subjects it is easier to find the expert who can broadcast than in others; in some subjects the authoritative note is even more important than excellence of voice or manner. Day by day the process of discovery goes on: day by day fresh speakers from every walk of life are recruited and tried out before the microphone. Here and there a talk or series of talks fails, so far as one can gather, to arouse interest; here and there a conspicuous success adds another name to the list of those who can address the unresponsive microphone with authority and charm combined. Sincerity, tolerance, humanity, vitality, and a sense of humour, seem to be among the positive virtues in this connection; and pomposity, superiority, and a didactic or dry-as-dust manner, to be among the positive vices. Listeners are quick to recognise those who can, as it were, enter their room as a friend might enter it, and talk to them as a friend might talk. And if the noise they hear from the loud-speaker is not always all they desire, perhaps they will sometimes put themselves in the place of the poor broadcaster, of whom so much is required.

ARE TALKS TOO HIGHBROW?

YES: no; it doesn't really matter what you answer. It depends upon the height or shallowness of your brow. It depends upon which talks you mean. A member of the B.B.C. staff was staying with friends some time ago when his host turned on a vaudeville programme on the wireless. After a trial of a few minutes he switched over to the other wave-length to hear the Cesar Franck Symphony. The son and heir of the house at this point unobtrusively but with a very determined look on his face walked out. Now, many people who have come to love music remember doing just that sort of thing, and that in its degree is typical of many people's attitude to talks. Much of the criticism comes from people who have either never listened to a talk or who have never paused to consider what policy might lie behind it all. Broadcasting is very young and there is nothing depressing about all this. The B.B.C. still has a good deal to learn about its own job; listeners no less have a lot to learn about theirs. Few have yet attained to what, after all, is the first state of grace in listening—few, that is, approach broadcast programmes with any attempt at intelligent selection.

The range of interests and of standards of intelligence among listeners creates, of course, an almost insoluble problem, yet even a superficial glance at the general chart always published in the B.B.C.'s Talks Programme reveals the extraordinary range of subjects dealt with. Here is an infinite variety; and that is just the trouble, for there is no end to variations on this theme of talks. They could go on for ever and there would still be many listeners wholly dissatisfied with what was given.

Tastes differ: as listeners we must pick and choose; and if we learn to substitute for intolerance a genial curiosity for men and things beyond our immediate ken, we shall find our brows more flexible than we had dared believe. Every man wants in his heart to be a highbrow. We rather hate our ignorance, and if we abuse highbrows it is because we envy them their knowledge.

There is another problem involved in this question of highbrow talks which the programme builder faces every day, but which must be even more obscure to the ordinary

listener. Given an infinite variety of subjects he is still entangled in the problem of presentation. Here let us admit quite frankly that he is far from ultimate success, but the fault cannot be laid entirely at the doors of Savoy Hill. It is a problem of finding men who are not only competent authorities but who have the common touch. There are those who, like Midas, turn everything they touch to gold; personalities so live, so vivid, and so essentially true in their relation to experience, that they communicate the fine essence of their personality to those who listen, whatever the subject may be. This is the gift of genius, and genius is as rare as it is lovely. For the rest it is a matter of imaginative training. A broadcast speaker has to go to school, to learn a new technique in presentation, to discard the academic gown, or the stentorian tones of the public orator, to forget that he is a lecturer or a man of high position, to become for a few brief moments a friendly and human person talking to fireside listeners with faces familiar but unseen. It is a feat not easy of achievement.

During the last year many attempts have been made to explore new ground in this matter of technique; dialogues long and short, discussions and debates of varying methods, all have been tried. Some have succeeded, but there has been the inevitable residue of failure. The failures leave no despondency. For those who are concerned with talks the future of them is one of the bright prospects in the future of broadcasting. There are so many worlds to conquer. The innate prejudices of the uneducated cannot long survive the test of facts. The B.B.C. knows now, and it is a great discovery, that there is scarcely a subject on earth which cannot be made palatable to the ordinary man or woman. One grows shy of singing the praises of Vernon Bartlett, but international affairs, in spite of the war, is not a subject that one would have expected to be the common interest of millions; and yet it is a fact that by his unobtrusive charm and his respect for truth and a certain quality of fair play which is inherent in his work, Mr. Bartlett has made of international affairs a subject of general interest, accepted as naturally as the discussion of the latest Test Match. The same applies in its degree to other subjects even more abstruse. Some will remember the public interest aroused by Professor Macmurray's course on a new

philosophy of freedom. Many will know of the extraordinarily widespread interest created by Professor Burt's talks on "The Study of the Mind." Philosophy and psychology are fierce words, but through broadcasting they are acquiring a familiarity which breeds not contempt but confidence among listeners.

That is the vindication of the B.B.C.'s policy, the changing, growing interest of listeners. Correspondence proves it. So do the sales of pamphlets and the ascending figures of the Talks Programme circulation. There is only one sense in which the charge of highbrow talks could be admitted. There are those who believe that they know "what the public wants": men, masters of a trick psychology, who know how to exploit the meaner and more vulgar elements in our anatomy. It is easy, and to some profitable, to deprave the public taste in such a way, but it is not a creed, it is irrelevant to life except as it effaces beauty and belies the truth. Wireless preserves the sense of its own adventure. It has its creed. It has no concern with that kind of thing. If to be highbrow is to be in the vanguard of thought, to be curious for new knowledge, to believe in human nature, to press far more wide open the doors of our imagination, then the B.B.C.'s Talks are highbrow. Broadcasters and listeners have great issues at stake. They cannot afford to lay waste their powers, to emasculate their spirit, or to lose the fine temper of their imagination. Losing this the B.B.C. loses public confidence, which from its early days has inspired so intimately every section of its work. Don't let us worry about our brows: we are concerned with life, and the future is ahead of us.

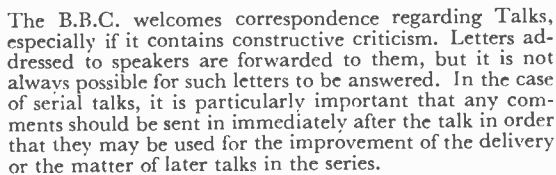

The B.B.C. welcomes correspondence regarding Talks, especially if it contains constructive criticism. Letters addressed to speakers are forwarded to them, but it is not always possible for such letters to be answered. In the case of serial talks, it is particularly important that any comments should be sent in immediately after the talk in order that they may be used for the improvement of the delivery or the matter of later talks in the series.

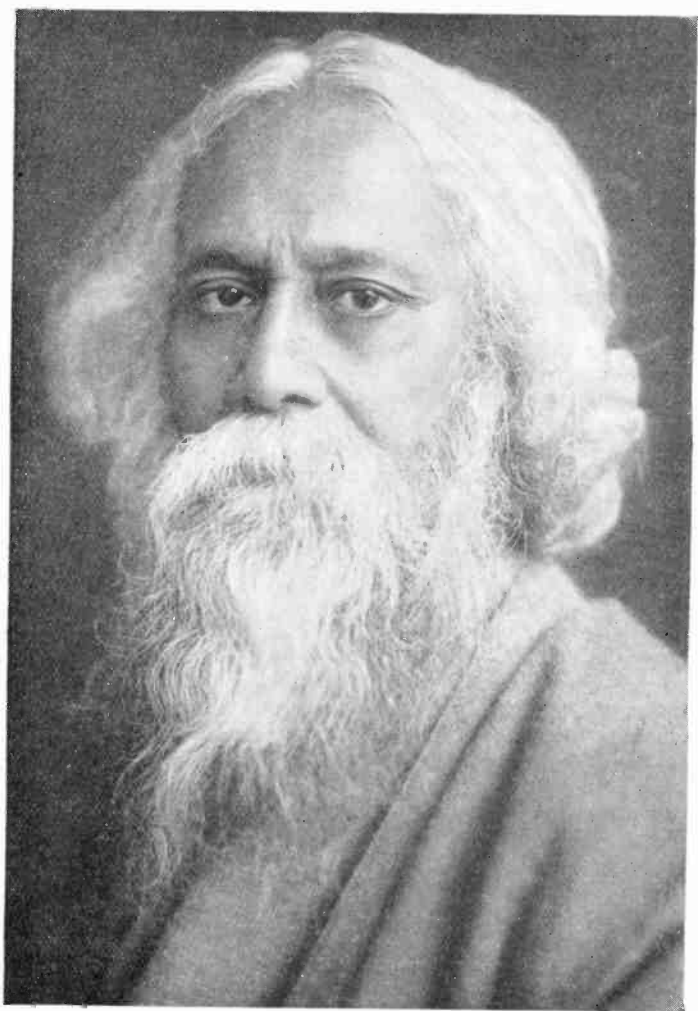

E.N.A.

SIR RABINDRANATH TAGORE

who broadcast an address from Manchester College, Oxford, on May 25

[218]

THE IMPORTANT SYMPOSIUMS

A SYMPOSIUM has long ceased to be, as the dictionary describes it, "a drinking together—a merry feast;" but if the banquet has been dropped, the philosophic conversation which constituted the rest of the bill of fare is still left us. A symposium remains to-day a useful and popular method of discussing many aspects of life, and one which is peculiarly suited to broadcasting.

The term will be used here to cover series of talks given during the past year which were in fact prolonged discussions of a single main subject; it will disregard those series which attempted to give a kaleidoscopic view, for example, of the day's work of various people; or the long list of distinguished men and women who, in the "Looking Backward" series, attempted to piece together a picture of days that are past. Similarly, it will not refer to the cooperative series in which specialists on various aspects of a large subject pooled their knowledge for the benefit of listeners, such as the series on Biochemistry, on the Making of a Personality, on the Industries of Great Britain, etc. The true symposium—or the nearest possible approach to a true symposium—seems to involve some degree of discussion between people holding a diversity of views.

When the ban on controversy was lifted by the Postmaster-General, the B.B.C. made their earliest experiments in the form of discussions and debates. It soon became clear, however, that a long list of the most interesting subjects lay quite outside the range of debate. The "dog-fight" method has advantages for straight and simple issues, in which there is a clear pro and con; and conversational discussion between two or three people is useful for conveying good talk of an after-dinner kind. But if the object is to let men and women with individual and original points of view develop the reasons which lead them to hold those views, or to give a series of personal statements on a subject in which a number of different view-points are essential, then the symposium is clearly the most interesting and most satisfactory method.

In the autumn of 1929 the B.B.C. invited Mr. G. Lowes Dickinson, the Cambridge scholar and philosopher, whose



SIR JOHN SIMON

who came to the microphone to explain to the public the bearings of his Commission's report on India.

little book, "A Modern Symposium," shows in brief his peculiar gifts of simplicity, sympathy, and tolerance, to introduce and to close a series of "Points of View," in which Dean Inge, Mr. Bernard Shaw, Mr. H. G. Wells, Mr. J. B. S. Haldane, and Sir Oliver Lodge took part. With the exception of Sir Oliver Lodge, these speakers were all strangers to broadcasting (though speeches by Mr. Shaw had been relayed two or three times from public meetings); and they were strangers partly because an invitation to give a non-partisan talk or to engage in a set debate held no attraction for them. The possibility of a frank symposium, however, at once enlisted their interest and co-operation, and the result was even more encouraging than had been hoped. The sense of reality, the interest of hearing such men speak their inner mind, led many people to appreciate for the first time the possibilities—the peculiar possibilities—of broadcasting, and to become then and there regular listeners. The talks were subsequently published in book form.*

* "Points of View," Allen and Unwin, 4s. 6d.

As a corollary to this first series, a second group of distinguished speakers was invited the following spring to take part in a supplementary series. They were the Archbishop of York, Viscount Grey of Fallodon, Sir James Jeans, Dame Ethel Smyth, Sir Josiah Stamp, and Sir Henry Newbolt, and their talks too have been reprinted.

The same method can very usefully be applied to more specialised subjects on which there are a variety of interesting and conflicting views. A series on "To-day and To-morrow in Architecture" led to considerable interest and induced two of the speakers to meet later a large group of listeners in order to pursue the subject of modern architectural developments. Similarly, a symposium was arranged on the domestic servant problem in which a general servant and a maid in a large house, as well as the mistresses of various kinds of households and a mother of domestic servants, all took part.

The future development of broadcast talks is bound to follow up and expand these experiments. Few things are more interesting than to compare and contrast a series of frank statements on the problems of life by those with some real claim to speak on them, especially if they reveal something of the process which went to form the speaker's philosophy. Few things, again, are more illuminating, or more refreshing, than to hear points of view not often expressed—the views of ordinary men and women whose claim to speak is just that their experience is that of thousands of others. The claim to impartiality and fairness made by the B.B.C. indicates the carefully arranged symposium as the ideal way of ensuring that all important views are focussed on any given question. To invite a controversial speaker to the microphone, and then to find room as far as possible for the spokesmen of such minorities as happen to demand a subsequent hearing—as is sometimes suggested—would be to leave to chance one of the most important responsibilities of the Corporation. No symposium will ever represent all possible opinions; but, taken as a whole, each symposium can and should represent the main currents of responsible opinions on a wide range of subjects, and thus play a not inconsiderable part in educating and stimulating an informed public opinion.

THE BROADCASTING OF POETRY

THE broadcasting of poetry probably arouses the critical, indeed the combative, instinct in listeners more acutely than any other part of the programme. This fact seems to be an additional proof—if additional proof be needed—that poetry has very deep and therefore very individual roots in the English character. People usually get angry about things in proportion as they care about them. It may be argued, therefore, that there is a strong case for the reading of poetry.

Broadcasting, however, may seem on the face of it a wholly unsuitable medium. It has of necessity a more or less universal appeal; how can it be brought to serve a peculiarly individual art like poetry? The loud-speaker sends out what it receives in whatever company it may find itself—a noisy street, a busy kitchen, a living-room containing half a dozen people of different ages engaged in different occupations. How can an English lyric, however lovely, find the right reception in such circumstances? The answer, of course, is that it cannot; poetry, possibly more than any other kind of programme, demands some degree of co-operation on the part of the listener. It is a fact that much of the criticism of poetry reading does come from those who are waiting for the news or dance music to begin, for whom the reading is merely an annoying interlude. For such critics switching off must remain the only remedy.

But the important part of the problem concerns those who genuinely love poetry—or some poetry. Among these, the diversity of taste is clearly endless. There are those who have a strong prejudice against all contemporary poetry; there are others who are wearied by readings from poetry written in what seems to them archaic English. There must be many whose enjoyment of the poetry is marred by a feeling that they are not getting its full meaning—that they know too little about the poem, or the circumstances in which it was written, or the poet, or the point of the allusions. There are others, again, with a wider range of knowledge, who are irritated by any attempt at comment or explanation, which seems to them academic and tiresomely informative. Another set of controversies

centres round the kind of poetry to be read. Some maintain that dramatic poetry or narrative poetry is the only poetry suitable for broadcasting; others, that these sound either too rhetorical or require too sustained an effort for broadcasting, and that lyric poetry, pure poetry, can make a more direct and more certain emotional appeal.

So much for the poetry; what of the reader? At one end of the scale are those who admire the manner and delivery of the trained elocutionist, the manner of the platform or of the stage. At the other end are those who feel strongly that the reader's voice should be entirely neutral and impersonal, letting the poetry speak for itself. In between, so far as one can judge, comes the large public which has no cut-and-dried theories, but which knows what it likes when it hears it. The available evidence seems to show that those who like, on the wireless, the elocutionary style are a small minority, and a dwindling minority; that the school of the ultra-monotone tradition is also a small one, and that for the largest public which listens to poetry it is important to avoid the extremes at both ends and to look for the following essentials:—

1. The reader should have the kind of voice which has a compelling quality of tone—the kind of voice one would want to listen to no matter what it said—a voice, therefore, without mannerism or affectation. Moreover, it must be of a kind which preserves these qualities even through the microphone.
2. He must understand the nature and structure of poetry, so that he can strike the right balance between bringing out the rhythm of the poem, the value of the words, and the meaning of the content, neither unduly obtruding his own personality nor repressing it by any trick.
3. He must be chosen specially for the poetry to be read. No one “poetry reader” would serve for all kinds of poetry. He (or she) should have the appropriate timbre of voice, as well as a personal interest in, and feeling for, the poetry in question. In proportion as the reader is soaked in the poetry and has been able, as it were, to get inside the poet's conception, is the reading likely to be a success.

It will be seen, therefore, that the broadcasting of poetry demands quite special qualities and quite special study. Wireless is a universal medium, yet it makes its appeal to people, not in crowds, not as collected audiences, but as individuals. Poetry broadcasts must aim at something which will give the illusion of a reader at one's own fireside, *i.e.* a reading, not a performance. The reading must combine the right voice (and this means a voice which shall seem right to a very great diversity of listeners) and an understanding of the poetry—it cannot, in fact, be a perfunctory business. The most sensitive readers, therefore, are often those most vividly aware of the difficulties and most liable to suffer from a peculiarly paralysing kind of self-consciousness, which is not only a severe strain in itself, but which makes it difficult to continue to read poetry with success for long at a time. It is rare indeed that the poet himself is the right person to read his own poetry, because it is rare to find the poet's gifts combined with the right qualities of voice and diction, and unaffected by the conditions of studio and microphone.

All that can be said with certainty is that, since poetry was written not to be read only, but to be heard, broadcasting must surely continue to study the problem of how to let it be heard to the best advantage, so as to give pleasure to the largest number of listeners. There is no cut-and-dried theory of broadcast reading; but concentrated study and research during the last two years have enabled members of the B.B.C. staff to learn at least some of the difficulties, some of the things to be avoided, and a few of the qualities which are essential. There is room for much experiment in presentation—from the occasional short reading of ten or fifteen minutes, to the half-hour talk illustrated by reading. The size of the present-day audience means that some degree of specialisation is inevitable in this as in other kinds of programme; no one kind of reading can hope to please everybody. But the aim should be, and is, to ensure that listeners should hear some of the finest poetry in the world read in a manner worthy of it, and that this should include the best of both old and new.

TWO POET-LAUREATES

IN the old Laureate, broadcasting has lost a staunch ally. There is a passage in the "Testament of Beauty" (IV. 605) which treats of Education, and the importance of Beauty as providing the good environment for a child's growth. This passage is repeated almost word for word in prose in Robert Bridges's National Lecture on Poetry, which was broadcast on February 28th, 1929, and has been republished in pamphlet form by the B.B.C. After this passage, in its prose version as delivered by wireless, the late Laureate inserted a striking passage on the possibilities of broadcasting in education, and concluded: "My moral is that our educational authorities should use this means to flood our Primary Schools with spiritual teaching, and those who have to exploit broadcasting for the public advantage must not forget that they are responsible teachers." He spoke of wireless as providing the one means of escape from the vicious circle in which teacher and taught merely succeeded one another in our schools. This discourse is still an inspiring motive among broadcasters on the educational side. Many people of poetic temperament are apt to regard wireless as among the irrelevant and mechanical intrusions of the day, but Robert Bridges had enough of the youthful spirit of inquiry even at his advanced age to be fully cognisant of the possibilities of the new medium.

He took the greatest possible interest in all matters appertaining to broadcasting, and in particular its reactions upon the English speech. Pure English was one of his chief interests. For two or three years he presided over the B.B.C. Advisory Committee on Spoken English, and, until ill-health forbade, was a regular attendant at its meetings. That Committee needed a powerful Chairman to hold the balance between the professional and the amateur and to see that B.B.C. speech was not pure dictionary, and Robert Bridges made an ideal Chairman.

The new Laureate, who resides upon the selfsame hill overlooking the plain of Oxford, is certainly not uninterested in broadcasting; he has even read part of his poem "Reynard the Fox" at the microphone. He is known to be no less interested than his predecessor in the fine speak-



By courtesy of the Fine Arts Society

JOHN MASEFIELD

ing of poetry, and has done much to create a school of verse-speaking in Oxford. The art and practice of speaking verse is, however, a vexed and difficult question in which there are almost as many schools as professors.

Readings of John Masefield's poems have frequently been broadcast, as well as many of his plays, notably in the past year "Pompey the Great," "Philip the King," "The Locked Chest," and "Good Friday."

ROBERT BRIDGES ON BROADCASTING

*Science comforting man's animal poverty
and leisuring his toil, hath humanized manners
and social temper, and now above her globe-spread net
of speeded intercourse hath outrun all magic,
and disclosing the secrecy of the reticent air
hath woven a seamless web of invisible strands
spiriting the dumb inane with the quick matter of life :
Now music's prison'd raptur and the drown'd voice of truth
mantled in light's velocity, over land and sea
are omnipresent, speaking aloud to every ear,
into every heart and home their unhinder'd message,
the body and soul of Universal Brotherhood;
whereby war faln from savagery to fratricide,
from a trumpeting vainglory to a crying shame,
stalketh now with blasting curse branded on its brow.*

From "The Testament of Beauty" (Oxford University Press)

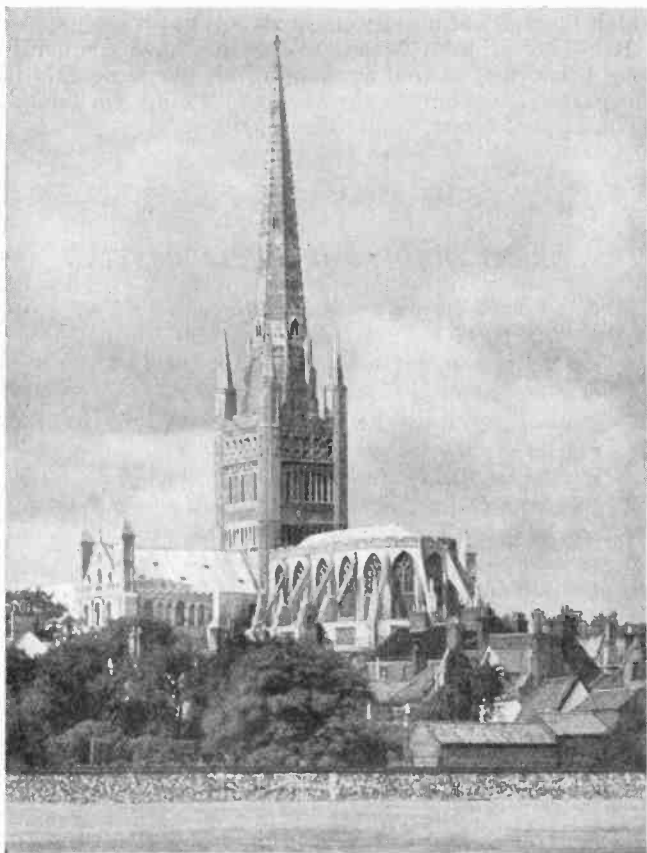

NORWICH CATHEDRAL

Will F. Taylor

which celebrated the 1300th anniversary of its foundation on August 18, 1930

RELIGIOUS BROADCASTING

AFTER eight years of continuous broadcasting of religious services it is still possible to report progress and many new and interesting features. The issue of the B.B.C. publication "Services for Broadcasting" has met with general acceptance and no criticism. Its purpose is stated with due modesty in the prefatory note:—"It is merely the humble adaptation of existing forms to the necessary requirements of a new medium." It is assumed that the majority of the listeners to these evening services—which have now become standardised, as it were, to a service lasting three-quarters of an hour and beginning at eight o'clock—have already attended public worship at their own accustomed place, and a mere repetition of forms of service used elsewhere, though undoubtedly welcome to invalids and others who are not able to go to church in the ordinary sense, might have an effect of monotony upon those who had already heard an evening service. "Services for Broadcasting" is intended only for the ministers who conduct studio services. It provides them with a series of fifteen distinct services, each with its own intention: The Presence, the Kinship of Life, Home and Friendship, Business and Industry, etc. Some of these forms of service, which have received the approval of the Central Religious Advisory Committee, and have been edited by a very well-known liturgiologist, have been tried in the studio during the period under review by ministers of various denominations, and have met with general approval.

Although the majority of services now broadcast come from outside places of worship which are able to provide a special service for broadcasting, yet there seems to be still a place for the service from the studio, in which the address may be given by an eminent preacher who has no particular local attachment, the music being provided by the wireless choir. The studio service has an intimacy of its own, and the singing a quiet perfection different and perhaps not inferior to the results of large congregations backed by a powerful organ. Recently there have been some experimental attempts to strengthen and beautify the studio service by the addition of a string orchestra.

Among many new features of the past year, the following may be selected as among the most interesting:—

The Union of the Scottish Churches was celebrated in October 1929 by a service from Glasgow Cathedral. The Reverend Father Waggett preached in the Church of Great St. Mary's, the University Church of Cambridge. Father John Baptist Reeves, O.P., of St. Dominic's Priory, Haverstock Hill, preached in the studio. Mr. Hubert Simpson is added to the list of very successful broadcast preachers, and the Westminster Congregational church provided a fine service. Bishop Gore and Archdeacon Holmes were also heard for the first time at the microphone during the past year. A richly musical service from St. Sepulchre's, Holborn, was conducted by Dr. Sydney Nicholson and supported by his choir from Chislehurst. On this occasion the boy choristers were prevented by measles from participating at the last moment, but the splendid congregational singing conducted by Dr. Sydney Nicholson proved a very efficient substitute. The service of Benediction was broadcast, for the first time at any rate in the south of England, by the Bishop of Pella, from St. Anne's Church, Upper Kennington Lane. Chichester and Bangor are to be added to the list of cathedrals from which broadcasts have been given. The Reverend G. F. McLeod, the Collegiate Minister of St. Cuthbert's, Edinburgh, has found himself able to provide special services for broadcasting, which have been much appreciated.

Other features of the year's religious broadcasting have been the magnificently decorative People's Service just before Christmas from Liverpool Cathedral, and the service from Canterbury Cathedral at which the Archbishop of Canterbury preached the address on the last Sunday in 1929. The first Sunday in January was devoted to the World's Evangelical Alliance. On May 18th Dr. Norwood gave an impressive sermon from the City Temple. On May 25th Archbishop Lord Davidson was to have preached in connection with the Southwark Cathedral anniversary, but his lamented death occurred on that date. His place was taken by the Bishop of Southwark, the Chairman of the B.B.C. Central Religious Advisory Committee, who paid an eloquent tribute to the deceased Primate.

On June 25th the Thanksgiving Service was broadcast



Photopress

FIXING THE MICROPHONE ON ST. PAUL'S FOR BROADCASTING THE BELLS

[231]

from St. Paul's Cathedral, and subsequently Evensong has been relayed from there. On August 13th a service was broadcast from Norwich Cathedral in commemoration of the 1300th anniversary of its foundation.

Favoured preachers of the past have again been included on the list for 1929-30, such as the Reverend Father C. C. Martindale, S.J., Dr. Archibald Fleming of St. Columba's, Pont Street, Canon W. H. Elliott, and the Reverend Eric Southam.

The 7th Lambeth Conference has been celebrated in various ways. The celebrations began with a great assemblage of Bishops at York Minster at the end of June 1930. The Archbishop of Canterbury described the objects of the Conference in a special talk, and at its close the Bishop of Chichester, the Right Rev. G. K. H. Bell, D.D., summarised the findings.

In response to numerous requests for typical services from country churches, broadcasts have been made from Cransley Church, Kettering, Buckfast Abbey, and Great Mellis Church near Frome, Somerset; though it must be said that in each case there are special facts which raise these services far above the ordinary level. Mr. Greville Cooke's experience as a precentor has enabled him to make the services at the little church at Cransley particularly inspiring in the musical sense, while the Rector of Great Mellis Church is no other than George A. Birmingham, the witty writer of Irish stories, in his other capacity as Canon Hannay.

Services from Wesley's Chapel, Crowstone Congregational Church, Westcliffe-on-Sea, the Union Church, Brighton, Spurgeon's Tabernacle, Eastbourne Presbyterian Church, indicate the wide range of broadcast services. The Brotherhood Movement, the Salvation Army and the Society of Friends have also been included.

Naturally, the possibility of alternative services on the London Regional wavelength has thrown more work upon the B.B.C. but it has at the same time given greater freedom in the provision of contrasts suitable to everybody; and complaints of one-sidedness in religious presentation have practically disappeared from the B.B.C.'s correspondence.

SCHOOL BROADCASTING

THE Central Council for School Broadcasting has now established effective machinery for developing the service of broadcast lessons for schools. No departure has been made, however, from the B.B.C.'s original policy, which envisaged the broadcast lesson as a supplement to the school curriculum, which would provide something that the resources of the ordinary school could not provide; its special aim the stimulus of interest and imagination.

| It is no easy matter to translate such a policy into effect. The initial disadvantage of the medium with its appeal to the ear alone can only be met by securing unusual personality in the broadcast teacher, whose material must be vivid and memorable in character. Nor is this all. The broadcast lessons must be related to some extent to the school curriculum, and the brilliant traveller, the naturalist, or the historian will not necessarily be able to strike the right level unaided by knowledge of conditions in the schools. If his personality and specialist knowledge are to make their impression on the children, he must have collaboration both at the studio end and in the class-room.

| The nature of this collaboration calls for expert research work, and the Central Council has therefore set up a number of subject committees which allow specialists in various subjects, educational administrators and broadcasting experts to pool ideas with teachers who are experimenting with broadcast lessons in their schools.

These committees are responsible for examining the place and value of broadcast lessons in relation to the teaching of the several subjects of the curriculum. They make recommendations as to the engagement of broadcast teachers, and they scrutinise in detail the material submitted by the latter both for the lessons and the pamphlet which accompanies them. To them also is submitted every criticism received, in order that its relevance may be considered, and suitable action taken.

| That such committee work is valuable is readily admitted by all concerned. Experience has shown the difficulty of knowing beforehand what will make a successful broadcast lesson and what will not, that is, what will

actually interest and stimulate the child listening in class to a loud-speaker. Yet some measure of certainty is desirable before broadcasting is adopted as part of the official educational system of the country. It is hoped that, from the evidence now being amassed as the result of the subject committees' investigations, conclusions may be drawn which will so materially increase the proportion of successful to unsuccessful broadcast lessons that no school will feel justified in depriving its pupils of the chance of profiting by them. In the first instance it must be decided what subjects lend themselves to treatment by broadcasting. Can you stimulate a child's interest in arithmetic by broadcast talks? Probably not. Can you direct practical experimental work in biology or physics by microphone? Again, the chances of success are small. But what about music? Watch a child's response to Sir Walford Davies. And geography? Formal geography from a loud-speaker would make dull hearing. The class teacher with his diagrams would undoubtedly secure more attention. But there is more to learn about the world than text-book facts and figures. By means of wireless Alan Sullivan's voice may suddenly fill the school-room, telling of his own visits to the Eskimo; Captain Finch can come to describe the Everest Expedition; Clifford Collinson will take you with him to his Cannibal Island; Ernest Haddon will tell about the Pigmies. Such travellers' tales, in the ordinary way, would be quite inaccessible to nine-tenths of elementary schools. In geography the place of the broadcast is easily proved.

In this way the committees are working through the subjects taught in the schools, allotting the broadcasting time placed at their disposal to those subjects which seem most suitable, experimenting perhaps with others in which the suitability has yet to be demonstrated, and discarding altogether those in which they are convinced experiment would prove merely waste of time. Having chosen the subject, the aim and scope of the course has then to be defined. With this is bound up the question of the place the course is to take in the school time-table. Is it to be supplementary to a concurrent school course: is it to be the basis of the school course: is it to figure as an extra only? Finally, a great amount of research work must be done, with the

assistance of teacher members, on the nature and extent of the collaboration between the specialist teacher at the microphone and the class teacher in the school.

| The subject committee for history has already collected a considerable body of evidence regarding broadcast history lessons, and this has been issued by the Council as the first of a series of inquiry pamphlets, published for circulation to educational organisations with a view to ascertaining how far the value of the lessons may be taken as proved. While the evidence is not to be regarded as conclusive, it is hoped that its publication may result in a greatly extended use of the lessons throughout the country.

| The reorganisation of elementary education at present taking place in England is opening the door, as never previously, to experiment with new methods. Already many of the most prominent educationists have recognised that the resources of broadcasting offer an exceptional means of enriching the curriculum in the new senior schools, and of broadening the horizon of the adolescent boy and girl before the end of their school life.

| The machinery of the Central Council is inspiring confidence both in teachers and educational administrators to such an extent that it is now believed that the end of the period during which school broadcasting, in common with all other new things, is regarded with uncertainty, is probably already within sight.

AN AMERICAN ON BRITISH BROADCASTING

An extract from Chap. I of "Science and the New Civilisation," by Prof. R.A. Millikan of the Michigan University:

. . . But the programme that is on the air in England is incomparably superior to anything to be heard here, for the B.B.C. provides the public of England with the largest return in education and in entertainment for eight mills a night ever provided, I suspect, anywhere in the history of the world. For it employs only high-class speakers, musicians, and entertainers of all sorts, so that the whole British nation is now being given educational advantages of the finest possible sort, at less than a cent a family a night, collected only from those who wish to take advantage of them.

THE DEVELOPMENT OF ORGANIZED LISTENING

THE past year has seen a steady growth in the number of discussion groups organised in connection with series of wireless talks. In the autumn of 1929 there were 218 such groups; in the spring of 1930 there were 349. In the summer the counter-attractions of fine weather and long evenings caused an inevitable falling off, followed, however, by a still greater increase in numbers in the autumn. This development is due both to the increased interest taken in wireless as a medium of adult education by local education authorities, universities, and voluntary bodies, and to the increased scope of the work undertaken at the listening end by the Central Council for Broadcast Adult Education, particularly through its Area Councils and local committees. In the construction of a new public library at Burnley, special arrangements are being made for the accommodation of listening groups, and a grant has been made for the installation and upkeep of wireless apparatus. Special provision for group listening is also being made in the house at Garstang which has been purchased by the Lancashire Education Authority for the establishment of a rural community centre. These are two striking examples of the recognition now being given to the possibilities of the educational work of the B.B.C.

The Central Council, now working under the chairmanship of the Archbishop of York, has settled down to its dual task of directing the educational part of the programme, and furthering the follow-up work at the listening end. It is in the latter function particularly that it has received important assistance from its Area Councils and local committees. Area Councils have now been formed in the West Midlands, the North-West (Lancashire, Cheshire and Westmorland), Yorkshire, and the West (Wiltshire, Somerset and Gloucestershire); in addition, local committees have been formed in Kent, in Plymouth, and in the area covered by the Scottish Experiment (Lanark and Dumfriesshire). Each of the Area Councils has been formed in response to a definite local demand,

and it is in these areas particularly that the number of discussion groups is growing.

No description of this work would be complete without mention of the generous assistance which has been given by the Carnegie United Kingdom Trustees. Grants have been made in aid of experiments in the West Midlands, Yorkshire, Kent, and Scotland (Lanarkshire and Dumfriesshire). In Kent an experiment has already run for over a year, and the Organising Committee have submitted an interim report, containing much interesting evidence, to the Central Council. In the West Midlands also much useful work has already been done, while in the other two areas the work has only lately been undertaken.

The report of a discussion group at an evening institute, printed on pp. 240-1, is a typical one. Perhaps the most important and interesting point about it is that the members of the group were not content with listening to the talks and discussing them, but rather stimulated to further study by reading. Several Public Librarians have collected evidence of the influence of broadcast talks on their book issues, and others are now regularly organising discussion groups on their premises. A large Public Library in the North recorded the following interesting figures, which show the number of books recommended in the B.B.C. Programme of Broadcast Talks which had been issued from the library within a period of twelve weeks.

Subject.	Philosophy.	Religion.	Sociology.	Philology.	Science.	Useful Arts.	Literature.	History.
Total number of books mentioned in broadcast talks	31	37	80	62	39	81	27	116
Total issues of these books from the city libraries	80	119	289	124	97	328	93	386

Many other librarians have given evidence of the encouraging effect which broadcasting has had on their non-fiction book issues.

Besides the organisation of discussion groups, other



Fox

IMPROMPTU "GROUP LISTENING"

Hearing the commentary on the Derby while travelling in the Restaurant Car of an Express Train

interesting experiments in "follow-up" work have been or are being attempted. During the exhibition of Italian pictures at Burlington House, a series of talks was given by Mr. S. C. Kaines Smith on Italian Painting. A special supplement of pictures from the exhibition was published in *The Listener*, and throughout the series Mr. Kaines Smith gave the Exhibition Catalogue number of each picture which he mentioned. In this way many of those who visited the exhibition were able to do so with their interest heightened by the talks to which they had listened. In the summer a series of talks was given on "To-day and To-morrow in Architecture." Two of the speakers in this series, Mr. Maurice Webb and Mr. Howard Robertson, offered to arrange a lecture with lantern slides of buildings about which they had been talking. Over 200 listeners applied for tickets and attended the lecture. Again, in the autumn of 1930 Sir James Jeans gave a series of talks on "The Stars in their Courses." In connection with these talks, the Director of the Science Museum, South Kensington, arranged a special illustrative exhibition in the Entrance Hall, which was on view throughout the period of the broadcasts. Similar co-operation has been arranged

with museums in the provinces, and it is probable that "follow-up" work of this sort will play an increasingly important part in the educational activities of broadcasting.

One of the most interesting developments during the past year has been the number of meetings for group leaders organised by Councils and local committees. Day schools have been held in Maidstone, Birmingham, Manchester, and Bristol, at which group leaders have come to discuss difficulties and to criticise the programme and make suggestions for the future. This has proved probably the most effective means of co-operation between those who are responsible for programme building and those who are trying to make effective use of the programmes through organised listening.

The training of group leaders is also being considered. Following on the week-end school organised at Hull University last year, the Central Council made grants for twelve students to attend the Summer School at Coleg Harlech for a week, during which they had practice in the art of group leading, and studied the whole question of the organisation of wireless discussion groups. Arrangements have also been made for similar classes at one of the W.E.A. Summer Schools in Yorkshire.

The result of this increased co-operation and of the reasoned criticism and discussion which it has made possible will, it is hoped, have a definite effect on the programme itself. In response to a strong demand, efforts are being made to include a certain number of series of a really elementary nature, which will demand no previous background of knowledge on the part of the listener. Differentiation of objective and standard will be clearly stated in the published programme of broadcast talks, so that the organisation of a discussion group will no longer be such a step in the dark as it has too often been in the past. It has become increasingly clear that the majority of listeners are not interested in purely academic subjects, but only in matters which can be related to their own experience. This principle has been closely considered throughout the planning of the autumn programme, with the result that nearly all the series of talks, on whatever subject, are concerned with the present and the future rather than with the past.

MAKING WORK

THE REPORT OF A LISTENING GROUP IN

Two young machine-minders at a large motor factory in the district had attended the Central Technical College during two sessions to study mathematics and drawing to fit themselves for promotion. Each session they had failed to stand the pace and had been compelled to give up. Last September the Principal of the College suggested them attending the Evening Institute where more individual attention might be possible. They made slow but steady progress until, owing to various causes, the classes were closed.

The following week these young men came to talk over the difficulties the "machine-minder" experienced in the large factories and to ask for suggestions as to subjects of study to fit them for promotion *if it ever came*. Both felt that they had rotten jobs—jobs that "any fool could do to satisfy the boss (the foreman)"—and both felt that intelligence and ambition were useless in the production shops. They had lost interest and were fed-up with their work!

The next evening one of them (22 years of age) came again with the request that assistance be given to form a discussion group for young "production workers." The series of talks by Professor Pear on "Making Work Worth While" was to begin the next Tuesday. This man suggested that his group should be formed round these talks. The difficulties were discussed and finally he was offered the use of room and apparatus and told to carry-on.

The Tuesday came, and W— and his friend A— arrived an hour before the talk to see that all was prepared. They provided scribbling pads and pencils for note taking, and the head teacher had a copy of the *Aids to Study* pamphlet and *The Listener* for the eighteen young men who were expected. Copies of as many of the suggested books as were available in the city libraries had been obtained and were ready for reference and inspection. (These were returned next day and were available for issue from the local branch library).



W O R T H W H I L E

AN EVENING INSTITUTE IN THE MIDLANDS

Fifteen young men, all "unskilled" workers in the engineering industry, came in. The set was switched on, and at the request of W— they were left in the room alone. At 9.30 they were still engaged in discussion. At 10.0 they had to be asked to postpone the discussion until the next week.

The following Friday W— came again to talk over his plans. "May they smoke?" "Do you think you could get a foreman from another works to attend the group?" "Can a list of *easy* books on the subject be provided?" Yes, these could all be attended to!

The group continued with regular attendance of eighteen members. The discussion was enthusiastic and general. The depth to which they delved and the amount of reading done were surprising.

After a month, the library loan of the suggested books was withdrawn. Study and reading waned therefore. After one of the talks the group asked for additional information respecting the vocational guidance and selection tests mentioned by Professor Pear. An Assistant Organiser of the Juvenile Employment and Welfare Department was approached, and a demonstration of the apparatus and a short lecture was arranged. But this must not interfere with the talks!

The series was concluded and the lecture was given. But this was not the end of it. Not a week has passed without a visit from one or two of the group to ask for reading or study guidance, or to put up some new problem. They have had meetings in the homes of the members, but wish to come back to the class room next winter. . . . "It's too casual, and we ramble from the subject when we are at home." But best of all, they say that they find the same job more interesting than before, and that the "unskilled" job is really skilled.

THE NEWS BULLETINS

THE supply of a news bulletin is one of the many obligations which accompany broadcasting, for it is inevitable that some part of the programmes should be devoted to news. The public is naturally anxious to know what is happening in the world, and although the supply of news is mainly the task of the Press, there are certain duties which only a broadcasting service can accomplish. There is the task of sending out news which arrives too late for the evening papers; and there is the task of supplying a brief account of the day's events to people who live beyond the range of late editions of evening papers, or live in remote districts where even their morning paper arrives at a late hour. There are also some special services which will be mentioned later.

The general aim of the B.B.C. news bulletins is to give a summary of the most important events of the day. It is obvious that this summary must have widely different values for the various classes of people who hear it. For the listener who has thoroughly read and digested his evening paper the main interest of the bulletin must lie in those items of news which have arrived shortly before the bulletin is read; for the listener who has merely glanced through an evening paper the bulletin may serve to direct his attention to events which he has possibly failed to notice; while for the listener who has not read an evening paper at all the bulletin will naturally reach its maximum value. On a day when most of the important happenings have occurred in the morning or early afternoon it is beyond doubt that some listeners will find the news bulletin a repetition of what they have already seen in the Press; but by a fortunate dispensation of Providence such days are few, and even the most diligent students of evening papers can generally find in the bulletins—particularly in the second—news which is really “new.”

Something should here be said about the distinction between the first and second news bulletins. The material for the bulletins is supplied by four agencies—Reuter's, the Press Association, the Central News and the Exchange Telegraph Company—whose “tape” machines disgorge their varied treasure into the News Room all day. From



A MAP OF THE AREAS ALLUDED TO IN THE DAILY SHIPPING FORECASTS BROADCAST FROM DAVENTRY (5XX)

these sources, with the addition of Parliamentary and sporting news specially supplied by Reuter's, the editorial staff prepares the bulletins, ignoring the merely sensational items and striving to keep a strictly non-Party attitude in all political matter. The best of the material which comes in during the day-time is incorporated in the first news bulletin, which is broadcast at 6.15 p.m.

The preparation of the second news bulletin presents a problem, for it has to be remembered that some listeners hear both bulletins, while others hear one only. The aim of the second bulletin, therefore, is to give as much new matter as possible, while retaining (often with new details) all the most important items which have been given in the first bulletin. The relation between the two bulletins is something like the relation between the first and last editions of a newspaper; and anyone who has ever compared the early and late editions of a paper will know that they are, in many ways, two different compositions. In the same way the first and second general news bulletins are different compositions.

As for the actual arrangement of the news, it is easy to see that the editor of a wireless bulletin has special problems which do not confront the editor of a newspaper. In filling his pages with widely varied material, a newspaper editor knows that his readers can turn at once to the pages which interest them most; but the editor of a wireless bulletin knows that his listeners must hear the whole of it, unless they are to run the risk of missing some particularly interesting news. His task is to try to make the bulletin a dish which can be swallowed whole, and this is a difficult ideal to attain. Whatever ingredients are put into the bulletin and however they are mixed, there will always be listeners who complain that it does not suit their individual digestions. The racing man complains that more time should be given to the turf; the golfer wants fuller accounts of golf matches; the student of monetary affairs pleads for a daily record of foreign exchanges; and the student of Indian politics demands that Indian news should always come first in the bulletin. It is impossible to grant all the requests that reach the B.B.C. in the course of a year, and it is plain that the only criterion for a bulletin is the actual importance of

world-events, whether they come in the category of sport or of general news.

Some of the particular interests of listeners are covered by the Regional news bulletins, which give news of local importance, and by the special services. These include the weather forecasts, the shipping forecasts, and the gale warnings (all supplied by the Air Ministry); the London Stock Exchange report and the Wall Street summary; the bulletin of Fat Stock prices and the weekly "Market Prices for Farmers" (supplied by the Ministry of Agriculture and Fisheries); the official Road Reports, supplied by the Automobile Association at times when special information is of great value for motorists; police notices of traffic arrangements for events like the Royal Tournament, the Ascot Races, etc.; and the time signals.

The B.B.C. also issues warnings to intending holiday-makers. Among these are the requests for keeping the countryside free from litter, for the proper treatment of wild flowers, for the observation of maxims of "Safety First," and for making provision for pets during holidays.

Such services may be regarded as superfluous by some listeners, but to others they are undoubtedly useful; and it is only right that they should be broadcast when feasible.

But that question of feasibility is not to be lightly dismissed; for if all the requests for particular announcements and particular items of news were granted, the bulletins and the special services would occupy the greater part of the broadcasting programme. And that, in the end, would please no one at all.



HOW THE S.O.S. SERVICE WORKS

FOR most listeners who are not directly concerned, the broadcast S.O.S. message contains a strong dramatic element, and suggestions have been made that the detailed results of such messages should be made public through the microphone each week or each month. The B.B.C. cannot, however, regard the messages in the same light. They are, in general, the "urgent private affairs" of people who, in the last resort, are forced to make their anxieties public. It is true that in many cases the messages finally reach the addressees in strange circumstances, and that the details of the trouble taken by complete strangers to pass on these messages to the proper quarter would be valuable evidence for a royal commission on "The Inherent Kindliness of Human Nature"; but they are hardly suitable for broadcasting as entertainment.

To those who deal with the S.O.S. service, one of the most interesting cases was that in which a man installed his first wireless set one day and heard a message directed to himself the next evening. Experience shows, however, that it is not necessary for the person sought to be a listener. Even if he is a persistent hater of wireless, the S.O.S. message has every chance of reaching him. Recently, some ten minutes after a message had been broadcast asking for a man whose address had been unknown for two years, a listener telephoned to Savoy Hill and asked for the message to be read through to him. When this was done, he said that he had no doubt that the person sought was living two houses away from him and had no wireless set, and that he would inform him at once. The identification was correct and the message quickly reached its destination.

Apart from the messages directed to relatives of those who are dangerously ill and the police messages, which deal with missing persons, accidents, and identifications, there are occasionally unusual cases. There was the case of the doctor who found that a prescription had been inaccurately made up and that it was urgently necessary to warn the patient to whom the medicine had been given. Since the address of the patient had been lost, a message was broadcast. In such cases, in particular, the B.B.C. treats the matter as the "urgent private affair" of the

persons directly concerned, and the story behind a carefully worded broadcast message is treated as a strictly confidential matter.

From the rules printed in the Reference Section it will be seen that the S.O.S. is only broadcast in cases of real urgency—in illness, where it is a matter of life and death, and in the case of missing persons, when the police authorities are satisfied that the assistance of the public is specially desirable. The number of applications which have to be refused are numerous, and sometimes it is difficult to treat the requests with the same seriousness which animates those who make them. More than one lady has desired a message to be broadcast for an umbrella left in a London tube train, and a pet bird called “Billy Boy” in addition to causing its owner serious anxiety by its absence, gave the B.B.C. a great deal of trouble when it came to convincing the owner that a message on the subject could not be broadcast to the listening public. During the past year two men have desired to broadcast messages designed to obtain for them matrimonial partners (the description of the qualities essential in a good wife, which accompanied one application, would have been most amusing and instructive to our listeners), and one lady pressed the B.B.C. most strongly to broadcast for a dancing partner to replace a defaulter on the same evening.

Of every five applications, approximately four do not fall within the B.B.C.’s rules and have to be refused. The work of dealing with applications is very heavy. Every application which falls *prima facie* within the rules, necessitates a number of questions being put to the applicant, usually by telephone, to verify its urgency and collect all details which may be of value in compiling the message. Then the medical attendant or hospital must be telephoned to in order to confirm that the patient is “on the danger list.” Fortunately the public, and particularly the medical profession, are becoming more aware of the requirements of this service, and it is now the exception rather than the rule to find that the patient is suffering from a purely temporary and far from serious indisposition.

The care with which the verifications are carried out, together with the great honesty of the public as regards points which cannot be absolutely verified on the spot

(e.g. that all other means of communication have failed), have resulted in the B.B.C. being able to say that, since the day on which the S.O.S. service was instituted, there have been, so far as can be traced, only two cases in which it has been seriously abused. Were this not so, the S.O.S. service would soon cease to be valuable.

THE RESULTS

The number of S.O.S. messages of all kinds, including police messages, which are broadcast in a year is between 850 and 900. The percentage figures of successes in 1928 and 1929 were almost identical:—42 per cent. successful, 53 per cent. unsuccessful and 5 per cent. result unknown.

Success naturally varies in different categories of messages. A little over half (52 per cent.) of messages calling relatives to the bedside of persons dangerously ill are successful. Just under half (46 per cent.) of the police messages seeking witnesses of accidents produce results, but only 19 per cent. of the messages directed to tracing persons who are missing attain their object.

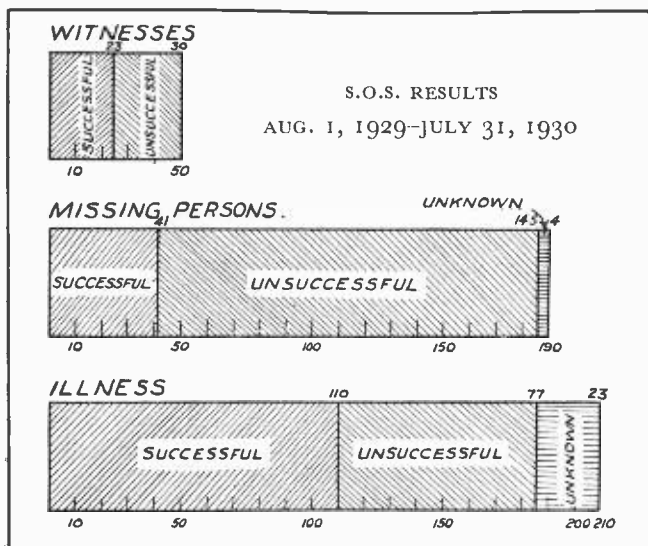



TECHNICAL
SECTION

TRANSMISSION
STUDIO AND LINES
RECEPTION
INTERNATIONAL

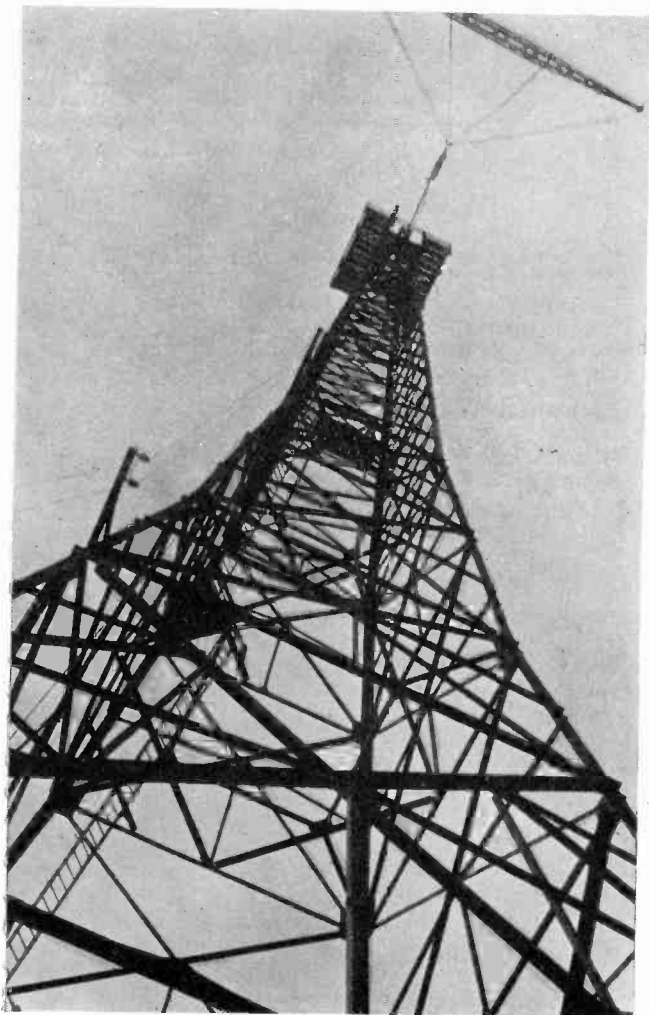

ONE OF THE FOUR AERIAL MASTS AT BROOKMANS PARK

TECHNICAL PROGRESS

FROM the point of view of the technical development of broadcasting in a general sense, the past year has been an exceptionally important one, since it was on March 9th, 1930, that the first Regional Station began a regular service of alternative programmes. This station, which serves London and the South-East of England, has radiated dual programmes for some six months—a sufficient time for much experience to be gained. Technically, as well as from the programme angle, this period has been of a pioneering nature and therefore of the greatest interest to all engaged in broadcasting, since this is the first station of its kind in Europe. It is satisfactory to be able to record that the remaining stations will follow the original design very closely, the only modifications being merely improvements in detail.

The progress of the Regional Scheme, however, is not confined to the opening of the new London Station. Some months before the latter was finished, work had begun on a station to serve the North Region. It stands on the hills above Slaithwaite near Huddersfield; at the time of writing the buildings and masts are nearly finished and the installation of the plant is progressing as rapidly as possible (see p. 254). In Scotland a site has been chosen at Westerglen, on the Falkirk-Slamannan Road, while tests of various sites are being made for a station to serve South Wales and the South-West of England.

While a new type of transmitting station is being gradually introduced, the important question of scientifically designed studios has been by no means neglected. The new B.B.C. headquarters in Portland Place will contain some 20 studios, ranging from small ones for talks and news, to a hall capable of accommodating an audience of a thousand in addition to a full orchestra and chorus. The problem of correct acoustic properties for studios intended for the many different types of programme has, for years past, been a most difficult and indeterminate one. Recently, however, scientific work of a quantitative kind has been undertaken which it is hoped will make it possible eventually to design studios without any more doubt as to the final result than exists in the case of a

transmitter. Important as it is, the acoustic problem is not the only one in connection with studio design, and it has been necessary to study modern methods of ventilation, involving the supply of an automatically regulated flow of "conditioned" air, as well as various methods of preventing sound from penetrating from one point in the building to another. Too much care cannot be taken over sound insulation when so many studios are contained in a comparatively small space and several programmes have to be produced simultaneously, free from mutual interference.

Again, the problem of the control of programmes from the electrical point of view has been investigated in relation to the increased programme activity which will exist in the new building. Methods which were satisfactory for the comparatively simple conditions existing only two or three years ago, are hopelessly cumbersome when applied to the complicated programmes which are produced today. In this connection it has to be remembered that accommodation has to be provided not only for the actual programmes which are heard by listeners, but for a much greater number of rehearsals and auditions, practically all of which require microphones and loud-speakers.

Turning to what might be called the less obvious activities, there is considerable progress to report in the relaying of Continental programmes by cable telephone lines. Successful programmes have been transmitted from Austria, Germany, and Belgium, the quality of which has, in some cases, been indistinguishable from local transmissions. This improvement has been due partly to the gradual introduction of new high quality cables on the Continent, and partly to close liaison with the technicians concerned, particularly as to the actual control of volume at the originating point and at the various repeater stations.

Finally, it must be recorded that a great advance has been made in the transmission of stage performances, particularly Grand Opera. Progress of this kind can only be achieved by patient experiment and by the skilful handling of a number of microphones, placed in positions which are often very difficult to find. Much other work is in progress and the above can only serve as a brief review of some of the more outstanding activities which have already been rewarded by successful results.

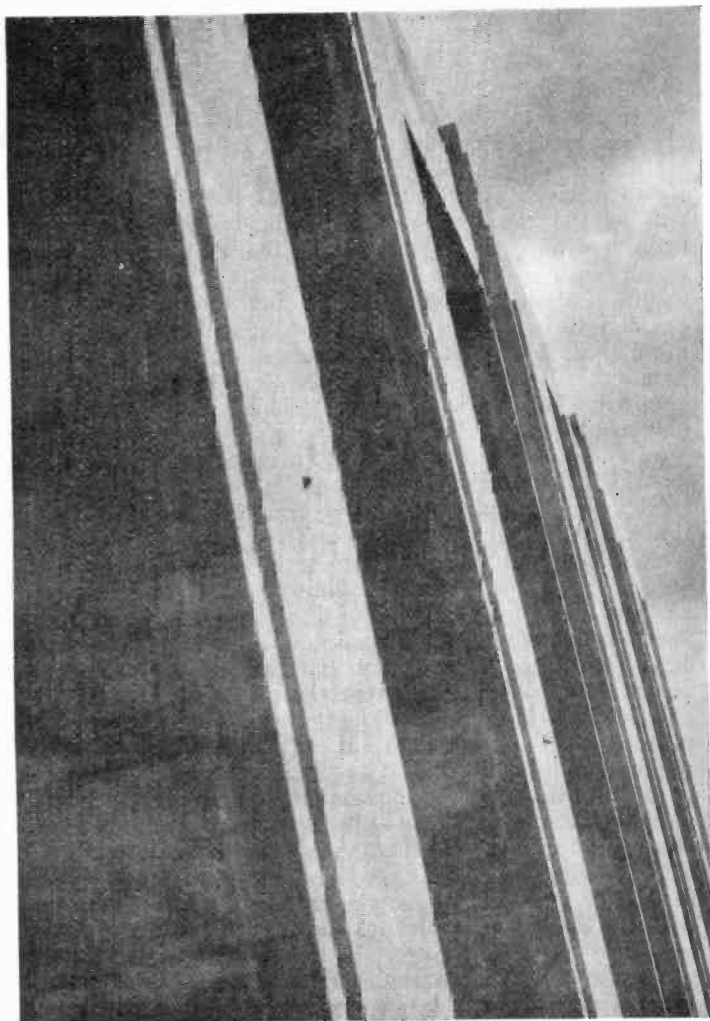

A VIEW OF THE MASONRY OF THE BUILDING HOUSING THE TRANSMITTERS
AT BROOKMANS PARK

THE NORTH REGIONAL TRANSMITTING STATION

IN order to serve the highly important districts on both sides of the Pennine Chain it was necessary to find a site for the new station high up on the hills themselves. At first it was difficult to find land which was at the same time suitable for building and free from screening by neighbouring hills. Various sites were tested with a transportable transmitter, all within a radius of about ten miles of the point where it had been decided to begin the search. One or two of these were more than 1400 feet above sea level. Eventually it was found that a flat piece of land some 31 acres in extent, about five miles west of Huddersfield and a mile and a half north-west of Slaithwaite, gave the most favourable results on test. On the ordnance map the actual spot on which the station is being built is marked "Moorside Edge," and for this reason it is sometimes referred to by that name. However, the station itself is to be called the North Regional Transmitting Station. Those who are familiar with this part of the country will realise that the weather conditions are likely to be unusually severe and far from ideal for the construction of buildings and masts. It is hardly necessary to say that this was realised long before the work began; nevertheless, the exceptional rain and snow of last winter did interfere with the progress rather more than was expected. However, it is far better to face the difficulties of an exposed site of this kind than to sacrifice the ultimate performance of the station.

By now the work is very well advanced, and by the time this book appears the station should be approaching completion. The building will stand at a height of a little over 1100 feet above sea level, and with the masts will be a very conspicuous landmark for some miles round.

The London Station having fully come up to expectations of performance, it was decided to proceed on very similar lines for the North Regional Station. Naturally it has been possible to introduce a considerable number of improvements, but the most important difference is the



MOORSIDE EDGE

A general view of the site in the earliest stages, when the foundations were being laid

height of masts. In the North the Government restrictions which limited their height at Brookmans Park do not apply; consequently there will be three masts each 500 instead of 200 feet high. They will be of the stayed type instead of "self-supporting," on account of the greater height, and each stay will be divided into certain specified lengths by insulators. Each mast itself will be insulated from earth at the base by porcelain insulators standing on a concrete base. The object of this insulation is to prevent "mast shadow" and maintain as far as possible symmetrical radiation in all directions.

There are certain additional innovations in this station which are in the nature of improvements, or have been necessitated by different conditions of working. One of them will be a reservoir for the storage of water, capable of holding some 200,000 gallons. A high-power wireless station of this type consumes up to a maximum of nearly 10,000 gallons of water a day, and it was found necessary to take this precaution to guard against a severe drought such as that which occurred in the summer of 1929. However, the reservoir will serve a double purpose, since it will be used in connection with the cooling plant for the water-cooled power-valves used in the transmitters.

Owing to the altitude it is necessary also to take special precautions against frost and to ensure that the Station will not be put out of action by a coating of ice on the aerial wires. To obviate this danger the aerials will be so designed that a strong current can be passed through the wires, heating them sufficiently to melt any ice or snow which may be adhering to them when the station is being prepared to start up in the morning.

It has been necessary to reconstruct part of the roadway leading to the station, since it must be possible to deliver heavy machinery during construction, as well as some 600 tons of fuel oil per annum when the station is in operation.

A full description of the plant at Brookmans Park appears on p. 269, and applies to this station also with the exceptions already mentioned, and a few other comparatively unimportant differences.

The North Regional Station will use the wavelength of 479 metres (626 kc/s) for its Regional programme and

301 metres (995 kc/s) for the National programme. Tests will begin on the longer of the two wavelengths. It is impossible to forecast an exact date, but ample notice will be given. The process of changing over the service from the present group of low-power stations to the new high-power station will be a gradual one. At first experimental transmissions will be made outside programme hours altogether. After a short time, part of the evening programme will be radiated from the new station, and as soon as evidence is forthcoming that listeners generally have adjusted their sets to the altered conditions, the complete change-over will be made.

It is fully realised that for those who possess valve sets and those receiving greater strength from the new station, the gradual "slide-in" is bound to be, to an extent, unnecessary and even irritating. Although such people will be largely in the majority, nevertheless, the minority will be considered, and it is inevitable that those who live within a mile or two of the existing transmitters must experience reduced strength, in spite of the vastly greater power of the new transmitters. For some listeners it will be necessary to erect an outside aerial where none exists at presents; others may need to improve their existing aerial, and so on. The B.B.C. will be only too glad to give advice when asked, and pamphlets are being prepared which attempt to give information concerning all likely difficulties.

The shorter of the two wavelengths radiating the National programme will not be introduced until after the station has been working for some weeks as a single programme station on 479 metres. When the time comes the sliding-in process will be repeated, giving listeners the opportunity of adapting their sets to the altered conditions, where necessary, with the least possible inconvenience. This station has been given the most effective wavelength in the "medium band" which this country possesses, and the site which has been chosen allows the greatest use to be made of it. Listeners in the North Region will realise, therefore, that every possible effort has been made to contend with the particular difficulties which are caused by the mountainous nature of the North of England.



THE BATTERY ROOM AT BROOKMANS PARK

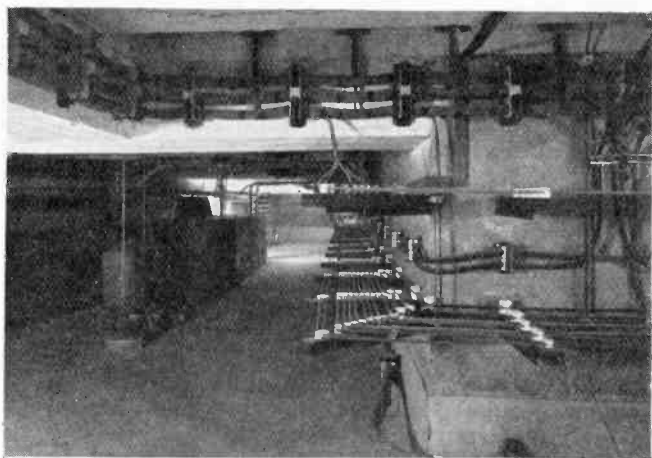

THE VAULT AT BROOKMANS PARK, SHOWING THE CABLE DUCTS

A description of the above illustrations will be found on pp. 274 and 276

SIDEBANDS AND HETERODYNES

WHEN listening to your wireless set at night you may hear a noise like a grasshopper "chirping." You may also have heard a faint noise like high-pressure steam escaping from the safety valve of a locomotive some distance away, the sound coming and going from time to time. A friend with some knowledge in these matters will perhaps tell you that the "chirping" sound is caused by sidebands of a distant station heterodyning with the carrier wave of the station you are listening to, and the "escaping steam" sound by just a heterodyne between the two stations. This will still leave you mystified. "What are sidebands, and what is heterodyning?" you will say.

Your *Radio Times* or daily paper will tell you that the wavelength of the London National transmitter is 261.3 m. or 1,148 kilocycles per second. This means that there are 1,148,000 oscillations per second transmitted from the aerial, the oscillations being known as the carrier wave. The frequency should remain steady under all conditions.

When this carrier wave is modulated by speech, music, or any other sounds, its amplitude or strength is varied in sympathy with the speech or music. For example, at a certain instant the music may consist of a pure tone having, say, 500 vibrations per second. In this case the carrier will be varied in strength 500 times per second. A more complicated sound will, of course, modulate the carrier wave in a more complex manner. This is not quite so simple in practice as it might appear.

In the process of modulation other waves are produced having frequencies slightly different from the carrier frequency. The difference is equal to the frequency of modulation. In the case of the note of 500 vibrations or cycles a second, two additional waves are produced, one 500 cycles above and one 500 cycles below the carrier frequency. The carrier wave itself does not (or rather should not) change in frequency. As the three waves are present at the same time the resultant will be a complicated wave. The mean or average frequency of the wave will be that of the carrier, while the resultant amplitude will be found to vary 500 times a second. We see,

therefore, that by the complicated process of modulation we produce in effect a wave having the carrier frequency which varies in amplitude in sympathy with the modulation, but is in fact composed of a number of waves. Actually, a number of other waves may be produced, but steps are usually taken to prevent these from being radiated, as they are not required.

Speech and music consist of a large number of different notes having frequencies between about 16 and 16,000 vibrations or cycles per second. In broadcasting it is usual to employ frequencies up to about 8000 or 10,000, and in some cases only up to 5000, although better reproduction would result if all the frequencies were used provided the loud-speaker and receiver could respond to them all. There are technical and economic reasons why this cannot be done, however.

In the process of detection (which is sometimes called rectification or demodulation) the sidebands and carrier combined are passed through a device called the detector, where they are reconverted into the original acoustic frequencies, equal to the differences between the sideband and the carrier frequencies. It is these which constitute the low frequency currents to be subsequently amplified and passed into the loud-speaker for re-conversion into sound waves. In addition, a number of other frequencies are produced, but these can be neglected in this discussion.

To sum up, let us take a particular example. We have a carrier wave of 1,000,000 cycles per second (300 metres) which is modulated by an audio frequency of 5000 cycles per second. After the process of modulation we have a carrier of 1,000,000, a sideband of 995,000, and a sideband of 1,005,000 cycles per second. These three waves arrive at the detector, and after rectification will have combined to produce a single vibration of 5000 cycles per second.

Fig. 1 shows the wave form of a violin note, the sidebands obtained when a carrier has been modulated, and how the sidebands and carrier combine to form a high frequency wave whose amplitude is varied in sympathy with the violin note.

We see, therefore, that any combination of oscillations applied to a detector will produce other oscillations whose frequencies are the differences between the frequencies of

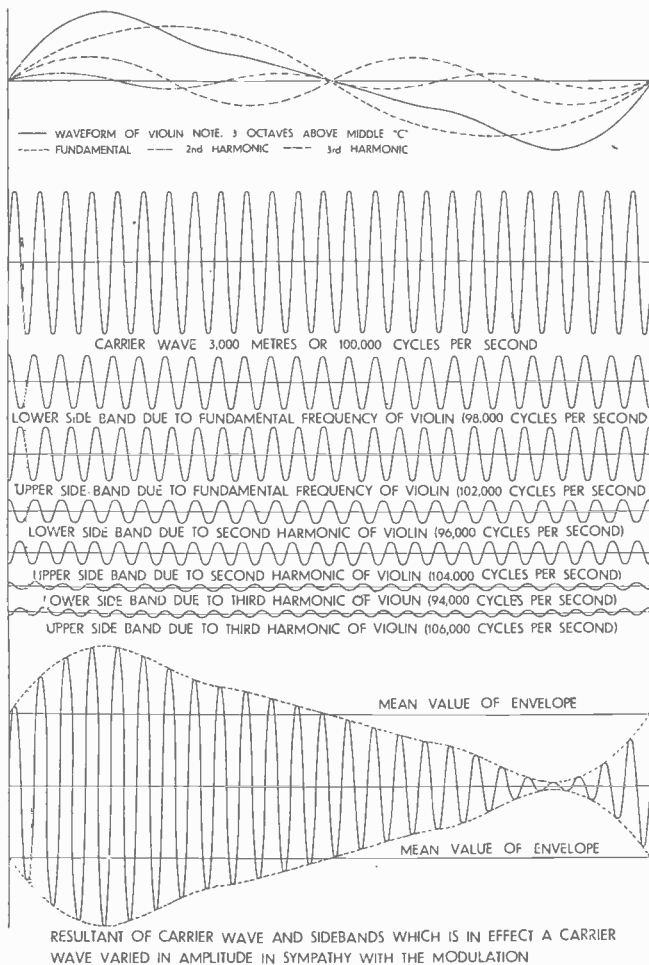

FIG. I

the oscillations applied to the detector. For instance, if an oscillation of 1,000,000 cycles per second and another of 1,009,000 cycles per second are both applied to a detector we shall produce, after rectification, an oscillation having a frequency of 9000 cycles per second. This is usually referred to as a heterodyne note. Thus, if another broadcasting station has a frequency 9000 cycles different from the one you are listening to, and your receiver is sufficiently flatly tuned to respond to this frequency as well as the station you are listening to, you will hear in your loud-speaker or telephones a note having a frequency of 9000 cycles. This is the note referred to at the beginning of this article as a noise like steam escaping from a boiler. When the other station modulates, it sends out sideband frequencies as described above. One set of these sidebands may have any frequency between that of the interfering station's carrier wave and the local carrier wave. The response of a receiver usually falls off rapidly above frequencies of the order 5000 cycles different from the carrier wave, consequently the receiver will have more response to one set of the sidebands of the interfering station than to its carrier. These sidebands heterodyne or combine with the local carrier, and are rectified to produce notes having a frequency which is the difference between the local carrier and the particular sideband frequency. As the audio frequencies most commonly encountered in the transmission of speech and music are below 3000 cycles per second, most of the sideband frequencies will be within 3000 cycles of their own carrier; consequently they will be different in frequency from the neighbouring carrier by 6000 to 9000 cycles. We shall therefore hear a number of notes of very high frequency which are varying all the time. These notes are referred to at the beginning of the article as like the chirping of a grasshopper.

Fig. 2 shows the intensity of speech and music with various frequencies. The average intensity of sidebands and low sideband interference from a distant station is modified by receiving circuits.

When a station over-modulates, the sideband frequencies are very strong; also another set of sidebands is produced whose frequency difference from their own carrier is double or treble, etc., the normal frequency difference. Conse-

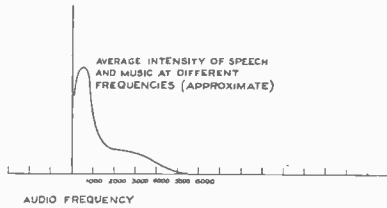
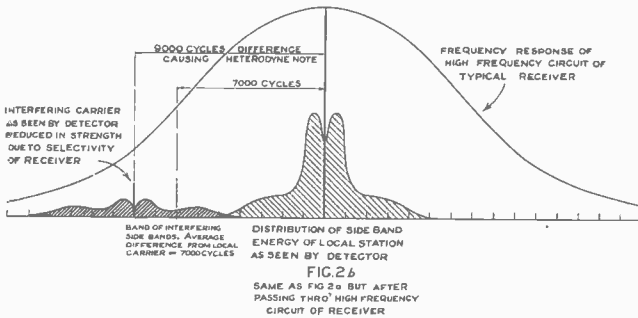
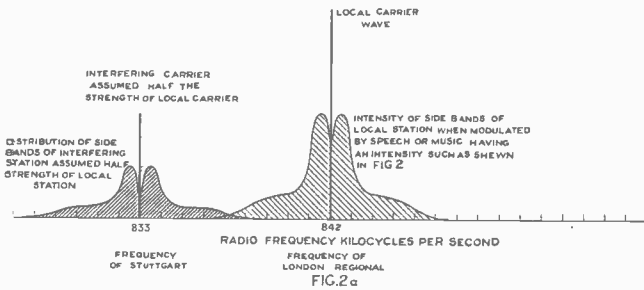

FIG. 2



FIGS. 2, 2a, AND 2b

quently these new sidebands will be nearer in frequency to that of the carrier wave of the adjacent station in the wavelength plan, and will produce lower-pitched notes which will be more easily audible due to the increased sensitivity of the receiver, the loud-speaker, and the ear at the lower frequencies. These new frequencies will be mostly round about 5000 to 7000 cycles.

From the point of view of quality and complete freedom from all interference it would be necessary to arrange broadcasting stations at least 30,000 cycles apart.

Two bands of frequencies are available for broadcasting, namely, 550 to 1500 kilocycles and a small band of lower frequencies from 160 to 224 kilocycles. The first of these has become known as the medium wavelength band and the other as the long wavelength band. As the main frequency band available for broadcasting is from 545 to 1500 kilocycles per second (545,000 to 1,500,000 cycles per second), the number of broadcasting stations which can work in it depends upon how far apart they are in frequency. As the range of frequencies is 955,000 cycles we can get only 48 stations if the separation is 20,000 cycles, 96 stations if the separation is 10,000, and 107 stations if it is 9000 cycles, as at present.

The distance or range to which stations on broadcast frequencies can give a really satisfactory service is very limited, and consequently it is necessary to have a large number of stations if a complete service is to be given. We therefore have to sacrifice a certain amount of quality, which is certainly not very noticeable on most receivers, and we still have left the undesirable and unpleasant heterodyne note. This can be eliminated in three ways:—
(1) by very sharp tuning of the H.F. circuits, which is bad for quality; (2) by a H.F. wave-trap; this is difficult to arrange, as the sharpness of tuning must be very great, and consequently the device will be difficult to adjust; (3) by a low-frequency filter circuit or wave-trap. The latter method is certainly the best, and may consist conveniently of an inductance of about one henry in series with a variable condenser of about 0.0005 μ F. capacity. The circuit thus formed can be connected across the loud-speaker, across the primary of an intervalve transformer, or across plate and filament of a medium magnification resistance-capacity or choke-capacity stage.

We will now look into the question of why the heterodyne from a distant station is normally only heard at night, why it varies in strength and why, when receiving a long-distance station at night-time, the strength varies, or "fades" as it is usually called.

When waves are radiated from a wireless station they are radiated in all directions—and *at all angles from the horizontal*. In a well-designed broadcasting aerial most of the energy is concentrated horizontally along the ground, but nevertheless a very considerable portion is radiated at quite appreciable angles. During day-time, at any rate on wavelengths in the medium band, the ground ray is the only one which is picked up by a receiving aerial. This ground ray, however, suffers considerable losses in its passage over the ground. Currents are induced in such things as mountains, hills, trees, drain-pipes, electric light wires, damp buildings, or in fact in any conductor or partial conductor. Currents are also induced in the earth itself. The amount of energy which is lost in any particular object depends on the magnitude of the actual currents induced, and on the resistance encountered by the currents.

A somewhat inaccurate analogy, but one which will convey to a non-technical person some idea of what happens, is as follows:—The shorter the wavelength the more oscillations there are in a given time. At each oscillation a certain amount of loss occurs. The more oscillations there are in a given time, the more loss of energy there will be in that time. Therefore short waves suffer very much more loss of energy than long waves. This loss of energy is usually called attenuation, a short wave having more attenuation than a long wave radiating the same power. That is why a long-wave station such as Daventry 5XX has during daytime a greater range than a short-wave station, such as Daventry 5GB. Of course, even when there is no loss of energy in intervening objects (absorption), there is attenuation and the signal strength varies inversely as the distance. That is to say, if we go twice as far away from a station we shall get half the signal strength, and so on.

The waves radiated upwards from the aerial—that is to say, not along the ground—are not greatly attenuated, as they meet no objects which cause losses of energy.

At a distance of about 60 miles from the earth there exists at night-time a layer of ionised atmosphere. During the day-time this layer is diffused by the sun's rays and becomes ineffective. At night-time, however, it acts to wireless waves rather like a dull mirror. This layer is normally called the Heaviside layer.

A simple analogy of waves being reflected from this layer has been described by Mr. T. L. Eckersley, in a highly technical paper on the subject, as something similar to the shining of a light on the clouds at night-time. The clouds give a partial reflection of the light. Most people have seen the reflection in the clouds at night of the lights of a large town, or of a big fire, also of a searchlight. The reflection of wireless waves by the Heaviside layer is, of course, not visible to the eye.

The layer is not smooth, nor do its properties of reflection remain constant from time to time, nor does it reflect all waves equally. It so happens that its reflection of the shorter wavelengths allotted to broadcasting is particularly good. At night-time, therefore, we see that we can have at least two sets of waves arriving at the receiver: (1) the direct ray, and (2) the indirect ray which is reflected from the Heaviside layer. These two rays may add or subtract from one another, depending upon whether the crest of the one wave arrives at the same time as the crest of the other wave. When the crest of the direct ray arrives at the same instant as the crest of the reflected or indirect ray, the two add together. If the crest of one wave arrives at the same time as the trough of the other wave, then the two waves will subtract one from the other. If in the latter case the two waves are of equal strength the resultant will be nothing at all, since the two waves will cancel one another completely.

As the height of the Heaviside layer and its reflective properties are varying all the time, we see that the down-coming or reflected ray from this layer will vary both in its time of arrival and its strength. The time of arrival, of course, depends upon the distance the wave has to travel. The higher the Heaviside layer the longer the path and the greater the time taken, since the velocity or speed of the wave is constant. The sidebands will be reflected also, and the reflection of the sidebands at any instant may not

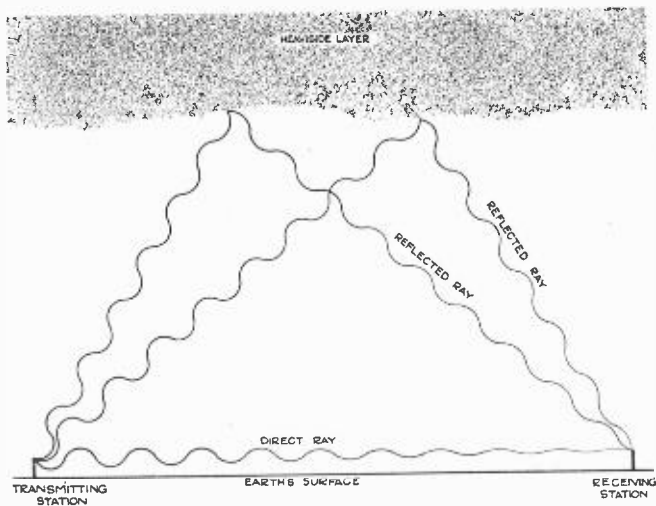

FIG. 3.

showing the paths of the direct and reflected rays from a transmitter to a receiver

be the same as that of the carrier, since they are of different frequency. Further sidebands of different frequencies are reflected differently; that is why, under some conditions, distortion occurs.

The reflected ray from this Heaviside layer is not necessarily a single ray, but may be reflected from a number of different places in the Heaviside layer, and thus at the receiver there may be a number of reflected rays. As the time of arrival of these various rays is varying all the time, we get conditions when they add together and conditions when they subtract, so that we get a very varying signal strength. This is known as fading. When there is little fading from a distant station it usually means that the distance and conditions are such that only one indirect ray is being received, and probably very little direct ray. There is therefore a critical distance where the fading is the worst, and this distance is where the strength of the average downcoming ray from the Heaviside layer and the direct ground ray from the station are about equal in strength. This distance varies with the wavelength, as the

range of the direct ray is less on short waves than on long waves. This critical distance definitely limits the range of good reception from a station irrespective of power, for no matter how much more power is radiated, fading still occurs. The following table indicates roughly the average effective maximum range of stations as a function of their wavelengths:—

Wavelength.	Maximum Range without Serious Fading.	Maximum Range for Negligible Fading.
200 metres	40-50 miles	15-25 miles
300 „	60-70 „	20-30 „
400 „	80-90 „	30-40 „
500 „	100-120 „	40-60 „

The distances given in this table can by no means be relied upon as strictly accurate distances. They will vary very considerably, depending upon the type of country over which the wave has to travel, that is to say, upon the attenuation of the ground wave. Hilly and rocky country cause the worst attenuation, while flat open country, with not many trees, causes the least attenuation. A wave travelling over a large town will lose a very considerable proportion of its energy. In all cases the effect is far worse on the short waves. Listeners living in flat open country, particularly on high ground, may expect much better signals and much longer ranges of reception and greater freedom from fading than listeners living in hilly or very thickly wooded country and in the centres of large towns, or on the side of a large town which is the most remote from its broadcasting station.

RELIABILITY FIGURES

October 1, 1929 to September 30, 1930

Total length of transmission	70,443 hours.
Percentage of breakdowns02%

THE LONDON REGIONAL STATION

PERHAPS the most difficult problem which the designer of a Broadcasting Station has to face is the selection of a site which will meet the various essential requirements. Naturally the first step is to consider the exact nature of the service which the projected station is to give, and the circumstances in which the service will be received by the listening public.

The main object of the new London Station is to provide, for a region which consists mainly of London and the South-Eastern Counties, a service of two contrasted programmes, both of which must be sufficiently strong to permit the use of inexpensive receiving apparatus. Moreover, the important fact that the service had hitherto been provided by a transmitter situated in the heart of London had to be carefully borne in mind, because this transmitter gave overwhelming strength in all districts within a radius of, say, three miles, in spite of the fact that its power was comparatively small. Naturally this fact affected the type, and even the condition, of receivers used by listeners living within this area, the result being that if an attempt was to be made to distribute the energy more evenly over the whole region by moving the site and raising the power of the transmitter, some dislocation was bound to occur in the immediate neighbourhood of the transmitter which was being replaced. This difficulty would disappear to a large degree were the designer free to choose any wavelengths he liked for the new station. However, it is now well known that the scarcity of wavelengths available for the broadcasting services of Europe is a severe handicap to development. Moreover, most of the wavelengths which are available are scientifically not the best possible for the purpose. As the direct result, the broadcasting station which does not possess one of the much-coveted long wavelengths (160 to 224 kilocycles per second; 1875 to 1340 metres) is automatically limited in the range it can give, however much power can be radiated by the aerial. The economic power for the two wavelengths to be used at Brookmans Park cannot be laid down as a hard-and-fast quantity, but may be considered to lie between 30 and 50 kW. of energy in the aerial, and the maximum range in

these circumstances is of the order of eighty miles. This, of course, assumes high quality reception, although, if the standard is lowered, the range is increased to a very large extent; but the B.B.C.'s Regional Scheme has been designed on a basis of high quality, and therefore the above range has to be assumed. These considerations largely determined the power to be used at Brookmans Park.

It was almost out of the question to consider building the new station close to the site of the old, owing to the large amount of space required for the twin transmitters and aerials, but, even apart from this difficulty, it would have been inadvisable for several reasons. Perhaps the most important of these was the fact that the surrounding buildings would have absorbed a large proportion of the energy radiated and so produced wide variations in the amount of radiation in different directions.

The question then arose as to how far from London the site should be. The dislocation effect has already been mentioned, and this in itself indicated that it would be inadvisable to go much more than fifteen miles away from Oxford Street, in which the old station was situated. Otherwise, of course, the existing insensitive receivers in central London would have become useless to their owners.

It was eventually decided that the station should be approximately due north of London and at a distance which was compatible with the above facts. The reasons for choosing a northerly direction are many, but it is only necessary to mention a few. In the first place, there were Government restrictions, which made certain districts out of the question. Again, it was necessary to be near one of the modern Post Office cable routes, in order to connect the new station with Savoy Hill by high quality telephone lines suitable for carrying music. Further, it was obviously desirable not to waste any serious amount of energy over the sea.

Several sites were considered, but none had the advantages of the remarkably flat stretch of land at Brookmans Park, on which the station now stands. It is fifteen miles from Charing Cross as the wireless waves travel, and stands some four hundred feet above sea level, and is therefore one of the highest points in Hertfordshire. The buildings face the old Great North Road, on the other side of which is Brookmans Park itself, part of which is now rapidly being

converted into a building estate. Brookmans Park gets its name from the family which held it in the reign of Henry IV. John Somers, the great Whig Lord Chancellor, lived in a stately old house on the estate, which was burnt down about thirty-five years ago. The mansion which replaced it was the home for some years of the Gausson family, who sold it to the present owner.

The Broadcasting Station occupies what was once a single field of some thirty-four acres in extent. The building is of a somewhat peculiar shape to conform to the best possible lay-out of the plant, all of which is on the ground floor. The first portion of the building has two stories, but the upper story does not house any of the essential apparatus. The office block, transmitter hall, and motor generator room are faced with Portland stone, and the power house, battery room, and repair shop, which are situated behind the main building, have a brick facing.

THE AERIAL SYSTEMS

There are two aerial systems, one for each programme, and each aerial is supported by two 200-foot self-supporting insulated lattice steel towers. These are placed on either side of the building, parallel with each other. Beneath each aerial there is an aerial transformer house, approximately eight feet square and faced with cement to harmonise with the main building. The earth system consists in each case of eighty copper wires radiating from the aerial transformer house in all directions and buried one foot below the surface of the ground.

The process of generating the high-frequency energy for the two aerials really begins at the back end of the building, with the generation of power in the form of direct current at 220 to 230 volts.

THE POWER HOUSE

Outside the building one encounters first of all the two main oil tanks, which, when full, contain a sufficient supply of fuel for several months' working. Between the two oil tanks there is a wooden tower for cooling the water circulating in the engines. Next comes the power house itself, containing the four six-cylinder Diesel engines, driving direct-current generators, each capable of an output of



[272]

THE LONDON RE
(For a description of the u



L. TRANSMITTER
the last paragraph on p. 276)

[273]

200 kW. Three engines are sufficient for running the two transmitters on full power, the remaining engine being held in reserve. A small compartment adjoining the engine-room contains a boiler heated by the exhaust gases of the engines. This boiler provides sufficient hot water to heat the whole building, but an auxiliary oil-fired boiler is provided for heating purposes when no engine is running, in order to make certain that the apparatus shall be kept dry at all times.

Elaborate precautions have been taken in the design of the engine bed to remove the possibility of any vibration reaching any other part of the building, it being particularly necessary that the transmitters should not be subject to even slight vibration.

THE BATTERY ROOM

The main battery room adjoins the power house. This contains a lead storage-battery of some 2000 ampere-hours, one object of which is to provide a supply of current for a short time during an emergency. It also serves to light the building, and to provide a small amount of power when neither of the main transmitters is in use. (See p. 258.)

Still proceeding towards the front of the building, next to the battery room there is a closed-in space where lorries can unload, and beyond this there is a repair workshop and a store for spare parts. Along one side of the battery room, packing space, and workshop there is a passage-way, to the roof of which are fixed the bare copper feeders running to the motor generator room.

THE MOTOR GENERATOR ROOM

This room contains altogether fifteen motor generator sets which convert the energy received from the power house at 220 volts to the various supplies at different voltages which are required for feeding the actual wireless transmitters. In the middle of the room there are three 160 kW. machines, generating direct current at between 10,000 and 11,000 volts. This constitutes the supply to the anodes of the main power-valves in the transmitters. Owing to the danger to life due to the high voltage generated by these machines, they are enclosed by a steel grill, the doors of which cannot be opened without shutting off the current. To the right,

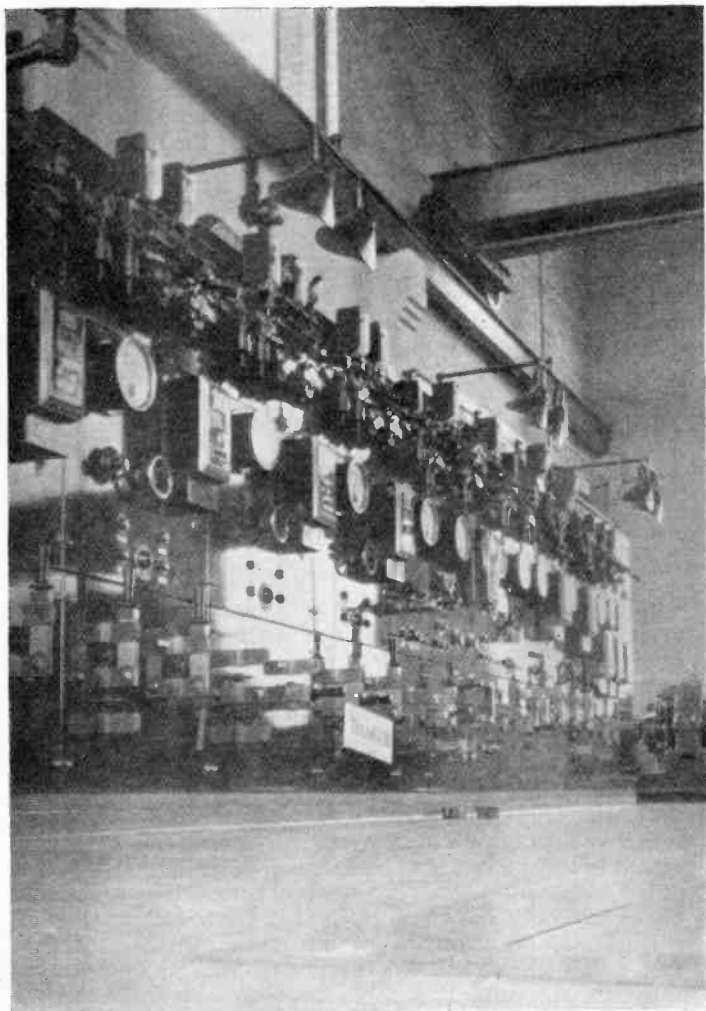

THE POWER HOUSE SWITCHBOARD AT BROOKMAN'S PARK

[275]

looking towards the front of the building, there are three machines each capable of producing 1300 amperes at approximately 23 volts. This current is for heating all the valve filaments in the transmitter with the exception of the "master oscillator" or "drive" valve, the filament of which is heated by a separate battery installed for this purpose only. At the opposite end of the room there are nine groups of small machines for supplying the anode current for the low-power stages of the transmitters, and for grid negative potential for all the stages with the exception of the "master oscillator," for which no external grid negative potential is necessary. In every case three machines of each type are installed: one for each transmitter and one in reserve.

The cables carrying the outputs from all these machines pass through earthenware ducts to the vault below the transmitter hall, which adjoins the motor generator room. The main switchboard for feeding the various supplies to the transmitters is mounted along the end of the transmitter hall, and all leads running to it from the motor generator room, and from it to the transmitters, are mounted on racks fixed to the walls of the vault. (See photo, p. 258.)

THE TRANSMITTER HALL

Running along each side of the hall, facing each other and at right angles to the switchboard, are the two transmitters, each of which consists of five separate units. These units are completely enclosed and are constructed of polished aluminium framework with enamelled steel panels. This type of construction provides the necessary amount of screening to prevent interaction between the various units. The two transmitters are identical in construction, and operate on the principle known as "choke control at low power." That is to say, the high-frequency oscillations are first of all generated at low power, then modulated, and afterwards magnified to the full power of the transmitter. The functions of the five units shown on pp. 272-3 are as follows:—

Beginning at the opposite end from the switchboard, the first unit contains the "master oscillator," the separator stage, the sub- and main modulator stages, and the modulated amplifier. All the valves in this unit are air-cooled. The second unit contains two water-cooled valves connected in "push-pull," water-cooled valves being used be-

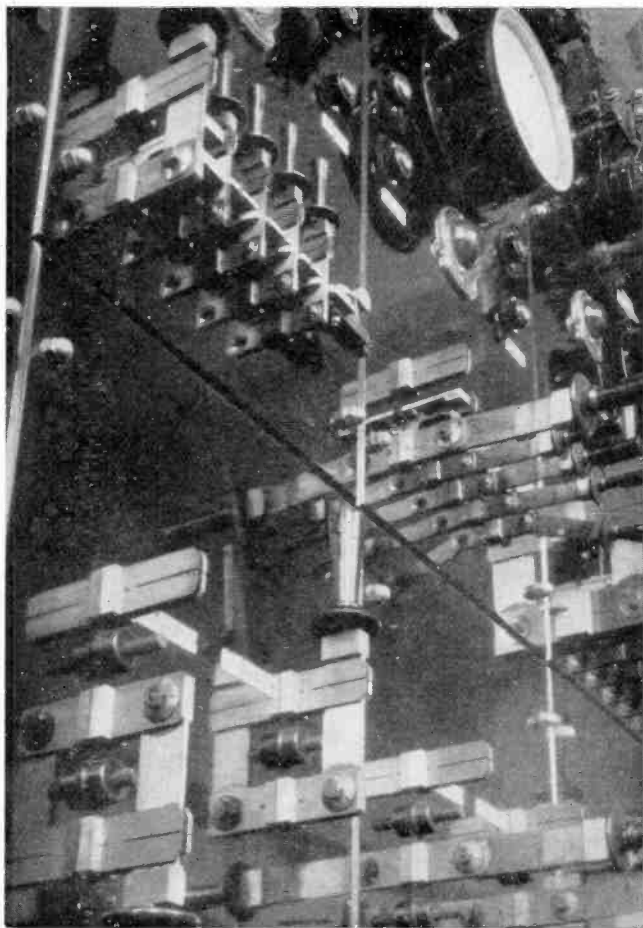

DETAIL OF THE SWITCHBOARD

[277]

cause this is the first stage in which any considerable amount of power is used. The third unit contains one-half of the total number of valves forming the final power stage, the other half being contained in the fifth unit, which is really a duplicate of the third. These two groups of valves are connected in "push-pull." The fourth unit contains the high-frequency tuning circuits, to which are connected the high-frequency feeder lines, which run out at right angles from the building to the aerial transformer house. The doors of all these units, with the exception of the one handling high-frequency currents only, are provided with an interlocking system of switches, which makes it impossible to open any door without automatically switching off the power. This is unnecessary in the case of the fourth unit, containing the high-frequency apparatus, because no fatal voltages exist. In each stage a spare valve is mounted in position and ready for use, and it is only necessary to close a switch to bring it into operation.

In the middle of the hall there are two control tables, each facing the transmitter which it controls. An engineer sits at each of these control tables, and from it he can operate the transmitter and adjust the various input voltages without leaving his seat.

Circulating water for the water-cooled valves used in the power stages of the transmitters flows by gravity from two tanks (one for each transmitter), mounted on the roof of the building, and after passing through the jackets of the valves it flows into two tanks situated in the vault. It is then pumped through two banks of tubes mounted over a concrete pond outside the building. After passing through this cooler the water is returned to the tanks on the roof. Water is pumped over the outside of the banks of tubes in order to cool the hot water flowing through them. Thus it will be seen that the water which actually comes in contact with the valves is entirely enclosed, which allows the use of soft water, without the necessity of constant replenishment.

THE CONTROL ROOMS AND STUDIO

Adjoining the transmitter hall, on the ground floor of the office block, are two control rooms, for handling the programme radiated by each transmitter. These rooms, which have windows communicating with the transmitter hall,

contain the amplifiers and switch-gear for controlling the music or speech before it is applied to the transmitters.

Brookmans Park is connected to the studios at Savoy Hill by four Post Office telephone cable circuits, which are specially arranged to avoid distortion. On arrival at the Brookmans Park control room, the music is amplified to the correct strength and is then passed to the sub-modulators in the main transmitters.

The remaining space on the ground floor of the office block is occupied by offices, a spare valve room, a garage, and a waiting-room for visitors. On the upper floor there are two rooms for checking (on loud-speakers) the quality of the transmission, and a test-room for taking precise measurements of the performance of the transmitters. There is also a studio, which is used normally for tests, and a room which has been left vacant for the installation of tuning-fork drive apparatus, should it ever become necessary to operate one of the transmitters on the same wavelength as that of a transmitter at one of the other Regional Stations.

The studio is used for testing and, in the event of a complete failure of communication with Savoy Hill, to make an announcement and carry on a programme while the lines are being repaired or changed. For the interest of visitors the first transmitter ever used by the B.B.C. (the original 2LO) has been placed in the studio. This was originally installed in Marconi House, and provides an interesting contrast with the latest design as seen in this station.

WAVELENGTHS AND PROGRAMMES

The two wavelengths used are 356 metres and 261 metres, and each transmitter is intended to work with a power of thirty kilowatts in the aerial (International rating 45 kW.). In order to equalise the strength received from the two transmitters over as wide an area as possible, arrangements have been made to enable greater power to be radiated on the lower wavelength. The transmitter used for this service delivers approximately 45 kilowatts to the aerial (International rating 67.5 kW.), but even so it cannot cover so great a service area as the transmitter working on 356 metres.



THE MUSIC CONTROL PANEL

showing the room in which musical programmes are checked on a loud-speaker

STUDIO AND LINES

P I A N O B A L A N C E

ONE of the most important duties to be undertaken by a member of the Balance and Control staff of the B.B.C. is that of the balancing of items, in which the piano plays an important part. The piano, perhaps more than any other musical instrument, provides a critical test of the efficiency of the whole broadcasting chain as a means of giving accurate and pleasing reproduction of a musical performance.

The piano has several distinct parts to play in broadcasting, each of which requires different treatment from the point of view of correct balance. As a solo instrument it is perhaps the easiest to treat. Under these circumstances it is merely necessary to ensure that the microphone is placed at a sufficient distance from the piano for the very considerable volume of sound which a piano is liable to produce under these conditions not to exceed the limits of linearity of the instrument—so that, in fact, it does not “blast” the microphone.

Probably the most frequent use to which the piano is put in broadcasting is that of providing an accompaniment. Here the all-important task is so to arrange matters that the solo, vocal or instrumental, bears the correct relation to the piano accompaniment. To determine this relation is plainly a matter requiring some musical experience, and means are provided whereby a trained musician can observe the effect and make the necessary adjustments.

In the case of performances of a piano concerto, which usually take place at some outside hall, where the piano becomes the solo instrument with an orchestral accompaniment, another method of attaining the best effect is employed. In such transmissions more than one microphone is employed, one comparatively near the piano, and

[281]



ONE OF THE B.B.C.'S EXHIBITS AT THE NATIONAL RADIO EXHIBITION AT OLYMPIA

[283]

concerned principally with reproducing that instrument, whilst one or more are so situated as to reproduce the orchestra. By means of what is known as a "fade-box," the individual outputs of these microphones can be controlled and mixed in the required proportions to produce the desired effect. In an important outside broadcast from a concert hall the effect is always judged at a rehearsal by a competent musician making use of a good loud-speaker. It has been found by experience that a modern loud-speaker is more satisfactory than headphones for the purpose of balancing a performance.

There remains for consideration one other type of piano broadcast which presents its own particular problem from the balance point of view. This is the expository talk on musical matters, illustrated by examples played on the piano. In these cases the speaker usually desires, whilst obtaining the best possible reproduction of his piano play-

S T U D I O A C O U S T I C S

DURING the period which has elapsed since the publication of the last issue of this book, work in connection with Studio Acoustics has been undertaken mainly with the object of reducing to a more scientific basis than has hitherto been possible the requirements of a good studio; and of devising means to apply in practice the theoretical principles so determined, both in the modification of existing studios and in the construction of new ones.

As has been explained on several previous occasions, probably the most important property of any room or hall used for listening to speech or music, whether through the medium of broadcasting or not, is what is termed the reverberation time. To recapitulate briefly, if in any ordinary room a source of sound (such as a musical instrument which has been playing a sustained note) suddenly ceases, the sound is still heard for a short period, the duration of which will depend on the amount of sound-absorbing material in the room. The time in seconds taken for a fairly loud sound to die away to inaudibility under these conditions is called the reverberation time, and is a definite property associated with the room. In more scientific language, it is the time taken for the average sound intensity in the room to die away to one-millionth part of its initial value.

Now it has been found by experience that for a room of any particular size, the reverberation time must have a definite value in order that music may be heard and appreciated at its best. For a fairly large studio such as is used by the B.B.C. for performances by an orchestra of medium size, the required reverberation time is about one second. For a small studio, used for solo items, for combinations of a few instruments, or for talks, the required value is still less, whilst for the largest studios, or for concert halls used for broadcasting, it may be two seconds or even more.

That some limitation of the reverberation period of a studio is necessary was recognised from the early days of broadcasting, when the normal treatment was to introduce into the studio a large quantity of drapings or curtains,

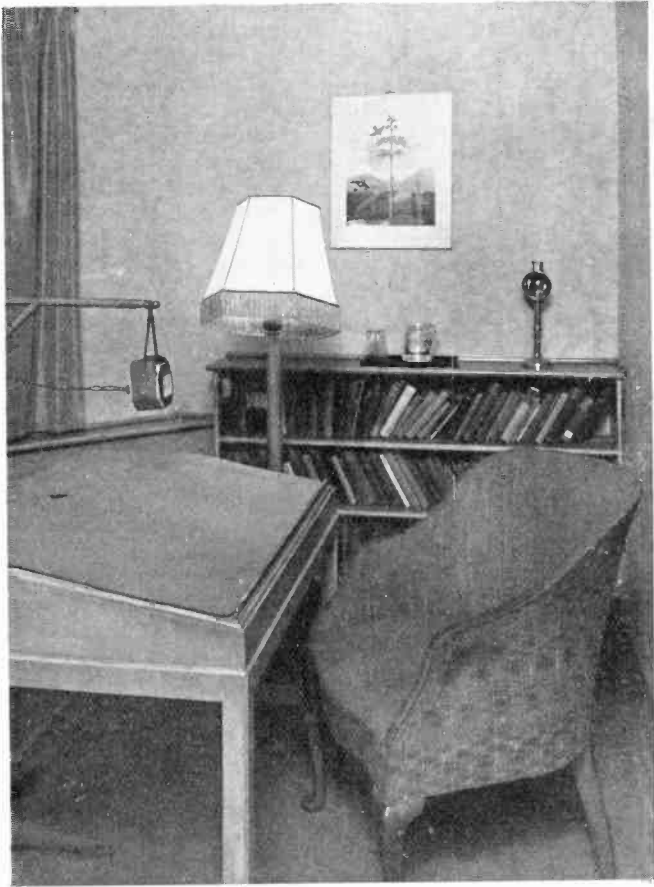

THE SMALLER TALKS STUDIO AT SAVOY HILL

with which the walls were covered. Sometimes as many as five or six layers of curtains were used.

Such treatment was far from satisfactory for several reasons. First, it was found that no matter what quantity of curtains were used, a really pleasing reproduction of music could not be attained. If too little draping were employed the result was "echoey" and unpleasing, whilst as the quantity of deadening material was increased the result became dull and lifeless with none of the brilliancy which would be a normal feature of the performance. The psychological effect on artists was very similar. They found difficulty in performing in the early studios, by reason of both the deadness to the ear and the depressing effect to the eye, for a heavily draped studio does not lend itself to pleasing decorative treatment.

The reason for these difficulties is now apparent, for it has been found necessary to take considerable account of the variation of reverberation time with pitch or frequency. The earlier measurements of reverberation time, whether in connection with broadcasting or undertaken in the study of architectural acoustics, were almost always made at a frequency of 512 cycles per second, corresponding with a pitch of one octave above middle C. It is necessary, however, in order to determine the acoustic behaviour of any room or studio, to make determinations of the reverberation time at various pitches or frequencies, and so obtain a reverberation-frequency characteristic, showing the value of the reverberation time throughout the musical scale.

According to present-day ideas, in order that the reproduction of music from a studio shall be pleasing and musically satisfying, the reverberation time must be practically independent of pitch, and must possess the value already indicated. A curtained studio, however, is very far from satisfying these conditions. Fig. 1 shows the reverberation-frequency curve for a comparatively lightly draped studio of such a type. It will be observed that the absorption of sound, as indicated by the shortness of reverberation time, is much greater at the high frequencies than at the low. This accounts at once for the lack of brilliancy of broadcasts from such a studio, and for the "boomy" sensation experienced on entering it, which is

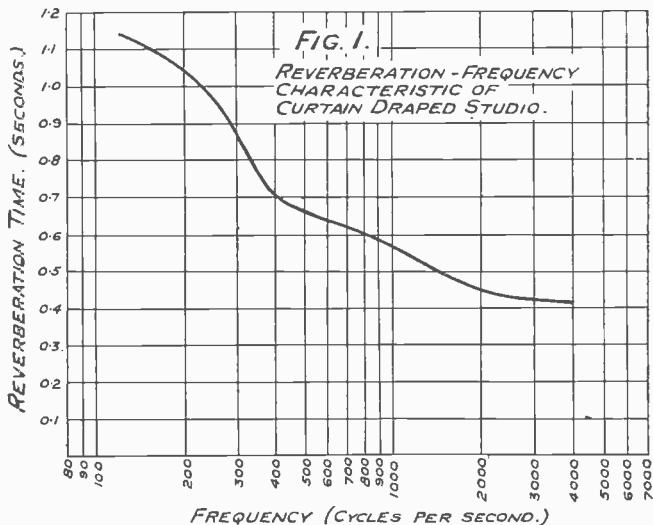

mainly responsible for the depressing feeling of "deadness" complained of by artists.

Any increase in the quantity of draping material would only reduce still further the reverberation at high frequencies, whilst making little change at the low. If indeed, by the use of an exceptionally large quantity of draping, the low-frequency reverberation were reduced to the desired value, the studio would be practically without reverberation at the higher frequencies. This was, in fact, the condition of the first studios used in broadcasting.

The problem of providing studios possessing a suitable reverberation time, independent of frequency, really resolves itself into that of finding sound-absorbing materials which are equally effective at all frequencies, and which are at the same time susceptible to decorative treatment without the destruction of their acoustic properties. The general requirements of such a material will be realised when it is understood that the sound waves at the higher frequencies seem to be absorbed in the pores of the material itself, losing their energy by multiple reflections from side to side of the minute apertures which form a large part of

the surface of a porous substance. The sound waves of the lower frequencies, however, are apparently most readily absorbed when the whole surface of the wall is capable of yielding under the variations of pressure exerted upon it by the sound waves.

A compressible porous material is therefore required for the successful treatment of a studio. Ordinary hair felt, if of loose texture and of sufficient thickness, fulfils these conditions fairly well, and has been used to a considerable extent in the treatment of B.B.C. studios in the last few years. The chief difficulty in the use of felt, in common with that of many other possible materials, is that of providing suitable decorative treatment. One method of decoration has been to cover the surface of the felt with a loose-textured wall-paper. This, however, destroys the porosity of the felt, and very considerably reduces its absorptive properties at the higher frequencies, producing unduly long reverberation at those frequencies, particularly when, as has not infrequently been the case, the decorative treatment has demanded the painting or distemping of the surface of the wallpaper. The effects of such treatment are shown in Fig. 2, by the full line, which represents the variation of reverberation time with

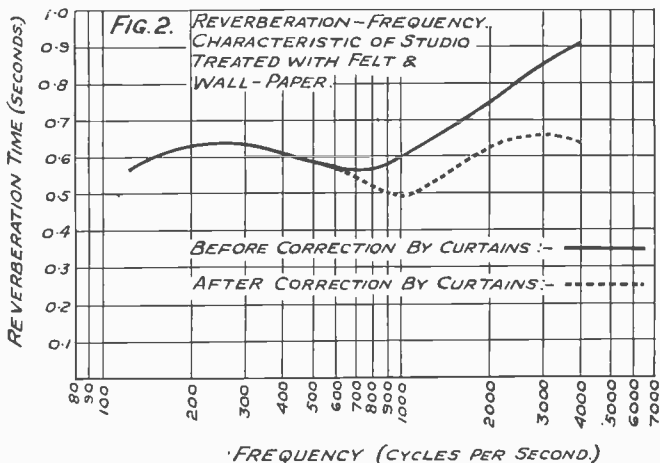

frequency of a medium-sized studio treated with felt and decorated with distempered wallpaper. The practical and easily observed effect of a reverberation-frequency curve of this type is that the studio exhibits a very pronounced "chink" or buzz for simple percussive sounds such as the clapping of hands. In the case in point the buzz, which is due to multiple reflection of the sound waves backwards and forwards between the walls of the room, was sufficiently pronounced to be readily audible during speech and certain kinds of music, particularly piano music.

Fortunately a fairly simple corrective treatment can be applied by making use of the fact that light curtains are most absorptive for the highest frequencies. It is possible to calculate, data being available regarding the properties of the curtains, exactly what area of wall surface must be curtained in order to produce the best effect. In the particular case under consideration the covering by light curtains, hanging in loose folds, of nearly one-third of the total wall surface resulted in the curve shown by the dotted line of Fig. 2. The undesirable buzz was found to have entirely disappeared as the result of the treatment and the studio to be very suitable for broadcast transmission.

A more suitable material for studio treatment would, however, appear to be felt with a decorative treatment of some fabric such as tapestry or fine canvas, preferably stretched over the surface of the felt. Such treatment is being tried in the construction of new studios, whilst at the same time a thorough investigation of new materials and methods of treatment for use in the future is being made.

It is hoped that in due course it will be possible so to construct studios that the use of artificial echo, as at present employed and as described in previous issues of this book, will be avoided. There seems no inherent reason why it should not be possible to modify the acoustics of the larger studios so as to produce an effect similar to that of the most popular of the outside concert halls and other buildings from which broadcasting is conducted.

GRAMOPHONE "PICK-UP" DEVICES

THE gramophone pick-up, which so far as the general public are concerned has only made its appearance comparatively recently, has been used by the B.B.C. for the purpose of broadcasting gramophone records during the last five or six years. It is a device which converts the vibrations of a gramophone needle as it travels along the groove of the record directly into electric impulses, similar to those produced by a microphone, without first converting them into sound waves. These impulses may be amplified and used to operate a loud-speaker, exactly as in the modern electric gramophone, or they may be used, again after sufficient amplification, to modulate a wireless transmitter. This is precisely the process which occurs in the broadcasting of gramophone records, and it is to be noted that no conversion of the impulses into sound waves takes place until they reach the listener's headphones or loud-speaker.

Electric gramophone pick-ups may be of several different types, they may be electromagnetic in action, in which case they are of either the moving-iron or the moving-coil type, or they may be electrostatic, in which case one of the plates of a charged condenser is caused to vibrate by the action of the needle and so to generate fluctuations of voltage across the plates of the condenser.

Actually, however, the majority of gramophone pick-ups are of the moving-iron electromagnetic type. The principle of operation is very similar to that of the ordinary telephone earpiece, but takes place in the opposite sense. The broad principle of the moving-iron pick-up will be understood if we imagine a small horseshoe magnet, around the poles of which coils of wire are wound. If a piece of soft iron situated near the poles is vibrated in such a way as to vary the airgap between itself and the poles, changes will occur in the magnetic force traversing the magnet, and corresponding electric currents will be generated in the coils if they are connected in a circuit.

In the case of the pick-up the soft iron, known as the armature, is set in vibration by the needle as it passes over the grooves of the record. In actual practice many different mechanical designs of pick-up have been devised

in order to overcome the difficulties of construction and to enable certain requirements to be fulfilled.

The principal requirements of a good gramophone pick-up are as follows:—

(1) It must possess a good frequency response; that is to say, for equal velocities of needle vibration at different frequencies corresponding with different pitches in the musical scale it must produce equal electrical impulses. This condition must be sustained throughout the range of frequencies employed in gramophone reproduction, say from 50 to 5000 cycles per second.

(2) It must possess linearity of response. This means effectively that its sensitivity must not vary between the lowest and highest intensities employed in recording. Neglect of this condition causes "blasting" distortion.

(3) The movement of the needle in accordance with the grooves of the record must be free so that a minimum of wear is caused to the records.

(4) It must be fairly robust and simple to handle.

Perhaps the most difficult condition to fulfil effectively in designing a pick-up is condition (1) above. The difficulty lies in the fact that the moving parts of the pick-up, in common with those of all mechanical devices, possess natural periods of vibration, or "resonances," of their own; and, moreover, the dimensions of a pick-up are necessarily such that these resonances occur well within the range of audible frequencies. It is unfortunate that the general effect of such a resonance is to increase very greatly the response of the pick-up at that particular frequency, with consequent serious distortion.

It is therefore the duty of the designer of a pick-up to render resonances less harmful either by damping the movement of the resonating parts or by moving the resonant frequency out of the range of audibility. By far the most important resonance in the majority of pick-ups is that of the needle and the armature to which it is attached. Unfortunately most methods of damping this particular resonance involve restricting the movement of the needle and causing record wear. Even should damping be relatively successful the pick-up is found to respond hardly at all to frequencies above that of resonance, owing to the flexibility of the needle. The best method of attack

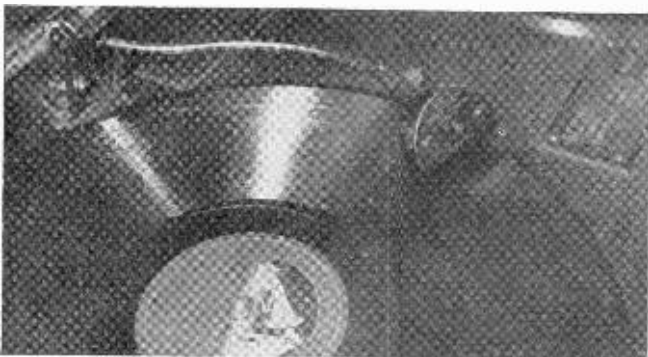

AN ELECTRICAL PICK-UP DEVICE IN POSITION ON THE END OF A
GRAMOPHONE TONE ARM

ing the problem, therefore, is to cause the resonance to be as high as possible in the frequency scale. This involves making the moving parts as small and as light as possible. Even, however, by using the steel needle itself as the armature and thereby reaching the practical limit of lightness, the resonance cannot be raised above a frequency of about 5500 cycles per second. The pick-ups used at present by the B.B.C. are of the needle-armature type, and fulfil the four conditions enumerated above to a very large degree, except for the existence of the needle-resonance. It is necessary to apply a correction for this resonance, although it is to all intents and purposes outside the limit of frequencies employed in recording, as if its effect is allowed to remain a very serious increase in the degree of "needle scratch" is observed. This correction is, however, a very simple matter, and the output of the pick-up is then dealt with by the same series of amplifiers as are employed in connection with the microphone.

The B.B.C. regrets that it cannot enter into correspondence with listeners on the subject of the design of receivers which are intended solely for the reception of foreign transmissions. Articles and other information on this subject are to be found in the B.B.C.'s Foreign and Technical Journal *World-Radio*.

SIMULTANEOUS BROADCASTING

NO Broadcasting Station, whatever its power, is capable of being received satisfactorily beyond a certain distance, this maximum range being governed by a number of factors, such as wave-lengths, as explained fully in the article on p. 259.

If all the medium wavelength transmitting Stations in the British Isles were to radiate a different programme, obvious difficulties would arise, due to cost and the exhaustion of available talent. Furthermore, listeners within the range of one transmitter might frequently require to hear programmes from another area, particularly those of obviously National interest, such as running commentaries of certain sporting events. This and many other considerations establish a definite need for the provision of some means by which the programmes originating in one area may be simultaneously broadcast by transmitters in other areas. This principle has now commonly become known by its initial letters "S.B.," and it can be carried out in two ways;

- (a) By the use of G.P.O. telephone routes.
- (b) By the use of Wireless Link.

These two methods are to a certain extent supplementary to each other, although the use of telephone routes is generally more satisfactory, particularly where the transmission of musical items is concerned. These remarks deal only with the land line method of S.B. Changes that occur in programme currents between the time they are applied at the sending end of a line and the time they are received at the far end are either of the nature of distortion of the original currents or the result of additional currents picked up during transmission along the line. Distortion of the first type almost always results from the fact that the different frequency components of the programme currents are transmitted with widely varying efficiencies, so that their relative magnitudes change very greatly along the line, and the final current at the receiving end may be very different from that at the sending end. Special electrical networks are designed for association with S.B. lines, these networks adding further distortion of a nature inverse to the inherent or natural distortion of the line, so that the overall

line and network will transmit all the frequencies of programme current equally efficiently. As far as the second type of change is concerned, the fundamental principle to be observed in constructing and maintaining land lines is to arrange the individual wires of the circuit so that any noise or cross-talk voltages that may be induced in them from neighbouring power systems, from telephones or telegraph systems, or even from thunderstorms and other natural electrical disturbances, are equal. If this is done, and if the two wires forming the circuit are in other respects alike, the currents which would flow as the result of these interfering voltages cancel out and, therefore, there will be no added interference at the receiving end of the line. It thus becomes evident from the S.B. point of view that the essential feature of land lines is that all the factors affecting the efficiency of transmissions should not alter with time. If this stability of conditions can be obtained, a line and network may be relied upon to give perfectly satisfactory service, once the network has been designed to correct for the distortion of any particular land line and once the line has been properly balanced as explained above.

Altogether there are four fundamental quantities which completely determine a telephone line from the point of view of the transmission of electrical waves along it. These quantities are (1) its effective resistance, (2) its inductance, (3) its insulation resistance or leakance, and, finally, (4) the capacity present between the two wires of the circuit and between each wire and earth.

It will be realised from the above remarks how important it is that these quantities should not change under practical working conditions. The ways in which changes occur in practice are outlined below, and it will readily be seen that they apply almost entirely to overhead circuits; also, in consequence, that considerably greater reliability and a much improved service may be expected from the special underground circuits which will be brought into operation in the new S.B. system designed as part of future development of the Service.

(1) *Effective Resistance*.—The effective resistance of telephone circuits changes with temperature, in exactly the same way as other types of electrical circuits, the temperature changes experienced being those between day and

night, the various seasonal changes, etc. As the chief result of temperature changes is an alteration in the efficiency of the circuits as a whole, without greatly affecting the relative efficiencies of various frequencies, the troubles introduced by them are not very important.

(2) and (4) *Effective Inductance and Capacity*.—These two quantities do not vary under practical working conditions sufficiently to matter very much in themselves, but their presence enormously increases the extent to which other variations (e.g. of resistance and insulation) affect transmission.

(3) *Insulation Resistance*.—So far as overhead circuits are concerned, and it should be remembered that S.B. in this country has, so far, been carried out almost entirely on overhead circuits, it is the enormous variations in insulation resistance which occur with changes in weather conditions that cause most of the troubles which have been experienced. As a typical example, the insulation resistance of a good grade overhead circuit may fall to less than 1 per cent. of its normal dry-weather value during gale periods. In such circumstances, not only is the transmission efficiency suffi-

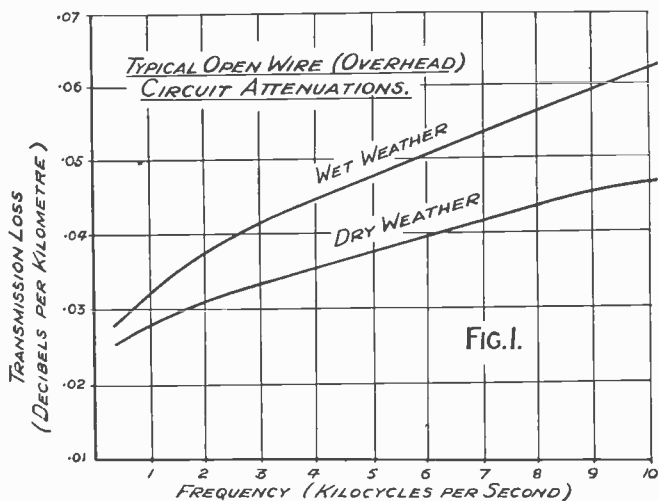
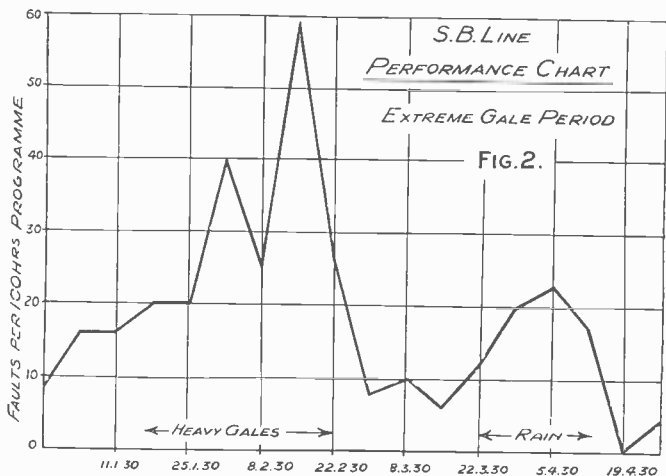

FIG. 1.



ently impaired to cause land line distortion, but the balance of the circuit and of many neighbouring circuits is frequently destroyed, so that relatively large amounts of noise and cross-talk currents are superimposed upon the programme. This is one of the reasons why overhead circuits are so sensitive to weather conditions, and why it is that these weather conditions may affect long-distance transmissions, even though they occur quite locally over a very small portion of the total length of the route.

Fig. 1 shows graphically the relatively enormous changes in the efficiency of transmission for various frequencies of programme current which may occur in typical "wet" and "dry" weather conditions.

Fig. 2 is a chart which illustrates the effect of the violent gales that occurred during the winter of 1929-30, upon an overhead S.B. land line which is, under normal weather conditions, outstanding for the excellence of its performance.

The problems so far enumerated have been those of circuits which remain physically in good condition. It will be understood that, in bad weather, troubles from falling trees, pole routes being blown down, etc., become much more frequent. These, with the many road accidents in

which telephone poles are involved, are responsible for a large percentage of the programme interference at present being experienced, which unfortunately must be classified as unavoidable when only overhead routes are available.

Overhead telephone routes are designed so that in the event of accident, the wires of the circuit will snap and the poles lean or fall rather than break, since actual pole-breakage might involve a dislocation running into days, whereas at present it is generally only a matter of hours before damage to the wiring can be repaired by special gangs held in readiness for the purpose.

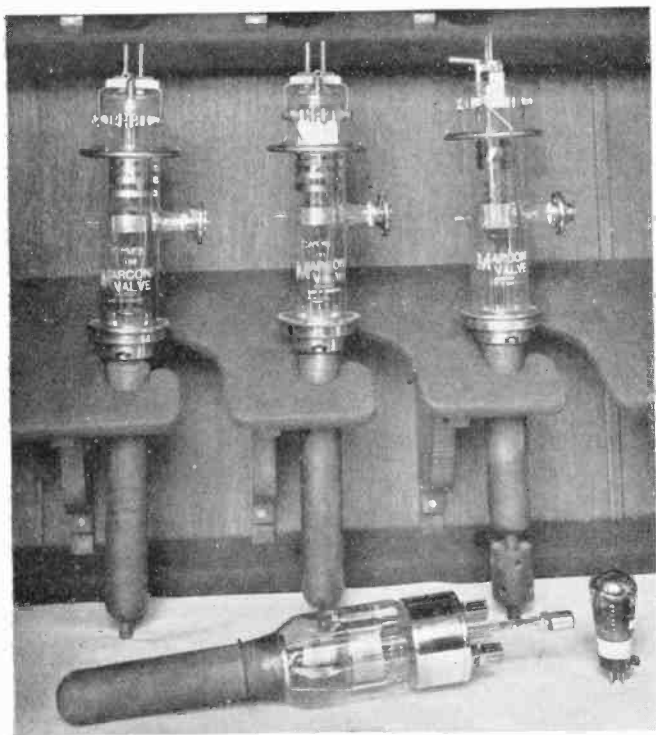

BIG VALVES USED IN THE BROOKMANS PARK TRANSMITTERS

GOOD RECEPTION

Elsewhere in this book will be found articles dealing with Receiving Sets, Aerials, Selectivity, etc.

Every listener should realise that on well-designed apparatus and with a modern loud-speaker it is quite easy to get *good natural reception of speech and music* within the service area of a broadcasting station.

The B.B.C. is anxious to help listeners to get good reception and realise what standard that implies. For this purpose the B.B.C. issues technical pamphlets from time to time. The Corporation's Technical Journal, *World-Radio*, also contains regular technical articles dealing with good reception.

It is necessary, however, for the B.B.C. to maintain strict impartiality in all matters affecting the wireless trade, and in no circumstances can any advice be given concerning the relative merits of the products of particular manufacturers. The B.B.C. recommends purchasers to obtain a demonstration of apparatus before they decide to buy it.

Where the listener wishes to obtain the best possible quality at the lowest cost he should concentrate on receiving his nearest station and not spend money on sensitive long-distance receivers.

The range of musical frequencies which are transmitted in their correct proportion by the modern broadcasting transmitters is 30 cycles per second to 8,000 cycles per second. This corresponds to the complete range of musical notes from C_3 to C^5 together with their correct overtones. If a receiver does not reproduce overtones in their correct proportion, the effect will not appear realistic, as the human ear has come by experience to associate various overtones with different musical instruments.

When a listener is situated within the service range of a modern British transmitter, such as 5GB or the new high-power London transmitters, it is possible for him to obtain a reproduction which to the majority is hardly distinguishable from the original.



R E C E P T I O N



HIGH QUALITY RECEIVERS

OWING to the development of the transmitting side of broadcasting during the last few years the requirements governing the design of receivers for the reception of broadcast programmes have been modified appreciably. The general trend has been to raise the power of transmitters to give greater range, and at the same time there has been an increase in the total number of transmitters in operation owing to the development of broadcasting in countries where it did not exist previously to any great extent. The tendency of this has been to decrease the importance of sensitivity in a receiver as compared with the selectivity.

Progress in the design of transmitters has enabled higher degrees of modulation to be employed without introducing distortion, thereby increasing the efficiency of the transmitter. Consequently receivers are now required to handle more heavily modulated signals than those of a few years ago, and a suitable detector for heavily modulated signals is an essential part of a modern good-quality receiver.

Improvements in broadcasting technique generally have resulted in transmissions of a higher standard than previously, and if full advantage is to be taken of these, it is necessary that the receiver shall not introduce appreciable distortion either before, during or after rectification.

The range of frequencies transmitted has been increased as well as the power to handle signals of large amplitude, and all parts of the receiver are now required to reproduce these increased ranges of frequency and amplitude.

Modern loud-speakers call for considerable undistorted power output from the receiver if full benefit is to be obtained, and special precautions are necessary to ensure that the output stage of the receiver will deliver the neces-

sary power at all the audio frequencies being handled. A few years ago the distortion introduced by loud-speakers was often sufficient to mask much of the distortion introduced by receivers, but to-day this has been very largely remedied, and it is therefore all the more necessary to avoid any distortion in the receiver.

THE DETECTOR

The detector may well be regarded as the best point at which to begin a general consideration of design. Its function is to reproduce without distortion the changes in amplitude of the incoming carrier. A detector which can do this is termed a "linear detector," from the fact that a graph showing the relation between amplitude of the high-frequency volts applied to it and the rectified voltage output is a straight line. A graph showing this relation is termed the "dynamic characteristic" of the detector, and its slope is determined by the value of the impedance across which the output voltage is developed, as well as by the varying resistance of the detector itself. If the value of the load impedance is very large compared with the resistance of the detector at all inputs, practically the whole of the output voltage will be developed across the load and very little across the internal resistance of the detector itself; consequently the dynamic characteristic will be practically a straight line. The internal resistance of most detectors is very high at low inputs, and the tendency is for the dynamic characteristic to be curved at low inputs, since a greater proportion of the output volts are dropped across the detector resistance for a given value of load impedance. In the early days of broadcasting this was not a serious matter, as the variations in amplitude of the carrier were not as great as they are to-day. This was because less modulation was then employed, and the amplitude of the carrier never fell to very low values during modulation. When 100 per cent. modulation occurs, however, the amplitude actually varies between zero and twice that of the unmodulated carrier, hence it is necessary for the dynamic characteristic to be straight right down to the origin, if no distortion is to occur, as well as being straight up to twice the amplitude of the unmodulated carrier.

In practice it is difficult to get rid of a slight bend at low

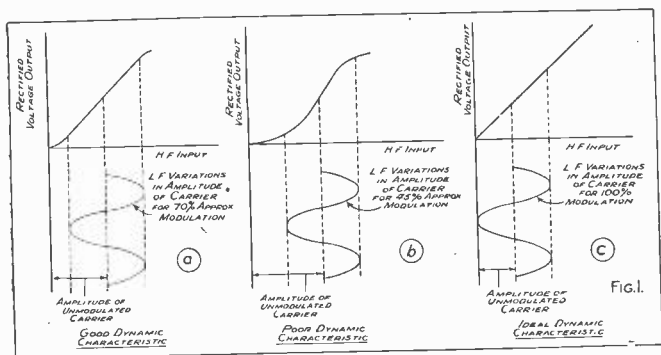

values, but provided the extent of this bend is small compared with that of the straight part and the input from the unmodulated carrier is located at the middle of the straight part, no distortion will occur except on very heavy modulation, *i.e.* on very loud signals.

The difficulty in obtaining a sufficiently high load impedance to get rid of the bend at low inputs is due to the necessity for making the impedance constant at all the audio frequencies at which the variations in amplitude occur, if they are to be treated equally. The stray capacities which must to some extent exist across the load will reduce its impedance at high frequencies and cause loss of high notes if the reduction in impedance is appreciable. Hence it is necessary to keep the load impedance low compared with the impedance at high audio frequencies of any capacity which is effectively across it, either stray capacity or capacity for shunting high-frequency currents to keep them from the low-frequency stages.

A good detector should therefore have a low resistance at low inputs so that a reasonably straight dynamic characteristic can be obtained readily, and it should not require an excessive input to cause the variations in amplitude to be confined to the straight portion, otherwise considerable H.F. amplification will be necessary. Figs. 1A, 1B and 1C show dynamic characteristics of detectors. Figs. 2A and 2B show methods of connection of detector output circuits.

TYPES OF DETECTORS

All detectors function on the same principle. The diode

detector utilises the anode to filament path of the valve and a linear dynamic characteristic is obtained at high inputs. The curved portion at the lower end extends for a considerable distance unless excessively high values of output resistance are used, owing to the high resistance of such valves when no voltage is used on the anodes. The resistance can be reduced by using a three-electrode valve as the diode, utilising the grid and giving it a positive bias; by this means the extent of the curved portion at low inputs can be reduced. Good characteristics can be obtained under these conditions using comparatively low values of output resistance with large values of input volts, but the damping on the input circuits is considerable.

If a steady positive voltage is applied to the anode and the voltage to be rectified is also applied to the anode circuit, as in the case of the diode detector, no fundamental change has been made, the anode-filament resistance merely having been reduced by applying the steady anode voltage. If the voltage to be rectified be now fed to the grid of the valve so that variations in resistance of the valve are caused by variation of grid potential instead of anode potential, rectification still takes place as before, but amplification has also been obtained from the same valve. This is "anode rectification." The dynamic characteristic of such an arrangement has a considerable length of curved portion at low inputs; it is therefore necessary to work at relatively high values of H.F. input voltage if the curved portion is to be negligible. The maximum value of this

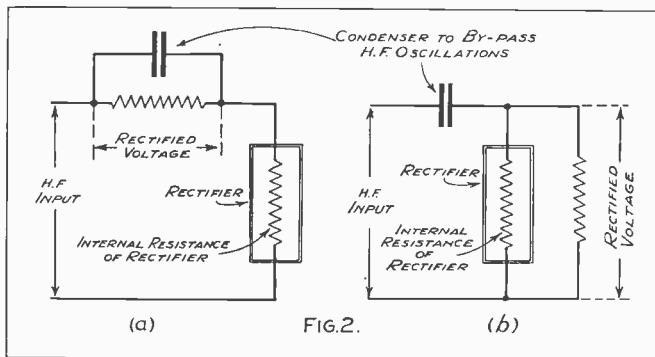

input is also limited by the capability of the valve to act as an amplifier (*i.e.* grid current, etc.), and unless special precautions are taken in design of input circuits, grid current must limit the available excursion of grid potential.

The grid-filament path of a three-electrode valve acts in a manner similar to that of a diode: consequently rectification can take place there, and the resultant rectified signals amplified by the valve as in a low-frequency amplifying valve.

The resistance of the grid-filament path is high at very low inputs, but decreases rapidly as the input voltage is increased. Consequently it is possible to produce a dynamic characteristic which is straight except for a very small portion at the lower end. This can be made negligible by choosing a reasonable value of input.

The value of grid leak required is determined by two factors: the resistance of the grid-filament path, and the total capacity of the grid condenser and grid-filament capacity. The leak resistance must be high compared with that of the grid-filament path at all amplitudes, or else the dynamic characteristic will be curved and the efficiency may suffer as well.

The maximum value of grid leak resistance is limited by the shunting capacity of the grid condenser and that of the grid-filament path. An increase of the leak resistance above a certain value increases the efficiency much more at low modulation frequencies than at high ones. Since a high-resistance leak is desirable from the point of view of efficiency and straightness of characteristic, it is desirable to keep all the capacities as low as possible. To this end the stray capacities between grid and filament should be reduced as much as possible by having short leads and by spacing all the components well away from each other and from earthy places. For instance, it is advisable to use a grid condenser of very small actual bulk, and not to screw it on to a conducting panel or place it near conducting surfaces. When suitable precautions have been taken the value of the grid condenser can be reduced to quite a small value between 50 and 100 μF without reducing the efficiency. This makes it possible to use a fairly high resistance leak. Of course, the more efficient the valve is as a rectifier, the lower the value of grid leak resistance that can be used for a given straightness of

dynamic characteristic and efficiency. This means that the frequency characteristic will be straighter.

The resistance of the grid-filament path, and particularly the rate of change of resistance, depends largely upon the type of filament. The less the voltage drop across the filament the greater the rate of change of resistance with input. Thus a 2-volt valve should make a better detector than a 6-volt, and an indirectly-heated valve better still.

The valve, as stated above, acts also as an amplifier, amplifying the signals after rectification. It is therefore necessary so to arrange matters that amplification takes place only over the straight portion of the characteristic. Unfortunately the grid has both low and high frequency variations of potential impressed upon it. In other words, the maximum value of potential across the grid-filament path is equal to the maximum rectified voltage across the grid leak plus the maximum value of high-frequency potential applied. If the valve is a 100 per cent. rectifier, the potential across the grid leak due to the rectified current for the carrier wave only will be equal to the peak voltage of the carrier wave applied to the grid. When the carrier is modulated 100 per cent. the voltage across the grid leak will rise to twice the steady rectified voltage and fall to zero during each cycle of 100 per cent. modulation, so that for the maximum value of potential on the grid we have a rectified voltage of twice the carrier peak voltage plus a high-frequency component equal to twice the carrier peak voltage—in all four times the carrier peak voltage. If the carrier peak voltage is 2, then the excursion of grid potential will be from approximately zero to minus 8 volts, and a valve must be chosen whose characteristic is straight over this range. It is therefore desirable to use a fairly high value of anode resistance and to use a high value of anode voltage. For an ordinary valve where the H.T. is usually limited to 180–200 volts, it would be desirable to use the whole of this voltage actually at the anode if the very best results are to be obtained.

It is interesting to note in passing that some years ago the anode bend detector was in greater favour than the grid leak detector from the point of view of quality. This is probably largely because the grid leak detector was used under its worst conditions, that is to say,

with a very low anode voltage. While this arrangement was efficient from the noise-making point of view, it produced very bad quality for obvious reasons.

Another interesting point is that an ordinary grid leak rectifier cannot be used as a first detector in a superheterodyne receiver. It is not easy to obtain a high rectification efficiency up to high audio frequencies. It will therefore be very much more difficult when the supersonic frequency in use is of the order 100,000 instead of an audio frequency of 10,000 max.

Recent experiments have shown that it is easily possible to arrange grid detectors to give no measurable distortion on 80 per cent. modulation, and measurable but not audible distortion on 100 per cent. modulation. It does not appear to matter whether low or high amplification valves are used, as the best working output in all cases is approximately the same. If low amplification valves are used, however, a considerably greater input is required to give the same output as a higher amplification valve. This entails more high-frequency amplification, and it therefore seems preferable to employ fairly high amplification valves as grid detectors.

It is difficult to obtain as good characteristics from anode detectors under practical conditions, and although diode detectors can be made to give similar characteristics they are considerably less efficient, as the amplification properties of the valve are not utilised.

Grid detection has the disadvantage that it imposes more damping on the preceding tuned circuits than does anode detection. This is not due to the grid current which flows on rectification as is commonly supposed, but chiefly due to what is known as "Miller effect." This can be simply explained as anti-reaction resulting from feed-back at high frequencies between the grid and anode of the valve due to their capacity. If a neutrodyne circuit is used and balanced up in the same way as for a high-frequency amplifier, it will be found that the damping of a grid leak detector is quite small. The reason that this damping is greater in the case of a grid leak than an anode bend detector is because with a grid leak the valve is arranged to work on the straight part of the characteristic; consequently there is greater magnification, hence the feed-back is greater.

It is to be noted here that one of the chief reasons why resistance-capacity amplification is not effective at high radio frequencies is due to the anti-reaction effect caused by the grid-anode capacity. This effect is much more serious than the pure shunting effect of the stray capacities.

One method of eliminating the damping due to the Miller effect in a detector is to use two valves with the grids fed push-pull and the anodes in parallel. With this arrangement there can, of course, be no difference of potential between the two anodes, and if the valves and the input circuit are fairly carefully balanced, the anodes will in effect be at earth potential with regard to high frequencies and no feed-back can take place.

This method of detection has several other advantages. As practically no high-frequency potentials exist at the anode of the detector system, elaborate precautions to prevent high-frequency voltages from passing into the low-frequency amplifiers and causing trouble there are not so necessary. It is, however, advisable to connect a small condenser between the detector anodes and earth to take account of small out-of-balance currents and harmonics which are produced in the process of rectification.

With this push-pull arrangement, if the input circuit is completely disconnected from earth it is not necessary to use grid condensers, as each valve acts as a high impedance to the other during the alternate half-cycles of high frequency, and the capacity to earth of the whole circuit acts as the grid condenser. Of course, unless care is taken that the capacity to earth is small, there may be little or no advantage in this method. As the blocking condensers are unnecessary, the total capacity can be decreased considerably, and it follows that the leak resistance can be increased without impairing the relative efficiency at high audio frequencies with a gain in straightness of dynamic characteristic and over-all efficiency. It is questionable, however, whether the advantages to be gained balance the disadvantage of having to use an additional valve. For the very best quality of reproduction it is probably an advantage to use push-pull rectification, whereas where over-all efficiency per valve used is very desirable the single detector scheme is probably the best.

HIGH-FREQUENCY STAGES

It will be obvious that the number of high- and low-frequency stages required in a receiver are determined very largely by the type of detector used. If grid detection is employed using medium impedance valves, an input to it of one or two volts of H.F. carrier is required. Such an arrangement seems to be the best for most purposes, as the rectified output is of the order of 10 volts, which enables one low-power, low-frequency stage to be used followed by the output stage.

For most purposes one high-frequency stage is capable of delivering the required one or two volts to the detector stage without the use of reaction except for distant stations. Where a certain amount of reaction can be permitted, and the distortion liable to occur when reaction is used is not objected to, additional H.F. stages are not necessary for general use. Where the best possible results are required, however, two H.F. stages without reaction are necessary to ensure that the input to the detector can always be kept at the optimum value, even when receiving distant stations. Obviously some form of volume control is required for such a receiver to keep the input to the detector at the correct value, and this should be placed in front of the first high-frequency stage to ensure that no overloading occurs in the high-frequency stages. The potentiometer device shown in Figs. 5 (a), (b), and (c) is satisfactory, as it has no great effect on the functioning of the receiver in other respects.

Screened grid valves are used in most modern receivers, as they enable efficient and reliable H.F. stages to be constructed with considerably less difficulty than when other arrangements are used. Bias for the screening grid should be obtained by a potentiometer arrangement rather than by a series resistance, as better control can be effected.

Adequate screening is necessary if stability is to be obtained, as the high amplification obtainable from these valves will cause oscillation if any feed-back occurs between anode and grid. Such feed-back is liable to occur in numerous ways, both by direct pick-up, which can be prevented by suitable screening, and by common impedance in battery leads, etc. The latter can be prevented by ensuring that the oscillatory currents flowing round the grid or anode circuit of every stage are confined as far as

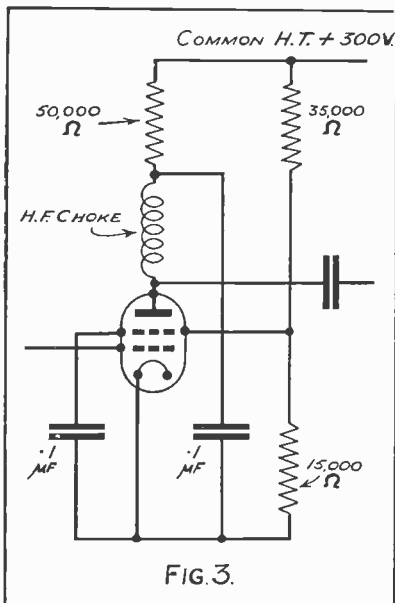

FIG. 3.

possible to such stages. These currents should not be allowed to flow through any common batteries or battery leads, and so-called de-coupling units as shown in Fig. 3 should preferably be fitted in all anode and grid leads from common batteries to compel all oscillatory currents from either anode or grid to return as directly as possible to the actual filament of the valve to which they must eventually find their way. It is not always sufficient to lead these currents by a very low impedance path to the negative

end of the filament to which they are to go. The current flows through the whole length of the filament, and the resistance between the negative end of the filament and other parts of it may be sufficient to cause trouble, as the potential difference set up across this resistance may be fed to other filaments, thus causing interaction. Where indirectly heated valves are used the filament is replaced by the cathode which is all at one potential, and this difficulty does not arise. Where it does arise it can be overcome by providing alternative low-impedance paths to each end of the filament. All so-called earthy returns should be led direct to the filament of the valve concerned, and not to any convenient point supposed to be connected to earth. Filament leads should be regarded as filament leads only, and not as high-frequency leads.

The high-frequency circuits in a receiver must be designed to respond equally to all changes in the carrier being received, if no distortion is to occur. The changes in ampli-

tude of the carrier occur at all frequencies up to about 10,000 cycles per second with modern transmitters, and as these high frequencies play an important part in the reality of the reproduction it is necessary that they should be dealt with equally with the lower frequencies. All the H.F. circuits must be sufficiently damped to respond to these rapid changes in amplitude of the carrier, which may also be regarded as equivalent to oscillations of frequencies equal to the sum and difference of the frequency of the carrier and the frequency at which the changes are taking place. Thus the circuits must respond equally to the carrier frequency and frequencies differing by as much as 10,000 from the carrier frequency each side of it. In other words, the circuits should have an over-all response curve which is flat over a band of 20,000 cycles per second, the carrier frequency being the mean.

In order to prevent interference from other stations there should be no response outside this frequency band, the ideal response curve therefore being a rectangle. It so happens, however, that owing to the necessity for accommodating a very large number of stations in a limited waveband it is only possible to allow 9000 cycles separation between the frequencies of some of these stations. This means that with a response band of 20,000 cycles a receiver might suffer from interference from either of the stations on adjacent frequencies if they gave field strengths comparable with that of the station it was desired to receive at the point where the receiver was situated. It is often desirable, therefore, to reduce the width of the response curve of a receiver if interference is liable to occur, although this is not desirable from the quality point of view; but it is a question of the choice of two evils.

In order to produce flat-topped response curves without introducing so much resistance that the circuits are not sufficiently selective to prevent interference, it is necessary to employ some form of loosely coupled tuned circuits. Such circuits react on each other and produce a response curve which has two pronounced peaks instead of one if the damping is sufficiently low, and if the two circuits are tuned to the same frequency before the coupling between them is increased until they react on each other. These two peaks occur on each side of the frequency to which the

circuits are tuned, and the distance between them is determined by the tightness of coupling and the damping. By suitably choosing the values of the inductance and the capacity of the circuits, and the damping, it is possible to flatten out these peaks so that the response curve is practically flat-topped. The steepness of the sides of the response curve can be increased by using several such coupled circuits.

Electromagnetic coupling or capacity coupling can be employed. By judicious combination of the two it

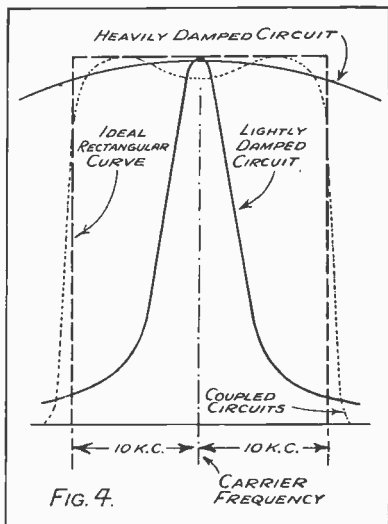

is possible to obtain a constant band width over a wide range of carrier frequencies, but for general purposes satisfactory results can be obtained by either method alone. The condensers can be ganged if desired, and if the coupling is made adjustable the width of the response curve can be controlled according to circumstances, and if desired can be increased to cause a greater response to the higher frequencies of modulation to compensate for

any reduction in other stages of the receiver. Fig. 4 shows frequency response curves for various types of circuits.

Any single-tuned circuits which are used should preferably be sufficiently damped to prevent them from reducing the response to the "sideband frequencies," as otherwise it may not be possible to obtain sufficient compensation from the coupled circuits. If loosely coupled intermediate circuits are used it is not usually necessary to employ such circuits for the aerial unless the receiver is so close to the local station that overloading of the H.F. stages would occur from this station when receiving considerably weaker

stations. Sufficient selectivity can generally be obtained to prevent this overloading by using a small aerial series condenser, the intermediate tuned circuits ensuring adequate selectivity to prevent any interference reaching the detector. In really bad cases a wavetrapp tuned to the strong local transmitter can be used and left set, as critical adjustment is not necessary.

LOW-FREQUENCY STAGES

Sufficient factor of safety should be allowed in all the low-frequency stages to prevent overloading occurring on peaks of signals, otherwise audible distortion will occur due to rectification of the audio-frequency currents. The maximum permissible anode voltages should be used and the anode impedances should be sufficiently high to ensure that the amplifying characteristics are as straight as possible. It is difficult to obtain really straight amplifying characteristics, and as the distortion introduced increases with input voltage, the valves should preferably be of sufficiently large capacity to enable them to be worked at considerably less input than they are apparently capable of handling.

All anode impedances should be of sensibly constant value at all frequencies up to 10,000 cycles per second if no frequency distortion is to be permitted. Really well-designed transformers have sufficient inductance to give good response at frequencies as low as 50 cycles, which is sufficient for most requirements. The resonances which occur at the higher frequencies are damped out if the transformers are used with valves for which they were designed. Ultra-high impedance valves cannot be used satisfactorily with transformer coupling, as there is liable to be an appreciable variation in the amplification obtained from the valve at various frequencies. The presence of anode current in the winding of a transformer usually reduces the inductance and consequently considerably affects the frequency response. On the other hand, if the transformer is either choke-capacity coupled or resistance-capacity coupled a resonant circuit is produced which may introduce distortion. The condenser used in such cases should be of such a value that the resonance occurs at frequencies not greater than about 10 cycles per second.

Recent researches have shown that certain magnetic

materials used for transformers are liable to introduce harmonics. These harmonics can be kept to a very low value if the A.C. flux density in the iron is kept low, also if the ratio of inductive reactance of the transformer is high compared with the anode A.C. resistance of the valve preceding it, and if the magnetising current is kept very small compared with any load current. It is, however, a point that should be borne in mind, as the general quality of reproduction of broadcasting has improved very considerably and is likely to improve still more in the future.

Distortion which is at present unnoticeable in the presence of distortion from a number of other causes may become an appreciable factor when the latter distortion has been reduced to a small value.

The question of whether a "phase shift" matters in very high quality speech and music still remains to be proved. There is no doubt that at the moment considerable phase distortion must occur in various parts of the broadcast chain, not the least of these being the loud-speaker; and as there is a number of transformers in the broadcast chain, it is probable that one additional transformer will make no appreciable difference in the over-all result, particularly if this transformer is well designed. There is a number of extremely well-designed transformers on the market at present. Nevertheless, a number of designers who desire the very best possible quality from their receivers prefer to use resistance-capacity coupling.

It is to be noted that distortion is liable to occur in output transformers. It would, of course, only be noticeable where other forms of distortion are already extremely small.

The principal alternative to transformer coupling is resistance-capacity coupling, which also has disadvantages. The values of resistance should not be so high that stray capacities cause reduced amplification of the higher frequencies. The coupling condensers should be of sufficiently large capacity, compared with the resistance of the grid leak, to prevent appreciable reduction in response to low frequencies and distortion of transient impulses. If the grids of valves are overloaded and grid current is allowed to flow, these large condensers will be charged up and the grid will be "choked" until the charge has had time to leak away.

Low-frequency stages should preferably be de-coupled

in the same way as high-frequency stages to confine the currents as closely as possible to the valves through which they flow, and to prevent interference from electric light mains, etc. through pick-up on battery leads.

As two low-frequency stages are all that are normally required with the type of detector that appears to be the best, the first of these must be capable of supplying sufficient voltage to operate the output stage, and a fairly low impedance valve will do this. For use with a gramophone pick-up the detector can be used as an extra L.F. stage.

The output stage should be capable of giving an undistorted output of one half to one watt if good loud-speaker results are required in a living room of average size. This means that the valve or valves in the output stage will dissipate about five to ten watts of power supplied to the anode. A greater output is preferable if a good factor of safety from distortion is to be allowed.

There is considerable difference of opinion as to whether push-pull in low-frequency amplifiers is worth while. There is no doubt that there is considerable advantage to be gained from push-pull in several directions. We will take the point of view of quality first of all. Theoretically speaking, there is no such thing as absolutely perfect quality, since there is no such thing as a valve with an absolutely straight characteristic under normal working conditions. Therefore the first advantage of push-pull is that with balanced valves all second harmonics are cancelled out, which means that considerably more of the characteristic of a valve can be used when two valves are working push-pull than when the same two valves are working in parallel for a given amount of over-all distortion, and hence considerably greater efficiency can be obtained.

If an output transformer or choke is used, the currents in the two halves are opposite in direction, and therefore the D.C. flux cancels out. In the case of a choke, it is therefore not necessary to use an air-gap, and in the case of a transformer the latter can be connected directly in the anode circuit of the valve without any fear of saturation of the iron.

The undesirable effects of what is called "motor boating" are to a large extent eliminated when push-pull is used, since the alternating components of the anode current cancel one another in the common high-tension lead.

It has been said that considerably less smoothing is required with the push-pull system. This is true provided the criterion is the presence of a given proportion of hum to signal. While the hum may not be audible it may affect the quality considerably by varying the characteristics of the two valves during the time that a signal is passing. The signal may under these circumstances be modulated by the hum, while the hum is not actually audible as such.

For a push-pull amplifier it is necessary to use some device to obtain grid voltages for the two grids 180° out of phase. It is further necessary to use some device where the phase difference of 180° is fairly accurately preserved over the whole frequency band. If this is not the case, distortion of the frequency response curve will result and amplitude distortion may occur. A transformer with a split secondary is frequently used for this purpose. Great care should be taken to select a transformer where the above-mentioned requirements are complied with. Where appreciable capacity exists between the primary and secondary windings of the transformer, and particularly where one side of the primary winding is in effect at earth potential as regards A.C., it is probable that these requirements will not be complied with.

Another method of phase reversal has recently been devised, and is the subject matter of a patent. This system uses a valve to split the phases. While there is less danger of the phase differences being less than 180° , for those designers who object to the use of transformers it has the advantage that the transformer is eliminated.

It is frequently stated that for maximum efficiency the load impedance from an output valve should be twice the valve impedance. This is not necessarily the case, but depends upon the conditions of operation. Where a low-impedance valve is used at high anode voltage and low current, the ratio of output impedance to valve impedance may be as much as 10:1. It will be seen, therefore, that the output impedance depends upon the valve impedance and upon the ratio of H.T. voltage to anode current. There are no simple rules for guidance in this matter; every case must be dealt with on its own merits by a study of the characteristics. The use of a very high output impedance in a valve has the effect of straightening the characteristic as well as

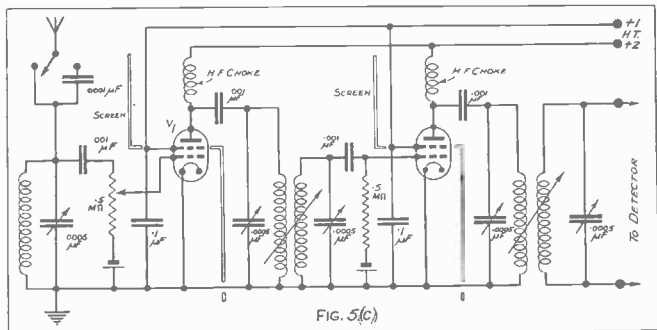
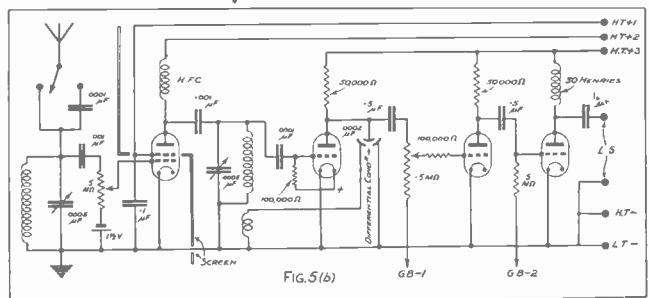
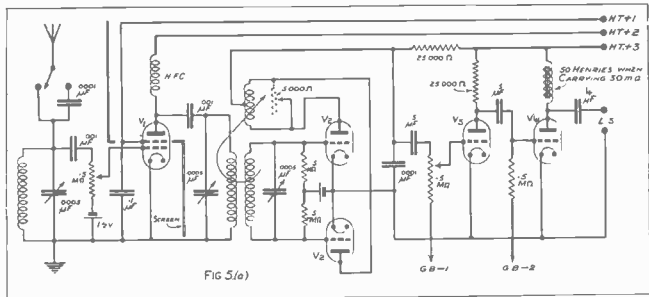

FIGS. 5 (a), 5 (b), AND 5 (c).

enabling the maximum use to be made of the available changes in voltage and current in the valve. When transformer or choke coupling is used for the output circuit, it is necessary that the reactance of the choke or transformer in question shall be high compared with the load impedance, and not necessarily the valve impedance.

The above, of course, has been written for the ideal case of a pure resistance output which is not usually realised in practice, although with a good moving-coil loud-speaker the effect is not far removed from that of a resistance output. In the case of moving-iron loud-speakers the impedance varies considerably with frequency, being low at low frequencies and high at high frequencies. These loud-speakers are usually arranged to work best out of a valve of a certain impedance, and under these conditions give a certain definite frequency characteristic. If a valve of lower impedance is used the low frequencies will be reproduced in greater proportion than the high, while if a high-impedance valve is used the low-frequency reproduction will be reduced in relation to the high. So we see that the problem of design of an output stage for moving-iron loud-speakers is quite different from that with a pure resistance load or even moving-coil loud-speakers. It is not possible in this case to design so that the output impedance is many times the valve impedance at the lowest frequencies unless the loud-speaker is so designed that its frequency characteristic and other conditions will be correct, or unless a resistance is included in the output circuit. Whether or not this is economical is largely a matter for treatment of individual cases.

Pentode valves may be used where especially good quality is not the only consideration. These valves have an extremely high impedance, and consequently may modify considerably the frequency characteristics of a loud-speaker. It is not advisable to design the output impedance conditions for a pentode in the same way as that advised for an ordinary valve, as the operation of a pentode is peculiar, and if a very high load impedance is used, considerable distortion may result and extremely high voltages may be produced. It is usual to use an impedance in the anode of a pentode of the order 5000 to 10,000 ohms. An ordinary moving-iron loud-speaker can frequently be

connected either directly in the anode or through a 1 to 1 transformer.

There are various methods of altering the frequency characteristic of a low-frequency amplifier by introducing resonant circuits. Such circuits are not usually necessary, but it may be found desirable to remove an interfering heterodyne note in some cases. A satisfactory method of doing this is to connect an inductance of about one henry in series with a variable condenser of about .0005 microfarad capacity across any of the anode resistances if they are not greater than about 25,000 ohms. The condenser can then be adjusted to tune out the interfering note without reducing the strength of the higher audio frequency signals appreciably. If the filter is connected across a high value of anode resistance it will reduce the response to other frequencies. Usually a suitable place is across the primary of the output transformer, or across the loud-speaker if no output transformer is fitted. Fig. 5 (a) is a diagram of connections of a receiver with one stage of high-frequency amplification, a magnetically loose-coupled interstage circuit and a push-pull detector. Fig. 5 (b) shows the arrangement of a receiver without a loose-coupled H.F. interstage circuit and having an ordinary grid leak detector.

Fig. 5 (c) shows a two stage H.F. amplifier with magnetically loose-coupled circuits.

CONCLUSION

The views expressed above are the outcome of work which has been carried out by the Research Department of the B.B.C.

It will be realised that the design of high quality receivers is carried out by the Corporation only because they are necessary for the regular checking of the quality of transmissions. The highest possible standard of performance is also necessary for the receivers which are used for wireless links, and relaying foreign programmes.

The B.B.C. fully realises that difficulties arise in the manufacture in large quantities of receivers which make it impracticable for all refinements, such as are outlined above, to be incorporated in sets which are sold at popular prices and which must be capable of being handled with comparative ease, perhaps by unskilled listeners.

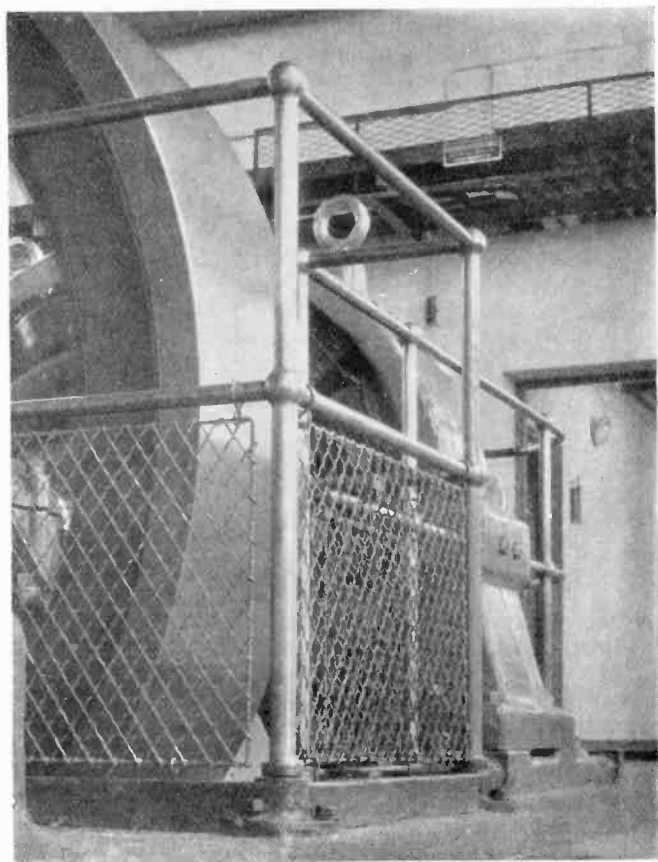

THE FLY-WHEEL OF A DIESEL ENGINE AT BROOKMANS PARK

WAVE RANGES OF RECEIVERS

THE provision of alternative programmes from the dual wavelength Regional Stations will create a need for receivers to be made conveniently adjustable to either wavelength.

In the past some listeners have not bothered to change the tuning of their receivers, merely leaving them adjusted to the wavelength of a single programme. If, however, they are to obtain the full benefit the alternative programme scheme offers, it will be advisable for them to endeavour to arrange matters so that their receivers can be tuned to either programme at will without any laborious process, such as the finding and fitting of different coils every time a change of programme is desired.

A certain separation in the two wavelengths of the Regional Stations is necessary in order that the two transmissions shall not interfere with each other. Furthermore, the B.B.C.'s choice is confined to those wavelengths which have been allotted to them by international agreement.

During the introduction of the Regional Scheme, therefore, listeners may find a need to increase or modify the range of wavelengths which their receivers will cover, and some information about simple steps which they can take may be of assistance. In the majority of cases listeners will require to reduce rather than increase the wavelength to which their receiver can be tuned; for example, in the London area the Regional programme is radiated on the previously used wavelength of 356 metres, and the National programme on the lower wavelength of 261 metres.

TO OBTAIN A LOWER WAVELENGTH

If a receiver does not tune down to the required wavelength, as evidenced by the fact that the wanted programme is heard loudest at the lower end of the tuning range, there is one extremely simple remedy which will be found satisfactory in a very large number of instances. Fig. 1 (a) shows diagrammatically the method of connection of the most simple type of aerial circuit, the circuit being redrawn in Fig. 1 (b), in which the aerial is shown as a capacity Cae in parallel with the tuning condenser,

C_t . Even when the tuning condenser, C_t , is in its minimum position, the capacity of the aerial, C_{ae} , is still in parallel with the tuning inductance, L . When the tuning condenser, C_t , is increased to its maximum value, the total capacity across the tuning inductance is the capacity of the aerial plus the capacity of the tuning condenser, *i.e.* $C_{ae} + C_t$. If a large and high-capacity aerial is used and the aerial circuit is tuned with a variable condenser of the normal type, the tuning range of the circuit, that is, the range of wavelengths to which it can be tuned, will be decreased and some difficulty may be experienced in tuning-in both programmes without a change of tuning inductance, L . This difficulty can be overcome in many cases by inserting a small aerial series condenser, C_s , in the aerial lead as is shown in Fig. 2. Such a condenser will limit the capacity of the aerial, and thereby increase the tuning range, for the total capacity of any two condensers which are connected in series cannot be greater than the capacity of the smaller condenser. An aerial series condenser, therefore, will increase the tuning range of the circuit, and at the same time decrease the lowest wavelength to which the circuit can be tuned. The smaller the capacity of the condenser the more noticeable will this effect become. Not only will the condenser reduce the minimum wavelength, that is, enable the receiver to tune to a lower wavelength, but it will at the same time provide a definite increase in the selectivity of the circuit.

The inclusion of an aerial series condenser will, in some cases, therefore, solve the problem of tuning range and the separation of the two programmes in one move. It is

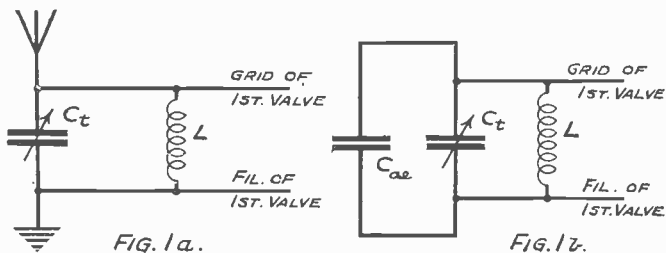

pointed out, however, that it is not likely to be effective when a very small aerial, say one of not more than ten feet in length, is being used, as the "standing capacity" which such an aerial would possess and throw across the tuning circuit would be very small in itself. Further, the addition of an aerial series condenser is not likely to be effective if one of low capacity is already incorporated in the internal circuits of the receiver.

In general, there will be little noticeable loss of volume if an aerial series condenser is used in conjunction with a valve set which employs a reasonable amount of reaction, but the loss will be more noticeable when it is used with a crystal receiver. In choosing the capacity of an aerial series condenser some compromise has to be made between the desired increase in tuning range and selectivity on the one hand, and resultant loss of volume, due to the use of too small a capacity, on the other hand. The value which has been found satisfactory in a large number of cases is $0.0001 \mu\text{F}$. Small fixed condensers having a capacity of $0.0001 \mu\text{F}$ can be obtained at almost any wireless dealer at a cost of about 2s. A variable condenser can, of course, be used in place of a fixed condenser and is slightly more satisfactory, as it gives a choice of capacity and allows the best compromise to be found. A small variable air dielectric condenser, having a maximum capacity of $0.0003 \mu\text{F}$, such as is sold for use as a reaction condenser, is quite satisfactory for this purpose, particularly if arrangements can be made for mounting it in a small box or on the panel of the receiver.

If it is found that the use of an aerial series condenser brings about too great a loss of signal strength or does not reduce the minimum wavelength sufficiently, a smaller inductance should be tried. Possibly, if plug-in type coils are used, that which is used in the reaction coil holder may be smaller than that which is used in the aerial circuit and an interchange of the two coils would be effective. Many well-known coil manufacturers give the tuning ranges of their coils when tuned with different capacities. If cylindrical coils are being used, a reduction in wavelength can be brought about by removing some of the turns from the coil. If a coil has 50 turns and it tunes to a wavelength of, say, 300 metres, the wavelength to which

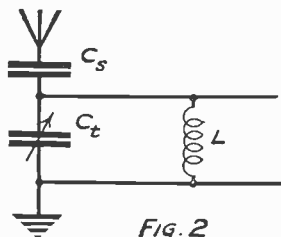

FIG. 2

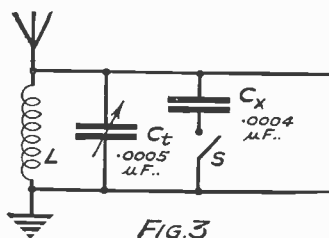

FIG. 3

it will tune down with the same aerial and tuning condenser if half its turns are removed will be approximately 140 metres.

FOR A HIGHER WAVELENGTH

If it is desired to increase the maximum wavelength to which the receiver can be tuned, the best course to adopt is to employ a larger coil, or to add turns to the inductance already in the receiver. Should there be no room for more turns, owing to the fact that the existing number of turns already fills the tube or former on which they are wound, either a former of a larger diameter should be tried or a longer one of the same diameter which will accommodate more turns. If it is quite impracticable to use a larger former, that is, one of greater diameter or length, another possible method is to strip off all the existing turns and to wind a fresh coil with a thinner wire. It is not advisable to wind additional turns over the existing turns, as such a coil would probably be somewhat inefficient.

Another method of increasing the tuning range of the receiver is to add a small fixed condenser (C_x in Fig. 3) in parallel with the existing tuning inductance or variable condenser. The value of the capacity so added will depend on the increase in wavelength which is desired, but it is advisable that the added capacity should not be greater than approximately three-quarters of the capacity of the variable condenser, *i.e.* about $.0004 \mu\text{F}$, assuming that a $.0005 \mu\text{F}$ variable condenser is already in use (see Fig. 3). When using a loading capacity of this nature it is convenient to incorporate a switch, S , to disconnect the condenser when tuning to the shorter wavelengths.

In making any alterations to an inductance, great care

TECHNICAL CONSIDERATIONS

Having dealt with the actual calibration of a receiver, it is well to consider certain technical aspects which affect such calibration and which, it is thought, will be of value to the reader who is more particularly interested in such details, and, for the same reason, a few formulæ are included in the Reference Section of this book (Nos. 9, 17 and 18) for ease of reference.

For the estimation of scale readings at which the set will tune to a particular wavelength, given the reading at which one known wave is received, it is necessary to have a knowledge of the law of the variable condenser in use. In general, variable condensers used in receivers are of four types—viz. (1) straight-line-capacity, (2) straight-line-wavelength (square law), (3) straight-line-frequency, and (4) logarithmic. In the first type, equal angular movements of the moving plates give equal increments of capacity; in the second they give equal increments of wavelength, which varies as the square of the capacity; in the third, equal increments of frequency; and, in the fourth, increments of capacity which are proportional to the logarithm of the change of capacity. In practice the fourth type gives a curve which is intermediate between the second and third types.

It is interesting to consider the reasons which have resulted in the design and production of these four types of condenser. The original type of variable condenser, as used very extensively before broadcasting started, was the straight-line-capacity type. The moving plates of this type are semicircular and, as stated above, equal angular movements of the moving plates result in equal increments of capacity. As the initial addition of condenser capacity in parallel with the inductance, or tuning coil, effects a greater change in wavelength than subsequent additions, stations are found to be crowded together in the first few degrees of the condenser dial. To remedy this inconvenience, the straight-line-wavelength (square law) condenser was evolved and gave considerable improvement. As stated above, its moving plates are so shaped as to give equal increments of wavelength for equal angular movement, and the apparent crowding together of stations at the bottom end of the dial was partially overcome.

stations can then be read off. This line can be corrected later as the exact dial reading is confirmed by actual reception. It will be found that, towards the bottom and top of the condenser scale, the line joining up the dots will not be straight, even if the appropriate metre or kilocycle-per-second scale has been chosen according to the law of the condenser. It is for this reason that the first two stations selected should be chosen not too near the top or bottom. The cause of this is dealt with in detail later.

It is well to consider the first curve drawn as experimental, and afterwards, when by its aid the majority of stations have been identified, and it has been corrected to take account of the new readings, to make a much more precise chart. A larger sheet of graph paper may be used, which will permit of larger scales and correspondingly greater accuracy in reading. It has been mentioned that a separate chart is required for each range or set of coils—it should also be realised that, if the receiver has several high-frequency tuned circuits, a separate curve can be drawn for each set of condenser readings. By suitable arrangement—as will be pointed out in a later section of this article—it is often possible to make all these condenser readings the same. If they are not, but are within a few degrees of each other, then the various curves for one range can be marked on the same chart by the use of coloured inks to distinguish the one from the other.

RECEIVER DIAL READINGS

There are, of course, many other methods of recording calibration which will occur to readers, and considerable ingenuity can be exercised in making up various kinds of charts with movable pointers, so that when one end of the pointer is set to a given wavelength, the other will indicate the dial setting, but these must be left to readers themselves. One very simple method, however, which can be mentioned depends on the use of certain types of condenser dials on which provision is made for a card on which either metres, kilocycles-per-second, or even the names of stations can be entered. A fresh card must be used for each "range" or change of coil. A typical example is given on p. 34¹.

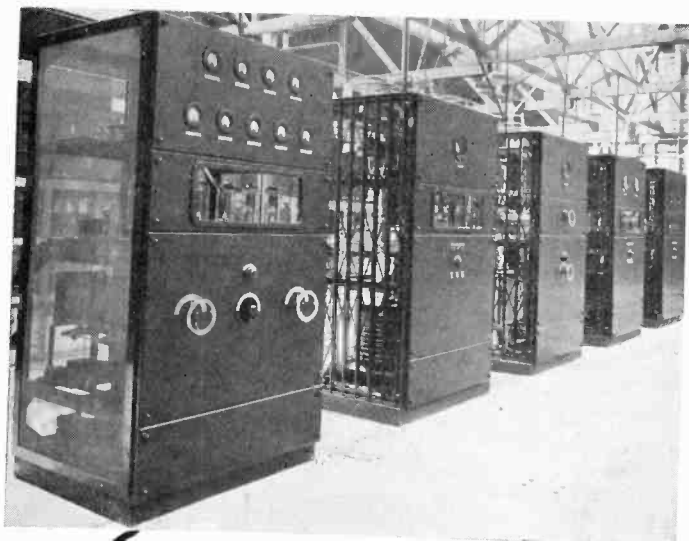

Standard BROADCASTING EQUIPMENT

"Standard" Broadcasting Equipments are renowned for the highest possible quality of programme transmission. The circuit arrangement is such that the carrier frequency remains unaffected by modulation, changes in antennae current or normal variation in the supply voltage. They are capable of 100% modulation without audible distortion, and are made in all power ratings for towns, cities or large countries.

The illustration above shows a 25/50 K.W. broadcasting equipment supplied for SOTTENS, Switzerland.

Full details upon request.

Standard Telephones and Cables Limited

COLUMBIA HOUSE, ALDWYCH, LONDON, W.C.2.

Telephone: HOLBORN 8765 (24 lines)

Works:

HENDON, NORTH WOOLWICH, NEW SOUTHGATE

Branches: Birmingham, Glasgow, Leeds, Manchester,
Dublin, Calcutta, Cairo, Johannesburg
and Singapore.

Actual figures have been quoted as an example, but in practice any scale can be used that will fit conveniently the size of the paper available.

Having thus prepared the paper, and having identified certain stations, their settings and wavelength can then be entered by making a series of dots—each one at the intersection of the respective vertical and horizontal lines corresponding to the particular wavelength or frequency and dial setting. Thus, for instance, if Rome, whose wavelength has been found from the list to be 441 metres, tunes at 70 divisions on the dial, it is necessary to run one's pencil up the vertical line corresponding to 441 metres read on the wavelength scale at the bottom, and to make a dot where this vertical line intersects with the horizontal line corresponding to 70 divisions on the condenser dial read on the dial setting scale at the left. And so on until all the stations have been entered and are represented by dots. These dots may now be joined up, when it should be found that a smooth curve or straight line will result.

At any point on this curve intermediate between the dots, it is now possible to read off the dial setting corresponding to any given wavelength or *vice versa*. It should be noted that where it is required to draw a curve from a fairly large number of existing readings, it is immaterial whether the horizontal scale is marked off in metres or in kilocycles per second, and it is not necessary to know what type of condensers are in use. The shape of the resulting curve will differ, but this does not matter.

LOGGING NEW STATIONS

Dealing now with the listener who wants to be able to interpolate readings between those of only two identified stations some distance apart on the dials, the following procedure should be adopted. If the condensers in the set are "straight-line-wavelength" (*i.e.* square law), then the horizontal scale must be marked in metres, whereas if they are straight-line-frequency condensers, then the scale must be marked in kilocycles per second. The readings of the two stations selected previously (suggested as Rome, at 70, and Turin, at 27) should then be marked by dots exactly as indicated above. These two dots should then be joined by a straight line from which approximate settings of other

FOR 30 YEARS

**the Ever Ready Company has
been making reliable Batteries**

The Ever Ready Battery is made by a particular and exclusive process, which gives it the ability to yield fluent unfailing power throughout its long constant life. The prime of its life is practically the whole of its life

Ever Ready batteries are made for all wireless sets. If you own a portable you can obtain an Ever Ready of the right size and shape to fit it. Write for free list, which gives full particulars, including exact dimensions in inches



HIGH TENSION BATTERIES

The batteries that give unwavering power

**The Ever Ready Co. (Great Britain) Ltd.,
Hercules Place, Holloway, London, N.7**

A COMPLETE RANGE OF A.C. AND D.C. RECEIVERS

If your electric mains are A.C. or D.C., if you want a portable or battery set, if you want a 2, 3 or 4 valve receiver, or a radio gramophone . . . you want Philips radio. In the complete Philips range of Receivers, Loudspeakers and H.T. Units, there is one to suit every requirement and every purse. Each product is constructed to the Philips tradition of trouble-free and simple radio, and carries the Philips guarantee. Ask your radio dealer to let you hear one.

Made by the manufacturers of the famous Philips Argenta electric lamps, commercial and industrial fittings, and neon signs.

PHILIPS ALL - ELECTRIC RADIO

Philips Lamps Ltd., Philips House,
145, Charing Cross Rd., London, W.C.2

[335]

making the graph, the idea is that distances measured horizontally from a given line at the left of the paper shall represent wavelength or frequency, as the case may be, and that distances measured vertically from a given line at the bottom of the paper shall represent condenser or dial setting. The use of squared paper gives a very simple method of measuring these distances by counting the squares.

PREPARING THE GRAPH PAPER

Having procured the necessary paper, pencil a line over one of the thick vertical lines at the left of the paper and similarly over one of the thick horizontal lines at the bottom of the paper. Mark off the left-hand vertical line in divisions corresponding to condenser scale readings. If the condenser dial reads from 0 to 100, then let each large square represent 10 divisions or, if the paper is large enough, 5 divisions. If the condenser dial reads from 0 to 180, each large square can still represent 10 divisions, but obviously larger paper will be required, since it will have to be over 18 large squares deep. If smaller paper is used, then one large square can represent 20 divisions. The horizontal line at the bottom of the paper should now be marked off in wavelength (metres) or in frequency (kilocycles-per-second) as may be chosen. If the former, the metres should increase from left to right, and if the latter, the kilocycles-per-second should decrease from left to right.

A decision must be made as to the probable waveband to be covered by the coil, or "range," in question. Suppose, for example, that the whole medium broadcast band is covered, then we must start with 200 metres, or 1500 kc/s, on the left and finish with 545 metres, or 550 kc/s, on the right. It will be seen that a range of 345 metres, or 950 kc/s, has to be covered. If metres are to be used, each large square can conveniently correspond to twenty metres, in which case each small square will correspond to two metres, and the paper must be over 18 large squares long; or if kilocycles are used, then each large square can conveniently correspond to five kilocycles, when each small square will correspond to five kilocycles, and the paper must be over 19 squares long. The larger the scale used, the more easily can small differences be appreciated.

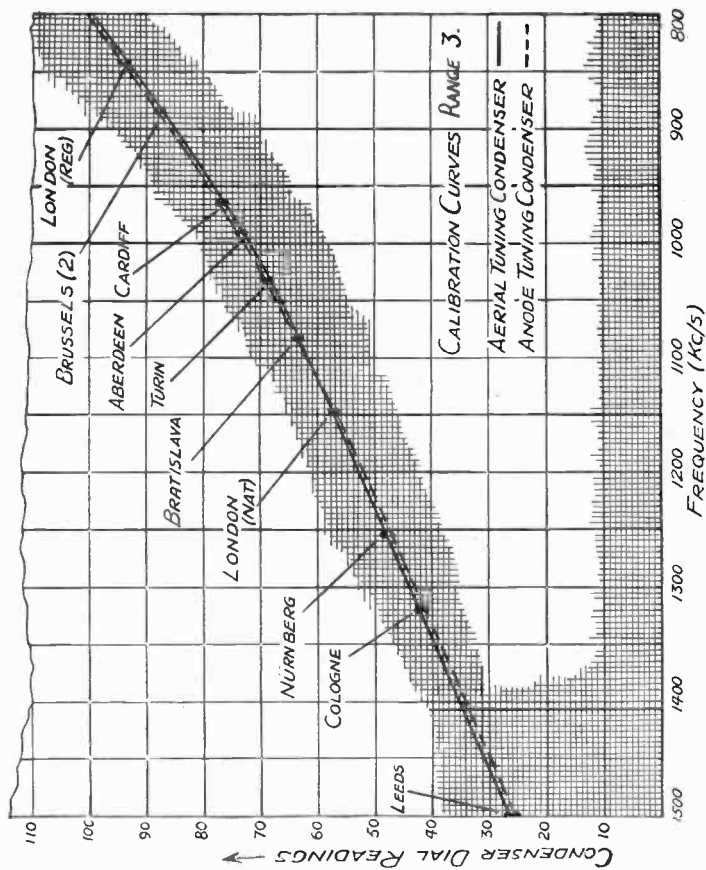

fusion existing as to which is which—they change their announced names every three months! In the medium wave band there are Budapest, Oslo, Daventry 5GB (now the Midland Regional transmitter), Rome, Radio Toulouse, London Regional, Turin, London National, Nürnberg, etc. If one's local station is used, then care should be taken, as, owing to the fact that it is, in general, received much more strongly than other stations, the method of volume control—which may be by reaction—may alter the dial settings. Having got a list of definitely identified stations, one can set out to make a chart by plotting these on squared paper.

MAKING THE GRAPH

It is, of course, possible for those who so desire, and who have not the time or patience definitely to identify many stations at the outset, to arrive at a calibration chart by a method of approximation, following the identification of only two stations. A knowledge of the type of variable condenser is necessary. To proceed, two stations whose settings are respectively at about thirty divisions from each end of the condenser scale should be identified. Let us suppose that these might be Rome at about 70 divisions (near the top end) and Turin at about 27 divisions (near the bottom end), or, on the long-wave range, Daventry (5XX) towards the top and Kalundborg towards the bottom. The readings should then be plotted on the chart and, subsequently, are to be joined by a straight line and used as will be explained presently. A separate chart should be drawn for each "range" on the receiver (*i.e.* for each set of coils if plug-in type are used).

The general method of drawing the graph is the same for those who have identified many or only few stations, and is as follows. Firstly get a piece of graph paper (squared paper), the larger the better. It can be bought ruled in centimetre or 1-inch squares, and each of the large squares is divided into a number of smaller squares. If the paper is metric, each of the centimetre squares will be divided into 100 small squares, each of 1 millimetre side. If it is in inches, then care should be taken that the inch squares are divided into 100 squares each (*i.e.* $\frac{1}{10}$ -inch side) and not into 64 ($\frac{1}{8}$ -inch side) or 144 ($\frac{1}{12}$ -inch side). In

As these notes are intended for the home constructor as well as for the purchasers of complete receivers, it is well to point out to the former that change in shape of inductances and wiring forming part of a tuned circuit will, of course, affect the wavelength to which a given circuit will respond, and that, therefore, the utmost rigidity in both is most desirable.

CALIBRATING A RECEIVER

Undoubtedly the best way to begin to calibrate any receiver is first of all to make a note on paper of the actual settings of the variable condenser dial (or dials) for a number of stations which have been identified definitely. The names of the stations can be noted down first, together with their settings, and a subsequent reference to the station list in *World-Radio* will then allow the correct frequency, or wavelength, as desired, to be entered against each. It cannot be stressed too strongly that one or two *definite* identifications first of all are necessary before embarking upon the making of a chart, or calibration curve. There is one point to beware of—namely, relayed programmes. For instance, to take a simple case of British stations, it is possible that during an S.B. one might be tuned to any one of twenty stations and hear the announcement: "This is London calling!" Other evidence must then be adduced to indicate which is the *actual transmitter* to which one's set is tuned—for it is this latter which is all-important in ascertaining the correct frequency or wavelength from the printed list.

Such evidence is given firstly by noting whether the dial setting is *above* or *below* that of some other definitely known station (say, one's local station). In the vast majority of receivers, if the scale reading is higher, then the wavelength will be higher, and so several other transmitters, lower in wavelength, will be ruled out. It is quite useful to have certain "reference stations"—stations which are well received and which are shown by the Brussels monthly charts, as published in *World-Radio*, to be stable in frequency. For instance, on the long-wave band, Radio Paris and Daventry 5XX towards the top, and Kalundborg towards the bottom, will answer this purpose. Huizen and Hilversum would also be suitable if it were not for the con-

PRESERVE THE BEAUTY OF YOUR HOME—

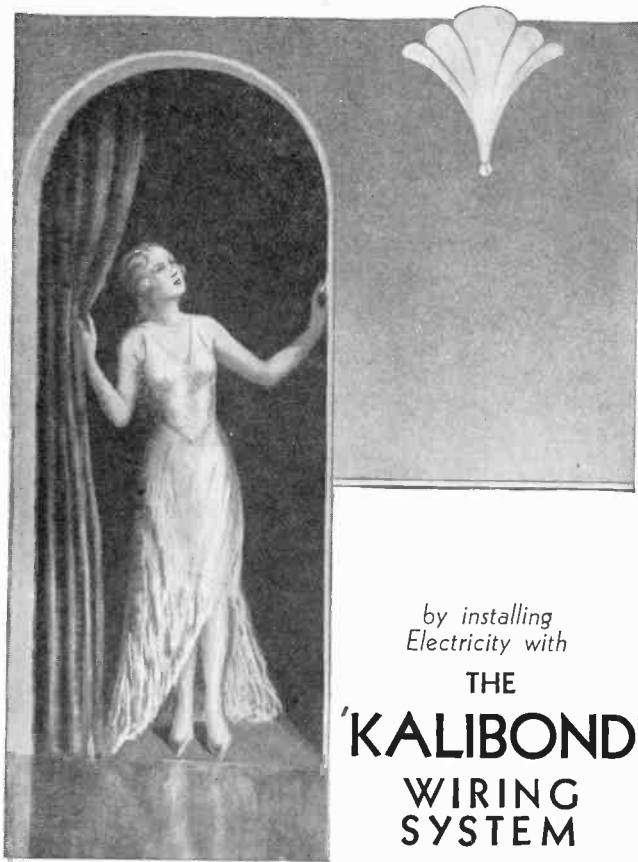

*by installing
Electricity with*

THE
'KALIBOND'
WIRING
SYSTEM

Electricity enables you to enjoy an atmosphere of refinement, comfort and convenience. It makes possible novel lighting effects, easy change of light and reduced labour. In order that the wiring installation may be carried without injury to the decoration of the home it is recommended that the **CALLENDER "KALIBOND" WIRING SYSTEM** be employed.

Ask your local Electrical Contractor for full particulars.

CALLENDER'S CABLE & CONSTRUCTION Co. Ltd.,
HAMILTON HOUSE - VICTORIA EMBANKMENT - LONDON, E.C.4.



Not just a 'box of tricks'—but a really superb all-electric receiver in a handsome, richly polished, solid walnut cabinet—that's the wonderful new Brownie DOMINION MAINSET '2'! It's the modern set for the modern home... no batteries, no accumulators... no bother, no expense! Just switch it on—and then sit back and enjoy at last—the perfect broadcast! Not only British stations, but Continental stations too, come singing through at brilliant loud speaker strength!



BROWNIE DOMINION MAINSET '2'

Including royalty and valves ... **£12.15.0**

Including royalty, valves, and Walnut Speaker ... **£15.0.0**

Also DOMINION MAINS S.G.3

Including royalty and valves ... **£18.10.0**

Including royalty, valves, and Walnut Speaker ... **£20.15.0**

Ask your dealer to demonstrate the new Brownie DOMINION MAINSETS, but in any case, write now for illustrated catalogue containing details of their complete range of mains and battery operated receivers to

BROWNIE WIRELESS Co. (G.B.) Ltd.,
Dept. T, Nelson Street Works, London, N.W.1

**The best
Eliminators,
The best
Mains sets,
Use
HYDRA
CONDENSERS**

LOUIS HOLZMAN, LTD.,
37, NEWMAN STREET, W.1,
Telephone: - - Museum 2641

CLIX

THE KEY TO
PERFECT CONTACT



CLIX
BRITISH &
BEST

*A choice of
27 fitments at
your command*

LECTRO LINX, LTD.,
254 Vauxhall Bridge Road, S.W.1.

the tuned circuit and predominating over the series resistance. A simple circuit consisting only of inductance, capacity, and resistance in series is most selective when the inductance to capacity ratio is large because in these circumstances $\frac{L}{R}$ is a maximum, *i.e.* the same condition as for maximum sensitivity.)

It should here be observed that it is not fundamental that a circuit with which it is desired to cover a band of wavelengths should have its tuning varied by a change in capacity only. In fact, in the very early days of wireless, a fixed condenser was often used and the tuning accomplished by means of a variable inductance, the mechanical difficulties involved being less at the time. However, it is not simple, mechanically, to make an inductance continuously variable over such wide limits as are desirable, and therefore, especially with the advent of the variable condenser, which is now found in practically every wireless receiver, it has become almost standard practice for tuning of wireless receivers over a given range to be accomplished entirely by variable condensers.

SELECTIVITY

The change in selectivity, however, which occurs in present-day receivers over the range of wavelengths covered by the average 0.0005 μF variable condenser, is considerable. The ideal solution would be, of course, to have continuously and simultaneously variable inductances and condensers, so that the inductance to capacity ratio only changed by a predetermined amount so designed as to give constant selectivity.

It is the change in selectivity which causes correspondents to write to the effect that such-and-such a station, which comes in at the lower end of the condenser scale, "spreads badly." Assuming the station in question to be modulating under correct conditions, it does not occupy more space in the ether than a similar one on a longer wave, but the effect is due merely to the fact that the correspondent's receiver is less selective when the capacity to inductance ratio in the tuned circuits becomes less as the condenser is decreased, while the inductance remains constant.

screws holding the dial or scale plate to the moving plates of the condenser are quite tight before starting on any calibration work.

TUNING ARRANGEMENTS

The tuning may be accomplished in a variety of ways mechanically, but essentially it consists in altering the inductance (the size of the coil) or the capacity (the size of the condenser) in the circuit. For those who are interested, the formulæ by which the frequency and/or wavelength of a circuit can be calculated are given in the Reference Section. It should be realised, however, that there is an infinite number of different values of capacity and inductance which give the same wavelength—*e.g.* a certain small inductance and a certain large capacity will give the same wavelength as another certain large inductance and a certain small capacity. Other constants of the circuit, such as its selectivity, will, however, be changed. It therefore follows that the condenser setting for a given wavelength on a set having plug-in type of coils will depend on the size of coil used, and that, by choosing a suitable series of coils, the wavelengths given by a smaller coil with the condenser nearly at its maximum can be made to overlap those given by the next larger coil with the condenser nearly at its minimum. Thus a continuous range of wavelengths can be covered.

CHOOSING TUNING COILS

The choice of coil for any one wavelength will then depend on whether greater sensitivity or greater selectivity is required; for it so happens in practice that, with the average broadcast receiver, selectivity will be increased if a larger condenser and smaller coil be used—whereas greater sensitivity will be given by the use of the larger coil and smaller condenser. In practice, too, the use of a smaller coil generally means that its own resistance will be lower, and, therefore, the selectivity will be found to increase all the more as the coil becomes smaller and the capacity larger. (It should be added, however, for those more technically inclined, that these conditions met with in practice, with the average broadcast receiver, imply the presence of resistance and other damping in parallel with

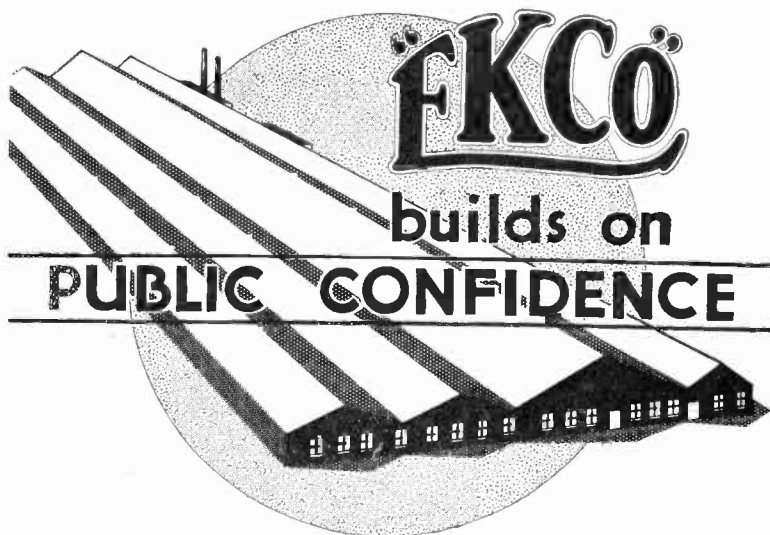

At Southend-on-Sea now stands the most modern electric radio factory in Europe

Built by the pioneers of British All-Electric Radio. Built, as all "Ekco" products are, up to a standard and not down to a price. Backed by British Capital, British Labour and British Brains. Behind it an organisation that has experienced and overcome the thousand-and-one pitfalls common to All-Electric Radio. Making over 80% of the total sales of Electric Radio Devices in the British Isles. Specialising solely in the application of electric power to radio.

In buying "Ekco" products, you are assured of the absence of batteries and accumulators with their attendant worries and continual expense; instead, you will enjoy continuous smooth reception, volume to order, constant voltage output at really negligible running costs.

Write for Free Booklet on "All-Electric Radio" and details of Easy Payments, to E. K. Cole, Ltd. Dept. B.B.C. "Ekco" Works, Southend-on-Sea.



Insist on an "Ekco" Demonstration before you make your final choice. Any dealer will be pleased to help you.

Plug-in—that's all !

ALL-ELECTRIC RADIO

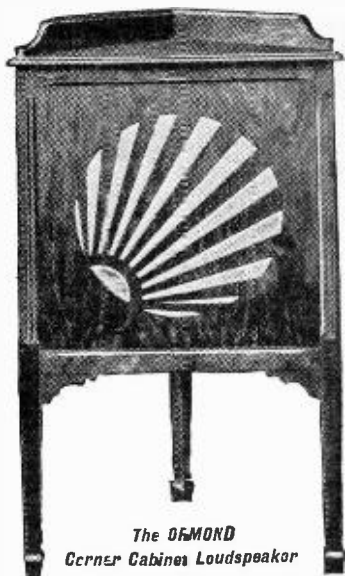

*The ORMOND
Corner Cabinet Loudspeaker*

3 Models

unique in Value & Performance

The ORMOND Range of Loudspeakers

Every Ormond Loudspeaker is a revelation of that high standard in production and design which has made Ormond world-famous for quality. At the same time remarkably low price proves that these superb loudspeakers are also worthy exponents of the amazing value which Ormond always gives.

The ORMOND Corner Cabinet Loudspeaker. Height 39". Width 21½". Depth 13". Fitted with the Ormond Large Chassis and cone in a solid Oak Cabinet. Price **79/6**

*The
ORMOND
"De
Luxe"
Loud-
Speaker*

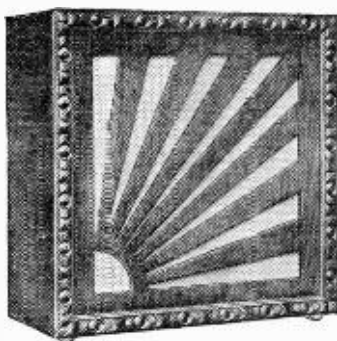

The ORMOND "De Luxe" Loudspeaker with a new type cone and baffle, with adjustment, in either Oak or Mahogany. Price **50/-**

The ORMOND "Popular" Loudspeaker in Oak or Mahogany. Fitted with an adjustment at the back. Price **29/6**

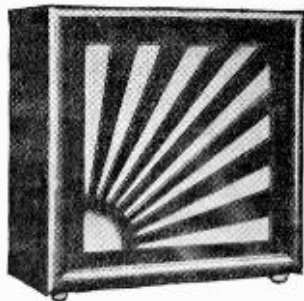

The ORMOND ENGINEERING Co., Ltd.,
Ormond House, Rosebery Avenue, London, E.C.1

Telephone: Clerkenwell 5334/5/6 & 9344/5/6.

The ORMOND "Popular" Loudspeaker
Telegrams: "Ormondengi, Smith."

HOW TO IDENTIFY STATIONS

CALIBRATING THE RECEIVING SET

BEFORE dealing with the actual calibration of the set, it is well to realise what actually happens when the knobs are turned and how it is that different settings bring in different stations. Throughout this article "dial setting" refers, of course, to the tuning dials or knobs on the set, and not to the other knobs which may be variously labelled "Intensifier," "Reaction," "Volume control," "Range control," etc. Although it is by no means always true that the tuning setting on a receiver is independent of the setting of these other knobs, yet it ought to be so if the design is good, and it is certain that, as receiver design progresses, a great improvement will result in this respect. Ideally, the setting of each knob should be independent of that of all the others in order to give the greatest simplicity and ease of adjustment.

TURNING THE DIALS

The act of turning the dials in the majority of present-day receivers alters the wavelength (or frequency), to which the receiver circuits will respond, by changing their electrical capacity through the movement of the vanes of a variable condenser. This action may be followed by observing the interior of the set. The dials of the condensers generally in use are divided into 180 divisions, in which case each division corresponds to one degree, or else into 100 divisions. It does not in the least matter which is used. In some types of condenser mounting, the scale is engraved on the dial or knob itself, which, by the slackening of one small screw, will change its setting relative to the moving plates of the condenser. In most types of slow-motion dial it is the scale plate itself which is fixed to the moving plate spindle by a set screw—the drive to the moving plates from the actual knob being by friction. In this case, the setting of the knob relative to the moving plates is immaterial. It is essential, of course, that the scale itself shall not change its position in relation to the moving plates—for, if it does, any previously noted readings for given stations will become quite useless. As a precaution, it is, therefore, always well to make sure that the screw or

should always be taken to avoid damaging the insulation of the wire. If this is done to an extent which allows two adjacent turns to come into electrical contact, the coil will become extremely inefficient.

Finally, it is well to remember, when altering a coil, that the turns can be removed far more easily than jointed and wound on again. It is better, therefore, to try the effect of removing a few turns at a time rather than to run the risk of taking off too many turns and of subsequently having to wind some on again.



PREPARING FOR THE BROADCAST FROM MID-STREAM IN THE
POOL OF LONDON

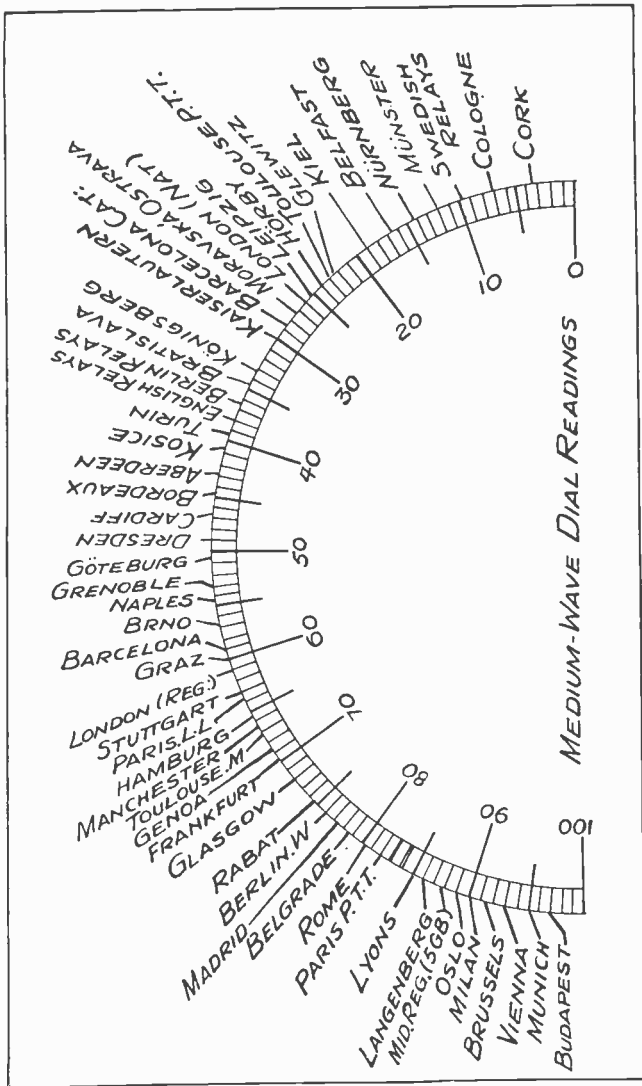

Note.—Some of the stations in the above diagram and that on p. 333 may have altered their positions since the diagrams were made out.

THE EUROPEAN FREQUENCY PLAN

With the development of broadcasting in Europe, it became essential to formulate some definite wave plan if constant interference between stations was to be minimised. The work of the Union Internationale de Radiophonie (now Union Internationale de Radio-diffusion), which was formed on the initiative of the B.B.C. in 1925, is now well known to listeners, especially in connection with its wavelength allocation plans—first of Geneva in 1926 and then of Brussels in 1928. In July 1929, the Prague wavelength plan, evolved by the Prague Conference of Postal and Telephone Administrations in April of that year and based on the previous work of the Union, was put into force and is still in operation. For reasons outside the scope of this article, all these so-called wavelength plans are based on a constant frequency separation between stations, and not on a constant wavelength separation. Thus, in general, stations are separated by 9 kc/s (kilocycles per second)—a figure which experience has indicated is a minimum, although not an ideal. It has to be accepted in practice in order to accommodate a maximum number of stations in the bands of frequencies allotted to broadcasting by international agreement.

If, therefore, stations are to be spread equally over the condenser dials of a receiver, it will be seen that a straight-line-wavelength law condenser will not be quite adequate. For this reason, straight-line-frequency (S.L.F.) condensers were designed—in which, as already mentioned, equal dial movements give equal increments of frequency. From the foregoing, it would appear that the latter type of condenser would have come into almost universal favour, for stations should then be spread at equal distances apart over the whole range of dial settings.

EFFECT OF STRAY CAPACITY

In the above consideration it has been assumed that the only capacity in the tuned circuit is that of the variable condenser, but in practice this is by no means the truth. If the receiver has one tuned circuit only, with the aerial connected to it, the capacity of the latter will be added to that of the variable condenser, and for a 100 ft. aerial this additional capacity may be of the order of 0.0002 micro-

farad. If a condenser of $0.0001 \mu\text{F}$ is connected in series with the aerial, as is often done, then the net extra capacity added by the aerial will be $0.000067 \mu\text{F}$ (see Ref. Section). In addition, the tuning coil, the valve, and the associated wiring, etc., will add capacity effectively in parallel with the variable tuning condenser, which results in the true law of the condenser not being realised in practice over its whole range.

This effect is particularly noticeable at the minimum setting of the condenser, where, of course, the added capacity is largest in comparison with the effective condenser capacity. The result is that stations at the bottom end of the scale of a straight-line-frequency condenser (say over the first twenty divisions) are unduly spread out, a given angular movement of the plates not giving the intended change in capacity.

LOGARITHMIC CONDENSERS

The effect is also apparent (but to a less degree) even in anode or grid circuits across which no aerial is connected. It has been overcome in practice by the use of logarithmic condensers in which there remains always a certain minimum capacity—higher than that in other types. These condensers have the further advantage that they are more suitable for “ganging” owing to the fact that a given displacement of the moving plates gives the same frequency increment at any part of the scale. Thus “trimming” condensers may be used in parallel with them to compensate for slightly different values of inductance and stray capacities in the various circuits ganged. By this means, separate circuits can be set to give maximum response for a given station, chosen preferably towards the middle of the dial scale, after which they will remain in step over the rest of the scale.

A knowledge of the type of condenser and size of coil fitted in a receiver, together with consideration of the foregoing remarks, will indicate that it is possible to predict roughly the dial settings of a number of stations. Practically, however, it will not be found possible to achieve great accuracy in such predictions, and they will be found of real value only to the home constructor who wants to get a rough idea of initial settings when first trying out a new receiver.

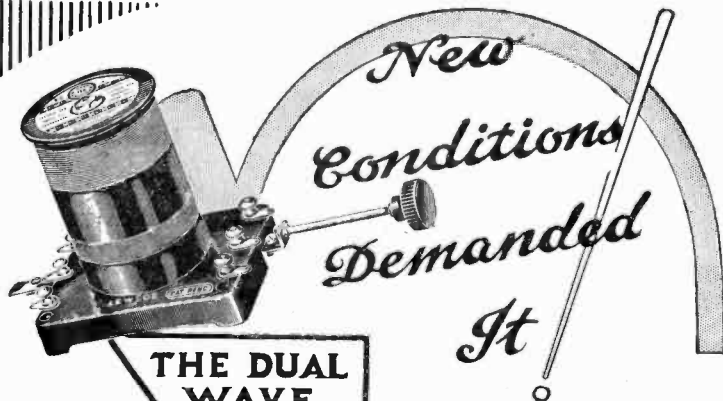

**THE DUAL
WAVE
COIL**

and

LEWCOS REGD.

**MADE
IT!**

Lewcos Dual Wave Coils are the direct result of a demand for highly efficient though selective coils covering both the medium 235/550 M. and long 1,000/2,000 M. wave-bands. These coils are of the radiating type and are mounted on moulded bases fitted with the standard six terminals and push-pull switching mechanism so that the wave-band required is selected by a single operation of a push-pull rod, which is arranged to protrude through the panel of the receiver.

A descriptive leaflet of this wonderful new Lewcos product will be sent on request. Write for it to-day. Please quote reference R.65.

Write for the Lewcos free sheet of blue prints of four suggested circuits utilizing Lewcos components. Please quote reference R.70.

THE LONDON ELECTRIC
WIRE COMPANY AND
SMITHS LIMITED
CHURCH ROAD, LEYTON
LONDON, E.10



LARGE STOCKS OF
LEWCOS COMPONENTS
HELD AT
ALL BRANCHES

RADIO PRODUCTS FOR BETTER RECEPTION

AERIAL SERIES CONDENSER

It is desirable to refer again to the question of the extra capacities which are across a tuned circuit in addition to the variable condenser, as well as to one or two other points which can conveniently be borne in mind. For instance, it will be appreciated that the calibration of a single circuit receiver, in which the aerial capacity is added to that of the variable condenser, will vary if the aerial or earth wiring or conditions are changed. Further, that any such change will be minimised if a small series condenser is used in the aerial circuit. In addition, it should be realised that the range of wavelengths covered by a given variable condenser will be restricted by any increase of its minimum capacity. Thus, an aerial series condenser, although reducing the maximum wavelength to which a circuit will tune, will, at the same time, increase the range of wavelengths covered by a greater reduction of the minimum than of the maximum wavelength.

To take a numerical example. Assume the aerial capacity to be $0.0002 \mu\text{F}$, the variable tuning condenser to have a maximum capacity of $0.0003 \mu\text{F}$, and the tuning inductance to be 150 microhenries (the approximate value of a No. 40 coil). With the tuning condenser at a minimum, the capacity across the coil will be approximately $0.0002 \mu\text{F}$. With the full condenser capacity it will be $0.0002 + 0.0003 = 0.0005 \mu\text{F}$. The wave range can, therefore, be calculated from the formula given in the Reference Section to be 325 to 515 metres. If an aerial series condenser of $0.0001 \mu\text{F}$ be used, the capacity across the coil will then be variable from 0.000067 to $0.000367 \mu\text{F}$, which corresponds to a wave range of 183 to 440 metres.

It must also be appreciated that other tuned circuits in the receiver, although having inductances of the same size, and variable condensers similar to those in the aerial circuit, will not have the same condenser setting for a given wavelength as the aerial circuit. Even if circuits are not "ganged," it is quite desirable that the condenser readings should be approximately the same for ease in subsequent setting. This can quite easily be accomplished if small "trimming" condensers are fitted across the variable condensers in all tuned circuits except the aerial circuit. The value of these "trimming" condensers will have to be the

same as the effective capacity added by the aerial-earth capacity. As mentioned, the effective additional capacity of a normal 100 ft. aerial with a $0.0001 \mu\text{F}$ condenser in series is about $0.000067 \mu\text{F}$. If a $0.0002 \mu\text{F}$ series condenser were used, then it would be about $0.0001 \mu\text{F}$. There are many suitable types of "trimming" condensers available, but it is perhaps preferable to fit one of the several semi-variable types so that once it has been set initially it can be left without further attention. The "law" of the variable condenser, unless of the logarithmic type, will be changed by the use of a trimming condenser, especially towards the minimum setting, and slightly greater difficulty may be experienced in initial calibration, but subsequent ease of operation will compensate for this.

It has already been stated that the value of the inductance is also a determining factor in the wavelength or frequency to which a circuit may be tuned. Rigid coils and wiring were recommended to ensure that this factor remained as constant as possible. There are other factors, however, which may cause a change of inductance and thus a change of calibration. For instance, if a metal screen is introduced into a previously calibrated set, and is placed too close to a coil, the inductance value of the coil will be changed. Although it might seem at first that if the screen is of iron the inductance would be increased, whereas if it is of copper or other non-magnetic material it would be decreased, it will be found in practice that the inductance will be decreased whatever metal forms the screen. Secondly—and this is a much more prevalent trouble—the reaction setting may alter the calibration. If magnetic reaction (swinging coil) is used, then as the coupling is increased, and the reaction coil comes nearer to the fixed coil, the mutual inductance between the two changes and there results a change in the effective inductance of the coil in the tuning circuit. If capacity reaction (de-neutralisation or Reinartz) is used, the setting of the reaction condenser may alter the effective capacity across the circuit. If a neutralised triode is used, and reaction is obtained by de-neutralisation or over-neutralisation of the valve capacity, it will be seen that there is at once a change of capacity which is effectively across the tuned circuit, and that this will be most noticeable when the capacity across

DESIGNS OF CRYSTAL SETS

IT was thought by many listeners during the period of introduction of the new London dual-programme Station that crystal receivers could not be made suitable for the reception of the alternative programme service. This idea was quite erroneous, as in general crystal sets can be made to receive either of the two programmes at will without there being any trace of interference from the unwanted programme.

Before the alternative programme scheme was introduced there was no need for crystal receivers to possess any degree of selectivity, as only one programme was of sufficient strength to be audible. In consequence some highly inselective crystal sets have come into use, and it was these which required an improvement in their selectivity when the alternative programme scheme was introduced in the London area. The slight cost of modification, if any modification is necessary, is, of course, repaid by the fact that a choice of two programmes will be available instead of the single programme of the past.

Crystal-set listeners who are in difficulty in separating the two programmes divide themselves into two categories: those who wish to modify their existing receiver and those who look upon changes in the system of transmission as an incentive to reconstruct their receivers entirely. If a listener possesses no technical knowledge whatsoever and does not care himself to make any alterations in his existing crystal set, or to construct an external selectivity unit which he can use with it, he would be well advised to purchase a wave-trap. A detailed description of the method of construction of a wave-trap is given in the Technical Section of the *B.B.C. Year-Book* for 1929 and need not be repeated herein. It is merely a tuned circuit which can be connected in the aerial lead and prevents the passage of all transmissions on the wavelength to which it is tuned: transmissions on all other wavelengths are unaffected by the presence of the wave-trap, and pass through it to the receiver in almost exactly the same way as if the wave-trap were not in circuit. If, for instance, a crystal set produces both the National and the Regional programmes jumbled up together, when its owner wishes to hear, say, the

The Highest Recommendations

THE GREATEST ARTISTES
THE LEADING PROFESSORS
AND THE FOREMOST
COLLEGES OF MUSIC PRAISE
AND PLAY THE CHAPPELL

Uprights from 65 Gns.
Grands from 122 Gns.
Your present Piano
taken in Part Exchange

Convenient Deferred Terms
Write for Illustrated Catalogue
and names of nearest agents



CHAPPELL

The CHAPPELL PIANO CO. LTD 50 New Bond St. London W.1

**USED IN ALL B.B.C.
STUDIOS**

National programme, the wave-trap can be tuned to the wavelength of the Regional programme and will then entirely stop that transmission from reaching the receiver. If a change of programme is desired, the receiver itself should be tuned to the Regional programme and the wave-trap be tuned to eliminate the National programme. Wave-traps can be obtained at a cost of about 3s. upwards, and any wireless dealer will probably be able to supply one, at the same time showing the way in which it should be connected to the existing receiver and operated.

A theoretical diagram of a simple type of crystal set with a wave-trap circuit in use is shown in Fig. 1. In the condition shown the receiver is tuned to receive the London National programme transmitter, while the wave-trap is "holding off" or eliminating the London Regional programme transmitter. It is advisable to make quite certain that the receiver can tune to the wavelengths of the two transmitters and can reproduce both transmissions at sufficient strength before an attempt is made to separate them with the wave-trap.

For the satisfactory reception of the alternative programme service it is desirable to be able to change quickly and conveniently from one programme to the other. When the correct settings on the receiver have been found for the two programmes, the tuning adjustments of the receiver and wave-trap should be marked so that a quick change from one programme to the other can afterwards be effected.

Crystal-set users who are situated within 25 miles of a Regional Station and who are prepared to reconstruct their receivers, using the minimum number of new components, may be interested in the arrangement which is shown in Fig. 2. It is not guaranteed, however, that such an arrangement will in all circumstances entirely eliminate the unwanted programme, as there may be a faint trace of the unwanted programme in the silent periods of the programme which is being listened to, particularly when long and electrically "heavy" aerials are being used. Actually, however, this circuit has been tested within half a mile of the Brookmans Park transmitter and succeeded in separating the two transmissions. Despite the fact that it may not in all circumstances remove all trace of the unwanted pro-

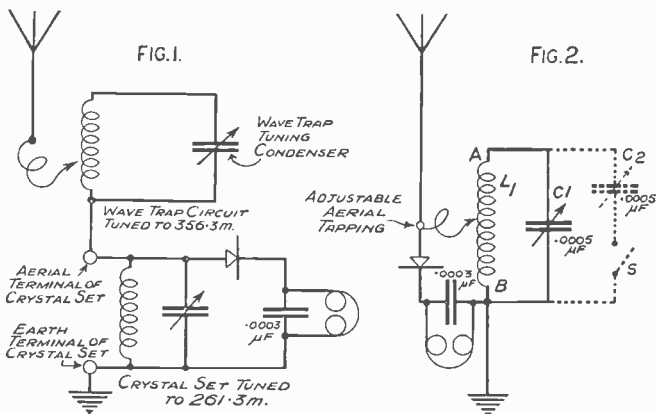

gramme, its simplicity warrants its inclusion in these remarks.

The coil L_1 should consist of a winding of, say, No. 20 double-cotton-covered wire on a cylindrical tube or former. The actual number of turns which are required depends upon the range of wavelengths which it is desired to cover. For example, approximately 40 turns on a $3\frac{1}{2}$ " diameter tube probably will be found satisfactory for the wavelengths of the two London transmitters, 356 metres and 261 metres. In winding the coil L_1 arrangements should be made for the aerial to be connected to different positions on the coil, as the best position or tapping point depends upon a number of factors, such as the distance from the dual programme transmitting station, the size of the aerial, etc. If every third turn is raised in such a way that the insulation can conveniently be scraped off, the best tapping point for the aerial can be found experimentally by means of one of the many spring connecting clips which are obtainable. It is stressed that the tapped turns should be raised by being wound over a thin strip of wood before they are bared, otherwise there is a risk of the insulation accidentally being scraped off adjacent turns. If two neighbouring turns of the coil come into electrical contact, the efficiency of the receiver would be impaired very seriously.

When experiments are being carried out with this circuit it will be found that the selectivity is increased as the tapping is lowered towards the end "B" of the coil, but the sensitivity is greatest when the aerial is tapped to the end "A." Too low a tapping, therefore, cannot be employed if the listener is situated some distance from the transmitting station.

In using this circuit we would stress that the aerial should be no longer than is necessary to give sufficient volume of reception of both programmes, that it should be efficient (see article on p. 375), and finally that one of the high-resistance type of crystals should be employed together with high-resistance headphones.

This circuit can be elaborated slightly by connecting a variable condenser and a switch across the coil, as is shown by dotted lines in Fig. 2. If this is done and the switch "S" is opened, the National programme can be tuned in on the condenser C_1 ; the switch is then closed and the condenser C_2 is turned from its minimum position until the Regional programme is tuned in. The two condensers, C_1 and C_2 , can then be left set or locked, and henceforth all that will be necessary to change from one programme to the other will be to open and close the switch "S"

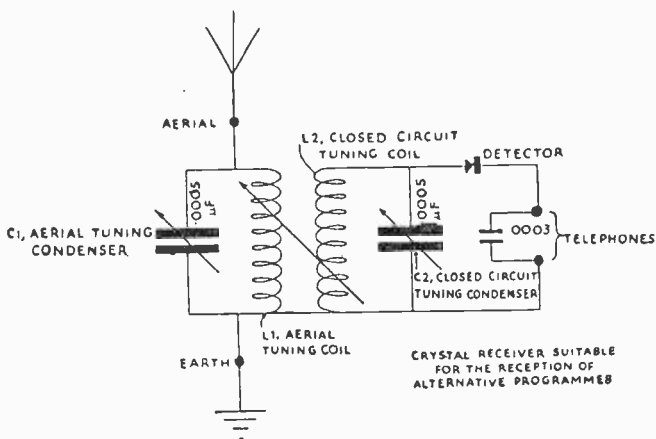

FIG. 3.

Another crystal circuit which most certainly will give sufficient selectivity for dual programme conditions is that shown in Fig. 3. In this arrangement two tuned circuits are employed, coupled together magnetically by the relative position of the coils L_1 and L_2 . Plug-in type coils can conveniently be used in conjunction with a two-way adjustable coil-holder, which allows one of the coils to be moved so that it is face to face or at right angles with the other. In the London area, for example, satisfactory results will probably be obtained when a No. 30 coil is used for L_1 , and a No. 50 coil for L_2 , the relative position of the two coils being adjusted so that they are about at an angle of 30° with each other. Actually this circuit has been tried successfully in the transmitter hall at Brookmans Park and in a very large number of other districts of London. In no case did it fail to separate entirely the two programmes. Furthermore, the necessary degree of selectivity can be obtained with less loss of volume than with the tapped-down arrangement shown in Fig. 2. It does, however, involve the use of two tuned circuits and is, in consequence, a little more expensive, but there is no doubt that it is the better arrangement if it can be constructed and worked without difficulty.

CONCLUSION

The above remarks do not include many of the other ways in which crystal sets can be made to possess adequate selectivity for the alternative programme service, as, for example, the use of an external tuned aerial circuit, capacity coupled to the existing receiver. It is hoped, however, that they will provide information to listeners who may not yet have solved the problem of really satisfactory reception of the alternative programme service on a crystal receiver. Furthermore, it is hoped that they will serve to dispel any erroneous idea that crystal-set listeners cannot take the full advantage which the Regional Scheme offers to them.

POWER SUPPLY FOR RECEIVERS

IT is not the purpose of these remarks to discuss the relative advantages of battery power or an electric light supply as a means for the provision of the necessary power for the satisfactory working of a wireless receiver. Neither need it be stressed that adequate power must be supplied to the receiver if the best results are expected.

During the past few years a very large number of mains units and all-mains receivers have come into general use by the listening public, and some description of the principles governing their design may be of interest.

The B.B.C. is anxious to dissuade listeners from themselves attempting to construct a mains unit, unless they are used to the handling of power mains and are thoroughly conversant with the danger and difficulty which it implies. Furthermore, the Institution of Electrical Engineers has laid down necessary regulations governing the design and manufacture of all wireless apparatus which is connected to electric light supplies. Apparatus which does not comply with these regulations is liable to cause its owner some inconvenience in the future, as, for example, at times when a change in the nature of the supply is being effected by the Supply Authorities. Possibly the Fire Insurance Company may also object to it.

There is no justification for a listener to assume, if he has been successful in building a wireless receiver, that he will be equally successful in building a mains unit; neither is it probable that a mains unit can be built and made to work satisfactorily by an inexperienced listener at an appreciably lower cost than the works-made article.

If a listener has an electric light supply available in his house and wishes to change from batteries to a mains unit, he should first ascertain whether his supply is of the alternating current or direct current system.

ALTERNATING-CURRENT MAINS

If the supply is alternating current (A.C.) little difficulty should be experienced in obtaining a receiver to work entirely off the mains, or in procuring a unit for the supply of high tension. The voltage of an A.C. supply is not an

ONE BATTERY WITH THE LIFE OF TWO



... Pertrix of course. And the reason? Not far to seek. Made by an improved process that prevents corrosion... that prevents deterioration when not in use... that entirely eliminates battery noise, Pertrix Non-sal-ammoniac Dry Batteries offer the best H.T. investment you can possibly get. You're getting the best out of your set when it is powered by Pertrix.

PERTRIX NON-SAL-AMMONIAC DRY BATTERIES

Pertrix Limited, Britannia House, Shaftesbury Avenue,
London :: W.C.2

Works: Redditch.

The batteries you can trust

[355]

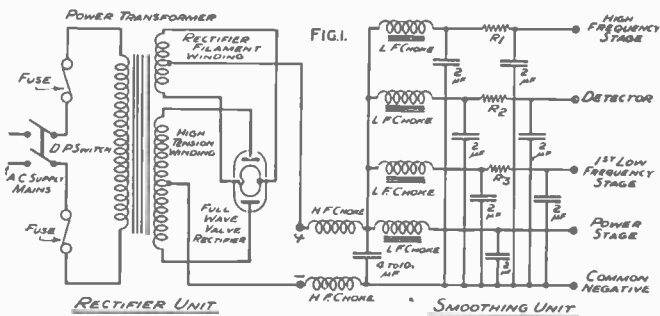

all-important factor, as it can be changed conveniently and economically by means of a transformer. Nevertheless, the voltage of the A.C. supply should be ascertained carefully, together with its frequency, and both figures submitted to the firm from which the mains unit is being obtained.

As the anode circuits of a wireless receiver require direct current, it is necessary to rectify the alternating current supply, *i.e.* convert it to direct current, before it can be applied to the receiver. Rectification can be carried out by various means, such as, for instance, valve or metal rectifiers. A metal rectifier probably has a longer life than a valve rectifier, but cannot be replaced so conveniently. After the alternating current supply has been rectified it is necessary to filter or smooth it so that the pulsations of the A.C. supply may be removed. If this were not done, the receiver would give a disagreeable hum. The connections of a typical valve rectifier system, followed by the necessary smoothing circuit, are shown in Fig. 1. It will be noticed that there are four positive high-tension feeders, these being intended to give an individual supply of high tension to each stage of a four-stage receiver, such as a set consisting of one high-frequency stage, a valve detector, a first low-frequency stage and a power stage. The resistances R_1 , R_2 , R_3 , etc. in the feeders to the early stages are included to reduce the voltage which is applied to these stages, as the maximum permissible anode voltage of high frequency and detector valves is usually lower than that of power valves. No resistance is included in the

power-stage feeder, as it is beneficial to use the full available voltage. Care must always be observed, however, to ensure that the maximum anode voltage of all the valves in the receiver, as specified by their manufacturers, is not exceeded, otherwise their working life will be reduced appreciably. This maximum permissible voltage is that actually at the anodes of the valves, and not that at the positive high tension terminals. If two or more stages are fed from one feeder, in which there is an appreciable amount of "common" resistance, the receiver will tend to make a noise somewhat similar to a motor cycle or motor boat. This fault is commonly known as "motor boating." A supply of low tension for valve heating and a supply of grid bias potential can also be obtained conveniently and economically from A.C. supply mains. We would, however, not recommend listeners to attempt this without obtaining the advice of a competent wireless engineer, or from the manufacturers of valves which are specially designed to work with an A.C. low-tension supply. Unless certain precautions are taken, dependent upon the design of the receiver in use, a most unsatisfactory hum may be introduced.

DIRECT-CURRENT MAINS

If the domestic supply is of the direct-current type (D.C.), its voltage is an all-important factor. We would not recommend the employment of direct-current house supplies of pressures under 110 volts for the provision of high tension unless special arrangements have been made in the design of the receiver to give satisfactory results at such a low high-tension voltage. Direct-current supplies, however, of a pressure of 200 or more volts are quite suitable for the supply of high tension, but in no circumstances should the mains be connected direct to the receiver without the use of an intermediate mains unit and a protective aerial series condenser. If these are not used, the receiver and its external components, such as the aerial, may become extremely dangerous to handle, besides there being a risk of severe damage to the receiver itself. As there is no need to rectify direct-current supplies, a direct-current mains unit will be a slightly cheaper article to purchase than an alternating current mains unit. Direct-

current supplies, which are suitable for the provision of high tension, cannot easily be employed for the provision of low tension. There are, however, D.C. all-mains receivers on the market and the various difficulties have been met in their design. Before installing an all-mains receiver or a mains unit on a direct-current supply, it would possibly be advisable to ascertain from the Supply Authorities whether they have any intention of changing the nature of the supply from direct to alternating current. In communicating the intention to install a direct-current mains-driven receiver or mains unit, it will be advisable to inform the Supply Authorities of its make and the fact that it complies with the I.E.E. Regulations. It should also be ascertained whether the positive or negative pole of the D.C. mains is earthed.

CONCLUSION

Some houses are wired for power as well as for light, and the voltage at the power plug points may be different from the voltage of the lighting circuit. If the mains unit is to work from a power plug, the voltage of the power circuit should be ascertained carefully either by reference to the power circuit meter or by application to the Supply Authorities. It is not safe to assume that the voltage of the power circuit is the same as the voltage of the lighting circuit if the house is wired for both lighting and power.

The exact details concerning the type of receiver with which the mains unit will be expected to work should be given to the source from which it is being obtained. In the first place, the receiver may contain certain components which are not designed to withstand the far higher pressure which the mains unit may supply to it. Secondly, the arrangement of the high-tension wiring in the receiver may be quite unsuitable for use with the mains unit in question, and "motor boating" may result. Lastly, it is advisable to make certain that the valves of the receiver are capable of handling the voltage which the mains unit will supply.



DON'T FORGET YOUR LICENCE

RUN YOUR RADIO FROM THE MAINS THROUGH



METAL RECTIFIERS

and do away with periodical and expensive replacements.

Westinghouse Metal Rectifiers do not employ fragile filaments or chemical action, and there are no moving parts. Once installed they are always there and the first cost is the last cost.

There are high tension units from 15/- for those who wish to make up their own eliminators.

The full range is described together with circuits and instructions in our 40 page book "The All Metal Way 1931." Send 3d. stamp for a copy.



H.T.5. 120 volts, 20 m.a.
15/-

Most of the leading manufacturers are now using these units, and it is only necessary to specify "Westinghouse Rectification" when ordering new sets or eliminators.

THE WESTINGHOUSE BRAKE & SAXBY SIGNAL CO. LTD.
82 York Road, King's Cross, London, N.1.

FERRANTI

Moving Coil MAGNO-DYNAMIC SPEAKER

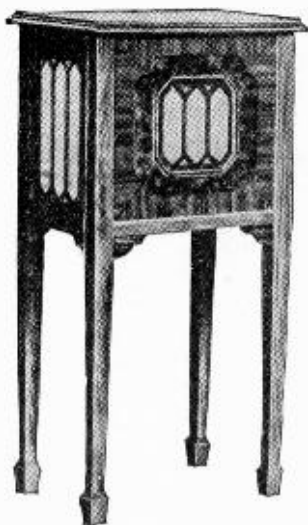

*The Speaker that
Satisfies the
Critical Listener*

The Ferranti Magno-Dynamic speaker is a MOVING COIL Permanent Magnet Speaker that equals in performance the best mains-driven models.

Many discriminating listeners have expressed amazement at its natural reproduction, and found that preconceived objections to Permanent Magnet Speakers have been completely shattered by this new Ferranti MOVING COIL.

It can be operated successfully by a good 3-valve receiver. It is self-energising, and needs no connection to supply mains or batteries. It is guaranteed to retain its magnetism indefinitely.

Your dealer will be pleased to demonstrate this Speaker, or we will gladly arrange for a demonstration in your home.

PRICE

PEDESTAL CABINET

Oak	£18	5	0
Mahogany	£20	0	0
Walnut	£20	0	0

TABLE MODEL

Oak	£15	5	0
Mahogany	£16	14	0
Walnut	£16	14	0

Also in metal case, covered with Rexine, in choice colours, nicely figured—Brown, Blue or Grey

	£12	10	0
Chassis only	£9	10	0

Gradual payment terms can be arranged direct, or through your local dealer. Particulars will be sent on request. Ask for List W 408.

FERRANTI LTD.

Head Office and Works : HOLLINWOOD
LONDON : BUSH HOUSE, ALDWYCH, W.C.2

LANCASHIRE

VOLUME CONTROL

THE primary object of any form of volume control in a receiver or amplifier is, of course, to control the volume of sound emitted by the loud-speaker. There are other considerations to be taken into account, however, before the best form of control can be determined.

If a control is fitted at the loud-speaker itself it is possible for overloading to occur at any one or all of the stages which precede it, even when the loud-speaker is emitting the merest whisper. It is obvious, therefore, that it is desirable for some form of control to be fitted in front of the first stage of a receiver that can possibly be overloaded when a strong signal is being received. This position is in front of the first valve, and a suitable form of control is shown in Fig. 1. It consists of a potentiometer across the tuned circuit, the grid being connected to the sliding contact. A blocking condenser is inserted as shown to prevent the grid bias battery being discharged through the tuning inductance. The potentiometer has a resistance of about 500,000 ohms to prevent the tuned circuit from being appreciably damped, and by this arrangement the damping is kept practically constant whatever the position of the sliding contact, thus avoiding any change in selectivity when the volume control is adjusted.

In a well-designed receiver, with this form of control preceding the first valve, no overloading of any stage should occur when the potentiometer is properly adjusted. It is desirable to introduce an additional control, however, after the detector so that the first control can be used to keep the

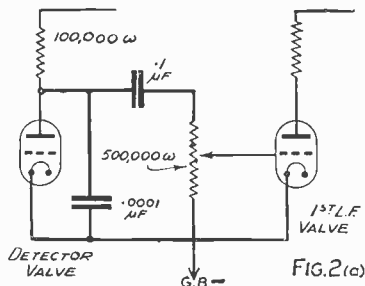
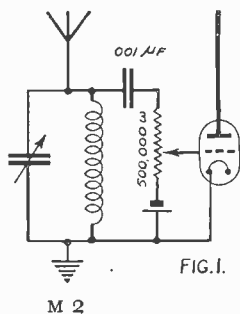

[361]

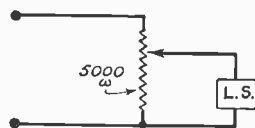
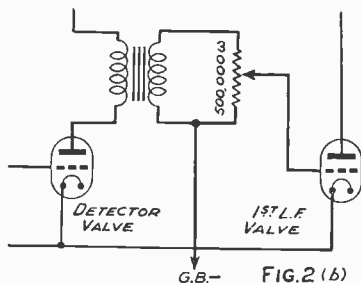

FIG. 3.

input to the detector constant at the most suitable value for distortionless rectification. The second control can then be used merely for adjusting the volume of sound emitted by the loud-speaker.

In general the most satisfactory position for this second control adjustment is immediately after the detector, that is in front of the first low-frequency stage as is shown in Figs. 2(a) and 2(b), and a potentiometer is again the best form of control. Fig. 2(a) shows the arrangement where resistance-capacity coupling is being used, and Fig. 2(b) where transformer coupling is employed. Its value will depend on the values of the components with which it is associated, to avoid affecting the amplification of the receiver and upsetting its response to different musical or audio frequencies. The object in view is to keep the impedance of the potentiometer and associated circuits as constant as possible at all audio frequencies whatever the position of the sliding contact, and the resistance of the potentiometer must not be so high that the capacity between grid and filament of the following valve is sufficient to cause the higher audio-frequency components to be by-passed when the volume control is set for maximum volume. When the sliding contact is near the bottom end of the potentiometer (reduced volume) the grid-filament capacity will be in parallel with only a low value of resistance and will therefore have little by-passing effect on the higher audio-frequency components.

For general use a potentiometer having a resistance of 500,000 ohms will usually be found to be satisfactory.

In some cases it is necessary to have some form of volume control actually at the loud-speaker itself, *e.g.* when the

THE heart of your set is the BATTERY

Make it "Young"



THE YOUNG ACCUMULATOR CO. (1929) Ltd.
Burlington Works, Arterial Road, New Malden, Surrey

Telephone:
Malden 1171.

Telegrams:
Youngacc, New Malden.

LISTEN-IN COMFORTABLY
STRETCHED OUT ON A

"TOBY" Convertible REST CHAIR

(PATENT NO.
292808.)

An upholstered arm-chair with springs which converts into a lounge or bed, giving complete "spring-mattress" comfort. Sent carriage paid, for seven



days' free trial for 10/- deposit. Money refunded if dissatisfied.

Call or write for Folder and Patterns to:—

THE TOBY
CONVERTIBLE
CHAIR Co. 2 Ludgate
Hill, London, E.C.4.



BACK
SETS
AT 5
ANGLES

AS A
BED



Cash Price,
£4-18-6, or
eleven pay-
ments of 10/-

FRIENDS OF THE POOR

(Incorporated)

40 & 42, Ebury Street,
London, S.W.1

Royal Patron:

H.M. THE QUEEN.

President:

H.H. PRINCESS MARIE LOUISE.

Hon. Secretaries:

MISS COLLIN, C.B.E.

MRS. H. R. BROMLEY-

DAVENPORT, C.B.E., J.P.

Hon. Treasurers:

LORD CHARNWOOD.

MR. G. BROMLEY-MARTIN.

Plead for funds to assist the deserving poor of all classes and denominations in times of illness and other emergencies.

**THE FINEST RANGE OF VALVES
THE WORLD HAS KNOWN ...!**

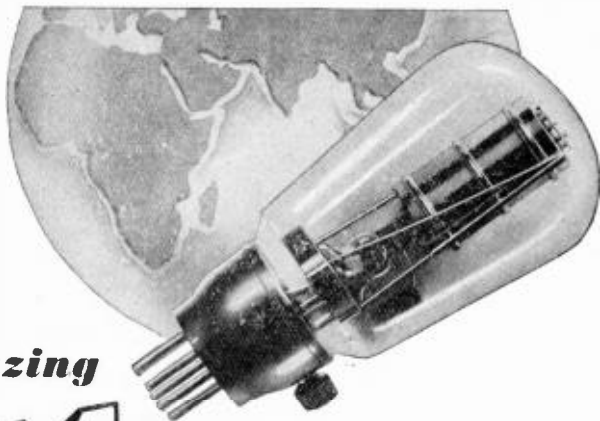

*The
amazing*

MAZDA

RADIO VALVES



THE EDISON SWAN ELECTRIC CO., LTD.
Incorporating the Wiring Supplies, Lighting Engineering, Refrigeration and Radio Business of the British Thomson-Houston Co., Ltd.

Radio Division:
1a, Newman Street, Oxford Street, W.1
Showrooms in all the Principal Towns

EDISWAN

VC4.

receiver or amplifier is not easily accessible owing to loud-speakers being placed in different rooms. A potentiometer device is again the most satisfactory, and a suitable arrangement for general use is shown in Fig. 3. In this case the impedance of the loud-speaker is not by any means constant and varies greatly with frequency; consequently it is very important to employ the correct value of potentiometer, otherwise the quality will vary with the adjustment of it. In practice a value of 5000 ohms is often satisfactory, but of course conditions depend on the type of loud-speaker and on the type of valve in the output stage.

A variable resistance in series with the loud-speaker should not be used for volume control, as the quality of reproduction will vary greatly with the adjustment, and the proportion of the total volts in the anode circuit applied to the loud-speaker, will not be the same at all frequencies owing to the varying impedance of the loud-speaker.

As already stated, it is important that some form of control should be fitted in the receiver or amplifier to ensure that no overloading occurs when a volume control is fitted at the loud-speaker.

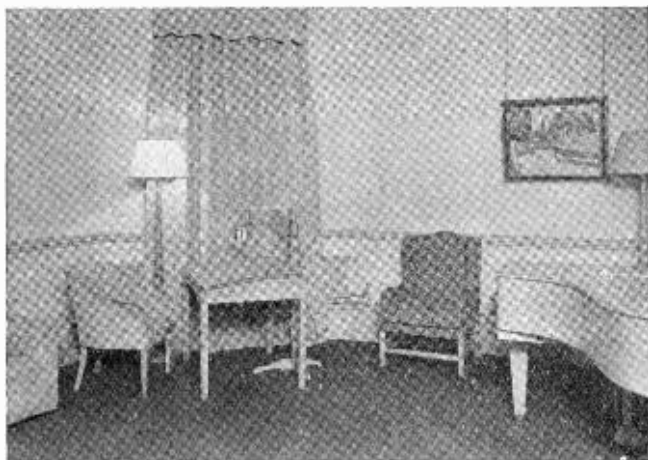

THE LARGER TALKS STUDIO

*often used for reading the News Bulletin and for musical broadcasts such as
Sir Walford Davies' talks*

 BBC

B.B.C. Artists who record only for COLUMBIA

B.B.C. WIRELESS SYMPHONY ORCHESTRA. Con. by PERCY PITT.

TANNHÄUSER—Pilgrims' Chorus: Grand March. (No. 9826—4/6.)

RUY BLAS—Overture (*Mendelssohn*). In Two Parts. (No. 9278—4/6.)

B.B.C. WIRELESS MILITARY BAND. Conducted by B. WALTON O'DONNELL.

BLACK DOMINO—Overture (*Auber*). In Two Parts. (No. DB25—3/-.)

LE RÊVE PASSÉ: Hungarian Dance (*Moszkowski*). (No. DX46—4/6.)

B.B.C. CHOIR

Hear them in complete "ELIJAH," "MESSIAH," and in the Opera "FAUST."

NATIONAL CHORUS

PILGRIM'S PROGRESS—Part 1: The Pilgrim Now. Part 2: In Praise.
(No. 9894—4/6.)

B.B.C. DANCE ORCHESTRA. Conducted by JACK PAYNE.

STEIN SONG—One Step. Moonshine is Better Than Sunshine, Fox
Trot. (No. CB62—3/-.)

FIRE! FIRE!! FIRE!!! ("Variety" Novelty); and Harmonica Harry,
One Step. (No. CB129—3/-.)

Ask for their Latest Records at your Dealer's

Complete Catalogue of Columbia "New Process" Records, free on request
from—COLUMBIA, 102-108, Clerkenwell Road, London, E.C.1.

Columbia
New Process RECORDS

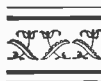

PROPERTIES OF FRAME AERIALS

WHEN a loop of wire is situated in an alternating magnetic field so that the latter passes through the loop, a voltage is induced in the wire and a current flows through it if the loop is a closed one, that is, if the ends of the wire are connected together. The induced voltage is proportional to the lines of force (or flux) which actually pass through the coil, and is obviously a maximum when the plane of the loop is at right angles to the direction of the magnetic field or lines of force, since in this position the maximum flux passes through the loop. When the plane of the loop lies in the same direction as the magnetic field, no flux will pass through the loop and there will be no voltage induced in it.

This is one of the fundamental principles of electro-magnetism and is utilised in all electrical machinery. It also has a very valuable application in the reception of electro-magnetic waves.

When an electro-magnetic wave is travelling along the surface of the earth it produces a horizontal magnetic field at right angles to the direction of travel. This magnetic field is an alternating one, the frequency of the oscillations being the same as the frequency of the wave. If, therefore, a loop of wire is placed so that it is cut by this magnetic field a voltage will be induced in the loop. This voltage will be a maximum when the loop is vertical and is situated so that its plane lies in the same direction as that in which the wave is travelling. If such a vertical loop is turned so that its plane is at right angles to the direction of travel of the wave, no part of the magnetic field will pass through it, and there will be no voltage induced in it. Hence if a loop of this nature is used as an aerial for the reception of electro-magnetic waves, it can be turned so that it is pointing towards the station from which signals are required, and any other stations which lie at right angles to this direction will not be able to induce any voltages in the loop or frame. Stations lying in intermediate directions will have some effect on the aerial, since their magnetic fields can cut it, but not to the same extent as the station towards which the loop is pointing.

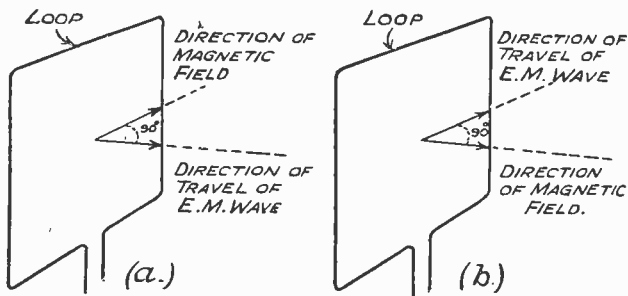

*NO VOLTAGE INDUCED
IN LOOP.*

*MAX. VOLTAGE INDUCED
IN LOOP.*

By connecting a condenser across the ends of the loop, and tuning it to the frequency of the required station, the voltage induced by the latter can be made to cause a larger current to flow than that produced by the unwanted stations, thereby reducing interference from such stations.

The fundamental principle of frame aerials has now been described, but there are, of course, further points to be considered when frame aerials are actually employed in practice.

In order to make such aerials of practical value the voltage induced in them must be sufficient to make it possible for the receivers with which they are used to produce signals of adequate strength. As already stated, the voltage induced is proportional to the flux passing through the loop, hence it is desirable to have a loop of large area. A similar effect is obtained by using a loop of more than one turn, thus keeping the dimensions more convenient for some purposes. The voltage is also proportional to the frequency of the waves being received, since the greater the frequency the greater will be the number of lines of force cutting the loop per second. Consequently larger frames are required for long waves than for short waves, and a small frame which may be efficient on the medium broadcasting band will not necessarily be satisfactory for receiving Daventry 5XX.

The size of frame and number of turns employed are therefore determined by the wave-band to be covered, the

The
THREE
POINTS



of this
TRIANGLE
are

1. Many unhappy little ones have lost home, health and happiness.
2. Four thousand of these have found them again in the Children's Home.
3. Your generous help is the means of their continued security.

NATIONAL CHILDREN'S HOME & ORPHANAGE
(FOUNDED BY DR. STEPHENSON)

30 Branches - - - 4,000 Children
Principal : REV. W. HODSON SMITH

GENERAL TREASURERS:

THE RT. HON. LORD WAKEFIELD OF HYTHE, C.B.E., LL.D.
SIR THOMAS BARLOW, BART., M.D., F.R.S.

Chief Offices : HIGBURY PARK : LONDON, N.5.

HOW RADIO HAS HELPED THE

DEAF

By adapting a Radio Microphone, an ingenious invention now gives the deaf an opportunity of regaining good hearing. Tests being given by General Acoustics, Ltd., at 77, Wigmore Street, W. 1—the British concern who have secured the invention—show how sensitive is the instrument and how it is almost invisible when in use. Ordinary conversation as well as wireless can now be heard distinctly by the wearer without any strain, and even very deaf people are able to hear a whisper. Ear Specialists of America, the American Otological Society, have given the invention their approval and have adopted it for general use in that country.

Other Home addresses of General Acoustics, Ltd., at which free tests can also be obtained are as follows:—14, New Street, Birmingham; 75, Puchanan Street, Glasgow; 19, Shandwick Place, Edinburgh; 14, St. Ann's Sq., Manchester, etc.

A NEW OSBORN RADIO CABINET



Ready to
Assemble
65/-

No. 219. A Radio or
Radio Gramophone
Cabinet, 3' 9" high,

2' 2" wide, and 1' 6" deep. The battery and loud
speaker compartments are at the bottom and are
partitioned off. Size of the baffle behind the fret is
24" x 24". Metallic fabric for the fret front is in-
cluded. Opening at the top and back. This cabinet
will take a panel 2' x 9" or smaller

Ready to Assemble: **Oak 65/-, Mahogany
70/-, Walnut 80/-.** Assembled ready to
Polish: **Oak 85/-, Mahogany 90/-, Wal-
nut 100/-.** Assembled and Polished: **Oak
105/-, Mahogany 120/-, Walnut 135/-.**
All Models Carriage Paid. Send for 56-page
Illustrated Catalogue. Enclose 3d. in stamps.

CHAS. A. OSBORN, The Regent
Works, Arlington St., London, N.1.
Telephone: Clerkenwell 5095.

At at 21, Essex Road, Islington, N.1.
Telephone: Clerkenwell 5634.

sensitivity of the receiver to be used with it, and mechanical considerations such as portability and ease of rotation. Portable frame aerials, on account of their small dimensions, must necessarily be less efficient than normal outdoor aerials from the point of view of signal strength. As regards freedom from interference, however, their advantages are pronounced. If one particular station is causing interference the frame can be turned so that the pick-up from that station is sufficiently small to cause no interference, or if necessary it can be turned so that it is at right angles to the direction of the interfering station, thus giving no pick-up. If, however, the required station lies almost in the same direction as the interfering one its strength will also be reduced, and the directional properties of the frame aerial will not help very much. Thus a frame aerial will not be of great value in separating the two transmissions from a regional station, from the point of view of its directional properties, but it usually has considerably less damping than most outdoor aerials with their associated earths, and selectivity is therefore assisted.

So far it has been assumed that an electro-magnetic wave travelling over the surface of the earth has a horizontal magnetic field. After dark, however, there is very often an appreciable amount of reflection from the Heaviside layer, and in addition to the normal magnetic field there is another which may cut the frame even when it is at right angles to the direction of the station, since the wave causing it has a different direction of travel owing to its reflection from some part of the Heaviside layer. Consequently it is not always possible to get a position of complete silence from a station after dark, and the position of minimum signal may vary considerably as the reflected wave changes in direction and strength. .

Another factor which may cause a certain amount of signal to be received, even when the frame is at right angles to the direction of the incoming wave, is that the frame may act as an ordinary vertical aerial which takes no account of direction. A voltage may be induced in the leads connecting the receiver to the frame aerial which may be independent of the direction of the frame, and the frame will have some capacity to earth and will act partly as a vertical aerial. Also there is bound to be a

certain amount of distortion of the magnetic field of the wave when a frame aerial is used inside a building, particularly if steel is used in the construction of the building. This may cause the apparent direction of a station to be totally different from its real one, and of course may reduce the strength considerably.

It should be noted that a frame aerial responds equally to waves coming from directions exactly opposite to each other, and this must be borne in mind when using its directional properties to determine the direction of a station or to cut out interference.





A World-wide BROADCAST

A **D** ICTIONARY defines "BROADCAST" as the "sowing of seed at large." In this light, the Salvation Army is the greatest broadcasting organisation in the world. For over sixty years it has scattered seed which has borne abundant fruit in the lives of men and women of all grades. The Salvation Army's record is a stirring story of



TRAGEDY and JOY

From deserted child to homeless aged—from Darkest London to Darkest Heathendom—all find a loving friendship and sane, practical help through "The Army of the Helping Hand." The Army began among the East End poor and is working chiefly among the poor to-day, although it has extended its work to

The Army's 16,711 Centres include:

CHILDREN'S HOMES	104
CRECHES	23
INDUSTRIAL SCHOOLS	9
DAY SCHOOLS	1098
PRISON GATE HOMES	13
INEBRIATE'S HOMES	6
WOMEN'S INDUSTRIAL HOMES	106
MATERNITY HOMES	90
FARMS	12
SLUM POSTS	168

Also many GENERAL, EYE, and MATERNITY HOSPITALS including THE MOTHERS' HOSPITAL, Clapton, which has more beds than any similar Institution in London; and LEPER COLONIES in INDIA, JAVA, and SUMATRA.

82 COUNTRIES & COLONIES

and its message is being broadcast in

72 DIFFERENT LANGUAGES

Some idea of the magnitude of the Army's efforts may be gained from the fact that

IN ONE YEAR

the Salvation Army supplied

61,886,071 cheap and free Meals, 25,829,061 Beds

through its Food Depôts, Shelters, etc.

548,289 Men given work

either temporary or permanent.

THE SALVATION ARMY

Gifts towards the maintenance and extension of this beneficent work are urgently required. Enquiries and donations should be addressed to GENERAL HIGGINS, at 101 Queen Victoria Street, London, E.C.4.

FOUNDED 1851

RESEARCH INSTITUTE
BUILT 1910

The Cancer Hospital

(FREE)

(Incorporated under Royal Charter)

FULHAM ROAD, LONDON, S.W.3

THE FIRST SPECIAL HOSPITAL IN LONDON FOR CANCER
NO LETTERS NO PAYMENTS

Fully equipped and specially staffed for the better treatment of, and research into the causes of, Cancer. A certain number of beds are provided for advanced cases, who are kept comfortable and free from pain.

Annual Subscriptions, Donations and Legacies are earnestly solicited

FORM OF BEQUEST OF A LEGACY.

To those benevolent persons who kindly desire to become Benefactors by Will to this institution, the following Form of Legacy is respectfully recommended:

"I give and bequeath unto (THE CANCER HOSPITAL FREE), situate in the Fulham Road, London, the sum of (free of Legacy Duty), to be applied towards carrying on the charitable designs of the said Institution."

Bankers:

Messrs. COUTTS & CO., 440, Strand, London, W.C.2.

Secretary:

J. COURTNEY BUCHANAN.

THE ROYAL SURGICAL AID SOCIETY

Chief Office:

SALISBURY SQUARE, FLEET STREET, E.C. 4.

Patron - - HIS MAJESTY THE KING.

Treasurer - - J. R. COOPER, Esq., D.L., J.P.

The Society was established in 1862 to supply

**SPINAL SUPPORTS, LEG INSTRUMENTS, TRUSSES,
ELASTIC STOCKINGS, ARTIFICIAL LIMBS, &c.**

Since the commencement of the Society it has supplied over

1,375,000 APPLIANCES to the POOR

Annual Subscription of ... 0 10 6

Life Subscription 5 5 0

Entitles to Two Recommendations per annum,
and so on in proportion to amount.

Subscriptions and Donations will be thankfully received by the Bankers, BARCLAYS BANK, LTD., 19, Fleet Street, E.C. 4, or by the Secretary at the Offices of the Society.

RICHARD C. TRESIDDER, Secretary.

Tel. No. City 5567.

A E R I A L S Y S T E M S

THE installation of an aerial system for the reception of broadcasting is usually a matter of finding the best possible compromise between theoretical laws on the one hand and the practical potentialities of the space and height available on the other.

During the period of introduction of the Regional Scheme, however, some listeners who previously happened to live in the wipe-out area of the old transmitters may find that satisfactory reception on a crystal set can no longer be obtained unless a more efficient aerial is used. Some remarks concerning the installation of aerial systems may, therefore, be of assistance.

If an increase in the sensitivity of the receiver is desired, it is always advisable to consider whether it can be brought about more economically and conveniently by an improvement of the aerial system or by an increase in the sensitivity of the receiver. For example, crystal-set users, in certain circumstances, may find it cheaper to purchase a one-valve receiver, continuing with the use of their old headphones, than to install a sufficiently satisfactory aerial to enable reception to be carried out on a crystal set.

T Y P E S O F A E R I A L

The most efficient aerial arrangement, from the point of view of its ability to pick up the maximum amount of energy, is a vertical wire suspended so that it hangs well clear of any material which is in contact with earth. In general, an endeavour should be made to obtain the maximum average height for the length of aerial wire which is being used. In Fig. 1, three types of aerial are shown, all consisting of 100 feet of wire. The average height of the aerial shown in Fig. 1*a* is 50 ft.; of that in Fig. 1*b* 32 ft., and of that in Fig. 1*c* 25.5 ft. It will be seen at once that the vertical arrangement is by far the most efficient, but as the suspension of a hundred feet of vertical wire is hardly a practical arrangement for a broadcast listener, a compromise has to be found.

In general it is not a good policy to make an aerial system inconspicuous; for example, it is bad practice to hide the horizontal portion of the aerial by running it close

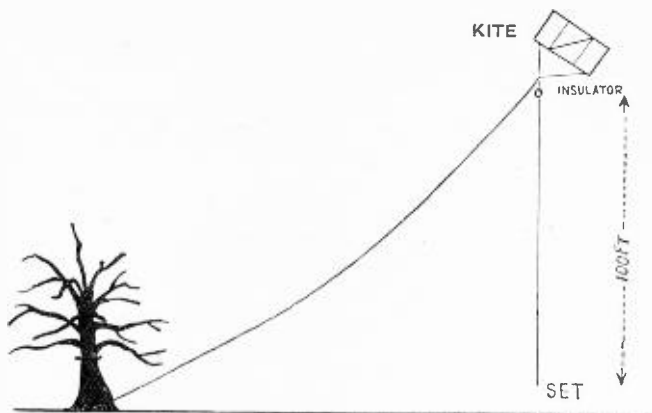

FIG. 1a.

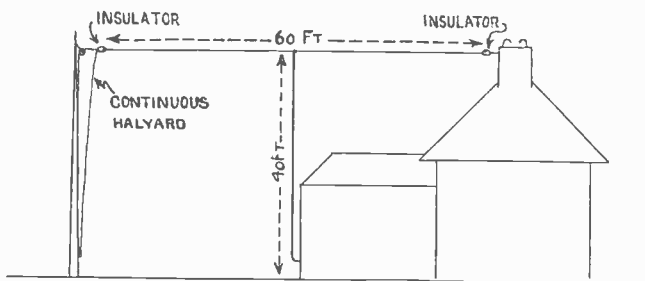

FIG. 1b.

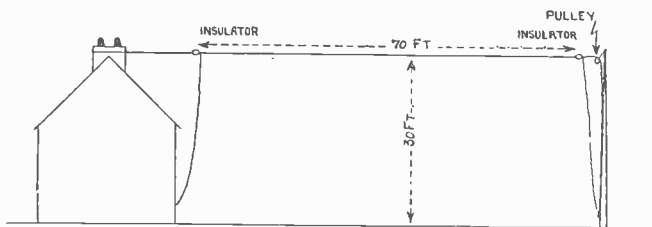

FIG. 1c.

to the eaves or roof of the house. Although aerials of this type usually succeed in being nearly inconspicuous, they are seldom efficient, for their effective height is small. If the roof of the house is covered with lead, which is usually in electrical contact with the ground, the aerial in effect is only slightly higher than ground level. If, on the other hand, the distant or high potential end of the aerial is suspended by a mast or tree so that it runs clear of the house, conditions are vastly improved and the effective height is greatly increased. There are many types of conductor used as aerial wire, but it is unlikely that any will give better results than properly installed stranded copper or phosphor bronze wire.

A tall tree is a perfectly satisfactory means of support for an aerial system, provided it is situated at a convenient distance from the house and gives the aerial wire a clear run. In fixing the aerial to a tree, however, it is advisable not to anchor the wire so high up the tree that it swings about unduly in the wind. Continual movement of the aerial wire is liable to break strands and depreciate any joints which exist in the aerial wire or down-lead. It is also inadvisable to run the active portion of the aerial close to the trunk of the tree, that is, inside the spread of the branches. This can be avoided by fixing a guy wire to the trunk of the tree and insulating the far end of the aerial from the guy wire outside the branches, as is shown in Fig. 2. Where excessive movement of the aerial due to the swaying of the tree in the wind cannot be avoided without seriously decreasing the height of the aerial, springs or balance weights can usefully be employed.

If there is sufficient space available but a suitable tree or other obvious means of support does not exist, it is probable that a local wireless dealer or

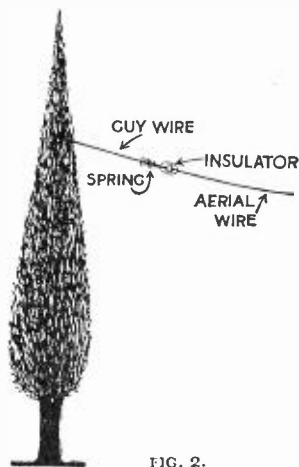

FIG. 2.

1881—1931

The Waifs & Strays Society

IS NOW CELEBRATING ITS JUBILEE.

IN FIFTY YEARS OF NATIONAL WORK

it has given homes, care and training to over 34,000 children. Its present family numbers 4,800, many of whom are cripples and babies.

Will you send a Jubilee Gift to the Secretary:

Rev. Dr. Westcott, Old Town Hall, Kennington
London, S.E.11 ?

BANKERS: BARCLAYS LTD., KENNINGTON.



Two of the boys

THE PROBLEM OF THE ELDER LAD

THE CHURCH LADS' BRIGADE

CARRIES ON THE WORK OF EDUCATION FOR CHURCH AND STATE.

It trains the elder lads between 14 and 21 years of age to become loyal Christian citizens.

Full particulars can be obtained from the Secretary, the

Rev. EDGAR ROGERS, O.B.E., M.A., F.S.A.,

GENERAL HEADQUARTERS, ALDWYCH HOUSE, CATHERINE STREET, LONDON, W.C.2



Trade Mark

NEW-SKIN is an ideal application for cuts, abrasions and fresh surface injuries to the skin. It protects the wound and allows it to heal naturally.

New-skin is waterproof. *It won't wash off.* You can wash over it. If edges of patch lift, touch them again with fresh New-Skin. It is transparent and flexible.

FOR MINOR REPAIRS

New-Skin is invaluable for minor repairs to Wireless Sets, for mending China and Glass, and for odd repair jobs about the home.

Obtainable from Chemists
everywhere

10½d., 2/- & 3/- per bottle.

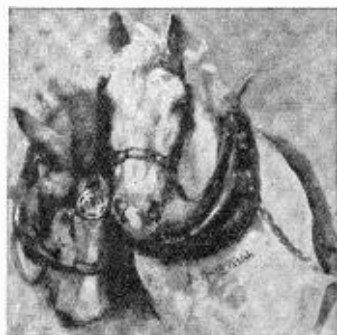

"OUR DUMB FRIENDS' LEAGUE"

72 Victoria Street, London, S.W.1.

Practical work for animals done in the following manner:—

ANIMALS' HOSPITAL, 1, High Street, Victoria, for treatment of animals of the poor free of charge.

BLUE CROSS & DRIVERS' BRANCH.

RECEIVING SHELTERS FOR STRAY, ILL AND DISEASED ANIMALS. Eleven Shelters in London.

NORTH LONDON DOGS' HOME, Willesden.

CHILDRENS' BRANCH to encourage children to take an interest in animals.

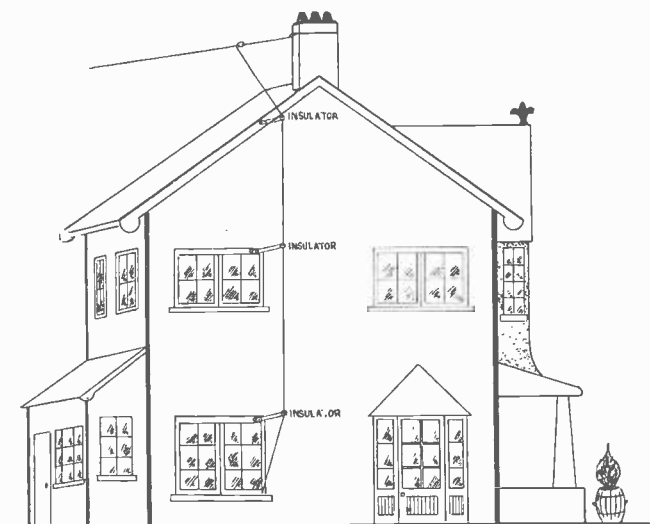

FIG. 3.

builder could supply and erect a wooden mast. A pulley should always be fixed on top of the mast for the convenient raising and lowering of the aerial system by means of a continuous rope halyard. When the exact position of the aerial mast has been chosen, careful measurements should be made in each direction from the foot of the mast to ensure that, should it fall, it will not cause serious damage to property or personal injury. If there is any option in the position for the mast, one should be chosen which will result in the aerial wire being at right angles rather than parallel with any other aerial wires in the immediate vicinity. It is highly advisable to employ at least one insulator at each end of the horizontal portion, even if insulated wire is used. It is not necessary, when choosing the position of an aerial, to make arrangements so that it points towards the broadcasting transmitter which it is most frequently desired to receive. "T" or inverted "L" shaped aerials of the dimensions used by broadcast listeners seldom have marked directional properties except those due to screening by

[379]

neighbouring buildings or trees, which impede the passage of the ether waves to an indefinite extent.

THE DOWN-LEAD

After the maximum height has been obtained, attention should be paid to the down-lead. Matters should be so arranged that the down-lead comes away clearly from the aerial wire, as is shown in Fig. 1c, without being doubled back on it. If the natural position of the aerial wire does not allow the down-lead to come unobstructed to the point at which it is lead through the wall of the house to the receiver, it is possible to use one or more spacing rods fixed horizontally to the roof or an upper window-sill. These spacing-pieces or jury-masts are shown in Fig. 3. Where it is possible, the down-lead should be kept at least two feet from the side of the house and should be quite clear of any foliage. If this is done, the down-lead will play a more active part in picking up the energy from the distant broadcasting station than it would if it were run within a few inches of the side of the house.

When erecting an inverted "L" type of aerial it is better to avoid making a joint between the horizontal portion of the aerial and the down-lead. The aerial wire should be passed twice through the hole in the insulator without being cut and the down-lead section tied or bound back to the horizontal portion as shown in Fig. 4. Any joint which has to be made, as, for example, in a "T" shape aerial, should be soldered. The mere twisting together of strands can easily lead to trouble, as the joint is exposed to the weather and may rapidly become a bad electrical connection.

In heating aerial wire for the making of a soldered joint,

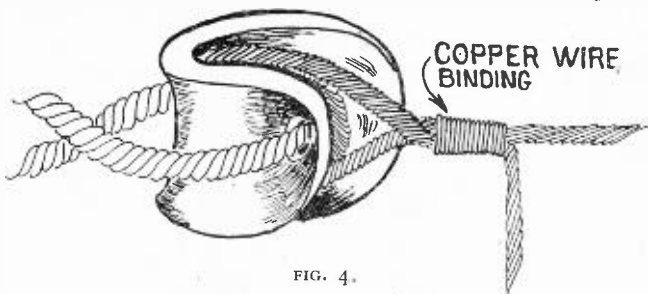

FIG. 4.

BRITISH "WIRELESS FOR THE BLIND" FUND

(Registered under the Blind Persons Act, 1920)

President:

H.R.H. THE PRINCE OF WALES

Through Wireless the Blind can mingle with the World

Without Wireless they are Alone

Can YOU Let Them Remain So?

The object of the British "Wireless for the Blind" Fund is to provide, as far as is practicable, every blind man and woman in Great Britain and Northern Ireland with a wireless set.

The Fund was launched on Christmas Day, 1929, when the Rt. Hon. Winston Churchill, M.P., broadcast an appeal which brought in enough money to begin a regular dispatch of 800 wireless sets per week.

To continue this delivery and ultimately fulfil the object of the Fund

£25,000 IS STILL NEEDED

Will every listener help to give the blind a constant means of
ENLIGHTENMENT, EDUCATION AND ENTERTAINMENT?

All donations should be addressed to the Rt. Hon. REGINALD MCKENNA, Hon. Treasurer, British "Wireless for the Blind" Fund, 226 Great Portland Street, London, W.1.

INSIST ON—

Marzawattee
THE
BRITISH *Tea*

SPURGEON'S ORPHAN HOMES

Hon. President—Rev. H. Tydeman Chilvers. Hon. Treasurer: Robert Percival Higgs, Esq.

Founded for the benefit of poor Fatherless children by Charles Haddon Spurgeon, who stated:
"Children need more than four walls to shelter them: they need a home where the virtues of a Christian Character shall be fostered and developed. . . adapted as far as possible to compensate the loss of parental influence and control."

Christian and unsectarian, the most necessitous cases are accepted first, and the family life is maintained, for **each house is a home. . . .**

Over 4,800 orphans have already been received and the ever present needs and claims are worthy of your support.

GIFTS AND DONATIONS ARE GRATEFULLY ACKNOWLEDGED BY

The Secretary, SPURGEON'S ORPHAN HOMES, STOCKWELL, S.W.9.

Our last Annual Report, containing a legal Form of Bequest, will gladly be sent on Application to the Sec.

IMPERIAL CANCER RESEARCH FUND

Patron—HIS MOST GRACIOUS MAJESTY THE KING.

President—HIS GRACE THE DUKE OF BEDFORD K.G.

Chairman of the Executive Committee—SIR HUMPHRY ROLLESTON, Bt.,
G.C.V.O., K.C.B.

Honorary Treasurer—SIR GEORGE MAKINS, G.C.M.G., C.B.

Director—Dr. J. A. MURRAY, F.R.S.

The Honorary Treasurer desires to thank those who have hitherto supported this Fund by their donations and subscriptions.

The object of the Research is for the good not only of the whole British Empire but of the whole world.

The Imperial Cancer Research Fund is working unceasingly in the cause of suffering humanity. Cancer is now one of the most important causes of death, and the suffering it entails in its protracted course makes the call urgent for improved methods of diagnosis and treatment, and in research work alone lies the one hope of checking its malevolent power. Radium treatment has been proved effective in some incipient cases and in cases near the surface of the body, but cancer when deep-rooted still presents a serious problem.

Donations and Subscriptions may be sent to the Honorary Treasurer, Examination Hall, Queen Square, Bloomsbury, London, W.C.1, or may be paid to the Westminster Bank, Ltd., Marylebone Branch, 1, Stratford Place, London, W.1, A/c Imperial Cancer Research Fund.

FORM OF BEQUEST.

I hereby bequeath the sum of £ _____ to the Treasurer of the Imperial Cancer Research Fund under the direction of the Royal College of Physicians of London and the Royal College of Surgeons of England for the purpose of Scientific Research, and I direct that his receipt shall be a good discharge for such legacy.

SHOW YOUR LOVE
OF ANIMALS BY
SUPPORTING THE

R.S.P.C.A.

105, Jermyn Street,
London, S.W.1.

Over 200 R.S.P.C.A.
Inspectors always
employed in . . .

PROTECTING THE
NATION'S ANIMALS

"All Sorts and Conditions"

of humanity are helped according
to their varying needs by the

CHURCH ARMY

It aids—

MEN: In Labour Homes; in and out of
Prison; Employment Bureaux;
in Disabled Men's Workshops, etc.

WOMEN: In Classified Homes,
Clubs, etc.

CHILDREN: Motherless,
Rescued, etc.

SUPPORT IS EARNESTLY ASKED.

All Communications to—

PREB. CARLILE, C.H., D.D.,
55 Bryanston St., London, W.1.

care must be taken not to subject the wire to too great a heat, as otherwise its mechanical strength may suffer.

If the most convenient point for leading the aerial into the house does not happen to be near the position in the house where it is most frequently desired to listen, it is better to install the receiver near the aerial lead-in and to extend the loud-speaker or headphone leads from the receiver to the required points in the house. This is preferable to placing the receiver a long way from the aerial lead-in insulator and employing a long lead-in wire. Any necessary connecting wire between the aerial lead-in terminal and the receiver should, as far as practicable, be run clear of walls, pipes, electric mains, or other "earthy" bodies.

THE EARTH LEAD

Space does not permit the inclusion of suggestions concerning earths and earth leads except to state that the earth should be as near the receiver as is possible and so avoid a long earth lead. If a water-pipe is employed, the earth lead should be fixed to it by means of a clip and not twisted loosely round the pipe. A lead cold-water pipe should be chosen for preference and should be carefully scraped or cleaned with fine emery cloth before the clip is fixed round it. The surface of the pipe should be cleaned over an area slightly larger than that occupied by the clip, so that the clip is not held away from the cleaned surface of the pipe by paint or other matter on either side.

The wire connecting the receiver to the earthing point should be at least as thick as the aerial wire, and as straight as possible.

It should be remembered that the earth lead and earth are part of the aerial system of the receiving equipment and should be treated with the same respect.

EFFECT OF THE AERIAL ON SELECTIVITY

It is not always realised that an aerial system provides damping when it is connected to the tuned circuit of the receiver, and has a definite influence upon the selectivity of the equipment. The extent to which an aerial reduces the selectivity of the equipment depends largely upon the physical size of the aerial, its high-frequency resistance, and its insulation.

It is inadvisable to use a larger aerial than that necessary for the provision of sufficient strength. If the volume is more than sufficient, the aerial should be reduced or a small condenser placed in series with it (see article, p. 319). The increase in the power of medium wavelength broadcasting transmitters will enable many listeners to reduce the size of their aerials without suffering from insufficient volume, but it is emphasised that an aerial should never be reduced unless it provides more than an adequate input to the receiver.

MAINTENANCE

Aerial systems, including the earthing arrangements, sometimes get forgotten in the regular maintenance of receivers. It is advisable to take down the aerial once a year, and to examine the wire foot by foot for broken strands or for any cracking or loosening in soldered joints. If an aerial consists of stranded wire and one or two of the strands are broken, it is quite likely to produce crackles in reception when it is swinging about in the wind and the broken ends come into intermittent contact.

The aerial insulators should be cleaned and freed from any soot or other deposit which they may have collected, particularly in densely populated districts. A cracked insulator should, of course, be replaced.

Aerial switches, especially those which are mounted outside the house and exposed to the weather, should be removed entirely and cleaned. Any corrosion which exists on the blades or terminal screws should be carefully scraped off and the contact cleaned with emery cloth.

If an aerial mast is used, its stays should be examined to avoid the danger of the mast falling and doing damage to property. Rope halyards particularly require attention, as it is usually far easier to splice a new halyard on to the old one and to run it through the pulley than it is to take the mast down.

Any internal wiring should also be examined and terminal nuts tightened up.

If an earth plate is used and the connection to it is underground, the earth wire should be given one or two vigorous tugs to ensure that it has not corroded underground and become disconnected from the earth plate.

THE HIGHEST TREBLE

Celestion Loudspeaker Model Z.20. Without doubt the most attractive Loudspeaker obtainable at the price. Its tone is really wonderful. Incorporating well-designed electro-magnetic reed movement working with special Celestion Reinforced Diaphragm. Remarkable results on low and high frequencies. In simple yet most beautiful cabinet.



Reg. Design.

Size 19 $\frac{1}{4}$ in. \times 17 $\frac{7}{8}$ in. \times 8 $\frac{5}{8}$ in.

PRICE: Oak . . £7 : 15 : 0. Mahogany . . £8 : 5 : 0

The New Celestion Model W.5 Electrical Pick-up with remarkable fre-



quency response. Exclusive Celestion features make record wear practically non-existent and result in an output hitherto believed unobtainable. A "quick needle release" device is another exclusive feature. Price, complete with tone arm for correct tracking. £3 : 15 : 0

CELESTION

The Very Soul of Music

Ask your dealer to demonstrate or write direct to
CELESTION, Ltd.,
 Kingston-on-Thames.

Showrooms:
 106, Victoria St.,
 S.W.1.

THE DEEPEST BASS

Now less recharging! Exide "D"

series L.T. Batteries can last a long time on one charge . . . made for modern economical valves . . . don't sulphate even under the most severe conditions . . . the world's most economical battery. Remember, next time

an **Exide "D" series L.T. Battery**

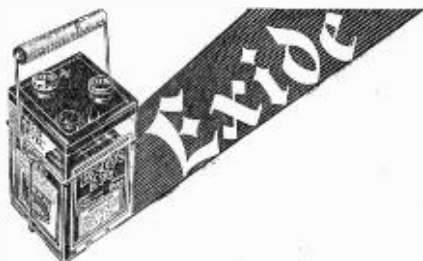

Prices per 2-volt cell

DTG, 20 amp. hrs. 4/6

DFG, 45 amp. hrs. 8/6

DMG, 70 amp. hrs. 11/6

DHG, 100 amp. hrs. 14/6

For the H.T. use an Exide High Tension

Battery . . . clearer tone, no buzz, no crackle, no howl

. . . aids selectivity . . . distant stations come in clearer.

Prices per 10-v. unit: W.J. 2,500 milliamps 5/6. W.H. 5,000 milliamps 6/3. W.T. 10,000 milliamps 12/6

Obtainable from Exide Service Stations or any reputable dealer.

Exide Service Stations give service on every make of battery.

Exide Batteries, Clifton Junction, near Manchester.

[386]

THE BEGINNING OF A NEW SERVICE

RECEIVING technique automatically follows transmission conditions. For example, a broadcast transmitter of low power provides an overwhelmingly strong signal at places in the immediate vicinity of its aerial, and therefore some listeners find that the crudest and most inefficient types of receiving equipment will give satisfactory results. Naturally such listeners do not wish any change to be made which would necessitate their using apparatus of even normal efficiency; neither, perhaps, is it any direct concern of theirs that reception conditions in other districts further from the transmitter may be inferior. In consequence, there must be a small minority who are adversely affected by a change in transmission conditions. An alteration in the system of distribution involves considerable expenditure, and naturally changes are not made unless a definite improvement will result therefrom.

Long before structural work was commenced on the new London Station at Brookmans Park, the extent of the dislocation, resulting from the necessary closing down of the old transmitter in Oxford Street, was considered in relation to the benefits which the new Station would provide. As far as the London area was concerned, it was anticipated that the two difficulties which a comparatively small minority of listeners would experience would be due to the use of either insufficiently sensitive, or selective, receivers.

It was known that the new transmitter, being 15 miles North of Oxford Street, would be definitely weaker in the area around Oxford Street than the old transmitter situated actually in Oxford Street, even though the new transmitter were many times more powerful than the old. Listeners in practically all other districts would be supplied with vastly greater strength, depending upon their distance from the sites of the old and the new transmitters. The second type of dislocation was due to the fact that the new station was built to radiate two contrasted programmes (the old transmitter could radiate only one) and at first listeners having sets with a poor degree of selectivity were expected to have some difficulty in separating the two programmes.

Considering first the sensitivity dislocation factor, it was not thought that valve receivers used by listeners in districts near Oxford Street would experience any serious trouble as the strength provided by the new transmitter, although weaker than that provided by the nearby old transmitter, would be adequate. The B.B.C., therefore, concentrated mainly on an endeavour to help crystal set users whose apparatus was too inefficient to work satisfactorily with an adequate, though not overwhelming, strength of signal. Consequently a pamphlet was prepared explaining in detail the various ways in which a crystal set could be made to give satisfactory results under the new conditions. This pamphlet was entitled "Crystal Sets and the Brookmans Park Transmitter" and publicity was given to the fact that the B.B.C. would supply it free of charge to any listener who cared to apply for it.

Despite the fact that the B.B.C. had given frequently repeated warnings of the forthcoming change in reception conditions, it was feared that a number of listeners would not take any active steps until it actually took place. When the new Station was ready, therefore, a process of "sliding in" was adopted. At first the new Station radiated on normal power, but only outside usual programme hours, namely, for half an hour each morning between 11.30 a.m. and 12 noon and from 12 midnight until 1 a.m. This phase was intended for those who wished to make in advance any changes which their receiving apparatus might require. The transmission of half an hour in the morning, was to give an opportunity for the wireless trade to carry out tests on listeners' apparatus. The first phase of the introduction was maintained for a fortnight before the second phase was commenced. The second phase was to transmit certain portions of the regular programme from the new transmitter instead of from the old transmitter. Three weeks after the second phase had been introduced the old transmitter in Oxford Street was shut down entirely and the service was taken over by the new transmitter at Brookmans Park. This was on October 21st, 1929.

During the period of introduction the incoming letters from listeners were examined carefully. Many of these, of course, were from listeners who obtained far better reception from the new Station than they had ever obtained

For Technical Supremacy

GECOPHONE

REGISTERED TRADE MARK

RADIO RECEIVERS & LOUD SPEAKERS

have earned an unrivalled reputation for efficiency and high grade workmanship. Constant research and the use of the finest materials under the supervision of highly skilled technicians combine to produce results of the highest order.



GECOPHONE ALL ELECTRIC 4-VALVE RECEIVER FOR A.C. MAINS. Advanced design giving maximum range and selectivity. Admirable for moving coil loud speaker. Provision for Gramophone Pick-up. Solid walnut cabinet. The finest all electric receiver of the year. (at Nos. B.C.3140 for 200/250 volt, 50/80 cycles; B.C.3140L for 95/150 volt, 50/80 cycles.

PRICE **£30**

(including OSRAM Valves and Royalty)

AN OUTSTANDING EXAMPLE FROM
THE COMPLETE GECOPHONE RANGE

All GECOPHONE Radio
Receivers are
Standardized with

MADE IN ENGLAND
Sold by all Wireless Dealers

Osram Valves

PUT VIGOUR INTO *YOUR* SET BY USING
OSRAM VALVES

Advt. of The General Electric Co., Ltd., Magnet House, Kingsway, London, W.C.2

[389]

from the old transmitter, and who were anxious for the new transmitter to be introduced fully with a minimum of delay. In Fig. 1 a graph is shown giving the number of letters received in each complete week ending on the dates shown on the horizontal axis. Despite the elaborate advance publicity, and the "slide-in" method, it will be seen that the bulk of the correspondence was not received until the actual time of the transference of the full service to the new Station. Subsequently the correspondence, that is complaints and appreciations, gradually died away as listeners accustomed themselves to the new conditions; and by the beginning of December, 1929, any difficulties which existed concerning sensitivity had in the majority of cases been overcome. It was possible then to start introducing the second transmitter.

A pamphlet similar to that for the assistance of those who were experiencing trouble due to the change in signal strength, was also prepared to help those who might find themselves in difficulty in separating the two programmes, this second pamphlet being entitled "The Reception of Alternative Programmes."

The same method of gradually introducing the second programme was again followed. Fig. 2 is a graph showing the number of letters which were received in each complete week during the period of the introduction of the second programme; again some being appreciations, and others requesting advice concerning individual difficulties. The second transmitter first radiated a scheduled preliminary transmission on December 9th, 1929, at a time when the first transmitter was not working. This was to enable listeners to tune in the second transmitter without complication due to a programme from the first transmitter. It was thought that if both transmitters were working some listeners might have more difficulty in finding and identifying the second programme. Subsequently preliminary transmissions of both programmes were carried out between the hours of 12 noon and 1 p.m. and during the late dance music. On December 22nd, additional preliminary transmissions were introduced before the regular Sunday afternoon programmes; the object being, of course, to enable those who were not at home during the week to ascertain whether or not

NUMBER OF LETTERS
RECEIVED IN EACH WEEK.

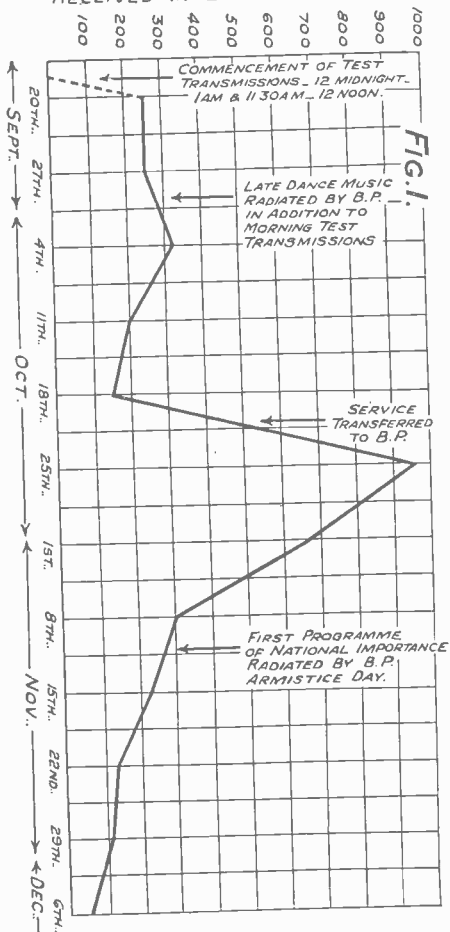

their receivers could separate the two transmissions satisfactorily.

The letters resulting from these transmissions were far fewer than was anticipated, indicating either that

(1) The degree of selectivity of listeners' apparatus was far better than was expected, or

(2) That those listeners whose apparatus needed an improvement in selectivity were taking no interest in the tests which were being carried out for their benefit.

Consequently the B.B.C. decided to radiate dual programmes on two evenings in each week. At the same time a questionnaire was published in each issue of the *Radio Times* for the use of listeners requiring technical information. This had the desired result and correspondence started to pour in, as can be seen from Fig. 2. The full evening bi-weekly preliminary transmissions were maintained for seven weeks, and by February 17th, incoming correspondence was found to be falling away rapidly. It was then possible to introduce the full daily service of contrasted programmes and this step was taken on March 9th—three months after the first preliminary test of dual programme conditions. The increase in correspondence consequent upon the commencement of full alternative programmes was very small (see Fig. 2). This indicates that the majority of those whose apparatus needed an improvement in selectivity had, at some stage or other of the system of gradual introduction, taken the necessary steps, thus fulfilling the object at which the B.B.C. were aiming in adopting the "slide-in" system. Space does not permit a detailed description of the methods which were used to handle quickly and accurately the heavy and helpful incoming correspondence but, in general, there was not more than 2 or 3 days delay in sending the information which individual listeners required. The opening of the London Dual Programme Station was carried out in a way which it is hoped was as convenient as possible for its listeners—at the same time it provided valuable experience to the B.B.C. which will be used to benefit listeners in the North and other Regional areas.

NUMBER OF LETTERS & QUESTIONNAIRES
IN EACH WEEK.

FIG. 2.

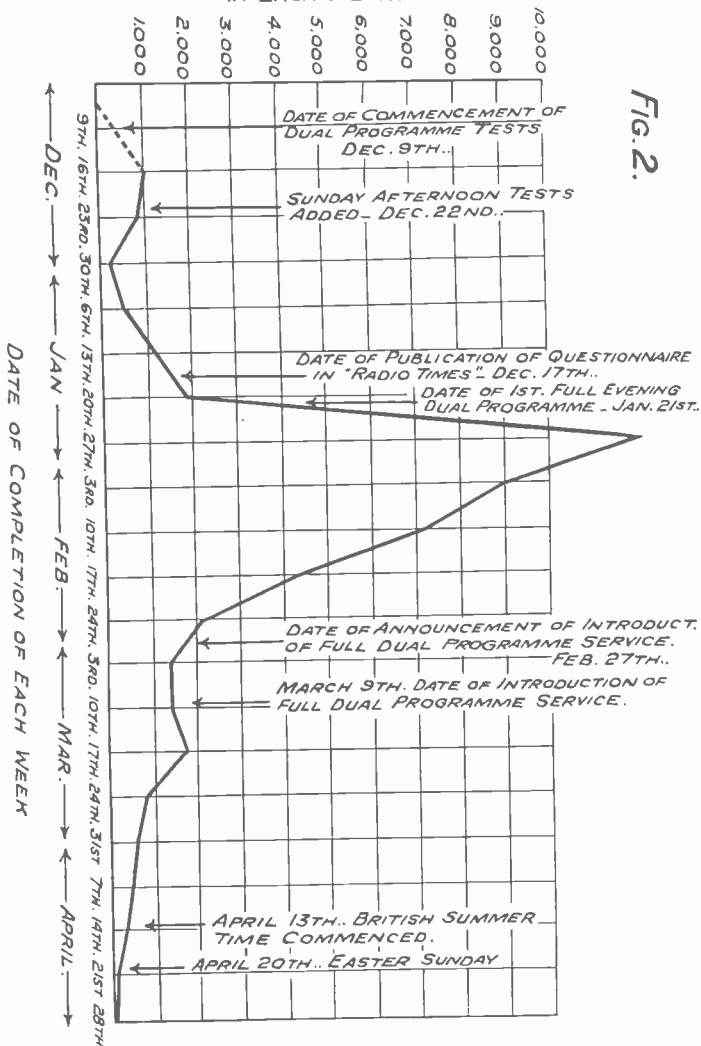

EARTH YOUR SET!

1. Don't forget that there are more than three million sets in use and it is very seldom that a set is damaged by lightning. There is, therefore, only a very slight chance of your particular receiver being damaged.
2. If you wish to listen with an absolute minimum of risk of damage to your house or receiver, a single pole c/o earthing switch should be mounted outside the house.
3. If this is inconvenient, the switch can be mounted inside the house as near the point of entry of the aerial as possible, but this is not as good as having it outside.
4. If you already have an earthing switch and are liable to forget to earth the aerial when the set is not in use, it is better to have a lightning arrester installed. A lightning arrester is an automatic earthing switch which will earth the aerial should it accumulate a heavy charge. It may not, however, be quite as effective a protection as an earthing switch. A lightning arrester should be inspected periodically, particularly after a thunderstorm.
5. Should your house already be fitted with a lightning conductor, don't disconnect it, as it will not have a bad effect upon your reception.
6. Don't continue listening when a thunderstorm is near, particularly if you are using headphones.
7. When earthing your aerial be careful not to touch the metal portions of the switch.
8. If you are using an indoor aerial it is immaterial whether it is earthed or not during a thunderstorm; but it is advisable not to continue listening.
9. Should you be listening during a fall of snow, hail-storm, or thunder shower and experience clicking noises in your reception, it is better to switch off and earth the aerial.

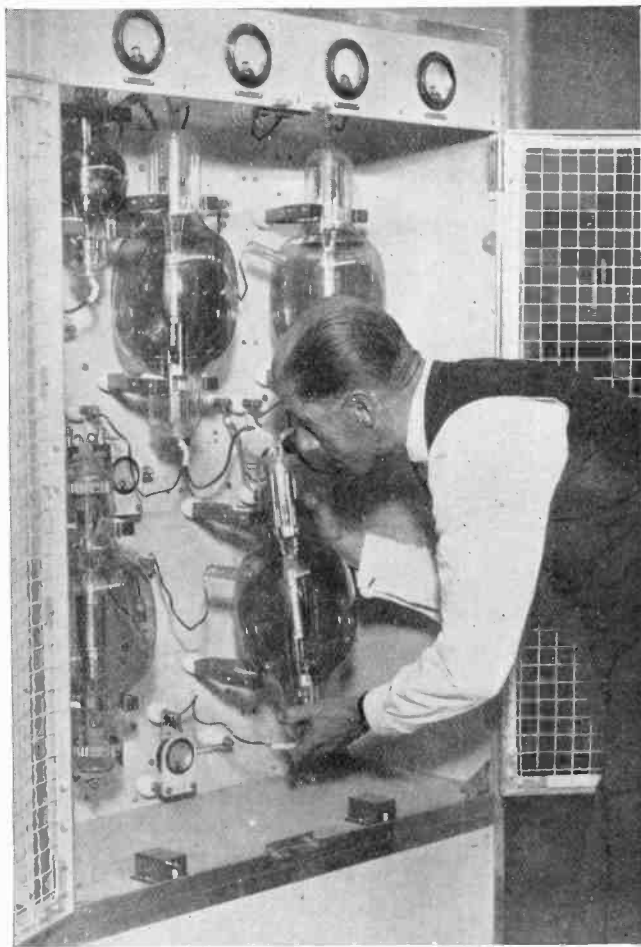

L.N.A.

THE B.B.C. AMPLIFIER USED AT THE NATIONAL RADIO EXHIBITION AT OLYMPIA FOR SUPPLYING ALL THE LOUD-SPEAKERS IN THE BUILDING

[395]



E.N.A.

SALZBURG

Mozart's birthplace, from which concerts from the famous annual festival were relayed to England on August 7 and 30, 1930



INTERNATIONAL



INTERNATIONAL RELAYS

THE development and possibilities of relays of European programmes by broadcasting stations situated in countries other than the country of origin was discussed in the last two issues of this book. The use of international trunk telephone lines for this purpose was shown to be desirable, and the necessary arrangements such as the provision of special repeaters, etc., were described. The year under review has been one of consolidation rather than of wide new developments. The line link to Belgium and Germany, which had been used experimentally in 1928 and a part of 1929, entered on a maintenance basis towards the end of the year, and can now be set up at short notice for the transmission of broadcast programmes. In fact it is now ordered from the General Post Office in much the same way as a special trunk line in this country is ordered for broadcast transmission. This achievement resulted, towards the end of 1929, in a meeting at Brussels between the Belgian, British and German broadcasting authorities, assisted by representatives of the three national post offices, to discuss the various points, both of programme and technical administration, involved in a regular interchange of programmes over this link. At this meeting a series of three-cornered programmes was arranged, which proved not only interesting as programmes, but a useful exercise in rapid setting up of the music lines. 1930 has seen this service international link extended in Germany, from Cologne to Berlin, Frankfurt, Stuttgart and Leipzig, all within the first few months of the year. As was foreshadowed in 1929, such an extension waited only on the completion of certain cables in Germany.

At the time of writing experiments are in progress for

the extension of these circuits to Austria, and already very good quality musical transmission has been achieved experimentally from Salzburg to London. Listeners had their first opportunity of hearing a transmission from Salzburg on August 7th, when part of the Mozart Serenade was relayed from there. This extension followed immediately on the completion of a special music circuit between Germany and Austria—from Nürnberg through Passau (Germany) to Linz (Austria) and thence on to Vienna. There is thus every reason to hope that Vienna also may be added within a very short time.

In addition to this side of international relays, in which only high-quality cable circuits entirely suitable for music are used, the past year has seen considerable development in the transmission of the spoken word internationally, in which the criterion of "intelligible speech" has been accepted, and indeed, in view of the material transmitted, has proved acceptable. Language difficulties have in general resulted in such transmissions being confined to the English-speaking peoples, either as talks from this country to the Dominions, the United States of America or *vice versa*, or as talks given by British delegates to various conferences at Geneva. The criterion of "intelligible speech" can be satisfied by the use of commercial telephone circuits and opens a wide vista of possibilities for international relays throughout a large part of the world.

Indeed the extent of present-day international telephone services is not generally realised. During the past few years announcements by the Postmaster-General have appeared in the Press from time to time, to the effect that a telephone service was to be inaugurated between this country and one or other of the continents or one or other countries in Europe. It is now possible to telephone from any place in Great Britain and Northern Ireland to almost every country in Europe, and there is also a daily service between 11.30 a.m. and 3 a.m., which is available for calls to any place in the United States of America, the island of Cuba, to all parts of Ontario and Quebec in Canada, as well as to certain towns in other Canadian provinces, to certain towns in Mexico, and to certain towns in the Argentine, Brazil, Chile and Uruguay. In addition, the telephonic service between this country



KOOTWIJK

A fine modern building housing the Dutch short-wave station

[399]

and North America is extended to include several European countries, the communication being by cable in two continents connected together by the wireless telephone link across the Atlantic. A telephone service was recently opened between this country and Australia, the opening speeches between the Prime Ministers of the two countries being broadcast. In addition to this extraordinary development of telephone communication between fixed points in most parts of the world, telephone services have recently been opened, during specified hours, between Great Britain, America and certain ships at sea. At present this service is confined to four of the large North Atlantic liners, viz. "Homer," "Majestic," "Olympic," of the White Star Line, and "Leviathan" of the United States Line, conversations between the two former and speakers in England having been broadcast.

Political difficulties at one time prevented certain of these commercial services being used for broadcast relays, but fortunately these have now been overcome and the circuits are all available. Indeed they have already been used in the past few months.

The second noteworthy development of the year under review is the use of international circuits (both high quality and commercial service) for extending the area from which a station can pick up its programmes. This may seem obvious, but the point in question is that such a pick-up can be and often is independent of the programmes of the broadcaster at the point of origin. This arrangement was first used extensively at the London Naval Conference, when the two great American broadcasting chains (Columbia and the National Broadcasting Company) both sent observers to London, and arranged for frequent talks to be given to their respective chain of stations in America by these observers and others in London. The B.B.C. provided the necessary studio and microphone facilities, and arranged for suitable line connection to the international telephone links required, but these talks formed no part of the B.B.C. programmes. This practice has continued and a regular series of talks on topical subjects is at present being given in this way to American radio audiences. Needless to say, similar arrangements can be and have on suitable occasions been



COLOGNE BROADCASTING HOUSE.

Cologne has played an important part in international relays as the first German station to be linked up with London and as a contributor to several international programmes

made on the other side of the Atlantic as well as in Europe for parts of the B.B.C. programmes. In Germany it is becoming quite a habit for the "wandering microphone" to visit adjacent foreign countries, and perhaps the first instance of this growing practice of relays not broadcast at the point of origin was the Stamford Bridge athletic meeting between Germany and England, when the B.B.C. (as noted in the last *Year-Book*) provided technical facilities for the relay of a running commentary to Germany given by Dr. Laven of the Frankfurt station.

A review of international relays during the past year would be incomplete without reference to the broadcast of His Majesty the King's and other speeches at the opening of the London Naval Conference on January 21st, 1930.* Every possible type of link was used for this broadcast, including high-quality music circuits, ordinary commercial line telephone circuits, commercial radio telephone circuits, experimental radio telephone circuits, and direct pick-up and subsequent re-broadcasting of B.B.C. transmissions—in particular of Daventry 5XX and the experimental short-wave transmitter G5SW at Chelmsford. The opportunities of world-wide reception of these speeches are best indicated by the fact that 242 broadcast transmitters radiated them—112 in Europe and 130 in the rest of the world: indeed a truly *international* relay.

* A detailed report of the relay will be found on pp. 121-123.

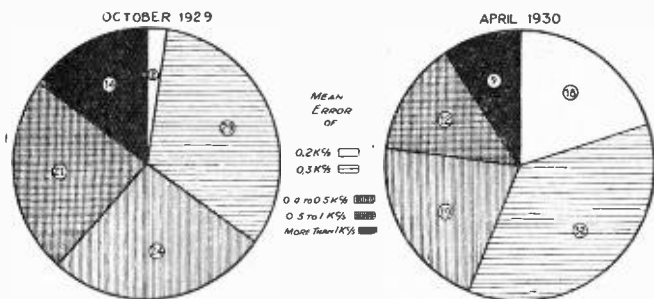

Diagram illustrating the improvement during the winter 1929-30 in the stability of carrier wave frequency of European broadcasting stations working on exclusive waves

SUMMARY OF DISTRIBUTION OF WAVE-LENGTHS UNDER THE PRAGUE PLAN

Country.	"Long" Waves.	"Medium" Waves.	Country.	"Long" Waves.	"Medium" Waves.
Albania . .	—	1	Hungary . .	—	2
Austria . .	—	2	Ireland . .	—	2
Belgium . .	—	3	Italy . .	—	6*
Bulgaria . .	—	1	Latvia . .	—	1
Czechoslovakia	—	5*	Luxembourg	—	1
Denmark . .	—	1	Norway . .	—	4
Estonia . .	—	1	Poland . .	1	5*
Finland . .	1	2	Portugal . .	—	1
France . .	1	13*	Romania . .	—	3
Germany . .	1	12	Spain . .	—	6
Great Britain .	1	9	Sweden . .	1	5
Greece . .	—	1	Switzerland	—	2
Holland . .	1	1	Yugoslavia .	—	3

* Plus 1 shared.

In addition, the Prague Conference authorised certain stations to use specified channels outside the normal broadcast bands allotted by the Washington Radiotelegraph Convention of 1927, provided that the stations using these waves did not interfere with the services occupying these bands.

There are also ten common waves, and one free wave.

The adjectives "long" and "medium" applied to broadcasting waves have become acknowledged through use. The Hague definition for the nomenclature for wave-lengths, as shown below in the Technical Dictionary, does not make this distinction. According to this definition, all waves between 200 and 3000 m. are medium waves.



TATSFIELD RECEIVING STATION

ABOUT twenty miles from London, at Tatsfield in Surrey, is situated the B.B.C.'s Receiving Station—the principal station of the B.B.C. which is concerned only with reception. Here are measured the frequencies of all British and Continental stations, and apparatus is available for the relaying of foreign programmes by means of wireless link.

Tatsfield is the successor of Keston, which was set up in 1924 originally for relaying purposes. Gradually the wavelength situation became more difficult and the importance of keeping on allotted frequencies was such that the daily checking of all stations' frequencies became necessary, and this work superseded to some extent the original reason for Keston's existence.

For various reasons the Keston site became unsuitable, the B.B.C. could not purchase the land, and the wooden huts were not suitable for the housing of delicate apparatus, such as standard wavemeters and high-quality receivers. A new site at Tatsfield was decided upon in 1929. It is in the heart of the country, away from all interference, and being some 800 feet above sea-level, it is exceptionally well situated for long-distance reception. A brick building of adequate proportions now houses the equipment, and the improvement in location and design of building is reflected in the greater ease and accuracy with which frequency measurements and long distance relays are carried out.

Keston was the first Receiving Station of its type in Europe. Its invaluable work of frequency checking not only of British stations led other prominent Broadcasting nations to build similar listening posts, and these now exist in

Brussels, Berlin and Prague. All are equipped with wavemeters of the type evolved by the Technical Committee of the Union Internationale de Radio-diffusion, and a record of the daily frequency tests of Tatsfield, Berlin and Brussels are sent to the official of the U.I.D.R. at Brussels, whose work it is to compare these results and take action with respect to any station in Europe seriously departing from its allotted frequency and causing interference to its neighbour on an adjacent frequency.

The photograph at the head of this article shows the two buildings at Tatsfield. They are in brick, the larger having double air-spaced walls to reduce the possibility of large temperature changes inside. It is, in fact, highly desirable that the inside temperature should remain practically constant whatever conditions are outside, because of the variations that would otherwise arise in the wavemeter readings. A station working on 300 metres has a frequency of 1000 kilocycles per second, and neighbouring stations work on frequencies 9 kc/s on either side. A heterodyne note of this frequency difference may sometimes be heard when listening to one of these stations if the receiving set and loud-speaker will reproduce it. In general this is not at all troublesome, but should this separation be reduced to say 7 kc/s, the interference becomes serious. Thus the importance of a station adhering to its correct frequency within a few hundred cycles cannot be over-emphasised. If measurements are to be useful they must therefore have an accuracy of at least 1 in 2000 or 3000, and the two wavemeters at Tatsfield fulfil this condition.

Apart from these wavemeters, the equipment of the station is at the moment in process of being modernised and considerably extended. Although this change has not yet been completed, it is desirable to describe what the final arrangements will be.

First, the Instrument Room in the main building contains receivers of various types for relaying and general listening work. Practically all the apparatus is rack-mounted, one rack divided into six bays occupying a length of eleven feet along one side of the room. Two bays are required for the main short-wave receiver, consisting actually of two superheterodyne units complete with intermediate and detector circuits for spaced-aerial reception. The third



DR. BARNARDO'S HOMES:

NATIONAL INCORPORATED ASSOCIATION

Charter:

"No Destitute Child Ever Refused Admission."

No Voting System.
No red tape.

The need of the child is
the only consideration.

On an average 5 children are added to this Family every day, which is the Largest Family in the World.

The children are rescued from unfavourable surroundings, given a new environment, trained and placed out in life as useful and self-supporting citizens.

109,000 children admitted.	17,797 children and	465 are crippled or afflicted.
young people dealt with last year.		1,095 are under industrial training.
8,000 always being supported.		30,257 have been migrated to the Overseas
1,264 are babies and toddlers under 5.		Dominions.

Will you help Barnardo's in their work for the Nation?

Please send a gift of 2/6 to their

Annual Appeal for 400,000 Half-Crowns
for the Children's Food.

* * * Cheques and Orders payable "DR. BARNARDO'S HOMES" and crossed, may be sent to DR. BARNARDO'S HOMES, 297 BARNARDO HOUSE, STEPNEY CAUSEWAY, LONDON, E. 1

SERVICES FOR BROADCASTING

One of the earliest of all B.B.C. activities was the Broadcasting of Religious services: there has been no interruption in the series of services broadcast since Christmas, 1922. The B.B.C. have now issued, in book form, a list of prayers, hymns, and epilogues, which have been found acceptable in the past. The contents consist of 15 groups of Hallowings, Confessions, Thanksgiving Prayers, Petitions, Evening Prayers and Blessings, Collects, etc., Epilogues, Hymns and Anthems. It costs 1s. 3d. in paper covers, and 2s. 4d. in stout boards, post paid, from the B.B.C.

Bookshop, Savoy Hill.

bay contains a common low-frequency panel with filter, corrector, and volume indicator circuits, which can be switched in and out of circuit at will. The H.F. units are connected by means of a buried D.F. type cable to half-wave aerials supported by two 120-foot masts.

Then follows two bays containing four receiver units, two for the long and two for the medium waveband. These units have two H.F. stages each, the over-all sensitivity being intentionally kept down to a reasonable amount because they are primarily used for quality relaying of foreign stations of relatively high field strength. A common low-frequency panel can be connected to any receiver. The aerials for these receivers are supported by three masts 60 feet in height.

The end bay contains two direction-finding units, one for the long and the other for the medium waveband, worked in conjunction with the receiver units mounted on the adjacent bays. One 70-foot mast supports an umbrella aerial system serving the D.F. equipment.

On the other side of the room are two low-frequency bays containing a final low-frequency amplifier providing sufficient gain for the received signals to be passed over the private line to the Control Room at Savoy Hill. In addition these bays contain line equalisers, volume indicator, fade unit, line switching and speaking facilities, microphone and microphone amplifier for local announcements, and other associated apparatus.

The other two sides of the room are occupied by benches containing an old-fashioned but extremely reliable short-wave superheterodyne set, together with four all-wave receivers for general purposes. There is sufficient space left for experimental and testing work on new apparatus.

Now we come to the Wavemeter Room. Here is situated the "Brussels" wavemeter already referred to, consisting of four valve oscillator units to cover the waveband from 175 to 600 metres. These units are calibrated periodically by means of a tuning-fork and multi-vibrator mounted on a substantial angle-iron stand at one end of the room. The wavemeter units are mounted on a reinforced concrete platform which entirely prevents any vibration. A similar mounting is adopted for the two Sullivan heterodyne wavemeters, one covering a range of 150 to 3000 metres, and the

other 10 to 100 metres. These wavemeters are accurate to within 1 in 3000, and thus enable absolute measurements on the medium waveband to be accurate within about 300 cycles. Variations in frequency of a few cycles only can, of course, be observed by the swinging of the beat frequency on either side of zero.

For frequency measurements two rack-mounted receivers are provided, one for the medium and one for the long waveband. This rack is situated conveniently near to the wavemeters, so that a station whose frequency is to be measured can be picked up on the receiver and then heterodyned by the wavemeter. The receivers used are of high sensitivity and selectivity, and their performance at low frequencies is particularly good in order that zero beat note between the received signal and the wavemeter may be judged most easily.

Power supplies both to the Instrument and Wavemeter Rooms are obtained by means of a busbar system running round the walls of each room. These busbars provide for a six-volt low-tension supply and two different values of high-tension voltage, all of which are obtained from batteries in a room conveniently situated between the Instrument and the Wavemeter Rooms. For certain purposes, especially short-wave reception, the use of batteries common to other receivers is undesirable, and in such cases local batteries placed next to the receiver are used instead.

All batteries are charged by a double motor generator set placed in a large workshop at one end of the building. Power for this purpose and for lighting is supplied to the station from the mains of the Sevenoaks and District Electricity Co. Facilities are available in the workshop for the making up of experimental apparatus of various types.

The smaller building is used at the moment as a store, but is available for experimental work should the need arise in the future. The interchange of programmes by wire and wireless is bound to increase; the checking of station frequencies is already of the greatest importance. The need for somewhere away from the disturbing influence of transmitters, where checking receivers can be tested and where an additional check on B.B.C. and foreign transmissions can be maintained, is evident. The Tatsfield Station meets these requirements ideally.



REFERENCE
SECTION

[409]

B B C . A D D R E S S E S



Headquarters

HEAD OFFICE AND }
LONDON AND }
DAVENTRY (5XX) }
STUDIOS

Savoy Hill, London,
W.C.2.

Telegrams: Ethanuz
London.
Telephone: Temple
Bar 8400.

Regional Centres

BELFAST
BIRMINGHAM
(MIDLAND REGION)
CARDIFF (WEST
REGION)
EDINBURGH (SCOT-
TISH REGION)
MANCHESTER
(NORTH REGION)

31, Linenhall Street.
282, Broad Street.
39, Park Place.
5, Queen Street.
Broadcasting House,
Piccadilly.

Telegrams and Telephone

Belfast 5870.
3761 Midland Birming-
ham.
2514 Cardiff.
30111 Edinburgh.
City 8396 Manchester

Other B.B.C. Offices

ABERDEEN
BOURNEMOUTH
DUNDEE
GLASGOW
HULL
LEEDS-BRADFORD
LIVERPOOL
NEWCASTLE
PLYMOUTH
SHEFFIELD
STOKE-ON-TRENT
SWANSEA

15, Belmont Street.
72, Holdenhurst
Road.
22, St. Salvador
Street.
21, Blythswood
Square.
26 & 27, Bishop
Lane.
Cabinet Chambers,
Basinghall Street,
Leeds.
85, Lord Street.
54, New Bridge St.
Athenæum Chambers,
Athenæum Arcade.
47, Corporation
Street.
Majestic Buildings.
Oxford Buildings.

2296 Aberdeen.
3460 Bournemouth.
5209 Dundee.
5230 Douglas,
Glasgow.
Central 6138 Hull.
Leeds 28131.
Bank 5018 Liverpool.
953 Central Newcastle.
2283 Plymouth.
24227 Sheffield.
Hanley 47170.
3107 Swansea.

Wireless Societies

THE INCORPORATED RADIO SOCIETY OF
GREAT BRITAIN

53, Victoria Street, London, S.W.1.

Hon. Secretary : John Clarricoats.

THE RADIO ASSOCIATION

22, Laurence Pountney Lane, E.C.4.

General Secretary : R. F. Tiltman.

THE WIRELESS LEAGUE

INCORPORATING

THE WIRELESS ASSOCIATION OF GREAT BRITAIN

12, Grosvenor Crescent, S.W.1.

Hon. Secretary : Miss I. Joss.

Wireless Trade Associations

RADIO MANUFACTURERS' ASSOCIATION

Astor House, Aldwych, London, W.C.2.

Hon. Secretary : D. Grant Strachan.

THE WIRELESS RETAILERS' ASSOCIATION
OF GREAT BRITAIN

70, Finsbury Pavement, London, E.C.2.

Hon. Secretaries : Messrs. Clifford & Clifford.

BRITISH RADIO VALVE MANUFACTURERS'
ASSOCIATION

59, Russell Square, London, W.C.1.

Hon. Secretary : H. Howitt.

RADIO WHOLESALERS' FEDERATION

35, Sicilian House, Sicilian Avenue,
Southampton Row, London, W.C.1.

Hon. Secretary : J. Macfarlane.

[411]

T H E R A D I O C I R C L E

The Radio Circle consists of two sections:

1. The Junior, for listeners up to 15 years of age.
2. The Senior, for listeners over 15 years of age.

Membership is for one year only, but may be renewed. The annual subscription of ninepence is due on January 1st in each year, but newcomers may join the Circle at any time. The first subscription entitles the newly-joined member to a badge, which takes the form of an enamelled device, common to all Stations—with a special pendant for each local branch. Subsequent subscriptions entitle rejoining members to a card of membership or some other token. Membership of the Junior Section gives the privilege of a broadcast birthday greeting. There are now no membership numbers. Applications for membership should include full name, full address, and, for the Junior Section, the day, month and year of birth. Some Stations have printed forms which are sent on request and facilitate registering. All applications should be accompanied by the subscription of ninepence.

DISPOSITION OF RADIO CIRCLE FUNDS

The balance of the subscriptions (over and above the cost of the badge and postage) is paid into the local Radio Circle Funds, which are further increased in various ways such as by the sale of "silver paper." Up to the end of June 1930 the amount distributed to Charity by the London and Daventry Radio Circle had reached a total of £3,152.

HOW TO APPLY FOR A BROADCAST APPEAL

Write, enclosing a copy of the latest report of the charity you are interested in, to:—

THE SECRETARY,
APPEALS ADVISORY COMMITTEE,
THE BRITISH BROADCASTING CORPORATION,
SAVOY HILL, W.C. 2.

NEW MUSICAL COMPOSITIONS

The B.B.C. is always ready to consider new music for broadcasting. Such music should be good enough to be worthy of performance on its own merits—and only works for orchestra and military band, or choral works, should be submitted. Scores (not parts) should be sent in. Chamber music, short instrumental pieces, and songs, as well as dance music and pieces, even if for orchestra, of a trifling nature, cannot well be used; the B.B.C. leaves the choice of all such items to artists, and such pieces have a better chance of performance if introduced direct to them.

New compositions are read by the B.B.C. in January and February of each year. Compositions submitted after February are normally held over to the next year.

S.O.S. RULES

In view of the greatly increasing number of S.O.S. messages that the B.B.C. is asked to broadcast, listeners are reminded of the rules and procedure which must be adhered to, careful attention to which will save a great deal of time and trouble to all concerned.

The B.B.C. will broadcast messages requesting relatives or friends to go to a sick person only when the Hospital Authority or the Medical Attendant certifies that the patient is *dangerously ill*, and *after all other means of communication have failed*.

The name, address, and, if possible, the telephone number of the Medical Attendant must accompany every application.

In no case can an S.O.S. be broadcast requesting the attendance of relatives, etc., *after* death has occurred.

Originators of S.O.S. calls would help considerably if they would let their nearest Station know if the S.O.S. has been successful or not.

Descriptions of "missing" persons are only broadcast when the B.B.C. is directly requested to do so by New Scotland Yard (in the case of a broadcast from London or Daventry) or by the Chief Constable of the district in which the B.B.C. Offices are situated (in the case of Regional or Local broadcast).

No S.O.S. can be broadcast regarding lost animals or property.

WEATHER FORECASTS

- 10.30. Daventry 5XX. Weather Forecast for ships. Read twice—first at natural speed, second time at long-hand dictation speed.
- 6.15. General Weather Forecast (National Programme).
- 9.0. General Weather Forecast " " "
- 9.15. Daventry 5XX. Weather Forecast for ships only.
- 10.15. General Weather Forecast (Regional Programme).

In addition:—

Gale Warnings are broadcast with the Shipping Forecasts, and at 1, 4.45, and 6.15 p.m., and on Sundays at 3 p.m., when received from the Meteorological Office.

MARKET BULLETINS, ETC.

The following Bulletins are broadcast at regular intervals. The actual time will be found in the B.B.C.'s published programmes in the *Radio Times*.

- Every Weekday.* London and New York Stock Exchange Report (except Saturdays).
Fat Stock Prices for Farmers.
- Weekly.* Market Prices for Farmers.
Horticultural Bulletin.
Empire Marketing Board Bulletin.
- Fortnightly.* Agricultural Bulletin.

B. B. C. TIME SIGNAL CHART

WEEK-DAY SERVICE

Station.	10.15 a.m.	10.30 a.m.	12.0 noon.	1.0 p.m.	4.45 p.m.	6.30 p.m.	9.0 p.m.	10.15 p.m.	11.30 p.m.
National 1554.4 m.	Big Ben	G.T.S.†	Big* Ben	G.T.S.	G.T.S.	G.T.S.	G.T.S.		G.T.S.
London National 261.3 m.			Big* Ben	G.T.S.		G.T.S.	G.T.S.		
London Regional 356 m.	Big Ben	G.T.S.	Big* Ben			G.T.S.		G.T.S.	
Midland Regional 479.2 m.			Big Ben			G.T.S.		G.T.S.	
Provinces						G.T.S.	G.T.S.		

SUNDAY SERVICE—TIME SIGNALS

Station.	10.30 a.m.	3.0 p.m.	3.30 p.m.	9.0 p.m.
National 1554.4 m.	G.T.S.	G.T.S.		G.T.S.
London National 261.3 m.		G.T.S.		G.T.S.
London Regional 356 m. and Midland Regional 479.2 m.			G.T.S.	G.T.S.
Provinces		G.T.S.		G.T.S.

BIG BEN

If circumstances are favourable, Big Ben will be broadcast at the beginning of any programme emanating from London. The day's programme on week-days will also be concluded, when possible, with Big Ben.

NOTES

G.T.S. on 1554.4 m. is compulsory and will always be broadcast even if this means its super-imposition.

* Saturdays excluded.

† Greenwich Mean Time.

STANDARD SYMBOLS

LETTER SYMBOLS

In the first two pages of the Technical Tables (pp. 420-421) will be found a list of symbols for various electrical units. These symbols take the form of the letters of either the English or the Greek alphabet. A note explains the difference between a symbol and an abbreviation.

GRAPHICAL SYMBOLS

In addition to these letter symbols, a large number of graphical or picture symbols are used in the drawing of electrical plans. The International Electrotechnical Commission has issued a standard list of graphical symbols for use in all forms of electrical engineering.

It is felt that these symbols might be useful both to readers of B.B.C. publications and to listeners who have at any time themselves to draw diagrams. They are therefore reproduced for ready reference on the four pages that follow.



WIRES IN CONTACT



WIRES NOT IN CONTACT



TWISTED PAIR



RESISTANCE
FIXED



RESISTANCE
VARIABLE
BY SLIDER



RESISTANCE
VARIABLE
BY STUDS



RESISTANCE
NON-INDUCTIVE



2 ELECTRODE
VALVE



3 ELECTRODE
VALVE



4 ELECTRODE
VALVE



PENTODE
VALVE



THERMO-
COUPLE



GENERATOR,
D.C.



MOTOR,
D.C.



A.C. GENERATOR,
SINGLE PHASE

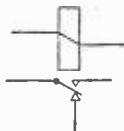

RELAY WITH
SINGLE COIL

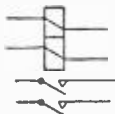

RELAY WITH
TWO COILS

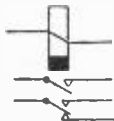

SLOW ACTING
RELAY



DIFFERENTIAL
RELAY



JUMPERED CONNECTION



U. LINKS



IRON CORE
CHOKE



IRON CORE
TRANSFORMER



TRANSFORMER
WITH SCREEN
BETWEEN
PRIMARY AND
SECONDARY



AIR CORE
CHOKE



AIR CORE
TRANSFORMER



VARIABLE
MUTUAL
INDUCTANCE



HEADPHONES



MICROPHONE



LOUD SPEAKER,
GENERAL SYMBOL



LOUD SPEAKER,
MOVING COIL



A.C. GENERATOR,
THREE PHASE



INDUCTION MOTOR,
THREE PHASE



MACHINES COUPLED
* MECHANICALLY



LAMP

O



TELEPHONE
TRANSMITTER



TELEPHONE
RECEIVER



MAGNETO
BELL

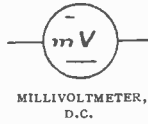
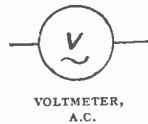
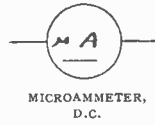
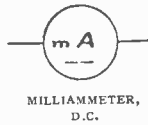
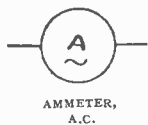
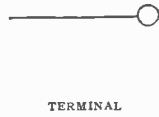
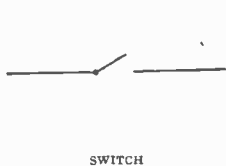
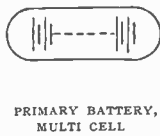



RHEOSTATIC
STARTER,
COMPOUND
MACHINE



RHEOSTATIC STARTER,
MULTIPLE CONTACT
SWITCH TYPE



CONTACTOR



CONTACTOR
WITH BLOW OUT



AIR BREAK
CIRCUIT
BREAKER,
MAXIMUM

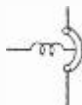

AIR BREAK
CIRCUIT
BREAKER,
MINIMUM



RHEOSTATIC
STARTER,
SERIES
MACHINE



BUZZER



2 WAY
PLUG



3 WAY
PLUG



PLUG
NO. 404

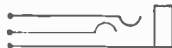

3 POINT JACK



PLUNGER KEY



2 POSITION LEVER KEY



5 POINT JACK



3 POSITION LEVER KEY

NOTE.—The letters L or NL are to be used in conjunction with keys to show locking or non-locking positions. The movement of the levers in above examples is vertical.

TECHNICAL TABLES AND FORMULÆ

1. UNITS (FUNDAMENTAL)

THE fundamental units, on which all practical units are based, are those of length, mass and time. In the C.G.S. System these are the centimetre, gramme and second respectively, and in the British System the foot, pound and second.

2. UNITS (DERIVED)

Unit of	C.G.S. electro-magnetic unit.	C.G.S. electro-static unit.	Practical unit.	Abbreviation for practical unit.	Sym-bol.
		(approx.)			
Current	10 ampères	$\frac{1}{3 \times 10^9}$ ampere	1 ampere	A	<i>I</i>
Resistance	$\frac{1}{10^9}$ ohm	9×10^{11} ohms	1 ohm	Ω	<i>R</i>
Electromotive Force	$\frac{1}{10^8}$ volt	3×10^2 volts	1 volt	V	<i>E</i>
Potential Difference	$\frac{1}{10^8}$ volt	3×10^2 volts	1 volt	V	<i>V</i>
Quantity	10 coulombs	$\frac{1}{3 \times 10^9}$ coulomb	1 coulomb	C	<i>Q</i>
Energy	1 cm.-dyne = 1 erg = $\frac{1}{10^7}$ joule	$\frac{1}{10^7}$ joule	1 joule	J	<i>W</i>
Power	$\frac{1}{10^7}$ watt = 1 erg per sec.	$\frac{1}{10^7}$ watt	1 watt	W	<i>P</i>
Capacity	10^9 farads	$\frac{1}{9 \times 10^{11}}$ farad	1 farad	F	<i>C</i>
Inductance	$\frac{1}{10^9}$ henry	9×10^{11} henry	1 henry	H	<i>L</i>

The above abbreviations and symbols follow the recommendations of the International Electro-Technical Commission which meets periodically to make such recommendations.

In addition, the following prefixes have been standardised:—

m for milli-	e.g. mA	means	milli-amperes	= $1/10^3$ ampere
k ,, kilo-	,, kW	,,	kilo-watts	= 10^3 watts
μ ,, micro- or micr-	,, μ F	,,	micro-farads	= $1/10^6$ farad
$\mu\mu$,, micro-micro-	,, $\mu\mu$ F	,,	micro-micro-farads	= $1/10^{12}$ farad
M ,, mega- or meg-	,, M Ω	,,	megohms	= 10^6 ohms.

It is important to note the different uses of the abbreviations and the symbols. The symbols are used *by themselves*, whereas the abbreviations are used in conjunction *with quantities*.

Thus, Ohms Law is given by

$$I = \frac{E}{R}$$

But, to express in equation form the fact that 5 amperes pass through a resistance of 2 ohms when an electromotive force of 10 volts is applied to the ends of the resistance, it is shown:—

$$5A = \frac{10V}{2\Omega}$$

The abbreviation kc/s is used to denote the frequency of an electro-magnetic wave in kilocycles per second.

3. EQUIVALENTS

1 inch	= 2.54 centimetres.
1 foot	= 30.48 centimetres.
1 yard	= 0.914 metre.
1 mile	= 1609.3 metres.
1 kilometre	= 0.62 mile.
1 ounce	= 28.35 grammes.
1 lb.	= 453.6 grammes.
	= 7000 grains.
1 kilogram	= 2.2 lbs.
1 gallon	= 4.55 litres.
1 litre	= 0.035 cubic feet.
1 gallon of water	= 10 lbs.
1 cubic foot of water	= 62.3 lbs.
1 mile per hour	= 88 feet per minute.
1 knot	= 6080 feet per hour.
π	= 3.1416.
1 radian	= 57.3 degrees.
1 B.Th.U.	= 0.252 calorie.
	= 778 foot-lbs.
1 C.H.U.	= 1400 foot-lbs.
1 Calorie	= 3087 foot-lbs.
1 foot-lb.	= 1.356 joules.
1 horse-power hour	= 1,980,000 foot-lbs.
1 horse-power	= 33,000 foot-lbs. per minute.
	= 550 foot-lbs. per second.
	= 746 watts.

[421]

1 joule	= 1 watt-second. = 10^7 ergs. = 0.7372 foot-lb.
1 kilowatt	= 1000 watts.
1 Board of Trade Unit	= 1 kilowatt-hour. = 36×10^5 joules.
1 dyne	= $\frac{1}{981}$ gramme. = $\frac{1}{445,000}$ lb.
1 coulomb	= 1 ampere-second.
1 atmosphere	= 14.7 lbs. per square inch. = 760 millimetres of mercury.
$\log_e x$	= $2.3026 \times \log_{10} x$.

A column of water 2.3 feet high corresponds to a pressure of 1 lb. per square inch.

Base of Napierian logs, $e = 1 + 1 + \frac{1}{2} + \frac{1}{3} + \frac{1}{4} + \dots = 2.7183$ approx.

4. TRIGONOMETRICAL FORMULÆ

$$\begin{aligned}
 \cos^2 \theta + \sin^2 \theta &= 1 \\
 \cosh^2 \theta - \sinh^2 \theta &= 1 \\
 \sin (\theta \pm \phi) &= \sin \theta \cos \phi \pm \cos \theta \sin \phi. \\
 \cos (\theta \pm \phi) &= \cos \theta \cos \phi \mp \sin \theta \sin \phi. \\
 \cos 2\theta &= \cos^2 \theta - \sin^2 \theta. \\
 &= 1 - 2 \sin^2 \theta. \\
 &= 2 \cos^2 \theta - 1. \\
 \sin 2\theta &= 2 \sin \theta \cos \theta. \\
 \sin \theta + \sin \phi &= 2 \sin \frac{\theta + \phi}{2} \cos \frac{\theta - \phi}{2}. \\
 \sin \theta - \sin \phi &= 2 \sin \frac{\theta - \phi}{2} \cos \frac{\theta + \phi}{2}. \\
 \cos \theta + \cos \phi &= 2 \cos \frac{\theta + \phi}{2} \cos \frac{\theta - \phi}{2}. \\
 \cos \theta - \cos \phi &= -2 \sin \frac{\theta + \phi}{2} \sin \frac{\theta - \phi}{2}.
 \end{aligned}$$

[422]

5. WIRE GAUGE AND STANDARD COPPER CONDUCTORS

IMPERIAL STANDARD WIRE GAUGE

No.	Diameter (ins.).	Sectional area (sq. ins.).	No.	Diameter (ins.).	Sectional area (sq. ins.).
0	0.324	0.0824	26	0.018	0.000255
1	0.300	0.0707	27	0.016	0.000211
2	0.276	0.0598	28	0.015	0.000172
3	0.252	0.0500	29	0.014	0.000145
4	0.232	0.0423	30	0.012	0.000121
5	0.212	0.0353	31	0.0116	0.000106
6	0.192	0.0289	32	0.0108	0.0000916
7	0.176	0.0243	33	0.0100	0.0000785
8	0.160	0.0201	34	0.0092	0.0000665
9	0.144	0.0163	35	0.0084	0.0000554
10	0.128	0.0129	36	0.0076	0.0000454
11	0.116	0.0106	37	0.0068	0.0000363
12	0.104	0.00850	38	0.0060	0.0000283
13	0.092	0.00665	39	0.0052	0.0000212
14	0.080	0.00503	40	0.0048	0.0000181
15	0.072	0.00407	41	0.0044	0.0000152
16	0.064	0.00322	42	0.0040	0.0000126
17	0.056	0.00246	43	0.0036	0.0000102
18	0.048	0.00181	44	0.0032	0.0000080
19	0.040	0.00126	45	0.0028	0.0000062
20	0.036	0.00102	46	0.0024	0.0000045
21	0.032	0.000804	47	0.0020	0.0000031
22	0.028	0.000616	48	0.0016	0.0000020
23	0.024	0.000452	49	0.0012	0.00000113
24	0.022	0.000380	50	0.0010	0.000000785
25	0.020	0.000314			

STANDARD COPPER CONDUCTORS

No. and diameter of wires.	Area (sq. in.).	Amperes at I.E.E. standard.	Resistance (ohms per 1000 yds.).	Nearest old standard size.
1/'036	0'0010	4'1	24'5	1/20
1/'044	0'0015	6'1	16'4	1/18
3/'029	0'0020	7'8	12'8	3/22
3/'036	0'0030	12	8'26	3/20
1/'064	0'0030	12'9	7'76	1/16
7/'029	0'0045	18'2	5'49	7/22
7/'036	0'0070	24	3'53	7/20
7/'044	0'0100	31	2'36	7/18
7/'052	0'0145	37	1'69	7/18
7/'064	0'0225	46	1'12	7/16
19/'044	0'0300	53	0'864	19/18
19/'052	0'0400	64	0'624	19/18
19/'064	0'0600	83	0'412	19/16
19/'072	0'0750	97	0'326	19/14
19/'083	0'100	118	0'245	19/14
37/'064	0'120	130	0'212	37/16
37/'072	0'150	152	0'167	37/14
37/'083	0'200	184	0'126	37/14
37/'093	0'250	214	0'100	37/12
37/'103	0'300	240	0'0818	37/12
61/'093	0'400	288	0'0608	61/12
61/'103	0'500	332	0'0496	61/12
91/'093	0'600	384	0'0408	91/12
91/'103	0'750	461	0'0333	91/12
127/'103	1'00	595	0'0238	127/12

6. SPECIFIC INDUCTIVE CAPACITY

The specific inductive capacity of a substance is the ratio of the capacity of a condenser with the substance as dielectric to the capacity of an air condenser of the same size.

Substance.	Specific inductive capacity.
Plate Glass	6-8
Flint glass	7-10
Paraffin wax	2
India-rubber	2-3
Mica	6
Ebonite	2'5
Shellac	3-3'5
Porcelain	4-6
Insulating oil	2-3
Turpentine	2'3
Air	1

7. SPECIFIC RESISTANCE

The specific resistance of a conductor is the resistance of a cm. cube between opposite faces.

Conductor.	Specific resistance in microhms per cm. cube.
Copper	1.6
Silver	1.6
Tin	10
Mercury	94
Platinum	9
Phosphor bronze	8
Zinc	6
Distilled water	7×10^{18}

8. DIELECTRIC STRENGTHS

Material.	Volts per mm.
Glass	8,000
Paraffin	12,000
Micanite	40,000
Ebonite	30,000
Porcelain	10,000
Empire cloth	10,000
Presspahn	5,000

Two sharp points in air, 10 inches apart, will flash over at approximately 100,000 volts.

9. RESISTANCES, CAPACITIES AND INDUCTANCES IN SERIES AND PARALLEL

Units.	Total in series.	Total in parallel.
Resistances: r_1, r_2, r_3	$R = r_1 + r_2 + r_3$	$R = \frac{1}{\frac{1}{r_1} + \frac{1}{r_2} + \frac{1}{r_3}}$
Capacities: c_1, c_2, c_3	$C = \frac{1}{\frac{1}{c_1} + \frac{1}{c_2} + \frac{1}{c_3}}$	$C = c_1 + c_2 + c_3$
Inductances: l_1, l_2, l_3	$L = l_1 + l_2 + l_3$	$L = \frac{1}{\frac{1}{l_1} + \frac{1}{l_2} + \frac{1}{l_3}}$

10. OHM'S LAW

In a D.C. circuit: Current (amps.) = $\frac{\text{E.M.F. (volts)}}{\text{Resistance (ohms)}}$, i.e. $I = \frac{E}{R}$.

In an A.C. circuit: Current (amps.) = $\frac{\text{E.M.F. (volts)}}{\text{Impedance (ohms)}}$, i.e. $I = \frac{E}{Z}$.

Circuit containing Inductance (L) only: $I = \frac{E}{\omega L}$, where $\omega = 2\pi f$.

„ „ Capacity (C) only: $I = \omega CE$, where $\omega = 2\pi f$.

„ „ Resistance, Capacity and Inductance in series:—

$$I = \frac{E}{\sqrt{R^2 + \left(\omega L - \frac{1}{\omega C}\right)^2}}$$

where $\sqrt{R^2 + \left(\omega L - \frac{1}{\omega C}\right)^2} = \text{Impedance } Z$

and $\left(\omega L - \frac{1}{\omega C}\right) = \text{Reactance } X.$

The angle ϕ of lag or lead is given by:—

$$\tan \phi = \frac{\text{Reactance}}{\text{Resistance}} = \frac{\left(\omega L - \frac{1}{\omega C}\right)}{R}$$

$$\text{Admittance} = \frac{1}{\text{Impedance}}.$$

$$\text{Conductance} = \frac{1}{\text{Resistance}}.$$

11. MAGNETIC LAW EQUIVALENT TO OHM'S LAW

$$\text{Magnetic Flux} = \frac{\text{Magneto-motive Force}}{\text{Reluctance}},$$

$$\text{i.e. } \phi = \frac{\text{M.M.F.}}{S}$$

$$\text{M.M.F.} = 0.4\pi NI,$$

where N = number of turns on the solenoid,

I = current in amperes.

Energy stored in a magnetic field = $\frac{1}{2}LI^2$

where L = inductance of the circuit in henries,

I = steady current in amperes.

12. FLUX DENSITY AND PERMEABILITY OF IRON

$$\text{Permeability} = \frac{\text{Flux density}}{\text{Magnetising force}}$$

$$\text{i.e. } \mu = \frac{B}{H}$$

13. BUILDING UP AND DECAY OF A DIRECT CURRENT

When an E.M.F. of E volts is applied to a circuit having a resistance of R ohms and an inductance of L henries, the instantaneous current is given by

$$i = \frac{E}{R} \left(1 - e^{-\frac{Rt}{L}}\right)$$

where t is the time in seconds.

The ratio $\frac{L}{R}$ is called the *time constant*.

When the source of E.M.F. is removed, the instantaneous current is given by

$$i = I e^{-\frac{Rt}{L}}$$

where I is the initial value of the current.

14. POWER IN ELECTRICAL CIRCUITS

D.C. Circuits.

Power (watts) = E.M.F. (volts) \times Current (amps.),
i.e. $P = EI = I^2R$.

A.C. Circuits.

R.M.S. value = $\frac{1}{\sqrt{2}}$ \times maximum value.

In a 3-phase system,

(a) Star Connection,

Line voltage = $\sqrt{3} \times$ phase voltage.

Line current = phase current.

(b) Delta Connection,

Line voltage = phase voltage.

Line current = $\sqrt{3} \times$ phase current.

With either connection, total power is given by

$$\sqrt{3} E_L I_L \cos \phi.$$

Where E_L = line voltage,

I_L = line current,

$\cos \phi$ = cosine of the angle of phase difference between the coil voltage and the current.

$$\text{Crest Factor} = \frac{\text{Maximum value}}{\text{R.M.S. value}}$$

[427]

$\frac{\text{R.M.S. value}}{\text{Average value}} = \text{Form Factor} = 1.11$ in the case of a sine wave.

$$\text{Power Factor} = \frac{\text{True Power}}{\text{Apparent Power}} = \frac{EI \cos \phi}{EI}$$

$$\text{True Power} = EI \cos \phi = I^2 R \cos \phi.$$

15. INDUCTANCE

The inductance of a single-layer close-wound coil wound on a cylindrical former is given by Nagaoka's formula, which is :—

$$L = \pi^2 d^2 n^2 / K,$$

where d = diameter of coil in cms.,

l = length of coil in cms.,

n = number of turns per cm.,

K = factor depending on the ratio of diameter to length of coil.

L = inductance in micro-henries.

$\frac{d}{l}$	K.	$\frac{d}{l}$	K.
0.00	1.000	1.5	0.595
0.10	0.959	2.0	0.526
0.20	0.920	2.5	0.472
0.30	0.884	3.0	0.429
0.40	0.850	4.0	0.365
0.50	0.818	5.0	0.320
0.60	0.788	6.0	0.285
0.70	0.761	7.0	0.258
0.80	0.735	8.0	0.237
0.90	0.711	9.0	0.218
1.00	0.688	10.0	0.203

For a single-layer close-wound coil, the coil of maximum inductance from a given length of wire is given by the ratio :—

$$\frac{\text{Diameter}}{\text{Length}} = 2.4.$$

16. CAPACITY

The capacity of a parallel metal plate condenser is given by :—

$$C \text{ (cms.)} = \frac{nkA}{4\pi d},$$

[428]

where n = number of sheets of dielectric,
 k = specific inductive capacity of the dielectric. For air $k = 1$,
 A = area of one metal plate in square cms.,
 d = distance between the plates in cms.

If a steady charging potential V is required to charge a condenser of capacity C farads with a quantity of electricity Q coulombs, then:—

$$Q = CV.$$

17. FREQUENCY, VELOCITY AND WAVE-LENGTH

The velocity of æther waves is 300 million metres per second.

$$\text{Velocity} = \text{Frequency} \times \text{Wave-length},$$

$$\text{i.e. Wave-length (metres)} = \frac{300 \text{ million}}{\text{Frequency (cycles per second)'}}$$

1 cycle per second = 1 hertz.

A wave-length of 300 metres corresponds to a frequency of 1 million cycles per second.

Frequency (kilocycles per second).	Wave-length (metres).	L.C. value (microhenries and microfarads).
300,000	1	0'000000281
100,000	3	0'00000253
50,000	6	0'0000101
25,000	12	0'0000407
15,000	20	0'000113
10,000	30	0'000253
5,000	60	0'00101
3,000	100	0'00281
1,200	250	0'0176
1,000	300	0'0253
900	333'33	0'0313
800	375	0'0396
700	428'75	0'0519
600	500	0'0704
500	600	0'101
400	750	0'158
300	1,000	0'281
200	1,500	0'633
100	3,000	2'53
60	5,000	7'04
40	7,500	15'8
30	10,000	28'1
20	15,000	63'3
10	30,000	253

18. OSCILLATORY CIRCUITS

(a) The wave-length of an oscillatory circuit LC is given by:—

$$\lambda = 1885\sqrt{LC},$$

where λ = wave-length in metres,
 L = inductance in micro-henries,
 C = capacity in micro-farads.

(b) The resonant frequency of an oscillatory circuit LC is given by:—

$$f = \frac{1}{2\pi\sqrt{LC}},$$

where f = frequency in cycles per second,
 L = inductance in henries,
 C = capacity in farads.

(c) If a voltage V is applied to an oscillatory circuit LC , then:—

$$\text{circulating current } I_R \text{ (ampères)} = V\sqrt{\frac{C}{L}} \text{ (approx.)},$$

$$\text{supply current } I \text{ (ampères)} = V\frac{RC}{L},$$

where R = resistance of the circuit in ohms,
 L = inductance in henries,
 C = capacity in farads.

The greater the ratio $\frac{C}{L}$, the less is the impedance of the circuit to current at a non-resonant frequency. In a receiver, the smaller the ratio $\frac{C}{L}$, the greater will be the cut-down of an interfering signal compared with the required signal, and therefore the resonance curve of the receiver will be sharper.

(d) The voltage across the inductance or condenser in a resonant circuit is:—

$$E_L = E_C = I\sqrt{\frac{L}{C}}$$

where I = current in ampères,
 L = inductance in henries,
 C = capacity in farads.

(e) Coefficient of coupling. If two oscillatory circuits, L_1C_1 and L_2C_2 , are tuned to the same frequency (*i.e.* $L_1C_1 = L_2C_2$), and are coupled together, then the coefficient of coupling between them is given by:—

$$k = \frac{M}{\sqrt{L_1L_2}},$$

where M = coefficient of mutual induction.

Each circuit will, when coupled together, radiate two frequencies given by:—

$$f_1 = f \times \frac{1}{\sqrt{1+k}},$$

$$f_2 = f \times \frac{1}{\sqrt{1-k}},$$

where f is the natural frequency of the circuits L_1C_1 and L_2C_2 .

(f) Inductance coupling. The coefficient of coupling between the two parts of the circuit shown in Fig. 1 is:—

$$k = \frac{L_M}{\sqrt{L_1 L_2}}$$

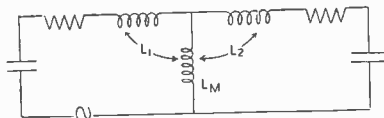

FIG. 1.

(g) Capacity coupling. See Fig. 2. In this case:—

$$k = \frac{\sqrt{C_1 C_2}}{C}$$

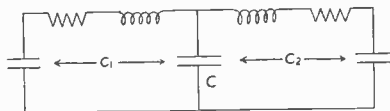

FIG. 2.

19. AERIALS

The natural wave-length of an aerial is approximately equal to four times its overall length.

The radiation resistance is given by:—

$$R_r = 1580 \frac{h^2}{\lambda^2} \text{ (approx.)},$$

where h = mean effective height or radiation height. For an inverted L- or T-shaped aerial, this is approximately 0.6 to 0.7 of the maximum height.

λ = wave-length.

Power radiated = $I^2 R_r$,

$$= I^2 \times 1580 \frac{h^2}{\lambda^2}$$

where I = aerial current (amps.).

20. SIGNAL STRENGTH

The signal strength from a transmitting station at a point distant d kilometres from the station is given by:—

$$E = \frac{377hI}{\lambda d}$$

where E = signal strength in milli-volts per metre,

h = effective height of aerial in metres,

I = maximum current in the aerial in amps.,

λ = wave-length in metres.

[431]

21. EQUIVALENT CIRCUITS

In two circuits coupled by a transformer in which the number of turns in the secondary winding is T times the number of primary turns, a resistance, inductance or capacity connected in the secondary circuit will be equivalent to a resistance, inductance or capacity respectively connected in the primary side of a value given by:—

(a) Resistance. $R_p = \frac{R_s}{T^2}$.

(b) Inductance. $L_p = \frac{L_s}{T^2}$.

(c) Capacity. $C_p = C_s T^2$,

where the suffix p indicates a primary quantity, and s a secondary quantity.

22. TELEPHONE TRANSMISSION UNITS

(a) A mile of standard cable has the following constants:—

Resistance = 88 ohms per mile of loop.

Capacity = 0.054 micro-farad.

Inductance = 1 milli-henry.

Leakance = 1 micro-mho.

(b) Two powers, P_1 and P_2 , differ by the number of decibels (or transmission units) given by:—

$$10 \log_{10} \frac{P_1}{P_2}$$

or by the number of nepers given by:—

$$\frac{1}{2} \log_e \frac{P_1}{P_2}$$

(c) Two voltages V_1 and V_2 or two currents I_1 and I_2 , differ by the number of decibels (or transmission units) given by:—

$$20 \log_{10} \frac{V_1}{V_2} \text{ or } 20 \log_{10} \frac{I_1}{I_2}$$

or by the number of nepers given by:—

$$\log_e \frac{V_1}{V_2} \text{ or } \log_e \frac{I_1}{I_2}$$

(d) 1 decibel (or transmission unit) is equivalent to a standard cable equivalent of 1.084 miles at 800 cycles.

1 decibel = 0.1151 neper = 1.084 standard miles.

1 neper = 8.686 decibels = 9.420 standard miles.

23. ATTENUATION

Along an overhead line, the voltage to earth V and the line current I at a point distant x miles from the sending end are given by:—

[432]

$$V = V_s \epsilon^{-ax} \quad \text{and} \quad I = \frac{V_s}{R_o} \epsilon^{-ax}$$

where V_s = sending end voltage.
 R_o = characteristic impedance of the line.

$$= \sqrt{\frac{R}{G}}$$

a = attenuation constant of the line.

$$= \sqrt{RG}$$

R = resistance of the line per mile in ohms.

G = leakance of the line.

24. LOW-FREQUENCY AMPLIFIERS

(a) Theoretical voltage amplification per stage of a transformer-coupled amplifier is:—

$$\mu \frac{N_2}{N_1} \times \frac{X}{\sqrt{X^2 + R_a^2}}$$

where μ = amplification factor of valve,

N_2 = number of secondary turns,

N_1 = number of primary turns,

X = reactance of primary = $2\pi fL$,

R_a = internal resistance of valve (see Technical Dictionary, p. 444).

(b) The grid bias voltage required for a valve used as a low-frequency amplifier is given approximately by:—

$$\frac{\text{Value of high-tension voltage.}}{2 \times \text{magnification factor of valve}}$$

25. MECHANICAL FORMULÆ

(a) Work = Force \times Distance.

(b) Momentum = Mass \times Velocity.

(c) Force = Mass \times Acceleration,

$$\text{i.e. } P = \frac{ma}{g}$$

where P = force in lbs.,

m = mass in lbs.,

a = acceleration in feet per second per second,

g = acceleration of a freely falling body,

= 32.2 feet per second per second.

(d) Kinetic energy of a body, mass m lbs. and velocity v feet per second,

$$= \frac{1}{2}mv^2 \text{ foot poundals,}$$

$$= \frac{mv^2}{2g} \text{ foot-lbs.}$$

(e) Time of complete oscillation of a simple pendulum,

$$= 2\pi\sqrt{\frac{l}{g}} \text{ seconds,}$$

where l = length of pendulum in feet,

g = acceleration of a freely falling body,

= 32.2 feet per second per second.

(f) Absolute temperature is 273 degrees below zero on the Centigrade scale.

TRIOTRON

The Valve that gets more stations

STAL H.T. ELIMINATOR KIT

The Stal Kit enables anybody to build a complete and efficient H.T. eliminator in less than two hours with only a screwdriver and a pair of pliers. No mess. No trouble. No possibility of error. Ask for leaflet. Obtainable of all dealers.

THE valves are the "heart" of your receiver, and unless they are "active," *i.e.*, pulsating with electronic activity, the best receiver will fail to give you complete satisfaction.

The Triotron Super Detector S.D.2 is such a valve—**THROBBING—THROBBING** with ceaseless activity—**SEARCHING—SEARCHING—SEARCHING**—Vienna—Paris—Berlin—New York—Budapest—bringing the world to your fireside.

No other factory has been able to produce a valve which gives so high a degree of efficiency for so small a current consumption.

Characteristics of Super Detector Valve S.D.2:

Slope 2.0 mA/V. Magnification Factor 21. L.T. Current Consumption 0.14.

ASK your dealer for Triotron Valves. Do not accept other valves advertised as "Just as good"—insist on Triotron.

A FREE SERVICE

We invite you to send us particulars of your set, and our technical experts will advise you, free of charge, of a suitable combination of Triotron valves to use with it. You will be astonished at the very marked increase in efficiency and delighted to find your accumulator lasting nearly twice as long.



Announcement of
TRIOTRON RADIO
COMPANY, LTD.,
91, Great Russell St.,
LONDON, W.C.1

TECHNICAL DICTIONARY

"A" BATTERY—An American term for the L.T. battery or *accumulator* used to heat the filaments of *thermionic valves*.

ABSORPTION CONTROL—A method of "controlling" the *high-frequency oscillations* delivered to the *aerial* in a wireless telephone transmitter, so that they vary in amplitude at the *low frequency of modulation*. The value of a *resistance* in the aerial circuit is made to vary in accordance with the low frequencies of the voice, thus modulating the amplitude of the high-frequency oscillations. The resistance usually takes the form of the *anode circuit* of a *three-electrode valve* in shunt, the resistance of the valve being varied by variations of its *grid potential* by means of a *microphone* placed in the circuit. Thus the valve absorbs a greater or less fraction of the power in the aerial circuit. Cf. *Choke Control* and *Grid Control*.

ABSORPTION WAVEMETER—A wavemeter consisting of a low-loss *oscillatory circuit* which is tuned to the transmission to be measured. Resonance is indicated (1) by lighting of a small lamp or the deflection of a galvanometer if used at or near a transmitter, or (2) by the stoppage of oscillations in a weakly oscillating receiver due to absorption by the wavemeter if used for receiver calibration.

A.C.—An abbreviation for *Alternating Current*.

ACCELERATION—The rate of increase of *velocity* of a body, equivalent to the force acting on the body divided by its *mass*.

ACCEPTOR CIRCUIT—A tuned *oscillatory circuit*, having the opposite characteristics of a *reflector circuit*.

ACCUMULATOR—One or more *secondary cells* connected in *series* or in *parallel*. Cf. "A" Battery.

ACOUSTICS—The science of sound.

ACOUSTIC WAVES—Waves of sound. They may be transmitted through a gas (as air), a liquid (as water), or a solid, their speed depending on the density of the medium. Sound waves have a speed of 1090 feet per second in air at a temperature of 0° C. and a pressure of 30 ins. of mercury.

ADJUSTABLE CONDENSER—See *Condenser*.

ADMITTANCE—The admittance of a circuit is the reciprocal of its *impedance* or apparent resistance. It is measured in *mhos*.

AERIAL—A wire or wires supported at a height above the ground and insulated from it except for a connection to earth through the wireless transmitter or receiver. For special types of aerial see under separate headings.

AERIAL CIRCUIT—In a wireless transmitter or receiver, the circuit between aerial and earth through which the high-frequency oscillations pass.

AERIAL IMAGE—It has been shown by T. L. Eckersley that radiation from an aerial situated at ground level can be resolved into radiation due to the aerial itself and radiation from an image of the aerial in the earth.

AERIAL INSULATION—By this is meant the insulation of the aerial from its supports

and thus from earth. The aerial wire itself may be, and generally is, bare.

AERIAL INSULATORS—Pieces of non-conducting material used for fastening the aerial wire to its supports. They are generally made of porcelain or glass.

AERIAL RESISTANCE—By this term is meant the *resistance* of the aerial to *high-frequency currents*. It may be split up into three parts: (1) *Radiation resistance*, (2) *Dielectric loss resistance* and (3) *Ohmic resistance* of the wire itself. Aerial resistance (effective resistance) varies with frequency, and an aerial is most efficient when (1) is large compared with (2) and (3). See *High-frequency Resistance* and *Radiation Resistance*.

AERIAL TUNING CONDENSER, INDUCTANCE OR COIL—A *condenser* or *inductance* (variable or fixed) connected in the aerial circuit of a transmitter or receiver to tune the aerial to a particular frequency.

AIR CONDENSER—A *condenser*, either fixed or variable, having air as a *dielectric*.

AIR LINE—A telephone line, generally of bare copper, supported above ground-level on insulators fixed to wooden or metal poles. Most of the telephone trunk routes in this country are air lines, and these lines are used at present for *Simultaneous Broadcasting*. Cf. *Cable*.

ALTERNATING CURRENT—Abbreviated as A.C.—is a current which flows in alternate directions in a circuit, *i.e.* it starts in one direction from zero, increasing to a maximum, through which it passes, decreasing to zero again, and then increasing in the other direction to a maximum and again decreasing to zero. This complete sequence is called one *cycle*, and the number of complete cycles passed through in one second is called the *frequency* or *periodicity* of the A.C. When two alternating currents pass through zero at the same instant and have their maximum values in the same direction at the same instant, they are said to be "in phase."

An alternating current is measured by its effective or Root Mean Square (R.M.S.) value, which is the value in amperes of the direct current which would produce the same heating effect. For sine waves it is

$\frac{1}{\sqrt{2}}$ or .707 of the maximum or peak value of the A.C.

ALTERNATOR—A generator for producing *alternating currents*.

AMMETER—An instrument for measuring current in "amperes." Abbreviation for "ampere meter." See *Voltmeter*.

AMPERAGE—Means the current in *amperes*.
AMPERE—The practical unit of electric current.

AMPERE-HOUR—The unit of quantity of electricity. An accumulator is rated in ampere-hours, *i.e.*, according to the quantity of electricity it will store.

AMPERE METER—See *Ammeter*.

AMPLIFICATION FACTOR OR AMPLIFICATION CONSTANT—of a *thermionic valve* often designated as "μ" or the "

value, is the maximum *voltage amplification* which the valve can give. It is the ratio of the change of *plate voltage* to change of *grid voltage* necessary to bring about the same change in *plate current*. See *Voltage Amplification*.

AMPLIFIER—An apparatus used to increase the strength of electrical oscillations. In a wireless receiver, amplification may take place before the high-frequency oscillations are rectified by the *detector* valve or crystal, and also after rectification. If before, the amplifier is called a high- or radio-frequency amplifier, and if after, it is called a low- or audio-frequency amplifier. For other types of amplifier see under separate headings.

AMPLITUDE DISTORTION—In electrical apparatus, the variation in response at different amplitudes with an input of constant frequency. Cf. *Frequency Distortion*.

ANODE—The *plate* of a *thermionic valve*. See *Plate*.

ANODE BATTERY—Another name for *high-tension battery*.

ANODE BEND RECTIFICATION—Rectification using the bend (usually the lower one) in the anode current-grid volt characteristic of a *thermionic valve*. Cf. *Grid rectification*.

ANODE CIRCUIT—See *Plate Circuit*.

ANODE CONVERTER—A small rotary electric machine designed to run off an *accumulator* of about 6 to 12 volts, and to give an output voltage suitable for a high-tension supply to a *thermionic valve*.

ANODE CURRENT—See *Plate Current*.

ANTENNA—See *Aerial*.

ANTINODE—In any alternating-current circuit, the point at which the current or voltage value is a maximum. Cf. *Node*.

ARMATURE—The rotating part of an electrical generator or motor.

ARTIFICIAL AERIAL—An arrangement of *resistance*, *inductance* and *capacity* connected together to take the place of a radiating *aerial* in the testing of wireless apparatus.

ARTIFICIAL LINE—An arrangement of *resistance*, *inductance* and *capacity* connected together to represent an actual line for use in telephone circuits.

ASTATIC COIL—An *inductance* so wound that its external field is limited.

ATMOSPHERICS—Electro-magnetic *waves* set up by flashes of lightning or other electrical disturbances in the atmosphere affect wireless receivers by producing irregular "grinding" or "grating" in the telephones or loud speaker. Also called X's, strays or static.

ATTENUATION CONSTANT—A constant determining the relationship between the *current* sent out along a given uniform length of line and the *current* received. Its value depends upon the ohmic *resistance*, *insulation resistance*, *capacity* and *inductance* of the line.

The formula connecting current sent out and current received is:

$$C_p = C_r e^{-\beta l}$$

where C_p = current received,

C_r = current sent,

e = 2.7183 (base of Napierian logs),

l = length of loop,

β = attenuation constant.

ATTENUATION FACTOR—A factor indicating the rate of reduction in amplitude of an *ether wave* as the distance from the point of origin increases. For *wave-lengths* within the broadcasting band, the *field strength* E_x at a point distant x from the transmitter is

proportional to $\frac{1}{x}(S)$, where S is a multiplier

of value always less than unity, which takes into account the attenuation due to the effect of the earth's finite conductivity. According to Sommerfeld, S is proportional to:—

$$\frac{\pi x}{\lambda} \left\{ \frac{1}{2\sigma\lambda c} \right\}$$

where λ = wave-length of the emitted ray
 σ = earth conductivity,
 c = velocity of light.

For pastoral country, σ has a value of 10^{-13} c.g.s. units, while for sea water, $\sigma = 10^{-11}$ c.g.s. units.

ATTENUATOR—An arrangement of calibrated *resistances* to introduce *loss* into a circuit. See *Transmission unit*.

AUDIO-FREQUENCY TRANSFORMER—A transformer which is used in an audio-frequency *amplifier*. It may be an input transformer (as from a telephone line), an intervalve transformer, or an output transformer (as to a loud speaker). It should be capable of dealing with all frequencies between 30 and 10,000 cycles per second so that none is favoured more than another, if it is used in a broadcasting receiver. It consists essentially of two separate windings on an iron core. See *Transformer*.

AUDION—Dr. Lee de Forest's first three-electrode *thermionic valve*. The term is still used in the U.S.A. and in Germany.

AUTODYNE—A *thermionic valve* incorporated in a circuit so that it generates oscillations due to grid and plate windings forming an *auto-transformer*.

AUTO-TRANSFORMER—A *transformer* either for radio or audio frequency in which the primary and secondary windings are formed by one and the same coil having three connections to it.

"B" BATTERY—An American term for a high-tension battery used to supply the *plate current* to a *thermionic valve*.

BACK E.M.F.—An *electromotive force* or *voltage* which acts in opposition to the flow of current in an electrical circuit.

BAFFLE—A screen of non-resonant material, generally wood, largely used in conjunction with cone-type loud speakers instead of a horn, to ensure the radiation of the very low audible frequencies. Also used in certain cases to alter the acoustics of broadcasting studios.

BALANCED ARMATURE—A type of movement frequently employed in *loud speakers* and *relays*, and consisting of a piece of soft iron (the armature) magnetically and mechanically balanced between the poles of a *permanent magnet*. *Alternating currents* passing through the operating winding upset this balance, causing the

armature and the diaphragm or cone to which it may be attached to move.

BALLAST TUBE—An American term for *Barretter*.

BAND-PASS FILTER—A filter circuit which is so designed that it will only pass a particular band of frequencies. See *Filter*.

BARRETTTER—An instrument for keeping constant the flow of current in a circuit irrespective of any change in voltage (within limits) across the circuit.

BASKET COIL—A coil generally used as an inductance in a wireless receiver formed by winding wire round an odd number of pins projecting radially from a central boss. Such a coil has the appearance of certain forms of basket work.

BEAM WIRELESS—A particular system of wireless transmission in which the waves are concentrated on the receiver in the form of a beam. An electrical reflector is used, and as this must be of large mechanical dimensions in comparison with the wave-length, beam transmission is in practice confined to short wave-lengths.

BEAT RECEPTION—A method of receiving continuous waves in which use is made of the Beat principle. It should be noted that the beats themselves are inaudible and must be rectified to produce combination tones which will be heard, and which are usually referred to as the beat frequency. See *Heterodyne Reception*.

BEATS—If two oscillations or alternating currents of different frequencies are superimposed, a further set of oscillations will be produced. This set will have a changing amplitude and the frequency of the amplitude change will be equal to the difference in the two original frequencies. If the two original frequencies are near together, then the difference between the two will be small, and in this case the beats due to the change of amplitude will be of low frequency.

BEL—Ten Transmission Units. Cf. *Neper*.

BEVERAGE AERIAL—An aerial whose length is several times the wave-length to be received, its height being only a few feet from the ground. It may be either connected to earth or left insulated at the free end. It has marked directional properties and gives a relatively large ratio of signal to atmospherics.

BINDING POST—An American term for a terminal.

BLASTING—Used in the electrical sense to indicate distortion, although originally brought into use from the sound produced in the loud speaker on particularly loud signals when such distortion was occurring. In the general case blasting is produced in a valve by overloading it so that it does not work without *arid current*.

BLOCKING CONDENSER—A fixed-capacity condenser of any suitable value connected in a circuit to stop direct current flowing, but to be conductive to A.C. of the desired frequencies.

BORNITE—Used as a crystal detector in conjunction with *zincite*. Bornite is a chemical compound of iron, sulphur and copper.

B.O.T. UNIT—or B.T.U. Board of Trade unit of electrical energy. Equal to one kilowatt-hour. See *Watt-hour*.

BRIDGE—An electrical circuit for the measurement of various electrical quantities. See *Wheatstone Bridge*.

BRIGHT EMITTER—A thermionic valve in which the filament gives its normal emission only when heated to a high temperature so that it glows brightly.

B.Th.U.—The British thermal unit. The quantity of heat required to raise the temperature of 1 lb. of water 1 degree F. Numerically equal to 778 foot-pounds. Cf. *Calorie*.

BUZZER—A piece of apparatus so called because it produces a buzzing sound, due to an armature vibrating.

BUZZER WAVEMETER—A wavemeter in which a buzzer is used to energise a calibrated resonant circuit for use as a low-power transmitter for the calibration of receivers.

BY-PASS CONDENSER—A fixed-capacity condenser of suitable value connected across an electrical circuit or part of it so that certain desired frequencies will pass through it in preference to passing through the part of the circuit across which it is connected.

"C" BATTERY—Term used in America to denote the *grid-bias* battery.

CABLE—A telephone line or lines laid either direct in the ground or in earthenware ducts. The use of cables for trunk routes is rapidly increasing, owing to their greater immunity from interruption during bad weather. Where suitable routes are available, these circuits are used for *Simultaneous Broadcasting*.

CALORIE—The quantity of heat required to raise the temperature of one gramme of water 1 degree C. 252 calories are equivalent to 1 B.Th.U.

CAPACITY—(of an accumulator or storage battery) is measured in *ampere-hours*, and indicates the number of *ampere-hours* the cell will give when fully charged. This quantity will depend on the discharge rate. In stating the capacity of a cell the manufacturers will also state the discharge rate. The capacity of an accumulator is sometimes stated on an ignition rate this is double the actual capacity.

CAPACITY—(of a condenser or isolated body) is a measure of the charge (or quantity of electricity) it is capable of storing. If it holds a charge of one coulomb and the difference of potential between its plates is one volt, then the condenser is said to have a capacity of one farad. This is too large a unit for practical purposes. Therefore, the microfarad is more generally used, and is equal to one millionth of a farad.

CAPACITY COUPLING—Indicates that the coupling between two circuits is formed by a condenser. See *Coupling*.

CARBON MICROPHONE—See *Solid-back Microphone* and *Reiss Microphone*.

CARRIER CURRENT TELEPHONY OR TELEGRAPHY—See *Wired Wireless*.

CARRIER WAVE—The high-frequency oscillations emitted by a wireless telephone transmitter. These are modulated during telephony. The analogy is that the telephony (music, speech, etc.) is "carried"

- by the high-frequency *oscillations* from the transmitter to the receiver.
- CASCADE**—Pieces of electrical apparatus are said to be connected in cascade when the output of the first is connected to the input of the second, the output of the second to the input of the third, and so on.
- CATHODE**—See *Kathode*.
- CAT'S-WHISKER**—A fine wire used to make contact with a particular point of a *crystal* in a *crystal detector*.
- CELL**—See *Secondary Cell* and *Primary Cell*.
- CHARACTERISTIC CURVE**—See *Static Characteristic* and *Dynamic Characteristic*.
- CHARGE**—See *Capacity*.
- CHECK RECEIVER**—A wireless receiver installed in the *control room* of a broadcasting station to enable a constant check to be kept on the quality of the transmission.
- CHOKE**—A coil of wire which, although it may be of small D.C. *resistance*, will offer a high *impedance* to A.C., the *impedance* offered depending on the *frequency* of the A.C. If the choke is for use with A.C. of low frequency it will generally be wound on an iron core, whereas for use with high-frequency A.C. it will have an air core, *i.e.*, be wound on a former of non-magnetic material.
- CHOKE CAPACITY COUPLING**—A method of coupling *thermionic valves* together in *cascade* in a high- or low-frequency *amplifier*. A *choke* is placed in circuit with the plate of the valve and the signal E.M.F. produces a varying *potential* at the *plate* end of this choke, and this is applied through a *grid condenser* to the *grid* of the next valve. This condenser is necessary to prevent the high-tension potential from affecting the second grid. In order that the negative charge on this grid may gradually leak away, a *grid leak* resistance is connected between the grid and filament of the valve. See *Resistance Capacity Coupling*.
- CHOKE CONTROL**—A method of "controlling" the high-frequency *oscillations* delivered to the aerial in a wireless telephone transmitter, so that they vary in amplitude at the low frequency of modulation. A large iron-core choke is used in the common H.T. circuit to the modulator and oscillator valves. If the modulated output from the oscillator valves is delivered direct to the aerial, the modulation is said to be at high power. If the modulated output is passed through one or more magnifying stages before being delivered to the aerial, the modulation is said to be at low power. See *Modulation*. Cf. *Grid Control* and *Absorption Control*.
- CLOSED-CORE TRANSFORMER**—A transformer in which the iron core forms a continuous magnetic circuit, *i.e.*, it has no air gap. Cf. *Open-core Transformer*.
- COEFFICIENT OF COUPLING**—A percentage indicating the tightness or otherwise of the coupling between two circuits. See *Tight Coupling* and *Loose Coupling*. See *Technical Tables*, p. 430.
- COHERER**—A *detector* used in early wireless experiments. It worked by virtue of the property of metal filings, which were only in imperfect contact, of cohering and forming a relatively good contact under the influence of *Hertzian Waves*.
- CONDENSER**—The simplest form of condenser consists of two metal plates separated by an insulator, which is called the *dielectric*. It has *capacity* and will store electrical energy.
- CONDENSER MICROPHONE**—A *microphone* consisting of two plates of a *condenser*, whose distance apart is altered by the sound waves impinging upon one of them. The consequent variations in *capacity* are made to affect an external circuit where they can be amplified to any desired extent.
- CONDUCTOR**—A substance which offers a comparatively low resistance to the passage of electric currents through it.
- CONTINUOUS CURRENT**—Another term for *direct current*.
- CONTINUOUS OSCILLATIONS OR WAVES**—Undamped *oscillations* or *waves*, *i.e.*, the amplitude of successive cycles remains constant and does not diminish. Abbreviated as C.W. Cf. *Damped Oscillations*.
- CONTINUOUS WAVE TRANSMISSION**—The method of radiating into space electric waves by means of a transmitter generating *continuous waves*.
- CONTROL ROOM**—The "Nerve-centre" of a broadcasting station. In this room are situated the low-frequency amplifiers and associated apparatus by which the microphone currents are controlled, before they are passed on to the *modulation system* of the transmitter.
- CONTROL SYSTEM**—Of a wireless telephone transmitter is that part of the transmitter which modulates the high-frequency *oscillations*. See *Choke Control* and *Modulator System*.
- CORRECTOR CIRCUIT**—An arrangement of *inductances*, *capacities* and *resistances* which is placed in a long telephone line circuit to counterbalance any effect the line may have on the speech currents passing along it, owing to the attenuation not being constant at all frequencies. See *Repeater Station*.
- COULOMB**—Quantity of electricity given by one *ampere* flowing for one second. One *ampere-hour* = 3,600 coulombs.
- COUNTERPOISE**—An arrangement used in some wireless transmitters instead of an "earth" connection, consisting of a system of wires supported on short *masts* underneath an *aerial* and insulated from earth.
- COUPLED CIRCUIT**—In a receiving set, the aerial circuit may be coupled inductively or capacitatively instead of connected directly as an effective method of obtaining greater selectivity. See *Coupling*, *Inductive Coupling*, *Direct Coupling*.
- COUPLING**—Two electrical circuits are said to be coupled when a change of *current* in one circuit produces an E.M.F. across the second circuit. See *Technical Tables*, p. 430.
- CROSS-TALK**—A term used to denote *induction* between low-frequency circuits.
- CRYSTAL**—See *Natural Crystal*.
- CRYSTAL CONTROL**—See *Quartz Crystal*.
- CRYSTAL DETECTOR**—A form of *rectifier* of *alternating currents* which works by virtue of the contact between certain dissimilar *crystals* or between one crystal and a metal, allowing *current* to pass in only one direction.

CUMULATIVE GRID RECTIFICATION—See *Grid Rectification*.

CURRENT—The flow of electricity along a wire or other conductor from a point of high potential to a point of low potential. The unit of current is the ampere. Mechanical analogy is gallons of water per minute flowing through a pipe.

CUT OFF—The limits of frequency below or above which a cable, air line, amplifier, microphone, loud speaker, etc., ceases to transmit or reproduce.

C.W.—Abbreviation for *Continuous Waves*.

CYCLE—See *Alternating Current*. One cycle per second is sometimes referred to as one Hertz.

DAMPED OSCILLATIONS OR WAVES—Oscillations or waves in which the amplitude of each successive oscillation or wave is smaller than that of the previous one. The amount by which each wave is smaller than the preceding wave depends upon the logarithmic decrement of the circuit. Cf. *Continuous Waves*.

DAMPING—The rate at which a train of oscillations dies away.

D.C.—Abbreviation for *Direct Current*.

D.C.C.—Double cotton covered (insulation of wire).

DEAD LOSS RESISTANCE—That part of the resistance of an aerial which does no useful work. See *Aerial Resistance*.

DECIBEL—One transmission unit, one-tenth of a bel.

DECI-NEPER—One-tenth of a neper.

DETECTOR—In a wireless receiver is a device for rectifying the high-frequency oscillations. See *Rectification*.

DETECTOR VALVE—A thermionic valve used as a detector or rectifier. See *Anode Bend Rectification, Grid Rectification and Rectification*.

DIELECTRIC—A substance whose resistance to the passage of electrical currents is extremely high. The insulator separating the plates of a condenser.

DIELECTRIC LOSS—Loss of electrical energy due to the passage of current through a dielectric when a potential difference is applied across it. The loss decreases with increase of frequency. Cf. *Eddy Currents*.

DIODE—A thermionic valve having only two electrodes, i.e., a cathode (filament) and an anode (plate). The original Fleming valve was a diode.

DIRECT COUPLING—See *Auto-transformer*.

DIRECT CURRENT—Abbreviated as D.C., and sometimes referred to as continuous current. A current which flows in one direction only. Cf. *Alternating Current*.

DIRECT RAY—In wireless transmission, the ray emitted parallel to the earth's surface.

DIRECTIONAL AERIAL—An aerial which will send out wireless waves in, or receive them from, one direction to a greater degree than other directions.

DIRECTION FINDER—A wireless receiver in which the directional properties of one or other forms of aerial are made use of to find the direction from which wireless signals are arriving.

DIS—Disconnection.

DISTORTION—A term used in telephony to

indicate any deviation from the original wave form of the speech or music which may be brought about during any of the various changes which take place between the microphone and loud speaker or telephones.

DOWN LEAD—The wire which "leads down" from the elevated part of an aerial to the transmitting or receiving apparatus.

DRAPING—Material hung in a studio to decrease the reverberation and echo.

DRIVE CIRCUIT—An oscillatory circuit tuned to the same frequency as the main oscillatory circuit of a transmitter and coupled to it in such a manner that the latter is forced to generate oscillations of exactly the same frequency, thus preventing any slight wave change due to keying or heavy modulation.

DRY CELL—A primary cell in which the liquid electrolyte is replaced by a paste.

DULL EMITTER—A thermionic valve in which the filament gives its normal emission at a relatively low temperature, thus using only a little current and lighting up only to a dull red.

DUPLEX-TELEPHONY—A system of point-to-point speech transmission in which messages can be sent and received simultaneously, thus allowing normal conversation between two points.

D.W.S.—Abbreviation for "Double Wound Silk" (the insulated covering of a wire).

DYNAMIC CHARACTERISTIC—Curves, generally of a thermionic valve, showing the performance under working conditions when the values of plate and grid voltages, etc., may be varying simultaneously.

DYNAMIC LOUD SPEAKER—See *Moving Coil Loud Speaker*.

DYNAMO—A rotary machine which generates direct-current electricity.

DYNE—The C.G.S. (centimetre-gramme-second) unit of force. One dyne will produce an acceleration of one cm. per second per second in a mass of 1 gramme.

$$1 \text{ dyne} = \frac{1}{981} \text{ gramme (approx.)}$$

EARTH CONDUCTIVITY—See *Attenuation Factor*.

EARTH POTENTIAL—The electrical potential of the earth is said to be zero and therefore connections made to the earth at various places will be at the same potential. It should be noted that if a large current is flowing through a lead connecting a wireless transmitter or receiver to earth, the potential of the earth terminal of the apparatus will only approach zero if the resistance of the earth lead and connection is very low.

EARTH SCREEN—See *Counterpoise*.

EBONITE—A hard, black substance consisting of rubber treated with sulphur at high temperature. It is easily polished and has high insulating properties.

ECHO—The recurrence of a sound after an interval of time due to the original sound being reflected from a surface, e.g., a bare wall. Cf. *Reverberation*.

ECHO ROOM—A room designed to produce echo or reverberation. In the broadcasting of certain musical items from a studio, an

artificial echo is superimposed to obtain a more pleasing effect.

EDDY CURRENTS—If a piece of metal is placed in a varying *magnetic field*, currents will be induced in the metal. These are called "eddy currents." The higher the *frequency* of variation of the field, the larger will be the eddy currents. The metal will become heated by these currents, and thus energy will be dissipated. This energy loss is known as eddy current loss. Cf. *Dielectric loss*.

EFFECTIVE HEIGHT—A value less than the actual height of an aerial and dependent upon its shape, situation, etc., which is used in the calculation of its *radiation efficiency*. Effective height can be calculated theoretically (for a *quarter-wave-length aerial* its value is $2/\pi \times$ actual height), but is better obtained by practical measurements applied to the formula:—

$$h = \frac{E\lambda d}{877 I}$$

where E = field strength at a distance d from the aerial, before attenuation due to earth sets in,

λ = wave-length,

I = maximum current in the aerial.

EFFECTS STUDIO—A *studio* in which the noise effects incidental to a transmission are made. See *Mixing Unit*.

ELECTRIC FIELD—If a body becomes electrified, certain effects will be observable in its vicinity, such as the attraction or repulsion of other electrified bodies. The space in which these effects can be observed is said to be in the electric field of the body. The magnitude of these effects at a given distance is a measure of the strength of the field. Sometimes called Electrostatic Field.

ELECTRODE—A component part of a *vacuum valve*, or of a primary or secondary *battery*.

ELECTROLYTE—The liquid (generally dilute sulphuric acid) in a *secondary cell*.

ELECTROLYTIC CONDENSER—A type of condenser of relatively large capacity in small bulk suitable only for low-voltage circuits. The principles underlying its operation are quite different from those of the usual type. The condenser is a form of polarisation cell having, in general, aluminium electrodes and ammonium phosphate electrolyte. On applying a potential to the terminals of the condenser, a momentary current passes, liberating hydrogen, which forms an insulating coating over the negative aluminium electrode, thus rapidly stopping the flow of current. The capacity of the arrangement is proportional to the quantity of electricity which passes to liberate sufficient hydrogen to polarise the cell, and thus in turn to the electrochemical equivalent of hydrogen. The order of these quantities is such that it is possible to obtain a capacity-bulk ratio of about one thousand times that obtainable with an ordinary air dielectric condenser. When the steady potential is removed, the hydrogen is re-absorbed. The maximum voltage for which these condensers are at present made is about 100 volts. For higher voltages a series arrangement of units is necessary.

ELECTRO-MAGNET—Soft iron becomes a magnet only in the presence of a *magnetic field*. If this field is provided by a current passing through a coil of wire wound round the soft iron, the latter is said to be an electro-magnet.

ELECTRO-MAGNETIC WAVES—See *Waves*.

ELECTROMOTIVE FORCE—(Abbreviated as E.M.F.) is electrical pressure or *voltage*. As, in the mechanical analogy, water is forced through a pipe by the "head" of water overcoming the resistance of friction in the pipe, so electrically the current is forced through the circuit by the E.M.F. overcoming the *resistance* of the wire.

ELECTRON—Thought to be the smallest particle of a substance which can exist as an entity. It is negatively charged electrically. See *Negative Charge*.

ELIMINATOR—An apparatus for providing high-tension, low-tension or grid-bias potential for a receiving set from the electric supply mains, thus eliminating the use of batteries.

E.M.F.—Abbreviation for Electromotive Force.

EMISSION—The stream of *electrons* which is given off from the *filament* of a *thermionic valve*.

ENERGY—The ability of a body to do *work* by virtue of its position or motion. The former is called "potential" energy, and the latter "kinetic" energy.

EQUALISER—See *Corrector Circuit*.

ETHER—For wave motion to be transmitted through space there is assumed to be an all-pervading medium through which it is transmitted. Ether is the name given to this assumed medium. See *Waves*.

EXPONENTIAL HORN—A loud speaker or other horn, the diameter of the aperture of which increases along its length in accordance with an exponential law of the type:

$$y = ae^{bx}$$

FADE UNIT OR MIXING UNIT—A *potentiometer* arrangement placed in the input circuit of a microphone amplifier in order that the outputs of several microphones may be connected to the amplifier at will and at any desired strength.

FADING—The variation in strength of a signal received from a distant station assumed to be due to changes in the Heaviside Layer which cause (a) alteration of the angle of *reflection* or refraction of the indirect transmitted ray in an irregular manner, or (b) interference between the direct and the indirect (reflected or refracted) ray. See *Reflection*.

FARAD—The unit of *capacity* of a *condenser*.

FEED BACK—See *Reaction*.

FEEDER—(in *high-frequency* circuits). An *air-line* loop employed to connect two high-frequency circuits remote from each other.

FIELD STRENGTH—The intensity of the *electric* and *magnetic field* due to a wireless transmitter at any point is called its field strength, which may be measured in millivolts induced in an *aerial* having an effective height of one metre, *i.e.*, field strength may be expressed in millivolts per metre.

FIELD WINDING—A coil usually wound on a laminated iron core to produce a strong

- electro-magnetic field when current is passed through the winding.
- FILAMENT**—In a *thermionic valve* the filament is a fine wire which is heated by the passage of electric current. Generally this filament itself emits *electrons*, but in some valves it heats a cylinder which surrounds it closely, and the latter gives the *emission*.
- FILAMENT RESISTANCE**—A *resistance* included in the filament-heating battery circuit to limit the *voltage* across the *filament* to the correct value.
- FILTER**—An electrical filter is a circuit composed of *inductances* and *condensers* which will pass or prevent from passing certain frequencies. See also *Band-pass*, *High-pass* and *Low-pass Filters*.
- FLAT TUNING**—A circuit is said to be flatly tuned if a large change in its resonant frequency (produced by changing its *inductance* or *capacity*) is accompanied by only a small change in the amplitude of the oscillatory current flowing in the circuit, the frequency of the applied *voltage* remaining constant. Cf. *Resonance*.
- FLEMING VALVE**—See *Diode*.
- FLUX DENSITY**—Is a measure of the strength of a *magnetic* or an *electric field*, and is stated as the number of lines of magnetic or electrostatic force per unit area of cross section of the field. Cf. *Permeability*.
- FOUR-ELECTRODE VALVE**—A *thermionic valve* having a *kathode* (filament), two *grids* and an *anode*. Sometimes called a *tetrode*. In the original four-electrode valve both grids were control grids. This valve should not be confused with the more modern four-electrode *screen-grid valve*. Cf. *Diode* and *Triode*.
- FOUR-WIRE REPEATER**—See *Repeater*.
- FRAME AERIAL**—An aerial, generally used for wireless reception, consisting of a number of turns of wire supported on a wooden frame of convenient shape. It has marked directional properties and is used on certain types of *direction finders*. See *Loop Aerial*.
- FREQUENCY**—The frequency of an alternating current is the number of complete cycles it passes through in one second. See *Alternating Current*. Frequencies are sometimes stated in Hertz, where one Hertz = one cycle per second.
- FREQUENCY: AUDIO-, HIGH-, RADIO-, SUPERSONIC**—See under appropriate letters.
- FREQUENCY CHARACTERISTIC**—See *Response Characteristic*.
- FREQUENCY DISTORTION**—In electrical apparatus, the variation in response at different frequencies with a constant input amplitude. See *Response Characteristic* and cf. *Amplitude Distortion*.
- FREQUENCY DOUBLER**—An apparatus for doubling the frequency of an alternating current. See *Harmonic Amplifier*.
- FREQUENCY METER**—For the measurement of high frequencies see *Wavemeter*. For the measurement of the frequency of an electric power supply, the instrument consists of a number of metal reeds mechanically tuned to frequencies within the range to be measured. When connected in the circuit, the reeds having natural frequencies nearest to that of the supply, will vibrate.
- FREQUENCY MODULATION**—A method of *modulation* in wireless telephony transmission which involves the shifting of the *carrier wave* frequency between defined limits at the rate of the modulation frequency. In other forms of *modulation* it is difficult entirely to eliminate slight frequency modulation. This produces distortion, because effectively the *carrier wave* is not constant in frequency.
- FULL-WAVE RECTIFICATION**—A system of *rectification* in which both half *cycles* of an *alternating current* are utilised.
- FUSE**—Usually in the form of a piece of wire included in an electric circuit as a protective device. On the current passing a certain value this piece of wire melts, thus breaking the circuit.
- GAIN**—The measure of the performance of a thermionic *repeater* generally stated as the number of miles of *standard cable* or the number of *transmission units* to which the amplification of the *repeater* is equivalent. See *Repeater*.
- GALENA**—A sulphide of lead used as a crystal detector in conjunction with a fine metal wire, called a *cat's-whisker*, or a piece of graphite.
- GALVANOMETER**—A sensitive electrical measuring instrument.
- GANGED CONTROL**—A mechanical arrangement whereby the several high-frequency circuits in a receiving set may be tuned by one handle.
- GENERATOR**—A machine for converting mechanical energy into electrical energy. It may be either a *dynamo* or an *alternator*.
- GRAMOPHONE ATTACHMENT**—A device for converting directly the mechanical vibrations, given by a record to a gramophone needle, into electrical currents, which can be amplified and caused to work a loud speaker or to modulate a wireless telephone transmitter. For broadcast transmission of gramophone records this obviates the use of a gramophone soundbox and a microphone, with a consequent reduction in possibilities of *distortion*.
- GROUND RAY**—See *Direct Ray*.
- GRID**—The electrode in a *thermionic valve* which controls the stream of *electrons* emitted by the filament. Mechanically it may have many forms, the normal being a spiral of wire. Additional grids for screening the control grid or the anode are employed in *tetrode* and *pentode* valves.
- GRID BIAS**—The *voltage* applied to the *grid* of a thermionic *triode* to determine its *potential* with respect to the *filament*. To ensure that a *triode* shall work on the straight portion of its *static characteristic* a negative bias must be applied, the voltage being dependent on the characteristics of the valve.
- GRID CIRCUIT**—The circuit connected between the control *grid* and *filament* of a thermionic *valve*.
- GRID CONDENSER**—A condenser, usually fixed in capacity, connected directly to the grid of a valve so that it is between the grid and the rest of the grid circuit. Cf. *Resistance-capacity Coupling*.
- GRID CONTROL**—A method of "controlling" the *high-frequency* oscillations

delivered to the aerial in a wireless telephone transmitter, so that they vary in amplitude at the *low frequency of modulation*. The low-frequency E.M.F.'s, due to speech, are introduced into the *grid circuit* of the oscillator valve, thus varying the grid potential relatively to its normal potential, and superimposing the low frequency of modulation on the aerial current. Cf. *Choke Control and Absorption Control*.

GRID CURRENT—If the *grid* of a *triode* becomes positively charged with respect to the filament, some of the *electrons* leaving the filament will not pass the *grid* on their way to the *anode*, but will return through the grid circuit to the filament, thus producing grid current. Cf. *Grid Rectification*.

GRID LEAK—A high resistance connected either directly across a *grid condenser* or else from the *grid* to the *filament* of a *triode* in order to maintain the mean potential of the grid at any desired predetermined value, providing a path for any charge, which may accumulate on the grid, to leak away.

GRID RECTIFICATION—Sometimes called cumulative grid rectification. For this system of grid rectification *grid current* must be allowed to flow in the *triode*, and use is made of the curvature of the grid volt-grid current characteristic. During an incoming high-frequency oscillation, the grid of the valve receives a negative charge through a grid condenser, and this reduces the value of the anode current. The presence of a *grid leak* allows this *negative charge* to leak away, thus ensuring that the mean *potential* of the *grid* shall not become so negative as to stop the *grid current* flowing. See *Rectification*.

GROUND—An American term for "earth."

HAGUE POWER RATING—The international definition of power rating of wireless transmitters. It is defined as the power supplied to the aerial under conditions of maximum modulation of which the transmitter is capable without appreciable distortion. If this is represented by P_m , while P is the mean high-frequency power delivered to the aerial system for the carrier condition, then the relation between them and the percentage modulation k is given by:

$$P_m = P \left(1 + \frac{k^2}{2} \right).$$

HALF WAVE-LENGTH AERIAL—An aerial having an equivalent vertical height equal to one half of the wave-length in use. Cf. *quarter wave-length aerial*.

HALF-WAVE RECTIFICATION—A system of *rectification* in which only one half cycle of the alternating current is made use of. Cf. *Full-wave Rectification*.

HARD VALVE—A *thermionic valve* from which all the gas has been exhausted, particular care being taken that no gas is left even in the surface of metal parts in the valve. Cf. *Soft Valve*.

HARMONICS—*Frequencies* which are multiples of another frequency or wavelengths which are sub-multiples of another wave-length are called harmonics of the original

frequency or wavelength; thus a frequency of 50 cycles per second (or Hertz) may have harmonics at frequencies of 100, 150, 200, etc. cycles, being twice, three times and four times the original frequency. Similarly a wavelength of 300 metres may have harmonics which will be at wavelengths of 150, 100, 75 etc. metres. In each case they are called the second, third and fourth harmonic respectively. The first harmonic is not usually referred to as it is the fundamental frequency or wavelength under consideration.

HARMONIC AMPLIFIER—An apparatus for distorting the *wave form* of an *alternating current* to produce *harmonics* from which one is selected by suitable *filter circuits* and amplified. This process can be repeated any number of times within limits, if further multiplication of frequency is desired. A Frequency Doubler is an Harmonic Amplifier which selects the second harmonic. Where constancy is essential, the original frequency is usually determined by a *tuning-fork* or *quartz crystal*.

HEAVISIDE LAYER—An upper layer of the atmosphere which is thought to exist and to vary in height from 60 to 150 miles above the earth's surface, and to become ionised by the sun's rays. Was originally postulated by Oliver Heaviside and Kenelly, and has since been held to account for *fading* of wireless signals and the transmission of short-wave wireless signals round the curvature of the earth. See *Reflection*.

HENRY—The unit of *inductance*.

HERTZ—A term sometimes used to designate frequency, meaning one cycle per second. Cf. *Kilohertz*.

HERTZIAN WAVES—Electromagnetic *waves* by which all wireless signalling is accomplished. They were called after Hertz, who first succeeded in producing them in 1888, but they were postulated by Clerk Maxwell, who gave mathematical proof of their existence in 1864.

HETERODYNE INTERFERENCE—Interference caused to broadcast reception by the *carrier wave* of an unwanted station beating with that of the wanted station, and giving an audible beat note in the receiver due to the two stations being on *wave-lengths* or *frequencies* separated by too small an amount. It should be noted that two nearly equal and relatively low-powered stations as far apart as 1000 miles can produce an audible beat note even at a few miles from either.

HETERODYNE RECEPTION—A method of receiving C.W. wireless signals in which use is made of a local *oscillator* to "beat" with or "Heterodyne" the incoming C.W. See *Beat Reception*.

HETERODYNE WAVEMETER—A wavermeter using the heterodyne principle by generating oscillations of a known frequency which may be tuned to the oscillations whose frequency is to be measured. When the "beat" note is zero the two sets of oscillations have the same *frequency*.

H.F.—Abbreviation for *High Frequency*.

HIGH FREQUENCY—There is no definite

dividing line between high- and low-frequency oscillations; but oscillations or alternating currents of frequencies up to about 12,000 are generally considered as low—or audio—frequencies, while those above this are spoken of as *Supersonic*, High or *Radio frequencies*.

HIGH-FREQUENCY AMPLIFIER—An amplifier which amplifies high or radio frequencies, e.g., the incoming wireless signals before they are rectified. See *Amplifier*.

HIGH-FREQUENCY CHOKE—A choke which offers considerable impedance to high-frequency currents. See *Choke*.

HIGH-FREQUENCY RESISTANCE—The resistance offered by a conductor or circuit to the passage of high-frequency current through it. This value is greater than the ohmic resistance offered to direct currents, since it includes also the effective resistance due to eddy currents and dielectric losses. See *Aerial Resistance*.

HIGH-FREQUENCY TRANSFORMER—A transformer for coupling together high-frequency circuits, e.g., an intervalve transformer in a high-frequency amplifier. See *Transformer*.

HIGH-PASS FILTER—A filter circuit which is so designed that it will pass all frequencies above a certain value. See *Filter*.

HIGH-POWER MODULATION—See *Choke Control*.

HIGH TENSION—The voltage applied to the anode or plate of a thermionic valve. Cf. *Low Tension*.

HIGH-TENSION BATTERY—A battery of dry cells or accumulators used to give the high-tension voltage for a triode.

HONEYCOMB COIL—A coil for use as a high-frequency inductance wound so as to reduce its self capacity, and so named from its resemblance to a honeycomb in appearance.

HORSE POWER—The unit of mechanical power, equal to 33,000 foot-pounds per minute.

HOT-WIRE AMMETER—An ammeter for measuring alternating or direct currents. The current to be measured is passed through a wire, which it heats. The wire expands, and the expansion is measured by a pointer moving over a scale. The temperature and therefore the expansion of the wire is proportional to the square of the current. The instrument is calibrated directly in amperes. Cf. *Thermo-ammeter*.

H.T.—Abbreviation for high tension.

HYDROMETER—An instrument for measuring the specific gravity of liquids. Used in particular for finding that of accumulator acid.

HYSTERESIS—If a magnetising force be applied to a piece of iron and increased or decreased, the magnetisation of the iron will lag behind the magnetising force. This effect is known as magnetic hysteresis.

I.C.W.—or Tonic Train. Abbreviation for *Interrupted Continuous Waves*.

IMPEDANCE—The opposition offered to an alternating current by a resistance, inductance or capacity, or a combination of the three. It is expressed in Ohms and is dependent on the frequency of the A.C.

except in the case of a pure resistance. See *Resonance*.

IN PHASE—See *Alternating Currents*.

INDIRECTLY-HEATED CATHODE—(of a thermionic valve). A cathode which is not heated directly by the passage of current through it, but by radiation from a heater placed in close proximity to it. This gives an equal-potential cathode, which improves the performance of the valve, and at the same time allows the heating current to be supplied through a transformer from alternating-current power mains unaccompanied by objectionable hum.

INDIRECT RAY—In wireless transmission, the ray reflected from the Heaviside layer. See *Reflection*.

INDUCED E.M.F.—If a conductor is moved in a magnetic field, or if the magnetic field changes in intensity so that the number of lines of magnetic force cut by the conductor changes (either increased or decreased), then an E.M.F. will be induced across the ends of the conductor, its value depending on the rate of the cutting of lines of force.

INDUCTANCE—A conductor is said to possess inductance if a current flowing through it causes a magnetic field to be set up round it. A straight wire therefore has inductance, but the value will be greatly increased if the conductor is wound in the form of a coil with the turns close together, so that the flux due to one turn will cut not only itself but also the neighbouring turns.

INDUCTION—See *Inductive Coupling*.

INDUCTION MOTOR—A type of motor for use on an alternating current supply which operates by virtue of the rotating field produced by the current in the stator winding inducing an E.M.F. in the conductors in the rotor which accordingly rotates.

INDUCTIVE CAPACITY—See *Specific Inductive Capacity*.

INDUCTIVE COUPLING—Coupling between two circuits by virtue of inductances in the circuits. A changing current in the one winding will cause a varying magnetic flux in it which will cut the other, thus inducing an E.M.F. in the latter. See *Tight Coupling* and *Loose Coupling*.

INDUCTIVE RESISTANCE—A resistance which has inductance and thus has an impedance to alternating currents which is greater than its D.C. resistance.

INERTIA—The property possessed by a body of opposing any change in its state of rest or uniform motion in a straight line.

INSULATION RESISTANCE—The resistance, usually measured in megohms (millions of ohms) between two conductors or circuits which are insulated from each other.

INSULATOR—Any substance which offers an extremely high resistance to the passage of electric current through it, and which is therefore used to separate two circuits electrically from each other, or from earth.

INTER-ELECTRODE CAPACITY—The capacity between the electrodes of a thermionic valve. That between the grid and anode is appreciable in the majority of triodes, and gives a capacity coupling between the grid circuit and the anode circuit, thus causing the valve to generate oscillations if these two circuits are tuned to the same frequency. This capacity may

- be balanced out by suitable arrangements. See *Neurodyne Receiver* and *Screen-grid Valve*.
- INTERFERENCE**—Unwanted signals in a wireless receiver due to any cause, *e.g.*, *atmospherics*, other transmitting stations, etc.
- INTERFERENCE PATTERN**. See *Mush Area*.
- INTERMEDIATE WAVES**—The Hague definition for waves between 50 and 200 metres (frequencies between 6,000 and 1,500 kc/s).
- INTERNAL IMPEDANCE**—Called also the "differential resistance" of a *thermionic valve*. The resistance referred to is that of the anode-filament circuit. It is given by the change of *anode voltage* divided by the change in *anode current*, the grid potential being kept constant. It will vary depending on the position on the *characteristic curve* at which it is measured. In general, it is measured over a small portion of the straight part of the curve. In valve manufacturers' pamphlets the impedance given is usually measured at an anode voltage of 100 and zero grid voltage, at which values a valve is seldom used.
- INTERRUPTED C.W.**—Abbreviated as I.C.W. A method of wireless telegraph transmission in which C.W. is used but is interrupted at an *audio frequency* so that it can be received on a wireless receiver without the use of *beat reception*.
- INTERVALVE COUPLING**—The components used to transfer *oscillations* from the *anode circuit* of one valve to the *grid circuit* of the following valve in a multi-stage *cascade amplifier*. It may be designed for radio or audio frequencies, and may be inductive (using a *transformer*), or capacitive (using condensers).
- INTERVALVE TRANSFORMER**—See *Intervalve Coupling, Amplifier and Transformer*.
- INVERTED L AERIAL**—An aerial having a horizontal portion and a vertical down lead at one end.
- IONISATION**—When a gas is split up into minute particles carrying *positive* and *negative charges* of electricity, it is said to be ionised, and these particles are called ions. In such a state the gas becomes a conductor of electricity. Ionisation of a gas can be effected by applying a high *potential* across it.
- JACK**—A device used originally on telephone switchboards to allow connection to be made to a number of circuits by a plug having at least two concentric contacts. At the same time a number of separate contacts may be closed or opened in the jack to allow any desired switching arrangement. See *Plug*.
- JAMMING**—*Interference* with wanted wireless signals due to other wireless transmitters.
- JIGGER**—A *high-frequency transformer* used originally and so named by Marconi to couple the *aerial circuit* of a wireless transmitter to the circuit in which the *oscillations* are produced.
- JUNCTION, THERMO-ELECTRIC OR VACUO**—See *Thermo-couple*.
- KATHODE**—The *electrode* of a *thermionic valve* from which *electrons* are emitted. In general the kathode is the *filament*, and it is heated by the passage of a current through it.
- KATHODE - RAY OSCILLOGRAPH**—An *oscillograph* in which a stream of kathode rays (*electrons*) is made to impinge on a fluorescent screen which glows, at the spot on which they are focussed, under their influence. This kathode stream can be made to move to and fro at any desired frequency under the influence of electrostatic or electromagnetic forces, and the spot lengthens into a line of light on the screen. Two pairs of plates are mounted inside the bulb and are disposed at right angles to each other for connection to the alternating E.M.F. to be examined.
- kc—Abbreviation for kilocycle.
- kc/s—Abbreviation for kilocycles per second.
- KILOCYCLE**—One thousand cycles. Abbreviation kc. A frequency of 1000 kc/s is equivalent to a wave-length of 300 metres.
- KILOHERTZ**—One thousand cycles per second.
- KILOWATT**—The practical unit of electrical power = 1000 watts.
- KILOWATT HOUR**—The practical unit of electrical energy. See *Board of Trade Unit kW.*—Abbreviation for kilowatt.
- LAG**—See *Phase Angle*.
- LAMINATED CORE**—An iron core used in *transformers*, *chokes*, etc. for use in *alternating-current* circuits, laminated or built up of thin sheets of iron, each sheet being insulated on one side by a coating of shellac varnish or other insulating material so that *resistance* will be offered to the passage of *eddy currents*. See *Transformer*.
- LEAD**—See *Phase Angle*.
- LEVEL RAISER**—Another term for a *Repeater*.
- LEYDEN JAR**—The original *condenser* consisting of a glass jar coated inside and out with metal foil. It was invented at the University of Leyden.
- L.F.—Abbreviation for low frequency.
- LIGHTNING ARRESTER**—A spark-gap connected between aerial and earth to provide a low-resistance path to earth while a spark is maintained, thus protecting a receiving set from a lightning discharge.
- LINEAR AMPLIFICATION**—Amplification in which the output *voltages* at all values and *frequencies* are directly proportional to the input *voltages*.
- LINES OF FORCE**—A *magnetic* or *electric field* is said to consist of an infinite number of imaginary lines which are called lines of force, and the electric or magnetic force acts along these lines. The density of these lines, or the number per unit cross-sectional area, is said to be the measure of the strength of the field. See *Flux Density*.
- LOADING COIL**—An inductance connected in series with an *aerial* to increase the *wave-length* to which the aerial can be tuned with its existing *inductance* and *capacity*.
- LOCAL OSCILLATOR**—An *oscillator* arranged to produce *oscillations* "locally" to act as a separate *heterodyne* for heterodyne or *beat reception*.
- LOGARITHMIC DECREMENT**—A number indicating the *damping* of an *oscillatory*

- circuit*. It is dependent upon the *resistance* of the circuit.
- LOGARITHMIC HORN**—A loud speaker or other horn the diameter of the aperture of which increases along its length in accordance with a logarithmic law of the type:
 $y = \log x$.
- LOG-LAW CONDENSER**—A *variable condenser* generally with air dielectric in which the angle of movement of the moving plates relative to the fixed plates, is proportional to the logarithm of the change in capacity. This type of condenser is specially useful for *ganged control* of high-frequency circuits.
- LONG WAVES**—The Hague definition for waves above 3,000 metres (frequencies below 100 kc/s).
- LOOP AERIAL**—An American term for *Frame Aerial*.
- LOOSE COUPLING**—Two inductances are said to be loosely coupled when they are so separated that the mutual *inductance* between them is small in comparison with their self-inductances.
- LOSS**—See *Transmission Unit*.
- LOUD SPEAKER**—A loud-speaking *telephone*. For true reproduction of Broadcasting it is necessary to have a loud speaker capable of reproducing all frequencies from 30 to 10,000 cycles equally well. The original loud-speaking telephone did not do this. Loud speakers are now made in many diverse forms with this end in view. See *Moving Coil Loud Speaker*.
- LOW FREQUENCY**—Frequencies up to about 12,000 cycles per second. Cf. *High Frequency* and see *Audio Frequency*.
- LOW-FREQUENCY AMPLIFIER**—See *Amplifier*.
- LOW-FREQUENCY TRANSFORMER**—See *Audio-frequency Transformer*.
- LOW-PASS FILTER**—A *filter circuit* which is so designed that it will pass all frequencies below a certain value.
- LOW POWER MODULATION**—See *Choke Control*.
- LOW TENSION**—The *voltage* applied to the *filament* of a *thermionic valve* as opposed to the high tension. Cf. *High Tension*.
- LOW-TENSION BATTERY**—The battery used to heat the *filament* of a *thermionic valve*. See "A" Battery.
- L.T.**—Abbreviation for low tension.
- MAGNIFIER VALVE**—The valve(s) in a transmitting set employed for amplifying the modulated or unmodulated continuous oscillations supplied to its grid circuit from the modulated magnifier valve.
- MAINS UNIT**—An apparatus for supplying power to a wireless receiver from the electricity supply mains, either for *high tension*, *low tension*, *grid bias*, or all three. In all types a *filter circuit* for smoothing purposes is incorporated, and for use with alternating current mains some type of *rectifier* is also required.
- MAGNETIC CIRCUIT**—Refers to the path through the air or the iron core of a *transformer*, *choke*, etc., which provides a circuit for the *magnetic flux*. See *Reluctance*.
- MAGNETIC DETECTOR**—A *detector* which makes use of the *hysteresis* in an iron wire for rectifying high-frequency oscillations in a wireless receiver. It was first used by Marconi, and was used for many years, particularly in ship installations, on account of its reliability and robustness. It is, however, comparatively insensitive and now obsolete.
- MAGNETIC FIELD**—See *Electric Field*. (For "electric" read "magnetic.")
- MAGNETIC FLUX**—See *Flux Density*.
- MAGNETIC SCREEN**—A screen of magnetic material such as iron, generally in the form of a box, placed over a piece of apparatus to screen it from the effects of any *magnetic field* in the vicinity.
- MAGNETISATION CURVE**—A curve showing the relation between the *magnetising force* applied to a piece of iron and the resulting *flux density*.
- MAGNETISING FORCE**—The force required to create a certain magnetic field. See *Reluctance* and *Flux Density*.
- MAGNETO-MOTIVE FORCE**—In a *magnetic circuit* the M.M.F. may be compared to the *E.M.F.* in an electric circuit. The M.M.F. forces the magnetic flux through the *magnetic circuit* against the "reluctance" of the iron.
- MAGNETOPHONE**—A form of *microphone* in which the sound waves impinge on a light, flat coil of wire supported in a *magnetic field*. The coil moves in the field and thus has an A.C. generated in it. The magnetophone is relatively insensitive, and its output requires considerable amplification before signals of telephone strength are obtained.
- MAIN STATION**—A wireless telephony broadcasting station of medium power.
- MANSBRIDGE CONDENSER**—A form of fixed *condenser* particularly suited to give large capacities in a relatively small space. The *dielectric* consists of a strip of waxed paper which is coated on both sides with tinfoil to form the conductors. The whole strip is then rolled and pressed together.
- MASS**—The amount of matter in a body. In the C.G.S. system the unit is the gramme; in the F.P.S. system the unit is the pound (lb.).
- MAST**—A steel or wooden erection for supporting an *aerial*. Masts have been built to a height of about 900 feet.
- MEDIUM WAVES**—The Hague definition for waves between 200 and 3,000 metres (frequencies between 1,500 to 100 kc/s).
- MÉGGER**—An instrument for measuring high resistances.
- MEGOHM**—One million ohms.
- MERCURY ARC RECTIFIER**—A *rectifier* whose action depends on the unidirectional conductivity of a metallic arc burning in a vacuum. The metallic arc is formed by mercury vaporised at the negative electrode, thus allowing, as a result of electronic emission, the passage of current from the cathode to the anode.
- METAL RECTIFIER**—A *rectifier* which in its simplest form consists of two plates of different metals in contact, e.g. a plate of copper, with a coating of copper oxide, in contact with a plate of lead forms such a rectifier. By series parallel arrangements of connection, various currents and voltages may be dealt with. See *Rectification*.

- METRE-AMPERE**—A measure of the power radiated by a wireless transmitter given by the product of the *effective height* of the aerial in metres and the current in amperes at the base of the aerial.
- N.B.*—As the maximum value of current is not necessarily at the base of the aerial, it follows that the above is not a reliable measure of the power radiated. In the particular case of a *half wave-length aerial* the current at the base is in fact zero. It is necessary, therefore, that if the metre-ampere figure is to be a true measure of the power radiated, the current value must be the maximum in the aerial, and not necessarily the value at the base.
- MFD.** or $\mu\text{F.}$ —Abbreviation for Microfarad.
- MHO.**—The unit of *admittance*.
- MICROAMPERE**—One-millionth of an *ampere*.
- MICROFARAD**—One millionth of a farad.
- MICROHENRY**—One millionth of a henry.
- MICROPHONE**—With the advent of Broadcasting the term microphone is now applied to any instrument which will convert sound waves into electrical currents; whether it be a *carbon microphone* which depends for its action on the varying resistance of carbon granules under the variable air pressure produced by the sound waves, or a *magneto-phone*, or a *condenser microphone*. These are the three most important types.
- MICROPHONE AMPLIFIER**—A low-frequency amplifier used in conjunction with a *microphone* and generally in its vicinity, to amplify the weak electrical currents given by the *microphone*, to a desired amplitude.
- MICROVOLT**—One-millionth of a *volt*.
- MILLIAMPERE**—The thousandth part of an *ampere*.
- MILLIVOLT**—One thousandth of a *volt*.
- MIXING UNIT**—See *Fade-unit*.
- M.M.F.**—Abbreviation for Magneto-motive Force.
- MODULATED MAGNIFIER VALVE**—The valve in a transmitting set employed for producing or magnifying continuous oscillations (the carrier wave) which are modulated by the output from the *modulator system*.
- MODULATION**—If *continuous waves* have their amplitude varied at an *audio frequency*, they are said to be modulated by it. For true reproduction of the audio frequency at the wireless receiver, it is essential that the change of amplitude of the continuous waves (*carrier wave*) shall be a true copy of the *wave form* of the audio-frequency oscillations at all frequencies and amplitudes. If this be the case, the modulation is said to be "linear." See *Choke Control, Grid Control, Absorption Control*.
- MODULATION METER**—An apparatus for indicating the depth of *modulation* in a telephone transmitter.
- MODULATOR SYSTEM**—The part of a wireless telephone transmitter in which the audio-frequency impulses are magnified. See *Choke Control, Grid Control, Absorption Control*.
- MOMENTUM**—The product of *mass* and *velocity*.
- MORSE CODE**—An international code used for the telegraphic transmission of messages by wire or by wireless, consisting of different numbers and combinations of dots and dashes representing the letters of the alphabet.
- MOTOR-BOATING**—A term used to denote the very low frequency oscillations which may be produced in a receiving set, and generally caused by a common *impedance* in two or more anode circuits. This trouble sometimes occurs, particularly if high magnification valves are employed, when using an eliminator in which separate *smoothing circuits* for each stage are not provided.
- MOTOR CONVERTOR**—An *induction motor* rigidly coupled to a *dynamo*. In addition to the mechanical coupling, the two rotating elements are also connected together electrically, a hollow shaft being employed for the purpose of carrying the connecting leads.
- MOTOR GENERATOR**—A *generator* which is mechanically directly coupled to an electric motor by which it is driven.
- MOVING COIL LOUD SPEAKER**—A loud speaker the movement of which consists of a cylindrical coil of fine wire held between the poles of a *permanent or electro-magnet*. Speech currents passing through the coil cause it to move in the *magnetic field*, thus setting up vibrations at speech frequencies in a conical diaphragm of stiff paper or similar material, the apex of which is attached to the coil. See *Baffle*.
- MULTIPLEX**—A system of transmission whereby one circuit provides several communication channels (telephone or telegraph) simultaneously.
- MULTI-VIBRATOR**—An instrument for producing continuous electrical *oscillations*, usually of an audible frequency, and very rich in *harmonics*. The *frequency* of the fundamental, and thus of the *harmonics*, is governed by the *capacity* and the *resistance* in the circuit, but is variable within limits, so that it can be brought into step with an outside source. Thus a standard of frequency (*e.g.* a valve maintained *tuning-fork*) can be made to regulate the fundamental frequency of a multi-vibrator. The *harmonics* are multiples of the fundamental, and *high frequencies* are thus produced as standard frequencies against which *wavemeters* can be calibrated.
- MUSH**—A form of *interference* emitted by *continuous wave* transmitting stations using an arc to generate the C.W.
- MUSH AREA**—If two broadcasting transmitters are synchronised so that their *carrier waves* are of exactly the same *frequency* and *phase*, it will be found that outside a certain limited radius from each of the transmitters bad quality reception will result. The area in which this takes place is called a *mush area*. Its extent depends on the distance apart of the transmitters and whether the same or different programmes are being transmitted. See *Single Wave-length Working*.
- MUTUAL INDUCTANCE**—If two *inductances* are coupled together so that a changing current in the primary winding produces

an E.M.F. across the secondary winding. the two circuits are said to possess mutual inductance. See *Inductance* and *Coupling*, and cf. *Self-inductance*.

NATURAL CRYSTAL—A chemical compound in crystal form which possesses the property of being able to pass an electric current in one direction only, and which therefore may be used as a *detector* in receiving sets.

NATURAL FREQUENCY OR NATURAL PERIOD—The *frequency* or *period* at which a circuit containing *inductance* and *capacity* will naturally oscillate if set in electrical vibration. The natural frequency is given by the formula $f = \frac{1}{2\pi\sqrt{LC}}$

cycles per second, where L is the inductance in henries and C is the capacity in farads. At this frequency, the condition of *Resonance* occurs.

NATURAL TIME CONSTANT—See *Time Constant*.

NATURAL WAVE-LENGTH—The *wave-length* at which an *aerial* or a *tuned circuit* will most readily oscillate by virtue of its own *inductance* and *capacity*. The natural wave-length of an *inverted L*-type aerial is about four times its length.

NEGATIVE CHARGE—The quantity of static electricity of negative sign which is not neutralised by the positive electricity in a body when it is negatively electrified.

NEGATIVE ELECTRIFICATION—A body is said to be negatively electrified when it contains an excess of *electrons* or particles of negative electricity.

NEGATIVE POLE—A pole that is at a lower *potential* relatively to another, the positive pole. Electron currents always flow from the negative pole to the positive pole, but it is generally assumed that electricity flows from positive to negative.

NEGATIVE POTENTIAL—See *Potential*.

NEGATIVE RESISTANCE—If when the *potential difference* across a piece of apparatus falls, the current rises, then the apparatus is said to have a "negative resistance." This property is made use of in various ways to produce continuous electrical oscillations.

NEGATRON—A special type of *thermionic valve* having four *electrodes* and possessing the property of *negative resistance*.

NEON LAMP—A glass bulb containing two metal *electrodes* and filled with neon gas at a low pressure. When a sufficiently high *potential difference* is applied across the *electrodes* the negative electrode glows, owing to a discharge taking place through the gas. If a neon lamp is placed across the *condenser* forming part of the closed circuit of a *wavemeter*, a visible indication will be given when the current in the wavemeter circuit is a maximum, that is to say, when the circuit is in *resonance* with the radiating oscillating circuit whose wave-length it is desired to measure. A special type of neon lamp is now used in television receivers to convert the electrical impulses back into light impulses, dependent for its action on a linear relation between light response and applied electrical potential and on an absence of time-lag.

NEPER—The continental unit of gain or loss by which a measure of the ratio of input to output power or vice versa may be obtained on a natural logarithmic scale given by the formula:

$$\text{Neper} = \frac{1}{2} \log_e \frac{P_1}{P_2}$$

1 Neper = 8.68 *Transmission units* or Decibels. See *Transmission Unit*.

NEUTRAL WIRE—The wire at earth potential in a *three-phase* system of electric power distribution.

NEUTRODYNE RECEIVER—A receiver employing a special circuit to neutralise the inter-electrode capacity of the H.F. valves. In the *high-frequency amplifier* part of this receiver the stray capacity coupling between the valve *electrodes* is neutralised by a reverse capacity coupling between the grid and a suitable point in the anode circuit, thus overcoming the inherent tendency of a multi-stage high-frequency amplifier to burst into self-oscillation.

NICKEL IRON—An alloy of iron containing a percentage of nickel. Such iron is of particular use for the cores of *transformers*, as, due to its high initial *permeability*, a considerably larger primary *inductance* is obtained for a given number of turns in the *primary winding* than when ordinary iron is used. Thus a flatter frequency response characteristic can be obtained. See *Transformer*.

NIGHT EFFECT—A general term used to denote various phenomena which take place in wireless transmission after sunset. See *Fading* and *Reflection*.

NODE—In any alternating-current circuit, the point at which the current or voltage value is a minimum. Cf. *Antinode*.

NODON RECTIFIER—A form of chemical *rectifier*, having an aluminium *cathode* and a lead *anode* immersed in a solution of ammonium phosphate, and suitable for charging accumulators from alternating current mains.

NON-INDUCTIVE RESISTANCE—A *resistance* whose *inductance* is negligible. Such a resistance is useful when it is desired to alter the *damping* of an oscillatory circuit without altering the *natural frequency* of the circuit.

NOTE MAGNIFIER—See *Amplifier*.

OHM—The practical unit of *resistance*.

OHM'S LAW—One of the fundamental laws of current electricity, which states that in a circuit carrying a constant current, the value of this current is proportional to the *potential difference* across the circuit and inversely proportional to the *impedance* of the circuit. The practical units of *current*, *voltage* and *impedance* have been so chosen that a P.D. of one volt is required to force a current of one ampere through an impedance of one ohm. In other words—

$$I \text{ (amperes)} = \frac{E \text{ (volts)}}{R \text{ (ohms)}}$$

ONE-WAY REPEATER—See *Repeater*.

OPEN CIRCUIT—A circuit which is not continuous and through which current cannot flow.

OPEN-CORE TRANSFORMER—A *transformer* in which the *magnetic circuit* consists

- partly of iron and partly of air. Owing to its bad *characteristic curve* an open-core transformer is never used in a *low-frequency amplifier*. Cf. *Closed-core Transformer*.
- OPEN-WIRE CIRCUIT**—A wire circuit employing conductors carried openly on poles or masts. Largely owing to their unreliability during bad weather, such circuits are gradually being replaced by cable circuits.
- OSCILLATION CONSTANT OR RESONANCE CONSTANT**—The *natural frequency* of a circuit depends upon the L.C. value of the circuit, and the product L.C. is called the Oscillation Constant.
- OSCILLATION TRANSFORMER OR JIGGER**—An air-core transformer used for transferring high-frequency *oscillations* from one circuit to another.
- OSCILLATIONS**—The high-frequency alternating current which flows round an *oscillatory circuit* which has been set in electrical vibration by an outside source of power. If the power supplied is sufficient to compensate for the resistance (heat) losses in the circuit, then the *oscillations* will be continuous or *undamped*, but if the resistance loss is greater, then the *oscillations* will gradually die away and are said to be *damped*. If the *reaction* coil of a receiving set is tightly coupled to the grid coil which may also be the aerial coil, then the transfer of power into the latter may be sufficient to overcome the losses in the circuit and sustain *continuous oscillations* which may be radiated from the aerial and cause interference to nearby receiving sets.
- OSCILLATION VALVE**—See *Valve*.
- OSCILLATOR**—An apparatus (generally an electrical circuit employing a three-electrode valve) for producing *oscillations*.
- OSCILLATOR VALVE**—The valve in a transmitting set or in certain types of receiving sets that produces continuous oscillations.
- OSCILLATORY CIRCUIT**—A circuit containing *inductance* and *capacity* which when supplied with energy from an outside source is set in electrical vibration and oscillates at its *natural frequency*. The *resistance* of the circuit must not be greater than a certain value, dependent upon the values of *inductance* and *capacity*, otherwise the *oscillations* will not be continuous. See *Damping*.
- OSCILLATORY CURRENT**—The current in an *oscillatory circuit*.
- OSCILLOGRAPH**—An instrument for showing the shape of waves of *alternating currents* and particularly used for the examination of high-frequency *oscillations*. The *Kathode Ray Oscillograph* is the most common type.
- OUTSIDE BROADCAST**—A broadcast item taking place at some point other than the *studio*.
- PACKING**—A trouble which occurs with microphones of the loose-contact carbon type when the granules settle into a heap. The instrument becomes less sensitive, and the inherent carbon hiss increases. Generally cured by shaking.
- PANCAKE COIL**—A flat *inductance* coil.
- PARALLEL CONNECTION**—If two or more pieces of apparatus are joined across a common voltage supply they are said to be in parallel, and the current flowing through each path is inversely proportional to the *resistance* of the path.
- PARAPHASE**—A system of low-frequency amplification employing two similar three-electrode valves per stage. The arrangement differs from *push-pull amplification* in that an input transformer with a split secondary winding is not required, the two grids being fed 180° out of phase by connecting the second valve grid to a point in the anode circuit of the first.
- PARASITES**—Another term for *atmospherics*.
- P.D.**—Potential Difference. Difference of electric pressure between two points of a circuit. See *Voltage*.
- PEAK VALUE**—The maximum value of an alternating quantity. The peak *voltage* reached in any circuit is an important quantity, as the components of the circuit must be designed to withstand this voltage and not merely the average voltage value.
- PEANUT VALVE**—A type of three-electrode receiving valve requiring low *filament current* and *anode voltage*. The dimensions of the valve are very small and it is therefore of use where space and small battery consumption are a consideration.
- PENTODE**—A *thermionic valve* having five *electrodes*, a *filament*, a *plate* and three *grids*. Used in a receiving set, it has the advantage of having a high *magnification factor* and being capable of giving a relatively large output.
- PERCENTAGE COUPLING**—The *coefficient of coupling* between two circuits expressed as a percentage.
- PERIKON DETECTOR**—A *crystal detector* consisting of *zincite*, and *bornite* in contact.
- PERIOD**—The time in seconds of one complete *cycle* of an alternating quantity.
- PERIODICITY**—See *Frequency*.
- PERMANENT MAGNET**—One which retains its magnetism for an indefinite time after it has been magnetised. Specially prepared steel is generally used. Heavy blows and heat will, however, destroy the magnetism.
- PERMEABILITY**—The magnetic conductivity of a material, generally denoted by the symbol " μ " and given numerically by the ratio of the *flux density* (B) in the material to the *magnetising force* (H) producing that flux density, *i.e.*, $\mu = B/H$. The permeability of air and all other non-magnetic materials is unity, but that of iron varies according to the purity of and heat treatment given to the iron. The quantity is of considerable importance in *inter-valve transformer* design.
- PHANTOM CIRCUIT**—A telephone or telegraph circuit which can be superimposed on two *physical circuits* without mutual interference. Thus with four wires between two points, three channels, two physical and one phantom, can be provided.
- PHASE ANGLE**—When two things occur at the same time they are said to be in phase. If two alternating quantities do not pass through their maxima or minima at the same time one will lead relative to the other, and assuming the quantities are represented as rotating *vectors*, then the amount of lead (or lag looked at from the point of view of the other quantity) may be

represented by the difference in angular displacement, the maximum, of course, being 360 degrees or 2π radians. The position and hence the value of either *vector* at any instant may be defined by its phase angle (remembering that 360 degrees represent a complete cycle) and the difference between the angles made by the two vectors is called the Phase Difference or Phase Displacement. If the *Periods* of the two vectors are the same, then the Phase Difference is constant. If a voltage *vector* leads or lags behind a current *vector* by exactly 90° (i.e., $\pi/2$ radians) they are said to be "in quadrature." On a pure inductive load the current lags behind the voltage by 90° ; on a capacitive load the current leads by 90° .

PHONE—Abbreviation for telephone.

PHOSPHOR BRONZE—An alloy of phosphorus, copper and tin, having greater tensile strength than pure copper and equally good electrical properties, and therefore largely used for *aerials*.

PHOTO-ELECTRIC CELL—A device which changes its electrical *resistance* according to the amount of light falling upon it.

PHYSICAL CIRCUIT—A telephone or telegraph circuit composed of two metallic conductors. Cf. *Phantom Circuit*.

PICK-UP—See *Gramophone Attachment*.

PICTURE TRANSMISSION—A system for the transmission of still pictures by line or wireless. Cf. *Television*.

PITCH—In music there are various standard pitches for the tuning of musical instruments. In broadcasting a transmission is said to be "low pitched" or "high pitched" according to whether the lower or higher audio *frequencies* are present to a greater extent in the reproduction than in the original.

PLAIN AERIAL—An *aerial circuit* arrangement which is connected directly to the transmitting or receiving circuit without the use of any form of *loose coupling* or intermediate circuit. The tuning in such cases is liable to be flat.

PLATE—The usual name applied to the *anode* of a *thermionic valve*. It consists of a cylinder of metal (generally nickel, tungsten, molybdenum or copper) surrounding the *kathode* or *filament* and at a higher relative potential, which enables it to attract the negative *electrons* emitted from the *filament* and thus give rise to the *anode current*, *plate current* or *space current*.

PLATE BATTERY—See *High-tension Battery*.
PLATE CIRCUIT—That part of a circuit of a transmitter or receiver connected between the *plate* or *anode* of a valve and the source of high-tension supply.

PLATE CURRENT—The current flowing in the *Plate Circuit* and between the plate and filament in the valve. See *Plate*.

PLATE IMPEDANCE—The *internal impedance* of a *three-electrode valve*.

PLATE VOLTAGE—The positive voltage of the *plate* or *anode* relative to the negative end of the *filament*. See *Plate*.

PLUG—A device used in conjunction with a *jack* to allow of easy connection and disconnection between two portions of an electrical circuit. The contacts are formed by a central pin terminating in a tip and

insulated from the other contact, which is in the form of a sleeve, and which fits over and is concentric with the central pin. Three contacts are sometimes provided by the addition of a small ring between the tip and the sleeve and insulated from both. See *Jack*.

PLUG-IN COIL—A convenient form of inductance coil, fitted with a plug and socket termination to facilitate quick coil changing.

PLUG-IN TRANSFORMER—A *high-frequency transformer* in a form convenient for quick changing to another transformer to cover a different range of wave-lengths. The windings terminate in plugs which fit into sockets on the instrument.

POLAR DIAGRAM—A curve drawn round a point representing the transmitting aerial showing the field strength of the emitted wave in any direction at a given distance from the transmitter. Cf. *Wireless Contour Map*.

POLARISED ELECTRO-MAGNET—One whose magnetism is partly permanent and partly due to a magnetising current flowing in the winding. Whether the latter adds to the total magnetism or otherwise depends upon the direction of the magnetising current. By arranging that the value of permanent magnetism brings the iron on to the steep portion of the *magnetisation curve*, then a relatively small value of magnetising current in either direction will cause a large variation in *magnetic flux* in the core. A *telephone* makes use of this arrangement.

POLARISED RELAY—A *relay* in which a *polarised electro-magnet* arrangement is used. A soft iron armature is magnetised by a *permanent magnet* and one end is also under the influence of an electro-magnet. Thus this end will swing one way or the other according to the direction of the magnetising current flowing in the coils of the electro-magnet.

POLARITY OF MAGNETS—Every magnet has two poles, one at each extremity. The north-seeking pole tends to move towards the north magnetic pole and the south-seeking pole towards the south.

POLE—See *Polarity of Magnets, Positive Pole, Negative Pole*.

POLYPHASE—An alternating current system consisting of several *phases*, the currents in each *phase* having a certain definite and constant *phase difference* relatively to each other.

PORTABLE TRANSMITTER—A transmitter of low power and limited range which can easily be moved from place to place.

POSITIVE ELECTRIFICATION—The state of a body when it contains less than its normal number of *electrons*.

POSITIVE POLE—The *pole* that is at a higher *potential* relatively to the other (negative) pole in any piece of apparatus when considered from the point of view of the external circuit.

POTENTIAL AND POTENTIAL DIFFERENCE—The force tending to drive electricity from a point of higher potential to a point of lower potential. In current electricity, a potential difference may exist between the poles of a piece of apparatus,

but the *electromotive force* generated by the apparatus will be slightly greater, the difference being lost in overcoming the internal resistance of the apparatus itself when a current flows. Potential difference is measured in *volts*.

POTENTIAL DIVIDER—An electrical apparatus which works on the same principle as a *potentiometer*, but which is used to obtain a variation of *potential*. Such an arrangement is often used to obtain variable grid potential by connecting across the *filament battery* in a receiving set.

POTENTIALLY - OPERATED DEVICE—A piece of apparatus whose operation is solely dependent upon changes of potential and not upon current. A three-electrode valve is an example of this, provided that the *grid* is always negative with respect to the *filament*, thus avoiding *grid current*.

POTENTIOMETER—An electrical apparatus for the accurate measurement of difference of potential. If a *resistance* is connected across a source of *potential*, the potential across any part of the resistance will be proportional to the resistance of that part. Thus by means of tapping points, any fraction of a known potential may be compared with a potential of unknown value. The term potentiometer is often loosely and incorrectly used to indicate a *potential divider*.

POUNDAI—The F.P.S. (foot-pound-second) unit of force. One poundal will produce an *acceleration* of one foot per second per second in a mass of one pound.

$$1 \text{ poundal} = \frac{1}{32} \text{ lb. (approx.)}$$

POWER—The rate of doing *Work*. Unit: one horse-power = 746 watts.

POWER AMPLIFIER—A *low-frequency amplifier* designed to handle without *distortion* relatively high power for working *loud speakers*.

POWER FACTOR—A number having a value less than unity by which the product of the *volts* and *amperes* in an alternating circuit must be multiplied to give the power in the circuit.

POWER RATING—See *Hague Power Rating*.

POWER VALVE—A *three-electrode valve* used in a *power amplifier*, and designed to handle a large output without *distortion*. To ensure this the plate current-grid voltage characteristic must be straight over as wide a range of grid voltage as possible.

PRIMARY CELL—A source of electrical energy, dependent upon the chemical action between two electrodes producing an *E.M.F.* Such a cell cannot be re-charged, as can a *secondary battery*.

PRIMARY CIRCUIT—The circuit which takes power from the source of supply and passes it on to the *secondary circuit*. The *voltage* may be stepped up or down during this transference of power from one circuit to another. See *Transformer*.

PRIMARY WINDING—See *Primary Circuit*.

PROTON—The smallest possible quantity of *positive electricity* existing in a free state.

PULSATING CURRENT—A current whose magnitude varies regularly, but whose direction remains constant.

PUSH-PULL AMPLIFICATION—A system of amplification employing two similar three-electrode valves per stage. The *grids* of the valves are fed from a single *secondary winding*, one end to each grid, and a centre tapping is connected to the common filament circuit. The two *plates* are connected one to each end of the output *transformer primary winding*, the H.T. being fed to the centre point of this winding.

QUADRATURE—See *Phase Angle*.

QUANTITY OF ELECTRICITY—In current electricity, quantity is measured by the product of the current flowing in a circuit and the time for which it flows. The unit is the coulomb, which is equal to one ampere flowing for one second, but the practical unit is the *ampere-hour* which equals 3,600 *coulombs*.

QUARTER WAVE-LENGTH AERIAL—An aerial having an equivalent vertical height equal to one quarter of the wave-length in use. Cf. *Half Wave-length Aerial*.

QUARTZ CRYSTAL—If an alternating voltage of a suitable frequency is applied to two opposite faces of a piece of quartz, mechanical vibrations are set up in it, the frequency at which this occurs being determined to within very narrow limits by the physical dimensions of the quartz. By suitable connections, the frequency at which a circuit is maintained in oscillation by a *thermionic valve* can be controlled with great precision. In turn, this circuit can be made to drive (control the frequency of) the *carrier wave* of a wireless transmitter. Alternatively, a quartz crystal resonator provides a simple and reliable method of checking the *frequency* of a transmitter.

R—The usual symbol for *resistance*.

RADIAN—The angle subtended at the centre of a circle by an arc equal in length to the radius. The value of a radian is approximately 57.5°, 2π radians being equal to 360°.

RADIATING CIRCUIT—A circuit carrying a *high-frequency* current, which is capable of throwing out its energy in the form of electric waves. The amount of energy radiated is proportional to the *radiation resistance*. An *aerial circuit* is a radiating circuit.

RADIATION—The transference of energy from a physical circuit carrying *high-frequency* current into space in the form of electro-magnetic waves, the medium through which the waves travel being the *ether*.

RADIATION EFFICIENCY—In a radiating circuit part of the energy is radiated in the form of electric waves and part is lost owing to the *resistance* of the circuit. The percentage radiated of the total energy in the circuit is the radiation efficiency of that circuit. See *Aerial Resistance*.

RADIATION RESISTANCE (of an aerial)—That quantity expressed in ohms which when multiplied by the square of the value of *aerial current* in amperes gives the power in watts being radiated from the circuit in the form of electro-magnetic waves. See *Aerial resistance*.

RADIO BEACON—A transmitting station

situated near the coast, which sends out special telegraphic signals to assist the navigation of ships at sea.

RADIO-FREQUENCY—A frequency used for radio-transmission purposes. The range at present in use is from approximately 300,000,000 cycles per second down to about 12,000 cycles per second. Transmissions on the very high frequencies are still at an experimental stage only.

RADIO-FREQUENCY AMPLIFIER—See *High-frequency Amplifier*.

RADIO-FREQUENCY RESISTANCE—See *Aerial Resistance*.

RADIO-FREQUENCY TRANSFORMER—See *High-frequency Transformer*.

RADIO-GONIOMETER—A calibrated instrument used in the Bellini-Tosi system of direction finding.

RADIOTRON—Another name for an ordinary three-electrode valve.

RATIO OF TRANSFORMATION—The ratio of the primary to the secondary voltage of a transformer. In the case of an iron-core transformer this ratio is approximately the same as the ratio of the turns in the two windings.

RAYLEIGH DISC—A small light metal disc, so arranged in the path of a sound wave in air that the angle through which the disc is deflected becomes a measure of air pressure due to the wave. Thus a method is given for the calibration of *microphones* and *loud speakers* in absolute terms, but practical difficulties render the method suitable for use only in the laboratory.

REACTANCE—The resistance offered to a current in an alternating circuit, due to the presence of *inductance* or *capacity* or both. See *Impedance*.

REACTION—An arrangement in a three-electrode valve circuit whereby the amplified currents in the *plate circuit* react on the *grid circuit*, thus compensating to any desired extent for the losses in that circuit. This is generally effected by means of a coil connected in the *plate circuit* of the valve, which is magnetically coupled to the grid coil. If this coupling is sufficiently tight then the transfer of energy is so great that the losses are completely overcome and the circuit is set into self-oscillation. In this case the circuit radiates energy, and if this occurs in a receiving circuit it is likely to interfere with near-by receivers. See *Oscillation*.

REACTION CONDENSER—A variable condenser connected between two points in the external circuit of a *thermionic valve* to control the amount of reaction in the circuit.

RECTIFICATION—The operation of converting an *alternating current* into a unidirectional *pulsating current*. This operation occurs in the detection of wireless signals, a *detector* or *rectifying valve* being used for the purpose. The term *rectification* is also used in heavy current work to indicate the operation of converting a low-frequency alternating current into a pulsating current, which is generally passed through a *smoothing circuit* in order to obtain a direct current without ripple. Either *half-wave rectification* or *full-wave rectification* may be employed.

RECTIFIED CURRENT—The current resulting from the process of *rectification*.

RECTIFIER—A piece of apparatus which performs the operation of *rectification*.

RECTIFYING DETECTOR—See *Detector*.

RECTIFYING VALVE—A *thermionic valve* capable of rectifying.

REFLECTION—(a) Of wireless waves. Electric waves travelling away from an aerial in an upward direction strike the *Heaviside Layer*, which refracts and partially reflects the waves to the surface of the earth. Thus at any point there may arrive two electric waves, one direct from the source and the other reflected from the Heaviside Layer. See *Fading*.

(b) On land-lines. The interference caused to speech-current frequencies when transmitted along long land-lines, generally due to incorrect terminal conditions or changes in the composition of the line along its length. Some of the frequencies are reflected back, producing nodes and loops of current and potential along the line.

REFLEX CIRCUIT—A valve circuit containing a high-frequency amplifying valve which acts as a low-frequency amplifying valve as well.

REGENERATION—See *Reaction*.

REGIONAL STATION—A high-power broadcasting station designed to serve a large area.

REINARTZ CIRCUIT—A valve receiving circuit using capacity reaction especially suitable for the reception of short waves.

REISS MICROPHONE—A type of *carbon microphone* in which, by special construction and by the use of an improved carbon filling, the ground noise or hiss is considerably less than that which existed in the older types. Additionally, the *frequency characteristic* is satisfactory over practically the whole range of audible frequencies. This microphone is largely used in Broadcasting Studios throughout Europe.

REJECTOR CIRCUIT—A tuned *oscillatory circuit*, consisting of an *inductance* and a *capacity*, the values of which are arranged so that the circuit offers a very high *impedance* to oscillations of a particular *frequency* which it is desired not to pass, and a low *impedance* to all other frequencies. Such an arrangement is used to obtain selectivity in a receiving set, the rejector circuit being tuned to the wave-length of the signal it is desired to receive. Cf. *Acceptor Circuit*.

RELAY—A device generally consisting of an *electro-magnet* and an armature which makes or breaks a local circuit when current is passed through the coils of the magnet. The coil current is generally small compared with the current in the local circuit.

RELAY STATION—A low-power broadcasting station which receives most of its programme material via a telephone line from a distant studio.

RELUCTANCE—The magnetic resistance offered to the passage of *magnetic flux* in a substance when a *magnetising force* is applied. Analogous to electrical *resistance*.

RELUCTIVITY—The reciprocal of *permeability*.

REMOTE CONTROL—The operation of electrical apparatus at a distance, generally by means of a relay.

REPEATER—A piece of apparatus placed in a long telephone line circuit in order to amplify the speech current before passing further along the line to a distant station. It consists generally of a *low-frequency amplifier* with suitable input and output transformers to match the incoming and outgoing lines. A "one-way" repeater is used to amplify low frequency currents passing in one direction only (as in broadcast transmission), while for simultaneous amplification of speech currents passing in both directions (as in commercial telephony), a "two-way" repeater is used. The "two-way" repeater consists of two "one-way" repeaters either each arranged in a separate circuit, one "go" and one "return" in which case it is referred to as a "four-wire" repeater or else arranged in only one circuit. In the latter case it is known as a "two-wire" repeater.

REPEATER STATION—One at which a number of repeaters is situated, and through which pass a large number of long-distance telephone lines. Such a station is used in broadcasting in connection with *Simultaneous Broadcasting*.

RE-RADIATION—When a valve receiver is adjusted with a tight reaction coupling, thus bringing the receiver nearly to the point of *self-oscillation*, the volume of the received signals is greatly increased and this increase will, to a certain extent, be re-radiated from the aerial of the receiver and may affect the signal strength in near-by receivers. If, however, the reaction is coupled too tightly the receiver will self-oscillate and cause interference. See *Reaction and Oscillation*.

RESISTANCE—The opposition which an electric circuit offers to the passage of an electric current. The power wasted in a resistance appears as heat. In a homogeneous wire the resistance is directly proportional to the length and specific resistance, and inversely proportional to the area of cross section. The practical unit is the *ohm*. See *Ohm's Law*.

RESISTANCE-CAPACITY COUPLING—A method of coupling *thermionic valves* together in cascade in a high- or low-frequency amplifier. A high resistance is placed in circuit with the *plate* of the valve, and the signal E.M.F. produces a varying potential at the plate end of this resistance, and this is applied through a *grid condenser* to the *grid* of the next valve. This condenser is necessary to prevent the high-tension potential from affecting the second grid. In order that the negative charge on this grid may gradually leak away, a *grid leak* resistance is connected between the grid and the filament of the valve.

RESISTANCE-COUPLED AMPLIFIER—A high- or low-frequency amplifier employing *resistance-capacity coupling* between valves.

RESISTOR—A resistance generally of fixed value, often used in a filament circuit to reduce the *low-tension* voltage to a value suitable for the valve in use.

RESONANCE—Occurs in a circuit containing *inductance* and *capacity* when an alternating

potential, whose frequency is equal to the *natural frequency* of the circuit, is applied to it. When this occurs the current is in *phase* with the voltage and the inductive reactance is neutralised by the capacity reactance.

RESONANCE CURVE—Curve showing the relation between the current flowing in a circuit containing fixed values of inductance and capacity when a constant voltage of varying frequency is applied.

RESPONSE CHARACTERISTIC—A curve showing the relation between input and output of a piece of electrical apparatus at different frequencies.

REVERBERATION—The continuation of a sound without apparent interruption for a short period after the original sound has ceased, due to reflection from hard surfaces, e.g., walls. Note the difference between reverberation and *echo*.

RHEOSTAT—A variable resistance.

ROTARY CONVERTOR—A piece of apparatus for converting alternating into continuous current and vice-versa, and consisting of a single machine fed with alternating current through slip rings mounted on one end of the armature. The rotation so caused induces an alternating back E.M.F. which is converted into a direct E.M.F. by means of a commutator mounted on the other end of the armature.

SATURATION (MAGNETIC)—When a magnetising force is applied to a piece of iron the flux density in the iron will increase up to a point. When a further increase of magnetising force will not increase the flux density, the iron is then said to be saturated, and this point is called the "saturation point."

SATURATION CURRENT—As the anode voltage applied to a three-electrode valve is increased, the anode current also increases up to a point, when a further increase in anode voltage does not increase the anode current. This maximum value of current is called the "saturation current."

SCANNING DISC—In *Television* or *Picture Transmission*, a rotating opaque disc perforated with a series of holes in the form of a spiral. A ray of light passing through the holes is thus caused to move over (scan) a picture or an object placed behind the holes on the farther side from the source of light.

SCANNING FREQUENCY—In *Television* the rate at which the picture or object is scanned. See *Scanning Disc*.

SCREEN-GRID VALVE—A four-electrode valve having two grids, and designed to reduce the capacity between the anode and the control grid. Such a valve is particularly useful in a multi-stage high-frequency amplifier. Cf. *Four-electrode Valve*.

SCREENING—An arrangement to prevent one circuit carrying alternating current from affecting another adjacent to it. It generally consists of a sheet of metal (usually copper) placed between the two circuits.

SECONDARY BATTERY—A battery of secondary cells, the most common being the lead-acid type. These cells can be recharged when run down by having

- electricity pumped into them in the reverse direction.
- SECONDARY CELL**—See *Secondary Battery*.
- SECONDARY CIRCUIT**—See *Primary Circuit*.
- SECONDARY WINDING**—See *Primary Winding*.
- SELECTIVITY**—The power of being able to select one particular *wave-length* or *frequency* to the exclusion of others.
- SELENIUM CELL**—A *primary cell* whose *resistance* varies according to the intensity of the light falling upon it.
- SELF-CAPACITY**—The *capacity* that exists between different parts of the same piece of apparatus. For example, the self-capacity of an inductance coil is due to the capacity that exists between turns, and that of a three-electrode valve to the capacities between *filament*, *grid* and *anode*.
- SELF-INDUCTANCE**—If the current passing through a coil of wire is changed, a back E.M.F. is set up which tends to stop the change taking place. This is due to the "self-inductance" of the coil and is analogous to mechanical inertia.
- SELF-OSCILLATION**—See *Oscillation*.
- SERVICE AREA**—Of a Broadcasting Station is the area in which listeners can be guaranteed a service, i.e., an area in which the *field strength* of received signals from that station is such that satisfactory reception is assured. It is the ratio of the strength of the wanted signal to that of the interference which will determine the extent of this area. It has been found convenient to divide the area into four parts: (1) the *wipe-out area* in which the field strength is greater than 30 millivolts per metre, (2) "A" service area between 10 and 30, (3) "B" service area between 5 and 10, and (4) "C" service area between 2.5 and 5.
- SHOCK EXCITATION**—The forcing into *oscillation* of a tuned oscillatory circuit at its *natural frequency* due to a sudden energy impulse from an outside source.
- SHORT-CIRCUIT**—A connection having very low *resistance* made between two parts of a circuit. If this connection is made accidentally, then the current in the circuit, owing to the drop in the resistance, may rise to a very high value and do damage to the apparatus in that part of the circuit which is not short-circuited.
- SHORT WAVES**—The Hague definition for waves between 10 and 50 metres (frequencies between 30,000 and 6000 kc/s).
- SHORTENING CONDENSER**—A *condenser* connected in *series* with the *aerial* in order to reduce its *resonant frequency* to a value below its *natural frequency*.
- SHUNTED BUZZER**—A modified *buzzer* often used to energise a receiving circuit in order that the wave-length of the latter may be measured.
- SIDE-BANDS**—When a constant high-frequency *carrier wave* is modulated by a low-frequency speech component in order to transmit telephony, a number of high-frequency waves is produced, the values of which are above and below the actual *frequency* of the *carrier wave* itself. The frequency bands occupied by these waves are called "side bands." See *Modulation*.
- SIDE-BAND TELEPHONY**—A system of telephony transmission in which the *side-lands* only are transmitted and not the *carrier wave*. The *carrier wave* having been modulated and the *side-bands* produced, the carrier wave is eliminated and supplied again at the receiving end. In this system of transmission there is a considerable saving in power, the disadvantage being that unless a special receiver, which will supply the missing *carrier wave*, is used, the sounds that will be heard will be unintelligible.
- SIMULTANEOUS BROADCASTING**—A system whereby the programme of one broadcasting station may be transmitted simultaneously from a number of other broadcasting stations, connections between the stations being made by ordinary telephone lines. See *Repeater Stations*.
- SINE WAVE**—A *wave form* representing an alternating quantity which varies according to a sine law.
- SINGLE PHASE**—A system of alternating current electricity consisting of one *voltage* and one *current* passing through one pair of wires only.
- SINGLE WAVE-LENGTH WORKING**—The working of two or more broadcasting transmitters on the same *carrier wave frequency*. The congestion of the ether caused by the opening of an ever-increasing number of broadcasting transmitters, when only a limited number of channels is available for them, and the consequent mutual interference, have rendered single wave-length working very desirable. Experiment to achieve this is still proceeding in this and in other countries. The solution lies in terms of absolute stabilisation of the transmitters' carrier frequency, probably by means of a *tuning-fork* drive and a certain reduction in *service areas* due to interference patterns produced by the *carrier waves* and *side-bands*. The extent of such *mesh areas* depends on the distance apart of the transmitters, and, in effect, the *service area* of each of two equal power transmitters, radiating the SAME programme, will be of the order of one quarter of the distance between them—with a maximum range at night of the order of 20 to 25 miles—this limit being imposed by the increase in received strength of the distant transmitter at night due to *fading*. With DIFFERENT programmes the range of the *service area* will be very much more restricted—being only of the order of $\frac{1}{2}$ to 1 mile at night, irrespective of the powers used, at the two transmitters.
- SKIN EFFECT**—The tendency of alternating currents to pass along the surface of a conductor instead of distributing equally over the whole area of the conductor. The effective resistance of the conductor is thereby increased.
- SKIP DISTANCE**—The distance between the point where the direct ray from a transmitting station becomes so attenuated as to be inaudible, and the point where the reflected or indirect ray strikes the earth's surface. The skip distance is a function of the *wave-length* employed and increases with a decrease in wave-length.
- SLAB COIL**—An *inductance* coil wound in a

- flat shape having the disadvantage of high *self-capacity*.
- SLIDE BACK**—An apparatus for indicating in the *control room* or at the transmitter of a broadcasting station the presence of grid current (and hence distortion) in the modulation system of the transmitter. A slide-back may be arranged to work either on high-frequency or on low-frequency circuits. In the former case a measure of maximum depth of modulation of the radiated carrier wave is obtained, whereas in the latter case an indication of the maximum allowable value of the applied low frequency modulation currents is given.
- SMOOTHING CIRCUIT**—A circuit consisting of a number of *inductances* and *condensers* used for eliminating the ripple or *pulsating* component of a uni-directional current, such as that obtained from a *rectifier*. A smoothing circuit is generally required if the resulting D.C. supply is to be used for supplying *high tension* to a wireless receiver or transmitter.
- SOFT VALVE**—One which contains an excess of gas. Extremely efficient when used as a detector, but difficult to operate.
- SOLID-BACK MICROPHONE**—A type of microphone employing two carbon discs, one attached to the diaphragm and the other to the solid back of the instrument, with carbon granules between them. See *Microphone*.
- SPACE CHARGE**—A cloud of electrons given off from the *filament* of a *thermionic valve*, which impedes the free flow of electrons between the *filament* and the *anode*.
- SPACE CURRENT**—See *Plate Current*.
- SPACE RAY**—See *Indirect Ray*.
- SPECIFIC INDUCTIVE CAPACITY**—Of a material, is the ratio of the *capacity* of a *condenser* with that material as *dielectric* to the capacity of an exactly similar condenser with air as dielectric.
- SPECIFIC RESISTANCE**—The *resistance* between two faces of a one-centimetre cube of any material.
- SPEECH AMPLIFIER**—See *Low-frequency Amplifier*.
- SPREADER**—A pole or hoop, generally of wood, used for separating the parallel wires of an *aerial*.
- SQUARE LAW CONDENSER**—A variable condenser generally with air dielectric in which the angle of rotation of the moving plates relative to the fixed plates is proportional to the square of change in *capacity*, and thus proportional directly to the change in *wavelength*. Cf. *Loj-law Condenser* and *Straight Line Frequency Condenser*.
- STALLOY**—A silicon-steel largely used for the cores of *low-frequency transformers*.
- STANDARD CABLE**—In line-telephony transmission a mile of Standard Cable is a unit of loss or gain, by which a measure of the ratio of input to output power in a circuit can be obtained. Standard cable, therefore, is an artificial cable having certain definite constants of *inductance*, *resistance* and *capacity*, etc., per loop mile with which other cables can be compared for loss and their performance specified as so many Standard Mile units. 1 Standard Mile unit = 1.084 *Transmission Units*. See *Transmission Unit*.
- STANDING WAVES**—Waves of sound produced by interference between the outgoing waves from the source of the sound and their reflection from the walls or ceiling or from objects in the room where the sound is produced.
- STATIC CHARACTERISTIC**—A curve showing the relation between various steady *voltages* and *currents* of a *thermionic valve*. Cf. *Dynamic Characteristic*.
- STATICS**—See *Atmospherics*.
- STEP-DOWN TRANSFORMER**—A transformer in which the *secondary voltage* is lower than the *primary voltage*, and the *secondary current* higher than the *primary current*.
- STEP-UP TRANSFORMER**—A transformer in which the *secondary voltage* is higher than the *primary voltage*, and the *secondary current* lower than the *primary current*.
- STORAGE BATTERIES**—See *Accumulators*.
- STRAIGHT-LINE FREQUENCY CONDENSER**—A *variable condenser* generally with air dielectric in which a given angle of rotation of the moving plates relative to the fixed plates alters the *frequency* of the tuned circuit by a constant amount whatever the original position of the moving plates.
- STRAYS**—See *Atmospherics*.
- STUDIO**—A room in which broadcast items are performed, generally *draped* to reduce *reverberation* and *echo*.
- SUB-CONTROL**—A low-frequency amplifying circuit preceding the *modulation system* of a transmitter.
- SULPHATING**—A white deposit of lead sulphate that appears on the plates of an *accumulator* when it is left uncharged for a long period. The removal of this deposit requires special treatment.
- SUPERHETERODYNE RECEIVER**—One employing a special circuit relying on a *beat reception* arrangement. The selectivity of such a receiver is considerable.
- SUPERSONIC FREQUENCY**—A *frequency* which is just above the audible range.
- SUPER-REGENERATION**—A valve receiver, employing *regeneration* or *reaction*, becomes most sensitive just before the reaction coupling is tightened up to the point at which the receiver oscillates. At this point the losses in the circuits are nearly balanced by energy fed from the *high-tension battery*. Super-regeneration provides a method by which the *oscillations* generated in the receiver are interrupted at a *frequency* above the range of audibility, thus allowing the receiver to be worked at a point where its circuits possess virtually *negative resistance*, and thus great sensitivity is obtained. The practical operation of such a receiver is, however, not simple.
- T AERIAL**—One in which the vertical down lead is attached to the middle of the horizontal span.
- TELEPHONE**—The instrument that converts the electrical energy of the receiving set into sound energy. It consists essentially of a soft iron diaphragm supported close to the poles of a *magnet*. The speech currents passing through coils wound on the pole pieces of the magnet disturb the equilibrium and cause the diaphragm to vibrate.

These vibrations are communicated to the air and thus made audible.

TELEPHONE CONDENSER—A small fixed condenser sometimes connected across a telephone receiver or loud speaker to assist in the bypassing of the high-frequency currents. It is not essential, as the self-capacity of the telephone winding itself is generally sufficient for the purpose.

TELEPHONE TRANSFORMER—A transformer whose primary winding is connected directly in the receiving circuit and whose secondary is connected to the telephones, thus isolating the telephone itself from direct electrical connection with the receiver.

TELEPHONE TRANSMITTER—A transmitter designed for the transmission of speech or music.

TELEVISION—A system, as yet in the experimental stage only, whereby a fixed or moving object is made visible at a distance by electrical means.

TETRODE—See *Four-electrode Valve* and *Screen-grid Valve*.

THERMIONIC CURRENT—The electronic current flowing between the filament and anode of a thermionic valve.

THERMIONIC VALVE—A vacuum tube containing two or more electrodes. The action of the valve depends upon the electron emission from a heated cathode, the electrons being attracted to the anode which is given a positive potential with respect to the filament. The valve can be made to act as a rectifier, high- or low-frequency amplifier, or a generator of electrical oscillations. It forms the basis of all modern wireless engineering.

THERMIONIC VOLTMETER—An instrument using a two- or three-electrode valve for the purpose of measuring small differences of potential.

THERMO-AMMETER—A type of ammeter suitable for the measurement of high-frequency currents. Its movement is dependent upon the current to be received being made to heat a thermocouple, the output of which operates a direct-current milliammeter. Cf. *Hot-wire Ammeter*.

THERMO-COUPLE—A generator of E.M.F., consisting of two dissimilar metals joined together, their junction being heated above the temperature of the rest of the circuit.

THORIUM—A rare metal used in the manufacture of the filaments of some dull-emitter valves, the Tungsten filament being coated with thorium-oxide.

THREE PHASE—An alternating current system in which the current and voltage of each phase are quite distinct and the phase angle between any two phases is 120° .

TIGHT COUPLING—If two coils are placed so close together that most of the energy in one is transferred to the other by induction, they are said to be "tightly coupled"; that is to say, the mutual inductance between the coils is large in comparison with their self-inductances. Cf. *Loose Coupling*.

TIME CONSTANT—In a circuit containing self-inductance, any change in the value of current in the circuit will be opposed by a back E.M.F. which at any instant is proportional to the rate of change of current. Thus if a steady voltage is applied to such a

circuit the current will not suddenly reach its maximum value of $\frac{E}{R}$, but will build up gradually, because the effective voltage at any instant will be the applied voltage minus the back voltage. The time taken to reach the maximum current value is called the "Time Constant" of the circuit and is equal to $\frac{L}{R}$ seconds in the case of a steady applied voltage, and $\frac{2L}{R}$ seconds where an oscillating voltage is connected across an oscillating circuit, R being the resistance in ohms and L the inductance in henries in each case. If the circuit contains capacity and resistance, the "Time Constant" is equal to CR seconds, R being the resistance in ohms and C the capacity in farads.

TIME PERIOD—See *Period*.

TIME SIGNAL—The broadcast Greenwich Time Signal consists of six dot-seconds, the first at five seconds before the hour, and the sixth exactly at the hour.

-tone—The term applied to the sound heard in a telephone receiver when low-frequency alternating or pulsating current is passing through it.

tone SOURCE—A calibrated apparatus capable of producing pure sine-wave low-frequency alternating currents of constant amplitude between the limits of audibility, i.e., from about 25 to 12,000 cycles per second. The apparatus is largely used to obtain the characteristic curves of low-frequency transformers, loud speakers, etc., by supplying an input of known frequency and amplitude from the Tone Source and measuring the output.

TONIC TRAIN—See *Interrupted Continuous Waves*.

TOROIDAL COIL—An inductance coil wound on a ring-shaped core. The coil may be made self-supporting, in which case no core is necessary.

TRANSFORMATION RATIO—See *Ratio of Transformation*.

TRANSFORMER—An apparatus for changing the voltage of an alternating current supply. It consists essentially of two windings tightly coupled to one another, so that energy in the one may be transferred to the other by electro-magnetic induction. Power and low-frequency transformers have a laminated iron core, while those used for high-frequency work have a non-magnetic core. The action of a transformer depends upon the E.M.F. which is induced in the secondary winding by the magnetic flux that is set up in the core due to the current flowing in the primary winding. The value of this E.M.F. is proportional to the number of turns which are linked by the magnetic flux, and therefore the secondary voltage is proportional to the number of turns in the secondary winding, losses being neglected. If the secondary is open-circuited, the primary will act as an ordinary choking coil and the only current flowing in the primary will be that due to its high impedance. This is called the magnetizing or no-load current. When the secondary is connected to the ends of a non-inductive resistance a current will flow which will tend to produce a flux

in the opposite direction to that already existing in the core, thus momentarily reducing the primary reactance. This will cause an increased current to flow in the primary until a state of equilibrium is again reached. The secondary ampere-turns must be counterbalanced by an equal and opposite number of ampere-turns in the primary, and, neglecting losses, the power (i.e., the product of current and voltage assuming unity power factor) in the primary circuit is equal to the power in the secondary circuit. That is to say, the ratio of voltages equals the ratio of turns and the inverse ratio of currents.

TRANSIENT—An instantaneous value of any quantity occurring when the conditions governing that quantity are rapidly changing.

TRANSMISSION UNIT—A unit of gain or loss by which a measure of the ratio of input to output power, or vice versa, may be obtained on a common logarithmic scale. The number of transmission units represented by the ratio of two powers P_1 and P_2 is given by the formula:

$$\text{T.U.} = 10 \log_{10} \frac{P_1}{P_2}$$

e.g. if $P_1 = 10,000$ and $P_2 = 1$

$$\frac{P_1}{P_2} = 10,000.$$

$$\log_{10} \frac{P_1}{P_2} = \log_{10} 10,000 = 4.0$$

$$\therefore 10 \log_{10} \frac{P_1}{P_2} = 40,$$

i.e. a power ratio of 10,000 to 1 = 40 Transmission Units. Cf. *Standard Cable*.

1 Transmission Unit = 0.9221 mile of Standard Cable. Cf. *Bel, Decibel, Neper*.

TRANSMITTER (WIRELESS)—The apparatus used for radiating into space electric waves, which may represent either telegraphic or telephonic signals. It consists generally of some form of *oscillation generator*, the output of which is remotely controlled by a Morse key for the sending of telegraphic signals, or modulated by a *low-frequency* (speech) current for telephony.

TRICKLE CHARGER—An *accumulator* charger which is arranged to charge at a low rate, so that a *battery* which has been in use during the day can be left on charge all night, and thus be fully charged for subsequent use. The mechanical analogy is water trickling to fill a tank.

TRIODE—Another term for a *three-electrode valve*.

TRUE POWER—Is the *apparent power* (product of volts and amperes) multiplied by the *Power Factor* of an alternating current circuit.

TUNED ANODE—A type of *intervalve coupling* used between two high-frequency amplifying valves in cascade, or between a high-frequency valve and the detector in a receiving set. An *oscillatory circuit* is connected in the *plate* circuit of the first valve and tuned to the frequency of the received signals. A *rejector* action is thus obtained and the high oscillating voltage set up across the inductance of the *oscillatory*

circuit is passed on to the grid of the second valve by means of a *grid condenser*. Cf. *Resistance-capacity Coupling*.

TUNED CIRCUIT—An *oscillatory circuit* whose *resonant frequency* has been adjusted to a desired value.

TUNED PLATE CIRCUIT—See *Tuned Anode*.

TUNER—An arrangement of one or more *oscillatory circuits* whose *resonant frequencies* are easily variable to receive any desired signals or to give an *acceptor* or *rejector* action.

TUNING—The operation of adjusting a *tuned circuit* to give *resonance* at any desired *frequency*.

TUNING COIL—An *inductance coil*, either fixed or variable in value, used in a *Tuned Circuit*.

TUNING CONDENSER—A *variable condenser* used in a *Tuned Circuit*.

TUNING-FORK—A piece of steel designed to have a natural period of vibration of a definite *frequency*. By means of a *thermionic valve* circuit these vibrations can be maintained, and used as a *frequency standard*. See *Multi-vibrator* and *Harmonic Amplifier*.

TUNING INDUCTANCE—See *Tuning Coil*.

TUNING NOTE—A *modulation* of the *carrier wave* of a broadcast transmitter with some form of continuous low-frequency note, so that listeners can tune in their receivers to the best advantage before the start of the actual programme. In some countries such a signal is radiated as an identification signal and is peculiar to a particular station.

TWO-ELECTRODE VALVE OR DIODE—A *thermionic valve* containing two *electrodes* only, a *plate* and a *filament*. The original form of the *thermionic valve* is still used for rectifying purposes, but largely replaced by the *three-electrode valve* for other purposes.

TWO PHASE—An alternating current system having two distinct circuits carrying current, the *currents* and *E.M.F.'s* of these circuits differing in *phase* by 90°.

TWO-POLE SWITCH OR DOUBLE-POLE SWITCH—A switch which opens or closes both *poles* of a circuit at one operation. In a "single throw" switch this operation is done to one circuit only, in a "double throw" two circuits may be controlled alternately.

TWO-WAY REPEATER—See *Repeater*.

TWO-WIRE REPEATER—See *Repeater*.

UMBRELLA AERIAL—An *aerial* arrangement consisting of a vertical centre pole from the top of which the aerial wires radiate symmetrically towards the ground.

UNDAMPED OSCILLATIONS OR UN-DAMPED WAVES—A train of electrical *oscillations* or waves whose amplitude is constant. The basis of all *continuous wave* telegraphy and telephony transmission.

UNIDIRECTIONAL—A *current* flowing or a *voltage* acting in the same direction but not necessarily with a constant *amplitude*. See *Pulsating Current*.

UNILATERAL CONDUCTIVITY—The property possessed by certain apparatus of being able to pass a current in one direction only. The most important examples of such apparatus are the *thermionic valve* and

the crystal, which are used in the process of *rectification*.

UNIT (BOARD OF TRADE)—The commercial unit of electrical energy equal to 1,000 watt-hours or one kilowatt-hour.

UNIT POLE—A *magnetic pole* which when placed at a distance of one centimetre from an equal *pole* exerts on it a force of one dyne.

UNLOADED AERIAL—One which has no added *inductance* or *capacity* and which will oscillate at its *natural wave-length* when energised from an outside source.

ULTRA-SHORT WAVES—See *Very Short Waves*.

UNTUNED AERIAL OR APERIODIC AERIAL—The *aerial circuit* of a receiving set which has not been specially *tuned* to the *frequency* of the incoming signal, an arrangement which is sometimes advantageous in the reception of short waves. The *aerial* is inductively coupled to the closed circuit *inductance* in the usual way.

VACUUM—A space entirely free from all matter.

VACUUM TUBE—A general name for all types of tubes or glass bulbs containing *electrodes* and from which all the gas has been exhausted.

VACUUM VALVE—A *vacuum tube* possessing *unilateral conductivity*, e.g., the *thermionic valve*.

VALVE—See *Vacuum Valve*.

VALVE AMPLIFIER—See *Amplifier*.

VALVE DETECTOR—See *Detector Valve*.

VALVE OSCILLATOR—See *Oscillator*.

VALVE RECEIVER—A wireless receiver employing one or more *thermionic valves*.

VALVE VOLTMETER—A sensitive form of *voltmeter* for the measurement of small values of alternating voltage. A *three-electrode valve* is employed, the voltage to be measured being introduced into the *grid* circuit, thus causing a deflection on a current-reading meter in the *plate* circuit. Alternatively a diode is sometimes used.

VARIABLE CONDENSER—One whose *capacity* is easily altered and consisting generally of two sets of plates which can move relatively to each other. See *Square Law Condenser*, etc.

VARIOCOUPLER—An arrangement consisting of two *inductance* coils, which can be moved relatively to each other to vary the *inductive coupling* between them. Cf. *Variometer*.

VARIOMETER—A form of variable *inductance* consisting of two coils, one of which rotates within the other. The coils are connected in *series* and by altering the relative position of the coils the *magnetic fields* set up by the currents in them are made either to assist or to oppose each other. Thus the effective inductance value of the combination is continuously variable between these limits without any alteration being made to the actual amount of conductor in the circuit. In a well-designed unit, an inductance ratio of about 10 to 1 may be obtained.

VECTOR—A straight line whose length represents the magnitude of a quantity and whose direction represents its direction in relation to other vector quantities. Vectors

may be added or subtracted by the method of parallelogram of forces.

VELOCITY—Distance traversed in unit time. The term implies a given direction and in this sense has not the same meaning as "speed."

VELOCITY OF ELECTRO-MAGNETIC OR ETHER WAVES—Electro-magnetic or Ether waves travel through space with the same *velocity* as light (which is itself an *electro-magnetic wave*), about 300 million metres per second or 186,000 miles per second.

VERNIER CONDENSER—The name given to a *variable condenser* of small *capacity*, generally used in *parallel* with a larger *variable condenser* in order to give a fine adjustment. It may either be a separate unit or incorporated in the main condenser, which will then have two control knobs.

VERY SHORT WAVES—The Hague definition for waves under 10 metres (frequencies over 30,000 kc/s.) The term "ultra-short waves" is not now used in official definitions.

VOLT—The practical unit of electrical pressure. If one volt is applied across the ends of a resistance of one ohm, a current of one ampere will flow. See *Ohm's Law*.

VOLT-AMPERES—The product of the *voltage* and *current* in an alternating current circuit. This gives the apparent power in the circuit, and to obtain the *true power* the former has to be multiplied by the *power factor*.

VOLTAGE—A term meaning *electromotive force* or *potential difference* measured in *volts*.

VOLTAGE AMPLIFICATION—The ratio of the output *voltage* to the input *voltage* of an amplifier. In a three-electrode valve amplifier, the static voltage amplification or *amplification constant* is dependent upon the physical measurements and *internal impedance* of the valve, but the dynamic amplification factor (i.e., the voltage ratio actually obtained when the valve is used in an amplifying circuit) depends also upon the *external impedance* of the plate circuit and is always less than the static constant, gradually approaching that value as the *external impedance* is increased relatively to the total *impedance*. There are, however, other considerations which limit the value of the *external impedance*.

VOLTAGE AMPLIFICATION FACTOR—See *Amplification Constant*.

VOLTAGE DROP—Across a circuit or a piece of apparatus is the *E.M.F.* or *potential difference* that is used up in driving a current through the circuit or apparatus. By *Ohm's Law*, the voltage drop in a direct current circuit is the product of the *current* in *amperes* and the *resistance* in *ohms*. In an alternating current circuit, it is the product of *current* and *impedance*.

VOLTAGE MULTIPLIER—A fixed *resistance* which is connected in series with a *voltmeter* to decrease the sensitivity of the instrument and allow higher *voltages* to be read.

VOLTMETER—An instrument used for the measurement of *voltages*. It is connected directly across the voltage to be measured and has a high *resistance* permanently in series with it so that the *current* passing

through the instrument may be limited to a small value. In the moving coil type, the current is passed through a coil which is free to rotate between the poles of a permanent horseshoe magnet. The coil tends to move so that its flux is at right angles to the magnet flux, thus for a given current the coil will take up a certain definite position and the pointer attached to it will indicate a certain voltage value on a scale. This type of instrument can only be used for the measurement of direct currents. In the cheaper and less accurate moving iron type, the coil carrying the current is fixed and is made to attract a pivoted iron disc to which the pointer is attached. Such an instrument will measure either direct or low-frequency alternating currents. There are other types, such as the hot-wire instrument for high-frequency measurements, but the moving coil and moving iron instruments are the most common. The working parts of an ammeter are similar, but the instrument is connected in series with the supply and the fixed resistance or "shunt" is connected in parallel with the instrument.

VOLUME INDICATOR—An instrument for measuring the average power of speech or music currents in a telephone or broadcasting system.

VULCANITE—See *Ebonite*.

WANDER PLUG—A brass plug connected to the end of a flexible wire to make connection with any one of a number of sockets in a high-tension dry battery or grid battery.

WATER-COOLED VALVE—A thermionic valve in which arrangement is made to cool the anode by circulating water round it.

WATT—A practical unit of electrical power, and equal to one joule per second. The watts in a D.C. circuit are equal to the product of the volts and amperes. In an A.C. circuit, this product gives the *apparent power*, which has to be multiplied by the *power factor* to give the *true power*.

WATTFUL CURRENT—That part of the current in an A.C. circuit which is in phase with the applied voltage, and which can therefore do useful work.

WATT-HOUR—The work done by a power of one watt in one hour. The commercial unit of electrical energy is the Board of Trade Unit which equal 1,000 watt-hours.

WATTLess CURRENT OR WATTLess COMPONENT—That part of the current in an A.C. circuit which is 90° out of phase with the applied voltage, and which therefore cannot do useful work.

WATTMETER—A meter for indicating directly the power in a circuit.

WAVES (ELECTRICAL)—A movement in the ether consisting of electric and magnetic forces alternating in direction, produced by electrical oscillations in a conductor. These disturbances spread outwards in the form of *electro-magnetic* or *ether waves* and travel at the speed of light, 300 million metres per second. Energy is conveyed by these waves. They are not perceptible directly to the ear, but can be made to be so by the aid of a suitable detector. See *Radiation*.

WAVE DISTORTION—See *Distortion*.

WAVE FORM—The shape of the curve

obtained when values of an alternating quantity are plotted on a time base.

WAVE-LENGTH—The distance between the crests of two successive waves. All electro-magnetic waves travel with the same velocity (300 million metres per second) which is obviously equal to the product of *wave-length* and *frequency*, i.e.,

$$\text{Wave-length (metres)} = \frac{300,000,000}{\text{Frequency (cycles per second)}}$$

In an *oscillatory circuit*, its *natural wave-length* (λ) is given by $\lambda = 1,885\sqrt{LC}$, where λ is in metres, L is the *inductance* of the circuit in *microhenries* and C is the *capacity* in *microfarads*.

WAVEMETER—An apparatus for measuring wave-length. The most general types are the *buzzer wavemeter*, *heterodyne wavemeter* and *absorption wavemeter*.

WAVE SHAPE—See *Wave Form*.

WAVE TRAP—A *rejector* or *acceptor* circuit used in some receiving sets in order to minimise the interference caused by an unwanted signal whose *frequency* is close to that of the signal it is desired to receive.

WEAK COUPLING—See *Loose Coupling*.

WEIGHT—The property possessed by a body due to gravitational force. Cf. *Mass*.

WET BATTERY—A term often used to denote an *accumulator battery*. Cf. *Dry cell*.

WHEATSTONE BRIDGE—An instrument used for determining the electrical *resistance* of an apparatus by balancing it against another of known resistance.

WIPE OUT—The state of affairs that occurs in a valve receiving set employing *grid-leak rectification* when an exceptionally powerful signal, e.g., an atmospheric, gives the *detector grid* such a high negative charge that the operation of the receiver is paralysed until the charge has had time to leak away through the *grid resistance* to earth.

WIPE-OUT AREA—The term given to the area very close to a transmitting station where the *signal strength* is so great that it is difficult, except with a selective receiver, entirely to tune out the signal in favour of another and more distant one.

WIRED WIRELESS—A system of communication employing high-frequency currents in which the transmitter and receiver are very similar to those used for wireless communication, but in which the medium is not the ether but ordinary telephone or power cables. By the use of different frequencies sufficiently separated from each other, several communication channels can be established on the same pair of wires. This system of transmission is now more generally referred to as *Carrier Current Telephony* or *Telegraphy*.

WIRELESS BEAM—See *Beam Wireless*.

WIRELESS CONTOUR MAP—A curve drawn round a point representing the transmitting aerial showing the distance from the transmitter in any direction at which a given field strength is produced.

WIRELESS LINK—An arrangement in which use is made of a *portable transmitter* for broadcasting purposes. The item is first

radiated by the portable transmitter on a short wave-length, received by a receiving station and sent by telephone line to a distant transmitter from which it is again radiated.

WOOD'S METAL—A soft alloy of lead, tin, bismuth and cadmium which melts at 60° C.
WORK—Work is done when a force overcomes a resistance over a certain distance. When a current of one ampere flows through a resistance of one ohm, the potential difference necessary is one volt. The power in the circuit is one *watt* and the work done per second is one joule.

X—The usual symbol for *reactance*.
"X's"—Another name for *atmospherics*.

"X" STOPPER—An *acceptor* or *rejector* circuit incorporated in a wireless receiver to minimise interference due to *atmospherics*.

Z—The usual symbol for *impedance*.
ZERO LEVEL—A level of transmission in telephony, the value of which is defined arbitrarily and serves as a datum level with which the level in other parts of the circuit may be compared. Cf. *Transmission Unit*.
ZERO POTENTIAL—See *Earth Potential*.
ZINCITE—An oxide of copper used together with *bornite* as a *crystal detector*. This combination is known as a "*Perikon detector*."

THE B.B.C. BOOK OF HOUSEHOLD TALKS

—◆—

One of the most popular of all B.B.C. publications has been this little book of household hints and suggestions. Every "department" of homemanagement is touched on: cooking especially: furnishing, dress-making, the care of children, etc. It is very well printed, and beautifully illustrated. You can buy it everywhere for one shilling—of all bookstalls, newsagents and booksellers: or direct from the B.B.C. Bookshop, Savoy Hill, London, W.C. 2 for 1s. 3d. post free.

BUYER'S GUIDE AND INDEX OF ADVERTISERS

GENERAL

	<i>See page</i>		<i>See page</i>
AIDS FOR THE DEAF		Royal Surgical Aid Society	374
General Acoustics, Ltd.	369	Shaftesbury Homes and "Arcthusa" Training Ship	370
APPEALS, CHARITABLE		Shaftesbury Society	370
Alexandra Orphanage	370	Spurgeon's Orphan Homes	381
Cancer Hospital	374	Waifs and Strays Society	378
Church Lads Brigade	378		
Dr. Barnardos Home	406	FURNITURE	
Friends of the Poor	363	Toby Chair Co.	363
Hospital for Epilepsy and Paralysis <i>(on wrapper)</i>		GRAMOPHONES AND RECORDS	
Imperial Cancer Research Fund	382	Columbia Gramophone Co., Ltd.	366
Lord Mayor Treloar Cripples' Hospital and College	19	MEDICAL	
Moorfields Eye Hospital <i>(on wrapper)</i>		New-skin	378
National Children's Home and Orphanage	369	PIANOS	
National Institute for the Blind	381	Chappell Piano Co., Ltd.	349
N.S.P.C.C.	370	TEA	
Our Dumb Friends' League	378	Mazawattee Tea Co., Ltd.	381
R.S.P.C.A.	382		

WIRELESS

	<i>See page</i>		<i>See page</i>
ACCUMULATORS (L.T. & H.T.)		Ever Ready Co. (Great Britain), Ltd.	336
Edison Swan Electric Co., Ltd.	364	General Electric Co., Ltd.	389
Ever Ready Co. (Great Britain), Ltd.	336	Lissen, Ltd.	15
Exide Batteries	386	Marconiphone Co., Ltd.	16
General Electric Co., Ltd.	389	Pertrix, Ltd.	355
Lissen, Ltd.	15	Young Accumulator Co., Ltd.	363
Marconiphone Co., Ltd.	16		
Pertrix, Ltd.	355	CABINETS	
Young Accumulator Co., Ltd.	363	Chas. Osborn	369
ACCUMULATORS, STATIONARY BATTERIES		CHARGERS FOR ACCUMULATORS	
Exide Batteries	386	E. K. Cole, Ltd.	326
General Electric Co., Ltd.	389	Edison Swan Electric Co., Ltd.	364
Young Accumulator Co., Ltd.	363	Exide Batteries	386
BATTERIES (DRY, H.T. AND GRID BIAS)		Ferranti, Ltd.	360
Edison Swan Electric Co., Ltd.	364	General Electric Co., Ltd.	389
		Lissen, Ltd.	15
		Marconiphone Co., Ltd.	16
		Philips Lamps, Ltd.	335

BUYER'S GUIDE AND INDEX OF ADVERTISERS

COILS	<i>See page</i>	LOUD SPEAKERS	<i>See page</i>
Brownie Wireless Co. (of Great Britain), Ltd.	329	Celestion, Ltd.	385
Edison Swan Electric Co., Ltd.	364	Edison Swan Electric Co., Ltd.	364
Lissen, Ltd.	15	Ferranti, Ltd.	360
London Electric Wire Co. & Smiths, Ltd.	344	General Electric Co., Ltd.	389
COMPONENTS		Lissen, Ltd.	15
Brownie Wireless Co. (of Great Britain), Ltd.	329	Marconiphone Co., Ltd.	16
Edison Swan Electric Co., Ltd.	364	Mullard Wireless Service Co., Ltd.	20
Ferranti, Ltd.	360	Ormond Engineering Co., Ltd.	325
General Electric Co., Ltd.	389	Philips Lamps, Ltd.	335
Lectro Linxs, Ltd.	329	Triotron Radio Co., Ltd.	434
Lissen, Ltd.	15	MEASURING INSTRUMENTS	
London Electric Wire Co. & Smiths, Ltd.	344	Ferranti, Ltd.	360
Louis Holzman, Ltd.	329	General Electric Co., Ltd.	389
Marconiphone Co., Ltd.	16	Louis Holzman, Ltd.	329
Mullard Wireless Service Co., Ltd.	20	MICROPHONES	
Ormond Eng. Co., Ltd.	325	Standard Telephones & Cables, Ltd.	338
Westinghouse Brake & Saxby Signal Co.	359	RECEIVERS, BATTERY	
CONDENSERS		Brownie Wireless Co. (of Great Britain), Ltd.	329
Edison Swan Electric Co., Ltd.	364	Celestion, Ltd.	385
Ferranti, Ltd.	360	Edison Swan Electric Co., Ltd.	364
General Electric Co., Ltd.	389	Ferranti, Ltd.	360
Lissen, Ltd.	15	General Electric Co., Ltd.	389
Louis Holzman, Ltd.	329	Lissen, Ltd.	15
Marconiphone Co., Ltd.	15	Marconiphone Co., Ltd.	16
Mullard Wireless Service Co., Ltd.	20	Philips Lamps, Ltd.	335
Ormond Engineering Co., Ltd.	325	RECEIVERS, MAINS	
ELMINATORS, BATTERY		Brownie Wireless Co. (of Great Britain), Ltd.	329
E. K. Cole, Ltd.	326	Celestion, Ltd.	385
Edison Swan Electric Co., Ltd.	364	E. K. Cole, Ltd.	326
Ferranti, Ltd.	360	Edison Swan Electric Co., Ltd.	364
General Electric Co., Ltd.	389	Ferranti, Ltd.	360
Lissen, Ltd.	15	General Electric Co., Ltd.	389
Marconiphone Co., Ltd.	16	Lissen, Ltd.	15
Mullard Wireless Service Co., Ltd.	20	Marconiphone Co., Ltd.	16
Philips Lamps, Ltd.	335	Philips Lamps, Ltd.	335
GRAMOPHONE PICK-UPS		RECEIVERS, PORTABLE	
Celestion, Ltd.	385	Edison Swan Electric Co., Ltd.	364
Edison Swan Electric Co., Ltd.	364	General Electric Co., Ltd.	389
General Electric Co., Ltd.	389	Lissen, Ltd.	15
Lissen, Ltd.	15	Marconiphone Co., Ltd.	16
Marconiphone Co., Ltd.	16	Ormond Engineering Co., Ltd.	325

BUYER'S GUIDE AND INDEX OF ADVERTISERS

	<i>See page</i>		<i>See page</i>
RECEIVERS, SHORT WAVE		Marconiphone Co., Ltd.	16
General Electric Co., Ltd.	389	Mullard Wireless Service Co., Ltd.	20
Marconiphone Co., Ltd.	16		
TELEPHONES		TRANSMITTERS	
Edison Swan Electric Co., Ltd.	364	Standard Telephones and Cables, Ltd.	338
General Electric Co., Ltd.	389		
Lissen, Ltd.	15	VALVES	
Marconiphone Co., Ltd.	16	Edison Swan Electric Co., Ltd.	364
TERMINALS		General Electric Co., Ltd.	389
General Electric Co., Ltd.	389	Lissen, Ltd.	15
Lectro Linxs, Ltd.	329	Marconiphone Co., Ltd.	16
Lissen, Ltd.	15	Mullard Wireless Service Co., Ltd.	20
TRANSFORMERS		Philips Lamps, Ltd.	335
Brownie Wireless Co. (of Great Britain), Ltd.	329	Triotron Radio Co., Ltd.	434
E. K. Cole, Ltd.	326		
Edison Swan Electric Co., Ltd.	364	WAVE TRAPS	
Ferranti, Ltd.	360	Edison Swan Electric Co., Ltd.	364
General Electric Co., Ltd.	389	General Electric Co., Ltd.	389
Lissen, Ltd.	15	London Electric Wire Co. & Smiths, Ltd.	344
London Electric Wire Co. & Smiths, Ltd.	344	Marconiphone Co., Ltd.	18
		WIRE	
		General Electric Co., Ltd.	389
		London Electric Wire Co. & Smiths, Ltd.	344

INDEX

A

- ABBEY THEATRE, Dublin, 146
 Acoustics, Studio, 170, 284
 Adult Education, 30, 236-41
 Advertising, by Wireless, 132, 134
 Aerial
 Down Lead, 381
 Earth Lead, 383
 Frame, 367-72
 Series Condensers, 345
 Systems, 375-84
 Types, 375-9
 Africa, 122
 Alternating Current Mains, 354
 Alternative Programmes, 42, 387-92
 America, U.S. of, 44, 122, 131-5
 Analysis of Alternative Programmes, 42
 Appeals, Broadcast, 149, 412
 Artists
 Musicians, 109
 Variety, 107
 Asia, 122
 Australia, 122

B

- Balance Sheet, 40-1
 B.B.C. Addresses, 410
 Orchestra, 26, 46, 159, 176-7
 Publications, 2-12, 151, 217, 229, 238
 Birthday Greetings, 140
 Braille, 149
 Bristol, 97
 Broadcasting House, 125, 251
 Brookmans Park (*see* London Regional Station).
 Bulletins
 Market, 413
 News, 242-5

C

- Calibration, 324-47
 Canada, 122
 Carnegie U.K. Trust, 237
 Children's Hour, 140-2
 Church Cantatas of Bach, 169
 Condensers
 Aerial Series, 345
 Logarithmic, 343
 Continental Relays, 44, 404-8
 Controversy, 219
 Councils
 Adult, 30, 236
 Schools, 233-5
 Crystal Set Designs, 348-53

D

- Dance Music, 105
 Davies, Sir Walford, 157, 234
 Detectors, 300-6
 Dial Readings, 339
 Dictionary, Technical, 435-59
 Direct Current Mains, 357
 Discussion Groups, 236-41
 Diversions, 202
 Drama, Broadcast
 Future of, 185-90

- Panel, 109
 Plays, 184, 191-3
 Sound Effects, 194-7

E

- Earthing the Set, 394
 Education
 Adult, 30, 236
 Schools, 233
 Eisteddfod, 174
 Empire Broadcasting, 29, 121
 European Frequency Plan, 342

F

- Finance, 35-41
 Formulae, Technical, 420
 Foundations of Music, 175

G

- Gale Warnings, 413
 Good Reception, 298
 Government, 26
 Governors, 23
 Gramophone Pick-up, 290
 Group Listening, 236-41

H

- Heaviside Layer, 266-7
 Heterodynes, 259-68
 Hospitals, 140

I

- International Broadcasting, 29, 44, 121,
 252, 397-402, 404-8
 Union, 29
 Ireland, Programmes, 146-8
 Isle of Man Week, 148

K

- Kent Experiment, 237

L

- Lambeth Conference, 252
 Licences
 Number of, 25, 30-3, 35
 Revenue, 36, 127
Listener, The, 6-7, 151
 Logarithmic Condensers, 343
 London Naval Conference, 121
 London Regional Station, 269-79
 Aerials, 271
 Batteries, 272
 Control Rooms, 278
 Motor Generators, 272
 Power House, 271
 Studio, 278
 Transmitters, 276
 Wavelengths, 279

M

- Mainland, Leslie, 145
 Mains
 Alternating Current, 354
 Direct Current, 357
 Maintenance—Receivers, 384

INDEX

- Market Bulletins, 245, 413
 Motor Generators, 272
 Music
 Bach, 169
 B.B.C. Orchestra, 159, 176-7
 Compositions, 412
 Critic, 153-5
 Dance, 105
 Foundations of, 175
 Halls, 105
 Light, 105
 Military Band, 181
 National Chorus, 164
 National Orchestra, 172
 Northern "Proms," 178
 Wireless Chorus, 166
 Musicians, 109
- N
- National Chorus, 164-6
 National Orchestra of Wales, 172
 News Bulletins, 242-5
 North Regional Station, 25, 251, 254
 Northern "Proms," 46, 178
- O
- Orchestra, B.B.C.
 Formation of, 30, 159-62, 176-7
 Outside Broadcasts
 Dance Music, 105
 Light Music, 105
 Music Halls, 105
 Public Ceremonials, 99
 Religion, 111
 Speeches, 100
 Sporting, 102
 Theatres, 105
- P
- Pamphlets, 151
 Piano Balance, 283
 Plays 184, 191, 198
 Poet Laureates, 225
 Poetry Broadcasts, 222
 Points of View, 220
 Power House, 271
 Power Supply, 354
 Prague Plan, 403
 Programme
 Alternative, 42, 387-92
 American, 133
 Analysis, 47
 Development, 43-6
 Events, 51-97
 Expenditure, 36-7
 Sponsored, 132-3
 Public Ceremonials, 99
 Publications, B.B.C., 36, 151, 217, 229, 238
- R
- Radio Circle, 140, 413
Radio Times, 2-3, 151
 Receivers
 Calibration of, 324-47
 Design of, 299-317
 Dial Readings, 339
 Maintenance, 384
 Power Supply, 354
 Wave Ranges, 319-23
 Regional Scheme, 25, 35, 38, 43, 137, 251
 Relays, International, 397-402
 Religion
 Lambeth Conference, 232
 Services, 111, 229-32
 Request Weeks, 140
 Road Reports, 245
- S
- School Broadcasting, 233-5
 Scotland, 136
 New Headquarters, 137-9
 Regional Transmitter, 251
 Selectivity, 328
 Shipping Forecast, 243, 413
 Sidebands, 259-68
 Simultaneous Broadcasting, 293-5
 Sir John Simon, 30
 S.O.S.
 Results, 248
 Rules, 413
 Service, 246
 Sound Effects, 194
 Speakers, 112-13
 Personality of, 211
 Speeches, 100
 Sport, 102
 Standard Symbols, 415-19
Starch Survey, 131
 Station Identification, 324-47
 Stock Exchange Reports, 245
 Stray Capacity, 342
 Studios, 125, 284, 137-8, 167, 251
 Symbols, Standard, 415-19
 Symposiums, Talks, 219
- T
- Talks, 112-3, 215, 219
 Tatsfield Receiving Station, 404-8
 Technical Tables, 420-33
 Theatre Broadcasts, 105, 252
 Time Signals, 117, 414
 Transmitters, London Regional, 276
- V
- Variety Artists, 107
 Vaudeville, 207
 Volume Control, 361-5
- W
- Wales
 National Orchestra of, 172
 Wavelengths 279, 403
 Weather Forecasts, 245, 413
 Wireless, American, 131
 Chorus, 166
 Industry, 26
 Singers, 166
 Societies, 411
World-Radio, 4-5, 151

*Published by the British Broadcasting Corporation, Savoy Hill, London, W.C.2.
 Printed by Richard Clay & Sons, Limited, Bungay, Suffolk.*

[No. 475]