

**TWO SIMPLE RECEPTION EXTENDERS THAT WILL IMPROVE ANY SET**

# Amateur Wireless

3<sup>d</sup>  
Every  
Wednesday

and  
Radiovision

**WHEN THE H.F.  
PENTODE IS BETTER**

**P. W. HARRIS ON  
SIMPLER WIRELESS**

**HIGH TENSION  
FROM THE MAINS**

**CHASSIS MAKING  
HINTS AND TIPS**

## Short-wave Adaptor/ Converter



## Add-on H.F. Unit



# Give Your Set a Tonic!

**A poor DETECTOR VALVE is a Brake on the performance of your Set**



The majority of broadcast receivers prior to 1933 used a Triode Detector. This valve may be said to be the 'key' stage in the set as upon its proper functioning depends the sensitivity, selectivity, quality of reproduction and general absence of background noise so essential to the correct working of a set.

**QUALITY of REPRODUCTION and ABSENCE of BACKGROUND NOISE.**

Absence of clarity in the reproduction or the presence of background noises can be removed by fitting a new Detector Valve. Long experience and attention to fine detail in the design of OSRAM Detector Valves has led to many improvements in mica bonding of the electrodes and special treatment to prevent parasitic noises.

Do not put up with inferior reception when your set can be so much improved by fitting a new OSRAM Detector Valve. There is a type for every class of broadcast receiver.

WRITE for the OSRAM VALVE GUIDE (1934 Edition). Sent post free.

**OSRAM DETECTOR TRIODES**

**HL2/K or HL2.....5/6**  
For 2-volt Battery Sets.

**HL210.....5/6**  
For old type "5-valve" portables.

**H210.....5/6**  
For OSRAM "MUSIC MAGNET" FOUR and OSRAM "FOUR" Sets.

**MH4 (CATKIN) or MH4...13/6**  
For A.C. Mains Sets.

**DH.....13/6**  
For 0.25 amp. D.C. Mains Sets.

# Osram Valves

MADE IN ENGLAND

Sold By All Radio Dealers.

## A TONIC TO ANY SET



Editor-in-Chief:  
BERNARD E. JONES

Technical Editor:  
J. H. REYNER  
B.Sc. (Hons.), A.M.I.E.E.

Radiovision Editor:  
H. CORBISHLEY

# Amateur Wireless and Radiovision

Editor:  
D. SISSON RELPH  
Research Consultants:  
W. JAMES and  
PERCY W. HARRIS  
M.Inst.Rad.E.  
Assistant Editor:  
ALAN HUNTER

Published by BERNARD JONES PUBLICATIONS, LTD., 58/61 Fetter Lane, London, E.C.4. Telephone: Central 4341 (four lines). Telegrams: "Beejapee, Fleet, London." Subscription post paid to any part of the world; 3 months, 4s. 6d.; 6 months, 8s. 9d.; 12 months, 17s. 6d. Published on Wednesdays and dated for the following Saturday.

## The "Big House" to Expand

WHISPERS that the "Big House" of the B.B.C. at Portland Place, London, is not big enough no longer draw such vehement denials from its chiefs.

For it is indeed palpably obvious.

If the London headquarters is big enough why St. George's Hall? Why No. 10 studio at the wharf? Why Maida Vale studios? Why is Henry Hall looking for a studio?

### Extension!

VERY soon now the B.B.C. will have to decide about its plans for extending Broadcasting House.

Already the Corporation has bought the two houses next door, and except for one occupant practically owns the whole of the island on which the House and the houses now stand.

### But How

IDEAS in broadcasting are changing so rapidly that the B.B.C. wants to be very certain this time it is planning studios of real service value.

Ornamental clocks and bizarre furnishings are not enough. The new studios must be built for the future technique of broadcasting.

This time the designers must use a little more imagination in planning for the future.

### Musical Broadcasts

WITH Maida Vale opened the musical side of broadcasting from London may be said to have solved its own problem. There is room for the largest conceivable orchestral combinations, as well as for the most ambitious choirs.

There is, too, ample room for a large audience—112 in the balcony seats and as many or more on the ground.

### Production Technique

ON the productions side—plays and the like—there is a growing school rejecting the complication of multi-studio technique, maintaining instead that only one or at most two studios are needed.

Suites of studios with dramatic control panels are therefore rather looked upon as *passé* by these advanced producers.

### Theatre Method

FOR variety and vaudeville broadcasting an entirely different technique is now deemed essential. As far as possible the



Here is the "Big House" at Portland Place—but it's not big enough! Plans are afoot to extend the building leftwards, where private residences now adjoin the existing accommodation

desire is to imitate the conditions of the theatre, but perhaps on a more intimate scale.

"Audience vaudeville," as advocated by the Director of Variety, is thought to have proved its appeal to the masses.

### Music Hall Coming

FROM these ideas the new Broadcasting House extension will be evolved. There will be, very probably, a miniature music hall seating at least 500 people.

In addition, there will be many more studios for productions.

### Oh, Douglas!

SO the merry Manxmen are gunning for a broadcasting station of their own? Maintaining that North Regional does not adequately serve their local interests.

At the same time advertising interests are seeking to capitalise the situation with thoughts of a sponsor station.

It will come to nought. Tynwald or not, our Postmaster-General is still the King of all the British Isles—ether—and that includes the Isle of Man.

### Recorded "Causes"

PERHAPS the most important—certainly the most controversial—series of broadcast talks this winter is "The Causes of War."

We are therefore interested to hear that they are being recorded especially for Empire consumption. Wax records will shortly be available from our head "blah" factory.

### If It's Foggy?

O.B. ENGINEERS have been shivering with gloomy forebodings while surveying the scene from the top of Westminster Hospital.

From their vantage point they have proved that a fog would spoil the commentator's chance of seeing the Royal Wedding procession below.

So they are praying that a "London particular" will not descend upon the *mis en scène* at the critical moment.

### Silent [Sic] Point

SAMARA, the Russian station tracked down as the culprit causing interference with North Regional, has been behaving better lately.

Apparently its engineers are in the habit of tuning to the silent point of North Regional's carrier and adjusting their station's wavelength to that.

All is well until a wobble occurs—then all is woe.

### Henry at No. 10

PENDING the completion of his special studio at Maida Vale,

Henry Hall has been allowed to box himself in with his band at No. 10 studio.

Apparently the wharf, after all the alarms and excursions by the bridge-demolition men, has been relieved for at least two more years.

### Sound-proofed!

ALREADY work has started on the sound-proofing of the main orchestral studio at Maida Vale from the proposed extra studios for vaudeville, dance-band and other purposes.

The vaudeville studio will be of the intimate type, with room for only a very select audience.

One guaranteed to clap hands at the right moment, we suppose. Ha, ha!

### Overseas Response

THANKS to the Empire stations some of the Week's Good Causes are now bringing in contributions from many parts of the world.

When the recent appeal in the British Empire Cancer Campaign was made, a large proportion of the response was from overseas.

Incidentally, the Empire section receives over 1,000 letters every month from different parts overseas.

### An Old One

JUST to make sure not even a little corner of the world misses a word of the King's Christmas message this year, the B.B.C. is bringing into action dear old G5SW, the Chelmsford short-waver that preceded the Daventry short-wave stations.

Of course, both Daventrys will be going, too.

### Empire "Shots"

IN this programme we shall hear successively a lumberjack in Canada, a native chief in South Africa, a colonel in the Indian Army at the Khyber Pass, and a bather or surf-rider from the beach of Sydney, Australia.

Gives you an idea of what this Empire really means!

### Bells, Bells, Bells

DID we say bells? No lack of them in the Christmas programmes.

First, the bells of Bethlehem, as last year. Then the bells of the Commonwealth. Finally, Big Ben, star bell of all.

**DON'T MISS OUR SPECIAL CHRISTMAS NUMBER NEXT WEEK!**

# Not a Super-het!

THIS is the first time that I have written to you as a Crusader," says CCI265. "Apparently the design of the new Crusaders' set, which is to appear in January, is arousing a lot of interest, which is only right.

"May I offer some suggestions for the design, which summarises my ideal set? It should have a straight circuit, be selective and give really good quality.

"The circuit should have two high-frequency variable-mu pentodes, double-diode-triode, and class B of the biased type or Q.P.P., with the new double-pentode.

### Question of Quality

"A super-het is not perfect unless it is expensive from the quality point of view, whereas the straight set can be made as selective with the freedom from whistles and background noises, which the cheap super-het is characterised.

"The tuning of the straight set can be looked after by the new 4-gang Varley permeability tuner, with the band-pass coupling placed between the two high-frequency pentodes.

"It should be provided with A.V.C. or delayed self-adjusting volume-control, a volume control on the low-frequency side, tone-control and reaction to obtain the maximum performance from the set.

"The whole circuit should be designed for really good quality to do justice to a speaker such as the W.B. Steñorian Senior.

"It should be provided with pick-up terminals or built up as a complete radiogram.

Power supply should be provided by batteries, as the majority of listeners are not on the mains yet.

"The high-frequency and low-frequency amplifiers should be separate units and connected by means of a 5-pin plug and cable. The low-frequency amplifier unit would only comprise the driver and class B stages. It could then be used for any tuning system such as the manner which CCI356 suggests.

"Chassis construction of the high-frequency unit should be adopted for compactness, neatness and greater stability and efficiency. Either metalised wood or aluminium may be used, but the former is recommended as it is more convenient to use with the average tools available. A separate speaker is advised.

"Finally, a really good short-wave super-het converter for use with the above for listening to America when the B.B.C. programmes fail.

"I quite realise that the above circuit will be rather expensive to build up, but seeing that it is to be the first star set of 1935, such a circuit will be a good start for the New Year, and as such, is fitting for the first set of the year. *What do other Crusaders think about it?*

### Sets of Renown

"The first of your sets that I built up was the 1932 Ether Searcher, which is still in use at home now, but will be scrapped within the next month. Meanwhile, being on my own, I built the Melody Ranger, which was scrapped after seven months and the Signpost Four took its place. The present set which I am using has no name, but was developed from the Signpost Four. The only similarity between

the two is the J. B. Linacore Unit. It now incorporates a high-frequency pentode, a double-diode-triode and class B with tone-control and reaction.

"Incidentally, I was using reaction with the double-diode-triode three months before you published the Crusaders' A.V.C.4. This will be scrapped and a set built upon the lines I have previously stated will take its place, as I have a 4-gang tuner on order and have been waiting for it since Radiolympia. The performance and especially the quality of the one in use now is very good.

### Amplifier Experiments

"At present I am experimenting with the low-frequency amplifier to improve its quality for records and its output. I am endeavouring to obtain an output of 4 watts from parallel class-B valves.

"I place really good quality from a few stations above obtaining hundreds of stations at mediocre quality. If any Crusader is interested in my present circuit and the results of my experiments in volume output, or if you are, I shall be pleased to let them have particulars if they will enclose a stamped-addressed envelope.

"I think that if every Crusader were to pool their knowledge and results of their experiments the Crusade would progress more rapidly and get stronger.

"Now, what about letting us have designs for test instruments such as valve-voltmeters, modulated oscillators into which a pick-up can be fed and so forth? I for one would be pleased to see them appear and build them."

# Constructor Crusaders . . . . . Get Four Full-size Blueprints Free!

## THE PRIVILEGES OF MEMBERSHIP

- 1.—Immediately on enrolment every Constructor Crusader receives free full-size photographic blueprints of the All-Britain Three (described October 6, 1934) and of the Crusaders' A.V.C.4 (published August 18). He will also receive a free blueprint, immediately on publication, of the two "Amateur Wireless" star sets to be released on January 23 and March 13, 1935.
- 2.—Every member will also be entitled to free technical advice in connection with any or all of the four special Crusader sets mentioned above (each query must be accompanied by a stamped and addressed envelope for the reply). In the case of queries regarding any other "Amateur Wireless" sets the usual rules of the Information Bureau must be observed.
- 3.—All Constructor Crusaders are invited to contribute ideas and suggestions to the Constructor Crusaders' Corner. Constructive suggestions will be specially helpful and will be interpreted by the "Amateur Wireless" Technical Staff as far as possible to the advantage of all set builders.
- 4.—Immediately his application for membership has been approved every Constructor Crusader will receive a certificate of membership. Note that the membership number must be quoted in all future correspondence.
- 5.—Constructor Crusaders will be authorised to wear the badge of membership. Badges for buttonhole wear can be obtained for 1s. extra each, post paid.

To Constructor Crusaders, "Amateur Wireless,"  
58-61 Fetter Lane, London, E.C.4.  
(Enclose in envelope bearing 1½d. stamp.)

Please enrol me as a member of the Constructor Crusaders. I enclose postal order for 1s. to cover postage on four free blueprints and office expenses (and also an extra 1s. for buttonhole badge).\* It is understood that I shall be entitled to free technical advice on any matters concerning the four free blueprint sets. My name and address are:

December 1, 1934

Value of Postal Order Enclosed	For office use only.			
	No.	C	B	L
.....				
*Delete if not required				



# The Range Extender

Simple unit that can be added to any existing broadcast set to increase its range. Especially useful for detector and low-frequency sets. Also good for sets with one high-frequency stage, such as the Lucerne Ranger. This is a design we have been asked for by many readers. It will always improve the set's range and often increase the selectivity, thanks to the iron-core tuning coil and series aerial condenser

**B**EFORE we describe the construction of this unit, let us clear up the facts about range.

All too often it is imagined that range in wireless reception is merely a question of a set's sensitivity; that, for instance, a detector and low-frequency-amplifier set's range is certain to be greatly enhanced by the addition of high-frequency stages.

Up to a point this is obviously true. Only up to a point, though. Given enough amplification—and enough patience—practically any station may be said to be “within range”, at some time or another. That does not mean every station in the world is yours for the asking, though.

### Initial Strength

For the truth is that reception depends not only on the amplification of the signal as it arrives on your aerial, but on the initial strength of that signal at the moment of arrival.

Always remember that when a signal arrives—if anything can be said to “arrive” when it travels a relatively short distance with the speed of light!—it is not the only bundle of



We have taken this pretty little picture simply to show smallness of the unit when placed in its cabinet. Of course it is never used alone, as shown, but connected to a wireless set to increase range

energy to do so. There are a hundred and one other disturbances in the ether, some of which will come into tune at the wanted signal's frequency.

If the signal's field strength at the receiving aerial is good the other noises will not worry you, simply because, being so very minute, they will not be amplified up to audible level. Supposing, on the other hand, the field strength of the wanted signal is small—as it may well be when the signal is coming from a long distance, the amplification needed to give good output volume will be so great that the little noises will come right up to audible level—and spoil the wanted programme with an annoying background.

Between the two extremes of the strong locals and the very weak foreigners there are, of course, dozens of stations

As this plan view shows, the high-frequency pentode valve is fitted horizontally to save baseboard space. Just by the valve holder is the high-frequency bypass condenser

that have a reasonable ratio of field strength to other noises at your receiving aerial—at least, after dark.

These, and these only, are the signals worth worrying about for programme alternatives. Maybe a detector and low-frequency amplifier set will not bring up such signals to full strength—this may even happen with a set having a stage of high-frequency amplification.

### Extra Stage Justifiable

Then an extra stage of high-frequency amplification is justifiable. Indeed, any amplification is justifiable on signals that are moderately strong but not quite strong enough to be heard at full loud-speaker volume.

Moreover, with an extra stage of amplification goes an extra tuning circuit. The selectivity of this circuit, if it is a good one, will often help to get several more stations at programme value, because it will help to get them clear of adjacent-wavelength interference.

Having cleared the air a little as to the exact function of a high-frequency amplifying unit, here goes with the description of a one-valve high-frequency amplifier.

Especially is it useful for detector and low-frequency-amplifier sets, but many listeners living in rather out-of-the-way districts will find it a useful adjunct for a set of the Lucerne Ranger type. For sets, that is, with a stage of high-frequency amplification.

Even if the range is not vastly increased, the set will be much easier to operate, since entire reliance will not be placed on a critical adjustment of the reaction control.

### Variable-mu Pentode

For a moment, then, let us examine the theoretical circuit diagram. It shows a variable-mu high-frequency pentode valve, connected up in the most modern way to give an enormous amount of high-frequency amplification, at the same time involving no loss of selectivity.

In designing a unit of this type we have to bear in mind the need for connecting it as simply as possible to the existing set; and of making the tuning circuits of the existing set do their part in the whole hook-up.

Now the first circuit of any ordinary set is the aerial tuning, which consists of a grid-tuning coil and condenser arrangement of average selectivity. The idea of this unit is to

## BUILD WITH A FULL-SIZE BLUEPRINT!

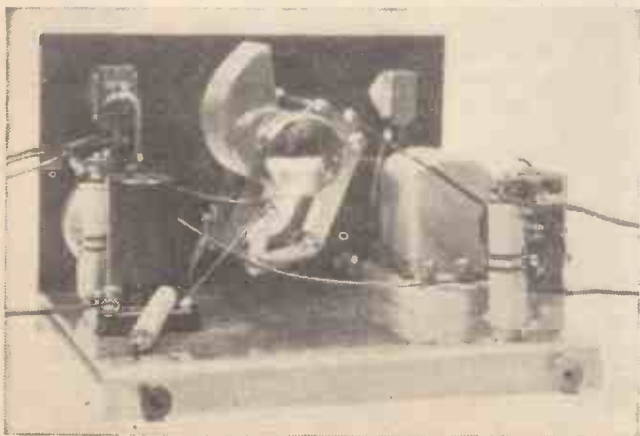

Only two terminals at the back, one for the aerial lead and the other for the lead going from the unit to the aerial terminal of the set whose range it is desired to extend



HALF-SCALE REPRODUCTION OF THE FULL-SIZE RANGE-EXTENDER BLUEPRINT

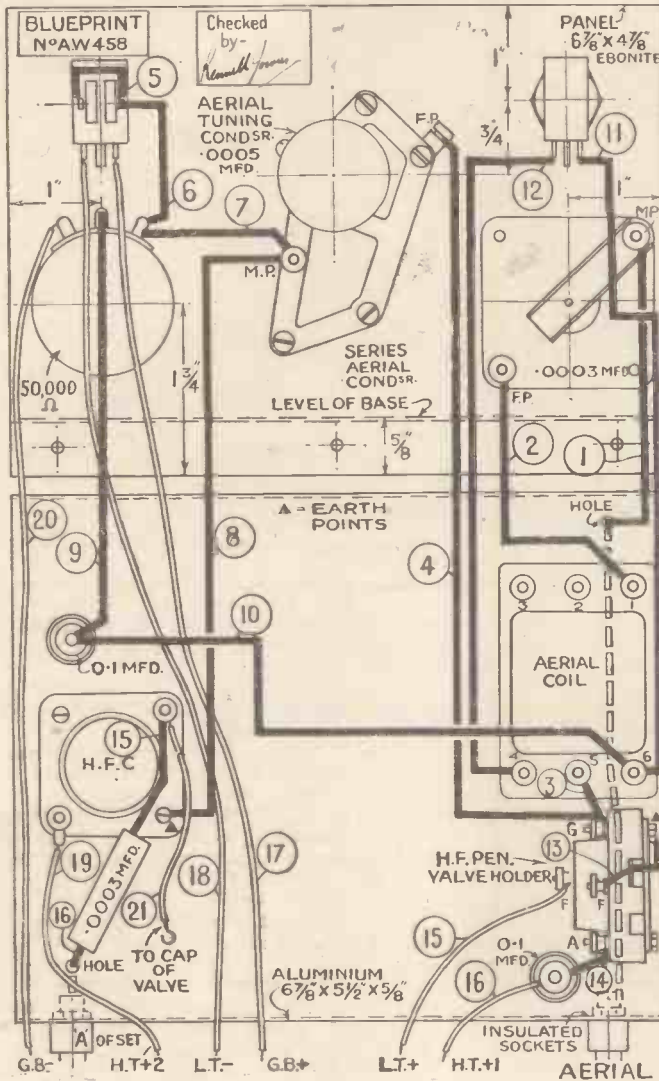

condenser to the parallel tuning circuit connected across the grid and filament of the following valve.

The second half of this coupling is already provided by the aerial-tuning circuit of the set, so that all we need is the high-frequency choke and coupling condenser for the unit.

The theoretical circuit diagram shows this very clearly. There is a high-frequency choke going to H.T.+2, and a .0003-microfarad condenser going from the anode to the terminal A—which goes on to the aerial terminal of the set.

The input tuning of the high-frequency pentode is well worth studying. We have used an iron-core tuning coil of the dual-range type, with external two-point switch for going over from one waveband to another. Across this is the usual .0005-microfarad tuning condenser, while the input is actually through a bakelite type variable condenser and an untuned primary winding.

Altogether, then, it is a selective aerial-tuning circuit—and one that offers scope for critical adjustment during actual reception.

The rest of the circuit is designed to give the variable bias for the high-frequency pentode, and to decouple the valve so that it works with complete stability with all kinds of sets.

Thus you will see that there is a 50,000-ohms

There is a metal baseplate fitted at right angles to a small ebonite control panel. On the panel at the centre is the single tuning condenser, left of it the series aerial condenser, right of it the volume control. Two small switches are at the top for on-off and wavechanging.

As can be seen, the high-frequency pentode is mounted horizontally on the baseplate in a four-pin holder. The terminal at the top of the bulb is, of course, the anode.

Screened Iron-core Coil

At one end is the screened iron-core coil, close to the series aerial condenser and the business end of the valve. The high-frequency choke is at the other end, with the coupling condenser.

It is all very simple if you take a look at the blueprint, a half-scale reproduction of which we give here.

When the unit has been assembled it can be connected up to the existing set with the greatest of ease. Take the battery leads either direct to the batteries of the set or to the corresponding battery terminals on the set. Simply remove the aerial lead from the set and connect to the aerial socket on the unit. That leaves only the A terminal of the unit to connect to the aerial terminal of the set.

Parts You Will Need for the Range Extender Unit

- BASEPLATE**  
1—Aluminium, 6 7/8 in. by 5 1/2 in. by 3/8 in. (Peto-Scott).
- CHOKE, HIGH-FREQUENCY**  
1—Telsen, type WH54.
- COIL**  
1—Dual-range iron-core screened (Formo A1).
- CONDENSERS, FIXED**  
1—.0003-microfarad, type tubular (T.C.C. or I.M.C., Dubilier).  
2—.1-microfarad (Formo, screened-paper type).
- CONDENSERS, VARIABLE**  
1—.0005-microfarad with slow-motion (J.B., type Popular Log).  
1—.0003-microfarad (Grabam-Farish).
- HOLDER, VALVE**  
1—4-pin baseboard mounting (W.B., or Telsen).
- PANEL**  
1—Ebonite, 6 1/2 in. by 4 1/2 in. (Peto-Scott).
- PLUGS, TERMINALS, ETC.**  
2—Insulated sockets and plugs, marked: Aerial, Aerial 1 (Clix or Goltone).  
4—Wander plugs, marked: G.B.—, G.B.+ , H.T.+1, H.T.+2 (Clix or Goltone).  
2—Spade terminals, marked: L.T.+ , L.T.— (Clix or Goltone).
- RESISTANCE, VARIABLE**  
1—50,000-ohm (Erie, or Lewcos).
- SUNDRIES**  
Connecting wire and sleeving (Goltone).  
3 yd. thin flex (Goltone).
- SWITCHES**  
1—Two-point shorting (Bulgin, type S80).  
1—Three-point shorting (Bulgin, type S87).
- ACCESSORIES**
- BATTERY**  
1—9-volt grid-bias (Drydex).
- CABINET**  
1—National Radio Service.
- VALVE**  
1—Cossor 210VPT (met).

(Above) Half-scale reproduction of the full-size blueprint, which can be obtained price 1s., post paid, from us on request. (Right) Control is quite easy, with a centre knob for tuning, a series aerial condenser hidden by the hand and a volume control on the right. The two switches are for wavechanging and for battery on-off

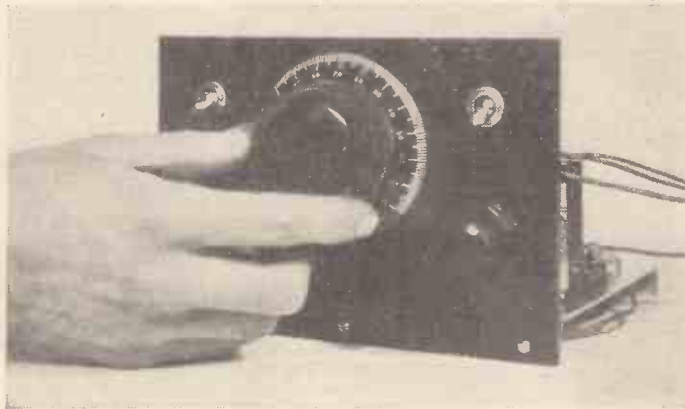

leave such a circuit just as it is—but instead of the circuit being for the aerial tuning it will be part of the inter-valve coupling between the preceding unit's high-frequency-amplifier valve and the first valve of the set—whether that is a high-frequency amplifier or a detector is immaterial.

Perhaps one of the most-used systems of high-frequency coupling is choke-fed tuned-grid, whereby a high-frequency choke is placed in the anode circuit of the high-frequency valve, while the signal energy is fed through a

“pot” across the grid-bias battery, and that a three-point switch is arranged to cut out this battery when the filament supply is cut off—thus preserving the battery from the current drain that would otherwise be imposed.

There is no high-tension negative terminal. If the unit's supply is commoned with the set there is no need for this connection. Nor is there any point in putting in an earth terminal, for the earth connection on the set serves for the unit, too.

About the construction we need say little.

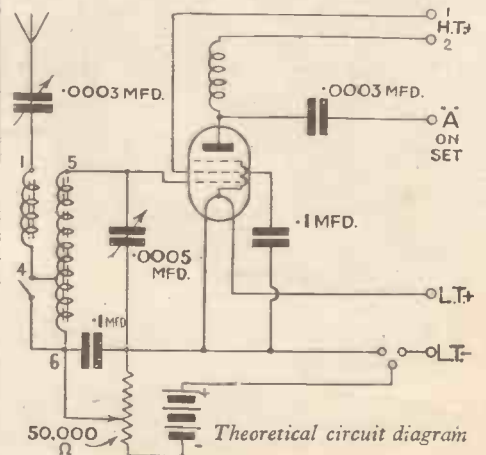



# When the H.F. Pentode Is Better

Both theoretical calculations and practical experience have now proved beyond doubt that the high-frequency pentode type of valve does give more amplification than an ordinary variable-mu screen-grid type when suitable coils are used

YOU have, of course, noticed that every modern receiver or circuit employs high-frequency pentodes for the high-frequency, and (in the case of super-hets) for the intermediate-frequency amplifier stages in place of the older screen-grid valves.

Perhaps you have wondered whether there is so much in the vaunted superiority of the high-frequency pentode or whether it is just another stunt—a changing fashion.

### Advantages Really There

If you have been assailed by any such doubts, please set your mind at rest, for both theoretical calculations and practical experience reveal that the advantages are really there.

Let us consider, first of all, the obvious question of amplification—for, after all, that is what the valves are used for. You realise, of course, that the degree of amplification is governed to a great extent by the amplification factor of the valve, so that since the amplification factor of a high-frequency pentode is demonstrably higher than that of a screen-grid valve, one would naturally expect an improvement in overall amplification.

There is another side to the question. A high-frequency amplifier stage is not merely a valve, it is a valve plus the following tuned coupling circuit, and the overall amplification, or stage gain, as it is called, depends not only upon the amplification factor of the valve but also upon the impedance of the valve and of the coupling circuit.

### Our Old Friend

The actual formula for stage gain is our old friend:—

Stage gain equals:—

Amplification factor of valve multiplied by Impedance of coupling divided by Impedance of valve plus Impedance of coupling.

It will, therefore, be clear that the higher the coupling impedance compared with that of the valve (within certain fairly wide practical limits), the greater will be the stage gain.

Now, it is not difficult to work out the stage gain obtained with different valves and with couplings of various impedances, but it is a rather tedious process, so we have done it for you and present the results in the graph.

Here you will see two curves from which can be determined the stage gain to be expected with either a screen-grid valve or a

high-frequency pentode in conjunction with coils of varying efficiency. To make the comparison quite fair we have selected two battery valves of the same make—a Mullard 2-volt "straight" screen-grid valve, and a Mullard 2-volt variable-mu high-frequency pentode operating at its point of maximum sensitivity.

You will notice two things about this graph. In the first place, the high-frequency pentode is considerably better all along the line. That in itself is sufficient proof that this type of valve represents a real advance in valve technique.

Then, and still more important, the advantage which the high-frequency pentode shows over the screen-grid valve is larger for high-efficiency coils than for less efficient coils.

This means that the high-frequency pentode, and the high-frequency pentode only, can take full advantage of the latest improvements in coil design. As a matter of fact, it is scarcely worth while spending good money on the latest and best coils unless you are going to use them in conjunction with high-frequency pentodes.

It is in connection with this last point that the value of the high-frequency pentode mainly lies. You will not require to be reminded that a 100-per-cent. increase of stage gain does not by any means represent a 100-per-cent. increase of volume, although it certainly does mean a noticeable audible improvement.

If, therefore, we compare what was fairly normal practice up to, say, eighteen months ago, namely a screen-grid high-frequency valve in conjunction with a tuned circuit of something under 100,000 ohms impedance, and a present-day high-frequency pentode working with a really efficient tuned coupling, the gain in amplification becomes really considerable.

### For Detection

Still more important is the improvement when, as in so many modern "straight" sets, the detector stage also makes use of a high-frequency pentode in place of the more conventional triode.

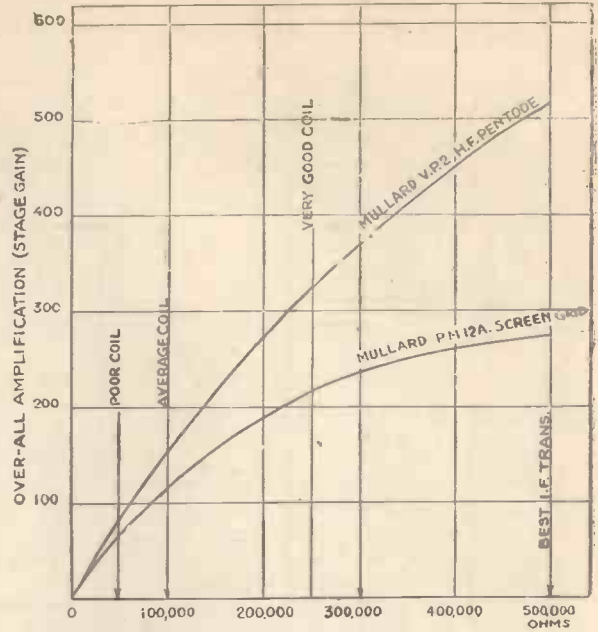

COIL "GOODNESS" AS MEASURED BY THE IMPEDANCE OF THE TUNED INTER-VALVE COUPLING

This graph shows how an increased stage gain is obtained from a high-frequency pentode as compared with an ordinary screen-grid type of valve

The cumulative effects of all these improvements—more sensitive valves and more efficient couplings—is mainly responsible for the very high performance of present-day "straight-three" receivers.

This increased efficiency can be applied to various purposes, according to the policy or requirements of the designer or maker. For example, if great volume is the goal, the increased gain can be passed on, stage by stage, to the grid of the last valve, and will be finally translated into increased output.

### Compensating for Losses

If increased range is wanted, the greater sensitivity of the early stages will greatly assist, for it can be applied in part to improve overall sensitivity, and in part to compensating for the losses inherent in most devices which are adopted to improve selectivity.

Finally, if high-quality reproduction and simplicity of control are the chief considerations, high-frequency pentode stages with their improved amplification will permit reaction to be dispensed with and thus, in one stroke, will reduce the number of controls by one, minimise the risk of distortion and avoid the necessity of making delicate adjustments to tuning every time the volume control is varied.

### Our Xmas Number

Next week "Amateur Wireless" will be full of good cheer—a Xmas Number with many special features; in particular

### TWO XMAS SETS

will be fully described. Make one of them in time for the festive season!

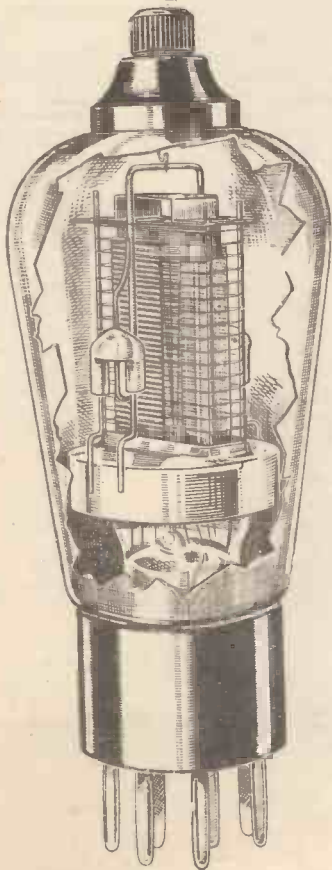

Mullard type VP2 variable-mu high-frequency pentode valve, with part of the bulb removed to show the electrode system



This Ekco model AC85 is typical of the new simplicity in control—note—the large and easy-to-read tuning scale forming a semi-circle round the robust tuning knob. Certainly towards simpler wireless!

LATELY I have been rather given to wireless day-dreaming, not because I have nothing better to do, but because all around me I see a growing and unnecessary complication which tends to obscure the essentials on which progress is based. Several readers have been kind enough to write an appreciation of these occasional notes of prophecy, and I am, therefore, venturing a few more.

#### What I Believe

I believe the wireless set of the future will be as simple as the present one is complicated. Take the back off a modern receiver and one cannot but feel appalled at the multiplicity of circuits, the double-diode pentodes, the innumerable subsidiary circuits, each of which has to get rid of some defect or other which should not occur, and the criminal waste of power, about which I have written quite recently. And all for what? Just to take one signal—and one signal alone—and magnify it up strong enough to give a pleasant sound in a room.

As an example of a receiver which takes the longest possible way home and uses the utmost complexity to do the simple things, commend me to the superheterodyne. It was invented by a French non-commissioned officer connected with the wireless branch during the war, as a means of giving stable high-frequency amplification, and not with any idea of obtaining selectivity.

#### Reasons for Instability

Attempts to get much gain on ordinary wavelengths with the sets then available led to instability, the reason being, as we now know, that feed-back effects brought about self-oscillations. As one reduced the frequency (increased the wavelength) these feed-back effects became less and less objectionable until on the very long waves quite a reasonable amount of stable high-frequency amplification could be obtained. By the ingenious idea of heterodyning the short-wave signal by another so as to give a long wave for the intermediate

frequency, more high-frequency amplification than had previously been possible was readily gained.

#### The Neutrodyne

With the invention of the neutrodyne by Professor Hazeltine and later the development of the screen-grid valve, the necessity of transferring the signal from the medium to the long wave in order to get stable high-frequency amplification no longer obtained.

You heard little of the superheterodyne for several years, for it has disadvantages as well as advantages, and then began the superheterodyne period of wireless design, incidentally for quite a different reason from that which for it had been originally invented.

Selectivity becoming more and more pressing in its demands, more and more tuned circuits became necessary in order to get this selectivity, and while the ganging of two or three circuits does not present very great or insuperable commercial difficulties, anything much beyond this becomes too tricky for low-price quantity production.

You see, by transferring your signal to a fixed intermediate frequency you use a number of fixed condensers for tuning, instead of ganged variables. Single-control receivers became easier to make because the commercial bugbear of "matching" did not rear its ugly head. The "super" looked a nice easy solution of the manufacturers' problem, but soon a whole new crop of troubles arose.

#### Difficulty of Frequency

First of all, it is necessary to choose a suitable intermediate frequency, and here you are up against a lot of difficulties. You must choose one which is not exactly equal to the difference between two important stations within range, for if this is chosen you will receive both simultaneously.

One will be much stronger than the other, but there will be a background of interference, due to the fact that your local oscillator frequency producing the beat will be the same as the other station frequency and both will produce the beat or intermediate frequency, one distorted and the other undistorted. Similarly if your intermediate frequency is half the spacing between two stations in range, both will also be brought in simultaneously. The station to which you are tuned will come in the stronger, but unless you have a very high intermediate frequency the other station will also come in objectionably.

With always every available channel packed with two or three stations somewhere or other, the choice of an intermediate frequency is an extraordinarily difficult one and somewhere or other on the tuning scale you are bound to get squeaks and howls due to this kind of interference. However, the modern manufacturer,

by careful searching, is able to find a fairly satisfactory intermediate frequency and he gets rid of the "second-channel interference" by putting a highly selective circuit or circuits before the mixing circuit, thereby adding one more complication to get rid of an inherent defect in the superheterodyne circuit itself.

And then there are all kinds of troubles with the mixing circuit and the ganging of the oscillator with the tuning condenser so as to keep a constant frequency difference. The oscillator valve is just a "passenger" necessary for the circuit, so in recent sets it has been combined with the first detector valve into a multi-electrode device, which saves some space and money, but has its own disadvantages.

#### More "Noisy"

Furthermore, when you come to the second detector, which is preceded by a fairly low intermediate frequency, it is much more difficult to keep this intermediate frequency out of the audio amplifier than it is to keep out the ordinary medium-wave signals, and frequently quality is spoiled by the necessity of shunting fairly large condensers across the detector output. Generally speaking, too, a superheterodyne circuit is more "noisy" than a straight circuit, for reasons that I have not the space to describe here.

So, you see, the superheterodyne circuit is a most elaborate affair, which exists simply to make it easy to construct a multi-circuit receiver without the necessity of ganging all the condensers. Is there no way of getting away from all this complication? I asked the question earlier, what are the essential parts of a wireless receiver?

All we really need is one circuit sufficiently sharply tuned to eliminate the signals we don't want; one valve which will magnify the signals enough; some form of rectifier (which need not be a valve) in order to turn these high-frequency signals into audio-frequency currents; and a device, such as a loud-speaker (which need not necessarily be of the present form) to make these currents audible as sound.

#### Corrected Distortion

A year or two ago all the experts told us bluntly that very sharp-tuned circuits were impossible for use with telephony owing to distortion, but it has now been shown that this distortion can be corrected without losing the selectivity. Nobody yet knows of a single circuit which will give the necessary selectivity except the quartz crystal, which has the great disadvantage that its frequency is fixed and cannot be varied over the wavelength scale.

Only for this reason is the superheterodyne circuit used with quartz crystal in some Stenodes, for if you wished to receive from one station only, and that station had a constant frequency, the quartz crystal can be connected to the first tuning circuit without complication.

Extraordinarily good work has been done in recent years with iron-dust cores, in this way producing circuits of such a low damping that they would have been thought impossible a year or two ago. Have we finished progress in this line? I certainly do not think so.



# On Your Wavelength

The Week's Radio Gossip :: By THERMION

## A Radio Friendship

LAST week I met for the first time in my life a man who has been a friend of mine for over a dozen years. This may seem a queer statement, so I will tell you how it all happened.

When "A.W." was an infant but a few months old I wrote a paragraph deploring the noisiness of high-tension batteries, many of which were rather cranky affairs in those days. A month later I had a letter from America. It came from Mr. W. B. Schulte, vice-president of the Burgess Battery Company, who told me that he was sending me a battery from which he had had all the crackles carefully removed!

The battery duly turned up, and proved to be a very good 'un. I wrote to thank him, and since then we have corresponded regularly, forming a close friendship.

## American Wireless Ideas

FROM Mr. Schulte, when we met, I learnt a heap of interesting news about the present state of wireless in the United States. One thing that he told me indicates clearly the great difference in the march of radio in the two countries.

Americans are not and never have been model-builders (in the whole of the United States there is no shop dealing in parts of model engines, ships, and so on) and very few of them know the first thing about the insides of their cars. This has had two important effects on wireless. First of all the home construction of sets was never very popular in the States. Secondly, those who buy wireless sets are quite unable to appreciate the improvements and refinements made from year to year by manufacturers.

Over here, buyers of sets discuss with the salesman the advantages of S.A.V.C., band-pass tuning, visual-tuning indicators, and so on as a regular thing. But in the States men and women just buy radio sets and leave it at that.

## Lyons' Hefty Signals

PROBABLY you have noticed that though the 463-metre Lyons station still appears as La Doua and is given in the lists as having an output of only 15 kilowatts its signals are coming in very strongly; in fact on some nights they are about as hefty as anything that comes from the Continent.

The new 150-kilowatt Tramoyes transmitter at Lyons is, I feel sure, pretty frequently at work just now, and that is why signals are so immense. This is one of the French Government stations under the new regional scheme.

Another is Toulouse Muret, which is due to start in at any time now. When these two stations are fully at work, France, with Radio-Paris, the

Poste Parisien and Fécamp as well, will be about the most fruitful of European countries for the long-distance listener.

We'll be grateful for the French programmes—we'd be still more grateful if the French Government would close down some of its wavelength-wandering nuisances.

## A Queer Radio Law

ONE of the weirdest wireless laws I have yet come across in my meanderings is that recently made by the Hungarian Government. It forbids Hungarians to listen to what is considered to be the wrong sort of propaganda from other countries. Political speeches of the subversive type are particularly banned.

It has always seemed to me that it is no use making laws unless you can enforce them, and for the life of me I cannot see how the imprisonment lavishly promised by the Hungarian law could ever be enforced.

Perhaps the Government intends to allow only special sets to be used. These would be fitted with special filter circuits making it impossible to receive on the wavelengths on which the reprehensible foreign stations work.

The whole business seems rather silly, and I expect that the chief result is that many Hungarian thumbs are being applied to the noses of their owners.

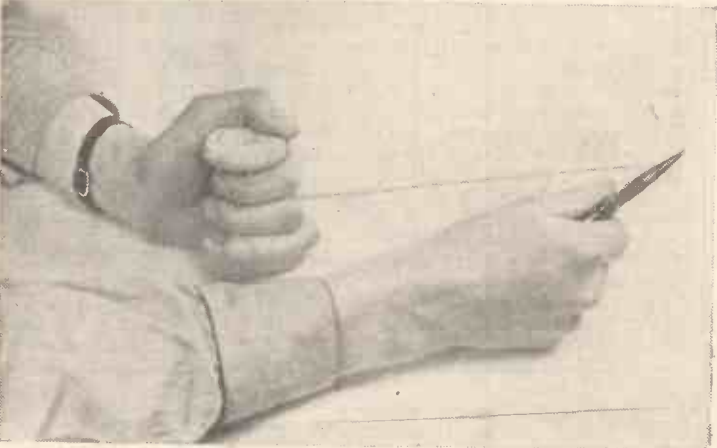

Before you attempt to wire up your new set, take care to stretch the wire on the reel. This can be done with a pair of pliers, as shown above, and then cut the wire into 2-ft. lengths ready for the job

## Cutting It Out

IT's not perhaps generally realised that a very large proportion of the interference that takes place with wireless reception is brought in by the electric-lighting mains. They act as collectors and impulses due to interference are imposed on the current that they carry.

It is often possible to reduce interference enormously by the simple expedient of fitting a couple of condensers in series across the mains close to the point at which they enter the house and earthing the centre of the network.

Several firms make up little devices on these lines—the original design comes from the General Post Office people—which incorporate both safety fuses and condensers capable of standing up to the voltage. Their cost is quite small and they are jolly well worth every penny of it.

## Plenty of Variety

IF you want variety in your hobbies, take a hint from me and start dabbling in television: it is surprising what a number of subjects are included in this infant science. Wireless, of course, enters into it very largely, and one great attraction to me in this respect is that you can see the results of your work.

Then there is plenty of scope if you are of a mechanical turn of mind and any amount of opportunity for ingenuity. If you are a short-wave fan, it opens up a new field, as several experimental transmissions are now being put out round about 7 metres. Incidentally, I see there is a description of a novel 5 to 10 metres receiver in the December issue of *Television*.

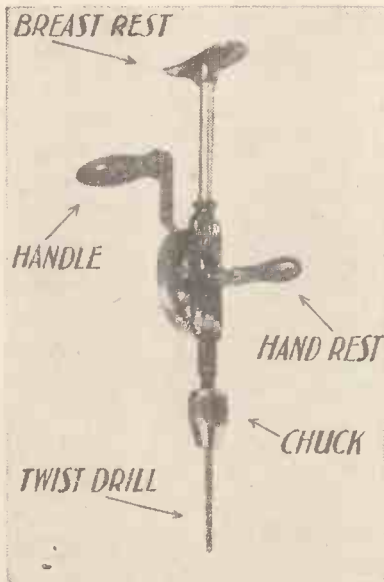

The constructor's friend—a breast drill to take twist drills. This tool will help you not only for panel- and-baseboard sets, but with metal-chassis constructions

## Report Wireless Interference

INTERFERENCE with wireless reception is becoming so bad in many localities now that readers should determine to do all that they possibly can to stop it. At present we have no laws on the subject, but undoubtedly we shall have some time. Wasn't it an eminent Frenchman who said: "English laws are the best in the world, but they always come ten years late"?

Though legislation is still lacking, the Post Office is doing very good work on behalf of listeners. Here's the way to enlist their aid if you are troubled by crackles, fizzes, hums, moans, and so on due to radiation from

"A.W." Reference Sheet.—No. 9.

## Automatic Battery Grid Bias

A RATHER useful example of the application of Ohm's Law is given by the method used to obtain the necessary values of resistance, for automatic grid bias. It will be remembered that when a current flows through a resistance a certain voltage is dropped; this forms the basic principle of all forms of automatic grid bias.

In the circuit shown it will be seen that a resistance has been inserted between the negative high-tension and negative low-tension leads. Remembering that the anode current path is not complete until a return is made to the filament, it is obvious that the resistance must handle the full amount of current flowing.

This will cause a voltage drop which means that the high-tension negative side of the resistance will be so many volts negative (or below earth potential) in respect of the filament, which is connected direct to the common earth line.

It is this negative voltage which is used for the grid bias, and its amount will depend on the value of the resistance and the amount of current flowing.

The grid circuit is completed via the transformer secondary to the negative high-tension and according to the makers' specification the valve needs a bias of 10.5 volts.

We now have to find out the total current taken by all the valves. This can easily be determined by reference to the makers'

characteristic curves or details. We will assume that the total current consumption is 10 milliamperes, and from the previous Charts we know that

$$\text{Resistance} = \frac{\text{Volts} \times 1,000}{\text{Milliamperes}}$$

therefore, in this case, we have

$$R = \frac{10.5 \times 1,000}{10}$$

which equals 10.5 by 100, equals 1,050 ohms.

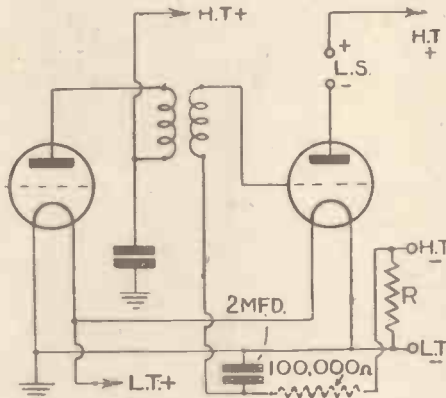

Circuit for automatic grid bias with battery-operated valves

### Compact Car-Radio

I REFERRED some time ago to the reappearance in Germany of the old reflex type of circuit, in which the same valve is made to serve both as a high-frequency and low-frequency amplifier. In that particular instance the object was to save expense by producing a three-valve super-het.

The same principle is now being used in America to produce a specially compact set for listening-in on the road. As space is pretty limited in the ordinary type of motor-car anything which helps to preserve elbow-room is all to the good.

In the original reflex circuit it was usual to pass the incoming signal currents through the first and second high-frequency valves to the rectifier, and then feed back the low-frequency components through the same valves in the same sequence.

The American designer, however, prefers to use "reverse" reflexing, in which the rectified currents are fed back to the second valve before the first. In this way the first valve, which handles the comparatively weak input signal, takes the heavier low-frequency currents, and vice versa, so that the total load is more evenly divided between the valves than it is in "straight" reflexing.

### More Static

THE steady growth of the electric grid system is beginning to make the problem of "artificial static" a live issue in many country districts which were formerly free from this kind of interference. In most cases the trouble is due to the insulators used for suspending the cables from the pylons.

Owing to the high electric stress set up across the air gap formed between the overhanging "skirts" and the main body of the insulator, small spark and "corona" discharges are liable to occur both in fine dry weather and in heavy rain.

The resulting high-frequency currents get into the power lines and in this way are distributed over a wide area. Recent investigations have, however, shown that the mischief

can be largely prevented by metal-spraying parts of the outer surface of the insulator.

### Visualising Impedance

IT is fairly easy to form a mental picture of the magnetic field surrounding the windings of a choke coil, and to realise that it will offer a considerable resistance to sudden changes. This is, of course, a measure of its impedance, and it is often compared with mechanical "mass."

The impedance of a condenser is, however, rather more difficult to visualise, though it is really due to the opposition offered by the molecules of the dielectric to the strain set up by the voltage across the plates. For this reason capacity is usually considered to be the electrical equivalent of ordinary elasticity.

Such comparisons become more difficult when we attempt to apply them to the internal impedance of a valve or a neon lamp. In the latter case, for instance, the passage of current is due to secondary ionisation, and as there must be a "lag" between the ionisation and the applied voltage which causes it the impedance is, in a sense, inductive in character. On the other hand, as it tends to approach a constant value at high frequencies it may also be regarded as a resistance.

### Cure for Curves

ONE man's meat is another man's poison, and a curve which may delight the eye of an artist will almost certainly give the wireless designer a pain in the neck—if it has anything to do with output.

He wants to see a straight-line response, every time, no matter how hard it is to come by. Even the valve, which is a miracle of perfection otherwise, falls down in this respect, producing distortion, harmonics, and other troubles if worked "over the bend."

One remedy is to use a push-pull combination, so as to increase the length of the straight-line path, but a still simpler plan, if it were possible, would be to eliminate the curved part of the characteristic altogether.

An approach in this direction is now being

made with the help of a special type of resistance known as Thyrite, which, like the valve, does not obey Ohm's law. Actually its characteristic is curved in the opposite direction to that of the valve, so that when inserted in shunt across either the input or output circuit one pair of "bends" offsets the other, giving the combination a substantially straight-line response.

### Robot Transmitters

THIS business of exploring the upper regions of the atmosphere is quite a fascinating game. Professor Compton, for instance, has just secured records of the pressure and temperature existing some twenty miles above sea level, which is, of course, far beyond the height yet reached by any human being. As exploring "agent," the Professor used a tiny wireless transmitter weighing only 7 lb., which he sent up in an unmanned balloon measuring some 15 ft. in diameter.

The set consists of a single valve-oscillator driven by a 4-volt dry cell, the high-tension for the plate being produced from the same cell by means of a vibrating-spring contact and a step-up transformer.

The valve sends out a continuous signal consisting of a carrier-wave, modulated by the "note" frequency of the make-and-break contact. As the balloon ascends the falling air-pressure alters the tuning of the H.F. circuit, and so varies the C.W. frequency, whilst any change in temperature affects the tone frequency due to the vibrating contact. Both variations are measured during the ascent by receivers on the ground, so that the records are available whether the balloon and its instruments are subsequently recovered or not.

### Acoustics!

AS you probably know, a gramophone record is now protected by copyright, on a footing of its own, i.e., quite apart from the actual words or music reproduced. This point was decided in the Law Courts on the ground that, no matter how meritorious the original performance might be, its successful recording must always depend upon the artistic skill of the maker of the record.

One difficult factor which comes into account—and it also applies to broadcast transmission—is what is known as "studio acoustics."

An orchestral performance, for instance, requires a large hall with a long reverberation period, and if the necessary room space is not available, then an extra "echo" effect must be added artificially.

Chamber music, on the other hand, only sounds at its best in a medium-sized studio with very little reverberation.

### An Unusual Fault

EVERY now and again one comes across an instance of a set which suddenly, and for no apparent reason, falls off badly in selectivity. I am not referring here to an old-fashioned circuit, which was once "good enough," but is no longer able to cope with existing conditions in the ether.

One more or less expects that kind of thing—but not to find a set of fairly recent design suddenly "packing up" to the extent of refusing to separate the London Regional from the London National. Yet that is what happened the other day, though I should perhaps mention that the set was a reconstructed one.

Quite obviously the trouble was due to some heavy damping of the high-frequency circuits, but it was not quite so easy to find out exactly why and where. Ultimately it turned out to be due to a badly soldered joint on one of the tuning condensers. The flux had started to "creep," and in course of time had got across to the second terminal, thus forming a high-resistance shunt which took all the merit out of the tuned-input circuit.



# Short-wave Adaptor/ Converter

With the unit described below it is possible to adapt an existing detector and low-frequency amplifier set to short-wave reception. By a slight modification, the unit can be used as a super-het short-wave converter with sets having a high-frequency stage



As you can see from this front view of the control panel, there are very few knobs to twiddle. A wide-vision scale helps to log stations accurately

WHAT is it that makes a short-wave set essentially different from an ordinary broadcast set? Surely it is mainly in the tuning circuit and associated tuning arrangement?

### Ordinary Sets On Short-waves

Working on this assumption, it is clear that much of the existing equipment of an ordinary broadcast set, designed to tune only on the medium and long waves, is eminently suitable for the short waves, too.

Indeed, the low-frequency equipment of any detector and low-frequency amplifier receiver can easily be made use of with a suitable short-wave unit, the two together forming an efficient if unambitious short-wave equipment installation.

Going a step farther, a set designed for broadcasting and having one or more stages of high-frequency amplification can be so converted, that even its existing high-frequency equipment will form part of a complete short-wave sequence—with a unit, that is to say, designed to convert the straight set into a short-wave super-het.

Common to both types of unit is this short-wave tuning circuit and reaction auxiliary.

### Basic Circuit

In passing, we might mention that such basic circuits are indeed part and parcel of a one-valve short-wave set. So that the general point emerges that it is possible to make a unit that will be (1) a one-valve set, (2) a

simple adaptor for detector sets, and (3) a converter for short-wave super-hetting.

We have therefore made up the very simple short-wave unit illustrated in these pages. For the present we will confine ourselves to only two of its functions—as adaptor and converter. Next week we will show how the unit can be turned into a simple but effective short-wave one-valver.

### Our Short-wave Coils

Forming the basis of the design is the now well-known "A.W." short-wave coil series. Three of these coils are available, either made up at home according to the instructions given in the November 10 issue of this paper, or obtained ready wound for use from either Peto Scott Ltd., or Wright and Weaire Ltd.

Tuning in steps from about 12 to 170 metres,

pins. A suitable stand with sockets to take these coils has also been described, this forming the main component at the back of the baseboard.

Closely connected with the tuning coil are three condensers. The first, naturally, is the tuning condenser; having a maximum capacity of .00015-microfarad.

This condenser is specially designed for short-wave working, being away from the control panel, with well-spaced vanes and a noiseless pigtail connection for the moving ones. Moreover, to ensure accurate and easy logging on the short waves, the condenser is worked by a dual-ratio slow-motion tuning dial with a full-vision scale.

### Reaction Condenser

Then there is the reaction condenser, of .00025-microfarad capacity. This is in series with the reaction winding, of course, and has been chosen to give good oscillation over all wavebands. It has air-spaced vanes, incidentally.

The third of the condensers is the series aerial condenser—a very important component that makes a great deal of difference in a unit of this type to the results that will be obtained with under the varying conditions it will be expected to work under.

Actually, this is a neutralising type condenser, having the very small maximum capacity of .00005-microfarad. It comes between the aerial lead and the grid end of the tuning winding, and effectively reduces the damping of the aerials so that good oscillation can be obtained.

### Baseboard Layout

As can be seen from the photographs, the rest of the baseboard is taken up with the low-loss valve holder, the short-wave choke and one or two other very small parts.

Looking at the circuits, it will be seen that except for the outputs they are both the same.



(Right) This back view of the completed unit shows how the tuning-coil stand is mounted, the photographed unit being for plug-in adaptor use. (Below) To-day there is no reason why any member of the family should not achieve success on short waves.



these coils, with a suitable short-wave condenser, cover all the most exciting bands on the short waves, with plenty of overlap for maximum tuning efficiency.

They each consist of two simple windings, one for the tuning and the other for the reaction, the tuning windings going to the widely spaced pins on the former, and the reaction to the closely spaced

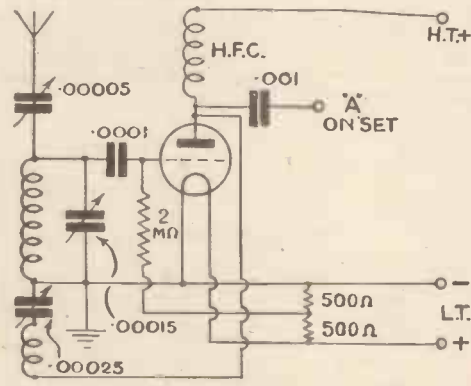
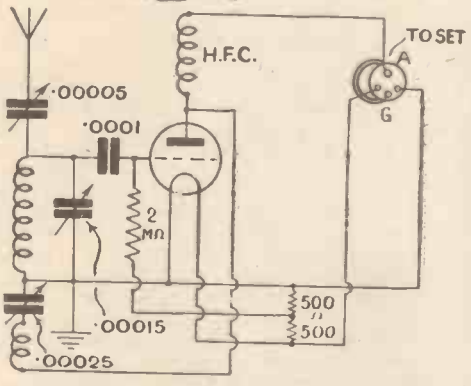
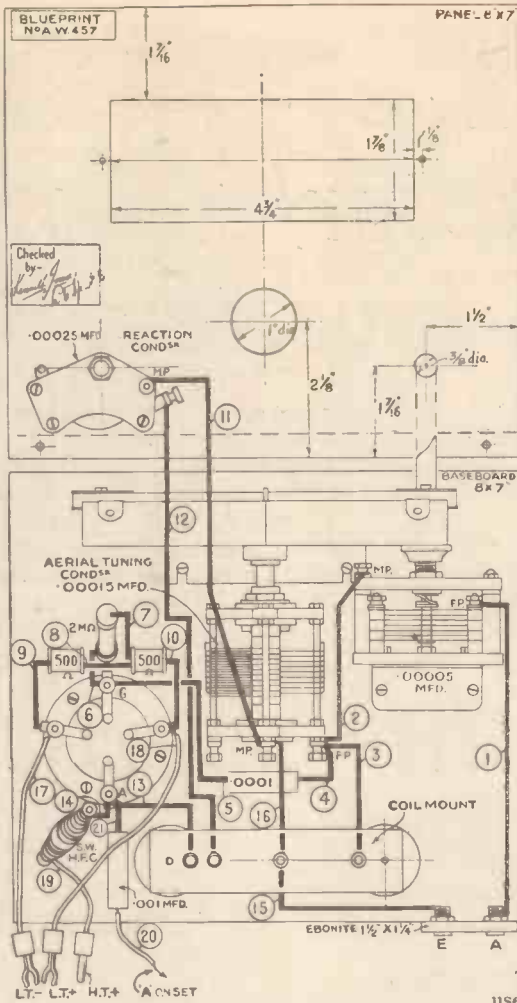
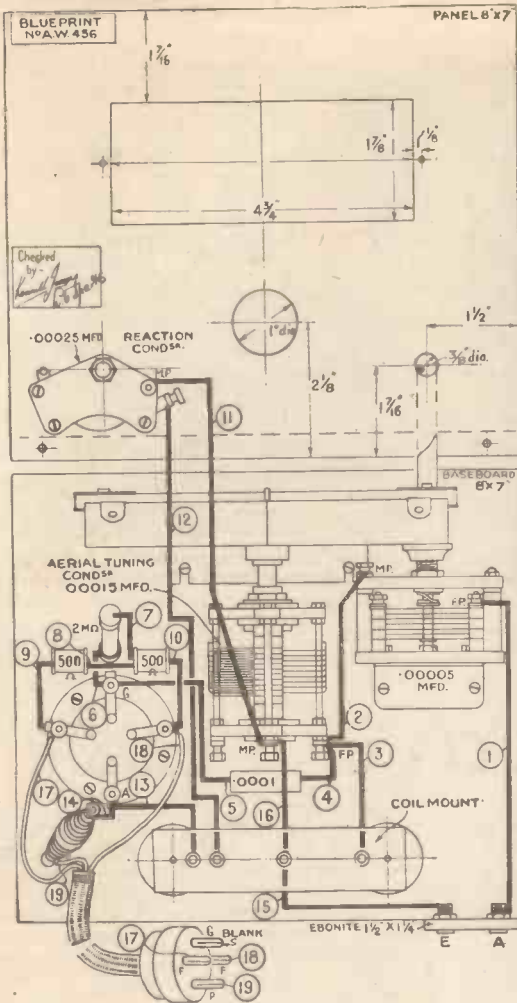

Here are the reduced reproductions of the two blueprints for the dual-purpose short-wave unit, together with their appropriate circuits below. On the left is the blueprint and circuit of the Plug-in Adaptor, and on the right the super-het Converter. These blueprints are available full-size, price 1s. post paid

The grid condenser is of .0001-microfarad—rather lower in capacity than for medium-wave working. The grid leak is of 2 megohms, but note that the lower end, if we may call it such, is not taken direct either to positive or negative low-tension.

In practice, we find that the positive connection gives the maximum signal strength but reaction then tends to be a little on the harsh side. If the leak is taken down to the negative side of the low-tension the reaction is beautifully smooth, but, of course, there is some loss of sensitivity.

So as usual, we have to compromise. A potentiometer arrangement is connected across

the low tension with the leak taken to the centre tap.

Actually we have used two of the small and inexpensive 500-ohm resistances joined in series for this "pot."

Now about the outputs. Dealing with the simple adaptor use first, it will be seen that the anode and the two filament connections are taken to a four-pin plug the grid pin of which is ignored.

**Idea of the Plug**

The idea is that this plug shall be inserted in the detector valve holder of the existing set. The set's tuning circuit will then be cut out of action—the grid pin being blank, remember—and the short-wave unit's valve will take its high- and low-tension supply from the set's supply.

This function of the unit is intended for sets having no high-frequency set stages. A detector and two low-frequency broadcast set would therefore become a short-wave three-valver, with the unit's short-wave tuning and detector and the set's low-frequency side working together.

With many modern sets, though, it is a waste of a good stage to use this function of the unit. It can, of course, be attached to sets with a high-frequency stage, but then the high-frequency stage is inoperative.

This is where the super-het idea comes in. The second circuit shows how. The anode circuit choke goes to a high-tension positive socket—say, 100 to 120 volts.

**Separate Feed**

The low-tension of the set can be used to supply a separate feed to the filament circuit of the unit's valve, just as the set's high-tension has an extra connection for the anode of the unit's valve.

The anode itself passes on energy through a .001-microfarad fixed condenser to the aerial terminal of the set. The set's existing valves are all left alone. The set is tuned to a long wavelength and left at, say, 1,300 metres—clear of interference, of course.

The unit's reaction is then adjusted so that the valve is just oscillating, and the unit and set will then behave as a short-wave super-het. Tuning on the unit is normal, and there is no need to touch the set's tuning or reaction.

**PARTS NEEDED FOR THE SHORT-WAVE UNIT**

- BASEBOARD**  
1—5-ply 8-in. by 8-in. (Peto Scott).
- CHOKE, HIGH-FREQUENCY**  
1—Short-wave (Wearite, type HF3, or Eddystone, type 048).
- COILS**  
1—Set home-made with base as described in AMATEUR WIRELESS dated November 10 (or Wearite, Peto Scott).
- CONDENSERS, FIXED**  
\*†—1 .0001-microfarad, type tubular (T.C.C., or T.M.C., Hydra).  
†1—.001-microfarad, type tubular (T.C.C. or T.M.C., Hydra).
- CONDENSERS, VARIABLE**  
1—.00015-microfarad (Eddystone, type 042).  
1—.00025-microfarad (Eddystone, type 057).  
1—.00005-microfarad (Peto Scott, type neutralising).
- DIAL, SLOW-MOTION**  
1—Dual-ratio full-vision (Utility, type W530).
- HOLDER, VALVE**  
1—4-pin (Eddystone, type 040).
- PANEL**  
1—Ebonite 8-in. by 7-in. by 1/8-in. (Peto Scott).
- PLUGS, ETC.**  
\*2—Metal sockets (Clix).  
†3—Metal sockets (Clix).  
†1—Wander plug, marked H.T. (Clix).  
†2—Spade terminals, marked L.T., L.T.— (Clix).  
\*1—4-pin plug (Goltone, type R 19/145).
- RESISTANCES, FIXED**  
2—500-ohm 1/2-watt (Franklin, or Dubilier).  
1—2-megohm (Dubilier).
- SUNDRIES**  
Connecting wire and sleeving (Goltone).  
2 ft. 4-way flexible cable (Goltone).  
\*†1—Ebonite strip 1 1/2-in. by 1 1/2-in. by 1/8-in. (Peto Scott).  
†1—Ebonite strip 1 1/2-in. by 1-in. by 1/8-in. (Peto Scott).
- VALVES**  
1—Cosor 210 Det. (Met.) or  
1—Marconi L21 (met.) or  
1—Mullard PM2DX (met) or  
1—Mazda L2 (met.) or  
1—Osram L21 (met.) or  
1—Micromesh HLB1 (met.).  
\*Indicates parts required for adaptor.  
†Indicates parts required for converter.



If you have any ideas about breaking the the reception record these will probably want revising. BRS 1,353, S. Bradbury of Bradford, claims to have received 1,270 during a period of sixteen months. All these stations were using 'phone. This record ought to stand for quite a while.

I am getting quite a number of letters about the short-wave contest. Most of them are of the opinion that the contest should be divided into two sections—one for CW and one for telephone stations and to take place over one week-end.

#### Problem of Allocation

Mr. Bradford suggests this and goes on to say that only the 20, 40 and 80-metre bands should be included. The problem of allocating points for the stations received seems to be a little more complicated. Some readers are of the opinion that European stations should count one point, while others feel that as the Europeans are so easy to hear, they should be disregarded. Anyway, letters on this topic will be appreciated.

Martin Railton, of Loughton, Essex, has just rebuilt his receiver, using a metallised base-plate and panel, so overcoming all traces of



This is the neat and efficient equipment of G5CU, operated by J. A. Cuthbertson, of Cross Lane, Scarborough. His signals are well heard on the 40-metre band

## With the Short-wave Fans

hand capacity. At the moment he is averaging about 50 stations per week and has heard over 735 during the past four months. This is pretty good going considering he only listens on Sundays.

#### Super-hets Not So Good?

He puts forward the suggestion that super-hets for short waves are not so good or reliable as the straight set. This is an old controversial topic and whether or not he is right in his statement that the straight set is better on weak stations owing to lower background noise, has yet to be proved. He uses a two-valver with headphones and occasionally hitches it on to an A.C. amplifier.

On the 20-metre band during the past week he has logged amongst other stations, W2VC, W2AMV, Bill Ingersoll, W9BHT, VE1BV, all using phone. W1CCI, EA3AC, and W1VEQ using CW.

On the 40-metre band the best stations heard were VE1DO, EA9AS, CT1ED, EA5BA, OK2RR, EA5BG, EA6BF all using CW!

The 80-metre band conditions were very bad in the Loughton district so no stations were reported. This was most probably due to the fact that the 80-metre band is not much good until the early hours of the morning, although a few amateurs can be heard between 2200 and midnight. If you want to hear W's or other DX stations, this band is only of use between 5 and 7 a.m.

While on the topic of wavebands, it is quite common for readers to complain that they are unable to obtain any results with the very low waveband coils.

#### The Real Difficulty

This point cropped up some time ago with the Melody Ranger, one of our first all-wave sets. Apparently the trouble is due not to the coils or the receiver, but to the fact that as the average listener has to work for his living, he cannot get home until the best listening period is over.

During the winter months stations of a wavelength of under 20 metres cannot be heard after 5 o'clock. One can easily be mistaken into thinking that the coil is completely dud,

for very often the entire waveband will not produce even one morse signal.

On the other hand, unless you are careful in adjusting the value of the aerial preset condenser, the amplification is inclined to drop off and the weak stations lost.

It is a good tip always to use the maximum capacity in series with your aerial that will give you even oscillation. The higher the wavelength, the less effect has the aerial series condenser, for when down below 30 metres, unless this condenser has a capacity of 50 microfarads or less, it is very likely that the receiver will refuse to oscillate.

Where amateurs slip up is that they set the preset to give smooth reaction on say 15 metres and forget to readjust it when on, say, the

mediate-frequency transformers. To allow for any variation in the windings of these transformers and other stray capacities in the construction of the receiver, both the primaries and secondaries of these transformers must be tuneable. You do not realise until you use a crystal just how much out are the average intermediate-frequency coils in spite of all the wonderful tests, methods of which we hear so much.

#### On the Right Lines

If you bear all these points in mind you will be well on the right lines. Quartz crystal super-hets will be the receivers of the future, and anyone who has tried one finds it very hard to have to go back to the conventional super-het.

### By Kenneth Jowers

80-metre band. Now although the adjustment will not cause any decrease in volume on 15 metres, in fact just the reverse, on 80 metres it is likely to cause as much as 75 per cent. decrease in volume.

Going on to a completely different subject, several amateurs have written to me about the use of a quartz-crystal gate in short-wave super-hets. Apparently they have the idea that it is a very simple matter to include a quartz crystal and that there are not likely to be any problems arising out of it. Believe me, there is a lot more in it than simply wiring up the crystal gate and the alternative condenser circuit.

In fact, as you will find, you must have at least two intermediate-frequency stages, for the very use of a selectivity device reduces the volume by a considerable extent. The balancing condenser must have a very low minimum capacity, the value of which is decided by the capacity of the crystal holder. This condenser must also be fitted with a slow-motion dial which is really slow in operation—something about 150 to 1.

Then the crystal must be calibrated and ground to the exact frequency of the inter-

I have been checking up the 40-metre band this week with surprising results. First of all, let me point out that this band is absolutely useless unless you are using a super-het. The amount of QRM on this waveband is worse now than it has been for a long time. However, judging from one week's check, it does seem as if amateur stations of reasonable efficiency and farther away than 100 miles can be received at good loud-speaker strength.

#### Struck a Bad Patch

The Scottish, Irish and West Country stations have been coming in decidedly well. The local amateurs within about 30 or 40 miles seem to have either struck a bad patch or have given up for a little while. Several Russians have been logged on 40 metres, while if you are up early in the morning, about seven o'clock, the Americans are coming in extraordinarily well on 75 metres. In fact, this is the best band for American reception with the exception of 20 metres between 1800 and 2100.

I have not been able to obtain any Australian or New Zealand stations on 'phone, although on Sunday afternoon, between 1200 and 1500, there were at least a dozen using C.W. Most of them were calling U.S.A. or Europe.

Several readers have remarked on the colossal strength of ZL4AO of Dunedin, who, as many know, has a daily talk with G2LZ. This station is now coming in at R6 or R7 on 40 metres round about breakfast time.

# High Tension from

Many readers of "Amateur Wireless" will have given serious consideration to the advisability of doing away with high-tension batteries and building an all-mains set, or at least an eliminator, for supplying the high-tension current for the anodes of the valves.

There has, however, been little written on the subject of converting the A.C. supply from the mains to a smooth and suitable direct current for wireless use.

This article is written with the intention of giving the reader an outline of the underlying principles involved.

**A**LTERNATING current, or A.C. as it is generally called for short, is coming more into general use every day and is rapidly supplanting all the direct current or D.C. supplies throughout the country.

An alternating current is one that rises from zero volts to a maximum; then falls to zero; and again rises to the same maximum, but in the opposite direction, followed by a return to zero again.

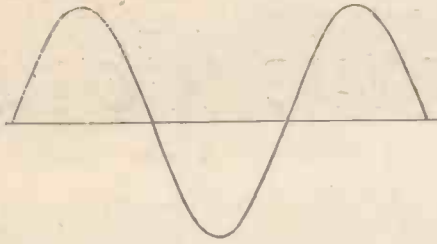

Fig. 1.—Graphic representation of a sine wave

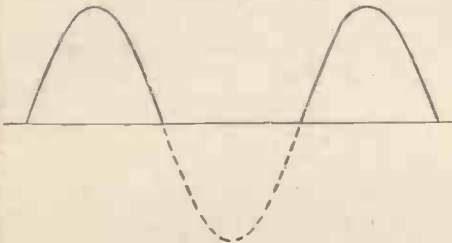

Fig. 2.—Effect of half-wave rectification

This cycle is repeated a certain number of times a second, generally fifty, but in some cases as few as twenty-five or as many as 100. This alternation is known as frequency of the cycles, indicated by the sign  $\omega$ . For example,  $50\omega$  would indicate a supply that went through the above changes fifty times per second.

Further, an alternating current as supplied by electricity supply authorities alternates in a particular manner known as sine wave, the rate of changes being greatest during the period the volts are lowest and gradually diminishing as the amplitude of the volts increases. Fig. 1 is a graphic representation of a sine wave.

The simplest method of turning such a supply into

uni-directional current, rectification as it is called, is to include in the circuit some arrangement which will allow the current to pass in one direction only, the result being the suppression of the negative half-cycles and our supply now takes the form as shown in Fig. 2. The suppressed half-cycle is indicated by the dotted line. This is known as half-wave rectification. The circuit required is shown in Fig. 3.

For this purpose some device is required which represents a very high resistance to current in one direction and, if possible, no resistance—or, at least, a very low one—in the other.

The only rectifiers now used are the so-called metal rectifier and the thermionic valve rectifier. The former consists of a number of discs of copper on one surface of which has been deposited either a layer of copper oxide or, in some types, copper iodide. These combinations have a very high resistance in one direction and a comparatively low one in the other, but suffer from the very serious defect of giving poor regulation—namely, the voltage across them varies very greatly according to the current taken.

### Infinite Resistance One Way

The thermionic valve rectifier, on the other hand, has an infinite resistance in one direction and a very low resistance in the other, and is capable, if used properly, of giving an output of which the voltage varies but little between no load and full load.

A rectifying valve consists essentially of two parts, an anode and a cathode, sealed in an

envelope (generally of glass) from which all the air has been exhausted. The cathode is coated with some substance, which, when heated, emits electrons, negative particles of electricity. These particles are attracted to the anode when a positive potential is applied to it, with the result that a current of electricity will flow through the valves

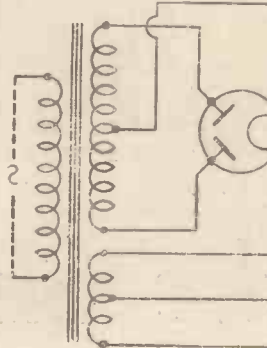

Fig. 4.—Circuit of

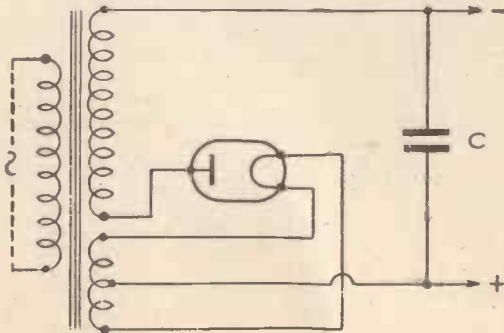
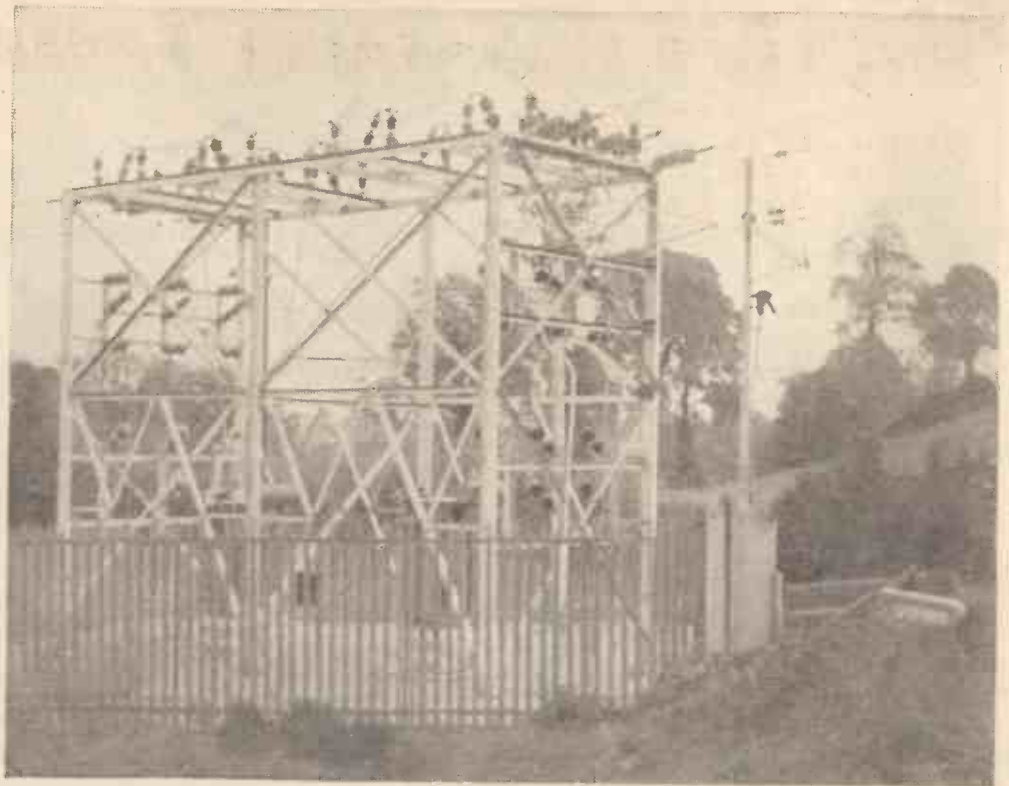

Fig. 3.—Circuit of half-wave rectifier



# From the Mains

By L. F. E. JOHNSON  
Ph. D.



Tapping off for the grid system—the gear that supplies a small Devonshire village with electric power

in a positive direction from the anode to the cathode only; if the anode becomes negative the electrons are driven back and no current flows.

### One-Way Valve

It will be seen that a rectifier is essentially a one-way valve.

In order to make use of the suppressed half-cycle, two valves can be used; or, what is more common, two anodes and a cathode in a single envelope.

For full-wave rectification a transformer with a centre-tapped secondary is required, each half giving the necessary voltage for the output required. Fig. 4 shows in a diagrammatic form the circuit required and the rectified output is shown in Fig. 5.

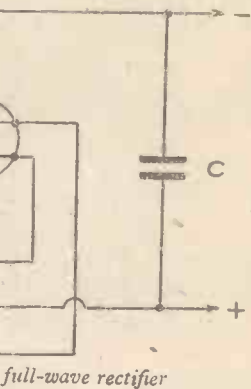

full-wave rectifier

over to the positive side. It will be appreciated that such a supply, although uni-directional, is quite unsuitable for wireless.



Fig. 5.—Output from full-wave rectifier



4 MICROFARADS

Fig. 6.—Full-wave output for 4-microfarad reservoir capacitor



2 MICROFARADS

Fig. 7.—Full-wave output for 2-microfarad reservoir capacitor

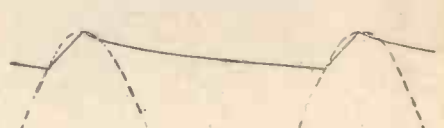

Fig. 8.—Half-wave output from reservoir capacitor

If we now join a condenser *c*, known as a reservoir (Figs. 3 and 4), across the output, a change is now seen in the waveform, for the condenser rapidly charges up to the maximum or peak voltage of our supply and then slowly discharges through our external circuit.

If the condenser is large enough and the current taken is not too large, the voltage of our rectifier has had time to build up again before the condenser has lost much of its charge.

Figs. 6 and 7 show the resulting wave form for a full-wave and Fig. 8 for a half-wave rectifier.

### More Constant Voltage

The net result of the reservoir condenser is to maintain a more constant voltage across the output, and if the current taken from the rectifier is kept fixed a voltmeter across the output will show that the mean voltage rises at first rapidly and afterwards much slower, with an increase of the capacity of the reservoir condenser.

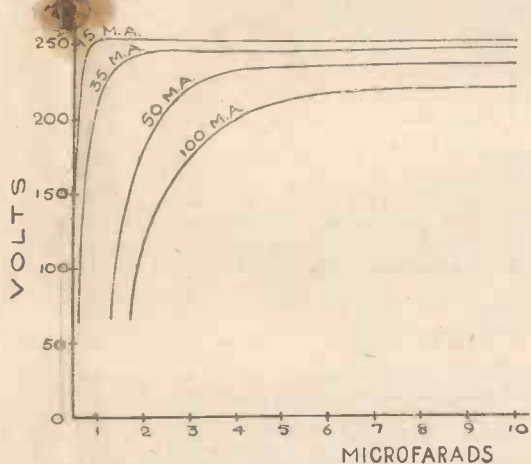

Fig. 9.—Series of curves showing effect of increase of capacity of reservoir condenser

Fig. 9 is a series of curves showing the effect of an increase of capacity in the reservoir condenser for outputs of 15, 20, and 50 milliamperes, and so on, respectively. The input A.C. volts to the valve being the same in each case.

### Important Facts

The following facts appear from what we have learned above:—

The optimum capacity of the reservoir condenser depends upon the output taken from the circuit.

With a load of 15 milliamperes, the voltage developed with a 2-microfarad condenser was as high as with a 6-microfarad; with a 20-milliampere load it was only very slightly lower; and 4 microfarads was quite as good as 6 microfarads. With a 50-milliampere load, however, it needed 6 microfarads to obtain maximum volts.

The output of the transformer should be adjusted to give the correct output volts and the capacity of the reservoir should never be reduced to lower the rectified volts or the smoothing will suffer, for it is obvious that the larger the reservoir (up to the necessary capacity to give maximum voltage) the smoother the output will be. Our curves show that 2 microfarads is large enough for outputs up to about 20

milliamperes and that 4 microfarads will be large enough for an output from 35-40 milliamperes; but for 50 milliamperes and over, 6 microfarads should be used; and this value is quite satisfactory up to 120 milliamperes.

Even now, however, the output of our rectifier will not be smooth enough for radio work, and in order to get rid of the remaining ripple it is necessary to include a filter in the circuit, such filter consisting of an iron-cored choke in series with the positive lead, followed by another condenser across the output.

The values of these components depend to some extent upon the degree of smoothing desired, but a 20-henry constant-inductance choke followed by a 4-microfarad (or, better, an 8-microfarad) condenser should be quite suitable.

The detector circuit is the most sensitive to hum, and in the event of an arrangement as above not giving sufficient smoothing it is advisable to include a separate

choke of higher inductance and an extra condenser in the output for this circuit alone (Fig. 10).

In using rectified A.C. for the anode supply, one very important consideration must not be lost sight of—namely, regulation; that is, the fluctuation of voltage for varying values of current.

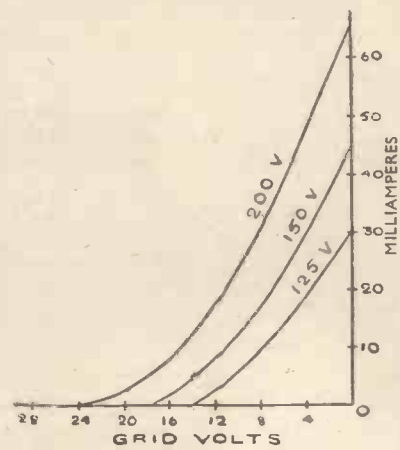

Fig. 11.—Characteristic of ordinary power output valve

At first it may appear that good regulation is quite unnecessary and that it will be sufficient if the output gives the correct voltage at the mean current, as shown by a D.C. milliammeter.

This is erroneous, for we must remember that the grid of our output valve is swinging both above and below its bias point, causing a very great variation of current in the anode circuit, which variation is responsible for the power of the audio output in the loud-speaker, the smaller the variation the lower the output for a given valve working into the same load.

Fig. 11, which is a curve for an ordinary power output valve

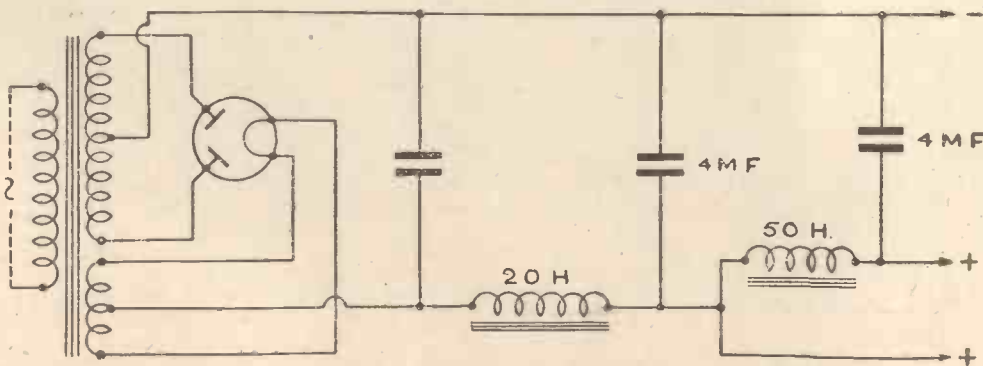

Fig. 10.—Extra choke and condenser in output of detector circuit to give additional smoothing

# Making Your Own Chassis

**G**RADUALLY the amateur's prejudice against sets with metal-chassis construction is dying. In place of this at one time justifiable grudge against the all-metal type of layout there is now evident a desire to make the most of its advantages.

More especially is this true among those who realise that a modern metal-chassis set is not necessarily any more complicated to make than some panel-and-baseboard sets.

Even among the enlightened ones, though, there is still a feeling that perhaps this all-metal working is a little beyond sheer mechanical abilities.

Thoughts stray to special tools, to elaborate scribers, cutters and bending devices. The

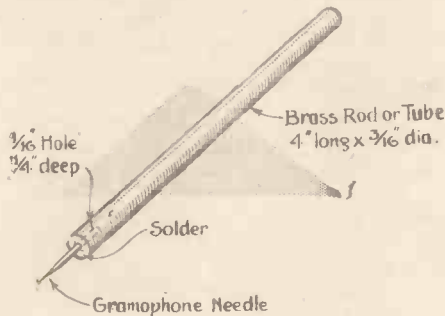

Fig. 1.—No need to spend a lot of money on special tools for chassis work—here is a scribe made with a gramophone needle

all-metal worker is envisaged as a full-blown mechanical engineer, whom the ordinary home constructor, duly conscious of his limitations, hesitates to emulate.

That is really rather an unjustified supposition, when you come to look into the possibilities of making up your own simple metal-working tools.

### Devices We Use

In this little article, for example, we draw your attention to one or two devices even we ourselves, with all our facilities, often utilise. We offer these ideas to the amateur who is really keen on metal-chassis construction but who, up to the present, has been deterred from going in for the idea through fear of "muffing" the mechanical side of the work.

Let us make a start—shall we?—with the simplest possible tool—but one you cannot do without when you are tackling anything to do with metal—the scribe.

Something of this sort, sharp and definite in its marking, is essential. It does not need to be very heavy, for the metal in which you are working—aluminium or brass—is of course quite soft, especially the first named.

Well, then. Get hold of an old piece of brass rod or tubing—there is sure to be a bit in your tool chest—and fix in one end an old gramophone needle, or better still a new one—a loud tone being perhaps preferable.

### Tool of Great Value

A drop of solder will hold this needle quite firmly in position—and the result will be a tool that will prove of great value as you go through your chassis making. Fig. 1 shows the idea, but, of course, you can vary it to suit yourself—and your own materials.

Now we come to the piece of metal that will eventually be your glorified chassis. At first, though, it will come to you as a rather ragged piece of metal—useless until the edges are trued up.

Start with any side and true up with a rule. No need for a set square if you haven't such

a thing available. A piece of machine-cut paper, such as a page of "A.W.," will give you quite a true edge.

Place a rule along the edge coinciding with the paper, as shown by Fig. 2, and so by going round all four sides you will have a perfectly trued-up piece of metal. This, by the way, is very important. Many a dud-looking chassis is so because it has never been properly trued up.

### For Valve Holders

Having started the work well you must keep it up. The Fig. 3 diagram shows another hint that may help you. There will almost sure to be holes to be cut for the valve-holders, which will be of the five-pin type with 1-in. diameter holes or seven-pin type with 1 1/4-in. holes.

Your original tool—the scribe—forms the basis of the tool needed to scribe out the circles. A thick cardboard strip, with holes punched just the radius apart of the required hole, is added to the original scribe.

Then, at the outer hole is fitted another gramophone needle—and it is this point that actually does the scribing of the hole as the cardboard strip is slowly turned round on the

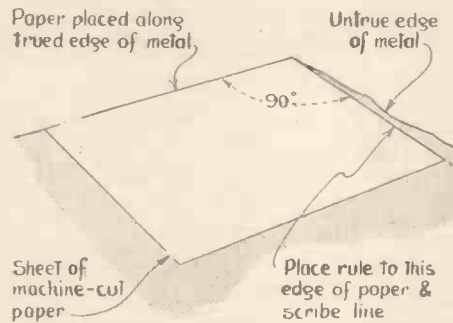

Fig. 2.—Before you can start work you must true up the piece of aluminium. It can be done with a piece of paper

pivotal point of the main scribe's needle. All this is clearly shown by the sketch at Fig. 3, so we will pass on to the next idea, which is also very helpful.

Holes have to be cut in the metal when it has been carefully scribed out. Many amateurs imagine that this is a serious and difficult business. Not a bit of it. Nothing could be easier than a metal-cutting fretsaw.

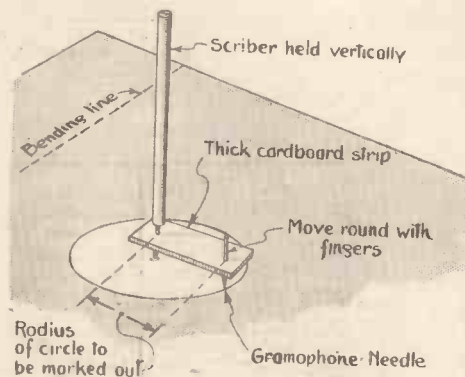

Fig. 3.—Hole-scribing for valve holders in metal holds no terrors if you make up this little cutter with cardboard and needles

For that is the tool you need. Don't forget, a metal-cutting fretsaw. A 1/8-in. starting hole at the centre of the scribed circle allows the blade to be threaded through, and then you can cut through the aluminium with the

metal-cutting saw blade just as easily as you would go through wood.

In the Fig. 4 sketch you will note, by the way, that the sheet of metal, although marked for the bending lines, is not yet actually bent. As a matter of fact, this bending is the last operation in chassis making.

Do all the other work first. That is to say, first do the truing up, the scribing and the drilling of the large and small holes.

Lastly, bend the ends or lips at right angles to the main baseplate. This again is often thought to be a very difficult job, and indeed it can be if you go the wrong way about it.

The essential feature must be a quite flat surface and a smooth pressure against it; with the metal sheet coming between.

### Bending the Metal

Fig. 5 shows a little hint for doing the bending in a thoroughly domestic way. You will need to co-opt the services of mother's washing mangle.

The top part of the mangle provides the usefully large and flat surface area required. In addition, it is perfectly rigid. Underneath this surface you must temporarily—assume the Lady of the House of that!—screw a short strip of wood a little longer than the metal sheet.

At the same time clamp the metal between the two surfaces of wood, having previously marked out with the scribe the bending lines. Bend the metal upwards, gently but firmly. Repeat the dose for the other side—and there you are.

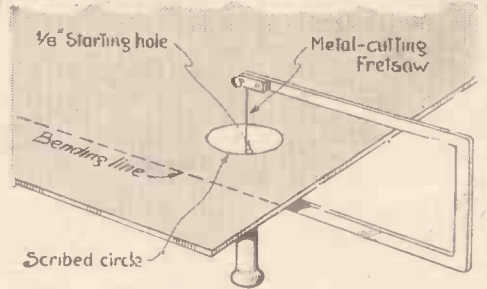

Fig. 4.—Large holes for the metal chassis are most easily cut with a metal-cutting fretsaw. Note the starting hole

From the foregoing hints we hope that we have been able to encourage amateurs in the making up of their own all-metal-chassis sets. The work is, as a matter of fact, fascinatingly interesting—and we ask you beginners to take our word for it that there are no great snags in construction.

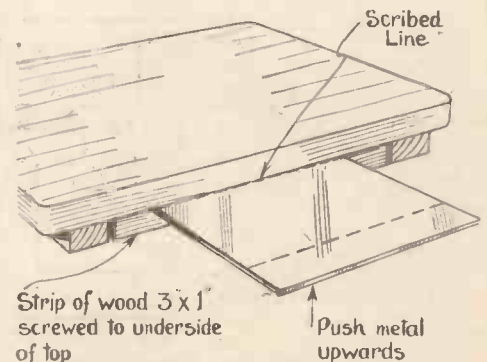

Fig. 5.—Bending the metal into chassis shape is easy if you commandeer the household mangle for the job



# I Re-make My Transformer

By A Constructor Crusader

WHEN the mains transformer in my set broke down, my thoughts naturally turned on the cost of a new one. With a view to replacement, I disconnected the defective instrument and removed it from the high-tension unit which formed part of my set.

## Post-mortem Examination

As I looked at the "dead" transformer, however, it occurred to me that, if I were to carry out a post-mortem examination, I might possibly discover and be able to rectify the fault, and so affect a considerable saving to my pocket.

Accordingly, I took the "corpse" to my humble workshop and began the operation.

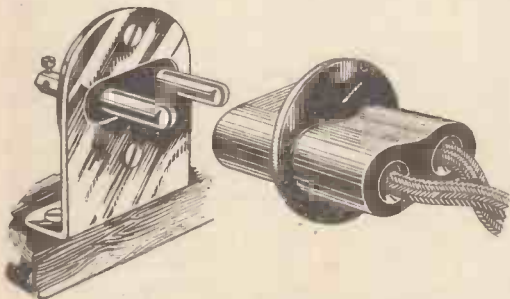

When using a mains transformer this Belling-Lee safety mains plug is a very useful device to fit to the baseboard

The transformer was of the familiar type which is enclosed in an oval metal case with terminal end-plates. I had some little difficulty in removing the end-plates, but this was done eventually with nothing more disastrous than a cut finger.

Next, I removed the transformer proper from its oval case. A few discreet taps with a hammer accomplished this safely. Then I loosened and bent back all the soft-iron strips which passed through and were firmly fixed in the central core of the transformer.

I was then able to take off the thin fibre cover which was wrapped round the transformer windings and which was held in position by a piece of sticky tape.

As soon as I removed this fibre cover, I saw what the trouble was. On one of the turns of the outer winding there was a small charred patch where the cotton covering of the wire had burnt away. This charred patch was about 1/2-in. long, and there was a corresponding burn in the layer of waxed paper underneath.

I knew from the thickness of the wire that this outer winding was the 5-volt filament supply winding. Obviously the fault was a break in the insulation between the filament winding and the mains winding underneath. Why this mischievous burning had occurred at this particular point I had no idea.

It would have been an easy matter to replace the filament winding and put the transformer back into use as before, but curiosity got the better of me. Here was a great chance of having a look inside a mains transformer and of obtaining some real inside knowledge about this formidable and mysterious component.

I took the chance, but perhaps I should not have done so if I had known what a call was to be made on my patience.

## It Was Easy at First!

The outer filament winding was easily removed. Of fairly thick wire, its length was 19.5 ft. and there was, of course, a tapping at the centre. Next, I removed the layer of waxed paper which had proved defective in the degree of insulation it gave between the filament and the mains windings.

Then I unwound the whole of the mains winding. The outer end was the 250-volt end. Between this end and the 200-volt tapping, I found 69 ft. of wire, 21 ft. in the first layer, 44 ft. in the second layer, and 4 ft. in the third layer.

Between the 230 and the 200-volt tappings, I found 106 ft. of wire made up of the remaining

40 ft. in the third layer, 64 ft. in the fourth layer and 2 ft. in the fifth layer.

From the 200-volt tapping to the start of the mains winding I found 572 ft. of wire in all. This length was made up of the remaining 80 ft. on the fifth layer and six layers of 82 ft. each.

## Down to the Anode Winding

With the removal of the mains winding and the layer of waxed paper under it, I got down to the anode winding, which I knew from the terminals on one of the end-plates gave 250-0-250 volts. Here I had a surprise.

The anode winding was of fine enamel-covered wire of a disturbing thinness. I saw that to remove this wire was to lose it, for I could never have re-wound such fine wire. Determined to get down to rock bottom, I unwound this enamel-covered wire. Its length was about 1,350 ft.

Now came the task of re-winding the transformer. I needed new wire for the anode winding, so I went out shopping. The first two wireless shops I visited were a little scornful with me. The days of stocking and selling wire were long since past, they implied. If I wanted to buy the very latest type of receiver, a valve or an accumulator—but I didn't.

I wanted wire and I got it at the third shop I visited, two reels of No. 34 D.C.C., each reel containing two ounces of wire. How dreadfully old-fashioned it seems to talk of wire in this way!

Now the original anode winding on my mains transformer was for 250 volts. I needed only half this voltage in the high-tension unit to which the mains transformer was to return. Since the original anode winding of 1,350 ft. gave 250 volts, I thought it would be a good plan to make my new anode winding about half this length.

## In Seven Layers

So I measured off 360 ft. of wire from one of the 2-oz. reels of No. 34 D.C.C. and wound it carefully on the mains-transformer core in seven layers.

Between the successive layers, I put a layer of waxed paper, and at the ends of each layer, I placed a strip of electrician's tape in order to build up the transformer firmly and to prevent any possible slipping of the turns of wire at the ends of

Continued at foot of next page



Although this is not a mains transformer but only a low-frequency-coupling model, the fundamental construction is the same—with laminations inside the wire bobbins

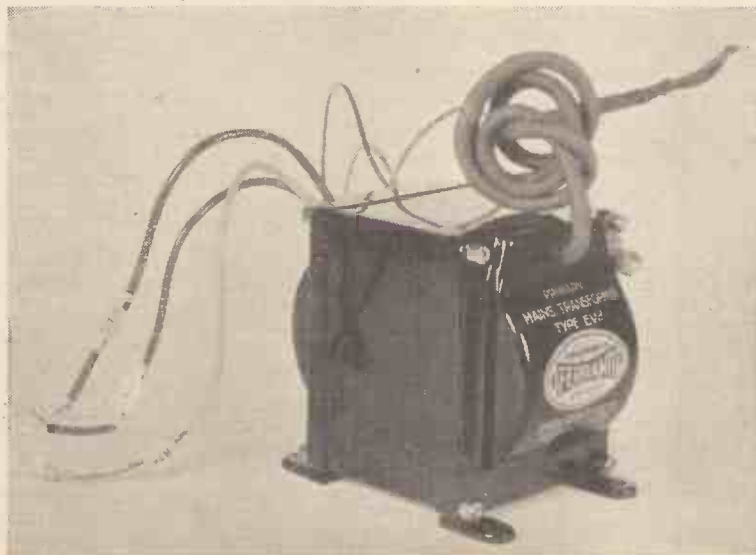

Typical mains transformer—one of the well-known Ferranti models, with marked leads coming from the metal case for the high-tension and heater connections to the set. Note the stout input cable

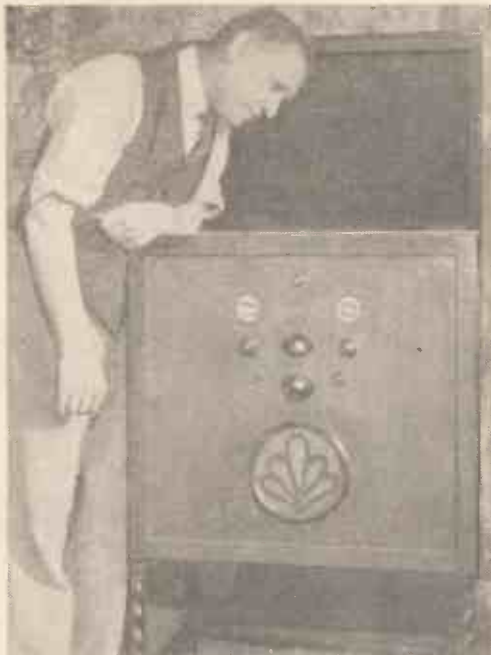

Meet William Plumpton with his modified 1934 Century Super Set, which he discusses in his informative letter this week

To the Editor of AMATEUR WIRELESS.

SINCE my letter which you published in your issue of June 30 regarding the 1934 Century Super, I have been making one or two slight modifications to the original circuit. As you are no doubt aware, I am a very keen experimenter and while appreciating the designs you publish I cannot resist trying various modifications.

#### Put In the Shade

You will no doubt remember how I praised the 1934 Century Super, but those remarks are now put in the shade by the various opinions I hear from friends who listen to the set now that I have made one or two slight alterations to the original circuit.

As several people have written to me I feel that the details would be of general interest

#### I Re-make My Transformer

Continued from preceding page

the layers. In similar fashion I wound on a second 360 ft. of the No. 34 D.C.C. wire from the second reel. I took out the join of these two lengths as the centre tap. Over the completed mains winding I placed a layer of electrician's tape.

You see, I was taking no risks of there being another breakdown in the insulation between the windings of my new transformer.

#### Original Winding Back

Next I put the original mains winding back. As my electric supply is 250 volts A.C., I did away with the 200- and 230-volt tappings and wound the whole length of 747 ft. on the transformer in ten layers, the successive layers being insulated from each other by waxed paper. Then, over the completed mains winding, I wound a layer of electrician's tape.

Now came a pretty little problem. I wanted to use a U8 rectifying valve, with a 7.5-volt filament, in my new high-tension unit. How could I find out the correct number of turns to wind in the filament winding to give the required 7.5 volts?

In re-winding the mains section of my new transformer, I had started with what was originally the 250-volt end. I counted the number of turns until I came to the 200-volt tapping, and then my patience became

## Modifying the 1934 Century Super

to other users of this circuit, therefore I am enclosing the necessary instructions to enable anyone to make the alterations and obtain results which I can assure you are superior to anything I have heard.

Wire No. 68 on the blueprint is removed from the .0001-microfarad condenser which is situated under the volume control. It is then connected to the terminal on the .0003-microfarad condenser which holds wire No. 1. Wire No. 59 is also removed from the .0001-microfarad condenser and fastened to the anode terminal of the L2DD valve holder.

This, together with wire No. 57, makes two wires on this terminal. I then take off No. 71 from the anode terminal of the intermediate-frequency coil holder and connect to this vacant terminal a Dubilier condenser, type 670, which has a value of .0002 microfarad. Two wires are connected to the other side of this, one going to the centre pin of the L2DD and the other to the centre terminal on the volume control.

The wire No. 66 which is already on this terminal is broken, and a resistance having a value of 5,000 ohms is joined in series. I found that smoother operation was obtained by using a 2-megohm volume control in place of the 1-megohm specified. This had the effect of removing an objectionable whistle which I experienced before making the change.

One point I would like to stress, and that is that I found results could be improved by matching up the intermediate-frequency transformers with the valves. Needless to say, a fair amount of time and care were expended in making the ganging perfect, but the results were well worth while.

In place of the PM12A I used a PM12,

exhausted, and I ceased to count the turns.

However, I knew the length of wire from the 250-volt end to the 200-volt tapping. It was 150 ft., and that length had given 237 turns. The total length of wire in the mains-winding was 747 ft.

Calculation: If 175 ft. of wire give 237 turns, how many turns do 747 ft. of wire give? Answer, 1,012 turns.

Next calculation: If 250 volts require 1,012 turns, how many turns do 7.5 volts require? Answer 30 turns and a bit. Neglect the bit and call it 30, since it is better to be under than over the required voltage in a case of this kind.

All very nice and easy, of course, but I have an uncomfortable feeling about all wireless calculations, and I did not like the idea of risking my U8 valve on a calculation. How was I to check the calculation though?

#### I Saw the Way!

A little quiet thinking and I saw a way it could be done. Amongst my old stores I have a thermal-ammeter of the type which measures either D.C. or A.C. currents up to 500 milliamperes. Assuming a voltage of 7.5 volts and a current of 500 milliamperes, by Ohm's Law I needed a resistance of the order of  $\frac{7.5}{500} \times 1,000$  ohms, that is 15 ohms, to keep the current within the range of the ammeter.

as I found this seems to suit the circuit. You will see from the photograph that I have made a fine radio-gramophone.

#### Eliminator for High Tension

Since my last letter, my house has been wired for electric supply, so I now use an eliminator which, if anything, has improved the efficiency of the receiver. Although I have an outside aerial I invariably use an indoor arrangement as the receiver is capable of getting all the stations I require on this.

As I feel that some of your readers may be sceptical over my enthusiastic claims, I would add that they are quite at liberty to call.

WILLIAM PLUMPTON

27 St. Helena Road, Rotherhithe, S.E.16. [1163

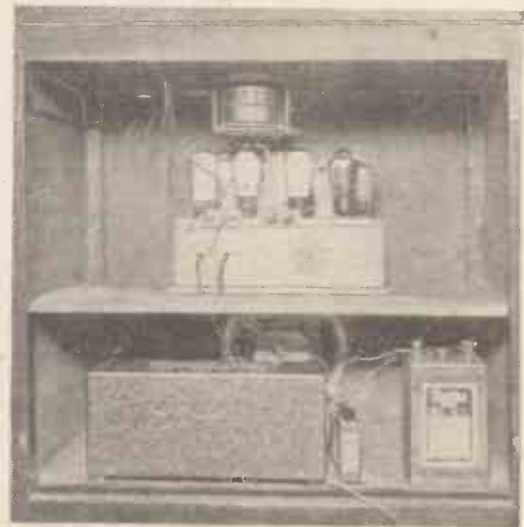

Back view of Mr. Plumpton's 1934 Century Super, showing the neat arrangement of the set, turntable and high-tension mains unit with the batteries in compartment below

I searched round for a suitable resistance and the nearest I could find was an old rheostat with a resistance of 40 ohms.

I then wound 30 turns of No. 22 D.C.C. wire, with a centre tap, on to my new mains transformer and proceeded to test my calculations. In series with the filament winding of 30 turns, I placed the 40-ohm resistance and the thermal-ammeter.

#### Fear and Trembling!

Then, connecting the mains winding to a mains plug, I plugged in to the mains supply. With a little fear and trembling I switched on. To my great delight nothing happened beyond the movement of the ammeter pointer to give a steady reading of 180 milliamperes.

Hastily I made the necessary calculation—volts equal current in amperes multiplied by resistance in ohms.

$$\text{Thus } \frac{180}{1,000} \times 40 = 7.2 \text{ volts.}$$

That was good enough for me. I needed 7.5 volts and I had obtained 7.2 volts.

It did not take me long to complete my transformed transformer. I wound a layer of electrician's tape over the filament winding. Then I bent all the soft-iron strips back into place and secured them by pieces of electrician's tape which I wound round the transformer.

I did not trouble to place the new transformer in the oval metal case, but I mounted it as it

Continued on page 584





*“When was Aunt Martha here?”*



*“Wasn't it the day you got that Drydex?”*

*“So it was—that's a long time ago.”*



# Drydex

## THE LONG LIFE H.T. BATTERY

*“Still keeps going when the rest have stopped”*

From Exide Service Stations and all good dealers. EXIDE BATTERIES, Exide Works, Clifton Junction, near Manchester. DX126  
Branches: London, Manchester, Birmingham, Bristol, Glasgow, Dublin and Belfast



# Kolster Brandes Consolette

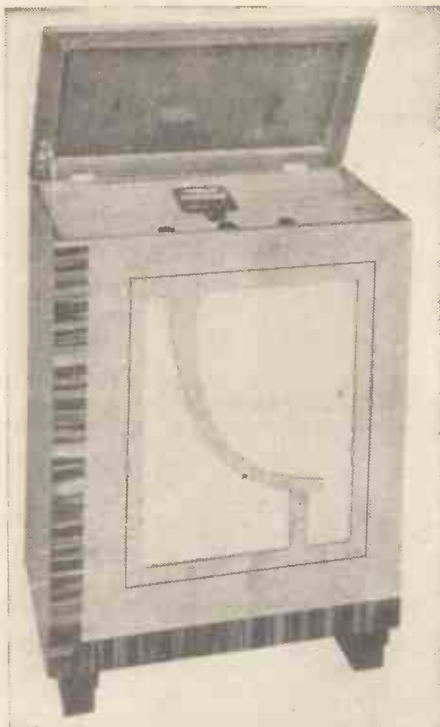

*What a delightful design, isn't it? The cabinet work has been carried out in exquisitely good taste—a worthy home for such a fine radio chassis*

**T**ESTING as we do practically every worthwhile receiver issued, you may realise that a receiver has to be a very good one if it is to stick in our memory.

Such a receiver is the new Kolster-Brandes seven-valve super-het for A.C. or D.C. mains. From every angle one can see new ideas and appreciate the time and trouble spent in perfecting a receiver that will meet with the approval of more than the usual number of listeners.

### Abbreviated Pedestal

At first the cabinet rather amused us. We didn't know whether to call it a table or pedestal model until we set to work to tune the receiver. Actually it is an abbreviated pedestal cabinet, just the correct height for the listener sitting in an armchair. The control panel, in the top under the lid, is at an angle to the front so we could see all of the knobs without getting a crick in the neck. Just imagine sitting down reading a book or paper, and, when the programme doesn't suit putting out one hand to bring in any of the continental or regional stations you wish.

There are four of these controls, by the way, not including the visual tuner which is automatic. First of all, is the combined switch and volume control in the centre, with wavechange and gramophone switch on the right of it. On the other side of the panel is a selectivity device which is invaluable with a highly sensitive receiver of this kind. With it one can alter the degree of selectivity to suit actual requirements. If you want maximum frequency response and the local station is not jammed, then turn the knob to the left and the response goes up to 7,000 cycles or equal to 14-kilocycles selectivity. On the other hand when listening to foreign stations where the greatest selectivity is wanted then turn the knob to the other extreme and the selectivity goes up to 5-kilocycles with a corresponding top note cut.

### Tuner At Centre

Finally comes the tuner at the centre. This knob actuates the condenser drive on which is

a drum calibrated in wavelengths. On one side of the drum is the medium-wave calibration from 200 to 600 metres, on the other side are long waves from 800 to 2,000 metres.

### Purely Refinements

There are two more controls at the rear of the chassis but these are purely refinements that only want attention now and then. The top one varies the sensitivity of the visual tuner. In one direction the tuner will operate on almost any station. If you only want the locals then turn the knob in the other direction and the tuner will only operate on the powerful stations.

Similarly with the second control. It is really for adjusting the background noise level but it has other uses. In one direction

background noise level can be reduced to a minimum, so in daylight station after station can be heard at full loud-speaker strength. How many receivers will bring in twenty-six stations on their loud-speaker at eight o'clock in the morning on a poor aerial?

After dark the background noise even with the suppressor out of action is as low as we have heard with a super-het. Another point that we want to stress is the absence of side-band splash. Stations either come in free from interference or not at all—no half measures. All the long-wave stations were free from whistles.

### Nine Miles From Brookmans

On an aerial 65 ft. in total length at Welwyn Garden City, about nine miles from Brookmans Park, the local stations might have been miles away for all the difference it made. Toulouse and Strasbourg were brought in at full loud-speaker strength with London Regional in between. No mutual interference. The National did not interfere with either Turin or Monte Ceneri. The selectivity is better than 9-kilocycles, in fact any station that is separated by 9-kilocycles from its nearest neighbour can be received free from interference or sideband splash.

Owing to the noise suppressor, stations that on normal sets would be ruined can with this Kolster-Brandes set be listened to for long stretches. The automatic volume control works as well as any we have tried. All of these points go towards making a really fine set that will entertain when other receivers cannot bring in any worthwhile stations.

### IN A NUTSHELL

Brand Name : K.B.

Model : 383.

Price : £19 19s.

**Technical Specification :** One of the largest universal receivers available. Uses seven valves in this order : Pentagrid frequency changer (Cossor 13PGA) band-pass coupled to a single intermediate-frequency stage (Cossor 13VPA) with a double-diode triode as a second detector (Cossor 13DHA). A special feature is the noise-suppression valve (Cossor 13SPA), while the output stage consists of two pentodes in parallel (Cossor 40PPA) with a half-wave valve rectifier (Cossor 40SUA).

Power Supply : 200-260 volts A.C. or D.C.

Makers : Kolster-Brandes, Ltd., Cray Works, Sidcup, Kent.

everything on the air can be heard including all the mush, while if it is turned in the other direction it can be arranged so that only stations of a pre-determined level will come in.

### Uncanny Results

In its extreme position the results are uncanny. Only about fifteen stations can be heard. These come in and out within about 2 degrees with absolute silence between stations. Even with one ear in the loud-speaker no sound can be heard when not tuned to a programme. This makes the receiver a very fine family one.

First of all one cannot help commenting on the fine quality, good top-note response and the crisp bass. This bass is unusually clear while all percussion instruments are free from rattle even at full volume.

The hum level on either A.C. or D.C. is so low that nothing can be heard unless the volume control is at maximum, a very unusual position for it. The tuning dial is easy to read for it is illuminated by two dial lights, one for each waveband. With careful adjustment of the noise-suppression control the

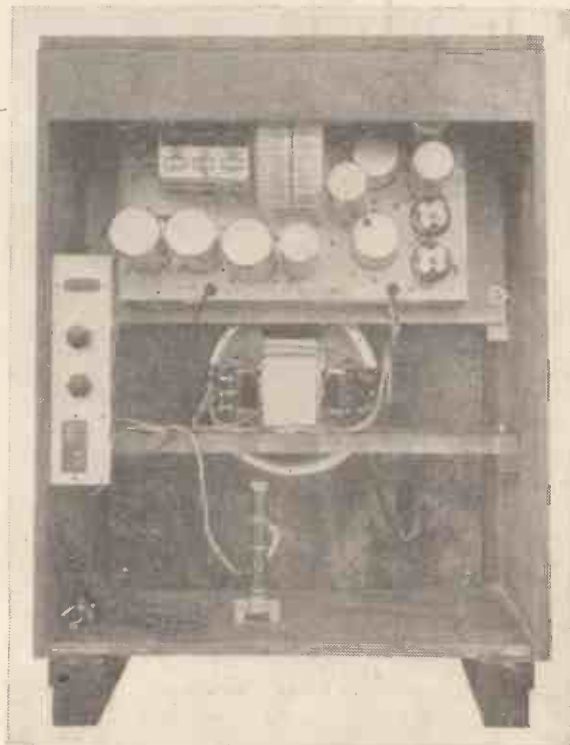

*Easy for the service man! Not that the K.B. radio-gramophone is likely to go wrong for a long time, of course. Note the controls on the terminal panel at the left*



# Here's the Secret of perfect Radio!



**GENERAL PURPOSE H.F., L.F. and DET. VALVES**

## 3/6

# TRIOTRON VALVES

The secret of realistic Radio is in the valves of your set. Buy some TRIOTRON VALVES to-day and hear how perfect the programmes can be—Vaudeville, Dance Music, Talks, Symphony Concerts, News—all the items with startling realism.

The technical pioneer work of the TRIOTRON laboratories played a very big part in making Radio popular. TRIOTRON VALVES are giving faithful service in millions of British homes. To-day, as always, you cannot buy a better valve, no matter what you pay.

- General Purpose, H.F., L.F. and Det.... 3/6
- Power and Super Power Valves .... 4/6
- Screened Grid, type S207 .... 9/6
- Steep Slope Screened Grid, type S215 10/-
- Pentode .... 10/6
- A wide range of mains types for every purpose from ... 6/-

If you have any difficulty in obtaining Triotron Valves from your local dealer, please write direct to us.

**FREE GIFT!**—A gramophone record of a beautiful Viennese waltz together with full particulars of a novel free competition with big prizes. Fill in your name and address on the adjoining coupon and post it with 2d. stamp to Triotron Radio Company, Limited, Triotron House, Bloomsbury Street, London, W.C.1.

**POST THIS COUPON NOW**

### “I'd like to try my hand at television . . .”

That is the comment we are often hearing from people who are interested in radio, but who are nervous of branching out into television.

TELEVISION has commenced a series of articles for the television beginner. This section deals with the technical side in such simple language as can be understood by any average radio home constructor.

Get a copy of the December issue of TELEVISION, now on sale, price 1s., and commence this beginners' course right away.

There are many other interesting features in the December issue—details of some of these are given below.

### THESE ARE SOME OF THE CONTENTS OF THE DECEMBER “TELEVISION”

- Germany to Start a Television Service.
- The Simplest Cathode-ray Receiver—Building a Time Base.
- Television Made Easy—Special Section for the Beginner.
- Modern High-definition Transmission—The First Authoritative Details.
- Methods of Holding the Picture Steady.
- A 5- to 10-metre Ultra-short-wave Receiver. Full Constructional Details.
- The Reason for Multiple Pictures.
- New Ideas in Ultra-short-wave Reception.
- A Novel Method of Controlling Motor Speed.
- The Amplification of Photo-electric Currents.
- Synchronising from the Mains.
- Recent Developments, etc., etc.

# TELEVISION

DECEMBER ISSUE

PRICE 1/-

### Full Details of the Special English Transmissions from

- LUXEMBOURG
- PARIS (*Poste Parisien*)
- RADIO NORMANDY

At least 8 pages a week in RADIO PICTORIAL are devoted to full details of the special programmes in English from the above and also many other continental stations. RADIO PICTORIAL is the only publication that supplies you with this information. Besides this exclusive programme feature, the rest of the 40 pages contain scores of pictures and many fine articles by and about Radio Stars and well-known broadcasters.

RADIO PICTORIAL is on sale Friday, November 30th, at all newsagents, price 3d.—don't forget to get a copy.

# RADIO PICTORIAL

Every Friday

3d.

You Want Supreme

QUALITY

**ROLA**

*the World's Finest Reproducers*

**"In a Class  
by themselves"**

says "PRACTICAL WIRELESS"  
TEST REPORT (Oct. 13th, 1934)

That is why British Radio Manu-  
facturers have used OVER 750,000  
ROLA SPEAKERS IN 3 YEARS

performance supremacy.

MODEL FR6-PM (Dia. 8") . . . . . 39/6

MODEL F6-FE (Dia. 8") . . . . . 35/-

All Field Excited Models are supplied in the following resistances: 8-ohm field (6-10 volts D.C.), 2,000-ohm field (100-165 volts D.C.), 2,500-ohm field (110-175 volts D.C.), 4,700-ohm field (150-200 volts D.C.), 6,500-ohm field (200-250 volts D.C.).

All models are supplied with transformer for either Pentode or Triode valves. If you are using high resistance Pentode or Class B valves state type of valve used when ordering. In the case of field-excited types state field resistance.

**IMMEDIATE DELIVERIES NOW AVAILABLE**

**EXTENSION SPEAKERS**

ROLA have published a chart showing the Extension speaker you should use with all factory-made receivers. ROLA supply speakers to the large majority of British Radio Manufacturers. It is essential that the speech coil impedance of the Extension speaker exactly matches that of the speaker in the set. You will see, therefore, why YOUR EXTENSION SPEAKER MUST BE A ROLA.

With most receivers Model FR6-PM (without transformer) is suitable. . . . . 32/-  
Also available in magnificent Burr Walnut Cabinet Model No. 2 . . . . . 62/6  
For all other receivers Model FR6-PM (with Transformer, as per Extension Speaker Broadsheet) is suitable. . . . . 39/6  
Also available in magnificent Burr Walnut Cabinet, Model No. 1 . . . . . 70/-

**NOTE** Rola do not market a model with a multi-tapped transformer, because on all tapings only a portion of the transformer is used, thus seriously impairing the quality of the reproduction. For example, in the case of a standard Pentode valve the whole of the Rola Output Transformer is used, whereas in a multi-tapped speaker only about one half is employed. By selecting a Rola you obtain the supreme quality of reproduction secured by nearly all British Radio Manufacturers.

Write for the Rola Folder and Extension Speaker Broadsheet showing correct speaker for all British factory-made receivers.

If your problem is a Speaker—ask for Rola

**THE BRITISH ROLA CO., LTD.**  
(Dept. A.)

MINERVA ROAD, PARK ROYAL, N.W.10  
Phone: Willesden 4322-3-4-5-6

With the Continental Stations

# Standing By for the Americans!

By JAY COOTE

**T**HIS has been a good week all round, and consequently I have been burning quite a lot of midnight oil. Conditions have been so favourable from dusk onwards that on most evenings I have overworked my superhet far into the night, tuning in European stations until they have signed off and then standing by for the transatlantic broadcasts on medium waves.

Of the latter it is curious how easy it is to capture WCAU (Philadelphia) and WBZ (Boston); it may be that it is because they are in the Eastern States.

LW (Cincinnati), the 500-kilowatt, is seldom found. I learn that KNX (Los Angeles, Cal.) has also now applied for licence to use 500 kilowatts, and if it is granted it will concentrate its transmissions towards the East; so that we may have a chance of hearing something from Filmland.

Whilst on the subject of power, I am glad I was premature in mentioning the increased output of Rennes. It had been only boosted temporarily, and the 40-kilowatt plant will not be available until the end of the month at the earliest.

## Strasbourg Is Louder

In the meantime, however, Strasbourg is producing a much louder signal, as you may notice when you detune London Regional, and Bordeaux Lafayette, which figures in my daily log, has stepped up to 25 kilowatts.

I am informed that the French State authorities are inclined to give way to the demands of the private transmitters, and have already authorised Radio Lyons to work on 25 kilowatts. It is one of the oldest stations in France. The site of the new transmitter will be some ten miles from Lyons and it is to be built at once.

In the course of the coming year we may see some changes in the Dutch broadcasting system, with possibly the addition of another high-power station. The two existing transmitters cannot cope with the demands of the numerous associations which now provide the radio programmes.

The State may take a hand and work in co-operation with the four most important broadcasting clubs. It is expected that Kootwijk will replace Huizen and that a powerful station will be built at Hilversum. They will be partly State owned and controlled.

Another big station to be erected is a 100-kilowatt which the Czech authorities plan to install somewhere in Western Czechoslovakia; the site has not yet been definitely fixed. In conjunction with this scheme, it is reported that one of the Podedbrady short-wave transmitters is also to be handed over to the broadcasting authorities for the relay of the Prague programmes.

## Breslau's New Feature

Listening to the German stations a few evenings ago, I noticed that Breslau had initiated a new feature in the programmes. In a similar way to the birthday greetings broadcast formerly in our Children's Hour, Breslau was in the habit of drawing special attention to golden weddings or the anniversaries of all "kiddies" over eighty!

Now, however, German mothers who have presented to their husbands a family of ten children are mentioned in the broadcast of local topics and specially congratulated by the studio authorities.

Do you sometimes listen to Polish stations? Their concerts are good and the dance broadcasts relayed from local restaurants are well transmitted. Instead of centralising their activities, the authorities have decided to decentralise, namely, to take all symphonic concerts from Lwow, to make Cracow responsible for all highbrow lectures and educational talks, to draw upon Wilno for light programmes, on Poznan for topical subjects, and to rely upon Katowice and Lodz for special broadcasts.

## 120-kilowatt for Cracow

It is not quite clear what the capital is to provide in addition to news and official communications. Anyhow, Cracow is to be endowed with a new 120-kilowatt transmitter which may later take over the Katowice transmissions. The new station at Torun (North-west Poland) is expected to be launched on the ether early in December.

Now for two alterations in wavelengths: PCF (Scheveningen-Haven, Holland), which may be heard working throughout the day giving out commercial news, has moved to 1,205 metres (249 kilocycles); close to this channel you will find Heston Airport (1,202 metres, 249.5 kilocycles), from which you may receive weather forecasts almost hourly during daylight.

# The A.C./D.C. All-Britain Three

**N**OW that we have had the A.C./D.C. version of the All-Britain Three in going order for some weeks it occurs to us that the cabinet of this set might be improved by the fitting of a piece of asbestos immediately above the filament voltage-dropping resistance.

This is not essential, but it will prevent any possibility of the varnish blistering due to the heat generated by the resistance when the set is in use for any length of time.

Some readers seem to have a habit of clipping the earth connection on to the metal chassis instead of using the earth socket provided. While this does not matter on an ordinary A.C. set, it is definitely wrong on a universal set—where earth-connection must be made through the isolating condenser between the earth terminal and the actual chassis. In other words, the chassis is not at earth potential in a universal set.



# Short Waves Romping In!

By J. GODCHAUX ABRAHAMS

IF you have not yet joined the ranks of short-wavers, now is your time, for we are rapidly approaching one of the most favourable periods of the year. Last week's weather may not have been pleasant for pedestrians, but it was undoubtedly kind to owners of short-wave sets, for distant stations on most channels below 50 metres romped in nightly.

Atmospherics generally were at a low level and on several days, when listening in the afternoon and early evening to stations working on wavelengths below 25 metres, the only interference which worried me was due to the motor vehicular traffic on the main road at the end of my street.

### Only Spasmodic

As, however, it is only spasmodic and not of regular occurrence, it does not cut out the broadcast for any lengthy period. It is possible in such cases to follow a car right down the street.

Curiously enough, in the same way I have detected the approach of the local postman on his rounds as he rings the electric bells of neighbouring houses. This may sound a tall story, but I have actually checked this source of interference by getting him to press the bell push of other houses after he had delivered my letters, and I was able to count his other calls half-way down my road.

### From Basle Radio Club

A new transmission on the air is that given by HB9B, the Radio Club of Basle (Switzerland), every Thursday evening from about G.M.T. 2100 to 2130 on 42.14 metres (7,118 kilocycles). At that period of the evening the club relays the programme of either Söttens or Beromünster for the benefit of Swiss nationals living abroad. The broadcasts are clear, and have been well heard over the greater part of Europe from England to Portugal and from Northern France to Jugoslavia, as well as overseas.

When last week I mentioned COC (Havana), I should have added that, in order not to confuse it with XEBT (Mexico City), it is wise to remember that the latter's interval signal consists of a long wail (siren), followed by three cuckoo calls not unlike those heard from CT1AA (Lisbon).

### He Speaks English

VQ7LO (Nairobi, Kenya Colony), on 49.5 metres, has again appeared on my log; I had not heard a broadcast since last spring. You can always make sure of the identity of this station by the fact that it usually ends its transmissions with about thirty minutes of gramophone records towards G.M.T. 1830 or 1900, followed by "God Save the King." Moreover, the announcer speaks English and not American!

I am informed that tests by the new N.I.R.O.M. short-wave station in the Netherlands East Indies are shortly due from Bandoeng (Java) on 49.05 metres (6,116 kilocycles) and from Sourabaya (Java) on 49.67 metres (6,036 kilocycles). As these are 1.5-kilowatt transmitters, it is fully expected that their signals will be picked up in Europe.

# Twenty-three Stations on Our £4 Two-valver

ONE of the features of the Christmas Number of WIRELESS MAGAZINE is an article on "How to Start Radio for £4." Full constructional details are given of a set that can be built at this cost—which includes cabinet, valves, batteries and a moving-coil loud-speaker. The set can be relied on to give a reasonable selection of entertaining programmes under all conditions, as is proved by the test report printed alongside.

In addition, this special issue contains scores of features covering every angle of radio interest. Some of the more important of these are indicated below.

## Some of the CONTENTS of the CHRISTMAS NUMBER

### FOR THE CONSTRUCTOR

THE DE-LUXE D.C. THREE.

### TECHNICAL FEATURES

- HOW TO START EXPERIMENTING.
- IS A TRANSPORTABLE STENODE POSSIBLE?
- WHAT YOU SHOULD KNOW ABOUT SHORT-WAVE DESIGN.
- SOMETHING NEW IN DETECTORS.
- READING PICK-UP RESPONSE CURVES.
- CURING CAR-MADE STATIC.

### GENERAL ARTICLES

- WORLD'S BROADCAST WAVELENGTHS.
- NEWS ABOUT THE CHRISTMAS PROGRAMMES.
- PARTY PRANKS WITH YOUR RADIO.
- THE B.B.C. PLANS A NEW REGIONAL SCHEME.
- NEWS OF THE SHORT WAVES.
- WIRELESS JOBS MADE EASY FOR MR. EVERYMAN.
- IS THERE A CURE FOR ATMOSPHERICS?
- THE MYSTERIES OF STATION FADING.

### TELEVISION SECTION

- HOW THE CATHODE-RAY TUBE WORKS.
- THE FUTURE OF TELEVISION.

### GRAMO-RADIO FEATURES

- CHOOSING YOUR RECORDS.

TWENTY-THREE stations in the first preliminary test of this two-valver was not bad going, particularly when local conditions were not good. One cannot expect super-het results from a receiver of which the chassis only costs about 29s.

### LOCATION FOR TEST

Using an aerial of approximately 75 ft. in length, situated about 15 miles from the local station, selectivity was good enough for me to tune in Brussels No. 2 clear of London Regional and Berlin between London Regional and Midland Regional.

### SIMPLE TUNING

Tuning, I found, is simplicity itself. All I had to do was to keep the reaction as far advanced as possible, adjust the tuning condenser between zero and maximum and reduce the reaction when volume was too great or quality suffered.

When the receiver was operated in this way, station after station came in at varying strength. Of course, those stations which were close to the locals in wavelength were not so strong, for I had to use the extreme selectivity tapping, but I found that by tuning in stations well below the National or above the Midland Regional, I could get very good volume.

### RADIO PARIS CLEAR

Radio Paris was free from interference, as was Huizen, but this latter station was not too strong.

Droitwich could be cut out as easily as Radio Paris.

A point that interested me was the low running costs.

### BIG OUTPUT

I tried the effect of using a large pentode valve, as suggested, and I was able to get an output of nearly 1,000 milliwatts. K. J.

## LIST of STATIONS HEARD

Station	Dial Reading	Station	Dial Reading
<b>LONG WAVES</b>			
Hilversum ...	155	Munich ...	133
Radio Paris ...	140	Midland Regional	128
Droitwich ...	118	Berlin ...	120
Luxembourg ...	50	London Regional	110
		Brussels ...	96
<b>MEDIUM WAVES</b>			
Athlone ...	169	West Regional ...	83
Stuttgart ...	156	Hilversum ...	80
Brussels No. 1 ...	149	Madrid ...	70
Prague ...	144	London National	50
North Regional	142	Trieste ...	36
Stockholm ...	138	Fecamp ...	12

# WIRELESS MAGAZINE

CHRISTMAS NUMBER—DECEMBER—PRICE 1/-

Apparently, some of the South American short-wave stations have formed themselves into a "chain" which they have termed the Cadena Indo-American Network.

It includes HJ3ABD (Bogota) on 40.6 metres, (HJ1ABB (Barranquilla) on 46.53 metres, HJ4ABB (Manizales) on 41.9 metres, YV4RC (Caracas) on 50.08 metres, YV5RMO (Maracaibo) on 49.42 metres, YV2RC (Caracas) on 49.08 metres, PRADO (Riobamba) on 45.31 metres, and others.

### Relaying Each Other

The aim of the combine is to relay each other's concerts at intervals for the benefit of all. Incidentally, programmes from YV4RC and YV2RC are sometimes relayed by YVQ (Maracay, Venezuela) on 44.96 metres (6,672.5 kilocycles). As this Government station is a

20-kilowatt, there is every chance of our receiving these broadcasts.

Finally, a listener writes me that he has picked up a call, *La Voz del Tropico*, on about 44.7 metres and that it would appear to be a new Central American transmitter. So far as my information goes, it would be San José, TízEP (Costa Rica), advertised to work on 45.05 metres (6,666 kilocycles), and it is another station which has joined the Indo-American Chain.

By the way, WEF (Rocky Point, New York) on 31.61 metres which has so often been used in connection with stunt relays to and from Europe, has now given up these duties, I understand, to WES, a 40-kilowatt station working on 31.75 metres (9,450 kilocycles).



Criticisms by WHITAKER-WILSON

# My Broadcasting Diary

I AM looking for an Aynjull, having heard no less than four singers this week all looking for Anjulls. Until a singer comes along looking for an Angel (in the sentiment of the song) I'll string along with anybody, preferably a good mezzo-soprano.

## Sunday

I THINK we English revere massed bands. At least, I have never heard anyone criticise them. I am going to—definitely.

The Cenotaph Service—such a place, such a time—might at first seem hardly the best opportunity. On the other hand, such a place and such a time should bring forth the best only.

The Pipes must have thrilled all Scots. Not being one, I can offer no opinion. When it comes to the massed bands of various Guards playing Chopin's "Funeral March," I feel something ought to be said, because the effect was so bad in the musical sense as to cause me considerable distress.

The arrangement was such that harsh chords in the heavier brass instruments marked the first beats of the bar. That was bad enough, but the way in which the march—a delicate piece of work—was *hacked through*, rather than played, deserves quiet but definite censure. The music at the Cenotaph this year was not good. I hope these words will be read in the right quarter.

Speaking definitely (as a musician), I offer the criticism that the bands sounded to me as though they had been massed for the occasion *without rehearsal*.

One other thing. The Last Post and Reveille should never be played by more than one trumpet. The result would be thin, but quite clear. I do not know how many trumpets were used, but I do know that they were all definitely out of tune and never together for two consecutive notes. I make this observation calmly and in the hope that such a solemn undertaking as the provision of music at the Hour of Armistice will, in future, be above suspicion.

## Monday

THE Entertainment Hour proved to be, so far as I was concerned, an Entertainment Quarter-of-an-Hour. Namely, the first quarter. I liked Marius Winter and his Band and I liked most of the tunes. Also I appreciated Eric Maschwitz as a hurlyburly compère. He kept things going.

The moment he left the show it dropped. The Four Yacht Club Boys were feeble in the extreme. They were not in the least amusing and I thought very little of their singing. As they ended the show they made something of an anti-climax to it.

Merely another case of *anything for lines*. Unfortunately anything won't do. In fact there is not much that will. It must be funny every time and all the time.

## Tuesday

I LOOKED at "Guess Who It Is" with misgivings after last night. However I thought I could try anything once and decided to miss *The Lady Sally* and do a bit of guessing.

The guessing proved very easy, as you probably found out. Our family is sharp at that sort of thing, I may tell you. We all spoke together—and right nearly every time.

A brilliant show it was. I guessed Rupert Hazell and Elsie Day before they had uttered two words, but I have the advantage of knowing them personally. They were excellent, I thought.

I guessed Beryl Orde simply because I knew nobody else could have impersonated up to that standard.

Bobbie Comber gave himself away instantly, but I never heard him so good. I have grumbled at him in the past and therefore must tell him I considered him brilliant to-night.

Claude and Enid—well, it was silly to have them if we were to *guess*. They squabbled beautifully. Professional squabbling needs technique. (My wife would like to add something about the amateur sort, but I do not allow interference in these notes.)

Ronald Frankau kept us in yells of laughter but we quarrelled sordidly over Stanley Holloway. I was right. The other two said he was being impersonated because he gave Sam an Oxford accent. I said it was Stanley—and it was.

I think the Western Brothers have created yet another vogue-expression. In the words of Mr. Hore-Belisha: *Beacons to you!* A splendid show with John Watt at his comperiest.

## Wednesday

BUSMAN'S holiday to-night. Casals for me only. Nothing else.

The greatest 'cellist for a hundred years either way, I imagine. Did one ever hear such tone and phrasing?

## Thursday

A MIDDAY orchestra, and a merry withal. Never heard of them before. The Rutland Square people, all the way from Edinburgh. So good I shall watch for them next time—if I happen to be at home in the day, that is.

I liked *Invitation to the Waltz*, both the yarn and the music. The Variety Director tells me he has disposed of the film rights. It will make a splendid picture, judging from the radio version. Whether it does or not, it was first-rate broadcasting.

## Friday

THE Kentuckies tip-top, as usual. Nothing the matter with them at all. Quite satisfactory.

The Kolisch String Quartet has a warm admirer in myself. I want to tell it something. That particular Beethoven can be shelved, or at least its last movement dropped. Also I noted the Quartet happened to be a little off pitch to-night. Definitely sharp most of the time. In fact, I had to switch them off.

Somebody not feeling up to the mark? Hard lines! I *still* consider this a fine quartet and am not surprised to find its members human.

I listened to Mr. Winston Churchill on the causes of war, and found myself in complete agreement with him. The speech of the series, to my way of thinking.

## Saturday

I DON'T mind telling you it was a trifle chilly on Big Ben to-night—but it was a thrill.

I arrived home for the Music Hall which I thought excellent. George Doonan has a topping style and was really funny. So were Alexander and Mose. All I offer to them is the suggestion they never employ stale gags. They can bring off most things by their voices but nobody (not even A. & M.) can make a stale joke anything else.

Will Hay and those two wets of his taught me something in history. They are inimitable. I don't think even Beryl Orde could imitate them, though she made a first-rate job of several other people earlier in the programme. I am dead against impersonations on principle, but I must weaken my argument by accepting her.

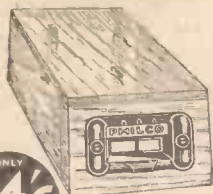

An Xmas Gift for all!  
**PHILCO**  
SHADOW-TUNING METER

ONLY 24/6 COMPLETE IN ATTRACTIVE WALNUT CASE

for any make of set with A.V.C.—either A.C., D.C. or Battery

Now you can put Philco Shadow Tuning on any make of A.C., D.C., or battery set which has A.V.C. This new accessory can be fitted without adjustment and makes this exclusive Philco tuning device available to all. The Shadow Tuning Meter is complete with its own cabinet, decoupling condenser, wire, lamp and full fitting instructions. Or, if desired can be fitted inside the set's own cabinet. Shadow Tuning shows you when you have half-line tuning—and therefore pure, undistorted reproduction. Tuning-in is completely silent. Makes station-finding child's play. Indicates, as well, the comparative signal strength of stations.

### AMERICAN TYPE VALVE REPLACEMENTS

Philco valves are suitable for all makes of American Radio sets. They improve the performance of any receiver. They can be purchased from any Philco Accredited Dealer—or write to us for full price list.

ONLY PHILCO VALVES HAVE A 90-DAY GUARANTEE

The Philco Radio & Television Corporation of Great Britain, Ltd., Aintree Road, Perivale, Middlesex.



**PETO-SCOTT**  
A.C. BAND-PASS S.G. 4  
LIST PRICE £11:11:0 BARGAIN PRICE £7:17:6  
YOURS FOR 10/- DOWN  
Cash or C.O.D., Carr. Pd.

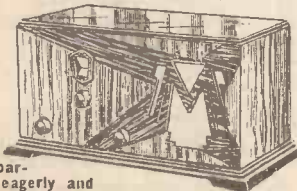

and 17 monthly payments of 10/-

Another wonderful bargain that will be eagerly and quickly secured. Brand new. Tested and guaranteed by N.T.S. Send your order now before stocks are exhausted. Absolutely complete. Ready to play.

- Single-knob Tuning.
- Illuminated Wavelength Scale.
- Combined Volume Control and On-off Switch.
- Pick-up Sockets.
- Bandpass Tuning.
- 200-250 A.C. (40-100 cycles).
- Inlaid Walnut Cabinet.
- 8-in. Moving-coil Speaker.
- 4 B.V.A. Valves (including rectifier).

**1935 PETO-SCOTT** SCREENED GRID **3**

With Peto-Scott Moving-coil Speaker, screened coils, British Valves, Oldham H.T. and L.T. Batteries, full aerial equipment, modern Cabinet. Ready to play. Cash or C.O.D. Carriage Paid, 28/6/0. Or 6/- down and 18 monthly payments of 7/9.



SEND FOR BARGAIN LISTS  
**NEW TIMES SALES Co.** 56 (A.W.2), Ludgate Hill, London, E.C.4



# Medium-wave Broadcasters

CONSULT THIS LIST OF WAVELENGTHS BEFORE YOU TUNE IN!

This week we give details of all the important European medium-wave stations. Next week we shall publish a list of short- and long-wave transmitters.

Metres	Kilo-cycles	Station and call sign	Country	Power (Kw.)	Metres	Kilo-cycles	Station and Call Sign	Country	Power (Kw.)
203.5	1,474	Plymouth	Great Britain	.3	304.3	986	Genoa	Italy	10
203.5	1,474	Bournemouth	Great Britain	1	304.3	986	Cracow	Poland	1.7
204.8	1,467.2	Pecs	Hungary	1.25	307.1	977	West Regional	Great Britain	53
206	1,456	Fecamp	France	.2	309.9	968	Grenoble PTT	France	15
207.3	1,447	Miskolc	Hungary	1.25	312.8	959	Foste Parisien, Paris	France	60
209.9	1,429	Newcastle	Great Britain	1	315.8	950	Breslau	Germany	60
209.9	1,423	Beziers	France	1.25	318.8	941	Goteborg	Sweden	10
211.3	1,420	Tampere	Finland	1.2	318.8	941	Algiers	North Africa	12
215.4	1,393	Radio Lyon	France	.5	321.9	932	Brussels (2)	Belgium	15
216.8	1,384	Warsaw (2)	Poland	10	325.4	922	Brno	Czechoslovakia	32
218.2	1,375	Basle, Berne	Switzerland	.5	328.6	913	Radio Toulouse	France	60
221.1	1,357	Turin (2)	Italy	.2	335.2	913	Limoges PTT	France	.7
222.5	1,348	Milan Vigentino (1)	Italy	.4	331.9	904	Hamburg	Germany	100
222.6	1,348	Konigsberg	Germany	.5	335.2	895	Helsinki	Finland	10
222.6	1,348	Dorpat	Estonia	.5	338.6	886	Graz	Austria	7
222.6	1,331	Paris (Vitus)	France	.7	342.1	877	London Regional	Great Britain	50
223	1,343	Dublin	Irish Free State	1	345.6	868	Poznan	Poland	20
237.2	1,348	Bordeaux S.O.	France	1	345.6	868	Fredrikstad	Norway	.7
224	1,339	Lodz	Poland	1.7	349.2	859	Strasbourg	France	11.5
224	1,337.9	Montpellier	France	.8	352.9	850	Bergen	Norway	1
225.6	1,330	Hanover and other Hamburg relays...	Germany	1.5	352.9	850	Valencia	Spain	.7
227.1	1,321	Magyarova	Hungary	1.5	356.7	841	Sofia	Bulgaria	1
230.2	1,303	Danzig	Germany	.5	360.6	832	Berlin	Germany	103
231.8	1,294	Linz and other Vienna relays...	Great Britain	1	362.8	827	U.S.S.R. (4)	U.S.S.R.	103
233.5	1,285	Aberdeen	Austria	.5	362.8	827	Radio LL Paris	France	2
235.1	1,276	Stavanger and other Oslo relays...	Great Britain	1	364.5	823	Bucharest	Roumania	12
236.8	1,267	Augsburg	Norway	.5	368.6	814	Milan	Italy	50
238.5	1,258	San Sebastian (EAJ8)	Germany	.25	373.1	804	Scottish Regional	Great Britain	50
238.5	1,258	Rome (III)	Spain	3	377.4	795	Lwow	Poland	16
240.2	1,249	Juan-les-Pins	France	.8	377.4	793.8	Barcelona (EAJ1)	Spain	8
242	1,240	Cork	Irish Free State	1	382.2	785	Leipzig	Germany	120
243.7	1,231	Dresden	Germany	.25	386.6	776	Fredrikstad	Norway	.7
243.7	1,231	Nurnberg	Germany	.2	386.6	776	Toulouse PTT	France	.7
245.5	1,222	Gleiwitz	Germany	.5	391.1	767	Midland Regional	Great Britain	25
247.3	1,211.9	Lille PTT	Italy	10	395.8	758	Katowice	Poland	12
249.2	1,204	Prague Stranice (2)	France	1.3	400.5	749	Marseilles PTT	France	1.6
251	1,195	Frankfurt-am-Main and relays	Italy	10	405.4	740	Munich	Germany	103
253.2	1,185	Kharkov (2)	Italy	10	410.4	731	Seville	Spain	2
255.1	1,176	Copenhagen	France	1.3	410.4	731	Madrid (Espana)	Spain	3
257.1	1,167	Monte Ceneri	Czechoslovakia	5	420.8	713	Tallinn	Estonia	20
259	1,158	Kosice	U.S.S.R.	20	420.8	713	Rome	Italy	50
261.1	1,149	London National	U.S.S.R.	17	426.1	704	Stockholm	Sweden	50
261.1	1,149	West National	Denmark	10	431.7	695	Paris PTT	France	7
263.2	1,140	Turin (1)	Switzerland	15	437.3	686	Belgrade	Yugoslavia	2.5
265.3	1,131	Horby	Czechoslovakia	2.5	443.1	677	Sottens	Switzerland	25
267.4	1,122	Belfast	Great Britain	50	449.1	668	North Regional	Great Britain	50
267.4	1,122	Nyiregyhaza	Great Britain	50	455.9	658	Cologne	Germany	17
270	1,110	Moravska-Ostrava	Great Britain	50	463	648	Lyons PTT	France	15
271.7	1,104	Naples	Italy	7	470.2	638	Prague (1)	Czechoslovakia	120
271.7	1,104	Madona	Sweden	10	476.9	629	Trondelag	Norway	20
274	1,095	Madrid EAJ7	N. Ireland	1	483.9	620	Brussels (1)	Belgium	15
274	1,095	Vinnitsa	Czechoslovakia	6.25	489.8	609	Florence	Italy	20
276.2	1,086	Falun	Italy	1.5	491.2	601	Sundsvall	Sweden	10
276.2	1,086	Zagreb	Latvia	1	499.2	601	Rabat	Morocco	6
278.6	1,077	Bordeaux PTT	Spain	1.3	506.8	592	Vienna	Austria	120
280.9	1,068	Tiraspol	U.S.S.R.	10	514.6	583.2	Riga	Latvia	15
283.3	1,059	Bari	U.S.S.R.	5	514.6	583	Agen	France	6
285.7	1,050	Scottish National	Sweden	.5	522.5	574	Stuttgart	Germany	103
288.5	1,040	Leninrad (2)	Yugoslavia	.75	531	565	Athlone	Irish Free State	63
288.6	1,040	Rennes PTT	France	13	539.6	556	Beromunster	Switzerland	60
291	1,031	Paredo (Lisbon)	U.S.S.R.	4	550.5	545	Budapest	Hungary	120
291	1,031	Heilsberg	Italy	20	559.7	536	Wilno	Poland	16
293.5	1,022	Barcelona (EAJ15)	Great Britain	50	559.7	536	Bolzano	Italy	1
296.2	1,013	North National	U.S.S.R.	10	569.3	527	Viipuri	Finland	10
298.8	1,004	Bratislava	France	1.3	569.3	527	Ljubljana	Yugoslavia	5.3
301.5	995	Hilversum	Portugal	5	578	519	Innsbruck	Austria	5
			Germany	60	696	431	Oulu	Finland	1.2
			Spain	1	748	401	Geneva	Switzerland	1.5
			Great Britain	50	748	401	Moscow	U.S.S.R.	20
			Czechoslovakia	14	765	392	Ostercund	Sweden	.6
			Holland	20	765	413.5	Boden	Sweden	.6

## London Chapter for I.D.A.

AS suggested some time ago, a London Chapter of the International DX'ers Alliance has now been formed. Meetings will be regularly held, and the Chapter has planned a fine programme for DX'ers during the coming winter.

All who are keenly interested in long-distance reception should write at once to J. Knight, 6 Fleetwood Street, London, N.16, who is the honorary secretary of the Chapter. He will be glad to forward full details of membership, as well as explaining the objects of the I.D.A., which now covers both medium- and short-wave reception from all parts of the world.

We understand from William Warner, the assistant publicity manager, that a second Chapter is contemplated for the benefit of Manchester and North of England fans. H.

## Police Radio in Paris

FOLLOWING a series of experiments, the French authorities for official transmissions between police headquarters, substations, and motor "flying" squads have decided to use medium wavelengths between 650 and 800 metres.

Tests carried out on short waves were far from encouraging their adoption inasmuch as transmissions made at Levallois, near the French capital, although not received in the city, were picked up at good strength at Dakar, in French West Africa!

Twenty-six Paris districts are being equipped with 200-watt transmitters and five mobile stations with 100-watt apparatus capable of working for a period of six hours on accumulators. The transmitter and receiver equipment used by the "flying" squads utilises both loud-speaker and headphones. J. G. A.

# PETO-SCOTT

SEND US YOUR ENQUIRIES FOR miscellaneous Components, Parts, Kits, Finished Receivers or Accessories for Cash or C.O.D. or H.P. on our own system of Easy Payments. Send us a list of your wants. We will quote you by return. C.O.D. orders value over 10/- sent carriage paid (GREAT BRITAIN ONLY). Hire Purchase Terms are NOT available to Irish and Overseas customers.

## PILOT AUTHOR KITS

### SHORT WAVE ADAPTOR SHORT WAVE CONVERTER

Described in this week's issue.

**COMPLETE KIT** of parts Yours for **5/-** for either the Adaptor or Converter,\* including Peto-Scott ready-wound S.W. Coils, Baseboard, ready-drilled Ebonite Panel, and specified Valve. Cash or C.O.D. and 11 monthly payments of 6/3 Carriage Paid, £2/6/6.

\*Please state which Kit required when ordering.

## ADD-ON H.F. UNIT

Described in this week's issue.

**KIT "A"** Author's Kit of First Specified parts, including ready-drilled Aluminium Baseplate, less Valve and Cabinet. Cash or C.O.D. and 6 monthly payments of 6/6 Carriage Paid, £1/19/6.

1 Specified Cossor Valve, 210VPT ... 13 6  
1 Peto-Scott Cabinet ... 12 6

## A.C.-D.C. ALL-BRITAIN 3

Described in November 17 issue.

**KIT "A"** Author's Kit of First Specified Parts, including ready-drilled Aluminium Chassis, less Valves, Cabinet and Speaker. Cash or C.O.D. Carriage Paid, £5/17/6.

Balance in 11 monthly payments of 10/9. £ s. d.

1 Peto-Scott Walnut Table Cabinet, type E.N. ... 17 6  
1 Peto-Scott ready-drilled Aluminium Chassis, 12 in. by 9 in. by 3 in. ... 7 0  
Set of 4 Oram Valves, as specified ... 3 4 6

## ROMA SHORT WAVE

Described in November 10 issue.

**KIT "A"** Author's Kit of First Specified Parts, including ready-drilled Aluminium Cabinet and Metaplex Baseboard, less Valve. Cash or C.O.D. Carriage Paid, £3/19/6.

Balance in 11 monthly payments of 7/3.

1 Peto-Scott ready-drilled Aluminium Cabinet with Metaplex Baseboard ... 17 6  
1 Set of Peto-Scott Short-wave Coils with Base ... 12 6

STILL A BIG FAVOURITE!

## "A.W." SHORT WAVE WORLD BEATER

Described in May, and November 10 issues.

**KIT "A"** Author's Kit of First Specified components, less Valves. Cash or C.O.D. Carriage Paid, £6/10/0. Balance in 11 monthly payments of 12/-

1 Set of 4 Specified Valves, £1/11/6.

## 1935 EDDYSTONE KILODYNE 4

**BATTERY MODEL.**—Kit of Eddystone 1935 Kilodyne 4 (battery model) components, including ready-drilled die-cast Aluminium Chassis and four Coils to cover wavelengths between 13.5-85 and 260-510 metres, less Valves and Cabinet. Cash or C.O.D. Carriage Paid, £4/19/6. If set of Specified Valves required, add £2/10 to Cash or C.O.D. price, or 3/9 to deposit and each monthly payment. ADDITIONAL COILS.—70-170 metres, 5/-; 150-325, 5/6; 490-1,000, 6/-; 1,000-2,000, 6/-.

We also supply the B.T.S. SHORT-WAVE KITS for Cash, C.O.D. or H.P. Send for two-colour art folders of all models.

**W.B. STENTORIAN STANDARD PERMANENT-MAGNET M.C. SPEAKER.** For Power, Pentode and Class B. Cash or C.O.D. Carriage Paid, £1/12/6. Send only 2/6. Balance in 11 monthly payments of 3/-.

**W.B. STENTORIAN SENIOR PERMANENT-MAGNET M.C. SPEAKER.** For Power, Pentode, and Class B. Cash or C.O.D. Carriage Paid, £2/2/0. Send only 2/6. Balance in 11 monthly payments of 4/-.

**W.B. STENTORIAN BABY PERMANENT-MAGNET M.C. SPEAKER.** With matching transformer, suitable for Power, Pentode, Class B or Q.P.P. Cash or C.O.D. Carriage Paid, £1/2/6. Send only 2/6. Balance in 9 monthly payments of 2/6.

**2/6 DOWN ALL MODELS**

## PETO-SCOTT CO. LTD.

77 (A.W. 11) CITY ROAD, LONDON, E.C.1  
Telephone: Clerkenwell 9400/7  
West End Showrooms 62 (A.W. D1) HIGH BOLBORN, LONDON, W.O.1  
EST. 1919



**PREPAID ADVERTISEMENTS**

Advertisements under this head are charged **THREEPENCE PER WORD**, minimum charge **THREE SHILLINGS. DEPOSIT SYSTEM.** As the publishers cannot accept responsibility for the bona fides of advertisers in this section, they have introduced a system of deposit which it is recommended should be adopted by readers when dealing with persons with whom they are unacquainted. It is here explained. Intending purchasers should forward to the Publishers the amount of the purchase money of the article advertised. This will be acknowledged to both the Depositor and the Vendor, whose names and addresses must necessarily be given. The deposit is retained until advice is received of the completion of the purchase, or of the article having been returned to and accepted by the Vendor. In addition to the amount of the deposit, a Fee of 6d. for sums of £1 and under, and 1s. for amounts in excess of £1, to cover postage, etc., must be remitted at the same time. In cases of persons not resident within the United Kingdom, double fees are charged. The amount of the Deposit and Fee must be remitted by Postal Order or Registered Letter (Cheques cannot be accepted), addressed to "Amateur Wireless," Advertisement Department, 58-61 Fetter Lane, London, E.C.4.

**PATENTS.**—Trade Marks, "Advice Handbook" free.—B. T. King, Regd. Patent Agent, 146a Queen Victoria Street, London.

**REPAIRS TO MOVING-COIL SPEAKERS.**—Cones and Coils fitted or rewound. Eliminators and Transformers quoted for. Loud-speakers, L.F. and Speech Transformers, 4/- each, post free. Trade invited. Satisfaction guaranteed. Prompt service.—Loud-speaker Repair Service, 5 Batham Grove, London, S.W.12, Battersea 1321.

**AMAZING Price, Power, Range, Tone.** 7-stage Super-hets, A.C. and Universal. Latest refinements. Stamp particulars.—Simmons Radio, 9 Ilfracombe Avenue, Southend-on-sea. Trade Supplied.

**CAMCO RADIOGRAMPHONE CABINETS AT 40/-.** Special offer of mahogany radiogram cabinets, complete with polished panel, 18 in. by 7 in. Listed at £6/15/-; now 40/-. Also a few to take panel 21 in. by 7 in., 42/6. Send for list.—Carrington Mfg. Co., Ltd., 24 Hatton Garden, E.C.1.

**BE MODERN.**—Exchange your old set and components for new. Highest allowance given. All constructors' specified kits stocked. Keenest prices quoted for Radio requirements.—Seywell Wireless Supplies, 64 Prestbury Road, London, E.7.

**HIGHEST POSSIBLE ALLOWANCE** made on used wireless goods in exchange for new sets, components, or Peto-Scott kits. All latest receivers supplied on easiest of terms.—E. Wigfield, Furlong Road, Goldthorpe, Yorks.

**WANTED.**—Good Modern Wireless Parts, Sets, Eliminators, Meters, Valves, Speakers, etc. Spot Cash waiting. Exchanges. Send or bring. We pay more than any other dealer. Open 9-8.—University Radio, 142 Drummond Street, Euston, N.W.1.

**BANKRUPT BARGAINS.**—List free. All S.T. kits. Lotus 2 pentode universal mains sets, 1935 M.C. speakers, 75/-. Lissen 2-valve mains, 55/-. Regentone 30 m.a. eliminators, 32/6. Triotron valves trade, supplied. Amplion Super-hets highest exchange allowances. Lumophon A.C. 4-valve chassis with valves, 75/-. Any set or part supplied. Part exchange.—Butlin, 143b Preston Road, Brighton. Preston 4030.

**INFORMATION BUREAU**

Will every querist please observe the following revised rules?

Please write concisely, giving essential particulars. A fee of one shilling, postal order (not stamps), stamped, addressed envelope and the coupon on this page must accompany all queries.

Not more than two questions should be sent at any time.

The designing of apparatus or receivers cannot be undertaken.

Slight modifications of a straightforward nature only can be made to blueprints. For more serious alterations the minimum charge is 2/6.

Blueprints supplied by us will be charged for in addition, but, of course, readers may send their own blueprints for alteration.

Modifications to proprietary receivers and designs published by contemporary journals cannot be undertaken. Readers' sets and components cannot be tested by us. Queries cannot be answered by telephone or personally. Readers ordering blueprints and requiring technical information in addition should address a separate letter to the Information Bureau and should see that their remittance covers the price of the Blueprint and the amount of the query fee.

We do not answer queries in cases where the fee is omitted.

Queries should be addressed to the Query Dept., "Amateur Wireless," 58/61 Fetter Lane, London, E.C.4.

**High Tension from the Mains**

Continued from page 573

put valve, makes this point quite clear. Assuming that the valve is biased 12 volts negative—namely, the mid-point of the 200-volt anode curve—we should have a steady current of about 17.5 milliamperes with no signal on the grid.

We must remember, however, that the grid is swinging positive and negative alternately, due to the signal voltage applied to it, which, when the valve is fully loaded, will vary between zero volts and 24 volts negative.

At first it would appear that the current would therefore vary between 65 milliamperes and zero, but owing to the load of the loud-speaker, the volts on the anode will fall as the current rises and rise as the current decreases, the load specified by the makers being so chosen to give equal variation of voltage for equal grid variations on either side of the bias point in order to avoid distortion.

Therefore, to obtain our maximum output it is necessary that the full voltage be maintained across the complete output circuit—namely, across the primary of the output transformer and valve together—and that the fluctuation of anode voltage applied to the valve should be due to the impedance of the transformer load only and not to resistance in the supply circuit or power will be lost in the supply circuit itself with a considerable falling off in output.

In addition, under certain conditions, distortion will result, as the valve is working into a much higher load than that for which it was designed.

We naturally conclude that although the ideal high-tension supply would be a bank of accumulators, this can be replaced quite successfully by a rectified supply from the mains, if simple precautions are taken with regard to the smoothing and regulation—and for this latter it is essential to keep all resistances low, both in the transformer and smoothing chokes.

The regulation of the transformer should be such that the voltage drop does not exceed 1 volt for every 5 milliamperes increase of current. The smoothing choke should have as low a D.C. resistance as possible and it should, in addition, maintain its inductance—about 20 henries—with the maximum current flowing. For example, if a mean current of 25 milliamperes is being taken, the choke should be capable of maintaining its inductance with at least 40 milliamperes.

**I Re-make My Transformer**

Continued from page 576

was in my high-tension unit and made the necessary connections.

There remained one thing to be done. I had to find the voltage given by the anode winding of my new transformer. Unfortunately, I had made no attempt to count the number of turns in the new anode winding. All I knew was the length of the winding, 720 ft.

However, as I had a milliammeter reading up to 50 milliamperes, on the negative high-tension side of the unit, it was not a difficult matter. With the rectifying valve in position, I placed a total resistance of 100,000 ohms across the anode winding and switched on. The milliammeter read 2 milliamperes.

Using Ohm's Law this gave a voltage of  $\frac{2}{1,000} \times 100,000$  volts, that is 200 volts.

I reduced the resistance in the anode circuit to 50,000 ohms and I obtained a reading of 4 milliamperes. This also gave 200 volts by Ohm's Law.

Lastly, I used a resistance of 15,000 ohms in the anode circuit and obtained a current of 13.5 milliamperes. Ohm's Law, from these figures, gave a voltage of 187.5 volts.

**ELECTRADIX BARGAINS**



**MOTORS;** fractional H.P. and larger sizes in stock, Television and sewing machine motors; 1-40 h.p., 220 volts, A.C., 15/- and 17/8 Foot Rheos, 15/-; 1-50 h.p. motor double ended shaft, 250 volts with resistance, A.C. or D.C., 22/8; 220-volt grammo. motor, with turntable, 50/-; Collaro double spring grammo. motor, with 12-in. turntable, 15/-.

**CHARGING DYNAMOS,** 12 to 16 volts, 10-12 amps., 25/-; or with full automatic switchboard, 47/6; Double current generators, 600 volts, 100 m.a., 8 volts 3 amps., 40/-; Engine dynamo sets, 1 k.w., 21s.

**LESDEX CHARGERS,** all steel, A.C. and D.C. mains, 2 to 200 cells, at low prices; state requirements; dynamo and rotaries in stock, all sizes, from 35/-; Brown's Superesders for 2-volt input, 80-volt output, 37/8.

**METERS,** panel, 0-6, 10, 20, 50 volts, 5/-; 100 volts, 5/8; 0-200 volts, 8/-; Special C.Z. ammeters, 3-0-3 ampe., 5/-; 0-20, 30, 50, 100, 250, 500 milliamperes, 5/-; pole testers, 2/6; meter movements, first grade M.C., 5/-.

**VISUAL TUNING METERS,** M.I. Edgewise, 6/6; flush panel, illuminated dial, 10 m.a., 25/-; M.I. flush panel, 12/-; watt meters, 200 watts, 250 volts, 50 cycles, 15/-.

**IMMERSION HEATERS,** 110 volts, 2/6; hot plates, 110 volts, 500 watts 3/8; 600 watts, 5/-; 3-heats, 220 volts electric geysers, 7/6; 220 volts hand motor blowers, 17/8.

**WAX HEATERS,** 100-250 volts, 15/-; bowl fires, 220 volts, bronze finish, 9/8; 1 k.w. bar fire, 12/8; 1 k.w., 220 volts, 20/-.

**COILS,** new Pop-Vox coils, 1/-; Bell dual range, 9d.; plug-in H.F. transformers, all ranges, 8d. each; with variable tapping switch, 1/3.

**TRANSFORMERS,** Intervalve; B.T.H., 4-1 and 15-1, as new, 7/8; Western Electric, 1.5-1, new, 2/6; Ericsson 2-1, new, 5/-; W.E. and Gambrell 4-1, soiled, 1/-.

**MAINS TRANSFORMERS;** Igranite 110-220 volts input, 300-0-300 volts, 60 m.a., 25/-; 71 volts, 21 amps, 51 volts, 11 amps., 15/-; H.M.V., 220 volts input, 500 volts, 120 m.a., 4 volts, 1 amp., 4 volts, 2 amps., 21-0-21 volts, 3 amp. output, 17/8.

**AMERICAN VALVES,** 3/8; Siemens 6-volt Bi-grid, 6d.; Weco Valves 4/6.

**SHORTWAVE KIT,** 121-80 metres, 21/-; 18-200 metres, 15/-; Peles short-wave set, 16-60 metres, type B.2, with valves, 60/-; Sullivan 5-W wavemeters, 9 to 10 metres, direct reading, as new, 45/-.

**FINE NAVAL TELESCOPES,** screw focus, 9-mile range, 20-in. gun type, 15/-; Spotting telescopes, lightweight, 17-in., 25/-.

**AMERICAN chassis type valve-holders,** 3d.; 4-pin English valve-holders, all types, 3d.; 2-pin coil-holders, 5d.; 6-pin coil-holders, 4d.

**RESISTANCES,** tapped wire wound, 100, 3,000, 15,000, 30,000, 50,000 ohms, 1/-; Eddihl wire wound, 6,000, 16,000, 38,000 ohms, 1/3; W.E. 48,000 ohms, 1/6.

**MICROPHONES** from 1/-; We are makers of 25 types for all uses; home radio mikes, solid bakelite body, 5/8; G.P.O. microphones on stand, with mouthpiece, 7/8; P.A. mikes, 50/-; 1st post free.

**MICROPHONE "A.W.P.D. TABLE MIKE"** as illustrated 15/- This is a Home Broadcasting mike containing transformer, switch and plugs. It is a marvel for 15/- only.

**ELECTRADIX 10/- BARGAIN PARCELS.** 10/- Bargain Component parcels, unused goods, containing Perno 0.0005 var. cond. Amoco twin gang, 0.0005 var. cond., set of four fixed condensers, 0.0001 to 0.0005, set of six glass sealed resistances, 0.01, 0.025, 0.05, 0.1, 0.5 1 mfd., six-pin coil base, 4- and 5-pin chassis, valve-holders, one pair aluminium screws, 2-valve metal chassis, part fitted, one pair dual range coils.



**ELECTRADIX RADIOS,** 218 Upper Thames Street, London, E.C.4 Central 4611

**Add 50/- WEEKLY to your earnings** by charging accumulators in your spare time.

Complete plant for A.C. mains incorporating Westinghouse Rectifiers to charge 105 L.T. cells weekly. Trade price £44.00 or 8/- monthly. Send for descriptive Booklet.

**M.P.R. Ltd. ROMFORD, ESSEX.**



With two readings of 200 volts, and one of 187.5 volts, I thought I could safely assume a voltage of 200 volts for the anode winding. This was rather different from the 120 volts I had expected to get.

However, I knew the four valves in my set required a total high-tension current of 10 milliamperes. All four valves in the set were of the 2-volt type with a maximum anode voltage of 120 volts. Hence I needed a resistance in the anode circuit which, with a current of 10 milliamperes passing through it, would give a voltage drop from 200 to 120 volts, that is a drop of 80 volts.

One last calculation: Required resistance  $\frac{80}{10} \times 1,000$  ohms, = 8,000 ohms.

The nearest I had to this value was a resistance of 10,000 ohms. I placed this resistance in series with the high-tension positive lead from the transformer and so obtained a drop in voltage of 100 volts. Thus my anode voltage was 100 volts (200-100).

**Amateur Wireless** INFORMATION BUREAU COUPON Available until Saturday, DECEMBER 8, 1934 FEE 1/-

Printed in Great Britain for the Proprietors and Publishers, BERNARD JONES PUBLICATIONS, LTD., 58-61 Fetter Lane, London, E.C.4, by The Sun Engraving Co., Ltd., London and Watford. Sole Agents for South Africa: CENTRAL NEWS AGENCY, LIMITED. Sole Agents for Australia and New Zealand: GORDON & GOTCH (A'SIA), LIMITED. Saturday, December 1, 1934.



# How to make a Silence SPEAK for itself . . . .



**SHOULD** your set become obstinately silent and your loud-speaker won't even whisper, it will readily confide the cause of the trouble to the AvoMinor. Trouble-tracking with the AvoMinor is fascinatingly simple with the help of the illustrated instruction booklet included with the instrument; and the AvoMinor gives you accurate readings in milliamps, volts, and ohms. It enables you to test valves, circuits, components, batteries, and power units with the ease and precision of the electrical engineer. The AvoMinor is a permanent investment in trouble-free radio. It's time YOU had an AvoMinor in the house.

**40%**

Deferred Terms if desired.

**CURRENT**  
0-6 m/amps.  
0-30 "  
0-120 "

**VOLTAGE**  
0-6 volts.  
0-120 "  
0-300 "

**RESISTANCE**  
0-10,000 ohms.  
0-60,000 "  
0-1,200,000 "  
0-3 megohms

Total Resistance 100,000 ohms.

Send for Illustrated Folder:  
**Automatic Coil Winder & Electrical Equipment Co., Ltd.**  
Winder House, Douglas Street, London, S.W.1.  
Phone: Victoria 3404-7.



## For a cool, rich smoke...



**10<sup>D</sup> PER OZ.**  
ALSO AIRMAN MIXTURE  
and AIRMAN FLAKE 10<sup>oz</sup>  
AIRMAN NAVY CUT DE-LUXE  
11<sup>oz</sup>.

P.A.42 A

You will Help Yourself and Help Us by Mentioning "A.W." to Advertisers

# UNIQUE IN POWER

THE NEW 'ATLAS' T.10/30 UNIT



**6 OUTPUTS**  
10, 20 or 30 m/A  
at 120 or 150 v  
**CASH PRICE 69/6**

Prices do not apply in I.F.S.

**UNIQUE IN VALUE**

The wonderful new "ATLAS T.10/30" is the *only unit in the world* to give these **SIX OUTPUTS** and to offer such value for money.

It converts your present battery set—whether straight, superhet, "Class-B" or "Q.P.P."—to mains-operation and gives correct outputs for any set you may own in the future.

It cuts your running expenses to less than 1/- a year—one-fiftieth the cost of batteries, and keeps your accumulator always fully charged.

INSIST ON "ATLAS." Other models for D.C. and A.C. from 39/6 cash. Ask your dealer to demonstrate, and post coupon to-day.

# ATLAS

MAINS UNITS **CLARKE'S "ATLAS"**

H. CLARKE & CO. (M/CR), LTD., Patricroft, MANCHESTER  20a

London: Bush House, W.C.2.

Glasgow: G.E.S. Co., Ltd., 38 Oswald Street.

I.F.S. Dists.: R. Marks, Ltd., 27 Upper Liffey Street, Dublin.

Send for this **FREE** folder now

MESSRS. H. CLARKE & CO. (M/CR), LTD., Patricroft, Manchester.

Please send me Folder No. 95, telling me how to run my battery set from the mains.

Name .....

Address .....

23/20

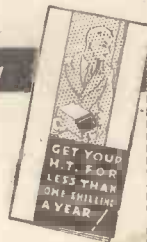



WINGS OF THE AIR

# COSSOR

## CONSOLE RECEIVERS

for BATTERY and ALL-ELECTRIC OPERATION



*Legs are detachable on all Console Models, and the receivers can be used as table models with legs detached.*

Incorporating the most advanced features in design these two Cossor Consoles provide really up-to-date Radio at a strictly moderate price. Both types employ

**VARIABLE-MU SCREENED GRID CIRCUIT**      **H.F. PENTODE DETECTOR**      **MOVING COIL LOUD SPEAKER**

and with their single dial tuning, programme selection is particularly simple. The cabinet work of these handsome models is exceptionally fine—but see and hear one for yourself—ask your dealer.

### BATTERY MODEL 355

With 3 Cossor Valves, viz: Screened Grid Variable Mu H.F., Screened H.F. Pentode Detector and Economy Pentode Output. Super-selective Iron-Cored Coils. Single-knob tuning, wavelength scale. 8" P.M. Moving Coil Speaker. Cabinet 34" high, accommodation for batteries. Provision for pick up and extension speaker.

**£8.15.0**

(Exclusive of Batteries)

*Hire Purchase Terms: 20/- deposit and 9 monthly payments of 20/-*

### ALL-ELECTRIC (A.C.) MODEL 356

With 4 Cossor Mains Valves, viz: Screened Grid Variable Mu H.F., Screened H.F. Pentode Detector, Pentode Output and Rectifier. Appearance and specification identical to Model 355 except that dial is illuminated and Moving Coil Loudspeaker is of Energised Type. For A.C. Mains only, 200/250 volts (adjustable) 40/100 cycles.

**£10.15.0**

*Hire Purchase Terms: 20/- deposit and 11 monthly payments of 20/- Prices do not apply in I.F.S.*

**PLEASE USE THIS COUPON**

To A. C. COSSOR LTD., Melody Dept., Highbury Grove, London, N.5.

Please send me free of charge a copy of your book "Cossor Radio" No. B.25, in which these Consoles and other Cossor Receivers are described.

Name .....

Address .....

**B 25**

A.W. 1712/34

