

# MIDGET SHORT-WAVE PORTABLE :: FITTING A NOISE SUPPRESSOR

# Amateur 3<sup>d</sup> Every Wednesday Wireless and Radiovision

**YOUR BATTERIES  
IN THE MAKING**

**CRUSADER'S  
AERIAL MAST**

**VOLUME CONTROL  
ON SHORT WAVES**

**MODERN LOUD-  
SPEAKER MATCHING**

**NEW  
LOUD-  
SPEAKER  
IDEAS  
to TRY**

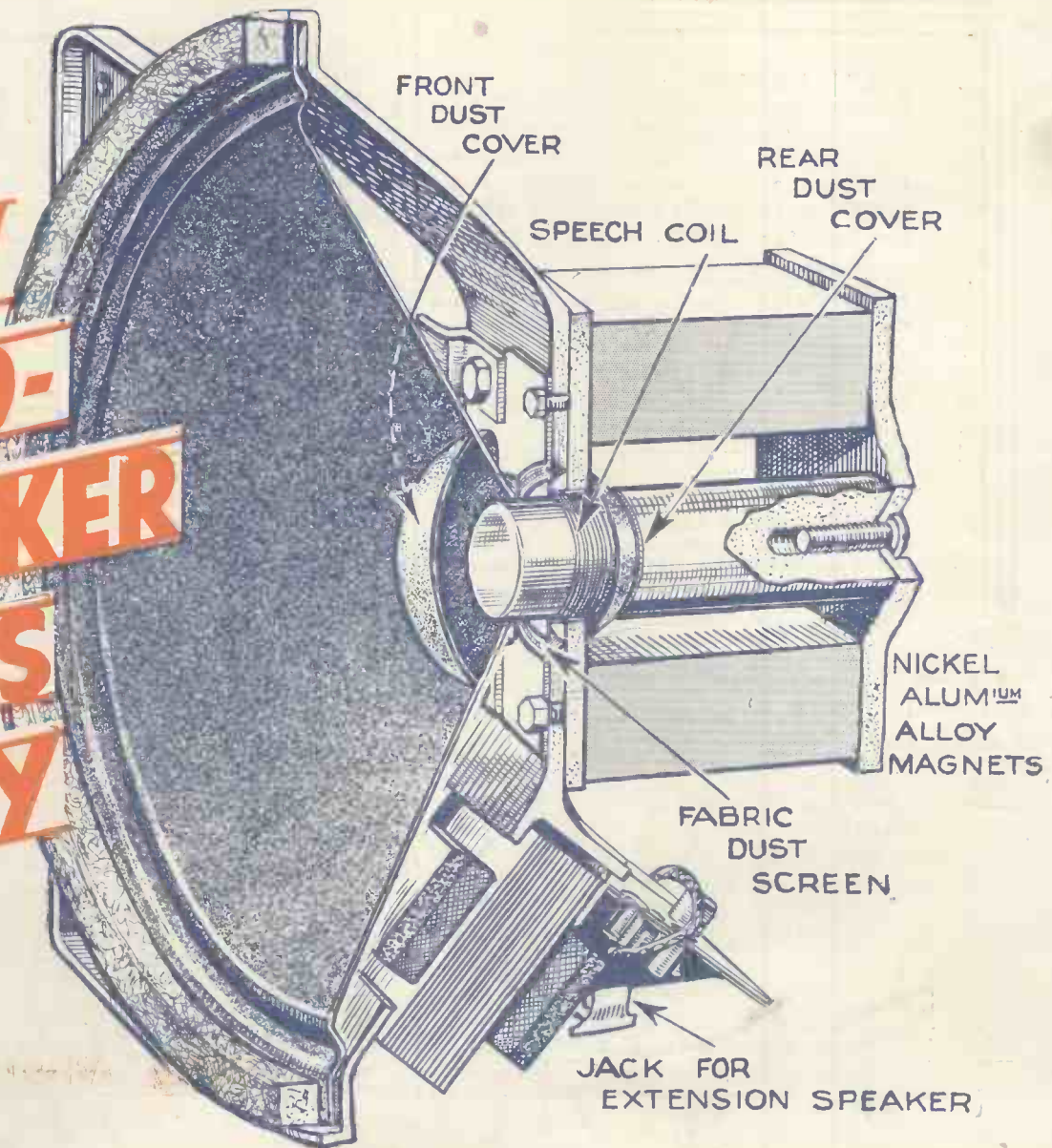



# Tradition



The Technical Press agrees with us in our statement that the Amplion 1935 "Lion" Speakers faithfully uphold our reputation for producing speakers that give life-like reproduction, fine tonal balance, sensitivity and the ability to handle heavy input without the slightest distortion.

"Popular Wireless" says:—

"To-day, Amplion moving coil loudspeakers are continuing to enjoy tremendous popularity, proof—if proof is wanted—that the old-time traditions associated with this famous name have been well maintained. . . . The Amplion "Lion" Speaker, a high-class permanent magnet moving coil instrument, is an outstanding example. It is a first-class Speaker and we congratulate Messrs. Amplion on their achievement."

"Amateur Wireless"

We understand that *Amateur Wireless* is publishing a test report in this issue. See what they say. Un-biased opinions of radio engineers all confirm our own statements of Amplion superiority.

UNIVERSAL TRANSFORMER, 1 to 20 AND 2,000 to 40,000 OHMS.

PROVISION FOR VOLUME OR TONE CONTROL AND USE OF ADDITIONAL SPEAKER.

"Lion" 7 in. cone . . . . . 47/6  
 "Lion" Super 10 in. cone . . . . . 55/-

AMPLION SPEAKER AND RECEIVER LISTS FREE

**47/6**  
(7" CONE)

# AMPLION

## LION LOUDSPEAKERS

AMPLION (1932) LTD.

2-84 Rosoman Street, London, E.C.1.

## SPECIFIED . .



Use the three Varley components specified by the designer for your "Universal All-Britain Three." Remember you can rely on Varley components for all round efficiency

**NICHOKE 2-L.F. TRANSFORMER**

**DP23 10/6**

**GANGED UNIT OF 2 BP5I COILS Complete 22/-**



BLCOMFIELD ROAD, WOOLWICH, LONDON, S.E.18 Tel.: WOOLWICH 2345



"Good...that's found the fault..."

*what a good thing I bought myself a*

**PIFCO**

## ROTAMETER

A whole night's job becomes but a few minutes' work with the Pifco ROTAMETER. For quick tracing of troubles there is nothing like it. It tests and checks everything, even itself; any one of eight dials being brought into view by turning the octagonal knob at the side of the instrument. Convenient in size and of amazing accuracy, over 100 tests are possible with this mains or battery radio testing instrument.



**9 SEPARATE METERS IN ONE ROTAMETER-DE-LUXE**

- |                |                            |
|----------------|----------------------------|
| 1—0.5 volts.   | 5—0.10 milliamperes.       |
| 2—0.20 volts.  | 6—0.50 milliamperes.       |
| 3—0.100 volts. | 7—0.250 milliamperes.      |
| 4—0.400 volts. | 8—Resist/valve test.       |
|                | 9—Plug-in test for valves. |

Ask your dealer to show you one now or write for the new Pifco Testmeter Folder, describing all instruments, to:—PIFCO LTD., SHUDEHILL, MANCHESTER, or 150 Charing Cross Road, W.C.2

42/

# PIFCO ROTAMETERS

**PIFCO ON THE SPOT WILL TRACE YOUR TROUBLES LIKE A SHOT**

Don't Forget to Say That You Saw it in "A.W."

Editor-in-Chief:  
BERNARD E. JONES

Technical Editor:  
J. H. REYNER  
B.Sc. (Hons.), A.M.I.E.E.

Radiovision Editor:  
H. CORBISHLEY

# Amateur Wireless and Radiovision

Editor:  
D. SISSON RELPH  
Research Consultants:  
W. JAMES and  
PERCY W. HARRIS  
M.Inst.Rad.E.  
Assistant Editor:  
ALAN HUNTER

Published by BERNARD JONES PUBLICATIONS, LTD., 58/61 Fetter Lane, London, E.C.4. Telephone: Central 4341 (four lines). Telegrams: "Beejapee, Fleet, London." Subscription post paid to any part of the world: 3 months, 4s. 6d.; 6 months, 8s. 9d.; 12 months, 17s. 6d. Published on Wednesdays and dated for the following Saturday.

## News and Gossip of the Week

### Royal Wedding

As a gracious act, the B.B.C. has offered its commentary and relay of the service of the forthcoming Royal wedding to all European countries.

The Germans are sending over their own commentator, who will be housed in a little hut alongside Howard Marshall on the roof of Westminster Hospital.

Vienna will take this German commentary, in addition to all the German stations.

### Rival Commentaries

It is largely a question of language that decides the countries in taking this unique broadcast. Holland and Denmark are both taking the English commentary, as in these countries the English language is, of course, widely understood.

Belgrade will take only the service, as the commentary would be quite meaningless to the majority of its subscribers.

### America, Too

Relying on reception from the Daventry Empire stations, the American broadcasting chains propose to relay the whole of the wedding proceedings.

Both N.B.C. and Columbia have arranged to take Daventry.

### Many "Mikes"

Altogether no less than twelve microphones of the latest type will be used for the Abbey service and commentary.

Of these, eight will be inside the Abbey, but only one will be seen. Another "mike" will be outside the west door of the Abbey, then there will be the commentator's "mike," and two hanging down the walls of the hospital to pick up crowd noises.

### Italian Relays

Not long ago we took an opera from Italy over the new music lines, and now Italy is reciprocating by taking a great interest in some of our concerts.

On November 28, for example, she will relay over land lines a B.B.C. Symphony Orchestral concert.

Last week, too, an Italian commentator sent his account of the international football match through the same medium.

### Television Romance

So charming Jean Bartlett, able assistant to Eustace Robb, the television producer, is tying the nuptial knot with—isn't it romantic?—a television engineer.

Mr. Bridgewater, it is. He works in the London television department. Surely the first television romance ought to be chalked up somewhere?

### Robin Whitworth Back

When Miss Bartlett marries she will, of course, leave the B.B.C. Her place as assistant television producer will be taken by young Robin Whitworth.

He thus returns to London after a comparatively short sojourn at the Manchester studios, where he had been helping Archie Harding with plays and all that.

### More "O.B.'s"

It does not need a very keen scrutiny to realise that in the programmes of to-day the B.B.C. is making much more use of outside broadcasts than ever before.

A hard-worked gang, the O.B. section. Gerald Cock surely has his hands full as O.B. director.

Christmas will see all the boys on duty—no plum duff for them

on the day itself. Too many important links to look after with the rest of the world.

### —And Why

Part of this increased O.B. activity is due, naturally, to the general expansion that has recently taken place in all the B.B.C. programmes.

Then, too, we must not forget the work entailed for this department in the B.B.C. tours of the countryside—such as the recent highly successful Oakham relay from Rutlandshire.

### Listen for Sheila!

Mrs. (Sheila to you!) BORRETT will return to the microphone in an announcing rôle very shortly.

We will not spoil the fun by specifying the exact programme—for she will come as a mystery turn.

### Sir John Back

We welcome back Sir John Reith, the director-general of the B.B.C., hoping that he has enjoyed his strenuous trip.

When he landed he certainly looked fit and as bright-eyed as ever after his dose of South African sunshine.



Hubert King tries to tune-in to the voice of Nomo King's "brudders" from the Dark Continent—but they have to be content with some pleasant music from Europe, logged on a Cossor 535 all-mains super-het.

### Not a Holiday

Yet the tireless Chief of the B.B.C. allowed himself only one free weak-end during his stay in the Union.

All the rest of the time he was busily interviewing hundreds of people in all spheres of activity, learning their radio likes and dislikes.

Travelling round in a special train, Sir John was really on a tour of discovery—and what he learnt was duly passed on to the Government.

### Another Eric

Let us give a hand to Eric Tann, the latest arrival in the B.B.C. Dance Orchestra.

He is twenty-three years young and plays the trombone. Seems like he always has done that—ever since he was twelve, anyway.

Earned fame when, during the run of the play, *Wonder Bar*, he put his foot through a 'cello in Arthur Rosebery's Orchestra, in which he was at the time a trombonist.

### Better Balance

With the coming of Eric Tann the B.B.C. Dance Orchestra will have its full complement of fourteen players, excluding George Hodges, the announcer, and Kit-tie Masters, the lady vocalist.

There will be altogether four saxophones and four brass in the band—plenty strong in the crash-bang stuff!

### Underpaid?

At last the secret is out. What do you think the little Dancing Daughters earn a week?

Three pounds. Is it enough—or too much—for a Daughter? That depends on whether you think you can enjoy hearing dancers without seeing them.

Having seen them in the studio, we think you are missing a pretty good eyeful. Where's that television—hi, hi!

### Just Zinc of It!

Latest toy of the B.B.C. engineers looks like a zinc bath—but means more. We saw it at the Maida Vale studio.

Inside it is a microphone. Which is thus surrounded on three sides and from the top by zinc.

When a singer wants to create that "distance" effect he just steps into the bath.



# "Walk Up the Mast!"



This is C.C.1029's aerial mast, which our Crusader member mentions in his letter this week. Note the weathercock!

FOR a change, let us talk about the aerial and earth—and leave our absorbingly interesting discussions on set design to take care of themselves.

Among letters on subjects not discussing sets is one from C.C. 1029, who has been reading about the troubles of C.C. No. 1, whose aerial mast won't stand the strain of Cornish gales and salt sea air.

## Aerial-mast Arrangement

We are reproducing herewith three photographs of our correspondent's aerial-mast arrangement, which he has taken the trouble to send along in the hope that the idea may be of use elsewhere.

But let C.C.1029 speak for himself—he is quite capable of doing so in an interesting way.

"Having seen that C.C. No. 1 has been in trouble in Cornwall with his aerial, I am sending you some photos and an account of my aerial, which has been in position since the year 1923," he says. The italics are ours!

"The mast is 30 ft. high and is bolted in the centre; it has also three wire stays and, being a fisherman, I have a model of H.M.S. Hood as a weather-cock.

"The mast is mounted in a tabernacle as used in the Thames barges in order that they may be dowsed when negotiating bridges.

"The uprights of the tabernacle are of 6 in. by 3 in. oak, 4 ft. 6 in. long, of which 18 in. is sunk in the ground in concrete.

"They were creosoted and painted, the lower half being tarred. Each stay is fixed in the ground by an eye, which is set in concrete, the hole for this anchor being 3 ft. wide by 2 ft. deep, the eye being set when the material is in a liquid state.

## Not Stirred In Eleven Years

"Neither the stays nor the post have ever stirred in eleven years. To put up the mast, one bolt is driven through uprights and mast and secured by a nut (see Fig. 2).

"The mast is then ready to hoist. It takes

two men to carry out this operation: No. 1, 'Back-stay Man'; No. 2, the 'Mast Man.'

"No. 1 then orders, 'Walk up the mast!' and at the same time he heaves on the back stay.

"As soon as the mast is in a perpendicular position, No. 2 drives the second bolt through uprights and mast and secures with a nut.

"No. 1, in the meantime, has made fast the stays and made them taut. In order to lower the mast, reverse this procedure. This may be necessary for painting, or in order to fit a new aerial wire hoist, which may have carried away. When down, the mast should be supported in a crutch in order to paint or to carry out necessary repairs.

"The actual aerial is 100 ft. of wire, with about 70 ft. of 'ceiling,' the rest being down-lead."

We like the bit about walking up the mast! Seriously, though, the idea is commendable and will appeal to keen Constructor Crusaders.

## Evergreen Topic

Now to return to our evergreen topic of set design, here is a letter from another advocate of a super-het for the next Crusader set.

"I have followed with great interest your Crusaders articles and would like to add my name to those who favour the baseboard-and-panel type of

receiver, the advantages of which I need not stress here, with the loud-speaker in a separate case—not built in the set.

"The blueprints already issued are, I take it, for contributors who are satisfied to build a medium-sized receiver, but no doubt there are others, like myself, who have more ambitious ideas.

"When the design appeared in 'A.W.'"



The lead-in arrangement. Note how a stand-off insulator keeps the wire well clear of the house



Close-up of the tabernacle—as used by the Thames barges. Read how our Crusader applied the idea to his aerial-mast erection

(December, 1931) I built the W. James A.C. Britain's Super, but although it is very selective, I find great difficulty in bringing in all the obtainable long- and medium-wave stations at a sufficient volume and strength to allow of the various programmes being really enjoyed.

"The set, as you are aware, has eight tuned circuits, but appears to me to want that something added, which by making it more powerful will bring in the stations at greater strength, with freedom from what I call 'crackle,' etc., and, as far as possible, from atmospherics.

"Although an engineer, I have not sufficient knowledge of the theory of wireless to enable me to re-design my present set, or even to design a new one on similar lines, which, whilst still being very selective, will fulfil the conditions above mentioned and at the same time having added such extra refinements as 'A.V.C.', 'fluid lighting,' etc." So we go on!

Practical Experiments with Your Loud-speaker

# Four Hints for Better Quality

By the "A.W." Technical Staff

WE don't yet know all there is to know about loud-speaker reproduction—not by long chalks. There is plenty of scope for the keen experimenter in this interesting field. The wonder is that more work and ideas are not concentrated on what is, after all, the most vulnerable link in the reproduction chain—the loud-speaker.

Perhaps it is that loud-speaking, as such, is regarded as a question of abstruse scientific research—all wrapt up in acoustical mumbo-jumbo that the average fan ought not to touch.

That is really quite a wrong idea, believe us. There are many ways in which you, as an ordinary amateur—or should we compliment you by saying an extraordinary amateur?—can go ahead with improving the quality of the output.

### Not Difficult—Or Expensive

Nor are these ways particularly difficult. Certainly they are not expensive, as we show by the four examples on this page.

We do not present these hints with the idea of being original—but more with the ambition of encouraging amateurs to work out their own loud-speaker's salvation.

Take the ordinary loud-speaker cabinet, for a start. It is little more than a box, really. In fact, often enough it is just that—a well or badly finished box.

Now the trouble with boxes is that they resonate. That means they cause low-note "thumps" in the reproduction, which can become almost unbearable to a sensitive musical ear. And even to the most unmusical listener there appears to be something tediously monotonous in the repeated "thump" in the so-called bass.

A way out of this boxiness is to do away with

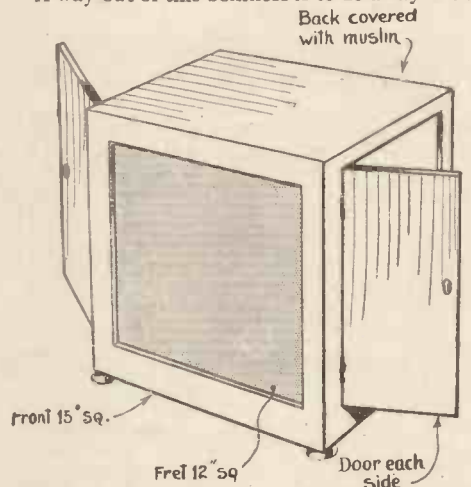

Fig. 1.—By hinging the sides of the cabinet and removing the back altogether that "boxy" tones of reproduction can often be eliminated

the box. Do away, we mean, with the formation of a box, and let a little fresh air into the business. The Fig. 1 diagram shows exactly how this can be done—in a variable way so as to achieve the exact effect required.

Take the back of the box off altogether. That is the first move to eliminate box

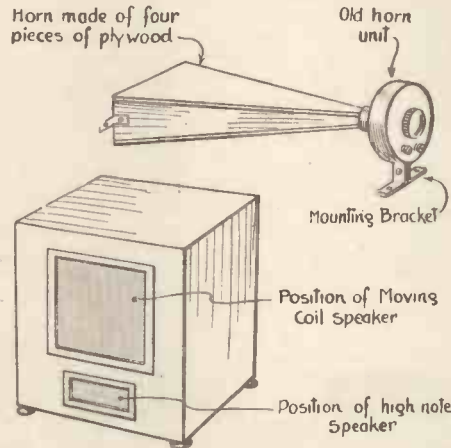

Fig. 4.—(Above) How the "tweeter" loud-speaker can be made up from an old horn-type unit and some plywood. (Below) How the two frets for the moving-coil and "tweeter" should be cut in the loud-speaker cabinet

resonance. Then, going a step farther, hinge the two sides.

When the set is not in use the sides can be shut to, in order to keep the dust out of the loud-speaker mechanism and to make a tidy job of it.

But for actual reception the two sides can be flapped open, so as to form something like a continuous front baffle, which will have just as good an effect as a box baffle without the annoyance of the boxiness in the bass reproduction.

### Covering the Back

The back can, of course, be covered with the same material as the fret at the front—some kind of ornamental or quite plain muslin being ideal.

During reception you can, of course, experiment in order to find out just how much of the boominess was due to the closed sides. Quite a lot, as a rule, we can assure you from bitter experience.

Now we come to the Fig. 2 idea. What about that old piece of carpet lying in the

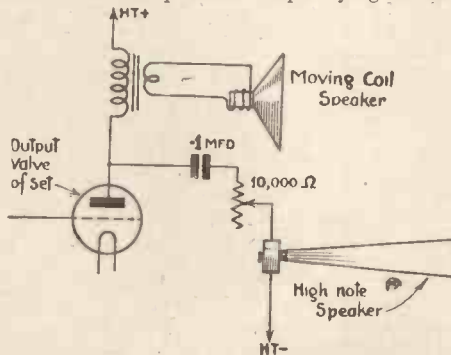

Fig. 3.—Circuit for using a "tweeter" type loud-speaker with an ordinary moving-coil in order to bring out the higher frequencies in their correct proportion

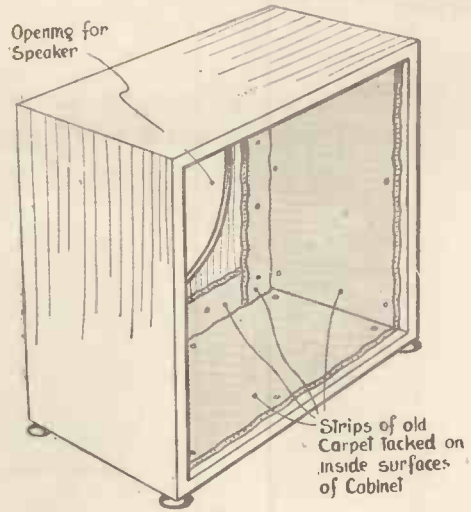

Fig. 2.—Lining the inside surfaces with old carpet strips will help to avoid harshness in the loud-speaker reproduction

attic? Out with it—for use in the loud-speaker box.

Cut suitable-sized strips, as shown by the diagram, and tack them inside the cabinet, so that the inner surfaces are well lined.

With what object? Well, very often it will be found that highly polished or very smooth surfaces will impart a certain harshness to the reproduction, which can be smoothed out by the carpet lining as suggested. A more mellow tone, as distinct from a mere boxy tone, will result from this practice.

### Better Still, Leave It off!

See that it is fitted well round the loud-speaker itself, and lines the sides and the top and bottom in like manner. If there is a back to the loud-speaker cabinet, treat that to a lining, too, but better still leave the back off as already suggested.

We come now to some rather more ambitious ideas. Fig. 3 shows a circuit that ought to interest a great many of our experimentally inclined readers.

It is nothing less than a circuit for incorporating a "tweeter" type loud-speaker to deal with the higher frequencies. As you know some of the big sets at the Show included "tweeters" to handle high frequencies normally lost with the average moving-coil.

The circuit is really very simple when you come to analyse it. There is the usual transformer in the anode circuit, with the usual moving-coil loud-speaker connected to its secondary.

The "tweeter" circuit is in the nature of a parallel extra. That is to say, the "tweeter" loud-speaker is connected between the anode of the power valve and high-tension negative. It is so connected through a fixed condenser and a variable resistance.

### Just the Right Proportion

The condenser has a value of .1 microfarad, which will effectively pass all the higher frequencies, but not the lower ones. The 10,000-ohms variable resistance will control the passage of these higher frequencies through the loud-speaker, so that you can obtain just the right proportion to your liking.

The actual "tweeter" loud-speaker can be made up as shown by Fig. 4. An old horn-type unit is wanted, with a horn made up as shown from four pieces of plywood.

Then you can fit the small "tweeter" underneath the large moving-coil, as shown by the lower sketch in Fig. 4. A small opening or fret for the "tweeter" should be arranged below the large fret for the moving-coil, so that you actually hear the output as a merging of the sounds from the two reproducers.



# The Midget Short-

We present here something new in short-wave sets, a battery two-valver practically self-contained within a small box. Although so compact, the detector and low-frequency-amplifier circuit is ultra-sensitive and by careful tuning and reaction adjustments, it is possible to bring in stations from all parts of the world on the headphones at very good strength.

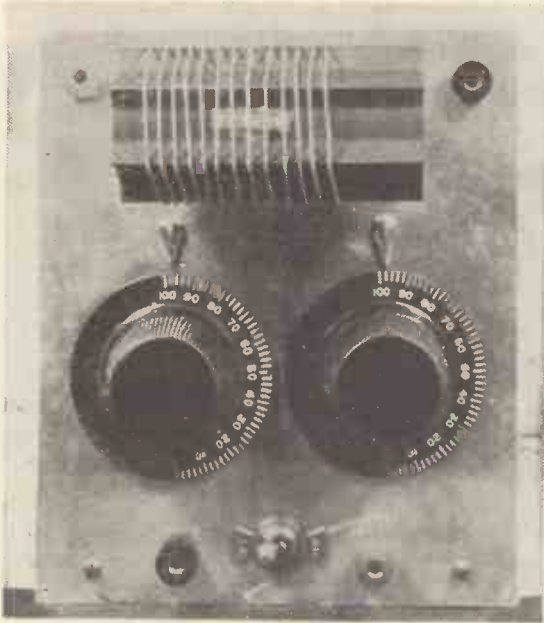

Close-up of the front panel of the Midget Short-waver, showing how the plug-in coil is fitted above the two controls

EVERY kind of short-wave set has been designed and produced by one organisation or another, but so far as we know nothing in the self-contained line has been attempted.

This week, therefore, you may be specially interested in the design we present to you in this practical article. The set, a two-valver with detector and low-frequency-amplifier circuit, is entirely self-contained so far as the coils, batteries, valves, and phones are concerned. The only externals needed are an aerial and an earth.

## Aerial and Earth

Right away, let us say that upon the quality of the aerial and earth largely depends the efficiency of the set. That does not mean to say that this short-waver is particularly sensitive about its aerial equipment—simply another way of saying that all short-wavers rely to a large extent on the efficiency of the pick-up arrangement.

True, you may be able to pick up the States on the proverbial clothes-line aerial, or even farther afield in this diminishing world. The fact that America can be picked up on an indifferent indoor aerial and possibly no earth in no way presents a case against the erection of the best possible aerial system for short waves.

For with a really low-loss aerial of the short-wave type, together with a first-class earth, a short-waver such as this one literally has no range limits. A 30-ft. aerial slung clear of all buildings except at the lead-in, and the lead-in kept as clear as possible of the walls, will provide a wonderful kick off for this set to "do its stuff."

## Counterpoise Recommended

A buried earth plate right under the aerial wire is the ideal to aim at, but short of that a counterpoise about 8 ft. from the ground and parallel with the aerial wire can be recommended. Of course, quite good results can be expected from even a main water-pipe earth, provided that the aerial is efficient.

Unless both aerial and earth are low-loss you may have some difficulty in obtaining smooth oscillation right down on the shortest wavelengths. Smooth oscillation is essential

on the short waves, much more so than on the medium wavebands.

Well, with that necessary little introduction, we can get along with the description of the Midget Short-waver. The whole thing is contained, as you will appreciate from the various illustrations, in a neat little box with a lid.

The box measures approximately 9 in. by 7 $\frac{3}{4}$  in. by 7 $\frac{1}{4}$  in., including the depth of the lid. There are three compartments, the largest

Provided with two clips for the positive and negative connections, this little battery is just the thing for a short-waver with only two valves.

## Equally Diminutive

Then, again, the accumulator for the low-tension supply is equally diminutive. It is type LCJ1—a jelly-acid cell in the large Exide range. A 2-volt cell that provides the current for the filaments of the detector and power valves of the short-wave combination.

These Lilliputian batteries are quite suitable for the set in question and there is no doubt about the handiness. They fit one on top of the other in the battery compartment on the right of the metal chassis set.

There now, we have mentioned metal chassis. Don't let this frighten you off the design. It is so much easier to design a good short-waver with a metal chassis than with the usual panel-and-baseboard arrangement—particularly when, as here, we want economy of space.

## Bent Aluminium Piece

From the blueprint reproduction you will see that the basis of the metal chassis is a simple bent piece of aluminium, with another piece forming the panel for the controls.

More of that in a moment. Just now it is opportune to give you some details of the little set's circuit, which has been engineered to be as simple as possible consistent with the special requirements of the short waves.

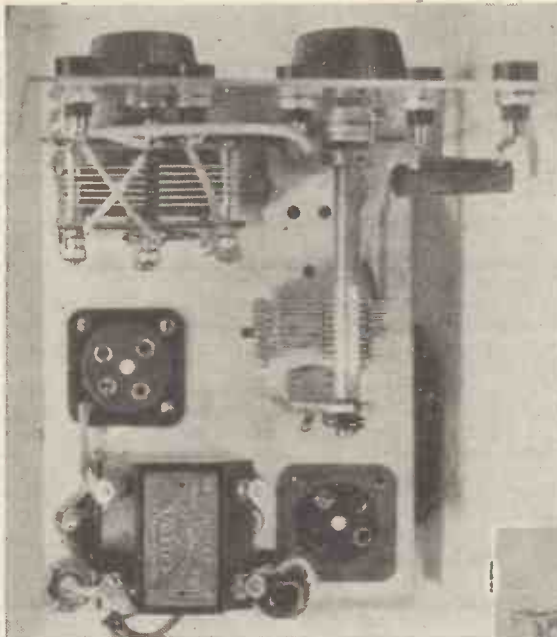

Looking down on the neat little metal chassis that forms the basis of the construction. Note the tuning condenser with its extension spindle for avoiding hand-capacity

being for the set itself. The compartment by the side of it is for the batteries, and at the back there is another compartment that takes the coils and the phones.

That leaves only the aerial and earth as "extras"—a compact arrangement that will appeal particularly to those who regard the short waves as something apart from ordinary broadcasting and who want, therefore, to have their complete short-wave equipment in a handy form for use at odd times.

Largely, the design of this midget has been made possible by the very useful little batteries that have been put on the market by Exide's.

The high tension must be the smallest ever made, we imagine. It is a 45-volt unit, type X325, and measures only 2 $\frac{3}{4}$  in. by 1 $\frac{3}{4}$  in. by 3 $\frac{1}{2}$  in. deep.

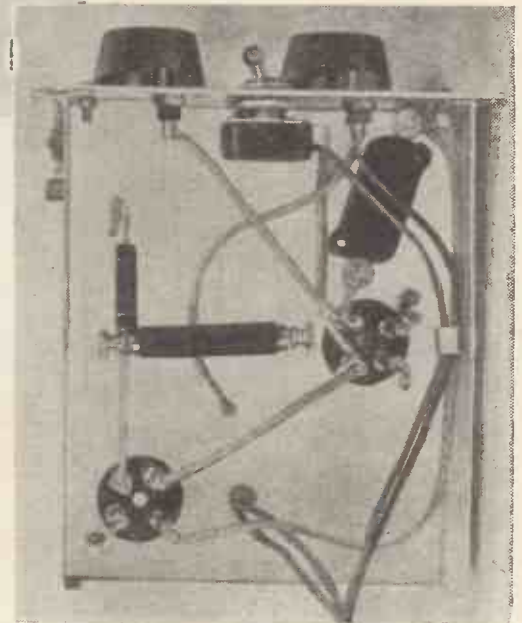

Underneath the metal chassis are fitted one or two of the smaller components, together with the on-off switch that comes below the main tuning and reaction controls

# Short-wave Portable

Note for a start that the circuit has been simplified in its draughtsmanship by the adoption of our familiar little triangular blobs, which indicate at every point the connection of that lead to the nearest part of the metal chassis, which is, of course, earthed.

In order, therefore, to gain a clear idea as to the real nature of the circuit, you ought to consider all the points shown as triangular blobs joined together and to earth. For example, the blob at the end of the tuning coil, shown as No. 2, should be regarded as actually connected to the blob end of the variable .00016-microfarad tuning condenser—and the two points being earthed.

Similarly with all the other connections that end in blobs. They each of them indicate the value of the chassis in providing easy and efficient connection to earth. With a short-wave set the shortness of the various leads brought about by the earthing to the metal chassis is a great advantage, as this system cuts down the losses considerably and thus enables the very high frequencies of the short waves to function with maximum efficiency.

Well, then, about this two-valve circuit. As you can see from the theoretical diagram, there is the usual detector with leaky-grid rectification and a transformer-coupled low-frequency amplifier, which is also the power output to the phones or loud-speaker.

Several points about this very simple circuit ought to be stressed; so here goes. First, about the aerial coupling. Note that there is a .00005-microfarad fixed condenser between the aerial lead and the No. 1 side of the aerial tuning coil.

### Small Condenser Essential

This very small condenser is essential to cut down the heavy damping of even the lowest of low low aerials. If it is omitted you will not be able to obtain oscillation—nor will this be possible with a much larger condenser.

The capacity value chosen will suit most aerials, even when they are on the long side.

The coil is tuned by the small maximum capacity tuning condenser, a special short-wave type with an extension spindle for the control knob—useful in cutting down further hand capacity effects.

Reaction, a very important aspect of any short-wave design, has received special attention in this Midget. You will see that the reaction winding is coupled to the aerial-tuning winding and the current from the anode of the detector valve controlled by a differential.

Actually, of course, the tuning and reaction windings are part of one of the "A.W." short-wave coils, which



Adjusting the controls of the Midget short-waver, a sensitive little set that will bring in the whole world—on headphones, anyway. Note the extra plug-in coils

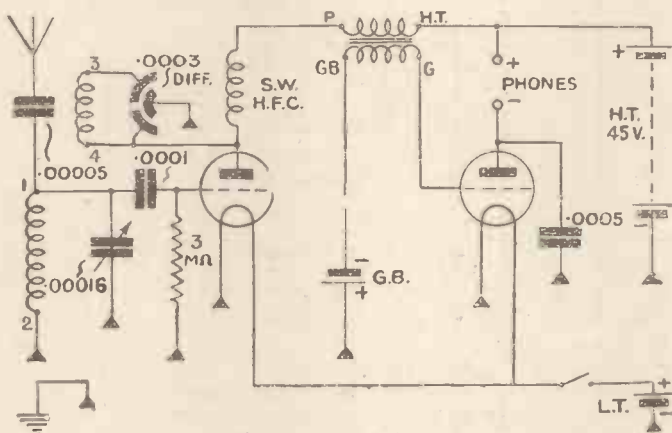

Study this theoretical circuit diagram before you read the article, which fully explains the various points of special importance. The triangular blobs indicate earthed chassis components

Associated with this differential condenser for reaction is a special short-wave high-frequency choke, which also helps to prevent the high-frequency current from getting into the low-frequency amplifier—where, if it arrived, it would proceed to produce hand-capacity and other irritating effects.

### Torchlamp Bias Cell

The rest of the circuit is very simple, as can be seen. Straight-forward transformer coupling without any decoupling follows the detector, with a single torchlamp cell acting as a suitable grid bias to the power output valve.

Note that from the anode of the power valve and earth, there is a .0005-microfarad fixed condenser. The function of this is to by-pass any residual high-frequency that may have trickled through in spite of all precautions. It will prevent high-frequency from

affecting the headphones—and that will prevent movements of the head affecting the settings of the tuning and the reaction controls.

A small on-off switch in the positive low-tension lead completes the circuit analysis, save to mention that the maximum high-tension is applied to both the anodes of the valves. Strictly speaking this is intended as a phones set, and the circuit has been engineered accordingly.

So much, then, for the circuit. Before you consider the construction, you might glance at the various illustrations, as they will give point to the few remarks that follow.

### A Metal-chassis Set

As mentioned, it is a metal-chassis set. The main chassis can be made up from a piece of No. 20 gauge aluminium with the two ends bent to the dimensions shown by one of the inset drawings given on the full size blueprint and reproduced half scale this week.

The panel, which is also aluminium, should be of No. 16 gauge, and it can be fixed to the lip of the chassis with a couple of 6BA bolts and nuts.

The two holes for the valve holders can be cut in the metal chassis with a fret-saw quite

were described in detail in the Short-wave Number, dated November 10, 1934.

You will find full details on page 493 of that issue, from which it will be gathered that there are three coils, covering between them a wavelength range from about 12 to 175 metres with a .00025-microfarad variable condenser. The ranges will be slightly less on the maximums with the specified condensers, of course. If you don't want to make the coils yourself they can be obtained from either Wright and Weaire or from Peto Scott, both of these well-known firms making them up exactly to our specification.

By the way, the coil base will not be needed because the coils plug straight into insulated sockets in the metal panel—but of that more anon.

Differential reaction, to revert to the circuit, provides smooth reaction with the reaction windings of the short-wave coils, and at the same time acts as an effective by-pass of the unwanted high-frequency currents at the anode of the detector.

As the reaction by-pass is reduced, the anode-to-earth by-pass is increased, so that the total high-frequency by-pass from the anode of the detector to earth is always constant—and so therefore, is the efficiency of the detector.

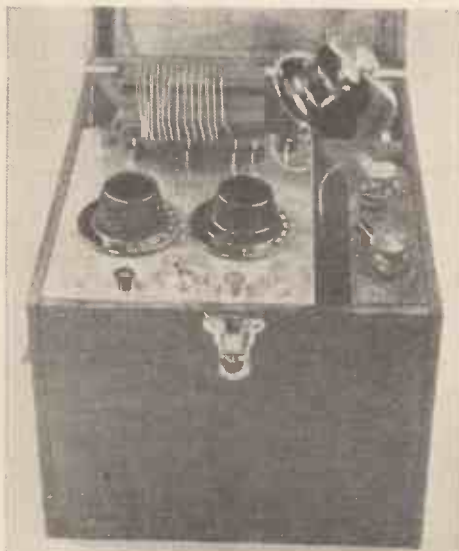

The whole short-wave installation fitted into its neat little cabinet. Even the headphones are placed in a small compartment at the back as you can see here



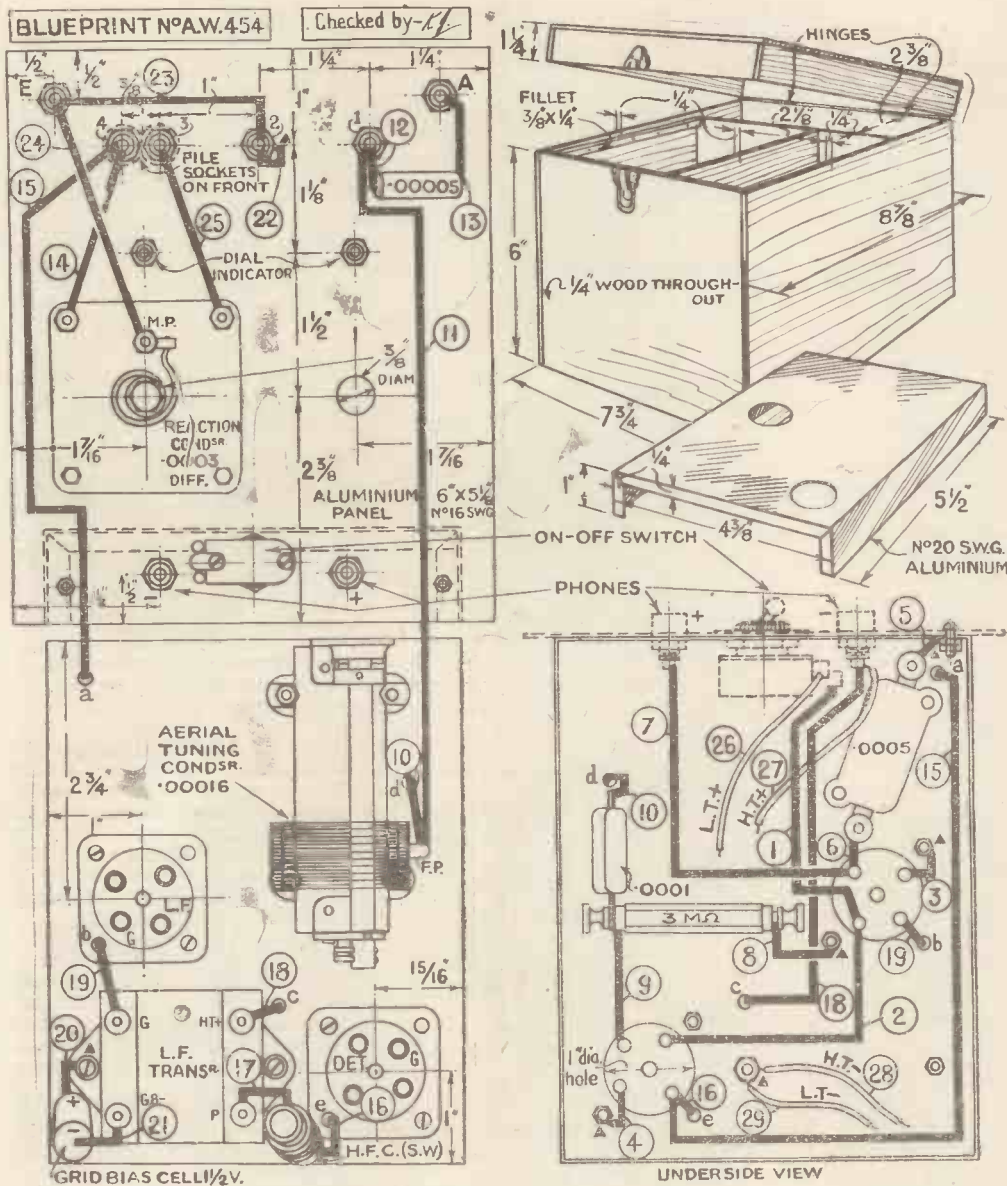

Before you attempt to build the Midget short-waver, consider the advantages of the full-size blueprint, a working reproduction of which we show above. It can be obtained, price 1s., post paid, from the Blueprint Department, 58-61 Fetter Lane, E.C.4.

easily, likewise the rest of the smaller holes are easily drilled with the usual twist drill or even with a brace fitted with a twist drill chuck.

All the dimensions are given on the full-size blueprint, which is well worth any constructor's "bob" for all its invaluable information.

**Sub-chassis Switch**

The tuning condenser with its extension spindle is mounted on the left of the panel and the differential reaction with air-spaced vanes on the right. Below the chassis level on the panel is the on-off switch, its connections being sub-chassis, therefore.

The insulated sockets for the coils are mounted at the top of the metal panel, all being thoroughly insulated except of course the socket corresponding to No. 2 end of the tuning winding, which is in any case earthed.

These sockets must be exactly spaced as shown by the blueprint, so that they correspond with the pins of the interchangeable coil units. Sockets are also fitted on the panel for the aerial and earth and phones, all insulated except the earth socket.

There is very little sub-chassis work to be done. A couple of fixed condensers and the

battery switch are all the important parts down there, with of course the connections of the chassis mounted valve holders.

From the top-plan view you will see that the layout is particularly clean, even when,

as shown, the wiring has all been done. This in itself is a recommendation for a short-wave set—the fewer the wires and the shorter they are the better.

Note that the little cell for the grid bias has a lead soldered to its zinc, so that it can be connected to the grid bias and earth. Also that the small input aerial condenser is mounted above the chassis.

Follow the blueprint when you wire up, making the leads in sequence, and taking note that the holes through which the wires pass from top to bottom of the chassis are key lettered to avoid any possibility of error.

**Home-made Box**

The completely wired metal chassis is screwed face downwards into the compartment provided in the home-made box, the details for whose construction are also clearly given on the blueprint.

When the little switch is moved to the right, the batteries are brought into operation, and you can then tune in on the left-hand condenser, keeping the reaction condenser in such a position that the detector is nearly, but not quite, oscillating. Always slacken off reaction when you have tuned-in the required station, unless of course it is so weak that full reaction is essential.

We say this about slackening off, because the set is more stable in that condition than when right up to the oscillation point.

Try the set with the middle-sized coil first, and then when you have grown used to its operation, you can explore with the smaller and the larger coils.

Use a good pair of headphones and you ought to be able to hear the whole world—if you choose your time and wavelength.

Where a great many short-wave novices make a mistake is in trying to explore too large a waveband at once. It is much more lucrative to deal with a very small band at one sitting—assuming, of course, that the band in question is "alive" at that time.

Remember always that on the short waves a very slight difference in capacity means a big difference in frequency—and between two coarse adjustments may be lurking a dozen or more good short-wave signals.

By concentrating on one band at a time, and turning the tuning-control knob ever so slowly, results will come as surely to the novice as to the expert. Always bear this point in mind—patience is more than a virtue on short waves; it's an essential requirement.

**LIST OF PARTS REQUIRED TO MAKE THE MIDGET SHORT-WAVE PORTABLE**

**CHASSIS**

1—Aluminium to specification.

**CHOKE, HIGH-FREQUENCY**

1—Short-wave (Eddystone, type 948).

**COILS**

1—Set of home-made with holder, as described (or Wearite, Peto Scott).

**CONDENSERS, FIXED**

1—.0005-microfarad tubular (Graham Farish).  
1—.0001-microfarad type 685 (Dubilier).  
1—.0005-microfarad type 670 (Dubilier).

**CONDENSERS, VARIABLE**

1—.00016-microfarad (Polar, type E).  
1—.0003-microfarad differential (J.B., type air spaced).

**HOLDERS, VALVE**

2—4-pin type chassis mounting (Goltone).

**PLUGS, TERMINALS, ETC.**

8—Insulated sockets marked; red (2), black (6), (Clix).  
4—Plugs marked: Aerial, Earth, Phones+, Phones- (Clix).  
2—Spade terminals, marked: L.T.—, L.T.+

**RESISTANCE, FIXED**

1—3-in. megohm (Graham Farish, type Ohmite).

**SUNDRIES**

Connecting wire and sleeving.  
2 doz. 1/2-in. 6 B.A. bolts and nuts.  
3 ft. thin flex.  
1 cell of 2T5 battery (Drydex).  
2—2-in. dials engraved 0-100.  
2—Dial indicators (Bulgin).

**SWITCH**

1—Single-pole on-off (Bulgin, type S102).

**TRANSFORMER, LOW-FREQUENCY**

1—Radio 1/3.5 (Varley, type Niclet).

**ACCESSORIES**

**BATTERIES**

1—45-volt high-tension, type X325 (Drydex).  
1—2-volt accumulator, type LCJ1 (Exide).

**CABINET**

1—Home-made as described.

**PHONES**

1—Pair Lissen.

**VALVES**

2—DL2 (Record).



# On Your Wavelength

The Week's Radio Gossip :: By THERMION

## Training Not Wanted?

LAST week I referred to the excellent training schemes which are being mooted for the benefit of wireless servicemen. The advantages of such training are pretty obvious, and one would have thought that those concerned would have leapt at the opportunity.

From inquiries, I learn that the response is nothing like what it should be; in fact, a common attitude is that training isn't necessary because the serviceman knows his job already.

Well, some do, some don't; and there are few who wouldn't benefit vastly from a sound course in servicing as well as in the technicalities of wireless. I hope that dealers won't throw this opportunity away, for it is the finest chance they have had of acquiring something better than a mere artisan status.

## Safety First

THE necessity for servicemen to be fully qualified after a course of training is greater to-day than ever it was, since so many more sets of the all-mains type are being installed. Properly put in, these sets are safety itself; but I have come across installations by the ham-handed kind of serviceman who knows and cares little about wireless or electricity, which were thoroughly dangerous.

One that I recall particularly was an eliminator that had been made for a customer by one of these johnnies. The bits and pieces were put together on a plain, uncovered baseboard; ordinary bell wire was used for some of the connections; the terminals were of the plain uninsulated type; and the condensers were cheap affairs not fit to deal with the necessary voltages.

To make matters worse, the whole gadget—without any cover at all, remember—was placed on a low shelf in a scullery with a zinc-covered floor.

And probably the chappie who installed that little death-trap is one of those who say that courses of training are unnecessary.

## Valves of Yesteryear

PERCY HARRIS'S recent article on ancient valves was particularly interesting and must call up memories for most old hands. I never used the German valve illustrated in the article, but, like many others, I had several of a similar pattern. These came into this country in 1919 or 1920. They were made by the Siemens-Haelske Company, but they were mounted horizontally instead of vertically.

Some of you will remember them. There were two contacts at each end and a pair of "pinches." One carried the horizontal, sagging filament; the other the grid and the plate. The former was a disc of what looked like gauze about the size of a shilling. The plate, grid, and filament were all placed  $\frac{1}{4}$  inch or more apart.



This is the Philco shadow tuning meter referred to by Thermion in his notes this week. It is suitable for super-hets with self-adjusting volume control. The price for the gadget as shown is 24s. 6d.

Though I have searched through my diaries, I cannot find any record of the characteristics of these valves; but I do remember that almost their only virtue was their cheapness. Compared with the "R" valve or the "Ora," which came along a little later, they were hopelessly inefficient and their filaments burnt out pretty quickly.

## Crystal Relic

GOING through my junk-box the other day, I turned out a remarkable relic of the days just after the War. This was the then last word in crystal detectors. It cost a guinea, and the price probably wasn't exorbitant, for it was made up in the expensive style that characterises, or used to characterise, laboratory electrical apparatus.

The terminals, for instance, as well as the pillar supporting the catwhisker arm and the crystal cup, were turned from solid brass. The little baseboard was a beautifully polished piece of mahogany, and there was a micrometer screw for fine adjustments.

I had a lot of fun with that old detector in its day. There wasn't much to hear in the way of telephony that was within its range, though I do remember tuning in the Eiffel Tower broadcasts on occasion.

I can endorse P.W.H.'s remarks about quality. When I made my first two-valve set, operating a weird horn loud-speaker, admiring friends used to troop in to hear its perfo mances. They stood or sat spellbound during a musical item, but at the end there was nearly always an argument whether we had been listening to a piano, banjo, or a harp.

## An Early Demonstration

A POIGNANT memory of the early days concerns a set which was then regarded as the absolute goods. It was built up in units (high-frequency, detector and low-frequency), each of which cost a good few pounds.

I had been asked to give a lecture and demonstration at the house of some friends in London, and for the occasion they had invited a score of people to dinner. A voluntary assistant and I spent the whole afternoon in rigging up five units—two high-frequency, detector, and two low-frequency—in the drawing-room, and these were yoked to a Brown type-H loud-speaker.

In those days the only "broadcasting" available (except on Tuesday nights, when Writtle was at work for an hour) came from amateurs. The idea of the demonstration was that I should give a talk on wireless, what time my helper twiddled things and listened with ear-phones.

As soon as he had found something he was to signal to me. I would then break off and the audience, none of whom had previously heard wireless, would be lost in wonder and amazement.

## The Set That Wouldn't

THE talk started off rather well. When it had gone on for ten minutes or so I kept casting agonised glances at my assistant, who



Striking view of the automatic-record-changing radio-gramophone in the Marconiphone range—a nine-valve super-het that sells for the moderate price of forty-seven guineas

simply shook his head whenever he caught my eye. I passed from "The Wonders of Wireless Waves" to "The Marvels of the Wireless Set."

Still no signal from my helper. Faint but pursuing, I went on to "The Future of Wireless." After about half an hour I had told them all that I knew about wireless, and probably a good deal that I didn't. The set refused utterly to bring in anything.

## Those Were the Days!

Leaving my helper to carry on as best he could, I dashed to the telephone and rang up the factory. Could they send round another set? They couldn't, but they had one working there, and if I liked to bring the party round, all might still be well.

The hostess bundled them into cars and taxis, and off we went. It was now getting rather late and most of the amateurs had closed down. But we succeeded in getting hold of one who was transmitting a gramophone record of a Harry Lauder song. This saved the situation, and, though it was after ten o'clock when we sat down to dinner, it was voted a great evening.

Those were the days!

## "A.W." Reference Sheet—No. 8

## What Ohm's Law Really means

JUST over a hundred years ago G. S. Ohm propounded a law which stated that the difference of potential between two points on a wire is proportional to the current flowing along the wire. This still holds good, and forms one of the basic laws governing calculations relating to electrical problems. Without going into details, the statement can be expressed in the following manner:

Current = Electro Motive Force divided by Resistance. Replacing the terms with the standard units we get Amperes =  $\frac{\text{Volts}}{\text{Ohms}}$ .

With radio work we are not often concerned with amperes, except in some low-tension circuits, so it will be necessary to remember that

$$\text{Milliamperes} = \frac{\text{Volts} \times 1,000}{\text{Ohms}}$$

Example: 200 volts is applied through a resistance having a value of 5,000 ohms. What current will pass?

$$\text{Milliamperes} = \frac{200 \times 1,000}{5,000} = \frac{200,000}{5,000}$$

which equals 40 milliamperes.

From the first formula we can also obtain

$$\text{Volts} = \text{Amperes} \times \text{Ohms}, \text{ or}$$

$$= \frac{\text{Milliamperes} \times \text{Ohms}}{1,000}$$

Example: A loud-speaker has a resistance of 4,000 ohms. A current of 7 milliamperes is flowing. Question: What voltage will

be dropped or lost across the loud-speaker?

$$\text{Volts} = \frac{\text{Milliamperes} \times \text{Ohms}}{1,000}$$

$$7 \times 4,000 = \frac{28,000}{1,000} = 28 \text{ volts.}$$

Giving this statement another twist we can say that Resistance =  $\frac{\text{Volts} \times 1,000}{\text{Milliamperes}}$

Example: A voltage of 150 is applied to a resistance which is not marked. We find that the current flowing is 3 milliamperes.

Question: What value is the resistance?

$$\text{Resistance} = \frac{\text{Volts} \times 1,000}{\text{Milliamperes}}$$

$$\frac{150 \times 1,000}{3} = \frac{150,000}{3} = 50,000 \text{ ohms.}$$

The table given below shows these simple calculations and should be kept in a handy spot for easy reference.

$$\text{Amperes} = \frac{\text{Volts}}{\text{Ohms}}$$

$$\text{Milliamperes} = \frac{\text{Volts} \times 1,000}{\text{Ohms}}$$

$$\text{Volts} = \text{Amperes} \times \text{Ohms.}$$

$$\text{Volts} = \frac{\text{Milliamperes} \times \text{Ohms}}{1,000}$$

$$\text{Resistance} = \frac{\text{Volts}}{\text{Amperes}}$$

$$\text{Resistance} = \frac{\text{Volts} \times 1,000}{\text{Milliamperes.}}$$

## Shadow Tuning

YOU have probably noticed in "A.W." advertisements of the Philco shadow-tuning unit. This is an especially interesting gadget that I have used quite a lot with various self-adjusting volume control superhets.

You know the difficulty with sets of this kind if they haven't some effective form of tuning indicator. It is easy enough to tune in distant stations, for they have no spread worth talking about, and the exact setting is pretty obvious. But even with the most selective superhet the local and other very powerful transmissions spread over perhaps a division of the dial, and it is extraordinarily difficult to determine, without a lot of fiddling, when you are exactly "there."

If you don't get your tuning exact, there is bound to be distortion in the reproduction. The Philco Indicator is very easily attached to any kind of S.A.V.C. super-het. It shows a ribbon-like shadow which is at its fattest when you are right off resonance and at its thinnest when your tuning is exact. It is the easiest thing in the world to use, and if you have it you can be pretty sure of avoiding distortion that comes from inexact tuning.

## Strong Motala Again?

FROM a Swedish friend I hear that the new Motala transmitter is well on the way to completion, and that test transmissions should begin in about a month's time. The new transmitter will have an output power of 150 kilowatts, and it should be amongst the best of the long-wavers in this country when it gets into its stride.

The present Motala transmitter has, in one way, the most amazing history of any broadcasting station. When it first came into operation—six or seven years ago, so far as I can remember—the volume was simply colossal. My home is only forty-five miles or so from Daventry, but even in daylight the Swedish station was the stronger of the two.

This state of affairs continued for over a

year. Then Motala began to "go off." It became steadily a poorer and poorer signal, until a good set was required to receive it at loud-speaker strength after dark.

A certain amount of improvement was made two or three years ago, though Motala has never been more than a moderately good Continental station since the end of its first year. With a brand-new transmitter and five times its present power, it ought to come through magnificently. Let's hope that it will.

## Droitwich Quality

IT is surprising to hear, as I have done from several sources, that Droitwich is not too well received in a good many localities. Speaking generally, long-wave stations are not subject to fading or night distortion to any great extent; but Droitwich appears to have these faults at receiving stations in certain directions at distances of 150 to 250 miles.

This suggests that the radiating system is possibly not all that it might be, and the B.B.C. might find it helpful to consult the authorities of WLW, who brought their new 500-kilowatt station into operation some time ago.

WLW has never, so far as I know, had any trouble with fading, and has achieved the most astonishing ranges.

We know a whole lot about aerials of the transmitting type, but there is also a whole lot that we don't know, and it is probably by a pooling of experiences that we have the best chance of achieving perfection.

## Tit for Tat Interference

FOR some little while now France has been one of the worst offenders in the matter of causing interference with stations in other countries, owing to the wavelength wobbling or wandering of her own broadcasting transmitters.

Radio Vitus and Radio LL have been amongst Europe's worst nuisances ever since the day when they came into operation. They are still at it, and until a really strong and stable French Government comes into power

it seems that they will continue their ill-doings.

At the present time a rather amusing situation has been created by Radio Paris, which works on a wavelength of 1,648 metres. Radio Paris has a strong eighth harmonic, and if you divide 8 into 1,648 you will find that it comes to exactly 206. This is the wavelength of the unfortunate Fécamp, or Radio Normandie, as it likes to be called.

The result is that Radio Paris comes in powerfully right on top of Fécamp; so that we have the interesting phenomenon of one French station jammed by another. What will be the outcome I don't quite know, but, if the other French stations are anything to go by, Radio Paris will insist upon using its present wavelength and radiating its eighth harmonic, whilst Fécamp will probably start a little tour of the broadcast band.

Some fun, what?

## Cutting Out Receiver Noises

IT is a long time now since I told you—and I think I was the first person in this country to do so—about such things as quiet self-adjusting volume control and the squelch valve. The purpose of these contrivances is to cut out those noisy and annoying noises that occur when you are passing from one station to another.

I am glad to see that the go-ahead firm of Ekco is making full use of these things in their newest set, in which they are also incorporating devices to cut out or cut down the interference caused by electrical machinery.

Some years ago I experimented with the shielded frame aerial, which is a most interesting device. The entire windings are contained in a metal shield except for one small gap. With an aerial of this kind interference is enormously cut down and the whole arrangement is very effective for broadcast reception. A shielded frame is used in this new Ekco set.

## Ganging the Cores

I BELIEVE the idea of using a finely powdered core of magnetic material to increase the inductance of a high-frequency coil first originated in America, though it was also exploited in Germany before reaching this country. However that may be, iron-cored high-frequency coils have now obviously come to stay, both in the original "fixed" form, and in the later development where the core is mounted to move in and out for permeability tuning.

The problem of ganging several moving cores for single-knob control is not, however, so simple as may appear at first sight. This is particularly the case with the super-het, where a constant "difference" frequency must be maintained between the local-oscillator and signal circuits.

The latest refinement to overcome this difficulty is to mould each core to a distinctive shape according to the particular circuit in which it is to be used. Such cores can also be designed to give straight-line-frequency tuning.

## Improving Disc Television

I RECENTLY had an opportunity of witnessing a demonstration of a new scheme for obtaining screen pictures with the simple disc-television receiver. The pictures are about  $4\frac{1}{2}$  inches by  $2\frac{1}{2}$  inches, and considering the simplicity of the apparatus are wonderfully clear; in fact they very closely approach mirror-drum results. Another point is that they are nearly black and white.

An examination of the apparatus showed that any disc receiver is convertible to this system, the only requirements being a few lenses and a special lamp which has recently become available.

Full details are given in the current issue of *Television* and readers who are at present using a disc machine would do well to investigate this new idea.



A Visit to the G.E.C. Works

# Batteries in the Making

THE G.E.C. has long been recognised as manufacturers of a wide range of batteries. Due to the greatly increased demand, it was recently found necessary to extend considerably the facilities available for battery manufacture and in July, 1933, there was put into operation one of the most up-to-date works in the country for the production of flash-lamp, torch, wireless high-

Here you see the girls soldering small sockets on to the zinc containers for the high-tension and grid-bias batteries



(Left) General view of the "cooking" machines mentioned in the article. (Below) These machines are used for the depolarising mixture—probably the most important ingredient in the making of the batteries

tension and grid-bias batteries. This works, which forms one of the large and important group of the G.E.C. factories at Witton, covers an area of 45,000 square feet and is capable of producing hundreds of thousands of battery cells per day.

The layout of the factory is on the most modern lines, the raw materials being received at one end of the building, whence they pass through the necessary processes until the finished product in the form of a battery is delivered at the far end of the factory ready for packing and despatch.

Everyone is familiar with the small electric battery, but few realise the many processes and care required in its manufacture.

At the end of the building at which the raw materials are



received are situated the mixing rooms, where the electrolyte and the depolarising mixture are prepared. From these two rooms the products are transferred individually through the works until they meet at a given stage in the manufacture of batteries.

### Forming the "Dolly"

After the various ingredients which form the depolarising agent have been thoroughly mixed, they pass on to presses which compress this mixture into a solid cylinder round the central carbon rod of the battery to form what is known as a "dolly."

These dollies are conveyed on travelling belts to wrapping machines, which automatically tie a muslin cover round them. They are then loaded into boxes in readiness for the next operation.

At this stage in the construction of the battery the "dollies" are inserted in small zinc cylinders which are supported in suitable carriers and travel slowly along an automatic conveyor, the "dollies" being inserted into these containers by hand.

The next process is that of filling the containers with the electrolyte. This operation includes a process known as "cooking" whereby the electrolyte is jellified.

From here the cells, as they may now be called, pass through a machine which fixes the small brass caps on top of the carbon rods, and at the same time fits a cardboard washer into the open top of the zinc container thus sealing the cell, after which the short lengths of wire for connecting adjacent cells are soldered automatically on to the containers.



This is a general view of the final assembly and packing department—the last stage in G.E.C. battery making and a very important one, too



Special wrapping machines, which you see at work here, automatically tie a muslin cover round the "dollies"—the nucleus of the little cells making the batteries



Here is smiling Les Allen with his supporting "boys" playing into the microphone you can see in the foreground

AS many readers know, Les Allen, the famous vocalist (for a considerable time with the B.B.C. Dance Orchestra), is now making personal appearances all over the country at theatres and variety centres.

He is singing all his popular numbers to a microphone and in order to give a performance in a theatre which is comparable with that on the air, he is taking specially designed amplifier and loud-speaker equipment.

#### Interesting Combination

Supporting Les Allen in his vocal items is an interesting combination comprising a number of radio artists. Jackie Phillips, the pianist, was previously with the B.B.C. Dance Orchestra; Cyril Helier, the violinist, is also an ex-member of the B.B.C. band, while the trumpet and guitar players are also men of radio and recording experience.

Les Allen wanted microphone equipment which would give him and the supporting combination every chance of presenting their

material on the stage just as he did at the B.B.C.

A. Cecil Barker, an expert in amplifier equipment, was recommended to Les Allen through the B.B.C., and he advised Les not only to have a specially built microphone and amplifier, but to tour with a balance-and-control engineer who would, in each theatre, perform just as valuable a job at the controls as do the B.B.C. engineers at Broadcasting House when Les Allen is on the air.

Mr. Barker immediately began designing a special microphone to suit Les, and Brian Denny, an expert in amplifier and acoustic matters, is touring with the act. Having arranged the microphone and loud-speakers on each occasion to fit the theatre, he then manipulates the controls for loud-speaker balance at every performance.

Cecil Barker made a study of Les's vocal characteristics and finally decided that a modified Reisz microphone would be best, if corrected so that it had no objectionable peak.

# Les Allen through the Loud-speaker

Now that Les Allen has left the B.B.C. he is touring with a supporting combination of radio stars, and is using specially designed public-address apparatus when he vocalises his famous numbers in theatres and variety halls all over the country. He still keeps his microphone technique, you see!

A new type of diaphragm is used in the carbon microphone, mounted on the familiar marble block of the Reisz structure.

The amplifier is a modified version of the B.T.H. standard 50-watt job. It has two entirely separate low-frequency stages, one being resistance-coupled and the other parallel-fed transformer. The resistance-coupled stages give low gain and for normal theatre work the parallel-fed transformer arrangement is generally used.

The output comprises two PP5/400's in push-pull. The degree of amplification is enormous and in the average theatre the amplifier is working at only about a third of its maximum capacity.

#### Balance and Control

Brian Denny carries out his job of balance and control on the amplifier panel itself, the volume control being in the second grid circuit. It does not matter to him where the amplifier is placed. On the occasion of Les's first public appearance at Brighton the control was in the orchestra pit, while at the Holborn Empire, London, it was in the wings.

## Fitting A Noise Suppressor

NOISE SUPPRESSORS are all the rage this season. They are especially useful on sets fitted with automatic volume control, for they cut out background-noise when tuning between stations. The majority of the latest mains sets can boast of some device for the purpose, but very few battery sets—if any.

Although there are several types of suppressors, the one most commonly met with is fitted to sets using diode detectors. Briefly the theory is as follows. The rectifying action of a diode does not commence until its anode becomes positively charged with relation to the filament. When this occurs, the anode attracts electrons from the stream emitted by the filament, and a current pulsating at low frequency is formed.

#### Cutting Out Weak Signals

It is readily seen that if we give the diode a small negative bias to begin with the weaker signals and background noises will not be powerful enough to throw the diode positive, and they will not be heard. This kind of noise suppressor is really a means of cutting out all signals below a certain strength.

In a mains set the required negative bias is easily obtained. It is merely a case of fitting a variable resistance, with by-pass condenser, between the cathode of the valve and the earth line. In a battery set it is rather more

difficult. If we use a grid-bias battery the lowest tapping gives  $1\frac{1}{2}$  volts, and in most sets this will not only cut out background noises but a good number of worth-while stations as well. The obvious remedy is to fit a potentiometer across the grid-bias battery,

but this means an extra switch or there will be a continuous drain on the battery even when the set is not in use.

All these difficulties vanish if full use is made of one of the latest 2-volt double-diode valves. The valve the writer has in mind is the Mazda L2DD, but of course, there may be others having the same features. Both the diodes of this valve are fitted round the positive limb of the filament, so that the triode portion of the filament acts as a resistance and provides automatic bias to the value of about .7-volt.

#### Delay Voltage

The original purpose of this bias was to provide the delay voltage for automatic volume control. The makers recommend that the detector diode circuit be returned to the positive side of the filament, so that it has a slight positive bias.

We can use this valve for noise suppression in two ways. We can either have the amount of suppression fixed or variable. Both methods are simple, but the writer much prefers to have the adjustment variable so that it can be set at exactly the right position to cut out the prevailing background and yet leave the weakest stations untouched.

All that is required is a variable potentiometer. This is connected across the low-

Continued on page 551

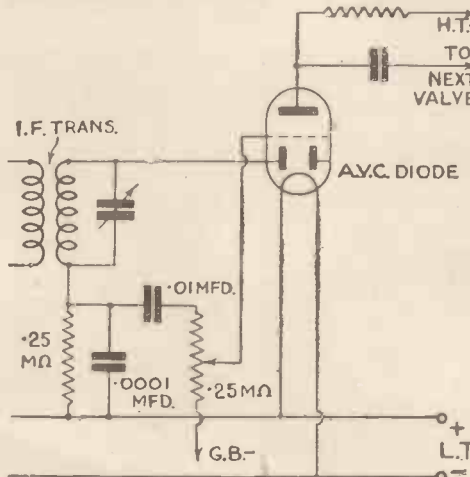

This is the standard L2DD circuit without noise suppression. See circuit on page 551 for additional suppression arrangement



All-Britain A.C./D.C. Three

# It Works on ANY Mains!

In this article we sum up the points about the A.C./D.C. mains version of the popular All-Britain Three design—a set that many readers have been asking for. Although a metal chassis is employed the construction has been kept reasonably simple, very little complication being allowed sub-chassis.

SINCE we gave the details last week of the A.C./D.C. All-Britain Three we have had more chance to try out the set under various supply conditions. Of course, the set had been put through its paces very thoroughly before we disclosed anything—good results having been obtained on our D.C. supply and through the usual A.C. generator.

## No Background Hum

Now we have been trying the set on other D.C. supplies. It works splendidly, there being absolutely no background of mains hum. This in itself is a great boon—as those who have tried some D.C. sets will willingly admit.

The special characteristics of the universal mains valves seem to fit them very well for eliminating residual mains hum—but, of course, we are always up against that old bugbear of modulation hum.

This is a peculiar effect that only manifests itself when the reaction is brought up to its most sensitive position—just below the point of oscillation, that is.

In this condition the set is very sensitive to any hum—and there sometimes occurs a faint super-imposed type of disturbance that has nothing to do with the smoothing of the mains supply.

## Modulation Effect

The proof of this is that if a suitable condenser is placed in the correct position in the circuit of the mains-valve rectifier the hum due to modulation effect quickly disappears.

Should you be using the set on a D.C. supply, therefore, and should you experience this form of mains-hum interference, we suggest that you add a little condenser.

The right capacity is .1 microfarad, which should be connected between the anode of the mains-rectifying valve and the nearest earthed point on the chassis.

With this hum eliminator the set is just as quiet in action on D.C. mains as though it were a battery set. We know that this

takes a bit of swallowing—but then very few amateurs yet realise how wonderfully good the universal mains type of valves are in cutting out all trace of mains hum—always assuming, as in this set, that the initial smoothing circuit has been adequately designed.

As will be seen from the list of components,

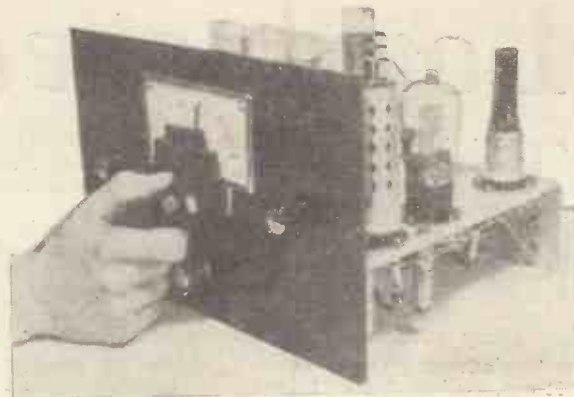

Tuning is simplified by this wavelength-calibrated scale, which can be tried up during reception by an adjustment at the back of the condenser. Other controls are also simple

which has tappings to make it suitable for all voltage inputs.

By the way, on this resistance you will see that there is a 100- to 110-volt tapping, from which you might jump to the conclusion that

## Components Needed for the All-Britain A.C./D.C. Three

### CHASSIS

1—Aluminium, 12 in. by 9 in. by 3 in. (Peto-Scott).

### CHOKE, HIGH-FREQUENCY

1—Graham-Farish, type Snap.

### CHOKE, LOW-FREQUENCY

1—Varley, type Nichoke II.

### COILS

1—Set Varley, type 2BP51 (or Goltone).

### CONDENSERS, FIXED

1—.0005-microfarad, type tubular (T.C.C. or T.M.C. Hydra).

1—.001-microfarad, type tubular (T.C.C. or T.M.C. Hydra).

1—.005-microfarad, type tubular (T.C.C. or T.M.C. Hydra).

1—.01-microfarad, type tubular (T.C.C. or T.M.C. Hydra).

1—.05-microfarad, type tubular (T.C.C. or T.M.C. Hydra).

3—.1-microfarad (Formo, type screened paper).

1—1-microfarad (Formo, type screened paper).

2—2-microfarad (Formo, type screened paper).

### CONDENSERS, VARIABLE

1—Two-gang .0005-microfarad (Formo type, with Mystic drive).

1—.0003-microfarad reaction (Graham-Farish).

### HOLDERS, VALVE

4—Seven-pin, type chassis mounting.

### PANEL

1—Ebonite, 12 in. by 8 in. (Peto-Scott).

### PLUG, TERMINALS, ETC.

6—Plugs and insulated sockets, marked: Aerial,

Earth, insulated Pick-up (two), L.S.+, L.S.— (Clix)

3—Insulated sockets (red) and 1 plug (for tone corrector).

### RESISTANCES, FIXED

1—100-ohm (Dubilier, or Ohmite, Erie).

1—300-ohm (Dubilier, or Ohmite, Erie).

1—1,000-ohm (Dubilier, or Ohmite, Erie).

2—25,000-ohm (Dubilier, or Ohmite, Erie).

1—3-megohm (Dubilier, or Ohmite, Erie).

1—Series filament (Bulgin, type MR34).

### RESISTANCE, VARIABLE

1—50,000-ohm (Erie, or Ferranti, Graham-Farish).

### SUNDRIES

Connecting wire and sleeving (Goltone).

2 ft. screened sleeving (Goltone).

4 dozen 6BA ½-in. bolts and nuts (Peto-Scott).

3—Matched knobs (Bulgin, type K46).

1—Aluminium ½-in. mounting bracket.

### SWITCH

1—Double-pole, on-off (Bulgin, type S104).

### TRANSFORMER, LOW-FREQUENCY

1—Ratio 1: 3.5 (Ferranti AF8, or Varley Niclet),

### CABINET

1—Peto-Scott, type AWEN.

### LOUD-SPEAKER

1—W.B. type senior, cabinet model.

### VALVES

1—Osram W30 (catkin).

1—Osram H30 (met).

1—Osram N30 (catkin).

1—Osram U30.

the valve combination is an unusual one. First there is a Catkin W30 high-frequency pentode—giving an enormous step-up in amplification before the signal reaches the detector, which in this set is a metallised H30 universal mains type.

The output valve is another pentode, an N30 Catkin.

Then for supplying all these valves with their high tension of direct current when on a D.C. supply, there is a U30 mains valve for rectification.

Actually this is a double-wave rectifier, but in this design the two anodes are bridged, likewise the two cathodes, so as to produce a half-wave rectifier. This, of course, is essential with a set of this type, where the rectifier is more or less of a passenger when the set is working from the D.C. type of mains.

Please note that the filaments of all four valves are connected in series, and not in parallel as in the usual A.C. type of set. Also that in series with these filaments and the mains there is a special voltage-dropping resistance,

such a low-voltage D.C. supply is quite suitable for working this set.

Actually that is not so. We have tried the set on a 110-volt D.C.-mains supply, but the results, although just passable, are not good enough to justify us recommending anyone to build the set especially for such a supply. Reaction is squawky and the whole performance very much below the fine standard attainable with anything from 200 volts upwards.

## Simple Metal Chassis

If you are on the lookout for a universal mains set we do strongly recommend this All-Britain Three for your consideration. The full-size blueprint makes the construction of the metal-chassis design perfectly simple. Order AW455, price 1s. 6d., post paid, from AMATEUR WIRELESS, 58 to 61 Fetter Lane, E.C.4.

Very little of the component fixing and wiring is done underneath the baseplate, so that there is the minimum of complication. Where leads go from one side of the plate to the other we have taken care to key them with lettered holes.

These, taken in conjunction with the numbered sequence of wires, provide an infallible guide that no ordinary amateur is likely to slip up over.

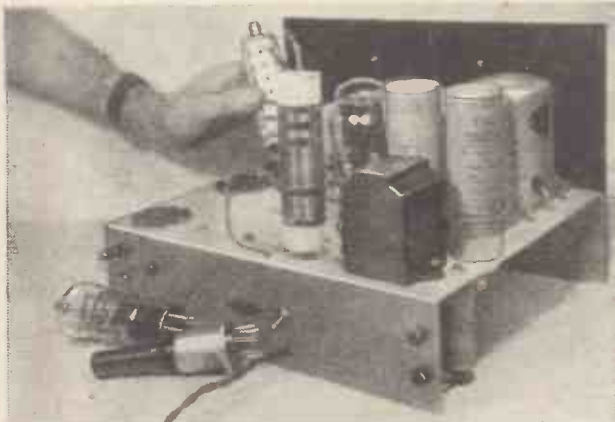

Catkin valves are included in the valve specification for this set—valves that work from either A.C. or D.C. mains

# Loud-speaker Ideas

THE fact that nearly every modern commercial receiver has a built-in loud-speaker shows that this self-contained type of design is the best, on the whole, for factory-built sets.

With home-constructed sets, however, it is quite a different story. In fact, letters received from Constructor Crusaders indicate that the vast majority of home constructors vote for loud-speakers in separate cabinets.

## Many Advantages of Separate Loud-Speaker

The advantages of a separate loud-speaker are many. It can, for instance, be moved about easily, and you can experiment to find the exact position which gives best results in any particular room. Another advantage is that, as it can be placed well away from the aerial, set, etc., there is no risk of the interaction and similar troubles that sometimes occur with a built-in loud-speaker unless special precautions are taken.

In this eminently practical article ideas for improving loud-speaker suggestions he puts forward all have to average sets. We would particularly to the idea of dual loud-speakers application than has so far been menters. Then, too, the experim reflecting back ought to appeal to the ideas for decorating your loud

firmly secured in any convenient way. Sometimes it is advisable to insert a layer of felt, with a circular hole cut in the centre to coincide with the diaphragm aperture, between the inner baffle and the cabinet-front itself.

## Advisable To Fit a Small Shelf

If the baffle is of such a size that the fixing-lugs at the base of the loud-speaker are above the "floor" of the cabinet, it is advisable to fit a small shelf (firmly supported at right angles to the baffle by means of metal brackets) to which the base of the loud-speaker can be screwed. This helps to take the weight and strain off the chassis-casting which surrounds the diaphragm.

You have probably noticed that, with certain types of loud-speaker, a marked improvement in tone and volume results from placing a baffle or open-backed cabinet diagonally across the corner of a room, so that the sound produced at the back of the diaphragm is reflected forward by the walls.

This idea can be carried a step farther by using a special type of cabinet so constructed that the back of the cabinet reflects the sound forward in much the same way as the walls of the room would do. This gives you the desired effect irrespective of the loud-speaker position.

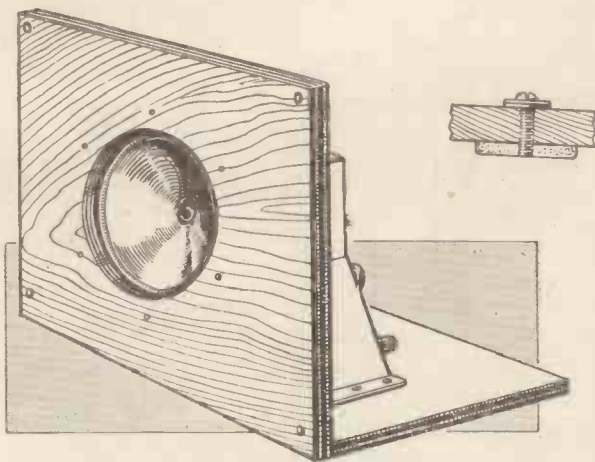

Fig. 1.—To make an easy and convenient fit into the set's cabinet it is a good plan to mount the loud-speaker on an inner wooden platform and baffle

Yet another asset, which is sure to appeal to you if you are keen on experimenting, is that you can try out all sorts of baffle arrangements and so on, if the loud-speaker is of the separate-cabinet type, without disturbing any part of the set or altering its cabinet.

## Look and Sound Best!

Well, here are some ideas and suggestions that will help you to take full advantage of these good points. The hints which follow should enable you to make the "separate-cabinet" type of loud-speaker look its best and sound its best!

Baffles are rather a problem. (Yes, I nearly said a baffling problem!) For a really effective baffle, of course, you need to use pretty thick wood. But thick wood does not lend itself very well to the cutting-out of a loud-speaker fret.

## Separate Chassis Idea

In making a cabinet loud-speaker with an ornamental fretted front, therefore, you will find it a good plan to mount the loud-speaker on a separate chassis or baffle made of cheap, thick wood (plywood, if you like) arranged to slide into the cabinet (Fig. 1). This arrangement, while giving you the advantages of a thick baffle, enables the front of the cabinet to be of comparatively thin wood in which an ornamental aperture can be cut easily and neatly with a fretsaw.

The inner baffle-chassis, which must be of an adequate size, should be pushed well up against the front of the cabinet and

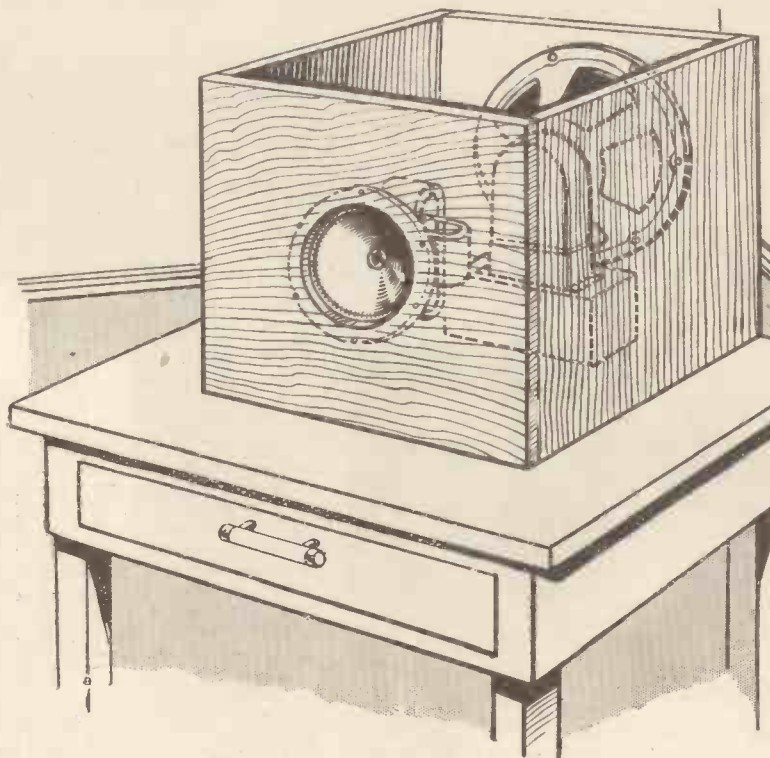

Fig. 3.—How to arrange dual loud-speakers in a cabinet, with the high-note re at the front and the low-note one at the back. A good back-to-back stum



# Worth Trying

W. OLIVER tells of his novel reproduction. The various merit of being applicable particularly like to draw attention, which is worthy of a wider noted among amateur experimental cabinet with a sound-quality connoisseurs. Finally, loud-speaker fret are worth study

There are various ways of embodying the idea in cabinet design, but the one illustrated here-with (Fig. 2) will suggest a basis for experiment. With certain types of loud-speaker, at any rate, this novel method of cabinet construction not only improves tone and volume to some extent but also helps to diffuse the sound more evenly throughout the room, instead of projecting it mainly in one direction.

## Impression of Reality

This diffusion (as opposed to a focused beam of sound) is certainly a good effect to aim at in the reproduction of music, especially band and orchestral pieces, as it helps to create an impression of reality.

Another rather unconventional idea that you may like to try out is to mount two loud-speakers back to back on a double baffle, one loud-speaker being a large model with a tendency to emphasise the low frequencies, and the other a small one with a pronounced high-note response but not much bass (Fig. 3).

If this dual-speaker arrangement is placed diagonally across the corner of a room so that the deep-voiced fellow projects his sonorous notes into the angle of the corner, whence they are reflected back with added richness, while the little chap dealing with the high notes faces the audience, the blending of the output from the two loud-speakers will often be found to produce a very pleasing result.

Admittedly much depends on the acoustic properties of the room, and other considerations of that sort, but the idea is worth trying.

I have already mentioned that an impression of reality in reproduction of music can best be attained by diffusing the sound as much as possible. To get the effect of, say, a military band convincingly you need a good volume of sound throughout the room.

## For Talks and News

For talks, news, etc., however, one might almost say that the reverse holds good. The human voice when amplified much beyond its normal volume sounds far from pleasing in an ordinary room; and if the sound of the voice is diffused so that it seems to be coming from all quarters at once it may sound decidedly unnatural!

A "life-size" voice, coming definitely from one direction only, just as though an actual person was speaking in the room, is naturally the most convincing and pleasing effect for spoken parts of the programme.

In view of this, a good idea, if you happen to have two separate loud-speakers available, is to use one for music and the other for speech.

The "musical" one can be arranged with a big baffle or cabinet to give full-bodied reproduction of band, orchestral and other music, and should be placed at some little distance from the listeners.

The other loud-speaker can have a much smaller baffle or cabinet to give a crisp tone to speech, and may be placed fairly near to the listeners so as to give an intimate effect to talks, news and so on, instead of the uncomfortable impression of a disembodied voice shouting at you from a distance!

A simple change-over switching arrangement, plug-and-jack, or fader control can be used to enable you to bring either loud-speaker

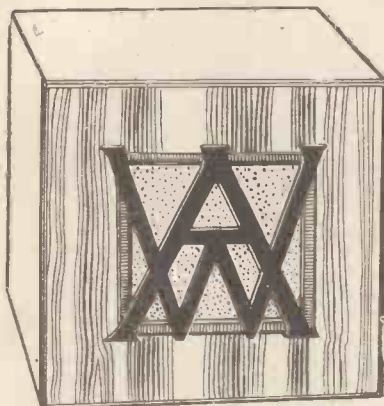

Fig. 5.—No mistaking the monogram here! "Amateur Wireless," of course. But you can easily work your own initials into a pleasing fret

speaking voice, without your having to adjust the volume control on the set.

Having made your loud-speaker sound its best, the next job is to make it look its best!

## Use Simple Ornaments

To strike a modern note in a home-constructed cabinet for a loud-speaker, an effective idea is to use a light-coloured wood for the cabinet itself, and to apply decoration in the form of darker wood strips and chromium-plated metal bars (Fig. 4).

If these simple ornaments are skilfully placed, you can achieve an artistic result very easily and at small cost.

For the metal fittings, a length of the chromium-plated brass strip that is sold for use as curtain-rails will do quite well.

There are various ways of fixing a metal strip of this kind inconspicuously. Minute holes can be drilled in the strip and tiny nails driven through them into the wood. That is one method; but a better one is to drill and tap a 6 B.A. hole near each end of the strip, drill corresponding holes in the cabinet-front, and then secure the strip to the cabinet by means of short plated screws (6 B.A. of course) inserted with their heads on the inside of the cabinet.

A washer or two can be slipped on under the screw-head if necessary to pack it out so that the tip of the stem comes flush with the surface of the metal strip. This results in what amounts to an almost invisible fixing.

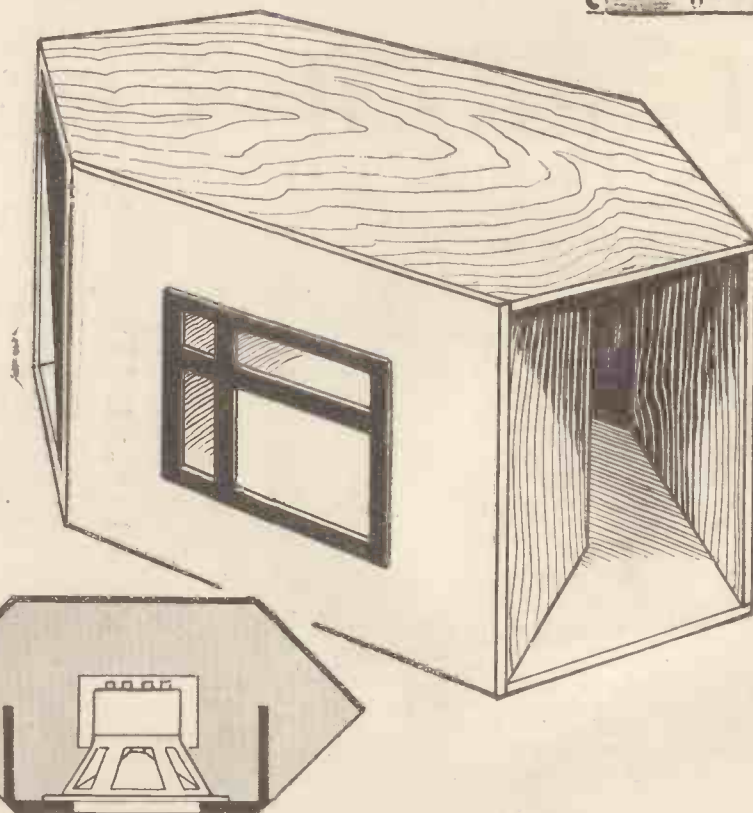

Fig. 2.—What about this experimental cabinet? It has a solid sound-reflecting back. It helps to diffuse the sound more evenly and often improves the tone

into circuit at will, according to the type of programme being received.

If you liked, you might arrange a fixed volume control across the "speech" loud-speaker to cut down the output to the level of a normal

If you want to add a distinctive personal touch to your home-built loud-speaker cabinet, why not ornament the sound-aperture with a fret consisting of your own initials cut out in a thin wood of contrasting colour? (Fig. 5).

This can be done very easily with a fretsaw, if you mark the letters out accurately beforehand.

## How To Arrange the Monogram

Dark letters against a light wood surround look best. It is advisable to arrange the monogram in such a way that there are projecting extremities to the letters which will facilitate fixing to the woodwork surrounding the sound-aperture.

The fixing can be done with very small screws or panel-pins, the heads of which (if they are driven in from the outside of the cabinet) can be rendered inconspicuous by just touching them with the point of a fine camel-hair brush dipped in lacquer or enamel of a colour matching the wood.

Any ornamentation of this kind across the front of a loud-speaker cabinet must be fixed securely, to avoid any possibility of rattling or vibration being set up when the loud-speaker is handling a big output.

Oriental lacquers or enamels can often be used with good effect on home-made loud-speaker cabinets. If you do not care to cover the whole of the woodwork with enamel or lacquer, a very pleasing decoration of a simple kind can be added to a plain oak cabinet in the following way.

## Pleasing Contrast

With a suitable tool, cut a narrow, shallow groove around the front of the cabinet parallel with the edges and an inch or so from them. Then fill the groove with a coat or two of bright enamel or lacquer in a colour that will contrast pleasingly with a natural oak background.

While the lacquer is drying, place the cabinet in a horizontal position so that it will dry with a flat surface and not tend to trickle down the groove. Well, that is something to go on with. At least, I have shown that there are many ideas worth trying out to improve the quality as well as the looks of your loud-speaker.

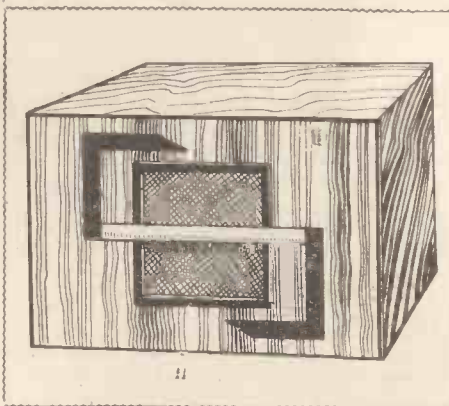
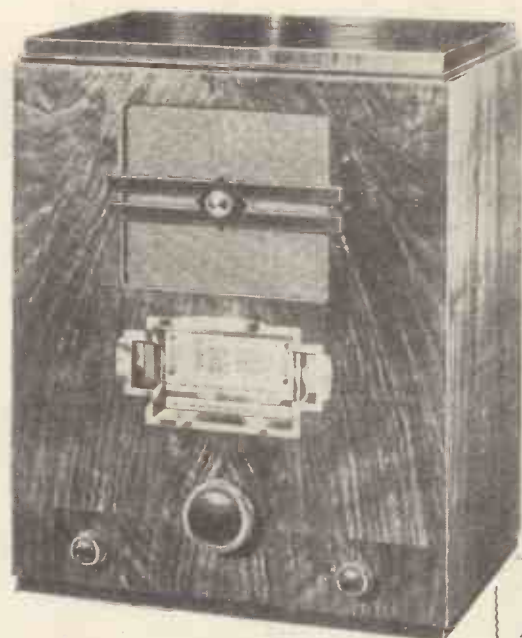

Fig. 4.—Something striking in decoration! Use a light wood with dark strips and chromium-plated metal bars





From this front view of the Cossor super-het you can appreciate the full-vision tuning scale, which also includes visual tuning and other useful visual indications linked with the simple subsidiary controls

SO many of the modern super-hets are designed to bring in everything that is on the air that it is a change to find a receiver which passes over the weak stations which would not be of any entertainment value.

When one first tries an average super-het, as a general rule sixty or seventy stations have been tuned-in, some of which are free from whistles.

#### Log of Actual Programmes

Compare the Cossor super-het with this type of set and for a little while you get the impression that the sensitivity is lower than usual. After a while, however, if you take the trouble to make a log of the actual programmes you have heard, it does not take very long before this exceeds 40-45.

Then go back to the normal super-het and after you have separated all the stations that have whistles and those that haven't, in many cases the actual number of programmes available rarely exceeds 30-35.

This new Cossor set has been designed to bring in all of the stations that will be of entertainment value and to ignore all others.

Of course all this is due to the arrangement of the circuit. First of all the aerial is fed into a combined detector-oscillator through a highly-selective band-pass filter. This eliminates practically all second-channel interference and helps to preserve that very necessary 9-kilocycles selectivity.

This pentagrid valve is then followed by a single variable- $\mu$  intermediate-frequency stage, using a variable- $\mu$  pentode. So efficient are these first two stages that it was found necessary to use diode rectification in the second detector stage to keep quality at a high level. This diode valve feeds into a steep-slope pentode through a resistance-capacity-coupled stage while the output is approximately 2,500 milliwatts.

#### Unconventional Tuning Scale

A feature every user will admire is the unconventional tuning scale. Instead of using the more familiar type of indicator with station names and wavelengths all mixed up, they have used a very wide scale along the bottom of which is the normal wavelength calibrations covered by a travelling pointer.

Actually the receiver is calibrated between 200 and 550 metres and 800 to 1,950 metres. At the top of the scale is a selection of the more powerful stations up against which is shown the actual wavelength of the station.

If, for example, you wish to tune in Droitwich, by referring to the top scale, you see that the wavelength is 1,500 metres. Then all you have to do is to adjust the pointer on the bottom scale to that wavelength and there you are!

# Cossor Super-het

## MODEL 535 FOR A.C. MAINS

### IN A NUTSHELL

Brand Name : Cossor.

Model : 535.

Price : £12 12s.

**Technical Specification :** Five-valve super-het for A.C. mains, entirely self-contained with the exception of aerial and earth. The first valve is a combined detector-oscillator (Cossor 41MPG) which is bandpass-coupled to an intermediate-frequency amplifier (Cossor MVS/Pen). The second detector is a double-diode (Cossor DD4) coupled to a steep slope power-pentode (Cossor 42MP/Pen) and a full-wave valve rectifier (Cossor 442BU).

**Power Supply :** A.C. mains 200-250 volts 40-100 cycles.

**Makers :** A. C. Cossor, Ltd., Cossor Works, Highbury Grove, N.5.

To make quite sure that the receiver is correctly tuned and to allow for any slight discrepancies in calibration or variation in coils and so on, on the right-hand side of the dial has been fitted a visual tuner.

This tuner is of the neon-gas type and all you have to do is to adjust the tuner to give maximum glow. You can, if you wish, reduce the volume control to zero and tune in your station visually so that any noises there might be through atmospherics or stations jamming are completely eliminated.

#### Cabinet of High Standard

We had not seen any of the large Cossor cabinets since they decided to make their own. The cabinet for this model 535 is up to a high standard, has been particularly well finished, while the design will meet with general approval.

Quality is very good indeed, due to two reasons. First to the diode detector, and secondly to the large output pentode. It is fed with a very generous supply of high tension and has been carefully matched to a loud-speaker designed for this receiver. Incidentally, the diode will handle an input of 200 volts R.M.S. so there is very little possibility of it overloading even if the receiver is used close to a local station.

We rather like the idea of having terminals instead of sockets for the aerial and earth connections. Our experience so far of sockets has not been a very happy one, for as a general rule, sockets have not made very good contacts. Of course, provision has been made for the connection of additional loud-speakers while with the gramophone pick-up in circuit, volume is if anything a little too great for the average room.

You will find the receiver very simple to tune, for in addition to the tuning scale we have already mentioned to you the drive is fitted with a large knob which is very helpful. On the left of this knob is the volume control, which works in a clockwise fashion, while the on-off, gramophone, and wave-change switch is on the right. The knob on this switch is engraved, so there is no need for us to say any more about it.

#### You Can Alter the Pitch

A variable tone corrector has its adjusting knob protruding through the loud-speaker fret so if you do not like the pitch you can alter it to suit your own particular taste.

Selectivity is approximately 9 kilocycles so the receiver will separate all of the stations adhering to the Lucerne Plan. When we tested the receiver within 9 miles of Brookmans Park on a 60-foot aerial, only two channels either side of the local station were lost through interference or side-band splash.

The number of stations that we tuned-in over a period—by stations we mean programmes—was about sixty, and as a general rule 40-50 programmes were receivable on any one evening.

#### Background Noise Level

The background noise level is low. This is due to the design of the intermediate-frequency stage and in practice it means that the volume control can be turned up



Back view of the Cossor super-het, showing the clean metal-chassis construction and the moving-coil mounted at the top of the cabinet, with plenty of room everywhere to avoid "boxiness" of reproduction

to the maximum, and weak stations brought in without their being drowned by mush.

Second-channel whistles were not very noticeable—as a general rule there were three on medium waves and two on long waves. Five whistles with a set of this price is very good going indeed, bearing in mind that the receiver embodies all modern ideas, including visual tuning, automatic-volume-control, and tone correction.



**How to Fit A Noise Suppressor**  
Continued from page 546

tension battery and the detector diode circuit is returned to the moving contact. Thus we can provide the detector with positive bias or with any value of negative bias up to .7 volt. The resistance of the potentiometer does not matter very much, but if it is very low, there will be an unnecessary drain on the low-tension battery. About 500 ohms is a good value and the consumption will then be only 4 milliamps. To avoid possible trouble due to imperfect filtering of the high-frequency currents, it is perhaps as well to connect a non-inductive

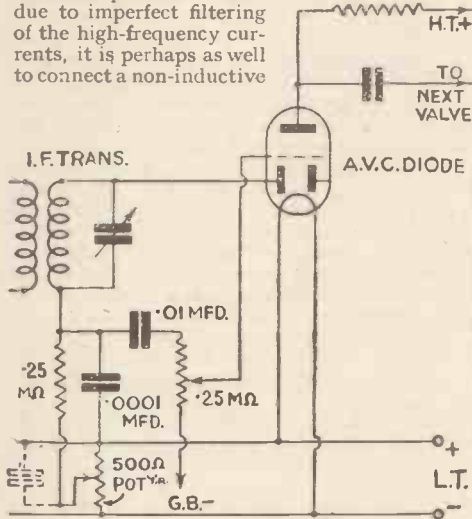

Same circuit as on page 546, but including adjustable noise suppression arrangement

fixed condenser of .001 microfarad or upwards between the moving contact and negative low tension.

Should it be desired to use a fixed amount of "suppression" all that is required is a throw-over switch. The switch is arranged so that the detector circuit can be returned to either negative or positive low tension. A condenser of .001-microfarad or larger should be connected across the low-tension battery.

A drawback to the "fixed" method is that the switch produces a click each time it is thrown over. Also, it has already been pointed out that the amount of suppression obtained may be more than is desirable for some receivers.

In conclusion, it will be found that the amount of noise suppression produced by .7 volt is quite sufficient for most uses.  
—A. H. C.

**Notes and Jottings**

IF any reader of AMATEUR WIRELESS has a spare copy of the issue dated May 3, 1930, will he please send it to Mr. P. J. Woodfin, of 35 Neswick Street, Plymouth, Devon, who wants constructional details of the Wavelets Two? This issue is out of print and cannot be supplied from this office.

Those who are interested in ultra-short-wave reception should note that Baird television transmissions, of an experimental nature, of course, are being sent out almost continuously from the Crystal Palace on a wavelength of about 6 metres.

Just to hand is the tenth edition (1935) of *The Wireless and Gramophone Traders' Year Book and Diary*, available only to those connected with the radio and gramophone trades. This year book is a mine of information on all subjects of interest to the trader; the price is 5s. 6d. (3s. 6d. to subscribers to *The Wireless Trader*). Applications should be addressed to The Trader Publishing Co., Ltd., Subscription Dept., Dorset House, Stamford Street, London, S.E.1.

THE ASTOUNDING ETHER CONQUERING

# 'RAIDER'

ALL EUROPE AND BEYOND...

20,000 LISTENERS NOW ENJOY BETTER RADIO *via the* 'RAIDER'

Never before have home constructors had opportunity more dazzlingly offered to them! Opportunity to build the most amazing three-valve radio set in existence—the "Raider"! Features new and unique are incorporated in this set of the century—new components, new valves, new coils, new transformers, new speakers . . . ensuring results unsurpassed by any 3-valve set hitherto offered to the home constructor. For selectivity, sensitivity, range of stations available and sheer perfection of reproduction, no other set is the 'Raider's' superior.

Full Details for construction are given in "Contact"

Apart from a host of interesting articles on radio topics, "Contact"—the new wireless journal—contains a FREE 1/- blue-print and complete information concerning the "Raider" set. "Contact" also contains wiring diagrams and full details of the "Stentorian" Straight Three and "Mystic Q" two-valver. "Contact" may be purchased at most bookstalls and radio dealers—but if you have the slightest difficulty in obtaining a copy, please send the coupon below.

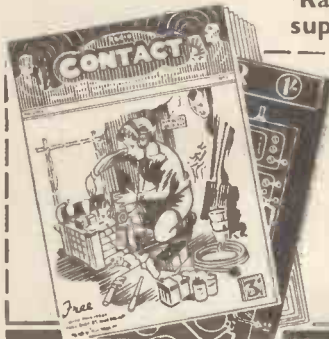

**1/- Blue-print FREE**

To Graham Farish Ltd., Masons Hill, Bromley, Kent  
I enclose 4½d. in stamps. Please send RADIO CONTACT, containing instructions for building three sets and FREE 1/- Blue Print.

NAME.....  
ADDRESS.....

# Volume Control On Short Waves

By KENNETH JOWERS

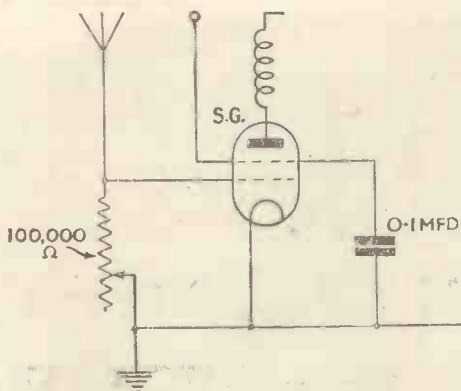

Fig. 1.—Volume-control circuit for use with a set having a tuned or untuned high-frequency stage—very popular in the States, by the way

A SHORT-WAVE set that during daylight can be such a useful little fellow, is inclined, as the hour gets later, to become a nuisance. Feeble signals that at normal times can only just be heard on the loud-speaker, in the early hours of the morning to people trying to sleep sound rather like a raucous noise.

### Wife a Fire-Eater!

A young married man I know has just started to get interested in short waves and is using a two-valver. The maximum output is about 300 milliwatts, but I can see some trouble brewing if he burns the midnight oil much longer. Very probably, as I started him on the short waves, I shall get the blame and I don't want that. His wife is a bit of a fire-eater.

No matter how hard you try, it is a very difficult matter to keep the volume down to a reasonable level. With the broadcasters it is not so bad, but the intermediate commercials pushing out Morse are inclined to come over with a bit of a bump even with the reaction well down.

You have to be careful in fitting a volume control for any arrangement that might upset

States for a long time where the problem of volume control is more acute. Providing the variable resistance is of a high value the control works very smoothly without causing any loss in signal strength. Too high a value will cause a jerky movement, while, on the other hand, too low a value will drop the volume very considerably.

The happy medium is 100,000 ohms. As a

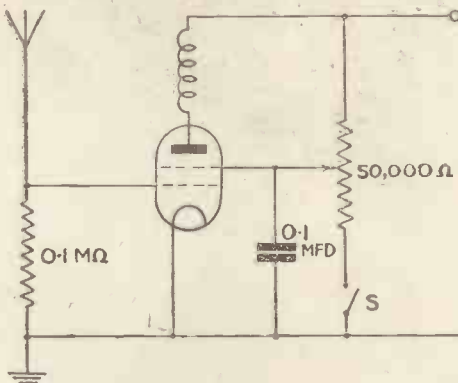

Fig. 2.—Variable potentiometer provides variable screen volts and at the same time provides a very sound system of volume control on the short waves

general rule this circuit is perfectly stable and silent in operation even with cheap resistances. You see, there is no D.C. current flowing to cause noises or breakdowns in the resistances.

A circuit that has a lot to recommend it is shown in Fig. 2. This method kills two birds with one stone. Instead of having to use a fixed resistance and condenser network to obtain the proper screen voltage, a variable potentiometer is used instead.

In this way the

I have purposely omitted to mention variable-mu screen-grid valves because it is a well-known fact that you do not get the same gain from a variable-mu screen-grid valve as you do from one having a fixed grid base.

The only point to watch with the circuit in Fig. 2 is that the resistance is a 50,000-ohm one and it will take 2.5 milliamperes out of a 120-volt dry battery if it is left permanently in circuit. Make quite sure that you have a three-point switch to cut out the battery or that the potentiometer has a switch as an integral part.

### No Need to Alter Set

If you have already built up your receiver, you may not like having to make alterations to the circuit. In that case take a look at Fig. 3. If you use this hook-up it can be connected in the circuit without having to alter the wiring in any way. The value of the resistance should be around 10,000 ohms and it should be a good one, otherwise there will be a lovely crackle. As a precautionary measure, connect a condenser across the slider and the anode of the resistance. This will cut out all the noises.

A variation of this idea that requires a little alteration to the wiring is shown in Fig. 4. It is much smoother in operation than the previous idea but requires a 500,000-ohm potentiometer which is connected across the whole secondary of the low-frequency transformer.

It is always very smooth and quiet in operation but you must not in any circumstances connect across a condenser, otherwise top notes will suffer. The same remarks apply if you use a resistance of a low value. 250,000 ohms should be the absolute minimum.

### For Commercial Receivers

If you have a commercial receiver none of the previous arrangements will be very much good. As a general rule most of these sets have been built on a chassis in which the wiring is "un-get-at-able." If you have such a set, take a look at Fig. 4 again. You will see that across the loud-speaker I have dotted in a variable resistance of 10,000 ohms

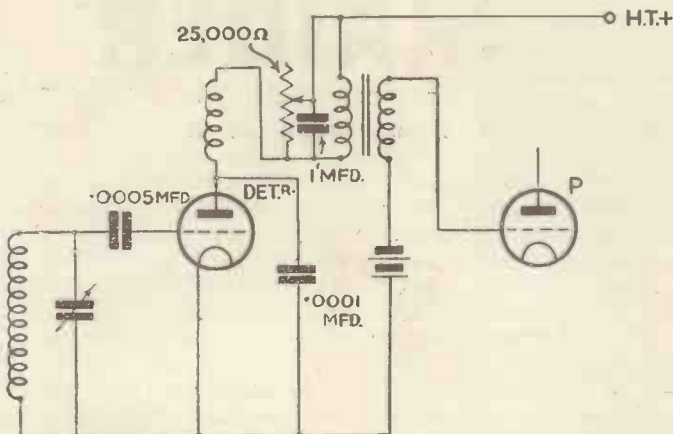

Fig. 3.—This arrangement can be connected to the set without making any alterations. Make sure that you connect a condenser across the resistance as shown above

the constants of the circuit or is likely to be noisy must be ruled right out.

Here are five different ideas that I have used from time to time that all work out well in practice. It has been suggested that a differential condenser in the aerial circuit should have been included, but this upsets the tuning to such an extent that it is useless, although, of course, on the normal broadcast band it is very effective.

If you have a tuned or untuned high-frequency stage, Fig. 1 is worth considering. This arrangement has been popular in the

maximum gain can be obtained from the valve while, with a flick of the control knob, the signal can be reduced to a minimum. It is always a sound scheme to have variable screen volts for no two valves are exactly similar and you do really want the last ounce out of this stage, particularly on low wavelengths.

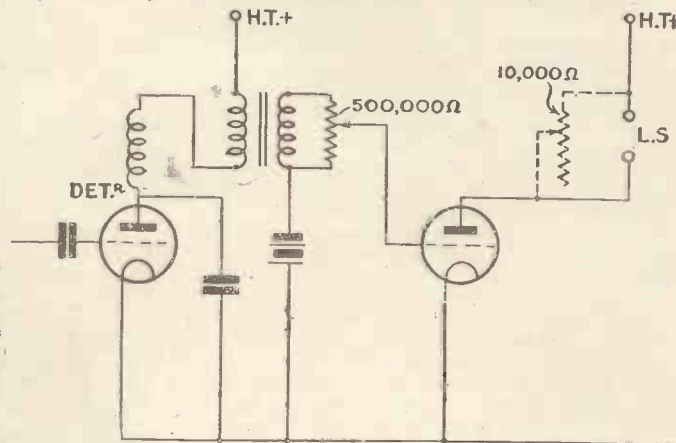

Fig. 4.—Variation of the Fig. 3 idea, involving a small alteration to the set's wiring. It is much smoother, but needs a 500,000-ohm potentiometer in order to work it



## Beyond The Fortieth Meridian

By JAY COOTE

**A**LTHOUGH considerable improvement may be observed in the strength of signals received from the more distant European stations since the shorter days have come along, there is no doubt that with the advent of autumn much more interference is being experienced.

The Lucerne Plan was devised to govern the wavelengths of stations in Europe as far as the 40th meridian, or roughly as far as a line drawn through Russia from Archangel in the north to the eastern edge of the Black Sea.

Now, there are many U.S.S.R. transmitters in towns lying between the 40th and 50th degree of longitude; they do not work on the Lucerne Plan, and the U.S.S.R. authorities may allot to them any suitable channel in the broadcast band. In this fact lies the present trouble.

### Samara the Culprit

Interference recently experienced by listeners in Great Britain to North Regional transmissions on 449.1 metres (668 kilocycles) has been traced to broadcasts by Samara, RW16, a 10-kilowatt which, previously working on 404 metres (743 kilocycles), has moved to 668 kilocycles, and therefore clashes with the B.B.C. station.

Samara is roughly situated at 50 degrees east of Greenwich, and consequently well outside the area governed by the Lucerne Plan.

Another case is that of Kazan (RW17), a station of equal power, working on a channel (644 kilocycles) within 4 kilocycles of Lyons P.T.T. Kazan's position is about 49 degrees east. Fortunately, Lyons has increased its power and now suffers less. Between Trondheim (476.9 metres) and Brussels 1 (483.9 metres) we find Ivano-Vosnesensk (480 metres), or a separation of respectively 4 and 5 kilocycles. Here we have a station situated at about 200 miles north-east of Moscow, and yet it has been heard in the United Kingdom.

Radio Strasbourg and Simferopol (RW73), U.S.S.R., on 349.2 metres (859 kilocycles) are bad partners; this shared channel was allocated in the Lucerne Plan as the Russian station on 34 degrees lies within its limits. A bad combination also is Athlone and Palermo on 531 metres. You may often notice the Irish broadcasts marred by a wobbly wave, which apparently emanates from Sicily.

Lastly, listeners report a Russian broadcast on 424.3 metres in the early morning, a channel, under the Prague Plan, occupied by Moscow (RW39), but which is supposed to have been relinquished by the U.S.S.R. since January, 1934. So far, no call has been heard, but on two occasions it was taking the Moscow 1,724-metre programme.

### Slightly Better On Long Waves

On the long wave band conditions are slightly better and in general it is possible to secure a clean broadcast from a number of stations. The Eiffel Tower appears to have reduced its power and Moscow No. 1, on 1,724 metres, would seem to be working on its full 500 kilowatts, to judge by its volume and clarity.

But Radio Luxembourg (at times), Warsaw, and Motala do not appear to be free from trouble. The last named is marred frequently by Novosibirsk, a 100-kilowatt operating on a channel within 1.5 kilocycles of the Swede.

Warsaw and Luxembourg are too close to one another, and a 6-kilocycle and 8-kilocycle separation from respectively Kharkov and Kalundborg is insufficient.

# AGAIN

## EXCLUSIVELY

## SPECIFIED BY "AMATEUR WIRELESS"

# —WHY?



Model P.M.S1

What Mr. A. K. JOWERS ("Amateur Wireless") says:

"Without question the introduction of the new magnetic alloy in the construction of the W.B. 'Stentorian' range of loud-speakers represents a definite advance in design. I feel that these units are considerably better than the average loud-speaker of their type and price."

Read what some users say:

"I was, and still am, amazed at the all-round supremacy of the STENTORIAN Senior. It definitely gives greater volume and better tone balance than any I have heard."  
W. B., Birmingham.

"The sensitivity is enormous, the quality beautiful, and bass response is perfect."  
A. E. G., Edmonton.

"Your advertisements in no way exaggerate the superiority of STENTORIAN Speakers."  
C. A. N., New Milton.

- Unique New Magnetic Material (Prov. Pat.) gives nearly double strength and sensitivity at similar cost.
- New Whiteley Speech Coil brings amazingly crisp attack and better bass response.
- Improved "Microlode" feature provides really accurate matching to the individual set.



Stentorian Senior (PMS1), 42/-.

100 per cent. dust protection. Oversize cone.

Stentorian Standard (PMS2), 32/6.

Stentorian Baby (PMS6), - - - 22/6.

Write for the new W.B. Stentorian leaflet.

# STENTORIAN

## PERMANENT MAGNET MOVING-COIL SPEAKERS

Whiteley Electrical Radio Co., Ltd., Dept. A, Radio Works, Mansfield, Notts. Sole Agents in Scotland: Radiovision, Ltd., 233 St. Vincent Street, Glasgow, C.2. Sole Agents in I.F.S.: Kelly & Shiel, Ltd., 47 Fleet Street, Dublin.

**ELECTRADIX**

**CIRCUIT BREAKERS** replace fuses now. Magnetic Trip Overload Switches, A.C. or D.C. mains, 2 to 4 amps. 7/6; 6 amps., 10/-; 10 amps., 12/-; 15 amps., 14/-; 20 amps., 16/-. Trips may be remote controlled. Illustration shows with cover removed. D.P. and triple poles with trips and thermal delays. Cheap. Reyrolle Power Plugs, 15 amp., shrouded panel wall two pairs on iron box, unused, 10/-.



**LESIDX CHARGERS.** We have 25 models to offer and build special types to special requirements. Three popular sizes are the AC109A for 36 cells at £10 9s. The AC106 for 108 cells at £12 10s. and the Lesdix Super Six for 200 cells at £32 7s. 6d. Ask for Charger leaflet "A."



**METERS.** Panel and Portable A.C. and D.C. all ranges and sizes milliamps. to 1,000 amps., millivolts to 10,000 volts. Meggers, Bridges, Galvos Frequency Meters, etc. Write for Special Meter Lists, "A."

**DYNAMOS, CHARGING OR LIGHTING.** 240 watt Enclosed Dynamo, 12/20 v. 12 amps. Ball Bearings, Vee Pulley, Type C, Marine type Switchboard with Ammeter, maximum and minimum Auto Cutout main Switch and Fuses, Field Regulator, etc., 50/-.



**DOUBLE CURRENT GENERATORS, D.C.,** 600 volts, 100 m.a., and 6 volts 3 amps., 49/-.

Write for Special Bargain List "A.24." Free.

**ELECTRADIX RADIOS**  
218 Upper Thames Street, London, E.C.4  
Telephone: Central 4611.

**WONDERFUL BARGAIN**



**24 ONLY**  
**PETO-SCOTT 1935**  
**Walnut**  
**ADAPTARAM**  
**BRAND**  
**NEW** **47/6**  
*Oak or Mahogany 10/- extra.*  
Cash or C.O.D. Carriage and Post Packing, 2/6 extra.  
**PETO-SCOTT CO. LTD.,**  
77 (A.W.I), City Road, London, E.C.1. 62 (A.W.I), High Holborn, W.C.1.

**ENGINEERS!**  
**ARE YOU EARNING**  
**LESS THAN £10 PER WEEK?**

If so, you cannot afford to carry on without reading our 256-page Handbook. The book explains clearly and definitely many ways of carving out a successful career. Among other things, it explains the Services of our unique Appointments Department, outlines Home-Study Courses in all branches of Civil, Mechanical, Electrical, Motor, Aero, Wireless, "Talkie" Eng., Building, etc., and gives details of B.Sc., A.M.I.C.E., A.M.I.A.E., G.P.O., Matric., and all Exams. We alone Guarantee—No Pass—No Fee.



Whether you be an old hand or a budding apprentice, get this book to-day—FREE and POST FREE.  
**BRITISH INSTITUTE OF ENGINEERING TECHNOLOGY,**  
409 Shakespeare House, 29/31 Oxford Street, London, W.1.

**High Tension for your Radio from the Mains at 1/- PER YEAR**

Model AC/TC. 150 volts at 30 milliamps, with S.G. and Detector Tappings. 2 volt 1/2 amp. Trickle charger.



Send for full particulars  
**M.P.R. Ltd ROMFORD, ESSEX**

**NOVEMBER ISSUE OF TELEVISION**

On Sale at all Newsagents—Price 1/-

**Modern Loud-speaker**



Showing the switching arrangement of terminals on the back of the Amplion loud-speaker—giving 14 different ratios

tivity is of the highest order, while the response due to the lightly damped cone is particularly good.

So as to prevent dust getting into the gap, the whole of the front has been completely enclosed. This ensures complete protection of the speech coil. With an input of up to 5 watts there is no trace of cone rattle, while any slight resonance that happens to be round about 200 cycles is more of an advantage than a disadvantage.

The same features have been embodied in the mains energised models, which are available in various resistances between 2,000 and 6,500 ohms, so that they can be used on any D.C. mains voltage between 100 and 250 volts.

**For the Expert**

It has been realised that although excellent quality can be obtained from a well-designed unit, the expert requires a balanced pair so as to obtain the correct predominance of bass and treble. Rola units can be balanced and consist of either two permanent magnets or combination of permanent-magnet and field-energised types.

Remember when buying your new loud-speaker that all the Rola units embody a constant inductance output transformer so that you can be sure that even with a high current flow there will not be any falling off in quality.

**A Sensation!**

The only resemblance between the original Amplion Lion loud-speaker of 1930 vintage and the present one is that as the original model was the sensation of the 1930 show, so was the new Super Lion at this year's Exhibition.

This new Lion has been designed solely for the home constructor. Ease of matching and the correct tonal balance have all been carefully thought out.

To the average constructor the ratio of the output transformer is not very important. He realises that to obtain good quality the loud-speaker should be carefully matched to the output valve, but how to work out the correct ratio of the output transformer is quite a different matter.

The Amplion people have overcome this difficulty in quite an ingenious way. Fourteen tappings have been provided and these tappings are marked 40,000, 30,000, 18,000 right down to 2,000 ohms, corresponding to widely different loads. When you buy an output valve from your local dealer on the slip inside is given the optimum load. With small pentode, for example, this is approximately 8,000 ohms.

All you have to do, then, is simply to use the 8,000-ohm tapping and you know without a shadow of a doubt that the loud-speaker is accurately matched to the output valve.

The panel on this Amplion chassis is more like a

**D**URING the past two years or so there has been a marked improvement in the reproduction given by small moving-coil loud-speakers. Novel features such as dust covers, high-permeability magnets, and specially designed cones are now standard in the better class of unit.

Even so, we are surprised that so little attention has been paid to the design of input transformers. The Rola company were quick to realise that the loud-speaker could only give good quality providing it is correctly matched and that the matching transformer had a high primary inductance.

It is their claim that Rola speakers, in addition to being more efficient than other units at a similar price, give much better quality because they do not use a multi-ratio input transformer.

Many small units embody a matching transformer that is tapped to suit all types of valves from small triodes up to the highest impedance pentode. Such transformers have to have tappings so that all loads from about 2,000 up to 20,000 ohms can be obtained.

It is quite obvious that such a transformer, if it were to have a good inductance at, say, 2,000 ohms, would have to be of colossal dimensions.

This would not be a commercial proposition, so many manufacturers design a transformer that has a good primary inductance at its maximum impedance but falls off very badly at a low impedance.

We have just been testing some of the new Rola units for this season. The F7/PM, at £3, does give amazingly good quality. It is constructed with a 9-in. diameter cone with a very large magnet having a high flux density. Consequently the sensi-

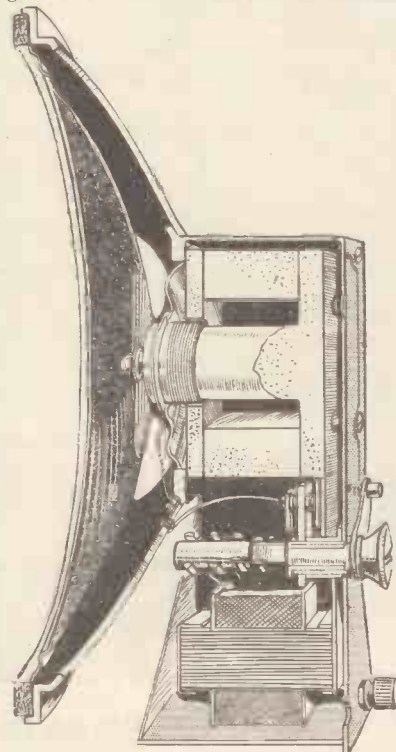

Construction of the W.B. loud-speaker, showing the two switches and the built-in input transformer giving correct matching



# Matching

switchboard than anything else, for in addition to these fourteen tappings, there is a switch for high- and low-impedance valves, terminals for tone control and a tapping for additional loud-speakers.

As the unit is also suitable for push-pull, class-B and straight output, it is truly universal and once and for all enables the constructor to buy one loud-speaker that will be suitable for any type of set he may eventually make.

### Does Not Rattle

The cone is quite light but it does not rattle with heavy inputs. The gap and speech coil are completely isolated, so that no dust or other foreign matter can upset the centring.

You may wonder how it is that such good quality is obtained from a loud-speaker with a multi-tapped matching transformer.

In this case, any possibility of a low inductance has been overcome by using a transformer with a constant-inductance primary,

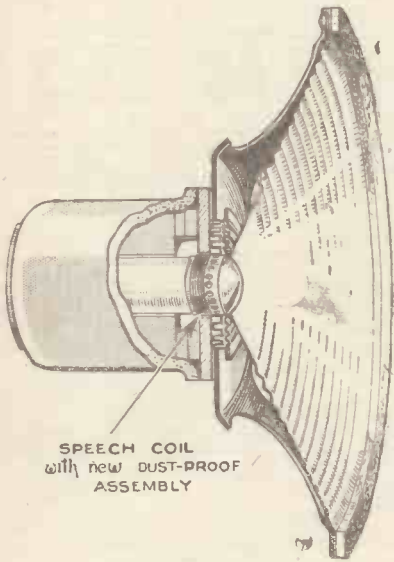

●Rola speech coil is effectively protected from the ravages of dust by the domed covering as shown by this sketch

the varying ratios being obtained by tapping the secondary.

The cone is of a patented material specially constructed for this unit and is 7 in. in diameter. This coupled with the fact that the loud-speaker magnet is of colossal dimensions and over 7 in. in length, accounts for the good quality and sensitivity. During our tests we were surprised to find that this unit was almost as sensitive as one of the D.C. mains-energised type.

### Struck A New Note

W.B. loud-speakers were announced earlier in the year with a very great splash as they were supposed to have struck a new note in loud-speaker design. Many thousands of our readers have since then proved for themselves that the claims for these units were in no way exaggerated.

The magnets used have a very high flux density; higher, in fact, than any other magnet of similar weight. In view of this it is quite obvious that the sensitivity is greater than that of other units with a similar weight magnet.

There are only three units in this year's W.B. range, for they are of the opinion that the largest one, the Senior at 2 guineas, is equal to anything on the market, while the

Junior, at 22s. 6d., gives quality good enough for the average reader.

It is a bold claim to make that no reasonable increase in price can effect any noticeable improvement in quality, but we have discovered that the W.B. Senior unit is as good as many other units costing as much as twice the price.

They have again embodied their patented system of matching, using a transformer with a high-inductance primary and a tapped secondary.

A novel idea that will appeal to all constructors is the switch that enables the loud-speaker to be cut out of action. If this unit is built-in, an external loud-speaker can be used with it, and the internal one can be cut out if required.

As you probably know, it is a difficult job to match up two odd loud-speakers, but when you have a W.B. you can obtain nine different ratios by merely rotating a simple switch. Of

course, it is suitable for all types of valves and output circuits, so it does not matter whether you have pentode, triode, class B or push-pull, it is all the same with this unit.

The cone is 7 in. in diameter—quite a popular size for the intermediate-priced units—while the whole is entirely dust-proof.

### Better Quality Now

The centring is semi-automatic, but the speech coil can be adjusted if necessary. One of the points that must be realised, however, is that this unit will give you greater volume and better quality than the unit you are using if it is more than twelve months old.

In all of our tests we use a standard Stentorian unit as we know this will give us the best possible results for a low-priced unit.

The frequency response is sensibly level between 60 and 5,000 cycles, while it will handle up to 4 watts without showing signs of distress in operation.

## PETO-SCOTT EVERYTHING RADIO—CASH C.O.D. or EASY TERMS

SEND US YOUR ENQUIRIES FOR EVERYTHING RADIO... (Miscellaneous Components, Parts, Kits, Finished Receivers or Accessories for Cash or C.O.D. or H.P. on our system of Easy Payments. Send us a list of your wants. We will quote you by return. C.O.D. orders value over 10/- sent carriage and post charges paid (GREAT BRITAIN ONLY). Any surplus refunded immediately. Hire Purchase Terms are NOT available to Irish and Overseas customers.

### ROMA SHORT WAYER

**KIT "A"** Author's Kit of First Specified Parts, including ready-drilled Aluminium Cabinet and Metaplex Baseboard, less Valve. Cash or C.O.D. **7/3** Yours for  
Carriage Paid, £3/19/6. Balance in 11 monthly payments of 7/3.

1 Peto-Scott ready-drilled Aluminium Cabinet with Metaplex Baseboard	£ 1 0
1 Set of Peto-Scott Short-wave Coils with Base	12 6
1 Hivac ACHL Valve (for mains use)	9 6
1 Hivac D210 Valve (for battery use)	8 9

### Peto-Scott Guaranteed Life BRITISH VALVES



Set of 3 Peto-Scott Valves—Screened Grid, 10/8; Detector, 3/9; Super Power, 10/8. British Valves of guaranteed life. Cash or C.O.D. Carriage Paid, £14/9. Or yours for 5/-, balance in 4 monthly payments of 5/6.

**5/- DOWN**

Peto-Scott have the largest stocks of B.V.A. Valves in the country. Any number or types available on similarly attractive easy terms for orders over £2.

### Peto-Scott LUCERNE S.G.3 KIT

Independently tuned circuits; Slow-motion tuning; Electrostatically screened Super Coils.



**KIT "A" 39/6** Yours for  
Comprising complete kit of parts including ready drilled, hand french polished Walnut panel and Metaplex Baseboard, less valves, cabinet and speaker. Cash or C.O.D. Carriage Paid 39/6. and 11 monthly payments of 3 9.

**KIT "B"** As Kit "A" but with set of 3 BVA Valves S.G., Detector and Super Power, less Cabinet and Speaker. Cash or C.O.D. Carriage Paid, £3 9/6. Yours for 5/- and 11 monthly payments of 5/6.

**KIT "CT"** As Kit "A" but with valves and Peto-Scott Walnut Table Cabinet, less Speaker. Cash or C.O.D. Carriage Paid, £4 2/0. Yours for 5/- and 11 monthly payments of 7/6.

**KIT "CD"** As Kit "A" but with Walnut Console Cabinet less Speaker, Cash or C.O.D. Carriage Paid, £4 7/0. Yours for 5/-, and 11 monthly payments of 8/3.

If Peto-Scott Permanent Magnet Moving Coil Speaker Type S1 required add 19/6 to cash prices or add 1/9 to deposit and each monthly payment.

**AVOMINOR D.C. MEASURING INSTRUMENT.** 11 ranges. Complete in case with leads, clips, and testing prods. Cash or C.O.D. Carriage Paid, £2 0/0. Balance in 10 monthly payments of 4/8. **2/6 only**



**W.B. STENTORIAN STANDARD PERMANENT-MAGNET M.C. SPEAKER.** For Power, Pentode and Class B. Cash or C.O.D. Carriage Paid, £1/12/6. Send only 2/6. Balance in 11 monthly payments of 3/-.



**W.B. STENTORIAN SENIOR PERMANENT-MAGNET M.C. SPEAKER.** For Power, Pentode and Class B. Cash or C.O.D. Carriage Paid, £2/2/0. Send only 2/6. Balance in 11 monthly payments of 4/-.



**W.B. STENTORIAN BABY PERMANENT-MAGNET M.C. SPEAKER.** With matching transformer, suitable for Power, Pentode, Class B or Q.P.P. Cash or C.O.D. Carriage Paid, £1/2/6. Send only 2/6. Balance in 9 monthly payments of 2/6. **2/6 DOWN ALL MODELS**

**ATLAS T10/30.** For A.C. Mains 200-250 volts, 40/120 cycles, three tappings: 10, 20 or 30 m.a. at 120/150 volts. Trickle Charger incorporated, 2 volts .5 amperes. Cash or C.O.D. Carriage Paid, £3/9/6. **5/- only**

Also available in 25-cycle model at same price. **GOLVERN COLPAK TUNING UNIT.** Incorporates the famous Ferrocart coils. Cash or C.O.D. Carriage Paid, £2/17/6. Balance in 11 monthly payments of 5/3. **5/- only**

**NEW GARRARD A.C. 6. INDUCTION ELECTRIC MOTOR.** Complete with 12-in. turntable, 12-in. Unit Plate and fully automatic switch. Cash or C.O.D. Carriage Paid, £2/2/6. Balance in 11 monthly payments of 4/- **2/6 only**

**B.T.H. MINOR PICK-UP AND TONE ARM.** With volume control. Cash or C.O.D. Carriage Paid £1/1/0. Balance in 8 monthly payments of 2/9 **2/6 only**

### LUCERNE COILS

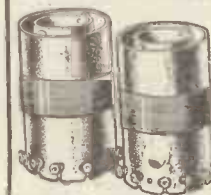

**Ready Wound LUCERNE AERIAL COIL OR GRID COIL**

Wound exactly to 'Amateur Wireless' specification. Manufactured, Tested and Guaranteed by Peto-Scott. **3/-** Each. Postage 6d. Extra. 6/6 Per Pair Post Free

## PETO-SCOTT Co. Ltd. 77, A.W.N2, CITY RD., LONDON, E.C.1

West End Showrooms—Telephone: Clerkenwell 9408/7  
62 High Holborn, London, W.C.1. Telephone: Holborn 3243

Buy by Post—its Quicker—CASH—C.O.D.—EASIWAY



# When Was the FIRST Wireless?

THE first wireless signals to be heard by man fell on the ears of D. E. Hughes fifty-five years ago. Hughes, an indefatigable experimenter, was in 1879 investigating two new inventions. One was the induction balance and the other the Graham Bell telephone. It was Hughes who invented the word "microphone."

Working one day with his induction balance, he could not get the results he expected and at length discovered that there was a loose contact in the apparatus.

Being very familiar with the primitive microphones of that time, the loose contact looked to him as though it might be making some kind of microphonic contact. He fitted up another microphone and head-telephone set some few feet away from the induction balance and found that every time he passed a current through the coils of the balance, he heard a click in his microphone-telephone circuit. His microphone was a steel needle touching a block of coke. This crude apparatus was the first wireless transmitter and receiver ever deliber-

By E. H. ROBINSON

ately put into operation by a human being.

Hughes then made a small transmitter fitted with a clockwork drive so that he could set it going and walk about his house in Baker Street with his telephones and microphone. In the end he walked right out into the street and found that he could hear his signals five hundred yards away.

In February, 1880, the month in which the present writer was born, Hughes gave a demonstration before the President of the Royal Society who visited Baker Street with two of the Honorary Secretaries of the Society, Professor Huxley and Professor Stokes.

After three hours, during which Hughes' apparatus did everything he expected of it, Professor Stokes told him that his theory of aerial electric waves had not been proved and that the phenomena he had shown them was simply due to induction.

Six years before, Clerk-Maxwell had mathematically shown that electro-magnetic waves must be propagated in certain circumstances and it certainly is amazing that two men of the standing of Huxley and Stokes did not immediately recognise that here was an experimental proof of Maxwell's theories.

Though Hughes was the first man to hear wireless signals, visual detection had been recorded over a hundred years before by an investigator who noted that when he discharged a Leyden jar tiny sparks could be seen passing between loose contacts in apparatus some distance away from the jar.

Sixty years after Adams had seen and written about these tiny sparks, Henry, whose name has been given to the unit of induction, showed that Leyden jar discharges were definitely oscillatory.

In 1880, therefore, the bare facts of wireless transmission of energy were known and it was an enormous piece of bad luck that Hughes, who really did know what he was doing, could get no one to believe him.

## GIVE YOURSELF A TREAT

—and your set too



Why put up with worn out valves? Buy a set of Record valves and enjoy the full benefits of your receiver. Record valves are the **cheapest** you can buy yet in quality they are **equal to the finest** valves made. A complete range of 2-volt and A.C. mains valves is available.

- BATTERY HEATED VALVES**
- D.L.2. Special non-microphonic Detector.
  - H.2. High Frequency Amplifier.
  - L.2. Low Frequency Amplifier.
  - L.P.2. Low Consumption small power
  - P.2. Power (suitable in 2nd L.F. stage).
  - S.P.2. Super Power.
  - P.T.2. Pentode
  - S.2. Screen-grid H.F. Amplifier and Det.

- INDIRECTLY HEATED A.C. VALVES**
- AC/HL. A.C. Detector and Triode Amplifier.
  - AC/S. A.C. Screen Grid H.F.
  - AC/VS. A.C. Variable Mu.
  - AC/PT. A.C. Pentode
  - AC/P. A.C. Power.
- RECTIFYING VALVE**
- FW.350. Full Wave Rectifier (output 300 volts, 80 milliamperes).

From your wireless dealer or from any branch of Currys.  
If you have any difficulty write direct to:  
**RECORD RADIO LTD.,**  
ELDON ST. HOUSE, 2-3 ELDON STREET, LONDON, E.C.2  
Tel: Bishopsgate 1301.

PRICES FROM  
**3/3**

**ARE YOU TUNING IN...**

to the RADIO PICTORIAL Celebrity Concerts which are broadcast regularly from PARIS (Poste Parisien) and RADIO NORMANDY?

Full details in this week's issue of

**RADIO PICTORIAL**

Every Friday  
Threepence

## ATLAS S.G.3

**A.C. SET, Model 334**

LIST PRICE £9 : 17 : 6 BARGAIN PRICE £6 : 6 : 0

YOURS FOR Cash or C.O.D. Carriage Paid

**5/-**

DOWN

and 18 monthly payments of 7/6.



You should send for this Amazing Bargain NOW if you are not to be disappointed. Comprises: Variable Mu S.G., Detector and Power Valves, Westinghouse Rectifier, Full-vision illuminated Wave-length Scale, Moving-coil Speaker, Sockets for Pick-up and extra Speaker. A.C. Mains, 200/250 volts, 40/120 cycles. Complete with Valves, Speaker and Cabinet Guaranteed BRAND NEW in manufacturer's Sealed Carton. Ready to play.

SEND FOR BARGAIN LISTS

**NEW TIMES SALES CO.** 56 (A.W.1), Ludgate Hill, London, E.C.4

**NEW!**

## PHILCO SHADOW-TUNING METER

for any make of set with A.V.C., either A.C., D.C. or Battery.



**24/6**

COMPLETE IN ATTRACTIVE WALNUT CASE

Now you can put Philco Shadow Tuning on any make of A.C., D.C., or Battery set which has A.V.C. This new accessory can be fitted without adjustment and makes this exclusive Philco tuning device available to all. The Shadow Tuning Meter is complete with its own cabinet, decoupling condenser, wire, lamp, and full fitting instructions. Or, if desired can be fitted inside the set's own cabinet. Shadow Tuning shows you when you have hair-line tuning—and therefore pure, undistorted reproduction. Tuning-in is completely silent. Makes station-finding child's play. Indicates as well the comparative signal strength of stations.

**AMERICAN TYPE VALVES** Philco Valves fit any American set. Philco are the only valves with a 90-day Guarantee.

**THE PHILCO RADIO & TELEVISION CORPORATION**  
OF GT. BRITAIN, LTD., AINTREE ROAD, PERIVALE, MIDDLESEX.

If you want a **FREE** Blueprint, see page iv of Cover



Readers' Views On This and That

# Listeners' Letters

## Home-made Portable Sets

To the Editor, AMATEUR WIRELESS,  
I ENCLOSE a photograph of two portable wireless sets I have made with the help of your valuable paper. They are two-valve sets and are of my own design, and it shows what one can do with a little perseverance.

The wiring of the sets is simple but effective, the circuit was issued in a supplement of

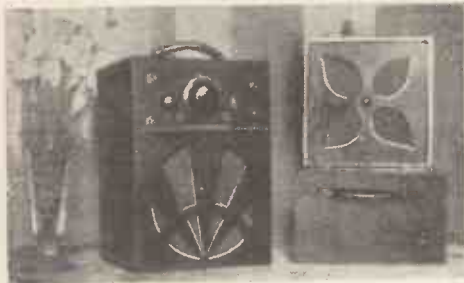

Photograph showing the two portables made up by Mr. Graham from information in "Amateur Wireless"

AMATEUR WIRELESS, October 25, 1930—the only difference is that I have used a .00015-microfarad differential reaction condenser. They are wired only for the medium wave-lengths, as I found they give the best results.

Without an aerial or earth, the local stations come in very well, and with a short aerial and earth they are very loud on the speaker, and several foreign stations can be got any evening.

ERNEST C. GRAHAM.

8 Caledonian Crescent, Edinburgh. [1158]

## Crusader Super-het Wanted

I THINK you have catered for quite a lot of Constructor Crusaders in producing the A.V.C.4, a well-designed set which I'm sure appeals to quite a lot of Crusaders.

Next you have the All Britain Three, another good set which would suit the Crusaders who could not afford the A.V.C.4.

Well, I am sorry to say I have built neither. I am waiting to see what the third Crusader set will be. I hope and trust that it is going to be a superhet.

Here is an outline of the superhet I would like to see for the Constructor Crusader.

A superhet four with A.V.C. single-knob tuning and class-B output.

The following valves could be used: Cossor pentagrid and B.V.A. H.F. Pentode, Osram double-diode-triode, and, of course, you could have alternative outputs—class B, Q.P.P., and pentode, like the A.V.C.4.

Chassis construction without doubt.

I think I have given you a good idea what I should like to see in your third set.

W. R. GIRVAN.

Irish Free State. [1159]

## World's Smallest Set?

AS a reader of AMATEUR WIRELESS, I was very interested in your article re the smallest wireless set by Alfred Hinch.

As you will see by the enclosed newspaper cutting my set is without doubt the smallest wireless in the world. Hoping that you will give this publication. ALFRED HOWARD DAVIS, Wolverhampton. [1160]

[The cutting describes Mr. Davis's miniature crystal set, which is built on an ebonite former 1/4 inch deep and 3/8 inch wide.

A tiny chip of crystal is mounted inside the opening in the centre of the ebonite former.

The coil consists of wire from a telephone

coil. This wire is much finer than a hair, and it has been carefully wound into a groove in the former. The catwhisker is made of the same wire.

The set can pick up the Droitwich long-waver on an indoor aerial.—ED.]

## Renewing Old Sets

THE letter of Mr. Wardel in "A.W." of Oct. 20, fits my case pretty well. I am writing to put my case to you. I can't build a new set, but am keen on wireless, and have been a reader of "A.W." right from the old crystal days and have found it most helpful.

Just a few of the things I can call to mind; making the linen loud-speaker; putting up my aerial again without taking the mast down; making the B.B.C. moving-coil speaker cabinet; making my aerial vertical; making the Mascot set which is giving me a lot of enjoyment; but I am bothered with high waves as the dials don't work in step.

I think it would be helpful to many readers if you could bring some of your older sets more up to date without the cost being too high.

H. Sherwin.

Worley. [1161]

## Our Short-wave Number

I WISH to show my appreciation of the Short-wave Number of "A.W." dated November 10. Up to the present, few English periodicals have given much space to the short-wave side of radio work, and it gives me great pleasure to find that at last one famous wireless journal is really giving S.W. working the boost it badly needs in this country.

I first became interested through building the famous 1931 "Century Super," and since I have used several receivers, including one and two-valve "hook-ups" and various super-hets, all of which have given world-wide reception. I have about 100 verifications and QSL cards which are a great source of interest to visitors and very useful to convince "doubting Thomases" of the reception of almost mythical-sounding stations such as XEBT, Mexico City; YV3RC, YV2RC, YV4RC of Caracas; HJ1ABB, of Barranquilla; LS X, Buenos Aires; PRBA, PRA3, and PRF5 all of Rio de Janeiro.

Other captures include, VUB, VK2ME, VK3LR, PLV, PMN, VE9BJ, VE9DR, VE9GW, CP5, W4 XB, W9 XF, VQ7LO, KNRA, *The Seth Parker* (which is sailing round the world and was in the Pacific at the time of reception with 1,000 watts power), VLK, CGA, SUZ, etc., etc.

Frequently running commentaries of events taking place abroad, like test matches, the Kentucky Derby, disasters, long-distance flights, surveys of the League of Nations' work, descriptions of ceremonies and celebrations are picked up long before the newspapers have published the details, or the local broadcast station given its bulletin.

The dance-band fan can hear America's latest hits played in luxurious hotels in New York, whilst the Roman Catholic can get religious information from the Vatican City, and the proletarian can turn to Moscow to learn of the Soviet.

Mr. Jowers' contribution is most welcome, and I am very sorry to find that his article is missing from the current number.

Finally, I thank AMATEUR WIRELESS for the great help and pleasure it has given me during the last four years or so, and I sincerely hope that the short waves will now have a permanent place.

F. A. BEANE.

Ridgewell, Essex. [1162]

## FERRANTI

### THE TRANSFORMER WITH A PEDIGREE

THE  
AF8

All over the world, wherever wireless men meet, the name Ferranti is synonymous with unfailing, unvarying quality.

The use of sectional windings on non-hygroscopic bobbins; the many unique features of design, and the stringent electrical and mechanical tests which every Ferranti Transformer must pass before it is allowed to leave the works ensures almost absolute freedom from breakdown.

YOU BUILD BETTER  
WHEN YOU BUILD  
WITH FERRANTI!

Type	Ratio	Inductance	Price
AF3	1/3.5	220/60 hys. 0.6 m/A.	25/-
AF5	1/3.5	260/80 hys. 0.10 m/A.	30/-
AF6	1/7	85/50 hys. 0.6 m/A.	30/-
AF7	1/1.75	400/120 hys. 0.8 m/A.	30/-
AF8	1/3.5	42/20 hys. 0.6 m/A.	11/6
AF10	1/3	35/20 hys. 0.6 m/A.	8/6

FERRANTI, LTD.,  
Hollinwood, Lancashire  
London: Bush House, Aldwych, W.C.2



Criticism by WHITAKER-WILSON

# My Broadcasting Diary

**M**ANY, many centuries ago the Devil foresaw broadcasting. He wasn't particularly musical, but he *had* heard a harp because better people than he played it. He noticed how they were made and then invented some twingy-twangy instruments of his own so that he could annoy us with them later.

Guitar, mandolin, banjo did he invent. (We were duly annoyed.)

Then someone got his own back. A man who could make a guitar sound really attractive. His name is Segovia and—

## Sunday

**I** HAVE just been listening to him playing Bach beautifully on a guitar. He shamed the Devil, who has now gone out of the musical instrument business and is concentrating on the crooners.

## Monday

**I** HONOUR Tod Slaughter. He lives up to his name. He wallows in slaughter. Great stuff, it is, too. I laughed in all the wrong places, but that is how melodrama affects me. A fine show this murder in that red barn. A fearsome lot, those Barnstormers.

After that I calmed down under the influence of William Barrand and the Wireless Male Voices singing Students' Songs. A generous selection beautifully rendered.

No sooner had I cheered up when Mr. Aldous Huxley upset me over "The Causes of War." I thought him a pleasing speaker with a concise way of putting his facts. Convincing, too.

Felt I must have a nightcap. The English Ensemble played Mozart so charmingly that I forgot Mr. Slaughter broadcasting slaughter, and Mr. Huxley telling me how to prevent it. Slept soundly all night after all. Have decided to continue my licence another twelve months.

## Tuesday

**R**ICHARD STRAUSS' *Salome* received a good rendering to-night. The effect of John the Baptist, called in the opera Jokanaan, singing in prison was excellent. It was effected by Arthur Fear standing in the three-sided cubicle with his back to the microphone.

At ten o'clock I ended my evening's listening by sitting in the freelight for Sir James Jean's talk on "The Sun and its Family."

First time I knew the thing was married, but he interested me thoroughly.

He was convincing. He talked as though he had been there for a holiday. And if an astronomer can be convincing he is worth his salt, for some of the statements take swallowing.

He ended up by telling me that one day the moon would get so near the earth that it would break up and become a whole lot of moons. Unfortunately he didn't say when. I was upset.

## Wednesday

**I** WANT a word with Mr. Geraldo. Sir, I like your "Dancing Through," but you danced through so much I felt I wanted less of all of you and more of some of you, if you understand my meaning.

One thing, though. Don't dance through the classics, please. You annoyed me over Liszt's *Liebestraume*. Wrong time and a lot of silly accompaniment. If you do that again I shall call you Vandalo, instead of Geraldo. *Naughty*.

I was so cross with Geraldo that I had to be soothed. Ethel Bartlett and Rae Robertson calmed me with their lovely playing. And now I have forgiven him and will hear him next time.

## Thursday

**I** RENEWED my erstwhile acquaintance with *Our Miss Gibbs* whom I found as attractive as in the days when first I knew her. After a while I took leave of her and metaphorically stepped over to Queen's Hall to hear the Delius Memorial concert.

Actually, I stoked up the fire, switched off the light, stayed put for an hour and forgot I was a radio critic. I so enjoyed the music that I have nothing to say about it. Busman's holiday, I suppose, but worth having for once in a way.

## Friday

**I** MISSED the Roosters by accident and the speeches from the Lord Mayor's banquet by design, and devoted my attention to Scrapbook for 1918.

I took this seriously and not as an entertainment. Candidly, I think it not too much to say Leslie Baily and Charles Brewer between them offered something of world-wide importance.

My opinion of it as a broadcast—the sort of opinion I am supposed to express in this column—is that it was beautifully done so far as Brewer is concerned and written by Baily with far more imagination than he has yet employed. Some of its English was almost epic.

Apart from that, I feel inclined to add the opinion that it should be translated into every language on earth and offered to every nation to broadcast.

## Saturday

**I** HEARD a certain amount of "In Town To-night" through various loud-speakers in the group of studios used for the transmission.

I liked the quartet of disabled soldiers. Two were able to stand but the other two, including the speaker, were wheeled in chairs to the microphone.

The Music-Hall I heard at home. Not a wonderful show, I thought. Far too many weak lines. There is always a risk of that in sketches. Robb Wilton ruined his "Lion-hunting" with several silly lines—some surprisingly so. And yet the sketch had possibilities.

The trouble is that we are not accepting sketches with possibilities. That is not enough. They must be certainties or they are of no account. Until these people are told quite plainly that they can keep their less amusing lines for the halls, where they do stand some chance of hiding obvious weaknesses with their own personalities, we shall continue to be disappointed.

The Cole Brothers were very smart with their patter. "Where there's a will there's relations," rather tickled my fancy.

Anona Winn sang well. I liked her "Ghost of the Christmas Turkey."

I sat up and listened to Henry Hall's Guest Night. I thought the band played well and Will Hay amused me, but I am bound to say I classed the Palladium Crazy Gang with entertainers who depend on an occasional smart remark to brighten up the dullness of their general patter. They were not, in my view, the success they should have been.

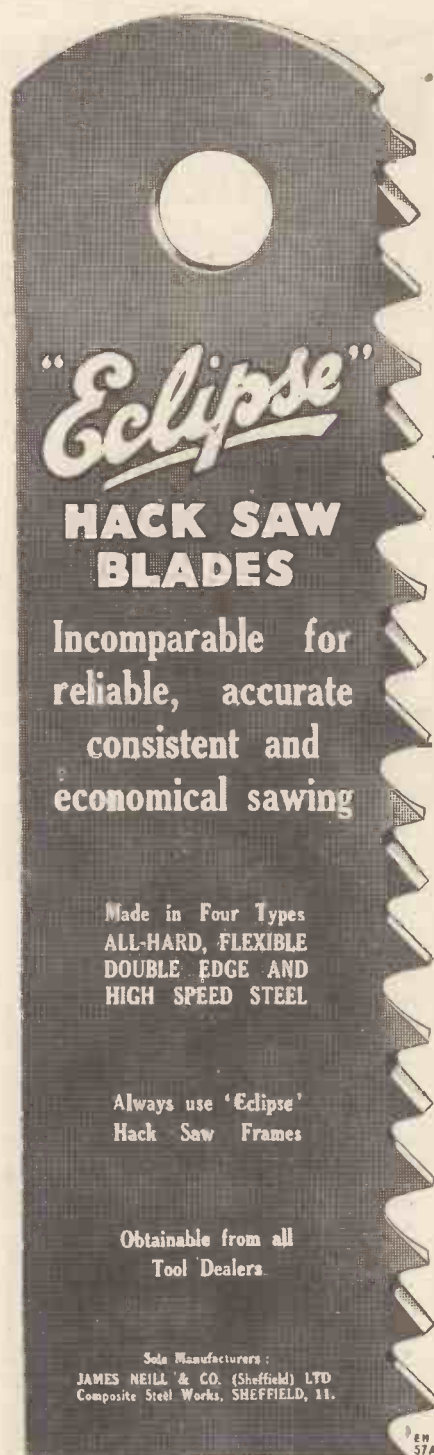

**"Eclipse"**  
**HACK SAW  
BLADES**

Incomparable for  
reliable, accurate  
consistent and  
economical sawing

Made in Four Types  
ALL-HARD, FLEXIBLE  
DOUBLE EDGE AND  
HIGH SPEED STEEL

Always use 'Eclipse'  
Hack Saw Frames

Obtainable from all  
Tool Dealers.

Sole Manufacturers:  
JAMES NEILL & CO. (Sheffield) LTD  
Composite Steel Works, SHEFFIELD, 11.

## SMASHING PROOF



Any voltage supplied

Recharges itself overnight

**WET H.T. SUPREME**

If you want to really solve the H.T. problem for good you cannot do better than follow the lead of the thousands who use a Standard Wet Battery. "12 months' service on a 3-valve set going ten hours a day, when an ordinary dry battery lasted only 7 weeks," writes R.S. 120-r. 12,500 m.a. £2 complete, carriage paid. Lasts years. Replenish at long intervals—that's all. All Standard H.T. spares supplied. Write for details of this money-saving H.T. Note new address:—

WET H.T. BATTERY CO. (A.W.),  
95 DEAN STREET, OXFORD STREET, W.1. Gerrard 6121.

LISTEN to the  
**"RADIO PICTORIAL"**  
Celebrity Concerts from the Continent!  
See details in this week's issue, price 3d.



Leaves from a Short-wave Log

# When to Listen

By G. GODCHAUX ABRAHAMS

WITH the shortening days we are steadily curtailing the listening period of a portion of the short-wave band, inasmuch as transmissions on channels between 16 and 18 metres are not heard now much before G.M.T. 1400 or after 1700; on the other hand, such transmissions as W8XK, Pittsburgh, on 19.72 metres are quite strong signals from 1500-1730 or 1800.

Towards dusk you will find that the best stations are those in the 25-30-metre band and from about 1800-midnight those operating on channels between 30-40 metres. From, roughly, midnight wavelengths below 40 metres start fading out and it is wise if searches are being made to concentrate on 40-50-metres.

It would facilitate matters greatly if we could give a distinctive name to these bands of short waves, and I would welcome suggestions. The term "short wave" is too vague, as it covers from, say, 10 metres-200 metres. Below 10 metres the term metre-wave is recognised and in more scientific quarters they talk glibly of decimetre. (In any case we must stop calling 200-800 metres or the broadcasting band *shorts*, and speak of them as *medium*, otherwise there is bound to be confusion.)

So far the most practical method found has been to classify stations in the twenty, thirty, forty, or other metre bands. On some occasions, when I have made a reference in this

way, I have been asked for a precise wavelength—but if you are told that a transmitter operates in a particular band, as in practice, it only covers, roughly, 10 metres; although you may not know the exact wavelength, your search is considerably narrowed. With the knowledge of the band in which it works, you can pick out a transmitter from even the most elaborate wavelength list in a few seconds.

One of the best South American stations now heard is the one to which I referred last week—namely, PRF5, Rio de Janeiro—and which, by the way, works on 31.58 metres (9,500 kilocycles), or slightly higher than Daventry GSB.

In conjunction with these Rio broadcasts you may now cancel all the odd calls which have been associated with them (PRAB, PRBA, PRFS, and so on); they are either obsolete or fictitious.

The transmission which has been heard on 36.65 metres (8,185 kilocycles) emanates from the commercial transmitter PSK at Marapicu, near Rio de Janeiro, and is only an occasional one—namely, when it is desired to relay the PRF5 programmes to Buenos Aires.

The broadcast in Spanish on 49.92 metres and which was thought to originate in Brazil is undoubtedly Mexico XEBT, but care should be taken not to confuse it with COC, Havana, on the same channel.

# Broadcast Wavelengths

This week we give details of the principal short-wavers and the European long-wave stations. Next week we shall publish a list of medium-wave transmitters

## Principal Short-wavers

Metres	Kilo-cycles	Station and Call sign	Country
14.00	21,420	Deal, N.J. (W2XDJ)	United States
14.17	21,160	Buenos Aires (LSL)	Argent. Republic
14.28	21,000	Podybrady (OKO)	Czechoslovakia
14.47	20,730	Buenos Aires (LSY)	Argent. Republic
14.72	20,380	Rugby (GAA)	Great Britain
15.25	17,540	Rome (IRW)	Italy
15.78	18,900	Pragins (HBF)	Switzerland
16.86	17,790	Daventry (GSG)	Great Britain
16.87	17,780	Bound Brook (W3XAL)	United States
16.83	17,770	Eindhoven (PHI)	Holland
16.89	17,760	Zeesen (DJE)	Germany
19.47	15,410	Riobamba (PRADO)	Ecuador
19.57	15,390	Schenectady (W2XAD)	United States
19.64	15,270	Wayne (N.J.) (W2 & E)	United States
19.67	15,250	Boston (W1XAL)	United States
19.68	15,243	Paris (Colonial) (FYA)	France
19.72	15,210	East Pittsburgh (W8XK)	United States
19.73	15,200	Zeesen (DJB)	Germany
19.82	15,140	Daventry (GSF)	Great Britain
19.84	15,122	Vatican (HVJ)	Italy
23.39	12,825	Rabat (CNR)	Morocco
24.83	12,082	Lisbon (CTICT)	Portugal
25.00	12,000	Moscow (RNE)	U.S.S.R.
25.25	11,880	Paris (FYA)	France
25.27	11,870	E. Pittsburgh (W8XK)	United States
25.29	11,860	Daventry (GSE)	Great Britain
25.40	11,810	Rome (2RO)	Italy
25.45	11,790	Boston (W1XAL)	United States
25.51	11,760	Zeesen (DJD)	Germany
25.53	11,750	Daventry (GSD)	Great Britain
25.63	11,705	Paris (Colonial)	France
28.98	10,350	Monte Grande (LSX)	Argent. Republic
29.04	10,330	Ruyssedele (ORK)	Belgium
30.43	9,860	Madrid (EAO)	Spain
31.25	9,600	Lisbon (CTIAA)	Portugal
31.28	9,590	Philadelphia (W3XAU)	United States
31.28	9,590	Sydney (VK2ME)	New South Wales
31.3	9,585	Daventry (GSC)	Great Britain
31.35	9,570	Boston (W1XAZ)	United States
31.36	9,565	Bombay (VUB)	India
31.38	9,560	Zeesen (DJA)	Germany
31.45	9,540	Jeloy (LKJ)	Norway
31.48	9,530	Schenectady (W2XAF)	United States
31.51	9,520	Skamlebaek	Denmark
31.55	9,510	Daventry (GSB)	Great Britain
31.55	9,510	Caracas (YV3BC)	Venezuela
36.65	8,186	Rio de Janeiro (PRA3)	Brazil
37.33	8,035	Rabat (CNR)	Morocco

Metres	Kilo-cycles	Station and Call sign	Country
38.48	7,797	Radio Nations (HBP)	Switzerland
43.86	6,840	Budapest (HAT2)	Hungary
45.37	6,611	Moscow (RW72)	U.S.S.R.
46.53	6,447	Barranquilla (HJAB)	Colombia
46.69	6,425	Bound Brook (W3XL)	United States
48.86	6,140	Pittsburgh (W8XK)	United States
49.02	6,120	Wayne (W2XE)	United States
49.08	6,112	Caracas (YVIBC)	Venezuela
49.18	6,110	Chicago (W9XF)	United States
49.18	6,110	Bound Brook (W3XAL)	United States
49.22	6,095	Bowmanville (VE9GV)	Canada
49.48	6,060	Byberry (W3XAU)	United States
49.48	6,060	Mason (W8XAL)	United States
49.5	6,060	Skamlebaek (OXY)	Denmark
49.5	6,065	Nairobi (VO7LO)	Kenya Colony
49.5	6,060	Bandoing (PKIWK)	Java
49.59	6,050	Daventry (GSA)	Great Britain
49.67	6,040	Boston (W1XAL)	United States
49.83	6,020	Zeesen (DJC)	Germany
49.92	6,010	Havana (COC)	Cuba
49.96	6,005	Montreal (VE9DR)	Canada
50.0	6,000	Moscow (RNR)	U.S.S.R.
50.27	5,968	Vatican (HVJ)	Italy

## Long-wave Stations

1,107	271	Moscow (RCZ)	U.S.S.R.	100
1,144.2	262	Madona	Latvia	20
1,153.8	260	Oslo	Norway	60
1,209.6	248	Scheveningen Haven	Holland	5
1,224	245	Leningrad	U.S.S.R.	103
1,250	240	Vienna (Exp.)	Austria	3
1,261	238	Kalundborg	Denmark	60
1,293	232	Kharkov	U.S.S.R.	35
1,304	230	Radio Luxembourg	Grand Duchy	100
1,312.9	229	Ankara	Turkey	7
1,345	223	Warsaw	Poland	120
1,354	221	Motala	Sweden	30
1,395	215	Eiffel Tower (Paris)	France	8
1,442	208	Reykjavik	Iceland	16
1,442	208	Minsk	U.S.S.R.	35
1,500	200	Droitwich	Great Britain	150
1,571	191	Deutschlandsender	Germany	60
1,612	186	Istanbul	Turkey	5
1,648	182	Radio Paris	France	80
1,724	174	Moscow (I)	U.S.S.R.	500
1,807	166	Lahti	Finland	40
1,875	160	Hilversum	Holland	50
1,886.7	159	Brasov	Roumania	20
1,935	155	Kaunas	Lithuania	7

The Perfect Potentiometer Specified for "The ALL-BRITAIN A.C.-D.C. THREE"

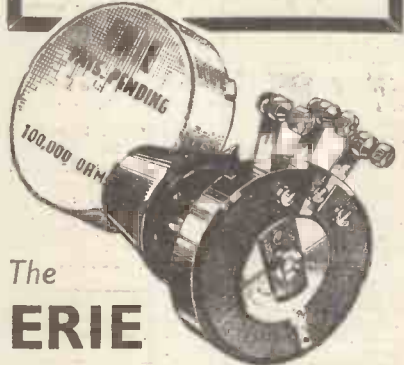

The ERIE VARIABLE RESISTANCE

Here is the variable resistance that will never develop faults—never fail or become noisy. The hard Eerie resistance and nickel-silver contact ensure smooth efficiency for a life-time's use. If unobtainable locally, send direct.

FREE! The invaluable "Eerie Service Instruction Booklet" gives helpful data on getting best results from resistors. Send for a free copy to-day!

THE RADIO RESISTOR CO., LTD., 1, Golden Sq., Piccadilly Circus, London, W.1.

There was a young fellow named Dick  
At making Radio Sets he was slick  
Every Set a success—  
Nothing more—nothing less—  
"Using FLUXITE" he said  
"does the trick!"



See that FLUXITE is always by you—in the house—garage—workshop—anywhere where simple speedy soldering is needed. Used for 30 years in government works and by the leading engineers and manufacturers. Of all Ironmongers—in tins, 4d., 8d., 1/4 and 2/8. Ask to see the FLUXITE SMALL-SPACE SOLDERING SET—compact but substantial—complete with full instructions—7/6. Ask also for Leaflet on CASE HARDENING STEEL and TEMPERING TOOLS with FLUXITE.

## THE FLUXITE GUN

is a handy and economical tool that enables you to put the Fluxite where you want it on the soldering job, and is clean and simple to use. Nothing to remove—no mess—no trouble. Always READY FOR USE. Also used to project grease into grease cups, bearings, etc.—Just fill the nozzle portion—half fill the cup—put together and press as required. Price 1/6



ALL MECHANICS WILL HAVE  
**FLUXITE**  
IT SIMPLIFIES ALL SOLDERING

Fluxite Ltd. (Dept. 326), Dragon Works, Bermondsey Street, S.E.1.



## PREPAID ADVERTISEMENTS

Advertisements under this head are charged **THREEPENNY PER WORD**, minimum charge **THREE SHILLINGS. DEPOSIT SYSTEM.**

As the publishers cannot accept responsibility for the bona fides of advertisers in this section, they have introduced a system of deposit which it is recommended should be adopted by readers when dealing with persons with whom they are unacquainted. It is here explained.

Intending purchasers should forward to the Publishers the amount of the purchase money of the article advertised. This will be acknowledged to both the Depositor and the Vendor, whose names and addresses must necessarily be given. The deposit is retained until advice is received of the completion of the purchase, or of the article having been returned to and accepted by the Vendor. In addition to the amount of the deposit, a Fee of 6d. for sums of £1 and under, and 1s. for amounts in excess of £1, to cover postage, etc., must be remitted at the same time. In cases of persons not resident within the United Kingdom, double fees are charged.

The amount of the Deposit and Fee must be remitted by Postal Order or Registered Letter (Cheques cannot be accepted), addressed to "Amateur Wireless" Advertisement Department, 58/61 Fetter Lane, London, E.C.4.

**REPAIRS TO MOVING-COIL SPEAKERS.**—Cones and Coils fitted or rewound. Eliminators and Transformers quoted for. Loud-speakers, L.F. and Speech Transformers, 4/- each, post free. Trade invited. Satisfaction guaranteed. Prompt service.—Loud-speaker Repair Service, 5 Balham Grove, London, S.W.12. Battersea 1321.

**AMAZING Price, Power, Range, Tone.** 7-stage Super-hets. A.C. and Universal. Latest refinements. Stamp particulars.—Simmons Radio, 9 Ilfracombe Avenue, Southend-on-sea. Trade Supplied.

**MICROPHONES.**—Best Value Ever Offered. 1,000 Western Electric type, perfect transmitters, complete with cord, 2/6 each. 100/1 Microphone Transformers, 3/6 each. All post free.—Electronico, Dept. M., 34 Queen Street, Hammersmith.

**10/6 ONLY!** Brand New Manufacturers' Surplus Moving-coil Speakers, by one of the best-known British makers; energised, 2,500 or 6,500 ohms field, power or pentode transformer, 8-in. cone; 10/6 each.

**12/6 ONLY!** As above, but 10-in. cone; 12/6 each.

**15/6 ONLY!** Permanent magnet, with power or pentode transformer, 8-in. cone; 15/6 each.

**17/6 ONLY!** As above, but with 10-in. cone; 17/6 each.

**CABINETS** for any of the above, 2/9 each only; secure one of these amazing bargains now; cash with order or C.O.D.—Hulbert, 6 Conduit Street, W.1.

**HIGHEST POSSIBLE ALLOWANCE** made on used wireless goods in exchange for new sets, components, or Peto-Scott kits. All latest receivers supplied on easiest of terms.—R. Wigfield, Furlong Road, Goldthorpe, Yorks.

**WANTED.**—Good Modern Wireless Parts, Sets, Eliminators, Meters, Valves, Speakers, etc. Spot Cash waiting. Exchanges. Send or bring. We pay more than any other dealer. Open 9-8.—University Radio, 142 Drummond Street, Euston, N.W.1.

**CAMCO RADIOGRAMPHONE CABINETS AT 40/-.** Special offer of mahogany radiogram cabinet, complete with polished panel, 18 in. by 7 in. Listed at £6/15/-; now 40/-.. Also a few to take panel 21 in. by 7 in., 42/6. Send for list.—Carrington Mfg. Co., Ltd., 24 Hatton Garden, E.C.1.

**BE MODERN.**—Exchange your old set and components for new. Highest allowance given. All constructors' specified kits stocked. Keenest prices quoted for radio requirements.—Servwell Wireless Supplies, 64 Prestbury Road, London, E.7.

## INFORMATION BUREAU

Will every querist please observe the following revised rules?

Please write concisely, giving essential particulars. A fee of one shilling, postal order (not stamps), a stamped, addressed envelope and the coupon on this page must accompany all queries.

Not more than two questions should be sent at any time.

The designing of apparatus or receivers cannot be undertaken.

Slight modifications of a straightforward nature only can be made to blueprints. For more serious alterations the minimum charge is 2/6.

Blueprints supplied by us will be charged for in addition, but, of course, readers may send their own blueprints for alteration.

Modifications to proprietary receivers and designs published by contemporary journals cannot be undertaken. Readers' sets and components cannot be tested by us. Queries cannot be answered by telephone or personally. Readers ordering blueprints and requiring technical information in addition should address a separate letter to the Information Bureau and should see that their remittance covers the price of the Blueprint and the amount of the query fee.

We do not answer queries in cases where the fee is omitted.

Queries should be addressed to the Query Dept., "Amateur Wireless," 58/61 Fetter Lane, London, E.C.4.

## Postcard Radio Literature

Here "Observer" reviews the latest booklets and folders issued by well-known manufacturers. If you want copies of any or all of them **FREE OF CHARGE**, just send a postcard giving the index numbers of the catalogues required (shown at the end of each paragraph) to "Postcard Radio Literature," AMATEUR WIRELESS, 58-61 Fetter Lane, E.C.4. "Observer" will see that you get all the literature you desire. Please write your name and address in block letters.

## Ferranti Valves

HERE is another most interesting and useful book regarding valves and their circuits. Each type of valve is described in a most comprehensive manner, thus greatly assisting in the selection of a valve for any particular circuit. The essential details are not merely stated in figures, for with each specification useful points are explained and helpful curves provided. With the introduction of valves having numerous pins or legs, it has become increasingly difficult to memorise the necessary connections to the required valve holder. This snag will be eliminated for those who write in for this splendid catalogue, as the publishers have very thoughtfully provided a pictorial illustration of a valve holder for each type of valve. 215

## Wet High-tension Batteries

ONE of the leaflets we received this week is from the Wet H.T. Battery Co., showing all the details of their standard leclanché type cells. All the various parts are illustrated and it appears that a battery of these cells can be formed with very little outlay. The advantage claimed for this source of supply of high or low tension is freedom from battery noises, and long life. Of course they are very economical in use and require practically no attention. If you are interested we would remind you that this leaflet, together with others, is yours for the asking. 216

## Davenset Products

PARTRIDGE, WILSON & CO., the makers of the above products, wish us to state that copies of their latest catalogue are now available for those interested in mains gear. The full range of class-A transformers and smoothing chokes is described, together with the most interesting matter regarding the processes employed in their manufacture. The booklet should prove most useful to all constructors, as the components most lavishly illustrated and valuable data is also provided. 217

## Rotary Converters for Radio

WE have just received from the Electro-Dynamic Construction Co., Ltd., several leaflets relating to converters suitable for operation off A.C., D.C. or the low-tension battery. It appears from the numerous details supplied that there are types and sizes to suit every requirement. They describe units suitable for the ordinary radio receiver, to the more powerful radiogram-phones and public address-apparatus. 218

## Philips Public-address Equipment

FOR those constructors whose ambitions and pockets allow them to soar to power amplifiers, microphones and rather large moving-coil speakers, the new leaflet from Philips will prove of considerable interest. It is impossible to enumerate all the various products described and illustrated, but we would mention that the catalogue includes a two-stage 5-watt amplifier and various intermediate outfits up to those capable of giving an output of 20 watts. 219

AMATEUR giving up hobby offers high-class modern components. Particulars.—Hagwood, Woodstock, Abergavenny.

AND STILL MORE ASTOUNDING BARGAINS FROM OLYMPIA RADIO'S LATEST PURCHASE

Comprising various Components, decontrolled Receivers for A.C. Mains and Battery operation

EKCO S.H. 25 Super-het Chassis-only. Complete with Valves and Loud-speaker. Brand new. Just ready to build into your own Cabinet. Our price, £6/19/6.

G.E.C. MODEL S.H.8 A.C. 8-valve Super-het Receiver. List price, £22/1/-. Our price, £12/12/-.

MARCONI 2-valve Battery Receiver, complete with Valves and all Batteries. Self-contained Cabinet. List price, 4 Guineas. Our price, £2/2/6.

LISSEN 2-valve A.C. Receiver. Absolutely complete in handsome Bakelite Cabinet. List price, 8 Guineas. Our price, £2/19/6.

BLUE SPOT 60R Unit and Chassis. Our price, 22/11.

BLUE SPOT 60R Unit only. List price, 27/6. Our price, 14/11.

ATLAS P.M. Speakers. One of the finest Moving-Coils made. Complete with Transformer. Suitable for Pentode or Power Valve. List price, 42/6. Our price, 17/6.

TRIOTRON Complete Class-B Unit. Complete with P.M. Speaker and Class-B Valve. List price, 60/- Our price, 29/6.

REGENTONE W.I.C. Eliminators. Brand new 150v. 20 m.a. Output. List price, £2/15/-. Our price, 35/-.

REGENTONE W.I.A. Eliminator. 150v. 30 m.a. Perfectly new. List price, £3/7/6. Our price, 42/6.

ATLAS T.12 Eliminator. Output, 120v. 12 m.a. Complete with Trickle Charger. List price, 77/6. Our price, 45/-.

THE ABOVE RECEIVERS are mostly brand new decontrolled models. We have large numbers of slightly shop-soiled or second-hand models in addition. Illustrated lists post free on application. Also numerous other Bargains in Speakers, Eliminators, and Components.

TERMS: Cash with Order or C.O.D. All Good Carriage Paid. Everything guaranteed O.K. Money refunded if not satisfactory. Please mention this paper when replying.

OLYMPIA RADIO, LTD., Mail Order Dept., 49a Shudehill, Manchester. BRANCHES in all Principal Towns.

BANKRUPT BARGAINS. List free with 3-valve diagram. All S.T. kits. Mains sets from £3. P.M. M.C. speakers from 9/6. Celestion PPM/W, 16/6. Regentone 30 m.a. eliminators, 32/6. Triotron valves from 3/-. Trade supplied. All Graham-Farish components. Large stock. Get my price first. Part exchange. Anything radio supplied.—Butlin, 143b Preston Road, Brighton. Preston 4030.

Grand Tone

RADIO GRAM CABINETS

As supplied to B.B.C.

65/- Polished Cabinet for 35/-

No Middle Profits!

Famous maker offers these Radio Furniture. As supplied to B.B.C. A Quality and Value impossible to better. Beautifully hand polished! GUARANTEED Piano-Tone Acoustically.

Trial Will Delight You! (Cash or 10/- Monthly.)

LIST FREE! From Makers—

PICKETT'S

Piano Tone

Cabinet (A.W.) Works, Albion Rd., Bexleyheath, Nr. London

## Goltone Nodalizer

THE makers of this component state that despite its size it will be found to be a giant in action. It is quite true that it is a midget component, but its construction leaves no doubt that it is very efficient, and reliable. It is not always possible in these days of mass-produced transformers to be certain that the tap provided is the true dead electrical centre. With the Nodalizer centre taps can be ignored, as it will provide the necessary hum balance under the most exacting conditions. The resistance value is 30 ohms. The List No. R23/143 and the price 2s. 6d.

Full information is contained in Ward & Goldstone's latest catalogue. 220

## Pasteurised Radio

THIS is the heading used on the descriptive matter of the Ekco nine stage super-het transportable receiver. Prices at £15 15s. and suitable for universal A.C./D.C. mains, it contains many features which warrant the heading. It appears that in addition to the five stages included in all modern super-hets, the Ekco model 95 has four extra stages used solely for pasteurisation purposes. For those without mains, we would mention that a battery model is available. 221

Amateur Wireless

FEE 1/-

INFORMATION BUREAU  
COUPON

Available until Saturday,  
DECEMBER 1, 1934

Printed in Great Britain for the Proprietors and Publishers, BERNARD JONES PUBLICATIONS, LTD., 58-61 Fetter Lane, London, E.C.4, by The Sun Engraving Co., Ltd., London and Watford. Sole Agents for South Africa: CENTRAL NEWS AGENCY, LIMITED. Sole Agents for Australia and New Zealand: GORDON & GOTCH (A'SIA), LIMITED. Saturday, November 24, 1934.



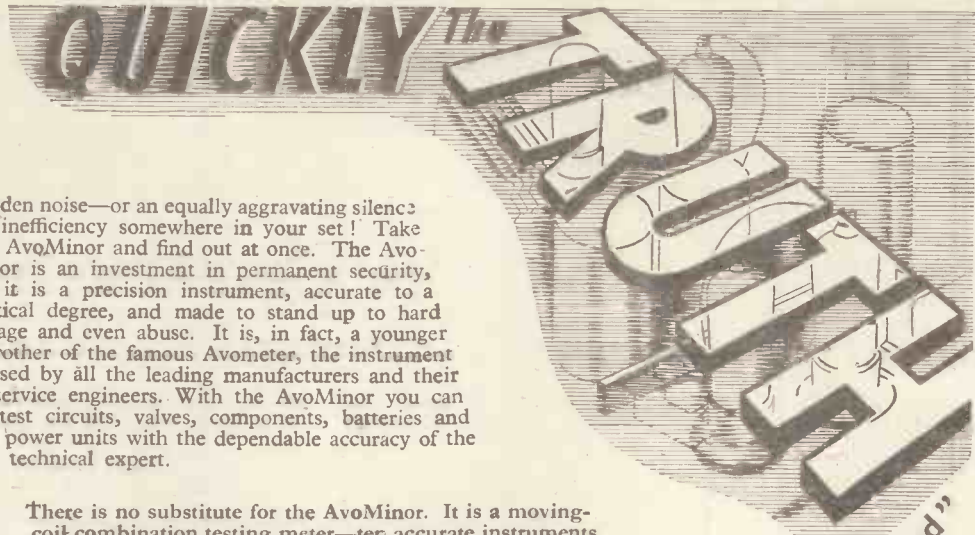

A sudden noise—or an equally aggravating silence . . . inefficiency somewhere in your set! Take your Avometer and find out at once. The Avometer is an investment in permanent security, for it is a precision instrument, accurate to a critical degree, and made to stand up to hard usage and even abuse. It is, in fact, a younger brother of the famous Avometer, the instrument used by all the leading manufacturers and their service engineers. With the Avometer you can test circuits, valves, components, batteries and power units with the dependable accuracy of the technical expert.

There is no substitute for the Avometer. It is a moving-coil combination testing meter—ten accurate instruments in one. Supplied in convenient case with leads and interchangeable testing prods and crocodile clips, and complete instruction booklet adequately illustrated.

Fully descriptive folder post free from:

THE AUTOMATIC COIL WINDER & ELECTRICAL EQUIPMENT CO., LTD.  
Winder House, Douglas Street, London, S.W.1. Telephone: Vic. 3404/7.

THE D.C. **AVOMETER** REGD. TRADE MARK  
TELLS THE WHOLE TRUTH

**"Radio Servicing Simplified"**  
Everyone should have this invaluable new book. It explains every phase of fault-tracing step by step in non-technical language. The comprehensive information and numerous diagrams make testing a matter of straightforward procedure.  
2/6 post free

TEN ACCURATE METERS IN ONE

CURRENT	VOLTAGE
0-6 milliamps	0-6 volts
0-30 "	0-120 "
0-120 "	0-300 "

RESISTANCE

0-10,000 ohms	0-60,000 ohms
0-1,200,000 ohms	0-3 megohms

40%

Size 4 by 3 by 1 1/2 ins.  
Total Resistance: 100,000 ohms.  
Full scale deflection on 3 milliamps.

Deferred Terms if desired.

Full Details of the Special English Transmissions from

- LUXEMBOURG
- PARIS (Poste Parisien)
- RADIO NORMANDY

At least 8 pages a week in RADIO PICTORIAL are devoted to full details of the special programmes in English from the above and also many other continental stations. RADIO PICTORIAL is the only publication that supplies you with this information. Besides this exclusive programme feature, the rest of the 40 pages contain scores of pictures and many fine articles by and about Radio Stars and well-known broadcasters.

RADIO PICTORIAL is on sale Friday, November 23rd, at all newsagents, price 3d.—don't forget to get a copy.

**RADIO PICTORIAL** Every Friday 3d.

84 STATIONS ON THE "W.M." STENODE...

★ Extracts from a report by Capt. E. H. Robinson on Paul Tyers' A.C. Stenode which appears in "Wireless Magazine" for November.

When I tell you that on one Saturday night in October I received and logged 84 stations on the A.C. Stenode, you can take this statement as a general indication of the sensitivity and selectivity of the set. . . .

. . . I was amazed to find that I had starred no less than 32 stations as coming in with good volume and quality, and having a really satisfactory programme value.

I care only for quality . . . when I say that I could listen with pleasure to at least 30 stations brought in by the Stenode, I am making a statement which amazes me so much that I can still hardly believe it.

A point which struck me very favourably, also in comparison with other super-hets, was the absence of valve noises and other atrocities of a similar kind.

The Stenode is remarkably easy to use.

The extreme selectivity of this set will be a revelation to those who have not previously used a Stenode.

November issue **WIRELESS MAGAZINE**

**A BEGINNER'S COURSE IN TELEVISION**

A section of TELEVISION, the first publication in the world of its kind, is devoted to beginners. Written in simple language it is indispensable to every radio constructor who wishes to enter this new field of home construction. Get a copy of TELEVISION to-day Price 1/-

# IF You Want a Free Blueprint of the **ALL-BRITAIN THREE** Join the Constructor Crusaders



## THE PRIVILEGES OF MEMBERSHIP

- 1.—Immediately on enrolment every Constructor Crusader receives free full-size photographic blueprints of the All-Britain Three (described Oct. 6 ) and of the Crusaders' A.V.C.4 (published on August 18). He will also receive a free blueprint, immediately on publication, of the two "Amateur Wireless" star sets to be released on January 23 and March 13, 1935.
- 2.—Every member will also be entitled to free technical advice in connection with any or all of the four special Crusader sets mentioned above (each query must be accompanied by a stamped and addressed envelope for the reply). In the case of queries regarding any other "Amateur Wireless" sets the usual rules of the Information Bureau must be observed.
- 3.—All Constructor Crusaders are invited to contribute ideas and suggestions to the Constructor Crusaders' Corner. Constructive suggestions will be specially helpful and will be interpreted by the "Amateur Wireless" Technical Staff as far as possible to the advantage of all set builders.
- 4.—Immediately his application for membership has been approved every Constructor Crusader will receive a certificate of membership. Note that the membership number must be quoted in all future correspondence.
- 5.—Constructor Crusaders will be authorised to wear the badge of membership. Badges for buttonhole wear can be obtained for 1s. extra each, post paid.

## WHAT THE CONSTRUCTOR CRUSADER UNDERTAKES

*To further the interests of home construction in every way that may present itself, and to encourage as many people as possible to take an active interest in the greatest hobby ever invented.*

*To do everything possible to raise the standard of radio reception—by making suggestions and by using only the best and newest methods and circuits so that other listeners will realise what great strides radio makes from year to year.*

*To build at least one new set every year and not to make do with an old receiver that should have been scrapped, or at least rebuilt, years ago.*

*To report on the performance of every new set made up and tried out—and to make reasonable and fair criticisms.*

To Constructor Crusaders, "Amateur Wireless,"  
58-61 Fetter Lane, London, E.C.4.  
(Enclose in envelope bearing 1½d. stamp.)

Please enrol me as a member of the Constructor Crusaders. I enclose postal order for 1s. to cover postage on four free blueprints and office expenses (and also an extra 1s. for buttonhole badge). It is understood that I shall be entitled to free technical advice on any matters concerning the four free blueprint sets. My name and address are:

November 24, 1934

Value of Postal Order Enclosed

For office use only.

No.	C	B	L

\*Delete if not required



Join Now by  
Completing the  
Membership Form