

MAKING YOUR OWN RADIO CABINET :: EXPERIMENTER'S 5-METRE SET

Amateur Wireless

3d
Every
Wednesday

and
Radiovision

EUROPE'S RADIO
CHIEFS IN LONDON

MORE ABOUT THE
A.C. PENTA-QUESTER

TELEVISION and
SHORT-WAVE
FEATURES

DUPLIX RECEIVER for
WIRELESS CONTROL

What

CAR RADIO

Really Gives

to the

MOTORIST

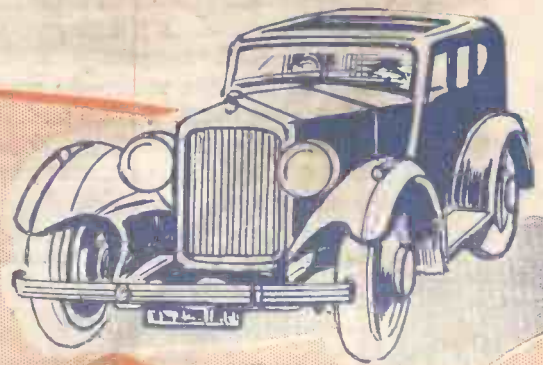

PERCY HARRIS Tells of His Own Experiences



FLUID-LIGHT TUNING

to get finest results from extreme selectivity

All Electric Superhet PORTABLE FLUID-LIGHT SIX

This new "His Master's Voice" Mains Portable with automatic volume control and fluid-light tuning, works off the mains electricity supply and needs neither aerial nor earth. It is the answer to all who have waited for true to life "mains reception" in a portable set. Its selectivity is so acute that it is fitted with fluid-light tuning—the sensational new device that ensures accurate tuning always. In this model, two illuminated arrows gradually approach each other until they show the exact point of perfect reception. So that by sight alone, unassisted by ear, you can tell when this set is tuned to concert pitch.

MODEL 463. Mains Portable, with self-contained earth and aerial (six valves including rectifier). Fluid-light tuning incorporated in wavelength scale. Automatic volume control. For A.C. only.



MODEL 463
16 GNS
or by hire purchase

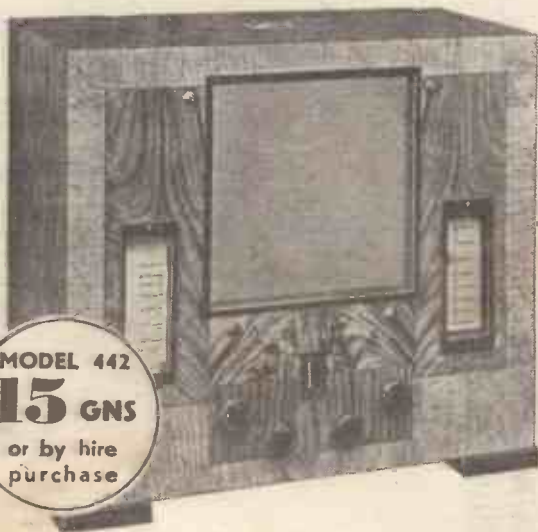

MODEL 442
15 GNS
or by hire purchase

All Electric Superhet FLUID-LIGHT FIVE

A new five-valve superhet table model with automatic volume control and fluid-light tuning. It is a delight to look at, a joy to hear, and a pleasure to handle. Its range is extraordinary and every station is kept distinct. The fluid-light tuning device in this model is a thin column of light which rises and falls in a slender central window, indicating the exact spot at which perfect tuning is reached. Only by means of this fluid-light can the extreme selectivity of this set be fully appreciated.

MODEL 442. Superhet Table Model (five valves including rectifier). Fluid-light tuning in central window. Automatic volume control. For A.C. only.

"HIS MASTER'S VOICE"

Write to-day for special illustrated leaflets.

THE GRAMOPHONE COMPANY, LTD., 108 E CLERKENWELL ROAD, LONDON, E.C.1. (Prices do not apply in U.F.S.)

To Ensure Speedy Delivery Mention "A.W." to Advertisers

Editor-in-Chief:
BERNARD E. JONES

Technical Editor:
J. H. REYNER
B.Sc. (Hons.), A.M.I.E.E.

Radiovision Editor:
H. CORBISHLEY

Amateur Wireless and Radiovision

Editor:
D. SISSON RELPH
Research Consultants:
W. JAMES and
PERCY W. HARRIS
M.Inst.Rad.E.
Assistant Editor:
ALAN HUNTER

Published by BERNARD JONES PUBLICATIONS, LTD., 58/61 Fetter Lane, London, E.C.4. Telephone: Central 4341 (four lines). Telegrams: "Beejapee, Fleet, London." Subscription, post paid to any part of the world: 3 months, 4s. 6d.; 6 months, 8s. 9d.; 12 months, 17s. 6d. Published on Wednesdays and dated for the following Saturday.

News and Gossip of the Week

Variety Bands Coming

HERE is a new slant on variety. The B.B.C. is going to put over dance bands during evening shows.

Van Stratten, of Quaglino's, comes to the studio for the first time on July 9. Dare Lee and his band will be heard in the same way on June 28.

All Stars!

VAN PHILLIPS, who won many bouquets over the air with his all-star dance-band programme, is returning to the microphone.

On July 25 he will do another all-star show.

A la Paul Whiteman

GET ready for a brand new dance orchestra created by Harold Ramsay, of Granada organ fame.

He aims at producing something on the lines of the giant Paul Whiteman's band. Harold has ideas of his own, don't forget.

You may remember that he introduced the much-talked-of six-piano act.

Listen, North Wales!

YOUR long-promised relay is coming visibly nearer. At Bangor the B.B.C. engineers have been very busy of late—and we should not be a bit surprised to hear they have located a site for the relay station.

Anyway, a studio is going to be erected there. Don't say we didn't give you a straight tip about a transmitter, too.

D.G.'s All-night Duty

EMPIRE programmes keep many senior members of the B.B.C. at Broadcasting House at all hours of the day and night.

Last week Sir John Reith, who always keeps closely in touch with every staff activity, was at headquarters all night.

Les Allen's Record

TALKING of out-of-the-way times, we must tell you about Les Allen's record—gramophone of that ilk.

At 9 a.m. on a recent Sunday he was up and doing at Clerkenwell Road, recording with his wife and little boy.

Norman, aged six, said his prayers, mother gave him a good-night hug, and Les did his stuff in the background.

Royal Visit from Siam

WHEN the King and Queen of Siam visited Broadcasting House the other day, the King was fascinated by the signal lights, while his Queen was equally intrigued with the kitchen arrangements.

Siam is definitely radio-minded. At Bangkok, for example, there is a main medium-waver and two relays, while almost every amateur must be familiar with the Bangkok short-waver.

Ever-popular Hylton

NO amount of competition or counter attraction can dim the amazingly wide popularity of Jack Hylton and his band.

Evidence of this is once more brought home to us by Copenhagen's request for a relay of the band when Jack brings it to the B.B.C. microphone on July 7.

Merseyside Tunnel Relay

WHEN Their Majesties the King and Queen perform the opening ceremony of the great new Merseyside Tunnel on July 18, the proceedings will be broadcast.

More Moving-coil "Mikes"

IN many of the regional centres now the B.B.C. has installed the moving-coil type of microphone.

As at London, reports seem to indicate that this type of microphone is highly successful. It is ousting the carbon microphone everywhere.

For O.B. Work

AT Broadcasting House more and more moving-coil "mikes" are being brought into action. They are readily adaptable for "O.B." work—a factor that in these days weighs quite heavily with the engineers.

Snappier Empire Programmes

A CERTAIN liveliness is becoming evident in the hitherto somewhat staid Empire programmes.

Gossip hours, dramatised short stories, revues, songs, and syncopation—a fine medley of entertaining hours are now being arranged.

We are sure this is along the right lines. Empire listeners, especially Colonials, really want live entertainment



Marshall photo
Austen ("Soft Lights and Sweet Music") Croom-Johnson handles a hefty "tube" at John Ferguson's amateur transmitting station down in Surrey. Even in shirt sleeves they still look rather warm, don't they?

Sir John v. Liberals

BY this time Sir John Reith must feel he has a cast-iron case for the B.B.C. against all-comers.

But, with his usual courtesy, he is going to the Houses of Parliament on July 4 to meet a bombardment of questions fired at him by members of the Liberal Party.

Variety Anniversary

HARDLY seems a year since Eric Maschwitz burst on the air with his characteristic pep, does it? But it is—a year of bright variety ideas that have done a lot to raise the standard of B.B.C. entertainment.

Whatever you may think about some of the individual broadcasts sponsored by Maschwitz, you must admit that such shows as the "Café Collette" and "In Town To-night" are first-class entertainment.

Maschwitz's Secret

"WHAT people like best," maintains Eric Maschwitz, "is what they know. Hence the popularity of the 'Songs from the Shows.'"

He is giving us many more musical shows in the autumn, and

John Watt will continue the good work with songs from films.

100 Per Cent. Coverage

WHY, asks a correspondent, must the B.B.C. put out the first news from all stations—thus wasting the whole idea of alternative programmes.

We don't know. All the B.B.C. can say, by way of excuse, is that once during the evening they want to be sure of a 100 per cent. coverage for the news.

Well, every area covered by the medium-wave nationals is already covered by a twin regional—so that won't wash.

Keeping in Touch

THAT the B.B.C. is remote from its listening clientele is often pointed out by carping critics. But John Morgan, in the B.B.C. tent at agricultural shows, is helping to overcome this disadvantage.

He is meeting, on behalf of the B.B.C., for whom he arranges a good many talks, many interested farmers and countrymen.

They seem to appreciate the special services of stock prices and weather forecasts—but they don't seem to have fallen for 24-hour time. Who does, anyway?

Making Your Own Radio Cabinet

Useful and Practical Constructional Hints
by the AMATEUR WIRELESS Technical Staff

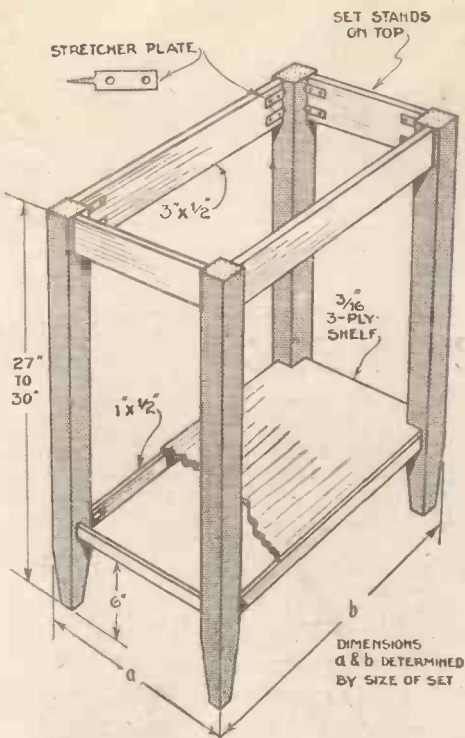

Fig. 2—Here is a neat little stand for your radio cabinet, which can be fitted together with what are known as stretcher plates obtainable from almost any hardware stores

BEFORE you attempt to build a cabinet you must, of course, decide on what size your set is going to be. The size of the panel and baseboard, and the number and size of batteries—not forgetting the question of loud-speaker accommodation—must all be well thought out before you embark on your home-made cabinet.

We mention this rather obvious truism because it is amazing how many perfectly good cabinets are lying about the country doing nothing—misfits that won't take the reigning receiver.

So just have a jolly good think before you trot along to the local joinery—plan out the size and shape of the cabinet with an eye to the future.

If you are more or less a novice at woodwork you had better stick to something very simple. It need not be unattractive on that account. The modern trend of design in all furniture is towards stern, almost Spartan, simplicity of line.

Simple Design

Fig. 1 gives you an idea of what we call a simple radio-set cabinet. Nothing pretentious about it, admittedly, but just a good solid job of work. It can be made up from almost any wood—the all-pervading walnut probably being first choice, though just for a change, you might think about good old mahogany or nice quiet oak.

Then, again, if you want to avoid expense, ordinary plywood can be used, though this will not look so good because you cannot work up a really nice finish.

The diagram is really self-explanatory, so let us not bore you with repetition of what you can just as well read for yourself. The order of assembly is not shown—so here are just a few hints.

We suggest you start off by nailing the top

to the two sides—with panel pins. Then you might as well nail on the front, having previously fretted out a space to take the loud-speaker.

Next comes the screwing of the bottom. This ought to be done with countersunk screws, of course, so that the cabinet will not leave a trail of scratches whenever it is moved on the table.

Those support strips you see fitted for the battery or set shelf and for fixing the back of the cabinet can be put on when you like.

As the back will be removable you will have to arrange that to screw on—or perhaps you would prefer to arrange a couple of clips for quick removal.

On the Right Track

Admittedly, these hints are only sketchy—but then we are not trying to give you a course in woodworking. Enough is provided to set you on the right track if you are really keen.

Now we come to a very interesting idea—at least we think it is. Nothing less than a stand for that table-cabinet set. Look at Fig. 2, which gives the whole story.

You see those four legs? They can be bought from a sixpenny stores for, well, 6d., of course. Or you can get ornamental legs for a few pence more.

No woodworking technique is needed to make this stand. The whole secret is the use of what are known as stretcher plates, which you can obtain from almost any ironmonger's store quite cheaply.

Screw the stretcher plates into the legs, and then screw the side and end pieces to the holes in the plates. Two plates at the top of each leg are advisable for strength, though only one at each side of the legs is needed at the bottom for the support of the shelf.

By making use of these ready-made legs,

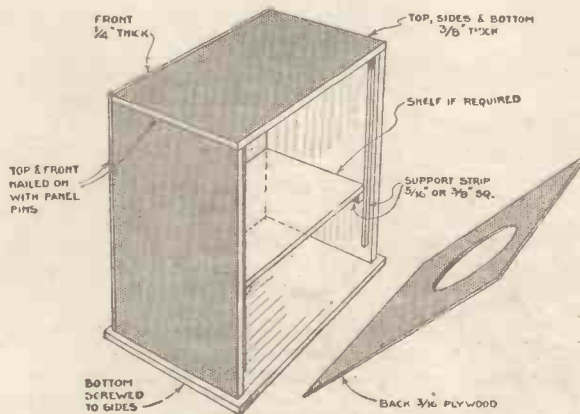

Fig. 1—This simple design enables you to make up a good-looking cabinet without any knowledge of woodworking

and connecting them by straightforward strips of wood with stretcher plates, you can very cheaply assemble a neat and attractive stand—the dimensions of which will, of course, depend on the size of the set you propose to support.

When you are about this job, don't forget to make use of steel screws, for upon the strength of these depends much of the rigidity of the whole assembly. This is particularly important

if you are building the stand to support an outside in radio receivers.

May we, in passing, comment upon the very great convenience of this arrangement? A table set is much more movable than a pedestal set—and none of this mobility is lost through using it with the type of stand we suggest.

You can still move the table-cabinet set from room to room—and the light weight of the stand makes that easy to move, too. Contrast

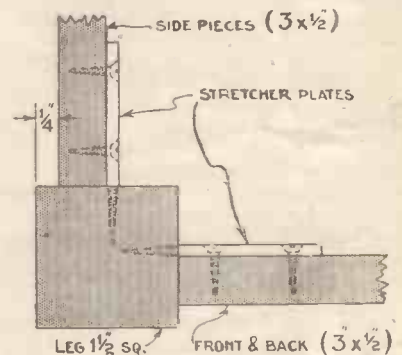

Fig. 3—Detailed diagram to show you how stretcher plates are used to join together in a rigid way two pieces of wood

this with the Herculean efforts often involved in moving an ornate pedestal type of set.

There is no reason why you should not fit castors to the bottoms of the legs, along the lines of a tea wagon or "dumb waiter."

As the wood of the legs is rather cheap you will have to stain and varnish them—unless you propose simply to rub down with sandpaper and leave it natural.

Close-up of Stretcher Plates

Fig. 3 gives you a close-up idea of how each leg is connected by a cross-piece through the stretcher plates. Note how the screw ends of the stretcher plates adequately clear one another—mind yours do, too.

Fig. 4 is in the nature of an afterthought. Our artist ran away with himself, we mean. He suddenly remembered the difficulty of finding the correct positions for the front-of-cabinet holes to take the spindles of the variable components. Just a smear of paint or paste on the ends of the spindles as the set is pushed home into the cabinet will do the trick.

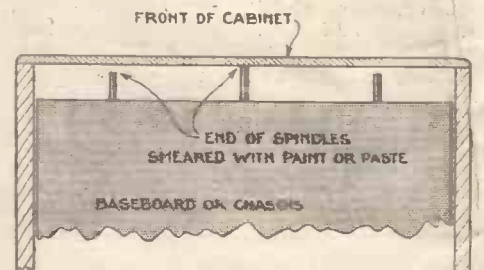

Fig. 4—Remember this tip—it will help you when drilling the holes in a cabinet to take the spindles of the variable controls

Europe's Radio Chiefs Came to London

—and Here ALAN HUNTER Tells You What They Discussed

IF you had been sitting in the lounge of the Dorchester last Wednesday, as I was, you would have seen passing to and fro the cream of Europe's broadcasting chiefs.

Raymond Braillard, the head of the technical commission of the International Broadcasting Union; Noel Ashbridge, the chief engineer of the B.B.C.; Major Atkinson, the B.B.C.'s foreign liaison—I picked them out at once.

There were Frenchmen, Germans, Poles, Scandinavians, Americans, Cubans . . . a potential babel, indeed. But they stood there talking quietly in small groups, waiting for yet another photograph.

Arthur Burrows Pleased

Then I ran into Arthur Burrows, the energetic secretary-general of the I.B.U. He looked a little tired, complained of slight hay fever, but was very pleased with the way things had gone.

"Uncle Arthur," as we used to know him in the old 2LO days, might well be pleased. This London meeting of seventy-three delegates belonging to the union, has proved a huge success—socially, politically and—if its recommendations are acted upon—technically, too.

Some people seem to think the entertaining of the visitors was overdone. Let me tell you that only once was the work of the Union interrupted for an "outing"—for the trip down the Thames, whose tide waits for no man.

In spite of all the jollifications, the delegates got through sixty hours of discussions on many subjects to do with broadcasting.

Increase of Prestige Abroad

Their visits to such places as the Tower of London, the London Trunk Exchange of the Post Office, Droitwich high-power transmitter and Broadcasting House will enormously increase British prestige abroad. These delegates will go back to their countries impressed with the radio prowess of Great Britain.

Yes, that is fine, you will say. But what did all these good delegates actually decide?



At Broadcasting House the European delegates were fascinated by the intricacies of the control room, which links up all stations in the B.B.C. broadcasting system, including National, Regional and Empire transmitters

For a start, the technical commission put the long waves "on the spot." The Union admits that all is not well. It does not see any way out of the *impasse* unless there is an extension of the long wave band.

Not in so many words does the Union commit itself, but that is the obvious significance of its resolution to press for more ether room at future conferences.

Meanwhile, the Union says that the long wave mix-up would be materially reduced if all stations abided by the modified Lucerne layout suggested at Geneva last February. Very politely the delegates mention that Luxembourg and other pirates complicate the situation. They certainly do that.

Dealing with the medium waveband, the Union notes with regret that its more recent suggestions for wavelength re-adjustments have not all been carried out.

Troubles still existing on medium waves can be classified under one of the following heads: mutual interference between shared-channel stations not properly synchronised; use of unauthorised wavelengths by certain "pirates"; mutual interference between Europeans and Russians east of the forty degrees East "boundary" separating the European and Russian zones; and instability of stations working on international common waves.

Under M. Braillard, the technical commission of the Union has done a lot of good work on recording systems for re-broadcasts. Its most notable step, though, was alluded to by Arthur Burrows, when I met him at the Dorchester.

"The telephone administrations have now accepted the principle of the creation of a mixed committee consisting of five members representing their interests and five representing the I.B.U."

Improved Music Lines

This means, as Mr. Burrows went on to explain, that music line hook-ups between the various parts of Europe will be still further improved. Moreover, the preparatory period will be reduced, as will, therefore, the cost of the relay.

By no means all the work of the Union delegates had to do with technicalities. Such vexed subjects as author's rights and the attitude of gramophone recording companies to broadcasting were discussed.

Importance is attached to the free interchange of programmes between European broadcasters. Half-hourly international concerts are being arranged, mainly of national works performed by national artists. One concert a month is suggested, each organisation taking the onus in turn for the benefit of all other members of the Union.

There, then, you have a few of the more important achievements of the delegates. Before they broke up they re-elected Vice-admiral Sir Charles Cappendale as president for the tenth successive time.



[Fox photo

U.I.R. delegates took a look around Broadcasting House—and were especially intrigued with the dramatic control panel under the direction of Val Gielgud—it is unlike anything used abroad, Mr. Gielgud is seen at the extreme left of the control panel

The A.C. Penta-quester

Hints on Its Operation

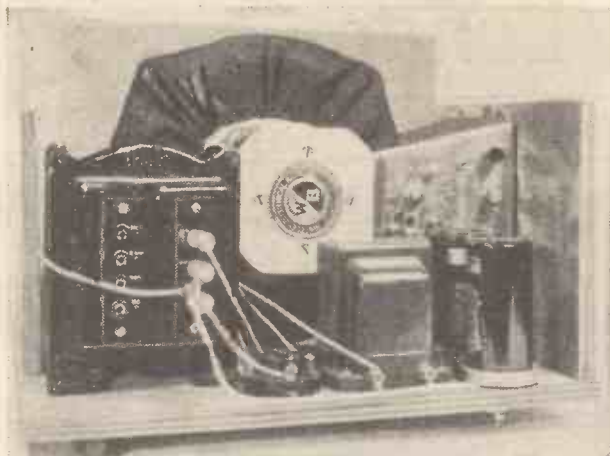

The mains unit for the A.C. Penta-quester is built up as a separate assembly

WHEN you come to make the A.C. Penta-quester you should most certainly consult our full-size blueprint, which you can obtain, price 1s. 6d. post paid, from the AMATEUR WIRELESS Blueprint Department, 58/61 Fetter Lane, E.C.4; ask for No. A.W. 439.

For a chassis set such as this the full-size blueprint is, of course, specially valuable, because it helps you to understand how the wires from the top part of the chassis are led to the underside.

Each of the holes is carefully lettered from a onwards, so that you have an infallible means of checking up the above- and below-chassis connections that pass through these holes.

Moreover, the connections follow our usual practice in being numbered from No. 1 onwards, so that if you follow this sequence there is

little chance of an error—not a serious one, anyway.

From the views of the top part of the chassis you have seen that, apart from the two-gang condenser and the terminal strip for the pick-up, the only components to be seen are three condensers, two with associated resistances.

Two of these condensers are cathode-resistance by-passers, actually for the detector and pentode output stages. The other condenser is the screen decoupling condenser of the output. Incidentally, the remaining cathode-resistance condenser is underneath with its associated resistance, both

tubular. At the back of the chassis are several small gadgets, including the tone-control knob, the aerial and earth terminals, and the terminals for the connection of the moving-coil loud-speaker. Also there is the toggle switch for the mains on-off connection.

Seven-pin valve holders of the chassis-mounting type are fixed to the top of the chassis by four screws each, the connections then projecting through underneath for connection to the rest of the set by means of the small terminal heads.

Held in the Wiring

When you come to put together the underside of the chassis you should note that the many resistances and some small tubular condensers are held in position by the connecting wires and are not therefore screwed down at all. Their fixing is part of the wiring sequence and they should be left until their turn comes.

The two screened coils are very easy to fix, and so is the separate gang-switch mechanism, with the knob projecting to the front of the chassis. The switch pieces are raised on a piece of wood as shown by the blueprint.

Very little else needs explanation regarding the fixing of the components. You will see that the reaction and aerial-input variable condensers are mounted on metal brackets so that the control knobs come in line with the switch knob.

Do please follow the blueprint when you come to the wiring process. Use tinned-copper wire with insulated sleeving, and cross off each wire on the blueprint as you actually make it in the set.

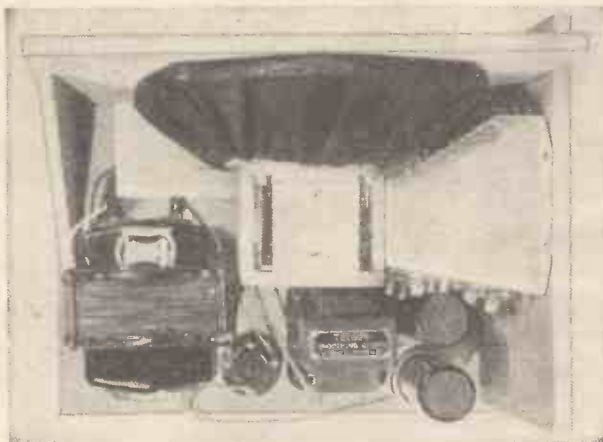

A plan view of the A.C. Penta-quester mains unit

Layout and Wiring Guide for the A.C. Penta-quester

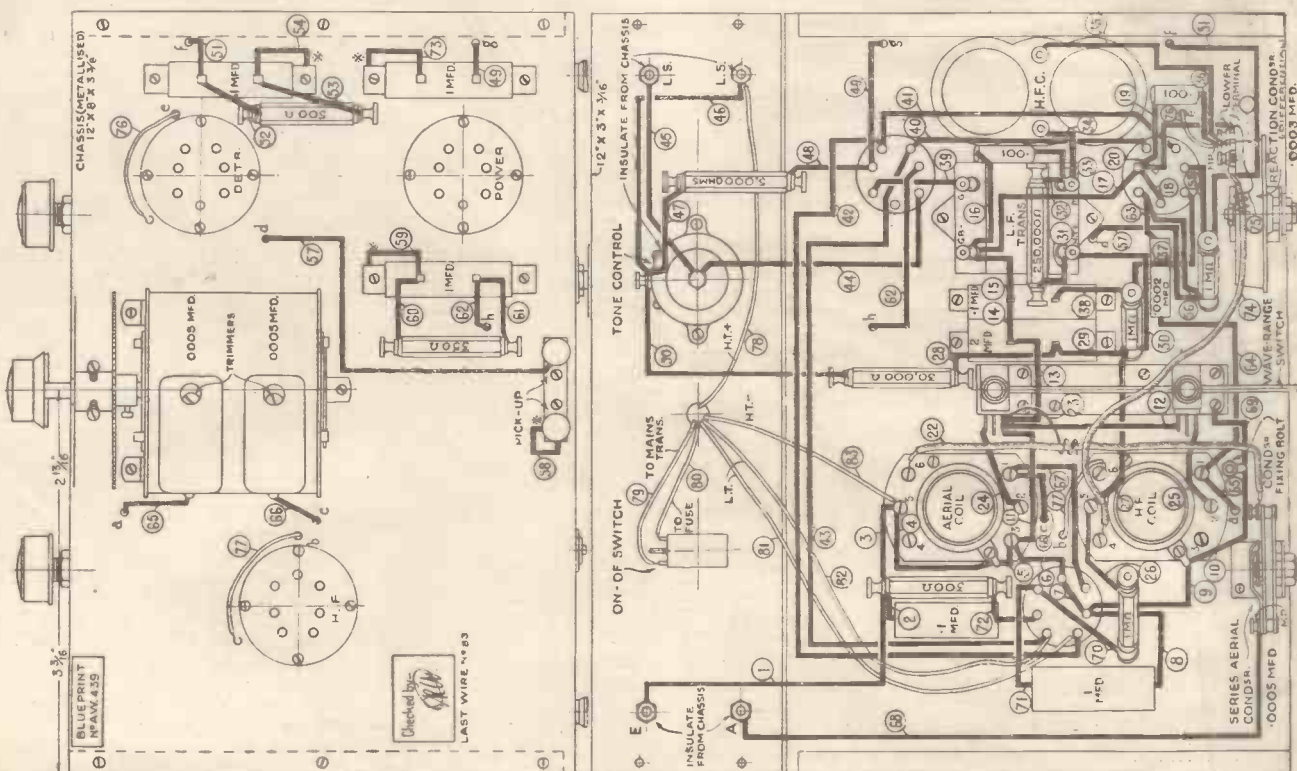

There is very little needing mention in the power-supply compartment. The two electrolytics and the smoothing choke are conveniently fitted into one corner, with the mains transformer in the other, a valve holder near by taking the full-wave rectifier.

The W.B. moving-coil loud-speaker chassis is fitted to one side of the wooden compartment, with its terminals and matching adjustment accessibly placed for subsequent action.

Both these parts fit into the specially designed Penta-quester cabinet, which, as you may recall, has chromium bars down each side to act as a local aerial. Also the gang condenser works on a chain-and-sprocket drive, so that you can obtain clock-face tuning—with the advantage of a complete 360-degree revolution of the minute hand for a 180-degree turn of the condenser plates.

Before you can actually connect up to the mains, leads have to be taken from the chassis to the power supply, two for the high tension, two for the low tension and two for the mains from the toggle switch. One of the toggle leads goes to the mains and the other to one side of the mains transformer, the remaining transformer connection going to the mains.

Transformer Adjustment

Note carefully the adjustment on the mains transformer tallies with your domestic supply voltage—plug into the nearest socket marked on the transformer panel, either 200, 230 or 250 volts.

In operation you should very quickly find your way with the A.C. Penta-quester. Tuning on the clock face is very easy and logging is made simple by the very open degree markings. Reaction has been made very smooth, as you will find when you approach the oscillation point. The volume is controllable over quite wide limits on the aerial input control.

Do not forget, though, that this input control exerts a very great effect on the selectivity. If you decrease the input and make up any lost volume on the reaction you will often be able to obtain perfectly clear reception of stations that appear to be jammed—as indeed they may be with the input control full on.

The tone control will cut down the high notes a little, and here again don't forget the other

function, namely to reduce background noises when conditions are bad.

You should experiment with the adjustments on the Micro-lode loud-speaker, but take care to switch off the mains when you tackle this little job.

You ought to be able to get quite good reception of the local on the chromium bars as the aerial, especially if you use a good earth. But for normally good reception an outdoor aerial of, say, 60 ft. will do fine.

Another point—do remember to keep that input control well in hand—and then you will have a very selective set capable of roping



Another view of the A.C. Penta-quester mains unit with the rectifying valve fitted in position near the transformer



The A.C. Penta-quester in the specially designed cabinet all ready for use

the control as being purely and simply a means of cutting down the volume. To some extent this supposition is, of course, correct but it is by no means the whole of the story.

By all means use the input control to cut down the strength of the locals, which will, naturally, come through at too great a volume to be tolerated on the loud-speaker.

Real Selectivity Aid

But, when you are trying, as you will frequently be doing, to cut out side band interference and other interference due to stations working very closely together in the ether, look upon the input control as a potent aid to greater selectivity.

Reduce the input to the point where the interference, on readjustment of the tuning control, is cleared away. Then see if you can't make up for the ensuing loss of volume on the reaction—that is what it is there for, anyway. If you find that reaction cannot do the trick, you will have to increase the input a little, and put up with perhaps a trifling amount of inevitable interference.

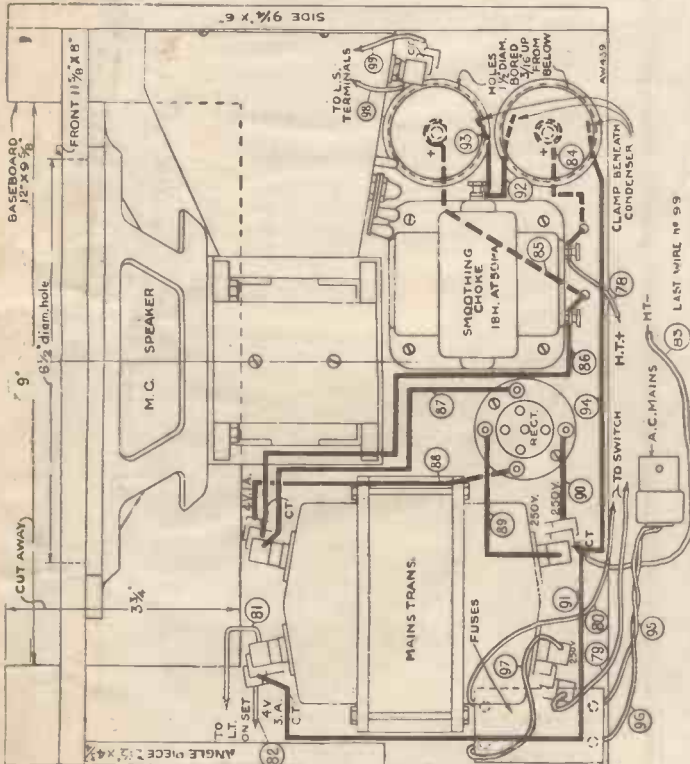

COMPONENTS NEEDED FOR THE A.C. PENTA-QUESTER

- CHASSIS**
 - 1—Peto Scott Metaplex, 12 in. by 8 in. by 3 1/2 in.
- CHOKES, HIGH-FREQUENCY**
 - 1—Graham Farish screened, type LMS (or Bulgain, Telsen).
- COILS**
 - 2—Telsen dual range screened, type W340.
- CONDENSERS, FIXED**
 - 3—T.M.C. Hydra, tubular type, values: .0002, .001-microfarad (2) (or Dubilier, T.C.C.).
 - 2—Dubilier 1-microfarad, tubular type (or T.M.C., T.C.C.).
 - 5—T.M.C. Hydra, type 25, values: 1, (2), 1- (3), 2-microfarad (or Telsen, T.C.C.).
- CONDENSERS, VARIABLE**
 - 1—British Radiophone two-gang .0005-microfarad with slow-motion drive type PQ.
 - 1—Graham Farish .0005-microfarad, reaction type (or Telsen, Telsen).
 - 1—Telsen .0003-microfarad differential reaction type (or Graham Farish).
- HOLDERS, VALVE**
 - 3—Clx seven-pin, chassis-mounting type.
- PLUGS, TERMINALS, ETC.**
 - 4—Belling Lee terminals, type R, marked: A, E, L.S. (2).
 - 1—Telsen terminal block.
- RESISTANCES, FIXED**
 - 9—Graham Farish 1 1/2-watt type, values: 300, 350, 500, 5,000, 30,000-ohm, 1/2, 1-megohm (3) (or Ferranti, Lissen).
- SUNDRIES**
 - 4 yards thin flex.
 - Connecting wire and sleeving.
- ACCESSORIES**
 - 1—Peto Scott, type PQ, with clock-face dial and chain drive.
- LOUD-SPEAKER**
 - 1—W.B., type PM44 (or Amplion, Blue Spot).
- VALVES**
 - 2—Mazda ACS9Pen.
 - 1—Cosor 5A11P1.
 - 1—Cosor 500BU.
- UNIT**
 - 1—Bulgain tone control, type CT.2.
- MAINS UNIT**
 - 2—British Radiogram 1 1/2-in. metal mounting bracket.
 - 1—Bulgain knob, type K14.
 - 1—Strip of wood 2 ft. 4 1/2 in. by 1/4 in.
- SWITCHES**
 - 2—Bulgain on-off toggle, type S80B, complete with 6 in. by 5/32 in. rod.
 - 1—Bulgain on-off toggle, type S80L.
- TRANSFORMER, LOW-FREQUENCY**
 - 1—Varley, type Nicore II.
- CONDENSERS, FIXED**
 - 2—Telsen 4-microfarad type W390 Electrolytic (or T.C.C., Dubilier).
- HOLDER, VALVE**
 - 1—W.B. four-pin (or Telsen, Lissen).
- TRANSFORMER, MAINS**
 - 1—Hayberd, type 717.

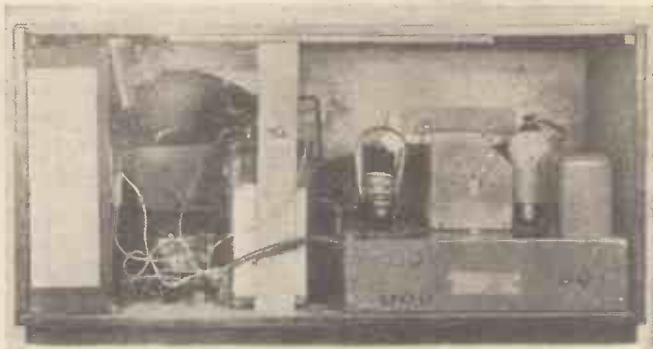

This photograph shows the neat layout of the Halcyon 301 Battery Three, a straight three-valver

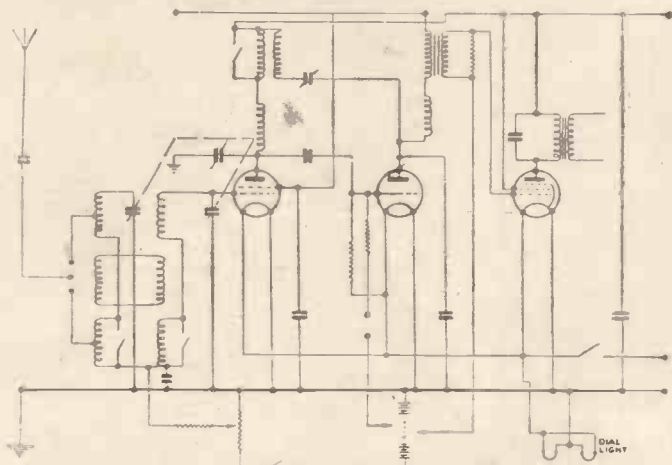

Circuit of the Halcyon 301 receiver. Note the band-pass aerial coupling

THIS battery three-valver is the first receiver we have received from the new Halcyon Company.

Construction has been reduced to great simplicity, and all ideas likely to cause complications have been rejected, so that in addition to the receiver being easy to make, and thus lowering the cost to the man in the street, it is not likely to go wrong in use.

Expensive-looking Cabinet

Walnut is used throughout in the construction of the cabinet. The first impression one obtains after inspecting this is that the receiver *must* be expensive, for it looks so solid.

Although the woodwork is good, by clever production methods the cost has been kept to a low level: anyway, a horizontal cabinet always looks very imposing and good value for money.

The cabinet is 23 in. in length, 10 in. deep, and 11 in. high—quite a useful size, not too small or too bulky.

All of the control knobs match the cabinet finish, so that the final effect is very pleasing. By "all of the control knobs," do not jump to the conclusion that the front of the cabinet is sprinkled with knobs of all kinds. Actually, there are only three altogether. On the left-hand side is the master switch which brings into circuit the long or medium waves, the gramophone pick-up, or switches off the receiver at will. The various positions are marked on the knob so there is no trouble in finding out where you are when you first switch on.

The centre knob is the only tuner and it actuates a vertical knife-edge travelling along a tuning scale calibrated in wavelengths.

and one in front of the detector.

A variable- μ screen-grid valve is in the first stage, coupled to one of the new Osram triode detectors, type L21. The output pentode is another Osram of the PT2 type and gives a high output with only a low anode current.

With volume at normal room strength the average anode current for the whole receiver is in the region of 10 milliamperes, so that the 144-volt high-tension battery supplied will last a long while. The low-tension accumulator is also inside the cabinet and is held in position by means of a metal rod across the top. This safety catch idea is very good, for the acid cannot spill as the accumulator cannot move from the proper position.

A permanent-magnet moving-coil loud-

Halcyon 301 Battery Three

On the right-hand side is the third control—volume-cum-reaction. This is only used on the more distant stations, as during our tests most stations could be tuned in without it.

All wavelengths between 200 and 550 on medium waves and 750 and 2,000 on the long waves are marked on the tuning scale, so that readers in the relay-station area or who wish to listen to Fécamp need not worry about the minimum wavelength.

Provision has been made for a gramophone pick-up and external loud-speakers. As there are alternative loud-speaker tapplings, units of different resistances can be used, an unusual feature on a commercial receiver.

Selectivity is obtained by using three sharply-tuned circuits, two in

front of the detector. speaker is on the right-hand side of the receiver. This unit is of generous dimensions and gives exceptional quality, good enough to make you forget that the receiver is battery-operated.

On test the receiver behaved very well indeed. One of the first points noticed was the simplicity of the installation. All of the leads have voltages marked on them so that it is a simple matter to plug them into the battery and to get their correct position first time.

Ample Selectivity

With an aerial 50 ft. in length at a distance of forty miles from the two local stations the selectivity was ample for all normal needs.

Care must be taken to adjust the trimmer on top of the tuning condenser as mentioned in the instruction book. This makes all the difference in the world between good and bad results.

On the long waves we were able to tune in Croydon, Oslo, Kalundborg, Warsaw, Luxembourg, during the early part of the evening, Berlin was blotted out by Daventry, but Radio Paris was quite free.

Of course, the medium waves yielded many more stations and at even greater strength. The first programme to be heard came from Radio Normandie at good loud-speaker strength—at lunch time.

IN A NUTSHELL

Makers : Halcyon Radio, Ltd.

Model : 301.

Price : £8 19s. 6d.

Valve Specification : Band-pass coupling to a variable- μ high-frequency stage (Osram VS24), triode detector (Osram L21), transformer coupling to power pentode (Osram PT2).

Power Supply : Internal dry batteries and low-tension accumulator.

Type : Horizontal type of table receiver.

Remarks : We are glad to acknowledge a manufacturer with original ideas. The change in cabinet design is welcome.



Trying out the Halcyon 301, a set that gives remarkably good results; it can be thoroughly recommended

As the average selectivity was about 13 kilocycles we were able to hear stations at almost every three or four degrees. As a rough estimate we feel quite safe in saying that the average bag of stations would be about forty to fifty, all on the loud-speaker.

The early morning programmes from Hilversum could be heard with only a very short length of wire around the picture rail—this will give some idea of the sensitivity of the high-frequency stage.

We can confidently recommend this receiver to the non-technical listener, for the controls are so simple. There are not any minor adjustments to make, and we cannot see a weak point anywhere.

It is a handsome piece of furniture, but at the same time it is not just an ornament. There is no doubt about it being good value for money.

On Your Wavelength

New Radio Discovery?

I WAS thrilled by a note on the projected ascent of the American stratosphere balloon which appeared in one of our lay papers. The occupants of the gondola, the gifted writer told the world, were to have with them a wireless transmitting set by means of which they would keep in constant touch with the groundlings.

All right so far; but how about this? Though the power used will be only eight watts, continued the scribe, strong and clear reception will be possible in this country. Wireless waves will travel unimpeded owing to the clearness of the air at a height of fifteen miles!

Has a new discovery been made in radio? Or is it a matter of hot air, rather than clear air?

Launched by Wireless

THE other day a new liner was launched at a range of several hundred miles by means of the wireless link and a relay.

This comes as a sequel to a good many other examples of "action at a distance," performed by radio—the switching on of illuminations at the other side of the world, the opening of exhibitions and that kind of thing.

It is, in fact, possible now to do all kinds of wonderful things of this sort by wireless. There is no reason, for instance, why a foundation stone should not be actually lowered into position by wireless-actuated relays at ranges of thousands of miles.

When television is fully developed, those who are watching the ceremony will be able, at the same time, to see the Big Noise in the act of pressing the button.

About My Output Units

SEVERAL correspondents have asked me to tell them something about the separate-unit low-frequency working that I mentioned in these notes last week. Actually, I have three of them, any one of which can be connected instantly by means of a flexible cable and a five-pin plug and socket to any of my sets.

The first is a class-B unit with driver and output stages and an extra low-frequency stage that can be used or not as one likes.

The second is a class-A or ordinary push-pull unit with one low-frequency stage and an output stage containing two PM202's.

By THERMION

The third has single valve output. It enables either a triode or a pentode to be employed in the last holder, a tapped output choke being provided for matching purposes.

Class A versus Class B

ONE of the most interesting aspects of these units is that they enable direct comparison between class A or ordinary push-pull and class B or quiescent push-pull to be made. I must say that I was very surprised by the results when I first brought the class-A unit into operation.

Of course, there is no comparison in the current consumption. The class-B unit, even if an additional low-frequency stage is used in front of it, requires only about 10 milliamperes for as big an output as most people would want at any time. On the other hand, the class-A unit needs over three times as much high-tension current all to itself.

Class A gives distinctly greater amplification and its quality is better. The reason for this is that two valves used in true push-pull straighten out one another's characteristics and eliminate harmonic distortion.

What a pity it is that push-pull requires so much current from the high-tension battery.

Atmospheric Oddities

ATMOSPHERICS are queer things. They come when you wouldn't expect them at all and at times when everything points to a fat crop of fizzes and crackles, there is not a sign of them to be heard.

What happened in the middle of this month is a good instance. We had a very hot spell, accompanied by forecasts of thunderstorms. Such storms did actually occur in some parts of the country, and nearly everywhere they looked likely at times, for heavy threatening clouds kept on blowing up.

Yet when one switched on the wireless set there was scarcely a crackle. In fact, such was the freedom from even small atmospheric effects that you could use the full amplification of a big set without having a noisy background. Queer, isn't it?

Service Point

A SALTASH correspondent raised a most interesting point in last week's "A.W." Referring to my remark that the value of a free service guarantee depended mainly upon the competence or otherwise of the retailer, he points out that many sets are sealed and that the service man is not allowed to break the seals in order to get at the "works."

Thus willy-nilly he has to return defective sets to the makers, with consequent big bills to his customers.

The whole question of guarantees and of service is most unsatisfactory. The first task that makers should set themselves is that of giving us sets so reliable that they need little or no servicing. The second is that of ensuring that when breakdowns do occur through defective components, labour charges are kept within reasonable limits.

Cathode Emission Mystery

ALTHOUGH the introduction of the dull-emitter filament practically "made" the modern valve, we are still very much in the dark as to why a thin coating of oxide should make all the difference.

The cathode itself is generally made of nickel—or a nickel alloy—covered with a mixture of barium and strontium oxides in equal parts by weight.

Some people hold that, as the wire is heated, free barium is produced and forms the actual source of the electron stream, whilst others believe that the electrons are really emitted from the oxide by the "catalytic" action of the barium. In both cases the presence of the latter seems to be an essential part of the process.

Radio Catalysts

THIS business of "catalysis" is one of the deeper mysteries of modern chemistry, though it also seems to be creeping into radio science.

The underlying idea is that certain operations can only take place in the presence of a "third-party" element, which although necessary to the process, does not itself suffer any change. In the case of the oxide-coated filament, the free barium simply serves to release the electrons by a sort of trigger action, which is as much mechanical as chemical.



H.M.V. photo

Even the dog cannot resist this one; a new model radio-gramophone provides entertainment for three—and that means the dog, too!



Radio factories all over the country are humming with pre-Exhibition activity. Mass-producing coils for the new season's range of radio sets



Marconiphone photo

"You see, sir, it is so simple!" Demonstrating a modern radio-granophone to a prospective—or should we say a practically converted?—customer

The mysterious cosmic rays provide another example of the same kind of thing, particularly in connection with gas-filled relays, such as the thyratron and neon tube. In the ordinary way, any gas is a perfect insulator, and will not pass an electric current unless it is first ionised. At the same time we know that a neon tube "strikes" at a certain critical value of applied voltage.

The reason is that the invisible cosmic rays have already prepared the way by causing a slight preliminary ionisation of the gas inside the tube. This, so to speak, "triggers" the discharge directly the proper voltage is applied across the electrodes.

Car Sets in the Home

If you are a battery user, have you ever thought of the possibility of using one of the new car radio receivers, not in your bus, but in your home?

As you know, they work straight off a six-volt (or 12-volt) accumulator—there is no high-tension battery, since each set contains its own converter, either rotary or of the vibrator type.

The battery which means the greatest source of trouble and expense is the H.T.B. By using a car receiving set, you can cut out the H.T.B. for good and all.

And you can obtain splendid volume and quality as you can judge for yourself by hearing one of these sets demonstrated.

They seem to me to be just the thing for country houses which make their own electric light supplies—usually 50 or 100 volt D.C. A 6-volt accumulator can be charged up from the house lighting plant.

Cars and Short Waves

If I am right in believing (and I think that I am) that the future of broadcasting and television may be very closely bound up with the short waves, there is no doubt that something will have to be done pretty soon about the interference radiated by the ignition systems of motor cars.

Those who happen to live on or near a main road know that almost every passing car causes terrific interference. You can hear it coming when it is some distance away. The rat-tat-tat swells to a roar as it passes your house and then dies away as it recedes into the distance.

Such radiation can be prevented and if only our authorities would keep an eye on the future it would be easy to stamp it out quickly by making a regulation that no car sold after a certain date should be permitted to radiate.

I am afraid, though, that we shall be content to muddle along. In a year or two's time, when the position becomes acute, a committee will be appointed which will discover that there are so many cars on the roads causing interference that it cannot be eliminated for many years.



Ultra-cheerful fans enjoying a spot of sun from Fécamp, which in the extreme south is heard well even in daylight

Battery Big 'Un

MY Philco Model 34, which is the battery version of the A.C. mains 16B, turned up a couple of days ago. Trials that I have made already have convinced me that it is a most interesting set with real pep and punch and all the selectivity that one could desire.

As you may know, it takes in all wavelengths from 12 to 550 metres without any coil-changing. A single wave-change knob takes you over instantly to any desired band.

It is a magnificent performer on the medium waves; in fact, I don't think that any set could bring in more stations, for with the volume control full on its high-frequency and intermediate-frequency amplification must closely approach the maximum that can be used for wireless reception. During daylight hours it brings in a good dozen medium-wave foreigners and after dusk you can run round Europe at full loud-speaker strength with the volume control hardly at all advanced from its minimum position.

I haven't yet had time to make very thorough tests on the short waves, but during the odd spells that I have put in it has been bringing in distant short-wavers splendidly.

A superhet—particularly a big superhet—with S.A.V.C. is a marvellous thing to use for short-wave reception.

What's Wrong with S.A.V.C.?

TALKING of S.A.V.C. reminds me that I ran across friend E. H. Robinson at Bisley the other day. We are both interested in rifle shooting and he, as you may remember, won the King's Prize some years ago.

"What's your objection to S.A.V.C.?" I inquired—you recall that he had an article in "A.W." a week or two ago in which he said that he didn't like it.

"Can't abide the beastly thing," sezee.

"Why?" I inquired.

But he went on to talk about bulls-eyes and wind allowance and things like that.

I cannot understand, myself, why some people have a down on S.A.V.C. To my mind it is one of the biggest advances in wireless reception made in recent years.

Aerial Makes All the Difference

ONE possible reason for its unpopularity in some quarters though, occurs to me. Many people try to use S.A.V.C. sets with utterly inefficient aerials. The result, when you come to think it out, is that they can derive little if any benefit from the device.

Take the case of a station that is fading. Unless your aerial is good enough to collect such a share of impulses that at normal signal strength the set is working well within itself, S.A.V.C. cannot possibly flatten out fading.

S.A.V.C. varies the amount of amplification to suit the signal, but it cannot take it above its maximum level. Therefore, if you are using a small or inefficient aerial, there is no reserve of amplification to cope with the minimum-strength periods and fading still occurs.

To give S.A.V.C. a fighting chance you must use a good aerial. If you do so it will straighten out all ordinary fading as well as preventing the set from being overloaded by the local station.

Why Foreigners Are Weak

WITH the big increases in power that have taken place since last year on the medium waveband, everyone expected that long-distance listening would remain good right through the summer. Actually, we struck rather a bad patch just after the beginning of June.

There were times when the biggest of sets seemed almost lifeless until about an hour before sunset. This is particularly curious since nothing of the kind occurred last year or the year before, when many stations were using much less power.

I think that we must blame the drought very largely. The soil is now woefully dry for many feet beneath its surface, and it is well known that wireless waves travel very badly over dry ground.

Some time ago it was found that the range of a station when the ground was wet might be reduced to one-tenth under conditions of absolute drought.

The ground waves from distant stations are simply not reaching us and it is not until round about sunset that the sky waves come into action.

Meantime, several of the nearer and more powerful medium-wave foreigners are pretty well heard at most times. Amongst them are Radio Normandie, Turin, Hilversum, the Poste Parisien, Leipzig, Munich and the two Brussels stations.



H.M.V. photo

Three little maids from school are they—and we don't wonder they prefer to spend their time this way, listening on a portable to Henry Hall's afternoon dance-music programme—or was it Charlie Kunz?

Specially Designed by the
AMATEUR WIRELESS Technical Staff

An Experimenter's Set for 5-metre Working

Here we describe a simple three-valve super-regenerative receiver for use on wavelengths of the order of 5 metres: Already there are amateur stations working on this band and it is likely that in the near future television transmissions will be made on these ultra-short wavelengths: With this experimental set you will be able "to get your hand in" in good time!

FROM time to time we have devoted a certain amount of energy to the development of receivers for 5 metres. All pre-determined notions on the design of ultra-short wave receivers were thrown overboard and we got down to the design of a receiver that would do the job for which it was intended.

Wide Field for Development

Some of the results of our experiments have been published, and from correspondence we discovered that there is wide interest and a field for development on the ultra-short waves.

In the issue for June 16 we described a three-valve super-regenerative receiver. Although this was originally an experimental circuit which we had constructed purely out of curiosity, its efficiency was such that we decided to make it up in a manner suitable for the home constructor.

Fortunately it is possible to buy all of the

little snags that are likely to crop up on these very short waves.

There is at the present time a large number of amateur transmitters who are constantly putting out test programmes between 5.005 and 5.35 metres, which can be picked up within a radius of about 20 miles. Some of them have definite schedules, so they can actually be picked up without having to search round the whole evening.

G6OM of Heswall, G6GL of West Kirby, and G6DO of Birkenhead, are operating every Monday, Wednesday, and Friday from 2230 to 2330, and on Sundays from 1100 to 1230. This is only an example of the schedules that have been arranged between amateurs in different parts of the country.

Then there is the Baird transmission from the Crystal Palace on a little over 6 metres, which can be heard up to distances of over 60 miles.

A super-regenerative receiver will pick up all these transmissions, and although the quality from this set will not be sufficiently good for television, it will give a good idea as to what happens on such wavelengths.

This three-valve super-regenerative receiver is simpler to handle than the average short-wave set, for it only covers a waveband of 3 metres, spread over a 180-degree tuning dial. No possibility of jamming on this set!

The first valve is one of the new Marconi-

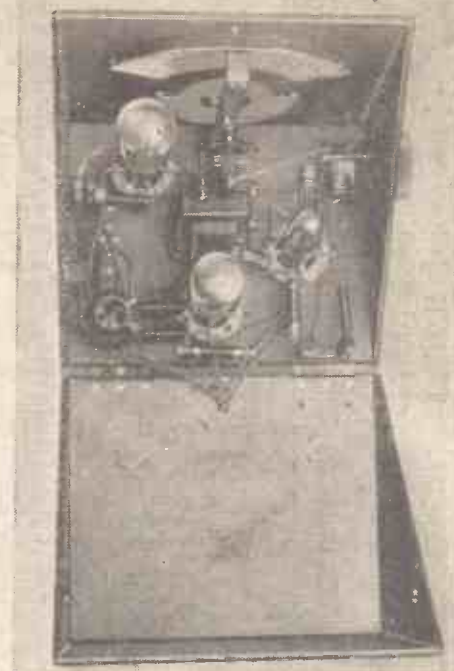

Plan view showing the arrangement of the "A.W." 5-metre experimental set

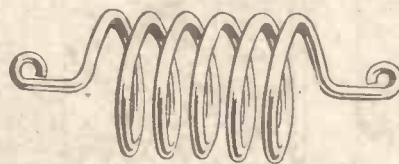

This diagram shows how the 5-metre coils are made; no former is required as the coil is self-supporting

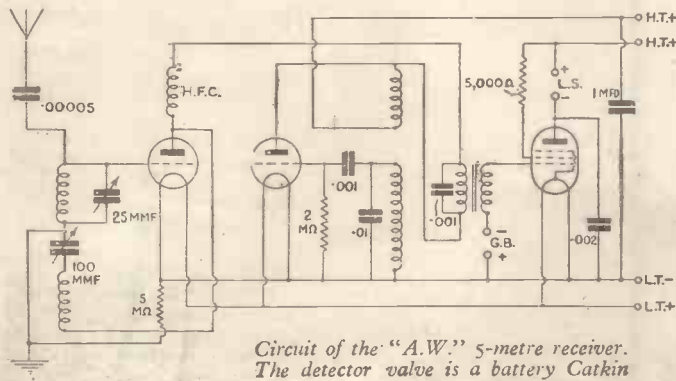

Circuit of the "A.W." 5-metre receiver. The detector valve is a battery Catkin

components, including the quencher coil, a special metal container for the whole receiver, and the midget condensers. Stratton's, who have spent the last few years with an experimental 5-metre transmitter and various types of 5-metre receivers, gave us a considerable amount of help and made a number of suggestions which we have embodied in this receiver, so that it now represents the most up-to-date three-valve super-regenerative 5-metre circuit it is possible to make.

Preparing for Television

It must not for a moment be thought that a 5-metre receiver is going to provide programmes and supersede the family or even the normal short-wave set. The whole idea of this set is for the amateur to be able to extend his knowledge of short-wave listening, so that when high-definition television does arrive he will have some knowledge of the

Osram battery Catkins of the 210HL type. This is very small in size, just what we wanted to make a compact receiver, and at the same time is very quiet in operation. The remaining two valves are standard battery types.

A separate quencher is used (a Marconi-Osram L21) followed by a Mullard PM22A output pentode.

Making the Tuning Coils

Although it is possible to buy the tuning coils, it is hardly worth while, for they can be constructed in a matter of moments. Both L1 and L2 consist of five turns of No. 14-gauge bare copper wire wound on a 1/2-inch former.

Before attempting to wind the coil, cut off about 1 ft. of wire and stretch this with a vice and a pair of pliers, so as to remove all



This photograph shows the completed 5-metre receiver, a simple three-valver

BLUEPRINT
No. A.W. 438

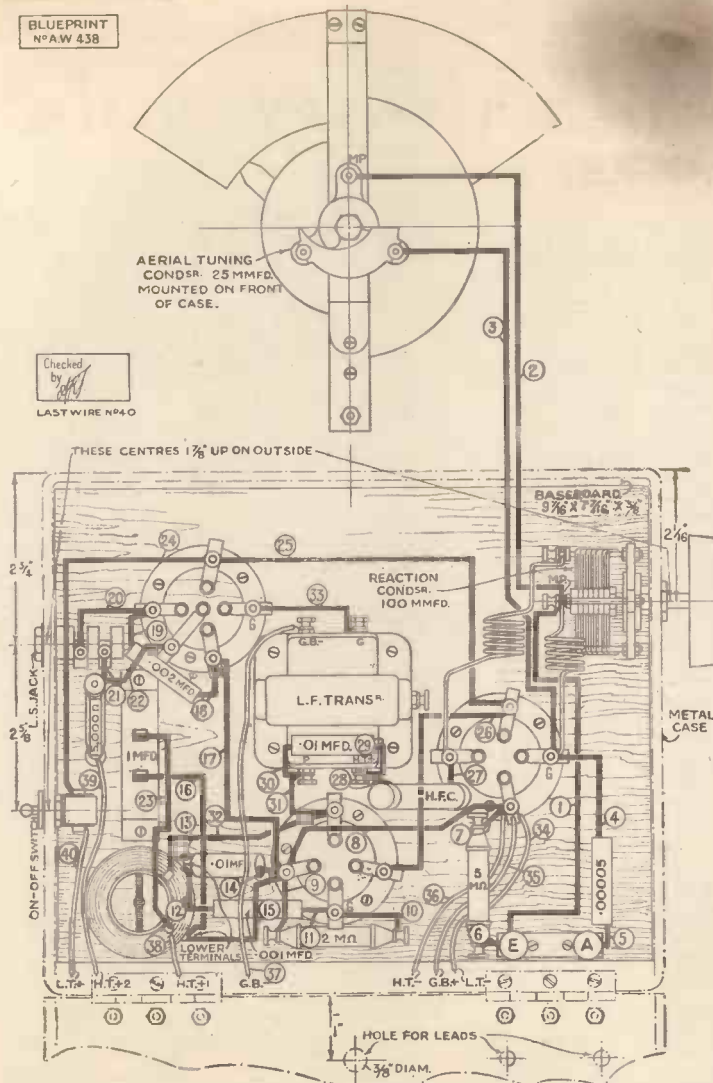

This layout and wiring guide is reproduced at one-third scale. A full-size blueprint (No. A.W. 438) can be obtained for 1s., post paid

of the kinks. Bend one end into an L shape and then wind on your five turns with a space of about 3/16 in. between turns, finishing off by making another L-piece, and that's that. When the coil is taken off the former it will spring to a little over 1/2 in. in diameter.

It is really not worth while trying to wind a quencher coil. It is a nasty job and it can be bought for 4s. 6d.

When you buy the screened box it is supplied complete with the hole cut for the escutcheon. Even so, the metal is quite soft, so that there will be no trouble in drilling through the left-hand side to take the .0001-microfarad reaction condenser or through the right-hand side to take the loud-speaker jack and the on-off switch.

Both of the tuning condensers are at earth potential so that hand-capacity and similar troubles are absolutely non-existent. The construction can be clearly followed from the illustrations.

One or two points must be borne in mind, otherwise everything is

quite straightforward. For example, the valve holders are of special Frequentite material, and you must not, in any circumstances, attempt to use the standard type of valve holder made up with ordinary material. The losses with such valve holders are colossal.

Similarly, with the ultra-short wave high-frequency choke. This could be made at home, but as it is not possible to buy the necessary Frequentite or Steatite former, and it is not worth while spoiling the results of the receiver to save the few pence that the proper choke costs.

Direct Connections to Avoid Capacity Effects

Note how, wherever possible, the components are connected directly without any intermediate wires so as to prevent straggly wiring and stray capacities. It is essential that the wiring be point to point; pretty, square wiring, although it can be recommended on medium-wave sets, is not successful below 20 metres.

It must be realised that long grid wires in the detector circuit can raise the minimum wavelength and upset the calibration out of all recognition.

We decided that it was not really necessary to go to the expense of putting a variable microdenser in series with the aerial for, unlike the usual short-wave listener, the 5-metre enthusiast does realise that the aerial must be something round about 2.5 to 5 metres in length.

If you intend to use a normal broadcast aerial about 50 ft. in length, then it would be advisable to use a smaller condenser in series with the aerial lead-in, but if you will only remember that the aerial need not be more than 9 or 10 ft. in length then the fixed condenser of .0005 microfarad that we have specified will do admirably.

Fitting the Set in its Metal Cabinet

The receiver can be completely wired with the exception of the reaction condenser, loud-speaker jack and on-off switch before it is placed in its box. The two wires on each of these components can be put on after the receiver has been fitted to a metal cabinet.

In addition to the extra holes that must be drilled to take these components, two 1/4-inch holes should be drilled at the back of the cabinet above the left-hand hinge so that the aerial and earth lead-in wires can be internally connected and the metal cabinet shut.

Continued on page 674



Listening to an amateur 5-metre transmission; this branch of short-wave work is of ever-increasing importance

COMPONENTS NEEDED FOR THE "A.W." 5-METRE RECEIVER

BASEBOARD

1 Peto Scott 9 3/8 in. by 7 3/8 in.

CHOKE, HIGH-FREQUENCY

1—Eddystone, type 947.

COILS

2—5-metre coils wound with No. 14-gauge copper wire to specification.

1—Eddystone quench-coil unit, type No. 958.

CONDENSERS, FIXED

5—T.M.C. Hydra, type tubular, values: .00005-, .001-, .002-, .01-microfarad (or Telsen, British-Radiophone).

1—T.M.C. Hydra, type 25, value: 1-microfarad (or Dubilier, T.C.C.).

CONDENSERS, VARIABLE

1—Eddystone 25-micromicrofarad, type 900.

1—Eddystone 100-micromicrofarad, type 900.

HOLDERS, VALVE

2—Eddystone, four-pin, type 949.

1—Eddystone five-pin, type 950.

PLUGS, TERMINALS, ETC.

5—Belling-Lee wander plugs, marked: H.T.+1, H.T.+2, H.T.—, G.B.—, G.B.+ (or Clix, Ealex).

2—Belling-Lee spade terminals, marked: L.T.—, L.T.+ (or Clix, Ealex).

1—Telsen terminal block.

RESISTANCES, FIXED

2—Graham Farish, type Grid Leak, values: 2-5-megohm (or Telsen Dubilier).

1—Graham Farish type Ohmite 1/4-watt, value: 5,000-ohm (or Telsen, Dubilier).

SUITABLE VALVES

Make	Detector	Quencher	Power
Cossor	210HL	210LF	220HPT
Dario	TB282	TB102	TC432
Hivac	H210	L210	Y220
Lissen	HL2	L2	PT225
Marconi	HL2K*	L21*	PT2
Mazda	HL2	L2	Pen220
Mullard	PM1HL	PM2DX	PM22A*
Osram	HL2K	L21	PT2
Triotron	HD2	SD2	P225
Tungsram	HR210	LD210	PP230
362	HL2	L2	ME2

*Valves used during "A.W." tests.

SUNDRIES

Connecting wire and sleeving.

1—Igranic Midget, single circuit type.

4 yards thin flex.

1—Eddystone, type 902 to fit 1/4 in. spindle.

SWITCH

1—Bulgin on-off toggle, type S80SB.

TRANSFORMER, LOW-FREQUENCY

1—Telsen, type Acc.

(Peto Scott's supply complete kit of above parts for £3 14s. 6d.)

ACCESSORIES

BATTERIES

1—Lissen 120-volt high-tension (or Drydex, Ever Ready).

1—Lissen 9-volt grid-bias (or Drydex, Ever Ready).

1—Lissen 2-volt accumulator (or Drydex, Ever Ready).

CABINET

1—Eddystone metal, complete with slow-motion drive, type 960B.

HEADPHONES

1—Pair Lissen, type LN173.

The Uses of The Cathode-ray Tube

By H. CORBISHLEY

THE cathode-ray tube has come into considerable prominence of late because it has been appreciated that it may provide the ultimate solution of high-definition television; in fact, in practically all television systems which have involved a greater scanning frequency than 180 lines, it has formed the basis of the scheme.

Amongst these may be mentioned the latest Baird system with 120-line scanning, the Cossor velocity-modulation system, the Ardenne and several others. Primarily, however, the cathode-ray tube was not developed for television purposes, and even at the present time it finds greater application in other directions.

The Action of the Tube

There are two very well-known makes of tube in this country, the Cossor and the Ediswan, and these differ chiefly in detail construction.

Briefly the action of the tube is as follows: Electrons which are emitted from a small coated filament are drawn through a gun (which actually is a circular metal plate with a small hole in it); the electron beam then passes between two pairs of deflecting plates and it behaves like a conductor carrying a current, so that it can be deflected either by a magnetic field or potentials applied to the plates.

After a fairly long travel the electron beam impinges on a specially prepared screen on the inner end of the tube, and its presence is revealed by causing this to fluoresce at the point where it strikes.

In addition to the cathode, gun and deflecting plates, there is a cylindrical shield which completely surrounds the cathode and which is negatively biased. The purpose of this shield is to compress the beam so that it can pass through the small hole in the gun.

The shield, therefore, plays an important part in the focusing of the electron beam so that the area of the spot on the screen can be made quite small, an important point when the tube is used for high-definition television.

As the beam has no weight and practically no inertia, its deflections can take place at extremely high speeds, and it provides an accurate record of the differing potentials applied to the deflecting plates.

Three Types of Application

The applications other than those for television purposes can be divided into three main groups which are as follows: those requiring a time base, those not requiring an independent base and those requiring some independent base other than time.

Applications which require a time base comprise the general study of wave form, and the method of using the tube is roughly that across one pair of plates is placed a time-base potential which has the effect of causing the spot to move forwards and backwards across the screen at a certain speed.

The voltage under investigation is applied to the other pair of plates, and the design that appears on the screen is the wave form under examination.

Other applications in this group are the study of periodic phenomena, such as the wave-form study of alternators, transformers, ripple on D.C. supplies, valve oscillators, and amplifiers. Also transient phenomena such as the making and breaking of circuits, study of electric sparks, atmospheric, physiological phenomena measurement of explosion pressures

and study of wave form of speech and music.

Of the applications not requiring an independent time base there are the observation of valve characteristics, comparison of the input and output of amplifiers and transformers, studies of phase relationship, frequency comparisons, synchronisation of alternators, study of modulation and detection and several others of a specialised nature.

Television comes under the applications requiring some independent base other than time. The scanning effect is produced by two time bases and then the travelling spot is modulated by the television signals. One difficulty that still remains to be overcome is that modulation of the intensity of the light spot cannot be effected without a certain loss of focus, and this naturally imposes some limitation on the scanning frequency, though as mentioned before, excellent results have been obtained up to 180 lines.

Deflecting the Beam Magnetically

In the foregoing applications the deflection of the beam is brought about by applying potentials to the deflecting plates, but as was mentioned earlier, the beam may also be deflected magnetically, a method which it is advantageous to use when current rather than voltage effects are to be observed. Used in this manner the deflection of the beam is at right angles to the magnetic field.

The foregoing uses of the tube are practically all of an electrical or electromagnetic character, but these by no means exhaust its possibilities, for it can also be used for the study of mechanical phenomena in all cases where it is possible to translate these into electrical effects.

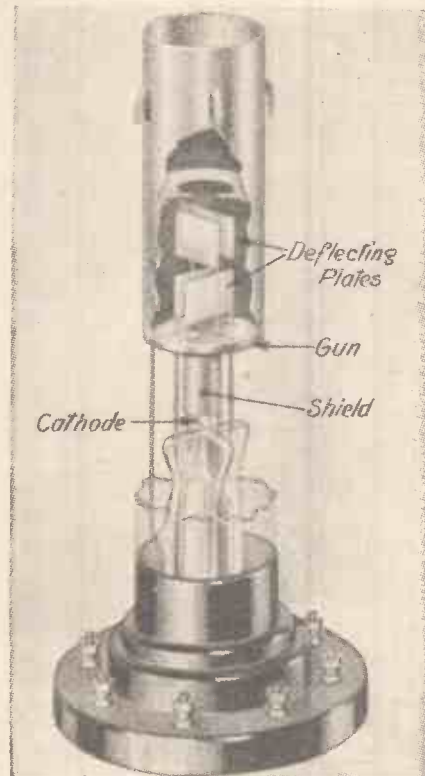

A cut-away picture of the base of the Cossor cathode-ray tube showing the arrangement of the electrodes and deflecting plates

Reception from Zeesen

REFERENCE was made a short time ago to the Zeesen 30-line transmissions, which are of one hour's duration on Tuesday mornings and one other day during the week. These are, of course, upon the long waves, and they differ from the B.B.C. transmissions in that the scanning is horizontal. This fact, however, does not preclude the possibility of receiving the pictures on the standard type of mechanical scanner provided certain modifications are made.

A recent attempt to secure these transmissions, using a Baird mirror drum, was quite successful after a little alteration had been made to the receiver. In the first place it was found necessary to turn the whole machine on its side so that it would conform with the horizontal system of scanning. It

course, several ways in which this could be obviated, and in this particular instance it was found convenient to add another low-frequency stage.

The pictures were now easily recognisable, but they were reversed; this was not of great consequence unless it was desired to read the notices that were displayed and correction was easily applied for this purpose by viewing the images in a mirror when the words "Pause" and "Ende" could be easily read.

Among the items in the programme were two close-ups of girls talking; a tent with dogs running out; a close-up of a white dog which barked; and a close-up of a couple, who later were seen dancing together.

Although a mirror drum was used for the reception on this particular occasion, there is no reason why results should not be obtained with a disc scanner, and this would be more easily adaptable for the special conditions.

The neon lamp would, of course, require to be placed at the top of the scanning disc and the lens moved to correspond; also it would not be a difficult matter to reverse the direction of rotation by changing the connection from the fields of the motor to the other commutator brush; in fact, these connections could be brought out to a change-over switch so that direction of rotation could be altered quite easily when desired.

As the programme lasts for an hour, it allows time to make any necessary adjustments.

**USING YOUR ORDINARY
SET FOR TELEVISION
"TELEVISION" for JULY
NOW ON SALE, 1/-**

was turned over with the left side undermost when viewed from the front.

Using the same receiver and amplifier as are ordinarily used for the B.B.C. transmissions, a negative picture resulted. There are, of

What CAR RADIO Re



L. N. A. photo

Radio on cars is a matter of business and not of pleasure in the Army. Here is a wireless car of the 10th Field Battalion near Blackdown Camp, Aldershot

MY first real experience of car radio dates back to 1925, when I started making a practice of taking my own portable sets round the country to test their performance. I have published on various occasions the results of such tests, but it should be remembered that it is quite impossible to operate ordinary receivers in these circumstances while the engine is running (unless the electrical system is suitably treated to prevent interference emanating from the high-tension side) and, furthermore, even "portables" are scarcely suitable for use in a constant state of vibration.

Then, in 1931, during my last visit to the United States, I gained first-hand experience of what may be termed "built-in" car radio, with sets specifically designed for permanent use in cars, and was considerably impressed thereby.

Car-radio Design Problems

It is not always realised how different built-in car radio must be from the type of set designed for use in the home. The aerial, which must be contained somewhere in the car, *must* be non-directional (thereby ruling out a frame aerial) and the set must be sufficiently sensitive to give at least a few programmes all the time.

In this connection it should be pointed out that some car-radio advertising is misleading, being based on the performance of sets after dark. We all know that distant reception is much better at night, but on the other hand car radio is likely to be used mostly during the daytime, and the daylight range of such a set is of perhaps greater importance than in the case of a home receiver.

The next point to consider is that owing to a variety of conditions—change of locality, screening, absorption from high buildings, trees, etc.—the field strength of the station one is receiving on a moving car radio set is varying all the time. To be safe and practical a car radio receiver must "stay put" once it is

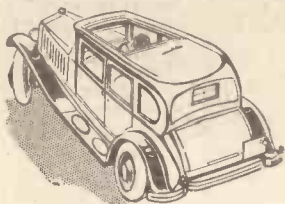

device known as a "suppressor" and then by shunting various parts of the equipment by fixed condensers of suitable capacity. This work, by the way, must be done by the installing engineer on the car itself.

Realising that car radio is going to play an important part in the motoring life of this country, I recently had a Philco Transitone set installed in my new car which, fortunately, has a built-in roof aerial as a part of its regular equipment. Quite a number of British cars now have such built-in aerials to facilitate the fitting of car-radio sets.



Four-valve super-het for car use developed by British

Car radio
"on" he
will ad
who al

switched on, and it should not be necessary for the operator to be continually fiddling with the volume control. Therefore, self-adjusting volume control is essential on such a receiver.

Thirdly, in practical conditions it is found essential to have the controls conveniently at hand and the set itself somewhere out of the way, which means in effect that one must have remote-controlled tuning.

One of the first troubles encountered by designers of built-in car radio was the suppression of the noises caused by the spark plugs, for here all the time we have a stream of sparks, each one of which is capable of setting up a good deal of etheric disturbance which can normally be heard in the loud-speaker.

These noises are eliminated firstly by inserting very close to the plug itself a special resistance

ally Gives the MOTORIST

radio, a comparatively recent innovation in this country, has not yet "caught on" to the same extent as in America. Some people have suggested that it adds to the dangers of motoring. This week, PERCY W. HARRIS, M. Inst. Rad. E., who always prefers facts to theory, gives you some interesting views on the subject

In my particular receiver, which is a five-valve super-het, the tuning control—consisting of a small escutcheon with illuminated dial, combined volume control and on-and-off switch, and separate tuning knob—is attached to the steering pillar.

The set itself goes underneath the facia board, there is a separate moving-coil loud-speaker alongside of it, and a dynamo, which is driven by a motor running off a car accumulator, to provide the necessary high tension, is tucked away beneath the chassis. The framework of the car is used as the "earth" and the aerial itself consists of a wire mesh in the roof.

Safety and Amusement

Over the Whitsun holidays I made an intensive study of the practical side of car radio with the view to finding out whether it could be considered safe in normal driving conditions; whether it is really practical and; what kind of an amusement value it has.

On the first point—safety—I am convinced that car radio does not in any way add to the risks of the road and may conceivably reduce them. During town and traffic driving one has not the slightest desire to use it, and if it should happen to be switched on for the benefit of anyone else in the car, either you take no notice of it, or else you have it switched off.

The position here is exactly the same as that of conversation with

definitely non-distracting and I find a tendency to drive slower through the country when the radio is going than without it, for the simple reason that often in flat, uninteresting country one speeds up a little to get over a period of boredom which the radio effectively removes.

I have listened to Sir Walford Davies while spinning along the North Circular Road without finding my attention in any way distracted from the traffic and I have been very thankful to have the news bulletins, which otherwise I should have missed through not being at home.

Of course, if anybody is fool enough to try hunting for foreign stations while driving up Guildford High Street on a Sunday evening, he or she must expect trouble, but then actions of this kind are comparable with trying to do up your bootlace while steering or

trying to light your companion's cigarette while you are driving.

A lot of cars are fitted with automatic cigarette lighters which get hot when you press a button and can be taken out and passed round, but I have not heard such devices condemned as adding to the dangers of the road. Car radio can be abused, but so can every other fitment of the car and after inquiry I find that in the United States, where car radio is now pretty general, it is not considered that it has added in any way to the risks of the road.

What happens in practice is that, having found out the tuning position for the nearer stations, you choose one of these and leave it there, adjusting the volume once for all to suit the car you are using. In view of the small space in a closed car one can easily hear well without big volume and I do not find that it in any way blunts one's perception of such sounds as motor horns and other traffic noises which it is essential that one should hear properly.

So far as daylight range is concerned, in Whitsun runs which covered practically all Surrey, Sussex and Kent, I could always get the London National and Regional, the Northern Regional and the Western Regional at really adequate strength in daylight, with Fécamp at the bottom of the scale quite loud most of the time and Poste

Parisien as a decent alternative whenever it was needed and it happened to be working.

This fact, to my thinking, will sell a lot of car-radio sets! After dark I have picked up some twenty-six or thirty stations fairly satisfactorily, but many of these fade in and out too much to be of useful programme value in spite of self-adjusting volume control which, of course, cannot bring in a signal which is not there!

And let me tell you of a final advantage which I have not seen mentioned in print anywhere. I am one of those strange people who like to listen to a programme without interruption, which is rarely possible in the home. The average woman is incapable of listening to a news bulletin all the way through without butting in with some kind of irrelevant conversation and fortunately she does not seem to want to do this in a car.

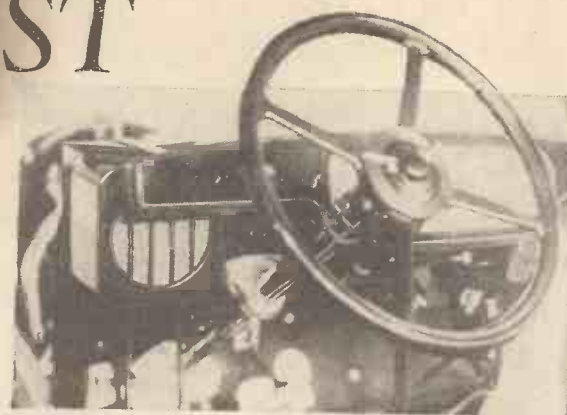

Photopress photo
A German example of car-radio production



"A.W." photo
Here is a suppressor fitted to a spark plug

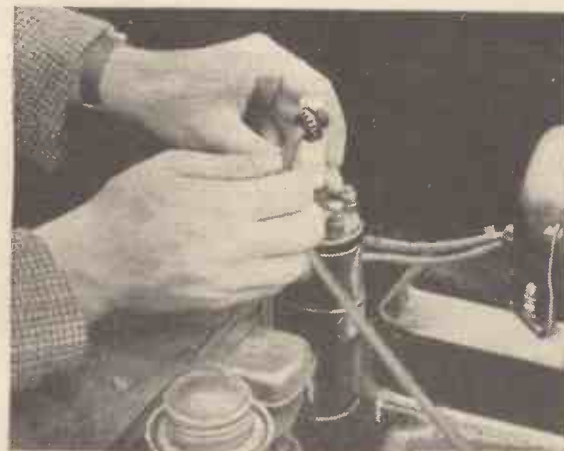

"A.W." photo
Fitting a suppressor to the ignition coil



"A.W." photo
Even if you use a portable set you want suppressors fitted to your spark plugs!

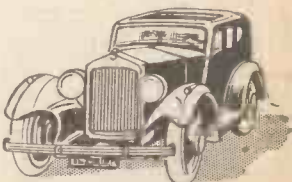
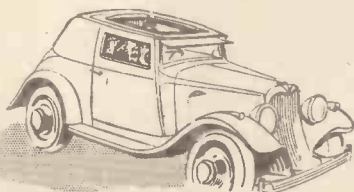

The latest Philco car-radio dial closely resembles a speedometer or "rev." counter. It can be mounted on the steering column or on the facia board



Philco photo

passengers. If, during a tricky piece of traffic driving, your companion tries to start a conversation, you either ignore it or else get him or her to be quiet.

On the open road no one dreams of checking interesting conversation and similarly car radio affords a pleasant interlude, but with this important "safety" difference—you do not have to take part! Musical items which go to make up the bulk of the programmes are



Photopress photo
Radiophone, Ltd.

New Car Outfit

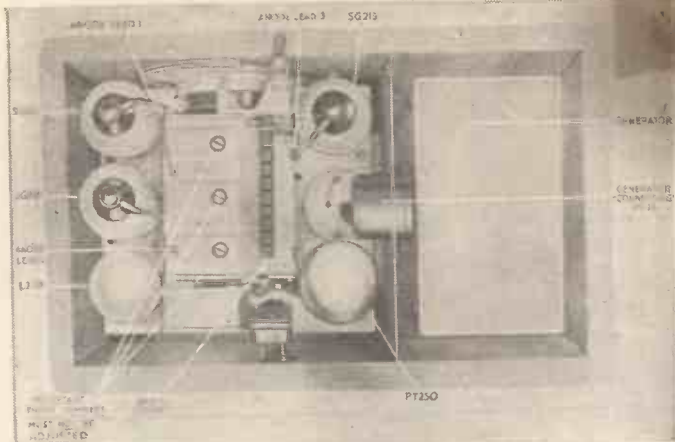

How the neat Lissen car-radio chassis is laid out. Note generator on the right and the neat valve arrangement on the left

BECAUSE a straight circuit, as distinct from a super-het, has been employed in the new Lissen car radio, there is a very minimum of background noises.

In the apparatus shown by our illustrations six valves of the 2-volt battery type are used, with three of them as straight high-frequency amplifiers.

Formidable Combination

Following these is a valve for diode detection and low-frequency amplification, then a driver, and finally a class-B output. Altogether a formidable combination—always assuming a good power supply is on tap.

Which, in the Lissen arrangement, it most certainly is. Low-tension current to heat the valve filaments is taken from the 6- or 12-volt

car battery, of course. High tension can be taken, according to the model, from either a battery or a rotary converter.

The output is fed into a moving-coil loud-speaker, energised again by the car battery.

As usual, the control unit for tuning and so on is fitted to the steering column of the car, while the receiver chassis and loud-speaker are separately disposed in suitable positions. The remote controls work special relays—a good point.

Prices, in our opinion, are distinctly moderate. For the battery model the price of the complete equipment is only 16 guineas, while for the generator model the price is naturally higher—20 guineas.

As was explained during the luncheon given



Neat and compact, isn't it? A good view of the Lissen car-radio six-valver, showing the extension cable at the front

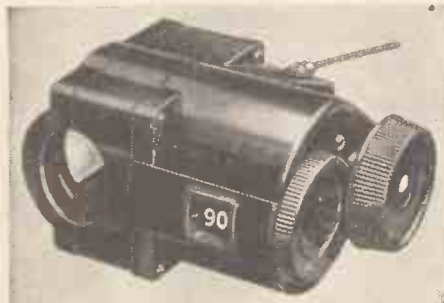

Remote control unit, which works special relays connected to the set's controls

recently at the Savoy Hotel, these receivers are entirely British made and will tune both medium and long-wave European broadcasting stations.

Service stations are being instructed in the method of installation of the Lissen radios on all well-known makes of car.

Our Tests of New Apparatus

Conducted by
J. H. REYNER, B.Sc., A.M.I.E.E.

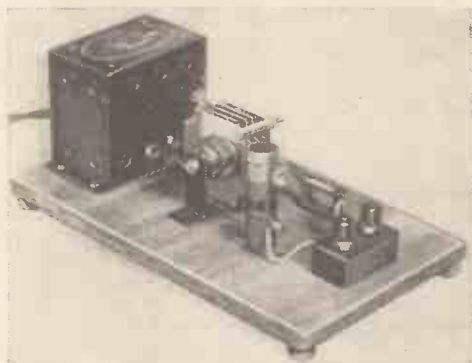

Mains Power Radio trickle charger, as made up from the kit of parts

M.P.R. TRICKLE CHARGER

A NEW interest for the home constructor has been provided by Mains Power Radio, who are offering a trickle charger in the form of a kit of parts.

One of these kits has been submitted for test, and we can safely say at the outset that those who may be a little timid of home constructing apparatus for harnessing to the house-lighting mains need have no fear.

The assembly of the kit can be accomplished in less than an hour with the aid of a screwdriver and pair of pliers.

Provision has been made to guard against shocks, whilst all the components—five in number

—are high grade. The charger is designed for use on A.C. main, but the transformer is not of the universal type, it being necessary to state when ordering whether the kit is required for use with 100/120- or 200/250-volt mains.

The sample supplied was rated to give a charging current of .5 ampere, and comprised a straightforward Westinghouse

metal rectifier connected to a mains transformer.

A fuse designed to blow at 1 ampere is incorporated in the negative output lead whilst a ballast resistor in the positive lead ensures stabilisation of the charging current and at the same time offers protection in the event of the battery being incorrectly connected.

A similar unit is available for charging at 1 ampere.

Test Report.—Tested on 240-volt mains the charger gave 2.8 volts at .5 ampere, which is more than sufficient to maintain the charge, even when the battery is fully up.

Makers: Mains Power Radio Ltd. **Price:** 22s. 6d. for .5-ampere rate; 26s. for 1-ampere rate.

BENJAMIN TRANSFEED

A NEW edition of this well-known low-frequency coupling unit has been submitted for test. As readers will remember, this is a complete parallel-feed transformer, and the makers claim that it is an improvement on their earlier version.

A new method of winding the transformer has resulted in an increased ratio of 1:3.5. In addition to this, a high-voltage condenser has been incorporated, making it suitable for mains sets.

The unit consists of a tapped resistor, giving alternative values of 30,000 or 50,000 ohms, a 25-microfarad condenser and alloy-cored transformer.

The resistance, which is wire wound on a rectangular bobbin, is mounted alongside the condenser, with the transformer above.

The whole is enclosed in a cylindrical metal case fitted with a bakelite moulded base carrying special one-piece terminals,

and is for baseboard mounting **Test Report.**—The unit was tested with the 30,000-ohm resistance following a 15,000-ohm valve. The effective step-up will be seen from the curve to be between 2.5 and 3 over most of the

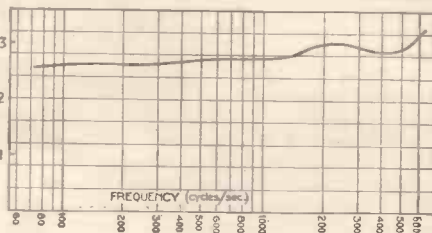

(Above) Benjamin Transfeed. (Left) Frequency response curve

audible range. The rise in the treble will be useful in modern sets.

Makers: Benjamin Electric, Ltd. **Price:** 17s. 6d.

The Real-quality Controversy

MR. MOIR'S LAST WORD

To the Editor, AMATEUR WIRELESS.

I WOULD like to congratulate Mr. Bonavia-Hunt on his manner of evading the answers to my criticism, and would suggest that this be added to the list of "tripe."

Without going over all the old ground again, it is impossible to deal with each point he mentions. It is to be regretted that while all the leading technicians take frequency characteristics as I would do, that is, one frequency at a time, Mr. Bonavia-Hunt wants all frequencies taken at once, a ridiculous proceeding and an entirely unnecessary thing, as the performance can be represented by the usual characteristic.

Now, I have taken a characteristic on the "real quality" amplifier, and it definitely does not do what he claims for it. If Mr. Bonavia-Hunt will let me into the secret of taking a characteristic with all frequencies simultaneously, I will oblige and let the Editor have the result.

It should be noted that no letter from a technical reader in support of Mr. Bonavia-Hunt has yet been printed.

Thanking you for giving me the opportunity of demonstrating that while Mr. Bonavia-Hunt may be a tone expert or musician, he certainly knows nothing about electrical engineering.

JAMES MOIR, Grad.I.E.E.

Rugby.

Following are extracts from a subsequent letter received from Mr. Moir:—

In my reply to Mr. Bonavia-Hunt's statements about response curves, I believe that I did not make it perfectly clear that in an amplifier operated so that the output is a linear function of the input—that is, not overloaded—the response curve taken in single frequency steps accurately represents the response obtained when a complex wave (or Mr. Bonavia-Hunt's massed frequencies) is applied.

The presence of any one frequency does not affect in any way the response at any other frequency. Mr. Bonavia-Hunt's statements are therefore absolutely without foundation and arise because he has no knowledge of the principles of the subject. A little elementary mathematics will convince Mr. Bonavia-Hunt of the accuracy of these statements.

[2019

ACTUAL EXPERIENCE

I WOULD like to give my experience from an actual test and subsequent continuous use of an A.C. filament transformer for the output transformer for a moving-coil loud-speaker as recommended to me by Noel Bonavia-Hunt.

I have obtained by the use of an A.C. filament transformer, in place of the ordinary output transformer, highly satisfactory results, which, in conjunction with the use of Mr. Bonavia-Hunt's "Stereophonic" coupler for the output stage, I obtain the highest possible quality reproduction and as near realism I believe it is possible to get.

I have carried out exhaustive experimental wireless work for obtaining highest quality reproduction for a long time past, and can inform your readers from personal knowledge and contact with Mr. Bonavia-Hunt (whom I have had the privilege of knowing for many years) that any advice given by him re radio and gramophone reproduction is absolutely reliable, and what he does not know relating to highest-quality reproduction is not worth knowing.

Mr. Bonavia-Hunt's articles which appeared previously in *Wireless Magazine* are a very

valuable contribution to radio science, and any of your readers who are desirous of obtaining the highest possible quality reproduction who have not seen these articles will be well advised to obtain the back numbers containing all his articles.

If they make up an amplifier, as I have done, embodying his couplers, they will consider that they have reached finality as far as highest quality low-frequency amplification is concerned. By means of these couplers I am able to reproduce the whole range of frequencies in proper proportion from below 50 to 11,000 cycles.

Those well able to judge and who have heard the reproduction from my amplifier say that they have never heard anything to equal it, and I believe that I can safely say, without exaggeration, there is not its equal in South London.

H. WIGHTMAN HARRIS.

London, S.E.4.

[2020

YEARS OF HARD WORK

HAVING been greatly interested in the controversy or, I suppose, "attack" on quality in wireless reception, may I be permitted to butt in?

If Mr. Moir expects us to believe that the talkies demonstrate quality, he is certainly insulting our intelligence.

I have for over four years had a quality receiver of my own ideas and construction. Mr. Bonavia-Hunt has given the public, through your journal, the basis of quality—what it has taken me, as well as I suppose numerous constructors, years of patience and perseverance, not to mention expense, to get.

EDWARD HARRINGTON.

Wrestlingworth.

[2021

REAL-QUALITY SERIES

I AM interested in quality reception, but fail to appreciate the function of Noel Bonavia-Hunt's article of June 2. The novice needs blueprints and fuller details—the advanced amateur (like myself) needs only the circuit with certain values.

Also the cost of the set is quite absurd—I work it out at over £11 for valves and components only. The complication of change-over from anode-bend to Westector costs over £3 alone and has no useful purpose.

My point is that a three-valve set, equally good for quality and volume, could be built for £3 10s. Indeed, I have such a set, using diode detection (an L2DD) with a low-frequency arrangement something on the same lines as Mr. Bonavia-Hunt's.

I could mention many other points which would cheapen and simplify, and I firmly believe with gain in quality.

I think it would be helpful to your readers for Mr. Bonavia-Hunt to re-design the circuit—having one form of detection, and there's no question as to which, most (90 per cent.) having poor aeriels. This and other improvements would cut cost almost in half.

There's no point in your experts designing sets to amuse each other regardless of cost or designing the usual poor quality receiver mainly suitable for boys. That period is past.

Really good all-mains and battery receivers by first-class makers can now be purchased at moderate cost. The only lines on which you can compete is by designing quality receivers costing no more (if not less) than the average commercial receiver.

Make your experts design what is needed to meet the definite requirements of 70 per cent. of the wireless public. If my job was just amusing myself regardless of cost—I wouldn't last a week.

My position puts me in touch with a great number of wireless users—the one complaint is the rotten quality. The really musical folk I know simply refuse to bother, until something really good develops. *

AUSTIN OSMAN SPARE.

London, S.E.1.

[2022

* I could make a really good income by making quality receivers at a reasonable price—battery operated.

FREQUENCY RESPONSE

WHILE not wishing to approve of the wording of James Moir's attack on the articles of Mr. Bonavia-Hunt, we feel that certain of your correspondents who attack Mr. Moir are not in possession of some facts which we are in a position to supply.

Those who seem to suppose that talking-film reproduction must necessarily be vile are evidently unaware that amplifiers are now being manufactured with a measured straight-line frequency response from 10,000 cycles down to well below 50. What happens to the reproduction when these amplifiers are installed in theatres is now being investigated by the firm employing Mr. Moir, who is testing theatres throughout the country.

The apparatus used in these tests would satisfy the most critical purist with regard to its accuracy and completeness.

In passing we would say to your correspondent, Mr. F. Ramsay-Weston, who questions the advisability of building a receiver capable of reproducing frequencies up to 8,000 cycles, that so far as gramophone reproduction is concerned there is, of course, no advantage, since the higher frequency capabilities cannot be utilised, but on radio, if he is fortunate enough to live outside a swamp area and would adapt his receiver for purely local reception, not straining for too high a high-frequency gain, he would appreciate very considerable improvement in quality, with frequencies, at any rate up to 7,500 cycles, without suffering from mush or background.

Finally, in our radio club, we have carried out experiments with various systems of tone correction, and conclude that the resonances produced outweigh any advantage gained by their use, and unless one must use the cheapest of components, one is well advised to aim at correct matching at every stage and leave all compensating devices severely alone.

"TWO ACQUAINTANCES OF MR. MOIR."

Rugby.

[2023

[P.S.—Mr. Moir is not by nature vitriolic; he has the happiest of dispositions and is very well liked by all who know him.]

GREAT TONAL EXPERT

I SHOULD like to join in with the many other readers of AMATEUR WIRELESS who have written to thank Mr. Bonavia-Hunt for his excellent articles on high-quality reproduction.

I know nothing of Mr. Bonavia-Hunt's qualifications as a radio engineer, but I do know a great deal about his abilities as a tonal expert. Anyone who has had the pleasure of hearing some of the organs designed and voiced by him know only too well what a master he is at the art of tonal production.

I am perfectly satisfied that if he considers any radio set to be giving "real quality," then indeed it must be good. To doubt Mr. Bonavia-Hunt's abilities as an acoustician and tonal expert is to show the grossest ignorance, for his text books on these subjects are recognised as standard works.

A. V. GRAVES.

London, W.5.

[2024

[This correspondence is now closed.—Ed.]

A Duplex Receiver for Wireless Control

By Major RAYMOND PHILLIPS, O.M.E.

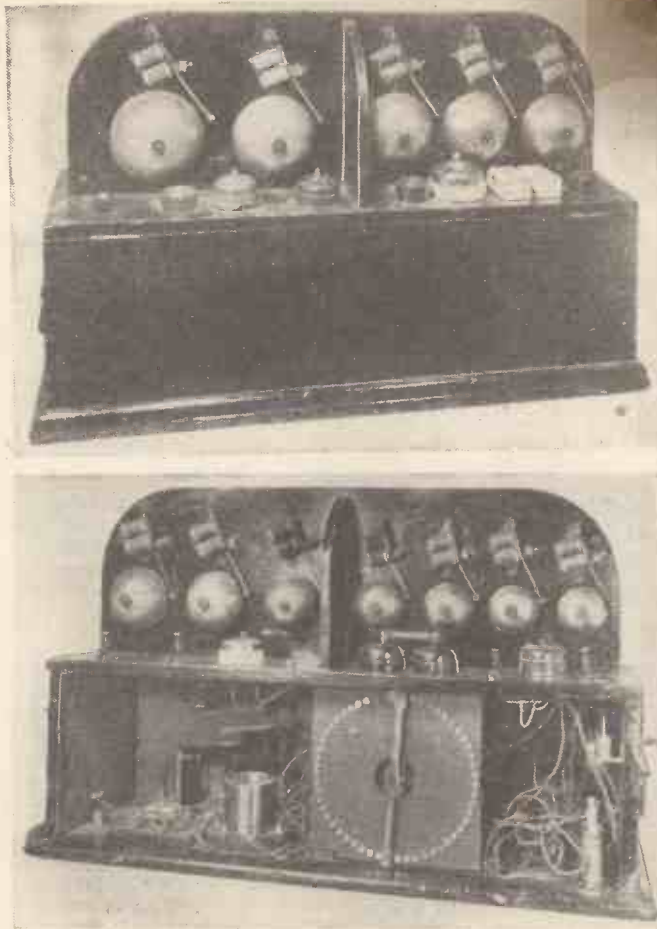

Fig. 1.—Two views of Major Raymond Phillip's duplex receiver for wireless control

THE duplex receiver described in this article is an instrument which the author specially designed and constructed for use with the wireless transmitter controlled by a "human battery." Details of the latter were given on pages 640-641 of AMATEUR WIRELESS dated June 23.

The complete duplex receiver is shown by Fig. 1. It is fitted with twelve electric bells, also various switches, and plugs, the use of which will be fully described. The instrument is so arranged that the bell or other circuits can be controlled independently of each other either "in sequence," or "collectively"; the control depending upon intermittent or continuous oscillations radiated from the transmitter referred to.

It will be apparent that the whole apparatus has been devised with a view to making one instrument available for several experiments.

A key diagram of circuits is shown by Fig. 2. It will be noted that the author's well-known vertical coherer (marked A) is used as a detector for the pilot circuit.

There would really be no advantage to have a valve for such a purpose, as a reliable coherer is very suitable for public demonstrations in a room or hall where transmission range is very limited, and in addition it effects a considerable saving in initial cost and maintenance of apparatus.

The usual de-coherer or tapper (marked B) simply comprises an electric-bell movement such as would be supplied for a 3-in. gong or bell. A relay (marked C)

is arranged to control all circuits shown in the key diagram (Fig. 2) other than the pilot or detector circuit.

As the duplex receiver is designed to be affected by intermittent or continuous oscillations an additional relay marked D (Fig. 2) is provided. The armature of this relay is connected to miniature bellows (forming a "pneumatic dashpot"). The latter are arranged to retard the upward movement of the relay armature, so that if the wireless receiver is affected by continuous oscillations the armature of relay marked C will vibrate rapidly, and will intermittently close a circuit connected with the electromagnet of relay marked D.

The upward movement of the armature of this relay being retarded as previously explained causes the long rubbing contacts marked M to be kept closed, but the rubbing contacts marked N being shorter, intermittently close a circuit connected with the de-coherer marked B.

With intermittent oscillations the same sequence of events is involved except that the armature of relay marked C is more stable. It will thus be apparent that in this instance a circuit connected with the winding of an electromagnet (controlling a selector, or distant-control switch) could be controlled by either of the relays marked C and D, but in order to simplify matters the relay marked D

is arranged to control all circuits shown in the key diagram (Fig. 2) other than the pilot or detector circuit.

Twenty-seven Contacts

The selector marked F (Fig. 2) is for convenience shown with only three contacts, but there are twenty-seven in all. The wiring of the contacts is so arranged that the electric bells are controlled "in sequence" from the first bell. This involves twelve contacts.

The next contact controls a number of the bells together producing what is known in musical circles as "striking a chord." The next thirteen contacts are wired in such a manner that as the selector contact arm slowly revolves a few bars of a well known tune can be played on the bells. The final contact controls a "chord" again.

The contact arm of the selector is caused to revolve slowly by means of reducing gear. The latter is connected to the armature spindle of a small shunt-wound electric motor. The speed of the motor armature is regulated by means of a variable resistance as shown in Fig. 2.

Controlling the Motor

When it is desired to control the electric motor switches marked Nos. 2, 3, 4 and 5 are closed, but switches marked Nos. 6, 7, and 8 are left open.

The lower circuit shown in Fig. 2 can be connected either to a "main" source of electrical energy or a battery as desired. It is controlled by a supplementary relay marked G. This circuit is protected by two fuse boxes marked I and J.

The plug and socket marked K is for connecting to either a battery or a main source of electrical energy. The plug and socket marked H is for connecting to apparatus or mechanism to be controlled either by electric motors or electromagnets.

The author's well-known wireless-controlled model railway is mains operated, so that the plug and socket marked H is connected in series with a lamp resistance and the conductor and outer rails of the model railway.

The author constructed the supplementary relay G by converting a 3-in. electric-bell movement. This was effected by removing the hammer, and attaching to the bell armature a short length of No. 12-gauge brass wire suitably bent to shape, and arranged to dip in a brass cup containing mercury each time the bell movement functions.

The usual wire connection from the electro-magnet windings to the contact screw of the electric bell movement is removed, and connected in series with the control circuit as shown in the diagram.

When the lower circuit shown by Fig. 2 is in use switches marked Nos. 1, 2, 3, 6, 7, 8 are closed, and switches Nos. 4 and 5 are left open. The complete receiver can now be controlled by continuous oscillations radiated from the transmitter when the latter is controlled by a "human battery" as described in the previous article, but on account of the switches marked Nos. 4 and 5 being left open the electric bells and motor

Continued on page 670

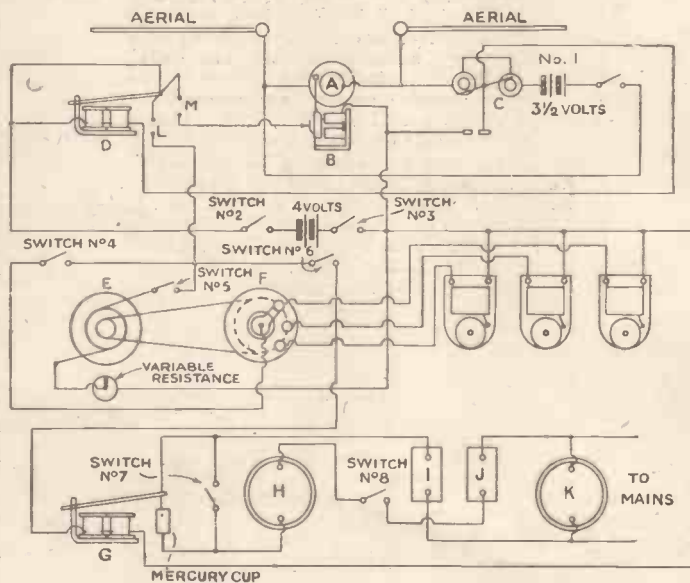

Fig. 2.—Key diagram of circuits of duplex receiver

TELSEN

provide the

BEST *Transformer* FOR EVERY PURPOSE

TELSEN 'CLASS B' DRIVER TRANSFORMERS
 Made in two ratios to cover the requirements of all 'Class B' valves.
 RATIO (overall) 1-1 (primary to half-secondary) 2-1.
 RATIO (overall) 1.5-1; 10/6 (primary to half-secondary) 3-1

TELSEN 'CLASS B' OUTPUT TRANSFORMER
 Provides correct matching to M.C. speakers having low resistance speech coils. Very large core section, and low primary resistance (200 ohms per half winding).
 RATIOS 35-1, 50-1 and 65-1. 10/6

TELSEN 'RADIOGRAND' TRANSFORMERS
 Evolved from the results of extensive research, coupled with the soundest engineering principles, every 'Radio-grand' transformer is subjected to rigorous tests to ensure faultless performance and lasting efficiency.
 RATIO 3-1 } 7/6
 " 5-1 }
 " 7-1 10/6
 " 1.75-1 10/6

TELSEN 'ACE' L.F. TRANSFORMERS
 Eminently suitable for use where highest efficiency at low cost is required and where space is limited. Its characteristic will bear comparison with that of much more expensive transformers.
 RATIO 3-1 } 5/6
 " 5-1 }

TELSEN 'MULTI-RATIO' OUTPUT TRANSFORMER
 For use with M.C. speakers having a low impedance speech coil winding. Its three ratios of 9-1, 15-1 and 22.5-1 allow for correct matching of speakers of widely different characteristics. Suitable for anode currents up to 40 m.a. 10/6

TELSEN (RATIO 1-1) OUTPUT TRANSFORMER
 Enables a high-resistance speaker to be connected to the output circuit of a receiver using a triode output valve without passing D.C. through the speaker windings.
 Suitable for anode currents up to 40 m.a. D.C. 10/6

TELSEN 'D.R.' TRANSFORMERS
 The Parallel-fed Transformers with an absolute straight line characteristic, giving uniform amplification over the entire range of audio frequencies. Designed and constructed on entirely new principles eliminating all possibility of breakdowns and shorted turns. Very high inductance.
 D.R.3 (Ratio 3-1) D.R.5 (Ratio 5-1) 8/6

TELSEN 'G.S.' TRANSFORMERS
 The Directly-fed Transformers based on the same advanced principles. Exceptionally good frequency characteristic. Can be connected directly into the anode circuit of detector valves.
 G.S.3 (Ratio 3-1) G.S.5 (Ratio 5-1) 8/6

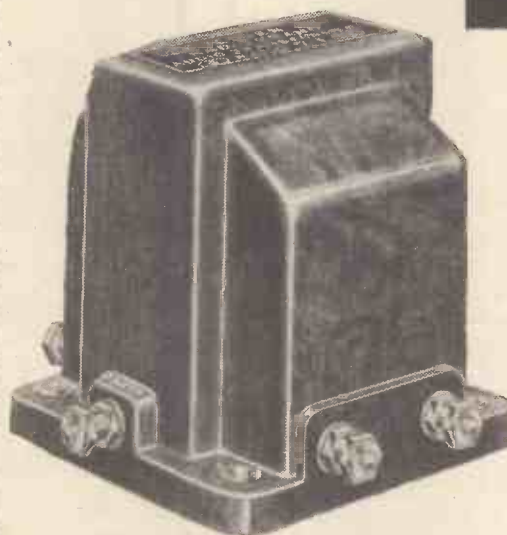
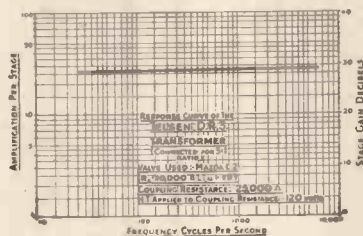

TELSEN AUDIOFORMER

Solves the problem of tone compensation created by to-day's demand for super-selectivity. Its fixed compensation restores all the high notes which have been lost through the cutting of the sidebands, without losing amplification, reducing bass response or necessitating an extra L.F. stage or additional components. Ratio 5-1. 11/6

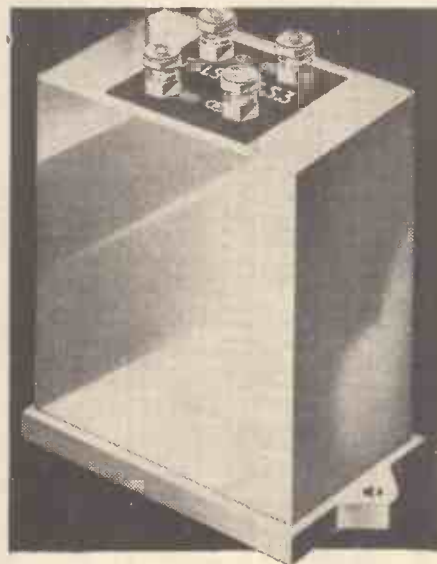

TELSEN 10-1 INTERVALVE COUPLING UNIT

A filter-fed transformer using a high permeability nickel alloy core, securing a 10-1 voltage step-up while preserving an exceptionally good frequency characteristic. The response is compensated in the higher frequencies for use with a pentode valve giving an amplification greater than anything previously achieved, equal to two ordinary L.F. stages but with better quality of reproduction. 12/6

TELSEN 1-1 INTERVALVE COUPLING UNIT

A modern development of the deservedly popular R.C. unit incorporating a low pass filter feed in its anode circuit, thus preventing "motor-boating", "threshold howl" and other instability due to common couplings in eliminator and battery circuits. Used with an H.L. type valve it gives an amplification of about 20 and a perfect frequency response on a negligible consumption of H.T. 7/6

TELSEN R.C. COUPLING UNIT

In handsome bakelite case, 4/- similar to above.

TELSEN FOR EVERYTHING IN RADIO
 Announcement of THE TELSEN ELECTRIC COMPANY LIMITED, ASTON, BIRMINGHAM

Please Mention "A.W." When Replying to Advertisements

Medium-wave Broadcasters

This week we give details of all the important European medium-wave stations. Next week we shall publish a list of short- and long-wave transmitters.

Metres	Kilo-cycles	Station and Call Sign	Country	Power (Kw.)	Metres	Kilo-cycles	Station and Call Sign	Country	Power (Kw.)
203.5	1,474	Flymouth	Great Britain	.3	312	962	Grenoble PTT	France	.3
203.5	1,474	Bournemouth	Great Britain	1	312.8	959	Poste Parisien, Paris	France	60
204.8	1,465	Pecs	Hungary	1.25	315.3	950	Breslau	Germany	60
206	1,456	Fecamp	France	20	318.8	941	Goteborg	Sweden	10
208.6	1,438	Miskolez	Hungary	1.25	321.9	932	Brussels (2)	Belgium	15
209.6	1,431	Beziers	France	1.5	322.2	931	Algiers	North Africa	13
209.9	1,429	Newcastle	Great Britain	1	325.4	922	Brno	Czechoslovakia	35
209.1	1,435	Radio LL Paris	France	1	327.7	915.6	Radio Toulouse	France	60
211.3	1,420	Tampere	Finland	1.2	331.9	904	Hamburg	Germany	100
214	1,402	Sofia	Bulgaria	5	335.2	895	Limoges PTT	France	.7
215.1	1,394.9	Radio Lyon	France	7	335.2	895	Helsinki	Finland	10
216.8	1,384	Warsaw (2)	Poland	2	338.6	886	Graz	Austria	7
218.2	1,375	Basle, Berns	Switzerland	.5	342.1	877	London Regional	Great Britain	50
221.1	1,357	Turin (2)	Italy	2	345.6	868	Poznan	Poland	17
222	1,354	Dublin (2)	Irish Free State	1.2	347.2	864	Sofia	Bulgaria	.3
222.2	1,354	Milan Vigentino (2)	Italy	4	349.2	859	Strasbourg	France	15
222.6	1,348	Koenigsberg	Germany	.5	350	857	Bergen	Norway	1
222.6	1,348	Bordeaux S.O.	France	3	352.9	850	Valencia	Spain	3
222.6	1,348	Paris (Vitus)	France	1	356.7	841	Berlin	Germany	100
222.6	1,348	Montpellier	France	.8	360.6	832	Moscow (4)	U.S.S.R.	100
224	1,339	Lodz	Poland	1.7	364.5	823	Bucharest	Roumania	12
224.1	1,338.9	Hanover and other	Germany	1.5	368.6	814	Milan	Italy	50
225.6	1,330	Hamburg relays	Germany	1.5	373.1	804	Scottish Regional	Great Britain	50
227.6	1,318.5	Magyarovad	Hungary	1.25	378.8	792	Lwlow	Poland	21.5
230.2	1,303	Danzig	Germany	.5	379.8	789.8	Barcelona (EAJ)	Spain	8
231.8	1,294	Linz and other	Austria	.5	382.2	785	Leipzig	Germany	120
		Vienna relays	Austria	.5	386.6	776	Toulouse PTT	France	.7
233.5	1,285	Aberdeen	Great Britain	1	386.9	775.2	Fredriksstad	Norway	.7
234.3	1,280	Dresden	Germany	1.5	391.1	767	Midland Regional	Great Britain	25
235.1	1,276	Stavanger and other	Norway	5	395.8	758	Katowice	Poland	16
		Oslo relays	Norway	5	400.5	749	Marseilles PTT	France	2.5
236.8	1,267	Nurnberg	Germany	2	405.4	740	Munich	Germany	100
238.5	1,258	San Sebastian (EJ8)	Spain	.6	410.4	731	Seville	Spain	1.5
238.5	1,258	Rome (III)	Italy	1	410.4	731	Tallinn	Estonia	11
240.2	1,249	Juan-les-Pins	France	2	412	728	Madrid (Espana)	Spain	1
241.9	1,240	Cork	Irish Free State	1	415.5	722	Kiev	U.S.S.R.	36
243.7	1,231	Gleiwitz	Germany	5	420.8	713	Rome	Italy	50
245.5	1,222	Trieste	Italy	10	426.1	704	Stockholm	Sweden	50
247.3	1,213	Lille PTT	France	1.4	431.7	695	Paris PTT	France	.7
249.2	1,204	Prague Stranice (2)	Czechoslovakia	3	437.3	686	Belgrade	Yugoslavia	2.8
251	1,195	Frankfurt - am - Main and relays	Germany	17	443.1	677	Sottens	Switzerland	25
253.2	1,185	Kharkov (2)	U.S.S.R.	35	449.1	668	North Regional	Great Britain	55
255.1	1,176	Copenhagen	Denmark	10	455.9	658	Langenberg	Germany	60
257.1	1,167	Monte Ceneri	Switzerland	15	463	648	Lyons PTT	France	15
259.1	1,158	Moravska-Ostrava	Czechoslovakia	11	470.2	638	Prague (1)	Czechoslovakia	120
261.1	1,149	London National	Great Britain	50	476.9	629	Trondheim	Norway	1.2
261.1	1,149	Turin National	Great Britain	50	476.9	629	Lisbon (tests)	Portugal	20
263.2	1,140	West (1)	Italy	7	483.9	620	Brussels (1)	Belgium	15
267.4	1,122	Belfast	N. Ireland	1	483.9	620	Cairo (tests)	Egypt	20
267.4	1,122	Nyireghyza	Hungary	6.25	491.8	610	Florence	Italy	20
267.7	1,120.9	Horby	Sweden	10	499.2	601	Sundsvall	Sweden	10
269.5	1,113	Kosice	Czechoslovakia	2.5	499.2	601	Rabat	Morocco	6
271.7	1,104	Naples	Italy	1.5	506.8	592	Vienna	Austria	100
274	1,095	Madrid EAJ7	Spain	3	514.6	583.2	Riga	Latvia	15
276.2	1,086	Falun	Sweden	.5	514.3	574	Agen	France	5
277.2	1,082	Zagreb	Yugoslavia	.75	522.9	574	Muhlacker	Germany	100
278	1,079	Bordeaux PTT	France	13	531	565	Athlone	Irish Free State	60
280.9	1,068	Tiraspol	U.S.S.R.	10	539.6	556	Beromunster	Switzerland	60
283.3	1,059	Bari	Italy	20	549.5	546	Budapest	Hungary	120
285.7	1,050	Scottish National	Great Britain	50	559.7	536	Wilno	Poland	16
288.6	1,040	Leningrad (2)	U.S.S.R.	100	569.3	527	Viipuri	Finland	13
288.6	1,040	Rennes PTT	France	1.3	578	519	Ljubljana	Yugoslavia	7
290	1,034.5	Paredo (Lisbon)	Portugal	5	578	519	Innsbruck	Austria	5
291	1,031	Heilsberg	Germany	60	596	431	Oulu	Finland	1.2
293.5	1,022	Barcelona (EAJ15)	Spain	2	724.6	414	Ostersund	Sweden	.6
296.2	1,013	North National	Great Britain	50	748	401	Geneva	Switzerland	1.5
298.8	1,004	Bratislava	Czechoslovakia	14	748	401	Moscow	U.S.S.R.	20
301.5	995	Hilversum	Holland	20	775.2	387	Boden	Sweden	.6
304.3	986	Genoa	Italy	10	824	364	Smolensk	U.S.S.R.	10
304.3	986	Cracow	Poland	1.7	833.4	360	Budapest (II)	Hungary	3
307.1	977	West Regional	Great Britain	50	845	355	Vadso	Norway	10

NOTE.—The following wavelengths are common to several transmitters: 206 m. (1,455 kcs.); 207.3 m. (1,447 kcs.); 208.6 m. (1,438 kcs.); 211.3 m. (1,420 kcs.); 218.2 m. (1,375 kcs.); 221.1 m. (1,357 kcs.); 225.6 m. (1,330 kcs.); 228.7 m. (1,312 kcs.); 235.1 m. (1,276 kcs.); 236.8 m. (1,267 kcs.); 251 m. (1,195 kcs.).

A Duplex Receiver for Wireless Control

Continued from page 668

operating the selector will be unaffected. When the plug and socket marked K is disconnected from a main source of electrical energy and connected to a battery (a 4-volt accumulator, for example) the lower circuit shown in Fig. 2 can be used to control an additional "sequence" selector and supplementary relay by connecting the electro-magnet windings of the selector with the plug and socket marked H.

Controlling All Circuits

With this arrangement intermittent oscillations radiated from the transmitter can be made to control all circuits as desired by closing or opening the various switches as previously described.

The additional apparatus is useful because it enables the author's transmitter to be used in the ordinary way by tapping a morse key, and an audience generally displays keen interest if

asked to operate a morse key with their own hands.

The supplementary relay referred to is always necessary when it is desired to control a circuit carrying electric current of any magnitude because for efficient working the contacts of a selector should be as light as possible.

With the duplex receiver described in this article it will be apparent that it is not only possible to control the movements of a model train, but many other types of mechanism; in fact the author has used the instrument for demonstrating numerous methods of control before large audiences.

Many amateurs and others have frequently asked for constructional details of the apparatus, and a diagram of the circuits involved.

It will be noted that the circuits are so arranged that it is not possible to short-circuit any part of the system should a mistake be made in the manipulation of the various switches, as if the latter are all closed it simply means that all circuits are controlled simultaneously, but it is obviously better to avoid

such a mistake during a public demonstration as it is likely to create an unfavourable impression to a non-technical audience.

As practically everyone to-day has at least a little knowledge of wireless too much care cannot be taken when demonstrating apparatus.

Notes and Jottings

TWO new high-frequency pentodes, types VP215 and HP215, have been added to the Hivac range. The VP215 is a short grid-base variable-mu. Complete control is effected with 9 volts negative bias.

The HP215 is a straight high-frequency pentode for use as a first detector or frequency changer in a super-het.

The London chapter of the International Short-wave Club has arranged for a special programme to be broadcast from EAQ, Madrid, on a wavelength of 30.4 metres, on July 1 from midnight until 12.30 a.m.

The record number of 750 delegates and guests attended the fourteenth Annual Exide Convention held at Scarborough from June 12 to June 14.

In the test report of the Ekco model B54 receiver published in AMATEUR WIRELESS dated June 9, the price of the black and chromium model was given as 11 gns.; it should have been 10½ gns.

Mullards have now announced the date for the general release of their new class-B valve, type PM2BA. This valve is available as from June 11. The PM2BA is a valve having similar characteristics as the PM2B except that it is designed for operation with approximately 4.5 volts grid bias.

A new Marconiphone battery receiver is now available. This is the model 284, and is a three-valver. Marconiphone claim for this receiver that for range, tone and quality of reproduction it has no equal. High-tension consumption is the minimum that can be attained with good performance.

A note for your address book! T. R. P. Williams, manufacturer of Tonic trickle chargers, has moved to larger premises at 96 Stourbridge Road, Halesowen, Birmingham.

Those who are on the look-out for a new set to buy should note that next week's AMATEUR WIRELESS will include a test report of the new Cossor battery three-valver—the 345B.

Short-wave fans should note that Bombay, VUB, transmits on 31.36 metres with a power of 4.5 kilowatts in the aerial. The next transmissions will be made on June 27 and 30 from 1,700 to 1,830 B.S.T. Reports of reception should be sent to the Indian State Broadcasting Service, Irwin House, Sprott Road, Ballard Estate, Bombay.

An Electric Prompter

MANY of the spectators at the opening performance of the Runnymede Pageant must have wondered how it was possible to convey cues and stage directions to the five thousand performers taking part.

Actually, this was effected by means of a special arrangement of screened microphones and a dozen concealed loud-speakers installed by Philips Industrial.

Some of the loud-speakers were sunk in the turf 35 ft. in front of the audience with the backs to the spectators' stands; in this way the voice of the prompter reached the players but was inaudible to the audience.

THE ANTI-FADING BATTERY VALVE . . .



The OSRAM
HD.21 Double-Diode-
Triode

Price **9/-** each

Write for further particulars

OSRAM QP.21
(double Pentode)
for Q.P.P. Price 22/6 each

The *NEW* OSRAM HD.21 Double - Diode - Triode *The valve for automatic volume control*

This remarkable new Battery Valve combines three vital advantages in one valve :—

1. Distortionless diode detection.
2. Automatic volume control in a suitable circuit.
3. High gain L.F. amplification.

Ideal for use in conjunction with the new OSRAM QP.21 double pentode (Q.P.P.) in the output stage.

Nominal Rating

Filament Volts	2.0 max.
Filament Current	0.2 ampere
Anode Volts	150 max.
Amplification Factor	27
Impedance	18,000 ohms
Mutual Conductance	1.5 m.a./volt
(Measures at Anode Volts, 100; Grid Volts, 0)					

Osram Valves

MADE IN ENGLAND

Advt. of The General Electric Co., Ltd., Magnet House, Kingsway, London, W.C.2

Advertisers Appreciate Mention of "A.W." with Your Order

Readers' Views on This and That

Listeners' Letters

£5 5s. S.G. THREE

To the Editor, AMATEUR WIRELESS.

JUST a line of congratulation, thanking you for the way you have tackled and completed my request in letter No. 1069 (revising the £5 5s. S.G. Three).

There are three things I am going to say. First, I should not like your job in trying to please all of us enthusiasts.

Secondly, how nice it is to be a regular reader of "A.W." Nothing seems too much trouble in setting things in front of us to get the best out of radio.

Thirdly, I shall never scrap this set. It was the first set I ever built, and I am delighted with the new model. I am going to build it up straight away. C. GIBBONS. [1111]
Chester.

"OFFICIALLY RECOGNISED"

THERE is a point on page 576 of the June 2 issue of "A.W." which may upset many readers. Under the picture of Jack Wilson we read, "at his officially recognised receiving station", etc.

As an experimenter and listener since the early days of the War I have always been under the impression that any holder of a Post Office receiving licence was "officially recognised" or has the P.M.G. been set aside by the R.S.G.B.?

I find that to obtain the privilege of adding "BRS No.—" after one's name costs £1 is. per year, but have not yet been able to find out, even from members of the R.S.G.B., what benefit is obtained at this cost.

With many others, I have made many friends through radio, just by reception on the amateur and short-wave bands from all parts of the world. Many, of course, are correspondence acquaintances only, but are valued none the less for lack of personal contact. B. PEDDER. [1112]
Southgate, N.14.

AMAZING CRYSTAL RESULTS

I CONSTRUCTED my first crystal set about three years ago. On first tests with this set I was very disappointed: maybe I ought not to have been, as our local station, Bombay, on a 3-kilowatt rating, is 450 miles away. To expect to get Bombay on a crystal set at that distance would seem rather a wildish dream to many radio fans.

Well, at first I was disappointed and laid the set on one side for about six weeks. Finally, I decided to dismantle it, but before doing so I gave it another test, and to my intense delight I got Bombay at about R4.

With this encouragement, I persevered, and to my surprise I also picked up Colombo 800 miles away, on 1.75 kilowatts, at R2 and R3, and so the set was allowed to remain intact.

After a few weeks practice (as this was my debut into radio) I managed to get Bombay up to R6 and Colombo up to R5. The reception of Colombo, though, was mostly R4; only on rare occasions did I get him at R5.

I reported my success to both stations, which created quite a nine-day wonder—especially my reception of Colombo. Both stations were much interested and asked for particulars.

Since then I have reported my reception of both stations on several occasions, and have received their verifications of my correct reception, which they willingly sent me and complimented me on my wonderful reception on a crystal set.

I have also heard Moscow at 3,000 miles

and Berlin on the same set, but these signals were very faint, R1 and R2.

I have, however, much difficulty in getting good crystals, and there is scant information re crystal sets available. My coil is not too good; it is wound with No. 23 d.c.c. wire.

I should be glad to send particulars of the set to anyone on request.

Thanking you for all the good things we get weekly from "A.W." There are a few of us here who look forward each week to the next copy, and what it has in store for us. R. BELL. [1113]

Hubli, South India.

MELODY RANGER RESULTS

WITHOUT doubt the Melody Ranger is the best set for this part of the world—this district is considered one of the world's worst places for radio reception. We are situated on the edge of a barren dry desert extending some hundreds of miles, and there is no rainfall. Houses are built of wood with corrugated iron roofs. The only earth we can rely on is a connection made to a water pipe, and we are badly screened by hills.

I can pick up all the worth-while short-wave stations at loud-speaker strength, but, of course, reception varies with the time of year. Just now our winter is starting, so we can rely on good reception until October.

Daventry comes in quite well on 31.3 metres, that is the No. 5 transmission; the No. 4 transmission on 31.5 metres is very weak just now, and can scarcely be heard. Three or four months ago the opposite was the case, the No. 4 transmission on 49, 31 and 25 metres came in much stronger than No. 5, in fact it was often almost impossible to receive the No. 5 transmission. The No. 1 transmission comes in very well indeed, but as we have to sit up until 1.15 a.m. to receive it nobody bothers much.

W2XAF and Germany on 31 metres are also coming in very strongly, but there is a considerable amount of jamming or interference from these two when receiving Daventry. On the Melody Ranger I can separate them easily, but the majority of sets here, all Americans, frequently experience some difficulty in doing so, and at times cannot receive Daventry.

The Melody Ranger is by far the best set here, and can beat the American Super Wasps or Pilot short-wave receivers or any of their super-hets. Without exaggeration, wireless reception here was always considered impossible until the arrival of the Melody Ranger; people seemed astounded at the results obtained on so small a set, now there is a craze for short-wave sets.

On the medium waves the Melody Ranger is also quite good, Argentine stations are received at good loud-speaker strength and also Americans during our summer months. Reception on the medium waves can never be relied upon, as atmospherics are sometimes very bad. VICTOR T. JESSOP. [1114]

Iquique, Chile.

HIKER'S PORTABLE

I FEEL I ought to congratulate you on your Hiker's Portable. On Saturday last I got North Regional, London Regional, and Scottish Regional at full loud-speaker strength.

Then I decided to see what it would do on 150 volts high tension. So, with a home-made and designed rotary converter, 15-1 transformer, and rectifier, I was astounded to get no less than eleven stations on a moving-coil loud-speaker.

It is true I had to use differential reaction

for such a high voltage, but nevertheless I didn't alter much. May I wish you and your paper much success.

"12-YEAR-OLD."

Kirkby Lonsdale.

[1115]

CENTURY SUPER RESULTS

I HAVE built the 1934 Century Super battery set, according to the "A.W." specification, and I can say I have one of the finest receivers anyone can wish for.

When I first built the set I had a lot of trouble in the L2DD valve, which has now been overcome.

I find I get more volume on the long waves than I do on the medium. Take Huizen, Radio Paris, Daventry, Kalundborg, Luxembourg, Motala, Moscow, and Warsaw: all these come in loud enough to blow you out of the house.

I have logged twenty-seven stations on the long waves and eighty-three on the medium waves. All these stations are at good loud-speaker strength, not counting about fifteen stations which are not loud and fade out. Most of the stations are too loud with full volume on, such as London Regional, London National, Brussels, Munich, Leipzig, Prague, Poste Parisien, Hamburg, Luxembourg, Radic Paris, Huizen, and Daventry.

When I get one of these stations tuned in all the family shouts out: "Tune it down a bit, we're not deaf."

WM. PLUMPTON.

London, S.E.16.

[1116]

TWENTY-FOUR HOUR TIME

NOTICE that on the leading page of the current issue of AMATEUR WIRELESS there is a reference to 24-hour time which is distinctly misleading. The B.B.C. is not reverting to ordinary timing in its publications, but only giving the old times in brackets after the much more sensible 24-hour times.

The experiment is not at all "fantastic" as you state: while the method of dividing the day into two 12-hour cycles is a relic of the era before clocks were invented, when the sun was utilised to give the time by means of a primitive sundial.

I note also that Thermion refers to the same subject at the head of his page. He remarks that in foreign countries, although use is made of the 24-hour system for railway time-tables, it is not used for radio programmes, and leaves one to infer that we should do likewise.

But why stop at time tables when we are merely logical in carrying the system into broadcasting? (And we are logical in this.)

Let us remember that the B.B.C., like many other big organisations, works all round the clock and not just a few hours during the day. To such organisations the 24-hour system of timekeeping must, without doubt, make for simplicity and accuracy.

L. G. MATTHEW.

Edinburgh.

[1117]

"ROYAL EAGLE" RADIO

IN your article entitled "Radio Down London River" which appears in your June 16 issue, might I draw your attention to a little inaccuracy?

The rotary convertor mentioned supplies 240 volts A.C. only. The 1,000-volt high-tension for the output stage is derived from a transformer and ESU75 mercury-vapour rectifier mounted in the amplifier case.

The amplifier is made up of two resistance-capacity coupled stages "direct coupled" (anode to grid) to the two parallel output valves. This "direct coupling" is arranged at low impedance in order to permit a degree of positive drive without undue distortion.

pp. Pamphonic Reproducers, Ltd.

PAUL H. TAYLOR,
Technical Director.

London, N.W.8.

[1118]

With the Amateurs on the Short Waves

By KENNETH JOWERS



An American amateur station—W8AFM—which works regularly on 20- and 75-metre bands

During the past week I found a general tendency for the 20-metre stations to be very poor until almost midnight, and even then static was so bad that they were almost entirely wiped out.

The Cuban station CN2WZ is coming over well these days. On June 19 it was heard up in Scotland four times between midnight and 0100. K4SA is also being heard up there.

This is rather surprising, for the majority of reports received from the South of England do not make a note of this station.

R. D. Everard, of Standon, sends me two very good photographs of two stations that he has logged. The first is of OK2HM, Czechoslovakia. This photograph shows the transmitter, microphone, receiver and the other gear needed with an amateur transmitter.

As a direct contrast in design the second photograph shows the American station W8AFM, which is regularly heard on the 20- and 75-metre bands. This station uses approximately 500 watts and looks more like a commercial transmitter than an amateur station.

Mr. Everard pulls me up for quoting Jelöy as using a frequency of 9,550 kilocycles instead of 9,540 kilocycles. I don't know whether I am wrong or not, but this station seems to change its frequency every week. Any reports will be appreciated.

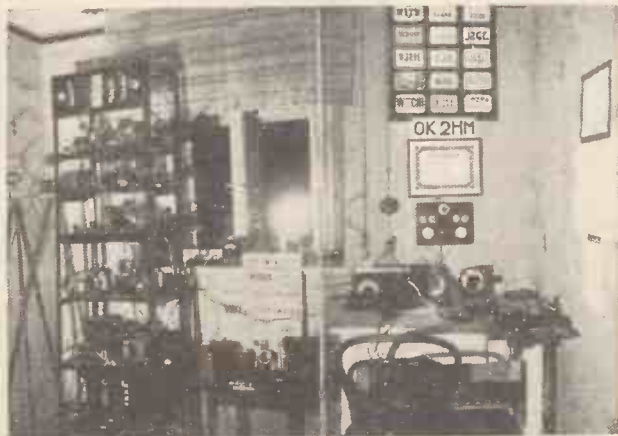

An interesting photograph of station OK2HM, Czechoslovakia

IN the mail this morning was a long and interesting letter from W9BHT, of Canton, Illinois. This station, which has been heard so consistently, will be heard no more—at least till the end of the year.

Bill Ingersoll, the operator of W9BHT, is going up north, where the temperature will be 100 degrees below zero. He is taking with him a Collins type 150B portable transmitter, which will put about 100 watts into the aerial. This station runs from a gasoline-engine-driven 2-kilowatt generator.

Bill Ingersoll would very much like to have any reports on this station during the next three or four months. Wavelength, 20 metres; call sign, W9DXJ. He has also promised me some photographs and a full description of the station.

Everyone who has heard W9BHT must also have heard W1CAA, operated by Lloyd D. Morse. Lloyd Morse will not be on the air for some time yet, for he is too ill to operate the station, so that means that the two star stations of the 20-metre band will be off the air for the best period of the year.

If anyone wants to demonstrate the possibility of the short waves, then tune-in W3XAL on the 16-metre band. This station comes on the air at 1200 and results are very poor until about 1600. From then onwards signal strength improves until between 1900 and 2100, and a good receiver will give sufficient output fully to load quite a large moving-coil loud-speaker.

W1AJZ is another station that is worth having. It is operated—as I mentioned briefly some weeks ago—by Miss Sally Parker, who asks for reports from listeners.

Leaves from a Short-wave Log

By J. GODCHAUX ABRAHAMS

RECEPTION of short-wave broadcasts from overseas during the past fortnight has been fairly good—in fact sufficiently encouraging to induce one to make searches daily. There are still alterations to be noted in the time schedules of some transmitters and their careful entry in your log will save considerable disappointment.

VK2ME, Sydney (N.S.W.), which is being captured fairly regularly, now works at the following times on Sundays: B.S.T. 0600-0800, 1100-1500 and from 1730-1930; the first broadcast seems to be the easiest to catch on 31.28 metres.

Two South Americans

From South America comes precise information regarding two stations which should not prove difficult logs. HKE, Bogota (Col.) on 41.55 metres (7,220 kilocycles), works on Tuesdays and Fridays between B.S.T. 0015-0100 and on Thursdays and Mondays between 0200 and 0300; HJ1ABB, Barranquilla (Colombia), 46.53 metres, of which the interval signal is a high-pitched gong, can be picked up now and again at good strength between B.S.T. 2330 and 0400.

On Sundays, as one of the last items in the programme, it gives a relay of a concert by the local police band playing "al fresco" in the Parque de Bolivar.

HIX, Santo Domingo, on 49.5 metres (6,060 kilocycles), has been picked up in the British Isles between B.S.T. 0355 and 0500. In the latest lists it is given as transmitting regularly every Tuesday, Friday and Sunday. Translated into B.S.T., the schedule is as follows: 0110-0310 (Wednesdays and Saturdays), and 1920-2140 (Sundays).

If you listen on the 49-metre band, immediately below Moscow RNE you should have no trouble in finding COC, Havana (Cuba) on 49.92 metres, which usually operates between B.S.T. 2200 and midnight. When this station closes down do not move from the spot, and you may hear three cuckoo calls which will indicate that you are tuned-in to XEBT, Mexico City, of which the time schedule is midnight-0600 B.S.T.

The South American stations are very active just now and HJ4ABE, Medellin (Colombia) on 5.900 kilocycles (50.6 metres), which sometimes announces itself as HKO, is an easy capture between 0200 and 0400 B.S.T.; also HJ3ABD, Bogota (Colombia) on 7.407 kilocycles (40.5 metres); this station in its call styles itself "Colombia Broadcasting."

Searching for China

Chinese stations are seldom heard, but it might be worth while to make a search for CQN Macau, at about midday on roughly 19 metres. It appears to be a new station announcing itself as the "Federal Post Office Transmitter, Macau, China." The position of this port is roughly seventy-five miles south of Canton on the South China Sea.

Another catch of which I should feel proud is one reported to me from Southern England of signals from the schooner *Seth Parker*, flying the Stars and Stripes, which, manned by a number of well-known American radio fans, is making a world tour. It works daily with W2XBJ, Rocky Point (N.Y.), which passes on the messages for re-broadcast in the N.B.C. programme.

The call letters are KNRH, and channels used 6,660 kilocycles (49.05 metres); 8,820 kilocycles (34.01 metres); 13,200 kilocycles (22.73 metres) and 17,600 kilocycles (17.045 metres).

DISCOVERER SHORT-WAVE S.G.3

AS USED BY THE J. H. MARTIN ARCTIC EXPEDITION

PETO-SCOTT "DISCOVERER" S.W. RECEIVER as chosen by the Arctic Explorer, Mr. J. H. Martin, who writes: "An absolutely reliable Receiver... very much impressed by the clearness of reception and simplicity of design."

5-METRE RECEIVER KIT "A" Author's kit of first specified components less Valves and Cabinet. **5/3** Cash or C.O.D. Carriage Paid, £2/4/0. Balance in 8 monthly payments of 5/3.
 1 Set of 3 Specified Valves £1 10 6
 1 Eddystone metal Cabinet as specified £1 18 0

BUILD IT YOURSELF. This is one of the most magnificent S.G. 3-valve Receivers ever designed for short-wave work. It combines all the advantages of high efficiency, S.G. amplification with amazing simplicity of operation, and in the words of the designer—represents the last word in modern short-wave technique. Complete Kit for building, in sealed Carton with all parts, including Valves and Cabinet. Every Kit includes a FREE Full-size Blueprint and FREE copy of PETO-SCOTT SHORT-WAVE BOOK, as described on left.

KIT "A" less valves, cabinet and batteries. Cash or C.O.D., Carr. Pd. £4/10/0.

OR **8/3** FOR YOURS **8/3** Balance in 11 monthly payments of 8/3.

Complete Kit, with valves and cabinet, Cash or C.O.D. Carriage Paid, £7/2/3, or 12 monthly payments of 33/1. Additional Plug-in Coils to tune 40-120 metres, 6/6.

1/- BOOK FREE.—Simply send 3d. in stamps. Peto-Scott's Short-wave Book, 48 pages profusely illustrated. Constructional articles for building 2-, 3-, and 4-valve Short-wave Sets, including the Peto-Scott "Discoverer" Short-wave S.G.3. With full-size Free Blueprint and Wiring Diagrams. A detailed list of priced parts for every set.

PETO-SCOTT CO. LTD. 77S1 CITY RD. LONDON, E.C.1. West End Showrooms: 62 HIGH HOLBORN, LONDON, W.C.1

5 METRES

See that you get the specified Eddystone components for the "Amateur Wireless" 5 metre receiver. Designed and built by the leading Short-wave specialists.

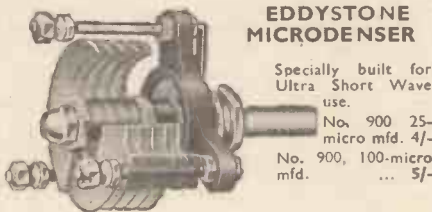

EDDYSTONE MICRODENSER

Specially built for Ultra Short Wave use.
No. 900 25-micro mfd. 4/-
No. 900, 100-micro mfd. ... 5/-

EDDYSTONE QUENCH COIL UNIT

for super regenerative receivers.
No. 958 ... 4/6

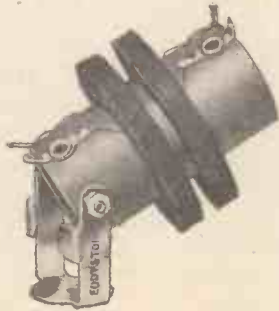

EDDYSTONE SHORT-WAVE VALVE HOLDER



Frequentite the finest insulator for ether Short Wave work is used in this valve holder.
No. 949 4-pin. 1/5 each.
No. 950, 5-pin. 1/8 each.

EDDYSTONE METAL CABINET

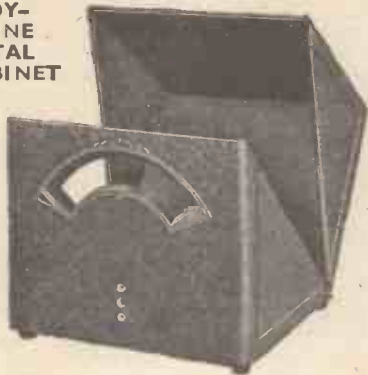

An entirely new method in cabinet design. Diecast in two halves, gives perfect screening when closed. Beautifully finished.
No. 974, price 27/6.
Special tuning drive for above, No. 970W Price 10/6.

EDDYSTONE

SHORT-WAVE COMPONENTS

STRATTON & CO., Ltd., Bromsgrove St., Birmingham
London Service Depot.: Webb's Radio Stores, 14 Soho St., Oxford St., W.1. Telephone: GERRARD 2089.

Still a Welter of Stations

By JAY COOTE

NOTWITHSTANDING the intense heat reception on the medium- and long-wave bands continues to remain good for the time of year. We are certainly deriving the benefit of increased power on the part of the transmitters.

From 2100 or 2130 almost nightly one can tune-in a welter of stations and even some of the weaker brethren can be picked up at good volume. One or two spots of the medium band have improved by the withdrawal of two Paris stations which had been causing trouble with their incessant deviations. I refer to Radio LL, now working on 209.9 metres, and Radio Vitus, also reduced to 222.6 metres. The latter, since the move, has changed its call; no more do we hear a reference to Montmartre but a somewhat misleading one, namely, Poste de l'Île de France, which might induce the uninitiated to believe that he was hearing a transmission from the coast.

In recent notes I referred to the extraordinary volume at which nightly I hear broadcasts from Juan-les-Pins. This state of affairs continues and it will be worth your while to turn to this Mediterranean station more frequently in future, as from July 1 it will carry out regular relays from the famous Casino at Monte Carlo. Tune-in at B.S.T. 2115 (9.15 p.m.).

The P.T.T. transmitters are also reaching out to Vichy for radio entertainments of which they will give two to three broadcasts every week; also worth noting as the Vichy Casino has an orchestra of ninety-five instrumentalists!

In comparison with previous years our summer log is considerably extended and it may be said that even at the worst period of the year, from the distant listener's viewpoint, we are getting a remarkable number of worthwhile broadcasts nightly. This is likely to be increased in the near future, as most countries possessing transmitters suffer from the "power urge."

Radio Alger is working on the transformation

of its plant to secure 100-110 kilowatts and Lisbon Barcarena, which is already well heard in the later evening hours, is designed to blossom out as an 80-kilowatt when the opportunity arises.

New Station for Greece?

Greece, which so far has only possessed a small private station at Salonica, may see its wish shortly fulfilled at Athens, as I understand that negotiations are being carried out with an Italian concern for the construction of a transmitter near the capital. By next year we shall be tapping the entire European continent with a simple three-valver!

During the past week or so, rising early in the morning—the best part of the day in my opinion—I have found that there is no lack of programmes on the air. Breslau, I take it, must be the earliest bird on the wing, for you can get a concert of gramophone records from that station at 5 a.m.; by 6.15 a.m. all the Germans are in full swing.

Radio Paris opens up at 7 a.m. on Sundays and thirty minutes later on weekdays; Toulouse at 8 a.m. and 11 a.m. on Sundays; Poste Parisien may be regularly tuned-in at 7.10 a.m. (Sundays excepted) and Fécamp (Radio Normandie) at 10 a.m.

Daytime Gramophone Music

If you want to hear gramophone records during the day you may turn to a number of stations, including Frankfurt-am-Main, Stuttgart and Breslau, which as a rule on Sundays give a review of the latest numbers published at respectively B.S.T. 1315 and 1430. Brussels also may be relied upon on most days at midday, Vienna at 1600, followed by Prague an hour later.

I need not refer to Huizen, Hilversum, Radio Toulouse, Luxembourg or Radio Normandie, which you can switch on at any time with the assurance that from some of them at least this kind of programme is available.

An Experimenter's Set for 5-metre Working

Continued from page 662

A standard 120-volt high-tension battery is all that is required, the full 120 volts being applied to H.T.+2, but a lower voltage to H.T.+1, which feeds both the quencher and the detector. Although in our original receiver we found 60 volts to be about right, you must not take this as a definite figure, for variations in valve impedance make such a very big difference down on 5 metres.

We suggest that you adjust the voltage applied to H.T.+1 until the receiver is in a completely stable condition, and any further increase causes oscillation.

On the other hand, after a station has been received you may find that by reducing the voltage still further the background noise will be decreased without making any appreciable difference to the volume of the station. This point can only be determined by experiment.

Although background noise is higher than obtains with a normal short-wave set, by careful adjustment of the detector and quencher voltages, this can be reduced to a level so as not to interfere with reception. It will be noticed that immediately a station is tuned-in, the background noise automatically fades to a negligible level.

One of the most important points is the length of aerial. As a general rule 9 ft. of wire, fixed vertically, will do quite well, but,

as this is not always convenient, a half-wave aerial with a half-wave downlead should be used.

In our original tests we erected an aerial 8 ft. 6 in. in length. This is approximately half of 5 metres. The downlead was 17 ft. in length, which we found to be about right. On the other hand, if this aerial had caused damping and lack of oscillation, we should have reduced the length of downlead to half-wave, or 8 ft. 6 in.

Ultra-short waves being quasi-optical, there will be a vast improvement in reception if the receiver is used on top of a hill or in the upper room of a house, so that the aerial is clear of surrounding objects.

Amateur Transmissions

Those fortunate people close to a large town where amateurs abound will find that for the next few months 5 metres will be occupying the attention of amateur transmitters.

This receiver, used in conjunction with the 5-metre transmitter described in the June 16 issue of AMATEUR WIRELESS, will make a complete outfit which can be constructed quite cheaply. None of the components are expensive, and even should the power be derived from dry batteries, the range should not be less than 15 miles.

Before making up the transmitter, remember that you must obtain a licence to do so from the Postmaster-General!

Criticisms by WHITAKER-WILSON

My Broadcasting Diary

Sunday

NOT often I listen to light music on a Sunday. Not because I am shocked or anything silly like that; don't want it—that's all. This afternoon someone switched on the Scottish Studio Orchestra and I listened to them playing a selection from Gilbert and Sullivan. A very good band. Nicely balanced.

I did intend to hear Peter Dawson because he so rarely broadcasts. I liked him, as I thought I should, but was a trifle disappointed over his songs.

There was a pleasing chamber music concert later in the day. As I have said before, chamber music suits me on a Sunday. Robert Murchie (flute), Leon Goossens (oboe), and Francesco Ticciati (piano), playing a Trio of Handel appealed to me as just the sort of thing for a summer Sunday evening. They kept a nice balance throughout.

Monday

I HAVE always been keen on dialect plays, but I am not so sure they can be expected to rely on the dialect entirely for their broadcasting value. That was what *T. Marsdens* did. There was nothing in the dialogue worth hearing. Nothing much in the plot. The fact that the play was perfectly produced and was really Yorkshire in spirit, was hardly enough—for southern listeners, especially. Unless the lines are there, no matter how clever the production the play is bound to be dull. This was on that account.

Tuesday

OUT OF TOWN TO-NIGHT easily the best variety show since Radiolympia last year. I have rarely heard a stronger cast.

I liked Davy Burnaby all through. He made a jolly compère and left out his limericks, which was all to the good. Leslie Sarony and Holmes thoroughly up to form. Also Ben Osborne and Nellie Perryer. I mention them particularly because I have never really been keen on them before. Their scene on board ship was brilliant. I sympathized with Ben when he told Nellie not to say "up." I should have been in the same state.

Sandy Rowan's patter very original. Tommy Handley fairly sparkled. I have never heard him so funny.

One of the best turns of the evening was given by Bobbie Comber and Claude Hulbert in their yachting scene. It sounded so well rehearsed, by which I mean nothing went wrong, although they took it at danger speed.

The Carlyle Cousins—well, they were themselves, which is what we all wanted them to be. Muriel George and Ernest Butcher surprised me with their excellent dialect. I do not remember hearing them quite like that

before. Mabel Constanduros good, of course, but I think I like her in the Buggins family scenes best. Where was Michael?

Previous to all this I cooled my fevered brow in the Canterbury Cloisters. An open-air feeling pervaded the serenade, but, perhaps, that was because I knew they were outside. Anyhow, it all sounded delightful, the Mendelssohn *Scherzo* in particular.

Wednesday

NOT too keen on the choir's rendering of the Purcell anthem. Rather dull and not "cathedrally" enough. I think they might have spared us Wagner and Brahms. We can have them any old time from the studio. I should have liked Delius or Elgar or Holst or Vaughan Williams. Something English at all events. Perhaps someone will make a note of



Leslie Sarony



Tommy Handley

the idea for next year? Let the Canterbury Festivals be English, please!

Thursday

LISTENED for a while to Christopher Stone to-night. Thought his selection quite diverting. Noticed he referred to a *Pole-ha*. Christopher getting refanned?

Friday

CEDRIC WALLIS'S play intrigued me. His admirable characterisation was his downfall in the end. The dialogue was beautifully written throughout, but the author landed himself in a situation where there had to be a tragedy. Honestly, I don't see how else he could have ended it.

Frank Cellier as *Melchior* and John Gatrell as *David* were wonderful in places. Indeed, the whole production made an interesting entertainment. I am sorry it was not perfect as a play.

Saturday

THE best of the Variety to-night was very good. The Ventriloquist Coram (and "Jerry") provided some first-rate patter. Hardly a weak line in it.

Mamie Soutter, whose impersonation of the Impossible Child always attracts me, gave a splendid scene in which she was a maid at the boarding house. I like her account of the landlady's meanness. She rubbed the brass with the kitten to save the dusters.

Ronald Gourley is almost too artistic for an ordinary vaudeville. I want him to be asked to give a short recital consisting of his most delicate comedy songs and plenty of whistling. His technique and musicianship are really amazing. Let us have him alone in the studio one night.

Claude Hulbert and Enid Trevor, who appeared as Mr. and Mrs. Hulbert, had a lovely row. The best they've ever had.



Claude Hulbert



Sasha Photo
Enid Trevor

PILOT AUTHOR KITS

Exact to Specification

Quotations for EVERYTHING RADIO by return of post. Send list of your requirements. CASH—C.O.D.—H.P.

BATTERY PENTA-QUESTER KIT "A" Author's Kit of First Specified parts, including ready-drilled METAPLEX Chassis, but less Valves and Cabinet. Cash or C.O.D. Carr. Pd. £4-7-6 Or 12 monthly payments of 8/-

PENTA-QUESTER WALNUT CABINET

Designed at the special request of "Amateur Wireles." In handsome band french polished Walnut. With unique 360 degree Tuning Scale and 2-1 reduction sprockets, driving chain, scale and speaker baffle. Carriage 2/6 extra. Or 7/6 deposit and 7 monthly payments of 8/-, Carriage Paid.

LUCERNE STRAIGHT 3

Kit "A" Yours for 5/- Balance in 6 monthly payments of 4/9
Comprising Author's Kit of First Specified parts, less Valves, Cabinet and Speaker. Cash or C.O.D. Carriage Paid. 29/6

KIT "B" As for Kit "A," but including set of 3 specified Valves. Cash or C.O.D. Carriage Paid. £21/3 Or 12 monthly payments of 4/8.

KIT "C" As for Kit "A," but including set of 3 specified Valves and Cabinet. Cash or C.O.D. Carriage Paid. £37/8. Or 12 monthly payments of 6/2.

* If Assembled Lucerne Parts required add 2/- to Cash Price or 2/- to deposit.

LUCERNE COILS

Complete kit comprising 3 ready-drilled Formers, 2 Reels of enameled Wire, 6 B.A. Terminals, Nuts and Screws. Exact to specification for Aerial or Grid Coil. Postage 6d. extra. 2 Complete Kits for both Aerial and Grid Coils, 5/- Postage 6d. extra. 2/6

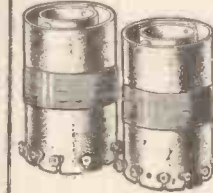

Ready Wound LUCERNE AERIAL COIL OR GRID COIL Each
Wound exactly to "Amateur Wireles" specification. Made in England, Tested and Guaranteed by Peto-Scott. Postage 6d. Extra. 6/8 Per Pair Post Free. 3/-

MORE BARGAINS

ATLAS CLASS "B" 4
LIST PRICE £11.17.6 OUR PRICE £6.17.6
Or 12 monthly payments of 13/3.



A splendid chance to own a complete Class "B" 4-valve set. Factory built and tested. Supplied ready built—BRAND NEW—and fully guaranteed in working order by PETO-SCOTT. Absolutely complete with Cabinet, Valves, Speaker and Helicon and Exide Batteries. READY TO PLAY. FULLY-SCREENED—BAND-PASS TUNING. MAINS PERFORMANCE with only 8 m a Quiescent H.T. Battery Consumption.

- B.V.A. Variable-Mu S.G. Detector, Class B Driver and Power Valves.
- All Metal Chassis.
- Permanent Magnet Moving-Coil Speaker.
- Illuminated Wave-length Scale.
- Combined Volume-Reaction Control.
- Output 1 1/2 watt.
- Single-knob Tuning.

NEW FERRANTI CLASS "B" SUPER POWER CONVERTER. Instantly converts your set to Class "B" complete with Valves. Ready assembled. Cash or C.O.D. Carriage Paid, £3/3/0. Balance in 11 monthly payments of 5/9. only 5/9

NEW W.E.P.M. 4A. MICROLODE PERMANENT MAGNET SPEAKER, complete with switch-controlled multi-ratio Input Transformer. Cash or C.O.D. Carriage Paid, £2/2/0. Balance in 7 monthly payments of 5/9. only 5/9

PETO SCOTT PERMANENT MAGNET M.C. SPEAKER for Power or Pentode, complete with Input Transformer. Cash or C.O.D. Carriage Paid, 15/- only 2/6

Balance in 4 monthly payments of 4/-.

PETO-SCOTT CO. LTD.
77 (A.W.5.), CITY ROAD, LONDON, E.C.1.
Clerkenwell 9406/7
West End Showrooms: 62, High Holborn, London, W.C.1.
EST. 1919

PREPAID ADVERTISEMENTS

Advertisements under this head are charged **THREEPENCE PER WORD**, minimum charge **THREE SHILLINGS. DEPOSIT SYSTEM.**
As the publishers cannot accept responsibility for the bona fides of advertisers in this section, they have introduced a system of deposit which it is recommended should be adopted by readers when dealing with persons with whom they are unacquainted.
The amount of the Deposit and Fee must be remitted by Postal Order or Registered Letter (Cheques cannot be accepted), addressed to "Amateur Wireless," Advertisement Department, 58/61 Fetter Lane, London, E.C.4.

REPAIRS TO MOVING-COIL SPEAKERS. Cones and Coils fitted or rewound. Eliminators and Transformers quoted for. Loud-speakers, L.F. and Speech Transformers, 4/- each, post free. Trade invited. Satisfaction guaranteed. Prompt service.—Loud-speaker Repair Service, 5 Balham Grove, London, S.W.12. Battersea 1321.

SCREENED COILS.—Will give you greater selectivity. Aluminium Coil Screens with base, size 3 1/2 in. high, 2 1/2 in. diameter. Price 1/6 each.—"M.P.R.," Ltd., Romford, Essex.

N.P. (late Nash Products) for Battery Charging Plants, 20/- to £20.

N.P. for Battery Chargers on Hire Purchase. No interest, no guarantees, etc.

N.P. send photographs and terms. State your requirements.—N.P. Electrical Co., 514 Alum Rock Road, Birmingham.

UTILITY SALES CO. Stock Everything You Require in Radio, electrical, scientific, and domestic goods of all descriptions; send P.C. for complete lists; there's much to interest you.

VERY SPECIAL.—Just arrived; 5-valve 200-2,000 metres Superhet. Midget Chassis, with M.C. speaker, A.C.-D.C., 100-250 volts, gramophone plug and valves, latest type; limited quantity; will never be repeated at this price, 82/6.

RADIO-GRAM Electric Motor, complete with turntable, accessories, works from 4 1/2-volt dry cell, 4-volt accumulator; 15/-.

ELECTRIC SOLDERING IRON.—Perfect, very handy, specify voltage; 4/6.

"METRO-VICK" MAINS TRANSFORMER. 200-240 volts, 250-0-250, 60 millamps, 4 volts 5 amps., 4 volts 2 amps., guaranteed; 10/-.

"IGRANIC" BAND PASS UNIT, 3 iron-cored screened coils on base, with switch; 14/6 (list 33/-).

"VARLEY" CONSTANT SQUARE PEAK COILS, new, boxed; 3/3 each (list 15/-).

TIME SWITCH CLOCK, to turn off Radio at pre-set time; 3/6.

ELECTRIC CLOCK, in beautiful Bakelite case; works from 4-volt battery, without attention for 2 years; sent complete; guaranteed; 12/6.

ALL GOODS Delivered Within 24 Hours, carriage paid; cash with order.

UTILITY SALES CO., 27a Sale Street, Paddington, London, W.2.

WANTED.—Good Modern Wireless Parts, Sets, Eliminators, Meters, Valves, Speakers, etc. Spot cash waiting. Send or bring. We pay more than any other dealer. Open 9-8.—University Radio, 142 Drummond Street, Euston, N.W.1.

HIGHEST POSSIBLE ALLOWANCE made on used wireless sets or parts in exchange for any new set, kit, or parts. Peto-Scott kits supplied. Goods bought for cash.—R. Wigfield, Furlong Road, Goldthorpe, Yorks.

INFORMATION BUREAU
Will every querist please observe the following revised rules?
Please write concisely, giving essential particulars. A fee of one shilling, postal order (not stamps), a stamped, addressed envelope and the coupon on this page must accompany all queries.
Not more than two questions should be sent at any time.
The designing of apparatus or receivers cannot be undertaken.
Slight modifications of a straightforward nature only can be made to blueprints. For more serious alterations the minimum charge is 2/6.
Blueprints supplied by us will be charged for in addition, but, of course, readers may send their own blueprints for alteration.
Modifications to proprietary receivers and designs published by contemporary journals cannot be undertaken. Readers' sets and components cannot be tested by us. Queries cannot be answered by telephone or personally. Readers ordering blueprints and requiring technical information in addition should address a separate letter to the Information Bureau and should see that their remittance covers the price of the Blueprint and the amount of the query fee.
We do not answer queries in cases where the fee is omitted.
Queries should be addressed to the Query Dept., "Amateur Wireless," 58/61 Fetter Lane, London, E.C.4.

- BURGOYNE** 3-valve Battery Sets, complete, £2 10/0.
- MARCONI** 3-valve Battery Sets, complete, £2 5s.
- TRIOTRON** Class B Units, with Valve, 21/6.
- STALL** Class B Driver and Choke; pair, 8/6.
- TRIOTRON** 8 Mfd. Electrolytic Condensers, 2/6.
- DUBILIER** 1,500-volt Condenser Banks 1 by 2, 1 by 25, 3 by 1, 4 by 1 Mfd., 4/6. Dubilier 1,500-volt Condensers 2 by 2 Mfd., 2/6.
- LUCERNE** Iron Cored Coils, 2/6.
- AMPLION** Dual Range Coils, 2/6.
- VARLEY** Constant Square Peak Coils (list 15/-), 2/6.
- COSMOS** 2-volt Green and Blue Spot Valves, 2/6.
- COSMOS** 4 or 6-volt Red Spot Valves, 1/6.
- TRIOTRON VALVES,** 3/6; Power, 4/6; Super, 5/-; S.G., 6/6.
- AMPLION** 39/6 Permanent Magnet M.C. Speakers, 17/6. Amplion 27/6 Sonette Permanent Magnet M.C. Speakers, 10/6. Celestion 47/6 Permanent Magnet M.C. Speakers, 19/6. Celestion 27/6 Soundex Permanent Magnet M.C. Speakers, 10/6.
- IGRANIC** 7/6 Parvo Transformers, 2/6.
- FERRANTI** A.F.3 Transformers, 11/6; A.F.8, 6/6.
- OSRAM** Thirty Three Music Magnet Kits, Assembled and Tested. List £6 15s. 6d.; 70/-.
- POST PAID,** cash with order, or C.O.D. P.C. for Bargain List.
- TUNNEL RADIO,** Chester Street, Birkenhead.

TRADE INQUIRY.—Engineer seeks firm or individual to build experimental amplifiers. Cost unimportant, quality workmanship essential. Experience mains amplifiers necessary. No amateurs.—Box No. 28, "Amateur Wireless," 58 Fetter Lane, E.C.4.

WANTED.—24-volt Converter; 230 volts, 50 cycles, 100-watt output. Also Film Industries 1.84 Speaker Base.—Sansom, 4 The Broadway, St. Margarets, Twickenham.

BANKRUPT BARGAINS. List free. Positively the cheapest for Radio Goods.—Butlin, 143b, Preston Rd., Brighton.

NEXT WEEK!

Look out for the following interesting features in the next issue of AMATEUR WIRELESS:—
Percy Harris will discuss the merits of various types of tuning scales and explain their real functions.
Two keen amateurs will discuss the advantages and disadvantages of having an all-wave set and of using two separate sets for ordinary and short-wave reception.
"Russia's 1,500 Kilowatts" is the title of an authentic article explaining how the Soviet is developing the world's most ambitious broadcasting system.

ENGINEERS!
ARE YOU EARNING LESS THAN £10 PER WEEK?
If so, you cannot afford to carry on without reading our 256-page Handbook. The book explains clearly and definitely many ways of carving out a successful career. Among other things, it explains the Services of our unique Appointments Department, outlines Home-Study Courses in all branches of Civil, Mechanical, Electrical, Motor, Aero, Wireless, "Talkie" Eng., Building, etc., and gives details of B.Sc., A.M.I.C.E., A.M.I.A.E., G.P.O., Matric, and all Exams. We alone Guarantee—"No Pass—No Fee."
Whether you be an old hand or a budding apprentice, get this book to-day—FREE and POST FREE.
BRITISH INSTITUTE OF ENGINEERING TECHNOLOGY,
409 Shakespeare House, 29/31 Oxford Street, London, W.1.

ILLUSTRATED LIST of RADIO-GRAM-O PHONE CABINETS at BARGAIN PRICES and descriptive literature of the **HOWE BOX BATTLE**, recommended by the B.B.C. **POST FREE, GILBERT, Cabinet Maker, SWINDON.**

H.T. THAT SAVES POUNDS
Why not end H.T. problems for good with a Standard Wet Battery? Smooth, abundant H.T. year in, year out at half cost of dry H.T. Cheap, annual replenishment. Saves pounds. 120v. 12,500 m.a. £2, curr. paid. All Standard H.T. Spares. Lists Free.
WET H.T. BATTERY CO. - 28 LISLE STREET - LONDON, W.C.2

RADIO SUPPLIES
Send your list of Radio needs for our quotation. Kits, Parts, Sets, etc. Everything in Radio stocked. prompt delivery. 7 days' approval. Catalogue free. Tavlex & Standard Wet H.T. Replacements stocked.
A. TAYLOR, 9 GROVE ROAD, BALHAM S.W.12

*** FULL-SIZE BLUEPRINTS ***

When ordering, please send Postal Order, NOT STAMPS. Quote the Blueprint number shown below: not the number of the issue.

- CRYSTAL SETS (6d. each)**
- 1931 Crystal Set AW308
- Four Station Crystal Set AW427
- ONE-VALVE SETS (1s. each)**
- Easy to Build One AW304
- Portable Short-wave One AW354
- B.B.C. One-valver AW387
- S.W. One-valver for America AW429
- TWO-VALVE SETS (1s. each)**
- B.B.C. National Two (D, Trans) AW377
- Melody Ranger Two (D, Trans) AW388
- "A.W." Iron-core Two (D, Trans) AW395
- "A.W." Iron-core Two with Q.P.P. AW396
- Big Power Melody Two, with Lucerne Coils (SG, Trans) AW338A
- B.B.C. National Two, with Lucerne Coils (D, Trans) AW377A
- Consoletric Two (D, Pen) A.C. AW403
- Lucerne Minor (Det, Pen) AW426
- Hikars' Headphone Portable (Det, Trans) AW434
- A Two for 7 Metres (D, Trans) WM255
- New-style Radiogram (D, Trans) WM299
- A.C. Quality Gem (D, Trans) WM312
- THREE-VALVE SETS (1s. each)**
- Our Up-to-the-Minute Three (SG, West-ector, LF, Trans) AW384
- Class B Three (D, Trans, Class B) AW386
- "Up-to-the-minute Three" with Class B, 1/6 AW384B
- A.C. Triodyne (SG, D, Pen) AW399
- Home-built Coil Three (SG, D, Trans) AW404
- Fan and Family Three (D, 2LF) AW410
- £5. 5s. SG. 3 (SG, D, Trans) AW412
- A.C.-D.C. Universal Three (SG, Det, Pen) AW414
- 1934 Ether Searcher (SG, Det, Pen) Baseboard AW417
- 1934 Ether Searcher (SG, Det, Pen) Chassis AW419
- Lucerne Ranger (SG, Det, Trans) AW422
- P.W.H. Mascot (Det, R.C, Trans) AW337A
- Cosior Melody Maker with Lucerne coils AW423
- Mullard Master Three with Lucerne coils AW424
- Schoolboy's Three (Det, 2 RC) AW428
- Penta-quester (HF, Pen, Det, Pen) AW431
- £5 5s. Three—De-luxe version (SG, Det, Trans) AW435
- Lucerne Straight Three (Det, RC, Trans) AW437
- FOUR-VALVE SETS (1s. 6d. each)**
- Home-lover's New All-electric 3 for A.C. mains (SG, D, Trans) AW383
- Melody Ranger (SG, D, RC, Trans) with copy of "A.W." 4d. postage AW375
- Signpost Four (SG, D, LF, Class B) AW398
- "A.W." Ideal Four (2SG, D, Pen) AW402
- 2 H.F. Four (2SG, Det, Pen) AW421
- Lucerne Major (2 H.F., Det, Trans) AW433
- "A.W." Short-wave World Beater (HF Pen, Det, RC, Trans) AW436
- FIVE-VALVE SETS (1s. 6d. each)**
- The Etherdyne (Super-het) AW406
- Super-quality Five (2 HF, D, RC, Trans) WM320
- Ideal Home Super (Super-het) WM280
- Easytune 60 (Super-het) WM284
- New Class-B Five (SG, D, LF, Class-B) WM340
- Class-B Quadradyne (2 SG, D, LF, Class-B) WM344
- SIX-VALVE SETS (1s. 6d. each)**
- 1934 Century Super (Battery super-het) AW413
- 1934 A.C. Century Super (Super-het) AW425
- SEVEN-VALVE SETS (1s. 6d. each)**
- Super Senior (Super-het) WM256
- Seventy-seven Super (A.C. Super-het) WM305
- PORTABLES (1s. 6d. each)**
- General-purpose Portable (SG, D, RC, Trans) AW351
- Midget Class-B Portable (SG, D, LF, Class-B) AW389
- Holiday Portable (SG, D, LF, Class B) AW393
- Town and Country Four (SG, D, RC, Trans) WM282
- Everybody's Portable (five-valve Super-het) WM291
- Spectrum Portable (SG, Det, QP21) WM357
- AMPLIFIERS (1s. each)**
- Universal Push-pull Amplifier AW300
- "A.W." Record Player (LF, Push-pull) AW319
- Battery-operated Amplifier AW362
- "A.W.'s" Push-push Amplifier AW376
- Class-B Gramophone Amplifier AW391
- Universal A.C. Amplifier (3-valve) AW411
- Five Q.P.P. Output Circuits WM315
- MISCELLANEOUS (1s. each)**
- "A.W." Trickle Charger AW352
- Add-on Band-pass Unit AW359
- Plug-in Short-wave Adaptor AW382
- Experimenters' D.C. Mains Unit AW430
- Experimenters' A.C. Mains Unit AW432

Copies of the "Wireless Magazine" and of "Amateur Wireless" containing descriptions of most of these sets can be obtained at 1s. 3d. and 4d. respectively, post free. Index letters "A.W." refer to "Amateur Wireless" sets and "W.M." to "Wireless Magazine." Address letters: Amateur Wireless Blueprint Dept., 58-61 Fetter Lane, London, E.C.4

Amateur Wireless **INFORMATION BUREAU COUPON** Available until Saturday, JULY 7, 1934
Printed in Great Britain for the Proprietors and Publishers, BERNARD JONES PUBLICATIONS, LTD., 58-61 Fetter Lane, London, E.C.4, by The Sun Engraving Co., Ltd., London and Watford. Sole Agents for South Africa: CENTRAL NEWS AGENCY, LIMITED. Sole Agents for Australia and New Zealand: GORDON & GOTCH (A/SIA), LIMITED. Saturday, June 30, 1934

★
ARE BRITISH PROGRAMMES WORSE?
by S. P. B. Mais

★
AT HOME WITH SZIGETI

★
A FULL PAGE PORTRAIT of ROY DE GROOT
—the North Regional Announcer

★
HOW THE B.B.C. CHOOSES YOUR DANCE MUSIC
by Paul Hobson

★
The BLUE SATYR
A Romantic Story by Ethel Mannin

These are just some of the splendid contents of Friday's issue of Radio Pictorial. Don't forget to get your copy—the folks at home will enjoy it, too.



EVERY FRIDAY

RADIO PICTORIAL

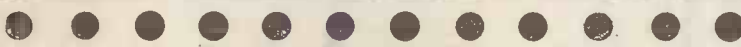

THIS SIGN . . .
 in the theoretical diagram of a receiver means that a Westinghouse Metal Rectifier is incorporated. But, to those who look further than mere theory, it means much more . . . a constant undeteriorating high tension supply, with no replacements or renewals. It stands for reliability . . . which is just another way of saying

WESTINGHOUSE METAL RECTIFIERS

The Westinghouse Brake and Saxby Signal Co., Ltd.,
 82, York Road, King's Cross, London, N.1.

COUPON

Please send me 44-page text book "The All Metal Way, 1934" relating to Westinghouse Metal Rectifiers and their uses. I enclose 3d. in stamps.

Name.....
 Address.....
 A.W.20.6.34

BUILDING THE SIX-GUINEA AC/DC THREE

The July issue of **WIRELESS MAGAZINE** contains constructional and operating details of a reliable all-mains three-valver that can be operated from both A.C. and D.C. supplies without alteration—the "Six-Guinea A.C./D.C. Three." The price of £6 6s. includes every component used in the set, valves and loud-speaker, but not the table cabinet.

Thirty-six stations in an hour's test proves the efficiency of this remarkably inexpensive set.

There are many other fine features in the July **WIRELESS MAGAZINE**—get your copy to-day, price 1/-.

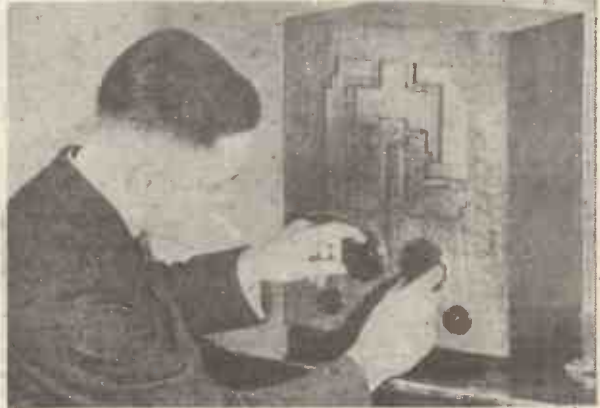

You will agree with us that this six-guinea set is a neat-looking job. And it works well, too!

KINGS OF THE AIR

UNIFORMITY OF CHARACTERISTICS

ensured by the Mica Bridge

Uniformity of valve characteristics depends entirely upon the accuracy with which the elements are spaced. In Cossor Mains Valves this accuracy is ensured by the use of the famous Mica Bridge—a system of construction which permits of the employment of

laboratory precision at all stages of manufacture.

Further, because of the rigidity which the Mica Bridge imparts to the electrode assembly this uniformity of characteristics is maintained throughout.

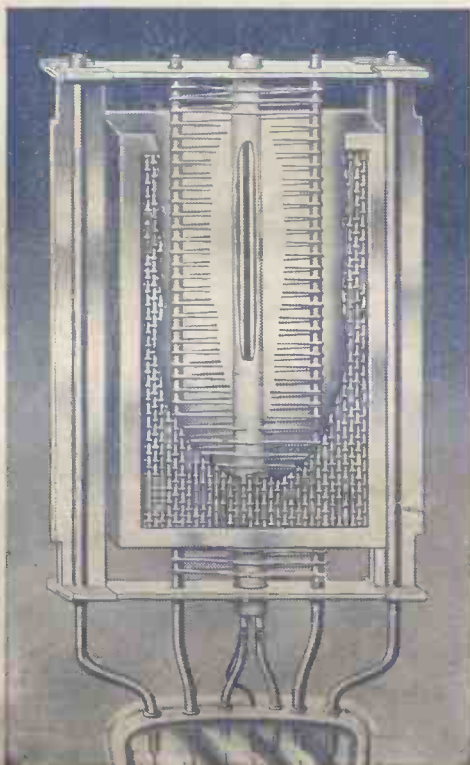

COSSOR

A.C. MAINS VALVES

FREE!

72-page WIRELESS BOOK

From cover to cover this new Cossor 72-page Wireless Book is packed full of useful and interesting information—latest circuits—explanations of technical terms—how a superhet works, etc. Send at once for free copy. Please use the coupon.

To A. C. COSSOR LTD.
Melody Dept.,
Highbury Grove, London, N.5

Please send me free of charge, a copy of the Cossor 72-page Wireless Book.

B.V.33

Name

Address

A.W. 20/6 34

25