

Amateur Wireless,  
June 18, 1932

19  
PUTTING RIGHT UNUSUAL FAULTS

A HOME-MADE SPEAKER GADGET

# Amateur Wireless

Every  
Thursday 3<sup>d</sup>

and  
Radiovision

Vol. XX. No. 523

Saturday, June 18, 1932



THE  
**MIDGET  
TWO**

A  
**HOME-MADE  
LOUD-SPEAKER  
GADGET**

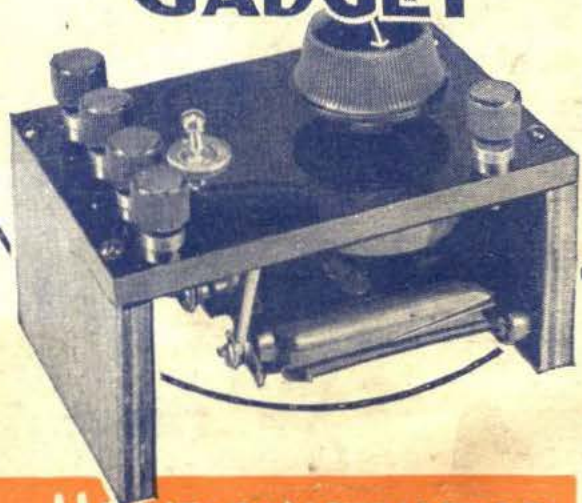

TWO NOVELTIES FOR THE HOME-CONSTRUCTOR

Registered at the G.P.O. as a Newspaper

**SLEKTUN TRANSFORMERS** show a primary inductance 50% greater than any other transformer at double the price. The dependability and the performance of Slektun Transformers are guaranteed for at least three years—a tribute to the skill of British radio engineers and a recommendation to both amateur constructors and expert designers.

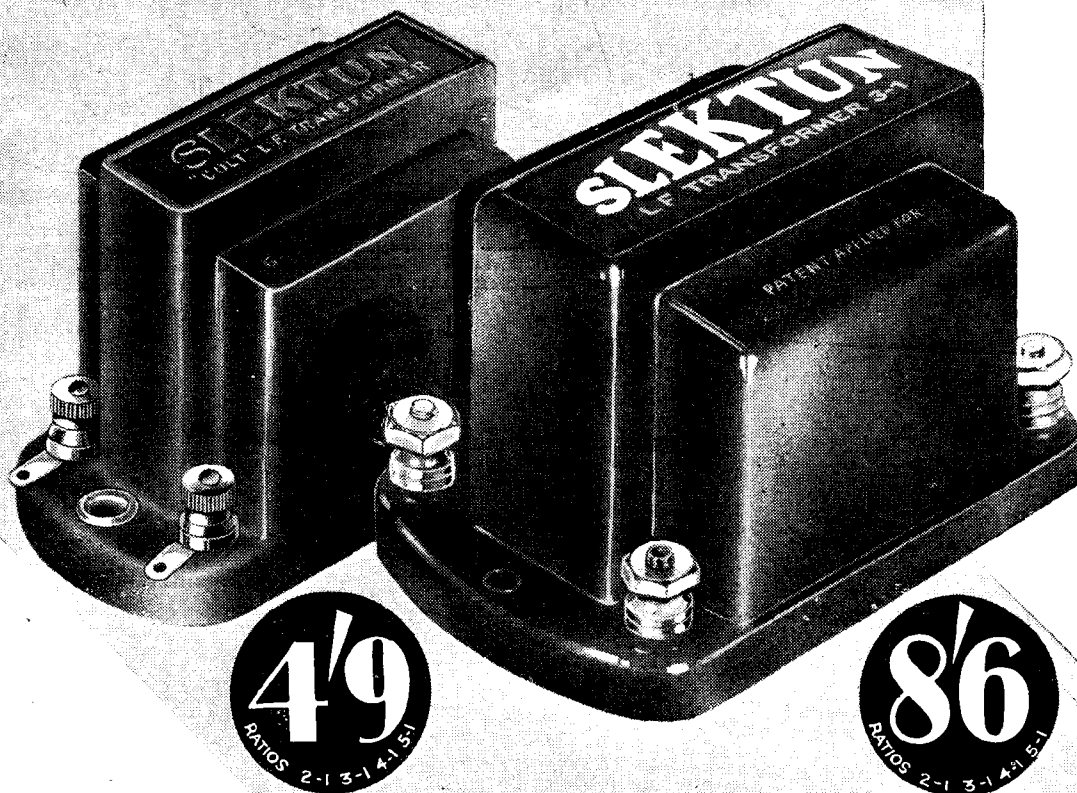

Increase volume and improve quality from your existing receiver—change over to Slektun all-British Transformers and follow the lead of the experts.

# SLEKTUN

The new and amazing L.F. Transformers (obtainable from all good Radio dealers).

SLEKTUN PRODUCTS LTD., 21, DOUGLAS STREET, VAUXHALL BRIDGE ROAD, S.W.1

*You will Help Yourself and Help Us By Mentioning "A.W." to Advertisers*



**BRITAIN'S LEADING RADIO WEEKLY**  
**FOR CONSTRUCTOR, LISTENER & EXPERIMENTER**

**EDITOR:**  
**BERNARD E. JONES.**

**TECHNICAL EDITOR:**  
**J. H. REYNER, B.Sc. AM.I.EE.**

**RESEARCH CONSULTANT:**  
**W. JAMES.**

**ASSISTANT EDITOR:**  
**H. CORBISHLEY.**

**NEWS & GOSSIP OF THE WEEK**

**A REAL PORTABLE**

**A**N extremely useful little portable for hiking or motoring has been specially designed for "A.W." by P. K. Turner, and is described by him in the centre pages this week. This little set measures only 7½ in. by 3½ in. by 5 in. Constructors will also be interested in a novel speaker control unit which changes the tone and switches from one circuit to another. Read about it on page 1003.

**A NEW NATIONAL ORCHESTRA**

**Brighter Scottish Broadcasts**

**Y**ET another new orchestra! The B.B.C. is co-operating in the formation of a Scottish National Orchestra and has arranged to broadcast five concerts of the present Scottish orchestra from public performances outside Glasgow. These broadcasts are to cost £100 each. The B.B.C. is hoping that next year the Scottish authorities will support the Scottish National Orchestra project. It certainly looks as though the critics will have nothing to grumble at in the B.B.C. support of music in Scotland.

**WRITTEN FOR BROADCASTING**

**A** PLAY on midsummer eve, written expressly for broadcasting in the National programme, is a new event by John Drinkwater. Several Drinkwater plays have been broadcast previously, but this well-known dramatist has lately been making a special study of B.B.C. technique.

**BROADCAST FROM BISLEY**

**A** FREQUENT contributor to "A.W.", Capt. E. H. Robinson, is broadcasting a running commentary in the National programme. On July 16 a broadcast will be made of the final of the King's Prize and Capt. Robinson will "commentate" before a microphone. Capt. Robinson is an old prizeman.

**SCOTLAND'S PROBLEMS**

**F**OLLOWING the recent deputation of members of Parliament representing Scotland's interests, the B.B.C. has issued

a well-thought-out survey of broadcasting conditions in Scotland, and it is clearly shown that with the present limitation in wavelengths the North of Scotland cannot hope for any material improvement. Only another long wavelength would solve the problem of covering the mountainous highlands with a signal of real service value. We have only one long wave, and in view of the tremendous population served by the Daventry station there is no hope of Scotland ever making use of it.

**TELLING FIGURES**

**P**ROBABLY the most striking vindication of the present distribution of wavelengths is that afforded by recent statistics issued by the B.B.C., correlating population with licences. The London Regional serves a population of over 13,000,000 people, and there are 1,672,694 licences, while in the Northern region about the same population produces just over a million licences. Midland region, with over 5,000,000 people, has 631,258 licences, Western region with just over 3,000,000 people has 255,886 licences, and the Scottish region, with nearly 4,000,000 people, has 212,292 licences.

**RELAYING BIG BEN**

**Chimes to be Heard in Portland Place**

**A**CTING on the suggestion of the Director General himself, B.B.C. engineers have been trying out the idea of relaying the chimes of Big Ben from loudspeakers erected near the clock on the roof of Broadcasting House. The first tests were done with only two speakers, but these do not make enough noise, so another attempt will be made with a batch of four. If the test is successful it is likely that the chimes of Big Ben will be heard regularly once or twice a day from Broadcasting House. This excellent piece of showmanship may possibly cause a little local feeling, and it might be complained that the relayed chimes are blotting out the near-by chimes of All Soul's, Langham Place.

**IN THE COCKPIT**

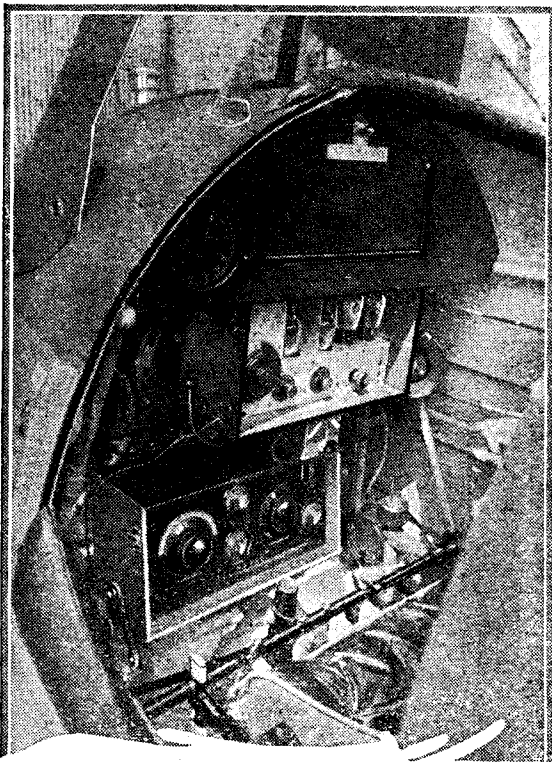

Here, in the cockpit of an Autogyro 'plane, are the radio transmitter and receiver which the police used to control traffic on Derby Day, and which will be used in further police tests. A travelling van with similar radio apparatus was used on the ground

**NEXT WEEK: A CHEAP REGIONAL THREE-VALVER**

# NEWS · & · GOSSIP · OF THE · WEEK —Continued

## QUID PRO QUO!

AMONG the eminent visitors to Broadcasting House—which, by the way, is now looked upon as one of the "show places" of London—must be included Sir Kingsley Wood, the Postmaster-General. Passing through the artistes' foyer he noticed the stamp machine, installed for the convenience of broadcasters, and remarked: "How appropriate—you sell my stamps and I sell your licences!"

## "ENCOUNTERS"

WHAT promises to be a very exciting successor to the "Hazard" series is the new "Encounters" series of talks, arranged to be broadcast every Wednesday evening. One of the most interesting will be given on July 13, when Hashagen, the German U-boat commander, will appear before the "mike" with Commander Lewis, who was in charge of a British submarine during the war. This will not be the first time the two commanders have met. They will recall to listeners how they first met during the war—Lewis's submarine being rammed and sunk by Hashagen! The British crew were taken in tow by the Germans, and on the voyage back to Germany a strong friendship sprang up between Lewis and Hashagen. A curious encounter!

## THE "HAZARDS" CRITICISM

SOME curious objections have been raised about the recent broadcast of a German Zeppelin commander's talk in the "Hazards" series. As the B.B.C. points out, many extraordinary hazards were experienced in the War, and not only by Britishers. If the programme staff were

to listen to the plea that such talks as the Zeppelin raid on London should be barred for fear of hurting the feeling of relatives of war victims, the logical plan would then be to exclude from the programmes all references to war. Actually, it is surely obvious that talks showing how much both sides suffered are the best antidote to war we could possibly have?

## FOOTBALL BAN TO CONTINUE

IN spite of valiant attempts to bring a little reason into the proceedings, Dr. R. Simpson, of Newcastle United, was unsuccessful in his recent plea to the Football League that running commentaries should be allowed at the discretion of the individual clubs. The general ban on broadcast "footer" continues, and the outlook for the coming season is, from the listener's point of view, gloomy.

## THOSE UNDECORATED STUDIOS

MANY of the studios at Broadcasting House, as we have previously remarked, are still awaiting decoration, especially the Productions and Children's Hour studios. The B.B.C. proposes to take its time over these, so as to avoid the constant alterations that occurred in many of the studios at Savoy Hill. In the meantime, the undecorated studios can, of course, be used, as the walls are acoustically treated to produce the required reverberation periods.

## THESE THINGS WILL HAPPEN

DID you by any chance hear the unintentional broadcast of an engineer's test remarks during last Sunday's midday concert from Broadcasting House? Apparently a pilot loud-speaker placed between the dramatic studio and the studio in which the orchestra was playing was turned full on, so much so that its output penetrated right through the studio wall—and the engineer's speech was picked up on the all-too-sensitive microphone!

VERY LIGHT MUSIC  
TALKING of the Sunday programmes, have you not been agreeably surprised at the lightness of the light music. Even dance tunes have been played. Radio Paris will have to look out!

## VERY HEALTHY!

What the Fifth Annual Report Reveals  
IN the fifth annual report of the B.B.C. is disclosed a very sound financial

position, with licence and publishing revenues well up on the previous year, in spite of the generous gift to the Treasury. Fears are again renewed that the Treasury, noting the steadily increasing revenue from licences, may seek to divert part or all of the money to the needy coffers of the State. "Hands off listeners' money!"—and so say all of us!

## SPONSORED PROGRAMMES

INDIGNANT denials of any change in its point of view to sponsored programmes are voiced by B.B.C. officials. They admit that there is a renewal of talk about handing over the onus of paying for the programmes to advertisers, but it is thought that such rumours as have gained ground are due to fears of Treasury designs on the revenue. What seems to have escaped notice is the rather obvious reflection that listeners would immediately stop paying licence fees if advertisers took over the service, for it would be maintained, with some justice, that the purchase of the sponsored goods was indirect payment for the programmes!

## WELL-DESERVED HONOUR

WE should like to add our congratulations to those offered by the B.B.C. staff to Admiral Carpendale on his recent knighthood, as announced in the Birthday Honours List. The "breezy gallant sailor" has long been Sir John Reith's right-hand man, and he is, of course, responsible for the discipline of the B.B.C. staff. He has the sailor's faculty of being able to shed his official cloak when necessary, and is usually the life and soul of B.B.C. staff parties.

## STILL EFFECTIVE!

WE understand that the Post Office "detection" van has been busy around the west, particularly in Torquay, Exeter and Plymouth. A good crop of licences has resulted, thereby giving the lie to the rumour that the van had ceased to strike terror in the hearts of "pirates."

## IMITATION IS . . .

FRANCIS LAWTON, the station manager of Radio Excelsior, in the Argentine, is over here to study B.B.C. methods of broadcasting. He is taking back with him a 20-kilowatt Marconi transmitter, so no doubt before long the South American audience will have a taste of broadcasting as we know it. Very nice too!

## OH BOYS!

### Natty Summer Suitings for Henry's Boys

FOR the summer season the members of Henry Hall's dance band have evolved a new uniform. The details are most alluring. Imagine for yourself—light blue jackets, grey flannel trousers, soft tennis shirts, with electric blue bows—and brown shoes. No rule has been made as to the colour of socks, and Henry's boys are expected to run into a riot of individuality in this one particular!



"I think an outdoor aerial is a great aid to reception."  
"Yes, but an indoor aerial is an aid to deception!"

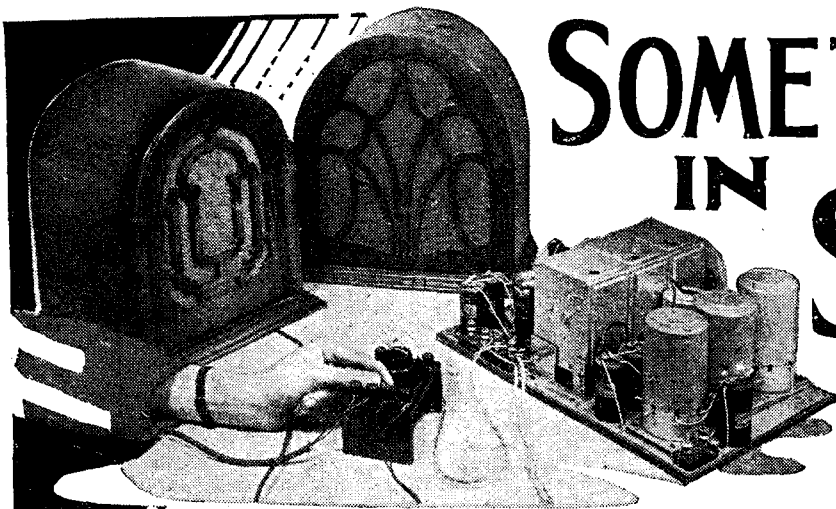

# SOMETHING NEW IN SPEAKER CONTROLS

If you have more than one loud-speaker then you cannot fail to be interested in this simple little device for switching, and matching up the tone

**T**HIS new idea in speaker control is more than just a switch for two speakers, or a tone control on only one circuit.

It is far more helpful than that. Just what it does is best explained by an illustration of what happens when two speakers are used on a set, one close to the output stage and the other at a distance, perhaps in another room.

First, there is the difficulty of switching. If no switch is fitted to change over from one speaker to another then there is the tiresome necessity of changing over the actual speaker leads. This is not only tiresome but rather likely to produce short circuits, so that neither of the speakers works.

Second, there is the difficulty that unless the speakers are of exactly the same type, the output of each will not be the same, and while the speaker close to the set can be conveniently adjusted for tone and quality, the distant speaker cannot be so easily regulated.

The little unit which is illustrated here overcomes these difficulties. It is designed

to fit close up to the set or it can be fitted inside the set itself, so dispensing with external leads. It is fitted with a two-way switch so that at the touch of the switch knob the set output can be changed from one speaker to another. If the unit is mounted inside the set, then the switch should be on the panel so that the non-technical members of the family can choose the speaker they want.

A further advantage with this new speaker control is that it has a variable tone-control, so that instant and easy variation of tone can be made, thus matching up both speakers. This is handy because the position of the knob at a suitable resistance value for each speaker can be marked, and when the change-over switch is moved the tone control can be correspondingly varied, ensuring that the tone is satisfactory on both speaker lines.

There are several ways of changing the natural reproduction tone of a speaker, but the method used in this unit and shown in the theoretical circuit diagram is very easy and quite effective. A .02-microfarad condenser in series with a variable resistance is placed across the input terminals of the unit. The value of the shunt circuit is varied by changing the resistance value. A resistance having a maximum value of 50,000 ohms is used and a variation of this has exactly the same effect as variation of the shunt capacity. It results in a varying degree of high-note cut-off. If your speaker is too sensitive to the higher frequencies,

then the presence of the condenser across the windings will bypass part of the high-frequency input, and will result in the tone being changed.

The connections of the few parts needed for the unit are quite straightforward, and the theoretical circuit is shown in the circuit diagram. It is so simple that no detailed wiring instruction is needed.

To ensure good results you must have parts of exactly the same electrical values

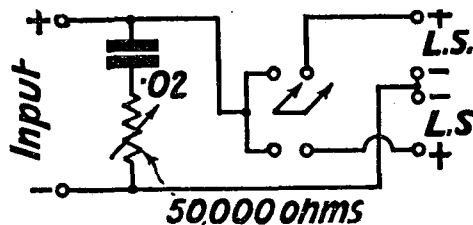

The circuit of the control

as those used in the actual unit described. The parts will be found in most enthusiasts' junk boxes. The values are suitable for every standard type of speaker and set output arrangement. The 50,000-ohm resistance gives a useful range of tone control on most circuits.

It does not affect the results in any way if one or other of the speakers is disconnected. The switch is simply moved over to the "on" position for the speaker being used and the tone control varied to suit the windings.

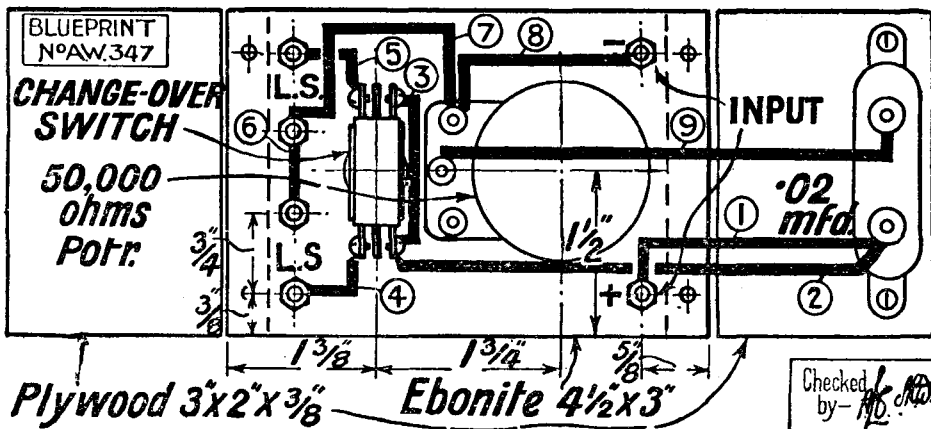
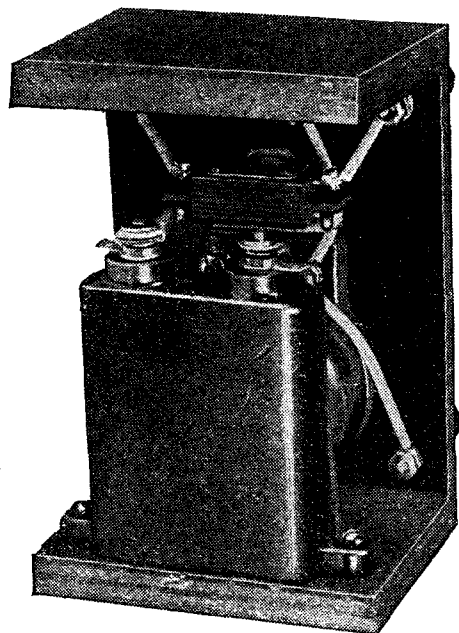

An underside view of the speaker control and the layout and wiring diagram

## PERCY W. HARRIS ON SOME UNUSUAL FAULTS

THE other evening I had the opportunity of looking over a reader's "Mascot" which was not up to the mark. However, before the evening was out we had it working in fine style. The faults we discovered could have happened in many kinds of sets, so I am going to devote this week's article to them. It was one more case of several faults together producing rather strange results.

Briefly the faults were these. The tuning positions were all wrong, London Regional coming about where you would expect North Regional to be, London National falling where you would expect London Regional, and nothing much could be found above London Regional when using the set on the band-pass side. Secondly, when used on this side, the performance was poor and the tuning on the first condenser very flat. If the compression condenser was unscrewed sufficiently to get anything like reasonable selectivity for modern conditions, the signal strength was cut down almost to vanishing point. Thirdly, while reaction seemed satisfactory on the medium band, the set could not be made to come anywhere near the critical reaction point over more than half of the long-wave band, and Radio Paris was by no means the strength it should be, even on a good aerial.

### Points to Watch

The valves were all of a well-known make, suitable for the sockets in which they were used, and comparative tests with other valves showed they were "up to scratch." At first glance it might be expected the wrong tuning position and the impossibility of getting anything on the upper end of the medium-wave band would be due to faulty coils—in particular to insufficient turns. The coils were home made, but I know the set so well that a glance at the medium-wave band coil showed me that it had approximately the correct number of turns. There was a similar trouble on the long-wave side, although not quite so marked, but here, of course, one could not see by

inspection whether the number of turns was correct.

More careful examination of the set suggested that the variable condensers were by no means up to their rated capacity. It is often difficult to judge these matters visually, but I felt convinced that they were well below .0005 and on looking to see the name of the maker, I found it had been missed out! This always arouses suspicion in my mind, for a good maker ought to be and generally is proud of his product, so that when condensers or other components are not marked, they are immediately suspect as far as I am concerned. It was a simple matter in the laboratory to disconnect the two leads from each condenser and connect it to a capacity bridge, whereupon measurements showed that the maximum capacity was .00027!

### A Substitution Test

We then took the two condensers out and replaced them by two well-known makes of the full rated capacity. The wavelength range of the set was now found to be correct, but reaction, while still adequate on the medium band, was insufficient on the long. Furthermore, the flatness of tuning and lack of sensitivity still remained, although there was some improvement in this regard.

I then observed that .01 coupling condenser in the by-pass circuit was of the Mansbridge or paper type. You will have noticed in the full-sized diagram of the "Mascot" I used the mica type of .01 condenser and not the Mansbridge type. The mica type is much more satisfactory in such a circuit as this, for condensers with paper dielectric were not designed for use in radio-frequency circuits although they are excellent for shunting batteries, decoupling, and so forth. If you examine the circuit you will see that this .01 condenser is in series with each of the variable condensers, being indeed, the coupling between the two circuits, and the effect of having a high-loss condenser here is to add very appreciably to the total loss in the circuit. By substituting a suitable type of condenser here, both signal strength and selectivity went up at once and the set worked satisfactorily on the medium band.

We were still faced, however, with inadequate reaction on the long-wave band and as both bands should now be adequately covered in the tuning range, and as moreover the reaction winding was adequate to the medium band, I could see no reason why it should not be for the long wave. A possible source of trouble could, in this

case, be a poor radio-frequency choke. If it did not "choke" on the long-wave band, this would, of course, account for the whole trouble. Taking from my shelf an inexpensive choke of well-known make which I knew to be satisfactory, I took out the original choke and replaced it by this new one, whereupon reaction was delightfully smooth over both bands and results were equally satisfactory on either.

### Check the Valves

A quick run round the dial, both on an indoor and an outdoor aerial, showed that the "Mascot" was now "bringing them in" as claimed. I then went to demonstrate the separation of Mühlacker from the London Regional. With the valve in use, the separation was by no means complete and another of a different make, but with similar characteristics, was substituted, whereupon we were able to get complete separation with good strong signals from Mühlacker. This suggested that there was considerable difference in the valves, but after one or two other changes of quite inconclusive nature, the quality of the set went right off and the sensitivity went down nearly to zero, accompanied by a tremendous hum. Further examination showed a faulty detector valve-holder, this being of the type where there are a number of screwed connections inside, one of which had come loose. The set could be put right by "wiggling" the valve, when it worked satisfactorily for the time being, but of course a change of valve holder was necessary. After this contact had been put right, the original valve worked quite satisfactorily, giving all the separation required.

### AUTOMATIC D.F.

ALL passenger ships of over 5,000 tons are now compelled by law to carry wireless direction-finding equipment as an aid to safe navigation in foggy weather. In the latest type of apparatus the bearings of a beacon station on shore are indicated directly and automatically to the navigating officer. A frame aerial on board the ship is rotated mechanically at high speed, and the varying pick-up, from maximum to minimum, is passed through the moving coil of a galvanometer. The needle of the galvanometer tends to set itself in the direction of maximum current, i.e. in a direction pointing towards the shore beacon transmitter. The rotating frame aerial is usually mounted on the deck of the ship, whilst the course indicator is conveniently located in the chart-house.

M.A.L.

*The Fly on the Wall*, by Elizabeth Illingworth, is a short play which will be heard by North Regional listeners on June 23.

An orchestral concert by the Northern Studio Orchestra, to be broadcast on June 24, has been entitled "Midsummer's Day."

Mr. Alfred J. Brown's talk in the "Holidaying with Our Ancestors" series in the North Regional programme on June 20, deals with "Tramping the Drove Roads."

The soloists in the Sunday afternoon concert on June 26 for Scottish listeners are Guy Daines, who is the leader of the studio orchestra, and Ian Whyte, the B.B.C.'s Musical Director in Scotland.



Resourcefulness at Pangbourne—or when the nightingale refused to broadcast

# How the Derby was TELEVISED



**A**BOUT fifteen miles from Epsom Downs a London cinema audience on June 1 watched the parade of the horses and the finish of the world's classic Derby race at the same instant as it was seen by the crowds on the course itself. This was the result of the most ambitious experiment ever attempted in the science of television and reflects the greatest credit on Mr. J. L. Baird.

As I was a participant in the work involved I am sure readers of **AMATEUR WIRELESS** will be interested in learning how the results were achieved.

## Daylight Television

First of all, then, a word as to how the plans were laid. Some time ago demonstrations had been staged at the Baird Company's laboratories in which daylight scenes were shown on an ordinary Televisor,

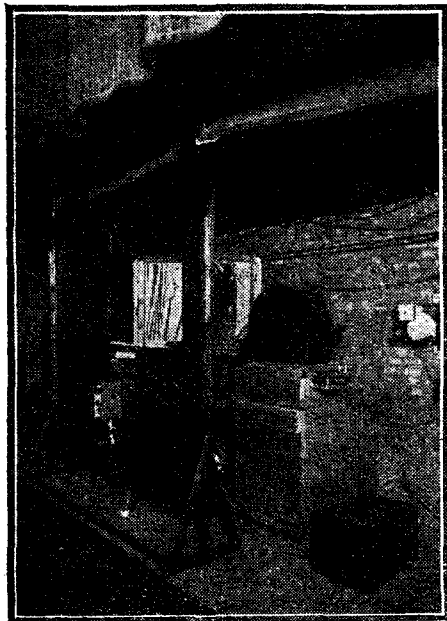

A side view of the three-zone projection receiver installed at the back of the Metropole cinema

and on another occasion a three-zone experiment portrayed flood-lighted scenes on a small screen built up as a three-section picture.

With the data obtained it was decided to combine the two results and about a fortnight before Derby Day an innocent-looking trailer caravan took up a position beside the rails of the Epsom course opposite the finishing post at the Grand Stand. The apparatus in the caravan was

By **H. J. BARTON CHAPPEL**  
Wh. Sch., B.Sc.

able to "pick-up" daylight scenes through the medium of a three-zone transmitter.

Briefly this transmitter consisted of a large and heavy mirror drum driven at a speed of 750 revolutions per minute by a constant-speed motor. Around the periphery of this drum were arranged thirty mirrors each set at a slightly different angle from the preceding one.

## The Three-Zone Scheme

When revolving rapidly, therefore, a succession of images of the scene reflected on the mirrors was thrown on to a lens, and these were made to move over three distinct apertures admitting the different degrees of light and shade comprising the scene to three individual photo-electric cells. Part of this apparatus is seen in the accompanying illustration, while the explanation will be made clearer by a reference to the pictorial diagram on next page.

Each of these cells converted the light and shade effects, into equivalent terms of electrical variations in the associated amplifier circuit and the separate signal zones each had powerful valve amplifiers for the purpose of increasing the signal strength hundreds of times before being passed to the telephone lines laid under the course for transmission to the Baird Company's control room at Long Acre.

From here they were relayed to the back of the stage at the Metropole Cinema, Victoria, where the television receiving apparatus complete with amplifiers had been installed. This giant televisor was of entirely new design and had never before been used.

Essentially it consisted of three small arc lights set at the ends of two arms arranged at right angles. At the end of the fourth arm was a thirty-mirror drum geometrically similar and automatically synchronised with the transmitter drum.

Three light valves were interposed in the paths of the arc-light beams, each valve being responsible for one zone. In this way the beams were modulated in accordance with the received signals and passed to the revolving mirror drum. The centre zone reached the drum in a direct line, but the other two, as they were situated on either side of this direct path, had their beams bent at right angles by means of Nicol prisms.

The three separate zone beams, varying in intensity, were reflected from each of the thirty mirrors as the drum revolved, but owing to the lack of depth at the back of the stage it was not possible to throw these resultant reflected beams directly on to the screen, and the drum therefore revolved in a plane parallel to the screen, and the light was diverted by means of a large plate-glass mirror set at an angle of 45 degrees.

The three adjacent zones built up of  
*(Continued at foot of next page)*

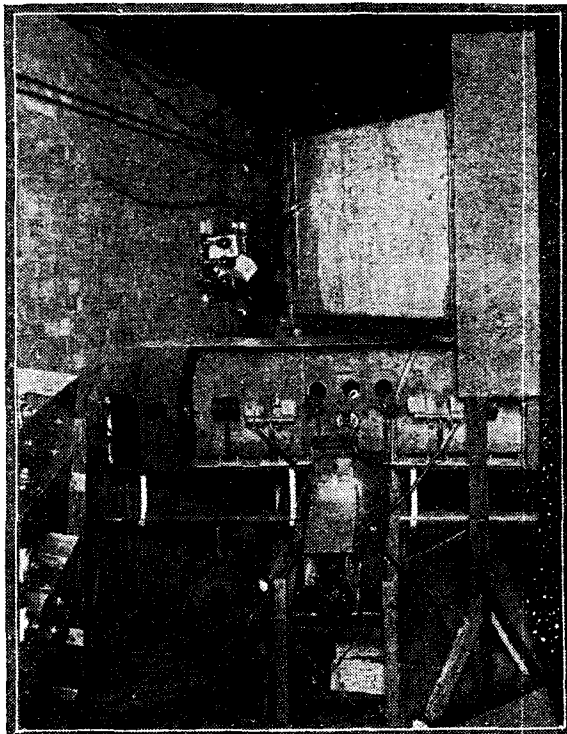

Showing the positions of the arc lights relative to the screen

**WHAT IT IS FOR.**

**THE GRAMOPHONE PICK-UP**

**I**N brief, the gramophone pick-up, or electric sound-box, as it is sometimes called, is for converting mechanical variations into electrical variations.

The mechanical variation is set up by the gramophone needle travelling over the grooves of the record. As the record revolves the wavy lines in the groove cause the needle to move from side to side.

This mechanical movement is utilised in the pick-up to cause variations in a magnetic field. This field is created by a permanent magnet, usually having four poles.

Lines of force are set up across the space between the pole pieces and in this field of force is an armature. Between the armature and the magnet poles is a coil of very fine wire, and this is known as the armature coil.

The armature is pivoted between the poles of the magnet, and is mechanically connected to the needle socket.

The action of this mechanism is quite easy to follow. Let us start with the

vibration of the needle, as caused by its movement on the record.

The needle vibrates, and so therefore does the armature. But the armature

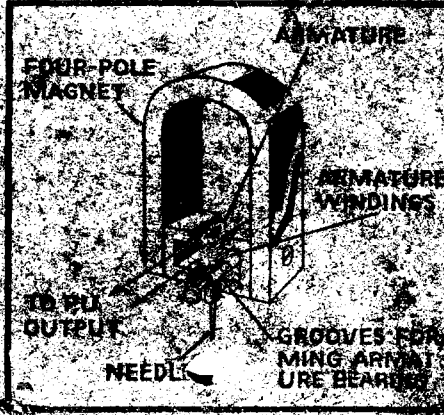

This sketch shows the main construction features of a typical gramophone pick-up. At the centre is the armature, pivoted between the pole pieces of a permanent magnet. Between the armature and the magnet is the armature coil, in which the voltages are developed, as explained in the article.

is in a magnetic field, which is consequently disturbed by the vibrations. But also in this field is the armature coil. When the field is varied, voltages are set up in the coil.

Thus indirectly we see that needle vibrations cause voltage variations in a pick-up or armature coil.

These voltages are much the same as wireless signals of low-frequency, and they can be amplified accordingly, and turned into sound by a loud-speaker.

Although a relatively simple apparatus, the pick-up is not easy to design for an even-frequency response. The aim is to make the armature vibrate equally well to all frequencies from about 50 cycles to 5,000 cycles, without unduly accentuating any particular frequency.

It may vary considerably in a soft spot. Some give a very small voltage output, and others a volt or more.

As is easy to amplify the pick-up voltage, this point is not a very important one, and should be considered as being of secondary importance to frequency response. **Horsbur**

**"HOW THE DERBY WAS TELEVISED"**

*(Continued from preceding page)*

thirty light strips were carefully phased, matched, and framed so that they would bind themselves into a composite picture, and in this way the large screen picture was made possible. The size was approximately 10 feet wide and 8 feet high, the screen itself being made up of a specially prepared wax composition.

Since telephone facilities were used for this experiment it is reasonable to enquire why the picture ratio of each zone was maintained at 7 by 3, the Baird standard, and the flicker not removed by doubling the speed to 25 pictures per second. The reason was so that the centre zone could be broadcast by the B.B.C., and this wireless transmission took place on the afternoon of Derby Day through the medium of the London National transmitter on a

wavelength of 261 metres. In this way it was possible for owners of Televisors to see sections of a televised Derby in their own homes.

At 2.40 p.m., through the medium of two P.A. loud-speakers, were heard the remarks of the commentator perched on the top of the caravan at Epsom, as soon as the parading horses came within the range of the transmitter the curtains were drawn aside and on a well-lighted screen in the centre of the stage was visible the course and the Grand Stand in the background. The jockeys on their horses then trotted past in succession, turned round and cantered to the starting post.

Although the screen blurred and was somewhat blurred at times, men and mounts were clearly visible and the audience, amongst which were numbered many scientists, was quick to respond to the wonder of Mr. Baird's achievement. After a pause the commentator called that the start of the race had been made, and about two and a half minutes later the winning jockey flashed by with the remainder of the field close behind. Tom Walls was afterwards seen leading his winning horse into the paddock.

The experiment was repeated for the Oaks with equal success while during the whole of Derby week single zone transmissions from the Baird studios formed part of the Metropole programme, being shown three times daily. Celebrities and artists were televised and amongst those seen by the audience, although two miles away, may be mentioned Lord Amptill, Sir Richard Gregory, Sir Ambrose Fleming, Sir Ian Hamilton, Mr. Gordon Setridge, Col. Moore-Drabazon, Captain Ian Fraser, H. W. Austin, Miss Amy Johnson, Miss Gracie Fields and Mr. James Mollison.

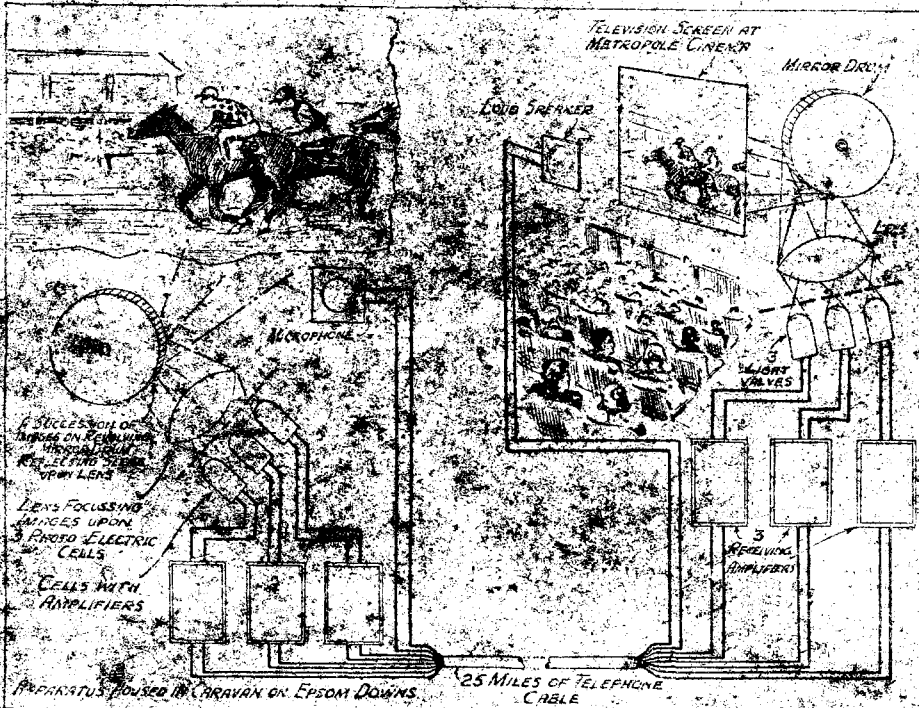

A pictorial diagram showing the scheme used for televising the Derby.



*A Special Offer  
you must not  
Miss*

A WORLD-FAMOUS MAKE OF  
**TRIPLE SPRING  
GRAMOPHONE MOTORS**  
BRAND-NEW

At  
**Less Than  
HALF  
PRICE**  
THE FINEST SPRING MOTOR EVER MADE

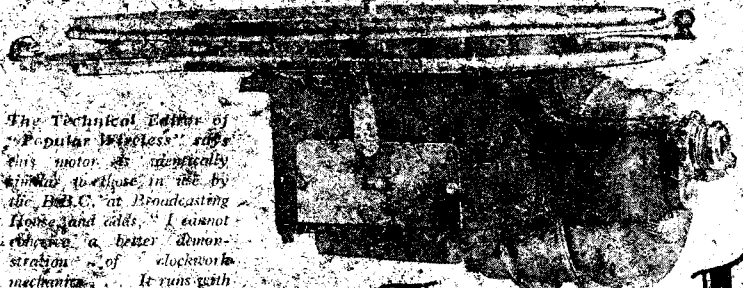

The Technical Editor of "Popular Wireless" writes: "This motor is identical with those in use by the B.B.C. at Broadcasting House and adds a better demonstration of clockwork mechanics. It runs with perfect sweetness and dead silence... it will be an exceptionally good and probably extremely expensive electric motor which will displace this bargain-price triple spring motor." —Popular Wireless, May 28, 1932.

OFFERED AT  
LIST PRICE  
**£4 : 1 : 3**  
**B5H**  
CARRIAGE PAID

PLAYS 3-12" or 4-10"  
RECORDS AT ONE WINDING

If you have a gramophone or radio-gram, here is your opportunity to convert it easily into a long-playing, silent-running super instrument. Or you can make a fine new gramophone at very little cost. These Super Triple-Spring Gramophone Motors were specially made by the famous Garrard Company for one of the largest English gramophone factories, which has since closed down. The motors were intended for use exclusively in gramophones selling at £25 and upwards. List Price 81/3, but now offered to readers of "Amateur Wireless" for only 35/- This is indeed the opportunity of a lifetime. Secure yours while the offer lasts.

This Super Triple-Spring Motor embodies three distinct spring drive units and is thus three times as powerful and long-running as ordinary single-spring motors. Fitted with motor plate, speed regulating lever, safety friction clutch, 12-inch turntable, winding handle, and automatic brake. All bright parts heavily nickel plated. All working parts totally enclosed. Silent running, silent wind.

**CABARET ELECTRIC CO.**  
170, Vauxhall Bridge Road, London, S.W.1.  
and 258, High Street, Lewisham, London, S.E.13

Postal Orders and Money Orders should be crossed and Treasury notes sent by registered post

Manufactured by  
the world famous  
**GARRARD**  
Engineering & Mfg. Co. Ltd.

**IMPROVE YOUR SET  
with the BEST CHOKE YET!  
IGRANIC!**

UNCOMPARABLE FOR CLARITY  
OF RECEPTION!

Put an IGRANIC Choke in your set and you will be astounded at the remarkable smoothness and beautiful clarity of your reception. IGRANIC chokes entirely banish all "harshness" — the crowning effort of years of research work by IGRANIC experts. Supplied in the following types:

Type C45 is specially suitable as a smoothing choke in R.T. supply units for receivers where the total output is not more than 40 milliamperes. Also suitable as a low-frequency choke. Price 12/6 each — and worth it!

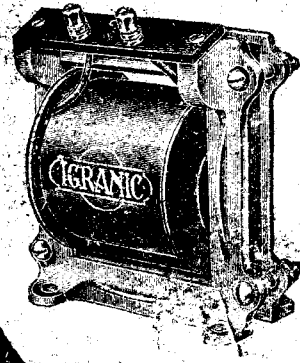

FROM  
**8'6**

"If it's IGRANIC.....it's best for your set!"



IGRANIC ELECTRIC CO., LTD.  
149 Queen Victoria Street, London.

Type C20. Constant inductance of 20 henries with pole-zero currents up to 15 milliamperes, D.C. resistance, 1,000 ohms. Price 8/6 each  
Type C80. Constant inductance of 80 henries with currents up to 80 milliamperes, D.C. resistance, 840 ohms. Price 17/6 each

Write for descriptive leaflet No. C17.

Mention of "Amateur Wireless" to Advertisers will Ensure Prompt Attention

# New Times Sales Co

## EVERYTHING RADIO

### EASIEST TERMS

- SUPER V.3. KIT** ("Radio for the Million") for mains, including valves, cabinet, speaker, and A.C. mains equipment. Cash Price **£15/11/3**. Balance in 11 monthly payments of **28/6** only.
- V.3 RADIO FOR THE MILLION.** With Valves, less cabinet. Cash Price **£5/10/9**. Balance in 11 monthly payments of **10/1**.
- GOSSOR EMPIRE MELODY MAKER Model 234.** With Valves and Cabinet. Cash Price **£6/8/6**. Balance in 11 monthly payments of **10/-**.
- GOSSOR ALL-ELECTRIC MELODY MAKER, Type 235.** Complete with Valves and Cabinet. Cash Price **£9/9/6**. Balance in 11 monthly payments of **17/4**.
- W.B. PERMANENT MAGNET MOVING-COIL SPEAKER P.M.3.** Complete with 3-ratio input transformer. Cash Price **£2/12/6**. Balance in 11 monthly payments of **4/10**.
- R. & A. "100" PERMANENT MAGNET MOVING-COIL SPEAKER.** Complete with multi-ratio input transformer. Cash Price **£2/17/6**. Balance in 11 monthly payments of **5/4**.
- BLUE SPOT SPEAKER UNIT AND CHASSIS, TYPE 1000.** Cash Price **£1/19/6**. Balance in 7 monthly payments of **5/5**.
- W.B. PERMANENT MAGNET MOVING-COIL SPEAKER. Type P.M.4.** Complete with Transformer. Cash Price **£2/2/0**. Balance in 7 monthly payments of **5/9**.

- R. & A. CHALLENGER PERMANENT MAGNET MOVING-COIL SPEAKER** With special Ferranti multi-ratio input transformer. Will operate from a 2-valve set up to a power amplifier. Cash Price **£1/15/-**. Balance in 5 monthly payments of **6/6**.
- CELESTION P.P.M. PERMANENT-MAGNET MOVING-COIL SPEAKER,** with impregnated diaphragm and dual-impedance input transformer. Cash Price **£2/7/0**. Balance in 7 monthly payments of **6/6**.
- ULTRA IMP PERMANENT-MAGNET MOVING-COIL SPEAKER,** with input transformer. Cash Price **£2/15/0**. Balance in 11 monthly payments of **5/-**.
- BLUE SPOT PERMANENT MAGNET MOVING-COIL SPEAKER R.100,** with input transformer. Cash Price **£3/15/0**. Balance in 11 monthly payments of **6/11**.
- CELESTION MOVING-COIL SPEAKER R.P.M.12.** Complete with step-down transformer. Cash Price **£7/0/0**. Balance in 11 monthly payments of **12/10**.
- ATLAS A.C.188 ALL-MAINS UNIT.** Two variable and one fixed tappings. Trickle charges 2, 4, or 6 v. at .5 amp. Cash Price **£5/0/0**. Balance in 11 monthly payments of **11/-**.
- ATLAS A.C. ELIMINATOR, TYPE A.C.244.** Three tappings S.G., detector, and power. Output, 120 volts at 20 m.a. Cash Price **£2/19/6**. Balance in 11 monthly payments of **5/6**.
- EPOCH J.1 PERMANENT MAGNET MOVING-COIL SPEAKER** with 3 ratio input transformer. Cash Price **£2/5/0**. Balance in 11 monthly payments of **4/2**.
- ANY ITEMS ADVERTISED IN THIS JOURNAL SENT C.O.D. IF VALUE OVER 10/- SENT ALL C.O.D. CHARGES PAID.**

**To NEW TIMES SALES CO.**  
 56 Ludgate Hill, London, E.C.4  
 Please send me (a) Free 1932 Catalogue  
 (b).....for which I enclose  
 first payment of £.....s.....d.....  
 Name.....  
 Address.....  
 A.W. 18/6/32

## DON'T TAKE RISKS!

**LISTEN WITH SAFETY**  
 When you fit an "Ealex" Combined Switch you do more than interpose a switch between your aerial and set, you put safety in the circuit because in every Ealex Switch there is incorporated a lightning spark-gap of approved pattern and robust construction that will short to earth lightning—even when your Set is working. It also incorporates a lead-in tube. This neat three-in-one gadget costs only 2/-. Beware of inferior imitations. You can have no better guard for your house and set than an "Ealex" Lightning Switch.

**PRICE 2/-** WRITE FOR LIST B22

**J. J. EASTICK & SONS,**  
 EELEX HOUSE, 118 BUNHILL ROW, LONDON, E.C.1.  
 Phone: Metropolitan 0314/5/6

## ELECTRADIX BARGAINS

- LOUD SPEAKERS.**  
 New 2,000-ohm Horn Silvervox, as illustrated, by Silvertown Co. A two-guinea speaker for **11/6**. Limited number. Moving Coil 4/6 volt Kolster, **20/-**; Jensen 6 volt, **25/-**; 6 volt Dyno plus, **25/-**; B.T.H. 100 volt Speaker Pots, **10/-**; R.K. 220 volt, D.C., **40/-**; ditto big Cinema Speakers, **45/-**; A.C. Speakers, 120 to 250 volt four-guinea Jensen for **55/-**.
- TRANSFORMERS.**  
 Intervale Erisson, **2/6**; Sifam, ditto, power, **4/9**; Western Electric, 2-1 ratio, **2/6**; Mains Parmeko, big power H.T. and L.T. £4 10s. type for **45/-**; B.T.H. Panatrop, ditto, **45/-**; Mains 220 volt to 8 volt 1 amp., **6/6**.
- PHOTO CELLS, 25/-.**  
 Genuine U.X.867, as illustrated, made famous by the well-known R.C.A. Talkies. Faithful light to sound reproduction with a 50-watt lamp only. Every radio user should have one of these £7 photo cells whilst available at **25/-**; B.T.P.-King Cells, **15/-**.

**H.T. & L.T. DYNAMOS**  
 A Bargain  
 To clear our surplus we are offering these £15 Double Current Generators at less than a twelfth cost. They have two comms. for D.C. 6/8 volts at 3/5 amps. L.T. 400/600 volts 100 m/a. H.T. 12 in. long, 17 lb. weight, 3,500 revs. Ball bearings, carbon brushes. Clearing surplus soiled stock at sacrifice price of **22/6**. Each machine tested and guaranteed 12 months. Carriage **2/6**.

**ELECTRADIX RADIOS**  
 218, UPPER THAMES STREET, E.C.4.

## 1st AGAIN

Concurrent with the latest Westinghouse Rectifiers, HEAYBERD introduce their new Mains Transformers. Since 1923 Heayberd have been leaders in the design, quality, and delivery of Transformers. Now... first again! Three new Mains Transformers for use with the latest Rectifiers, HT9, HT10, and HT11.

	Secondary Tappings	Capacity	Rectifier	Rectified Output
W.33	240 v.	200 ma.	HT9	300 v.
	4 v.	5 amps.	A.C. valves	60 ma.
W.34	150 v.	550 ma.	Power valve	200 v.
	4 v.	1 amp.	HT10	100 ma.
W.35	300 v.	550 ma.	A.C. valves	100 ma.
	4 v.	1 amp.	Power valve	500 v.
	4 v.	5 amps.	HT11	120 ma.
	4 v.	2 amps.	A.C. valves	120 ma.

Prices: W.33, 35/-; W.34, 45/-; W.35, 65/-

Send now, enclosing 3d. stamps, for Lists, with diagrams, giving the range of Heayberd Mains equipment.

**F. C. HEAYBERD & CO.**  
 10 FINSBURY ST., LONDON, E.C.2  
 One minute from Moorgate Und. Station

*Your Faithful Servant*

Are you hearing the broadcast as really should be?—every instrument, every note clearly identified? Only a high grade speaker makes this possible, and here is one at a price as low as its quality of performance is high. Hear it and know how satisfying good Radio can be.

**39/6**  
 INCLUDING MULTI-RATIO O.P. TRANSFORMER

**GOODMANS DREADNOUGHT PERMANENT MAGNET MOVING COIL REPRODUCER**

From your Dealer or direct from  
 M.C. Dept., Goodmans, 60 St. John St., London, E.C.1

# On Your Wavelength!

## HEARING THROUGH THE AGES

**H**OW much more attention has been paid to the science of hearing since broadcasting started is once more emphasised by some interesting experiments recently carried out by Bell Laboratories. The question was: "Do Our Ears Grow Old?"—meaning, of course, does the response to the frequency range of speech and music deteriorate with age?

The answer appears to be very encouraging for the old folks, for, although some loss of high-note appreciation was found to occur, this was found to be much less than is generally supposed. The investigation was carried out with a Western Electric audiometer, which consists of an oscillator capable of producing any one of eight different pure tones varying in octave steps from a frequency of 64 cycles to over 8,000 cycles.

Various age groups were gathered together for the experiments, which indicated that in general the effect on the hearing ability of advancing age is simply to reduce the effect of high frequencies above 2,000 cycles. Below 2,000 cycles the difference between young and old was found to be negligible.

It is pointed out that even those suffering from high-note loss, so to speak, would not notice it in certain circumstances. The loss of the higher notes normally means inability to distinguish certain consonants and the timbre of certain musical instruments. In ordinary conversation the measured loss would not be appreciated by those suffering from it owing to the high level of sound at the ear.

## LOSS OF HIGH NOTES

**I**N the concert-hall the loss would be more appreciable, owing to the fact that by the time the sounds reached the aged hearer's ears the high notes would, in any case, be attenuated, owing to the absorption effects of the room's furnishings. Difficulty would then be experienced in distinguishing between certain consonant sounds, and "thin" might be mistaken for "sin" and "famish" for "vanish" to mention but two examples.

Music also would suffer a little, lacking brilliance in some tones, but it is doubtful whether the hearer would be aware of the defect, *because he would have no standard of comparison.* This is an important point, and accounts in large measure for the seeming satisfaction given to many broadcast listeners by loud-speakers known to be lacking in high-note response. Unless a superior reproducer is heard for comparison, you may easily get used to one deficient in high-note response.

## NEW RADIO-GRAMPHONE LICENCE

**S**EE that the radio trade has secured very substantial concessions in the radio-gramophone licence, originally issued in February. It

may be recalled that a patent pool of six companies drew up what was termed the RG1 licence, based on a four-year agreement, the main point being that 10s. per valve-holder should be paid in royalty.

Apparently very few makers took up this licence, which was not generally approved, and so now we have the RG2 licence, the amendments of the RG1 licence being as follows: For complete radio-gramophones with five valves or less (the eliminator not counting as a valve-holder) the royalty is reduced to 5s. per valve-holder, plus an additional 5s. per valve-holder on all valves working when the instrument is being used as a record reproducer. For radio-gramophones with more than five valves the royalty remains as before.

When valves are connected in parallel, as in the power output stage, these will count as one valve, but for push-pull power stages the valves will count as two. One point about this—the use of push-pull in a five-stage instrument will not bring it into the higher royalty class mentioned above.

## NO SALES RESTRICTIONS

**A**NOTHER much-discussed point about the original licence has also been settled. There used to be a restriction regarding the sale of the instruments, hotels, public-houses, and the like being ruled out. This has now been waived, and instruments may now be sold to hotels, dance-halls, and presumably to those conducting public-address work.

The new ruling will certainly make the popular screen-grid, detector and pentode radio-gramophone even more popular, for on such an instrument the royalty would work out at the very reasonable figure of 25s., arrived at in this way: 5s. per valve-holder for the three valves used as a radio set makes 15s., and 5s. per valve-holder on the valves used for record reproduction—namely, the detector and pentode—making another 10s., or 25s. in all.

## D.C. VALVES AND STANDARDISATION

**W**ONDER when we are going to reach some finality in the matter of D.C. valves. The A.C. valve has been standardised in this country with a heater taking 1 ampere at 4 volts, although the current may be more than this in special cases. This also happens to be the Continental standard, so that everyone seems to be quite happy. With D.C. valves, however, the position is not quite so simple. We started off with the Mazda valves, which were similar in general characteristics to their A.C. series, but were provided with heaters taking half an ampere at 6 or 8 volts, according to type. They fulfilled a distinct need, but they suffered from the disadvantage arising from the somewhat heavy current, since

the spare voltage not required for the valves—usually amounting to some 200 volts—had to be dropped on a series resistance involving the dissipation of 100 watts or so. This is quite O.K. in a large case, but in a small cabinet the heating becomes very troublesome. The Osram range followed, the heater current of these being 0.25 ampere only, which meant considerably lower heat loss on the voltage-dropping resistance. Even so, the heating is still troublesome, and the latest Mazda valves take only 100 milli-amps., which brings us back to the same conditions as in the old days of directly-heated valves as far as dissipation is concerned.

## CONTINENTAL TYPES

**H**ERE one might imagine the matter would rest, but we now find that the Continental valve makers have adopted a current of 0.18 amp. as their standard. Why this odd value should be chosen I do not quite know, but the fact that such a standard exists is preventing the adoption of a uniform rating in this country.

There are parts of the Continent where it is difficult to obtain British valves, so that if a manufacturer exports a D.C. set with any of the existing British types of valve there is this difficulty to be overcome. Time alone will show whether this factor is sufficient to cause us to adopt the Continental standard or not. Probably before we arrive at any decision all the D.C. in this country will have been changed over to A.C., so that the problem will settle itself.

## MOVING-COIL MUSINGS

**E**VERYONE is agreed that at present we know of no more perfect means of obtaining faithful reproduction than the moving-coil loud-speaker; that is, of course, assuming that both the receiving set and the loud-speaker are first-rate in their way and are operated so as to give each of them a proper chance of doing itself justice. When it was first introduced, the moving-coil loud-speaker was a very expensive instrument and found its way, therefore, only into the homes of those with long purses. Early speakers of this kind, too, all required an energizing current from batteries or mains, and therefore cost something to run. We have now a number of very moderately priced permanent-magnet instruments produced by firms of the highest repute; the moving coil loud-speaker is therefore becoming increasingly popular.

## LOUD-SPEAKER MAGNETS

**I**N a good moving-coil loud-speaker of the permanent magnet type the magnet must always be an expensive item. The reason is that it *must* retain its magnetism practically unchanged, if not indefinitely, at any

On Your Wavelength! (continued)

for many years. When the magnet weakens quality suffers at once, and the instrument becomes a source of pain rather than pleasure. Good magnets are made of cobalt steel, which is not exactly given away; they are magnetised so that the densest possible field is obtained and they are subsequently aged either naturally or artificially. This ageing process is extremely important.

A NEW FIELD

**I** MENTIONED recently that a licence had been granted for the broadcasting of television upon the short waves and that it was understood that a transmitter for the purpose was being erected. This will give a far greater chance to the television people, since they will not have to restrict their activities to 9-kilocycle channels. It should therefore be possible to obtain both better definition and larger pictures. This being so, would it not be advisable, as soon as the short-wave transmitter is at work, to take television transmissions out of the medium-wave programmes? It would be exceedingly interesting to know how many amateur-owned television receivers are at present in regular use. I have no precise data available, but I very much doubt whether the average number of amateurs receiving any simultaneous broadcast of speech and vision at present reaches three figures. Don't think I am trying to crab television or to do anything to hamper its progress. Nothing is farther from my thoughts.

PUSHED AND PULLED

**M**Y old friends the Varley people take me gently to task over a paragraph that I wrote some weeks ago about push-pull. In it I said what a pity it was that manufacturers did not make more of a feature of supplying matched pairs of power valves. I am still pushed by this opinion, though I confess that I am pulled by the Varley contention that if you use a "split" transformer you can obtain good working even though the valves are not exactly matched. The split transformer

has its secondary (or both its primary and its secondary) made in two independent sections. Suppose that the secondary only is split, you can adjust the grid bias of each valve until both are passing just about the same amount of plate current. They will then do pretty well in double harness. If both parts are split the grid bias and the H.T. can be adjusted and still closer working obtained. Myself, though I do like to have my valve team equally matched in themselves, and it is such a very easy business to do it if you have a fair number to select from that I still think the makers might meet our wants in that matter. The Varley split transformers are altogether excellent, and I use them myself. The firm deserves the warmest of pats on the back for having helped constructors out of a difficulty.

D.C. TROUBLES

**O**NE thing that I would not like to be is a designer of receiving sets for D.C. mains operation! At first sight, this may seem to be an easy job, since there is no rectifier to incorporate in the set. The current comes to it ready ironed out, and all that you have to do is to regulate the voltage by means of suitable resistances. Yes . . . but . . . in many localities the direct-current supply is far from being ironed out; really, in fact, it ought almost to be called alternating, owing to the big ripple that it carries. I know one place where the current which eventually reaches wireless sets starts life as A.C. delivered by a dynamo. But, since the day load is comparatively small, local conditions make it advisable to charge up a big battery of accumulators and to bring these into action after 9 p.m. Clearly, you cannot deliver A.C. through the mains for part of the day and D.C. for the rest. Therefore, the original A.C. output of the dynamo is put through a mercury-arc rectifier. The result is about the roughest D.C. that I have ever struck, and if you yoke an ordinary set to these mains the hum(!) is reminiscent of the exhaust of a motor-cycle at a distance—and no very great distance, either.

THE NEW VIENNA

**T**HE present 15-kilowatt transmitter in use at the Rosenhugel station near Vienna is by no means an all-the-year round station in this country. An examination of my log for several years past shows that it is generally an excellent winter-time station, but that as summer draws on he is apt to vanish altogether. This year his record has been very curious, for though, on the whole, his strength is very small just now, there are nights when he comes in at first rate strength. The existing station is shortly to be replaced by one of real super-power—either 100 or 150 kilowatts, I forget which. Work on this new station has already started and, according to the contract, it should be finished before the end of this year. The wavelength used will be 517 metres, as before, and, owing to its long wavelength combined with super power, the new Vienna should be a splendid all-the-year-round station in our country.

VALVE MATCHING

**H**OW should valves be matched for use as a pair in push-pull? The most usual method is to do so by the mutual conductance. This is, on the whole, pretty satisfactory, but the method has certain drawbacks. Mutual conductance as you know, is the goodness factor of the valve, and is found by dividing the impedance into the amplification factor. To get the result in milliamperes per volt you knock off the last three noughts of the impedance. A moment's thought will show you that you can get the same mutual conductance figure for two valves that are really very different in their characteristics. For example, a normal Cossor 230XP with an impedance of 2,000 ohms and an amplification factor of 4 has a mutual conductance of 2 m.a. per volt. But you would get the same figure from an abnormal valve with an impedance of 3,000 ohms and amplification factor of 6. Strictly speaking, then, a pair of valves should be matched on both impedance and amplification factors if you really want close working.

THERMION

PERSONALITIES IN THE WEEK'S PROGRAMMES

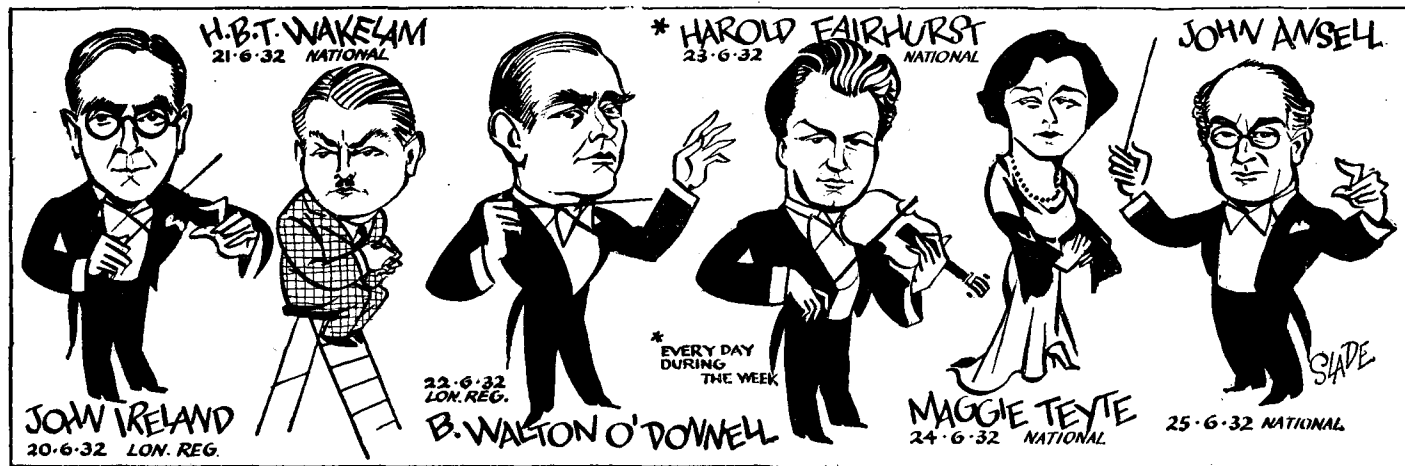

# The B.B.C.'s LATEST PLANS For SOLVING ITS WAVELENGTHS PROBLEMS

Alan Hunter gives the authoritative details of the B.B.C.'s proposals for putting Newcastle and Aberdeen on new wavelengths, outside the "exclusive ten" at present unappropriated by other countries

FOR a long time all the B.B.C.'s wavelength plans have been on the basis of ten exclusive wavelengths, one long and nine medium. Until recently the problem of making the fullest use of these wavelengths has been solved automatically, as one regional after another has been completed and has appropriated two of the wavelengths for national and regional programme radiation.

Now we are up against the fact that to complete the regional scheme *there are not enough wavelengths*. That is to say, the opening of the latest Regional, at Westerglen, does not enable all existing stations within a hundred miles or so to close down, and one or two, such as Aberdeen and Newcastle, will have to go on, even when the scheme is fully in action.

While Glasgow, Edinburgh and Dundee can be safely closed down owing to their service areas being adequately covered by the new Scottish Regional, the wavelengths relinquished do no more than provide Westerglen with its National and Regional outlets, the Regional taking Glasgow's 376.4-metre wavelength and the National taking the relay wavelength of 288.5 metres.

## Sharing Wavelengths

The change-over of the Glasgow wavelength for Scottish Regional is plain sailing, and this station is now on full-time schedule. But the problem of the National wavelength is much more ticklish, and involves a considerable amount of spade work.

When Scottish National goes on to 288.5 metres it will share this wavelength with several of the distant relays such as Plymouth and Swansea. It will not be possible for the relatively near-by Aberdeen and Newcastle relays to continue on 288.5 metres, owing to the severe mush that would be set up inside the relays' service areas.

**Problem:** To find wavelengths for the two relays, Aberdeen and Newcastle.

**Solution:** Put them on shortish medium waves at present not appropriated by the countries to which they have been allocated under international agreement.

The wavelengths to be used by the relays were exclusively announced in AMATEUR WIRELESS weeks ago. Aberdeen will go on 214.3 metres, and Newcastle on 211.3 metres.

Such wavelengths are of limited service value, for, as is well known, the shorter the wavelength the greater is the attenuation of the signal, and the less is the effective range for a given power. But as the B.B.C. points out, a transmitter on an exclusive wavelength of 200 metres will give a better service than on a shared wavelength higher up in the scale.

Remembering the bother when Newcastle was temporarily synchronised with North Regional, and the indignation regarding the resulting mush to Newcastle listeners, this alternative idea of taking up a shorter but exclusive wavelength certainly seems quite attractive.

For the time being, then, the B.B.C. has managed, on paper, at least, to get its quart into the pint pot. At some future date these two short exclusive wavelengths may be wanted by foreign countries, and then Aberdeen and Newcastle will have to shift on to near-by international common wavelengths. Some mush would then be produced, but probably not as much as with near-by synchronisation with high-power Regionals.

## Newcastle and Aberdeen

The immediate intention is to utilise two low-power test transmitters, one in Aberdeen and the other in Newcastle, so as to accustom listeners to the new wavelengths. During one week of these tests the higher-powered Aberdeen and

Newcastle stations will be off the air.

Many sets now in use will not tune down to such low wavelengths as are proposed for the Aberdeen and Newcastle relays (which, incidentally, will cease to be *relays*, since their exclusive wavelengths will enable them to originate local programmes, if desired) and so the B.B.C. has produced pamphlets to show how certain simple modifications can be made.

These suggestions are helpful as far as they go, but for once the B.B.C. has undoubtedly under-estimated the position, and many listeners will find it quite a job to tune down to the local's new and shorter wavelength.

Such ideas as inserting a series capacity in the aerial lead or taking a few turns of the aerial tuning inductance, would be a very fine if all sets were restricted to one tuning circuit. But there are many sets, such as portables and all-mains consoles, with two or even three tuning circuits, and only the makers could tackle the job of reducing the tuning range, which at present ends somewhere around 220 metres.

Perhaps this is a little pessimistic, and in any case there will be plenty of time to effect the alterations, for neither of the stations concerned will change over until Scottish National comes into regular operation in the autumn.

No real solution to the B.B.C.'s internal wavelength problem, which is quite distinct from the general problem to be fought out at Madrid in September, can be hoped for until the new high-power long-wave National station is ready. Work is now in hand at Droitwich, but it will be quite eighteen months before test signals are sent out.

Then it may become apparent that there is no need for three 50-kilowatt medium-wave stations to send out the National programme within one hundred miles of Droitwich—that the long-wave National will render redundant the medium-wave Nationals.

If this state of affairs should come to pass we may see a radical alteration to the regional scheme as it now stands. And the wavelengths released by the closing down of the unwanted medium-wave Nationals would then be most useful, either for allocation to parts of the country outside any real regional service area, or to enable wider frequency separation to be obtained.

## PLOTTING IT OUT

Do not work by chance when making up a new set. Put the blueprint flat on

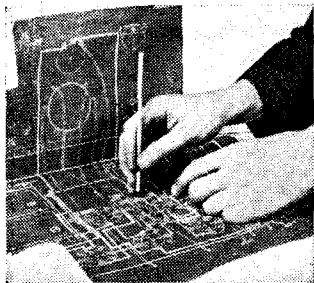

the panel and baseboard and prick through the mounting centres with a pencil or sharp point as shown here.

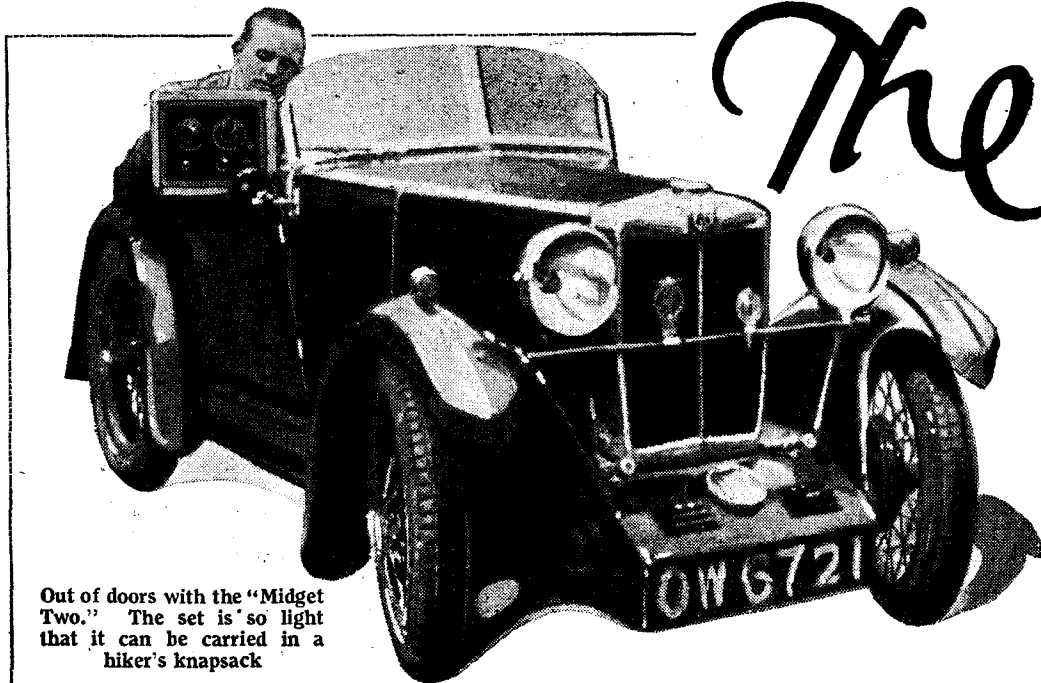

Out of doors with the "Midget Two." The set is so light that it can be carried in a hiker's knapsack

# The Midget

## A SET FOR CAMPER

The "Midget Two" for outdoor use. The battery—cyclists and hikers. For high-ten

By

RECENTLY I decided to build a special portable set. I say a *special* one, because there's nothing on the market at all like what I wanted. To start with, I had no idea of building anything like the ordinary portable. These sets are certainly "portable" in the strict sense of the word; that is to say, one *can* carry them about. But I am a lightweight camper, and the ordinary portable is nearly as bulky and heavy as the *whole* of the rest of my camping outfit for two people!

As far as reception was concerned what I wanted most of all was the weather reports and next the news, and I decided that I would use phones. This at once meant one

valve less—and the valve that used most current.

### To Receive 5XX

Then I began to think what stations I should go for. As I wanted news and weather, I obviously needed only the nearest Regional station, or 5XX. But until the Regional scheme is complete, there are many places in the country where the nearest Regional is a rather weak station many miles off; and these are just the likeliest places for a camping holiday—Devon, Cornwall, and the north of Scotland, etc. So I came to the conclusion that I must be able to get 5XX, which, generally speaking, is not too bad anywhere. And then I soon saw that it wasn't necessary to have anything else; so I decided to cut out the medium-wave range altogether, and concentrate on 5XX only.

Next came the question of the aerial; and I decided at once not to use a frame but an ordinary aerial and earth, for a frame would mean an H.F. valve, and this would mean such an increase in the size of the set as to make it altogether too big.

Now it is a practical certainty that one will often

have to fix the aerial with one end on the tent—say 6 ft. high—and the other on a hedge or something quite low, therefore it would not be particularly efficient, so that although a one-valve set might do, it was unlikely. On rigging up a rough "lash-up" on the bench, and trying it on a short vertical aerial about 15 ft. high, I found this was the case; two valves were needed, and after a few experiments I arrived at the scheme shown in Fig. 1.

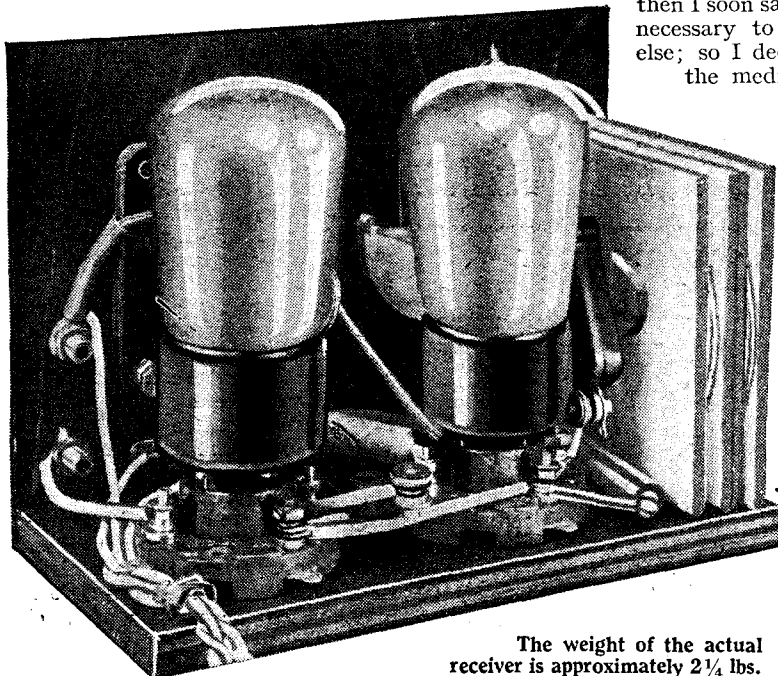

The weight of the actual receiver is approximately 2 1/4 lbs.

### THE CIRCUIT AND COMPONENTS

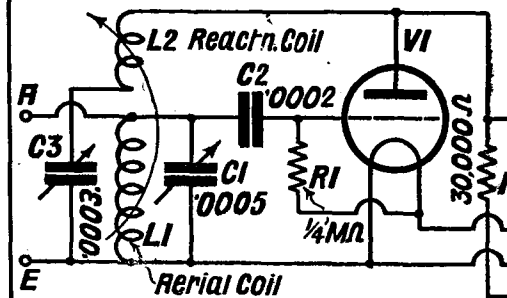

- .0005-mfd. bakelite dielectric variable condenser (Lissen, Polar, Readi-Rad, Peto-Scott, Lotus).
- .0003-mfd. reaction condenser (Telsen, Peto-Scott, Readi-Rad, Polar, Lotus).
- Two 4-pin valve holders (W.B., Lissen, Telsen, Lotus).
- One 1-megohm and one 1-megohm grid leak with wire ends (Lissen).
- One 30,000-ohm spaghetto resistance (Lissen, Lewcos, Tunewell, Telsen, Bulgin, Varley, Sovereign).
- Push-pull filament switch (Bulgin, Readi-Rad, Lissen, Telsen, W.B., Sovereign).
- One .0002-mfd., one .01-mfd. condensers (Dubilier, type 670, Lissen, T.C.C., Ormond, Formo).
- Dial 2 ins., engraved (Lissen).
- Four sockets marked Aerial, Earth, Output + Output- (Belling-Lee, Clix, Ealex).
- Six wander plugs marked H.T.-, H.T.+, Aerial Earth, Output-, Output+ (Belling-Lee, Clix, Ealex).
- Two spade terminals marked L.T.-, L.T.+ (Belling-Lee, Clix, Ealex).
- Two yards thin flex (Lewcoflex).
- 1-lb. 30 D.C.C. wire (Lewcos).
- Connecting wire and sleeving (Lewcos, Quickwyre, Hiffilinx).
- 50-ft. wire 24 D.C.C. (Lewcos).

# GET TWO OR MOTORIST, OR HIKER

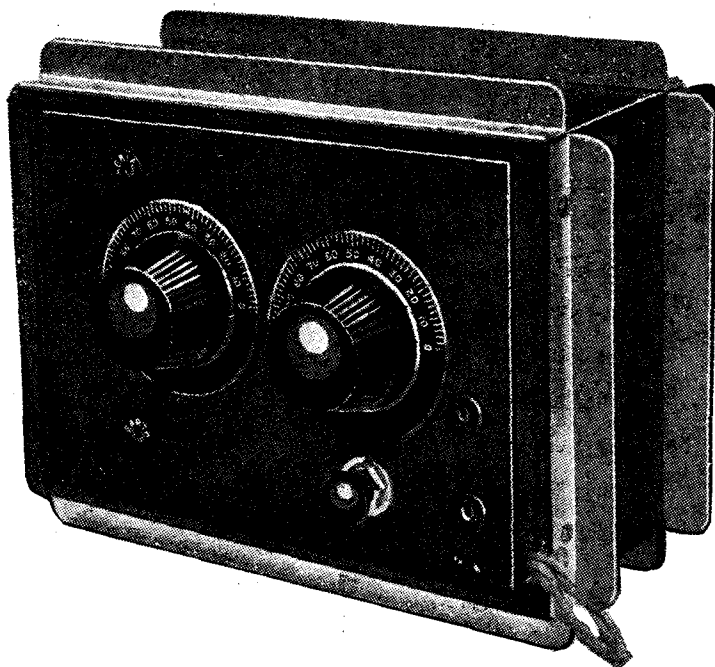

As been specially designed for every motorist can run it from the lighting hikers from the smallest of accumulation supply grid batteries are used.

P. K. TURNER

As you see, this is a simple detector and one L.F. set with reaction, resistance coupled, and (anticipating a little) I managed to get it into a box  $3\frac{1}{2}$  in. by  $7\frac{1}{2}$  in. by 5 in., weighing only  $2\frac{1}{4}$  lbs. The circuit is ordinary, except for one or two points which I will deal with now. First, the aerial is not connected to a tapping on the coil, but to the top. This, of course, is because I expect the set to be used on quite a small aerial all the time. Next, there is no bias

on the L.F. valve. Of course this is very wrong in theory. But for the particular purpose of this set—receiving speech at phone strength—it really doesn't matter a bit; and the absence of bias enables us to use a really low H.T., which is much more important. Thirdly, there is the resistance  $R_4$ . This is provided so that the valves may be fed from a 6-volt motor-cycle battery, for which purpose it is made  $20\text{-ohms}$ . Any reader using this set on a car with a 12-volt battery must use a  $50\text{-ohm}$  resistor here, while one using a 2-volt battery will, of course, omit it. Last, it will be noted that H.T. — is connected to L.T. positive. This is another very old-fashioned way of doing things, which is not sound practice in ordinary sets. But here, where the whole H.T. is only 30 volts or so,

the extra 6 volts obtained from the filament battery is very well worth having. The valves are a Mullard PM1HL as detector, with a PM2DX as L.F., and the total H.T. current on 30 volts is about 1 milliampere, so that it can be got from grid bias batteries. Two 16-volt batteries are best, which have a voltage of 38 when new.

#### H.T. Supply

It will be noted that to save space, weight, and H.T. volts, there are no decoupling circuits—not even a condenser across the H.T. battery. This has the natural result that the set is not as sweet in action as it might be; but it is reasonably good, owing to a rather special arrangement of the reaction circuit. It is, however, important not to let the phone-cord get mixed

#### PARTS OF THE "MIDGET TWO"

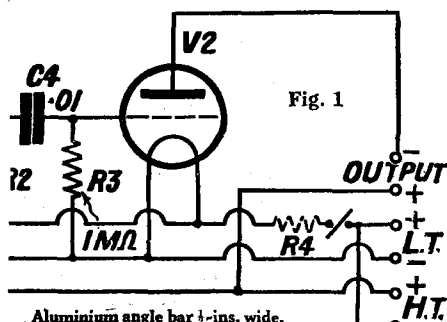

- Aluminium angle bar  $\frac{1}{2}$ -ins. wide.
- Four pieces  $7\frac{1}{2}$ -ins. long.
- Four pieces  $4\frac{1}{2}$ -ins. long.
- One piece 2 B.A. screwed rod,  $3\frac{1}{2}$ -ins.
- One piece 2 B.A. screwed rod,  $2\frac{1}{2}$ -ins.
- One piece ebonite tube  $2\frac{1}{2}$ -ins. with hole drilled  $\frac{3}{8}$  in.
- One piece  $1\frac{1}{2}$ -ins. long.
- $1\frac{1}{2}$  doz. 6 B.A. nuts and bolts,  $\frac{1}{2}$  in. long.
- Two 1-in. 4 B.A. bolts and nuts.
- One Meccano angle bracket or piece of aluminium angle bar.
- Wood to specification,  $3\frac{1}{2}$ -in. 3-ply  $7\frac{1}{2}$  ins.  $\times$  8 ins.,  $\frac{1}{2}$ -in. 3-ply  $14\frac{1}{2}$  ins.  $\times$  12 ins., (or complete cabinet and coils, Peto-Scott).
- Six 2 B.A. nuts.

#### ACCESSORIES

- Two 16 volt G.B. batteries (Lissen, Pertrix, Ever-Ready, Drydex).
- 2 volt accumulator (Exide type M.R.2, Lissen, Pertrix, Ever-Ready).
- Phones, 2,000 ohms (Ericsson).
- 20-ohm or 50-ohm resistance (Colvern) if 6 volt or 12 volt car battery is used instead of 2 volt accumulator.

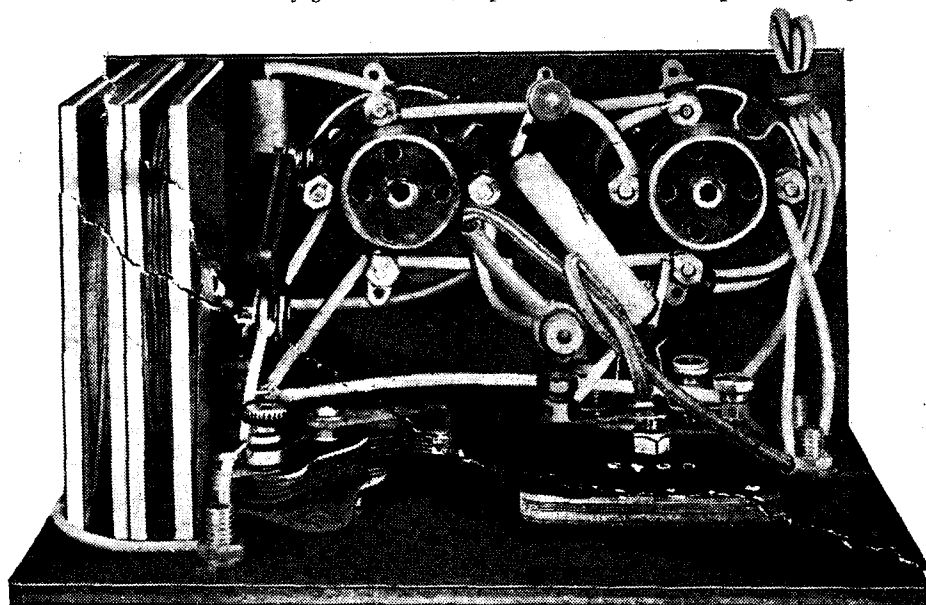

This is a plan view which shows the simple construction and few parts required

# "THE 'MIDGET TWO'" (Continued from preceding page)

up with the aerial, as the absence of an H.F. choke in the detector output allows some H.F. to get through to the L.F. valve, and hence to the phones, where it will react on the aerial if this is brought too close.

### Reaction

It will be seen that the reaction circuit looks quite ordinary in the schematic

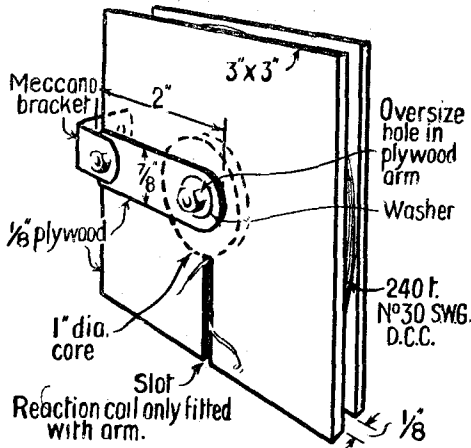

Fig. 2. This sketch gives the necessary details for winding the coils

diagram; the "special" point doesn't show. This is that the reaction coil L2 and its condenser C3 are tuned to the signal. The exact effects of this are too complicated to go into here; but the main result is that the

reaction is much sweeter when near the oscillation point. There is, however, a practical difficulty. How are we to tune the reaction circuit; and then how is the reaction to be controlled? In this set the difficulty has been got over as follows: the two coils are exactly similar, and the reaction coil is so arranged that it can be moved about and then left in the best position when that has been found. We start by setting the coil so that the reaction is weak, putting the reaction condenser to about 25, and tuning to 5XX on the main condensers. Then we note the setting of the latter, look at the table, and set the reaction condenser to the corresponding value. We shift the reaction coil till the set is near but not on the oscillation point, and fix it. After this, any small adjustment of the reaction is made by its condenser, as usual.

The coils for this set are, of course, special ones; for those who prefer to make them up themselves, their specification is as follows. Each coil is wound on a single-slot former, of the dimensions shown in Fig. 2, and the winding is 240 turns of No. 30 gauge double-cotton-covered wire. It is important not to use any other kind or covering. The formers can be built up of 3-ply, ebonite, or bakelite.

The other components of the set call for no remark—except that the phones should be of 2,000-ohms resistance.

There are, however, one or two unusual accessories that must be provided for a set like this. It is essential to have some sort of reel for the aerial. Only those who have tried quickly rigging an aerial in the open, and neatly coiling it up when done with can realise what a awful mess can be made of 50 ft. or so of wire and the same of cord, unless special provision is made. So for this set we use a special reel which fits neatly over the set itself and forms its box. On this reel is wound first a length of 50 ft. of 24-gauge D.C.C. wire, and then, tied on to the end of it, the same length of string; the free end of the string has a weight of about 1-lb. attached, so that it can be thrown over the branch of a tree. Attached to the box are two small handles for use in winding up the aerial.

It will be seen that the set is housed in a light plywood box on the large side of which is fitted the handle for winding, while there is also a centre handle inside the box. This just clears the components of the set. Aluminium strip of L section is fixed to the edges of the box to form flanges by

which the aerial wire can conveniently be spooled up.

Any small variations in these accessories will not alter the functioning of the set, and you can make the aerial spool, for instance, any convenient size to fit a knapsack or the cubby-hole of the car.

### Condenser Settings When First Adjusting

Tuning Condenser	Reaction Condenser
20 ... ..	5
30 ... ..	10
40 ... ..	25
50 ... ..	40
Log law, .0005	Semi-circ, .0003

The above readings only apply when the specified condensers are used.

Dimensions of the suggested arrangement are given on the blueprint, a small reproduction of which is shown here. If you

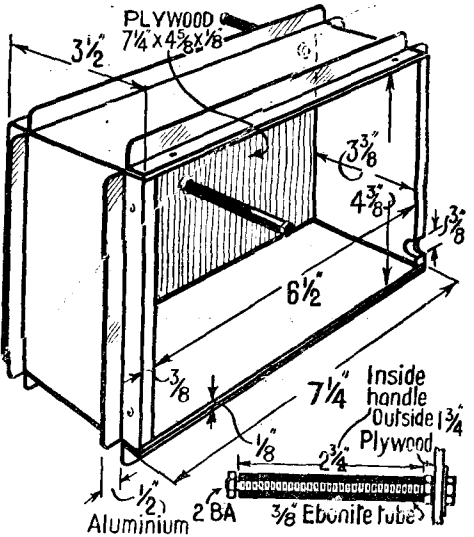
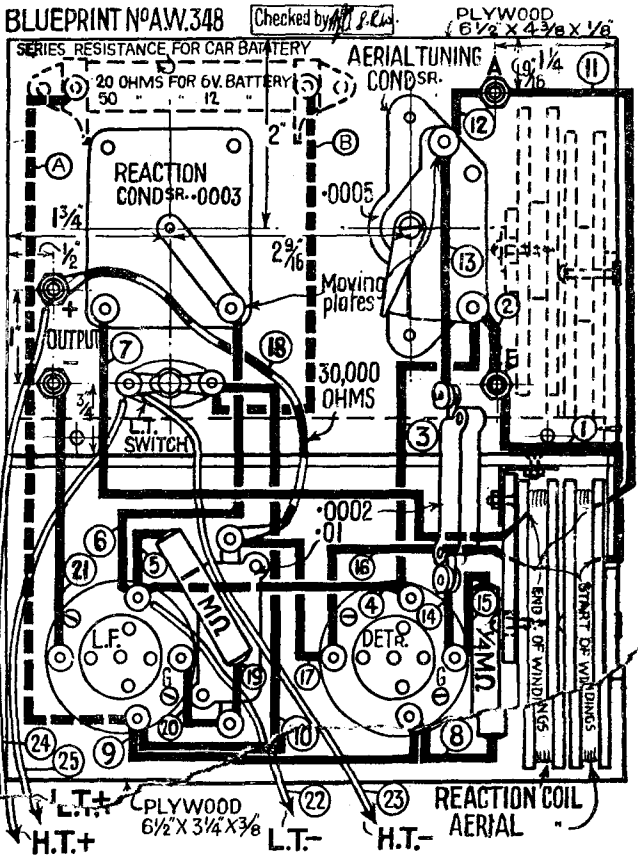

Fig. 3. Dimensioned details of the case

want to avoid any trouble when making up the set and cutting out the plywood for the box and aerial former, then work from the full-size blueprint which can be obtained, price one shilling, post free, from the Blueprint Department, AMATEUR WIRELESS, 58-61 Fetter Lane, London, E.C.4.

Provision must be made for the earth connection. There are two ways of doing this, of which the better is also the heavier and bulkier. This is to use an "earth mat," which is just a piece of wire netting laid on the ground. The very best earth mat is a strip of copper gauze, 2-3 ft. wide, and anything up to 12 ft. long. Next to this, and much lighter, is ordinary wire netting—say 1/2-in. mesh—and as much as can be carried up to the above size. But these are only suitable to motor camping. For the real lightweight camper the only possible earth is a tent peg, and this must, of course, be a metal peg.

A new edition of a revue by Rex Evans is in the programmes for June 28 (National) and July 1 (Regional).



The layout and wiring diagram. A full-size blueprint is available, price 1/-



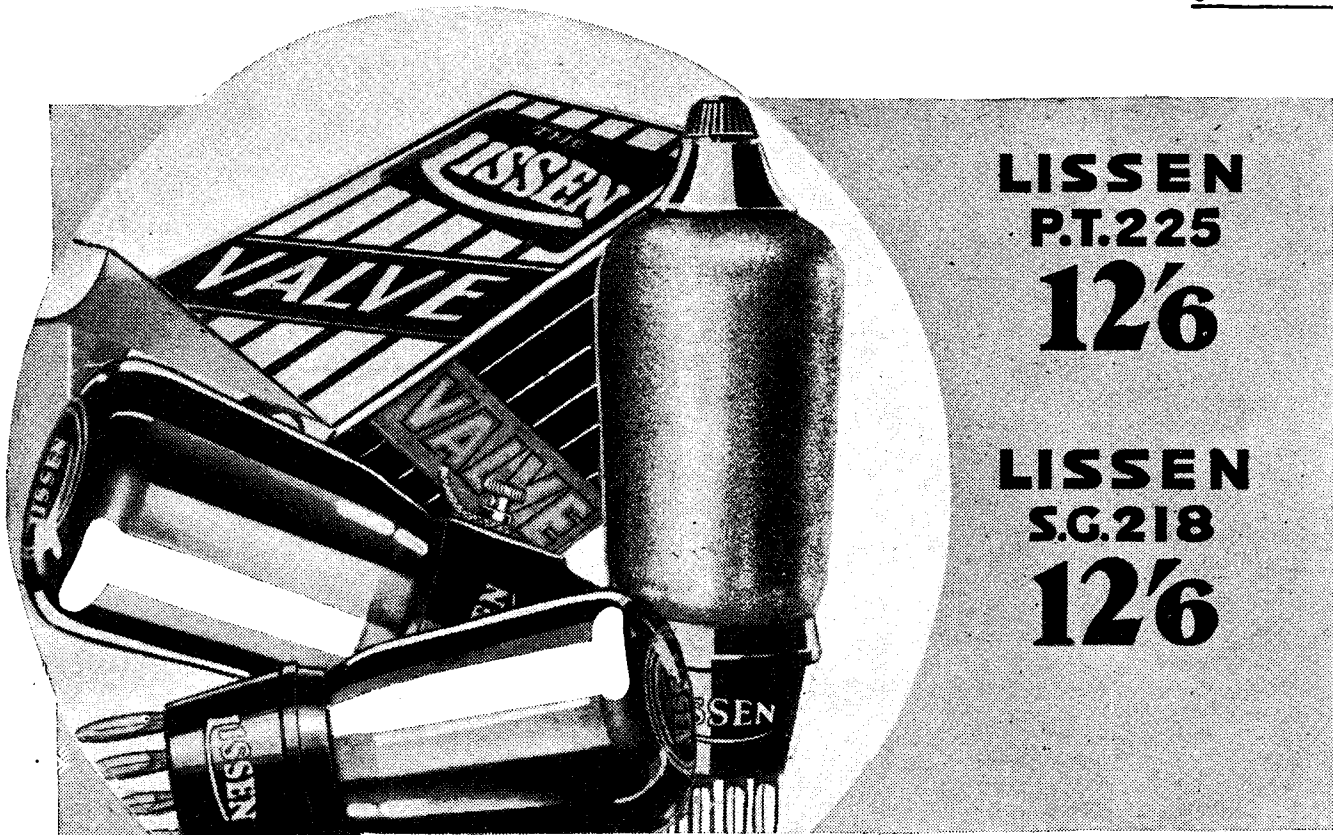

**LISSEN  
P.T.225  
12<sup>6</sup>/<sub>6</sub>**

**LISSEN  
S.G.218  
12<sup>6</sup>/<sub>6</sub>**

**LISSEN  
H.L.210  
5<sup>6</sup>/<sub>6</sub>**

**Three Valves  
to give you**

**RANGE VOLUME CLARITY  
NEW LISSEN LISSEN POWER LIVELY LISSEN  
SCREENED GRID PENTODE DETECTOR**

**LISSEN  
PARTS  
USED in  
the Midget  
Two**

- .0005 Bakelite Variable Condenser 2 6
- 1/4-meg. and 1 meg. Grid Leak with wire ends 1/-
- 30,000-ohm Spaghetti Resistance 12
- Two 16-volt Grid Bias Batteries 19

The new Lissen Metallised Screened Grid Valve will give you much higher amplification without instability. During months of research Lissen have succeeded in getting the inter-electrode capacity of this Screened Grid Valve down to the minute figure of .001 micro-microfarads. (Inter-electrode capacity causes instability and howling). Lissen have also been able to increase the magnification figure of this valve to 1,000. Get one of these new Lissen Metallised Screened Grid Valves in your receiver and get higher amplification than ever before. It will give you immensely increased range and bring in many stations you have never heard before. Ask for Lissen S.G.215. Price

**12<sup>6</sup>/<sub>6</sub>**

The Lissen Power Pentode Valve—P.T.225—converts any set with one stage of L.F. amplification into a fine, full-volume "Pentode-output" receiver. This valve puts new power into your loud-speaker, and new brilliance of tone, too. Use it instead of a power valve and at once you get an amazing step-up in volume. Where before you got a whisper, now you get a torrent of pure sound. And it takes no more current than the power valve it replaces—its H.T. consumption is only 7m.A. Ask for Lissen P.T.225. Price

**12<sup>6</sup>/<sub>6</sub>**

The Lissen Detector Valve—H.L.210—liven up your tuning, gives you extra range, greater sensitivity. It is so responsive that it brings the foreign stations in like magic. Not only this, but it passes a crisper more powerful signal on to the L.F. stage of your receiver, and you get louder, clearer radio altogether. Ask for Lissen H.L.210. Price

**5<sup>6</sup>/<sub>6</sub>**

**LISSEN**

**LISSEN LIMITED, WORPLE ROAD, ISLEWORTH, MIDDLESEX**

*You will Help Yourself and Help Us By Mentioning "A.W." to Advertisers*

# Our Broadcast Critic

## TALKS ABOUT

### A MORBID PLAY



FLOY PENRHYN  
in Vaudeville

THERE is a difference between what is generally known as a "thriller" and what is more accurately described as morbid.

That the adaptation of Henry James's book "The Turn of the Screw" was morbid is only my opinion. I have discussed it with friends, not all of whom have agreed with me. I disliked the idea of evil spirits influencing little children; the whole production left a distinctly unpleasant impression.

I am no spiritualist, but I do think that plays dealing with the supernatural lend themselves to broadcasting. My objection to those I have heard thus far has been that the spirits were evil, or at least loitering about with evil intent. If it is to be admitted that spirits return to the earth, is it not possible that they may do so to help rather than to damage? No one seems to have thought of the idea of decent-minded spirits!

The suggestions contained in the play under discussion were rather advanced in their unpleasantness; I imagine the correspondence will rival that occasioned by *Rope* which, you will remember, created a disturbance some time ago. Perhaps it is a compliment to Mr. King Bull that he contrived to make the play so realistic, but I fancy the very fact that he did so will be the cause of much criticism.

Thinking of spirits and ghosts, *Hamlet* was a great success. John Gielgud's moody mannerisms in playing the name part impressed me deeply. There is no doubt about it; Shakespeare's the stuff! I should like to add a word of congratulation to Val Gielgud as producer. He certainly understands microphone presentation.

There has been some good vaudeville-playing this week; I do not remember having heard better lines, taking them as a whole. Haver and Lee defined an optimist as a man who worked a crossword puzzle with a pen. That must indeed be the acme of self-assurance. One of them also remarked that he had changed his mind; it must have been in a degree humiliating when the other asked if the new one worked any better. They are a cheerful couple.

Alexander and Mose discussed matters of importance in their inimitable fashion. Alexander said that he was in the habit of taking a cold bath every morning, but quarrelled with Mose when he described it as a *miniature* bath. The full explanation of the term seemed to be that one "miniature" were in it and the next "miniature" were out. I agree. Mose has a broad outlook on life; he does not believe the statement that marriage is a lottery, for instance; he says in a lottery you *do* have a chance.

The Vaudevillian saying of the week, however, came from Doris—or it may have been Elsie—Waters. I am never quite sure which is which. Discussing a neighbour she said she was certain he was of good family because he parted his name in the middle! There are few entertainers who keep fresher than these two; their imitations of Alexander and Mose on the Saturday night were really splendid. I hope A. and M. remained to hear them.

Talking of imitations, did you hear Imito? His farmyard imitations are as good as anything I have heard in that line thus far. I consider his performance brilliant.

#### PROGRAMME POINTERS

*Despite the criticism I have heard, I say frankly that I do like the playing of Henry Hall's band. It so chanced that I watched a rehearsal in Broadcasting House; listening to the band broadcast the other night I recalled an impression gained at Portland Place. I think it wrong in principle to use a violin—even two or three of them—just as one would use, say, a saxophone. A violin in an orchestra of this type has no place unless another violin plays a second part; neither of these has a place unless a viola and a cello complete the four-part harmony. In other words, a string quartet (with a double bass for deepening purposes) must be employed if string quality is to be properly represented. History and tradition have proved it to be so. Applying the principle to Mr. Hall's band, I am of opinion that nine string players are necessary to stand up against so much wind tone; a double string quartet with one bass. Apart from the mellowing influence string tone is bound to exert—and it is needed in this orchestra—there would be endless resource in a complete string representation; scoring could be made so much more effective. Mr. Hall told me that everything had to be scored specially; I am bound to state I think some of the scoring ineffective merely because the combination of instruments is faulty in principle. Mr. Hall is doing something for our dance music; I appeal to him to have respect unto tradition and to complete his strings. He will never regret it.*

There was a clever little sketch on Derby night played by Gordon McLeod, Enid Trevor, and Cyril Nash. It was appropriately called *The Sweep Ticket*, written by G. Astall. Apart from its being suitable for such an evening I point to it as being eminently suitable in type for vaudeville. It was a mere scene with three characters and was consequently easy to follow. When listening to a vaudeville show one does not expect to have to rivet one's attention on every line; that sort of thing is naturally left to more serious work. This little sketch had many ideal broadcasting points about it.

Another type of vaudeville item that appealed to me as one to be more often exploited was Floy Penrhyn's little scene *Mrs. Bolter and the Lion*. I have heard her do that sort of thing before; what I want to point out here is that comedy telephone conversations, especially when they burlesque American speech, can be very entertaining.

Thanks to the B.B.C.'s determination to give us variety we are able to judge what is and what is not suitable for broadcasting. I think everyone will agree that the simpler the construction of any item—comedy or serious—the better chance it has of success. Floy Penrhyn was eminently successful in presenting H. N. Ege's text, so written as to indicate *both sides* of the telephone conversation; that is, of course, good microphone writing.

A pleasant trait in the character of a vaudeville is the introduction of a singer, especially one who is capable of singing light songs in several languages. George Seversky sang in Russian, French, German, and English. His diction was so good that, had I known Russian, I should have understood every word. Unfortunately, my Russian is not what it was! Leslie Weston was funnier than ever; also I thought Rupert Hazel and Elsie Day very entertaining.

To have them as well as Norman Long was certainly generous in one vaudeville. Mr. Long's burlesque on the adenoidal dance-singers won me completely. The line "You must say *dew* or people will think you English, and that would never *dew*" contains so much truth in it that it almost passes out of satire altogether.

Christopher Stone's recital of thirty-year-old records interested me. I found myself thinking that the vocal faults in some of the singers would hardly pass in these advanced days; we were evidently content with less in the technical way at one time. WHITAKER-WILSON.

# MY WIRELESS DEN

Weekly hints—constructional and theoretical — by W. James.

## AN R.C. STAGE

A RESISTANCE-COUPLED low-frequency stage is cheap to build and for many purposes the amplification to be obtained is quite sufficient.

You can, at all events, be sure of one thing when using this form of coupling. The amplification will be uniform over a wide range of frequencies and distortion will be the minimum.

It is interesting to look at a typical resistance stage and to note the chief points (see the accompanying diagram). In the first place there is a resistance in the anode circuit,  $R_1$  in the sketch. As a current passes through this part there is a fall in voltage across it. Thus the voltage of the anode is less than the voltage of the high-tension supply.

There is a coupling condenser between the anode of the first valve and the grid of the next. This condenser must be well

of 20,000 ohms, the resistance may be of about 50,000 ohms.

## IS IT QUIET ?

I WONDER how many amateurs succeed in making a mains set with a reasonably silent background?

The noises and hum sometimes heard, even when the parts used in the smoothing circuit seem satisfactory enough, show that the wiring and the layout of the parts are at fault. A little screening here and there often works wonders. You may not believe it, but quite a loud hum can often be produced by holding one of the mains leads near the grid of the detector valve.

If, therefore, the heater wires, which carry alternating current, are poorly arranged, it is possible that noises will be produced. Hum may be picked up by a transformer. This is well known. But the wiring may also pick up hum and for the best results the position of the wires must be carefully thought out.

Sometimes relief is obtained by joining a grid leak across the secondary winding of the low-frequency transformer. If you try one, of about .5 megohm, join it between the ends of the transformer and not between the grid and the heater of the valve. Hum is sometimes reduced by shielding the detector valve and a metallised valve may be used with advantage. Noise cannot be eliminated by using an adjustable potentiometer in the heater circuit, but hum may be reduced to a negligible amount.

## RADIO-GRAM SWITCH

THE simple switching arrangement so often used as the radio or gramophone control is satisfactory enough in many cases. But very often there is a difficulty, as wireless is heard when the switch is placed in the "gramophone" position unless the set is tuned to avoid this.

The usual method of controlling the circuit is to join the grid to the centre contact of the switch, and the other contacts to the wireless circuit and the pick-up respectively. But this does not effectually disconnect the grid of the valve from the wireless circuit when the switch is placed in the "gramophone" position. The contacts of the switch usually have a fair capacity and there is also that of the wiring as well. The capacity is relatively little, but still, is enough to carry high-frequency currents to the grid of the valve.

A suitable switch must therefore be used, and it is necessary to take care of the wiring. Space the wiring so far as possible. This will reduce the capacity and therefore the strength of the radio signals which are passed to the valve. A condenser joined between the pick-up contact of the switch and the filament will reduce the interference, but it is sometimes necessary to disconnect the radio part of the set entirely.

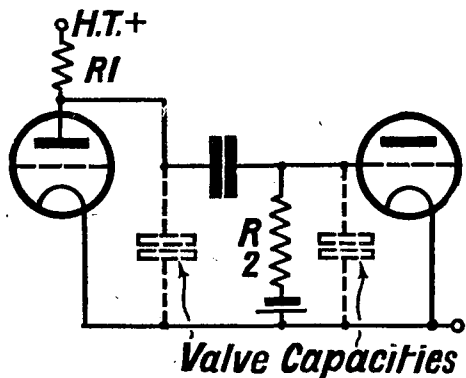

This is the resistance-coupled stage which Mr. James describes in the accompanying paragraph

insulated. If there is an appreciable leak the results will be affected. The correct value depends partly upon the size of the grid leak  $R_2$ . Speaking generally, the capacity should be as high as possible. If the capacity is small, the lower notes will be reduced in strength in comparison with those of the middle frequency. For a leak of 1 megohm a capacity of .005 or more should be used.

Now across the resistances are the capacities of the valves and the small capacities formed by the wiring. The result is that the impedance in the anode circuit is less than the value of the resistance. Further, the impedance falls with an increase in the frequency.

The result is that the amplification tends to fall off at the higher frequencies. Sometimes there is a by-pass condenser in the circuit, especially in the detector stage. This further increases the effect. The resistance used in the anode circuit should, therefore, be no higher in value than necessary, such as twice or three times the impedance of the valve. Thus, with a valve

## The Easy Way TO PERFECT RADIO

We are the largest radio-by-mail house in the Country. If your requirements are not advertised—Write for special quotations.

C.O.D.—CASH—H.P. Immediate Delivery

- COSSOR EMPIRE MELODY MAKER** Send Model 234. With Valves and Cabinet. Cash Price £6/8/6. **10/-**  
Balance in 11 monthly payments of 11/10. only
- COSSOR ALL-ELECTRIC MELODY MAKER** Type 235. Complete with Valves and Cabinet. Cash Price £9/9/6. **17/4**  
Balance in 11 monthly payments of 17/4. only
- SUPER V.3 KIT** for A.C. mains, including valves, cabinet, speaker, and mains equipment. Cash Price £25/11/3. **28/6**  
Balance in 11 monthly payments of 28/6. only
- PILOT SELECTIVE FAMILY 3.** Less Valves and Cabinet. An amazing 60 station set described by Maxamp in Tit-Bits, May 7, 1932. Cash Price £3/5/0. **6/-**  
Balance in 11 monthly payments of 6/- only

**R. & A. CHALLENGER**  
PERMANENT MAGNET MOVING-COIL SPEAKER  
With special Ferranti multi-ratio input transformer. Will operate from a 2-valve set up to a power amplifier. Cash Price £1/15/-.  
Balance in 5 monthly payments of 6/6. **6/6** only

- BLUE SPOT SPEAKER UNIT AND CHASSIS, TYPE 100U.** Cash Price £1/19/6. **5/5**  
Balance in 7 monthly payments of 5/5. only
- EPOCH A2 PERMANENT MAGNET MOVING-COIL SPEAKER.** Fitted with multi-ratio input transformer. Cash Price £3/3/0. **5/9**  
Balance in 11 monthly payments of 5/9. only
- EPOCH J.1. PERMANENT MAGNET MOVING-COIL SPEAKER** with 3 ratio input transformer. Cash Price £2/5/0. **4/2**  
Balance in 11 monthly payments of 4/2. only

**EPOCH 20C** PERMANENT MAGNET MOVING-COIL SPEAKER  
Complete with 3-ratio input transformer ready to connect to any receiver. Will handle up to 5 watts undistorted. Cash Price £1/15/-.  
Balance in 5 monthly payments of 6/6. **6/6** only

- R. & A. "100" PERMANENT MAGNET MOVING-COIL SPEAKER.** Complete with multi-ratio input transformer. Cash Price £2/17/6. **5/4**  
Balance in 11 monthly payments of 5/4. only
- ULTRA IMP. PERMANENT MAGNET MOVING-COIL SPEAKER,** with input transformer. Cash Price £2/15/0. **5/-**  
Balance in 11 monthly payments of 5/- only
- W.B. PERMANENT MAGNET MOVING COIL SPEAKER.** Type P.M.4. Complete with Transformer. Cash Price £2/2/0. **5/9**  
Balance in 7 monthly payments of 5/9. only
- W.B. PERMANENT MAGNET MOVING-COIL SPEAKER P.M.3.** Complete with 3-ratio input transformer. Cash Price £2/12/6. **4/10**  
Balance in 11 monthly payments of 4/10. only

PETO-SCOTT CO. LTD. 77, City Road, LONDON, E.C.1

Dear Sirs, Please send me CASH/C.O.D./H.P.

for which I enclose £.....s.....d.....  
CASH/H.P. Deposit.

NAME .....

ADDRESS .....

A.W. 18/6/32. ....

West End Showrooms: 62 High Holborn, W.C.1

## OPERATING THE

## INEXPENSIVE ALL-ELECTRIC TWO



Further details of special interest to builders of the simple and

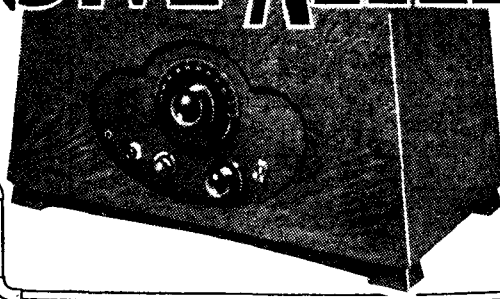

economical mains-driven two-valver, first described in the middle pages last week

THOSE who intend to construct the two-valve all-electric set described in the preceding issue will be glad of some notes on the operation. Naturally, the handling of the various controls is very simple, due to the fact that the first valve is the detector, and that there is only one tuning circuit to be varied.

In spite of the simplicity of the tuning you will find that a good balance between power and selectivity is provided by the screened coil, which is outstandingly good in design.

There is one preliminary tuning adjustment to be carried out before settling down to the normal manipulation of the panel controls. We refer to the pre-set condenser mounted on the baseboard near the coil base.

This should be adjusted to give a good compromise between selectivity and aerial coupling, and then left alone. The longer the aerial the smaller the capacity needed, but this is a test that must be carried out by the individual constructor.

Tuning is done with the large central control, and there is nothing to comment on here, as local stations come in at great strength and can be easily logged.

For the reception of the more distant foreigners you will have to operate the

reaction control in conjunction with the tuning control. Operate with care, and many stations will come in at great strength, especially after dark.

Of course, you need not wait for the hours of darkness on long-wave reception, as the stations such as Radio Paris and Huizen come in on the direct ray, and can be heard at fair loud-speaker strength at all times of the day. For the long waves push in the wave-change switch on the left, and for medium waves pull out, thus shorting part of the coil.

The set is switched on in the first place by inserting a suitable plug into the mains socket, and then pulling down the mains switch on the panel. You will have to wait a few moments while the valves warm up.

If there is no sign of the mains supply coming into action when the above has

been carried out it is possible that there is a break in the fuse circuit. The fuses, it will be recalled, are incorporated in the special safety-switch device at the back of the baseboard.

Make sure also that the mains transformer is correctly connected for the voltage of your supply—there are three tappings,

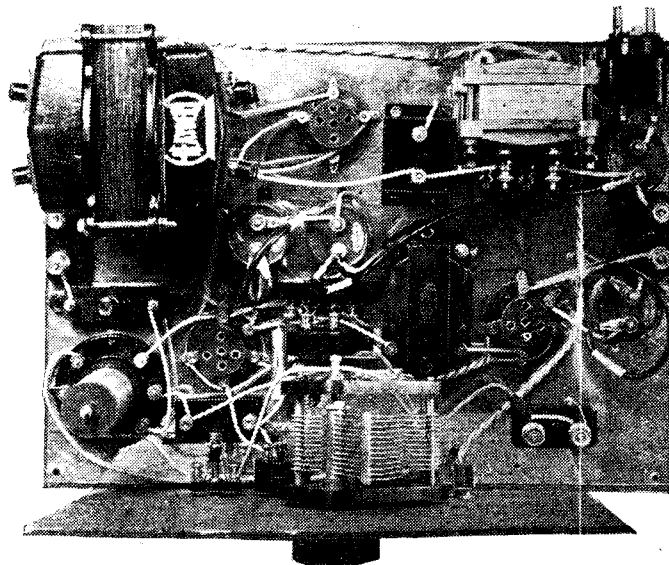

A plan view of the "All-electric Two," useful for comparison with the layout diagram given last week

#### THE COMPONENTS REQUIRED FOR BUILDING THE "ALL-ELECTRIC 2"

.0005-mfd. variable condenser (Lotus, Lissen, Telsen, J.B., Polar, Utility).

.0003-mfd. reaction condenser (Peto-Scott, Lissen, Lotus, Read-Rad, Telsen, J.B., Polar, Utility).

Push-pull shorting switch (Wearite, Bulgin "Junior," Lissen, Telsen, Read-Rad, W.B., Tunewell, Sovereign).

Mains on-off switch (Bulgin, toggle type, S.80; Wearite, Igranic).

Gramo-radio switch (Bulgin, rotary type; Read-Rad, Lissen, Wearite, Telsen).

Dual-range tuning coil (Lissen).

Two five-pin valve holders (Clix, Lissen, W.B., Lotus, Telsen, Junit, Wearite, Benjamin, Igranic).

Four-pin valve holder (Clix, Lissen, W.B., Lotus, Telsen, Junit, Wearite, Benjamin, Igranic).

High-frequency choke (Lissen, Lotus, Wearite, Telsen, Climax, Varley, Tunewell, Igranic, Read-Rad).

Low-frequency transformer (Lissen "Torex," R.I., Telsen, Igranic, Climax, Atlas, Lotus, Varley, Ferranti, Burton).

1-megohm grid leak with wire ends (Lissen).

.0001-mfd. and .001-mfd. fixed condenser (Lissen, Dubilier, T.C.C., Telsen, Formo, Graham-Farish).

Two 1-mfd. fixed condensers (Dubilier, type 9200; Lissen, T.C.C., Telsen, Formo).

.2-mfd. fixed condenser (Dubilier, type 9200; Lissen, T.C.C., Telsen, Formo).

2-mfd. fixed condenser (Dubilier, type 9200).

2-mfd. fixed condenser, 400 volts D.C. working (Formo, Dubilier, T.C.C.).

Smoothing choke, 20 henries, 25 milliamps (Tunewell, type S20/50; Igranic, Ferranti, Climax, Lissen, Varley, Bulgin, Wearite).

Mains transformer to specification (Heayberd, type 716).

Combined mains plug and fuse holder (Bulgin).

Three terminal blocks marked Aerial, Earth, P.U.2, L.S.+, L.S.— (Lissen).

.0003-mfd. max. pre-set series aerial condenser (Sovereign, type J; Formo, Ormond, Varley, Igranic).

Three-ply panel, 11 in. by 7 in. (Peto-Scott).

Piece of thin aluminium foil, 14 in. by 10 in. (Peto-Scott, Read-Rad).

Three spaghetti resistances, one 500 ohms, one 750 ohms, and one 30,000 ohms (Lewcos, Lissen, Bulgin, Tunewell, Sovereign, Varley, Read-Rad, Telsen).

Baseboard, 14 in. by 10 in. (Peto-Scott, Read-Rad, Cameo).

Connecting wire and sleeving (Lewcos).

Two yards thin flex (Lewcoflex).

Length of shielded cable (Lewcos, Peto-Scott, Read-Rad) one foot.

#### ACCESSORIES

Cabinet (Peto-Scott).

Loud-speaker (Blue Spot, W.B., Lissen, H.M.V., Celestion).

providing for mains between 200 and 250 volts.

This is an ideal set for reproducing gramophone records by electrical means. All you need is a pick-up, connected to the pick-up terminals of the set, and a potentiometer volume control across the pick-up.

Then the gramophone switch on the panel is moved to the left for "gramo" and the detector is automatically biased as a low-frequency amplifier.

A suitable loud-speaker for this set would be the Bluespot cone, of the high-resistance type, or, if you like, a moving-coil, with built-in step-down transformer, such as the W.B. Good quality reproduction is a feature of this set, which gives ample volume for the average domestic requirement.

LET "A.W." SOLVE YOUR WIRELESS PROBLEMS.

# OUR LISTENING POST

By JAY COOTE

DO you recall Radio Schaarbeck (Brussels), which was compelled to close down some months ago? The station, "under entire new management," started up again on May 23; it is operating on 245.9 metres, or as near thereto as it can get, and for the present its transmissions are limited to one broadcast daily between midday and 2 p.m. B.S.T.

It is difficult to understand why in Belgium, a State which is only about equal in area to Yorkshire and which possesses already two 20-kilowatt transmitters, there should be any crying need for other stations. And yet, during the past year there have sprung up in that country, especially in the Liège district, a number of small privately owned broadcasting plants.

## The Belgian Stations

On the eastern front we find Radio Franchimont (207.3 metres), Seraing (210 metres), Liège Experimental (241.5 metres), and Cointe (269.3 metres). At Antwerp, in the north-west district, Radio Eglise du Christ still works on 209 metres, and in the south, from Binche and Bonne Espérance, transmissions are carried out respectively on 220.3 and 241.5 metres, the latter (Radio Wallonia) being the older of the two stations.

Most of these one-horse installations broadcast local programmes, falling back upon gramophone records for their more important concert numbers. Radio Cointe (Liège), however, goes one better than its rivals, inasmuch as every Monday from 9 to 11 p.m. B.S.T. it relays dance music from its local Revellers' Club and on Sundays induces artistes and instrumentalists from the Atlanta Music Hall to perform in its studio free of charge. If you make a search for any of these stations, bear in mind that the wavelengths may vary from those stated; it is true that they keep as near to these channels as they can, but even that does not mean much.

Radio Barcelona (EAJ1) may now be found on the air every Wednesday and Friday night between midnight and 12.30 a.m. B.S.T., and for which period a new feature has been inaugurated. The studio at the end of the day's work allows listeners who possess relatives at sea to appear before the "mike" and broadcast personal messages to them.

## Radio Paris Changes

Some months ago Breslau decided that, as the announcer in charge of a programme fulfilled all the duties of a Master of Ceremonies and *compère*, he was entitled to receive his mead of praise—and publicity—and consequently, casting anonymity aside, the name of the individual is coupled with the broadcast for which he is personally responsible. As a result of this innovation, German listeners throughout the country are insisting that the same principle should be adopted for all their stations.

From all accounts, France generally, and Paris in particular, is dissatisfied with Radio Paris. As a rule, the new high-power transmitter is used for all broadcasts except for the morning programme, for which the older and weaker plant is brought into action. But the main objection is that the quality is not considered equal to that of the more recent Poste Parisien, and rumour has it that Radio Paris may again be entirely reconstructed and that advantage may be taken of this opportunity to boost it up to some 200 kilowatts. With Radio Luxembourg and Athlone looming large on the horizon, a serious loss in revenue from publicity looks like a certainty; such competition must be coped with. It is anticipated that

Radio Luxembourg will be officially opened in July, and there is a strong possibility that a power of even more than 200 kilowatts may be attained.

The new Breslau 60-kilowatt transmitter is now ready and will start testing in the course of a few days; you should tune in to its wavelength just below that of the Poste Parisien. As the construction of the high-power Leipzig and Frankfurt-am-Main stations is also up to time, we may expect to see them launched on the ether in July; Munich, however, will not be ready before October.

## R. & A. SPEAKERS

IN the announcement of Reproducers and Amplifiers, Ltd., in last week's issue, there is a certain amount of confusion with regard to the prices of the two models shown. Amateurs who are in need of a new speaker should note that the type 40 R. & A. instrument, shown on the left in the announcement, costs 16s. 6d., while the special "Challenger" permanent-magnet moving-coil speaker shown on the right costs 35s., complete with a three-ratio transformer. Full details of both these models can be obtained free on mention of "A.W." from Reproducers & Amplifiers, Ltd., Frederick Street, Wolverhampton.

## SERVICE ON MAINS UNITS

A SERVICE in connection with mains units and mains-driven sets which is well worth considering is that offered by the Express Radio Service Co., of 5 Great Chapel Street, Oxford Street, W.1. This concern undertakes the conversion of sets from D.C. to A.C. and A.C. to D.C. operation and all apparatus is carefully "tuned up" and subjected to laboratory tests. Incidentally, the Express Radio Service Co. are the sole repairers of Undy speaker units and they carry a large stock of spares.

## AN AUTOMATIC NEEDLE CUP

A very ingenious needle cup which will save radio-gram users a lot of trouble has just been put on the market by British

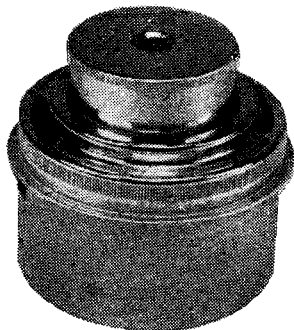

Goldring Products, Ltd. There are two models. There is a cylindrical compartment holding two hundred needles, which is loaded by rotating a cut-out lid over an appropriate opening. The lid is then turned over a narrow slit in the top of the compartment through which the needles are delivered, one at a time, simply by pressing down and releasing the top. The base of the device serves as a container for used needles and is easily emptied when necessary. At the price of 5s. the cup makes a very useful accessory for any type of gramophone.

**HINTS TO BETTER RECEPTION. II.**

### PERFECT BALANCE OF TONE

To remove excessive treble, such as is commonly necessary when a pentode is used, employ circuit A.  
To eliminate some of the bass and raise the pitch, use circuit B. The above must be used in conjunction with a filter output circuit. Fig. C shows a pick-up arranged to avoid excess of top register.

For full details send 2d. postage for 75 pp. Catalogue and Manual.

**BULGIN VOLUME CONTROLS**

0-2,000	0-25,000	0-100,000
0-5,000	0-50,000	0-250,000
0-10,000	0-75,000	

Ohms. Ohms.

Price **BULGIN** Price

5/6 **7/6**

The Choice of Critics

Advert of A. F. Bulgin & Co. Ltd. Abbey Road, Barking, Essex.

## SET CRACKLING IS ANNOYING!

**IF IT'S YOUR SWITCH**

**FIT THE "BUSCO" SWITCH**

and ensure perfect switch contact! There is no contact point to turn round, and when you "switch on" you have contact like a power switch.

They are as cheap as the inferior type but far superior in operation.

From your local dealer  
Halford's Cycle Stores, or

**BUSBY & CO., LTD. (Patentees)**  
Dept. A.W., PRICE ST., BIRMINGHAM

## EASY TERMS

WE supply all good quality Radio Receivers, Components and accessories on deferred terms. We carry adequate stocks and can give PROMPT DELIVERY.

12 EXIDE W.H. HIGH-TENSION ACCUMULATORS (120 volts 4,000 m.f.s.) Large capacity type. Cash Price .. £3 15 0

Or 5/- with order and 10 monthly payments of 7/11.  
Carriage charged on all orders from Scotland.

This is the best and cheapest form of High Tension supply where the electric light mains are not available.

Send list of requirements, and quotations will be sent by return. Price list FREE on request.

**LONDON RADIO SUPPLY CO., (ESTABLISHED 1925)**  
11, OAT LANE, NOBLE ST., LONDON, E.C.2  
TELEPHONE: National 1977

**FREE A Luxury Wireless Set**  
or components of equivalent value.

Wonderful offer to introduce the Radialaddin Club.  
Write for particulars. (enclosing 11d. stamp)  
**RADIALADDIN CLUB, Dept. A.W., 47/48, Berners St., London, W.1. Museum 1821**



A weekly review of new components and tests of apparatus conducted by J. H. Reyner, B.Sc., A.M.I.E.E.

**BULGIN RADIO-GRAM SWITCH**

THE Bulgin S.110 Radio-off-Gramo switch is a rotary double-pole double-throw switch, having a central off position. It has been designed for use with battery receivers and should therefore not be used to switch the supply to mains receivers.

The movement is spring-controlled, giving a good snap action with positively defined positions. The moving arms are of phosphor bronze and they actually move across the heads of the screws forming the stems of the terminals.

The switch is built up in a moulded bakelite casing, the six terminals being located at the back. Single-hole fixing is

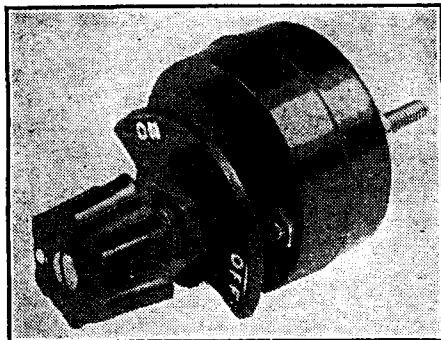

One of the range of Bulgin rotary switches

employed and as the two poles of the switch are insulated from each other, and from the fixing bush, insulating washers are not required if mounted on a metal panel. If it should be required to mount the switch away from the panel a 4-in. extension handle and mounting bracket can be obtained.

The switch retails at 2s. 6d. complete with small faceplate, indicating the three positions. The extension handle and bracket are 2s. 3d. extra.

**PERTRIX JUNIOR BATTERY**

WE were very interested to receive recently for test one of the Junior series of Pertrix batteries which have just been placed on the market. This series had been introduced with the object of providing a battery at a very competitive price, but which has, at the same time, an attractive performance. There are three sizes rated at 60, 100, and 120 volts, the relative catalogue numbers being 401, 402, and 403. The batteries are housed in yellow cardboard cartons, and tappings are provided at every 10 volts, in addition to a tapping at 6 volts at the bottom end of the battery.

The battery was tested in accordance with our usual practice, this consisting of a

discharge through a fixed load resistance for an 8-hour period with a 16-hour rest period between. At various times throughout the discharge period, the voltage and internal resistance on load are measured. The result of the test on this battery can be seen on the chart accompanying this report, in which the rest periods have been omitted to enable a smooth curve to be drawn.

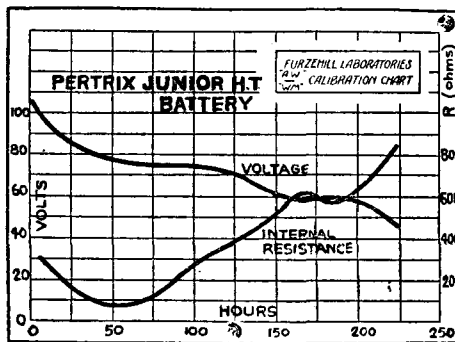

The performance curve of the Pertrix battery tested

It will be seen that the voltage dropped somewhat sharply for the first twenty-five hours, after which the fall is much more gradual until the cut-off point which occurs in the region of 220 hours. In the case of the internal resistance it will be seen that this commences at a value of about 300, dropping to 100 ohms and then rising slowly throughout the rest of the discharge. Assuming the cut-off point to be approxi-

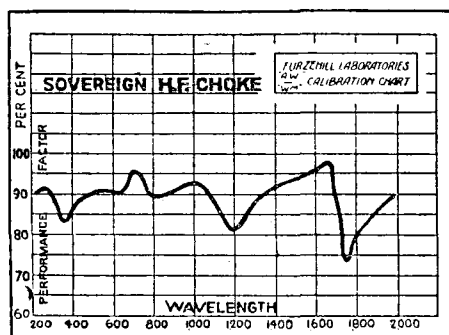

Frequency-factor against wavelength curve of the Sovereign H.F. choke

mately at the 220-hour mark, the milli-ampere-hour capacity of the battery is 1,600. This figure is really very good for so cheap a battery, it being well in excess of our arbitrary standard of 1,200 milliampere hours.

These batteries retail at 5s. 6d., 9s., and 11s. respectively, for the 60, 100, and 120-volt types, and they are well up to the Pertrix standard.

**SOVEREIGN H.F. CHOKE**

WE have tested, this week, one of the Sovereign Super H.F. Chokes. This choke is wound on a moulded bakelite former, having six slots.

In accordance with our usual practice, a high-frequency test was conducted on the choke, which indicates the efficiency of the choke as a stopper of high-frequency currents when bypassed by a .0001-microfarad condenser. The results are shown



The new Sovereign H.F. choke

plotted on the curve accompanying this report, and it will be seen that the factor averages about 90 per cent. over the whole range.

The inductance is approximately 172,000 microhenries, the D.C. resistance 500 ohms, and the self capacity 7 micro-microfarads.

The choke retails at 3s. 6d.

**VENESTA PLYWOOD**

WE have received from Messrs. Venesta, Ltd., a sample of aluminium Plymax panels. These are constructed on the same principle as ordinary plywood except that the outer ply on one or both sides is of metal instead of wood.

Applications of such material will appear at once. In many cases of home construction it is necessary to employ a metal screen along the back of the panel or on top of the baseboard. By the use of this special Plymax material the screen is already provided and the construction is thereby considerably simplified. The aluminium covering is relatively thin and the fixing of components on to the material either as a panel or baseboard does not present any difficulty.

BROADCASTING STATIONS

Broadcasting Stations classified by country and in order of wavelengths. For the purpose of better comparison, the power indicated is that of the carrier wave.

Table of broadcasting stations with columns for Country, Station Name, Wavelength (Kilo-Metres), Power (Kw.), and Frequency (Metres). Includes sections for Great Britain, Norway, Poland, Portugal, Romania, Russia, Spain, Sweden, Switzerland, Turkey, Yugoslavia, and various other European countries.

PILOT AUTHOR KITS Exact to Specification

CASH—C.O.D.—H.P. Immediate Delivery

3 VALVE RADIO-GRAMOPHONE

Described in "A.W." 21st May, 1932. KIT "A" Author Kit, with Ready drilled Panel, less Valves, Cabinet, Motor, Pick-up and Speaker and Batteries.

CASH or C.O.D. £2 16 6

or 12 monthly payments of 5/2. Selected C.O.D. Lines—You pay the postman—we pay post charges on orders value over 10/—

KIT BITS

1 Peto Scott Tablegram cabinet ... 1 11 0
1 R. & A. loudspeaker, 5-in. diaphragm (Type 50) ... 16 6
1 Cabaret triple-spring motor ... 1 15 0
3 Valves as specified: 1, PM2H; 1, PM2DX; 1, PM2A ... 1 2 9

HOME-LOVER'S ALL-ELECTRIC 3 KIT "A"

Author Kit, less Valves and Cabinet and Speaker Equipment. Panels and terminals strips ready drilled. Complete with ready drilled panel to specification. CASH or C.O.D. or 12 monthly payments of 11/11.

£6 10 0

KIT BITS

Selected C.O.D. Lines. You pay the postman—we pay all post charges on orders over 10/—
Specified valves ... 3 0 0
Specified cabinet (fitted with bar 2 6 extra) ... 1 0 0

"A.W." A.C. 2 Described in last week's issue.

KIT "A" Author's Kit with Ready drilled Panel, less Valves and Cabinet

£5 3 11

KIT BITS

Or 12 monthly payments of 9/6. Selected C.O.D. lines. We pay post charges on orders value 10/—
Set of specified valves ... 2 1 0
Specified Peto-Scott cabinet ... 17 6
Heavy-duty motor transformer ... 1 6 0
Tweedell smoothing choke (Type 820-25) ... 12 6

SELECTIVE FAMILY 3 PILOT ENVELOPE

An amazing 60 Station Set described by "Maxamp", in "Tit-Bits," May 7th, 1932.

AN AMAZING 60 STATION SET The Selective Family 3 YOU CAN BUILD THIS SET IN AN EVENING with this PILOT RADIO ENVELOPE containing FULL SIZE BLUE PRINT 5 PHOTOGRAMS COMPLETE LIST OF PARTS AND FULL ASSEMBLING AND WIRING INSTRUCTIONS. complete

PELO-KOITCO LTD 77 CITY RD. LONDON, E.C1. PIONEERS OF CONSTRUCTOR KITS IN 1919

Full-size Blue Print, 5 photographs, List of parts with newly invented, Simplified System of Home Construction and easy to follow operating notes. Get your copy of the PILOT RADIO ENVELOPE TO-DAY and build this wonderfully simple family Receiver.

1/1. Obtainable from Bookstalls and shops of Messrs. W. H. Smith & Son, Newsagents and Radio Dealers

PELO-KOITCO LTD. 77, City Road, LONDON, E.C.1

Please send me C.O.D., CASH, H.P. KIT "A". Parts as indicated.

for which I enclose £. CASH/H.P. Deposit. NAME. ADDRESS.

A.W. 186132.

WHEN SUBMITTING QUERIES . . . . Please write concisely, giving essential particulars. A Fee of One Shilling (postal order), a stamped addressed envelope, and the coupon on the last page must accompany all letters. The following points should be noted. Not more than two questions should be sent with any one letter. The designing of apparatus or receivers cannot be undertaken. Modifications of a straightforward nature can be made to blueprints, but we reserve to ourselves the right to determine the extent of an alteration to come within the scope of a query. Modifications to proprietary receivers and designs published by contemporary journals cannot be undertaken. Readers' sets and components cannot be tested at this office. Readers desiring specific information upon any problem should not ask for it to be published in a forthcoming issue, as only queries of general interest are published and these only at our discretion. Queries cannot be answered by telephone or personally. Readers ordering blueprints and requiring technical information in addition, should address a separate letter to the Query Department and conform with the rules.

A group of interesting artistes appear in George Sharat's "The Town Topics" Concert Party, which will be relayed from Jephson Gardens, Leamington Spa, on July 1. During the past year a large increase was shown in the number of wireless licences taken out in Glasgow. The total figure now stands at 83,000, which is 17,000 more than twelve months ago.

SETS of DISTINCTION

# PORTADYNE CHALLENGER PORTABLE

Maker: Portadyne Radio  
Limited.

Price: £12 17 6



THIS is the time of year when portables really come into their own. Lured on by enticing pictures of radio on the river and by the sea, set buyers succumb to temptation and invest in all kinds of suitcase and upright cabinet portables. Later, the discovery is made that the portable, provided it is one of the better models, is an all-the-year-round proposition, supplying a high standard of performance with all the advantages of being entirely self-contained.

This preamble is inspired by tests of the latest upright cabinet type of the species—the Portadyne, which has already achieved a great popularity on account of its clever design and reasonable price. The Portadyne, as its name implies, is portable power—there is plenty of punch wherever it is installed.

I am impressed with the layout of the set, which is a breakaway from convention, especially regarding the controls. These are entirely hidden from sight by a neat flap on the top of the handsome cabinet.

## The Controls

Raising the flap we find three controls, or rather three separate controls, for actually the two centre discs might be considered as one control, so simple is the operation, with the combined wave-change and battery switch on the left and the volume control on the right.

The tuning arrangement is as clever as anything I have yet seen. It consists of a two-disc action, each disc working a variable condenser, one for the frame aerial tuning and the other for the interval-coupling. The important point is the provision of celluloid scales for each condenser.

One of these scales is marked in wavelengths, and there is a curved diagonal indicator. A similar indicator is on the other scale, and all you have to do to keep the two circuits in tune is to keep one diagonal superimposed on the other. Most ingenious!

In addition to profuse wavelength calibrations for medium- and long-waves many of the well-known home and foreign stations are marked on the scale, and this still further facilitates the tuning process.

Due to the ingenious nature of the scales, two-circuit tuning, with its obvious advantages of cheapness and accuracy as compared with some ganged circuits, is in-

corporated without the slightest sacrifice of ease in control.

Apart from the tuning, there is another novelty, though not so obvious to the lay user. This is the use of swinging-coil reaction, instead of the more usual reaction condenser. Actually, the so-called old-fashioned system of swinging-coil reaction often provides extraordinary results, especially in smoothness of signal build-up, as in this set.

The circuit generally is a well-tryed one, specially suitable for self-contained sets

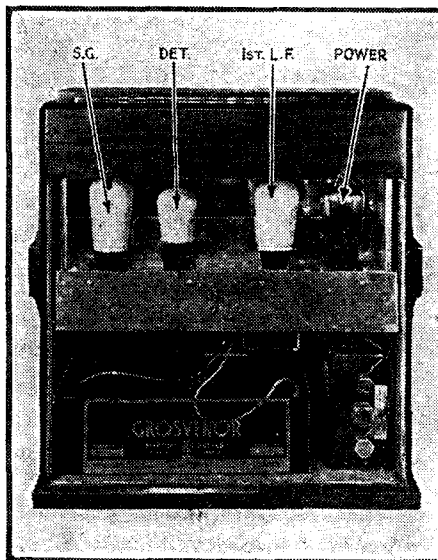

A rear view of the Portadyne Portable showing the interior with components and valves inserted

with only a frame-aerial for the signal pick-up. Here in the Portadyne I find two stages of transformer coupling following a detector, which is preceded by an efficient stage of screen-grid amplification.

The actual valves used in the set may be of interest. The first stage is a Mazda S215A, the next is a Cossor 2r0HL, and then comes a Mazda HL2 for the first low-frequency. Lastly there is a Mullard PM2A—well suited to portables.

The whole batch of valves work well together, and with a great economy of anode current. I found the total current taken from the 108-volt high-tension battery was a shade over 7 milliamperes, which means that the battery will give

several months' service before renewal.

The battery compartment at the back is one of the neatest I have seen, and above the batteries are the valves, which are easily got at for inspection or replacement.

Now for test impressions. Firstly, I should like to say the quality is above the average, so long as the necessarily limited output of the small power valve is not exceeded. Although there is a suspicion of high-note cutting the quality of both speech and music is pleasing. There is, thank goodness, an entire absence of that woofiness that used to characterise most portables!

Selectivity on the two tuning circuits is well up to average—perhaps a little above. I got Midland Regional quite clear of London Regional. Neither London station spreads unduly on the dial, and adjacent foreigners came in clear of side-band interference.

Sensitivity seems equally good on medium- and long-waves. I was more than pleased with the strength of Radio Paris, and several other long-wavers came in well.

For average locations I do not think the external aerial connection will be needed; there is ample volume on the frame aerial.

SET TESTER.

Joseph Farrington will sing in the North Regional concert on June 19.

The Rev. J. Dyfnallt Owen will give the Welsh Interlude from Swansea for West Regional listeners on June 29. He will tell about a noted body of waggish bards.

"Amateur Wireless and Radiovision." Price Threepence. Published on Thursdays and bearing the date of Saturday immediately following. Post free to any part of the world: 3 months, 4s. 6d.; 6 months, 8s. 9d.; 12 months, 17s. 6d. Postal Orders, Post Office Orders, or Cheques should be made, payable to "Bernard Jones Publications, Ltd."

General Correspondence is to be brief and written on one side of the paper only. All sketches and drawings to be on separate sheets. Contributions are always welcome, will be promptly considered, and if used will be paid for. Communications should be addressed, according to their nature, to The Editor, The Advertisement Manager, or The Publisher, "Amateur Wireless," 58-61 Fetter Lane, London, E.C.4.



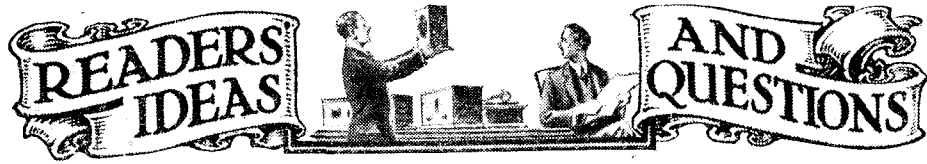

“Magnetics.”

SIR,—Please may I be permitted to correct M. A. L. in his paragraph headed “Magnetics” in AMATEUR WIRELESS dated May 14?

Ferromagnetism is the term applied to the type of magnetism exhibited by iron and steel and also the associated metals: nickel, cobalt and manganese. These metals are similar in that they all show a hysteresis effect to a greater or lesser degree.

Paramagnetic elements, e.g. oxygen, have no hysteresis effects, although they show a very slight induced magnetism. When paramagnetic elements are placed in a magnetic field they acquire polarities similar to those which would be induced in a ferromagnetic element under the same conditions but the pole strengths would be exceedingly small.

Diamagnetic elements, the most pronounced being bismuth, when placed in a magnetic field acquire opposite polarities to those which would be produced in members of the ferromagnetic group but again the pole strengths would be of infinitely smaller magnitude. Diamagnetic elements show no hysteresis effects.

It may be noted that the so-called “asymmetrical” elements of chemistry are those which show paramagnetism, these elements having an unbalanced magnetic moment to each atom and thus they exhibit slight signs of magnetisation when placed in a magnetic field.—S. G. B. (London, N.).

Mains Hum in A.C. Amplifier

SIR,—I experience a slight but nevertheless annoying mains-hum in a gramophone amplifier I have constructed. The trouble does not appear to be due to insufficient smoothing, as extra smoothing has been tried without effect. Furthermore, I have kept all grid leads short and have my input volume control close up to the first valve holder. The valve-heater circuits are wired with thick flexible wire and do not couple unduly with the other wiring of the set.—B. D. (Addiscombe).

You do not say whether you have tried earthing the amplifier direct to a good earth connection. This should be tried whilst at the same time it is recommended that you use screened-flexible leads or cable between the pick-up and the input terminals to the amplifier. These two suggestions should enable you to overcome the difficulty. If not, we advise you to use an 8-microfarad capacity condenser of the electrolytic type in the smoothing circuit.—Ed.

Faulty Switch Contacts

SIR,—I have a built-up receiver which has quite recently developed a fault. It appears quite satisfactory on the medium waves, but refuses to give results on the long waves. I have inspected the interior so far as possible, and notice there is a rotary type of switch used for wave-changing. It is impossible to see the contacts in this switch as there is an ebonite disc arranged above the switch contacts. So far as can be seen, the long-wave coil

winding has no break. Can you suggest how I might test the switch for a faulty contact?—A. D. (Kent).

If you have not a meter of any kind available, we suggest you get a flashlamp and a suitable battery and connect up as follows: Join one terminal of the lamp-holder to one terminal of the battery and then connect a flexible lead to the other terminal of the battery and another lead to the other terminal of the flashlamp holder. The free ends of these latter leads should be connected to the contacts of the switch which are supposed to make contact to complete the different coil circuits. If the lamp lights up, the switch contacts are satisfactory. Should the lamp fail to light, a faulty switch contact is obvious. In this case, the switch should be dismantled and the contacts readjusted to overcome the trouble.—Ed.

Detector Valve Types

SIR,—With reference to the “Mascot” receiver, which I have made, I have used every component exactly as specified, including home-made coils, which, I am sure, are wound in accordance with the instructions, but I regret to state that I am only able to receive the two London stations. The detector valve gave satisfactory results in my previous set although it is not of the type specified, and I believe it has an impedance of about 10,000 ohms. Also I must state that at present I have only about 40 or 50 volts H.T. available. Is it probable that the detector valve or the low H.T. voltage will account for my poor result?—G. T., (Bromley.)

It is absolutely essential in a set of this type to use a detector valve having an impedance of about 20,000 ohms or so and to apply at least 110 to 120 volts H.T., owing to the voltage drop through the high resistances in the anode circuit of the detector valve. If you will use the correct type of valve as the detector and increase your H.T. voltage to the amount stated, we feel sure your results will be perfectly satisfactory.—Ed.

A NEW “AMATEUR WIRELESS” HANDBOOK  
**The HOW & WHY OF RADIO**

By ALAN HUNTER  
2/6 NETT.

This book has been expressly written for beginners. It provides a clear conception of the general theory and practice of wireless reception in simple non-technical terms. It has been mainly compiled from the series of articles in “Amateur Wireless”—“The How and Why of Radio”—which proved so popular during the past twelve months.

Of all Newsagents and Booksellers, or 2/9, post free, from “Amateur Wireless,” 58/61 Fetter Lane, London, E.C.4

THE MOST POPULAR  
**RADIO-GRAM CABINET**  
ON THE MARKET

REDUCED TO **39/6** Carriage Paid!!!  
QUALITY GUARANTEED IMPROVED

Soundly constructed in selected oak, etc., and hand polished.

SPECIFICATION.—3 ft. 3 in. high, 1 ft. 10 in. wide, 1 ft. 6 in. deep. To take panels up to 18 by 7 in. Panel opening to suit set. These cabinets allow ample room for the following: Pick-up, Motor, Speaker, Batteries, etc., all for the reduced price of 39/6.

Catalogue Post Free. From one of the Largest Mail Order Works in England.

W. S. WILKIN, Cabinet Manufacturer,  
12-26 Nelson Mews, Southend-on-Sea, Essex

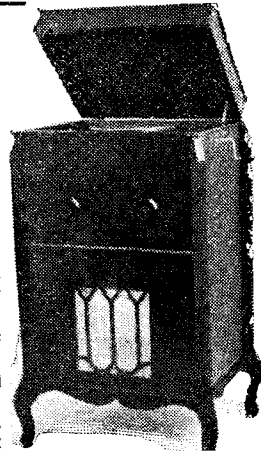

**YOU CAN'T GO WRONG!**

The most efficient and safest device for connecting accumulator and radio set. Eye-sockets permanently fastened to accumulator terminals, connectors attached permanently to the wires from set.

Non-reversible and differing in shape, colour and lettering. Wrong connections impossible, deliberately or accidentally. Completely insulated, safeguarding valves. Lead-plated, non-corrosive eyes, vaseline-filled cavities.

BELLING-LEE  
ACCUMULATOR  
CONNECTORS

9d. per pair, complete in carton with instructions.

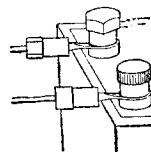

**BELLING-LEE**  
FOR EVERY RADIO CONNECTION

Advt. of Belling & Lee Ltd., Queensway, Ponders End, Mdx.

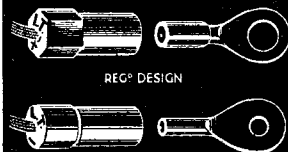

PREPAID ADVERTISEMENTS

Advertisements under this head are charged THREEPENCE PER WORD, minimum charge THREE SHILLINGS. DEPOSIT SYSTEM. As the publishers cannot accept responsibility for the bona fides of advertisers in this publication, they have introduced a system of deposit which it is recommended should be adopted by readers when dealing with persons with whom they are unacquainted. It is here explained. Intending purchasers should forward to the Publishers the amount of the purchase money of the article advertised. This will be acknowledged to both the Depositor and the Vendor, whose names and addresses must necessarily be given. The deposit is retained until advice is received of the completion of the purchase, or of the article having been returned to and accepted by the Vendor. In addition to the amount of the deposit, a Fee of 6d. for sums of 21 and under, and 1s. for amounts in excess of 21, to cover postage, etc., must be remitted at the same time. In cases of persons not resident within the United Kingdom, double fees are charged. The amount of the Deposit and Fee must be remitted by Postal Order or Registered Letter (Cheques cannot be accepted,) addressed to "AMATEUR WIRELESS" ADVERTISEMENT DEPARTMENT, 58/61 FETTER LANE, LONDON, E.C.4.

PATENTS.—Trade Marks, "Advice Handbook" free.—B. T. King, Regd. Patent Agent, 146a Queen Victoria Street, London.

WIRELESS AS A CAREER.—Those already engaged in the radio industry and those who would like to obtain employment in this interesting profession should write for a copy of our booklet, sent post free without obligation.—Northern Counties Wireless School, 55-57 Guildhall Street, Preston.

"ENGINEERING OPPORTUNITIES." This is a book you must not miss. It contains brilliant articles by Prof. A. M. LOW, our Employment Supdt., etc., shows how to pass A.M.I.Mech.E., A.M.I.C.E., A.M.I.A.E., I.E.E., M.I.M.T., Matric, G.P.O., and all other Exams, and outlines over 100 Home-Study Courses in all branches of Engineering. Send for your copy to-day. FREE and without obligation. We alone guarantee—"NO PASS—NO FEE." BRITISH INSTITUTE OF ENGINEERING TECHNOLOGY, 109 Shakespeare House, 29 Oxford Street, London, W.1.

H.T. ACCUMULATORS CORRECTLY CHARGED by Specialists, also complete H.T. and L.T. Hire Services. Express delivery over wide area.—Aneloy Radio, 36, Hindmans Road, East Dulwich. Phone: New Cross 4074. Charging Contractors to Camberwell Council and Official Oldham Service Station.

REPAIRS—Undy Loud-speakers and all classes and types of radio and electrical equipment. Conversions D.C. to A.C. and vice versa. Long-wave coils fitted to American receivers, etc. All repairs guaranteed. Best-quality components only used. Write for quotation to Express Radio Service Co., Dept. A, 5 Great Chapel Street, Oxford Street, W.1. (Special terms to traders.)

VARIABLE CONDENSERS, .0003 and .0005, 1/6 each, post free. Suitable for any set.—Wood's, 390 Longmoor Lane, Liverpool.

BANKRUPT BARGAINS.—List free with 3-valve diagram. Three-valve kit, with cabinet, 32/6. Graham-Farish three kit, with Marconi valves, 42/-. Century Super, 76/- Any kit supplied. Transformers from 3/3. .0005 Variable, 2/6; S.M. type, 5/-. Dual Coils from 4/-. D.C. Eliminators, 16/6. Harlie modd 40 Pickups, 17/6. D.C. M.C. Speakers, 20/-. Eliminators, A.C., Ekeo, 1/1/20, 45/-. Ekeo A.C./V. All Mains, 43/-. Regentone S60, 50/-. Five-valve Super Hct with frame, 45/-. B.T.H. P.M. M.C. Speaker, 32/6. Anything radio. Quotes per return.—Butlin, 143b Preston Road, Brighton.

DETAILED INFORMATION ON ANYTHING RADIO.—We elucidate all those difficulties in connection with short-wave transmission and reception, including obtaining the amateur transmitting permit; dependable advice on broadcast and radiogram problems; full details, including diagrams. Charges: 3/- per query; four or more 2/6 each. Questions involving elaborate treatment quoted for by return.—Radio Technical Agency, 2 Westgate Chambers, Newport, Mon.

GILBERT INDUSTRIES GUARANTEED BARGAINS.—Three-gang .0005 Tuning Condensers by Polar, split end vane trimmers, with or without slow-motion drive. List price, 35/-; our price, 10/6, post free. Mains Transformers. Exceptionally heavy job, with core of 32 stalloys, clamp d in rigid girder frame; tagged and marked 210, 230, 250 volts tapped input, 50-60 cycle; 4 volts 4 amps. centre-tapped filament winding, 4 volts 2 amp. rectifier; 325-0-325 secondary, at 85 ma. Worth 50/-; offered at 15/-, post free. Polymer Electrolytic Condensers, 8 mfd., 435 working voltage. List, 12/6; our price, 4/-, post free. Stalloy and Lohys' stanpings and bobbins cheap. Small 20-h. Constant Inductance Eliminator Chokes. List price, 7/6; our price, 3/6, post free. Output Chokes tapped for pentode, or suitable for smoothing. List, 17/6; offered at 6/-, post free. Satisfaction or money refunded.—Gilbert Industries, 519 London Road, Westcliff-on-Sea, Essex.

WEEDUN POWER LINK RADIO CO.—New service to their many clients. Transformers, Loud Speakers, Pick-ups, any make or item repaired as new 3/6. Articles returned to you C.O.D. Post. Eliminator repairs quoted for. Supervised by specialists. Note new address.—185, Earlham Grove, Forest Gate, London, E.7.

CENTURY SUPER, less cabinet and frame aerial, 75/-.—Box 7, "Amateur Wireless," 58-61 Fetter Lane, E.C.

BANKRUPT BARGAINS.—Three-valve Kit, 15/6. Condensers, variable, 11d.; fixed, 31d.; Mansbridge, 11d.; 4 by .0005 gauged, 14/6. Grid Leaks, 5d.—usual values. H.E. Chokes, 11d. Valve Holders, 3d., etc. Limited stock only. Orders 5/- and over sent C.O.D.—British Radio Kits & Co., 65a Rylett Crescent, Hammersmith, W.12.

Postcard Radiō Literature

GET THESE CATALOGUES FREE. Here "Observer" reviews the latest booklets and 1 folders issued by well-known manufacturers. If you want copies of any or all of them FREE OF CHARGE, just send a postcard giving the index numbers of the catalogues required (shown at the end of each paragraph) to "Postcard Radio Literature," "AMATEUR WIRELESS," 58-61, Fetter Lane, E.C.4. "Observer" will see that you get all the literature you desire.

New Ferranti Set Book A NEW 8-page catalogue WB534 has been issued by Ferranti, Ltd., in connection with three popular sets, the model 32, the moving-coil console, and the inductor console. Full technical details are given, and instructions for working the sets with a mains aerial. 780

Metal Rectifiers It is possible to use Westinghouse metal rectifiers for measuring instruments, the models MBS 1, 5, and 10 being suitable. These handle a supply of 1, 5, and 10 milliamperes respectively. The new Westinghouse 11B booklet gives details, circuits, and curves, and will appeal to technical enthusiasts. 781

Electrifying Your Gramophone Some months ago I went to a first demonstration of the Simpsons electric turntable, and now Simpsons Electricals, Ltd., have sent me a useful leaflet describing the latest model. This is an electric turntable drive which fits flush on the motorboard. 782

The Chakophone Tuner A leaflet describing the Chakophone Universal tuner will interest you, I am sure, if you are building a set in which easy control is to be a chief factor. The Chakophone unit covers 200-550 and 1,000-1,900 metres when tuned with a .0005 variable condenser. Rotary magnetic reaction is provided. OBSERVER. 783

Make a Radiogram or Gramophone at quarter price. Order loose kits or sets and assemble them at home. Get for 2d. our 64-page catalogue with scale drawings and instructions how to make cabinets, gramophones or radiograms, what parts to choose and the lowest prices to pay. We sell motors from 7/6, tone-arms, rubberhorns, 1/6, pick-ups, horns, loud-speakers, radio kits, complete receiving sets, gramophones, radiograms and parts. Also accordions, violins and mandolines.—Established 1903.—The Result Fixings Co., A.W., 129 Old Street, London E.C.

REPAIRS to Blue Spots 5/-. Loudspeakers, Headphones and Transformers 4/- each. Mains and Eliminators quoted for. Prompt Service. 12 months' guarantee. Trade invited. Loud-speaker Repair Co., 2 SHIPKA ROAD, Balham, London

TAYLEX WET H.T. BATTERIES New Prices: Jars 1/3, Sacs 1/2, Zincs 1/0. Samples doz. 18 Volts complete with bands and electrolyte 4/1, post 7d. Sample unit 6d. Illus. booklet free. Bargain list free. AMPLIFIERS 39/-, 3 VALVE ALL-STATION SET 55. A. TAYLOR, 17, Studley Road, Stockwell, LONDON.

FULL-SIZE BLUEPRINTS

- When ordering, please send Postal Order NOT STAMPS CRYSTAL SET (6d.) 1931 Crystal Set AW308 ONE-VALVE SETS (1s. each) Easy to Build One AW304 Short-wave One-valver AW327 B.B.C. One-valver AW344 TWO-VALVE SETS (1s. each) Big-volume Two (D, Pen.) AW309 Two Star 2 (D, Pen.) AW315 The 25/- Two (D, Trans) AW330 Ten-Station Two (D, Trans) AW336 Big-Power Melody 2 (D, Trans) AW338 Ever Tuned Regional Two (D, Trans) WM241 Station-finder Two (D, Trans) WM1253 Music Lover's Two (D, Trans) WM260 New Economy Two (D, Trans) WM265 Family Two (D, Trans) WM1273 Economy A.C. Two (D, Trans) WM286 Inexpensive A.C. 2 (D, Trans) AW346 Midget Two (D.R.C.) AW348 THREE-VALVE SETS (1s. each) Square Peak Three (SG, D, Trans) AW293 35/- Three-valver (D, 2RC) AW323 Baby Three (D.R.C, Trans) AW324 1932 Ether Searcher (SG, D, Pen.) AW325 Wide World Short-Wave Three (D, RC, Trans) AW332 New Favourite Three (D.R.C, Trans) AW334 Home-lover's All-electric 3 (SG, D, Trans) AW335 'The P.W.H.' Mascot (D, RC, Trans) AW337 Home-lover's Battery 3 (SG, D, Trans) AW341 18 Radio-gram (SG, D, Trans) AW343 Five-point Three (SG, Trans) WM212 New Brookman's Three (SG, D, Trans) WM218 Five-point Short-waver (D, RC, Trans) WM223 Band-pass Inceptor-dyne (SG, D, Tra 1) WM244 Ether Marshal (SG, D, Trans) WM247 Meridian Short-waver (D, RC, Trans) WM256 Five-advantage three (D, RC, Trans) WM257 Everybody's Radiogram (SG, D, Trans) WM258 Double Band-pass Three (SG, D, Trans) WM259 Everybody's Radiogram (with Automatic G.B.) WM262 New Economy Three (SG, D, Trans) WM263 New Plug-in Coil Three (D, 2 Trans) WM270 Transportable Three (SG, D, Trans) WM271 Multi-Mag Three (D, 2 Trans) WM288 FOUR-VALVE SETS (1s. 6d. each) The 43 3s. Four (SG, D, RC, Trans) AW303 The 43 3s. Four (Improved Model) AW303A Everybody's Radio-gramophone AW310 Four Star 4 (SG, D, RC, Trans) AW318 50/- Four (SG, D, RC, Trans) AW331 Five-Point Four (SG, D, RC, Trans) WM216 Brookman's Three-plus-one (SG, D, RC, Trans) WM233 Ether Rover (SG, D, RC, Trans) WM266 Quadradyne (2 SG, D, Pen.) WM273 Double Band-pass Four (SG, D, RC, Trans) WM274 Everybody's Radio Gram. (SG, D, RC, Trans) WM276 A.C. Quadradyne (2 SG, D, Pen) WM279 FIVE-VALVE SETS (1s. 6d. each) A.C. Britain's Super (Super-het) AW322 James Short-wave Super (Super-het) AW328 Simple Super (Super-het) AW340 Regional D.C. Five (SG, D, RC, Pus. 1-pull) WM252 Ideal Home Super (Super-het) WM280 Easytune 60 (Super-het) WM284 SIX-VALVE SETS (1s. 6d. each) Century Super (Super-het) AW287 A.C. "Century Super" (Super-het) AW295 Mains Unit (1/-) AW295A Super 60 (Super-het) WM229 A.C. Super 60 Radio Gramophone (Super-het) WM239 A.C. Super 60 (Table Model) WM245 Super 60 (with Wearite base) WM249 Super 60 (with Lewcos base) WM251 1932 Super 60 (Super-het) WM269 1932 A.C. Super 60 (A.C. Super-het) WM272 SEVEN-VALVE SETS (1s. 6d. each) Super Senior (Super-het) AW256 Super Senior (Wearite base and Lewcos coils) WM261 PORTABLE Town and Country Four (SG, D, RC, Trans) WM282 Hiker's Two (D, Trans) AW345 AMPLIFIERS (1s. each) Add-on H.F. Screened-grid Unit AW296 Universal Push-pull Amplifier AW300 "A.W." Record Player (L.F. Push-pull) AW319 Quality Amplifier (P.C.), 1/6 AW264 A-P-A Power Amplifier for A.C. Mains AW275 A-P-A Radio Unit (SG, D) WM281 Economy Gramophone Amplifier WM277 MISCELLANEOUS (1s. each) "A.W." Tone changer (6d.) AW288 "A.W." Selectivity Unit (6d.) AW290 A.C. Trickle Charger AW305 Amateur's Linen Speaker AW307 D.C. H.T. Unit AW312 Output Unit for Pentode Sets AW316 Short-wave Plug-in Adaptor AW326 Short-wave Super-het Adaptor AW329 Ether Searcher Radiogramophone motor board "A.W." Short-wave Adaptor AW333 Big H.T. Unit for A.C. Mains WM230 Loud-speaker Tone Control WM234 "W.M." Linen Diaphragm Loud-speaker WM235 Two-Minute Adaptor for Short Waves WM240 Super 60 A.C. Unit WM248 A Simple Mains Unit WM283 Voltage Regulator WM285 Short-wave Director (6d.) (wavemeter) WM287 Copies of the "Wireless Magazine" and of "Amateur Wireless" containing descriptions of most of these sets can be obtained at 1s. 3d. and 4d. respectively, post free. Index letters "A.W." refer to "Amateur Wireless" sets and "W.M." to "Wireless Magazine." Address letters: Amateur Wireless Blueprints Dept., 58-61 Fetter Lane London, E.C.4.

Amateur Wireless INFORMATION BUREAU COUPON Available until Saturday JUNE 25, 1932 FEE 1/-

WESTINGHOUSE

REDUCED  
IN  
PRICE



H.T.8

NOW  
18/6  
ONLY

The demand for the popular H.T.8 has been so great that we have been able to make a reduction in manufacturing costs. We are passing the benefit on to YOU.

Full details of this and the new Westinghouse Metal Recifilers are given in "The All-Metal Way."

COUPON

WESTINGHOUSE PUBLICITY, 82, York Road, King's Cross, London, N.1.

Please send me a copy of your booklet, "The All-Metal Way" for which I enclose 3d. in stamps.

NAME.....

ADDRESS.....

A.W. 18,632

THE WESTINGHOUSE BRAKE & SAXBY SIGNAL CO., LTD.,  
82, YORK ROAD, KING'S CROSS, LONDON, N.1

45 Including Transformer and Baffle Board.

## The PRICE was made for YOU..

—but the only consideration that governed the design of the MoToR MINOR was a fixed determination to produce a Moving-Coil Loud-speaker that would positively defy comparison in sensitivity, tone quality, and value. Only the best components could achieve this object, so only the best were used. Only comparison can convince you, so compare before you choose. Your choice will surely be a

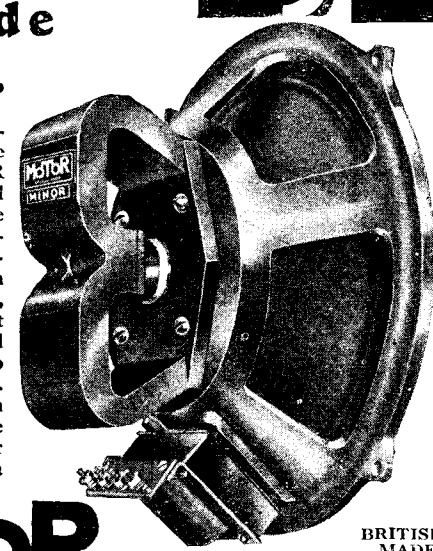

BRITISH MADE

# MOTOR MINOR

## P.M. MOVING COIL

Write for free descriptive pamphlet

TEKADE RADIO & ELECTRIC LTD.

147 Farringdon Road, London, E.C. 1.

Telephone: Clerkenwell 2486

Grnd Diameter, 9 1/2 in.

Overall Depth, 4 1/2 in.

Cone Diameter, 7 in.

D.C. Resistance: 10 ohms.

Impedance of Speech-coil: 5 ohms.

Approx. Coil Gap: 1 mm.

Transformer Tappings: 25:1, 20:1, 15:1.

Available also in handsome Walnut Cabinet.

The CHESTER 75/-

# PLAYER'S

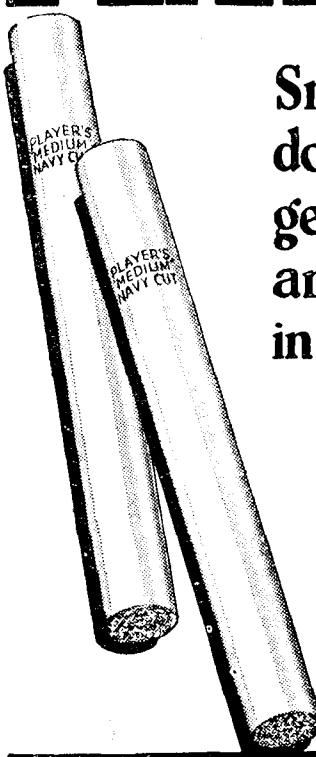

Smokers make doubly sure by getting Quality and Quantity in the Cigarettes



10 for 6<sup>p</sup>  
20 for 11<sup>1/2</sup><sup>p</sup>

NCL 103B

## The DOOM of "BOOM"!

Flawless reception is impossible while undesirable resonance and "boominess" are present in your Loud-speaker.

The Howe Box Baffle definitely eliminates them and gives you perfect quality of reproduction.

The Howe Box Baffle is scientifically and acoustically perfect. It is bound to improve your reception.

The B.B.C. Year Book says "Actually, the results obtained from a Loud-speaker thus treated are . . . superior to those obtained using a flat baffle."

Any home constructor can fit a Howe Box Baffle. It requires no alteration to your set and no technical knowledge. The Kit contains full instructions and every single item required to construct it. Price, including royalty, 20/- delivered free.

Don't put up with anything but the best any longer. Ask your dealer or post this coupon for full particulars to F. McNeill & Co., Ltd. (Radio Dept. 9), 16 Lamb's Passage, Bunhill Row, E.C.1.

### The Howe Box Baffle Kit

"The Doom of Boom"

Not suitable for Portables

POST THIS FOR FREE BOOKLET

To F. McNEILL & CO., LTD. (Radio Dept. 9)  
16 Lamb's Passage, Bunhill Row, E.C.1.

Please send me details of the Howe Box Baffle Kit

Name.....

Address.....

Advertisers Appreciate Mention of "A.W." with Your Order



**THERE'S MORE IN LOW ANODE CONSUMPTION  
THAN JUST SAVING YOUR BATTERIES**

The low anode consumption of P.M.I.H.L. means this, too. There is no risk of saturating the intervalve transformer, and in consequence, quality is improved. Again, the effective inductance of the transformer is not impaired, which means an increase in stage gain.

The P.M.I.H.L. is also built on the new RIGID UNIT PRINCIPLE, which renders it absolutely free from microphony.

Apart from these advantages, you are always glad to save your H.T. So use the P.M.I.H.L., the valve that combines efficiency with economy.

Price 7/-

MADE IN ENGLAND

#### OPERATING DATA

Filament Voltage	-	-	-	2.0V
Filament Current	-	-	-	0.1A
Max. Anode Voltage	-	-	-	150V

#### CHARACTERISTICS

(At Anode Volts 100; Grid Volts Zero)				
Anode Impedance	-	-	-	20,000 ohms
Amplification Factor	-	-	-	28
Mutual Conductance	-	-	-	1.4 mA/V

**Mullard**  
**THE MASTER VALVE**

Advt. The Mullard Wireless Service Co., Ltd., Mullard House, Charing Cross Road, London, W.C.2. ARKS