

THE SET FOR TO-DAY—THE "1930 CLARION 3"

Amateur Wireless

and
Radiovision

Every
Thursday 3^d

Vol. XVI. No. 405

Saturday, March 15, 1930

The 1930 CLARION THREE

our
latest
success!



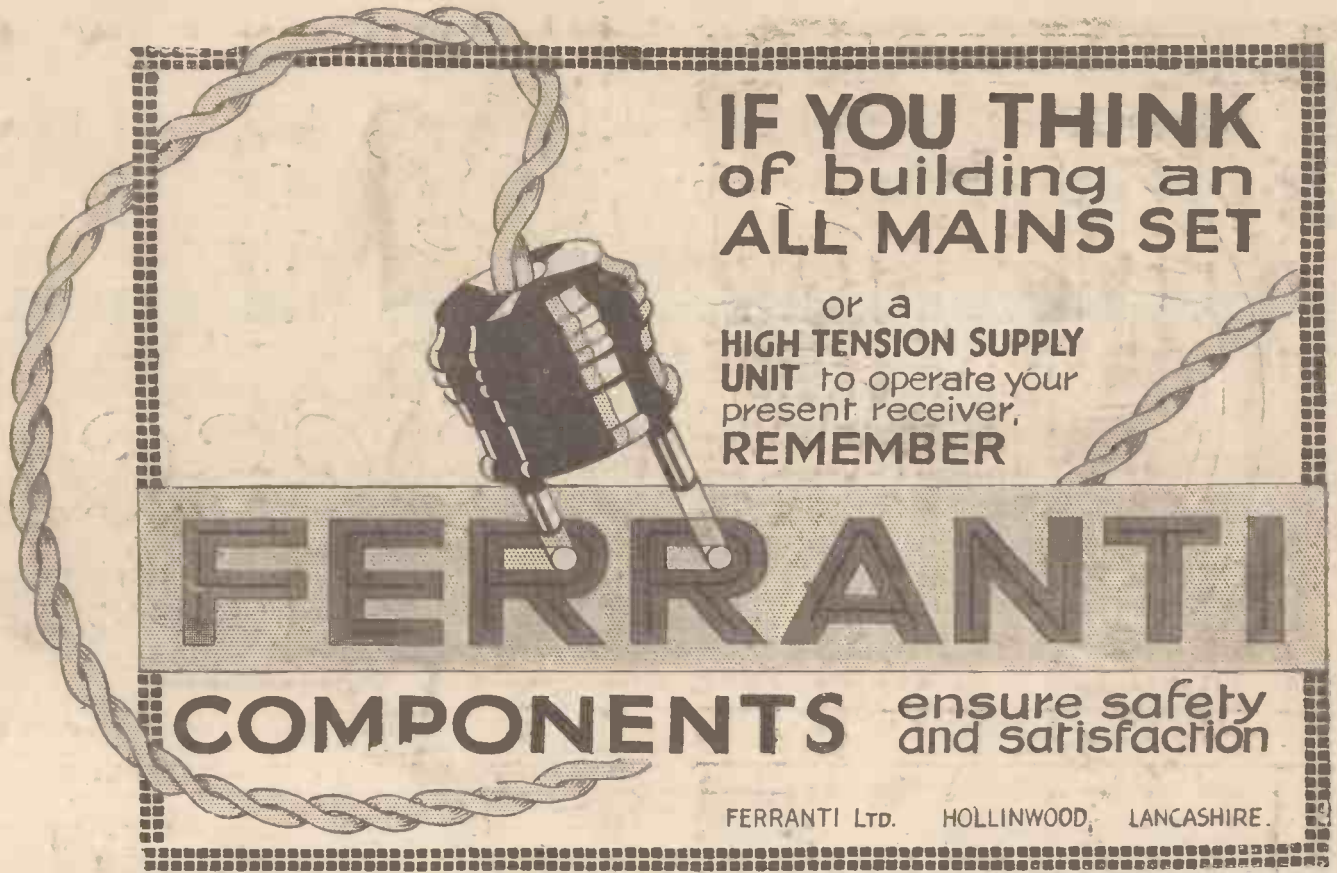

**IF YOU THINK
of building an
ALL MAINS SET**

or a
**HIGH TENSION SUPPLY
UNIT** to operate your
present receiver,
REMEMBER

FERRANTI

COMPONENTS ensure safety
and satisfaction

FERRANTI LTD. HOLLINWOOD, LANCASHIRE.



A GAP FILLED!



THE new Hegra "MAGNET DYNAMIC" Loud-speaker fills the gap between the standard speaker and the moving-coil type. An entirely new unit is used and unique principles of design are employed.

Quality of reproduction is equal to that of a moving coil and yet no field energising current is required. An input up to 4 watts can be handled with ease.

It costs no more than the standard type and yet it gives sufficient volume to fill a large hall.

Ask your dealer to demonstrate this new speaker; you will be astonished!

OBTAINABLE FROM ALL GOOD DEALERS.

Ideal for Radio-Gramophones and all-mains Receivers.

Perfect reproduction with small or powerful sets.



Price in Chassis form
(as illustrated) £2 : 16 : 0
In polished Walnut
Cabinet £5 : 10 : 0

M.C.1

Don't Forget to Say That You Saw it in "A.W."



The New
CELESTION
LOUD - SPEAKER
MODEL Z.20

"Renowned for brilliancy and quality . . . speech and music particularly good . . . a handsome instrument."
PERCY HARRIS in "Wireless Constructor."

The modern receiver must be selective. But selectivity alone is not enough. Any programme worth hearing at all is worth hearing well. To appreciate it fully you must hear it with the realism of tone for which Celestion is renowned.

Model Z 20 is designed specifically to give the finest possible results with any set from a Two-Valve to a Power Amplifier. Crowned with the Celestion hall-mark — a beautifully designed and hand-polished cabinet.

In Oak	£7. 15. 0.
Mahogany	£8. 5. 0.
Walnut (to order)	£9. 0. 0.
Other models from	£3. 15. 0.

WRITE FOR AN ABSORBING FREE BOOK ON 'SOUND-RECREATION'
CELESTION LTD.,
DEPT. J.,
KINGSTON-ON-THAMES.

London Showrooms:
106, Victoria Street, S.W.1.

CELESTION
The Very Soul of Music

Write to us about the new Celestion Electrical-Gramophones and Radio-Gramophones . . . the finest yet.

THE
BIG STRIDE
FORWARD

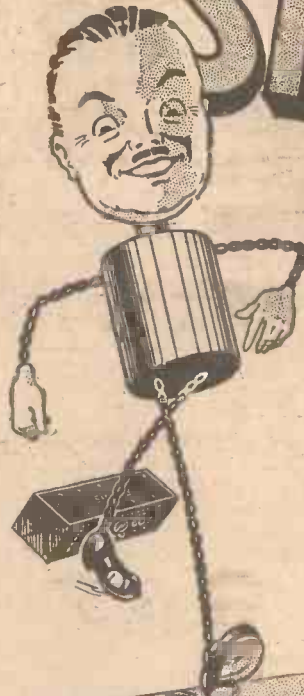

IN
BATTERY PERFORMANCE



IT
COSTS
NO
MORE!

NEW design, new materials, new methods of construction all combine to make the Full O' Power Battery of outstanding merit.

The exclusive employment of seamless drawn zinc cylinders of exceedingly high purity—

AVOIDS: corrosion,
GIVES: larger output of current.
ENSURES: longer service.

GUARANTEES: maintenance of a high standard of efficiency over a long period.

No. 1210. SIZE—50 VOLTS

Tel. Woolwich 1161

Siemens Brothers & Co.

Woolwich, S.E.18

Advertisers Appreciate Mention of "A.W." with Your Order



RADIO THAT WILL LIVE!

THE VARLEY BI-DUPLEX WIRE-WINDING, invented over a quarter of a century ago and used in all our ANODE RESISTANCES, TAPPED RESISTANCES and VARIABLE RESISTANCES, is almost a classical achievement in Radio. No other method of winding can compare with it for performance.

VARLEY ANODE RESISTANCES, which are accurate to within five per cent., are supplied in a universal holder—an original Varley feature enabling the resistance to be mounted either vertically or horizontally.

Write for Sections B and C of the Varley Catalogue giving details of the 16 models in the Varley range of ANODE RESISTANCES, varying from 5,000 to 500,000 ohms!

Prices from 4/6 to 17/6



Advertisement of Oliver Pell Control Ltd., Kingsway House, 103 Kingsway, London, W.C.2, Telephone: Holborn 5303

An All-Electric Radio Set for £12. 17. 6

or on Easy Payments

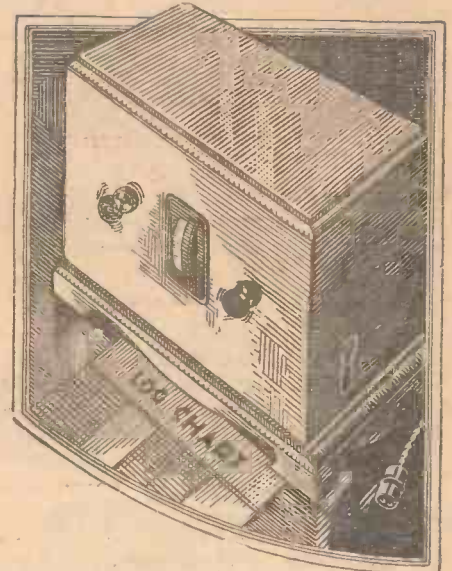

Model P.2 (illustrated) Two Valves, superior to ordinary three valve sets - £12. 17. 6
 Model S.G.P.3 (Three valve) - £21. 0. 0
 (Prices include valves and royalties)

Plug-in the "Ekco" adaptor to your electric light or power supply—Switch on—and know what it means to receive radio in the modern way. No batteries to run down—no accumulators to recharge—no bother—no mess.

"Ekco-Lectric" Radio Receivers are in hand-polished Walnut cabinets—with volume and selectivity controls—sockets for gramophone pick-up—Westinghouse Rectification in A.C. models—and they are British made for D.C. or A.C. Mains.

There are also "Ekco" Power Supply Units for electrifying or partly electrifying your present set. Write for Free Booklet and details of Easy Payments to

E. K. COLE LTD. (Dept. K), "EKCO" WORKS, LEIGH-ON SEA



Plug-in—That's all!

EKCO-LECTRIC RADIO RECEIVERS

NO BATTERIES NO ACCUMULATORS

Mention of "Amateur Wireless" to Advertisers will Ensure Prompt Attention

Amateur Wireless and Radiovision

The Leading Radio Weekly for the Constructor, Listener and Experimenter

Editor:
BERNARD E. JONES

Technical Editor:
J. H. REYNER, B.Sc., A.M.I.E.E.

Research Consultant:
W. JAMES

Assistant Editor:
H. CORBISHLEY

“Castor and Pollux”—We Explain—Will the Super-het Return?— A Frenchman’s Opinion—Pleasant Sunday Afternoons!

“Castor and Pollux”—The “Heavenly Twins” at Brookmans Park (Castor and Pollux, says our tame astrologer) have now started operations. An interesting commentary on the regional scheme is in this issue. There is only one point: why are the terms “National,” “Regional,” and “London Regional” used? ask readers.

We Explain—The National programme (wavelength, 261 metres) is so called because it is of interest throughout the country and it will be relayed to stations outside London. In character and in the fact that its items will, from time to time, be broadcast simultaneously by other stations, it resembles the programme which has hitherto been known as the “London and Daventry programme.” When each of the regions is equipped with a twin-wave transmitter, a National programme will be broadcast in its entirety on one of the two wavelengths, while the other is reserved for local programmes. Until this is so, and while they have only one transmitter, Regional stations will broadcast a proportion of National items among their own local programmes. In the London area the alternative programme to the National is known as the “London Regional programme.”

Will the Super-het Return?—“Thermion” set the ball rolling when he suggested that owing to modern conditions the super-het might make a “come-back,” to use an expression from Hollywood. Within the last few years super-hets have been supposed to be as much out of general popularity as the Armstrong super, or even the humble crystal set; but perhaps the new broadcasting conditions will bring the multi-valver back again. At the present time French amateurs should know more about super-hets than we do, for this is one of the most popular types of set across the Channel. Particular interest, therefore, attaches to a letter we have received from a French Professor of Science.

A Frenchman’s Opinion—He says: “As a weekly reader of AMATEUR WIRELESS, I am always very interested in ‘Thermion’s’ articles. In the issue dated February 22, ‘Thermion’ deals with the question of the super-het and shows the advantages of this type of receiver. However, he does not mention one of its greatest advantages, namely, the good use to which it can be put in connection with short-wave work. By putting a short-wave adaptor in the place of the first intermediary frequency valve, one can easily get

PRINCIPAL CONTENTS

	PAGE
Current Topics	395
KDKA to have an Improved Transmitter	396
The “Mag” Gramo Unit	397
Is the Regional Scheme Wasting the Ether?	399
My Wireless Den	400
On Your Wavelength	403
More Cheap Mains Sets are Wanted	405
Without Fear or Favour	406
Making Your Own Binowave Coils	407
Continuing the “1930 Clarion Three”	408
Parallel Feed	412
“A.W.” Tests of Apparatus	414

down below 14 metres, and the tuning is as simple as that of a crystal set. In this way one can work a set incorporating an autodyne stage, two I.F. stages, the second detector, and two low-frequency stages with very simple tuning. With such a set Monte-Grande fills the house here, 5SW (when it can be received) is very strong, and the American relays wake the family. I am certain that a really up-to-date study of the super-het by your Technical Staff would be in the interest of many readers—perhaps a larger number than might be thought. A super-het with screen-grid valves in the I.F. stages, and incorporating a short-wave adaptor which could be brought into operation by the simple movement of a switch, would doubtless be a great success. No other special apparatus for short-wave reception has the advantage of such simple tuning as would be given by this combination.” Then he goes on to say kind things about the interest which AMATEUR WIRELESS has in France! The super-het question is waking ‘em up.

Pleasant Sunday Afternoons!—“All that we get is a song and poetry recital that might have been borne in the Sunday afternoon department of the British Broadcasting Corporation.” So says a well-known film critic, in reviewing a new and boring talkie. Shame upon the fact that the B.B.C.’s standard of Sabbath boredom should thus be used for comparison!

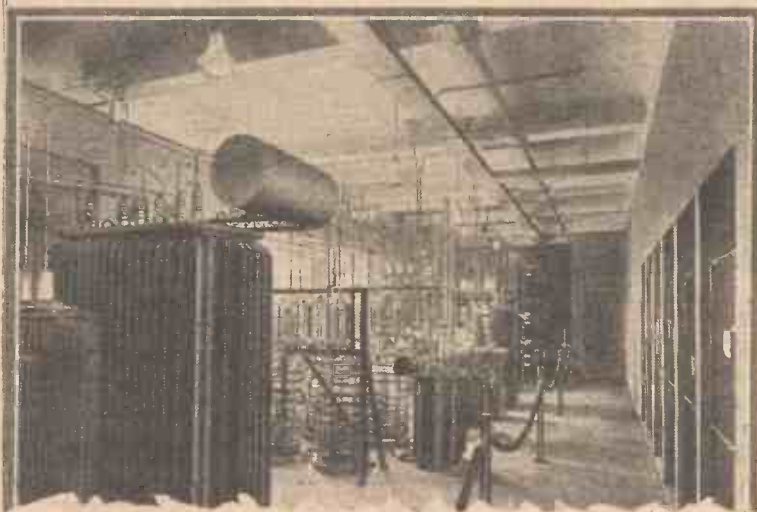

Oslo is making itself heard with its giant power of 60 Kw. Listen for him on 493 metres. Here is where the 60 Kw.’s are developed—a peep into the power supply room



For the Newcomer to Wireless: OVERLOADING

WHY is it that if I try to obtain a very large volume of sound from my wireless set I notice a distinct loss of quality?

You mean, I take it, a volume of sound far greater than would ordinarily be either necessary or pleasant?

Yes. The other night I tried to reproduce dance music in a big hall, but couldn't obtain good reproduction.

With an ordinary receiving set you certainly wouldn't. What you were doing was equivalent to attempting to take a dozen passengers up Porlock Hill in a baby car.

How to you mean?

You were overloading the apparatus. What exactly is overloading?

We'll take the set first of all—for you can overload the loud-speaker also. You have, I believe, a single valve in your output stage.

Yes. I've only one output valve, not two in parallel or in push-pull.

And isn't that a small power valve?

Yes.

With 150 volts on the plate of such a

valve the maximum amount of grid bias that you can use is about 9 volts. This means that the biggest voltage swing that can be applied to the valve without causing it to distort is one of 18 volts. Such a grid swing is not big enough to enable the valve to reproduce broadcast speech and music with anything greater than the volume needed in a living-room of average size.

What happens if the voltage swing is greater; and I suppose it was when I tried my dance music?

The working point is taken down on to the lower bend of the characteristic and up into the grid-current area. The result is that the valve not only amplifies, but also re-rectifies, with horrible results.

How can one make sure of not overloading?

The best way is to use a milliammeter in the output circuit. The needle should remain practically steady.

Supposing you haven't got a milliammeter?

The ear is a pretty good guide. Harsh-

ness, blaring and notes that sound "cracked" are all sure signs. If ever you are in doubt see whether the quality is not improved by slight detuning. If it is, the set was previously being overloaded.

What about the loud-speaker.

A good moving-coil loud-speaker may be capable of producing an enormous volume of sound, but those that depend upon electro-magnetic drive can't go beyond certain limits.

Why not?

With a horn loud-speaker too great a volume means often that the diaphragm is drawn so far down that it actually touches the magnet poles. This produces a horrible "zizzing" noise. Similar sounds may be caused in reed loud-speakers if the reed is pulled down on to the air gap. In balanced-armature loud-speakers the armature can move only a very short distance one way or the other without producing distortion. If the movement is increased it comes into contact with the magnets with dire results.

STATION KDKA, of the Westinghouse Electric Company, is to have at its new transmitter near Saxonburg, Pennsylvania, U.S.A., a newly-developed aerial system which is expected will overcome one of the major obstacles of high-power broadcasting. This aerial, it is claimed, will not send a "blanketing" signal over the surrounding territory, but will send out a powerful one to distant points.

By reason of this receiving sets near the station can be tuned in to distant transmissions from other stations, despite the fact that they are within short range of an aerial which is radiating powerful signals.

Sky or Ground Wave at Will

The picture above shows the experimental short-wave aerial at Saxonburg, Pennsylvania, which has been evolved by



Dr. Frank Conrad, Westinghouse Assistant Chief Engineer.

The experimental aerial which has been established bears out the theories advanced by Dr. Conrad. In this, eight vertical antennae are set in a small circle, the position of each pole being established accurately in advance. The effect is that the horizontal signal from each vertical antenna

is absorbed or "blocked off" by the signals from another. Thus only a small amount of signal escapes along the ground and the greatest signal force is upward. These skyward signals go up to the Heaviside layer, whence they are deflected to the area outside the immediate vicinity of the station.

By reversing the action of the aerial it will be possible to send out a strong ground wave and a weak sky wave, which is a condition valuable in a local station.

The actual KDKA aerial will be formed by a huge circle of wooden poles bearing a bird-cage aerial. This circle will be 800 ft. in diameter and the poles 110 ft. in height. The points on the aerial from which the signals will emanate being so placed in the radiation pattern that the cancelling of strength will be effected to suit the desired conditions.

The "MAG" GRAMMO UNIT

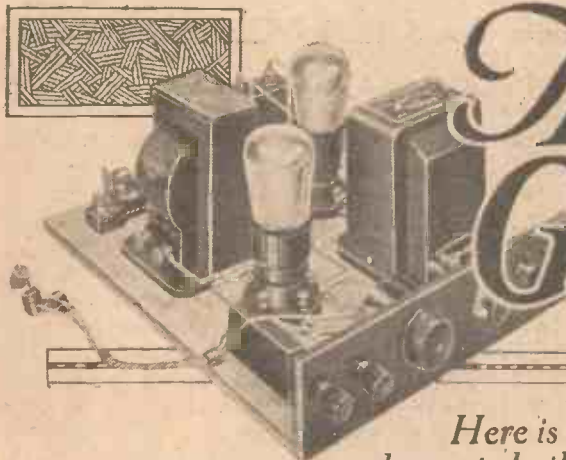

Here is an amplifier for Gramophone purposes which is both cheap and easy to build. The pentode in the last stage ensures adequate volume

IT is, of course, quite true that the low-frequency side of most ordinary receiving sets can be used to give electrical reproduction of gramophone records.

The whole idea is so simple. A pick-up is attached to the bayonet-catch end of the tone arm, two wires are taken to the grid circuit of the detector valve of the set, and, preferably, a 1½-volt dry cell is introduced to place the correct bias on to the grid of the detector. It sounds easy, which it is; the whole point depends on the quality of the results obtained.

So much depends on each of the factors involved—the H.T. supply, the loud-speaker, the type of set and the make of pick-up used—that frequently the idea is not worth trying. There are people who will tell you that unless you care to use 400 volts H.T., push-pull L.F. stages, and a moving-coil loud-speaker you will not get results worth the additional cost of the pick-up. This, of course, is an exaggeration, and is only a half-truth.

A Special Amplifier Desirable

A great deal depends on the pick-up employed. If this gives a fairly considerable voltage swing, then an ordinary set may be capable of giving very good results on electrical reproduction and with volume comparable with that delivered by the ordinary gramophone.

Certainly the idea of allowing for the addition of a pick-up to any set is a most commendable feature, and one to be found in all the more recent AMATEUR WIRELESS receivers; but there is a definite limit to the utility of such an arrangement. Outside this limit the full advantages of electric reproduction can be obtained only by the use of a special amplifier made up for the job.

Mention of a special amplifier may immediately cause you to conjure up the wholly incorrect impression of an elaborate contrivance, costly to build, and far more expensive to maintain than the ordinary receiving set itself; which impression is quite wrong.

This little amplifier, which is illustrated herewith, and which on account of its great magnification has been dubbed the

"Mag" Grammo Unit, is neither expensive nor complicated. It uses a pentode valve; so the number of power stages necessary is reduced, thereby saving the cost of additional components; and the expense of running is certainly no more than that entailed by the average use of a radio receiver.

Many Uses

There are several other uses for such a handy little unit as this; it forms, in itself, a very useful L.F. side which could be added to a set deficient in this respect; it is, moreover, an amplifier which will be found invaluable in the radio den by all who like "tinkering about" with one circuit and another. The form in which it is made up is a very convenient one. Although in a unit such as this it is not strictly necessary to follow the layout exactly, as is the case in a radio set where incorrect spacing of the leads and components may cause trouble, those who build up the "Mag" are advised in their own interests not to deviate more than is necessary from the layout here given.

Any piece of board can be used on which to mount the parts, and perusal of the list of components show that the number of parts necessary is not at all lengthy. The two biggest items are the pentode output transformer and the low-frequency coupling transformer, and particular regard should be paid to these two components; those chosen in the original specification match well and result in a pleasing tone. Incorrect matching in this respect can be productive of poor results in the matter of natural tone.

For those who wish to follow the layout

exactly, and have no wish to deviate from the specification here given, a blueprint has been prepared. This print, No. 224, can be obtained, price 1s. post free, from the Blueprint Department of AMATEUR WIRELESS, 58-61 Fetter Lane, London, E.C.4. As is the case with all other AMATEUR WIRELESS blueprints, it shows the actual layout and gives every wire in its exact position. It is an invaluable guide to the mounting of the parts and to the wiring.

Construction has been simplified in the "Mag" by the use of flexes for the battery connections. The terminal strip at one side of the baseboard carries terminals only

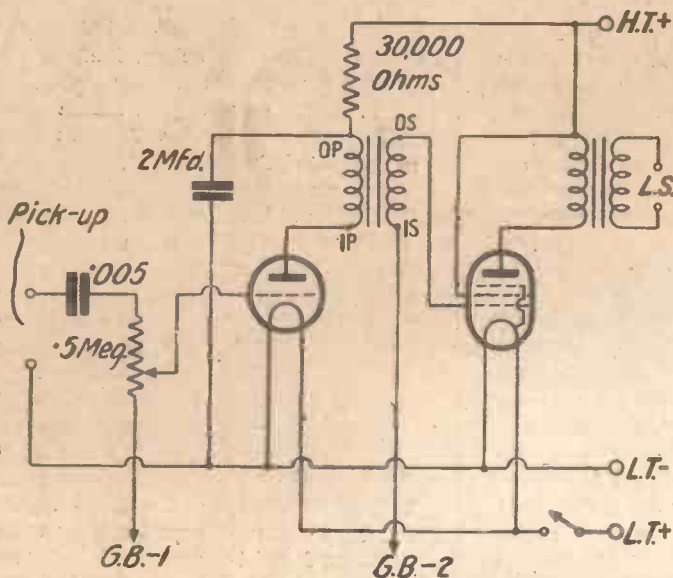

Two points to note in the circuit of the "Mag" amplifier are the way the volume control is added and the efficient anti-motor-boating device.

for the input and output; on this strip also are fixed the volume control and the on-off switch.

Apart from the flex leads, the main part of the wiring is carried out with rigid insulated wire. The wiring should be done very carefully in the "Mag," for some users may wish to apply high H.T. voltages to the power and pentode valves, and so the possibility of "shorts" in a poorly wired receiver is greater.

Volume Control

When you commence to make the connections, if you follow the theoretical circuit diagram you will notice two features of the "Mag's" circuit. The first is the

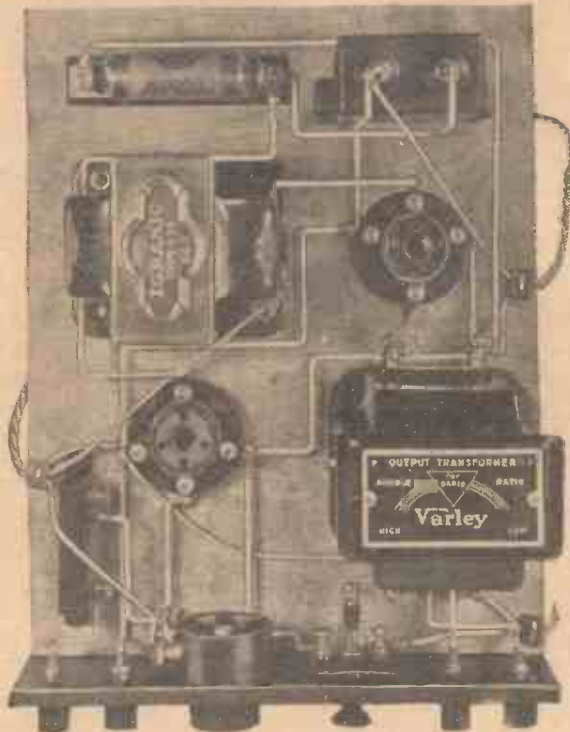

Compare this plan view with the wiring diagram on the right and note the simple layout

method of inclusion of a volume control, and the second is the complete stabilising arrangement present in the power valve anode circuit to prevent L.F. howling or motor-boating.

The volume control is so connected that variation of volume does not produce a corresponding "tinniness" of tone; this is a fault found in so many receivers wherein particular regard has not been taken of this point. The input is coupled to the "Mag" by means of a .005-microfarad condenser, and the volume control is really the winding of a high-resistance potentiometer, to the slider of which the power-valve grid is connected.

Anti-motorboating Unit

An anti-motorboating unit in the anode lead of the power valve includes a 2-microfarad condenser and a wire-wound resistance of 30,000 ohms. This ensures complete stability and freedom from any of the troubles so frequently associated with high-magnification low-frequency amplifiers.

Plenty of H.T. is advisable for the correct working of the "Mag." Pentodes can be worked according to the characteristics published by the manufacturers and, also, they can be worked in a considerably more economical way (in some cases) by proper reduction of the H.T. and bias.

Suitable Valves

The first valve should not be of the normal power type. An ordinary L.F.

valve of the "L" type is most suitable, and can be selected from the following makes and types:—

(Two-volters): Cossor 210 LF, Dario Univ., Marconi L210, Osram L210, Six-Sixty 210LF, Mullard PM1LF, Mazda HL210, Lissen L210. (Four-volters): Mullard PM4, Osram L410, Marconi L410, Selfridge "Key" 210LF, Cossor 410LF. (Six-volters): Cossor 610LF, Marconi L610, Osram L610, Mullard PM5X, Mazda HL607.

The pentode valve should be selected from the following list: Lissen PT225, Six-Sixty 230PP, Mullard PM22, Dario Pent., Marconi PT240, Osram PT240, Cossor 230PT, Mazda 230Pen. Four-volt types: Dario Pent., Mullard PM24V,

Marconi PT425, Osram PT425, Mullard PM24, Six-Sixty 415PP, Cossor 415PT, Mazda 425Pen. Six-volt type: Mullard PM26.

Using the Amplifier

When using the "Mag" as a gramophone amplifier care should be taken to adjust the bias to the first L.F. valve, and to regulate the volume control so that overloading is not caused by too great output voltage swings of the pick-up. A little experimenting with the bias and high-tension voltages applied to each valve will result in pleasing results.

The great point about the "Mag" is that no adjustment is necessary. Once the correct voltages have been found, you just switch it on—and it "mags."!

AT THE QUEEN'S HALL

THERE was an inspired performance of Handel's "Solomon" at the fifteenth B.B.C. concert of the season. This work, one of the greatest in all music, was monotonously forgotten for a long period and revived two years ago by the great Sir Thomas Beecham, who conducted on this occasion—of course, without music. *Solomon* is too long to be performed at a concert of ordinary length, and a selection had to be made of the great choruses, airs, and recitatives. But I was unsatisfied at the end, and look forward to hearing the work in its entirety.

The Queen's Hall was much fuller than usual, and the applause was tremendous.

L. R. J.

A new broadcasting station in Hong Kong, China, is in the process of construction. It will operate under govern-

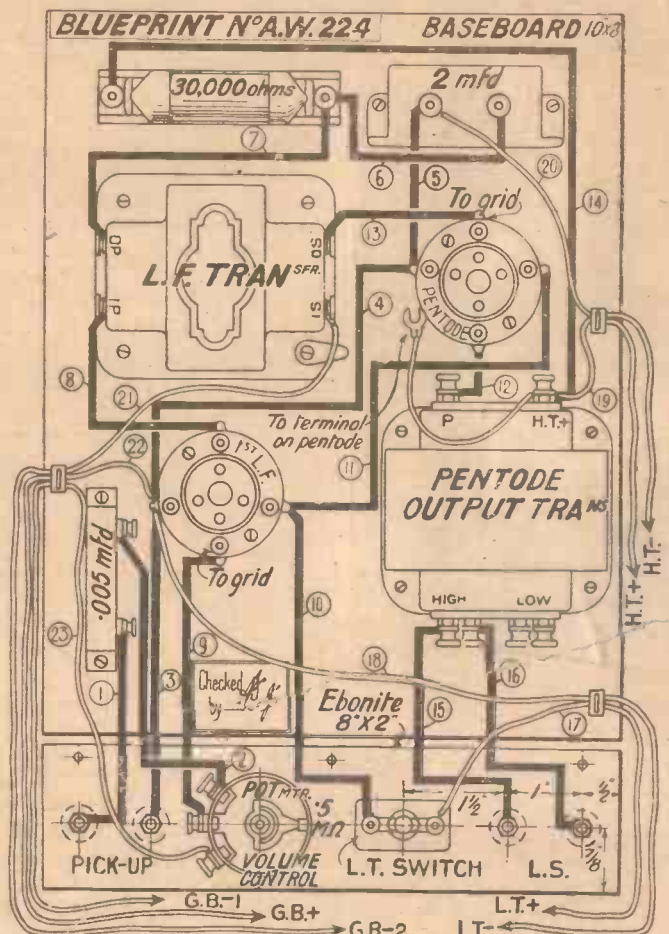

The wiring diagram. A full-size blueprint is available, price 1/-

NEXT WEEK :
THE
"AUTO-COUPLER THREE"
A UNIQUE SET

ment supervision, with the call letters GOW and a wavelength of 300 metres.

An increase in power of the Japanese station at Haranomachi permits of the direct transmission of messages from Japan to San Francisco.

A dispatch from Spanga, Sweden, states the new Swedish broadcasting station is now nearing completion; it is hoped that it will begin work some time during spring.

842 kc — 356.3 metres

L. Trytel and his Octet. 1-2—Reginald Foort at the Organ of the Regent Cinema, relayed from the Regent Cinema, Bournemouth. 3-B. from Bournemouth. 2.30—For the Schools: Speech and Language, by Mr. A. Lloyd James. 2.50—An Interlude. 3—Evensongs, from Westminster Abbey. 3.45—Dorane Marella (soprano); Frederick Taylor (baritone); Andrew Brown's Quintet. 5.15—The Children's Hour; Four Cautionary Tales (Liza Lehmann) and other Songs, sung by Cuthbert Smith. Mumbles Madness, a Gnome Story (Mabel Marlowe). 6—Great Expectations. Chapter 27—A Reading from Charles Dickens, by Mr. V. G. Clinton Baddeley. 6.15—Weather and News. 6.35—Market Prices for Farmers. 6.40—Haydn Quartets, Op. 9, No. 5 in B Flat, played by the Kitcher Quartet. 7—Plays and the Theatre, by Mr. James Agate. 7.15—Life in England in the Eighteenth Century. 6—Capital and Labour, by Mrs. M. Dorothy George. 7.35—The Halle Orchestra, conducted by Sir Hamilton Harty, relayed from the Free Trade Hall, Manchester. 3.B. from Manchester. 9.45—Weather and News; Local News: (Davenport only) Shipping Forecast; Stock Exchange Summary. 9.5—Reading from a London Studio. 9.20—The Halle Orchestra (continued). 10.5—Reading in Bed, by George Rylands. 10.25-12—Jack Payne and his B.B.C. Dance Orchestra

1148 kc — 261.3 metres

12—Harold Bolter (tenor); Ada Walker (violin); Winifred Payne (contralto); Sydney Hoard (flute); from Birmingham. 1—Maurice Toubas and his Orchestra, from the Kit Cat Restaurant. 1.15—The City of Birmingham Orchestra, conducted by Adrian Boult, relayed from the Town Hall, Birmingham. 2—Maurice Toubas and his Orchestra, from the Kit Cat Restaurant. 2.30-3—Reginald New at the Organ of the Beaufort Cinema, relayed from the Beaufort Cinema, Washwood Heath, Birmingham. 5.15—The Children's Hour: Gipsy John, a Play, by L. B. Powell. Songs by Harold Casey (baritone); Norris Stanley (violin). 6—Reginald New at the Organ of the Beaufort Cinema, relayed from the Beaufort Cinema, Washwood Heath, Birmingham. 6.15—Weather and News. 6.40—The Story of the Electric Light. 6—The Nemat Lamp, by Mr. J. Swinburne. 7—The Gershwin Parking-ton Quintet; Leslie Dudley (soprano). 7.45—A Pleasantly Dally, Second Edition. Compiled and produced by Gordon McConnell, with Leonard Henry Wynn Agello, Foster Richardson, Leslie French (by special permission of the London Hippodrome and J. C. Williamson, Ltd.), Dora Gregory, Frank Denton; Pianists: Harry S. Pepper and Dora Arnold. The Revue Chorus, conducted by Leslie Woodgate. Music selected and arranged by Doris Arnold. 8—Modern Sculpture. 6—Sculpture in Germany and America, by Mr. Stanley Casson. 9—Exiles, produced by Lance Sievking. 10.15-10.30—Weather and News.

Is the Regional Scheme Wasting the Ether?

BY March 9, according to the latest information available as I write, the first phase of the B.B.C.'s Regional Scheme will have started. Both the Brookmans Park transmitters should be sending out regular alternative programmes. For those coming within the London regional area the ideal of a choice of programmes with simple apparatus should have been achieved.

Listeners with inefficient apparatus will have trouble in separating the programmes, but those with modern apparatus, unless they live right under the shadow of the Brookmans Park aerials, should be able to get the two programmes clear of each other.

Ten Powerful Transmissions

In two years' time the state of affairs brought about by the Brookmans Park twin transmitters will have been reproduced all over the country. The ether will be filled with ten powerful radiations. How many of these radiations shall we be able to interpret as different programmes?

I put this question to the B.B.C. recently and was a little staggered at the reply. I wonder how many readers realise that the proposed ten stations, with all their power, will only provide the whole of the British Isles with two main programmes for a good proportion of the listeners' time. Possibly this is going too far, but it is an undoubted tendency.

—but Only Two Programmes

I understand that between 60 and 70 per cent. of the programme matter to be radiated from the London and Midland regional stations will be the same. For a large proportion of the listening time London and Midland listeners will have the choice of only two programmes—the common national programme and the common regional programme.

So, in spite of the fact that most sets in the London and Midland areas can quite easily pick up the four stations, there will only be two programmes. A two- or three-valve set in the London district can quite easily receive Daventry 5GB or Daventry

In this article Alan S. Hunter puts forward an aspect of the Regional Scheme, that of programme alternatives, which up to the present has not been commented upon

5XX. But what will be the use if, in tuning in either of these stations, we find the same programme matter as that sent out by the 261-metre and 356-metre London stations?

Perhaps I have been expecting too much; but I always had an idea that our London regional transmitter would send out a programme in contrast, not only with the national transmitter, but also with the programmes of every other regional station. Out of four radiations I thought we should have a choice of three programmes; one national programme and two regional programmes, all different one from the other. But according to my understanding of the B.B.C.'s statement, for a good percentage of the time there will only be two different programmes.

Waste of Energy

It does seem to me to be a waste of the ether, which is terribly overcrowded already. The first phase of the regional scheme involves 120 kilowatts of energy (assuming four stations of 30 kilowatts each). If this waste of energy is admitted, how much

more wasteful will be the complete scheme? Ten stations of 30 kilowatts each; 300 kilowatts for two main programmes!

In thus economising in programme matter, this is the B.B.C.'s attitude; we will assume that in arranging the programmes for the tea-time hour, light music is universally desired. A dance band from one station and some cinema organ music or a studio octet will satisfy this desire for light fare, and provide contrasted means of obtaining it. So far so good; the London regional is doing its organ relay; the London national is giving us some light music.

Now the B.B.C. contend that Birmingham listeners who do not like the national transmission of light music will be just as happy with London's regional relay of organ music as with organ music from a Birmingham cinema. There is something insidious in this argument.

The B.B.C.'s Attitude

The B.B.C.'s attitude assumes that at any given time it is possible to give only two contrasted programmes. But I think that between the ultra high-brow and the really low-brow moods could be fitted many more than two different kinds of programme. Some news from one station, a talk from a second, a play from a third, dance music from a fourth, a symphony concert from a fifth, and glee singers from a sixth; here are six quite different types of programme.

The big trouble with this regional scheme is that it does not take account of the greatly improved standard of modern receiving sets. There is something wrong with a scheme that is primarily designed to give satisfaction with sets that have been obsolete for a long time. It will be little use tuning in B.B.C. stations other than those allocated to the region in which the set is situated.

While our scheme of twin transmitters is developing, other European countries are not standing still. Already, Rome has increased its power enormously. So has
(Continued in third column of next page)



Miss Gertrude Kingston as our cartoonist sees her

MY WIRELESS

Weekly Tips,
Constructional and Theoretical—

A "Five" Forthcoming

MY new five-valve set is practically ready for publication. The whole of the experimental work is finished and the results are splendid.

I have designed a band-pass filter for it. This provides true selectivity without cutting the side bands. Therefore quality, as well as selectivity, is very good.

There are two volume controls, one being fitted in the high-frequency stage and the other in the low-frequency. With these two controls, ample variation in both high- and low-frequency magnification can be obtained. But the great feature is the band-pass filter and the resulting magnificent performance. Easily my best set!

A Hint for Gramo-radio Users

The voltage to be obtained from a pick-up varies according to the frequency of a note as well as its strength, and it is usual to allow about a volt. I have recently been testing a pick-up, however, which provides far more than this when playing a normal record. The pick-up actually has a rising characteristic at each end of the frequency scale. From 1,000 to 2,000 cycles the output when tested was .6 volt; at 500 cycles it had increased to .8 volt. A voltage of 1.3 was measured at 250 cycles and 3 volts at 100 cycles.

These are R.M.S. voltages, and when estimating the bias needed for the grid of the valve to which the pick-up is connected it would be advisable to allow twice the maximum. If now a transformer is included between the pick-up and the valve quite large voltages are applied. Thus, for a ratio of 3.5 to 1 the output would vary in this particular instance from 1.5 volts to 10.5 volts.

Pick-ups are given a rising characteristic in order to compensate, in part at least, for the weak bass and treble that is recorded. The high and low notes are not recorded at their correct relative strength, with the result that if the pick-up and amplifier dealt absolutely faithfully with what is recorded the quality would be poor.

As a result, the above range of voltages would probably not be produced; but, at the same time, a power valve would be needed in the first stage properly to deal with the input.



A Novel Volume Control

A volume control having advantages is illustrated in the accompanying diagram. It comprises a potentiometer connected across the aerial winding of a transformer and is not suitable, as it stands, for circuits having the aerial connected directly to the grid coil.

A value of 20,000 ohms is suggested, this being the best with the coils tested. The potentiometer must be non-inductive and have little capacity. If a higher re-

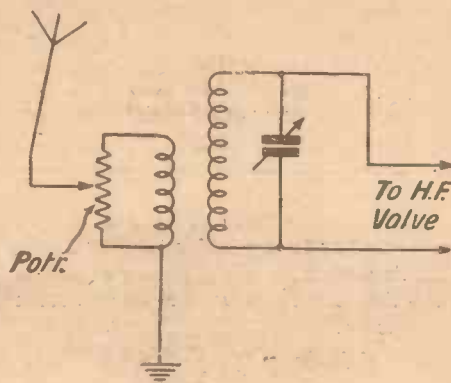

A novel volume control which you can try

sistance is used the signals will be cut down too quickly as the contact arm is turned. But a lower resistance would produce a falling off in the signal strength.

The advantage of the method is that the input to the set is controlled; therefore the first valve is not swamped by a strong signal. Expense is one of the disadvantages, also the fact that the control is not quite so gradual as when a filament resistance is used in the first (H.F.) valve. It could be used with success in many circuits, however.

What is Your Detector?

What type of valve do you use for detection? Is it of the R.C. or H.F. pattern? Usual R.C. valves have an impedance of at least 50,000 ohms for a magnification factor of 35. Valves of the H.F. type, on the other hand, have an impedance of about 20,000 ohms and a magnification factor of 20.

DEN

By
W. JAMES

For the
Wireless Amateur

Both types work very well as detectors but the quality of the reproduction will usually be better with an H.F. type. This valve, too, will deal with a little stronger signals, but has the disadvantage of passing a fairly heavy current if a voltage of, say, 100 is used. The usual practice is to fit a valve of the R.C. type and to provide it with plenty of high tension. This tends to lower the impedance and, at the same time, increases the ability of the valve to deal with strong signals.

Given a good transformer coupling, the quality is usually satisfactory, having regard to the loud-speakers used, but for the very best quality it must be admitted that the H.F.-type valve is the better. The point about the anode current should be watched, however, as some makes of transformers perform poorly when the current is over a milliampere or so.

"IS THE REGIONAL SCHEME WASTING THE ETHER?"

(Continued from preceding page)

Oslo, and so will stations in every European country. Except for the British Isles, every country is thinking in terms of hundred kilowatt transmissions.

We ought to see how our regional scheme could be modified to eliminate some of its present drawbacks. As I have said, the chief drawback seems to be the low ratio of programmes to transmissions. We could get over this difficulty and at the same time bring ourselves into line with other countries in this way; increase the power of one of the twin transmitters at each regional centre and decrease the power of the other twin.

From each high-power transmitter send out a distinct programme. Most or all of these could be picked in any part of the British Isles with fairly simple apparatus. From the low-power stations send out a common national programme. Since one each of the five twins would be sending out the same programme, no one would want to receive more than one of them.

Whereas I cannot see any objection to the lowering of the power of the national transmitting chain, I can anticipate some trouble from the increased power of the regional chain.



ACCURACY and APPEARANCE

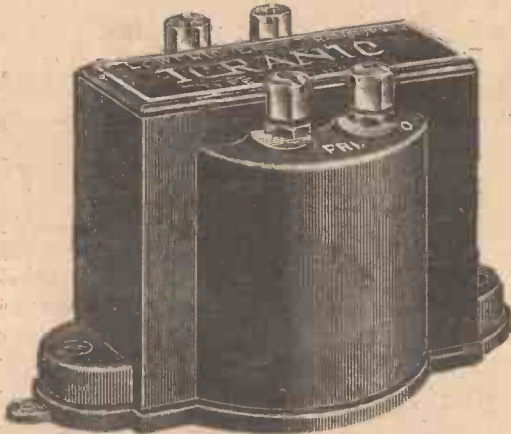

IGRANIC ELECTRIC Co., Ltd.
149, Queen Victoria St.,
LONDON, E.C.4
Works : BEDFORD



IGRANIC TYPE "J" L.F. TRANSFORMER
Small, neat and handsome, but with a straight line performance and a purity and constancy of amplification far above any transformer in its priced class. Use it and enjoy truly magnificent magnification. Obtainable in two ratios, 3 : 1 and 6 : 1. Price 17/6.

Apply to your dealer. If
he cannot supply you, please
write direct to Dept. D.143

IGRANIC INDIGRAPH VERNIER KNOB AND D'AL
Handsome and accurate slow-motion dial. Entirely free from backlash. Affords the most popular, simple and reliable vernier control.
Price 6/-. Midget size, 3/-.



NATIONAL MARCONI PHONE



PORTADYNE PYE

HALCYON MICHAEL

RÉES MACE DORIAN

COMBINED H.T. MAINS UNIT WITH L.T. CHARGER

Patents Pending. Design Registered.

IT FITS INSIDE THEM ALL!

—and it has been specially designed to meet their exacting requirements as regards critical values of High Tension Voltage, and sensitivity to stray electrical fields. It is, of course, equally suitable for all popular 2-, 3- & 4- valve Receivers FOR A.C. MAINS 100 VOLTS, 200/220, or 230/250. 40/100 cycles. Incorporates Westinghouse Metal Rectifier on H.T. & L.T. side.

Size : : 9" x 5" x 3 1/2"	H.T. Tappings : 2	L.T. : Trickle Charger for
H.T. Output : 120 volts	Variable (one S.G.)	2, 4 or 6-v. accumulators.
at 15 m.a.	and one Power.	PRICE : : £5 : 7 : 3

Write for FREE ART BOOKLET, "Radio from the Mains."

REGENT RADIO SUPPLY CO. 21, Bartlett's Bldgs. Holborn Circus, London, E.C.4. Telephone CENTRAL 5745 67

To Ensure Speedy Delivery, Mention "A.W." to Advertisers

JOIN THE
DYNAPLUS CRUSADE



**BUILD THE
DYNAPLUS
SCREENED**



Designed and proved under the shadow of Brookmans Park its selectivity goes without saying.

Cost of kit—including baseboard, panel and screen

£3 : 2 : 9

Ten Lucky Men Will Win Ten Dynaplus Kits Free Of Charge. Go to your dealer and get a free Voltron Docket. It gives details of how to build the Dynaplus 3, and of a competition by which you can get your Dynaplus Kit free of charge. Even if you already have a set you should get a catalogue of these splendid components. It is chock-full of useful data and it is free for the asking. In case of any difficulty write direct to makers giving your dealer's name & address

*DYNAPLUS moves to
Regent Street — the
street of Empire*

Breathing new life into the Amateur Set Building Movement, Dynaplus has swept the flame of enthusiasm throughout the length and breadth of the land.

And now TRUVOX, recognising its sterling worth, have placed their magnificent Showrooms at 149/151 Regent Street, at our disposal for special demonstrations. Go there—see the wonderful simplicity of the Dynaplus design—hear its glorious reproduction on the world-famous TRUVOX exponential Loud-speakers—ask the special demonstrators all the questions you like.

You'll be amazed—you'll want a DYNAPLUS set as you've never wanted anything before and you'll

marvel at its amazingly low price. Please do not miss this wonderful opportunity. There is no obligation to purchase.



**CURRENT
FOR YOUR
MOVING-COIL SPEAKER**

The comparatively heavy supply demanded by the pot magnets can be very easily obtained from your A.C. house mains with the aid of

A



METAL RECTIFIER

Full particulars, and circuits, showing how to use all types of Westinghouse Metal Rectifiers, are given in our 32-page book "The All-Metal Way, 1930." It includes a chapter of useful information on the running of moving-coil speakers from the mains.

Send 2d. stamp for a copy.

The Westinghouse Brake & Saxby Signal Co., Ltd.,
82 York Road,
King's Cross, London, N.1

A GOOD PANEL

Your set is made or marred by the panel you use. Make certain therefore that the panel you buy is a good one. Make certain that it is a "Trolitax" panel—the best panel of all.

Supplied in many different finishes, also with a metal sprayed backing.

Ask your dealer to show you the range.



F. A. HUGHES & CO., LIMITED
204-6 Great Portland Street, London, W.1.
Phone: Museum 3630 (4 lines)

Distributors for Northern England, Scotland and North Wales:
H. C. RAWSON (Sheffield and London), Ltd., 100 London Road, Sheffield, (Phone: Sheffield 26006) and 22 St. Mary's Parsonage Manchester, (Phone: Manchester City 3329).

On Your Wireless!

Chokes or Transformers?

MUTTON-CHOP whiskers gave way to tooth-brush moustaches, leg-of-mutton sleeves are abandoned, the dog-cart is displaced by the "baby" car, and the valve supersedes the magnetic detector. Fashions change with the seasons, but the tendencies of the changes are governed by the requirements of progress. There are fashions in radio which are responsible for many crazes. Someone has just done interesting research into the performance of valve-amplifier systems in regard to the relative response to loud and soft passages, and especially the distorting action in the case of *sforzando* chords of music. Photographic measurements have revealed the fact that the common or garden choke-output arrangement is not all that we think it is. These measurements show that, in dealing with transients, the output transformer gives a much better performance than the choke.

Oscillograph Hometruths

A few evenings ago I was a very privileged person. I was present at one of the final experiments in the laboratory of a certain gramophone company, which would determine future policy of the company in regard to certain arrangements of circuits in radio gramophones. A most elaborate apparatus was wired up for the measurement and photographic registration of every kind of distortion likely to be met with in amplifiers. The experiment on hand was the comparison of the time lag of amplifiers in building up and "closing down" their response to suddenly applied sustained notes of various audio-frequencies. A beat-note oscillator or "squeak" supplied the notes, which were cut on and off from time to time, and the resultant wave form photographed, first direct and then via amplifier systems on test.

It became immediately obvious that the choke-output system so commonly employed is a great offender in its treatment of these notes in regard to immediate response, and that quite an appreciable time elapsed before they built up to full strength or disappeared when cut off. At the same time, it was known that the choke-output circuit, when possessed of the correct values, passed on all the audio-frequencies equally, with no tendency to emphasise any particular band of frequencies.

Transients

On the other hand, the transformer in the output circuit, if of good design, was not inferior to the choke in its response to the audible frequencies; in addition, it

passed the "transient" test with flying colours. Notes from the "squeak" were switched on and clipped off, and the resultant photographic records made via an output transformer arrangement and direct showed very little difference. An interesting disclosure! Our ears and our loud-speakers are not perfect enough to detect these little defects at present, but there is no doubt that when loud-speakers get better and better, the question of "transients" will have to be given much more attention than it is at present. The chief difference in listening to an amplifier and loud-speaker which responds quickly to sudden notes, compared with the ordinary average receiver, is a marked crispness in the former, especially in the reproduction of music, and a much closer approach to reality and sense of "stereophony."

The Detector

This does not mean to say that we should all scrap our output chokes. Very few of us have the loud-speakers that will give accurate response to transients, even if we could deliver them undelayed. Our detector valves are possibly the chief brakes or obstacles. The grid leak and condenser is possibly the biggest offender, both in regard to audio-frequency response and treatment of transients. The anode-bend detector is much better, though less sensitive to weak signals, and the Kirkifier detector circuit, though terribly inefficient, is absolutely blameless in all "quality" tests, and should be carefully considered by advanced amateurs as the ideal method of valve rectification.

The Kirkifier

The Kirkifier is really a reversion to the old Fleming rectifier, with a grid inserted, which is used for the neutralisation of space charges in the valve. The incoming signal goes to the plate of the valve, which is fed with H.T. through a choke. The grid is biased positively, and the output comes from the plate via a coupling condenser and an H.F. choke. That is the fundamental circuit, and most ineffective you will find it!—if you are expecting strong signals. It really requires an H.F. stage in front of it to bring it up to the sensitivity of an ordinary straight grid-leak-and-condenser rectifier.

Beam Radio

The position with regard to beam radio is rather a curious one. It has been decided to develop telegraph and telephone services from the great G.P.O. station at Rugby, and not to make more extended use of

beam facilities. To many of us this seems rather a short-sighted policy for a great number of reasons. Long-wave stations must have enormous power behind them if they are to cover big distances, whereas comparatively small power suffices for a well-designed beam installation. The beam has already proved its usefulness to the hilt, and it would seem the simplest and most effective way of developing cheap and rapid communications with every part of the Empire. The snag seems to be that to make the best use of the beam you have to spread out your transmitting and receiving stations rather widely, and this means that tremendous mileages of telephone cable have to be used to connect them up.

In Canada

Canada, I see, has resolved to revise her whole broadcasting scheme. At present the position is rather a queer one, for there are in the country no less than eighty-one stations, mostly of moderate or low power. The majority of them are owned by newspapers, commercial firms, schools, colleges, churches, and so on. One of Canada's troubles from a wireless point of view is that her frontiers march with those of the States, and the latter country is, to say the least of it, pretty well provided with broadcasting stations. Mutual interference between Canadian and American stations has been a problem in the past, particularly as Canada's stations were not under Government control. It is now proposed that there shall be a national scheme on lines not unlike our own.

A Crystal Difficulty

A difficulty is being experienced by crystal users who live a little way outside what we normally regard as the swamp area of Brookmans Park, or in localities where signal strength is not very great. The trouble is this. The crystal set by itself is often not selective enough to separate the twin transmissions completely. If, however, a series condenser or a shortened aerial are tried, the separation can be effected, but signal strength becomes so small that listening to programmes is not worth while. The wave-trap produces just the same results. The only thing in such cases appears to be to rebuild the crystal set, using the old-fashioned double coil holder, which allows variable coupling between aerial and secondary inductances. By means of these it is usually possible to obtain the required selectivity and respectable signal strength.

Letters from the "Swamped"

A very large number of correspondents

:: :: **(On Your Wavelength! (continued))** :: ::

has written me with regard to what I had to say about the swamped area round Brookmans Park. Nearly all of those who live within the huge area contained in a twenty-mile radius of Brookmans Park (how many people realise, I wonder, that this means that the swamp area embraces over *twelve hundred square miles*) complained bitterly about the activities of Raucous Reg and Noisy Nat. By the time that these notes appear in print the twins will both be working full time, and I expect that a wail will arise from many thousands who find that they are now to be swamped night in, night out. Matters were not quite so bad when the noisy duet occupied only three nights of the week; but seven nights of the week is rather too much of a good thing.

Some are Satisfied

A few—surprisingly few—residents in the swamp area write in to say that they have no complaints to make. One reader from Hatfield, which is within three miles of Brookmans Park, finds no difficulty in separating the two, though he apparently uses neither a wave-trap nor a tuned H.F. circuit before his anode-bend detector valve. He also says that with a 40-ft. aerial the two can be separated even by a crystal set in his locality. That happy state of affairs is quite exceptional, and it must be that signal strength is poor in his locality. In places that are normally good spots for wireless reception no simple crystal or valve set will separate the two completely at a range of fifteen miles or more, even with an aerial much shorter than this. In such places, too, when apparatus is used that will effect the separation, the quality is appalling unless very special methods of detection are employed.

Swamped Foreigners

I am going so far as to say that the very deep modulation in use and the ridiculously high power behind the transmissions make reception of good quality almost impossible to obtain over the greater part of this twelve-hundred-square mile area for the man in the street, who is limited to about 100 volts of H.T. What galls him, perhaps more than anything else, is the knowledge that there are so many foreign stations which his set would receive to perfection if only he were not swamped by the raucous home transmissions. Still, of course, we must remember that one of the Very Great has told us that "this nonsense of searching for foreign stations must be stopped."

What Can Be Done?

Many correspondents in the swamp area write pathetically to ask what they can do. Letters to the G.P.O. and the B.B.C. produce no satisfactory answers, and no other

course of action seems to be open. The B.B.C. is, I am afraid, rather too prone to adopt the attitude that it cannot be wrong. It assures our correspondents, just as fathers used to assure their offspring when about to administer a spanking, that any little inconvenience suffered is really for their own good. The B.B.C. is committed to the regional scheme, and all of its officials are therefore bound to support it whole-heartedly. The only thing that I can see is for sufferers to write both to their M.P.'s and to the Radio Manufacturers' Association. Petitions sent to both quarters might eventually have some effect. The R.M.A. is a powerful body and it is in constant touch with the B.B.C. through its liaison officers.

The Trade

There is no question whatever that the wireless trade has been very adversely affected in the swamp area by the coming of the regional scheme, for many people, finding their expensive sets useless, are simply giving up trying to receive the wireless programmes. Perhaps the most pathetic case of all is that of people who are still paying instalments on sets that have become utterly useless. The points I would suggest for any petition are these:

1. No regional scheme can be successful unless it renders possible reception over a wide area with simple and inexpensive apparatus.
2. The deep modulation at present employed ruins reception except at comparatively long range.
3. High power is entirely unnecessary to give an adequate service area.
4. An excellent service can be provided with an output of 5 or 6 kilowatts.
5. So far from providing alternative programmes, the regional scheme has thrown many sets out of commission altogether and has reduced the alternative programmes of thousands of listeners, using expensive valve sets, to two instead of a dozen or more.
6. The Home Counties are at present the only ones affected. Matters will become worse and worse if other high-power regional stations with twin transmitters are allowed to come into operation.

A Good Tip

Here, by the way, is one tip that I would recommend to any friends of mine who find their reception on the medium waves completely hopeless as things are at present. Abandon these wavelengths altogether and conduct your reception entirely upon the long waveband. If you want the regional programme it is broadcast from 5XX, and the bigger coils will enable you to hear a good many first-rate foreign stations, such as Radio Paris, Motala, Hilversum, Huizen, and Kalundborg. It seems ridiculous that

people should be driven off the wavelengths popularly known as those of the broadcast band; but there it is.

New Jenkin's Television Apparatus

I have just been examining some first-hand information concerning the new Jenkin's Radiovisor. In the earlier forms of Jenkin's machines there was a wooden cabinet containing a horizontally mounted scanning drum which had a four-plate neon lamp in its centre, a synchronous motor and a commutator switch, and an inclined mirror complete with large magnifying glass mounted on its top. The drum itself was pierced with forty-eight holes arranged in four spiral turns of twelve holes each. Quartz rods from these openings extended along the radius of the drum and terminated at the inner side of the hub, each being opposite the corresponding plate of the glow lamp during a time of rotation equivalent to the passage of its outer end over an angle corresponding to the picture width. Each plate of the lamp was brought into commission to serve during one turn by means of the commutator. By this arrangement it was claimed that the four turns illuminated in rotation served to make up a field of glowing neon plate equivalent to that obtainable from a scanning disc about 36 in. in diameter.

Cutting Down Expense

The expense of the quartz rods, however, made this device quite unsuitable as a commercial proposition, and in consequence the design had to be changed considerably. Now there is a plain scanning drum, only a single-plate neon lamp, and what has been called a selector shutter. Three switches are included in the cabinet form of this device, one to render the neon operative, the second to cut the loud-speaker in or out of circuit, and the third to switch on the motor and, incidentally, control its speed. In addition, there is a knob to operate the framing device. When viewing the scanning holes through a magnifying lens there is an apparent picture size of about 6 in. square.

The selector shutter or obscuring disc has three slots cut in it, and these are so positioned that they reveal to the eye only the appropriate hole traversing the field of the light source. Actually, since there are four spirals round the drum and only a single-plate neon lamp, it is necessary to mask out the holes either immediately above or below the hole it is desired to see. This particular radiovisor, as it has been called, is to be used in conjunction with a special receiving set operating on the 100- to 150-metre waveband. A new design in sets is heralded by this same organisation, as the frequency response is spread over a much wider band than in an ordinary wireless set. THERMION.

MORE CHEAP MAINS SETS ARE WANTED

A PAGE FOR THE SET BUYER

Every set referred to in this regular feature by "The Set Tester" has reached a certain standard of efficiency in the "Amateur Wireless" Laboratory. Reports are not given on sets that fail to reach this standard. This will explain why reports that do appear express general satisfaction with the set's performance.



This view of the Ekco All-electric Two-valver for A.C. Mains emphasises its simplicity. The mains switch is on the right

SO much has been said in favour of all-electric sets that few listeners with an electric-light supply can be unaware of the advantages of mains working. But many would-be owners of all-electric sets still have to use battery-operated sets; all-electric sets are too expensive for them.

That the advantage of simple and fool-proof maintenance associated with an all-electric set can be enjoyed for a modest outlay is proved by my recent experience with the Ekco two-valver for A.C. mains. Model P.2, as it is called, is only £12 17s. 6d. complete with valves. As a value-for-money proposition, this little all-electric set is a great credit to the makers, Messrs. E. K. Cole, Ltd. I wish more set makers would provide cheaper mains sets.

Employing an indirectly-heated mains detector valve and a pentode output valve, the P.2 set is more efficient than any battery-operated two-valver. The mains detector valve provides an extra degree of sensitivity. The pentode output valve gives extra volume.

I know several people who are so keen on the all-electric idea that they are prepared to sacrifice something in reception range in order to do away with battery troubles. But they cannot afford the expense of the average mains set now on the market. Just what reception the P.2 model is capable of giving, was demonstrated to me the other night, when I tested the set under normal broadcasting conditions.

I first of all tried the long-wave stations. Hilversum came in at 7 degrees, at good loud-speaker strength. This surprised me. Kalundborg was logged at 15 degrees, at fair loud-speaker strength. The Eiffel Tower station was a good loud-speaker signal at 47 degrees. 5XX on 58 degrees was, of course, a giant voice. There was no inter-

ference by 5XX when Radio Paris was tuned in at 71 degrees. Huizen at 83 degrees was a fair loud-speaker signal and completed my long-wave log.

Good Selectivity

On the medium waves I had no difficulty in bringing in ten stations at good loud-speaker strength, including Catalana, Milan, Rome, Toulouse, Langenberg, and Stuttgart. Langenberg came in more loudly than Daventry 5GB! In tuning in this remarkable number of loud-speaker signals, I noted that the operation of the set was generally



Underneath the base of the Ekco two-valver are fitted the detector and pentode valves

good and really left nothing to be desired.

The reaction knob, since it is so often in use, might have been a little bigger. The tuning disc is easy to grip and works smoothly. The wave-change switch is not engraved for its two positions. It is very positive and smooth in action. So also is

In his comments on the performance of the Ekco Two-valver, "Set Tester" pleads for a general reduction in the price of all-electric sets

the mains on-and-off switch on the right-hand side of the cabinet.

One of the things that impressed me mostly was the entire absence of reaction back-lash. Oscillation stops at the same position of the reaction knob as it starts. Probably the good reaction effect accounts for the highly satisfactory log of stations. I wish more set-makers appreciated the importance of a good reaction control in a small set. The Ekco people evidently do.

Selectivity in a two-valve set is largely dependent upon its location and the aerial connected to it. I used a 70-ft. indoor aerial for my test. With this, the aerial terminal marked A.1 gave the best results. The alternative aerial terminals A.2 and A.3 cut down the signal strength considerably. I am not in the Brookmans Park wipe-out area, but, as a matter of interest, I tried the "Brookman's By-Pass" on this set. It cut out the 356-metre transmission without reducing the strength of the other stations logged.

No trace of mains hum could be heard in the loud-speaker, except when the set was made to oscillate. The metal rectifier, giving the high-tension current, is obviously working with a good smoothing system. As the rectifier is practically everlasting, the maintenance problem resolves itself into the replacement of the two receiving valves. Both of these should give well over a thousand hours' service.

Quality of reproduction was tested in two ways. Using one of the linen-diaphragm type of loud-speakers, the set gave excellent reproduction, not only of the local stations, but of many of the more distant ones.

Model P.2 can readily be used as a two-valve-gramophone amplifier.

We can do with more good and cheap all-electric sets.

SYDNEY MOSELEY'S WEEKLY PROGRAMME CRITICISM

The Amateur Shows
How To Do It

More Contrast

What About the Claque?

Symphony and Symphony

"Song Plugging"



I HAVE recently been enjoying myself by picking up amateur transmissions. I assure you, the occupation is just as fascinating as reaching out.

This I call "reaching in," because of the short wavelengths.

As I live on the coast, I pick up pilots' messages, and the conversations are very illuminating. In addition, I have picked up several well-known Amateur transmitters.

I must say the transmissions are all good, although in one case, apparently, there is a family gathering, and one can hear the delightful interjections of a child who wants jam with its tea! These amateur transmissions would give producers of "informal gatherings" a real idea of how it should be done.

My readers know that I am always delighted to hear from them, even when my views are called into question. But it always amuses me to receive letters from those who will deny me a personal expression of opinion, when they themselves are not at all backward in laying down the law.

Now, I like a letter of this sort, which comes from J. D. Woodham, of Reading, who says that, while agreeing that the "yew-blew-trew" sort of song ruins many—if not most—of our vaudeville programmes, "surely the case of Tommy Handley's sketch, *The Pot Boiler*, was in a different category?"

He thinks the low-brow tone of Jean Allistone's songs absolutely essential to the success of the sketch.

"What could there have been of interest had the irate composer returned home to find his wife singing some of his own—or similar—high-brow compositions? The theme would have been impossible."

That is a fair argument.

On the other hand, the theme is as old

as the hills. It has been done in regard to books, but the chief point of criticism is that the "yew-trew-blew" song was sung as a serious effort. If it had been a skit, which is about the only method of presenting this sort of tripe, then it would have passed muster. But the inclusion of the song was merely to give Miss Allistone an opportunity of singing a type of

composition with which many listeners are absolutely fed up.

So much for reasonable and sensible criticism.

I quoted the correspondent who called me a "Philistine" because I didn't enjoy the unaccompanied *basso profundo* of Madame Suggia. And I have always ventilated the spleen of the low-brows who think I am so high-brow.

Here is another correspondent, who invites me to have my ears tested because I wrote that I could not distinguish much difference between Harry Hemsley's "children."

Well, I would willingly follow my polite correspondent's advice, except that there were with me at the time I listened some half-dozen people of all types, and the view

I expressed was unanimously endorsed. This is not an apology. It is merely an acknowledgment to a correspondent of Tufnell Park that he can always be assured of attracting notice in these columns, even though he offers me chances by the nature of his letter to score off him.

The promise held out by the Director of Programmes of more contrasted programmes was heard with great satisfaction by listeners. One realises the difficulties hitherto, but it would be possible to give instance after instance where the programmes, instead of being contrasted, have been almost of a like nature.

I am not certain, but I think I have already pointed out that the latest of my suggestions—that is, to abolish the noise of the orchestra when an announcement is being made—has been acted upon.

Now, what about the studio claque? I wonder really what would be the comments of listeners. I still adhere to my argument that wireless broadcasts should be a thing in themselves, and should appeal to millions of listeners rather than the individuals of those who can see what is going on in the studio.

Olga Halcy achieved a *tour de force* in the tuneful "Le Roi D'Ys."

Sybil Thorndike in the relay from the Coliseum must have been listened to more or less universally. But the little sketch was disappointing. Neither in theme nor in treatment was it fresh, while the voices of the nurse and Sybil, strangely enough, were little contrasted. I suppose the reason was that the play was staged for the visual audience and not purely for wireless.

Don't be scared, readers, when you see a concert marked "symphony." There are symphony concerts and symphony concerts.

Melville Gideon sang the same sentimental sob-song, and let us know that he had a friend named "Jack Pepper" who wrote a song, "Goodbye to All That." I suppose this would not be called "song-plugging."

Norman Long, alas, does not get over so well as one thought he would when he made his debut.



A Slade Cartoon of Leonard Gowings

MAKING YOUR OWN BINOWAVE COILS

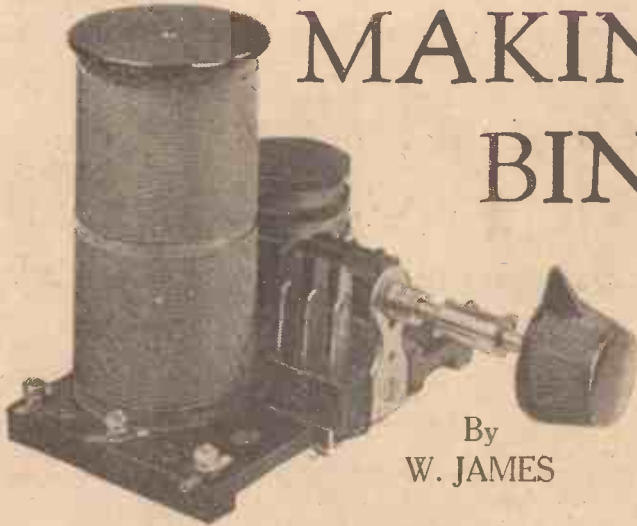

By
W. JAMES

AN examination of a dozen sets of the same type will probably show them to be alike apart from the tuning coils. There may, of course, be slight differences between the characteristics of the transformers used and the tuning condensers, being of different make, may not all tune a given station at the same point.

But the fact remains, the essential difference between the sets lies in the coils, from which it follows that the various sets have characteristics which could be determined from the electrical values of the coils. Thus, to take an easy case, if we had four sets of identical construction, apart from the coils, we could say that all differences in their behaviour were to be accounted for by the coils, and from practical experience we know that one set might be very selective, another very broad, whilst a third might give very little volume, and the fourth good volume and selectivity.

second coil of 2 in. diameter. A fine wire could also be used in the interests of compactness and cheapness, but better results are obtained when a relatively thick wire, depending upon the size of the former, is used.

As a rule, a coil of 2 in. diameter having a winding of from No. 22 to No. 30, combines compactness with efficiency, for the medium waves. Having this coil, how is it to be connected for the best results. If the aerial is connected as in Fig. 1A, the tuning range will be restricted and the voltage set up by a signal across the ends of the coil will not be very great. The selectivity, too, will be poor.

both wavebands. We therefore have two coils of good efficiency, each having an aerial winding to suit the respective secondaries. Now how are these coils to be switched without loss? The method is given in Fig. 2. A two-pole throw-over switch is fitted and is used to connect the aerial to the medium- or long-wave primary coil and the tuning condenser to the medium- or long-wave secondary coils. These coils are fitted on a base of ebonite having terminals.

For the medium-wave coil a tube, 4 in. long and 2 in. in diameter, is used and has

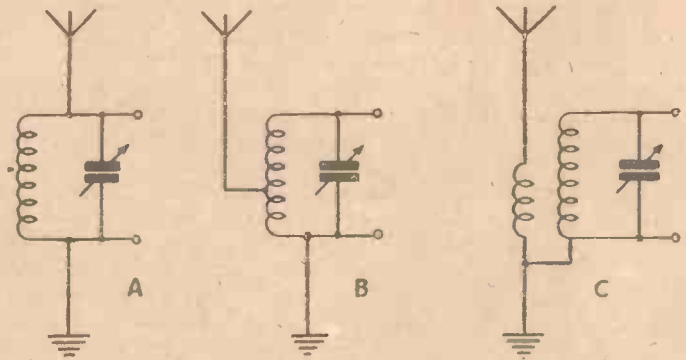

Fig. 1. Three types of aerial circuit

a winding of 85 turns of No. 22 d.s.c. The aerial winding comprises 25 turns of No. 38 d.s.c. wound at the earthed end of the secondary. A slotted former is used for the long-wave coil. It is of ebonite, 1 1/2 in. in

Aperiodic Coupling

The correct practice, except when a very short or indoor aerial is used, is to connect the aerial to a point on the coil or to a separate primary winding (Figs. 1B and 1C). Tests show that as the aerial is connected to a point on the coil (Fig. 1B) nearer the earthed end the selectivity improves. The signal strength also goes up as the tap is lowered, until a point is reached where further lowering the tap reduces the strength.

Similarly with the primary winding of Fig. 1C, as the turns are reduced the strength increases at first and then commences to fall off. Therefore, a suitable tapping point is chosen or a primary winding such that over the tuning range of the coil the best selectivity and strength for the purpose are obtained.

If the secondary coil is a poor one, no increase in the strength is to be looked for by the schemes of Figs. 1B or 1C, but the selectivity can, of course, be adjusted. In the 1930 Binowave coils, as used in "Everybody's 3" and also in "Everybody's All-electric 3," the scheme of Fig. 1C is used on

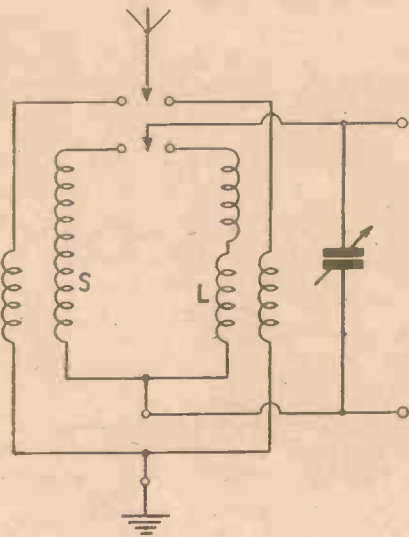

Fig. 2. Method of switching

Taking the coils on the market as a whole, such wide differences are found. My measurements show that a good set of coils will provide much better selectivity and something like six times the signal strength than a poor set.

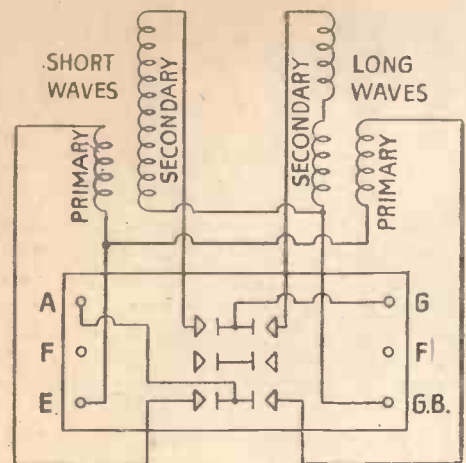

Fig. 3. Connections of coils to switch and base

diameter and 2 in. long, having five slots, each being 1/4 in. wide and 1/8 in. deep. This coil has four slots of No. 34 d.s.c. wire for the secondary and one slot of No. 34 for the aerial winding. The bottom slot is the one

(Continued on page 418)

Continuing The 1930 Clarion

The Modern Set with All Present-day Desirable Features : Known High-quality Reproduction : Splendid Volume :

THIS "1930 Clarion Three," as explained last week, is a new and greatly improved edition of the "1929 Clarion Three"—a set which absolutely swept the boards when it was produced. Readers will, of course, remember that the radio experts of a great London store, Messrs. Selfridge & Co., Ltd., were so impressed with the "1929 Clarion Three" that arrangements were made for blueprints to be given free on application to Messrs. Selfridge. The 1929 edition of the "Clarion Three" really was a winner. It still is a set which beats many others now on the market.

But it is useless to overlook the fact that great strides have been made during the past months, and, good as the original set undoubtedly was, there are now many ways in which it can be improved. Rather than tell readers just how to bring their old "Clarions" up to date, the AMATEUR WIRELESS Technical Staff thought it better to make up a new "Clarion," so that possessors of the old set can see in what direction the changes lay, and newcomers can make up a really top-hole receiver without having to refer back to the particulars originally given in AMATEUR WIRELESS.

Particular Advantages

In last week's issue, full details were given of the various advantages of this new set. In brief, they are that a special aerial tuning system is used which results in exceptionally good selectivity, the detector system is improved, provision is made for the addition of a gramophone pick-up, and finally, the construction of the whole set is somewhat easier.

For the benefit of those who are not able to carry out construction solely with

the aid of the blueprint and the photographs here published, a few constructional hints will be given which will assist those about to make up the set.

The blueprint, No. 223, should, of course, be obtained, because it is such a help in building. The price of the print is 1s., and it can be obtained post free from the Blueprint Dept. of AMATEUR WIRELESS, 58-61 Fetter Lane, London, E.C.4.

Simple Construction

A list on the next page shows the parts needed, and you will find, on totting up the cost, that the demand made by the new edition of the "Clarion" on your pocket is very modest indeed.

Construction is really quite straightforward. The various operations are, in order, the drilling of the panel and the mounting of the components thereon, the mounting of all the baseboard parts, wiring up and final testing.

The blueprint comes in very handy for drilling the panel. Depending on your skill with the tools, you can either mark off the dimensions on the panel from those obtained from the full-size blueprint, or you can temporarily attach the print to the panel (with spots of adhesive at the corners) and use the former as a template. In the latter case you should *not* drill straight through the print and panel, but should lightly punch the drilling centres, taking care not to split the panel in so doing; afterwards remove the paper template.

Apart from the holes needed for the mounting of the actual panel components, there are several other small holes necessitated by the wood-screws along the bottom edge of the panel, by the dial indicators and by the panel brackets. These holes must be drilled very carefully with a small drill. All the



There are only two controls and both can be worked practically in step

on Three

Life-edge Tuning on Both Wavebands: Adaptable for Gramo-radio

components on the panel are of the one-hole fixing type, so that you will have no trouble in mounting them properly. Make sure, however, that the centre fixing nut is really tight in each instance, for it is annoying to mount all the panel parts, only to find that one condenser, for instance, tends to turn when the knob is rotated.

When you have mounted the two large variable condensers, the reaction condenser, the two coils and the H.F. filament rheostat and two switches, the panel may be

up to the screen), the two valve holders, three small fixed condensers and one large by-pass condenser, low-frequency transformer, H.F. "stopper" resistance in its holder, and the grid-bias battery clips.

Next, before the wiring is commenced, the six terminals should be mounted on the three small strips, and the strips should be screwed to the back edge of the board. Again care should be taken to see that they are at right angles.

Wiring is done with rigid insulated wire

wiring, for this is all clearly shown on the print. Each lead thereon is shown in its correct position, and has a number attached. You should endeavour to follow the layout given as closely as possible, and you will find the whole job of wiring is simplified if you follow the order shown; that is, you should start at wire No. 1 (that between the aerial terminal and the pre-set Formodensor) and proceed in order through the whole of the connections.

Suitable Batteries

The main battery leads are twisted into groups as shown, but before twisting the flexes you should, of course, clearly mark the ends, or attach proper wander plugs so that there will be no confusion.

It should be unnecessary to stress the advice given each time a set is described in AMATEUR WIRELESS, namely, that the easiest way to avoid disappointment is to check the whole of the wiring very thoroughly before connecting up the batteries and plugging in the valves. The checking should be done with the blueprint as a guide. Make sure that you don't overlook any of the leads. After all, the whole job will take only ten minutes or so, and it may save expensive burn-outs.

A good double- or triple-capacity battery is advised for the H.T. supply of the "1930 Clarion." Nothing is so likely to cause poor results as the use of a "cheap and nasty" H.T. battery, or even of an H.T. accumulator or eliminator which is not properly up to the work required.

An eliminator which will only just supply the demands of a two-valve set will not

and with good-quality rubber-covered flex. The stiff wire, the ends of which should be most carefully bared

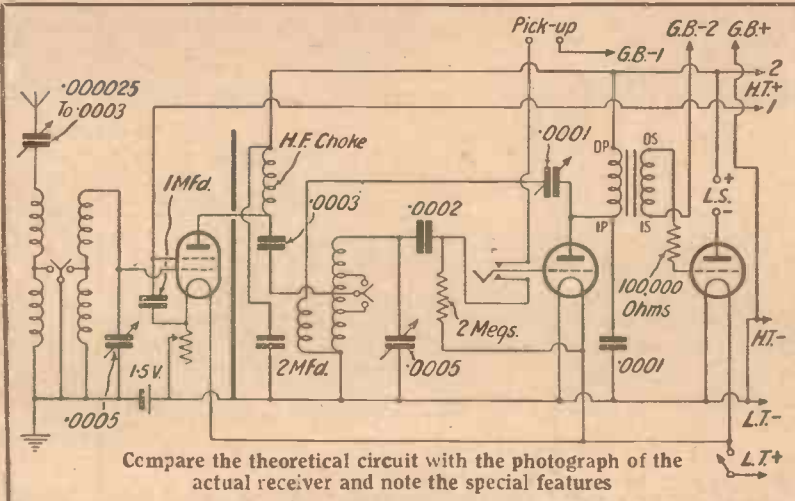

Compare the theoretical circuit with the photograph of the actual receiver and note the special features

screwed to the baseboard. The board should preferably be held in a vice so that there is no difficulty in attaching the panel properly at right angles. The panel-brackets will help.

The next step is to turn attention to the baseboard parts, and usually it is advisable to put the screen in place first of all, so that it will act as a guide to the positions of the other parts. Do not forget to clean the screen of insulating lacquer before making connections to it. This is highly important.

Wiring

To the right of the screen, looking from the back of the set, are the H.F. valve holder, the type J Formodensor, the shield earthing condenser, and the 1½-volt dry cell which biases the shielded valve.

On the other side of the screen are the H.F. choke (which should be placed close

and cleaned before the wires are put in place, is used for the larger connections, and flexes are used only for the battery leads (including the leads to the G.B. battery and the small 1½-volt cell) and for the lead to the top terminal of the shielded valve.

No instructions are necessary for

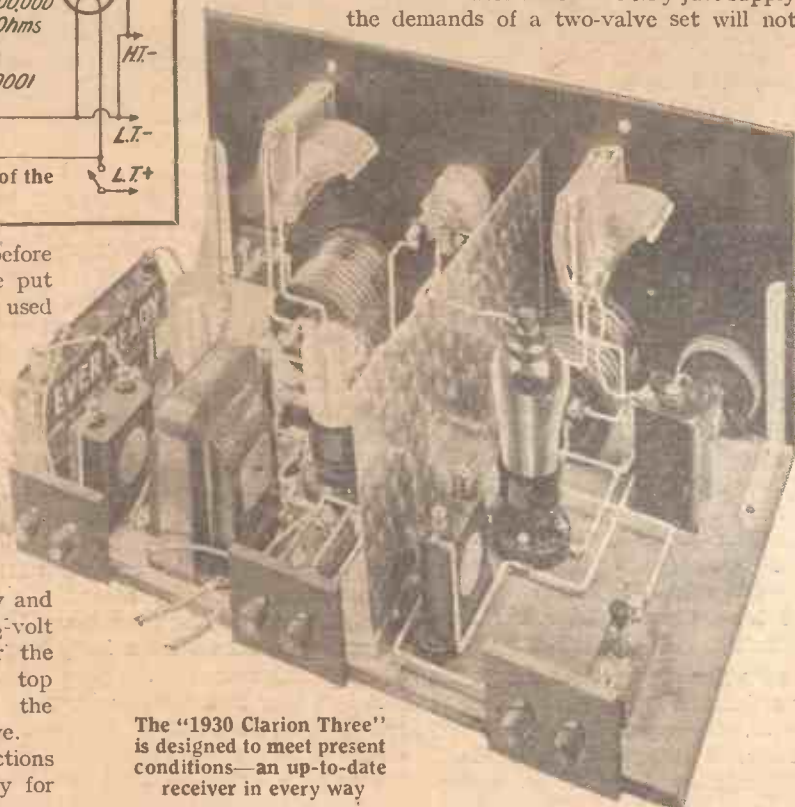

The "1930 Clarion Three" is designed to meet present conditions—an up-to-date receiver in every way

"THE 1930 CLARION THREE" (Continued from preceding page)

suit the new "Clarion." The actual H.T. current consumed depends very largely, of course, on the type of valve used in the power stage. The question of the choice of valves must be considered very closely, and readers are advised to purchase only

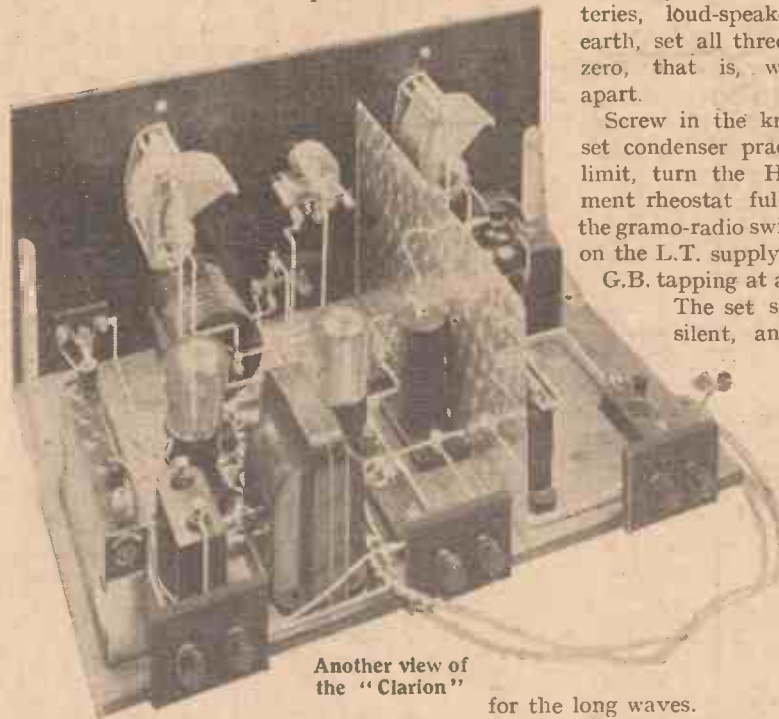

Another view of the "Clarion"

valves of well-known makes. In the following lists some typical well-known valves are given.

Suitable Valves

The screen-grid valve can be of any good make, such as the following two-, four-, and six-volters. (Two-volters): Cossor 220SG, Marconi S215, Osram S215, Six-Sixty 215SG, Mullard P.M.12, Mazda 215SG, Lissen SG215. (Four-volters): Mullard PM14, Six-Sixty 4075SG, Cossor 410SG, Marconi S410, Osram S410. (Six-volters): Six-Sixty SS6075SG, Cossor 610SG, Mullard PM16, Marconi S610, Osram S610.

The detector should be of the medium-impedance type and the following valves are suitable. (Two-volters): Cossor 210HF, Dario Univ., Marconi HL210, Osram HL210, Six-Sixty 210HF, Mullard PM1HF, Mazda HL210, Lissen HL210, Selridge "Key" 210RC. (Four-volters): Mullard PM3, Six-Sixty 4075HF, Osram HL410, Marconi HL410, Dario Univ., Cossor 410HF. (Six-volters): Cossor 610HF, Marconi HL610, Osram HL610, Six-Sixty D610, Mullard PM5X, Mazda HL607.

The power valve can be selected from the following makes and types: (Two-volters): Cossor 220P, Dario SP, Marconi P215, Osram P215, Six-Sixty 220P, Mullard PM252, Mazda P220, Lissen P220. (Four-volters): Cossor 410P, Dario SP, Marconi

P410, Osram P410, Six-Sixty 410P, Mullard PM4. (Six-volters): Cossor 610P, Marconi P610, Osram P610, Six-Sixty 610P, Mullard PM6.

Operating the set is very simple. For a first test, having connected up the batteries, loud-speaker, aerial and earth, set all three condensers at zero, that is, with the vanes apart.

Screw in the knob of the pre-set condenser practically to the limit, turn the H.F. valve filament rheostat full on, pull out the gramo-radio switch, and switch on the L.T. supply. Put the set

G.B. tapping at about $7\frac{1}{2}$ volts.

The set should be quite silent, and if there is

any sign of motor-boating, this may be cured by adjustment of the H.T. and G.B. values. The coil switches should be out for the medium waves and in

for the long waves.

Slowly rotate the two tuning condensers and pick up one of the local stations. This can quite easily be done with the reaction condenser at zero. Subsequently the pre-set condenser can be slacked off a little to improve selectivity, the filament rheostat can be turned back a little, and the H.T. may be adjusted until the quality is good.

The novel method of obtaining exceptional selectivity, both on the medium and long wavebands, will make its advantages manifest after a very short round of the dials. No matter whether the long-wave section is in circuit or is "shorted," the knife-edge properties of the tuning are still retained, owing to the aperiodic coupling.

The pre-set condenser needs to be operated with a little care, of course, for if it is slacked off too much, then a reduction of volume will be noticeable; on the other hand, too great a capacity will not result in the best selectivity that can be obtained from the circuit. If you are using an indoor aerial, then, generally speaking, you will find it an advantage not to slack off the knob by more than a turn or two; the capacity should, under otherwise similar conditions, be greater when a small aerial is being used than when a fairly long outdoor aerial is connected.

A half-hour at the dials will enable you to pick up many foreigners, and when some of the most important dial readings are known no difficulty should be experienced in obtaining a useful "bag" of stations.

For gramo-radio work, the centre switch should be pushed in, the pick-up should be put into action (there is no need to disconnect it from the pick-up terminals when it is not being used) and the separate grid-bias tapping adjusted until the purity

THE COMPONENTS

required for the "1930 Clarion Three" will be recognised in the photograph opposite

- Ebonite panel, 16 in. by 8 in. (Trolitax, Lissen, Becol, Keystone).
- Two .0005-mfd. variable condensers (Ready Radio, Igranic, Lissen, J.B., Dubilier, Lotus, Burton).
- .0001-mfd. reaction condenser (J.B. Dubilier, Bulgin, Keystone, Burton, Formo, Polar, Lissen).
- Two dual-range coils, one aerial and one anode (Tunewell).
- 15-ohm rheostat (Lissen, Wearite, Igranic, Varley).
- Single-pole double-throw jack switch (Lotus No. 7, Bulgin, Lissen).
- Filament switch (Bulgin "Q.M.B.", Claude Lyons, Igranic).
- Panel brackets (Lissen, Bulgin, Ready-Radio, Keystone).
- Three valve holders (Lotus, Benjamin, Burton, Igranic, Wearite, W. B.).
- High-frequency choke (Lewcos, Watmel, Sovereign, Varley, Lissen, Bulgin, Tunewell, Keystone, Ready-Radio).
- .0001-mfd. fixed condenser (Dubilier, T.C.C., Graham-Farish, Lissen, Watmel).
- .0002-mfd. fixed condenser with series clip (Dubilier, T.C.C., Graham-Farish, Lissen, Watmel).
- .0003-mfd. fixed condenser (Dubilier, T.C.C., Graham-Farish, Lissen, Watmel).
- 2-megohm grid leak (Dubilier, Lissen, Graham-Farish, Watmel).
- 100,000-ohms resistance with vertical holder (Graham-Farish, Lissen).
- 1-mfd. fixed condenser (Lissen, Dubilier, T.C.C., Hydra, Helsby, Ferranti).
- 2-mfd. fixed condenser (Lissen, Dubilier, Ferranti, T.C.C., Hydra, Helsby).
- Low-frequency transformer (Lissen, Ferranti, Varley, Lewcos, Telsen, Igranic).
- Three terminal strips, each $2\frac{1}{2}$ in. by 2 in. (Keystone, Junit, Becol, Ready-Radio).
- Six terminals marked A, E, Pick-up (2), L.S.+ , L.S.— (Belling-Lee, Eelex, Clix).
- Cabinet and baseboard, 16 in. by 10 in. (Cameco, Pickett, Keystone).
- Aluminium partition screen, 10 in. by 6 in. (Parex, Ready-Radio, Keystone).
- Pre-set condenser .0003-microfarad maximum to .00025-microfarad (Formodensator type J, Igranic, Sovereign).
- 1½-volt grid cell (Siemens, G.T., Ever-Ready).
- Six wander plugs marked G.B.+ , G.B.—1, G.B.—2, H.T.—, H.T.+1, H.T.+2 (Belling-Lee).
- Six spade terminals marked L.T.—, L.T.+ (Belling-Lee, Eelex, Clix).
- Grid-bias battery clips (Bulgin).
- Connecting wire (Koneceterkit No. 4, British Radio Gramophone Co., Ltd.).
- Four yards of thin flex (Koneceterkit No. 4, British Radio Gramophone Co., Ltd.).
- Two dial indicators (Bulgin).
- Two 4-in. dials (Ready-Radio, Keystone, Trolite).

is satisfactory. It will not be necessary to readjust the main G.B. tapping.

If there are any constructional points about which you still have doubts, take advantage of the fact that the original receiver can be seen in the Somerset Street windows—the radio department—of Messrs. Selfridge & Co., Ltd., Oxford Street, W. Somerset Street is just at the back of the main Selfridge buildings in Oxford Street. The fact that the original AMATEUR WIRELESS receivers can always be seen week by week at this radio stores in a central part of London is, of course, a great convenience to Londoners. Often it is a help if, apart from the photographs and descriptive matter here published, one can see the actual sets themselves before commencing construction.

Get HIGHER MAGNIFICATION

One-piece construction, no multiplicity of spot-welded joints (often the cause of parasitic noises, humming, crackling, etc.), pure, silent performance.

Slats (instead of round wire) placed edgewise giving a clear unresisting passage of electrons flowing from the filament to the anode. The wide surface of the slats afford perfect electrostatic screening.

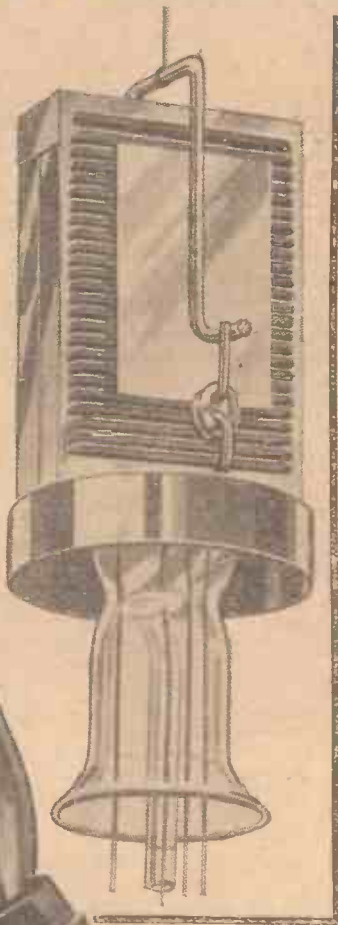

AND COMPLETE STABILITY

with this new SCREENED GRID LISSEN VALVE —the valve with the venetian screen!

Here is the Lissen new Screened Grid Valve which is going to revolutionise all ideas of distant signal reception. Instead of the usual round wire for screen, Lissen have employed a one-piece pressed screen composed of thin flat slats. By this construction the passage of the electrons on their way to the anode is clear and unrestricted because the frontal area of the slats is only of knife-edge thickness—in distinct contrast to the whole diameter of the wire in an ordinary screen which offers undesirable resistance.

On the other hand the breadth of the slats as opposed to the diameter of the round wire considerably increases the efficiency of the screen eliminating capacity between the anode and the grid. In this way the essential features of a screened grid valve, i.e. to reduce capacity between filament and anode, and to prevent self-oscillation, are developed and improved in the highest degree.

Have perfect stability, louder signals, longer range and silent working in your H.F. stage with the Lissen New Screened Grid Valve—the valve with the venetian screen.



USE THIS VALVE IN YOUR 1930 CLARION 3

—the improvement will be tremendous

S.G.215, 2 volts 22/6

Obtainable at any of the 10,000 Lissen radio dealers.

LISSEN VALVES

NEW PROCESS

Other Types and Prices:

H.210—R.C. and H.F. 10/6. H.L.210—H.F. and Detector 10/6. L.210—L.F. Amplifier 1st Stage 10/6. P.220 Power Valve 12/6. All other types available shortly.

LISSEN LIMITED,

Worples Road, Isleworth, Middlesex. (Managing Director: T. N. Cole.)

Factories also at Richmond (Surrey) and Edmonton.

To Ensure Speedy Delivery, Mention "A.W." to Advertisers

PARALLEL FEED: IS IT NECESSARY?

By J. H. REYNER, B.Sc., A.M.I.E.E.

The use of a parallel feed in low-frequency circuits is becoming increasingly popular. There are, however, certain precautions still necessary in order to obtain the best results, and these are outlined by our Technical Editor in the following article.

A PARALLEL-FEED circuit is one in which the steady anode current supplied to the valve does not pass through the primary winding of the transformer, but is fed to the valve through a resistance or choke. Fig. 1 illustrates two types of circuit using both of these arrangements. The audio-frequency currents are by-passed through a condenser on to the transformer primary, where they are stepped up and applied to the next valve in the customary manner. The presence of the condenser effectively prevents any of the direct current from flowing through the transformer primary, while at the same time the resistance or choke in the anode circuit of the valve should be sufficiently high in value to prevent any of the audio-frequency current from being by-passed through the battery.

The object of this class of circuit is to avoid the deleterious effect usually produced by the anode current passing through the transformer winding. With the ordinary form of transformer using silicon-iron (Stalloy), the effect of the steady anode current is to produce saturation of the iron and to decrease the inductance of the winding. This results in a reduction of the lower frequencies, which are not reproduced in their correct proportion.

One remedy is to use a heavy-duty transformer which has sufficient iron not to saturate seriously when carrying the normal current of the valves. The alternative is to use a parallel-feed method, isolating the transformer from the valves in the manner just described, and the added expense of this arrangement is

compensated for by the much smaller and cheaper transformer which can be made to give the same results.

With the newer forms of transformer using some of the special alloy steels now on the market, the avoidance of excessive anode current is much more important. A heavy steady current through the winding does not produce mere saturation, but may permanently reduce the efficiency of the transformer. While this undesirable feature is rapidly being overcome, nevertheless much of the iron at present on the market suffers from this defect and it is desirable,

is the better. The amplification obtained from the valve itself is a large proportion of the theoretical value, and this amplification is maintained down to quite low frequencies. Moreover, the danger of battery coupling is avoided to a large extent.

As was pointed out earlier, the audio-frequency current should all pass through the transformer and none should pass through the battery. How much this is so depends upon the impedance in the anode circuit. If this is very high then the actual condition of affairs will approach the ideal fairly closely. A choke presents a high impedance over the whole of the audio-frequency band provided it is well designed and has a small self capacity. As a general rule, therefore, the choke-fed circuit is reasonably free from battery coupling, and will give no trouble.

The resistance-fed circuit is not quite so good from various points of view. In the first place the resistance cannot be made too high or the voltage applied to the valve itself will be reduced beyond a satisfactory figure. Generally the value is about equal to the valve resistance, in which case only about 50 per cent. of the full amplification is obtained from the valve. Secondly, due to the fact that the value of resistance is limited, some of the audio-frequency currents do pass through the battery and if the circuit as a whole is an efficient one,

battery coupling will result, causing either a actual oscillation (or motor-boating if a mains unit is being used), or at any rate a tendency to instability.

If such back-coupling is found to exist, it may be overcome by the usual methods. The simplest is the use of a resistance-capacity filter in the detector circuit. Fig. 2 shows the use of such an arrangement where the first transformer is provided with parallel feed, the second

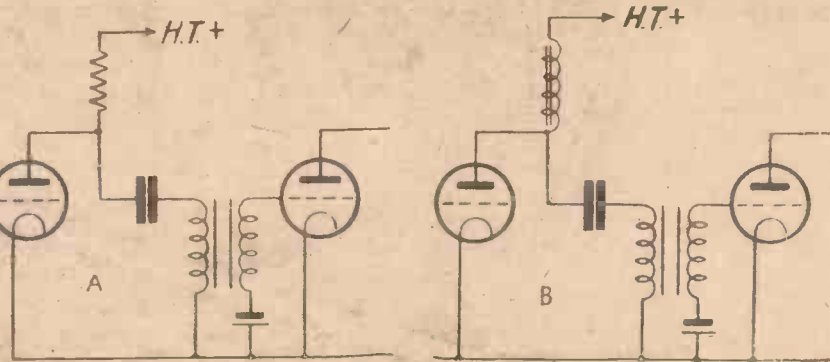

Fig. 1. (A and B). Two types of parallel-feed circuit

therefore, to avoid any serious overloading in the way of steady current.

In any case, even provided no such permanent damage is done, the high-permeability alloy steels saturate rather more rapidly than ordinary iron, so that it is again desirable to avoid the steady current.

From the point of view of satisfactory operation, the choke-coupled arrangement

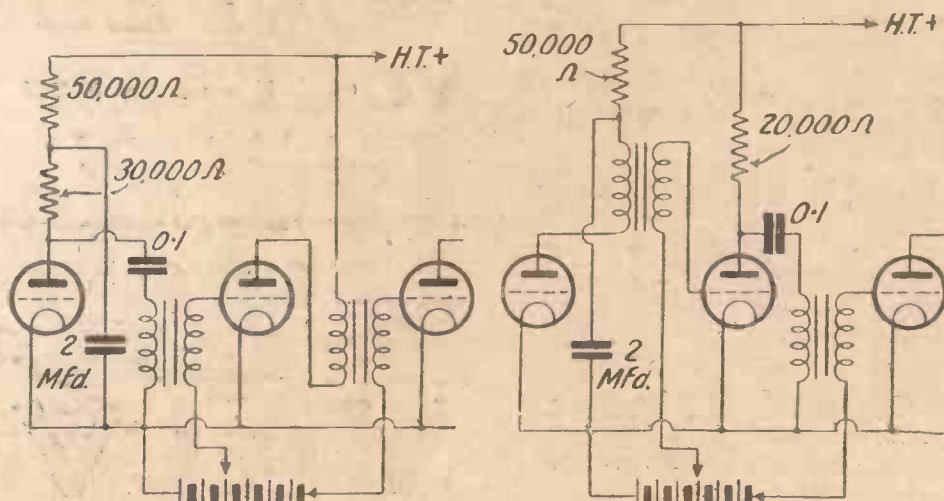

Fig. 2. The first stage is parallel-fed and filtered

Fig. 3. The first stage is filtered and the second paralleled

stage utilising a heavy-duty transformer. Fig. 3 shows the filtering necessary where the first transformer is connected normally, and the second transformer is parallel fed.

Which of these two methods is adopted, depends upon circumstances. In general, the anode current from the detector valve is small, so that no serious saturation is likely to occur. The first L.F. valve, however, takes rather more anode current, so that unless a transformer with a generous iron circuit is employed, a parallel-feed arrangement should be resorted to.

The use of a choke-output circuit or a transformer will also tend to avoid back-coupling, but in the present instance the detector filter is usually found to be preferable. With these precautions the parallel-feed circuit will be found to give an improved performance in almost every case, for owing to the absence of saturation, the inductance of the transformer maintains a very high value, usually at least twice as great as normal, with the result that the low frequencies are distinctly more in evidence than with the more usual methods of connection.

WIRELESS IN PARLIAMENT

COLONEL HOWARD-BURY asked the Secretary of State for India what steps the Government proposed to take with regard to broadcasting in India, and whether it was proposed to take over the Indian Broadcasting Company and to establish communal loud-speakers in the larger villages.

Mr. Benn said that the Government of India intended, subject to the assent of the Legislative Assembly, to purchase the property of the Indian Broadcasting Company and to carry on experimentally for a year the services hitherto offered by the company. Pending the result of this experience no new developments would be attempted, but the Government intended next year to appoint a committee to examine the position in the light of the experience gained and the possibilities of further development.

Quite a sensation has been caused in Scotland by the news that the northern headquarters of the B.B.C. are to be removed from Glasgow to Edinburgh. The contemplated change is causing considerable uneasiness in the West of Scotland, for it is felt, despite official denials, that this means the subordination of Glasgow interests to those of the capital city. The change is explained by the B.B.C. as part of the regional scheme, whereby headquarters for Scotland will be established in Edinburgh similar to those recently opened in Manchester. A small staff is to be left in Glasgow. It is understood that the new building in Edinburgh will incorporate, among other features, a complete small-scale theatre, with gallery, and it is believed the intention is to make this into a sort of cultural, musical, and dramatic centre for Scotland.

★
STILL LEADS!



The Wates "3-in-1" meter is recognised by experts and listeners as the first choice for accuracy, reliability and usefulness.

No other meter can equal its wonderful performance, and it stands supreme as the original "3-in-1" meter.

Gives the three essential readings to accurate set handling, all on one clearly calibrated dial. Any expert will confirm it! Ask your dealer. Fully descriptive literature free on request.

READINGS:

- 0-150 VOLTS
- 0-6 VOLTS
- 0-30 MILLIAMPS
- Res. 5,000 Ohms

WATES
"three in one"
VOLT-AMP
RADIO TEST METER

THE STANDARD BATTERY CO., Dept. A.W.,
184/189, Shaftesbury Avenue, London, W.C.2.
Phone: Tem. Bar 61:5.

PRICE

8/6

Standard Model:

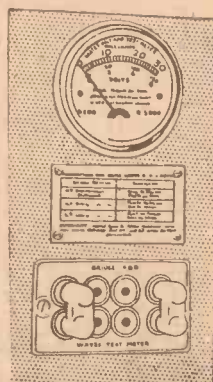

AND—a panel model too!

Supplied complete with instructions for fixing to panel. Readings on three scales obtained by varying position of plugs in coloured sockets.

METER CASE. For standard model. Satinette lined base and lid. Crystallised black finish, substantial fittings,
2/6

MILLIAMMETERS
0-25 or 0-50 M.A.
with jewelled bearings.
9/6

13/9



M.B.

"A.W." TESTS OF APPARATUS

Conducted by our Technical Editor, J. H. REYNER, B.Sc. (Hons.), A.M.I.E.E.

Voxkit Console Cabinet

THERE is an increasing demand for high-class cabinets and, more particularly, for cabinets which house the set, loud-speaker, and all the batteries or a mains eliminator. Home constructors are, slowly it is true, beginning to appreciate the fact that good appearance goes a long way in the case of a receiver for family use and that the slight increase in cost necessitated by the purchase of a well-made cabinet is amply repaid by the overall satisfaction given by the set.

There is a great advantage, too, in having the loud-speaker and batteries enclosed with the set; the popular "console" fashion, which renders almost any type of set as self-contained as a console-type gramophone, is in every way commendable.

It is with interest, therefore, that we review the Voxkit Console cabinet manufactured by the British Radio Gramophone Co., Ltd., of 77 City Road, London, E.C.1. A good idea of this cabinet can be gained from the accompanying photograph, but it does not do justice to the excellent finish of



This is the Voxkit cabinet containing an "A.W." set, the "1930 Ether Searcher"

the console, which is a handsome piece of furniture. Either an oak or a mahogany finish is available, and overlays are supplied to suit almost any type of set.

The receiver portion of the cabinet, at the top, will accommodate any set having a panel of the maximum dimensions 18 in. by 8 in., and the whole back portion of the console is removable so that instant access may be gained to the set, batteries, or loud-speaker.

If desired, the cabinet can be supplied complete with an Ultra double linediaphragm loud-speaker, the type K chassis being a standard fitting. This chassis was recently tested and reported on in these columns. The fact that the loud-speaker

can be supplied ready fitted in the console will be appreciated by those who wish to undertake only the minimum of constructional work.

There is ample room behind the loud-speaker for the accommodation of batteries or an eliminator, and no fear need be experienced that, in the case of a mains-driven set, hum will be introduced owing to the eliminator being in too close proximity to the loud-speaker unit.

The prices range from £4 4s. for the oak cabinet without loud-speaker, to £7 7s. for the mahogany cabinet complete with the type K Airchrome chassis.

A Useful Loud-speaker Adaptor

WE have received for test from Messrs. H. Weedon a double cone or linen diaphragm adaptor, suitable for fixing to any of the standard cone units now on the market. It comprises a 3-in. length spindle with two sets of brass cones. The distance apart of the cones may be fixed by adjusting two collar and set screws.

One of the features of this adaptor is the use of a ball-chuck, which can be set and fixed at any angle to the main spindle. The armature spindle of the actuating unit is fixed to the chuck by tightening a set screw.

This is a useful component and those who have made up, or are contemplating making up double-diaphragm speakers, will find it of value.

Telsen 7-tc-1 Transformer

THE multi-stage low-frequency amplifier appears to be out of fashion at the present time, and designers are concentrating their attention on producing efficient single-stage amplifiers. The utmost amplification may be obtained either by using a high-impedance detector valve or, alternatively, a high-ratio intervalve transformer. The latter method has distinct advantages, for with such a transformer it is necessary to use a low-impedance valve in the detector stage, and this is automatically capable of rectifying a high input voltage, a matter of considerable importance in these days of screen-grid valves and powerful transmitters.

We have just concluded a test on a new Telsen low-frequency transformer, having a step-up ratio of 7 to 1. This component is massively constructed and is fitted with a substantial iron core. Special precautions have been taken to withstand the use of high voltages, both as regards saturation of the iron and possible breakdown between primary and secondary windings.

The component was tested under normal working conditions in our laboratories and proved to have a primary inductance of approximately $8\frac{1}{2}$ henries, which value did not vary until the primary polarising current exceeded 10 milliamps D.C. The transformer may, therefore, be used in the anode circuit of a normal power valve without any fear of saturation; it will also operate efficiently after a low-frequency valve.

The price of 17s. 6d. is quite reasonable for an article of this type.

New Siemens H.T. Battery

IT is universally acknowledged that reproduction has become appreciably better during the past year; this fact may be attributed partly to the widespread use of special power valves in the final stages of



A new Siemens H.T. battery—the Full o' Power type

the amplifier. Unfortunately, such valves require a high anode current and are, therefore, expensive to operate on a standard-capacity battery. Double- or treble-capacity batteries, although more expensive to purchase, are considerably more economical when supplying anode current exceeding 7 or 8 milliamps.

We have received for test and report a new Siemens high-capacity battery, known as the Full-o-Power. The cells of this battery are housed in a cardboard container, measuring 11 in. by $7\frac{1}{2}$ in. by $3\frac{1}{4}$ in. high, and tappings are taken at every 15 volts up to the maximum of 60.

Tested in our laboratories, the discharge rate commenced at 14 milliamps D.C. and was continued until the voltage had dropped to half its original value. This continuous test lasted nearly fourteen days, during which time the capacity obtained worked out at 3,220 milliamp hours—a figure well in excess of the standard performance even for cells of this size.

Siemens Bros. & Co., Ltd., have had long experience in the manufacture of batteries of all types, and their latest example certainly upholds the tradition of the firm.

IN THE SPRING

JUST now there is a tendency to romance about a number of things, including the aerial. It is not necessary, for instance, to take it down and give it a coat of whitewash, but it will certainly do no harm if the insulators are freed from soot and other deposits. Also the stay-wires and ropes might well be overhauled and tested to see how they have withstood the onslaughts of winter. It is wiser to do this now, rather than risk a sudden collapse later on when you have invited a party of friends to take afternoon tea in the garden. Ladies, particularly, dislike such aerial excursions and alarms.

B. A. R.

CONDENSER "FAULTS"

IN high-powered transmission on long wavelengths, the aerial tuning condensers are generally of the oil-filled type, whilst in short-wave transmission air is used as the dielectric. In both cases very high voltages may be involved, so that great care is necessary to avoid breakdown.

For instance, the presence of stray fibres in the oil dielectric may easily lead to trouble. The effect of the electrostatic field is to draw out the fibres lengthwise, so causing them to bridge the gap between the plates. In the air-filled type of condenser, a small surface roughness on one of the plates may start a brush discharge which in turn will cause "arcing" at a comparatively low voltage.

M. B.

Broadcasting stations in the Soviet Union increased from 1 in 1925 to 65 in 1929. A five-year plan calls for the construction of 87 new major stations and 101 subsidiary stations.

China is to float a £2,000,000 loan which will be used in the construction of a network of radio stations for the transmission of messages between China and Europe, and China and America.

The Radioptimists, Glasgow's unique broadcasting concert party, has had a new revue written for it by George Gordon and Pete Nelson. The title is *Lend Us Your Amperes*.

Official circles in Berlin confirm the report that the Radio Corporation of America is negotiating for the purchase of the German Government's shares in Emelka the second largest motion-picture concern in Germany.

During 1929 the National Broadcasting Company in America handled more than one million letters from their radio audience. The personnel of the company, exclusive of artistes, increased during the year from 558 to 917.

The American Telephone and Telegraph Co. announce that the ship-to-shore telephone service will be extended to South America in the present month, and ultimately to Canada, Cuba, and Mexico.

Are You Earning 'Enough'?

THEN WHY NOT MAKE MORE IN YOUR OWN TIME?



If you want to earn more money, here is your chance! Seize it with both hands, for it is not every day that such an opportunity is put before you. Write for Free Particulars TO-DAY of THE BIG NEW HOME INDUSTRY, which the enormous expansion of wireless and electricity has created.

You can make a start on your kitchen table in your spare time to build a lucrative business by manufacturing at home our enormously successful patents. Big profits are being made in the wireless and electrical industry, and my patents will enable you to participate in them. They are in increasing demand everywhere because they are such a great improvement upon all others.

Both Men and Women are Making Money this way.

The work is not only interesting and profitable, but easy. Even the family can help you! You need have no previous knowledge of electricity and no special skill. No expensive "plant" or machinery is required. You need only a few simple tools and hand presses—most of which you can make yourself if you like, at small cost. Your business will be protected under Royal Letters Patent, so that no unlicensed person can copy you. Your "field" will be unlimited—your

Profits Guaranteed!

Anything up to £300 a year can be made on your own premises; your profit is only limited by the amount of time you have to spare. You have a FREE HAND in selling, but, if necessary, we will purchase sufficient of your stocks to ensure a weekly profit to you, providing they reach the required standard of efficiency, which can be easily attained, and we undertake to continue your training FREE until that standard is reached—could anything be more definite or fair? You can start NOW on the road to success and a bigger income by sending for Full FREE Particulars of this proposition. NOW you can turn those spare hours into GOLDEN hours, pleasantly, easily! The wireless and electrical industry is still expanding at a tremendous rate; here is YOUR chance to "jump in" and benefit! Post off the form below instantly—seize hold of this genuine, honest proposition and start forward to becoming an independent master man.

This Form will bring You Full Particulars

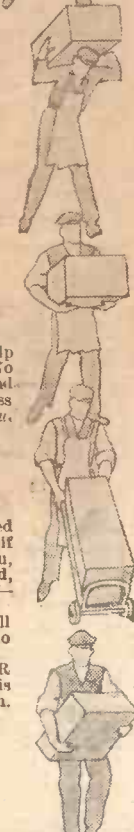

HOW CAN I MAKE £'S

To Mr. V. ENGLAND-RICHARDS,
THE ENGLAND-RICHARDS CO., LTD.,
1217 King's Lynn, Norfolk.

SIR,—Please send me at once, and FREE, full details as to how I can Make Money at Home in my spare time. I enclose 2d. stamp for postage.

NAME

ADDRESS

.....

Print your name and address boldly in capital letters on a plain sheet of paper and pin this coupon to it.

"Amateur Wireless," 15/3/30.

AUTO-COUPPLING An Interesting Development in Intervalve Coupling Devices

By L. A. CHAPMAN

AMPLIFIER design has been improved beyond all recognition in recent years. The various steps have been, first the L.F. transformer, later the resistance-wound transformer with a small coupling condenser, later still the choke-coupling or dual-impedance coupling as it was afterwards called. Then R.C.C. units came to the fore which enabled designers to introduce one R.C.C. and one transformer-coupled stage into a two-stage amplifier. More recently the "parallel-feed" or "resistance feed" transformer coupling came into being. Now comes auto-coupling. As usual, AMATEUR WIRELESS leads the way.

Quite frankly, auto-coupling is not new, but the degree of perfection to which the system has now been brought is new.

A glance at the diagram will make clear the system of coupling. There is the usual anode resistance with grid coupling condenser connected up in the normal manner. The connection from the output side of this coupling condenser, however, is taken to one of the windings of a tapped choke.

By connecting up a choke in this way, it is possible to obtain an auto-transformer effect and by having various windings to the choke it is possible to vary the transformation ratio.

One important point relating to the

auto-transformer arrangement having different ratios, is the possibility of changing the "tone" or "pitch" of reproduction. This is a great benefit inasmuch as it is possible, whilst working, to change the reproduction from a mellow to a crisp or

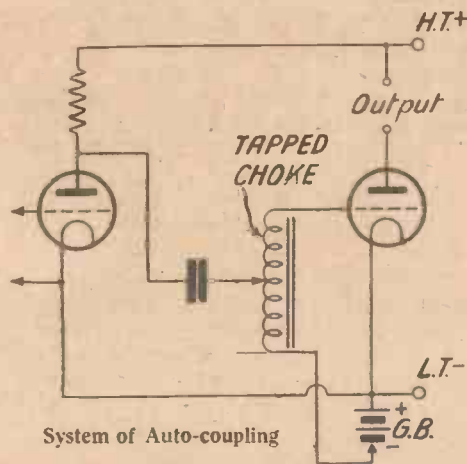

high-pitched tone as desired. In speech, for instance, a mellow tone usually gives rise to a muffled effect. This can easily be changed to a crisp effect by changing the step-up ratio of the auto-coupling unit.

The auto-coupling system covers all such

requirements. The use of the anode resistance permits constant amplification over the audible-frequency scale, whilst the coupling condenser makes it possible to emphasise those frequencies it is desired to bring out. A small capacity will pass the higher frequencies and tend to cut off the lower. A large capacity will pass both high and low frequencies. The tapped choke permits a variable step-up and, therefore, a variable tone control.

The foregoing remarks cover the salient features of the new form of coupling.

Purity of reproduction is one of the main features of the system. It also gives voltage amplification. It is possible, therefore, in each successive stage of coupling to get good amplification with maximum purity.

In next week's issue of AMATEUR WIRELESS we shall publish the constructional details of the first receiver making use of two stages of auto-coupling. This receiver, by the way, is to be known as the "Auto-coupler Three," and it will, of course, be particularly suitable for present-day regional-station conditions. It will be a highly selective receiver without being too tricky to tune, it will give true-tone amplification with good loud-speaker results from the more powerful British and Continental broadcasting stations.



ON March 15 listeners to the B.B.C. stations are to be treated to a somewhat longer relay of a musical performance than has hitherto been the case. For an hour and three quarters Savoy Hill will be connected to the Savoy Theatre for Gilbert and Sullivan's *The Yeomen of the Guard*.

Angela Baddeley, who recently appeared before the microphone in a short thriller, will broadcast a performance entitled *The Mouse* from London and Midland Regionals on March 31. Other contributors to the variety programme to be presented on that evening are Michael Hogan, Melville Gideon, Desirée Ellinger, Gillie Potter, Edith Clegg, and Fairchild and Lindholm.

On April 5 a running commentary on the England v. Scotland Association football match will be relayed from Wembley to all stations.

Sir Nigel Playfair will produce at the Savoy Hill studios on March 19 an operetta

entitled *There's No Fool Like a Young Fool*. If at all possible, Frederick Ranalöw, who created the principal part when the piece was presented at the Arts Theatre Club, will repeat his performance before the "mike."

The new Rome 12-kilowatt short-wave transmitter is now testing almost daily. It operates on two wavelengths at present, namely, 25 and 80 metres, and experiments will prove which of them is the most favourable. It is proposed to relay the programmes of the Rome studio as well as any other Italian stations on special occasions.

Both the private French broadcasting stations at Fécamp (Radio Normandie) and Béziers have been granted authority to use the State telephone cables and in future will relay performances from local theatres.

The Moscow broadcasting stations are temporarily experimenting with a new

form of opening signal. It begins with a deep-throated factory siren, gradually fades out, and is replaced by the noise of whirring machinery and ending up with a few bars of the "Internationale."

The Helsingfors broadcasting station is to be equipped with a new transmitter; its power will be 10 kilowatts, of the same type as that used by Hörby (Sweden) for the relay of the Stockholm programmes.

On Wednesdays and Saturdays from 9 to 11 p.m. a transmission is to be picked up from the Lisbon 1-kilowatt experimental station. The call CT1AA, "*Posto do Amador Abilio Nunes dos Santos Junior*," is also translated into French, English, and German. The programme of gramophone records is broadcast on 318 metres and closes with the national anthem, "La Portuguesa."

The new transmitter constructed as reserve plant for Berlin (Witzleben) is now ready for tests. Alterations to the Leipzig broadcasting station have permitted a 20 per cent. increase of power in the studio transmissions from that city.

Pending the construction of a special short-wave station at Rabat (Morocco) the programmes are relayed on Tuesdays, Wednesdays, Saturdays, and Sundays to SMC (Casablanca), which in its turn re-broadcasts them on 43.60 metres.

LETTERS TO THE EDITOR



The Editor does not necessarily agree with the views expressed by correspondents

Correspondence should be brief and to the point and written on one side of the paper.

The Super-het. and Royalties

SIR,—We have read with interest the paragraph in your issue of February 22, under the heading "On Your Wavelength," concerning the super-heterodyne question.

We are inclined to agree with you that the modern necessity for much increased selectivity is likely to bring about a renewed demand for super-heterodyne circuits.

We have no wish either to hinder the business of the manufacturer or to interfere with the pleasure of the amateur, but we would like once again to draw your readers' attention to the fact that we are the owners of British Patent 143,583, which covers the principle of super-heterodyne reception. We are prepared to grant a licence to any reputable firm or person on demand, the royalty per set being 25s., irrespective of the number of valves employed.

On the other hand, we shall, of course, take all necessary steps to protect our rights against those who infringe our patents.

STANDARD TELEPHONES AND CABLES, LTD.

Are Side-bands Necessary?

SIR,—"Thermion" has been answered out of his own mouth. He admits

- (a) Side-bands exist;
- (b) Quality is not so good without them. So now we know!

G. W. P. (Woking).

PS.—This article was dated one month too soon.

Why Not Lead Leads?

SIR,—It may interest you to know that my four-valve set is wired with lead—all wires except those for grid and aerial. The wire is lighting cable No. 18, single, and only costs 6d. per yard. I use no screen at all, but the components are well spaced. The set is a S.G., D., two L.F.

The lead is all earthed, either by direct contact and tied or by link of other wire. The set is quite steady, and in my case the added capacity necessitates the use of a 50 coil instead of 60, as heretofore.

H. B. (South Shields).

Brookmans Twins in South London

SIR,—It may interest some of your readers who reside in South London and district, and who are having a spot of bother with separating the dual transmissions from Brookmans Park, to know that I am using an aerial approximately

80 ft. in length, including lead-in, and by inserting a .0001-microfarad fixed condenser in the aerial lead I have no trouble in eliminating either of the two wavelengths. For the reception of 5GB, however, this condenser must be taken out or shorted. The set I am using is the "Britain's Favourite Two," published in AMATEUR WIRELESS dated May 25, 1929.

G. (Brockley).

What the "By-pass" Will Do

SIR,—I have made up a by-pass unit on the lines of the "Brookman's Park" unit published by your excellent paper, but in place of the coil you advise I have wound 270 turns on a 2½-in. former and used a .00035 variable condenser in place of the .0005 you specify. The wire used is No. 30 and I tapped it at every 20 turns. Now, using this in conjunction with my "Mullard Screen-grid Pentode Three," I can do the following things, which I have never been able to do before:—

- (a) Get Radio Paris without a murmur

from Daventry 5XX and without any loss of quality or volume.

(b) Separate completely Kalundborg from Huizen (1,071 metres).

(c) Cut out a lot of the morse on either of the above stations.

(d) Get Hilversum (1,875 metres) free from a lot of the morse which so often spoils this useful station.

Up here in Yorkshire it is easy to separate the two Brookmans Park transmitters, but your unit, adapted as suggested above, seems to cut out all trouble on the very useful upper band, and I am sure other northern listeners will be interested in my experience with a unit so easy and inexpensive to make. May I add that I have found AMATEUR WIRELESS a thundering good investment.

"LEEDS LISTENER."

"Brookman's By-pass 3"

SIR,—I built the "Brookman's By-pass 3." This set is the goods, not only on the broadcast waveband, but on the ultra-short waves, as I found out quite by accident. The first time I tried it out I received eight American stations—four on the loud-speaker—and any amount of morse stations—enough to blow your head off.

A very good set indeed; but, there, it's a habit of AMATEUR WIRELESS.

So far, I have heard nothing to touch your linen-diaphragm speaker.

C. (Cambridge).

BUILD THE WONDER 1930 CLARION THREE FROM THE FAMOUS "PILOT" KIT

which includes all components approved by "Amateur Wireless." Necessary coils, drilled panels, and requisite connecting wire, screws, etc., and free blueprint, specified valves and cabinet.

Cash £9:5:6 or 12 monthly instalments of 17/-

FINISHED INSTRUMENT—aerial tested and guaranteed. In table model cabinet. Valves, coils, and Royalty included.

Cash £10:17:6 Or first payment of 37/6 and 11 monthly payments of 18/-

OTHER FAMOUS "A.W." SETS
 EVERYBODY'S ALL-ELECTRIC THREE. Kit £16:11:0, or 12 monthly instalments of 30/-. Finished Instrument, cash £21 or send only 70/- balance by 11 monthly instalments of 35/-.
 BY-PASS THREE. Kit £7:10:8 or 12 monthly instalments of 13/9. Finished Instrument, cash £9:17:6 or send only 37/6, balance by 11 monthly instalments of 16/-.
 Any parts supplied separately. Detailed lists on application.

Send us a list of your requirements for a quotation by return. Post coupon for our magnificent 48-pp. catalogue.

PETO-SCOTT CO., LTD.

Free Demonstrations and advice by Qualified Engineers at our Show-rooms:—
 77 CITY ROAD, LONDON, E.C.1. Telephone: Clerkenwell 9403-7-9.
 62 HIGH BOLBORN, LONDON, W.11. Telephone: Chancery 9236
 4 Manchester Street, Liverpool. Telephone: Central 2134.
 33 Whitelaw Road, Chorlton-cum-Mardy, Manchester. Telephone: Chorlton-cum-Mardy 2029.

The Easy Way TO PERFECT RADIO

KITS, SETS & ACCESSORIES

In addition to their own extensive range PETO-SCOTT offer every known Radio Receiver, Kit, Component or Accessory on Easy Terms with Service after Sales

ACCESSORIES

"TWIN" BROOKMAN'S BY-PASS UNIT Complete kit of components, including panel, 25/6.

EXIDE 120-VOLT H.T. ACCUMULATOR, Type W.J., 2,500 m.a. In Crates. Cash £3 15s., or 12 monthly payments of 6/11. Type W.H., 120 volts, 5,000 m.a. In Crates. Cash, £4 13s., or 12 monthly payments of 8/6.

OSRAM MUSIC MAGNET. Cash £9, or 12 monthly payments of 16/6. Valves included.

REGENTONE W.I.B. S.G. (A.C. Mains). For S.G. and Pentode Sets. Cash £4 19s. 6d., or 12 monthly payments of 9/2.

ULTRA AIR CHROME. DOUBLE LINEN DIAPHRAGM SPEAKERS in oak or mahogany table model cabinets. Type K chassis. £4 4s. 0d. or 12 monthly instalments of 7/6.

Mail coupon in unsealed envelope under 1d. stamp.

COUPON

Please send me your 48-page Illustrated Catalogue, describing the 1929-30 products of all the leading makers.

NAME

ADDRESS

THE STAR OF ALL UNITS

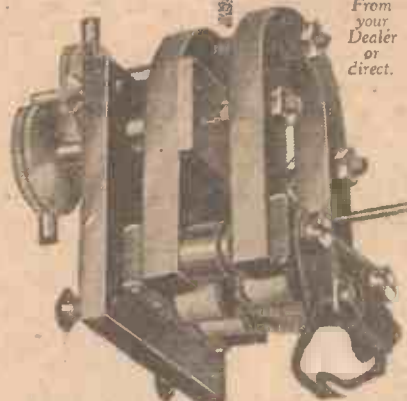

From your Dealer or direct.

MAGNIFICENT TONAL BEAUTY

If you are in search of all that is best in reproduction, then you need the Wates Star Unit. This wonderful unit is the heart and soul of the famous Wates Star Speaker. In conjunction with the Wates Double Cone Chassis you can build up a speaker that will give you unequalled quality and superb emission at every point of the musical scale. Exclusive principles of construction. 12 poles, double magnets, 4 coils

"... shall want another in the near future..." writes L.A.E.



WATES STAR LOUD SPEAKER UNIT

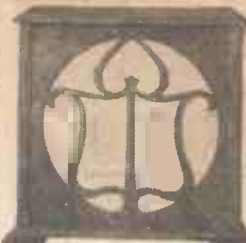

WATES DOUBLE CONE CHASSIS Pat. No. 309214 as above **12/-**
WATES STAR LOUD-SPEAKER in Handsome CABINETS
Oak £4 0 0
Mahog. £4 6 0
Telephone: Temple Bar 6195

THE SHAFTESBURY RADIO CO., (Dept. A.W.)
184-188, Shaftesbury Avenue, London, W.C.2

750 WATT "Q.M.B." SWITCH 2/6

LYONS' NEW "B.A.T." (Best-After-Test) QMB Switch breaks 3 amps. at 250 volts!
For H.F., L.F., H.T., L.T. circuits. For A.C. Sets, Mains Units, Gramo-Motors, and as Moving Coil Speaker Field Switch, etc. Send for FREE 4-pp. circular; request at the same time our famous 36-pp. "CLAROSTAT" Book (all about D.C. and A.C. Mains Units, with scale drawings).



CLAUDE LYONS, LTD.,
76 OLDHALL STREET,
LIVERPOOL: ENGLAND

"MAKING YOUR OWN HNO-WAVE COILS"

(Continued from page 407)

carrying the aerial coil and it has 15 turns of No. 34 d.s.c. In the other four slots are 105 turns of No. 34. This is one continuous winding, but the first two slots are wound in one direction and the next two in the reverse direction.

The Long-wave Winding

The long-wave winding is, therefore, of the astatic type, as it has two parts wound in opposite directions. This point should not be overlooked. The size of the former is important, and so is the gauge of wire. Fig. 3 shows how to connect the coil to the switch and the markings of a standard coil base. Terminals F are joined to the switch

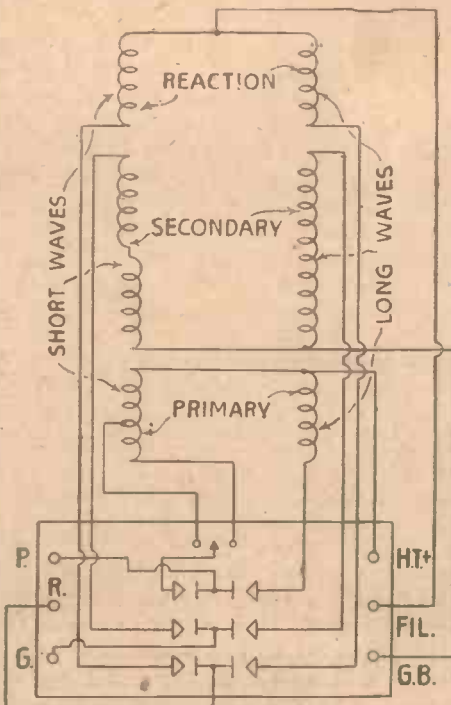

Fig. 4. Diagram of the complete connections of the Binowave coils

and are for the filament circuit. When the switch knob is upright, the filament circuit is broken, but is completed when the knob is turned to the left (medium waves) and to the right (long waves). The coils may be fixed in various ways to the base, and it is advisable to drill a number of holes for the ends of the coils to pass through to the switch and terminals.

These coils are designed to provide the strongest signals with good selectivity. It is for this reason that separate coils are used and a switch for connecting one or the other to the circuit.

For coupling the shielded valve and detector, a different set of coils must be used. Obviously, the coils must be designed to suit the valves and not the aerial circuit and, further, provision must be made for reaction.

The plain tuned-anode circuit is not too good, as I have explained before. Best

"POPULAR" TRANSFORMER

The Brownie POPULAR Transformer is every bit as good as it looks. Its purity of amplification gives vivid clarity throughout the full musical range, while its sturdy British construction ensures that it will give this quality of reproduction not just now and then, but always. It costs only 9/6, and does the work of transformers at double its price.

BROWNIE WIRELESS CO. (G.B.) LTD.
Nelson Street Works, London, N.W.1

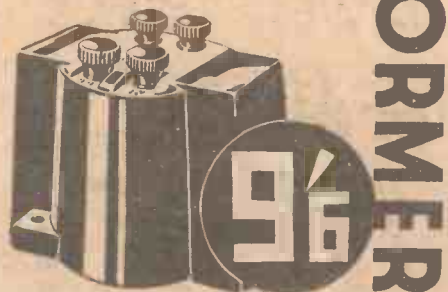

BROWNIE WIRELESS

12/6 12/6



A Wonderful New Transformer

Tunewell has done it again! This time it's a transformer—a 25/- job in everything but price. Ratios 3 to 1 and 5 to 1.

From your Dealer; or direct **12/6**

Other Tunewell Products include:
Bakelite Di-electric Brookman's By-Differential condenser Pass wave-trap .00013 3/11 coils, complete with Standard types, .0005 fixing brackets, and .0003 for aerial 3/3 each and reaction 3/11 ea.
New dual range coil Complete wave-trap, new type using X-tapped on both high Brookman's By- and low waves Pass principle, Super-selective, 10/6

TURNER & CO.

54 Station Road, New Southgate, N.11



DARIO VALVES

Best Way to All Stations!

NEWEST TYPES

SCREENODION

Enormous Range

BIVOLT .15 amps.
FORVOLT .075 amps.

15'6

SUPERBLY SELECTIVE

The best Screen Grid in the world.

SUPER HF

BIVOLT .15 amps.
FORVOLT .075 amps.

5'6

Also the New Super DETECTOR (2 or 4 v.) 6/6

HYPERPOWER

BIVOLT .3 amps.
FORVOLT .15 amps.

9'6

Designed to carry enormous volume by reason of an exceptionally large grid swing.

UNIVERSAL RESISTRON 5'6

SUPER POWER 7'6

and the Super Power **PENTODION** 18'6

DARIO L.F. TRANSFORMER

A little marvel. Guaranteed for two years. Completely shrouded. Perfectly designed and perfectly made.

5'-

5-1 or 3-1.

Write for Free Folder to:
IMPEX ELECTRICAL Ltd.
Dept. J, 538 High Rd., Leytonstone,
London, E.11

results are obtained from a transformer having a primary winding to suit the shielded valve. The intervalve coupling coil ought also to be so arranged, unless complete shielding is resorted to, that the magnetic coupling with the aerial-grid coil is negligible. Otherwise the circuit may be unstable and low amplification be obtained.

Constructional Matters

To fit a primary winding to suit valves of different makes, but having about the same values of impedance and amplification factors, is an easy matter, but unfortunately the valves vary a good deal, besides which those of the A.C.-mains type usually have a much greater impedance than battery types.

I have, therefore, altered the original coils to cover this point and now provide a tap on the medium-wave coil. None is needed on the long-wave coil, as the band of frequencies covered is much less. A reaction winding is also fitted to each coil. The medium-wave coupling, therefore, comprises an astatically-wound grid coil having a tapped primary and reaction windings.

A tube of paxolin, 2 in. in diameter and 4 in. long, is used. At the bottom is the primary coil; then comes the grid coil, wound in two parts; and, finally, at the top, is the reaction coil. As to the turns used, in the primary is a total of 50 turns, with a tap at the 25th turn of No. 38 d.s.c. The grid coil has 54 + 54 turns of No. 24 d.s.c., and the reaction 25 turns of No. 38.

It is necessary to connect the coils as indicated and to wind the primary coil in the same direction as the bottom part of the grid coil; whilst the reaction coil must be put on in the same direction as the top half of the grid coil.

For the long-wave coil a slotted former of the same size as the aerial long-wave coil is used. The bottom slot contains the primary, the next three the grid coil, and the top slot has the reaction winding. In the primary is 220 turns of No. 38 d.s.c. No. 34 d.s.c. is used for the grid coil and is put into three slots winding in the same direction 100 turns in each, a total of 300 turns. Sixty turns are put in the top slot for reaction. All windings run in the same direction.

The complete diagram is given by Fig. 4. Unfortunately the coils are difficult to construct; that is why Messrs. Wright and Weaire were supplied with details for the commercial manufacture. The coils give results which warrant the difficult construction, reports from readers who have built sets including them being most satisfactory.

The Kenya radio station has begun operations between Kenya and Great Britain. This is the first direct radio service between Great Britain and one of her colonies, with the exception of the Dominions and India.

1930 CLARION THREE

AVAILABLE IN COMPLETE
NON-SOLDERING
KITS OF PARTS

READY FOR IMMEDIATE DESPATCH

KIT A	less valves and cabinet	£5 14 0
KIT B	with valves less cabinet	£7 19 6
KIT C	with valves and cabinet	£9 4 6

Full List of Components in previous issue.

EASY TERMS

KIT A	12 equal monthly payments of	10/6
KIT B	12 equal monthly payments of	14/9
KIT C	12 equal monthly payments of	17/-

OR

KIT A	20/- down and 12 weekly payments of	8/3
KIT B	20/- down and 12 weekly payments of	12/3
KIT C	20/- down and 12 weekly payments of	14/6

READY RADIO LOGARITHMIC CONDENSER

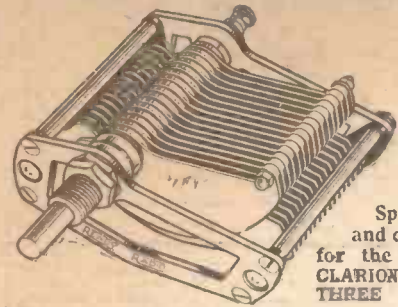

Specified and chosen for the 1930 **CLARION THREE** 4/6

TO HOME CUSTOMERS

Your goods are despatched post free in sealed cartons or carriage paid by rail. Note.—You can if you desire avail yourself of the C.O.D. system.

TO OVERSEAS CUSTOMERS

All your goods are very carefully packed for export and insured, all charges forward.

Ready Radio

159 BOROUGH HIGH STREET,
LONDON BRIDGE, LONDON, S.E.1

Telephone: HOP 5555

ALL UNITS

BLUE SPOT AMPLION B.A.2
WATMEL
G.E.C. TRIOTRON HEGRA
SILVER CHIMES LOEWE
W.E.B. BROWN VEE
B.T.H. LISSIN
ORMOND

50% BETTER RESULTS

Listen to the thrilling power, enchanting tone, brilliant emission, superb handling of the bass, the perfect pitch of the treble—that's what you get from your unit when you use the Wates Universal Double Cone Chassis. With a separate cone for high and low frequencies, can you wonder that reception is 50% better. It is the amazing double cone feature that is making the Wates Universal famous as Radio's greatest chassis. Both cones are scroll cut to avoid a direct line through the sound frequencies and specially treated for constant crispness.
If your dealer does not yet stock, obtainable direct. Full particulars free on request.

The **SHAFTESBURY RADIO CO.**, (Dept. A.W.),
184/188 SHAFTESBURY AVENUE, LONDON, W.C.2
W.C.2 Tel. TEM. BAR 6195
Price, complete with Universal-brackets and instructions for mounting unit.

11/6

WATES UNIVERSAL DOUBLE CONE CHASSIS



A short-wave station, at a cost of £120,000, has been built at Mukden in Manchuria, capable of communicating with Europe. There are eleven radio stations in Manchuria, these being at Harbin, Mukden, Changehün, Yingkow, Tsitsihar, Suifen, and Yenki.

A report from Guatemala indicates that new radio-telegraph stations are to be erected at the following points: Puerto Barrios, Flores, Coban, Livingston, Esquipulas, San Jose, Santa Cruz del Quiche, Huchustenanago, and Plancha de Piedra-Fallabon.

All America Cables Inc. has opened a radio-telegraphic station at Lima. The newly inaugurated station works with Seville, and Long Island.

"A.W.'s" BAIRD TELEVISOR

AS stated in our last issue, the AMATEUR WIRELESS Technical Staff have been conducting experiments with the first model of the new Baird Televisor.

We pointed out that this instrument does not include a radio receiver and amplifier, and we have been endeavouring to ascertain which types are best for the purpose.

We have tried a number of different circuits, but still find that an anode-bend detector followed by a three-stage resistance-coupled low-frequency amplifier give the best results.

Although we now learn that the televisor is to be marketed at 25 guineas, we feel confident in stating that a great step forward has at last been made in the right direction. Should the demand for these receivers prove large, no doubt a reduction in the price will quickly follow.

An interesting phenomenon has arisen during our tests. Should a receiver start to oscillate in the vicinity of the televisor, a check pattern of lines appears on the picture being received.

From time to time we shall still continue to give details of the experiments with the televisor installed in our Test Laboratory. Readers should, therefore, watch our pages for reports of further interesting developments.

King George soon will be able to hear himself as American listeners heard him when he opened the Five Power Naval Limitations Conference. Dictaphone cylinders which recorded his speech as picked up and rebroadcast to the United States have been mailed from the British Embassy in Washington in the official mail pouch of the King.

Expenditures of £600,000 for the construction of radio stations for the transmission of messages between China and Europe will be included in the proposed £2,000,000 telegraph loan which will be floated shortly by the Chinese Government, according to a dispatch recently received.

Mr. Cecil Lewis, former programme director of the B.B.C., is producing a series of radio dramatisations of plays by George Bernard Shaw for the National Broadcasting Company in America.

Listeners report that a new transmitter is testing at Brussels on 226 metres. The call—a cryptic one—is given as: "Ici Poste 21,401," and an address in the Belgian capital is carefully spelt out.

The Eiffel Tower, for its own musical transmissions, has adopted a new opening and time signal. At 8 p.m., G.M.T., listeners will now hear an imitation Big Ben followed by a bugle call somewhat reminiscent of "The Last Post."

8D. PER DAY

Buy anything connected with Radio on these terms. Pay Instalments when you like. Weekly, Fortnightly, or Monthly. With or without initial deposit.

1930 CLARION THREE

Complete kit with oak cabinet ... £6 7 9
Or 8d. per day for 30 weeks
Valves 45/6 extra

THE AMERICA SHORT-WAVE 2

In handsome aluminium cabinet, complete with valves (Royalties, 10/-) ... £9 17 6
Or 15/- down and 8d. per day for 44 weeks.

Complete kit for above, with blueprint and detailed instructions ... £8 7 6
Or 10/- down and 8d. per day for 38 weeks.

We guarantee that all complete sets supplied have on test received AMERICAN BROADCASTING on a LOUD-SPEAKER. Build this set yourself and do the same.

THE NEW COSSOR MELODY MAKER

Complete battery kit, with valves ... £8 15 6
Or 10/- down and 8d. per day for 40 weeks.

Mains-driven A.C. model, complete kit, with valves ... £15 0 0
Or 90/- down and 8d. per day for 12 months.

THE NEW CRUSADER (Wireless Magazine, March)

Tunes from 20 to 2,000 metres. Complete kit (Valves, 23/- extra) ... £3 10 0
Or 8d. per day for 17 weeks

THE NEW OSRAM MUSIC MAGNET

A selective set getting over thirty stations. Complete kit, with valves and cabinet (Cabinet only, with baffle 17/6) ... £9 0 0
Or 8d. per day for 10 months.

ULTRA AIR CHROME SPEAKERS

Mounted in handsome OAK CABINET, 14 in. square ... £3 9 6
Cabinet only with baffle ... £0 17 6

Large 24-in. model, OAK CABINET, on legs ... £1 12 6

A fine piece of furniture with baffle ... £1 12 6

P.B. double cone speakers on 2 1/2-in. baffle ... £2 2 6

Triotron unit ... £1 12 6

Blue Spot unit ... £2 2 6

SPECIALISTS IN RADIO GRAMOPHONES

Oak Cabinets for radio gramophones, with space for 22 in. by 7 in. panel ... £5 0 0

FREE EXPERT ADVICE

If you are in difficulty, our Technical Department will advise you as to the most suitable set for your requirements. WRITE NOW.

EVERYTHING RADIO SUPPLIED WITHOUT DELAY on Easy Payments or C.O.D. Carriage Paid on all Orders.

P.B. RADIO CO.

35 OXFORD STREET, LONDON, W.1
Phone: Gerrard 3546. Telegrams: Equipregim, London

IMPROVE THE TONE OF YOUR LINEN SPEAKER

Fit the "SELF CENTRE" device to your cone unit and you will be surprised at the improvement in the tone of your speaker. The "SELF CENTRE" will relieve driving-rod of side stress and chatter, positively centring driving rod, giving finer adjustment.

See page 414 of this issue for the test report on this ingenious device.

Price 2/6 C.O.D. terms available.

WEEDON, 80 LONSDALE AVENUE, LONDON, E.6

TAYLOR WET B.T. BATTERIES
New Prices: Jars 1/3. Sacs 1/2. Zincs 10d. Sample doz. 18 Volts complete with bands and electrolyte 4/1 post 9d. Sample unit 6d. - illus. booklet free. Bargain list free.
AMPLIFIERS, 30/- 3 VALVE ALL-STATION SET £5
A. TAYLOR, 57, Studley Road, Stockwell, LONDON.

5/6

General Purpose
and Power
7/6 Super Power

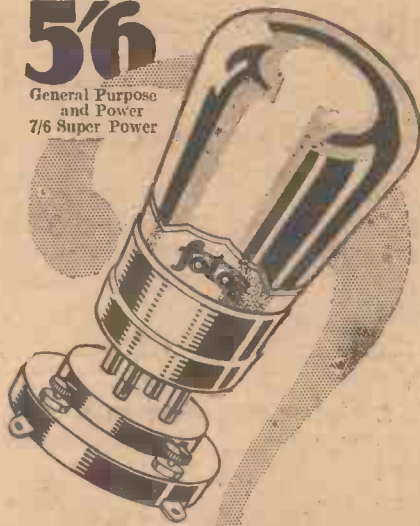

What valves in your holders

Good reception depends chiefly on your valves. Tone, volume, selectivity—all are determined by your valves. What are yours?

are they

fotos

CONCERT VALVES
THE HEART OF EVERY SET

Ask your dealer for FOTOS or write
for Descriptive Booklet A20.

CONCERTON RADIO & ELECTRICAL CO., LTD.
256-7, Bank Chambers, 329, High Holborn, W.C.1
Phone: Holborn 8667

"APTUS" LINEN DIAPHRAGM TRIPLE CHUCK ADAPTER FITS ALL UNITS



COMBINED BRASS AND CEMENT
LUBROID WASHERS. PREVENTS
RATTLE.

EXPERTS SAY:—"The most Success-
full Centre yet Devised."

PRICE 2/6 POST 3d.

"APTUS" DOPE .. 10 oz. 2/9
DOPE BRUSH .. 6d.
IRISH LINEN for 22 inch .. 7/6
8 ANGLE BRACKETS with
Screws .. 1/6
RUBBER .. 6d. yard
SET (4) 2 B.A. RODS (16
NUTS and WASHERS) .. 1/3

UNITS. Post Free.
APTUS 17/6. BLUE SPOT 25/-
HEGRA 19/- CHIMES 16/6. Etc.

ORDERS OVER 10/- POST FREE.
Makers of "APTUS" specialities.

MOORE & Co.

(Est. 50 YEARS)
101 & 103 Dale Street, LIVERPOOL
Phone: Cen. 5284. Grams: "Solutions."

GRAMOPHONES LATEST HORNS
AND PARTS
CATALOGUE FREE. CASH OR TERMS.
BUILD £12 MODEL FOR £3. INSTRUCTIONS 31.
W. BURT, 185 High St., Deptford, London, S.E.8

More Small Fry!

Jottings From My Log

By JAY COOTE

LAST week I mentioned some of the smaller fry which can be netted when a close search is made; to-day, I will add to my list by giving you the details of further "little 'uns" you may pick up in the course of an evening's potter round.

Right low down on the fringe of the usual broadcasting band in the section between 170 and 190 metres, there are carrier waves to be found and with a little patience and care some of these may be resolved into fitful transmissions of gramophone records. Try around 175 metres on Sunday mornings at 10 a.m. G.M.T., and you may hear the call given out between items by the Radio Club de Cannes, on the (sometimes!) sunny French Riviera. Although the transmitter is but a small one, the announcement takes on much greater importance, namely: *Ici F8FY (Ef-wheat-eff-ee-greck) le Poste de Radiodiffusion du Radio Club de Cannes, Cote d'Azur*. The broadcast consists of musical and vocal turns provided by red-hot fans or by gramophone records.

Somewhat higher up on 187 metres, almost daily, there is a transmission to be found; it emanates from Lille, not the PTT du Nord station, but from F8BC, a small private studio styling itself *Radio Flandres*. Towards 7 p.m. is the time it comes on the air and during some sixty minutes announcements are regularly put out giving the name of the firm responsible and the address from which the broadcast is made.

Again from Tourcoing (France), three times weekly, in the later evening hours, the Radio Club of that city transmits a concert on 195 metres with a power of some 200 watts in the aerial. The call letters are F8BH (*Eff-wheat bay-ash*), followed by the words: *Emission de la Societe Radio Tourcoing*.

Bigger Fish

Now, searching around as you may do now and again, you will land bigger fish, and there is small doubt that as you approach the broadcast band you will log immediately below Leeds, the small Swedish relay, Karlskrona, followed by other Swedes, Jonköping, Kristinehamn, and Gävle, immediately above the English station. Higher again, and just below Fécamp, of which I wrote last week, you should succeed in picking up a French talk, mainly on wine, emanating from Béziers. Herault, a private transmitter roughly 590 miles from London. If the name is heard, it will bear the sound "Bay-zee-aye," and a metronome is used in intervals of the programme. On some evenings it carries out a relay of the Radio Toulouse entertainments, on others it supplies dance

(Continued on page 424)

H & B

Sold over 300 Kits
for the 1929
CLARION THREE

Here is the
H. & B. 1930 SPECIAL KIT

Contains Components of the Highest
Quality Only. Resiston Panel, Telsen
7-1 1930 Transformer, etc.

	£	s.	d.
1 Ebonite panel and strips (Resiston) ...	7	6	
2 Variable condensers, .0005, and dials (G.F.) ...	9	6	
1 Reaction condenser, .0001 (H. & B.) ...	2	6	
1 Pair Clarion 3 coils (Tunewell) ...	1	10	
1 15-ohm rheostat (Wearite) ...	1	6	
1 Single-pole switch, No. 7 (Lotus) ...	3	3	
1 Pair panel brackets (H. & B.) ...	1	3	
3 Valve holders (W.B.) ...	3	9	
1 H.F. choke (Dubilier) ...	4	6	
1 .0001 fixed condenser (Graham-Farish) ...	1	0	
1 .0002 fixed condenser (Graham-Farish) ...	1	0	
1 .0003 fixed condenser (Graham-Farish) ...	1	0	
1 Series clip ...		6	
1 2-megohm grid-leak (Graham-Farish) ...	1	0	
1 100,000 resistance and holder (Graham-Farish) ...	1	6	
1 1-mfd. fixed condenser (Dubilier) ...	2	6	
1 2-mfd. fixed condenser (Dubilier) ...	3	6	
1 Telsen 7-1 Super Transformer ...	17	6	
1 Screen, 10 in. by 6 in. (H. & B.) ...	2	0	
6 Named terminals (Belling-Lee) ...	2	3	
1 Pre-set .0003 (Formo) ...	2	0	
1 1½-volt-cell (Siemens) ...		9	
8 Marked wander plugs (Belling-Lee) ...	2	6	
2 Dial indicators (Belgin) ...		4	

Cash Price **£4 14 1**

Included in this kit is a Full-size Blueprint, Baseboard, Wire, Screws, and the Panel is Drilled Ready for you.

WE ARE CONFIDENT THAT THIS H. & B. KIT IS THE FINEST OBTAINABLE AT ANY PRICE.

With the Telsen 7-1 Super Transformer, this set will give 50 per cent. greater volume. Will send this kit anywhere on approval against cash. Any parts sold separately.

Mullard, Cossor, or Marconi Valves £2 5 0 extra.
Hand-polished Cabinet ... 17 6 extra.
Clarion Three, ready built and tested, together with three Mullard Valves. Royalty paid £8 15 0

CABINETS! CABINETS! CABINETS!

Music Leader Cabinets, as specified, with Frame Aerial and Speaker Frame. Cash price, 35/-
Chummy Four 1929 Model Cabinets ... 35/-
H. & B. special hand-polished Cone Loud-speaker Cabinets, suitable for any cone up to 15 in. and not more than 10 in. deep.
Oak, 17/-; Mahogany, £1.

OAK AMERICAN TYPE CABINETS

18 in. by 7 in. panel, 10 in. deep ... 18/6
16 in. by 8 in. panel, 10 in. deep ... 17/-
14 in. by 7 in. panel, 9 in. deep ... 14/-
Any size made to order.

Special Line Western Electric Headphones, light weight, guaranteed new and perfect, 7/6 pair.
Brookman's By-pass Units, constructed exactly as per "A.W." specification, in Oak Cabinet, 19/6.
Screens for Everybody's Three, Brookman's Three, Push-pull Three, Clarion Three, Best-by-ballot Three, supplied with Earthing Terminals, packed ready for dispatch, 2/- each, post free

H. & B. 1930 CATALOGUE NOW READY, price 9d. Refund on First Order over 5/-.

H. & B. can supply complete Kits of Components for any Sets described in any radio journals.

Carriage Paid on all Cash Orders. C.O.D. Charges Paid on all Orders over £1.

H. & B. RADIO Co.
34, 36, 38, Beak St., Regent St.
LONDON, W.1

Gerrard 2834.

The CLEVEREST way to house YOUR SET! SPEAKER and BATTERIES



NOTE.—Improved Baffle and Sound Chamber. Used for "B.F. Five," "Electric Two."

For ALL Sets or Radio-Gram

The sort that people desire to possess and keep: Graceful design—sound construction—hand french-polished (piano finish), snug, compact, adding to the life of your set.

Over 3,000 delighted clients.

(Used by Radio Press—ly W. James, Percy Harris, etc.)

For your OWN set!

"Radiola" de luxe, from £5 5 0 to £11 11 0
"Popular" Oak Model, from £3 15 0

Cash or easy payments.

Sent ON APPROVAL—direct from the makers. If you wish to part with it we will willingly Refund FULL MONEY. Photographs and full particulars FREE!

PICKETT'S, Radio Furniture Makers, (A.M.) Works, Bexleyheath, KENT.
Established at the beginning of Broadcasting

DAILY MAIL WAVETRAP

PRODUCED by the Specialists in Selectivity. Exactly to Daily Mail Specification. Consists of an improved coil, with terminal connections, Bakelised former, silk-covered wire, and a "Sovereign" Type J Compression-type Condenser. Sold complete with straightforward diagram and wiring plan. From all Radio shops. If your dealer cannot supply "Sovereign" parts, do not accept substitutes.

4/-

"Sovereign" are "Always Better."

The Sovereign Compression-Type Condenser is made in three capacities. Type F1, .0001 mfd. Type G2, .001 mfd. Type J3, .0003 mfd. Price, 2/- From all dealers.



Produced by J.R. WIRELESS CO.
6-8, Rosebery Avenue, London, E.C.1

The Secret of its POWERFUL GRIP.



The Powerful grip of the Belling-Lee Wander Plug and its adaptability to any size battery socket are due to the long prongs made of special spring metal.

15 Engravings, side entry. Wire, rubber and braiding firmly gripped.

Ask your dealer, or send to us, for FREE Belling-Lee Handbook "Radio Connections."

Price 4d.

7-ray Battery Cord with Belling-Lee Wander Plugs and Spade Terminals for Orgola and other sets 5/9

BELLING-LEE FOR EVERY RADIO CONNECTION

Advt. of Belling & Lee, Ltd., Queensway Works, Ponders End, Middlesex

Let "Amateur Wireless" solve your problems

FULL-SIZE BLUEPRINTS

When ordering, please send Postal Order, NOT STAMPS

CRYSTAL SETS (6d. each)

B.B.C. Brookman's Park Set AW206
Regional Crystal Set WM177

ONE-VALVE SETS (1s. each)

B.B.C. Official One AW208
Reinartz One WM127
A.1 WM153

TWO-VALVE SETS (1s. each)

Loud-speaker America Two AW190
Talisman Two (D, Trans) AW194
Hyper-selective Two (D, Trans) AW198
Pentector Two (P. det, RC) AW213
British Broadcast Two (D, Trans) AW215
Clipper Two (D, Trans) WM135
Ether Ranger (D, Trans) WM156
Brookman's Two (D, Trans) WM168
A.C. Two (D, Trans) WM175
Programme Two (D, Trans) WM177
New Crusader (D, Trans) WM182

THREE-VALVE SETS (1s. each)

Broadcast Three (SG, D, Trans) AW192
All-wave High-mag. Three (D, 2 Trans) AW199
Knife-edge Three (D, RC, Trans) AW201
Talisman Two-three (D, RC, Trans) AW203A
Wide World short-wave Three (HF, D, Trans) AW207
Everybody's Three (SG, D, Trans) AW209
1930 Ether Searcher (SG, D, Trans) AW211
New All-Britain Three (HF, D, Trans) AW214
Best-by-Ballot Three (SG, D, Trans) Price 4d. free with copy of "AW" AW217
Brookman's By-pass Three (D, 2 Trans) AW220
Everybody's all-electric Three (SG, D, Trans) AW221
A.C. AW223
1930 Clarion Three (SG, D, Trans) AW223
Standard Coil Three (HF, D, Trans) WM117
Lodestone Three (HF, D, Trans) WM120
At Home Three (D, 2RC) WM141
Short-wave Link (D, RC, Trans) WM142
Binovave S.G. Three (SG, D, Trans) WM152
Fanfare (D, 2 Trans) WM157
Brookman's Three (SG, D, Trans) WM161
Community Three (D, RC, Trans) WM164
New Q3 (SG, D, Pentode) WM167
Brookman's Push-Pull Three (HF, D, Trans) 1/6 WM170
Celerity Three (SG, D, Trans) WM173
All-nations Three (D, 2 Trans) WM178
Inceptordyne (SG, D, Pentode) WM179
Brookman's A.C. Three (SG, D, Trans) 1/6 WM184

FOUR-VALVE SETS (1s. 6d. each)

Clarion All-electric Three (SG, D, Trans)—A.C. Rectifier AW200
Music-Lover's Gramo-radio (SG, D, RC, Trans)—1s. 6d. AW202A
Music-Lover's Gramo-radio (Loud-speaker)—1s. AW202B
Standard-coil Four (HF, D, 2RC) WM122
Dominions Four (2SG, D, Trans) WM134
Short-wave Adaptor for Dominions Four WM140
Music Player (HF, D, RC, Trans) WM144
Arrow (SG, HF, D, Trans) WM154
1930 Monodial (2SG, D, Trans) WM158
Electric Four (All A.C.—SG, D, RC, Trans) WM162
Outpost Four (SG, D, 2 Trans) WM165
Brookman's Four (2SG, D, Trans) WM174
Transportable Four (SG, D, 2 RC) WM180

FIVE-VALVE SETS (1s. 6d. each)

All-wave Lodestone Five (HF, D, RC, Push-pull) WM146
1930 Five (2HF, D, RC, Trans) WM171
Dual-screen Five (2SG, D, RC, Trans) WM185

AMPLIFIERS (1s. each)

A.W. Gramophone Amplifier AW205
Beginner's Amplifier (iv.) 9d. AW210
Brookman's Separator (HF Unit) AW212
Two-valve Amplifier AW216
"Mag" Gramo Unit AW224
Signal Booster (HF Unit) WM128
Concentrator H.F. Unit WM169
Radio-Record Amplifier (DC Mains) WM183

MISCELLANEOUS (1s. each)

Short-wave Adaptor (1 v.) AW183
High-tension Battery Charger AW191
Simplest H.T. Unit AW197
By-pass Unit (Wavetrap) AW218
Home-constructors' Loud-speaker (pleated paper) AW219
"Twin"—Brookman's By-pass (6d.) AW 222
H.T. Unit for A.C. Mains WM125
Lodestone Loud-speaker WM126
James H.T. Unit for D.C. Mains WM133
Two Ampere Low-tension Unit WM147
A.C. Mains Amplifier WM149
A.C. Mains Unit for All-wave Lodestone Five WM151
H.T. Unit for A.C. Mains WM159
"W.M." Linen-diaphragm WM172
Trimmer (Selectivity Unit) (6d.) WM181
Brookman's "Wipe-outs" WM186

PORTABLE SETS

Arcadian Portable (SG, D, 2 Trans) with Linen-diaphragm Loud-speaker (half-scale) AW177 1/6
Holiday Portable Three (D, RC, Trans) AW188 1/-
Music Leader (SG, D, RC, Trans) with copy "AW" AW203 -/4
Wayfarer Portable (Super Het) WM139 1/6

Copies of the "Wireless Magazine" and of "Amateur Wireless" containing descriptions of any of these sets can be obtained at Is. 3d. and 4d. respectively, post free. Index letters "A.W." refer to "Amateur Wireless" sets and "W.M." to "Wireless Magazine" sets.

AMATEUR WIRELESS 58-61 FETTER LANE LONDON, E.C.4

Please Mention "A.W." When Corresponding with Advertisers

ELECTRADIX

BIG BARGAINS

ANOTHER LARGE QUANTITY OF SNIPS FOR KEEN BUYERS.

Just in from Fellows Liquidation: SURPLUS

Royal, Efesca, Ediswan G.E.C. and Air Force 2-3-4- and 5-valve Receivers, Eliminators, Chargers, Portable Sets and Cabinets, Accumulators, Coils, Aerial wire, etc. Mains Transformers and Rectifiers. Public Address Mikes and Speaker Units. Valve Test Panels, Meters and Meggers, D.C.—A.C. Motor Generators.

SPECIAL SALE LIST ADDITION IN PRINT
Send addressed envelope if you cannot call.

PROMPT DESPATCH OF GOODS EVERYWHERE

ELECTRADIX RADIOS
218 Upper Thames St., E.C.4
St. Paul's & Blackfriars Stm. 'Phone: City 0191

A NEW BOON TO HOME CONSTRUCTORS

The **"KONECTERKIT"**

At last! What every constructor has waited for—all necessary connecting wire, flex, screws, etc.—everything for wiring up your new receiver. Supplied in neat carton container. Various sizes for all circuits from..... **2/3**

SPECIAL KONECTERKIT NO. 4.

FOR **1930 CLARION THREE**

containing 6 wander plugs, 24 ft. Keystone Connecting Wire, 24 1" x 3 Csk Brass Wood Screws, 12 3" x 4 Csk Brass Wood Screws, 6 6BA x 5/8" Csk Brass Screws and nuts, 3 ft. Rubber covered flex, 4yds. **5/-** Red and Black flex. PRICE

Order now. Full details on application to:

THE BRITISH RADIO GRAMOPHONE CO., LTD., 77 City Road, London, E.C.1

WIRELESS MAGAZINE

The Big British Wireless Monthly

1/-

BROADCAST TELEPHONY

Broadcasting stations classified by country and in order of wavelengths. For the purpose of better comparison, the power indicated is *aerial energy*.

Metres	Kilo-cycles	Station and Call Sign	Power (Kw.)	Metres	Kilo-cycles	Station and Call Sign	Power (Kw.)	Metres	Kilo-cycles	Station and Call Sign	Power (Kw.)
GREAT BRITAIN											
25.53	11,751	Chelmsford (5SW)	15.0	255	1,175	Toulouse (PTT)	1.5	*441	680	Rome (Roma)	50.0
*200	1,500	Leeds (2LS)	0.13	265	1,132.2	Lille (PTT)	0.7	453	662	Bolzano (IBZ)	0.3
*242	1,248	Belfast (2BE)	1.0	268	1,121	Strasbourg	0.5	*501	599	Milan (Milano)	7.0
261	1,143	London (2)	30.0	*272	1,102	Rennes (PTT)	0.5	LATVIA			
*288.5	1,040	Newcastle (5NO)	1.0	284	1,049	Radio Lyons	0.5	172	Riga		7.0
288.5	1,040	Swansea (5SX)	0.13	*285	1,049	Montpellier	0.3	LITHUANIA			
288.5	1,040	Stoke-on-Trent (6ST)	0.13	293	1,022	Limoges (PTT)	0.5	155	Kovno		7.0
288.5	1,040	Sheffield (6LF)	0.13	*304	986	Bordeaux (PTT)	1.0	NORTH AFRICA			
288.5	1,040	Plymouth (5PY)	0.13	307.0	975	Radio Vitus	1.0	364	824	Algiers (PTT)	13.0
288.5	1,040	Liverpool (6LV)	0.13	311	964.5	Agen	0.25	412	727	Radio Maroc (Rabat)	10.0
288.5	1,040	Hull (6KH)	0.13	*316	950	Marseilles (PTT)	0.5	NORWAY			
288.5	1,040	Edinburgh (2EH)	0.35	329	914	Grenoble (PTT)	0.5	824	Bergen		1.0
288.5	1,040	Dundee (2DE)	0.13	331.1	905	Poste Parisien	0.5	385	779	Frederiksstad	0.7
288.5	1,040	Bournemouth (6BM)	1.0	363	815	Radio LL (Paris)	0.5	445	674	Rjukan	0.18
288.5	1,040	Bradford (2LS)	0.13	*381	788	Radio Toulouse	8.0	453	662	Tromsø	0.1
*301	995	Aberdeen (2BD)	1.0	447	671	Paris (Ecole Sup. PTT)	3.0	453	662	Aalesund	0.3
*310	968	Cardiff (5WA)	1.0	468	640	Lyons (PTT)	5.0	453	662	Porsgrund	0.7
356	842	London Regional	30.0	1,444	207.5	Eiffel Tower	12.0	*403	608	Oslo	60.0
*377	797	Manchester (2ZY)	1.0	*1,725	174	Radio Paris	12.0	POLAND			
*393	753	Glasgow (5SC)	1.0	*218	1,373	Flensburg	0.5	214	1,400	Warsaw (2)	1.0
*479	626	Daventry (5GB)	25.0	*227	1,379	Cologne	4.0	234	1,233	Lodz	0.5
1,554	193	Daventry (5XX)	25.0	231	1,283	Münster	3.0	*313	959	Cracow	0.5
AUSTRIA											
*244	1,220	Linz	0.5	239	1,256	Nürnberg	2.0	385	779	Wilno	0.5
*283	1,058	Innsbruck	0.5	246	1,220	Cassel	0.25	383	779	Lemberg	0.5
*352	851	Graz	7.0	*247	1,215	Kiel	0.35	*405	734	Katowitz	10.0
*453	666	Klagenfurt	0.5	253	1,184	Gleitwitz	2.0	1,411	212.5	Warsaw	8.0
*517	587	Vienna	15.0	*259	1,157	Leipzig	1.5	ROUMANIA			
BELGIUM											
206	1,466	Antwerp	0.4	*270	1,112	Kaiserslautern	0.25	*04	61	Bucarest	12.0
210	1,391	Verriers	0.25	*276	1,085	Königsberg	2.5	824	364	Moscow (PTT)	20.0
210	1,364	Charleroy (LL)	0.25	*283	1,058	Magdeburg	0.5	938	320	Moscow (C.C.S.P.)	10.0
*33	1,256	Binche	0.25	*283	1,058	Berlin (E.)	0.5	1,000	300	Leningrad	20.0
244.7	1,226	Ghent	0.25	*315.8	951	Bremen	0.35	1,058	284	Tiflis	10.0
246	1,221	Schaerbeek	0.25	*320	937.6	Dresden	0.25	1,100	272	Moscow Popoff	40.0
*914	1,029	Liège	0.1	*325	923	Breslau	1.5	*1,304	230	Kharkov	25.0
337.4	869.2	Velthem	8.0	*360	833	Stuttgart	1.5	1,380	217.5	Rakou	10.0
*503	590	Brussels	1.0	*372	806	Hamburg	1.5	1,481	202.5	Moscow (Kom)	40.0
CZECHOSLOVAKIA											
*203	1,139	Moravská Ostrava	10.0	*390	770	Frankfurt	1.5	RUSSIA			
*279	1,076	Bratislava	12.5	*418	716	Berlin	1.5	208	1,727	Barcelona (EAJ13)	10.0
*293	1,022	Kosice	2.0	*453	662	Danzig	0.25	*343	860	Barcelona (EAJ1)	8.0
*342	873	Brno (Brno)	2.4	*456	657	Aachen	0.35	308	815	Seville (EAJ5)	1.5
*487	617	Prague (Praba)	5.0	*473	635	Langenberg	13.0	426	703	Madrid (EAJ7)	2.0
DENMARK											
*281	1,007	Copenhagen (Kjøbenhavn)	7.5	*500	536	Hanover	0.35	459	653	San Sebastian (EAJ8)	0.5
*1,153	260	Kalundborg	7.5	500	536	Augsburg	0.25	SWEDEN			
ESTONIA											
*206	1,013	Reval (Tallinn)	0.7	569	527	Freiburg	0.35	231	1,307	Malmö	0.6
FINLAND											
*221	1,355	Helsingfors	0.9	*1,635	183.5	Zeesen	30.0	*257	1,160	Hörby	10.0
*1,790	167	Lahti	40.0	1,635	183.5	Norddeich	10.0	270	1,112	Trollhättan	0.04
FRANCE											
31.03	9,479	Radio Experimental (Paris)	1.0	HOLLAND							
175	1,714	Cannes (5FY)	0.1	120	9,620	Eindhoven	30.0	297	1,020	Falun	0.5
175	1,714	S. Quentin	0.1	HUNGARY							
187	1,005	Radio Flandres	0.25	210	1,430	Budapest (Csepel)	20.0	*322	932	Göteborg	10.5
193	1,539	Tourcoing (F8BH)	0.2	550	545	Budapest	20.0	*436	689	Stockholm	1.5
210	1,413	Radio Savoie	0.3	ICELAND							
212.4	1,412	Fécamp (Radio Normande)	0.5	*1,200	250	Reykjavik	10.0	1,700	369	Ostersund	0.6
210	1,370	Beziere	0.1	IRISH FREE STATE							
215	1,274	Bordeaux (Radio Sud-Ouest)	1.0	*225	1,337	Cork (IFS)	1.0	*407	743	Berne	1.0
240	1,250	Nimes	0.25	*413	723	Dublin (2RN)	1.0	*459	657	Zurich	0.83
248	1,111	Juan-les-Pins	0.5	ITALY							
GERMANY											
214	1,030	Turin (Torino)	7.0	297	1,020	Stamboul	5.0	429	698	Belgrade	2.5
232	965	Naples (Napoli)	1.5	1,552	193.3	Angora	7.0	574.7	522	Ljubljana	2.5
235	979	Genoa (Genova)	1.0	YUGOSLAVIA							

BULGIN
RADIO PRODUCTS

A NOVEL PROTECTIVE DEVICE!

THE BULGIN "RHEOSWITCH" (TRADE MARK)

For POWER AMPLIFIERS, RADIOGRAMS, ETC.

PROTECTS VALVES, CHOKES, AND TRANSFORMERS FROM CURRENT SURGES

IT is a well-known fact that an excessive strain is thrown on certain components in all amplifiers when a large H.T. potential is switched on before the filaments. This new component saves you the trouble of thinking which. It is automatic in action and should be incorporated in powerful sets where H.T. eliminators giving high voltages are used.

PRICE 3/9 EACH

Send 2d stamps for our 56-pp. Catalogue.

A. F. BULGIN & CO.
9-10-11 CURSITOR ST., CHANCERY LANE
LONDON, E.C.4
Telephones: Holborn 1072 & 2072

RD 40 "RED DIAMOND"

2/-

THE RECOGNISED DETECTOR FOR ALL CIRCUITS USING CRYSTAL RECTIFICATION. By insured Post 2/3 or 2/6 with shield. Can be mounted on brackets or through anel. Once set always ready. Not affected by vibration. Each one is tested on broadcast before despatch, and is perfect.

"RED DIAMOND" 2-WAY COIL HOLDER

RD 32. 4/- EACH.

Parallel working. Worm driven. Coils cannot fall. Easy movement. Perfect finish. By Insured Post 4/6.

Of all high class Radio Dealers, or Sole Makers:
JEWEL PEN Co., Ltd.
(Radio Dept. 45), 21-22 Great Sutton St., LONDON, E.C.1.

CHIEF EVENTS OF THE WEEK

LONDON NATIONAL AND DAVENTRY (5XX)

Mar. 17 St. Patrick's Day programme from Belfast.
 " 18 Albert de Courville's Hour (3).
 " 19 *There's No Fool like a Young Fool*, an operetta.
 " 20 *The House Fairy*, a play by Laurence Housman.
 " 21 Symphony concert relayed from Queen's Hall.

LONDON REGIONAL

Mar. 18 International programme relayed to and from Germany and Belgium.
 " 20 *The Valley of Enchantment*, an "Interlude Protean," written for broadcasting by John Overton.
 " 21 Vaudeville programme.
 " 22 "B.B.C.—B.C.," a fantastical relay of Ancient Rome, by Graham Squiers.

MIDLAND REGIONAL

Mar. 17 *The Black Sheep*, a comedy by F. Morton Howard.
 " 18 London Regional programme.
 " 19 Programme of Old Favourites.

Mar. 20 *The Valley of Enchantment*, an "Interlude Protean," written for broadcasting by John Overton.
 " 22 "B.B.C.—B.C.," a "Fantastical Relay of Ancient Rome," by Graham Squiers.

CARDIFF

Mar. 23 *Samson and Delilah*, relayed from the City Hall, Cardiff.

GLASGOW

Mar. 17 Performance of the winning play in the annual festival, organised by the Scottish Community Drama Association.

Jazz music is not prevalent in the programme of the Columbia Chain System in America. A recent survey shows that more than 22 per cent. of the total Columbia time each week is devoted to instructional and informative broadcasting, while dance music takes up but 19.7 per cent. of the time.

OUR BLUEPRINT SERVICE

Constructors of receivers described in this journal should make full use of our Blueprint Service and avoid all risk of failure.

"MORE SMALL FRY"

(Continued from page 421)

music, but bear in mind that references to wine are the dominant factor of its broadcasts.

If you have located Flensburg—the Hamburg relay—almost in its immediate neighbourhood, some two metres below, the strains of some old favourite jazz melodies may be brought to your ears. They will come and disappear in an irritating manner, for the broadcasts from Radio Chateleineau (a suburb of Charleroi, Belgium) are usually subject to rapid fading, but the call: *Ici Radio LL, Chateleineau-Charleroi*, may be caught once or twice for it is persistently given out. Luxembourg on 223 metres you need not search for, as at present it is resting and no official intimation has been given regarding a resumption of its activities.

Finally, do not forget Radio Schaerbeek (Brussels) on about 250 metres, which turns up regularly at 8.30 p.m. nightly and remains on the air for two hours, with a later transmission on Fridays; mention must also be made of Nice-Juan-les-Pins, Nines, Ghent, and Strasbourg, of which from time to time whispers are obtained amongst their more hefty competitors.

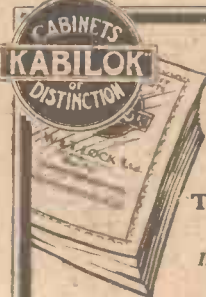

CABINETS
KABILOK
DISTINCTION

Put your trust and your set in **KABILOK**
The Cabinet of Distinction

Illustrated Catalogue Free on request

W. & T. LOCK LTD.
ST. PETER'S WORKS BATH.
LONDON: 11, Red Lion Sq., W.O.1

LINEN for Loud Speakers 46 YARD



Experts agree that Robinsons Special Linen is best for Loud-speakers. It is specially made for the purpose, is 38" wide and costs only 4/6 per yard post FREE.

Robinsons Linen Works, Ltd., 5-7, Barton Sq., MANCHESTER.



EELEX

2 DS SPADES, PINS, HOOKS & EYES
2 DP 6 Colours, 2d. each
2 DI

Write for List J 93
J. J. EASTICK & SONS,
118, Bunhill Row, London, E.C.1 2 DH

REPAIRS

Any make of L.F. Transformer, Loud-speaker or headphones repaired and dispatched within 48 HOURS—TWELVE MONTHS' GUARANTEE with each repair. 4/- Post Free.

Terms to Trade
TRANSFORMER REPAIR CO.
"Service" Dept.
214 High Street, Colliers Wood, London, S.W.19

RADIOGRAMS

THE radio industry in America has reached the stage where it now employs more than 350,000 people and represents an investment of more than £800,000,000.

Although the National Broadcasting Company in America received a gross income of £3,000,000 in 1929, all of it was devoted to service. In pointing out the growth of the organisation, Mr. Aylesworth, the president of the company stated that there is now a total of seventy-three stations affiliated with the National Broadcasting Company.

Another attempt to transmit a radio signal to the moon will be made in the near future at the United States Naval Research Laboratories of Washington, according to Dr. A. Hoyt Taylor, chief of the Radio Division. The signal is expected to be back to earth in slightly less than three seconds. To be exact, the signal should be reflected back to the laboratory in 2.8 seconds, this being the time necessary for it to travel the 250,000 miles to the moon and return at a speed of 186,000 miles a second. A high-frequency wave, probably between 20,000 and 30,000 kilocycles, will be used.

Despite the changes announced by the B.B.C. with regard to its service to Scotland, criticism seems to be no less prevalent. It is contended by some "fans" that they frequently have to give up the Glasgow programmes in disgust. As a consequence, it is no uncommon thing for the Continent to be looked upon as the usual source of wireless entertainment.

Between 4 and 4.15 a.m., if you are up betimes, you may hear the cuckoo calling to his mate; not from the woods but from Leningrad, which at that hour collects its listeners for the daily physical jerks.

During the daytime some interference is being experienced with the Glasgow broadcasting station's transmissions. The source of jamming proceeds from wireless operators of ships lying in harbour, who take the opportunity of being in port to test their transmitters and emergency apparatus. The disturbing signals spread over a wide band of wavelengths at times, and completely blot out 5SC in a certain area.

"Amateur Wireless and Radiovision." Price Threepence. Published on Thursdays and bearing the date of Saturday immediately following. Post free to any part of the world: 3 months, 4s. 6d.; 6 months, 8s. 9d.; 12 months, 17s. 6d. Postal Orders, Post Office Orders, or Cheques should be made payable to "Bernard Jones Publications, Ltd."

General Correspondence is to be brief and written on one side of the paper only. All sketches and drawings to be on separate sheets. Contributions are always welcome, will be promptly considered, and if used will be paid for. Queries should be addressed to the Editor, and the conditions printed at the head of "Our Information Bureau" should be closely observed. Communications should be addressed, according to their nature, to The Editor, The Advertisement Manager, or The Publisher, "Amateur Wireless," 58-61 Fetter Lane, London, E.C.4.

PREPAID ADVERTISEMENTS

Advertisements under this head are charged THREEPENCE PER WORD, minimum charge THREE SHILLINGS.

As the Publishers cannot accept responsibility for the bona fides of advertisers in this publication, they have introduced a system of deposit which it is recommended should be adopted by readers when dealing with persons with whom they are unacquainted. It is here explained.

Intending purchasers should forward to the Publishers the amount of the purchase money of the article advertised. This will be acknowledged to both the Depositor and the Vendor, whose names and addresses must necessarily be given. The deposit is retained until advice is received of the completion of the purchase, or of the article having been returned to and accepted by the Vendor. In addition to the amount of the Deposit, a Fee of 6d. for sums of £1 and under, and 1s. for amounts in excess of £1, to cover postage, etc., must be remitted at the same time. In cases of persons not resident within the United Kingdom, double fees are charged.

The amount of the Deposit and Fee must be remitted by Postal Order or Registered Letter (Cheques cannot be accepted), addressed to

"AMATEUR WIRELESS," ADVERTISEMENT DEPARTMENT,
58/61 FETTER LANE, LONDON, E.C.4

PATENTS.—Trade Marks, Advice Handbook free.—B. T. King, Regd. Patent Agent, 146a Queen Victoria Street, London.

GENUINE OAK SPEAKER CABINETS, 12 in. sq. 5 in. deep, 9 in. sunset fret, moulded top and base 10/6. Oak Cabinets for 15 in. x 7 in. and 16 in. x 9 in. panels and baseboard, nicely polished, hinged top, 10/6. Quotations given for your own designs. Quick dispatch. Post-1/- Cash with order, F. S. Gibson, cabinet specialist, 99 Burnley Rd., Ainsdale, Lancs.

WIRELESS and GRAMOPHONE CABINETS. Ready for assembling or assembled. Stamp for lists. D. Mendip Industries, Winscombe.

DOUBLE CHASSIS for 22 in. by 22 in. fabric speakers, strong oak, cut to exact sizes, 8 supporting brackets, tube liquid glue, drilled ready for assembling with screws provided, cannot possibly go out of shape when fabric is fixed; 6/- complete assembly; c.o.d., carriage paid; trade inquiries solicited.—W. T. Tucker, 2, Vincent Street, Moseley Road, Birmingham.

DOUBLE CONE CHASSIS (new), in oxidized copper drum, with polished fretted front, circular sealed cones, only wants hearing; sent on 7 days' approval against cash; cost 32/6, sell 13/6.—Brew, Pychley, near Kettering.

MAGIC PLUG-IN COILS.—Low loss, tested, guaranteed. 2s. 10d.; 3s. 4d. 50, 1/1; 60, 75 1/4; 100, 150 1/8; 250 2/8. CT 6d. and 1/- extra. Ultra short wave 1/9 each. Postage 3d. any quantity. Johnson, 31 Rosemead Avenue, Wembley.

BANKRUPT BARGAINS. Falco L.F. transformers 2/9. S.M. 0003 variable 3/6. B.T.H. cone units 6/6; others 4/-. Fixed 0003 and grid leak 10d. H.F. chokes 1/6. Formo-densers 1/6. H.T. units, D.C. and A.C. All mains D.C. units, EKCO £3/15/0. Bullphone B.C.C. units 3/-. Modern goods. New list free. Butlin, 143b Preston Road, Brighton

For the Best in Radio

WILL-DAY LTD.

(THE BEST IN THE WEST)
19 LISLE STREET, LEICESTER SQUARE, LONDON, W.C.2

OPEN TILL 7 P.M.
WRITE FOR OUR CATALOGUE
POSTAGE 6d. FREE TO CALLERS

EASY TERMS

We SPECIALISE in the supply of all Good Quality Radio Sets, Components and accessories on Easy Terms. We will give you efficient service. Send us your list of requirements and a quotation will be sent by return.

LONDON RADIO SUPPLY COMPANY
11, Oat Lane, Noble St., London, E.C.2
NATIONAL 1977



KAY'S CABINETS

This Cabinet soundly constructed of Oak and equipped with Baseboard Runners. Fall Front. Hinged Top. Polished rich Jacobean, 36 in. high. For panels 45/- up to 19 in. wide.

Also made to accommodate any Popular Set. Greatest Range of Wireless Cabinets Illustrated Lists Free

H. KAY, Cabinet Manufacturer,
Mount Pleasant Road, London, N.17
Phone: WALTHAMSTOW 1626

RELIABILITY
WIRELESS GUIDE N° 29C

A Complete List of all that is best in Radio at Keenest Prices! Trade Enquiries Invited.

J.H. TAYLOR & CO.
3, Radio House, MACAULAY STREET,
HUDDERSFIELD. Phone 3-1.

POST FREE ON REQUEST

Amateur Wireless **COUPON**
Available until Saturday
MARCH 22, 1930

BEWARE of IMITATIONS

There is

ONLY ONE "FORMO-DENSOR"

See NAME on ARTICLE and CARTON NONE OTHERWISE IS GENUINE

Obtainable in FOUR SIZES



- F. Max. '0001 2/-
Min. '00005
- J. Max. '0933 2/-
Min. '000025
- G. Max. '001 2/-
Min. '0302
- H. Max. '002 3/-
Min. '001

BE WISE!

Refuse Substitutes and thus avoid Disappointing Results.

Full Catalogue sent post free on receipt of post card.

The FORMO Co., Crown Works, Cricklewood Lane, N.W.

How to—

- Build a Set
- Take Care of Batteries
- Choose a Set
- Connect Accessories
- Erect an Aerial
- Select Valves
- Pick a Loud-speaker
- Tune a Receiver
- Use Electric Mains

These illustrated articles, written by men of wide experience, will be of infinite value to you, whether you be a beginner or an advanced craftsman.

Together with 42 other features they form part of the splendid contents list of the March

WIRELESS MAGAZINE

Now on Sale, 1/- Get a copy To-day



THE NEW COLLOIDAL VALVE with the Highest Efficiency Factor yet obtained

- H.F. and General Purpose 6/-
 - Super Power 7/-
- Shortly available: Vatea Colloidal Screen Grid, Pentode and A.C. Mains Valves.

Ask your local dealer for full particulars

ABBEY RADIO, 47, Victoria Street, Westminster, London, S.W.1
Telephone: Victoria 3914

DANCE AWAY THE NIGHT



The Lewcos L.F. Transformer specified as an alternative for the "1930 Clarion Three," described in this issue. Full particulars on request.

"Gee! that's fine!"
Listen. You can hear every note, and the volume is magnificent. That band might be in this very room."

And *that's* what Lewcos components do for your set. It would be no exaggeration to say they are the life and soul of any receiver. A "Lewcos enthusiast" writes:—

"They (Lewcos components) are more than you claim in your advertisements. I have spent any amount of money on coils experimenting on different circuits, but the set incorporating your two coils has never been dismantled. I use this set as my 'standard' when testing other circuits: it still holds pride of place."

The Lewcos H.F. Choke and L.F. Transformer, as illustrated "hold pride of place" for their extraordinary capacity.



The Lewcos H.F. Choke is specified for the "1930 Clarion Three," described in this issue. Write for leaflet Ref. R.33.



LEWCOS

RADIO PRODUCTS FOR BETTER RECEPTION



THE LONDON ELECTRIC WIRE COMPANY AND SMITHS LIMITED.
CHURCH ROAD LEYTON, LONDON, E. 10.
TRADE COUNTER: 7 PLAYHOUSE YARD, GOLDEN LANE, E. C. 1.