

WE GIVE AWAY NOVEL STATION FINDER

# Amateur Wireless

and  
Radiovision

SIXTY <sup>3</sup>d.  
PAGES

Vol. XIII. No. 333

Saturday, October 27, 1928

WITH **FREE** AUTOMATIC  
STATION  
FINDER



*A Practical Help to Every Listener*

# RADIO FOR THE MILLION

**Realistic reception of the World's best Programmes**

- ★Simplicity of design — you can build a Mullard Master 3★ in an hour.
- ★Simplicity of operation—one dial tuning.
- ★Simplicity of wavelength range—no coil changing.
- ★Sensitivity giving a wonderful choice of programmes.
- ★Selectivity of the highest order consistent with quality.
- ★ Volume—the greatest obtainable from three valves.
- ★Quality—to please the most discriminating.

Send for your free copy of "Radio for the Million." It contains scores of hints and tips which will help you to enjoy better radio. You will receive, too, Free Plans of Assembly and full instructions for building the new Mullard Master 3★—the ideal all-purpose receiver; the Mullard Master 5—a remarkable self-contained portable with one dial tuning and dual wave-length range; and the Mullard H.F. Unit.

Even if you are not at present in need of a new receiver you should keep abreast of modern radio developments by reading "Radio for the Million."

Your copy awaits you—post the coupon now.

*The New*  
**Mullard Master 3★**



**Cut here and post to-day** To the Publishers, 'Radio for the Million,' 63 Lincoln's Inn Fields W.C.2. Please send me FREE Simplified Plan of Assembly of the New Mullard Master 3★ with Vol. 2, No. 4 of 'RADIO FOR THE MILLION.'

Name \_\_\_\_\_  
(BLOCK LETTERS)  
Address \_\_\_\_\_

A. IV.

Mention of "Amateur Wireless" to Advertisers will Ensure Prompt Attention

# The Surest Links between Mains & Receiver

Philips Units exceed expectation. They are a sound investment. They save the money and provide a consistent and continuous supply of current to your set. Philips Units will be as efficient after years of hard work as they are when you first install them.

**PHILIPS BATTERY CHARGER 450**

Charges from 1 to 3 cells (2.6 volts) at 1.3 amps. The rectification is full wave and the current is automatically regulated. Complete with valve. Price **£3 - 10**



TYPE 450

**PHILIPS BATTERY CHARGER 1009**

For H.T. Accumulators and L.T. Accumulators. Charges any number of cells up to 60, the charging current varying between 60 and 90 mA. The rate for L.T. Accumulators of from 1 to 6 cells is 1.3 amps. Complete with valve, resistance lamp, and plug. Price **£5-10**

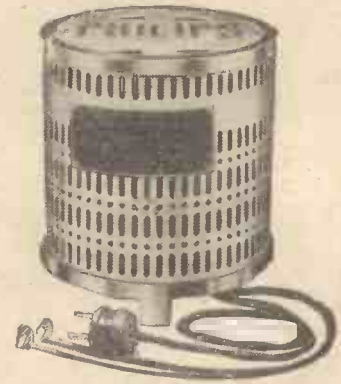

TYPE 1009



TYPE 1017

**PHILIPS TRICKLE CHARGER 1017**

Has a special switch which makes the operation of the charger and receiving set entirely automatic. Charges one cell at approximately 195 mA., 2 cells at 170 mA., or 3 cells at 150 mA. Complete with valve. Price **55/-**

**PHILIPS H.T. SUPPLY UNIT 3003**  
(For A.C. MAINS)

For H.T. and Grid Bias supply. Similar in design to type 3002, with the addition of 3 different variable tappings giving voltages between 0 and 40 Grid Bias. Complete with valves. Price **£8 - 15**

**PHILIPS H.T. SUPPLY UNIT 3002**  
(For A.C. MAINS)

In this model tappings are furnished for 6 different positive anode voltages. The current supply is 30 mA. at 150 volts and 50 mA. at 120 volts. Complete with valve. Price **£7**

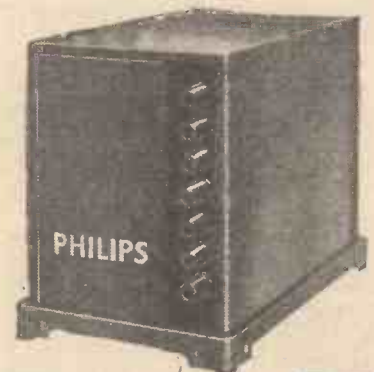

TYPE 3002



TYPE 3003

Write for Leaflets

From all Dealers

# PHILIPS for Radio

PHILIPS LAMPS LTD., Philips House, 145 Charing Cross Road, LONDON, W.C.2

Advertisers Like to Know That You Saw it in "A.W."

# Convert your "Master 3" into a Dual Range Set!



## LEWCOS REGD. "QAM" COIL

PRICE **21/-** RETAIL

The LEWCOS "QAM" Coil covers the 250/550 m. and 1,000/2,000 m. ranges by merely moving the switch holder provided with every coil

Can be fitted to your set in a few minutes.

*Write for full particulars.*

THE LONDON ELECTRIC  
WIRE COMPANY  
AND SMITHS LIMITED  
Church Road, Leyton,  
London, E.10

TRADE, COUNTER AND  
CABLE SALES, 7 Play-  
house Yard, Golden Lane,  
E.C.1

Phone : Walthamstow 2531  
Grams : "Lewcos, Phone, London"



Advertisers Appreciate Mention of "A.W." with Your Order

## HELLESEN DRY BATTERIES



### HELLESENS AT THE CLUB

At the Radio Club last night a debate was held. Subject: "The most satisfactory form of H.T. supply." Despite certain wise-  
acres the Dry H.T. Battery scored an overwhelming victory at the showing. On discussion afterwards it appeared that the great majority of the Battery users swore by Hellesens. Hellesen Batteries have, of course, been famous in this country for over 27 years, and they set the standard by which all other Dry Batteries are judged, so that explains why I found so many other members of my way of thinking.

1928 Reduced Prices  
Standard Capacity.

"Wiray" 9-volt Grid Bias Type	2/-
"Wirin" 60-volt H.T. Type	10/6
"Wirup" 90-volt H.T. Type	18/-
"Wisol" 108-volt H.T. Type	20/-
Triple Capacity.	
"Kolin" 60-volt H.T. Type	19/-
"Kolup" 90-volt H.T. Type	32/6

Your Dealer Sells Them.

Supreme for 27 Years.

## HUNT'S

HELLESEN DRY BATTERIES · INSTRUMENTS  
POLYMET. MICA & PAPER CONDENSERS  
HAND & CYCLE LAMPS, TORCHES, ETC.

A. H. HUNT, LTD, CROYDON, SURREY.

Build a



Completely

### "SCREENED-GRID THREE"

An amazingly simple set to construct and handle.

### NO COIL CHANGING

From HIGH to LOW WAVE and vice versa with ONE PUSH-PULL SWITCH.

One switch only operates Aerial Coil and the Coil in the Plate circuit of the S.G. Valve.

### NO WIRELESS KNOWLEDGE NECESSARY

### You can BUILD and OPERATE this set in ONE EVENING

Your dealer can supply a complete Set of Components including a most ELEGANT ALL-METAL CABINET, PRINTED BASEBOARD and all wires CUT TO SIZE and LOOPED.

### THE COST is a revelation

Send Postcard for FREE COPY

### "THE FORMO SCREENED-GRID THREE"

THE FORMO CO., CROWN WORKS,  
CRICKLEWOOD LANE, N.W.2

# WHY WORRY WITH BATTERIES?



Model "B"  
L.T., H.T. & G.B.  
Eliminator.

By substituting Cosmos A.C. Valves for your existing valves the new Met-Vick Model 'B' Eliminator enables you to dispense with batteries altogether, and operate straight off your Electric Supply.

Connected to a wall plug or lamp socket, the model "B" will provide you with heater current for your A.C. valve filaments, 5 tappings for the high tension supply to your valves, and automatically regulated grid bias taps for your last stage.

Model "B" Eliminators can also be obtained for supplying H.T. and G.B. only.

<p>L.T., H.T. &amp; G.B. <b>£8 : 0 : 0</b> A special model for 25 periods is supplied at £10 0 0 List M.S.4745.</p>	<p>Prices of 'Met-Vick' Model 'B' Eliminators for providing 180 Volts on the last valve. Complete with S.P. 41/U rectifying valves. 100-110 volts or 200-250 volts, 40-100 periods.</p>	<p>H.T. &amp; G.B. <b>£7 : 7 : 0</b> A special model for 25 periods is supplied at £9 5 0 List M.S.4746.</p>
---	---	--

These eliminators are eminently suitable for the operation of the Met-Vick A.N.P. receivers described in leaflets S.P. 7117/2 and S.P. 7117/4 and for 3 and 4 valve receivers listed in leaflet M.S. 4742.

## MET-VICK ELIMINATORS

See us at  
**STAND**  
**No. 30**  
Manchester  
Radio  
Exhibition

Other types of Met-Vick Eliminators for A.C. and D.C. circuits are briefly referred to below and the corresponding leaflet numbers given.

Ask your own dealer for copies, or write direct to

**Metro-Vick Supplies Ltd., 155 Charing Cross Road, London, W.C.2**



Mention of "Amateur Wireless" to Advertisers will Ensure Promot Attention

# IGRANIC

## 9 Components

specified by **SIX-SIXTY**  
for the famous  
**MYSTERY RECEIVER**

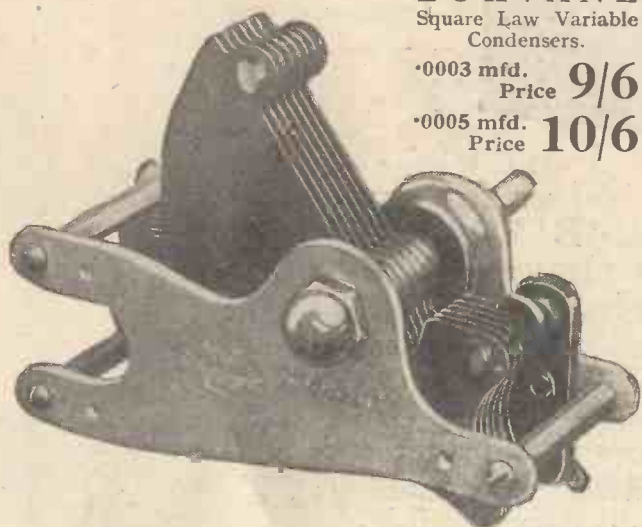

**LOKVANE**  
Square Law Variable  
Condensers.

•0003 mfd. Price **9/6**

•0005 mfd. Price **10/6**

- |  |     |       |
|--|-----|-------|
| Also                                       |     | Price |
| Indigraph Slow Motion Dials                | - - | 6/-   |
| Indigraph 2 in. Dial                       | - - | 1/6   |
| Rheostat, 50 ohms                          | - - | 2/6   |
| Neutralising Condenser<br>(Baseboard Type) |     | 4/-   |
| Single Filament Lighting Jack              |     | 3/9   |

Igranic can supply your every Radio need. Send for illustrated catalogue — post free.

### Have you read "RADIO

—How it works and how to get the best from it"?—price 6d. Send this coupon with your name and address and get your copy free.



149, Queen Victoria St.,  
LONDON, E.C.4.

Works: BEDFORD.

Please send me entirely free "Radio—How it works and how to get the best from it."  
Name \_\_\_\_\_  
Address \_\_\_\_\_  
Dept. A.W.

## Study these New **WHITELEY-BONEHAM** achievements

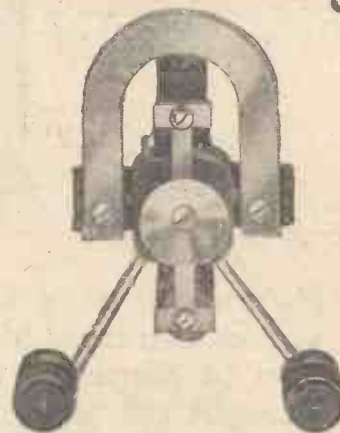

### A WONDERFUL CONE UNIT for the constructor

A new and remarkable Cone Unit marketed in response to a popular demand. Is entirely British made, and incorporates a Vickers-Armstrong Cobalt Steel magnet. Price, complete with 2 Belling-Lee insulated terminals, 18/6

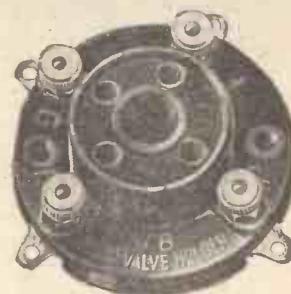

### The New **W.B.-RIGID VALVE HOLDER** a triumph in design

The latest W.B. achievement. Unique design in that there is continuous spring contact along the valve legs. Ideal for any receiver where space is a consideration. Price, 1/-, complete with terminals, 9d. without terminals.

**WHITELEY, BONEHAM & Co., Ltd.**  
NOTTINGHAM ROAD, MANSFIELD, NOTTS

# 3 of the new DUBILIER COMPONENTS

**MIDGET CONDENSER.**  
 This small variable Condenser is designed for panel mounting and is particularly suitable for use as a reaction condenser; or it may be employed when a neutralising condenser of large capacity is required.  
 Complete with knob .0001 or .0002, **5/6**

**H. F. CHOKE.**  
 To meet the need for a really efficient high frequency choke Dubilier have produced this well-designed component. The windings are protected by a moulded case, its appearance is neat, and not the least attractive feature is its low price. Four models to meet all uses, each **4/6**

**COMBINED R.C. COUPLING UNIT AND VALVE HOLDER.**  
 This component effects economy of space at no expense of efficiency. And it is worth noting that the valve-holder may be used for the valve which either precedes or follows the unit. Otherwise this component resembles the Dubilier Unit without Valve-Holder. **8/6**  
 Complete with 2 Dumetohms which are detachable

We are exhibiting at the  
**MANCHESTER RADIO EXHIBITION**  
 Oct. 22—Nov. 3

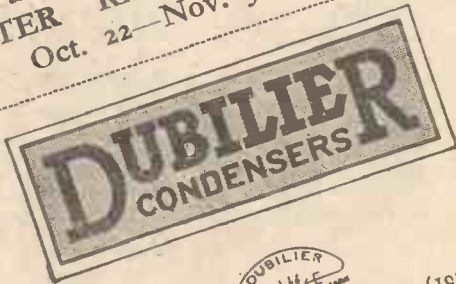

**DUBILIER**  
 Advt. of Dubilier Condenser Co. (1925) Ltd.  
 Ducon Works, North Acton, W.3

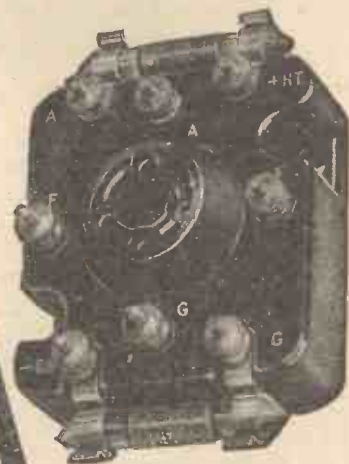

174A

Mention of "Amateur Wireless" to Advertisers will Ensure Prompt Attention



# "TENACIOUS COATING"

the secret of purity and maximum power throughout an abnormally long life.



### BADLY COATED FILAMENT

Reproduction from an untouched microphotograph of part of the filament of a badly coated valve before use, showing a serious gap in the coating. A gap such as this starts the valve off in its life with a poor performance, and may bring about a further portion of the coating falling away or peeling off. The valve then prematurely fails.



### OSRAM FILAMENT WITH "TENACIOUS COATING"

This untouched reproduction shows the coating typical of all OSRAM VALVES. Notice the absolute evenness of the coating. There are no gaps, the coating clings, so that the full benefit of the coating is maintained. The secret is the startling new discovery of the scientific process of "TENACIOUS COATING."

The life of a coated filament Valve depends upon an unceasing supply of the necessary electrons. These electrons are obtained from the coating. If the coating flakes or wears off the Valve becomes useless.

In the latest improved OSRAM VALVES with the "TENACIOUS COATING" the secret process chemically ensures that the coating is held firmly on to the filament core, not merely for one month, or even six months, but throughout an exceptionally long life.

## CHANGE

to the latest improved

# Osram Valves

and

## CHANGE for the Better!

**WRITE** for Booklet "OSRAM WIRELESS GUIDE" giving full particulars of "TENACIOUS COATING" and full range of OSRAM VALVES for 2v., 4v. and 6v. users, and users with A.C. Electricity Supply. Also helpful wireless information of importance to every listener. Sent **POST FREE** on request to THE GENERAL ELECTRIC CO., LTD., Publicity Organisation, Magnet House, Kingsway, London, W.C.2. Copies also obtainable from your local Wireless dealer.

Scientifically made by Experts in England. Sold by all Wireless Dealers.

Advt. of The General Electric Co., Ltd., Magnet House, Kingsway, London, W.C.2.

Advertisers Appreciate Mention of "A.W." with Your Order



# Amateur Wireless and Radiovision

The Leading Radio Weekly for the Constructor, Listener and Experimenter

— Editor: BERNARD E. JONES —

Technical Editor: J. H. REYNER, B.Sc., A.M.I.E.E.

Research Consultant: W. JAMES

Assistant Editor: H. CORBISHLEY

## Christmas Box for German Listeners—The Station Finder—Portable Licences—A Short-wave Triumph—Broadcasting Cenotaph Ceremony—A New A.C. Set!

**Christmas Box for German Listeners!**—Registered owners of wireless sets in Germany (writes our Berlin Correspondent), are promised a very practical Christmas box. Instead of reducing the monthly licence fee, as had been suggested, every owner is to be insured free of charge, as from January 8, against death or personal injury and against destruction or damage to property caused by the presence of wireless receiving apparatus. The maximum payment for personal insurance is £5,000, whilst the payment for property is limited to £1,250.

**A Short-wave Triumph**—By providing the clearest American relay on record, when the arrival of the *Graf Zeppelin* was graphically recounted by the American commentators, the new Chelmsford short-wave receiving plant has leapt to fame in a night. The short-wave transmissions from Schenectady were picked up at Parling, near Chelmsford, in Essex, and then sent over the land-line to Savoy Hill, where officials were so impressed by the excellent quality that, considering the great public interest in the *Graf Zeppelin*, it was decided to substitute the prearranged 2LO and 5XX programme at 10.15 p.m. for the American commentary. "DX" fans who tuned in Cologne or its satellites heard the American stations as early as 9 p.m. when the German stations started to rebroadcast the relay.

**Broadcasting Cenotaph Ceremony**—Arrangements have now been completed by the B.B.C. for an all-England broadcast of the Armistice Day ceremony at the Cenotaph. The broadcast will begin at 10.30 a.m. and continue until the conclusion of the commemoration service. The order of procedure will be: Massed Bands, Big Ben, Maroons, Two-minute Silence, and lastly the Service. The permanent microphone con-



This interesting photograph shows a member of the "A.W." Constructional Staff winding one of the coils for use in a Chapman-Reinartz 2. Full details of the coil windings are given on pages 664-665.

nections installed for the Whitsun ceremony will be put into commission, being linked up with Savoy Hill by the "O.B." van in Richmond Mews, just opposite the Cenotaph.

**Portable Licences**—When a portable receiver is purchased by a listener who proposes to confine his reception activities to his home address an ordinary licence should be taken out—not a portable licence, which is only required when it is

proposed to operate the receiver at various addresses. A good deal of confusion exists on this point, which can be dispelled when it is realised that a licence is granted for working a set at one particular address irrespective of its nature.

**Austria Starts Telephoty**—We have received a telegram from Wireless Pictures, Ltd., to the effect that the Austrian Broadcasting Company started on October 15 the first regular European picture-broadcasting service based on the Fultograph system. President Hainisch was the first to send his picture, when he and all the ministers of the Austrian Republic attended the opening transmission.

The daily time-table of transmissions is 3.30 p.m. to 4 p.m. and after 11 p.m. The station to tune in is Radio Vienna on a wavelength of 517.2 metres.

**The "Station Finder"**—This week AMATEUR WIRELESS presents every one of its readers with a novel aid to station identification in the form of a chart, which, with a special pivoted pointer also supplied, enables the listener quickly and unmistakably to identify every station tuned in.

Full instructions on the use of the "Station Finder" are given on the chart and a special article on the theory and practical use of the gift will be found on pages 648 to 650.

**Next Week**—Next week's issue will be notable for the presentation of full constructional details of a new A.C. receiver, which derives its H.T. and L.T. supplies direct from the A.C. mains and incorporates a simple H.F., detector and L.F. circuit of great merit. For those with A.C. mains this new set will mean the abolition of all battery problems—by the simplest practicable way—the H.T. and L.T. batteries are themselves abolished. An interesting announcement of a novel type of loud-speaker to be described next week appears on page 655.

### PRINCIPAL CONTENTS

Current Topics .. .. .	647
The "A.W." Automatic Station Finder .. .. .	648
Cut Out Your Local! .. .. .	650
A Universal Output Unit .. .. .	651
For the Newcomer .. .. .	652
On Your Wavelength .. .. .	655
The Menace of the Bad H.T. Battery .. .. .	657
My Wireless Den .. .. .	658
The League of Nations Wireless Station .. .. .	663
Making the Coils for the "Chapman-Reinartz 2" .. .. .	664
Practical Odds and Ends .. .. .	666
Without Fear or Favour .. .. .	667
The "Screen-grid 'Q'-coil Three" .. .. .	668
Volume Control .. .. .	674
"A.W." Tests of Apparatus .. .. .	676

# "Amateur Wireless" Auto

(Parker's Invention)

Short Waves

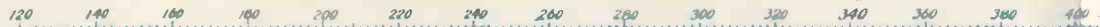

Long Waves

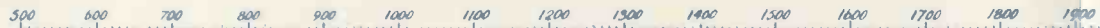

## HOW TO USE THIS STATION FINDER

### To Find Stations of Known Wavelength

1. Sharply tune in any station of known wavelength or frequency as accurately as possible, preferably a station at one end of the wavelength band. On one of the top scales mark the wavelength or frequency and on the appropriate bottom scale the exact condenser dial reading. With the help of a straight-edge connect these two points by a thin pencil line.

2. Similarly, tune in any other station of known wavelength or frequency, preferably at the other end of the wavelength band. Mark on the same scales as before and connect by thin pencil line, crossing the first line.

3. At the crossing or intersection of the two pencil lines insert the needle or pin of the pointer.

"Amateur Wireless"

Every Thursday 3<sup>d</sup>.



To Prepare Station Finder for Use:—Mount on strong, stiff card.

Use this edge

POINT

# Automatic Station Finder

ion)

920 940 960 980 500 520 540 560 580 600 620 640 660 Wavelength in metres

1460 1380 1300 1220 1140 1060 980 900 820 740 660 580 500 Frequency in kilocycles

2000 2100 2200 2300 2400 2500 2600 2700 2800 2900 3000 3100 3200 Wavelength in metres

340 320 300 280 260 240 220 200 180 160 140 120 100 Frequency in kilocycles

## HOW TO USE THIS STATION FINDER

(Continued)

4. To obtain the correct dial setting revolve the pointer to that wavelength or frequency on the marked scale, when the dial reading can be seen at the other end of the pointer on the condenser scale. Use the wavelength scales for square law or log. condensers and the frequency scales for S.L.F. condensers.

5. Separate settings are required for long and short waves or for any coil change.



### To Determine Wavelength or Frequency of any Unknown Station Heard

6. Mark the exact dial reading on the appropriate bottom scale, turn the pointer to the mark and read off the wavelength or frequency at the other end of the pointer. To identify the station consult the list of broadcasting stations given in AMATEUR WIRELESS.

For more complete instructions, see "Amateur Wireless," dated Oct. 27, 1928

When dry, accurately cut out the pointer and insert a needle or pin through its centre A.

Use this edge

ER



# "The" A.W. Automatic STATION FINDER

*This Station Finder is a Free Gift with each copy of this issue of "A.W." In this article we describe exactly how it should be used*

**T**HIS week AMATEUR WIRELESS is making its readers a gift of a novel accurate if log mid-line condensers are incorporated.

### The Scales

At the bottom of the Station Finder will be found two scales divided respectively into 180° and 100°, the former to be used if a tuning condenser dial is divided into 180°, the latter if, as in some makes, the dial is divided into 100° divisions.

It is necessary to ascertain the exact condenser settings of two stations of whose identity you are quite certain and whose frequency or wavelength values are contained on one scale, either the long-wave or short-wave set.

(It should be emphasised that the following is only an initial operation which does not have to be repeated every time it is required to use the Station Finder.)

Do not utilise the setting of the local station if the receiver is situated very near to it, otherwise difficulty may be experienced in deciding upon the exact setting to give maximum signal strength, which setting is, of course, the accurate setting.

Secondly, it is pointed out that, owing to the fact that most commercial condensers have not strictly straight-line characteristics towards the extreme maximum and minimum positions, it is advisable to obtain the

Given any particular broadcasting station's frequency or wavelength, the Station Finder will enable the reader to ascertain the approximate setting of the tuning condenser. With this knowledge it should be possible, providing the set is sufficiently sensitive, to hear that station without any searching.

### Identifying Stations

Another use for the Station Finder is its ability to check



You cut the pointer off

character; no less than a "Station Finder," which enables the reader to tune in automatically any desired station within the possibilities and capacities of his set, and conversely of recognising any station the identity of which is in doubt.

Our supplement this week is a chart which has to be used in conjunction with a pivoted pointer, also included in the presentation.

Whilst the principle has, of course, been known for some time, we think that this is the first occasion on which this particular method has been applied in practice. It has the great advantage that not only does it interest the technical wireless man, but that it can be used with ease by even the new-comer to wireless. Indeed, it offers itself as an automatic station finder to anybody who can work a wireless set.

### An Aid to Searching

If the receiving set is fitted with an S.L.F.-type tuning condenser, as is the case with many sets to-day, the Station Finder is of inestimable help. It is equally useful if the set is fitted with square law type condensers and is quite sufficiently



—and then rule two lines

the frequency or wavelength, and thus the identity, with a fair amount of accuracy of all the stations that are known to be within the range of the receiver.

At the top of the Station Finder will be seen two sets of scales—one for short waves and another for long waves. One scale of each set is calibrated in frequencies (that is, kilocycles), and on the other scale of each set the calibrations are in wavelengths (that is, metres).



—when the point of intersection indicates the pivot position of the pointer

# HOW TO USE the "A.W." AUTOMATIC STATION FINDER (Continued)

setting of two stations at not less than 20° from either end of the condenser scale.

Thirdly, it is advisable that these two

fore, alternative readings for any given type of condenser, but have to be used strictly according to the type of condenser involved.)

Up to now we have two sets of marks—that is, two marks well spaced apart on the dial scale and two correspondingly spaced marks on either the frequency or wavelength chart for one or other of the two wavelength bands.

Now carefully draw a perfectly straight line from one of the marks on the condenser scale to the mark on the frequency or wavelength scale which

corresponds to the station heard at that particular condenser setting. Then carefully draw another line between the two marks on the

one bottom) on the Station Finder are the suitable ones, the others should be ignored entirely. That is to say, if a 100° condenser scale is used, obviously the 180° scale must be ignored. Similarly, if an S.L.F. condenser is used, the wavelength scale on either set of readings for long or short waves must be ignored.

If the pointer is applied to any other transmitting station's frequency or wavelength and the condenser of the receiver adjusted to give the same reading as that obtained at the condenser-scale end of the now pivoted pointer on the condenser scale of the Station Finder, it will be found that the condenser is automatically adjusted to tune in the station possessing and working on the particular frequency wavelength read off at the other end of the pointer.

At any particular setting of the tuning condenser at which an unknown station is heard ascertain the correct reading of the condenser and turn the pointer to the corresponding figure on the condenser scale, and read the frequency of the unknown station as given by the other end of the pointer.



The pointer is moved to the correct position on the chart

settings be as far apart as possible.

Having tuned in the two known stations and noted their dial settings, accurately mark these two readings on the correct

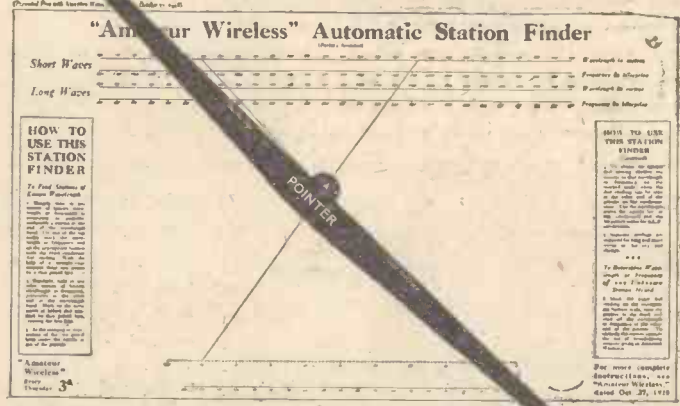
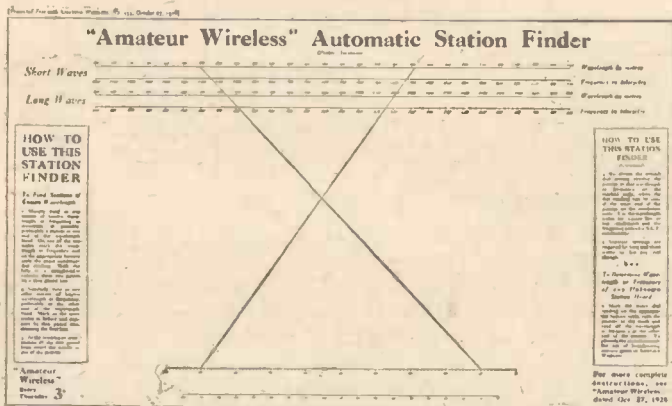

These two diagrams show how the lines are ruled on the chart and the position of the pointer is located

condenser scale—that is, on the 180° or 100° dial scale, according to the type of dial used—consult the "Broadcast Telephony" page of AMATEUR WIRELESS (page 686), and, having found the correct frequencies or wavelength, accurately mark these on the wavelength or frequency scale involved.

### S.L.F. Condensers

If an S.L.F. condenser is used, look up the frequencies of the known stations and mark the frequency scale accordingly. If, however, square-law or log-mid-line condensers are used, find out the wavelengths of the known stations and transfer the marks to the wavelength scale.

By way of explanation, it should be pointed out that the wavelengths and frequency scale are not mere conversion tables, but are included so that the Station Finder will be equally useful, irrespective of whether S.L.F., square-law, or, to a less accurate degree, log-mid-line condensers are used. (The two scales are not, there-

top and bottom scales which represent the other condenser reading and its corresponding frequency or wavelength.

At the exact point somewhere between the top and bottom scales where the two lines cross each other make a pin-hole and pin to the Station Finder the pointer supplied. This pointer, as per instructions, should be accurately cut away from the Station Finder and pasted on cardboard.

The above is very important. On the accurate positioning of these four points, on the drawing of the two lines and on the positioning of the pin-hole, depends the future usefulness—or, more exactly, the future accuracy of the Station Finder. It should be particularly noted also that, having decided upon which two scales (one top and

Consult the "Broadcast Telephony" page and find out which station corresponds to this frequency or wavelength according to which scale you are compelled to use by the type of condenser incorporated in



—and the wanted station comes in

# CUT OUT YOUR LOCAL!

—WITH THE SIMPLE ABSORBER DESCRIBED IN THIS ARTICLE BY H. J. BARTON CHAPPLE



The Simple Local Absorber

WHILE the six-pin coil, complete with base and cylindrical metal screen, has not been featured quite so much of late, there are still a large number of experimenters and constructors who use this type of coil. This being the case, it is certain that one or two spare "pots," complete with coils, will be found in the wireless fan's stock cupboard, and it may not have occurred to them how the split-primary aerial coil can be made up into a wave-trap for cutting out or absorbing the local transmission. This practice often has to be resorted to when the receiving set in use is not selective enough to allow transmissions on neighbouring wavelengths to be tuned

in and listened to without a background of the near-by station.

The accompanying photograph shows how simple is the construction, while on test I have found the arrangement admirable. All we require is a split-primary aerial coil (250/550 or 1,000/2,000 metres, according to which is your local station), complete with base. The addition of the screen is desirable, since the wave-trap is sure to be used externally to the set and, apart from shielding, a cover over the coil will, in consequence, keep it free from damage and possible leakage as a result of accumulated dust. The other component is a Formodensor, .00015 to .00005-microfarad capacity, panel-mounting type.

### Construction

Mount the Formodensor on a small metal strip bent at right angles, so that it is supported and held in position by the normal "earth" terminal and screw of the cover base. Referring to the diagram, it is seen that only two wires are necessary to join the condenser across terminals 1 and 2 of the coil, and the construction is complete.

To use the arrangement, accurately tune

your local station and then remove the aerial lead from the set and join it to tap points 3 or 4 of the coil. Connect terminal 2 to the aerial terminal on the set and adjust the Formodensor knob until the local transmission vanishes or nearly so. Try out both tap points to see which gives the best results, and then proceed to use your receiver in the normal manner without further adjustments on the condenser c. Readers who adopt this suggestion will be delighted with its convenience and efficiency.

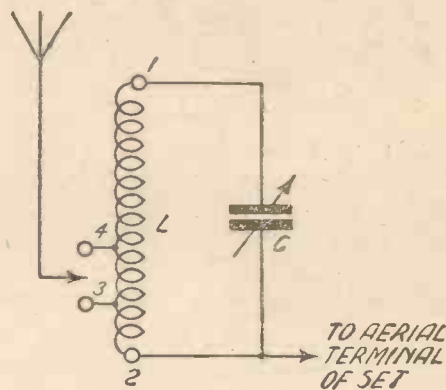

The Circuit of the Absorber

## "THE 'A.W.' AUTOMATIC STATION FINDER"

(Continued from preceding page)

the receiver. If no station can be found on this exact wavelength or frequency, look for a station having a frequency or wavelength nearest to that given by the Station Finder. In this way an unknown station can be quite easily identified.

*N.B.*—If the inductance or capacity of the receiver is altered in any way—by changing the aerial, for example, or by connecting the fixed condenser in series with the aerial, or by inserting another coil, or, what amounts to the same thing, by using another tapping on the tuning coil—the condenser readings will be changed, and it will be essential to draw another pair of lines and to find the point at which they cross, and upon which the pointer must then be pinned.

One particular centre point cannot be used with more than one top scale and one bottom scale. Which brings us to the final instruction; that is, it is essential that a separate point be found for long and short waves as given by the two sets of scales.

Do not be put off by the apparent intricacy of these instructions which, we can assure the reader, when interpreted in practice, will be found to work out in an exceedingly simple way.

Many readers will care to know that this

Station Finder—for which its inventor, Mr. H. Parker, has applied for a patent—is being made in *de luxe* form and will shortly be marketed by Messrs. International Inventions Corporation Ltd., Staple House, Chancery Lane, London, W.C.

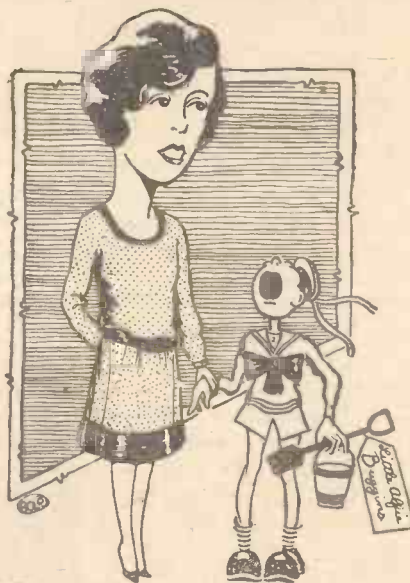

**MABEL  
CONSTANDUROS**  
(Mrs. Buggins & Co.)

## A DISTORTIONLESS LOUD-SPEAKER

WHENEVER a diaphragm is used to convert a varying electric current into corresponding mechanical vibrations, a certain amount of distortion must be present. The diaphragm naturally possesses mass and a certain degree of elasticity, and it must therefore have a "fundamental" frequency of its own, so that the corresponding musical frequencies are unduly emphasised.

In order to overcome this defect a German inventor has discovered a method of setting the air directly into audible vibration without the intervention of any diaphragm. He does this by utilising the brush discharge from a pointed electrode. The electrode is first charged up to a definite high potential, and the output voltages from a low-frequency amplifier are then superposed, so that a fluctuating brush discharge is created. The arrangement is stated to act as a loud-speaker of exceptional purity and clearness.

B. A. R.

The Irish Free State made a profit of £3,000 from broadcasting last year.

German radio authorities are considering the erection of three relay stations, all in the vicinity of Berlin, and with a wavelength of 236.2 metres.

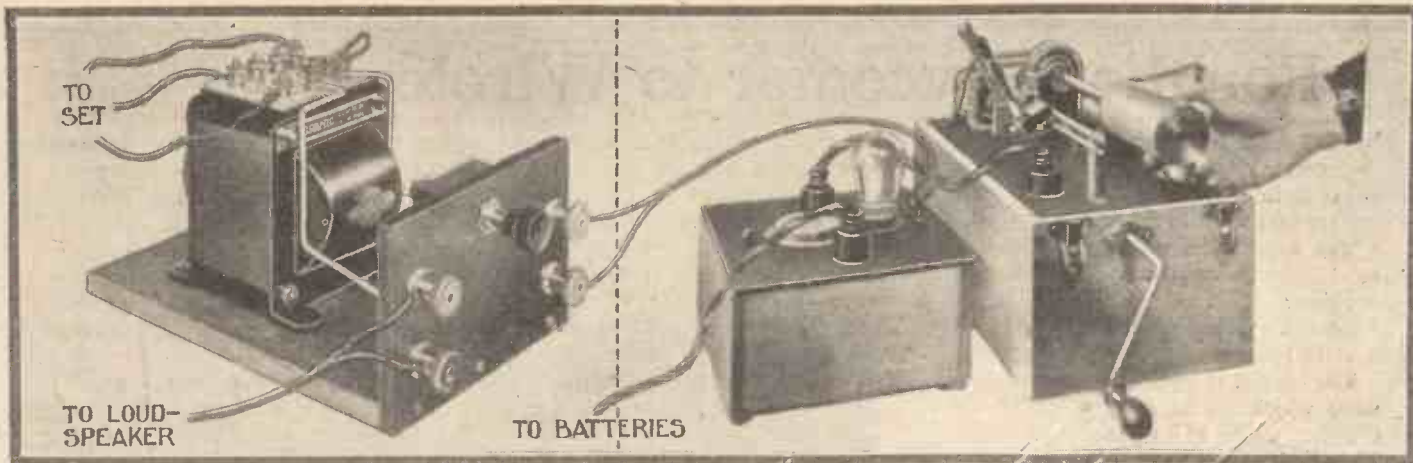

# A UNIVERSAL OUTPUT UNIT

## for Loud-speaker or Fultograph

THE experimenter who is not satisfied with anything but the best possible results from his receiving set and loud-speaker requires something more than a fixed output arrangement—he requires an output system with which step-up and step-down effects can be easily obtained so that experiments with different output valves and loud-speakers can be made to the best advantage. With the output unit here described quite a large number of different

step-up and step-down arrangements can be used. By means of a jack-switch either of two loud-speakers can be brought into action at will, providing a handy means whereby the results given by one loud-speaker can be compared with the results obtained from another; or, alternatively, the output may be instantly switched over from phones to loud-speaker or vice versa.

Fultograph users will find this unit of especial advantage, as the output from the receiving set can be diverted from the loud-speaker to the picture receiver immediately the transmission of a picture is announced without the trouble of having to undo and remake connections.

connected to L.T.— or H.T.— on the set, while terminal No. 1 on the unit is to be connected to L.S.— on the receiver.

To complete the connections the small spade terminal which is connected to a length of flex passing through the top of the "C.C." unit should be joined to No. 1 terminal.

Arranged in the foregoing manner the unit will function as a normal choke-capacity output filter unit suitable for use

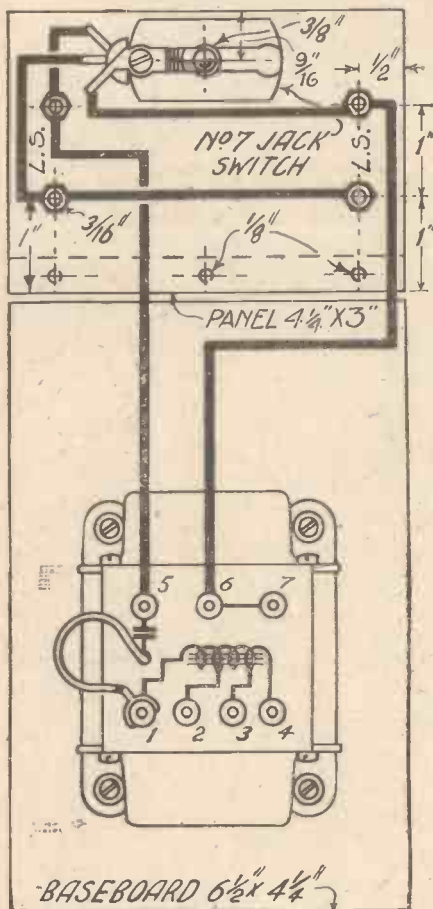

### Components

The parts necessary for the construction of this unit are as follow:—

- Tapped "C.C." Output Unit (Igranic).
- No. 7 Jack switch (Lotus).
- 4 Terminals marked "Output" (Eastick, Belling-Lee).
- Ebonite, 4 1/4 in. by 3 in. by 3/8 in.
- Wood for baseboard, 6 1/2 in. by 4 1/4 in. by 3/8 in.
- Glazite for wiring up.

### Construction

After drilling the small ebonite panel to the dimensions given in the drilling diagram (Fig. 1) the jack switch and terminals may be mounted in position and wired up as far as possible before fixing the panel to the baseboard.

As shown in the complete diagram of connections (Fig. 2) the addition of two wires only will then be necessary to complete the unit after fixing the panel to the baseboard and mounting the tapped "C.C." output unit to the latter.

### Using the Unit

To test the completed unit terminal No. 4 on the unit should be joined by means of flex to the terminal marked L.S.+ on the receiving set; terminal No. 7 should be

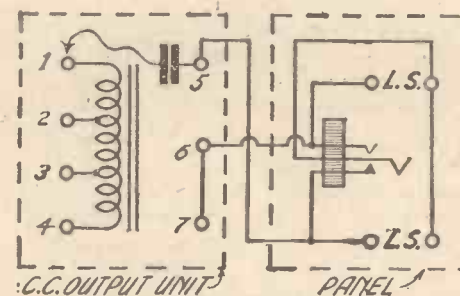

with an ordinary high-resistance loud-speaker, which should, of course, be joined to one of the pairs of output terminals on the panel of the unit.

A second loud-speaker or pair of headphones may be connected to the remaining pair of terminals.

Connections for various step-up and step-down ratios which may be obtained with the unit are given in the following table, which will prove useful when a number of loud-speakers are connected in series or parallel; as, for example, if the output valve used in the set is of suitable

(Concluded at foot of next page)

# For the Newcomer to Wireless: GRID CURRENT

**Y**OU have often spoken about grid current and I am always reading about it in wireless articles. Can you tell me just what it means?

You have got a pretty good idea of what happens inside a valve when it is working?

I think so.

Well, tell me.

The heated filament throws out electrons which are strongly attracted by the plate owing to its positive potential. They rush across the intervening space from filament to plate, passing through the meshes of the grid. If the grid becomes more negative the normal stream is thinned and when it is more positive more electrons flow.

Yes, that's quite correct—up to a point.

I thought there might be a catch somewhere!

If we make the grid slightly positive it exercises an attraction upon the electrons that leave the filament.

I follow that.

What happens is that though the greater part of the electrons pass through the grid and make their way to the plate, some are caught up by the positively charged grid and return to the battery by way of the outside circuit.

What do you mean by the outside circuit?

Well, whatever the connection may be between the grid and the battery. In a rectifying valve or a resistance-coupled note-magnifier this connection is the grid-leak; in other circuits it will be a grid coil or a transformer secondary.

When the grid is positive current actually flows through this?

Yes, and its effect is important.

How?

On the high-frequency side the main result is that such a flow of current introduces what is known as damping. Damping cuts down the selectivity and sensitiveness of the set. In old-fashioned receivers it was deliberately used to hold down the high-frequency valves by means of a potentiometer.

And on the low-frequency side?

Grid current spells distortion.

Why should it do so?

What we may call for simplicity's sake the upper half of a wave arrives upon the grid, making it less negative than normal. This should have the effect of producing an exactly corresponding rise in plate current. If, however, some of the electrons are diverted from the plate and make their way home through the grid circuit then the plate current is slightly cut down since it is robbed of its full quota of electrons and the resulting plate circuit impulse

takes the form of a slightly flattened distorted wave.

Obviously grid current is to be avoided.

That is so. In a well-designed modern receiver there is no need to hold down high-frequency valves by introducing damping. We can, in fact, economise by giving them a slight negative bias.

And on the low-frequency side?

Here we have to be careful that even the strongest signal does not make the grids of the low-frequency valves positive. We must even go further than that.

In what way?

Grid current actually begins to flow before the grid becomes positive. It is found that it occurs even when the grid is at zero voltage or very slightly negative.

What does this come to?

It means that we must make sure that the "upper half" of the strongest incoming impulse to the grid of the note-magnifier does not suffice to reduce the grid potential even to zero volts. Provided that we can keep the grid always half a volt negative or so, distortion will not occur unless—

Yes?

... bottom bending sets in, and that must form the subject of another of our chats.

## "A UNIVERSAL OUTPUT UNIT"

(Continued from preceding page)

impedance for use with a certain loud-speaker the connection of two such loud-

### STEP-DOWN

Ratio	L.S.— on set	L.S.+ on set	Spade on unit
2—1	4	1	2
3—2	3	1	2
4—3	4	1	3

### STEP-UP

Ratio	L.S.— on set	L.S.+ on set	Spade on unit
1—2	2	4	1
3—4	1	3	4
2—3	1	2	3

speakers in parallel will necessitate the use of the 2-1 step-down ratio for best results.

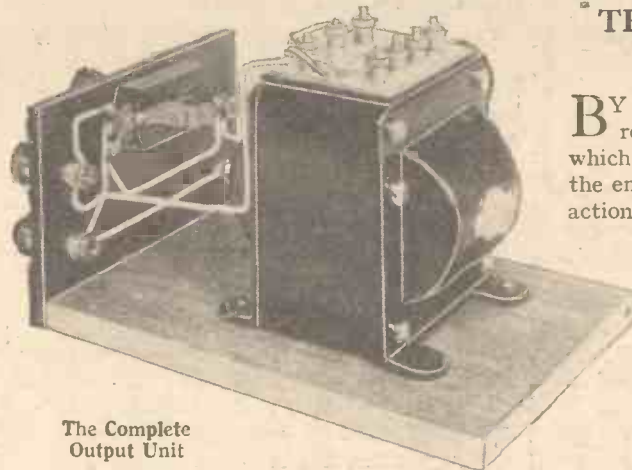

The Complete Output Unit

In conclusion it should be noted that the effective impedance of the L.F. choke in the "C.C." unit can be varied by connecting the spade and the wire from L.S.— on the receiving set together to terminals 2 or 3 instead of to No. 1 as advised for the normal working of the unit.

**FOR THE NEWCOMER  
NEXT WEEK:  
HOW LOUD SPEAKERS DIFFER**

## THE UBIQUITOUS GRID

**B**Y analogy with the three-electrode valve photo-electric cells, which depend for their action upon the emission of electrons under the action of light, are now being fitted with a third electrode or "control grid" to increase sensitivity. Normally such cells comprise two electrodes only, one a layer of some photo-electric substance such as potassium or sodium amalgam deposited over the inner surface of the

glass bulb, and the other a metal anode to which a high positive voltage is applied. The introduction of a third electrode or grid is a recent innovation which may have important results, particularly in television.

The addition of a grid or control electrode to the well-known "Osglim" type of neon valve is another recent development of interest. The newcomer has been christened the "Grid-glow Tube."

M. A. L.





Still  
the best Horn  
**LOUD SPEAKER**

PRICE

1925-£5.0.0

1926-£3.0.0

1927-£2.10.0

**TODAY-£2.5.0**

and better than ever

**B  
T-H** **LOUD  
SPEAKER**

The above price is applicable to Great Britain and Northern Ireland only.

13094. THE BRITISH THOMSON-HOUSTON CO. LTD.

Don't Forget to Say That You Saw it in "A.W."

The valves which maintain their emission throughout life

EDISWAN

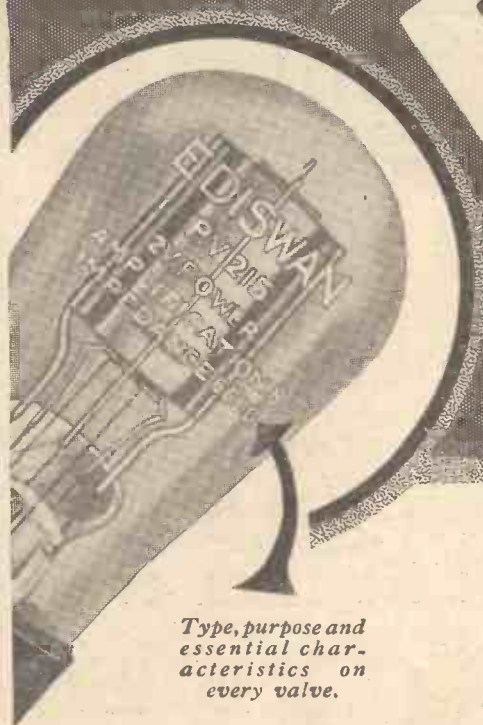

HIGH EFFICIENCY VALVES

Type, purpose and essential characteristics on every valve.

The very complete range of Edison Swan Valves includes Screen Grid, Pentodes and A.C. Mains Types.

The most complete and useful catalogue of receiving valves ever produced is available to you on request to The Edison Swan Electric Co. Ltd., Publicity Dept., 123/5 Queen Victoria Street, London, E.C.4.

MANUFACTURERS OF THE WORLD'S FIRST RADIO VALVES

To Ensure Speedy Delivery, Mention "A.W." to Advertisers

# On Your Wavelength!

## Can you Diagnose?

HERE is what happened to a set, which consists of a neutralised H.F. stage and a rectifier followed by two note-mags. In the ordinary way, tuning is exceedingly sharp in the grid circuits of both the H.F. valve and rectifier. It continued to be up to the mark in the case of the rectifier, but the tuning of the H.F. valve became flatter and flatter. Eventually it made very little difference to  $\lambda$ LO's strength whether the first condenser dial was set at 30 or 95 degrees! It seemed quite clear that there must be a short of some kind between the high potential point and earth; but just where was it?

## A Queer Short

In previous years I have had my tuning flattened by the misdeeds of spiders who would choose my aerial insulators as eligible sites for spinning webs. This year there aren't any spiders. The insulation of the lead-in tube was found to be satisfactory. There was nothing wrong with the wiring of the set, whilst that the valve itself was not to blame was proved when the substitution of a new one for it made no difference to results. Since the coils were found to be in good order, only two points remained as possible seats of the trouble. These were the coil holder and the valve holder. The first proved satisfactory when tested out, but the second, though there was nothing wrong to be seen, showed an undoubted high resistance leakage path between the grid leg and one of those belonging to the filament. It was not until the valve holder was turned over for an examination of its underneath that the cause of the trouble was spotted. The two contacts here are not very far from one another. A tiny piece of wire, probably a fragment of a single strand from a piece of flex, had somehow become attached to one of them and its end appeared to be touching the other. I suppose that when the holder was first mounted the wire was not making contact between the two points, but owing to vibration, due to passing traffic, it had eventually made a short. The leakage path was a high-resistance one, since both the wire and the lower part of the filament leg were distinctly dirty.

## An Adventure

In future I shall be very careful to test out every screen-grid valve that comes my way before it goes into use in the set. Faults don't often occur and manufacturers are not to blame when they do, but their consequences can be pretty serious. On its way through the post a valve which reached me the other day must have been subjected to some pretty rough handling. What

happened to it was that the electrodes were displaced so that the screen came into contact with the plate. Foolishly enough, I only tested out the filament and then put it straight into the set. It didn't function, and I was trying to find out why when my nose detected the unpleasant smell of hot ebonite. Touching various pieces of insulation in turn, I jumped into the air with a yell as my fingers came into contact with the high-frequency choke. The thing was—or seemed to be—nearly red hot! I was

## JUST THE LOUD-SPEAKER FOR THE AMATEUR!

TWO of the best exhibits for the amateur at the recent exhibition at Olympia were the linen-diaphragm loud-speakers that attracted such extraordinary attention on our stand. The amateur had seen nothing like them. He noted their extreme simplicity and coveted the nice little bit of perfectly straightforward wood-working called for in their construction. We could absolutely assure him of the high quality of their performance.

Now, Mr. J. Sieger, in charge of our construction department, who was responsible for both of the earlier speakers, has given us, after much experimenting, something even better.

## A NEW LINEN-DIAPHRAGM SPEAKER WITH BAFFLE

A cheaper and even more simple job, the sizes of its diaphragms being so proportioned that, good as were the bass notes in the first models, they are now still better, while the presence of the baffle increases volume. In next week's issue we shall describe this new speaker in complete detail, fully illustrating it with photographs and drawings.

No reader, particularly no new reader, should miss it. We repeat

## JUST THE LOUD-SPEAKER FOR THE AMATEUR!

Next Thursday's "A.W."  
Usual Price, 3d.

using a common H.T. battery made up of the batteries of the "super" type, which are capable of delivering a surprisingly big current. The plate was connected through the choke to the 130-volt tapping of the battery and the screen-grid direct to the 75-volt tapping. Hence, owing to the short, there was a straight-through path *via* the choke, and 55 volts were driving current through it. Besides burning out the choke, it dealt the battery a most unfair blow, for these big loads are certainly not good for even the largest dry cells.

## Trans-Atlantic Phone Progress

When it first came along with its £5-a-minute calls and a minimum fee of £15, it did not seem as if the trans-atlantic wireless phone service would leap into immediate popularity. But the reduction of charges to £3 a minute, with a £9 minimum, soon made an astonishing difference to the traffic. It has been found that the provision of a single wireless link is now quite insufficient for the needs of the service. Two-way working has hitherto been obtained by the use of a very long wavelength outwards from this country and a very short one inwards. It is now proposed to make use of at least four wavelengths each way, so that four conversations can take place simultaneously between this country and America.

## A European Relay

The big increase in the traffic is due to the fact that the Rugby transmitter has become the recognised relay of telephone conversations between most parts of Western Europe and America. A man ringing up New York from Berlin has his call passed over the land-line and cable to London, whence he is linked up with Rugby. Incoming messages from his correspondent are also received in England on the short wavelength and relayed *via* London. Further, just as London has become the hub of Europe's wireless telephony, so is New York now that of America. You can telephone from Mexico City to Paris, and your conversation takes place *via* New York and London.

## Wayward Wavelets

What is wrong with the short waves just now? Though reception has been pretty good upon them for some time, my set seems to be almost dead at present. 2XAF, 2XAD, KDKA, and the other stars have ceased to come roaring in, and it is quite difficult to pick up some of the smaller fry at all. So bad are things that I am quite sure that numbers of short-wave men have thought that the trouble was in their sets, and have pulled them to pieces in order to try to find it. I rather fancy that these hateful sun-spots are to blame for the bad reception that we are far from enjoying just now. Investigations made during periods of sun-spot activity have produced some queer results. It seems that the ranges of long-wave stations may be considerably increased at such times, whilst those of medium-wave stations become more and more uncertain.

## Freak Nights

Every night just now seems to be more or less a freak as regards long-distance reception; in fact, you never know what you

## On Your Wavelength! (continued)

are going to find in the way of foreign transmissions when you switch on and begin to twiddle your knobs. Possibly you start down at the bottom of the scale and find Karlskrona or Halmstad coming in with a strength that nearly blows your head off. These little Swedish stations are rated at only a quarter of a kilowatt apiece. You say to yourself "By jove, a splendid night! I will be able to get half Europe on the loud-speaker." You remember that Kattowitz had been pretty good on the previous night; he ought to be splendid now. Turning rapidly upwards you hear music coming in loudly and clearly, and pause for a moment to see what it is. It turns out to be Berne, whom you haven't heard for weeks and weeks.

### Why Is It?

It *must* be a wonderful night. Now for Kattowitz. Kattowitz is not there, or, if he is, he is so feeble that you can hardly hear him. You go up a little. Frankfurt is about half normal strength, but just above him you find little Frederiksstad coming in with a roar. And so the evening goes on. Some stations that oughtn't to be there at all, by all the rules, are tremendously powerful, whilst other transmissions, with Heaven knows how many kilowatts behind them, are but modest little whispers. On the next night some of your new friends have disappeared and probably the big stations have returned to their proper strength.

### A New Big 'Un

The latest giant station projected for Europe is that just decided upon by the Oslo Broadcasting Company, which now controls almost the whole of Norwegian broadcasting. The new station is to be constructed near Oslo, and it will be a real giant. The steel masts will be 480 ft. in height and the output is to be 60 kilowatts. It is expected to be ready next spring. When it gets under way the new Oslo station will be the most powerful broadcasting station in the world—unless, of course, somebody else gets in with a bigger one in the meantime! The Schenectady station WGY can use 100 kilowatts, and does so occasionally. Normally, however, its power is 50 kilowatts, for this is found to be quite as much as the sets of listeners in the neighbourhood can stand. With Oslo up to 60 kilowatts, excellent reception should be obtained in this country, for the existing transmitter, which has a power of only 1 kilowatt, is regularly received in Scotland and the North of England at excellent strength, and on good nights it may be picked up in many places in the South.

### The Zeppelin Broadcast

The arrival of the *Graf Zeppelin* in the United States of America was clearly

brought to the ears of millions of European listeners through the intermediary of German and British broadcasting stations. Punctually at 8.15 p.m. on Monday, October 15, the Stuttgart studio advised its hearers that it was already holding a transmission from WGY (Schenectady) and that as the airship passed over New York it would feed the running commentary to all German, Swiss, and Austrian transmitters. A few minutes later a call was put through from the Stuttgart listening post situated at Schloss Solitude on a hill in the neighbourhood of the city and the strains of dance music came through very clearly. Towards 8.50 p.m. Schenectady started a description of the Zeppelin's flight over New York city, and the Hudson River, from which the hooting of the ship syrens could be detected against a background of cheers, sounds of aeroplane and motor traffic and other noises.

### Realism

The American, for the benefit of its hearers, had followed by microphone the progress of the *Graf Zeppelin* from the time it had crossed the coastline on its passage over Washington, B.C., Philadelphia, and during its final flight to the Lakehurst Aerodrome. All German stations on receipt of the news that the airship was in sight of land cancelled the rest of their musical programmes.

### The B.B.C. Relay

At 10.15 p.m. British listeners were favoured in the same way by 2LO and 5XX, who interrupted their entertainments to take a running commentary on the landing of the *Graf Zeppelin* at Lakehurst, supplied by WGY (Schenectady), to which the new short-wave experimental station at Chelmsford (5SW) had tuned in. Later again Daventry 5GB also joined in. It was interesting to compare the quality of the transmissions put out by the German and British stations, and for some twenty minutes I captured the broadcast on some twelve different wavelengths. Although the Stuttgart relay, apart from sharp periods of quick fading, had been fairly satisfactory, it may here be said that by far the best relay was that obtained through the B.B.C. experimental station.

### A Success

Although British listeners have not for some time heard American stations through the medium of the B.B.C., it was fully proved that our home organisation is capable of carrying out these relays in a manner which can provide enjoyment to the general public, and there seems no adequate reason why, on favourable nights, the B.B.C. should not give us further samples of interesting incidents which may

take place on the other side of the Herring Pond.

### A Reyner Story

Mr. Reyner tells me an amusing story against himself. It appears that he was recently travelling up to Birmingham and was pleased to notice no fewer than three people enter his carriage with copies of AMATEUR WIRELESS in their possession, which they ultimately proceeded to devour with gusto. More than that, one of the readers actually sat down opposite to him and, after glancing through the morning paper, proceeded to get down to the real business of the day and opened his AMATEUR WIRELESS.

Mr. Reyner, stifling a certain justifiable pride, kept silent, glancing up occasionally to take notice of what particular features proved most interesting to this particular reader. There is no need to go into details, although the actual interest displayed in various articles naturally provided an interesting commentary. It appears, however, that this reader, after having glanced generally through the issue and after having read his THERMION (which, of course, he read first), proceeded to turn to an article by our worthy Technical Editor describing the new Metro-Vick elastic aerial.

"Ah, ha," thought our T.E. to himself, "he obviously considers this the real meat in the issue. What ho!" Whereupon he quietly settled down to his book and absorbed himself in reading. Glancing up a short time later, however, he noticed that the AMATEUR WIRELESS was still open at the same page. Lifting his eyes a little further, he found that the gentle reader had dropped off into slumber!

### The Sequel

I will draw a veil over the T.E.'s thoughts. The cream of the joke, however, is to follow. Shortly afterwards the train stopped at Coventry, and in the ensuing bustle the said gentle reader awoke. His first action on awaking was to turn to the end of the issue, where the conclusion of Mr. Reyner's article was to be found. Having located this, he proceeded to devour it with every appearance of relish!

### Wireless Beacons

Direction-finding services have long been working round our coasts, but a new and very perfect system of giving ships their bearings is gradually being installed at a number of places. Though out of sight of land, a ship can obtain her bearings in darkness or in fog by means of the radio beacons. The principle used is the familiar one of the frame aerial—as you rotate the frame, signals are strongest when it is pointing directly towards or away from the transmitter and weakest when it is at right angles to a line joining the two stations.

THERMION.



# The MENACE OF THE BAD H.T. BATTERY



BY  
R. W. HALLOWS

IT is unfortunately a fact that there are upon the market at the present time numbers of dry high-tension batteries which are almost incredibly bad.

During the past year I have conducted tests under laboratory conditions upon over five hundred high-tension batteries, covering the great majority of those at present on sale in this country. The tests made have been of a searching kind. To begin with, each battery on arrival has undergone voltage and internal resistance measurements. Some of the batteries of each kind have then been subjected to a continuous discharge test, readings being taken with a precision voltmeter twice a day, others have gone through a trial under intermittent discharge through fixed resistances for a period on each week-day corresponding to that during which the battery would be used under normal conditions to supply high-tension current to a wireless set.

## Results of Tests

At the end of the tests, batteries were taken to pieces so that details of their general construction might be noted and that the insulation and the cells themselves might be carefully examined. On the completion of the test for each batch of batteries of a particular type the results were carefully tabulated. The average number of service hours under both intermittent and continuous tests enable each battery to be classified under one of four headings—"Good," "Satisfactory," "Indifferent," and "Bad."

In Class I were placed batteries whose service hours reached or exceeded a figure which tests showed to be within the powers of any that were really well made. Class II contained batteries failing to reach this figure but giving not less than seventy-five per cent. of the standard number of hours. The Class III of "indifferent" batteries were those whose service hours were over fifty but under seventy-five per cent. of the standard, while the bad batteries in Class IV were those with a record of less than fifty per cent. of the standard number of hours.

The number of batteries which had to be classed as bad, that is to say, those which

failed to give more than half the normal number of service hours, was astonishingly large. Still more astonishing was the remarkably low percentage that some of them showed. *Taking the standard-capacity size alone (that is those made up of cells measuring approximately  $\frac{3}{4}$  in. in diameter by  $2\frac{1}{8}$  in. in height), quite a number of cheap foreign makes gave less than one-fifth the number of service hours shown by first-rate batteries of the same capacity.*

Batteries of the very worst type are imported from the Continent in thousands. Some of them, containing 44 cells, are to be bought wholesale in this country at a price in the neighbourhood of 2s. apiece. These are offered to the retailer, with specially printed gaudy labels bearing his own name, at very low prices.

As I write I have before me one such battery. Actually it is of much better quality than some of those on sale. Under test it gave just under a quarter of the standard number of service hours. I will pull it to pieces now and let you know what I find inside. To begin with the case, which I have just ripped off, consists of a single layer of undressed millboard, giving absolutely no protection from damp and providing only the poorest insulation for the sides and bottoms of the cells. The partitions between the cells are also of thin millboard with no water-proofing or insulating dressing. Let us extract a cell. It measures  $\frac{1}{4}$  by  $2\frac{1}{2}$  in., it is true, but the zinc pot is only about two-thirds filled. The cell is not sealed, as it should be.

## Worse and Worse

In batteries of still worse quality one finds cells that are very much under size and often these are not much more than half filled. Low grade zinc is used for the pots, with the result that local action takes place and one frequently finds bulged or burst cells at the end of a test.

It is quite certain that no receiving set can do itself justice with a poor high-tension battery. Let me give a case in point. The other day I put a poor quality battery through a test to ascertain its performances during three hours' use with an average three-valve receiving set drawing 10 milli-

amperes of current. The discharging resistance was so arranged that exactly this amount of current passed at the beginning of the test, though it fell off of course as time went on, just as the plate current in a receiving set would have fallen. The fall took place because the voltage of the battery dropped under the load. Every dry battery shows a fall in E.M.F. when it is placed under load for any length of time; but the fall will be small if the battery is a good one and of a size suitable for the work in hand.

## Discharge Rates

Here is what took place with the battery in question. At the end of the first half-hour the voltage had fallen from 65 to just over 60. Half an hour later it was down to 58.5 and at the end of three hours it was only 54.3 volts. Supposing that one had been using two of these batteries in series to supply the voltage necessary for working an output valve operating a loud-speaker, the voltage of the two would have fallen from 130 to 108.6. Two results would have followed. In the first place unless the grid bias was altered to correspond, the working point would have crept lower and lower down the characteristic curve of the valve and bottom banding would have set in half-way through the evening. Secondly, even if the grid bias had been adjusted to meet the fall in plate voltage, the useful straight portion of the characteristic would have grown shorter and shorter; in other words, overloading would have made its presence more and more felt.

Sometimes batteries of poor quality and of standard capacity size are stated to be capable of withstanding normal discharge rates of 10, 15, or 20 milliamperes. Actually there is no battery of this size in the world that can be used really economically under a greater load than about 5 milliamperes.

How is the purchaser to protect himself? The best advice that one can give is that he should never buy any battery that is made or sold by an unknown firm. He can protect himself still further if he watches the test reports upon batteries which appear in AMATEUR WIRELESS.

# MY WIRELESS DEN

by W. James

Weekly Tips for the Amateur



I HAVE noticed that comparatively few amateurs are really confident when connecting up the reaction coil. They always seem to think that, somehow, it might not work "that way round." Of course, really, there is, as in all branches of wireless, no element of chance in the matter at all; the connections of the reaction coil are very simply related to those of the grid coil.

To get the matter quite clear, you simply need to remember the drawing given here, Fig. 1(a). You will see that the grid and reaction coils are wound in the same direction, while the two outer ends are connected to the grid and the anode, and the two inner ends to the filament.

To help in eliminating hand-capacity effects and for convenience, the reaction condenser is usually connected between one end of the reaction coil and the filament. By the way, the same type of circuit may be used with a shielded valve, as indicated in Fig 1 (b), since, as you will notice, the two circuits are electrically similar.

### Another Point

You will notice that I have shown the reaction coil at the filament end of the grid coil. This is to reduce capacity coupling, which is more likely to occur when the reaction coil is near the high potential, that is, anode end of the grid coil.

Capacity coupling is definitely harmful and is often the cause of many of those peculiar reaction effects which puzzle the listener. In the old swinging-coil days these capacity effects were extremely noticeable.

For them, and I always give the same reply, namely, that so much depends upon local conditions and it is so easy to carry out a few experiments that it is more worth while to do this than to ask strangers for advice. The best thing to do is to try several different arrangements and then adopt the one you find best.

For example, an insulated wire taken from the receiver to the picture rail, and then fastened to the rail all round the room, sometimes is satisfactory, but often quite bad. Such an aerial is a poor collector and usually broadens tuning.

I have found that the best indoor aerial in my house to comprise a covered wire having one end fastened to the rafters. This is effective because it is fairly lengthy and not too badly damped as it runs clear of the walls. An indoor aerial is usually a much better collector than a small frame, but the frame aerial has the advantage that its directional properties may be utilised to reduce interference.

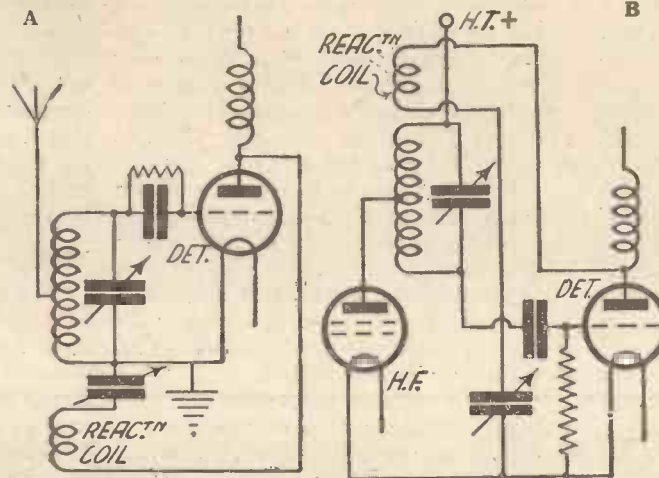

Fig. 1. How the reaction coil is connected

A way of yet further reducing this capacity effect is by the use of fine wire for the reaction coil. The thick wire generally used is not necessary, and makes the coil bulky and increases its capacity.

### A Useful Resistance

Have you ever tried substituting a resistance for the H.F. choke in the anode circuit of the detector valve? This can be done, and often with highly satisfactory results. Fig. 2 shows clearly what I mean. You will notice that the resistance is of the value of 5,000 ohms, and I must admit that vacuum-type resistances of this value are not generally obtainable. But the manufacturers who supplied me will, no doubt, be pleased to sell them.

Will L.F. magnification be reduced? Only very slightly, since the value of the H.F. stopping resistance is very small compared with that of the anode resistance.

It is always useful to have one of these resistances by one, as choking coils play strange tricks.

### Indoor Aerials

I am often asked by listeners to suggest suitable arrangements for indoor aerials

### A Peculiar Trouble

When two or three valves are paralleled in the last stage of the receiver they sometimes develop a peculiar habit of generating very high frequency oscillations. These spurious oscillations spoil the quality, but, fortunately, they may easily be checked.

All you have to do is connect a small high-frequency choke close to the grid of each valve, as shown in Fig. 3. The chokes need only have a few turns each.

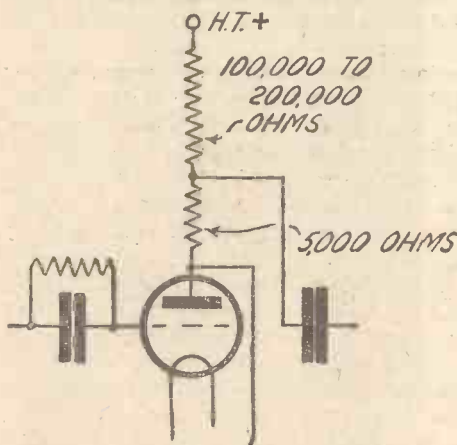

Fig. 2. A resistance used for a H.F. choke

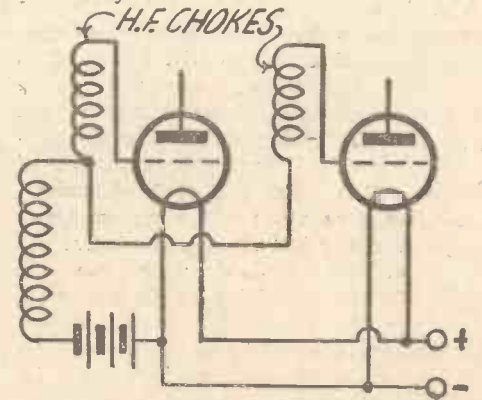

Fig. 3. How to stop a peculiar trouble

# Why the price is printed in big bold figures!

—because it is not merely the biggest of British-built speakers selling at 35/-.

—because it is not merely the most powerful instrument of its size. The other reasons are far more significant.

It is an Amplion speaker—designed by Amplion engineers and produced at the great new Amplion works.

It is the first triumph of Amplion's new super-production policy and only because it is made in thousands is the low price possible.

Wonderful value—and the performance is equally wonderful, clear-toned and resonant

*Twenty other  
models  
ranging in  
price to £42*

Height 20"  
Flare 12"

A handsome  
chocolate cry-  
stalline finish  
with a mottled  
red-brown  
Bakelite base.

# 35/-

CATALOGUES FROM GRAHAM AMPLION, Ltd.,  
26, Savile Row, London, W.1.

# AMPLION

*You will Help Yourself and Help Us by Mentioning "A.W." to Advertisers*

# Secrets of Success with the New Valves

**The Screened-Grid**  
by W. JAMES

**The Pentode**  
by Capt. H. J. ROUND

These two articles, which will provide answers to many queries asked about these new valves, appear in the November WIRELESS MAGAZINE, now on sale.

## OTHER CONTENTS INCLUDE :

**The Touchstone.** W. James's Startling New Four-valver.

Our Impressions of Television.

**The Inceptor Three** revolutionises Home Construction.

The New Telephoty Transmissions. By B.B.C. Officials.

**The Key-to-the-ether Two;** an all-wave Receiver with Detector and Pentode

Taking Care of Your Low-tension Battery.

Designing Your Own Gramo-Radio-Amplifier.

**The Super-power Unit.** For Wireless or Gramo-Radio.

In all over 60 features.

Full-size blueprints of all sets described are available to readers of WIRELESS MAGAZINE at half price.

# WIRELESS MAGAZINE

*for November is now on Sale, 1/-*

**GET YOUR COPY TO-DAY**



# FEATURED IN THE SCREEN GRID "Q"-COIL THREE

described in this issue

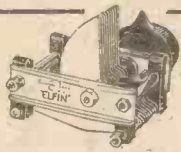

**ELFIN CONDENSER**

This miniature logarithmic condenser is a precision instrument specially designed for reaction control and tuning in Portable and other sets where space is at a premium. It is the smallest condenser on the market.

List No.	Mfd.		
311	.. .0001	..	5/9
312	.. .00015	..	6/-
313	.. .0002	..	6/3
314	.. .00025	..	6/6



**THE LOG MINOR CONDENSER**

A miniature logarithmic condenser of advanced design and new features. Cast steel spindle, 1/8" diameter on ball bearings, one piece pig tail.

List No.	Mfd.		
334	.0003	...	7/6
335	.0004	...	8/6
336	.0005	...	9/6

Also supplied with ebonite dielectric for sets where space is at a premium.

338	.0005	...	11/-
-----	-------	-----	------

**DRUM CONTROL CONDENSER**

A medium sized condenser designed for portable receivers. With escutcheon plate, drum control wheel, scale and drilling template.

List No. 323	.0003 single	11/-	List No. 326	.0003 double	16/-
List No. 324	.0004 single	11 6	List No. 327	.0004 double	17/-
List No. 325	.0005 single	12/-	List No. 332	.0005 double	18/-

Write for the Bpuyer-Lowe Component and Set Catalogues

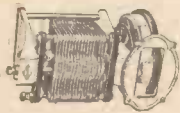

**BOWYER-LOWE**  
LETCHWORTH

New Type Log Condenser, '0005, 6/6

New Type Log Condenser, '0003, 6/3



Stocked by Harrods and good class radio dealers

## CONDENSERS

**1 2 3 4 5 6** AVOID SPURIOUS IMITATIONS

Nothing before has ever approached the amazing precision of this new condenser. Clear cut—razor sharp—station after station can be lifted out, with wonderful clarity. The Condenser that surprised the experts.

- One-hole mounting adjustable bearings.
- Movable spindle giving overhang for ganging or left or right hand drum dial.
- Rotor lifts out after removing spindle, for cleaning purposes, etc.
- Reinforced plates prevent vibration and make capacity dead accurate.
- U-shaped frame—rigid construction—exceptionally light.
- Insulated stator eliminates hand capacity.

Full particulars of the complete N.S.F. range of quality components from your dealer or (Dept. A.W.)

**S. W. LEWIS & CO., LTD., 39 VICTORIA ST., LONDON, S.W.1**  
Indian Agents: Bombay Radio Co., Bombay and Calcutta.

M.B.

# BUILD YOUR OWN ELIMINATOR



## THIS FREE BOOK SHOWS YOU HOW

If you have electric light you are wasting money every time you buy an H.T. Battery. Start saving money—build an Eliminator and get your current from the mains.

This free T.C.C. Book shows you how to do it. Shows you how to build H.T. and L.T. Eliminators. Its clear, concise instructions, aided by diagrams and photographs, are easily followed by anyone.

Send for it to-day. You will be amazed to find how easy it is to build your own Eliminator—H.T. or L.T.

BE SURE TO USE

# T.C.C. CONDENSERS

How to Build your own High Tension and Low Tension Eliminator.

To Telegraph Condenser Co., Ltd., Wales Farm Rd., N. Acton, London, W.3.

I enclose 1d. stamp. Please send me your book showing how to build Eliminators—H.T. or L.T.

Name.....  
Address.....  
A.W. 27/10/28

6160

Mention of "Amateur Wireless" to Advertisers will Ensure Prompt Attention



# WHY BE TIED to your local station?

NO longer is there any need to depend solely on your local station for broadcast music. With the wonderful new Cossor Melody Maker you can pick your programme from at least 23 stations. Its knife-edge selectivity will cut out your local station like magic. It will bring you superb Radio music from practically all Europe. Anyone can build it in 90 minutes. It's as simple as Meccano. You can buy all the parts, including the Cossor Valves, the handsome metal cabinet, the wire and even the tools in a sealed box ready for you to start assembly. Your wireless dealer will supply you. Get full details of this remarkable Receiver . . . .

**Fill in the  
coupon NOW!**

**GET MUSIC FROM ALL EUROPE  
with the NEW**

# COSSOR "Melody Maker"

Please send me free of charge one of your Constructor Envelopes which tells me how to build the new Cossor "Melody Maker."

Name.....  
Address.....  
A.W. 27/10/23

Advt. A. C. Cossor, Ltd., Melody Department, Highbury Grove, London, N.5.

GA 6132

Please Mention "A.W." When Corresponding with Advertisers

# The League of Nations Wireless Station

BY OUR SWISS CORRESPONDENT



The Studio of the Geneva Broadcasting Station in the building of the League of Nations in normal times

IT will be remembered that the Council of the League of Nations accepted a proposal put forward by the French delegate to erect, or at least to study the possibility of erecting, an independent wireless service for the exclusive use of the Assembly of the League of Nations, especially in times of crisis. This was in December, 1926. A general report on the question was submitted to the Assembly in 1927 (September) who congratulated the council on its initiative and asked for a more detailed report with definite suggestions as to cost and operation.

To this end, a committee of experts was convened in Geneva at the end of January, 1928, consisting of: General Ferrié, Chairman (France), Dr. P. Jager (Germany), Dr. Koomans (Holland), Lt.-Colonel A. G. Lee, O.B.E., M.C. (Great Britain), Prof. Vallauri (Italy). This committee elaborated a scheme by means of which the League should be able to communicate with the world quite independently of other existing means of communication. The whole plant would consist of two short-wave transmitters, and one station working on a wavelength between 3,000 and 5,000 metres.

## Eight Receivers

A range of eight receivers capable of receiving all wavelengths from 10 metres to 21 kilometres was also incorporated, as also a broadcast transmitter to work on a wave between 1,300 and 1,800 metres. This is the only mention of broadcasting with the exception that the telegraphy transmitters were to have been fitted with apparatus permitting of broadcasting speech. This first report was circulated to the members of the League in March, 1928.

In the meantime experts on the operation and upkeep, etc., of these transmitters were separately asked their opinions. The German, French, and Italian experts were of the opinion that the system would work all right, whereas the British expert, Mr. Phillips of the G.P.O. was unable to give an opinion in his individual capacity and also expressed doubts as to the working of the station in normal times as compared with times of crisis.

In the course of the spring the Swiss Confederation put forward a generous offer in declaring themselves willing to take over part of the cost of the medium-wave station and to operate it in normal times, and also to co-operate in the building and operating of the short-wave station.

## An Independent Station

In July, 1928, another committee of experts, this time on telegraphic operation, were invited to consider the two proposals before them. Here, both the French and Italian experts were of the same opinion as the German expert, namely that a station permanently and independently owned by the League would be more desirable, as commercial considerations might hamper the development of the joint station, which would only become the League's independent property in times of crisis. The British expert (Mr. Phillips) was of the opinion that in normal times the League traffic on a permanently owned station would be too little to guarantee the station working satisfactorily in times of crisis. Also the cost and upkeep of the permanent League station would be very great, as compared with the erection of the station under the Swiss proposal.

This report together with the Swiss proposal was circulated to the members on August 3. At the end of August, the Swiss Government submitted a further memorandum containing even more generous proposals, but also touching on grave doubts as to the possible infringement of the Swiss neutrality by the operation of an independent wireless station on Swiss territory and not under control of the Swiss authorities.

## The Swiss Offer

The Assembly referred the question to the Third Committee when a long discussion took place, the British delegate pointing out that if the League functioned properly, no times of crisis should arise and that there was sufficient expenditure of public money without erecting an independent communication, the efficiency

and urgent need of which was doubtful and the cost would hardly be commensurate with the possible service. The whole question was passed on to a sub-committee consisting of Mr. Paul Boncour (France), Mr. Cadogan (Britain), Mr. Dunning (Canada), Mr. Guerrero (Salvador), M. Sokal (Poland), Mr. Motta (Switzerland).

This committee came to the conclusion that the question was not urgent and that it should be placed on the Agenda of the Tenth Assembly (September, 1929); this would give the overseas governments sufficient time to consider the matter and also would give time for the accumulation of further technical material and data on the operation of the schemes. This proposal was accepted by the Third Committee



The Studio during the League Assembly. Owing to lack of space it is also used as a telephone and telegraph office

with an amendment by Mr. Motta (Switzerland) to the effect that the Swiss Confederation would erect the medium-wave station as this had already been ordered in 1927 and that until the League had come to a decision the Federal Government would attempt to find a *modus vivendi* so that the League would have complete freedom.

The whole was accepted by the Assembly without further discussion.

The League of Nations has thus adjourned the important question of independent means of communication in times of crisis to the next Assembly.

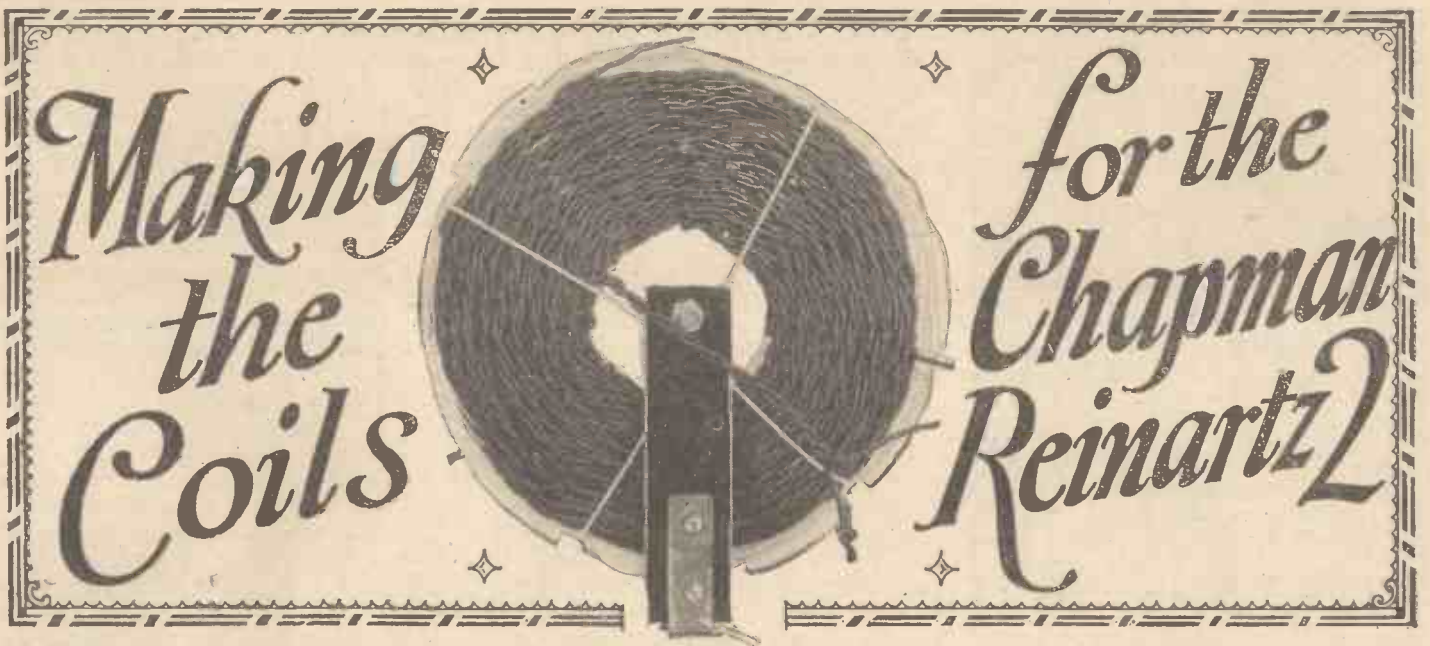

**T**WO of the new type of basket coils are incorporated in the Chapman-Reinartz Two. The smaller coil covers a wavelength range of 240 to 575 metres. The larger coil covers a wavelength range of 650 to 1,800 metres.

Requirements for the construction of the two coils are :—

*Full Constructional Details of the Receiver in which these coils are used were given Last Week when a Free Blueprint of the set was presented with every copy of "A.W."*

lead corresponding to the knotted lead is touched, a click is heard in the phones. When the other lead is touched only a slight scratching noise is heard. The identified end of the lead is then knotted, and this flex lead, knotted end to knotted end, used as the aerial-earth coil.

For the broadcast-band coil 12 ft. of the

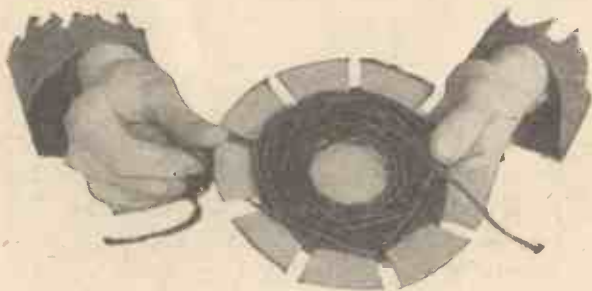

Two photographs of the "flex" coils in course of winding



Two sets of cardboard discs cut to the shape and measurements given in the blueprint and reproduced on the opposite page.

54 1/2 feet twin-lead bell flex (not electric-lighting flex).

198 feet No. 22 d.c.c. wire.

6 inches threaded brass rod with ten nuts.

In some makes of flex, one lead is distinguishable from the other by a coloured thread running through one lead. Where no such distinguishing thread is to be found, a knot should be tied in one lead of the flex at one end, and the corresponding lead identified and knotted at the other end of the flex. Fig. 1 shows how this identification can be made easily and quickly with the aid of a pair of headphones and a small dry battery.

As shown in Fig. 1, one phone tag is placed in a socket of the dry battery. The knotted lead at one end of the flex is placed in another socket of the dry battery. The end of a match may be pushed into this socket in order to get good contact

between flex and socket. A difference in voltage of 1 1/2, or perhaps 3 volts, between the phone-tag socket and the flex socket of the dry battery will prove sufficient.

The free phone tag is then touched lightly on each of the ends of the flex leads remote from the battery. When the

flex and 44 ft. of the 24 d.c.c. wire and the two 6-in. cardboard coil formers are required.

The flex is wound on one of the cardboard discs. The winding is "single basket," under over, under over, done in a clockwise direction. As the flex is being wound on the disc, the different sections of the disc are gradually bent over away from the winder, so that the disc takes a convex shape. When the winding is finished, the disc will have been bent one inch "out of flat."

Next, the d.c.c. wire is wound on the second cardboard disc in similar fashion, single basket in a clockwise direction. This disc is also gradually bent into convex shape as the winding is carried out.

A hole is then cut in the centre of the disc carrying the d.c.c. wire. The brass rod is passed through this hole and the disc secured to the rod by means of two nuts as shown in Fig. 2. Next, another nut is screwed on to the brass rod and placed

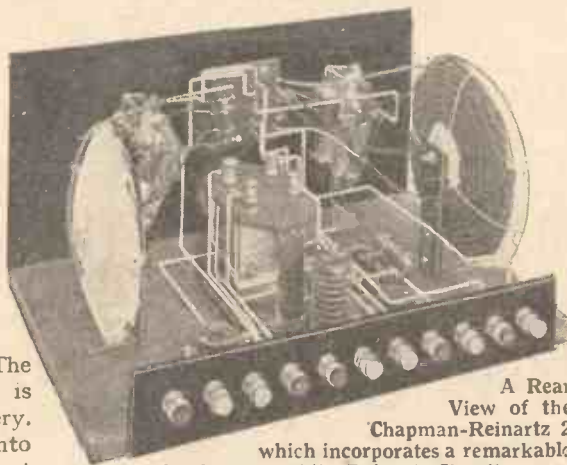

A Rear View of the Chapman-Reinartz 2 which incorporates a remarkable development of the Reinartz Circuit

# MAKING THE COILS FOR THE CHAPMAN-REINARTZ 2' (Continued)

about 2 in. from the two nuts holding the d.c.c. wire disc in position on the rod.

A hole is then bored through the centre of the flex disc which is put on the brass rod, another nut clamping it in position. As will be seen from Fig. 2 the two discs are put on the rod in what might be called a double-convex form.

At a point near to the flex disc, about an inch of the insulation covering of the unknotted flex lead at the outer rim of the flex disc is removed. The outer end of the

coil are tied together by a length of string. This again may not prove necessary and certainly need not be repeated if the coil discs are cut from stout cardboard.

The method of mounting the coil is shown in Fig. 2. The piece of ebonite used was about 3½ in. long and 1 in. wide. A hole is bored through the ebonite at one end to take the brass rod of the double-convex coil. At the other end of the ebonite, two holes are bored for the bolts which hold the ebonite to the small right-

to the switch can also be seen from the full-size blueprint, given away with last week's issue, the connections being:—

Knotted flex lead at outer rim of flex disc to switch point 6.

Knotted flex lead at centre of flex disc to switch point 7.

Other flex lead at centre of flex disc to switch point 8.

Other flex lead at outer rim of flex disc (the lead with the soldered joint) to switch point 9.

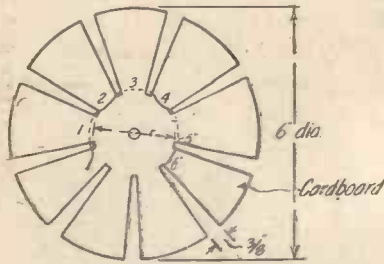

Method of winding D.C.C. wire on short wave coil

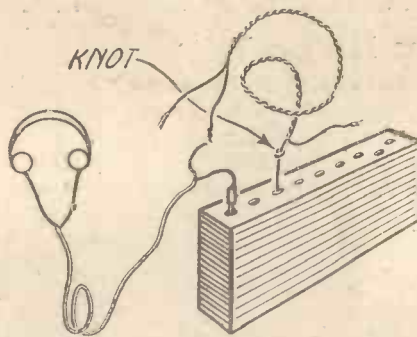
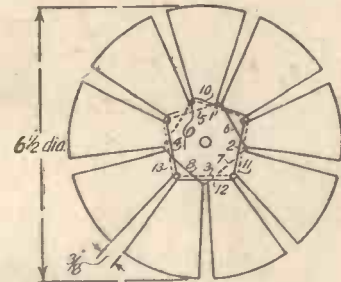

Fig. 1. Method of testing flex connections



Method of winding D.C.C. wire on long wave coil

d.c.c. wire is then soldered to this flex lead at this point (see Fig. 2).

With the two discs mounted in double-convex form in this way, it will be seen that the winding of the double coil is continuous. Starting at the centre of the flex coil, the winding passes to the outer

End of d.c.c. wire at centre of d.c.c. wire disc to switch point 10.

The long-wave coil is made in exactly a similar manner, the two cardboard discs being, however, six and a half inches diameter instead of six. The length of flex required is 40 feet, and the length of d.c.c.

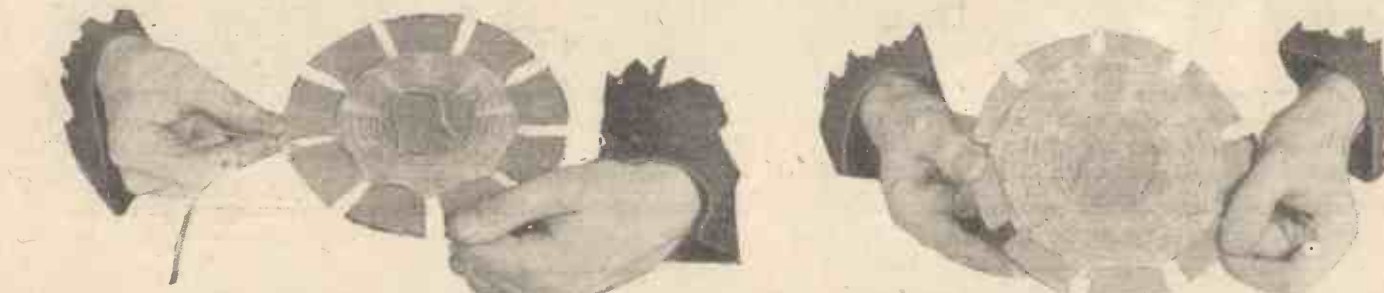

These photographs show the wire being put on the second former

rim of that coil, thence to the outer rim of the d.c.c. wire disc, and thence to the centre of the d.c.c. wire disc.

The soldered joint of the flex wire and the d.c.c. wire is wrapped with electrician's tape. When this is done, the flex coil is turned round in a counter-clockwise direction until the free portion of d.c.c. wire between the two discs is pulled tight. The flex coil is then secured in position by a fourth nut on the brass rod as shown in Fig. 2.

This coil as thus constructed, can be seen in the photograph in the heading. It will be noticed that, in this photograph, a few turns of the d.c.c. wire are to be seen on the flex disc. This is merely a matter of convenience in the construction of the writer's own coil. It will also be noticed from this photograph that the two discs of this

wire, 150 ft. No. 26 wire being used.

Double-basket winding is employed for both the discs in order to get all the wire on. With this type of winding the wire is taken from one slot to the next but one in the disc each time. This long-wave coil is mounted in similar fashion and connected to switch points 11, 12, 13, 14, and 15 (see blueprint).

When the lever of the switch is to the left the broadcast band coil is in circuit. With the switch lever to the right, the long-wave is in circuit.

Will readers note that in the blueprint given away last week the diameter of the "hub" of the coil former was given as 1 in.; this measurement refers to the radius.

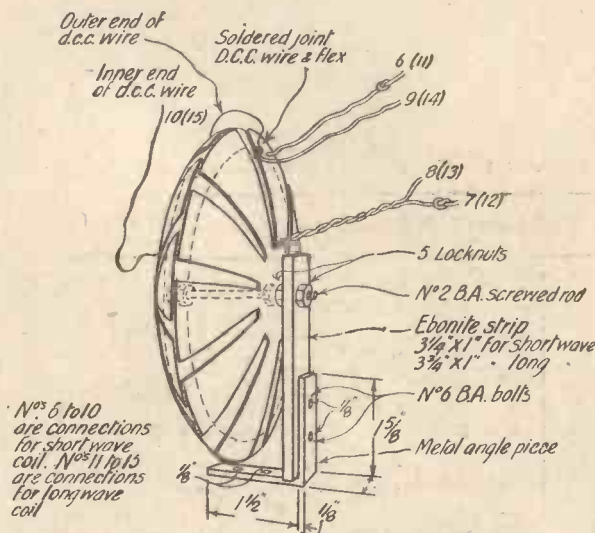
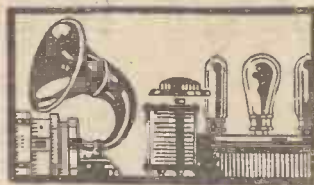

Fig. 2. Constructional details of coils

**NEXT WEEK:**  
**MORE ABOUT THE**  
**"CHAPMAN-REINARTZ 2"**



# PRACTICAL ODDS & ENDS



## A Useful Fitting

THE photograph shows a simple metal support which is designed for use as a baseboard-mounting adapter for panel-mounting rheostats and other similar components.

It consists of an inverted "T" piece,



A Useful Baseboard-mounting Adapter

the foot being bent to right-angles and screwed to the baseboard, with the rheostat attached to the upper part of the vertical arm. Amateurs who make these or similar fittings should note that the lower part of the arm is "ribbed" in order to add strength at the point where the strain is greatest. Such an operation calls for a press and special tools, but an efficient substitute for the rib may consist of a short

length of split brass rod which should be well soldered to the foot and the arm.

Obviously the device must be perfectly rigid; if the extra support is omitted the idea is usually a failure, unless it is made from very thick material. K. N.

## One Million Volts

SOME idea of the immense energy represented by electricity in bulk, at a pressure of one million volts, may be gained from the demonstrations given in the high-voltage laboratory of the National Physical Laboratory at Teddington. Three transformers in cascade are utilised to build up this high potential. The final "flash-over" takes place across an insulator six feet in length. B. A. R.

are accustomed on this side of the channel.

Opinions may differ as to which method is preferable, but it will be obvious that the French method is, to say the least, convenient, since the coil can be changed with the same ease and rapidity as an ordinary coil, there being no dangling flexible lead

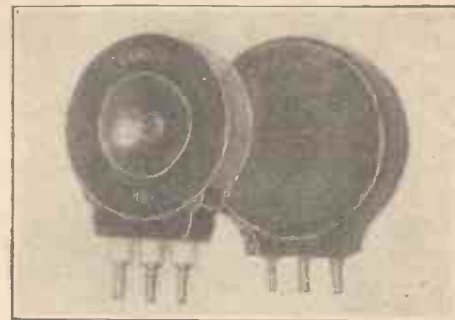

Trouble-saving Centre-tapped Coils

and terminal connection to the centre tapping, but simply a centre pin which engages the centre socket on the coil-holder.

The coil on the left is sold with or without the two ebonite flanges, and the coil on the right is totally enclosed in an ebonite casing, the flanges of which can be unscrewed in order to change the value of the coil if necessary. O. J. R.

## USING A PENTODE IN AN ORDINARY SET

We tell you how to do so  
NEXT WEEK!

## Centre-tapped Coils

THE accompanying photograph of two popular types of French centre-tapped coils illustrates a complete departure from the terminal-tap C.T.C.s with which we

## CERTAINLY A STAIR-ROD FOR AN EARTH—

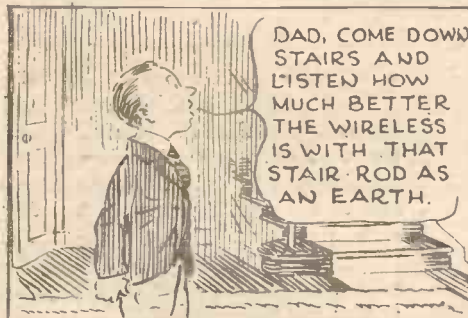

## —SHOULD BE TAKEN FROM THE BOTTOM STAIR!



# WITHOUT FEAR OR FAVOUR



*A Weekly Programme Criticism by Sydney A. Moseley*

A CAPTIOUS friend of mine told me he had found the cutting-out of applause "seriously detrimental to the broadcasts from the Queen's Hall." "Why?" I asked. "The applause was usually cut off after each item," he replied, "but not quickly enough to exclude the initial clap, which must surely be the most dangerous from the point of view of microphonic damage."

In addition to this, he pointed out that the damping down of the clapping and cheering robbed the transmissions of all their atmosphere. "On such an occasion as the last concert of the season," he added, "this damping effect was most regrettable. Instead of being a joyous finale to a brilliant season, in which listeners might have experienced the thrill of hearing the vast Queen's Hall audience clap and cheer, we had a sober, conventional concert, with weird unnatural pauses between the items." To be sure, there was just a tantalising suspicion of the audience's enthusiasm before Mr. Controller ruthlessly stepped in!

Usually, I am dead against being deafened by raucous clapping. Pity the poor earphone listener! Yet, while I do not agree that the applause and general enthusiasm were "almost as important to the listener as the actual music," perhaps on this special occasion a point might have been stretched. Besides, I am already deaf in one ear. However, the whole thing came over very well and the reception was excellent. So there you are!

Sir Thomas Beecham gave an illuminating talk on the aims and ambitions of the Imperial League of Opera. Good propaganda, Tommy!

It was with a slight sensation of sheepishness that we learned that Vienna spends on opera some £100,000 yearly—this sum being provided by the State. Berlin opera is also subsidised to the extent of some £50,000 or £60,000 annually. . . . Now, if it were a matter of a warship. . . . However, let us help Sir Thomas:—

For the small sum of 10s. yearly, the Imperial League of Opera will give England that which her musical soul hungers for—national opera. Perhaps the B.B.C. might look into this. As was pointed out, the educational value derived from listening to the best operas is almost as great as that obtained from listening to Mr. Stobart!

But what did Tom mean when he declared that fundamentally there was little difference between Gilbert and Sullivan and Mozart?

Seriously though, the talk was most interesting and must have especially appealed to those who snatched the rare chance of attending Covent Garden during its too brief season. We do want an institution like the Imperial League of Opera, and I hope we get it. Pity we haven't had it before now.

I have had occasion in the past to bemoan the poor and inferior plays which the B.B.C. have persistently offered to us. On many occasions they have fallen far short of the entertainment standard which they ought to reach. There have been exceptions to the rule, and I have not been backward in offering my appreciation.

The other night I listened to *The Betrothal*, by Maurice Maeterlinck. I can without hesitation say that both *The Betrothal* and *The Blue Bird* (to which the first-named is a sequel) are the best plays I have heard broadcast.

You'd think that a Maeterlinck theme would be difficult to put over and that this was the reason why penny novelettes with "ever so nice" plots are preferred by the

dramatic department. The broadcasting of *The Betrothal* disproves this.

Atmosphere and tone came over extremely well; the high treble of the children's voices, as well as the incidental music, gave the transmission a special charm.

In contrast, too, with the language of the average broadcast play, the purity and simplicity of Maeterlinck's lines are a delight to hear. This is the standard which "Programmes" should endeavour to retain.

Thus my provincial correspondent:—

"The B.B.C. deserve praise for the way in which they keep Sunday free from frivolous music, but I don't see why it should cram so much religion into the broadcasts. I think even the most religious man does his praying in the morning and settles down in the afternoon to some mild form of entertainment. Yet the B.B.C. insist on handing out religion in large quantities during Sunday afternoons. Take this programme for example:—

- 5.15 Missionary Talk.
- 5.30 Reading from *Pilgrim's Progress*.
- 5.45 Church Cantata.

This goes on into the evening transmission. For instance:—

- 8.0 Service.
- 10.30 Parables.



FROM MELBOURNE

Ned Tyrell and his Radi-O-Aces who provide the rhythm for thousands of dancing listeners to 3 LO Melbourne

# The SCREEN-GR



MANY readers have asked for details of a set utilising "Q" coils with screen-grid valves. Suitable circuits for such purposes have been given in previous issues, but an actual receiver has not hitherto been described. This delay has been deliberate, the publication of a suitable receiver being held up until the new types of

screen-grid valves were available. In a previous article I intimated that the new single-ended types of screen-grid valve were definitely superior to the triode in point of amplification. During the latter part of the summer I conducted a number of experiments with "Q" coils in conjunction with the newer types of valve, and the results were so encouraging that it was decided to wait until these valves were available to the general public before describing a screen-grid "Q"-coil set.

The present receiver is positively amazing in its performance. Although I had a good idea as to the results which would be likely to be obtained, I was not prepared for the exceptional results which were obtained on test. The signals on an ordinary outside aerial were over-poweringly loud and the

aerial was, in consequence, removed at the lead-in insulator, leaving merely a length of 12 ft. of lead-in wire on which to pick up the signals. The earth lead itself was not more than 4 ft. in length, so that the total length of aerial and earth was only 16 ft.

Despite this limited collector, however, over 25 stations were obtained at full loud-speaker strength. Langenberg, indeed, could be picked up at comfortable loud-speaker strength on the 4 ft. earth lead alone, while the replacement of the ordinary power valve in the last stage with a pentode caused the signals to fill the room comfortably. Any reader who feels inclined, therefore, may, if he wishes, use a pentode instead of a normal power valve in the last stage.

### The Circuit

The circuit of the receiver is shown by Fig. 1. It is straightforward in character, its principal feature being that "Q" coils are employed so that both wave bands may be received without any coil-changing. It should be noted that, owing to the use of the series-parallel switching on these coils, there are no dead-end effects and an efficient inductance is obtained on both wave-bands. Moreover, the astatic properties of the coil on the short-waveband are of considerable value, for a simple screen only suffices to keep the receiver under

perfect control, despite the high value of amplification which is obtained.

The grid circuit of the H.F. valve contains a simple tuned circuit, the aerial being coupled direct to the grid through a small pre-set condenser having a maximum value of .00015-microfarad and a minimum value of about .00005-microfarad (50-micro-microfarads). This method of coupling gives a very convenient control of the selectivity, for, as the value of the aerial condenser is decreased, the selectivity is progressively increased. There is a certain sacrifice in signal strength, but the

DESIGNED BY

amplification is so large that this is rather an advantage than the reverse. In any case, I would recommend the use of a small aerial only with this receiver, as the

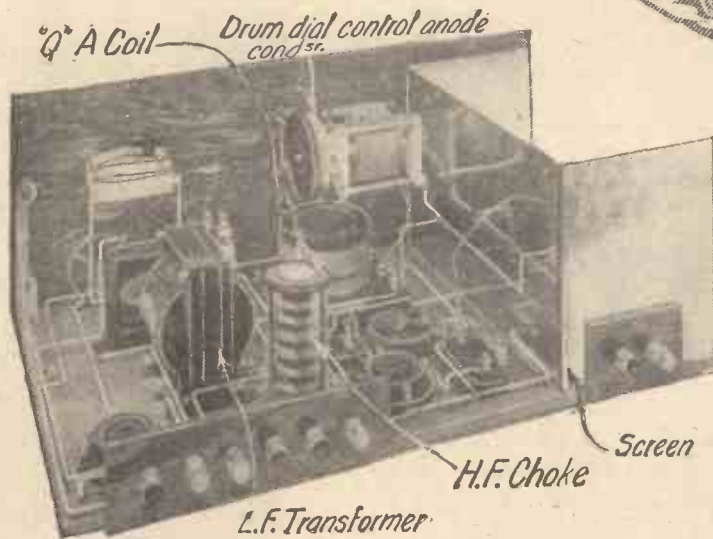
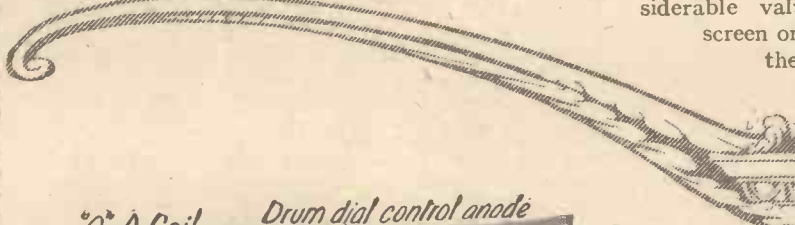

The Layout is quite Straightforward

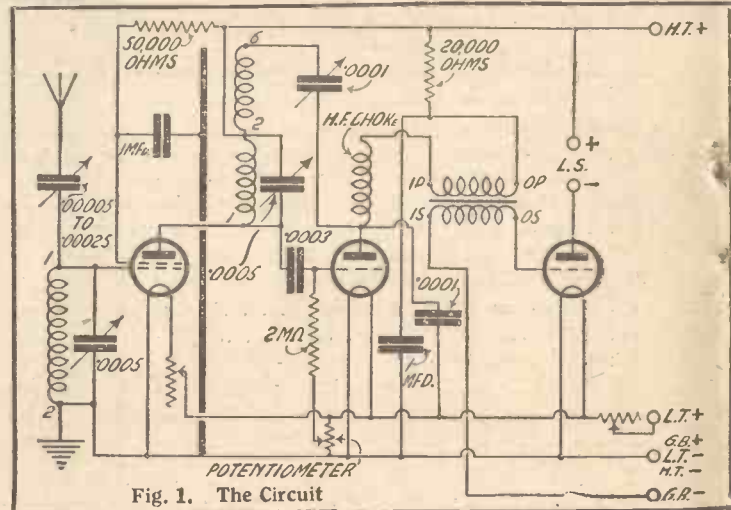

Fig. 1. The Circuit



# ID "Q" COILS

results will be found to be all that is desired.

Using the aerial system already referred to, Karkov, in Russia, was obtained on the loudspeaker in daylight, which is sufficient indication that the range of the receiver is not seriously impaired by the use of a short aerial.

A plain tuned-anode system is adopted to couple the H.F. valve to the detector. This in turn is followed by a transformer-coupled L.F. stage, capacity-controlled reaction being applied to the detector valve.

The voltage to the detector is obtained from the full H.T.

**J. H. REYNER** tapping through a resistance-capacity filter. Thus there is only one high-tension tapping, for the voltage to the screen-grid of the H.F. valve is obtained in a similar manner by breaking down

the H.F. voltage through a resistance.

This method is a convenient one, but appears to cause a little doubt in the minds of some readers, who are not quite clear as to how there can be any voltage drop on the resistance. The screen-grid, however, takes quite an appreciable current (between 1 and 2 milliamps, as a rule), so that there is a considerable voltage drop on the resistance in the lead to the screen-grid from the H.T. battery. What is more, the presence of this resistance gives an automatic regulation of the voltage on the screen-grid itself. As the voltage on the anode of the valve rises, so the anode current proper increases slightly and the screen-grid current decreases, the sum of the two currents being approximately constant. Since the screen current has decreased, the voltage drop on the external resistance will also decrease so that the voltage on the screen will rise. This is what we require for the best working conditions so that the resistance-feed method provides us with a more or less automatic adjustment of the setting.

It is essential to connect a condenser from the screen to L.T. in order to by-pass any high-frequency currents which may flow in the screen circuit. It is particularly desirable that this condenser should be of high quality, and it should preferably be of a non-inductive type. Thus a mica condenser of large value is desirable, or, alternatively, a paper condenser may

be used, provided it is made in a non-inductive fashion. Actually, a Polymet condenser has been utilised in this instance.

The layout of the receiver is straightforward. A drum-drive condenser has been employed for the second (tuned-anode circuit) condenser, and in order to obtain sharp tuning it has been made of the slow-motion type. The aerial circuit is not critical, and has, therefore, been provided with a small knob only. On the right-hand side of the set there is a reaction condenser, the knob of which matches the aerial control on the left-hand side. Along the bottom of the panel we have the two "Q"-coil switches and the master rheostat. It was not found desirable to link the two coils in this instance, so that the two switches have been brought out independently to the front of the panel.

The H.F. portion of the circuit is screened on each side and at the bottom, this giving effective shielding and avoiding any interaction whereby instability might be set up. There is one precaution which may be observed in this connection, and this relates to the valve holder in use. If the type of



## LIST OF COMPONENTS

Cabinet (Miscellaneous Trading Co.)  
 Ebonite or bakelite panel, 18 in. by 7 in., and two strips, one 7 in. by 2 in. and one 3 in. by 2 in. (Trolite, Ebonart, Pertinax, Becol, Raymond).  
 .0005-microfarad variable condenser (Bowyer-Lowe, Log-minor, Formo).  
 .0005-microfarad variable condenser thumb-control type (Bowyer-Lowe).  
 .0001-microfarad reaction condenser (Bowyer-Lowe Elfin, J.B. Cyldon).  
 7-ohm rheostat (Lissen, G.E.C., Igranic).  
 Two "Q" aerial coils (Lewcos, Wearite, Finstone).  
 Three anti-microphonic valve holders (W.B., Formo).  
 7-ohm baseboard-mounting variable resistance (Burton).  
 Formodenser, .00025 maximum, .00005 minimum (Formo).  
 1-microfarad fixed condenser (Hunt's "Polymet").  
 50,000-ohms anode resistance, with holder (Lissen, Graham-Farish, R.I. and Varley, Ferranti, Dubilier).  
 .0001-microfarad fixed condenser (Dubilier, Hunt's "Polymet," Lissen, Graham-Farish).

.0003-microfarad fixed condenser, with series clip (Dubilier, Hunt's "Polymet," Lissen, Graham-Farish).  
 2-megohm grid leak (Dubilier, Hunt's "Polymet," Lissen, Graham-Farish).  
 400-ohm baseboard-mounting potentiometer (Lissen, Igranic).  
 High-frequency choke (R.I. and Varley, Lewcos, Wearite, Polar, Burndepl).  
 20,000-ohm anode resistance, with holder (Lissen, Graham-Farish, R.I. and Varley, Ferranti, Dubilier).  
 2-microfarad fixed condenser (Ferranti, Dubilier, Hunt's "Polymet," Lissen).  
 Low-frequency transformer (Ferranti, R.I. & Varley, B.T.H., Lissen, Igranic, Ediswan).  
 One panel bracket (Peto-Scott, Bulgin, Camco).  
 Eight terminals marked: Aerial, Earth, L.T.+, L.T.—, G.B.—, H.T.+, L.S.—, L.S.+ (Belling-Lee, Eelex, Igranic).  
 Baseboard, 18 in. by 10 in. (Pickett).  
 Connecting wire (Glazite).  
 Copper screen and foil (for size see drawing) (Parex).

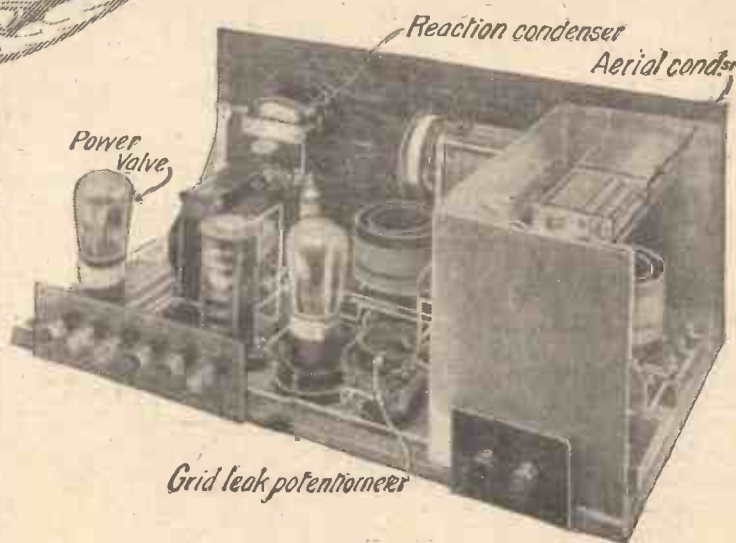

Construction is not Difficult

# "THE SCREEN-GRID 'Q' COIL 3" (Continued)

valve holder employed is of such a nature as to permit the valve pins to project right through the valve holder, then there is a

The drum-control condenser, the reaction condenser, and the master rheostat may now be mounted on the panel. The panel should then be placed in position, when the screen on the left-hand side will come up against the left-hand portion of the panel. The aerial tuning condenser may then be mounted in position. The "Q"-coils should then next be placed in their appropriate positions and the switch spindles pushed through from the front of

be placed in the positions shown. Little difficulty will be experienced in this connection, and no further comment is necessary.

The wiring up of the receiver may be accomplished by following the wiring diagram provided. Those who wish may obtain a full-size blueprint (price 1s. od., post free) from these offices. There is a slight difficulty in obtaining access to the fixed plates, on the drum-drive condenser, and it is advisable, before commencing wiring, to connect a flex lead to this terminal, this being subsequently connected to terminal No. 1 on the second "Q" coil. All other leads are easily accessible and no difficulty will be experienced.

A baseboard-mounting resistor has been included in the filament lead of the H.F. valve. This enables this valve to be switched out completely, if desired, when the detector and L.F. stage may be used for gramophone work with a suitable adaptor, if the user wishes. The rheostat, however, may be omitted, if necessary, without any detriment to the circuit. The volume of sound from the receiver is controlled by

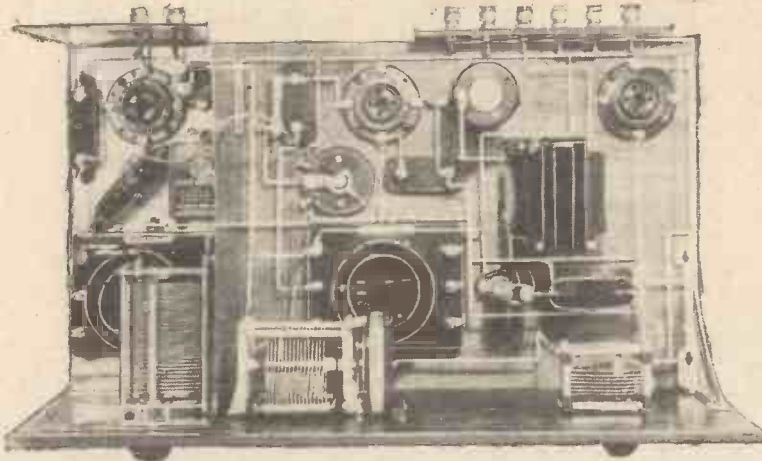

This plan view shows clearly the layout

danger that the pins may make contact with the copper screen underneath the valve holder if the valve is pushed in too

far. Having registered the position of the spindles, the coils may be screwed down and the change-over may be tried

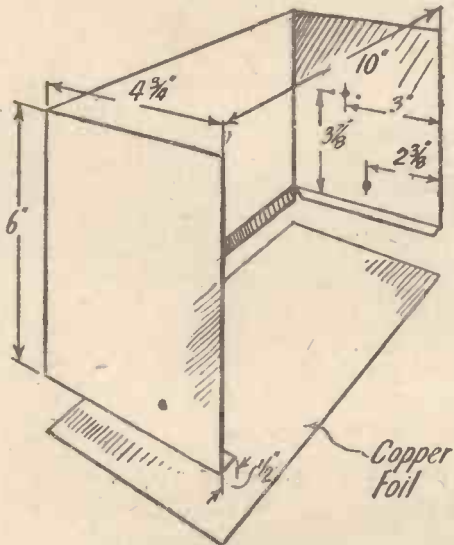

Details of Screening

far. This may result in damage to the valve, and it is desirable, therefore, to insert a sheet of paper underneath the valve holder to protect the valve from any such happening.

The components required for the construction of the receiver, are given on page 669.

In the construction of the receiver, the panel should be first drilled and cut in the manner shown in the wiring diagram, a large hole being required in the centre for the drum-drive, and holes drilled at the side and the bottom for the remaining controls. It should be pointed out that if any reader wishes to use an ordinary condenser in place of the drum-drive he can do this without any detriment whatever to the circuit.

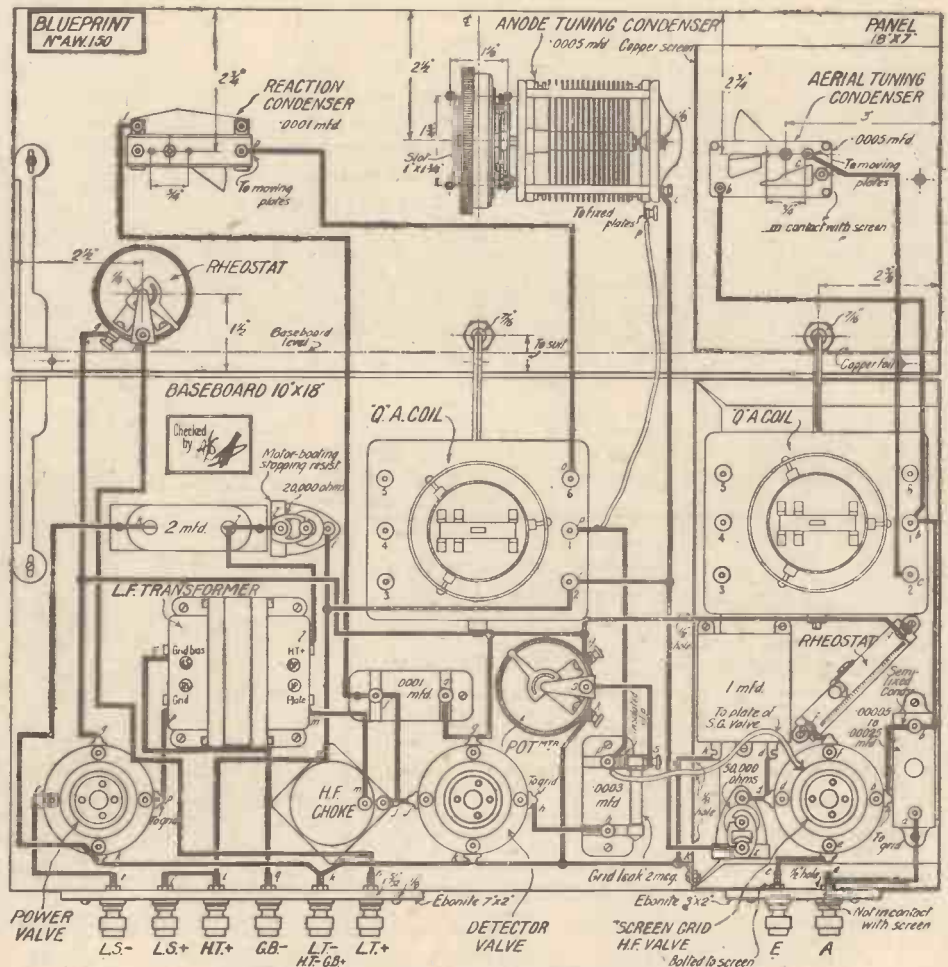

The Wiring Diagram: Blueprint available, price 1/-

once or twice to make sure that the switches are operating satisfactorily. The remaining components should then

varying the master rheostat. This may appear a little unconventional, but in (Continued at foot of page 672)

# Lissen consider that you know best —

*and believe you want to be free to choose your own parts for good reasons*

You do not want to be tied down to a kit of parts on the minor recommendation that they give you ease of assembly, when you know that by substituting Lissen parts you will not only get ease of assembly, but better results at less cost. Think of the advantages of using Lissen parts, too, when you come to alterations and improvements in your set. Then it is you will congratulate yourself that you had the initiative to use Lissen parts instead of those others which were specified, for Lissen parts are standard components which you can move about in any circuit and in any way.

You will save money by using Lissen parts instead of any other—Lissen have adopted a value-for-money policy which has become an unchallenged standard. The Lissen range is now complete. Let your friends build with specified parts, but you build with all Lissen parts—then compare results and let your friends see how much money you have saved and how much better your set is.

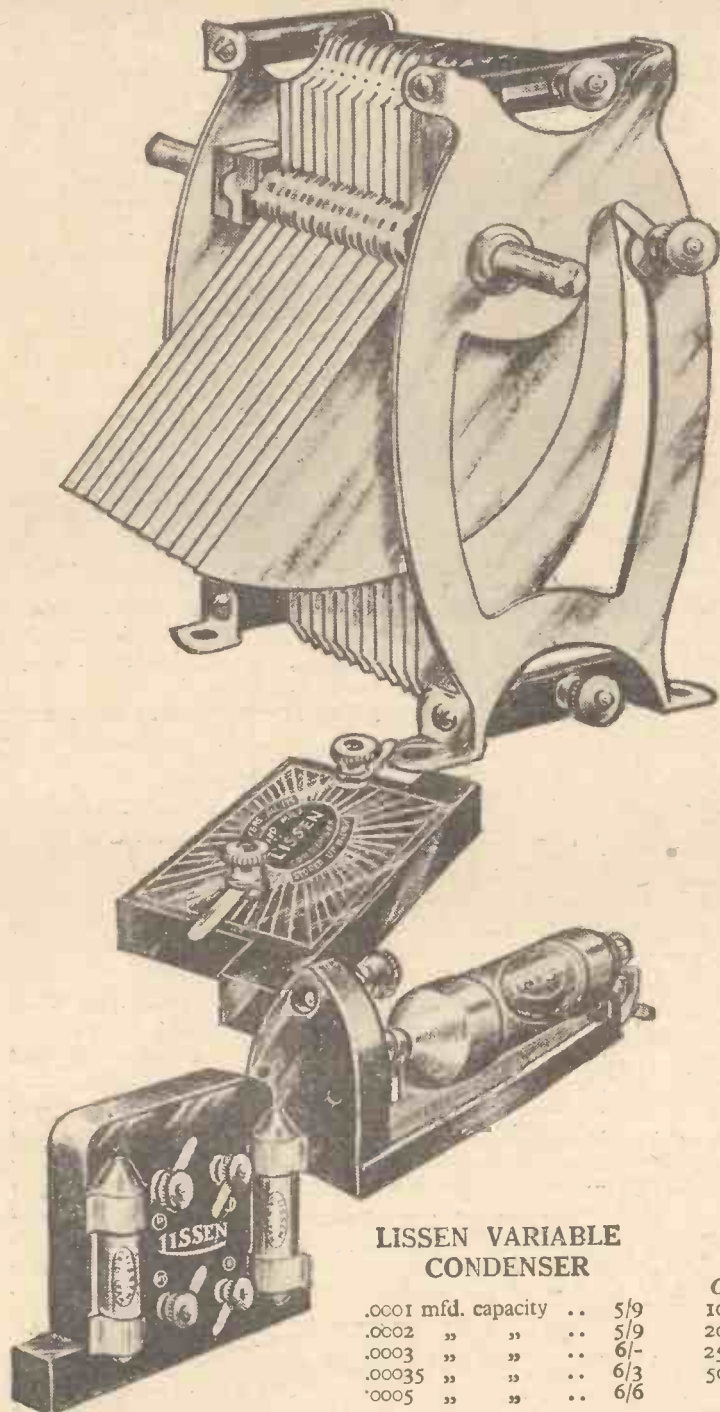

## LISSEN COMPONENTS

### LISSEN VARIABLE CONDENSER

.0001 mfd. capacity	..	5/9
.0002 " "	..	5/9
.0003 " "	..	6/-
.00035 " "	..	6/3
.0005 " "	..	6/6

### LISSEN WIRE-WOUND RESISTANCES

The Resistances are made in the following values:

Ohms	Price	Ohms	Price
10,000	.. 3/6	80,000	.. 4/-
20,000	.. 3/6	100,000	.. 4/6
25,000	.. 3/6	150,000	.. 5/6
50,000	.. 3/6	200,000	.. 6/-
		250,000 ohms	.. 6/6

### LISSEN FIXED CONDENSERS

Deliver all their stored-up energy.

.0001 to .001	..	1/- each
.002 to .06	..	1/6 each

### LISSEN R.C.C. UNIT

Provides a complete Resistance Capacity Coupling Unit. Includes 2 LISSEN Fixed Resistances and 1 LISSEN Condenser. May be mounted upright or flat. **4/-**

**Lissen Ltd., Friars Lane, Richmond Surrey**

(Managing Director: THOS. N. COLE)

*You will Help Yourself and Help Us by Mentioning "A.W." to Advertisers*



MISS MARGARET BONDFIELD, the Member for Wallsend, will describe "A Woman M.P.'s Day" from 2LO on November 8.

Gracie Fields will be before the microphone in a vaudeville programme on November 12, when Ronald Frankau, Claudie Coleman (the American disease), and Doris and Elsie Waters will also be heard.

A. J. Alan, the story-teller, will be heard on November 12. He will narrate a new story, entitled "Wottio."

Donald Calthrop, assisted by Ambrose Manning, Frederick Cooper, and other well-known wireless artistes, will broadcast on November 1 a new sketch, entitled *Wo Soy Ombre*.

A strong vaudeville programme has been arranged for broadcasting from 2LO and 5XX on November 7; it includes Kathleen Hamilton, whose impersonations of people she had never heard and never seen attracted considerable attention on her first appearance before the microphone

some three weeks ago. John Henry and Blossom, Sandy Rowan, Cyril Shields (The Wizard) and Jane Brazine (a French soubrette) will contribute to the entertainment.

Listeners to the Newcastle station on November 3 are to hear Arthur Prince and his sailor boy Jim.

On the occasion of the Lord Mayor's Banquet, to be held at the Guildhall on November 9 at 9.15 p.m., listeners to 2LO and 5XX will hear the Prime Minister's speech, which is given annually at this function.

A special remembrance festival which is taking place on Armistice Day, which falls on a Sunday, will be relayed from the Albert Hall to 2LO, 5XX, and all B.B.C. stations, with the exception of 5GB, from 9.5 to 11 p.m. Dr. Malcolm Sargent will conduct, and the bands of the Coldstream and Welsh Guards will take part. Daventry Experimental (5GB) will broadcast its own Armistice Day concert, concluding at 10.30 p.m. with an Epilogue.

The short-wave transmitter recently reconstructed at Motala will, within the course of the next few days, resume its transmissions on a wavelength of 48.5 metres, when it will simultaneously broadcast the Stockholm programmes.

The Copenhagen programmes are now nightly being relayed to the Kalundborg high-power transmitter (1,680 metres) and to the old Soro station, which is again working on 1,153.8 metres.

Now that the Oslo Broadcasting Company has gathered into its net a number of smaller transmitters in Norway, it has decided to construct in the immediate neighbourhood of the Norwegian capital a super-power transmitter in order to cover the greater portion of the country. This station, which is expected to be ready for work towards next spring, will, it is stated, possess an aerial power of some 60 kilowatts.

Relays from towns so far unacquainted with the "mike" are being carried out in Scotland. These O.B.'s arouse great interest in the districts concerned and, at the same time, provide something different from the ordinary programmes. The latest town to be visited in this way was Dunfermline, from which a concert, organised by the local Rotary Club, was transmitted.

Czecho-Slovakia is to acquire two new broadcasting stations. Work on a new station at Prague, which will be one of the most powerful in Europe, will begin early in the spring.

## "THE SCREEN-GRID 'Q'-COIL 3" (Continued from page 670)

practice it operates satisfactorily. The screen-grid valve is quite critical to changes of filament voltage and it was found on actual test that no distortion was introduced by slight reduction of the voltage on all filaments, while the volume could be completely controlled.

When the wiring of the receiver has been completed and carefully checked over, the receiver is ready for use. The L.T. terminal should be connected to a 2-, 4-, or 6-volt battery, according to the valve to be used. The H.T. should be connected to 120 volts, while 9 volts grid bias should be employed on the last valve. The valves in use should be a standard screen-grid valve for the H.F. stage, a medium impedance for the detector valve, and a suitable power valve for the last stage. Specific recommendations will appear in the valve chart to be given next week.

In tuning, it is simply necessary to set the centre dial to the approximate position given in the test report and to rotate the aerial condenser until the loudest signals are obtained. If the signal is a distant one, it may be desirable to increase the strength somewhat by judicious application of reaction, but in quite a number of cases it

### TEST REPORT

All stations received on loud-speaker on small aerial—total length, 16 ft., including earth lead.

#### LONG WAVES

Dial Reading	Station	Wave-length
73	Huizen ... ..	1,900
63	Radio-Paris ... ..	1,780
59	Kharkov ... ..	1,700
53	Daventry ... ..	1,604
29	Konigswusterhausen ... ..	1,300
19.5	Hilversum ... ..	1,070

#### SHORT WAVES

98	Laibach (?) ... ..	580
91	Budapest ... ..	555
88	Sundsvall ... ..	545.6
84	Munich ... ..	536.6
78	Riga ... ..	526.5
69	Daventry 5GB ... ..	491.8
64	Langenberg ... ..	471.6
61	Oslo ... ..	461.5
54	Fredriksstad ... ..	435.4
50	Frankfurt ... ..	429
44	Hamburg ... ..	396
42	Unidentified (Belgian) ... ..	389
39.5	Stuttgart ... ..	379.5
37	London ... ..	361.4
30	Barcelona ... ..	345
26	Breslau ... ..	322.2
21	Radio Vitus ... ..	299.9
19	Cologne ... ..	283
17	Dresden ... ..	274.9
10	Toulouse ... ..	245.7

will be found that the stations are received at full volume without any reaction control. In any case, it is a matter of extreme simplicity to pick up a large number of stations and after having become accustomed to the receiver the reader should adjust the value of the pre-set condenser in the aerial lead until the requisite selectivity is obtained. There will then be little difficulty in picking up numerous stations; probably many more than those given in the brief test report.

Changing over from one wave band to the other is a matter of the greatest simplicity, it being merely necessary to throw the two switches over to the right for short waves and to the left for long waves. This completes all that is necessary for the wave-changing operation and no further adjustment is necessary.

America is going to make a strong bid for the control of trans-Pacific wireless communication, which is regarded as of utmost importance to the American marine and foreign trade interests. The International Telephone and Telegraph Corporation proposes to erect before the end of the year five wireless stations to link the United States with the Far East.

**EACH NOTE  
STANDS OUT**  
*with stereoscopic  
clarity*

With a new *Super Transformer*, Lissen has solved the problem of amplifying song and speech and music—it amplifies in a background as silent as the night. Out of this utter silence comes each note sharply defined and true—the deep bass notes with their full depth retained, the high notes pure and true. Not only fine amplification at the beginning, but an amplification which remains true for all time.

Whenever there arises the need for using a superlative transformer, think of this **SUPER LISSEN**. You can bring your existing amplifier up to date or improve any published circuit you are building to by using the Super Lissen Transformer in place of any other.

**LISSEN**  
*SUPER*  
**TRANSFORMER**

This Super Lissen Transformer is made in two ratios, 3½ to 1 and 2½ to 1. The 3½ to 1 is suitable for use in either the first or second stage of an L.F. amplifier, or can be used in cascade for both stages and with practically any valve. The 2½ to 1 transformer is suitable for use after a high impedance rectifier valve without fear of distortion or loss of high notes and overtones. The price is the same for both ratios. 19/-

*The FAMOUS 8/6 LISSEN*  
**TRANSFORMER IS STILL SUPREME**

and will never break down.

The famous 8/6 Lissen Transformer is suitable for all ordinary purposes, and its huge sale proves it still supreme value.

Turns ratio, 3 to 1. Resistance ratio, 4 to 1. Price 8/6

*Obtainable from all Radio Dealers.*

**LISSEN LIMITED,**  
Friars Lane, Richmond, Surrey.

*(Managing Director: THOS. N. COLE.)*



# W. James on— VOLUME CONTROL



MODERN receivers, as a rule, provide far too much magnification for the satisfactory reception of the local station. This is because a receiver is invariably so designed that it will bring in two or three

reasons the most frequently used controls are barely satisfactory.

Let us consider, as an example, a receiver without high-frequency stages. We will assume it to have the usual type of aerial circuit and reaction, as in Fig. 1, where  $C_1$  is the aerial tuning condenser and  $C_2$  the reaction condenser. Now let us imagine the set to be tuned to the local station and that the volume is excessive. How may we reduce it?

Leaving the aerial tuning condenser properly adjusted so that the aerial circuit is in tune with the station being received, the reaction condenser  $C_2$  may be varied in order to weaken or, for that matter, strengthen the reproduction. As the capacity of the condenser  $C_2$  is reduced, the reaction effect is decreased and, as a result, volume is cut down.

But when the reaction condenser has a fairly large value such

more. The actual effect depends, of course, upon the value of the anode resistance. If this is a resistance of say 250,000 ohms, there will be a distinct reduction in the relative value of the higher notes as the condenser is varied from its minimum to its maximum value. But when the anode resistance is of only 100,000 ohms, the effect of altering the value of the shunting condenser will be less marked.

Similarly, when an intervalve trans-

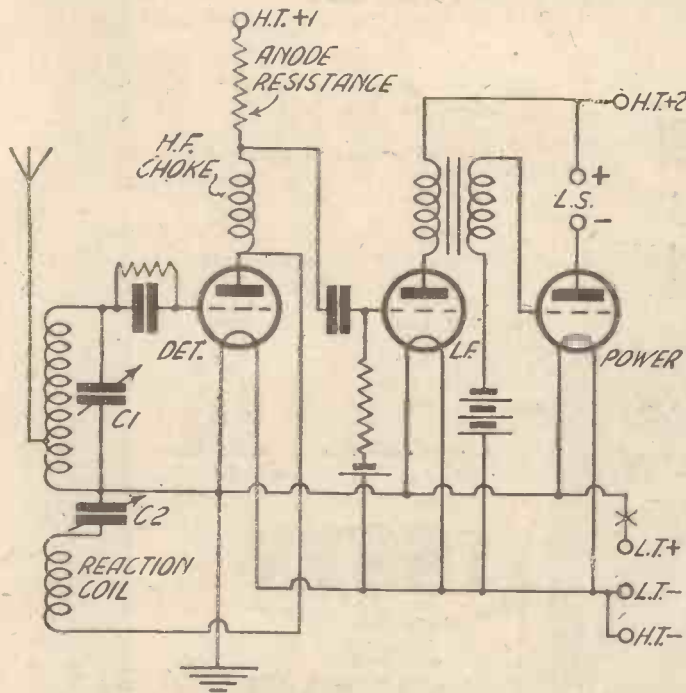

Fig. 1.—A Typical Three-valve Circuit

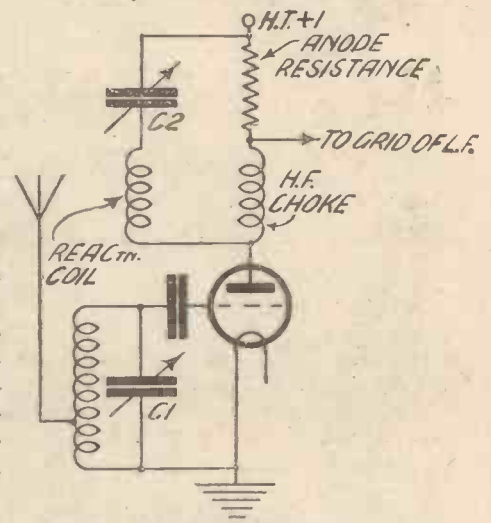

Fig. 2.—Detector Circuit of Fig. 1 redrawn to show effect of Condenser  $C_2$

distant stations in addition to the local one. As a result, therefore, of the large amount of magnification provided in order that distant stations may be heard at comfortable strength, the volume produced by the local station when the receiver is correctly tuned is excessive.

### Methods of Volume Control

Too much volume is undesirable as it probably means that one or more of the amplifying valves are being grossly overloaded, with the result that the quality of the reproduction is likely to be far from satisfactory. Further, there are many occasions when only a moderate output of sound is desirable, depending upon the nature of the broadcast.

Comparatively few receivers are provided with adequate means of controlling volume. Obviously a good strength control should not, of course, interfere with the tuning, neither should it alter tone, and for these

as .0005-microfarad, two other effects are produced. In the first place, as the value of  $C_2$  is reduced the selectivity of the aerial circuit is altered, the tuning is made broader and a more even response of the whole range of musical frequencies is obtained.

The second effect is due to the fact that the reaction condenser  $C_2$  is across the anode circuit of the detector valve, as will be seen from Fig. 2. Now, a condenser connected across the anode circuit affects the strength of the higher notes, for as this condenser is increased in value the higher notes are weakened more and

former is employed the quality will change according to the value of the shunting (Continued on page 690)

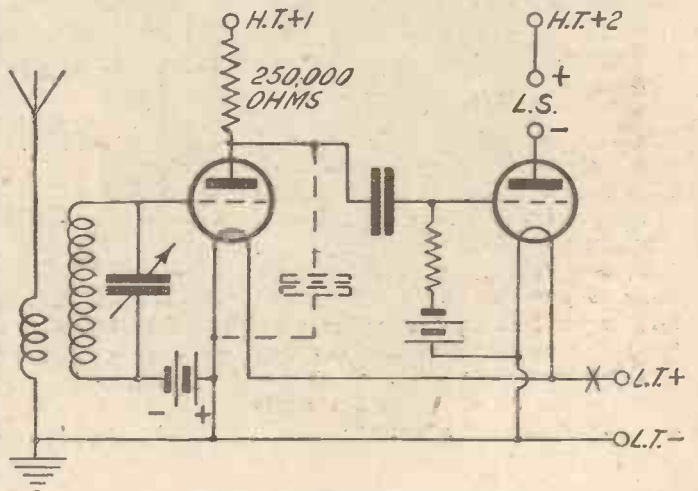

Fig. 3.—An Experimental Circuit



# Build it this evening and get 27 stations tonight

— the amazing

# Osram

## MUSIC MAGNET 3 VALVE CIRCUIT

Using **ONE DIAL TUNING** and without changing coils

**WRITE TODAY FOR FREE INSTRUCTION CHART**

**NOTE**—the simplicity of the circuit, the simplicity of the single-dial tuning, and that no changing of coils is needed.

**NOTE**—the price, £6 5s. 9d. for the parts and £2 5s. 6d. for the **OSRAM VALVES**.

**NOTE**—the performance, the 3-valve circuit with a 5-valve result.

—AND MAKE A NOTE to write for the **INSTRUCTION CHART TO-DAY.**

**Remember!** The **OSRAM MUSIC MAGNET** is designed for only

**OSRAM VALVES**—  
OSRAM SCREEN-GRID S215,  
OSRAM HL210 and  
OSRAM DEP215 or DEP240

**6 POINTS**

1. SINGLE TUNING CONTROL
2. NO CHANGING OF COILS.
3. One hour to make.
4. No soldering.
5. Gets 27 stations.
6. No interference with your neighbours through oscillation.



ALL PARTS MADE IN ENGLAND  
Sold by all Wireless Dealers

**COUPON**

To The General Electric Co., Ltd.,  
Magnet House, Kingsway, London, W.C.2.

Please send the **OSRAM MUSIC MAGNET** Instruction Chart to:

Name \_\_\_\_\_

Address \_\_\_\_\_

A.M.

Advt. of The General Electric Co., Ltd., Magnet House, Kingsway, London, W.C.2

To Ensure Speedy Delivery, Mention "A.W." to Advertisers

# "A.W." TESTS OF APPARATUS

Conducted by our Technical Editor, J. H. REYNER, B.Sc.(Hons.), A.M.I.E.E.

## Tonex Tuner

THE old-fashioned all-wave tuner suffered from the disadvantage of being particularly unselective. Nowadays this is not the case, however; modern all-wave tuners have been carefully designed to give a satisfactory degree of selectivity.

A high-class all-wave tuner called the Tonatuna marketed by the Tonex Co., of Walker Street, Blackpool, has been submitted for test and report. Both the high- and low-wave windings of this instrument are placed on a 3 1/2 in. insulated former, so shaped that the windings are held away from contact with it. In order to provide

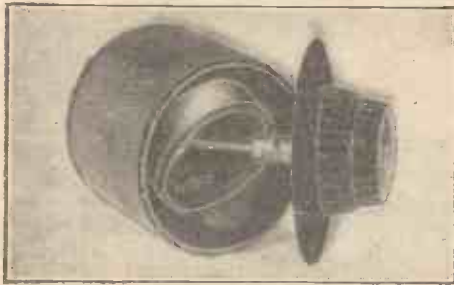

Tonex Tonatuna

a satisfactory degree of selectivity the winding is suitably tapped for connection to the aerial. A reaction winding is placed on an internal former capable of rotation from maximum to minimum coupling positions; this former is controlled by a large 4 in. dial, whilst an insulated knob, concentric with the dial, controls the switch over from one wavelength range to another. In the short-wave position, the long-wave winding is short circuited.

Tested in a circuit made up from the simple directions provided with each tuner, the instrument gave good results. With a .0003-microfarad condenser connected across the primary of the low-frequency transformer, excellent control of reaction was obtainable on all wavelengths. With the standard broadcast aerial the range on the short waves extended from 270 metres to 600 metres, and on the long waves from 1,080 to approximately 2,000 metres. On both wavelengths ranges, signal strength and selectivity were good.

The price of the tuner complete with blueprint and instructions is 2rs. and can be recommended to readers as a high-grade instrument.

## Marconi-Osram Valves

THE vast strides which have taken place recently in valve design will be appreciated after an inspection of the characteristics obtained from the new Marconi and Osram valves. We recently

tested a series of 6-volt valves in our laboratories.

The first valve which we tested, the HL610 type, is suitable for use in high-frequency and detector circuits where it will operate effectively with the popular split-primary transformer and also the tuned-anode system of high-frequency coupling. The impedance as obtained in our laboratory worked out at 37,000 ohms with an amplification factor of 35. These figures are excellent for a valve consuming only .1 of an amp.

The P625 is a power valve consuming .25 of an amp. and having a performance three times as good as the old type of power valve. We found that the impedance was as low as 2,100 ohms with an amplification factor of approximately 7; thus the valve is suitable for use in the final stage of a low-frequency amplifier and will give considerable volume without distortion.

The last of the series which we tested, the P625A, is a remarkable super-power valve designed to give an exceedingly large power output at a comparatively low anode voltage. We obtained an impedance of 1,400 ohms and an amplification factor of 3.35 for the valve and found that when employed in the last stage of a powerful amplifier with 150 volts on the anode, it

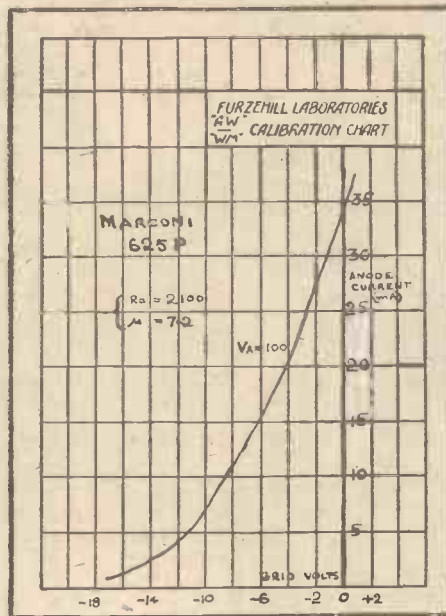

Characteristics of Marconi-Osram 625P Valve gave sufficient volume to operate a moving coil speaker at good volume without distortion.

## Ekco A.C. Mains H.T. Unit

E. K. COLE, LTD., manufacturers of Ekco apparatus, are well-known for

their A.C. and D.C. units. A recent model of an A.C. eliminator known as the No. 1 V.A.20, has been sent in for test by the makers.

It consists of a single-wave rectifier and is capable of supplying approximately 16 milliamps at 120 to 150 volts output. The valve, chokes and condenser are mounted inside a metal case having external dimensions of 11 1/4 in. by 7 in. by 4 1/4 in. There are two positive H.T. tapings, one giving the maximum voltage and the other, which is controlled by a variable resistance, will give up to 120 volts for the detector or high-frequency valve. The filter circuit



Ekco H.T. Unit

employed for cutting down the voltage to this tapping is also instrumental in preventing battery feedback in receivers where more than one low-frequency stage is employed.

Tested in a multi-valve circuit, the eliminator gave quite satisfactory results. An efficient smoothing system has evidently been employed as there was scarcely a trace of hum in the loud-speaker. During our test, an output of 16 milliamps was given at a voltage of 150 and in conjunction with a suitable output valve, good reproduction was obtained at considerable volume.

The address of the manufacturers is Ekco Works, London Road, Leigh-on-Sea, Essex.

## Lewis S.L.F. Condenser

MESSRS. S. W. LEWIS & CO, LTD., of 39 Victoria Street, S.W.1, have submitted for test an inexpensive S.L.F. log condenser. In this component the rotating spindle is electrically connected to the metal end plates in the approved style, whilst the fixed plates are mounted between the two insulated supports bolted to the end plates.

Although plain bearings are employed at either end of the spindle, the motion is pleasantly smooth without any stiff spots. The spacing washers are accurately gauged.

(Continued at foot of page 678)



# MARCONI HEADWAY

## VALVE REFINEMENTS

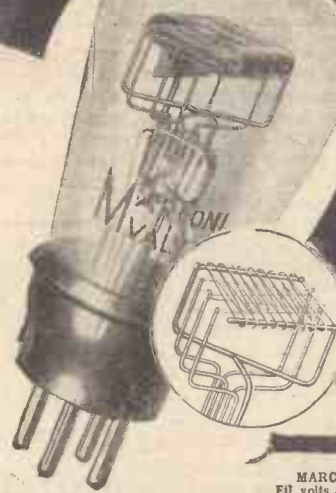

MARCONI P425 is a new super-power valve for receivers operating from a 4-volt accumulator, designed for use in the last stage, and will handle sufficient power for the largest horn or cone speakers without overloading.  
 MARCONI P625 is a new 6-point Marconi super valve which will be welcomed by all moving coil enthusiasts. Its power output at 250 volts H.T. is sufficient to drive such a speaker at full volume. The low impedance matches the average high resistance coil, while the high magnification gives increased volume for a given input.  
 MARCONI P625A is a 6-volt super power valve giving an exceptionally large output at a moderate high-tension voltage. Recommended for operating moving coil and other powerful loud-speakers, where not more than 180 volts is available.

Write for full particulars of New Marconi Valves mentioning "Amateur Wireless."

# MARCONI VALVES

THE MARCONIPHONE COMPANY, LTD., 210-212 TOTTENHAM COURT RD., LONDON, W.1  
 MV13-90

**MARCONI P425**  
 Fil. volts . . . 4.0 max.  
 Fil. curr. . . . 0.25 amp.  
 Anode volts. . . . 180 max.  
 \*Amp. fact. . . . . 4.5  
 \*Imp. . . . 2,300 ohms.  
 Norm. slope 1.95Ma/v.  
 Price 15/-

**MARCONI P625**  
 Fil. volts . . . 6.0 max.  
 Fil. curr. . . . 0.25 amp.  
 Anode volts. . . . 250 max.  
 An. curr. max. 24 mA.  
 \*Amp. fact. . . . . 6  
 \*Imp. . . . 2,400 ohms.  
 Norm. slope 2/5 Ma/v.  
 Price 15/-

**MARCONI P625A**  
 Fil. volts . . . 6.0 max.  
 Fil. curr. . . . 0.25 amps.  
 Anode volts. . . 180 max.  
 An. curr. max. 28 mA.  
 \*Amp. fact. . . . . 3.7  
 \*Imp. . . . 1,600 ohms.  
 Norm. slope 2.3Ma/v.  
 Price 15/-

\*At Anode: Volts 100, Grid Volts 0

# FERRANTI FIXED CONDENSERS



**PRICE 5/6**  
 Capacity: 2 MFDS.  
 Working pressure up to 400 volts D.C.  
 Test pressure 1000 volts D.C.  
 Dimensions 4 1/8" x 2 7/8" x 1 1/8"  
 Weight 7 1/4 oz. Type C1.

Specially designed for mains work.

Wound with pure metal foil, and not with metallised paper as in the case of Mansbridge type Condensers.

They are subject to a higher insulation test and offer less resistance to H.F. currents.

Compare the prices, and consider the quality.

British Condensers, made at Hollinwood, Lancashire.



**PRICE 3/6**  
 Capacity: 2 MFDS.  
 Working pressure up to 200 volts D.C.  
 Test pressure 500 volts D.C.  
 Dimensions 3 1/2" x 2 1/8" x 1 1/8"  
 Weight 5 1/4 oz. Type C2.

**FERRANTI LTD. HOLLINWOOD LANCASHIRE**

Don't Forget to Say That You Saw it in "A.W."

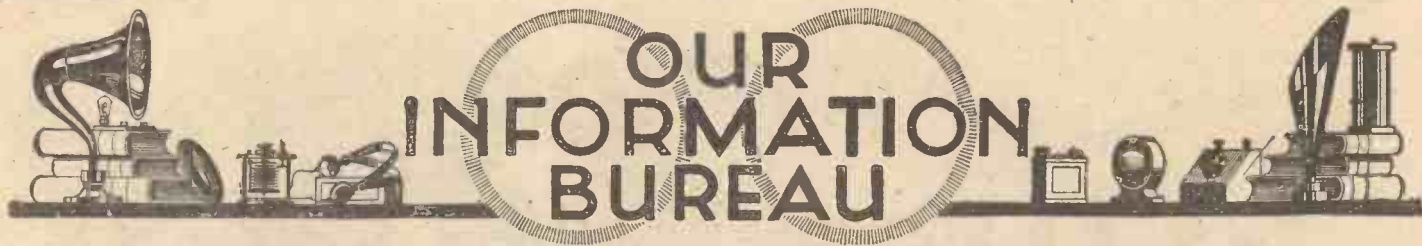

**RULES.**—Please write distinctly and keep to the point. We reply promptly by post. Please give all necessary details. Ask one question at a time to ensure a prompt reply, and please put sketches, layouts, diagrams, etc., on separate sheets containing your name and address. See announcement below. Address Queries—AMATEUR WIRELESS Information Bureau 58-61 Fetter Lane, London, E.C.4

#### Anode-bend Bias Battery.

**Q.**—I have a five-valve receiver in which the detector valve works on the anode-bend principle. Recently reception seems to have failed, and although I have tested through all batteries and components, I cannot seem to trace the cause of the loss in signal strength. Can you suggest what is likely to be the cause?—F. G. (Ealing).

**A.**—It is quite possible that the anode-bend biasing battery has developed a high-internal resistance and this is the cause of the falling signal strength. The biasing battery that is used for anode-bend rectification should not be trusted after it has been in use for more than three months, as after this time the internal resistance of each cell increases enormously and so affects reception.—C. L.

#### Wavelength and Kilocycles.

**Q.**—In the published lists of broadcast and other stations one sees the wavelength of the various stations and also the kilocycles. In what way does the wavelength relate to the kilocycle figure and exactly what do these figures mean?—F. L. (Watford).

**A.**—Briefly, wireless transmissions consist of strains set up in what is termed the ether by electrical currents travelling up and down an aerial at very high speeds. These currents are "oscillatory," and the number of times per second that they reverse their direction of flow is known as their frequency. Thus all transmissions are at a certain frequency. This frequency is measured in cycles per second, and a kilocycle is 1,000 cycles. The vibrations set up in the ether may be likened to the waves or ripples set up in a pond when a stone is thrown in. The rate (i.e. number per second) at which the waves radiate and pass any given point is the frequency, which is, obviously, made the greater the shorter the waves are apart, that is the shorter the wavelength (the distance between the crests of two waves) is. It will be seen that a definite relationship

exists which can be found if the speed of travel of the waves is always the same. This is the case in wireless, and the following formula enables the relationship between wavelength and frequency (kilocycles) to be found: speed (300,000,000 metres per second) ÷ wavelength (metres) = frequency (cycles per second).—C. C.

## When Asking Technical Queries

PLEASE write briefly and to the point

A Fee of One Shilling (postal order or postage stamps) must accompany each question and also a stamped, addressed envelope and the coupon which will be found on the last page.

Rough sketches and circuit diagrams can be provided, but it will be necessary to charge a special fee (which will be quoted upon request) for detail layouts and designs.

#### Transmitting Licences.

**Q.**—I have been interested in wireless reception ever since broadcasting first commenced and can honestly say that I am fairly conversant with all types of present-day receivers. I now wish to turn my attention to wireless transmitting for experimental purposes, but not having possessed a transmitter before and having no previous experience in transmitting, I am at a loss to know exactly how I stand in this matter. Can you tell me what qualifications are necessary before an experimental transmitting licence is granted?—F. D. (Ilford).

**A.**—It is not essential that you have previous transmitting experience provided that you have a thorough understanding of the principles and theory of wireless. You will be required to be able to send and receive morse code messages at twelve words per minute, and you have to satisfy the Postmaster-General upon your ability to conduct experiments in wireless transmission. A definite line of experiments must be stated, general experimenting being an unsatisfactory reason for wanting a licence. An experimenter's licence is the only licence issued to amateur transmitters. You would obtain considerable assistance in this matter if you were to join a wireless society.—C. A.

#### Batteries and Capacity Effects.

**Q.**—I have recently built a short-wave set and find that when the various batteries are arranged more than 18 in. away from the receiver I get quite good results. When, however, the batteries are placed close up to the receiver, although tuning appears to be easier, the results are greatly impaired. Can you explain why this should be and why this trouble should be so noticeable with a short-wave receiver?—H. B. (Middlesex).

**A.**—We assume that you are using dry-cell batteries for H.T. and grid bias. This being so, the batteries themselves contain a certain amount of metal in their internal construction. This metal, when placed in close proximity to the receiver or the tuning circuits, creates rather a large damping effect on the tuning and at the same time increases the inductance of the tuning coils. As the tuning of a short-wave set is extremely critical in the ordinary way, any alien damping due to nearby metals causes rather a large variation in the tuning. Even when a grid-bias battery is placed inside a broadcast receiver the effect on reception is noticeable and by taking away the battery signals can often be considerably improved.—A. L.

## “‘A.W.’ TESTS OF APPARATUS” (Continued from page 676)

in width and hold the plates at even distances apart. Friction contact is made between the spindle and corresponding ter-

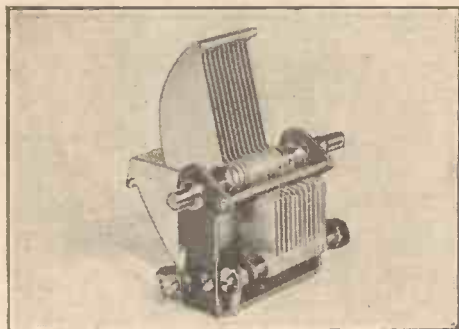

Lewis S.L.F. Condenser

minal, but does not cause noise on the normal broadcast wavelengths.

In order to obtain a true logarithmic

characteristic from this component, it was necessary to add a capacity of 50 micro-microfarads, a value somewhat in excess of that normally added. The maximum and minimum capacities proved to be .00055 and .0000145 respectively. The price is 6s. 6d.

#### M.P.A. De Luxe Cone

**W**E recently reviewed on our "Tests" page the Popular Plaque loud-speaker made by M.P.A. Wireless, Ltd., of 62 Conduit Street, London, W.1. For an inexpensive loud-speaker, the results were good. We have just completed tests on the De Luxe model. This is 2 in. larger than the Popular and is fitted with a wooden base instead of the metal stand. The same type of unit is used, but the cone is made from heavier paper. The results obtainable were, as expected, rather more sensitive, with an

increase of bass notes owing to the larger plaque or baffle and heavier diaphragm employed.



M.P.A. De Luxe Cone Speaker

The loud-speaker is finished in either mahogany or oak, and is sold at the attractive price of 47s. 6d.

# NEW MARCONIPHONE CONDENSERS

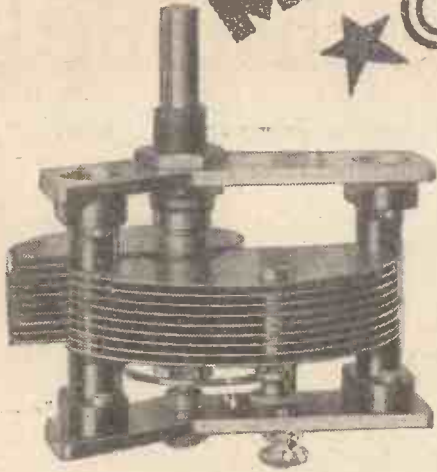

To secure satisfactory results from your receiver you should make sure that it is built with Marconiphone components

throughout. The great resources of Marconiphone enable this world-famous organisation to pursue the most vigorous and untiring research. All Marconiphone components bear the stamp of finished workmanship and unerring accuracy in design.

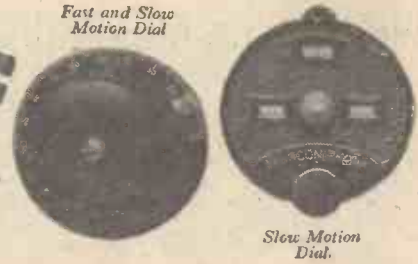

### SLOW MOTION DIAL

An inexpensive dial with conventional edge drive, the knob being below the scale opening. Fits standard spindles. Price 5/9.

### FAST AND SLOW MOTION DIAL

A high-class concentric drive dial for fast and slow movement. When correctly fitted no back-lash is possible, and the reduction ratio of 18 to 1 allows for the finest adjustments. This is a quality component, and as such is most reasonably priced. Price 9/-.

### LOGARITHMIC VARIABLE CONDENSERS

High-class but moderately priced variable condensers with ball and friction bearings. Nickel-plated finish. The vanes are shaped to give equal spacing of stations over the whole dial and two capacities will be available. Prices: .0003, 15/-; .0005, 18/6.

### FIXED MICA CONDENSERS

A range of mica dielectric condensers for grid circuits, R.C. units, H.F. by-passing, etc., all fitted with terminals and soldering tags and contained in neat, moulded cases. Price, 2/- and 2/6.

### MANSBRIDGE CONDENSER, 800-VOLT TEST

A range of Mansbridge condensers tested to 800 volts D.C. and suitable for high-voltage eliminators. The self-sealing properties of the well-known Sterling 300-volt type are retained. Capacities are .5, 1, 2, and 4 mfd. Prices, 3/3, 3/9, 6/-, 10/6

## THE MARCONIPHONE CO., LTD.

(P.Dept.), 210-212 Tottenham Court Road, London, W.1

Showrooms: 210-212 Tottenham Court Rd., London, W.1, and Marconi House, Strand, London, W.C.2

# CARBORUNDUM

## ANODE RESISTANCES & GRID LEAKS

are incorporated in the leading purity receivers

CARBORUNDUM RESISTANCES ARE PERMANENT. Experimenters have tried to burn them out by applying as much as 850 volts and failed. At this voltage 100 Milliamps were passing and the resistances were afterwards as good as ever. That troublesome crackle spoiling your programme is probably due to a faulty anode resistance. Carborundum resistances are unconditionally guaranteed against this.

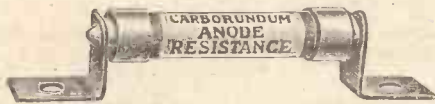

Made in all values from 2,500 ohms up to 7 megohms, 2/6 each (complete with two clips for mounting).



CARBORUNDUM R.C.C. UNIT embodies all the special features of our Resistances and Grid Leaks and is now recognised as the only perfect form of R.C. Coupling. NOW REDUCED TO 7/6.

CARBORUNDUM STABILISING DETECTOR UNIT, 12/6.

CARBORUNDUM DETECTOR, 5/-.

SEE OUR EXHIBIT, STAND NO. 14, "MANCHESTER EVENING CHRONICLE" WIRELESS EXHIBITION.

THE CARBORUNDUM CO., LTD.  
MANCHESTER.

If your dealer is unable to supply you, send us his name on a postcard and state your requirements. The goods will be despatched by return of post. Per C.O.D.



Mr. W. James, Research Consultant of "A.W." and "W.M.," demonstrating the capabilities of the "Touchstone" to a group of enthusiasts at Watford

"WELL," someone remarked, "there is certainly no need to touch wood before building the 'Touchstone'!" A cryptic sentence with which to begin an article, no doubt, but the meaning of it will be perfectly clear when the reader knows that it refers to a new *Wireless Magazine* one-knob four-valve set specially designed by W. James, who has recently joined the staffs of *AMATEUR WIRELESS* and the *Wireless Magazine* as Research Consultant. It is seldom indeed that reference is made in these pages to receivers described in "A.W.'s" big brother, but the publication of details of the "Touchstone" in the November issue of the *Wireless Magazine* marks such an important step in receiver progress that it is felt that *AMATEUR WIRELESS* readers would be deprived of something of real merit were their attention not drawn to the new four-valver in this way.

#### A Revolutionary Set

We of the *Wireless Magazine* believe that the "Touchstone" is the most revolutionary four-valver yet described in any wireless periodical. This, of course, is only to be expected when Mr. James's success with the "Everyman Four," designed and described during the summer of 1926, is taken into consideration.

Although our conviction of the merits of this set did not really need any outside support to strengthen it, we arranged, as a matter of interest, to demonstrate the "Touchstone" to a number of readers of the *Wireless Magazine*, by special invitation, at the Watford works of our printers, the Sun Engraving Co., Ltd., on Tuesday, October 16, and the remark which opens this article was made on that occasion.

At this demonstration there were present approximately forty people. The meeting was quite informal, and under Mr. James's personal guidance everybody present was able to tune-in and test the "Touchstone" for himself if he so desired.

#### Amazing Amplification

It was explained that the "Touchstone" is a one-dial set, capable of receiving at least thirty stations at really good strength on even a large loud-speaker. That this claim is no exaggeration will be appreciated when it is known that the actual magnification obtained from the single stage of high-frequency amplification (employing a three-electrode valve) varies from 42 to 49, while with 2-volt valves the overall magnification of the "Touchstone" is at the very least 2,000,000; in the case of 6-volt valves it may even reach 8,000,000!

Front view of the "Touchstone," showing the main tuning knob in the centre of the panel, with the volume control on the left and a small "trimming" condenser on the right

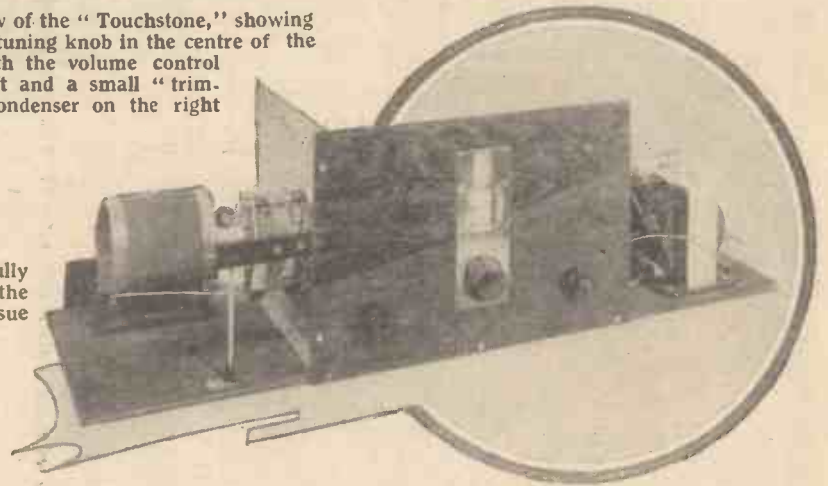

This set is fully described in the November issue of the "Wireless Magazine," now on sale, price 1s.

These figures are colossal and the results obtained with the "Touchstone" are no less amazing.

#### No Variable Reaction

No variable reaction of any kind is employed, the efficiency of the receiver depending almost entirely upon the special types of tuning coils employed; these are developments of those originally used by Mr. James in his well-known "Everyman Four." Moreover, the selectivity is really astonishing for a one-knob set.

# An Evening with the "Touchstone"

The "Wireless Magazine" Staff Demonstrates a New Set

Although the receiver has one-knob tuning, reference to the photographs reproduced in these pages will show that there are actually three knobs on the front panel. Of these, the centre one is the tuning control, while that on the left is a volume control and that on the right a small "trimming" condenser for balancing the ganged condensers at the extreme ends of the scales.

Normally, a large number of stations can be tuned-in simply by operating the main control, the "trimming" condenser being left untouched. Those who were present at the Watford demonstration had every opportunity, as will be seen from the photograph reproduced here, of testing this point out for themselves.

#### Only One Criticism

"I made it my business," writes the Assistant Editor of the *Wireless Magazine* staff, "to discuss the 'Touchstone' with the

majority of the people present, and without exception I found that they were all greatly impressed with its performance—as I had been myself on a previous occasion.

"The only criticism I came across was that of price, for the cost of the complete kit of parts is approximately £11. I pointed out, however, that when the cost was considered it would be seen that the 'Touchstone' compares favourably with any other set of equal power, for it uses three ordinary valves, which cost only

(Continued on page 682)



**T**HE best results can only be obtained by using specified components. Therefore, to ensure satisfaction *insist* on Siemens Batteries which are British Made throughout and offer the highest efficiency, finest value and longest life—at competitive prices.

SPECIFIED FOR THE  
**"MASTER 3\*"**  
 and  
**"MASTER 5" PORTABLE.**

Size No.	Volts
1202	100

PRICE **13/-**

An alternative Battery for the "Master 3"  
 Size No. 1206 Power 100 volts  
 Price 22/6

(This will last 3 times as long as the 1202 size and costs less than double)

Write for Cat. No. 641

SIEMENS BROTHERS & CO., LTD., WOOLWICH, S.E.18

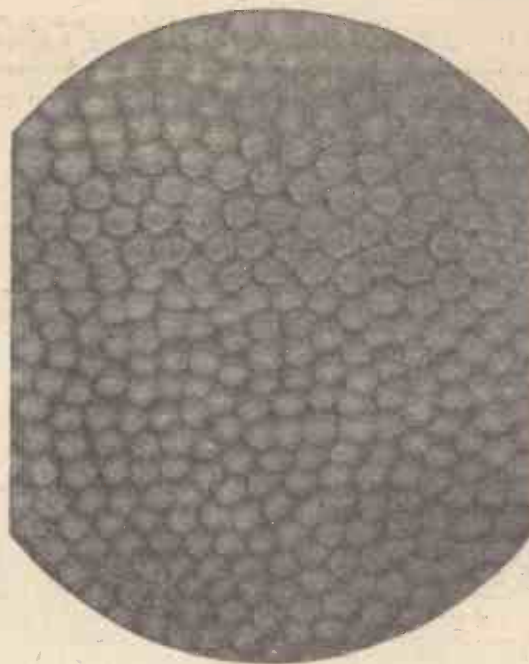

## A SOUND BASIS

It's an axiom. Yet how many wireless constructors follow it? Useless to design a high efficiency circuit; waste of time to assemble carefully chosen components unless—unless the panel is right. The panel is your foundation.

Trolite panels have high insulating properties and do not collect moisture. By using Trolite you have taken every possible precaution against panel leakage. Moreover Trolite keeps permanently good appearance and will not discolour through oxidisation however long in use. The etched patterns do not show scratches or finger marks.

Trolite is easily drilled, sawn and machined. The cellulose basis makes it readily soluble in acetone and offers special facilities for labelling, jointing, and beading. Special beadings are supplied to mortise at 45° giving a distinctive finish to the panel.

*The panel illustrated is the new "Trolite Morocco." Trolite panels are also available in black, walnut or mahogany grained, and in wavy or cut etched patterns, and are sold at competitive prices. Beadings are made in three colours and two patterns at ninepence a foot.*

# TROLITE

## RADIO PANELS

F. A. HUGHES & CO., LTD. (Dept. W.5.)  
 204-6, GREAT PORTLAND ST., LONDON, W.1.  
 MANCHESTER : 185, PRINCESS STREET

# THE "TOUCHSTONE" DEMONSTRATED (Continued)

10s. 6d. each, and one power valve, which is only 15s."

### Economical Running Costs

The fact that the "Touchstone" uses only ordinary valves is of especial interest not only from the point of view of first cost, but also because of its low anode-

difficulty whatsoever. There is no doubt that any AMATEUR WIRELESS reader who builds this set will be just as pleased with the results obtained as were the people present at the demonstration.

### No Difficulty in Construction

The set is exceptionally easy to construct, for every connection is shown full size and shape on the blueprint, which can be obtained for half-price if the coupon contained in the November issue of the *Wireless Magazine* is used when application is made for it. Do not forget to buy your copy from the bookstall before it is sold out; the cost is only 1s.

In designing the "Touchstone" for the *Wireless Magazine*, Mr. W. James has most certainly produced a winner, and we are sure that AMATEUR WIRELESS readers will be glad to know something about it.

## WIRELESS IN NEW C.P.R. LINER

THE Marconi International Marine Communication Company is responsible for the complete wireless installation in the new C.P.R. liner *Duchess of Atholl*. The equipment includes a newly-designed M.C.6 2-kw. set, capable of communicating on wavelengths of from 600 to 850 metres and from 2,000 to 2,750 metres. In addition to continuous-wave transmission, the set is adapted for the interrupted continuous-wave system—which can be detected by any type of receiver and is used for signalling on the shorter wavelengths. There is also an emergency quenched-spark transmitter.

The receiving apparatus is of the latest Marconi design, type M.R.4F, having a wave range up to 28,000 metres. This incorporates a recent development in the form of a note filter, which has been found to be of great advantage in minimising delay when receiving telegrams in places where wireless interference is prevalent, practically all interference being eliminated by the note filter.

There is a band repeater for the entertainment of passengers; this apparatus enabling the music of the ship's band or gramophone records to be relayed to all parts of the vessel. A wireless direction-finder has also been installed to enable the position of the ship to be determined.

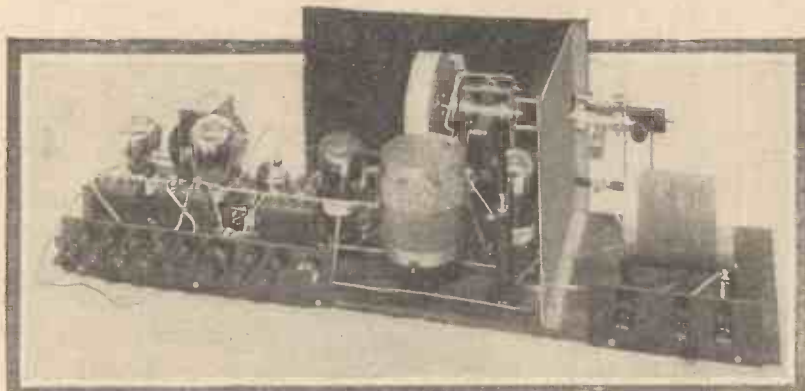

Another view of the "Touchstone," which is fully described in the November issue of the "Wireless Magazine." The coil in the centre is the H.F. inter-valve transformer, and that on the right is the aerial-grid transformer

current consumption. This is only about 12 milliamperes for all four valves, and is well within the capacity of modern dry batteries. Indeed, when range and volume are taken into consideration, it can safely be said that the "Touchstone" is the most economical receiver it is possible to design at the present time.

For the purpose of this demonstration the valves actually used were three Osram HL610's, which have an impedance of 30,000 ohms and a magnification factor of 30. In the final stage an Osram P265 power valve was used. The anodes of these valves were supplied from three 60-volt Columbia triple-capacity batteries, which are capable of giving a steady output of 16 to 18 milliamperes, while the low-tension current was obtained from a 6-volt Ediswan accumulator.

### Remarkable Volume

Two loud-speakers were tried, one a Celestion and the other a Gecophone cone. Both gave remarkable volume—more than sufficient for the large hall in which the demonstration was held. Actually, the "Touchstone" was not demonstrated under the best of conditions, for the aerial consisted of a length of rubber-covered flex hastily tied at one end to an iron gutter, while the earth was merely two or three turns of wire twisted round a convenient water tap.

So many people tried the set at various times that it was found impracticable to keep a log of all the stations picked up, but such well-known transmissions as those from Rome, Milan, Brussels, Barcelona, Toulouse, Leipzig, etc., were picked up at tremendous strength without any

On the blueprint each connecting wire is numbered and shown full size and shape. There is no need for any soldering

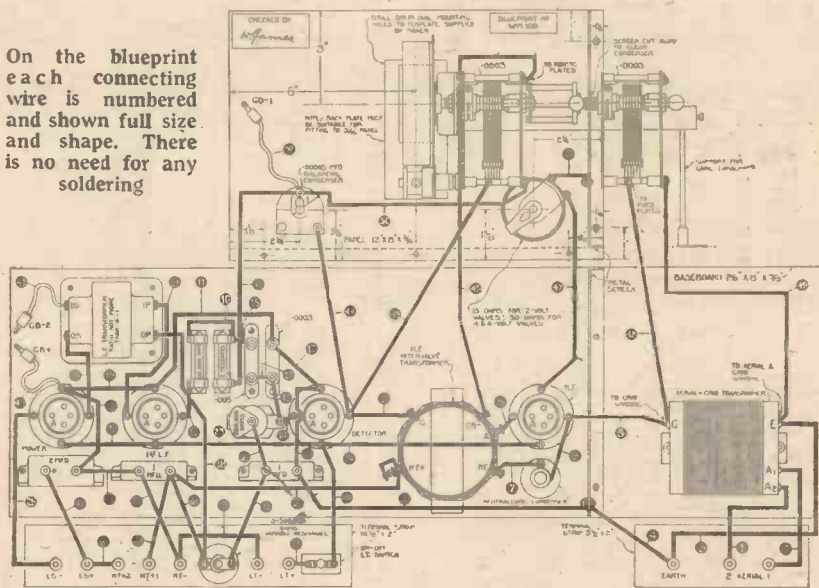

Full-size blueprints can be obtained for half price, that is 9d., post free, if the coupon contained in the November "Wireless Magazine" is used

Have you seen the announcement on page 655 of the Novel Loud-Speaker to be described Next Week?

# Why a nickel filament valve?

**It gives Steeper Slope**

**and therefore Better Radio**



Mazda Nickel Filament Valves possess certain unique qualities brought about by the use of a nickel filament. The quality of a valve is indicated by the mutual conductance or "slope" figure. Mazda Nickel Filament Valves have steeper slope values than those possessed by any other valves of corresponding types.

Remember that slope is the only real measure of the essential goodness of a valve to you as a listener. Because of the steeper slope values of Mazda Nickel Filament Valves they are therefore better valves. To ensure best reception use Mazdas.

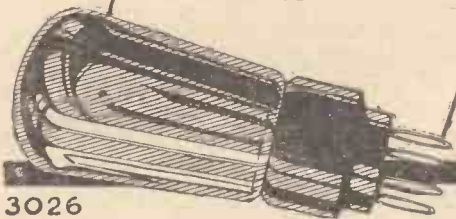

3026

Made in sixteen different types, covering every requirement of the 2, 4 & 6 volt user.

**MAZDA**  
Steeper Slope  
NICKEL FILAMENT  
VALVES

The British Thomson-Houston Co. Ltd.

## Get your power supply from the mains this winter — with these BURNDEPT units



If you have A.C. mains and you use the BURNDEPT "Ethopower" or L.T. Battery Charger, you will never be put to inconvenience and annoyance by run-down batteries. Ask your local radio dealer to show you these trouble-saving, economical BURNDEPT units.

### THE BURNDEPT ETHOPOWER

Even if you possess an eight-valve set, with super-power valves, the "Ethopower" will supply all the current necessary for H.T. and grid bias—and at a cost of only *one penny per ten hours*, with electricity at 6d. per unit. Requires no attention whatever when once set up, and its filamentless "Ethotron" rectifying valve hardly ever needs replacing. No noise. No Hum. Perfectly safe: conforms to I.E.E. regulations. Tappings are provided to give correct H.T. voltages for detector, amplifier, or screened-grid valves. Grid bias automatically adjusts itself. Maximum H.T., 150 volts. Total output, 25 milliamperes. For A.C. mains, 100/240 volts 40/100 cycles. PRICE £6 18s. 3d. (Marconi royalty, 12s. 6d.).



### THE BURNDEPT L.T. BATTERY CHARGER. (Incorporating Westinghouse Metal Rectifier.)

Your L.T. Battery always fully charged for 2d. a week! NO UPKEEP COSTS. NO ACID. NO VALVES. NO HUM. NO ATTENTION OF ANY KIND NECESSARY. The Charger is *absolutely safe*, for it conforms to the I.E.E. Sub-Committee's Regulations. A special feature of this Charger is the indicator-fuse lamp, which shows whether the battery is being properly charged, and also safeguards the transformer and metal rectifier against overload. Universal type, for A.C. mains, 100/110 volts, 40/100 cycles. Charges 2- 4- or 6-volt accumulators at half ampere. PRICE £2 9s. 6d. NOTE.—This Charger may be used, with excellent results, to excite the fields of 6 volt .5 ampere moving-coil loud-speakers, such as the Magnavox.

### AUTOMATIC CONTROL

An optional device, which disconnects the Charger and connects the H.T. eliminator (if any) and *vice versa* when the set is switched on or off. PRICE £1 5s. Can also be used for automatically cutting off field supply to moving-coil loud-speakers when set is switched off.

# BURNDEPT

Wireless - (1928) - Limited  
BLACKHEATH, LONDON, S.E.3  
Showrooms: 15 Bedford Street, Strand, W.C.2  
A.J.W.

# THE B.B.C. REFUSE BAIRD AN EXPERIMENTAL BROADCAST

WE are informed, just as we are about to go to press, that the B.B.C. have decided that they cannot at present undertake an experimental transmission of the Baird system of television. The B.B.C. statement is as follows: "In agreement with the Post Office, the B.B.C. required a studio demonstration of the Baird Television apparatus before considering whether there should be public experiments in which a B.B.C. station would participate. A demonstration took place at the offices of the Baird Television Development Co., Ltd., on October 9 and was attended by administrative and technical officials of the Corporation. The opinion of the B.B.C. representatives was that while the demonstration was interesting as an experiment, it failed to fulfil the conditions which would justify trial through a B.B.C. station. The Board of the Corporation has decided that an experimental transmission through a B.B.C. station shall not be undertaken at present. The Corporation would be ready to review its decision if and when developments justify it."

While we quite appreciate that the B.B.C. could see room for improvement in the

results which Mr. Baird could show them, we certainly are of the opinion that they would have done well in the public interest to have made an experimental attempt to broadcast televised images. Baird has the idea, possibly an embryo one, but nevertheless an idea of distinct promise, and on the other hand the B.B.C. have the means and the apparatus for public broadcasting and, furthermore possess the monopoly of them. We feel it would have been wise, having regard to the great public interest and curiosity, for the B.B.C. to have given the Baird system all possible facilities in an experimental way. If afterwards they had expressed the opinion that the Baird system was not yet developed sufficiently for public broadcasting, the public would have attached importance to it.

### A Test Wanted

As it is, nobody is likely to be convinced that the Baird system does not justify a broadcast trial. We go so far as to say most definitely that it does justify such trial and in taking up this attitude, we do not pretend the Baird system is perfect. How could it be with just four or five years of

experiment behind it? But the assistance of the B.B.C. at this juncture would have enormous value in giving it an opportunity of development, and we sincerely hope that the B.B.C. will very shortly change its mind in the matter. We don't ask it to change its opinion as to what Baird has accomplished. All we ask is that it should satisfy itself by a real trial on its own monopoly apparatus, built at public cost, whether there is sufficient in the Baird system to warrant a public broadcast.

Can we doubt that the Post Office Engineers must have been convinced that the system was worthy of B.B.C. attention? An official of the Post Office in an interview with the daily press stated that: "The demonstration made before the Post Office was private. Our engineers witnessed it with impartiality in order to determine whether the invention of Mr. Baird warranted further or special facilities being placed at his disposal for continuance of experiments. As a result of the demonstration our engineers decided that the Baird Television system had reached the stage where further experiments of a more practical nature might be worth encouraging."

## BURTON CONDENSERS STILL SUPREME.



REGD. TRADE MARK.

Write for Illustrated Catalogue  
of the Complete BurTon Range  
of Components.



### S.L.F. CONDENSERS

Patents pending.

	Each
0005 Complete with 4-in. Dial,	6/-
00035 Complete with 4-in. Dial,	5/9
0003 Complete with 4-in. Dial,	5/9
00025 Complete with 4-in. Dial,	5/9

**B**urTon Condensers have attained pre-eminence in the Wireless World, through the fact that they are constructed on sound engineering principles, being provided with adjustments to take up any lateral play which may develop in the spindle of any Condenser through wear.

BurTon Condensers assure a clean cut separation of all stations regardless of wavelength, and afford the clearest and smoothest reception possible, and are made in various capacities for practically every requirement that we are called upon to provide.

Manufactured by

C. F. & H. BurTon,  
PROGRESS WORKS, WALSALL

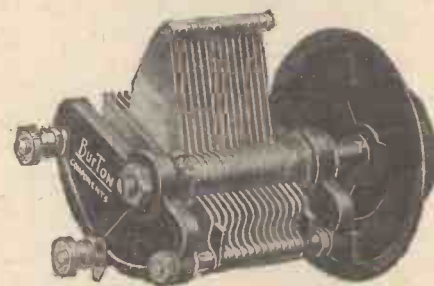

### MID-LOG CONDENSERS

Patents pending.

	Each
0005 Complete with 4-in. Dial,	6/-
00035 Complete with 4-in. Dial,	5/9
0003 Complete with 4-in. Dial,	5/9
00025 Complete with 4-in. Dial,	5/9



# MAKE YOUR OWN CONE SPEAKER

The New Wonder "Nightingale"

## CONE UNIT

Exactly as fitted to our Cabinet Cone Speaker.

Guaranteed to give results equal to the most expensive Loud-speakers yet made.

Full constructional details with each Unit.

## GRAMOPHONE ATTACHMENT

Reduced from 32/6 to 15/- solely as an advertisement for the famous Bullphone Nightingale Loud-speakers. Cobalt Magnet guaranteed for all time.

With 4-inch Diaphragm.

Instantly converts your own Gramophone into a full power Loud-speaker, giving a wealth of pure undistorted volume which must be heard to be believed.



**15/-** each

SATISFACTION GUARANTEED or money refunded!

AS FITTED TO OUR £6 POST HORN

**BUY ON EASY TERMS**

5/- Secures this Speaker

The Nightingale "DE LUXE"

50/- cash, or 5/- deposit and 11 monthly payments of 5/-

21 in. high with 14 in. Bell. Mahogany finished, with plated arm & stand.



5/- Secures this Speaker



**NIGHTINGALE CONCERT SUPREME SUPER**

Guaranteed free from metallic resonance.

60/- cash, or EASY TERMS, 5/- deposit and 12 monthly payments of 5/-.

Send Deposit NOW!

Obtainable from your Local Dealer or direct from:—

**BULLPHONE LIMITED**

**38, HOLYWELL LANE, LONDON**

E.C.2.

**NIGHTINGALE SPEAKERS**

# SELFRIDGE'S

ENGLAND'S RADIO HEADQUARTERS

Perfect Radio Reception for All.

Exhaustive tests prove

# BURNDEPT VALVES

are ideal for use with the **CHAPMAN-REINARTZ 2**

### SPECIFICATION

Name	Description	Filament Consumption	Impedance	Amplification Factor
<b>Valves for use with Two-Volt Accumulators</b>				
H.L. 213	General Purpose ..	.12 amp.	21,000 ohms.	7.6
L. 240	L.F. Amplifier ..	.40 amp.	8,000 ohms.	5.2
<b>Valves for use with Four-Volt Accumulators</b>				
H.L. 425	General Purpose and L.F. Amplifier ..	.25 amp.	9,000 ohms.	8
<b>Valves for use with Dry Cells—28-3 Volt</b>				
H. 310	H.F. Amplifier ..	.10 amp.	77,000 ohms.	15.0
H.L. 310	General Purpose ..	.10 amp.	19,000 ohms.	5.7

There is only a limited quantity available, and early ordering is strongly urged, as this price cannot be repeated once the remainder of our stock is cleared. Each valve undergoes a vigorous test before being sent out, and should any valve fail to give complete satisfaction, it will be replaced without question or quibble—free, of course.

PRICE,



Postage and packing on orders under 10/-, 3d. extra.

Radio and Television Dept., First Floor

**SELFRIDGE & CO., LTD., OXFORD ST., LONDON**

'Phone: Mayfair 1234

Please Mention "A.W." When Corresponding with Advertisers

TUNEWELL DUAL RANGE COIL



From 240/580 m. to 920/2,000 m. without changing coil.

Turns your set into a Star Set; adds another star to the Mullard Master Three circuits.

Fits standard Six-pin base and allows for changing over to short-wave 20/90 m coils.

Price 7/9

Bases 2/- each extra. No. 1 coil for 30/45 m. No. 2 coil for 40/90m. . . 3/11 each

All types six-pin coils supplied.

Two-pin coils for Inceptor 3, Radiano, etc., from 1/6 ea., standard; 2/3 C.T.; 2/6 X types.

TUNEWELL TUNING UNITS ... 13/9 each H.F. CHOKES ... 5/9 each

From all live dealers

TURNER & CO.,

54 Station Rd., New Southgate, London, N.11

—THE FIRM THAT SAVES YOU MONEY—



MERIT ALONE HAS PUT

EPOCH

MOVING COIL SPEAKERS AHEAD OF ALL OTHERS

THREE NEW MODELS:

Improved Model A £3 - 3 - 0

Model 66 (shown above) £4 - 7 - 6

Junior Model - £2 - 10 - 0

MANCHESTER EXHIBITION, STAND NO. 163. GALLERY

From all Dealers and from

EPOCH ELECTRICAL SOCIETY, LTD. 53, Gracechurch St., London, E.C.3

Full particulars on application.

BROADCAST TELEPHONY

(Broadcasting stations classified by country and in order of wavelengths)

Table listing broadcasting stations by country, including Great Britain, Ireland, France, Germany, Austria, Belgium, Czechoslovakia, Denmark, Estonia, Finland, and others, with columns for frequency, power, and call sign.

CHIEF EVENTS OF THE WEEK

Table of chief events for the week, organized by city (Manchester, Newcastle, Glasgow, Aberdeen, Cardiff) and date, listing specific programs and performances.

A law passed in 1870 against "unnecessary noise" brought several Montreal radio dealers into court for demonstrating their radio apparatus and loud-speakers in their shop fronts.

**THE INVENTION OF THE YEAR!**  
**A MOVING COIL SPEAKER WHICH WORKS OFF AN ORDINARY 2-VALVE RECEIVER, WITHOUT SPECIAL VALVES, ACCUMULATORS, OR MAINS**

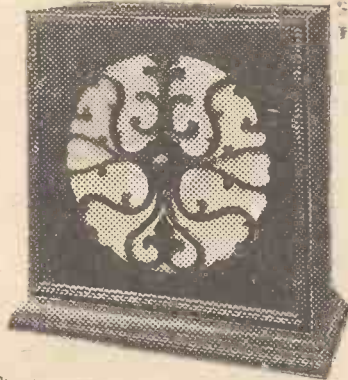
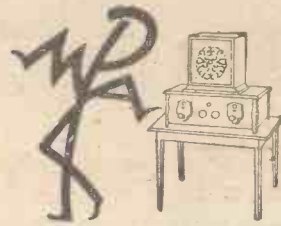

★ Other M.P.A. Models are: The Popular Plaque (29/6), De Luxe Plaque, Table Cabinet Speaker, "Octroda" 8-Electrode Self-Contained Stationary Set, and the "Etha-trope". All - Electric Radio Gramophone - "As Good as an Orchestra."

THE M.P.A. WAY. Products to the value of £5 or over can be obtained on Hire Purchase Terms for £1 down.

**THE DUAL INDUCTANCE SELF-ENERGISING MOVING COIL SPEAKER** is the greatest advance in inexpensive sound reproduction to date. Although built on the moving coil principle, it has none of its disadvantages and will work off an ordinary 2-valve Receiver without accumulators, mains connections, special valves or transformers. Uncannily responsive! Drums sound real! The highest notes come as if direct from artist or instrument. A handsomely polished mahogany cabinet, scientifically and attractively fretted both sides, gives unison to a symphonic whole. Its astonishing price - - 7 guineas!



For illustrated Literature write to Dept. 19

Streets

**M.P.A. WIRELESS LTD., 62, CONDUIT ST., LONDON, W.1. TEL. GERRARD 6844-8.**

# CLIX

World-Wide Patents

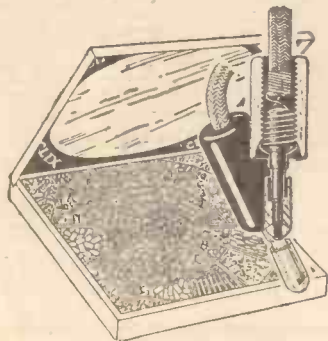

Look for this Showcase on your Dealer's counter.

## CLIX-LOX

### ADJUSTABLE WANDER PLUG

is a complete solution to faulty contact caused through variations in diameter of H.T. Battery sockets. Clix-Lox adjustable wander plugs cut out all risks of shorts. They "stay put" in any H.T. socket and can, if desired, be permanently locked in position by a turn of the insulator.

NOTE.—When wiring, screw insulator well down on wiring shoulder. Expanding leaf should be eased up to ensure suppleness

Clix-Lox in 3 colours, Red, Black or Green.

Price 2½d. each.

## CLIX ACCUMULATOR KNOBS

defy the damage caused by creeping acid, because of the patented vaseline trap, which ensures clean and constant contact, gives purity to reception, as well as lengthening the life of all accumulators fitted with them. Note the special socket provided for a clean, quick connection with a Clix-Lox Wander Plug.

Supplied in Red and Black, Price 5d. each.

Extension stems for counter-sunk type of accumulators, price 1d. each. Supplied in various threads to suit most accumulators.



(Pro. Pat.)

**LECTRO LINX, LTD.**

**254, VAUXHALL BRIDGE RD., LONDON, S.W.1**

# What the SOUTH missed

at the National Radio Exhibition, Olympia, London, the North has accomplished. The secret will be out at the

**MANCHESTER RADIO EXHIBITION**

City Hall, Manchester, on

# STAND N<sup>o</sup>. 42

H. CLARKE & CO. (M/CR), LTD.

"Atlas" Works, Old Trafford, MANCHESTER  
 Makers of Clarke's "Atlas" Battery Eliminators

You will Help Yourself and Help Us by Mentioning "A.W." to Advertisers

# LETTERS TO THE EDITOR

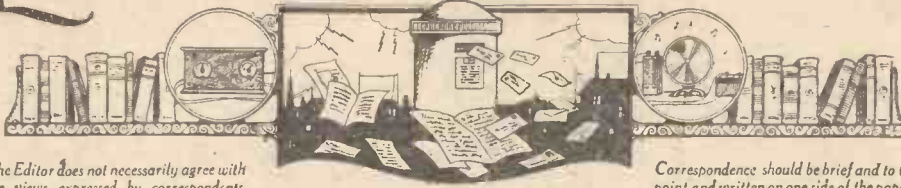

The Editor does not necessarily agree with the views expressed by correspondents.

Correspondence should be brief and to the point and written on one side of the paper.

## Horn or Cone Loud-speakers?

SIR,—In answer to R.R.G. (Glasgow) regarding horn-type speakers, I was referring to horn-type speakers that are on the market at the present time. I have not had the pleasure of hearing a spiral exponential horn speaker such as R.R.G. describes, but I do not think it can be better than a good cone speaker.

The reason is that the diaphragm of a horn speaker is incapable of moving at all below 150 cycles. The horn speaker, in my opinion, being mostly made of metal, is too mechanical, and anyone with a good musical education will be the first to admit it.

With regard to moving-coil speakers, I don't think anyone minds the expense, etc., if he has a keen ear of how music should be reproduced. Perhaps R.R.G. imagines he gets the bass notes when they are only echo effects, resonance, etc.

W. E. S. (Birmingham).

## Telephotography and Phototelegraphy

SIR,—As a very appreciative reader of your paper, I should be glad if you would permit me to make a few remarks in friendly criticism of THERMION'S page in your issue of August 25, in which he speaks of experiments in telephotographic transmissions carried out by the B.B.C.

"Telephotography" is a word which has been in use for a great number of years in relation to photography (*i.e.*, the taking and making of photographs, but not their transmission), in which telephoto lenses are used.

This is "telephotography," and I claim that the experimenters to whom THERMION refers should coin a word of their own.

Having now had my say on this matter, I have an appeal to make, and that is that the English language might be spared some of the horrors that are at present being imported into it by the wireless fraternity. I am a wireless enthusiast myself, but I see no necessity for "audition," "audionic," etc.; and I am quite sure that, with the expenditure of a little thought, something much better could be thought out. In regard to "audition," for example, what is the matter with our English word "hearing," in any case? New things, of course, require new words, but I think we should try to avoid the experience of the French, who, due to the sudden outburst of national interest in sport, now find their incomparable language loaded up with things like "recordman," "knock-out," "groggy," etc.

Here in the jungle, where I seldom see a white man and hear all too little of the English language, wireless is a very real blessing, and your paper is of the greatest possible interest.

ORANGE PEKOE (South Sylhet).

## 5GB and Alternative Programmes

SIR,—If 5GB is a station to enable us to get a programme with as much contrast as possible from 5XX, why cannot we have music, or talk, or a play when 5XX has the Sunday evening service?

It is generally stated that jazz is not music, but is solely for dancing. Then why do we so often have the Payne's noise for, say, twenty minutes during the earlier part of the evening? Do people dance for twenty minutes? If the B.B.C. use them to "fill in" a few minutes, we should prefer a string quartet or something like that. G. C. H. (Nottingham).

## CLUB NOTES

We have received a copy of the *Edinburgh Journal*, in which is included the "Transactions" of the Edinburgh Wireless Society. This go-ahead society has drawn up a very full and interesting syllabus for the coming season. Under the "Transactions" of the Edinburgh Electrical Society there is an interesting note on bakelite.

The Wembley Wireless Society, now beginning its seventh season, has prepared an attractive syllabus, and readers who would like to join are invited to write to the Hon. Sec., Mr. Faulkner, of 40 Clifton Avenue, Wembley Hill.

At the meeting of the Brighton and Hove Branch of the Wireless League, held at the Union Church Institute, Queens Square, Mr. A. W. Privett opened the forthcoming winter programme with a lecture on the "Fundamental Principles of Wireless Transmission and Reception."

The Croydon Wireless and Physical Society has prepared a very fine programme for the coming season. Readers interested should write to the Hon. Sec., Mr. H. Gee, of 51 and 52 Chancery Lane, W.C.2.

## WORTH WRITING FOR

AN attractive folder from the Tudor Accumulator Co., Ltd., of 2 Norfolk Street, Strand, W.C.2, contains useful information on the subject of Tudor accumulators.

The catalogue of the Igranic Electric Co., Ltd., of 149 Queen Victoria Street, London, should be in the hands of every wireless enthusiast. It is full of information and is attractively produced.

We have received a copy of the latest Bulgin catalogue. All the Bulgin products are listed and an interesting section consists of a manual on the use of certain components.

E. K. Cole, Ltd., of London Road, Leigh-on-Sea, have issued a very attractive poster dealing with Ekco mains units.

Station WTIC, of Hartford, Connecticut, has applied to the Federal Radio Commission to be allowed to increase its power to 50,000 watts.

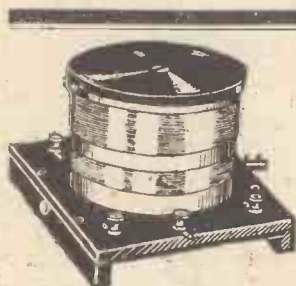

## Finston "Q" COIL

The "Q" Coil is a very efficient type of tuning inductance and gives exceptional results, covering a waveband of 250/550 and 1,000/2,000 metres.

The Finston "Q" Coil was recommended by J. H. Reyner in his "Ace of Twos" receiver. (*Amateur Wireless*, September 22.)

AERIAL COIL 15/- H.F. TRANSFORMER 21/-  
REINARTZ COIL 21/-

As specified and officially approved.

From all Dealers or

STONE MFG. CO., 108/9 Great Saffron Hill, London, E.C.1.

## NOW ON SALE

LETT'S' 1929 AMATEUR WIRELESS NOTEBOOK DIARY. 88-PAGE REFERENCE SECTION. ALL USEFUL DATA.

Prices 1/6 and 2/6 from "Amateur Wireless" Offices

# HYDRA

*Serves you well*

There must be something unusual in this condenser to win and hold the confidence of the most important Eliminator manufacturers, not only in Britain, but the world over.

ALL CAPACITIES OBTAINABLE  
To work on 240, 450 volts D.C., 240, 450 volts A.C., and upwards to 5,000 volts D.C. working voltage.

Tested 500 volts, 240 volts D.C. working voltage, 2 Mfd. 3/6; 1 mfd. 1/9



Visit our Stand No. 60, Manchester Radio Exhibition

LOUIS HOLZMAN, 34, Kingsway, London, W.C.2.

## WEARITE WEAIRE, Ltd.

COMPONENTS 740, HIGH ROAD, TOTTENHAM, N.17.

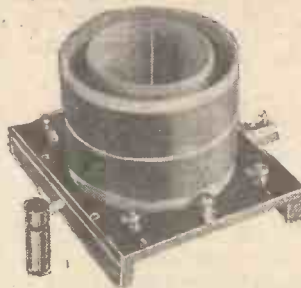

### "Q" COILS

- Aerial Coil - 15/-
- H.F. Transformer 21/-
- Reinartz Coil - 21/-

WEARITE H.F. CHOKE as used in the new COSSOR MELODY MAKER and in DR. CHAPMAN'S REINARTZ TWO **6/6**

WEARITE CHOKE (SHORT-WAVE) 4/6

WEARITE CHOKE 10/6 (HEAVY-DUTY)

A.C. SWITCH (2-way) - 6/-

VALVE HOLDER (A/M) 2/6

WRITE FOR LISTS

Telephone: Tottenham 3847 and 3848

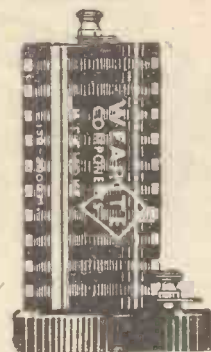

## IT'S THE EMISSION THAT MATTERS

THE emission of the Triotron Dark Emitter filament is seven times greater than of ordinary Dull Emitter filaments, while it consumes only .05 amps. on 2 volts. No other valve can equal its quality of performance.

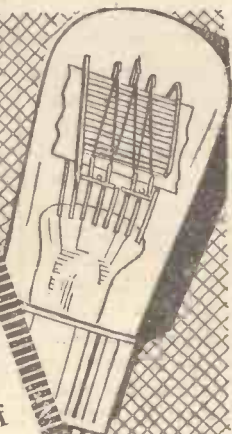

INSIST ON



# TRIOTRON DARK EMITTER VALVES

Mention of "Amateur Wireless" to Advertisers will Ensure Prompt Attention

## POLYMET RADIO PRODUCTS

### HUNTS POLYMET for your 'RANGER 4'

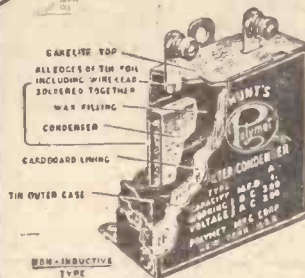

The 'Ranger 4' appearing in 'Amateur Wireless,' Oct. 6, is proving one of the star sets of the year.

Here are the Hunts Polymet products which were specified. Glance at the list and you will see that by using them you will effect a very substantial saving.

Hunts Polymet products are made by one of the largest manufacturers of radio components in the world, and you are assured of absolute satisfaction in using them.

- TYPE A.  
Paper Condenser, Working Voltage, 300 D.C., 200 A.C., 1 mfd. to 8 mfd. 2/9 to 15/6.
- THESE ARE WHAT YOU NEED.
- 2 2-megohm grid leaks at 1/6 ... 3/-
  - 2 Grid leak holders at 9d. ... 1/6
  - 1 .0003 "Postage Stamp" fixed mica Condenser at 1/- ... 1/-
  - 1 .01 "Postage Stamp" fixed mica Condenser at 2/6 ... 2/6
  - 1 1-microfarad fixed Condenser, non-inductive Hi-volt type A ... 3/6
  - 2 2-microfarad fixed condensers, non-inductive Hi-volt Type A at 4/6 ... 9/-
- 20/5**

A. H. HUNT, LTD., CROYDON, SURREY

# HUNT'S

HELLESEN DRY BATTERIES · INSTRUMENTS  
POLYMET MICA & PAPER CONDENSERS  
HAND & CYCLE LAMPS, TORCHES, ETC

“W. JAMES ON VOLUME CONTROL” (Continued from page 674)

condenser. Certain types of transformer are much more sensitive than others, and with certain makes the reproduction markedly changes with alterations to the shunting condenser.

**A Simple Method**

The simple method of varying volume by adjusting the reaction condenser is therefore not as straightforward as it might appear. Nevertheless, the method has the advantage of simplicity, which counts a great deal these days. When the reaction condenser is small, the shunting effect may be negligible, but there still remains the effect of the varying selectivity of the aerial circuit. As a rule, little reaction

will be employed when receiving the local station, with the result that it may be decreased in order to weaken the signal without producing a noticeable difference in the quality. A further effect is produced, however, and as it is an important one, let us consider it in more detail. It concerns the efficiency of the detector.

If we connect a well-designed tuned circuit to an anode-bend rectifier, as in Fig. 3, we can study this effect. We will assume the grid coil to be wound with Litz wire or high-frequency cable, and the aerial to be coupled to it through a small coil in order that maximum signal strength and selectivity be obtained. No reaction is used and in the anode circuit of the detector is connected a resistance of 250,000 ohms. The values of the other components do not matter very much as regards this discussion.

**An Example**

Now let us tune in a station, but not the local one. In London, for example, tune to 5GB, with a small aerial. Adjust the anode voltage of the detector in order to obtain maximum volume. Do not receive a loud signal, but cut down the size of the aerial or insert a small fixed condenser in the aerial wire until the signal is just comfortably audible. Now join a fixed condenser of .0001-microfarad across the anode resistance in the detector valve circuit (as shown by the broken lines) and listen to the signal strength. You will notice a decided improvement.

Next connect a larger condenser, such as one of .0002-microfarad, and again compare the signal strength. You may have to retune a little, but connect and disconnect this condenser in order to make a fair comparison of the volume. If you have them, join larger fixed condensers and notice the effect. You will find that as the condenser is increased in value up to about .0005-microfarad the volume increases. It will also be noticed that the higher notes are weakened by comparison with the lower ones, even though the volume on the whole is much greater. In my own tests I employed a grid coil three inches in diameter having 68 turns of number 27/42 Litz, which was tuned with a .0003-microfarad condenser.

The aerial coil was wound at the earthed end and had eight turns. I found the signals from 5GB could be doubled by connecting a condenser of .0003-microfarad across the anode resistance. The experiments are very easily carried out, and the results are to be explained by the self capacity of the valve and the shunting effect of the condenser across the anode resistance. A valve of the resistance-capacity type is, of course, used as the detector.

The circuit of Fig. 1 is, therefore, not quite as simple as it looks, for by altering the setting of the reaction condenser we change the characteristics of the tuned

circuit of the detector, and of the low-frequency output circuit, which in the example considered comprises an anode resistance.

As the value of the reaction condenser is increased the signal is strengthened, but the higher notes are not increased in the same proportion as the lower ones. When, on the other hand, the setting of the reaction condenser is lowered, the tuning of the aerial circuit broadens, and there is less high note loss. The volume is, of course, reduced.

**Another Way**

The second obvious way of reducing the volume given by a receiver wired as in Fig. 1 is by detuning the aerial condenser. Detuning appears not to alter the quality by a great amount when the tuning is broad but detuning cannot be recommended when other considerations necessitate the employment of a fair amount of reaction in order to sharpen the tuning. Distortion is bound to be produced when the tuning is fairly sharp and the circuit is not exactly tuned to the station being received.

There are many ways of controlling volume by connecting additional apparatus, but I have confined myself in this article to a simple circuit.

Joan of Arc has been elected patron saint of wireless by French amateurs.



Stand 85  
New Hall  
Manchester  
Radio  
Exhibition

FOR EVERY  
USER OF -



**RADIO METERS**

This enterprising innovation marks a new step forward in after-sales meter service. Now you can buy Sifam, the unchallenged leader in popular priced Radio Meters and at the same time be assured of a first-class meter repair service. Repairs are carried out in our own works by a staff of experts. In price and guaranteed accuracy Sifam meters are all that you need. Use them for detecting and rectifying distortion, avoiding run-downs, batteries and burnt-out valves and regulating plate and filament supply. Ask your dealer to show you the complete range, and send for free leaflet, "What simple meters can show you" from Dept. A.W.

**THE SIFAM ELECTRICAL INSTRUMENT CO. LTD.**  
Radiometer Headquarters, Bush House, Aldwych, W.C.2



Moving Coil Instruments 25/-  
Moving Iron 10/-  
New Pocket Voltmeter, 0-6-120 volts, 7/6.  
0-30 dush type illustrated

**The BROWNIE WIRELESS**



9/6

**Transformer**

The Brownie "popular" has been designed to meet the public demand for a general purpose transformer giving really good reproduction suitable for inclusion in home-constructed sets.

The remarkable results obtained on these "Popular" transformers are made possible by very careful attention to the windings and preparation of the core. The magnetic field is composed of special laminations of the softest iron procurable, and the accuracy of the windings on their moulded bobbins gives a resonance and reproduction unequalled by transformers costing twice the price.

This transformer is being used with great success in the "Simplicity Screen-grid Three" recently described in "Amateur Wireless."

**The BROWNIE WIRELESS COMPANY (G.B.), LTD.**  
Dept. 23, Nelson St. Works, London, N.W.1

**HERE IS THE  
OAK WIRELESS CABINET  
YOU ARE LOOKING FOR**

Do not put a fine piece of work into a fourth-rate box.

Install a **"LANGMORE"** and be proud of your set.

These cabinets are made in the following sizes:—

- No. 1. Panel, 16 in. x 7 in. Cabinet, 2 ft. 6 in. high, 1 ft. 8 in. wide, 12 in. deep.
- No. 2. Panel, 18 in. x 7 in. Cabinet, 2 ft. 6 in. high, 1 ft. 10 in. wide, 12 in. deep. The Cabinet for the British Station Three, described in July 21 issue.

- No. 3. Panel, 21 in. x 7 in. Cabinet, 2 ft. 6 in. high, 2 ft. 1 in. wide, 12 in. deep. Suitable for the Cossor Melody Maker and Britain's Favourite Three. Price **32/6**

All are fitted with hinged top, heavy baseboard, etc., and a tray underneath gives accommodation for batteries. London made. Highly finished in Jacobean style. If required, enclosed Battery tray with double doors in front of same 10/- each extra to above prices.



Nos. 1 and 2  
**PRICE ONLY 27/6 EACH**

**PACKED AND SENT CARRIAGE PAID ANYWHERE**

*Please note this price does not include Panel. Other sizes and styles, prices on application. Trade enquiries invited.*

**The MISCELLANEOUS TRADING CO. LTD.**  
Phone: Hol. 4894. 143, High Holborn, London, W.C.1

**THE MOST  
EFFICIENT  
SOLDERING  
IRON  
IN THE WORLD**

Guaranteed for one year

**12/6**

**COMPLETE**



**K.N. ELECTRICAL PRODUCTS LTD.**  
87 Wardour St., London, W.1. Phone: Regent 4632

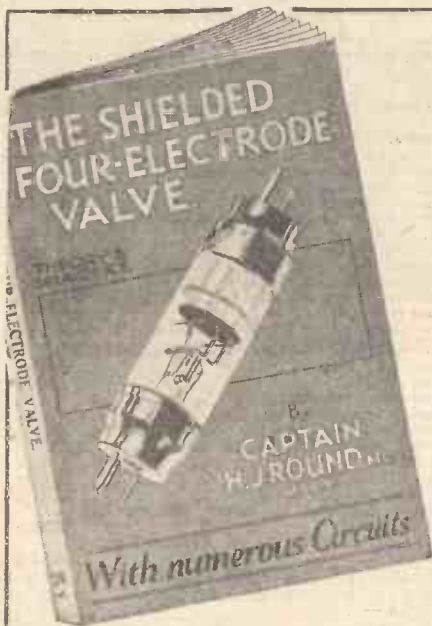

**NOBODY**  
Who Wants to  
Get the Best  
Results from  
These New  
Valves  
**CAN**  
**AFFORD**  
**TO MISS**  
**THIS**  
**BOOK**

**2/6**

GET A  
COPY  
TO-DAY!

From All Newsagents and  
Booksellers

Published jointly by  
**Bernard Jones Publications, Ltd. and Cassell & Co., Ltd.**

**Orphean  
RADIO**

**CONVENIENT, RELIABLE, AND HOW EASY**

NO aerial to erect, no earth wire to fix, and no unsightly battery leads to connect, but instead a remarkably handsome self-contained 3-valve portable. This new set combines extreme efficiency with handsome appearance. It is strongly constructed for outdoor use. The polished cabinet is of solid oak mounted upon ball-bearing turntable measuring 17½ in. high, 15 in. wide, and 8½ in. deep. For those who have already a wireless set, we recommend our "Standard" cabinet cone speaker. Its refined and artistic appearance, combined with a clear mellow tone, makes it a bargain which ought to be secured at once. Price £3 : 15 : 0



Write TO-DAY for Lists

**OTHER  
"ORPHEAN"  
BARGAINS**

- "SUPER" CABINET £6  
Cone Speaker
- "THE ORPHEAN CONE" £2  
Loud-Speaker
- GRAMOPHONE PICK-UP 50/-
- HORN TYPE LOUD-SPEAKERS  
"De Luxe" 50/-  
"Standard" 40/-  
"Gem" 30/-

Send for List.

**ORPHEAN 3-VALVE  
PORTABLE**

Price - £21 : 0 : 0

Royalties Extra

Deferred Payments can be arranged

**LONDON RADIO MFG. CO., LTD.**

Head Office & Works:  
Station Rd., Merton Abbey, London, S.W.19  
Telephone: WIMBLEDON 4658

Advertisers Appreciate Mention of "A.W." with Your Order

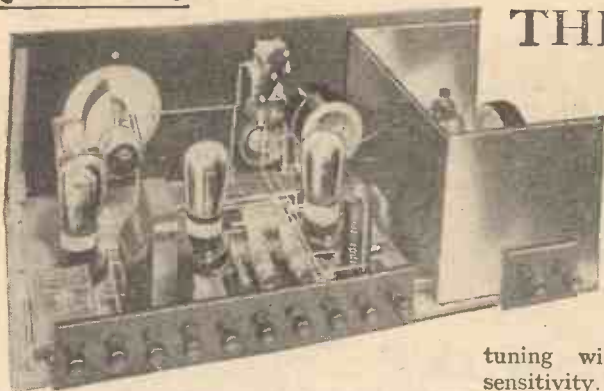

# THE "RANGER"

*A D.X. Four incorporating a Screen-grid Valve and Improved Tuned-anode Coupling, which was Described in "A.W." No. 330. Below the Operating Notes are Given*

TESTS with the "Ranger" have been extended over a period of six weeks and during that time nearly every station worth its carrier wave so to speak, has been pulled in at good loud-speaker strength on both long and short waves, i.e., between 2,000 and 200 metres.

One reason for the masterly way in which the "Ranger" delivers the goods lies in the fact that the sensitivity is so readily controllable by means of the reaction condenser and the separate filament rheostat in the positive lead of the screen-grid-valve filament.

Emphasis was laid earlier in this series on the necessity for a short aerial, especially when there is a powerful broadcasting station in close proximity.

With a 60-ft. aerial the lead-in can be taken to the centre tap of the aerial tuning coil; thus providing sufficiently selective

tuning without too great a loss of sensitivity.

On most moderately powerful signals the reaction control can be set at zero, the amplifying properties of the screen-grid valve being quite enough to enable the operator to tune in signals without heterodyning the carrier waves.

It will be understood that the aerial-tuning and anode-tuning condensers must be worked in unison, that is to say, both circuits with which these controls are associated must tune to the same wavelength—the wavelength of the incoming signal.

It is quite possible to hear stations even when the circuits are not exactly in tune, but under these conditions the maximum volume possible will not be obtained. It is, therefore, very important to know when the two circuits are exactly in tune.

The reaction control can be used as a rough-and-ready, but quite practicable,

way of ensuring an accurately-tuned signal. The reaction demand is least when the two circuits are in tune, and with one condenser at any particular setting and the reaction condenser half-way in, an audible reaction indication in the form of a "squeak" will be heard when the other condenser is correctly adjusted for resonance.

It is definitely *not* recommended that undue use be made of reaction, but as a means of ensuring correct tuning adjustments it is valuable, especially at the outset, when the operator is "feeling his way." The filament rheostat for the screen-grid valve can be operated as a volume control, providing that the required elimination is not excessive.

Fifty thousand miles of telephone and telegraph wire, from the Atlantic seaboard to the Pacific coast, are used every Saturday night in the broadcasting of the Lucky Strike Dance Orchestra Hour.

## BLUEPRINTS

- CRYSTAL SETS. 6d. each, post free.**
- "Best-yet" Set .. .. . AW114
  - Centre-tap Set .. .. . WM50
- ONE-VALVE SETS. 1s. each, post free.**
- Ultra sensitive Hartley One .. .. . AW103
  - Fan's Short-wave One .. .. . AW119
  - Super Reinartz One .. .. . AW127
  - Beginners' One-valver .. .. . AW140
  - Long-range Hartley .. .. . WM54
  - Reflexed One for the Loud-speaker .. .. . WM66
- TWO-VALVE SETS. 1s. each, post free.**
- Britain's Favourite (D, Trans) (Price 4d., with copy of "A.W.") .. .. . AW 77
  - Home-and-Abroad 2 (D, Trans) .. .. . AW 77
  - Ultra-selective Hartley (D, Trans) .. .. . AW 93
  - Oceanic Short-wave (D, Trans) .. .. . AW 91
  - Trapped Reinartz (D, Trans) .. .. . AW 92
  - "O" 2 (D, Trans) .. .. . AW 99
  - Long Distance Two (HF, D) .. .. . AW110
  - DX Headphone Two (HF, Det.) .. .. . AW134
  - Ace of Twos (D, Pentode) .. .. . AW143
  - Home Two (D, Trans) .. .. . AW146
  - Girdle Two (Price 1s. 3d., with copy of "W.M.") .. .. . WM30
  - Chapman-Reinartz Two (D, Trans—4d. with copy of "A.W.") .. .. . AW148
  - British Broadcast 2 (D, Trans) .. .. . WM44
  - Two-programme 2 (D, Trans) .. .. . WM56
  - Q-coil 2 (D, Trans) .. .. . WM62
  - Crusader (D, Trans) .. .. . WM69
  - Flat-dweller's 2 (HF, D) .. .. . WM76
  - Two Daventry Two (D, Trans) .. .. . WM97
  - Tetrode Short-wave Two (SG, D) .. .. . WM99
  - Key-to-the-Ether Two (D, Trans) .. .. . WM107
- THREE-VALVE SETS. 1s. each, post free.**
- Modern Tuned-anode (HF, D, Trans) .. .. . AW 35
  - All-from-the-Mains (D, 2LF) .. .. . AW 41
  - Short-wave (D, RC, Trans) .. .. . AW 50
  - Ether-searcher (D, RC, Trans) .. .. . AW 52
  - Britain's Favourite (D, RC, Trans) (Price 4d., with copy of "A.W.") .. .. . AW 72
  - Broadcast 3 (D, RC, Trans) .. .. . AW 76
  - Q-coil 3 (D, RC, Trans) .. .. . AW 82
  - Clarion 3 (D, 2 Trans) .. .. . AW 83
  - Summer-time DX Three (HF, D, Trans.) .. .. . AW106
  - Three-valve Mains receiver (HF, D, Trans) .. .. . AW109
  - British Station (Three HF, D, Trans) .. .. . AW122
  - Optional Two-three (D, 2LF) .. .. . AW124
  - "Simpler Wireless" Mains Three (D, 2 LF) .. .. . AW126

- Full-size blueprints are available of the following sets. Copies of the "Wireless Magazine" and of "Amateur Wireless" containing descriptions of all these sets can be obtained at 1s. 3d. and 4d. respectively, post free.**
- "Proms" Three (D, 2RC) .. .. . AW137
  - Adaptable Three (D, 2 Trans.) .. .. . AW139
  - New-style Baffle Three (D, RC, Push-pull) (Price 1s. 6d.) .. .. . AW141
  - All-wave Mains Three (HF, D, Trans, Rectifier—Price 1s. 6d.) .. .. . AW144
  - All-purpose Shortwave Three (D, RC, Trans) .. .. . AW147
  - Screen-grid Q-coil Three (HF, D, Trans) .. .. . AW150
  - Continental (HF, D, RC) .. .. . WM 7
  - Screened-grid (HF, D, RC) .. .. . WM21
  - Five-guinea 3 (HF, D, Trans) .. .. . WM29
  - Dominions Short-wave (D, 2 Trans) .. .. . WM39
  - Metropolitan (D, 2LF) .. .. . WM48
  - Everyday (D, 2 Trans) .. .. . WM52
  - Music Charming (D, RC, Trans) .. .. . WM60
  - Britannia (D, RC, Trans) .. .. . WM67
  - Home and Garden 3 (D, 2RC) .. .. . WM78
  - Pole-to-Pole Shortwave (D, RC, Trans) .. .. . WM89
  - Glee-singer Three (D, 2RC) .. .. . WM92
  - Aladdin Three (HF, D, LF) .. .. . WM95
  - Interceptor Three (SG, D, Pentode—is. 3d., with copy of "Wireless Magazine") .. .. . WM105
  - All-wave Screened-grid Three (HF, D, Trans) .. .. . WM110
- FOUR-VALVE SETS. 1s. 6d. each, post free.**
- Tuned-anode 3-4 (HF, D, 2 Trans) .. .. . AW 49
  - Near and Far Three-four (HF, D, RC, Trans) .. .. . AW113
  - "Pick-up" Three-four (D, 2 Dual Imp.) .. .. . AW118
  - Explorer Four (HF, D, RC, Trans) .. .. . AW120
  - Summertime Searcher (2HF, D, Trans) .. .. . AW128
  - Overseas Shortwave (HF, D, 2 Trans) .. .. . AW133
  - The Ranger (HF, D, RC, Trans) .. .. . AW145
  - Simplicity (HF, D, 2 Trans) .. .. . WM49
  - Gramo-Radio 4 (D, RC, 2 Trans Push-pulled) .. .. . WM70
  - Q-coil 4 (HF, D, Trans, RC) .. .. . WM71
  - Screened-grid 4 (HF, D, 2RC) .. .. . WM77
  - Frame Aerial 4 (HF, D, 2RC) .. .. . WM85
  - All-from-the-Mains Four (HF, D, 2LF) .. .. . WM86
  - Five-pounder Four (HF, D, RC, Trans.) .. .. . WM91
  - Symphonic Four (HF, D, 2LF) .. .. . WM98
  - Touchstone (HF, D, RC, Trans) .. .. . WM109
- FIVE-VALVE SETS. 1s. 6d. each, post free.**
- Exhibition 5 (2HF, D, RC Trans) .. .. . WM33
  - 1928 Five (2HF, D, 2 Trans) .. .. . WM46
  - All-the-world 5 (2HF, D, 2RC) .. .. . WM63
  - Cataract 5 (HF, D, RC, Push-pull) .. .. . WM79
  - Empire Five (2SG, D, RC, Trans) .. .. . WM96
- SIX-VALVE SETS. 1s. 6d. each, post free.**
- Short-wave Super-6 (Super-het, Trans) .. .. . AW 67

- PORTABLE SETS.**
- Easter 7 (Super-het, RC, Trans) .. .. . AW 89 1/6
  - Companion 5 (2HF, D, RC, Trans) .. .. . AW103 1/6
  - Daventry Loud-speaker Portable (2 HF, D, RC, Trans) .. .. . AW107 1/6
  - Town and Country (HF, D, RC, Trans) .. .. . AW111 1/6
  - House and Garden (screened-grid HF, D, RC, Trans) .. .. . AW116 1/6
  - Hand Portable (D) .. .. . AW125 1/-
  - "Best-yet" Portable (SG, D, 2 Trans) .. .. . AW136 1/6
  - Sunshine 5 (2HF, D, 2 Trans) .. .. . WM74 1/5
  - Chummy 4 (with modification for L.S.&H.T.) WM80A 1/6
  - Pilgrim Portable (D, Trans) .. .. . WM94 1/-
  - Super Chummy Four (2HF, D, Pentode) WM104 1/6
- AMPLIFIERS. 1s. each, post free.**
- One-valve LF Unit .. .. . AW 79
  - Add-on HF Unit .. .. . AW 82
  - Super-power Push-pull (2LF) .. .. . AW 86
  - Hook-on Short-wave (Amplifier) .. .. . AW104
  - Add-on Distance-getter (HF) .. .. . AW117
  - Add-on Three (D, RC, Trans) .. .. . AW121
  - Screened HF One .. .. . AW129
  - Screen-grid HF Amplifier .. .. . AW138
  - Range Extender (HF Unit) .. .. . WM38
  - True-tone Amplifier (3 valves) (Trans, RC, Parallel Power) .. .. . WM47
  - Gramo-radio Amplifier (2 v.) (Trans, Parallel Power) .. .. . WM74
- MISCELLANEOUS. 1s. each, post free.**
- Rectifier for "Simpler Wireless" Sets .. .. . AW 62
  - H.T. from A.C. Mains .. .. . AW 73
  - "AW" Moving-coil Loud-speaker .. .. . AW 97
  - H.T. Eliminator for A.C. (200 v. output) .. .. . AW102
  - Moving-coil Output Unit .. .. . AW115
  - L.T. and H.T. Mains Unit (DC) .. .. . AW123
  - Anti-motorboating Unit .. .. . AW130
  - Knife-edge Wavetrap (6d.) .. .. . AW131
  - All-metal Eliminator for H.T. .. .. . AW135
  - Duplex Diaphragm Loud-speaker .. .. . AW142
  - Power-plus Loud-speaker .. .. . AW149
  - A.C. Battery Eliminator .. .. . WM41
  - Cone Loud-speaker .. .. . WM55
  - Moving-coil Loud-speaker .. .. . WM58
  - D.C. Battery Eliminator .. .. . WM59
  - Wavetrap .. .. . WM64
  - Universal Short-wave Adaptor .. .. . WM82
  - Linen-diaphragm Loud-speaker .. .. . WM90
  - Valveless A.C. Power Unit (L.T.) .. .. . WM100
  - Valveless A.C. Power Unit (H.T.) .. .. . WM101
  - Super Power Unit (2v.) .. .. . WM103

Send, preferably, a Postal Order (stamps over sixpence in value unacceptable) to

**AMATEUR WIRELESS**  
58-61 FETTER LANE, LONDON, E.C.4





# MULLARD MASTER THREE \*STAR\*

This new and wonderful set must appeal to young and old, amateur or experimenter, in fact, EVERYBODY!

## YOU CAN PURCHASE

ANY ITEM SEPARATELY (OR A KIT OF PARTS). Every component is available at short notice. This list is strictly to Mullard specification. 3 Valve Holders, Lotus, at 1/3. Colvern Combined Wave Coll. 17/6. Permacore Transformer, 25/-.

**Total £5 : 12 : 6** Carriage paid

OAK CABINET AS SHOWN WITH PARTS for 12/6 CARR. PAID No Coil Changing

ALL H.T. and L.T. BATTERIES STOCKED

## CABINETS



LARGE STOCKS of really nice CABINETS, American type, hinged lid, baseboard. Oak (3 qualities). 12x8 9/11 11/9 13/6 14x7 12/11 13/11 16/6 16x8 12/11 15/6 17/11 18x7 15/- 18/6 21/- 21x7 15/- 18/- 21/- Carriage and Packing Free. Extra Irish Free State.

Anything Sent C.O.D. (WHERE POSSIBLE) U.K. ONLY

SCREENED GRID VALVES, PENTODE VALVES, also STANDARD COSSOR, MULLARD, B.T.H., EDISWAN, MARCONI, OSRAM in Stock.

## THE NEW COSSOR MELODY MAKER

Issued September, 1928

KITS OF PARTS AND CABINET with 3 SPECIFIED VALVES £7 : 15 : 0 In a Sealed Carton

We stock Igranic, Climax, Ever-Ready, Hellesen, Siemens, Formo, Ferranti, Wearite, Ormond, J.B., Benjamin, Lotus, Mullard, Dubilier, Lissen, Lewcos, Utility, Magnum, Peto-Scott, Peerless, Burndept, Pye, Marconi, McMichael, Cosmos, Carborundum, R.I.-Varley, Gambrell, Brown's, Sterling, Amplions - in fact, everything it is possible to stock.

## R. I. VARLEY

## AUTHORISED BRANDES DEALER

R.I.-Varley H.F. Choke, 9/6. R.C.C. Unit, 20/-; Type B, 22/6; Tuners, Model A, 47/6; Model B, 37/6; Standard, 39/6. Straight Line Super L.F., 25/-; with 4 terminals, 22/6. General Purpose L.F., 15/-; Push-Pull Output Transformer, 22/6. Filter Choke, 21/-.

L.F. 3-1, 12/-; L.F. 5-1, 12/6; .0005 Friction, 12/6; .0003 Friction, 12/-; Headphones, 8/- (matched 4,000 ohms); Brandola, 50/-; Ellipticon, 77/6. 3-Valve Sets, 135/- (including 3 Cossor Valves, plus tax).

DARIO VALVES (Radio Micro) Super-Power, 2 or 4-v., 7/6 G.P., .05, 2 or 4-v. ... 5/6 R.C.C., 2 or 4-v. ... 5/6 Post 3d. each.

## COSSOR NEW MELODY COMPONENTS FOR SAME

(sold separately post extra) 2 Ormond .0005 Log at 6/- each, 2 Cossor Pattern S.M. Dials at 3/9 each, Ormond Reaction .0001 (bushed) 4/-, Ormond P.P. switch, 1/3, 6 ohm Rheostat, 2/- (all knobs to match cabinet), 5 Lotus new type valve holders at 1/3, 1 Wearite H.F. choke, 6/6, 3 T.C.C. Condensers, 2 mid., 3/10, S.P. .0001, 2/4, 1, 1/10, Dubilier 3 meg., 2/6, 3 to 1 L.F., 15/- (compact, well known British make), 2 wound coils, Wearite, 15/- pair. Total £4 : 0 : 0

For 7/6 extra if you purchase above lot only, I will include Handsome metal cabinet to be specified on ready to assemble, drilled, with all nuts, bolts, spanner, screwdriver and baseboard, brackets, 2 Drilled Terminal Strips and 9 terminals, Screen assembly, Glazite, 9 volt Grid Bias, Rubber flex and plugs. Carriage 1/-. (Free to callers). Screened grid valve, 22/6. R.C. valve, 10/6. Power, 12/6.

**BULGIN Short-wave Chokes**, 8-80 metres. 3/-, post 6d. Bulgin Reaction, .0001, 5/6; Neutralising, 5/-; Grid Bias Clips, 6d.; 2-volt Bulbs, 6d. (with holder, 1/-). All Bulgin parts stocked.

**BRITISH GENERAL Aerial Tuning Unit**, 250/2,000 metres, 18/6.

**CLEARTRON Valves**, 2 volts, 4 volts, 6 volts, made for every purpose in radio, each, 4/- (Power, 6/-).

**CYLON Condensers**, Twin Thumb Control, for Inceptor 3, etc., 47/- each. Bebe, .0001, 7/6; .00015, 8/-; .0002, 8/6; .00025, 9/6; .0003, 11/-; Complete with 2-in. Knob and Dial.

**CLAROSTAT Vol. Control**, 8/6. Table Type, 13/6.

**GAMBRELL Neutrovernia**, 5/6. Voluvernia, 6/9.

**M.P.A. Popular Plaque**, 29/6. De Luxe Plaque, 47/6. Mahogany Table Cabinet Speaker, 5 guineas.

**MULLARD Permacore L.F. Transformers**, special winding, 25/-.

**ORPHEAN Loud-speakers**, "De Luxe" Cone, 40/-, "Gem," 30/-.

Panel Brackets, Aluminium, 1/-, 1/6; Magnum, small, 1/6; Master 3, 2/6.

**PHILLIPS Seven-cornered Loud-speaker** is new in value. A first-class article at the low price of 50/-.

**PYE L.F. Chokes**, 20 or 32 henries, 12/6. L.F. Transformers, 17/6. Valve Holders, 2/-, etc., etc.

**R.C.C. Units**, various, Lissen, 4/-; Cosmos, 8/6 (with V.H.), 10/6; Magnum, 7/6; Carborundum, 8/6; Dubilier, 7/-.

**SIFAM New Model Pocket Voltmeter**, H.B., 4,000 ohms, heavy nickel case, 7/6.

**Standard Wave Traps**, made to specification of G. Kendall, Esq., 11/9. Magnum, 15/-; Lewcos, 13/6.

**Short-wave Coils**, mounted, set of 4, 5/11. By post, 6/6.

**TELSEN L.F. Transformers** Radiogrand, 12 6. Telsen Ace, 8/6. Ratio 3 or 5 to 1.

**TRIOTRON Valves**, 2-volt power, 6/9; 2, 4/6; .05, 4/9; 4-volt power, 6/3; G.P. 4/3; .05, 4/6. Post 6d. each (20/- worth post free).

**Valve Holders**, all with terminals, Lotus, 1/3, W.B. 1/6; Formo, 1/3; Benjamin, 1/6; Millgate, 1/3; Harlie, 1/-; Bowyer-Lowe, 1/9; Lissen, 1/-.

**HYDRA CONDENSERS** Tested on 500 volts D.C. (working voltage 240 d.c.) 1 mid., 2/6; 2 mid., 3/3; 4 mid., 5/3.

**CONE SPEAKER CABINETS** take 12 in. cone (will take Blue Spot unit), handsome design, all enclosed, 9/11, 10/11, 12/11 each. OAK FINISH. 2/- each more by post.

"A.W.", "P.W." and "M.W." LOADING COILS, 7/6

**ELEX Terminals**, Plugs, and Spades Stocked.

## LOUD-SPEAKERS

Ediswan One-Der 50/- M.P.A. Plaque ... 29/6 Phillips Seven-Corner ... 50/- Amphion Cabinet 60/- Do., Mahogany ... 63/- Ferranti ... 63/- Orphean Gem ... 30/- Etc., etc.

# K. RAYMOND

27 & 28a, LISLE ST., LONDON, W.C.2

Come to LEICESTER SQUARE TUBE. This address is at the back of Daly's Theatre. Phones: Gerrard 4637 and 2821

## C.O.D.

Orders despatched same day as received where possible. Send ORDER with instructions and pay Postman.

C.O.D. APPLIES TO UNITED KINGDOM ONLY.

WE ARE OPEN ALL DAY SATURDAY ALL DAY THURSDAY ALL DAY EVERY DAY Hours 9 a.m. to 8 p.m. Sat. 9 a.m. to 9 p.m. Sunday morning 11-1

## QUOTATIONS

for SETS OF PARTS Special Prices on lists of 20/- and over (other than those advertised). CALLERS OR POST

## The Original COSSOR MELODY MAKER

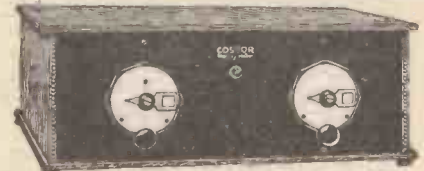

This was recently acclaimed as the "Wonder Set of the Season." It still remains so

SPECIAL PRICE £4 : 4 : 0

## SPECIFIED COMPONENTS:

2 Ormond .0005, 2 Do. S.M. Dials, 6 T.C.C. Condensers, 2 B.B. Clips, 1 B.B. Rheostat, 3 Dubilier Leaks, 3 Lotus V.H., Ferranti A.F.3. 2 Switches, 9 named Terminals, Glazite, 9-v. Grid Bias, splendid D.S.O. wound Coil on Pirite former.

Handsome Oak Cabinet, 12/3 with parts, Baseboard Free. Also Cabinets at 15/11, 13/11, and Mahogany Polished, at 20/- Carriage 2/-.

## FREE

WITH PARTS

Drilled High-grade 21 x 7 Polished Panel and Strip, Wood Screws. Carriage 1/- COSSOR VALVES 2, 4, or 6-Volt for above. L.F., D., R.C., or H.F., 10/6 each. Power, 12/6 each.

KITS of parts for all CIRCUITS. Make out LIST for keen quotation. DON'T worry, if it's Wireless WE HAVE IT.

## ASTOUNDING BARGAIN IN THREE-VALVE LOUD-SPEAKER SETS

Receives London, 5GB, 5XX, and many Continental stations.



## D. & ZL.F.

Call and hear one demonstrated.

NO OBLIGATION To Purchase

AS SHOWN £5 - 12 - 6

Assembled ready for use: NO COILS TO CHANGE

**SPECIFICATION** Tax Paid. Carr. & packg. 5s. Beautifully finished cabinet with hinged lid, all parts enclosed—3 British Dull Emitter Valves (1 Power). Latest Type Condenser. S.M. Dial, distance stations are easily obtainable with standard aerial. High Tension Battery 109 volts, L.T. 2 volt Exit or Oldham. All Aerial Equipment, Earth Switch and wire. Tunes 250 to 2000 metres. A REAL set, at a price within anyone's reach. TRY ONE. 2 VALVE SETS exact to above complete £4 17s. 6d. Carr. and Pack. 5s.

## COUPON No. 5

ONLY ONE COUPON on ANY ONE ORDER If you spend 25/- or more you can Buy for 3d. Extra

## ONE (ONLY) OF THE FOLLOWING LOTS:

S.M. Dial Fuse & Holder. Permanent Detector. 100 ft. 7/22 12 Nickel Term's. Battery Switch. Indoor Aerial 60X Coll. .0C03 & 2 meg. Leak. 12 yds. Lead in. II.F. Choke. 9 volt Grid Bias. ONE OF ABOVE 3d. WITH 25/- ORDER.

PLEASE ADD 3/6 TO PRICE (total £5 16 0) AND I WILL INCLUDE: 2 Handsome S.M. Dials, Set of connecting Links, 8 plugs, 2 Spades, 4 Engraved Terminals, 2 Ebonite Strips, Twin Flex, Splendid Aluminium Panel, 18 x 7, drilled ready for use. 9-volt Grid Bias, Baseboard. Carriage Paid.

VALVES 2 at 10/6 1 at 12/6 Super P.15/-

LISSEN Valve-holders, 1/-; Fixed Con., 1/-, 1/6; Leaks, 1/-; Switches, 1/6, 2/6; Latest 2-way Cam Vernier, 4/6; Rheostats, 2/6; B.B., 1/6; Lisenola, 13/6; L.F. Transformers, 8/6; Coils, 6/8, 6/4; 250X, 9/9; 60-v. H.T., 7/11; 100-v. 12/11; Super 60-v., 13/6; Grid Bias, 1/8; 4.5. 5d.; Super L.F. 19/-; Variable .0003, 6/-; .0005, 6/6.

ORMOND No. 3 CONDENSERS. .00025, 5/6. .00035, 5/9. .0005, 6/- (With 4-in. Dial). Friction Geared, .0005, 15/-; .0008, 14/6. .00025, 13/6. Straight Line Frequency Friction Geared, .0005, 20/-; .00035, 19/6. S.L.F. .0005, 12/-; .00035, 11/-; Log .0005, 13/-; .00035, 12/6. .00025, 12/-; S.M. Dial, 5/-; All Components Stocked.

J.B. CONDENSERS T.T. Friction Ver. .0005, 16/6; .00035, 16/-; .00015, 15/9. S. L. F. .0005, 11/6; .00035, 10/6; .00025, 10/-; .00015, 10/-; Neutralising ... 3/6 FOR MASTER 3 STAR Log .0005, 11/6. .0003, 10/6.

COSSOR VALVES MULLARD VALVES SIX-SIXTY VALVES B.T.H. VALVES EDISWAN VALVES MARCONI VALVES H.F., L.F., R.C., 10/8. Power, 12/6. Super Power, 15/-; 2-v., 4-v., C-v. Screen Grid, 22/6. Pentodes, 25/-

LEWCO'S PRODUCTS O.T. Coils, 40, 50, 60, 75, 3/6 each, 100, 150, 200, 5/3 each. Glazite, 10d. 10 ft. Litz, 27/42. 11/6 50 yds. Frame Aerial Wire, 3/6 100 ft. Battery Leads, 4-way, 5/6; 5-way, 5/6; 6-way, 7/6; 7-way, 8/6. All Binocular Coils. "Q" Coils, 21/- Aerial, 15/- In stock.

Ebonite cut while you wait at 1d. square inch, also 1/2 in. at 1d. Only the best supplied. Drilled Panels for all Circuits.

Mention of "Amateur Wireless" to Advertisers will Ensure Prompt Attention

# Amateur Wireless HANDBOOKS

each  $2/6$  net

*Of all Newsagents and Booksellers, or 2/9 Post free from  
Cassell and Company Limited, La Belle Sauvage, E.C.4.*

## The Shielded Four-electrode Valve THEORY AND PRACTICE by Capt. H. J. ROUND, M.C.

Capt. Round is one of the greatest authorities in the world on radio science and practice, and his book is a complete guide to the principles under which this latest and most remarkable valve should be operated.

## Loud-Speaker Crystal Sets How to Make and Manage Them

Provides working instructions for building a number of highly efficient crystal sets; making an attachment for simple connection to existing wireless set; and designs for crystal sets embodying the crystal loud-speaker system.

## Wireless-controlled Mechanism For Amateurs

This book is an illustrated practical guide to the making and using of short-range wireless control apparatus, and it has been written so simply that it can be understood by any enthusiast possessing an elementary knowledge of wireless.

## The Practical "Super-het" Book

Explains what the Super-het is, what it does, how it works, and how to build up a number of super-het sets made of tested, British-made components.

## Perfect Broadcast Reception By Ernest H. Robinson (5YM)

Explains how most sets fall short of the ideal and how to obtain perfect reception. Is virtually a popular exposition of the main problems of transmission and reception. Very valuable alike to listeners and experimenters.

## The Short-wave Handbook By Ernest H. Robinson (5YM)

Describes in very simple language the wireless apparatus used in short-wave work, shows how to make it and how to use it, and explains the technical principles with which the beginner will need to become acquainted.

## The Practical Wireless Data Book

The intelligent novice, and particularly the home constructor and the keen wireless amateur who is always rigging up different circuits and experimenting for progress will find this Data Book extremely helpful.

## The Wireless Man's Workshop By R. W. Hallows, M.A.

Written by a practical home constructor, this book—containing much useful wireless information—enlightens readers on the selection and right methods of using the tools and materials used in constructing wireless sets.

each  $1/6$  net

## Wireless Telephony Explained

CONTENTS: The Electron; Induction and Electro-magnetism; Waves and How they Travel; Inductance and Capacity; Rectification; Amplification; Reaction and Beat Reception; Aerials and Earths; Transmission Systems; Receiving Sets; Useful Formulae and Data; Index

## Crystal Receiving Sets And How to Make Them

CONTENTS: A Simple and Efficient Receiving Set; A Single-slider Set; Set with Semicircular Tuner; Crystal Set with Tapped Single Coil; A Loose-coupled Set; Set with Plug-in Basket Coils; Combined Crystal and Valve Receiver; Some Miniature Receiving Sets; Crystal Circuits; How Crystals Work; Making a Buzzer; Receiving C.W. Signals on a Crystal Set; Converting Low-Resistance Phones; The Morse Code; Index.

## Wireless Component Parts And How to Make Them

CONTENTS: Components and Their Varied Purposes; Crystal Detectors; Coils, Making and Mounting; Condensers; Variometers and Vario-couplers; Resistances or Rheostats; Transformers; Making a Test Buzzer; Index.

## Wireless Telegraphy and Telephony And How to Make the Apparatus

CONTENTS: General Principles of Wireless Telegraphy; Some Informative Experiments; Tuning and Resonance Explained; Transmission and Reception; Various Detectors Explained and Described; Thermionic Valves as Detectors, Amplifiers and Generators; Making a Single-circuit Receiving Set; Making a Complete Short-wave Receiving Set; Making a Valve Panel for a Receiving Set; Making a Five-valve Amplifier; Wireless Telephony; Arrangement and Erection of Aerials; Index.

*Of all Newsagents and Booksellers, 1/6 net each, or by  
post 3d. extra from Cassell and Company Limited,  
La Belle Sauvage, E.C.4.*

## Practical Guide to Wireless

(1s. net, Postage 2d.)  
CONTENTS: An Outline of Present Broadcasting; The Aerial; Tuners and Tuning; The Crystal Set; The Valve and Valve Sets; Telephone and Loud-speakers; Current for Valve Filaments; Index.

*A Useful Series for Wireless Amateurs*

# Cassell Books



La Belle Sauvage,

London E.C.4.

### THOSE MYSTERY STATIONS

**M**YSTERY stations still seem to crop up at regular intervals. Frequently, the mystification is caused by the sudden change in wavelength of a transmitter or its casual tests in a position of the broadcasting band which it may jealously covet. As an instance, San Sebastian may be cited, which, working on 335 metres for a long period, much to the discomfiture of Copenhagen, was advised to lower itself to 297 metres but has broadcast since that date on about 400 metres, where, if you care to try, you will find it at present.

Further, in that immediate neighbourhood at odd times we may pick up an Italian transmission which, heard by an AMATEUR WIRELESS reader, has been identified by him as emanating from the new Genoa broadcaster—an addition to the Italian system promised by the end of next month.

A gain to be registered is that of Goeteborg (Sweden), of which, on a wavelength of 416 metres, you must have noticed the extra power. For some time this station has been under reconstruction, and without warning has developed into a 6-kilowatt—a power which, in that position of the broadcast band, represents a big noise. If at times you have trouble in picking up Sweden's station, Motala, try for Goeteborg, as this "second string" may afford greater satisfaction. It possesses a steady signal, and during the last week or so has not suffered from fading.

Kalundborg, also, at times has puzzled us with its alternate broadcasts on 1,680 metres and on its old wavelength of 1,153.8 metres, the former one being the position it will eventually take, if favourable.

According to decisions taken at the last Washington Conference, many of the long-wave stations will have to adopt fresh wavelengths; as this change should be effected by the end of the year, we may hear transmitters working at positions on our condensers hitherto more or less silent, except for morse, "backwash," and other unpleasant interference.

"Amateur Wireless and Radiovision." Price Threepence. Published on Thursdays and bearing the date of Saturday immediately following. Post free to any part of the world: 3 months, 4s. 6d.; 6 months, 8s. 9d.; 12 months, 17s. 6d. Postal Orders, Post Office Orders, or Cheques should be made payable to "Bernard Jones Publications, Ltd."

General Correspondence is to be brief and written on one side of the paper only. All sketches and drawings to be on separate sheets. Contributions are always welcome, will be promptly considered, and if used will be paid for. Queries should be addressed to the Editor, and the conditions printed at the head of "Our Information Bureau" should be closely observed. Communications should be addressed, according to their nature, to The Editor, The Advertisement Manager, or the Publisher, "Amateur Wireless," 58-61 Fetter Lane, London, E.C.4.



ASK YOUR DEALER OR WRITE NOW!

Readings:  
0-150 VOLTS  
0-6 VOLTS  
0-30 MILLIAMPS

Resistance:  
5,000 OHMS. DEAD-BEAT MOVEMENT CRYSTALLISED BLACK FINISH.

PRICE

8/6

Stocked by Halfords Stores, Currys Stores, and most good-class Radio Dealers.

THIS new Wates Volt-Amp. Meter has caused a complete revision of all existing standards of measuring instrument values and performance! Single purpose meters are an unnecessary waste of money. This super meter with its wonderful "three readings on one dial" feature gives every essential measurement demanded by modern standards of set control and maintenance. The only Radio Meter that Does the Work of Three. No valve set user should be without it. Finished in attractive crystal black and nickel-plated fittings. Guaranteed dead-beat accuracy. From all good-class dealers or complete with explanatory leaflet direct from Dept. A.W.

**WATES**  
"three in one"  
**VOLT-AMP**  
RADIO TEST METER

THE STANDARD WET BATTERY CO., (The Wet H.T. Battery Co.)  
HEAD OFFICE, SHOWROOMS & WAREHOUSE, 181-188 SHAFTESBURY AVENUE. (Nr. Oxford St. End) LONDON, W.C.2



**H.T. UNIT**  
For Multi-valve Receivers. No valves required. No expensive replacements Components from  
**47/6**

**TANNOY**  
A.C. MAINS SUPPLY UNITS  
Please note new address of Head Office and Works—  
**TULSEMERE MFG. Co.**  
DALTON STREET,  
WEST NORWOOD, S.E.27

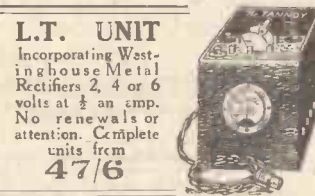

**L.T. UNIT**  
Incorporating Westinghouse Metal Rectifiers 2, 4 or 6 volts at 1/2 an amp. No renewals or attention. Complete units from  
**47/6**

**THE LITTLE CELLS THAT SATISFY**  
Eton Primary H.T. Battery. Pl Porous Pot Cells, S1 and S2 Sac Cells. All complete for assembly.  
1-cell. 6-cell, 12-cell, 30-cell.  
P1 6d. ... 3/3 ... 5/9 ... 14/-  
S1 6d. ... 3/- ... 5/3 ... 12/-  
S2 4d. ... 2/6 ... 3/10 ... 9/6  
Send 1d. stamp for booklet giving full particulars to—  
**THE ETON GLASS BATTERY Co**  
46 ST. MARY'S ROAD - LEYTON - E.10

**USE EEELEX**  
**TREBLE DUTY TERMINALS**  
AND OTHER WIRELESS ACCESSORIES  
J.J. EASTICK & SONS.  
EEELEX HOUSE, BUNMILL ROW, LONDON, E.C.1.6

### OUR BLUEPRINT SERVICE

Constructors of receivers described in this journal should make full use of our Blueprint Service and avoid all risk of failure.

**RADIOGRAMS**

**T**HE Radio Manufacturers' Association of America has decided to give out the true facts about television before it causes serious damage to the trade. A statement reads: "The R.M.A. Board, deploring presentation of television to the public until it is ripe, and convinced that premature exploitation of half-baked television apparatus is and would be injurious to the interests of the radio industry as well as to the public, has directed that the exact truth and real facts regarding television experiments and what may be expected, by the industry and the public, be given in authoritative announcements."

**Buy a VIOLINA Loud-Speaker**

Do you realise that these are the Best Hornless Loud-speakers ever put on the market and that these Five Guinea Cabinet Loud-speakers are being sold for 25/-? The famous Violina can be heard all day at Electradix.

**THE VIOLINA LOUD-SPEAKER**

is a beautiful £5 5s. cabinet, and gives wonderful reproduction of the complete tonal range. This Loud Speaker de Luxe is of beautifully polished mahogany. Price, complete with Reed producer and cord, 25/-.

The famous "VIOLA" Unit is of the latest design balanced armature, push-pull type, giving a powerful drive from moderate signals and a perfect purity and mellowness of tone unequalled. The power-drive is scientifically designed to utilise the maximum magneto-motive force, and the flux path is laminated efficiently to enable the true handling of full output volume.

**HOME CONSTRUCTOR'S KIT.** "Viola" Unit, fitted twin cord and bracket, 14/6. Brown's "A" Reed, 2,000 ohms, 14/-. Western Electric Unit, 10/6. Skinderviken Reed Unit, 2,000 ohms, 10/-. Texas Cone and Metal Centre, 2/-. Stand, with rim, 8/6, or with Cone, 10/-. Ampliton Cone, Gold or Silver, 2/-. Pleated Paper, 2/-. Wood Frames, 3/-. Metal Frames, 5/6. Hard Cone Paper, 15 in. square, 1/-. Pick-up Parts Magnet and Bobbins, 1 1/2; ditto, in case, 1/6. Special Sk. Adjustable Unit, 8/-. Booklet, "Wonders of Microphone," 6d., post free.

**THE DIX-ONEMETER.** The 55-range Rolls-Royce of Radio! The Dix-Onemeter is now the acknowledged Radio Standard and is popular with expert and amateur. Why? Because of its ample range, Exact Precision, Double Mirror Scale, Edge Needle and High Figure of Merit. Nearly electrostatic, a resistance of 60,000 ohms per 100 volts, and reading Crystal Signal Strength in microamps, to currents of 20 amps. Pressures of 2 millivolts to 2,000 volts and resistances from 50 ohms to 50 megohms measured with ease. A most valuable fault detector. Low Price, High Value. De Luxe Model with Moulded Base and Front Zero Adjuster, 55/-. Multipliers, 6/6 each. Complete Booklet of Tests Free.

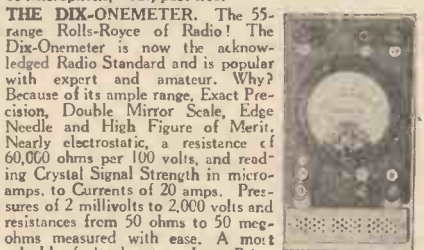

Our Bargain Catalogue will save you Pounds. 4d. Stamps

**ELECTRADIX RADIOS**  
218, UPPER THAMES ST., E.C.  
Blackfriars Stn. Met. Rly. City 0191

A giant variable condenser, with thirteen plates, each a foot square and spaced one inch apart, tunes the WTAM (Cleveland, Ohio) transmitter to its proper frequency. In spite of its great size, however, its capacity is no greater than that of the condenser in the average receiving set.

The new wireless telegraph receiving station for communication with Europe situated at Kaizo, near Yokkaichi, Japan, has begun working and has received messages from Nauen, Warsaw, and France. According to Mr. Korogi, of the station, the record was perfect, not a single word being mistaken.

**I**N the course of his remarks at the recent Exide luncheon, the chairman said: "The past year was the best in the history of the Company, and the Company's expansion all over the world continues as a tribute to the solid excellence of its products and the after-sales service given in all parts of the globe. On the wireless side, the Company has placed upon the market a specially large high-tension battery, having a capacity of 10,000 milliampere hours, which is widely used with public address equipments, photo-telegraphy, talking pictures, and with high-power receivers requiring a very high anode current."

**WORTH WRITING FOR**

A number of leaflets which A. H. Hunt, Ltd., of Tunstall Road, East Croydon, has sent in deal with the articles of interest to wireless amateurs handled by the company. These include, of course, batteries, condensers, measuring instruments, electric lamps, jacks, etc. Readers interested should certainly write for this helpful literature.

**TAYLEX WET H.T. BATTERIES**

New Prices Jars 1/3. Sacs 1/2. Zinc 11d. Sample doc. (18 Volts) complete with leads and electrolyte 4/3. post 9d. Sample unit 6d. Illus. booklet free. Bargain list free. AMPLIFIERS, 30/-. 2 VALVE ALL-STATION SET £4.

**YOUR MELODY MAKER** Kit 20/-. Completed 22/6. Balance by easy payments to suit your income. Send deposit to-day to ensure an early delivery. Any set or kit supplied.

**MONOTONE THREE** The 40 station, 3 valve, single tuning receiver by Allinson. Particulars free. Complete constructional envelope, 1/2.

**A. E. OAKLEY, 43 Carleton Road, London, N.7.**

**PREPAID ADVERTISEMENTS.**

Advertisements under this head are charged **THREEPENCE PER WORD**, minimum charge **THREE SHILLINGS.**

**DEPOSIT SYSTEM**

As the Publishers cannot accept responsibility for the bona fides of advertisers in this publication, they have introduced a system of deposit which it is recommended should be adopted by readers when dealing with persons with whom they are unacquainted. It is here explained.

Intending purchasers should forward to the Publishers the amount of the purchase money of the article advertised. This will be acknowledged to both the Depositor and the Vendor, whose names and addresses must necessarily be given. The Deposit is retained until advice is received of the completion of the purchase, or of the article having been returned to and accepted by the Vendor. In addition to the amount of the Deposit, a Fee of 6d. for sums of £1 and under, and 1s. for amounts in excess of £1, to cover postage, etc., must be remitted at the same time. In cases of persons not resident within the United Kingdom, double fees are charged.

The amount of the Deposit and Fee must be remitted by Postal Order or Registered Letter (Cheques cannot be accepted), addressed to

"AMATEUR WIRELESS," ADVERTISEMENT DEPARTMENT, 58/61, FETTER LANE, LONDON, E.C.4

**WOOD HORNS** for all gramophone units, etc.: List, Maddison, 1 Chapel St., Edgware Rd., N.W.1. Manufacturer of THE ALLWOODORNS.

**MIRACLE SUPER THREE-VALVE SET.** Loud-speaker and accessories; 5/- deposit, 16/6 monthly. Everything Wireless on easy terms. Lists free.—World's Wireles, Wallington.

**FREE: INVENTOR'S GUIDE ON PATENTS.** CHATWIN, 253a Gray's Inn Road, London, W.C.1.

**OAK CABINETS.**—Melody Maker, 15/-; Master 3, 15/-; H.F. Unit for Cossor, 11/6; Baseboards included. Loud Speaker Cabinets from 18/5. Hand made and french polished. Rubber feet. Crated and Carriage paid. Send for list.—Gilbert, Cabinet Maker, Swindon.

**EASY PAYMENTS.** We supply, by easy payments, components, accessories and sets, any make; 10% down, balance spread over 11 months.—Send list of requirements to London Radio Supply Co., 11 Oat Lane, London, E.C.2.

**PRIVATE GREETING CARDS.** Largest Manufacturers require Agents: Free sample book; delightful novelties. Calendars, Real Feather Bird, New feature in cut out Velour designs; Black Cats and Dogs with glass eyes; detachable sprays of Flowers; Notepapers, Celluloid pocket calendar, Blotter. Greeting cards for every taste. Most extraordinary book ever published. Enormous profits and prizes for all. Write—All-British Christmas Card Co., Dept. 408, Blackburn.

**CONE 12 in.** Mounted on frame. Free edge. Improved type: 3 G. Sirrah, 521 Heathway, Dagenham.

**"NOCOST" CHARGERS, (D.C.) 3/- only.** for H.T. Accumulators, post free with instructions. Marvellous value. Patented L.T. Chargers 21/-. Robin Hood Electrical Co. Sole Makers, Primrose Lane, Birmingham.

**This Free 36-page Book is yours for the asking!**



It will tell you how to be certain of perfect reception. Send a postcard TO-DAY.

**BAKER'S Selhurst RADIO**  
89 SELWORTH RD. SOUTH NORWOOD, SE21

**RELIABILITY WIRELESS GUIDE**

Send for New Edition No. T999. It's FREE. Packed full of good things at keen prices for Wireless Constructors.

Trade Enquiries Invited.

**J. H. TAYLOR & CO.**  
3, RAAD 10, HOUSE  
MACAULAY ST. HUDDERSFIELD

**The WIRELESS MAGAZINE**

The Big British Wireless Monthly

1/-

**JUST PUBLISHED**

A NEW WIRELESS BOOK—CONTAINING FULL INFORMATION THAT EVERY OWNER OF A RECEIVING SET WANTS TO KNOW.

**THE WIRELESS MANUAL**

By CAPTAIN JACK FROST, Member of the Institute of Radio Engineers.

IT provides valuable notes on the Working and Upkeep of Wireless Sets, Loud-speakers and Batteries. Its object is to make every Wireless enthusiast fully acquainted with everything essential for the satisfactory running of his own set at home.

Of a Bookseller. **5/- net.** Details post free.

Very fully illustrated and well bound in durable cloth.

**SIR ISAAC PITMAN & SONS, Ltd., Parker St., Kingsway, W.C.2**



Protect Your Set with the

**AERMONIC**

**Safety Earthing Switch**

Scientifically designed to adequately protect your set in all conditions. Has a fuse between the aerial and the set, thus giving security from lightning even if the set is left connected. Soundedly made with Bakelite cover to keep it waterproof. Price 4/6

Aermonic List Free

If dealers can't supply we send post free on money-back guarantee. **JAMES CHRISTIE & SONS, Ltd. 246, West Street, SHEFFIELD,** or London Agents: **A. F. Bulgin & Co., 10, Cursitor Street, LONDON, E.C.4.**

**Amateur Wireless**

**COUPON**  
Available until Saturday,  
**NOVEMBER 3rd, 1928**

**in bigger demand than ever  
— the Lotus valve holder**

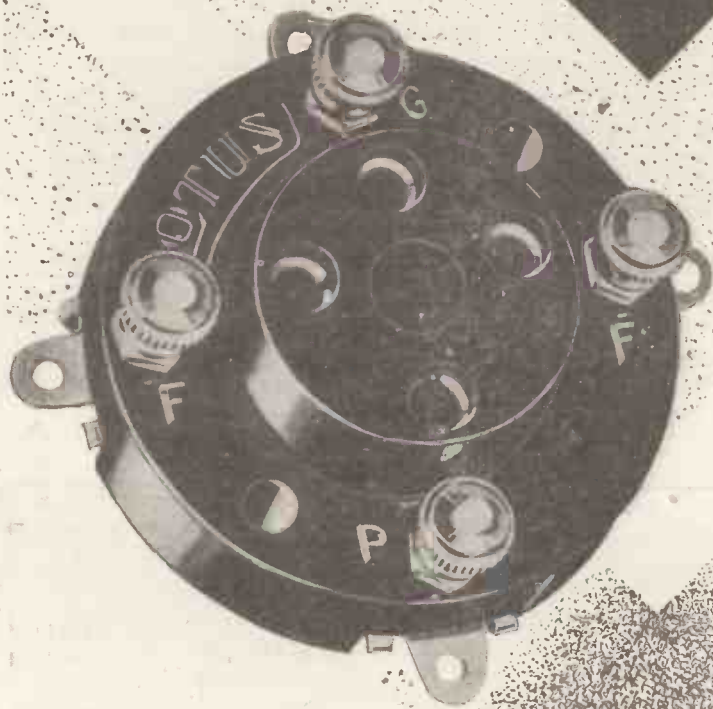

This new Lotus Valve Holder is only 1 1/8 in. in diameter. All surplus metal has been removed from between the valve legs and the phosphor-bronze springs and leg sockets are all in one piece. Made from finest bakelite mouldings, this valve holder is almost indestructible.

Price,  
**1/3**  
from all retailers.

Other types,  
1/6 to 1/9

**MULLARD  
SPECIFIED  
LOTUS  
for the  
MASTER 3**

# LOTUS

BUOYANCY

## VALVE HOLDER

MINIATURE

ANTI-MICROPHONIC

TYPE

Made by Garnett Whiteley & Co., Ltd., Broadgreen Road, Liverpool.

Causton

Advertisers Appreciate Mention of "A.W." with Your Order

# Do you know all the new products we have this Season?

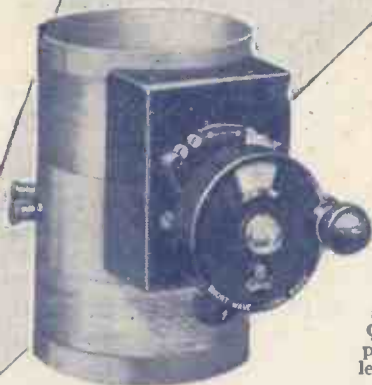

The new **APERIODIC TUNER** to both medium and long waves, 25/-

Last year R. I. Varley was singled out as "the firm with all the new products." To be exact, we had 18 new lines—this year we have more than 30. This will give you some idea of the progress we have made, particularly when you realise that each of these is a real engineering job, embodying the most up-to-date advances in radio science, and possessing that degree of **QUALITY** for which R. I. & Varley products are famous throughout the length and breadth of the country

Whether it be components, sets, gramophone electrical reproduction apparatus, complete eliminators, or eliminator components, R. I. & Varley make them all. Which of these are you interested in? Write to us and we will send you that section of our new Catalogue dealing with those particular products.



**Anti-mobo Resistance Capacity Coupler**  
 Type Z ... 25/-  
 Type Y ... 25/-  
 Type X ... 25/-



**Compound Mass Suspension Gramophone Pick-up**, £3 3 0



**Universal Power Transformer** (for both A.C. Valves and ordinary Valves), £2 7 6



**Bi-duplex L.F. Intervalve Transformer**, 27/6



**L.F. Chokes**  
 28/14 Henries, £1 1 0  
 14/7 Henries, £1 1 0

**THE MARK OF**

Kingsway House : 103 Kingsway, London, W.C.2

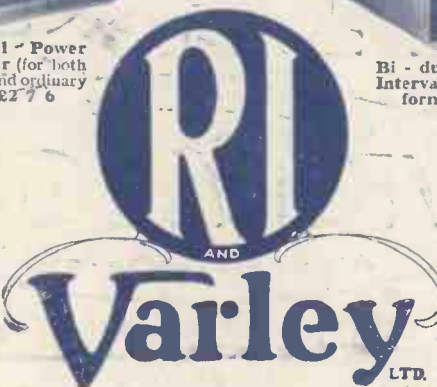

**BETTER RADIO**

Telephone : Holborn 5303