

GREATLY ENLARGED NUMBER

Amateur Wireless

Every Thursday 3^d
And Electrics

Vol. XIII. No. 326

Saturday, September 8, 1923

The **PROMS** 3

**FULL
DETAILS**

**A SET FOR
PURITY**

THE SENSATION OF THE SEASON

New Circuits, New Ideas, New Components

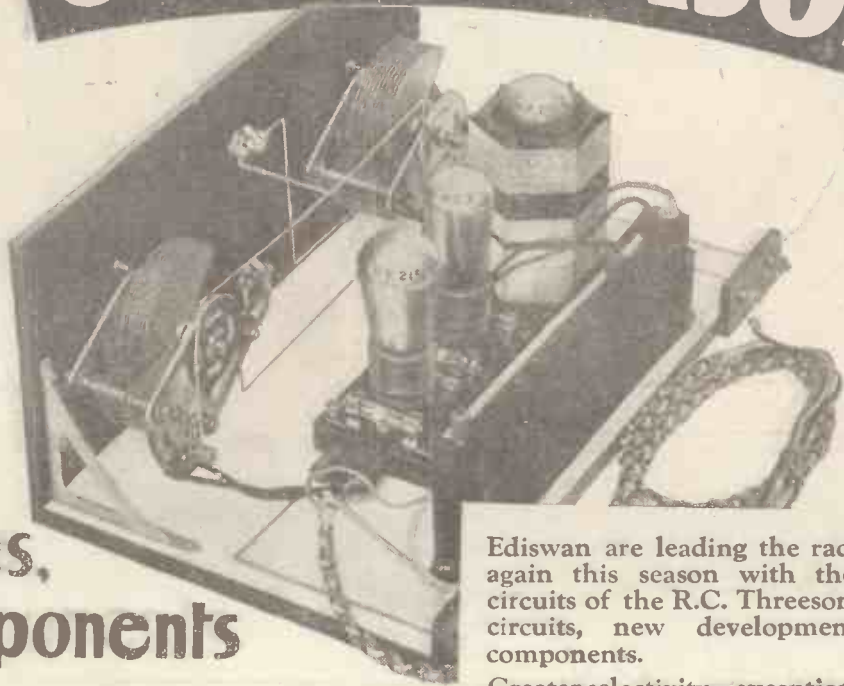

Ediswan are leading the radio-world again this season with their 1929 circuits of the R.C. Threesome. New circuits, new developments, new components.

Greater selectivity—exceptional purity—no coil changing—easy and cheap to make.

2 Standard 3-valve Circuits.

Circuit No. R/3 3-valve Resistance Capacity Coupling throughout, strongly recommended to those to whom purity of reproduction is of utmost importance.

Circuit No. R/3T 3-valve with Transformer Coupling in the last stage, for greater selectivity and volume.

Choose your set and send coupon for FREE Full-size Paper Model and Instruction Book.

COUPON. A.W. 8/9/28.

To the EDISON SWAN ELECTRIC Co., Ltd.,
123/5, Queen Victoria Street, London, E.C.4.

Please send FREE Paper model and Instruction Book as selected.

Name.....

R/3	<input type="checkbox"/>
R/3T	<input type="checkbox"/>

Address.....

.....

C.S./T.1 Please cross against Model required.

EDISWAN

R.C. THREESOME 1929 CIRCUITS

These circuits are specially designed for the famous Ediswan Valves, H.F.210, L.F.210, R.C.2 and P.V.215.

Advertisers Like to Know that You Saw it in "A.W."

A New Transformer by Igranic

Price
17'6

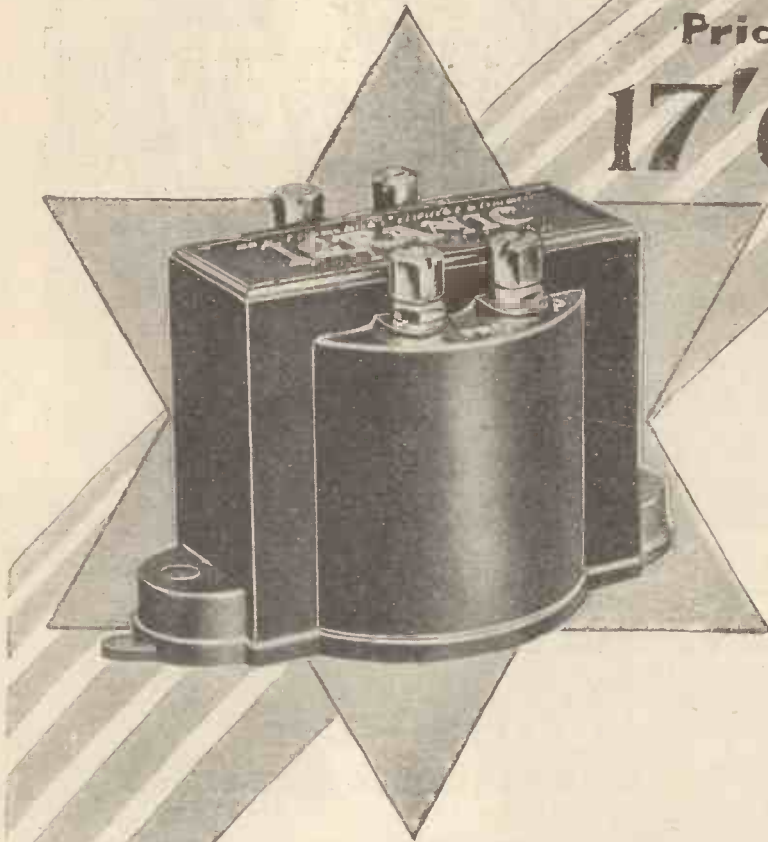

THIS new Igranic Transformer upsets all former ideas of value. The discovery of a super-efficient new iron circuit has enabled the Igranic engineers to design a transformer of less than *one half* the weight and size of other transformers that approach its performance and, consequently, with a much lower price.

The new iron circuit in the Igranic L.F. Transformer, Type "J," has the effect of giving a high primary inductance with a small winding, the interwinding capacity being therefore reduced to the minimum consistent with maximum coupling. The result is that the amplification of all notes between 100 and 9,000 cycles is practically constant, the low notes being reproduced with all their natural mellowness and the high notes with complete freedom from resonances.

IGRANIC L.F. TRANSFORMER Type "J"

For complete particulars of this wonderful new transformer write for List No. D.99. A free copy of "Selected Circuits," by H. J. Barton Chapple, B.Sc., will also be sent you.

Ratios
3 : 1 and 6 : 1

WE ARE EXHIBITING AT



Stands 53, 54 & 75

While at Olympia
Come and hear Igranic apparatus
demonstrated at
28 West Kensington Gardens
(Adjoining Olympia)



149 QUEEN VICTORIA STREET, LONDON, E.C.4

Works: Bedford

Branches:

MANCHESTER, NEWCASTLE, BIRMINGHAM, LEEDS, GLASGOW,
BRISTOL, CARDIFF

Mention of "Amateur Wireless" to Advertisers will Ensure Prompt Attention



A wonderful new series of Valves

This new series of valves, invented at Rugby and made and guaranteed by the largest and most up-to-date electrical organisation in the world, possess unique qualities. The reason lies in the use of a *nickel filament*.

Nickel Filaments mean Steep "Slope"

The quality of a valve is indicated by the mutual conductance or "slope" figure. Nickel filament valves have higher slope values than any other valves of corresponding types.

Steep "Slope" means better results

Remember that "slope" is the only real measure of the essential goodness of a valve, or of its value to you as a listener. Because of the higher slope value of Mazda Nickel Filament Valves they are better valves.

To ensure the best reception and the longest life for your valves, you must use Mazdas.

Ask for the Valves with the Nickel Filament, they cost no more than ordinary valves

3029

See them at



Stands 86 and 101

Please Mention "A.W." When Corresponding with Advertisers

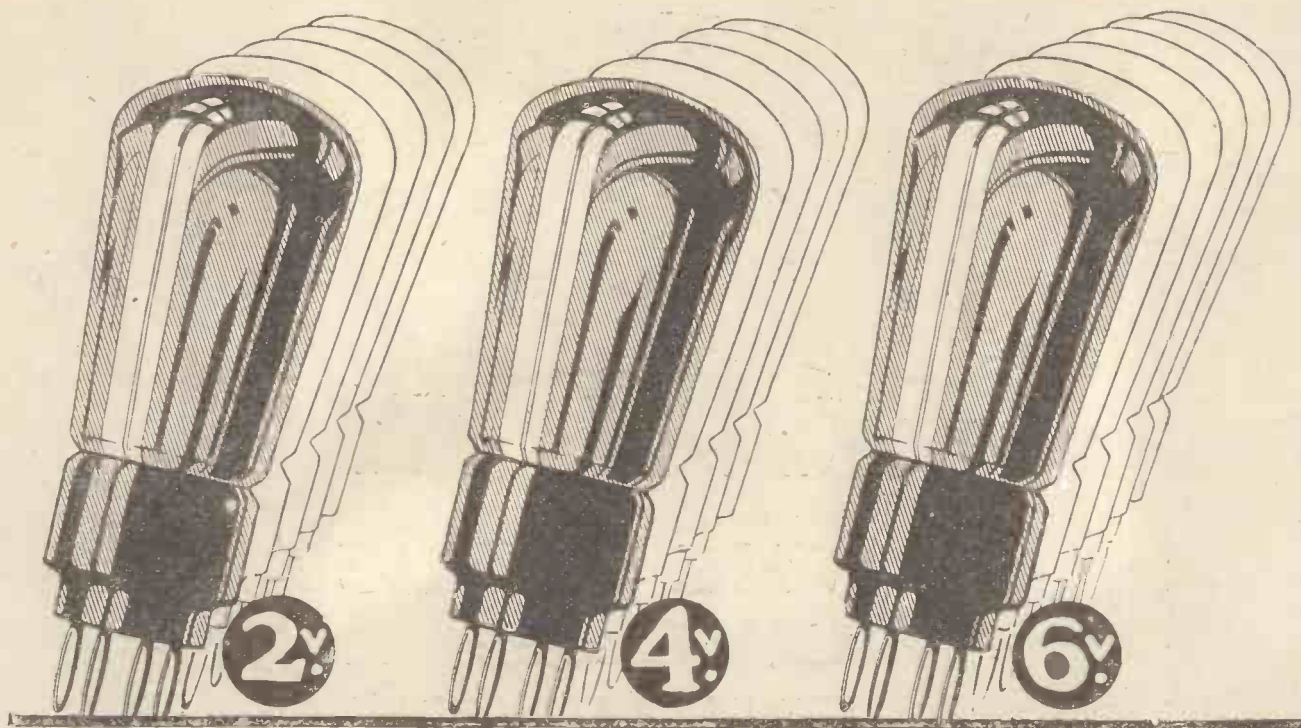

The New Mazda Valves are made in 2, 4 and 6 volt types

Mazda Nickel Filament Valves are made in a complete range of 16 Valves, covering every requirement of the 2, 4 and 6 volt user. Study the tabulation below and note the "slope" figure—the real indication of the goodness of a valve.

TWO VOLTS

Type	Max. H.T. Volts	Ampl. Factor	Imp. ohms	Slope
G.P. 210	120	13	14,000	0.90
H.F. 210	150	20	28,000	0.70
R.C. 210	150	40	86,000	0.47
L.F. 215	120	7	7,000	1.00
P. 227	120	4	2,900	1.40

FOUR VOLTS

Type	Max. H.T. Volts	Ampl. Factor	Imp. ohms	Slope
G.P. 407	120	14	14,000	1.00
H.F. 407	150	18	21,000	0.85
R.C. 407	150	40	100,000	0.40
L.F. 407	120	8	5,700	1.40
P. 415	120	5.5	2,900	1.90

SIX VOLTS

Type	Max. H.T. Volts	Ampl. Factor	Imp. ohms	Slope
G.P. 607	120	14	12,500	1.10
H.F. 607	150	20	20,000	1.00
R.C. 607	150	40	90,000	0.45
L.F. 607	120	9	5,300	1.70
P. 615	120	6	2,600	2.30
P.X. 650	200	3.5	1,750	2.00

The prefix letters indicate the purpose of a valve, and the figures which follow, the filament volts and amperes. For example:—L.F. 215 represents a 2-volt low frequency amplifying valve, taking 0.15 ampere.

Free Book : Ask your dealer for the Free Booklet giving detailed characteristics of the new range of Mazda Valves. To the technically inclined it gives positive proof of the superiority of the Nickel Filament Valve: for the non-technical it contains some valuable hints to bear in mind when choosing a valve.

The British Thomson-Houston Co. Ltd.

National Radio Exhibition Olympia

Advertisers Appreciate Mention of "A.W." with Your Order

109875
EVERY DAY

THE PUBLIC
GIVE US
EVIDENCE
THAT



REGD.

EVER READY
BRITAIN'S BEST BATTERIES

GIVE THE PUREST
SWEETEST TONE &
LONGEST SERVICE
AT LEAST COST

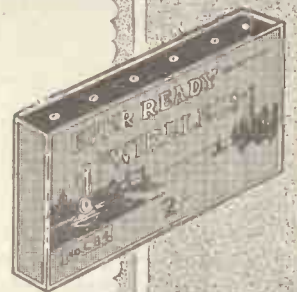

*Do you use
Ever Ready Batteries?*

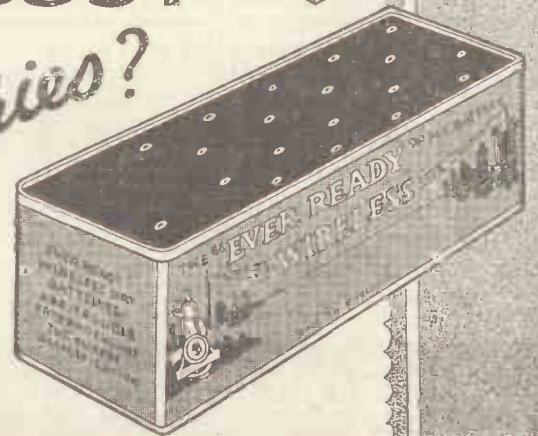

From all Wireless Stores, Electricians, etc. Complete Battery Catalogue post free from THE EVER READY CO. (Gt. Britain) Ltd., Hercules Place, Holloway, London, N.7.

Mention of "Amateur Wireless" to Advertisers will Ensure Prompt Attention

Amateur Wireless

and Electrics

The Leading Radio Weekly for the Constructor, Listener and Experimenter

Vol. XIII. No. 326

Edited by BERNARD E. JONES
 Technical Editor: J. H. REYNER, B.Sc.(Hons.), A.M.I.E.E.

SEPTEMBER 8, 1928

2LO Not Moving—Peace Pact Broadcast—Summer Appeals—Two Good Sets—Way of the World—More “Foundations”—Opera Broadcasts—Ostend Calling!

2LO Not Moving—“If premises elsewhere were suitable, we should seriously consider removal, provided that the new accommodation proved to be within the corporation’s means. But we certainly have *not* fixed on any site.” So saying, a B.B.C. official gives the lie to a persistent rumour that 2LO is “on the move.” As a matter of fact, the B.B.C. has been badly cramped for space for over two years, owing to the increasing developments in broadcasting.

Peace Pact Broadcast—All British stations successfully broadcast the historic signing of the Peace Pact in Paris, and 5SW radiated the ceremony on its 24-metre wavelength for the benefit of Dominion listeners. Mr. Briand’s speech was clearly picked up by the microphones, although, as he became more voluble, it was somewhat difficult to follow his French. The thanksgiving service in the early evening from St. Martin-in-the-Fields, London, was also transmitted through all the B.B.C. stations except Daventry and Edinburgh.

Is 5GB “Alternative”?—Sometimes it is decidedly not, for on two nights a week we have the Savoy bands S.B. to 2LO, 5XX, and 5GB from 10.30 to 11.15. We must ask our programme critic to have a word with the programme compilers about this!

Opera Broadcasts—Preparations for the B.N.O.C. broadcasts are now well advanced, and on September 28, Act I of the first performance of the season, *Aida*, will be relayed by 5GB. Following this it is hoped to give excerpts from *The Barber of Seville* and *The Magic Flute*.

Ostend Calling!—The symphony orchestra at the Kursaal, Ostend, will provide a Continental relay for 2LO and 5XX on September 9. M. Francois Rasse is the conductor and Mlle. Eugenia Buijko the vocalist. Among the items to be played by the orchestra will be the conductor’s own suite, “La Maitre à Danser.” The B.B.C.’s



John G. Leitch, the radio inspector of Philadelphia, photographed in the cabin of an aeroplane, from which an attempt was made to transmit a picture from the air to a broadcasting station in Philadelphia. A picture of Colonel Charles Lindberg, impressed on a gramophone record, was used.

by the wonderful response to two recent broadcast appeals. Canon Woodward, in his plea for the Women’s Holiday Fund, raised £3,500 on July 29, while a fortnight later Sir Beechcroft Towse, in his appeal for the Greater London Fund for the Blind, drew a £2,000 response from listeners.

Way of the World—Students of international politics who have followed Mr. Vernon Bartlett’s “Way of the World” series should note that during the Autumn Assembly of the League of Nations the talks for September 13, 20, and 27 will be given from a special studio at Geneva and relayed by land-line to 2LO. It is not certain whether Mr. Bartlett himself will be able to deliver these talks, but whoever does them will have an admirable environment.

More “Foundations”—Up to the present the Foundations of Music feature broadcast from 2LO at 7.15 each evening have, for the most part, consisted of instrumental music. But, beginning on September 17, a new departure will be madrigal singing by the Wireless Singers, who will be conducted by Mr. Stanford Robinson.

Lost and Found—Station WGBS (New York) has inaugurated a daily broadcast of “Lost and Found” announcements. This should be of much service to the public.

Two Good Sets—A novel idea in set design is embodied in the “Adaptable Three,” to be described next week. A few basic components form the nucleus of a good many popular receivers and this new design enables the real enthusiast, who is never satisfied for long with any one arrangement, to try another with the minimum of expense and alteration. For the listener of modest means there is a specially sensitive one-valver which, by virtue of its Hartley reaction, provides exceptional facilities for “DX” work. Both receivers have been tested by the AMATEUR WIRELESS Technical Staff, who can vouch for their high efficiency.

specially connected land-line network will be used, so that the quality of the transmission should be excellent.

Summer Appeals—Striking proof that interest in broadcasting does not diminish during the summer months is furnished

PRINCIPAL CONTENTS

Current Topics	261
The Electric Eye in Television	262
A Screened H.F. Amplifier	263
Development in Valve Design	265
Practical Odds and Ends	266
On Your Wavelength	271
The Radio “Sleuth”	273
Without Fear or Favour	275
The “Proms.” 3	276
Valve Royalties	280

THE ELECTRIC EYE IN TELEVISION

Interesting Details of the Latest Photo-electric Cells

By MORTON BARR

CERTAIN metals, particularly those of the alkali group, are known to emit electrons when subjected to the action of light. This Hallswachs, or photo-electric effect, as it is called, offers an interesting alternative to the use of selenium, say, for television, where the main problem is to convert varying light and shade effects into equivalent electrical currents.

Selenium

In the case of selenium, the presence of light causes a change of electrical resistance, so that the current in any circuit containing this element fluctuates in accordance with variations in the incident illumination.

A photo-electric cell, on the other hand, normally comprises two electrodes, one a cathode coated with a photo-electric substance, such as barium, potassium, or sodium hydride, or a suitable salt or amalgam, and the other an ordinary metal anode carrying a positive voltage.

The impact of light causes a stream of electrons to be emitted from the material of the cathode. Under the impulse or attraction of the adjacent positive voltage, the liberated electrons travel across the evacuated space inside the bulb or "cell" to the anode, and thus give rise to a feeble current in the external circuit.

Small Current

Though the response of the photo-electric cell to light is practically instantaneous, the quantity of the discharge is small. In fact, the reaction representing a change from darkness to normal daylight is only of the order of one-thousandth of a micro-ampere.

However, by connecting a photo-electric cell in the input circuit of a thermionic amplifier, as shown in Fig. 1, this effect can be amplified many thousand times, so that it becomes quite appreciable.

For instance, the action of the mirror *M* (which may be a reflecting galvanometer influenced by an incoming signal) is caused to vary the illumination of the photo-

electric cell *S* and so stimulates an electron flow from the sensitive cathode *C* to the anode *A*. The corresponding change in current through the resistance *R* affects

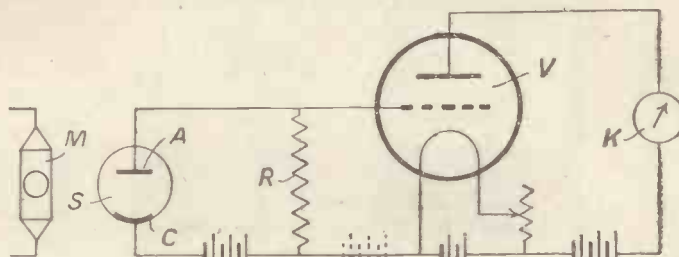

Fig. 1. Light-sensitive Cell and Valve combination

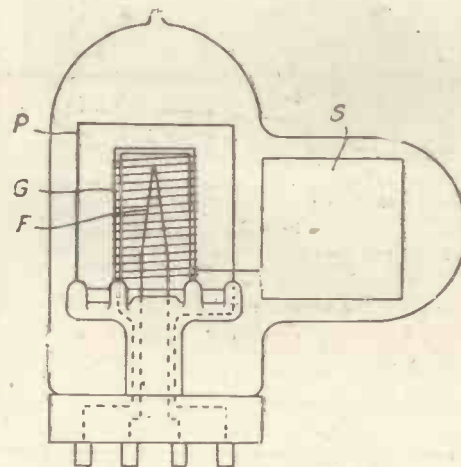

Fig. 2. The Nakken Valve

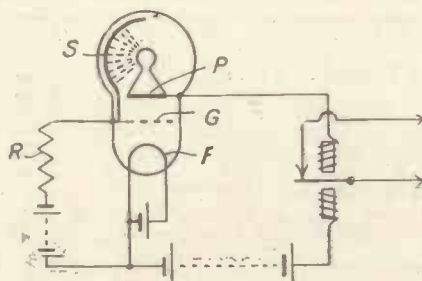

Fig. 3. The Zworykin Valve

the grid potential of the valve *V*, thus giving rise to an amplified current in the plate circuit of that valve, which will, in turn, operate any suitable indicating device *K*.

The photo-electric action whereby electrons are liberated from a sensitive surface by the impact of a light ray is in some degree analogous to, though it must be clearly distinguished from, the ordinary thermionic action of a valve filament. In the latter case electrons are liberated by the action of heat at a comparatively high temperature.

An ingenious attempt to combine these two effects, in the form of a thermionic valve in which the electron flow from a heated filament is controlled by a grid sensitive to the influence of light has been made by T. H. Nakken. His light-sensitive valve is illustrated in Fig. 2.

The valve comprises an ordinary filament *F*, a spiral grid *G*, and a plate *P*. The light-sensitive element *S* is in metallic connection with the grid *G*, and is mounted edgewise to the filament in a lateral arm or compartment of the exhausted bulb, as shown, so as to minimise the action of any direct light coming from the heated filament.

The external circuits of the valve are regeneratively coupled in any well-known manner, so that the valve generates sustained oscillations which are fed to a transmitting aerial. If now the sensitised member *S* is exposed to a beam of light, which changes in intensity, either by being swept across a transparent film or in any other way, so that the varying light and shade effects of the film or other picture are transferred to the surface *S*, the generated oscillations, or carrier wave, will be modulated accordingly.

As the light intensity of the incident beam changes, so does the emission of electrons from the sensitised surface *S*. The more electrons are discharged, the more positive does the element *S* and the associated grid become, and the value of the plate current changes accordingly. The effect is transient, and practically instantaneous, the normal grid voltage being restored, after each fluctuation, by the grid-biasing battery.

(Continued on page 288)

A SCREENED H.F. AMPLIFIER

By THE "A.W." TECHNICAL STAFF



WHEN 5GB started up, a large number of listeners must have been disappointed in the performance of their receivers under the new conditions. Some will have been forcibly reminded that a single-circuit tuner is not the last word in selectivity. Others will have been made to realise that, however powerful is the transmission, a stage of H.F. at sixty miles from the source is rather necessary unless reaction is to be forced.

Selectivity and Sensitivity

All of which is not mere conjecture, as our postbag continually proves. Listeners are, we know, in need of "hook-on" units that at one and the same time will improve selectivity and increase sensitivity. That is why we have had more than one H.F. unit in recent weeks. Here is another version this week. A screen-grid valve, one of the new type to be released next week by Messrs. Cossor, Ltd., and soon after by Messrs. Mullard, and others, has been incorporated in a special screening system.

As the majority of readers interested in such a unit as this will be those who have at present fairly simple detector-and-L.F. receivers, a word on screen-grid valves in general will not come amiss, especially as so many future receivers and units will embody this new type.

In the screen-grid valve, the grid near

the filament still remains as the control grid, but the anode is converted into a fine-mesh second grid, which is positively biased. Outside this second grid is arranged the anode. As a result of this construction, two valuable properties are obtained; great magnification and absence of feed-back energy from anode to grid.

The need for special neutralising circuits, therefore, vanishes, and quite simple high-frequency amplifiers can be arranged. The principle of shielding the grid and anode tuning circuits can, with a screen-grid

amateurs from attempting a high-frequency unit is the necessity, in a number of cases, for some wiring or structural alteration to the existing receiver. This point has received our special attention, and the unit now described can be added to the receiver, provided it is of the simple detector-and-amplifier type, by means of a single lead from the unit to receiver. The low-tension battery leads have to be duplicated and two leads provided for the screen-grid and anode of the screen-grid valve.

Although no serious trouble is likely to be met with as regards stability, it is advisable to keep the battery leads short and well separated. Inductive loops should be avoided wherever possible.

Owing to the enormous amplification derived from the screen-grid valve, the selectivity of the tuning system has to be improved. A short aerial will impart a measure of selectivity and, thanks to the enormous amplification of screen-grid valves, the sensitivity will not suffer very much.

The Circuit

The circuit of the unit, which has been described before, comprises a shunt-feed system whereby the tuning circuit of the receiver forms part of the inter-valve coupling. The anode circuit of the screen-grid valve is untuned, an H.F. choke being inserted between the anode and the H.T.+2 supply. A .0003-microfarad fixed condenser is connected between the anode

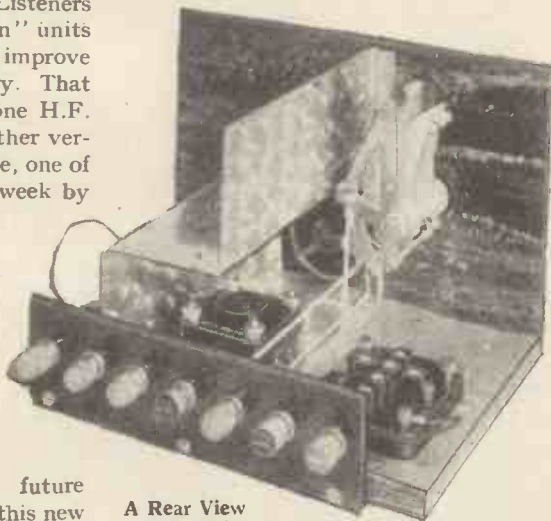

A Rear View of the Unit

valve, be carried to its logical limit, and the actual grid and anode with which these tuned circuits are associated, also screened one from the other.

At first the average listener will hesitate to scrap his existing receiver and to embark on the construction of an elaborately screened receiver, but there is no reason why the advantages of the new valve should not be exploited in unit form. Which brings us to the whole question of adding on high-frequency amplifiers to existing receivers. It is not advisable to try to work such units with receivers that already embody some form of high-frequency amplification. Such a procedure will almost certainly lead to instability, due to an upsetting of the stabilisation.

A consideration that deters many



The Unit with screen-grid valve in position

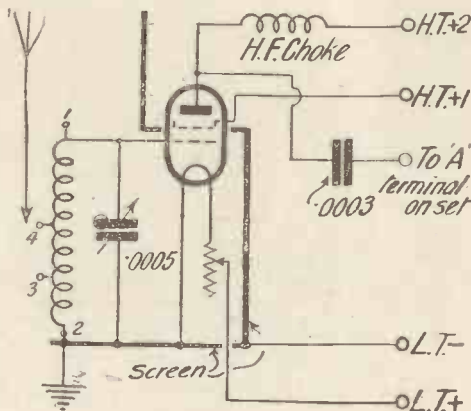

The Circuit of the Screened H.F. Amplifier

“A SCREENED H.F. AMPLIFIER” (Continued)

and a terminal, which is subsequently joined to the aerial terminal of the receiver. If anode-bend rectification is employed in the detector circuit this coupling condenser

magnetic field, shunted by a .0005-microfarad variable condenser. One end of the coil, marked No. 1, is connected to the control grid of the screen-grid valve and the other end, marked No. 2 to the L.T. — side of the low-tension battery. Connections Nos. 4 and 3 are alternative aerial-lead taps, giving moderately or very selective tuning respectively.

A filament rheostat is wired in the low-tension positive lead and a terminal H.T. + 1 is provided for the screen-grid voltage.

Components

A complete list of components and accessories is given below, together with suitable alternatives:—

- Ebonite or bakelite panel, 9 in. by 6 in., and strip, 7 in. by 2 in. (Bccol, Raymond, Pertinax).
- .0005-microfarad variable condenser (J.B., Burndept, Polar Ideal, Igranic).
- 7-ohm rheostat (Lissen, G.E.C., Igranic).

is at the extreme left of the unit terminal strip and the unit-to-receiver connecting terminal is on the extreme right. Between these two terminals are the battery terminals and earth terminal, which last-named can be dispensed with if the L.T. — terminal on the receiver is connected to H.T. —.

The variable condenser and filament rheostat are mounted on the panel, which is then laid aside whilst the baseboard assembly is completed. A sheet of copper

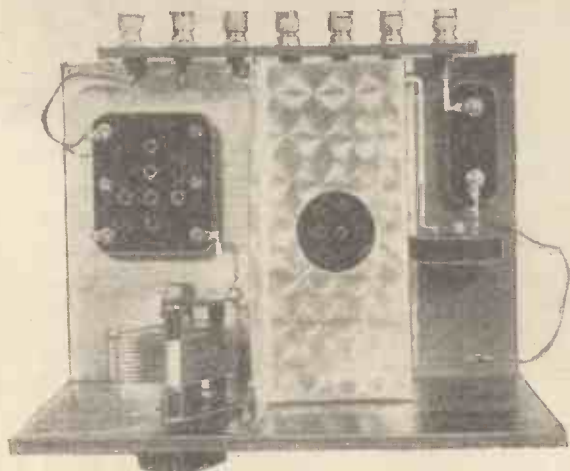

The Plan View of the Amplifier

also serves to isolate the detector grid from the H.T. battery.

The aerial tuning of the unit consists of a tapped binocular coil, having a restricted

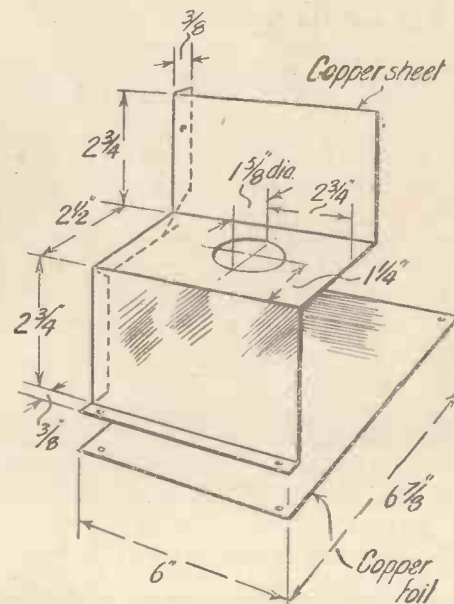

Measurements of the Screen

foil is tacked along just over two-thirds the length of baseboard, starting at the aerial-terminal end (left hand from front view) and finishing at the H.T. + 2 terminal. The valve-holder, six-pin coil holder, fixed condenser, and H.F. choke are then disposed as indicated. After this the panel, with its associated components, can be screwed at right angles to the baseboard.

As the unit is designed for use with the new upright type of screen-grid valve, with filament, screen-grid, and control grid brought out to the standard four-pin valve base and the anode to an insulated terminal on the top, the ordinary anti-microphonic valve holder is incorporated. But with the valve in an upright position the shape of the screening partition has to be modified, as has been done in this unit with very satisfactory results. A vertical partition twice bent at right angles to form a horizontal middle section serves to screen the six-pin tuning coil from the tuning system and at the same time forms a continuous external screen in the same plane as the horizontal screen-grid.

This shaped screening piece, which can be made by the constructor or obtained ready machined from E. Paroussi, of (Continued at foot of page 274)

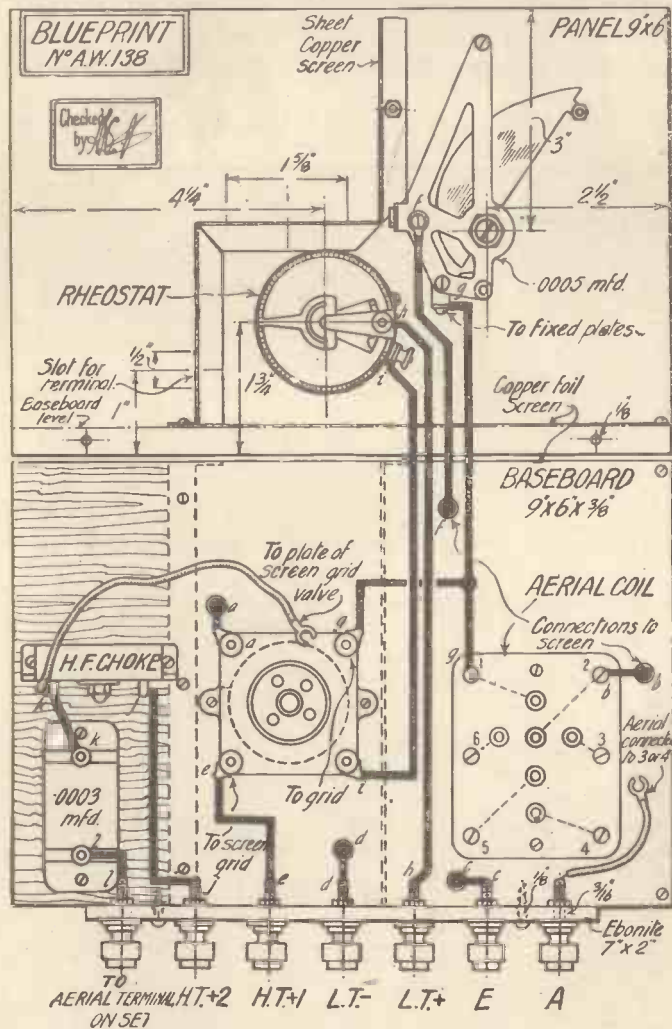

The Wiring Diagram. Blueprint available, price 1/-

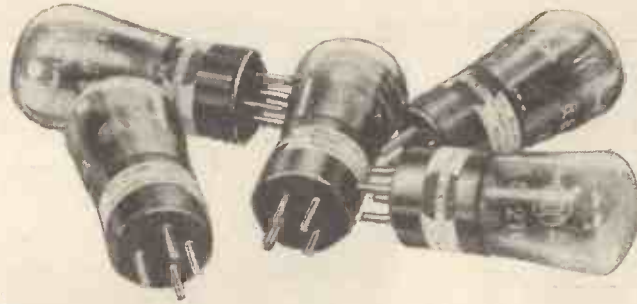

DEVELOPMENT IN VALVE DESIGN

THE valve is a component in which a more or less steady improvement is noted every season. From the simple so-called general-purpose type of valve we have now developed a range of valves suitable for a variety of purposes, the principal types in use last season being four in number. These were the resistance-capacity type, H.F. amplifier, the L.F., and the power type.

Standard Types

These four types appear to have become stable, and will be available this present season as before. In addition, however, there appear to be improvements in train in connection with power valves. It is becoming appreciated that in order to obtain power output a large anode-current variation must be obtained, and better and better valves are being produced capable of giving large variations in anode current, and consequently large power output. Particularly is this the case in the two-volt class, and we can expect to see some two-volt types capable of giving a very high standard of performance.

Anode Current

With the ordinary three-electrode type of valve, the production of a large anode current of necessity requires that the valve shall have a low resistance. It should not be thought that the two effects are necessarily bound up with each other. The pentode valve, to which I shall refer later, has an internal resistance upwards of 20,000 or 30,000 ohms, and at first sight it appears ridiculous to expect such a valve to give satisfactory quality. The primary consideration, however, is that of anode current variation, and since the pentode gives a large steady anode current and a very large variation for quite a small grid input it is clear that it fulfils the necessary conditions in a satisfactory manner.

This reference to the pentode leads up to the question of the screen-grid valve, and here considerable development has taken place since last season, with the result that

The second of the series of articles by our Technical Editor on probable developments during the coming season

character, and will result in a marked improvement.

Screen-grid Valves

The original type of screen-grid valve, as marketed by the Marconi and Osram companies and by A. C. Cossor, Ltd., is what is known as the double-ended type. Its construction is diagrammatically represented in Fig. 1. There is a V-shaped filament and a circular plate anode, in between which are placed the control grid and the screen grid. The filament and control grid pins are brought out to the one end and the screen-grid and anode connections to the other. This method of construction has the important advantage that the capacity between anode and grid circuits can be reduced to the minimum; such a valve is inherently very stable. The disadvantage of the method, however, is that only one side of the filament is being employed and that the emission from the other side is not utilised. If the filament consumption, therefore, is to be kept reasonable, it is necessary to accept a much lower value of mutual conductance than would otherwise be the case. In other words, the performance of the valve is not as good as it could be made.

This state of affairs is particularly noticeable with two- or four-volt filaments, where the emission surface is less, for the filament wattage of a two-volt 0.1-amp. filament is nearly eight times as small as that of the standard six-volt ¼-amp. filament as used in the S625 valve. The only solution to this difficulty lies in utilising both sides of the filament by reverting to the earlier and more conventional form of construction.

Such an arrangement is illustrated in Fig. 2. Here is the filament surrounded by a circular or flat cylindrical grid, outside which is the screen-grid, and finally the anode, which may be either cylindrical again or may take the form of two parallel plates. This method of construction gives a considerably higher mutual conductance

(Continued on page 294)

various new types of valve are likely to be available this season. The modifications which have been made are radical in

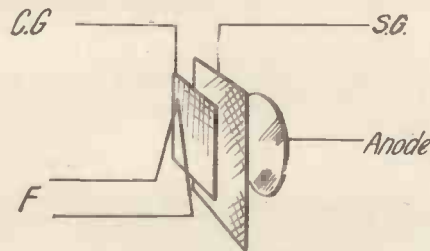

Fig. 1.—The construction of the original screen-grid valve

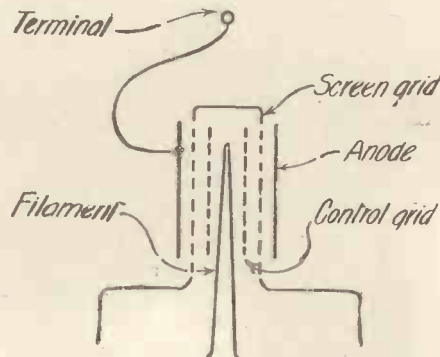
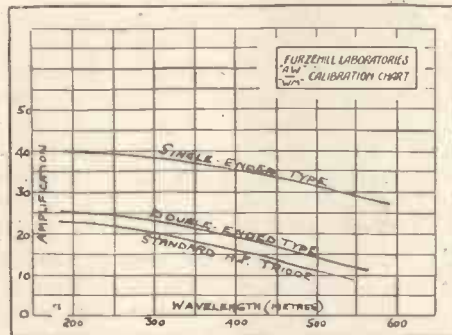
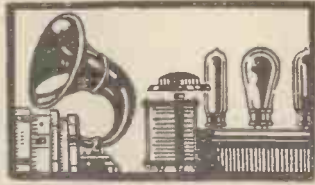

Fig. 2.—The Construction now adopted



Characteristic Curves of Screen-grid Valves



PRACTICAL ODDS & ENDS

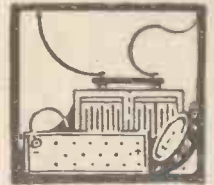

A Useful Saw Stop

UNLESS the slots in frame aerial spreaders, skeleton coil formers, etc., are all of equal depth, the appearance of the winding is anything but pleasing. The sketch depicts means whereby any number

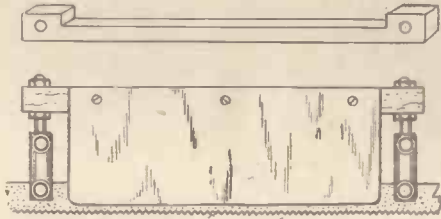

A Suggestion for the Constructor

of slots may be cut to an accurately equal depth.

A piece of hardwood, 6 in. long by $\frac{3}{4}$ in. in square section, is drilled at each end and grooved by means of a rasp and file, as shown in the upper figure. Into the groove is screwed a piece of $\frac{3}{16}$ in. sheet ebonite, about $1\frac{1}{2}$ in. wide, the edges being filed and smoothed off perfectly square. Two pieces of $\frac{1}{8}$ in. round brass rod, each $1\frac{1}{2}$ in. long, are then threaded at one end, passed through the holes in the hardwood support, and firmly secured by means of nuts. Two flash-lamp battery-connectors are slipped over the top edge of the hacksaw blade, where they are clamped to receive the pins fitted to the support. The use of the gadget will be obvious. O. J. R.

Improving the Wall Cone

IN order to prevent rattling between the frame of a hanging loud-speaker and

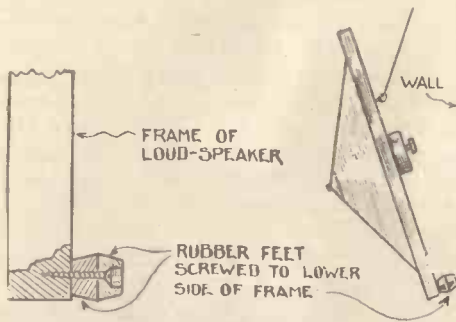

How to Improve Wall Cone

the wall, it is a good plan to fasten rubber feet, as shown in the illustration, to the two lower corners of the loud-speaker frame.

Besides preventing rattling, due to the vibration of the cone, the rubber feet prevent the collection of dust and damp-

ness at the line of contact between the loud-speaker and the wall.

If large rubbers cannot be obtained, two or more small ones may be used together in order that the distance between the wall and the speaker shall be at least one inch. S. N.

Two-room Loud-speaker System

THE simplest way of installing a two-room loud-speaker system is shown in the diagram.

A wall block is first fitted in Room 2, the wainscoting providing a suitable place for fixing. On the wall block is mounted either a wall jack or a two-socket adaptor. Extension lines of twin bell wire are then taken to a further wall block in Room 1, in which the set is also installed. On this block is mounted a further wall jack, or two-socket adaptor, and a D.P.D.T. switch.

The connections are made in the order shown, with further extensions from this block to the loud-speaker terminals of the

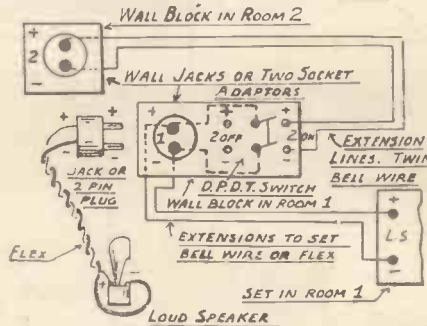

A Simple Two-room Loud-speaker System

receiver. The loud-speaker, or speakers, are provided with a jack or two-pin plug.

To listen in Room 1 only, the switch is "off" and the speaker plugged into adaptor 1. In this way the extension lines to Room 2 are entirely disconnected. To listen in Room 2 only, the switch is "on" and the plug withdrawn from the speaker in Room 1. To listen in both rooms, the switch is "on" and a speaker is plugged into adaptors 1 and 2 in each room. Thus the option is provided in the simplest possible manner, and the house wiring entailed consists only of a twin bell wire. H. B.

A Screening Safeguard

A WIRE which passes through a metal screen is often a source of trouble, due to fraying of the insulation at the point where the latter touches the sharp edges of the metal. Portable receivers are

very liable to this trouble, owing to the vibration of the wires on the screen when the set is being carried.

A simple method of obviating any trouble of this sort is illustrated in the drawing. After drilling the hole in the

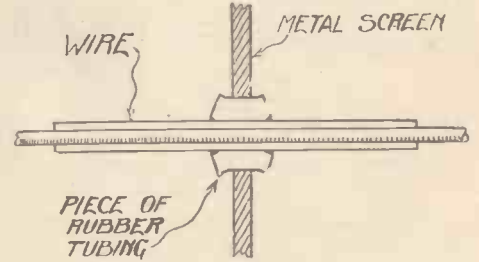

To Protect Wiring

metal a short piece of thick rubber tubing is pressed into the hole. The wire is then passed through the tube, which acts as a protecting shield, besides holding the wire concentrically—an important point with wires carrying H.F. currents. F. W.

Accommodating the Grid-bias Battery

A GRID-BIAS battery, being long and narrow, can be accommodated, without spoiling the appearance of the receiving set, at the back of the cabinet above the terminal strip.

Two strips of $\frac{3}{8}$ -in. by $\frac{1}{16}$ -in. brass are required—bent as shown in the illustration. The two brackets are then screwed to the cabinet at a distance apart to suit the length of the battery to be used.

If more than one battery is required,

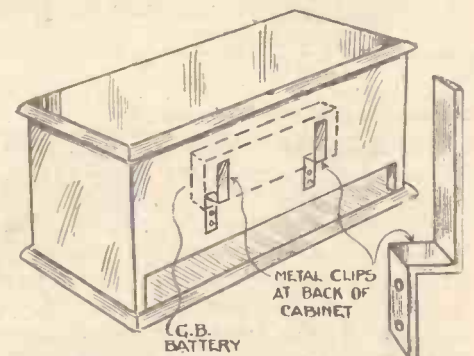

Where to Stow the Grid-bias Battery

such as would be if a super-power valve were used in the output stage of the receiver, strips of wood may be fixed to the horizontal and projecting vertical portion of two brackets fixed at the extreme ends of the cabinet back. F. B.

EXTENDING a Famous Line

In addition to the already renowned K.C. Condenser, Dubilier have now produced three new models. Well designed and well made of only the best materials, they maintain the standard of Dubilier efficiency.

"K.C." Condenser with drum-control and slow-motion device (illustrated on right).
·0003 or ·0005. **15/6**

"K.C." Triple Condenser (illustrated below), consisting of three ·0003 or three ·0005 units.

38/6

Combinations of ·0003 and ·0005. **40/-**



"K.C." Condenser (illustrated above), without Knob, Dial or Slow-motion device. **8/-**
·0003 or ·0005.

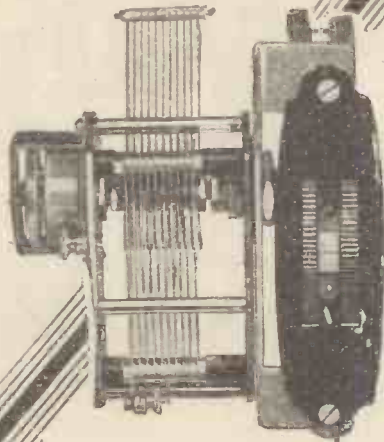

Come and see these Condensers at

STANDS

102 - 103

Radio Exhibition,
Olympia,
September 22 to 29.

DUBILIER
CONDENSERS

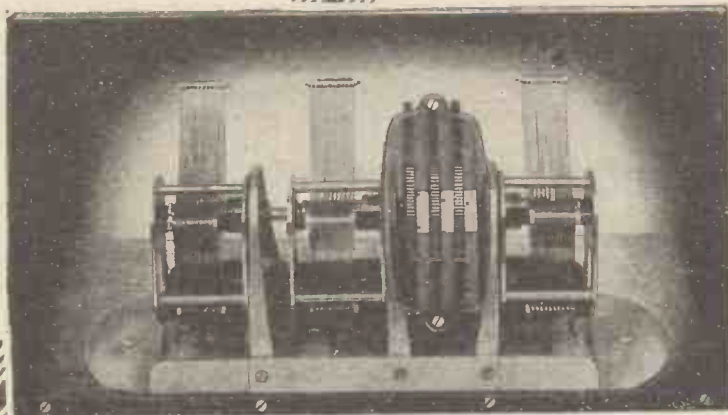

Adv. of Dubilier Condenser Co. (1925), Ltd.,
Ducon. Works, Victoria Road, North Acton, W.3.

© 175

Please Mention "A.W." when Corresponding with Advertisers



Some Wonderful New

Good News!
for 2 volt users
and users with
Electricity installed
from A.C. supply

**Osram
Valves**



The new
Osram
S.215 Valve

Made in England

S.215 A NEW SCREEN-GRID VALVE for 2 VOLT USERS

The Osram S.625 was the pioneer of screen-grid valves and now there's one for the 2 volt user.

CURRENT CONSUMPTION	AMPLIFICATION FACTOR	IMPEDANCE	PRICE
.15	170	200,000	22/6

These screen-grid H.F. valves will get you "distance"

NEW VALVES for use from Alternating Current Electricity Supply

OSRAM	CURRENT CONSUMPTION	AMPLIFICATION FACTOR	IMPEDANCE	PURPOSE	PRICE
H. Point 8	.8	40	55,000	R.C. Amplifier	15/-
H.L. Point 8	.8	17	17,000	General Purpose	15/-
P. Point 8	.8	6	6,000	Power Valve	17/6
S. Point 8	.8	160	200,000	SCREEN-GRID H. F. Amplifier	25/-

LOOK OUT FOR THE OSRAM PENTODES!
These wonderful new 5-Electrode power valves will shortly be placed on the market.

Those listeners who possess electric light from the A.C. mains have been waiting for these valves. *A complete range for the A.C. mains!*

Sold by all
Wireless Dealers

Advt. of The General Electric Co. Ltd., Magnet House, Kingsway, London, W.C.2.

Advertisers Appreciate Mention of "A.W." with Your Order



SUPER-POWER VALVES NOW REDUCED IN PRICE from 20/- to 15/-

**Osram
D.E.P.
240
Now 15/-**

The well-known Osram Super-Power Valve, the D.E.P.240, is now reduced in price to 15/-, and is within reach of all purses.

Use this valve with a 2-volt accumulator in the last stage of your set and banish distortion. The Osram D.E.P.240 will give you mellow reception.

VOLTAGE	CURRENT CONSUMPTION	MAX. ANODE VOLTS	AMPLIFICATION FACTOR	IMPEDANCE	REDUCED PRICE
2	.40	150	4	2,500	15/-

and NEW

Osram Super-Power Valves

sold at the New Standard Price of 15/-

OSRAM	VOLTAGE	CURRENT CONSUMPTION	MAX. ANODE VOLTS	AMPLIFICATION FACTOR	IMPEDANCE	PRICE
P.425	4	.25	150	4.5	2,250	15/-
P.625	6	.25	250	6	2,400	
P.625A		.25	180	3.5	1,600	

Osram
SUPER-POWER
Valves
MADE IN ENGLAND

Sold by all Wireless Dealers.

REDUCED PRICES
of the well-known
Osram
L.S.5 AND L.S.5A
NOW ONLY **25/-** EACH
former's 30/-

Advt. of The General Electric Co. Ltd., Magnet House, Kingsway, London W.C.2

You will Help Yourself and Help Us by Mentioning "A.W." to Advertisers



**THE BEST
BATTERY
VALUE
OBTAINABLE
TO-DAY!**

**Better than ever
—at a Lower Price**

TAKE advantage of these new prices and secure a battery which will give the Steady and Persistent Service for which SIEMENS BATTERIES are famous throughout the world.

**NEW PRICES
OF POPULAR TYPE,
(Green Label)**

Size No. 1200.	60 volts	8/-
" " 1202.	100 "	13/-
Power Size for Power-Valves		
Size No. 1204	Power 60	13/6
" " 1206.	" 100	22/6

Ask your dealer for the battery that is **BRITISH MADE** in every detail.

SIEMENS

RADIO BATTERIES

SIEMENS BROTHERS & CO., LTD., WOOLWICH, S.E.18

Write for latest Catalogue No. 641

giving particulars and prices of all types of Siemens Batteries, and information on how to obtain best results.

VIBROLDER

Vibrolder is a better name for a better valve-holder. The new Benjamin Vibrolder will fit every type of British four-pin valve. It ensures perfect results as the point of contact between valve leg and valve socket is self-aligning. It is truly anti-microphonic in character, protecting the delicate filament from every trace of shock and vibration.

Fit Vibrolders in your set this season and *know* your valves are working under the most favourable conditions.

1/6

Due to its great popularity the original Benjamin model is retained. Price 2/-

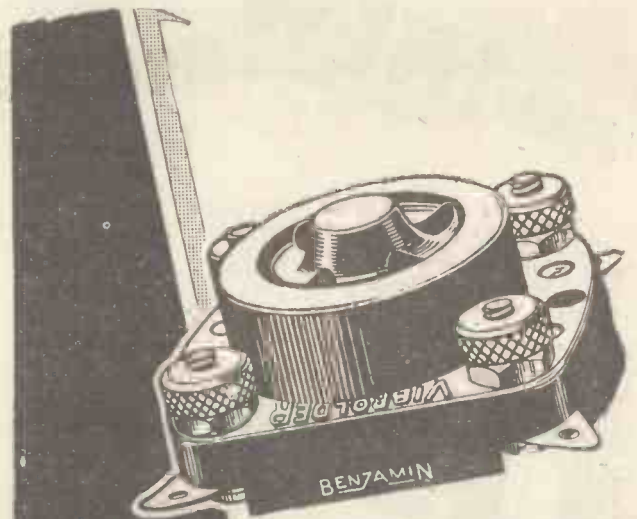

1,500,000
BENJAMIN
VALVE HOLDERS
have already
been sold.

BENJAMIN

**ELECTRIC
LIMITED**
BRANTWOOD WORKS
TOTTENHAM, LONDON
N.17

On Your Wavelength!

The Greatest Broadcast Yet

QUITE a number of years ago now I foretold, greatly daring, that ere long it would be possible for a man to speak to the whole world by means of wireless. On the day upon which I write this feat has been accomplished in a marvellous way. The proceedings in connection with the signing of the Peace Pact were picked up by a microphone installed in the famous "Hall of the Clock" at the French Foreign Office. Passing thence to Radio-Paris, they were broadcast from the great aerial that one sees as one enters the city from the west, as well as from the Eiffel Tower. Land-line relays were used, too, and the huge simultaneous broadcast took place in every country in Europe.

Short-wave Relays

But this was not all. Short-wave relaying was done by 5SW, whose transmission WGY had arranged to pick up and to re-broadcast through a great chain of stations in the States. From 5SW, too, the transmission was picked up and passed on by stations in every corner of the earth. Arrangements for relaying with 5SW's help had been made in almost all of our overseas dominions. It is wonderful to think that the words spoken in the Salle de l'Horloge were broadcast simultaneously by the world's wireless stations—by far the greatest piece of S.B. ever yet attempted.

A Big Thing

The recent decision of the Comptroller of the Patents Office in favour of an application for a compulsory reduction in the amount of wireless royalties marks probably one of the most important stages in the history of radio as a national hobby. The position, as described in the detailed findings of the Tribunal, is briefly this. Five "key" patents affecting wireless reception had been bought up by big concerns, who were thus able to create what was referred to as a super-monopoly. No sort of receiving apparatus can be made without using at least one or two of the devices covered by these patents; hence the holders of the rights in them could enforce what amounted to a very heavy burden on manufacturers and the public by exacting a royalty of 12s. 6d. per valve holder.

A Large Percentage

When one reflects that the royalties alone come to £3 2s. 6d. on a five-valver, *no matter what the cost of its components*, and £5 12s. 6d. on a nine-valve super-het., one can see how it is that such a comparatively small proportion of the receiving

sets at present in use in this country contain more than three valves. In the States, where the royalties amount to 5 per cent. of the selling price, the multi-valve receiver is the rule rather than the exception. One understands, too, why there are still so many crystal-sets to be seen here—more, I believe, than in any other country with a good broadcasting service. The big royalty killed the cheap valve set.

The Future

We may expect an immediate huge increase both in the general popularity of wireless and in the size of receiving sets. By "size" I mean, of course, the number of valves. The crystal set will disappear almost entirely, except, possibly, in the immediate neighbourhood of main stations; telephone reception will become less and less used, headphones being replaced by the much more enjoyable loud-speaker. The effects upon all branches of the trade should be very marked. With the coming of cheaper sets there will be a host of newcomers eager to purchase and many who have made out-of-date sets do because of the cost of replacing them with modern apparatus will no longer hesitate to provide themselves with receivers that enable broadcasting to be heard as it should be heard. Even the holders of the royalty rights won't suffer by the smaller amounts received for each valve holder. They, too, will gain by increased business and—an important point—many home constructors will not jib at paying the smaller sums for the use of patents.

SOS Fakers

There are always to be found people with a strange sense of humour who indulge in what they are pleased to call practical jokes without thinking of what the possible consequences of their actions may be. When an explorer is lost, such "jokers" launch faked messages in bottles, and doubtless crack their sides with laughing when these are picked up. They don't consider the pain that they must cause to people whose hopes are raised by the false messages, only to be shattered a little later when the hoax is discovered. The other day an amateur received six separate times SOS calls which purported to emanate from Mr. Bert Hassell and Mr. Parker Cramer, the airmen who left Ontario for Greenland and have been missing since August 18. The messages are believed to have been sent out by one of the aforementioned practical jokers, and the American Radio Relay League has offered a reward of £100 for the identification of the

sender. If the SOS was faked, it is devoutly to be hoped that the culprit will be caught and severely dealt with.

Portmanteau Valves

How many readers, I wonder, have had any experience of the multiple valves whose makers figured so prominently in the recent appeal? At present these are made in two patterns. The triple valve incorporates in one and the same bulb, a rectifier and two L.F. valves, the second of which is of the power type. The glass contains also all the necessary condensers, resistances, and so on, to form the inter-valve couplings. Owing to the extremely short connections that can then be used, many advantages—including increased stability—are obtained. Set construction becomes a matter of the utmost simplicity. You yoke a coil and a condenser to one end of the valve and a loud-speaker to the other. Having connected up the batteries you find that you have produced a three valve receiver!

A Drawback

The triple valve has, however, one drawback. Since there is no H.F. amplification before the rectifier and since reaction cannot be used, it is necessarily a short-range contrivance, suitable chiefly for receiving the broadcasts of the local station up to twenty miles or so. A dual H.F. valve is also made, which can be employed in conjunction with the triple. With the pair you obtain an ultra-simple five-valver of fair efficiency. Since both the multiple valves and receiving sets incorporating them are now to be made in this country, we shall, no doubt, see and hear a great deal more of them in the future.

Condensers—Good and Bad

Paper condensers are used to a considerable extent in modern wireless practice. I have often wondered whether we really know as much about these components as we ought. I came across a case only the other day where the substitution of one condenser for another made all the difference to the operation of a particular set. The condenser was being used as an H.F. by-pass condenser, and there was every evidence that the first condenser was not by-passing properly. The second condenser appeared to do the trick, because the set immediately functioned satisfactorily.

I, of course, suspected the condenser of leakage, and immediately tested its insulation resistance; but I did not find this unduly low, and, in fact, it appeared to show a better insulation resistance than

On Your Wavelength! (continued)

the second condenser, which was undoubtedly more satisfactory. Apparently, therefore, the trouble was something more deeply rooted than insulation resistance, and I was puzzled for some time as to how to account for the very marked discrepancy.

The Most Suitable Type?

As a matter of interest, I took down the two condensers which I had been using and there I found the solution. The first condenser—the one which did not work—was made on the Mansbridge principle, in which the plates of the condenser were made of tea-paper; that is to say, silvered paper prepared by a special process. The resistance of such foiled paper is much higher than that of pure tin-foil, and apparently this was responsible for the big difference I observed in the results. The second condenser was made of thin tin-foil interleaved with paper, an arrangement which has a much lower resistance.

A Matter for Experiment

This experiment seems to me very illuminating and indicated that we shall have to look into this question of the paper condenser more carefully. For low-frequency work, the resistance of the plates appears to be of less importance and the foiled-paper type of plate seems to be quite satisfactory; but at high-frequencies the resistance of foiled paper is too high, and metal foil must be used to obtain good results. There are, I believe, quite a number of points concerning paper condensers about which very little is known by the general public, and it would certainly seem that more definite information is desirable as to the suitability of various types of condenser in different circuits.

A Loud Screecher

I am writing these lines under difficulties. At the moment I am away by the sea, and in the house opposite there dwells a family with a passion for the noisiest kind of wireless. They have an ancient four-valver with a "second-stage L.F." valve in the last holder. But though the output valve is neither "power" nor "super," the volume that they make the ante-diluvian loud-speaker produce is both! With all the windows wide open the thing is filling the air with the most appalling cacophony. They revel in the ghastly travesty of music that it produces, whilst your poor THERMION sits and tears his hair. How any human ears can fail to be revolted by such an inferno of horrid noise are mysteries that appear to be insoluble.

Our Best Station

Whenever I take my trips to this part of the country or that, I make a point of asking which of the home stations is the best received in any particular place. Except in places very close to main stations, such as 6BM or 5WA, the answer to my question is, in nine cases out of ten, that 5XX is the station generally used when volume and quality are the prime considerations. In fact, I have no doubt whatever that Daventry Senior has almost, if not quite, as many regular "clients" as all the others put together.

Not only in this country, but on the Continent, too, 5XX is regarded as a sound and dependable transmission. In France, Belgium, Switzerland, and Italy I have found many who listen regularly to his programmes and swear by him. One great advantage of the long waves is that they are comparatively little affected by conditions of daylight and darkness. There are very few places where 5XX is found to fade in normal circumstances, and he is an all-the-year-round station over an enormously wide area, since he does not suffer from the summer-time feebleness that characterises so many of the shorter-wave stations.

Why Not?

Since 5XX has already proved his worth as one of the best stations in Europe, if not in the world, would it not be sound policy to make the fullest possible use of him by increasing his power to something really hefty? The problem of modulating satisfactorily an output of 50 kilowatts, or even 100, has been successfully solved, as you may test for yourself on almost any night in winter by tuning in America's giant WGY. If conditions are favourable, you will find that even at over 3,000 miles the quality is wonderful. Were 5XX put up to, say, 50 k.w. to begin with, the big area that he already serves so well would be greatly enlarged, and with 100 k.w. behind him he should cover a very large proportion of the entire country. A fortnight ago I listened to perfect reception of 5XX at places from 75 to 150 miles west of Daventry; to-day I am just about 100 miles to the east of him. Here he comes through well on the simplest crystal set, and with a good valve set reception of perfect quality is obtainable.

A Better Course?

I believe, somehow, that the B.B.C. engineering people might do well by putting the money available for developments into enlarging 5XX rather than into a medium-wave regional scheme in the immediate future. It may be said at once that 5GB has nothing like the service

area possessed by 5XX, though both use the same power. At a range of 75 miles westward, 5XX is 50 per cent. stronger than 5GB, and the longer the range, the more marked is the difference. A hundred miles east, 5GB is not receivable on the crystal set, and needs far more H.F. amplification than 5XX for quality reception on a valve set. Daventry Senior is good at all times of the year; "Junior" is a poor signal in summer.

Since we have one splendid long wavelength and a fine station working on it, why should we not get the best possible service by using a great deal more power than at present? The idea seems sound to me, and I feel sure that many readers will approve of it. There are, however, generally two sides to every question. I hope that both the "Cons." and the "Pros." will write to state their views.

Looking Ahead

It is rather sad that, now, before the regional scheme has become a *fait accompli*, it is being spoken of as a temporary compromise. After all, the whole method of radiation may be revolutionised and the scheme automatically become obsolete. In wireless, as in armaments, everything is obsolete as soon as it is in production.

Such a state of uncertainty prevents the better housing of B.B.C. provincial stations. I wonder how many of the governors of the B.B.C. have visited any of the provincial stations—say, Manchester or Liverpool? Here one has two of the largest cities of the North. One would expect to find a somewhat impressive building. Manchester is impossibly in the bowels of the earth, while the Liverpool studios are in rooms behind a café.

Promenade Concerts

The present season of Promenade Concerts is proving as great a success as that of last year. The broadcasting of this famous series has rather confounded those critics who foretold a loss of patronage at the Hall and a cheapening of the whole series. The reverse is proving the case, as broadcasting has filled the gaps in the ranks of the old promenaders, while the programmes have been quite as strong as before.

It is rumoured that next year some changes will be seen in the composition of the orchestra, and possibly the conducting, but for these arrangements there is plenty of time.

The B.B.C. is following up the promenade season with a series of concerts at which famous conductors will again be present. It is good news to hear that this policy is being followed. It was feared that the lack of support for last season's series might have affected the Corporation's plans.

THERMION.

THE RADIO "SLEUTH"

By the "A.W."
Technical Staff

FOR TESTING:—

- Fixed and variable condensers for good insulation.
- Coils, transformers, and choke windings for continuity.
- Valves for filament burn-outs or breakage.
- Valve holders before inserting the valves to see that there is no shorting of the H.T.
- Wiring for good contact at connections.
- Continuity of grid leaks and anode resistances.
- Loud-speakers and phones for broken windings.



NOTHING is more annoying when testing out a receiver to find that not a sound can be obtained from the phones or loud-speaker. More annoying still is it to find that several valves have been burnt out on connecting up the H.T. battery or switching on the set.

Under these circumstances the amateur is often at a complete loss as to what to do to put matters right.

- Ebonite panel, 6 in. by 4 in. by $\frac{3}{16}$ in. (Becol).
- No. 7 jack switch (Lotus).
- 2 phone terminals (Eastick).
- 4 valve sockets (Eastick).
- Twin flex and tinned copper wire.
- 4 $\frac{1}{2}$ -volt flash-lamp battery (Lissen).
- 2 ebonite tubes, $\frac{1}{4}$ in. diameter by 3 in. long.
- 4-volt flash-lamp bulb and holder.
- Old valve base.

The circuit of the instrument is shown by Fig. 1.

Construction

The panel should be drilled as shown by Fig. 2 and the various components mounted in position and wired up as indicated in the wiring diagram. Before screwing down the panel, the battery should be connected in the circuit by means of short lengths of flex, and the long length of twin flex should be passed through a $\frac{3}{16}$ -in. diameter hole drilled in one end of the box.

The ends of the projecting length of flex terminate in insulated handles and stiff wire contacts, the construction of which is shown in Fig. 3.

Fig. 4 shows the remaining component, which is a flash-lamp bulb and holder mounted, by means of sealing-wax or paraffin wax, in an old valve base. The holder should be connected to the wires projecting from the filament pins so that when a battery is connected across the latter the bulb lights up.

Using the Radio "Sleuth"

When the lamp is placed in the valve sockets on the panel and the two terminals connected by means of a piece of wire, the bulb will light up when the two contacts at the end of the flex are brought together, the switch being in the "out" position.

Coils, connections, and switch contacts can now be tested.

In order to test the valve holders of a receiver, before inserting the valves the

lamp should be withdrawn from the Radio "Sleuth" and placed in each valve-holder in turn with all batteries of the set wired up and the rheostat or rheostats of the set turned on. In the case of a set using 6-volt valves, however, the rheostats should be turned on just sufficiently to light the bulb, or the latter will probably be burnt out by the excess L.T. current.

For farther tests with the Radio

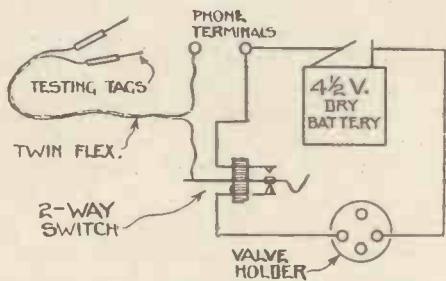

Fig. 1.—The Circuit of the Radio "Sleuth"

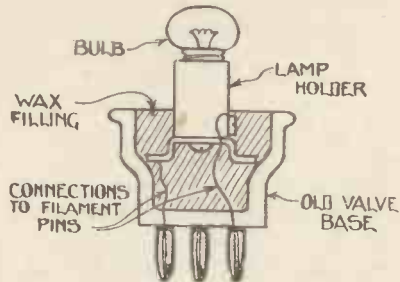

Fig. 4.—The Flash-lamp Unit

In order that the set-builder may, with a little patience, be able to detect in a short time any ordinary fault in a receiving set, we have designed a little instrument and named it the Radio "Sleuth." The Radio "Sleuth" can be made for a few shillings, and its possessor will never feel at a loss when a receiving set fails to work or it becomes faulty.

Components

The parts required are as follows:—

- Box, 6 in. by 4 in. by $1\frac{1}{2}$ in. deep inside (Carrington).

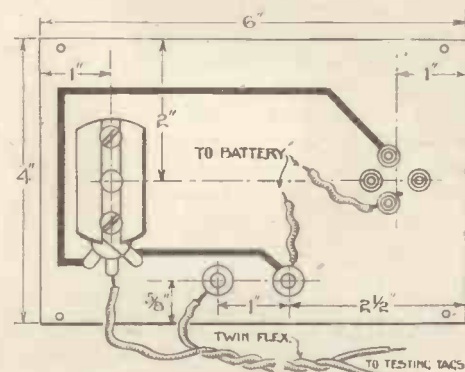

Fig. 2.—Panel drilling and wiring diagram

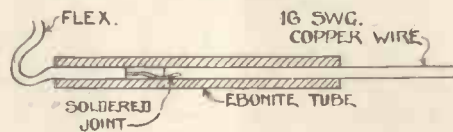

Fig. 3.—Construction of the Plugs

"Sleuth" a pair of headphones will be required, which are connected to the two phone terminals, the switch being in the "out" position.

By placing any doubtful valves in the valve sockets on the panel and bringing the two ends of the contacts together the valves may be tested for filament breakage. A click will be heard in the phones if the filament is sound and nothing if the filament is broken or burnt out.

With the lamp in position on the panel and the switch still in the "out" position, transformers, choke coils, loud-speaker,

(Continued on page 296)

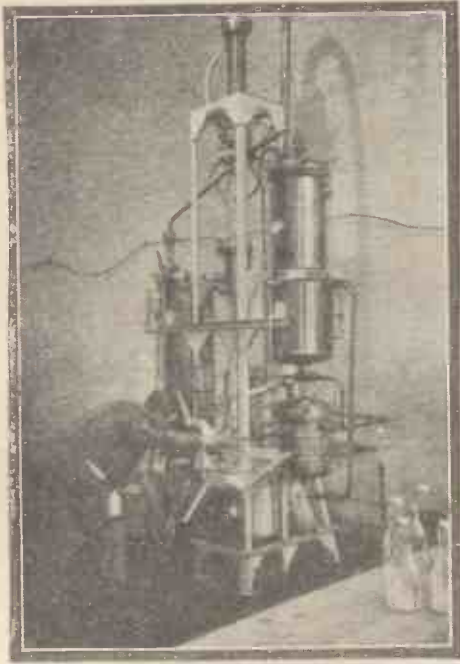

The Seidel Sterilising Apparatus

OUTSIDE of their original field in telegraphy and telephony, there is an ever-extending range of applications opening for radio waves. The latest advance in this direction has been made by Dr. Seidel, of Vienna University, who has discovered a new process in which these waves are to be employed in keeping milk fresh, thus rendering invaluable services, both from an economic and hygienic point of view.

Inasmuch as boiled milk, though freed from its bacteria, is at the same time deprived of those active components, the vitamins, and accordingly, loses much of its nutritive value, the milk destined for infant consumption should preferably be

RADIO TO KEEP MILK FRESH

Dr. Alfred Gradewitz Describes a Novel Application of Wireless Waves

sterilised by pasteurising, *i.e.*, heating in a closed vessel to about 60 degrees C. However, the effects of this process will only last for about 10-12 hours; as much as about 40 per cent. of the infants' milk and 20 per cent. of the skimmed milk thus treated frequently turns sour.

That electric waves should keep milk from curdling seems at the outset hardly plausible, nature's most grandiose electric process, the thunderstorm, which is certainly attended by the production of electric waves, being just one of the agents most conspicuous in hastening the curdling process. Still, Dr. Seidel's tests abundantly bear out his contention, and both the Austrian and Prussian Departments of Hygiene and Agriculture have lately been paying much attention to the new process. The wavelength and character of the waves used in this connection should, of course, be chosen strictly in accordance with the inventor's claims.

No New Apparatus

It is particularly fortunate that no new apparatus need be provided to apply the sterilising process, the special wave generator being simply fitted to, and exerting its bactericidal effect, in any existing pasteurising outfit. However, there are also outfits

specially made for the new electric device. These are made up of two vertical cylinders in one of which the milk to be treated is heated to a very moderate temperature, say, 40 degrees C., after which it is transferred into the other cylinder, in order there to be submitted to the germicidal action of electric waves.

Seidel's experiments go to show that more than 99 per cent. of the milk thus treated will be effectually kept from turning sour. His process warrants the freshness of milk if kept uncooled, for fully four days, and, if the milk be kept in a cool place, even for two to three weeks, or, in the special plant of large dairies, for as much as a month. The new method is bound to preserve much valuable material for the purposes of agriculture and to promote human nutrition and health.

One special use suggested for the milk thus treated is in connection with certain diseases which have been found rapidly to be cured by milk injections. The only drawback so far entailed by this treatment was a temporary, morbid condition (fever and general indisposition), which by the use of Dr. Seidel's milk in the place of ordinary milk has been found to be avoided, though the effectiveness of such injections is in no way curtailed.

"A SCREENED H.F. AMPLIFIER"

(Continued from page 264)

to Featherstone Buildings, High Holborn, W.C., is fitted on last, after the wiring of the components, has been completed with Glazite. Flaps at the baseboard and by the panel are screwed and bolted to the baseboard and panel respectively, care being necessary to ensure good contact between the shaped screen and the baseboard screen.

Where possible, the earthed terminals of the components are soldered to the adjacent copper screen. An inductive loop in the filament circuit is avoided by so joining, since the L.T.— terminal and the L.T.— side of the valve holder are earthed to the screen, thus dispensing with a lead.

A flexible lead from the aerial-lead terminal provides the necessary means for varying the tapping on the six-pin coil.

Another flexible lead from H.T.+2 provides the anode connection for the screen-grid valve.

If one of the old type of screen-grid valves is used, with screen-grid and anode pins at the one end, and filament and con-

trol grid pins at the other, then an extra flex will be required, to be taken from the anode terminal of the valve holder (which would be "dead" in this case) to the screen-grid pin on top.

The horizontal portion of the shaped screen should be the same height as the screen-grid when the valve is in position, otherwise instability may result. By the way, a small piece of the screen near the H.T.+2 terminal is cut away to avoid fouling.

The unit, when completed, can be put into commission by connecting up the requisite batteries. A 120-volt supply to the H.T.+2 and 80 volts to H.T.— will give good results, though slight variations in anode and screen-grid potentials can be tried. The unit can be worked off the mains, if desired. Using the two variable H.T.+ supplies on the all-metal rectifier described last week, the results were entirely satisfactory.

Having joined the unit to the set by means of the lead from the aerial terminal on unit to aerial terminal on set, the constructor should insert a Lewcos BAC5 coil in the six-pin holder and change the tuning

coil of the receiver for one a size larger. A No. 60 plug-in coil or a Lewcos BAR5 binocular coil is recommended.

As there is no neutralising to be done, the two circuits can be brought into tune and the local station brought in as a test signal. If any instability is experienced, such as a "squawk" when the two tuning circuits are brought into tune, try altering the position of the unit with respect to the receiver.

Persistent oscillation can be cured by shunting the grid-tuning circuit of the detector valve with a 250,000-ohm resistance or, better still, a continuously variable resistance of 0-½-megohm. But with due care there should be no difficulty in getting the enormous amplification from the screen-grid unit without resorting to these measures. On the long waves use a Lewcos BAC20 for the unit and a No. 200 coil or Lewcos BAR20 for the receiver.

Langenberg, Milan, Munster, and 5GB, on the short waves, and Moscow, Hilversum, Lahti, 5XX, and Radio-Paris, on the long waves, were all brought in at full loud-speaker strength when this unit was coupled to a simple two-valver.

WITHOUT FEAR OR FAVOUR



A Weekly Programme Criticism by Sydney A. Moseley

THUS Arthur Clifford, Esq., alias Stainless Stephen: "Dear Sidney," he wrote, calling famous critic and financial expert by his Christian name. Full stop. Stainless! Why? Aforesaid Christian name is spelt with a "y."

Stainless is very pleased in regard to my reference to his Harry Weldon act. He is labouring under the delusion, poor fellow, that I "took" him for Harry Weldon. I didn't! I knew who it really was—even though "the change of voice complete with sibilanto and vibranto" was most Harry Weldon-like. Well-done, Stainless! (Joke!)

Times have certainly changed in the gramophone world judging by the records of Patti and Caruso. Patti's little vocal "mannerisms" came over well, but even Caruso's sob-song from *Pagliacci* failed to move me. I suppose the younger generation will wonder what we went mad over. However, they should know that the electrical recording to-day is a totally different affair from the screechy-scratchy days of the tin trumpet.

"An elongated low-pressure area. . . ." Which is plain English meaning—what? "It's going to be pretty dud to-day." Or "Put your rain clobber on." When shall we come to plain English?

A John Masefield play should assuredly be given at a convenient hour. *The Locked Chest*, a play in one act "from a tale in the *Laxdaelasaga*" (in case you don't know it!), was started at about 10 p.m. Too late—too long to wait for!

May Huxley charmed us with the Strauss song at the "Proms." I noticed that another Mukle is appearing before the microphone. . . . What a musical family the Mukles are.

The Mukles of Musical England!

Certainly the military band concerts are coming into their own. Years ago I wrote a critical study on the kind of "samey" stuff usually played by military bands everywhere. The B.B.C. has altered all this. They vary their programmes these days—the wireless military bands.

And the instruments are better balanced than ever.

Take the last two programmes—modestly entitled "A Military Band Concert." We had such contrasted music as "A Roman Carnival," by Berlioz; the musical picture, "Sadko," by Rimsky-Korsakov; MacDowell's beautiful "Woodland Sketches" (of which, by the bye, I like "To a Water Lily" best); and Wagner, Elgar, Puccini, Schubert, and Sullivan.

In the Saturday night concert there was Alice Lilley and Ronald Chivers, both first-rate singers.

On Sunday night Marjorie Parry and Leonard Gowings were the vocalists. If you hear "Murmuring Breezes" being sung softly and sweetly, be sure it is Leonard Gowings singing it. I have no doubt he continues to give us this treat "by request." Marjorie Parry, too, gave us a song that has become extremely popular with listeners—"She Wandered Down the Mountain-side," by Clay.

As I say, hurrah for the military band!

Those of us who have been reading about the American author, Mr. Thornton Wilder, looked forward to his reading of his unpublished play, *Leviathan*. Alas, I must admit

I don't know what it was all about. Mr. Wilder was too staccato. He read short, sharp, hurried sentences—a not uncommon trait among celebrated people who come to the microphone and are either too big or too busy to be rehearsed.

Nevertheless, it was interesting to have him, even just to get some idea of his vocal personality!

Who was Euroswydd Richards, who sang "selected songs"? It would seem that he was put in the programme at the last minute, judging by the fact that his songs were not detailed. However, he sang "Onaway, awake, beloved," rather wistfully, as Coleridge-Taylor meant it, I suppose, and made me feel that, after all, this version is more appealing than the dramatic setting by Cowen. Mr. Richards has a strange throaty way of enunciating some words, which is probably due to singing English with a Welsh accent!

I only heard part of *Djin and Billers*, but what I did hear rather tickled my fancy. The idea was good, and no doubt I shall be getting an opportunity of sitting the thing right through.

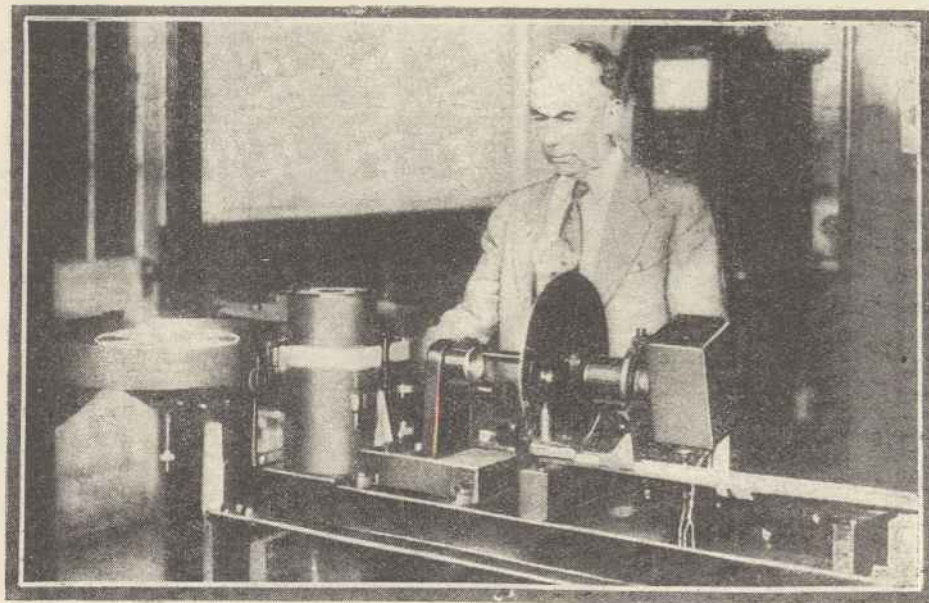

A DEMONSTRATION OF THE FIRST RADIO "MOVIE"

Dr. Frank Conrad, Westinghouse expert, and the television motion picture projector. The demonstration was made in Pittsburg, U.S.A.

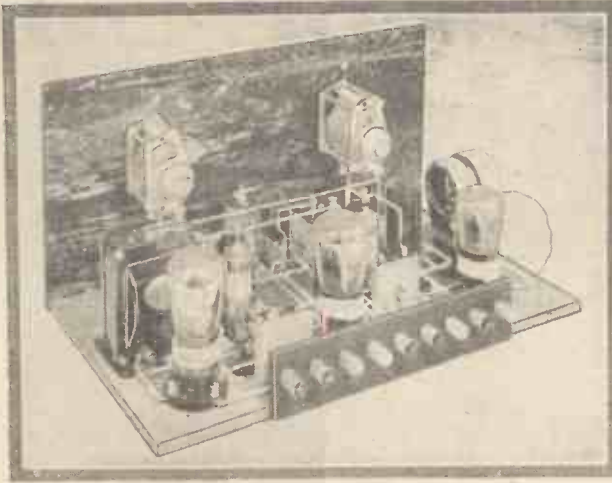

The layout is neat

LIKE the B.B.C., the designer of a wireless receiver can only appeal to some listeners some of the time. That is my excuse, if any is needed, for describing a receiver that may only appeal to some amateurs; but that is, I suggest, what discriminating listeners will appreciate—a good local-station set giving reproduction of unimpeachable quality. With the opening of the B.B.C. promenade-concert season the music-lover is provided with a continual feast of really good music. My "Promenade" receiver will enable the musical enthusiast to derive the greatest possible benefit from "Prom." concerts and other good broadcasts.

Such divergence of opinion exists as to what constitutes good-quality reproduction that I hesitate to be too dogmatic regarding ways and means of achieving it. I can only say that after listening to other people's receivers I turn with a sigh of relief to my own, which, in a less neat but otherwise identical form than that now described, has been in use for over eighteen months. It is only fair to explain that the good results I get with this receiver are not entirely due to the circuit, but to a

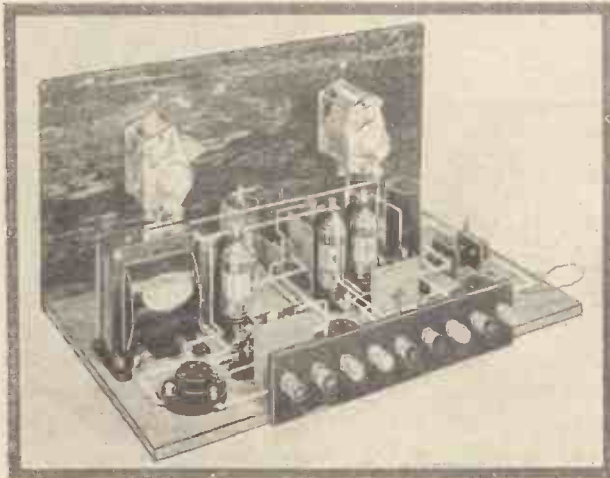

Wiring is simple

judicious choice of accessories. I am not referring to the component parts of the receiver; though these are, of course, important, but to the loud-speaker, the high-tension supply, and the valves, any of which, if ill-chosen, can nullify the good effects of the others.

The actual circuit arrangement is perfectly straightforward and must be well known to the majority of my readers. Without wishing to re-start the transformer

resistance-capacity-coupling controversy, I think most amateurs will agree that for evenness of amplification the resistance-capacity system is impossible to surpass and difficult to equal. Its comparatively restricted use is, I feel sure, due to the necessity for providing a big H.T. supply.

Before attempting to construct the "Proms" the reader should ask himself whether, in the interests of good-quality reproduction, he is prepared to go to the expense of installing at least a 150-volt supply and of providing himself with a really high-class cone loud-speaker of the balanced-armature type. If either of these is impossible it would be better to build some other type of receiver requiring a more moderate H.T. supply and not such a good loud-speaker. It is not very much use making a receiver that amplifies frequencies down to 30 cycles if the loud-speaker is incapable of reproducing anything below 200 cycles. Such a procedure would be definitely inefficient, since an amplifier with a 20-cycle low limit would more easily overload than one that "cut off" at 200 cycles.

Directly associated with the type of loud-speaker is the type of power valve preceding it. A super-power valve is absolutely necessary to do justice to the resistance-capacity-coupled amplifier



A Set Designed for Pur

preceding it. It is equally necessary, though, that a good-quality loud-speaker be used to justify the super-power valve. So it will be seen that the receiver, valves, and loud-speaker must be chosen logically to work one with the other if good all-round results are to be obtained.

The high-tension problem can be solved by those fortunate enough to have electric-light installations, by the sub-

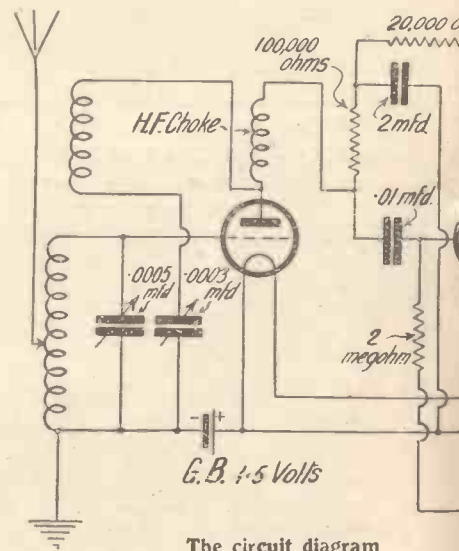

The circuit diagram



PROMS "3"

capacity dry battery, sold in 45-volt blocks, four of which would be required, or an accumulator high-tension battery made up of 20-volt blocks. If these considerations are borne in mind before the "Proms" 3 is constructed, I feel sure that no one who makes it up will fail to be immensely pleased with the resulting purity of reproduction.

At this point it will facilitate the explanation if the

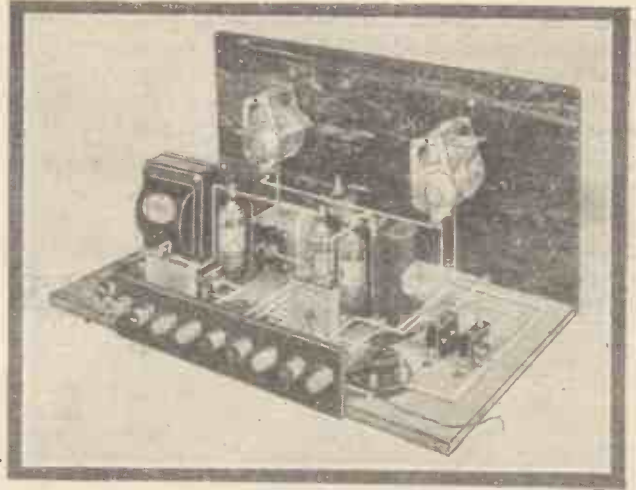

Few components are required

reader refers to the theoretical circuit shown by the diagram. Briefly described, the arrangement consists of an anode-bend detector valve with Reinartz reaction, followed by two stages of resistance-capacity-coupled low-

frequency amplification. No pains have been spared to incorporate all the latest improvements, but even so the circuit remains essentially simple. Dealing first with the detector valve, it will be seen that the aerial-tuning system consists of a tapped coil shunted by a .0005-microfarad variable condenser. In the interests of quality it is not desirable to make the tuning too selective, otherwise the signals will be mutilated even before they pass through the low-frequency amplifier. With a short aerial, a No. 60 centre-tapped coil will give adequate selectivity without impairing the quality, but with a larger aerial an "X"-tapped coil of the same size should be used. It will be noted that the earth end of the tuning coil is not connected directly to L.T.—, but that this lead is intercepted by a 1½-volt cell. By this means the grid of the detector valve is negatively biased through the tuning coil for anode-bend rectification.

Excessive reaction will also mutilate the signals, but as a judicious application will give good signal "boost-up" without impairing quality

By Arthur Yorke

stitution of mains units for the hitherto almost universally used dry batteries. A modern H.T. eliminator for A.C. electric mains supply, incorporating either a double-wave valve rectifier or a solid metal bridge rectifier will deliver at least 160 volts under normal three-valve load. The only satisfactory alternative to the use of a mains unit which I can offer to those without mains supply is the super-

frequency amplification. No pains have been spared to incorporate all the latest improvements, but even so the circuit remains essentially simple.

Dealing first with the detector valve, it will be seen that the aerial-tuning system consists of a tapped coil shunted by a .0005-microfarad variable condenser. In the interests of quality it is not desirable to make the tuning too selective, otherwise the signals will be mutilated even before they pass through the low-frequency amplifier. With a short aerial, a No. 60 centre-tapped coil will give adequate selectivity without impairing the quality, but with a larger aerial an "X"-tapped coil of the same size should be used. It will be noted that the earth end of the tuning coil is not connected directly to L.T.—, but that this lead is intercepted by a 1½-volt cell. By this means the grid of the detector valve is negatively biased through the tuning coil for anode-bend rectification.

Excessive reaction will also mutilate the signals, but as a judicious application will give good signal "boost-up" without impairing quality

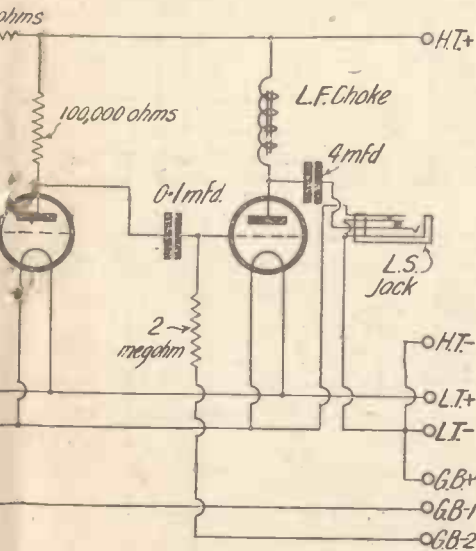

Construction is on orthodox lines

“THE ‘PROMS 3’” (continued)

and it is therefore only logical to follow the detector by resistance-capacity coupling, with a high-impedance in the anode circuit of the detector.

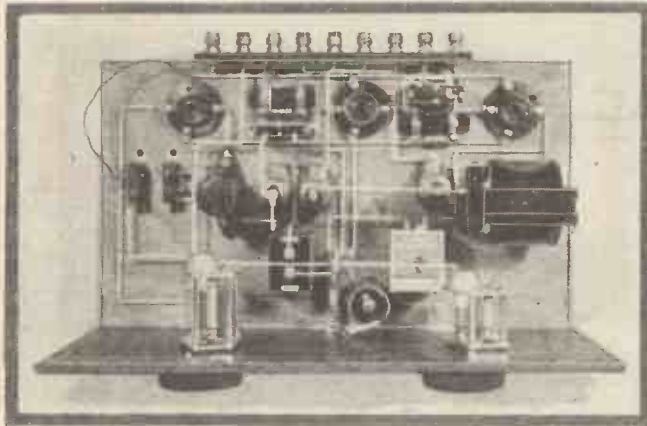

A plan view of the “Proms 3”

Many different values of anode resistances, coupling condensers, and grid leaks are advocated by designers as being the most effective in resistance-capacity-coupling units, and those I specify are simply the result of practical experience. Thus, the coupling condenser between the detector and first amplifying valve has a value of .01-microfarad, whilst between the first and second amplifying valves a .1-microfarad condenser is advocated. The resistance in the anode circuit of the detector valve is split into two sections of 100,000 ohms and 20,000 ohms, giving a total effective anode resistance of 120,000 ohms. This is high enough to ensure maximum amplification from the preceding valve, but not too high to cause a falling off in the amplification of high notes.

Anti-Motor-boating

A 2-microfarad blocking condenser is connected between the junction of the two resistances and earth. This system is particularly effective in preventing the phenomenon known as “motor-boating,” which would otherwise almost certainly occur on connecting up the receiver to a mains unit or high-voltage H.T. battery. I have not found it necessary to provide the split-anode feed in the second stage; in fact, in my experience, such a procedure results in an appreciable reduction of signal strength.

The grid leaks for the L.F. amplifying valves are 2 megohms each. Even on strong signals there is no grid choking, as some might possibly suppose, simply because when the valves are properly biased no grid current flows.

The anode circuit of the last valve is quite interesting. The high-tension potential to the anode itself is supplied through a low-frequency choke, so that the loud-speaker winding, which is connected in series with a 4-microfarad by-pass con-

denser, across the anode and low-tension minus, only provides a path for the low-frequency pulsations, and not for the direct current from the high-tension supply. With the large high-tension supply recommended it would not be advisable to have the loud-speaker in the direct-current circuit. Quite apart from this consideration, however, the interests of quality are best served by separating the direct-current from the low-frequency pulsations operating the loud-speaker.

As I take one side of the loud-speaker to low-tension minus, instead of by the round-about way through high-tension positive, I have been able to use a four-contact loud-speaker jack, thus simplifying the loud-speaker and filament switching. The low-tension supply from the

accumulator to the filaments of the valves is intercepted by two of the jack-switch contacts, so that when the loud-speaker jack is inserted the filament circuit is completed as well as the loud-speaker circuit.

I am all for simplicity, where possible, and assuming a 150-volt H.T. supply, I do not think it necessary to provide more than one H.T.+ terminal. Practically the whole supply is therefore applied to the last valve, whilst the detector and first low-frequency valve supplies are automatically reduced by virtue of the anode resistances. That is all there is to say about the circuit which, if followed in all its details, is my solution to the problem of good-quality reproduction.

Components

To assemble the “Proms 3” the intending constructor will require the following components or suitable alternatives:—

Ebonite or bakelite panel, 16 in. by 8 in.,
(Continued on page 280)

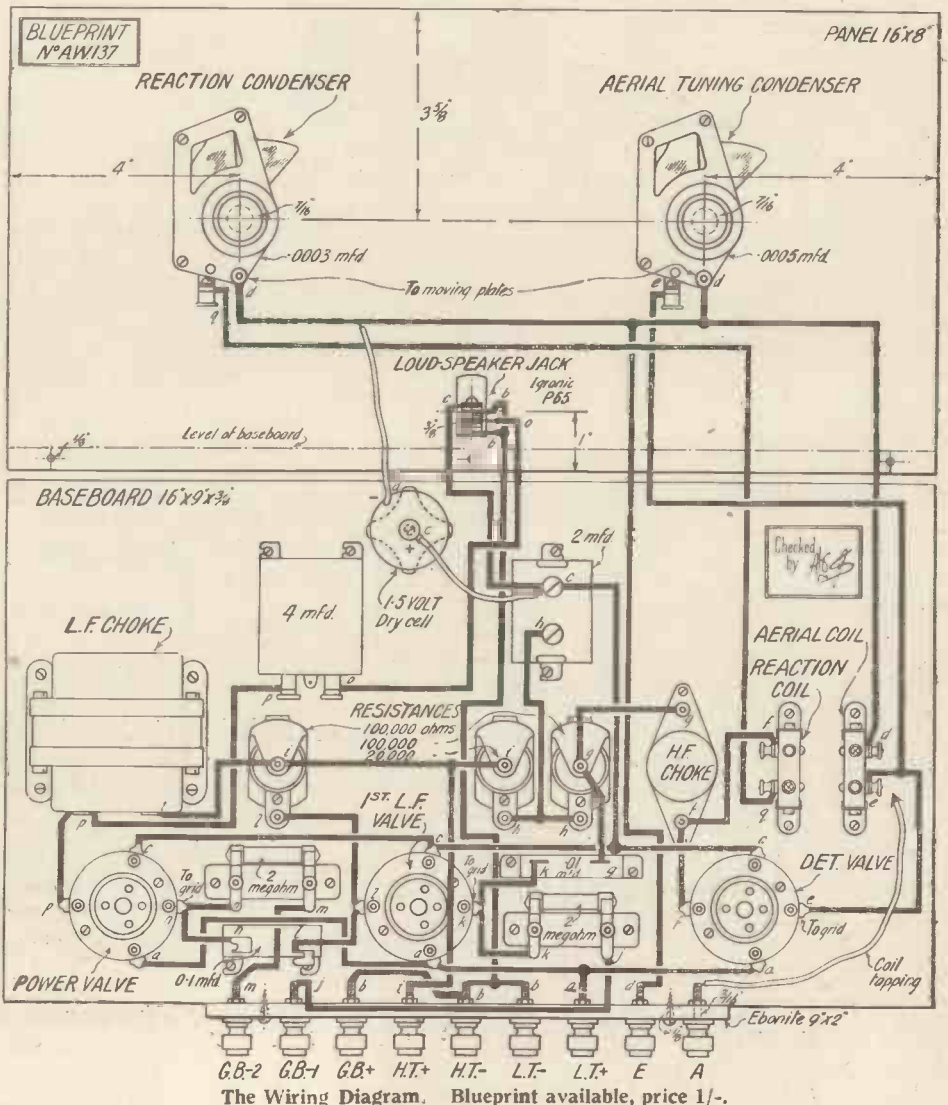

The Wiring Diagram. Blueprint available, price 1/-.

The Condenser which Improves all Tuning

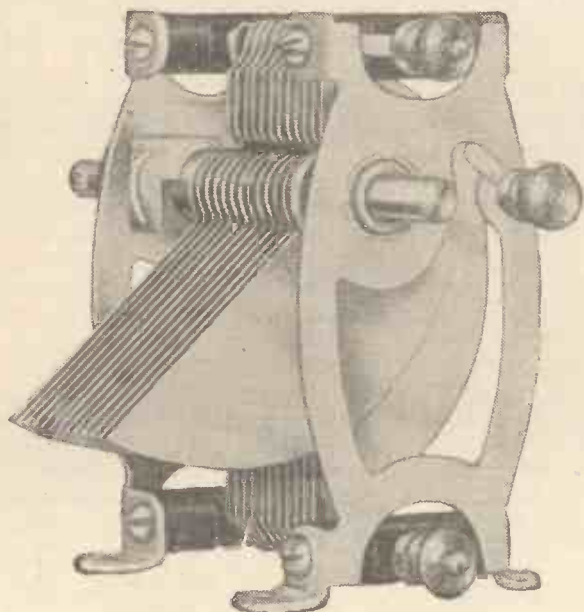

.0001 mfd. capacity	5/9
.0002 mfd. capacity	5/9
.0003 mfd. capacity	6/-
.00035 mfd. capacity	6/3
.0005 mfd. capacity	6/6

1. Standard 1/4" spindle. Will fit any standard dial or knob.
2. Bush fixing nut for one hole fixing, suitable for panel from 1/4" to 3/8".
3. Solid brass end plates that give rigid construction.
4. Accurately spaced, rolled and planished stator vanes.
5. Stator pillars located outside the dielectric field, giving exceptional low power loss.
6. Spindle goes right through bottom end plate for ganging purposes.
7. Braided copper pigtail connection ensures positive and unwearing connection.
8. Alternative stator terminals to simplify wiring.
9. There is no end pressure on any end plate to distort plates and vanes.
10. Four fixing feet provided give alternative panel or baseboard mounting. These feet, together with the fact that spindle is extended on each end, make the condenser suitable for drum control.
11. Rotor vanes made to improved logarithmic principle designed so that stations are easily separated and are tuned in all round the dial and not crowded together at one end.
12. Heavy spindle stop. No strain is thrown on the vanes of the condenser. There is therefore no vane distortion.
13. Long heavy bearings ensure everlasting wear.
14. Spindle locating spring and tension device ensure freedom from tight spots at any position of the dial.

The condenser is not under tension in use. Vane alignment is never affected by wear or temperature variations. Everlasting rotor damping features on the moving vanes which will last as long as the condenser without the slightest need for adjustment.

A condenser with nearly 20 features of outstanding excellence — sold at a price which can only be described as typical of Lissen value for money. If you desire to improve tuning, take out your existing condenser and replace it with this new Lissen. Certainly old condensers will never pay to patch up now that this new condenser is available.

You can get the new Lissen Variable Condenser from most radio dealers. If you have any difficulty, order on a postcard stating capacity required, and condenser will be sent C.O.D. by return of post. Kindly give dealer's name and address if possible.

LISSEN LIMITED, FRIARS LANE, RICHMOND, SURREY
 (Managing Director: Thomas N. Cole)

Don't Forget to Say That You Saw it in "A.W."

VALVE ROYALTIES YOUR RECEIVER WILL COST YOU LESS

—AN IMPORTANT DECISION

TWO decisions of great importance to all listeners have just been reached by the Comptroller of the Patents Office in respect of applications made by the Loewe Radio Co. and the Brownie Wireless Co. in the matter of patents controlled by Marconi's Wireless Telegraph Co., Ltd., and the British Thomson-Houston Co., Ltd., who may appeal.

In the first case a compulsory licence has been granted to the Loewe Co., which has a factory at Tottenham, to manufacture in this country triple and double receiving valves. The Patents Tribunal decided that royalties should be 10s. and 7s. 6d. for the triple and double valves respectively, instead of the £1 17s. 6d. and £1 5s. royalties asked by the opposers of the applications, namely, the Marconi Company and the British Thomson-Houston Company.

The same tribunal has also approved the application by the Brownie Wireless Co. for a compulsory licence to manufacture valve sets under Marconi patents, with reductions in the valve royalties paid to the Marconi Company for each receiver sold.

The Comptroller has ordered a reduction of the royalties from 12s. 6d. per valve to a 10 per cent. royalty on the wholesale selling price of the receiver, with a minimum charge of 5s. on the first valve and 2s. 6d. for each additional valve.

It has yet to be decided, however, how these judgments will apply to the trade generally, because most of the licences held under Marconi patents stipulate twelve months' notice to terminate them. These decisions are now a matter of great importance to every manufacturer, for although only about 150 of the 2,000 licences of the Marconi Company are

actual manufacturers, it will be appreciated that their position would become difficult if licences according to the terms of these judgments were issued by the Marconi Company or granted by the Patents Office exclusively to the Brownie and Loewe companies, unless the new terms are made applicable to all the licences.

Other Licences

As an official of the Radio Manufacturers' Association points out, an anomalous state of affairs would arise if the Marconi Company did not put all its licences on the same footing. If, in the three weeks allowed by the tribunal for an amicable settlement between the applicants and the Marconi Company, no agreement is reached, then, it is pointed out, the Patents Office could issue licences endorsed "Licence of right," which would supersede the old licences and so get over the difficulty of the year's notice. If the Comptroller of the Patents Office had to issue a licence, it was stated, it would immediately become operative.

The Report

We give below some of the principal points given in the Comptroller-General's report on the case: "Mr. Barber, of the Brownie Wireless Co., expressed the view that if the respondents, the Marconi Company, were to grant licences on such terms as would permit a cheap variety of valve receiver to be produced at a low scale of royalty, the respondents would gain. They would obtain a large aggregate sum, in spite of the reduced royalty, by reason of the large sales in what would practically be a new market, at present restricted by

consideration of expense to the purchase of crystal sets, which market cannot be reached under existing conditions. A friendly, instead of an 'antagonised,' trade could do a good deal to assist the respondents in securing payment of all the royalties to which they are entitled.

"The conclusions that we have so far reached," the report states, "involve in our view the finding that the monopoly rights under the respondents' patents have been abused and that the question of relief must be considered. We have found that it is in the public interest that a licence should be granted to the applicants (referring to the Brownie Wireless Co.) and we have found that the terms under which the licence is offered are unreasonable terms, prejudicial to their trade."

Referring to the position of the trade as a whole, the report continues: "Although, however, the conclusion at which we may arrive may logically involve the implication that the applicants have established the general case of prejudice to the trade of a class of persons as well as prejudiced to their own trade, we have, in fact, only one specific application to deal with, and this decision can go no farther than to define the relief to which the applicants themselves may be entitled."

The International Quotations Company Inc. has asked the American Radio Commission permission to find means of sending across the ocean the official quotations of stocks and commodities in the leading American markets. Tests on short waves have already been made from the radio station at Riverdale, and have been successful.

"THE 'PROMS' 3"

(Continued from page 278)

and strip, 9 in. by 2 in. (Raymond, Becol, Pertinax, Paxolin).

.0005 - microfarad variable condenser (Polar Ideal, J.B., Burndépt, Lissen, Igranic).

.0003 - microfarad variable condenser (Polar Ideal, J.B., Burndépt, Lissen, Igranic).

Loud-speaker filament jack (Igranic type P65, Bowyer-Lowe, Formo.)

Three anti-microphonic valve holders (Ashley, Wearite, Trix, Benjamin).

Two single-coil holders (Lotus, Lissen).

High-frequency choke (Lissen, Wearite, R.I. & Varley, C.D.M., Burndépt).

Two 100,000-ohm wire-wound resistances and holders (R.I. & Varley, Dubilier, Lissen, Mullard).

20,000-ohm wire-wound resistance and

holder (R.I. & Varley, Dubilier, Lissen, Mullard).

Four fixed condensers of the following capacities: 4 microfarads, 2 microfarads, .01 microfarad, and .1 microfarad (Hydra, Lissen, Dubilier, T.C.C.).

Two grid leak holders (Dubilier, Graham-Farish, Lissen).

Two 2-megohm grid leaks (Dubilier, Graham-Farish, Lissen).

Output choke (Ferranti type Br, Igranic, R.I. & Varley).

Nine terminals, marked: Aerial, Earth, L.T.+, L.T.-, H.T.-, H.T.+, G.B.+, G.B.-1, G.B.-2 (Belling-Lee, Eelex, Igranic).

Baseboard, 16 in. by 9 in. (Camco).

Connecting wire (Glazite).

Two dial indicators (Bulgin).

1½-volt grid cell (Ever Ready type UW1, Lissen, Siemens).

Clip for grid cell (Bulgin).

The best advice I can offer the intending constructor is to write to "Blueprint Dept.," AMATEUR WIRELESS, 58-61 Fetter Lane, London, E.C.4, for the full-size is. blueprint of the receiver, for, besides giving panel-drilling dimensions and panel and baseboard layouts, this valuable constructional aid gives point-to-point connections between the different components. A study of this blueprint in connection with the various illustrations accompanying this article will give a better idea than I can give in words of the appearance of the finished "Proms" 3.

The tuning condenser on the left, reaction condenser on the right, and loud-speaker jack between them, at the bottom, are all very easily mounted on the panel; after which the panel can be fitted to the

(Continued in third column on page 282)

Marconi VALVES

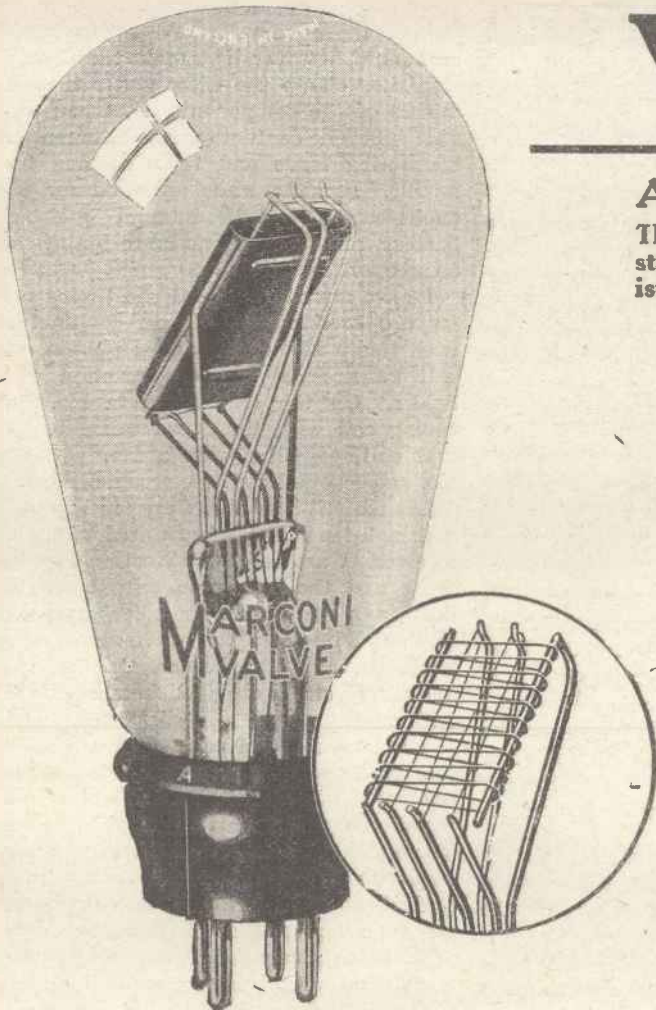

Advance Details for 1928-1929

The following valves of the present Marconi range will remain standard, but owing to certain developments the characteristics have been improved as shown in the table below.

Type	Fil. Volts	Fil. Amps.	Anode Volts	Imp.	Ampl. Factor	Price
GENERAL PURPOSE VALVES						
DEL210 ..	2.0	0.1	150	12,000	11	10/6
HL210 ..	2.0	0.1	150	23,000	20	10/6
DEL410 ..	4.0	0.1	150	8,500	15	10/6
DEL610 ..	6.0	0.1	150	7,500	15	10/6
RESISTANCE CAPACITY COUPLING AND HIGH FREQUENCY AMPLIFYING AND RECTIFYING VALVES.						
DEH210 ..	2.0	0.1	150	50,000	35	10/6
DEH410 ..	4.0	0.1	150	60,000	40	10/6
LS5B ..	4.25-5.25	0.8	400	25,000	20	25/-
DEH610 ..	6.0	0.1	150	60,000	40	10/6
DE5B ..	5-6	0.25	150	30,000	20	12/6
POWER AMPLIFYING VALVES						
DEP215 ..	2.0	0.15	150	5,000	7	12/6
DEP240 ..	2.0	0.4	150	2,500	4	15/-
DEP410 ..	4.0	0.1	150	5,000	7.5	12/6
LS5 ..	4.25-5.25	0.8	400	6,000	5	25/-
LS5A ..	4.25-5.25	0.8	400	2,750	2.5	25/-
DE5 ..	5-6	0.25	150	7,000	7	12/6
DE5A ..	5-6	0.25	150	4,000	3.5	12/6
DEP610 ..	6.0	0.1	150	3,500	8	12/6
SCREENED-GRID VALVE						
S625 ..	6.0	0.25	180	175,000	110	22/6
INDIRECTLY HEATED CATHODE VALVES						
KL1 ..	3.5	2.0	150	3,750	7.5	17/6
KH1 ..	3.5	2.0	150	33,000	40	15/-

Type P625.—DULL EMITTER, LOW FREQUENCY, POWER AMPLIFYING VALVE.

NOMINAL RATING

Filament Volts	6.0 max.
Filament Current	0.25 amps.
Anode Volts	250 max.
Anode Current max.	24 m/amps.

At Anode Volts 100, Grid Volts 0.

Amplification Factor	6
Impedance	2,400 ohms
Normal Slope	2.5 Ma/v

Marconi P625 is a new super-power valve which will be welcomed by all moving coil enthusiasts. Its power output at 250 volts H.T. is sufficient to drive such a speaker at full volume. The low impedance matches the average high resistance coil while the high magnification gives increased volume for a given input.

New Types of MARCONI VALVES

which will be introduced during next season.

Type	Description	Fil. Volts	Fil. Amps.	Anode Volts	Imp.	Mag.	Price
P425 ..	4v Super Power Valve ..	4.0	0.25	150	2,300	4.5	15/-
P625A ..	6v Super Power Valves ..	6.0	0.25	180	1,600	3.7	15/-
P.625 ..		6.0	0.25	250	2,400	6.0	15/-
HL610 ..	General Purpose 6v Valve	6.0	0.1	150	30,000	30	10/6
H Point 8	A.C. Directly Heated Cathode Valve for Res. Cap. Coupling or H.F. ..	0.8	0.8	150	55,000	40	15/-
HL Point 8	A.C. Directly Heated Cathode Valve, General Purpose ..	0.8	0.8	150	17,000	17	15/-
P Point 8 ..	A.C. Directly Heated Cathode Valve for L.F. ..	0.8	0.8	150	6,000	6.0	17/6
S Point 8 ..	A.C. Directly Heated Cathode Valve with Screened Grid ..	0.8	0.8	150	200,000	160	25/-
S215 ..	2v Screened Grid Valve ..	2.0	0.15	150	200,000	170	22/6
PT235 ..	Pentode Valve	2.0	0.35	150	55,000	90	25/-

THE MARCONIPHONE CO., LTD., 210-212 Tottenham Ct. Rd., London, W.1

Please Mention "A.W." When Corresponding with Advertisers



RADIOGRAMS

THE well-known racing correspondent, Mr. R. C. Lyle, will broadcast a running commentary on the St. Leger from 2LO on September 12.

Listeners to 2LO and 5XX will hear the Promenade Concerts from the Queen's Hall on September 6, 14, 17 and 28, and to 5GB on September 7, 13, 15, 19, 26 and 27.

A concert of Sullivan's music will be given by the Wireless Orchestra, conducted by John Ansell, from the 2LO station on September 8. Excerpts from musical comedy will follow, the artistes being Rose Hignell (soprano) and George Baker (baritone).

The Summer Symphony Concert to be relayed from the Bournemouth Winter Gardens by 5GB on September 13 will include the "Leonora" overture and one of the four overtures from Beethoven's only opera, *Fidelio*. The Bournemouth Municipal Augmented Orchestra will be conducted by Sir Dan Godfrey, the soloists being Ernst Slaney (violincello) and Owen Bryngwyn (baritone). The programme will conclude with Dvorak's "From the New World" symphony.

2LO will relay a service from St. Martin in-the-Fields on September 9, when listeners will hear an address given by the Rev. G. F. MacLeod.

5GB listeners on September 24 will hear *Maritana*, which is the first of a new series of libretto operas to be broadcast by the B.B.C. This will also be given from the 2LO studio on September 26.

An interesting broadcast, in the form of a recital of gramophone records from the end of the last century to the present time, will be made by the London station on September 21. Listeners will be shown how, from a very unmelodious instrument, the gramophone has become a very enjoyable means of entertainment.

John Ansell will conduct a concert to be given by the Wireless Orchestra from 2LO on September 10. The programme will include Henry Geehl's descriptive suite, "1745," which is to be conducted by the composer. The solo artiste is Robert Chignell, who will sing the "Mephistopheles Serenade," from Berlioz's *Faust*.

On September 9 the Daventry (5XX), Cardiff, and Swansea stations will broadcast a religious service in Welsh, to be

relayed from Ebenezer Welsh Congregational Church at Cardiff.

"The Day of Atonement" is the title of a talk to be given by the Chief Rabbi, Dr. J. H. Hertz, from the 2LO station on September 23.

A feature of the Plymouth programme to be broadcast on September 13 is entitled *Sea Foam and Sunlight*, arranged by Fred E. Weatherly, the well-known K.C. song-writer. Dennis Noble (baritone) and Ethel Dakin (mezzo-soprano) will sing songs of the sea.

A French variety programme is to be given from the Belfast studio on September 18. Artistes will include Alec Chentrens, in French *opera-bouffe*, and Claude Cavallotte and Yvette Darnac, in light French songs.

A thrilling dramatised novel, entitled *The Greater Power*, by Francis J. Mott, will be broadcast from 2LO and 5XX on September 18. Taking place in the year 1978, this story of an unhappy and wronged man, who tries to seek revenge on the world by exterminating the human race, conveys to listeners the horror of the use of death-rays and other similar devices.

From October 1 the Vienna Broadcasting Company will institute a daily transmission of wireless pictures to subscribers on the Fultograph System. It has been decided to try this system for a period of one year, in order to ascertain whether a regular and reliable broadcast can be carried out.



**MABEL
POULTON**

"THE 'PROMS' 3"

(Continued from page 280)

baseboard, the remaining components fixed in the positions indicated, and the process of wiring started. Grid-leaks and anode resistances should be removed from their clips during the wiring, as heat conducted to them may impair their efficiency. In the original "Proms" 3 all connections are soldered, but this is not absolutely essential if the constructor is one of those who "would rather not." Make sure, however, if you take the alternative, i.e. clamp the wires under the terminals of the components, that you provide sufficient contact surface between the connecting leads and the clamping terminals. Flexible leads are used for the anode-bend $1\frac{1}{2}$ -volt integral grid-bias battery and for the aerial-to-tuning-coil connection.

I have already specified the tuning coil for the broadcast band. In conjunction with this a No. 60 untapped plug-in coil will be necessary in the reaction coil-holder. On the long waves a No. 150 tuning coil with the aerial taken to the grid end, together with a No. 75 or a No. 100 reaction coil, are recommended.

Let me tell you about my loud-speaker and high-tension supply as used with this receiver. I use an 18-in. Western-Electric Kone and the maximum output obtainable from an eliminator incorporating a Mullard DU2 rectifying valve and Igranic 200-volt mains transformer. One hundred and sixty volts is obtained from a 200-volt A.C. input.

The choice of valves is, in my opinion, just as important as that of the loud-speaker. I emphatically do *not* recommend an "R.C." valve for the detector. These "R.C." valves do not oscillate very easily and, furthermore, they are more difficult to work in a purity receiver than the type I recommend, which is an H.F. valve—in my case, a Six-Sixty SS6075H.F.

The first low-frequency amplifying valve is also an SS6075H.F., whilst the power valve is a Six-Sixty SS625H.P. The first L.F. valve is negatively biased $1\frac{1}{2}$ volts and the power valve 18 volts. Whilst I do not recommend any deviation from the type of detector valve specified, there is, admittedly, a little more latitude as regards the choice of the first amplifying valve, which can, in some cases, be substituted to advantage for a valve of the SS610L.F. type. I use 6-volt valves throughout, but those who are prepared to sacrifice a little in amplification can use the corresponding types of 2-volters.

"The 'Best-yet' Portable"—The combination of valves shown in last week's photograph on page 246, of this portable, was: H.F., Cossor Screen-grid; Detector, Six-Sixty SS210L.F.; 1st L.F., Six-Sixty SS210L.F.; power valve, Six-Sixty SS215P. This combination gave good results

PICK UP AMERICA!

On the short waves you can pick up America—even on your one- or two-valve set.

But remember that short-wave success depends upon the coil—make it certain—fit

LEWCO'S
REGD.

SHORT-WAVE COILS



We are exhibiting at the NATIONAL RADIO EXHIBITION, OLYMPIA Sept. 22nd to 29th STAND 110

RECOMMENDED FOR USE WITH THE "MASTER 3"

THE LONDON ELECTRIC WIRE COMPANY AND SMITHS, LIMITED
Church Road Leyton, London, E.10



A new 'Blue Spot' speaker embodying the special 66K driving unit

The well-known Blue Spot supremacy of reproduction is here embodied in a speaker of exceptionally handsome design—Blue Spot One-o-One. Its appearance, no less than its interpretation, makes this speaker a notable addition to any set—the rim and cone shield faced throughout in Trolite; the pedestal shapely in form and solidly built.

The reproduction has the true-to-tone quality characteristic of all Blue Spot speakers. You have only to hear it and compare it to understand why even the most critical music lover finds its performance satisfying.

The new four-pole Unit embodied in the speaker—the secret of its delicate interpretation—is fitted with a special screw giving micrometer adjustment. Ask your dealer to demonstrate Blue Spot 101—it is now showing everywhere at £3:13:6

For the benefit of constructors wishing to build their own cone speaker at home, the new 66K Four-pole Balanced Armature Unit is sold with working instructions for building both free edge and floating edge cone. Price, complete with two padded washers, 25/-.

The original non-adjusting Unit 66A is now available at the special reduced price of 21/6.

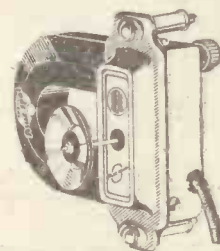

The **BLUE SPOT**
101
CONE SPEAKER

"Ideal Blue Spot Cone Speakers are sold under full protection of the patents owned by Standard Telephones and Cables and the Hopkins and Lektophone Corporations."

F. A. HUGHES & CO., LIMITED
204 - 6, Gt. Portland Street, LONDON, W.1
MANCHESTER: 185, Princess Street

Don't Forget to Say That You Saw it in "A.W."

"A.W." TESTS OF APPARATUS

Conducted by our Technical Editor, J. H. REYNER, B.Sc. (Hons.), A.M.I.E.E.

Lissen Super Transformer

FOLLOWING up the success attained by their small popular-priced low-frequency transformer, Lissen Ltd., of Richmond, Surrey, have just placed on the market a larger transformer which with a high primary inductance is claimed to give high and even amplification on all normal frequencies.

The windings and a substantial iron core are housed in a neat and well-finished brown moulded case, with terminals placed towards the base, two on each side. The casing is sealed and damp-proof.

It might be considered that with an efficient instrument of this type some trouble would be experienced, owing to the fact that the transformer is not shielded



Lissen Super Transformer

in an iron case. This trouble, however, is not apparent, as with the modern appliances for eliminating low-frequency interaction, an iron case is not always essential.

We tested the transformer on an inductance bridge at a frequency of 1,000 cycles, and found that the primary winding had an inductance of approximately 60 henries when passing a steady current of 2 milliamps. The step-up was $3\frac{1}{2}$ to 1. We then tested the instrument in a low-frequency amplifier, and obtained good volume and with quite satisfactory quality of reproduction.

At a price of 19s. the transformer should prove popular.

Bulgin Push-pull Switch

WE have received for test from Bulgin and Co., Ltd., of 9-11 Cursitor Street, E.C.4, a push-pull "on-off" switch. Although this component resembles closely the type marketed by Messrs. Bulgin for some time past, an inspection reveals that a number of improvements have been carried out which add to the pleasantness of operation and should increase the useful life and reliability of the component.

The metal contact strips, although fairly thin, will retain their springiness almost indefinitely, since it requires considerable

movement of a spring in order to give it a permanent set. The plunger is operated by a highly polished ebonite knob and is

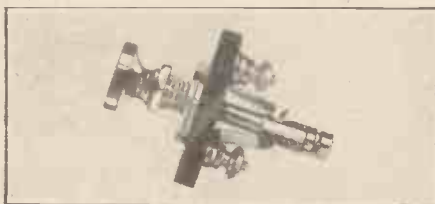

Bulgin Push-pull Switch

so shaped that the switch has a definite "on" and "off" position, but is in no way stiff to operate. A one-hole fixing device is, of course, employed. Readers should find this component thoroughly serviceable.

Magnum Short-wave Choke

THE efficiency and fascination of reception on the ultra-short waves have caused numbers of readers to build short-wave receivers. Most readers are aware that in short-wave receivers, if good results are to be obtained, the components must be thoroughly efficient in design and construction.

Owing to the ultra-high frequencies dealt with, such units as high-frequency chokes must receive extremely careful attention if direct by-pass of H.F. oscillations is to be prevented. The capacity of the windings and former must be reduced to as low a value as possible.



Magnum Short-wave H.F. Choke

From an examination of the Magnum short-wave choke which has been received for test, it is evident that Messrs. Burne-Jones, Ltd., of 288 Borough High Street, S.E.1, have given considerable attention to the design of this component. The former employed for the windings is similar to that used in the well-known standard Burne-Jones choke; in the short-wave variety, however, the windings are much smaller, and the number of turns per slot

is based on a mathematical progression to obtain an even choking effect.

Tested in an ultra-short-wave receiver, the choke was found to operate satisfactorily on wavelengths varying from 10 up to 60 metres, and there were no discernible peaks throughout this range.

R.I. and Varley Anti-Mobo Unit

THE increased use of battery eliminators and the modern tendency to build high-power amplifiers has brought a number of difficulties to the designer of L.F. equipment, since an amplifier, employing a number of valve stages fed by a common high-tension tapping, is liable to set up low-frequency interaction owing to the resistance of the H.T. circuit. One method



R.I. and Varley Anti-Mobo Unit

of overcoming this difficulty is to employ a filter circuit in the high-tension lead of each separate stage.

Messrs. R.I. and Varley, Ltd., of 103 Kingsway, W.C.2, have brought out a particularly neat filter unit known as the Anti-Mobo. This comprises a 2-microfarad condenser and a tapped resistance housed in a neat insulated casing. The resistance is tapped to 20,000, 30,000, and 40,000 ohms, so that the H.T. supply can be adjusted to give suitable voltages.

We placed the Anti-Mobo in a low-frequency amplifier which was motor-boating in an unpleasant manner: the component, however, effected a complete cure. The device can certainly be recommended to readers.

Historical Scots songs and regimental marches, arranged and introduced by George Eyre-Todd, will form a special feature in the programme given from the Glasgow studio on September 19.

Dr. Thouless, Lecturer in Psychology at the Glasgow University, is to give a series of six talks from the Scottish stations, beginning on September 19. They will bear the general title, "Straight and Crooked Thinking."



SEPT. 22ND TO 29TH

THE NATIONAL RADIO EXHIBITION OLYMPIA

11 A.M. TO 10 P.M. DANCING

ADMISSION 1/6 DAILY TUESDAY SEPT. 25. UP TO 5/6M 2/6

See all that is
Modern in
Radio

at

OLYMPIA

Sept. 22nd to 29th



Organised by The Radio Manufacturers' Association

2H



DON'T SPEND

MEND WITH FLUXITE

FLUXITE SOLDERING SET—complete

7/6
or LAMP only, 2/5

All Hardware and Ironmongery Stores sell FLUXITE in tins, price 8d., 1/4 and 2/8. Another use for Fluxite—Hardening Tools and Case Hardening. Ask for leaflets on improved methods.

FLUXITE LTD.,
(Dept. 326)
Rotherhithe, S.E.16

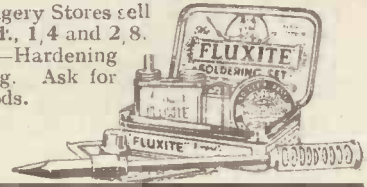

The **NEW**
DOUBLE RANGE TUNER

Price
12/6
complete with switch.

A scientifically designed tuner which when skunted with a variable condenser of .0005 mfd. max. capacity, covers wavelength ranges of 250 to 600 metres, and 1,000 to 2,000 metres change over being effected by push-pull switch supplied. Reaction controlled by variable condenser also of .0005 mfd. This instrument comprises a complete tuning unit which does away with all coil changing.

An illustrated leaflet giving full particulars of this and other Watmel Products will be gladly sent to you on receipt of a p.c.



Watmel Wireless Co., Ltd., Imperial Works, High Street, Edgware, Middlesex. Telephone: Edgware 0323

Advertisers Appreciate Mention of "A.W." with Your Order

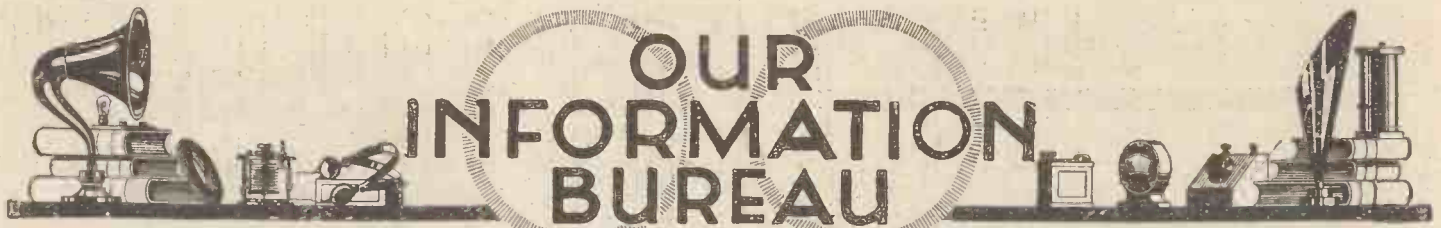

RULES.—Please write distinctly and keep to the point. We reply promptly by post. Please give all necessary details. Ask one question at a time to ensure a prompt reply, and please put sketches, layouts, diagrams, etc., on separate sheets containing your name and address. See announcement below. Address Queries—AMATEUR WIRELESS Information Bureau, 58/61 Fetter Lane, London, E.C.4

Faulty Variable Condenser.

Q.—I have built up a simple receiver consisting of a detector and two low-frequency valves, and although I receive the local station, the tuning condenser appears to make no difference to tuning. I have gone over my aerial and earth, and even renewed the aerial wire, and still things are no better. Can you advise me in this matter?—G. B. (London).

A.—The fault appears to be in your tuning condenser. You should test it by arranging a battery and a measuring instrument between the terminal of the condenser and the plates to which the terminal is connected. With either the fixed plates or the moving plates you may detect a disconnection between the plates themselves and the actual terminal to which the plates should be connected.—L. C.

Chattering from Cone Loud-speaker.

Q.—I have constructed the "Best-Yet" cone loud-speaker, and find that when dealing with heavy passages of music the speaker is inclined to chatter. I might mention that I am using a heavy material for the cone instead of that you specify and wonder if this has anything to do with the trouble.—F. D. (Hanwell).

A.—The quality of the material for the cone

diaphragm has much to do with the reproduction from the speaker, and it is quite possible that the material you have used is the cause of your trouble. You do not say whether you

When Asking Technical Queries

PLEASE write briefly and to the point

A Fee of One Shilling (postal order for preference) must accompany each question and also a stamped, addressed envelope and the coupon which will be found on the last page.

Rough sketches and circuit diagrams can be provided, but it will be necessary to charge a special fee (which will be quoted upon request) for detail layouts and designs.

have used the unit we specify, but if you have used any other, the chattering may be caused by the reed inside the unit. The material with

which the diaphragm is suspended has also a decided effect on reproduction.—C. B.

Screen-grid Valve Set.

Q.—I have constructed a screen-grid valve receiver to fit into a special cabinet which I wished to make use of, and now I find that it is almost impossible to prevent the set from oscillating. Are there any special features that must be given more consideration than is normally required when designing a screen-grid valve set, or, providing that screening is sound, is there anything that may account for this trouble?—D. K. (Middlesbrough).

A.—There are certain very important points that must be given special consideration in the design of a set such as yours, and the screening of the H.F. stages is not the most important. If there are any two wires parallel that belong to different H.F. circuits, then these will cause sufficient interaction to make the receiver oscillate. We suggest you go over the wiring of your set with the above points in mind and, above all, see that your screening is sound between the various circuits. An incomplete screen may account for considerable trouble. Do not allow the aerial lead-in wire to run anywhere near the H.F. circuits or tuning coils.—A. L.

Invaluable Guides to the Amateur

Amateur Wireless HANDBOOKS

2/6 EACH
NET

- The Shielded Four-electrode Valve.
- Loud-speaker Crystal Sets.
- Wireless-controlled Mechanism for Amateurs.
- The Wireless Man's Workshop.
- The Practical "Super-het" Book.
- Perfect Broadcast Reception.
- The Short-wave Handbook.
- The Practical Wireless Data Book.

1/6 EACH
NET

- Wireless Telephony Explained.
- Crystal Receiving Sets and How to Make Them.
- Wireless Component Parts and How to Make Them.
- Wireless Telegraphy and Telephony and How to Make the Apparatus.
- Practical Guide to Wireless (1/-).



Published by Cassell's





PRICE £1 : 0 : 0

BURNDEPT

ELECTRIC SOUNDBOX

ADAPTER: For plugging-in to any receiver. With 9 ft. twin flexible wire.

4/-

Publication No. 127 gives Complete Instructions and Circuit Diagrams, together with practical advice on how to get the best out of Gramophone Records—it is sent out with each Soundbox.

GRAMOPHONE VOLUME CONTROL With 2 ft. twin flexible wire for connecting to Soundbox. 8/6

Offices : Blackheath, LONDON, S.E.3

London Showrooms: 15 Bedford Street, Strand, W.C.2

THERE ARE UNHEARD BEAUTIES IN YOUR GRAMOPHONE RECORDS!

PERHAPS you possess a really fine gramophone, and no doubt many of the latest electrical process records. Maybe you think it impossible to improve upon the fine reproduction of these wonderful records . . . but just play them with the **BURNDEPT Electric Soundbox!** You'll be delightfully astonished by the *previously unheard beauties* of your records—rich, full harmonies, chords, and the highest and lowest notes of the musical scale. You'll be convinced that the new BURNDEPT device *does* improve your gramophone reproduction! You merely fit the BURNDEPT Electric Soundbox in place of the ordinary one, and connect to your wireless set—that's all. There is no surface noise with this device, and the tonal purity is unequalled—even by three times more costly attachments.

An unexpected tribute: *The Radio Corporation of Zurich use the BURNDEPT Electric Soundbox to broadcast gramophone records. This is specially interesting, as the Soundbox is practically a new-comer among record-reproducing devices!*

STANDS 112-113



A.I.W.

WHILE GOOD RECEIVERS ARE DESIGNED, SO THE W.B. ANTI-PHONIC HOLDER WILL BE SPECIFIED

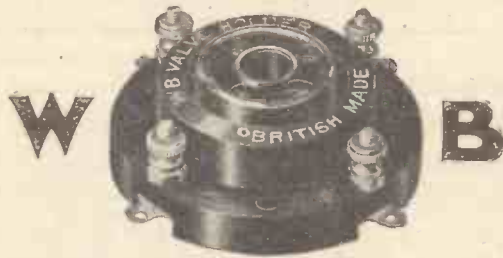

Prices: 1/9 with terminals
1/6 without terminals

Ask your dealer or write to us about the famous Whiteley-Boneham range of Loud-speakers, 47/6 to 84/-.

Stand No. 120 at Olympia

WHITELEY BONEHAM & CO., LTD.
Nottingham Road, Mansfield, Notts.

PRICES REDUCED

Splendid models now within the reach of all

That fine "De Luxe" model or "Standard" model which, after hearing, you have always longed to possess, is now obtainable at an undreamt of price—buy now and enhance your evenings with better and more enjoyable reception.

The 'De Luxe' model

50/-

The 'Standard' model

40/-

Get one on the way home and surprise the wife—they all love a real bargain.



'Phone Wimbleton 4658

Orphean
LOUD SPEAKERS

are the best possible value on the market to-day for their really fine artistic finish and the purity and volume of their tonal quality. All who hear them are amazed at their low price and high performance. Prices: "De Luxe" model, 50/-; "Standard" model, 40/-; "Gem" model, 30/-.

Your local dealer will demonstrate.

LONDON RADIO MFG. CO., LTD.

Head Office and Works:

Station Road, Merton Abbey, London, S.W.13

Come and see these models and the **ORPHEAN 3-VALVE PORTABLE** at **OLYMPIA**. Stands Nos. 209 & 210 (Gallery).

18-17.

Advertisers Appreciate Mention of "A.W." with Your Order

"THE ELECTRIC EYE IN TELEVISION" (Continued from page 262)

Aid to Television ?

Such a combination seems to offer a promising means of solving the problem of television—at least, so far as the modulation of the outgoing wave is concerned.

Another development in light-sensitive valves is due to V. K. Zworykin, and is illustrated diagrammatically by Fig. 3. In this instance the combination is adapted for the reception of incoming signals.

An Ingenious Device

The lower part of the device consists of a dull-emitter filament F, capable of emitting a stream of electrons at a temperature below red heat, together with an ordinary control grid G and plate P. One side of the upper surface of the glass bulb is coated with a photo-electric amalgam S metallically connected to the grid G as shown. Mounted on top of the plate is a wire loop which functions as an electron collector.

A grid resistance R of high value is connected in series with a heavy biasing battery of 30 to 40 volts between the grid and filament. The grid and plate potentials are initially so arranged that the highly negative grid prevents any electrons from reaching the plate, i.e., no current will normally flow through the indicator in the external plate circuit.

The impact of a light ray upon the sensitive coating S will, however, cause the latter to emit a stream of electrons, which are collected by the positively charged plate. The loss of electrons naturally leads to a rise in the voltage of the sensitive coating, and therefore of the control grid to which it is attached. The original state of balance is consequently upset, and the indicating device K receives a current the strength of which will depend upon the intensity of the incident light.

By suitably adjusting the initial setting of the grid and plate potentials, the light-sensitive valve can also be arranged so that no current will flow in the external plate circuit so long as the sensitive coating is

being exposed to light of a certain intensity. Should, however, the illumination fall below this prearranged intensity, the balance is at once upset and the relay is operated.

Such a device, situated, for instance, at the entrance to a harbour, could be used to give an automatic indication of the approach of fog by firing off a gun or actuating some other kind of alarm signal as soon as the gathering fog reaches a certain density. Or it could be employed to bring into operation a wireless directional beacon so as to assist mariners in

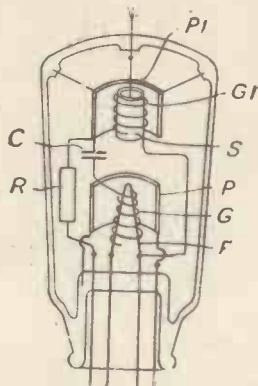

Fig. 4. A Two-stage amplifier with a photo-electric cathode

ascertaining their bearings relatively to the harbour.

Another Use

Again, it could be used to indicate when the smoke from a factory chimney falls below the standard of cleanliness insisted upon by the local authorities before it can be discharged into the open atmosphere.

For instance, a ray of light from an electric lamp mounted on the inside wall of the chimney is focused upon a light-sensitive valve mounted in the opposite wall, the beam passing across the internal diameter of the shaft.

If, for any reason, such as negligent stoking, the smoke becomes unduly foul

it will, in its upward passage, dim the light-ray, and so energise the sensitive valve and cause it to sound an alarm bell or otherwise attract the attention of the engineer in charge.

The Loewe-type Valve

One of the latest additions to the family of light-sensitive valves is shown in Fig. 4. It is of the well-known Loewe type, in which several stages of amplification are mounted in the same bulb, each stage being coupled together by compact high-resistance elements also housed inside the bulb.

In this particular instance the two amplifying units, each comprising a cathode, grid, and plate, are mounted vertically one above the other. The lower set of electrodes consists of a heated filament F, a spiral grid G, and a vertical cylindrical plate P. This complete amplifying stage is coupled through a resistance R and capacity C to the second or upper set of electrodes S, G I, P I.

In the upper group the place of the usual heated filament is taken by a photo-electric cathode consisting of a small cylinder S coated with aluminium sulphite, potassium hydride, or rubidium. This sensitive coating emits a stream of electrons under the influence of the combined light and heat energy radiated from the lower filament F. The liberated electrons are then controlled in their passage to the plate P I by the voltage variations transferred from the first set of electrodes to the second grid G I.

Although this valve has not yet been placed on the market, it affords an interesting indication of what is likely to be done in the near future in the way of reducing the filament current required to run a multi-valve set.

A special Irish programme, entitled *Begorra! It's Irish*, will be heard by listeners to Aberdeen on September 20.



BULGIN
RADIO PRODUCTS



The choice of cities.

THE LATEST IN LOGS!



Price 2/6 each

A. F. BULGIN & CO., Radio Manufacturers
9, 10, 11 Currier Street, Chancery Lane, E.C.4 Telephone: Holborn 2072

CAN be pulled out to remain at the required station and springs back on a touch of the release. The log sheet is printed with particulars of the best-known stations in Europe with spaces for their dial settings. Saves time, trouble and temper, and ensures really accurate tuning. When at Olympia make a point of visiting our Stands Nos. 203-204, where you will see the full range of Bulgin products.



FORMO
ARTHUR PREHN & CO.

FROM HIGH TO LOW WAVE WITHOUT CHANGE OF COIL.

A very neat and efficient Aerial Coupler with six pins in standard position, thus can be used with any standard six-pin base. The change over from High to Low is effected by means of a push-pull switch on panel. Send for Full Catalogue and Booklet

L.F. AMPLIFICATION
Post Free.

NEW (Six-Pin) TWO RANGE TUNER

(Reinartz)
Price **10/6**

Six-pin Base, **2/-**



ELECTRIC REACTION

CROWN WORKS, CRICKLEWOOD LANE, N.W.2
Phone: Hamstead 1737



LOW LOSS FORMER **GOLD MEDAL and FOUR FIRST PRIZES.**

THE FAMOUS ORIGINAL BECOL LOW LOSS FORMER. LOOK FOR TRADE MARK AND REFUSE IMITATIONS

Made in sizes 1 in. up to 4 in. outside diameters

THE LATEST. PINLESS FORMER **BECOL** Registered Trade Mark.

Can be fixed in the dark **FOOLPROOF**

Send for copy of Becol Handbook on Wireless Circuits, General data, and illustrations of coil windings **PRICE 4d. post free**

Standard Ebonite Panels, ground to size, guaranteed, Sheets, Fods, Tubes, Mouldings. Delivery from Stock

Sole Makers:
THE BRITISH EBONITE COMPANY, LTD.
HANWELL, LONDON, W.7.



THIS IS THE UNIT
—the P.G.3 Double-acting Reed Unit—
that everyone is talking about to-day. Probably no other wireless component ever marketed has been so instrumental in selling itself as the P.G.3. In scores of cases we have been able to trace as many as a dozen sales to one P.G.3 Unit.

It is really a wonderful movement, four-pole, adjustable, ultra sensitive, yet handles huge volume, and gives remarkably pure and undistorted reproduction.

Price 27/6, complete in bronze case, with cone bush, 6-ft. leads and fixing screws.

INSIST ON THE GOODMAN P.G.3.
New Process Cone Paper, 2/-
Send for Illustrated descriptive Leaflet D.A.

GOODMANS
27 FARRINGTON ST. LONDON, E.C.4
Telephone : City 4472

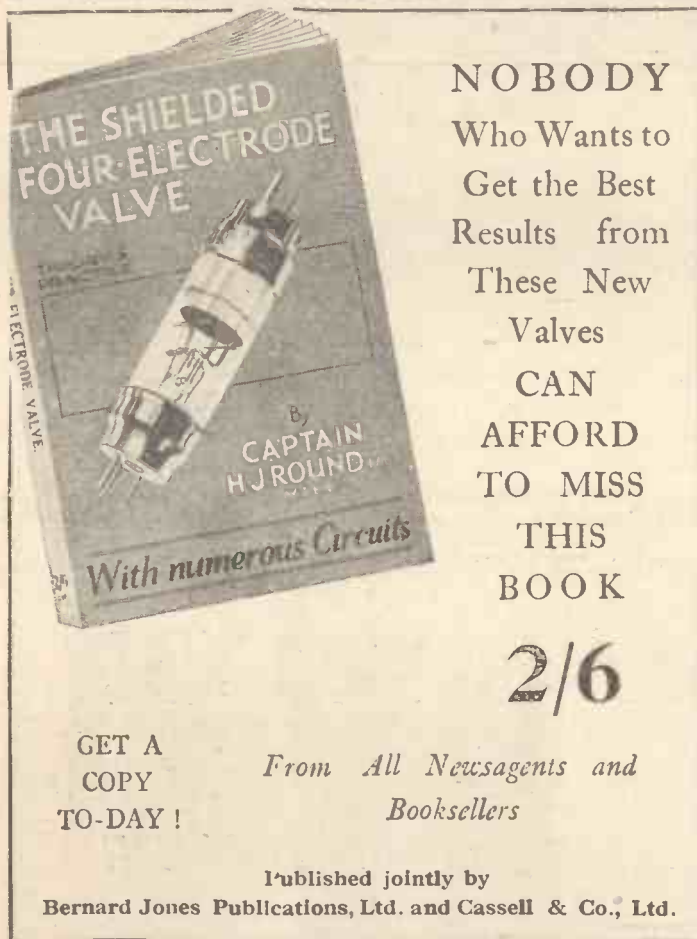

THE SHIELDED FOUR-ELECTRODE VALVE

NOBODY
Who Wants to
Get the Best
Results from
These New
Valves
CAN AFFORD TO MISS THIS BOOK

2/6

GET A COPY TO-DAY! *From All Newsagents and Booksellers*

Published jointly by
Bernard Jones Publications, Ltd. and Cassell & Co., Ltd.

TO EVERYONE who, between Sept. 1st & 22nd inclusive, buys a **RIPAULTS SELF-REGENERATIVE H.T. DRY BATTERY** (The Battery that gives 50% Longer Life) we will send Free, and Post Free, a **RIPAULTS 9-volt GRID BIAS BATTERY**

FREE

To the sender of the first coupon opened in our mail each morning from September 3rd to 24th inclusive we will also present Free, and Post Free, a **RIPAULTS 99-VOLT STANDARD SELF-REGENERATIVE H.T. DRY BATTERY.**

We know that our Batteries are the most efficient ever made and we want you also to prove to your own satisfaction that they not only give 50% Longer Life, but enormously increase the quality of the reception of your receiver.

HOW TO SECURE YOUR BATTERY.
Buy one of the "Ripaults" Batteries listed below, fill in the Coupon and post it together with your Dealer's receipt, to reach us not later than first post Monday, September 24th, 1923.

STANDARD CAPACITY (Chocolate Label)	60-volt. 10/6	90-volt. 16/6
DOUBLE CAPACITY (Blue Label)	45-volt. 11/6	90-volt. 22/6
TREBLE CAPACITY (Orange Label)	45-volt. 15/-	90-volt. 29/6
QUADRUPLE CAPACITY (Black Label)	45-volt. 18/6	90-volt. 36/6

FILL IN THIS COUPON. I hereby certify that I purchased on the date shown the "Ripaults" Self-Regenerative H.T. Dry Battery as covered by the enclosed receipt from my Local Dealer.

NAME.....
ADDRESS.....
Write in BLOCK letters and POST to:—
RIPAULTS LTD., 1 Kings Road, London, N.W.1.

RIPAULTS SELF-REGENERATIVE H.T. DRY BATTERIES

The TWO-DAVENTRY TWO



DESIGNED to give the choice of either of the two Daventry programmes, without changing coils. Comprises Detector with Reaction and One Stage of Transformer-coupled L.F. Amplification. Fully described in the **WIRELESS MAGAZINE**.

Other contents of
"WIRELESS MAGAZINE"
include:

An entirely new type of loud-speaker, with a linen diaphragm—**THE ALADDIN THREE**: A special receiver for any type of screened-grid valve.—**THE FRAME-AERIAL FOUR**: Entirely self-contained receiver using a screened-grid high-frequency valve.—**THE POLE-TO-POLE SHORT-WAVER**: Successful reception of long-distance stations is assured with this new three-valver.—**HOW TO RUN YOUR SET FROM THE LIGHTING MAINS**: By J. H. Reyner, B.Sc., A.M.I.E.E.—**THE INVENTOR'S**

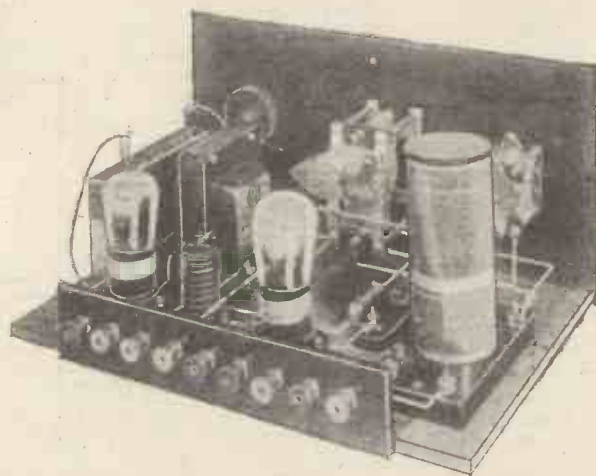

STORY OF THE NEUTRODYNE: Exclusive article by L. A. Hazeltine.—**BROADCASTING STILL AND MOVING PICTURES**. **GRAMO-RADIO SECTION**—Reducing Your Record Wear, Etc. Etc.

Full-size Blueprints of all sets described in this issue, available at half-price.

WIRELESS MAGAZINE

for September, 1/-

Get your Copy from any Newsagent or Bookstall

LETTERS TO THE EDITOR

The Editor does not necessarily agree with the views expressed by correspondents.

5SW in Burma

SIR,—It might interest you to know that I am receiving excellent results from the 6-valve super-het. short-waver (Jan. 7 issue). Amongst the many stations received, 5SW and PCJJ are undoubtedly the best. Both of these are received at good loud-speaker strength. I am not exaggerating when I say that 5SW is just as good as the broadcasting I used to receive from my local station at home. The total absence of background is remarkable. Even in a thunderstorm the interruptions are practically unnoticeable on 24 metres.

I use a 100-ft. aerial, with counterpoise 8 feet from the ground. The long aerial is found to give better results than the short, which I used at first.

I may add that this is the third set I have constructed in the effort to obtain good reception from home.

—J. O. G. (Upper Burma).

Still a Favourite

SIR,—Having constructed "Britain's Favourite Two," after London and 5GB closed down, I tried its pulling powers for Continental stations, expecting to get four or five at fair strength.

I was, however, agreeably surprised to log no less than twenty-three stations in thirty-four minutes. All except one were perfectly clear and at good strength.

Many would have been audible on the speaker. It is undoubtedly the ideal set for beginners.

—C. (London, N.).

Lightning and an Aerial

SIR,—I have two aerials, at right angles to each other, one is connected to the set, while the end of the other is hanging disconnected in front of the window (inside).

This morning (August 28) at 12 o'clock, we had a thunderstorm with heavy rain, when three distinct discharges took place from the end of the loose aerial; there was

a good seven seconds between a discharge and the thunderclap, the former being about what one would expect from a 60-volt H.T. accumulator battery (i.e., by sight and sound). The curious thing is that it did not seem to jump to anywhere unless to the window pane, which was three inches from it, and in a direct line from where I was sitting, and might have been damp. After it was all over I switched on the set, which was found to be O.K.

—C. C. B. C. (Spaxton).

The Best Crystal Set

SIR,—A few weeks ago I built your "Best Yet" Crystal Set out of old wireless junk, mostly home-made components. My brother being very deaf, has never heard anything on a crystal; this one, however, he did hear—in fact, connected to a 42-ft. aerial I was able to work a small loud-speaker. It certainly is the "Best Yet."

—R. A. M. (London, W.).

L.T. Supply

SIR,—A crying need to-day is an efficient substitute for that primitive abomination the L.T. accumulator. It is not necessary to explain why—words could not do it. Is there any hope, or must we go on suffering? There must be many thousands of country people debarred from wireless because of this difficulty. Where are the inventors?

—E. K. (London, W.).

"Amateur Wireless and Electrics." Price Threepence. Published on Thursdays and bearing the date of Saturday immediately following. Post free to any part of the world: 3 months, 4s. 6d.; 6 months, 8s. 9d.; 12 months, 17s. 6d. Postal Orders, Post Office Orders, or Cheques should be made payable to "Bernard Jones Publications, Ltd."

General Correspondence is to be brief and written on one side of the paper only. All sketches and drawings to be on separate sheets. Contributions are always welcome, will be promptly considered, and if used will be paid for. Queries should be addressed to the Information Bureau and the conditions printed at the head of "Our Information Bureau" closely observed.

Communications should be addressed, according to their nature, to The Editor, The Advertisement Manager, or The Publisher, "Amateur Wireless," 58-61 Fetter Lane, London, E.C.4.

Finished in black or beautifully grained mahogany

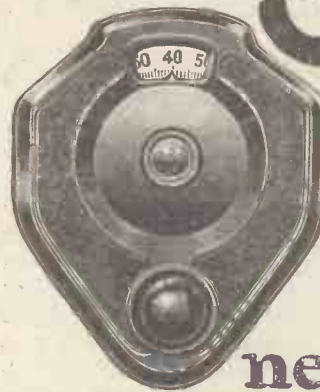

neat-accurate and inexpensive

Watch for Brownie's latest triumph in artistic moulded components — the "Dominion" Vernier Dial. Special non-back-lash slow motion drive gives very accurate turning, while the action will fit any condenser, and the new design of the dial will enhance the appearance of every set. Do not fail to see this attractive new Brownie production at the Radio Exhibition.

BROWNIE WIRELESS
"DOMINION" VERNIER DIAL

THE BROWNIE WIRELESS Co., (G.B.) LTD.
MORNINGTON CRESCENT, LONDON, N.W.1

HYDRA
Serves you well

There must be something unusual in this condenser to win and hold the confidence of the most important Eliminator manufacturers, not only in Britain, but the world over

CAPACITIES
2 MF. 3/6
1 MF. 2/6
.1 MF. 1/9
0.1 MF. 1/9
Tested at 500 volts



Obtainable from your Dealer, or
LOUIS HOLZMAN,
34 Kingsway, London, W.C.2
Telephone: Holborn 6209

Keystone

COMPONENTS
MEAN
CARE-FREE RADIO



KEYSTONE MIDGET REACTION CONDENSER
Price .0001, 5/-



SIX-PIN BASE, Price 1/9



KEYSTONE PUSH-PULL SWITCH
Price, 1/3 (A) 5733

PETO-SCOTT Co. Ltd.
77 CITY RD., LONDON, E.C.1

RELAY STATION WAVELENGTHS

—A COMING CHANGE

A CHANGE is to be made in relay station wavelengths. During November and December, ten of these stations will take over the national exclusive frequency of 1,040 kilocycles (288.5 metres), replacing the international common frequencies which they have been sharing with stations abroad. The change will be a gradual one, each station changing its frequency as soon as the necessary additional plant is installed. The few programme changes involved will take effect on November 1.

The reason for the change is that heterodyne interference has become so serious on the international common frequencies, that the service areas of relay stations have shrunk to one-half to two miles radius during the hours of darkness.

Pending the introduction of the Regional Scheme, rather than withdraw the relay stations, an attempt will be made to revive their usefulness by the expedient of single wavelength working. It is expected that this will considerably improve conditions of reception, particularly in the thickly populated areas of Liverpool, Stoke-on-Trent, Bradford, Hull, Sheffield, Swansea, Plymouth, and Dundee. Leeds being in

such close proximity to Bradford, and already working under conditions moderately free from interference, will continue on its present frequency of 1,080 kilocycles (277.8 metres).

The exclusive frequency of Bournemouth—920 kilocycles (326.1 metres) will be transferred to Aberdeen. The reason for this is the importance of enabling Aberdeen to serve a much wider area than is possible on a common frequency—national or international. The transmitter at Bournemouth will continue its service on the national frequency of 1,040 kilocycles (288.5 metres). It is expected that this arrangement will provide adequate service for Bournemouth itself, while the surrounding district will normally get its programmes from Daventry 5XX.

The changes will entail in some cases, a reduction of the proportion of local programme material. During the main evening period of transmission, all ten relay stations will be bound to radiate the same programme. Experience proves that after nightfall, stations on the same frequency, even a considerable distance apart, radiating different programmes seriously inter-

fere with each other's service. This disadvantage is partly offset by the probability that in the daytime, when interference is less acute, "group" transmissions will be satisfactory. "Group" programmes are programmes originating within the region concerned. While "Group" programmes will be composed mainly of material from the regional centres—Manchester, Glasgow, and Cardiff—it is hoped to retain and incorporate the best and most characteristic items of established local features such as the Children's Hour.

Nottingham will take its place beside Birmingham, in the service area of 5XX and 5GB. The transmitter at Nottingham will give way to the more efficient and uninterrupted transmitters at Daventry.

These arrangements are necessarily experimental, designed to supplement the serviceduring the interim period which must elapse before the new regional system of high-power stations is fully inaugurated.

The Board of the B.B.C. states that it feels that the substantial benefits to be derived from these changes will more than offset the temporary inconvenience caused in the adjustment of receiving apparatus.

BLUEPRINTS

Full-size blueprints are available of the following sets. Copies of the "Wireless Magazine" and of "Amateur Wireless" containing descriptions of all these sets can be obtained at 1s. 3d. and 4d. respectively post free.

CRYSTAL SETS. 6d. each, post free.

"Best-yet" Set	AW114
Two-programme Set	WM25
Centre-tap Set	WM50

ONE-VALVE SETS. 1s. each, post free.

Loud-speaker Special	AW 78
Fan's Short-wave One	AW119
Super Reinartz One	AW127
Screened-grid HF One	AW129
Long-range Hartley	WM54
Reflexed One for the Loud-speaker	WM66

TWO-VALVE SETS. 1s. each, post free.

General-purpose 2 (D, Trans)	AW 55
Britain's Favourite (D, Trans) (Price 4d., with copy of "A.W.")	AW 74
Home-and-Abroad 2 (D, Trans)	AW 77
Ultra-selective Hartley (D, Trans)	AW 90
Oceanic Short-wave (D, Trans)	AW 91
Trapped Reinartz (D, Trans)	AW 92
"Q" 2 (D, Trans)	AW 99
Long Distance Two (HF, D)	AW110
Three-waveband Two (D, Trans)	AW112
DX Headphone Two (HF, Det.)	AW134
Girdle Two (Price 1s. 3d., with copy of "W.M.")	WM30
Mains-fed 2 (D, LF)	WM37
British Broadcast 2 (D, Trans)	WM44
Two-programme 2 (D, Trans)	WM56
Q-coil 2 (D, Trans)	WM62
Crusader (D, Trans)	WM69
Flat-dweller's 2 (HF, D)	WM76
Two Daventry Two (D, Trans)	WM97

THREE-VALVE SETS. 1s. each, post free.

Modern Tuned-anode (HF, D, Trans)	AW 35
All-from-the-Mains (D, 2LF)	AW 41
Economy 3 (D, 2RC)	AW 48
Short-wave (D, RC, Trans)	AW 50
Ether-searcher (D, RC, Trans)	AW 52
Britain's Favourite (D, RC, Trans) (Price 4d., with copy of "A.W.")	AW 72
Broadcast 3 (D, RC, Trans)	AW 76
Q-coil 3 (D, RC, Trans)	AW 84

Clarion 3 (D, 2 Trans)	AW 88
Miniature Hartley Three (D, 2RC)	AW101
Three-valve Mains receiver (HF, D, Trans)	AW109
Summer-time DX Three (HF, D, Trans)	AW106
British Station Three (HF, D, Trans)	AW122
Optional Two-three (D, 2LF)	AW124
"Simpler Wireless" Mains Three (D, 2 LF)	AW126
Simplicity Screen-grid Three (HF, D, Trans)	AW132
"Proms" Three (D, 2RC)	AW137
Continental (HF, D, RC)	WM 7
Screened-grid (HF, D, RC)	WM21
Five-guinea 3 (HF, D, Trans)	WM29
Dominions Short-waver (D, 2 Trans)	WM30
Screened-grid Short-waver (HF, D, Trans)	WM51
Metropolitan (D, 2LF)	WM48
Everyday (D, 2 Trans)	WM52
Music Changer (D, RC, Trans)	WM60
Britannia (D, RC, Trans)	WM67
Home and Garden 3 (D, 2RC)	WM78
Pole-to-Pole Shortwaver (D, RC, Trans)	WM89
Glee-singer Three (D, 2RC)	WM92
Aladdin Three (HF, D, LF)	WM95

FOUR-VALVE SETS. 1s. 6d. each, post free.

Tuned-anode 3-4 (HF, D, 2 Trans)	AW 49
Near and Far Three-four (HF, D, RC, Trans)	AW113
"Pick-up" Three-four (D, 2 Dual Imp.)	AW118
Explorer Four (HF, D, RC, Trans)	AW120
Summertime Searcher (2HF, D, Trans)	AW128
Overseas Shortwaver (HF, D, 2 Trans)	AW133
Revelation (HF, D, RC, Trans)	WM29
Simplicity (HF, D, 2 Trans)	WM40
Station-finder (HF, D, 2RC)	WM68
Gramo-Radio 4 (D, RC, 2 Trans Push-pulled)	WM70
Q-coil 4 (HF, D, Trans, RC)	WM71
Screened-grid 4 (HF, D, 2RC)	WM77
Frame Aerial 4 (HF, D, 2RC)	WM85
All-from-the-Mains Four (HF, D, 2LF)	WM86
Five-pounder Four (HF, D, RC, Trans)	WM91

FIVE-VALVE SETS. 1s. 6d. each, post free.

Exhibition 5 (2HF, D, RC, Trans)	WM33
Phoenix (2HF, D, 2LF)	WM42
1928 Five (2HF, D, 2 Trans)	WM46
All-the-world 5 (2HF, D, 2RC)	WM63
Cataract 5 (HF, D, RC, Push-pull)	WM79

SIX-VALVE SETS. 1s. 6d. each, post free.

Short-wave Super-6 (Super-het, Trans)	AW 67
Adaptor for above (See Misc. List)	AW67A
Nomad (2HF, D, RC, Push-Pull Trans)	WM11
Connoisseur's Six (2HF, D, RC, Push-pull)	WM88

PORTABLE SETS.

Easter 7 (Super-het, RC, Trans)	AW 89	1/6
Companion 5 (2HF, D, RC, Trans)	AW100	1/6
Daventry Loud-speaker Portable (2 HF, D, RC, Trans)	AW107	1/6
Town and Country (HF, D, RC, Trans)	AW111	1/6
House and Garden (screened-grid HF, D, RC, Trans)	AW116	1/6
Hand Portable (D)	AW125	1/-
"Best yet" Portable (Sc. Grid, D, 2 Trans)	AW136	1/6
Sunshine 5 (2HF, D, 2 Trans)	WM74	1/6
Chummy 4 (HF, D, RC, Trans)	WM80	1/6
Sidcar (2HF, D, RC, Trans)	WM83	1/6
Pilgrim Portable (D, Trans)	WM94	1/-

AMPLIFIERS. 1s. each, post free.

Screened-grid HF Unit	AW 75
One-valve LF Unit	AW 79
Add-on HF Unit	AW 82
Super-power Push-pull	AW 86
Hook-on Short-waver (Amplifier)	AW104
Purity Amplifier (2 v.)	AW108
Add-on Distance-getter	AW117
Add-on Three	AW121
Screened-grid HF Amplifier	AW138
Range Extender (HF Unit)	WM38
True-tone Amplifier (3 valves)	WM47
Gramo-radio Amplifier (2 v.)	WM72

MISCELLANEOUS. 1s. each, post free.

Rectifier for "Simpler Wireless" Sets	AW 62
Adaptor for Short-wave Super-6 (61.)	AW67A
H.T. from A.C. Mains	AW 73
"AW" Moving-coil Loud-speaker	AW 97
H.T. Eliminator for A.C. (200 v. output)	AW102
Moving-coil Output Unit	AW115
L.T. and H.T. Mains Unit (DC)	AW123
Anti-motorboating Unit	AW130
Knife-edge Wavetrap (6d.)	AW131
All-metal Eliminator for H.T.	AW135
A.C. Battery Eliminator	WM41
Cone Loud-speaker	WM55
Moving-coil Loud-speaker	WM58
D.C. Battery Eliminator	WM59
Wavetrap	WM64
Universal Short-wave Adaptor	WM82
Linen Loud-speaker	WM92

Send, preferably, a Postal Order (stamps over sixpence in value unacceptable) to
BLUEPRINT SERVICE

AMATEUR WIRELESS
 58-61 FETTER LANE, LONDON, E.C.4

BROADCAST TELEPHONY

(Broadcasting stations classified by country and in order of wavelengths).

Metres	Kilo-cycles	Station and Call Sign	Power Kw.	Metres	Kilo-cycles	Station and Call Sign	Power Kw.	Metres	Kilo-cycles	Station and Call Sign	Power Kw.
GREAT BRITAIN											
24.1	2,500	Chelmsford (5SW)	20.0	268	1,728	Strasbourg	0.5	IRISH FREE STATE			
52.1	1,100	*Bradford (2LS)	0.2	273	1,098	Limoges (PTT)	0.5	310.1	940	Dublin (2RN)	1.5
53	1,099	*Sheffield (6FL)	0.2	286	1,048	Bordeaux	0.5	401	748	Cork (5CK)	1.5
57.0	1,080	*Nottingham (5NG)	0.2	291	1,030	Radio Lyon	1.5	ITALY			
57.7	1,080	*Leeds (2LS)	0.2	327.4	945	Marseilles	0.5	315.8	946	Turin (testing)	0.5
288.2	1,041	*Edinburgh (2EH)	0.2	340.9	880	Le Petit Parisien, Paris	0.5	333.4	900	Naples (Napoli)	1.5
294.1	1,020	*Stoke-on-Trent (5ST)	0.2	353	850	Algiers (PTT)	2.0	400	750	Bolzano	0.2
294.1	1,020	*Swansea (5SX)	0.2	370	811	Radio LL, Paris	1.0	449	668	Rome (Roma)	3.0
294.1	1,020	*Dundee (2DE)	0.2	389.6	770	Toulouse (Radio)	5.0	566	549	Milan	7.0
294.1	1,020	*Hull (6KH)	0.2	416	721	Grenoble (PTT)	1.5	3.8	971	Zagreb (Agram)	1.25
297	1,010	*Liverpool (6LV)	0.2	415	721	Rabat (Radio Maroc)	2.0	460	952	Belgrade	2.5
306.1	980	Belfast (2BE)	1.5	435	690	Lille (Radio Flandres)	0.25	JUGO-SLAVIA			
312.5	960	Newcastle (5NO)	1.5	445.7	673	Paris (Ecole Sup., PTT)	0.7	2,000	150	Kovno	15.0
326.1	920	*Bournemouth (6BM)	1.5	476.9	629	Lyons (PTT)	1.0	LITHUANIA			
353	850	Cardiff (5WA)	1.5	1,765	170	Radio Paris	8.0	LUXEMBURG			
361.4	830	London (2LO)	3.0	1,850	162	Radio Carthage (Tunis)	2	217.4	1,380	Luxemburg	0.25
384.6	780	Manchester (2ZY)	1.0	2,650	123	Eiffel Tower (L.L)	8.0	NORWAY			
400	750	*Plymouth (5PY)	0.2	GERMANY							
405.1	740	Glasgow (5SC)	1.2	14.84	20,270	Nauen (AGAI)	20.0	570.4	810	Bergen	1.0
491.8	610	Daventry EX (5GB)	24.0	37.65	7,968	Stettin	0.75	411	728	Notodden	0.7
500	600	Aberdeen (2BD)	1.5	41.45	—	Doberitz (AFK)	5.0	435.4	680	Fredrikstad	1.0
1,604	187	**Daventry (5XX)	25.0	67.65	4,434	Bergedorf (AFL)	3.0	448	670	Rjukan	1.0
*Relay stations. **Relays 2L.O.											
AUSTRIA											
253.8	1,182	Liuz	0.5	51	5,882	Hanover	0.7	461.5	650	Oslo	1.5
272.7	1,100	Klagenfurt	1.5	51.5	5,882	Koenigsberg	4.0	500	610	Lorsgrund	1.0
277.3	1,030	Salzburg (under const.)	0.5	52.5	4,434	Breslau	4.0	490	750	Aalesund	1.0
51.4	1,020	Innsbruck	0.5	52.5	4,434	Gleitwitz	13.0	566	530	Hamar	0.7
51.6	841	Graz	0.5	52.5	4,434	Leipzig	4.0	2,041	—	Bergen	5.0
51.7	800	Vienna	15.0	52.5	4,434	Stuttgart	4.0	POLAND			
57.7	520	Vienna	0.75	52.5	4,434	Hamburg	4.0	270.3	1,110	Lemberg (under construction)	10.0
BELGIUM											
220	1,360	Chatelineau	0.25	52.5	4,434	Aachen	0.75	343	874	Posen (Poznan)	1.5
2.2	1,292	Schaerbeek	0.5	52.5	4,434	Frankfurt-Main	4.0	422	711	Kattowitz	10.0
275	1,090	Ghent	0.5	52.5	4,434	Zeesen	25.0	426.7	703	Wilno	1.5
1,008.5	590	Brussels	1.5	52.5	4,434	Norddeich	10.0	567	529	Cracow	1.5
CZECHO-SLOVAKIA											
263.2	1,140	Kosice	2.4	52.5	4,434	Berlin (News)	8.0	1,111	270	Warsaw	10.0
500	1,000	Bratislava	0.5	52.5	4,434	Berlin	8.0	PORTUGAL			
3.9	1,59	Prague (Praha)	5.0	52.5	4,434	Munich	4.0	250	1,200	Oporto	0.5
441.1	1.00	Brunn (Brno)	2.4	52.5	4,434	Augsburg	0.5	379.7	790	Leningrad	1.0
DENMARK											
537.4	189	Copenhagen (Kjobenhavn)	1.5	52.5	4,434	Freiburg	0.75	1,450	809	Moscow (Moskva)	30.0
972	308	Soro	2.5	52.5	4,434	Berlin	8.0	1,703	176	Kharkov	15.0
1,153.8	200	Kalundborg	7.0	52.5	4,434	Berlin	8.0	SPAIN			
ESTHONIA											
408.5	735	Reval (Tallinn)	2.2	52.5	4,434	Berlin	8.0	272.7	1,090	Oviedo (EAJ19)	0.5
FINLAND											
575.4	589	Helsingfors (Helsinki)	1.2	52.5	4,434	Berlin	8.0	277	1,083	Barcelona (EAJ13)	2.0
1,522.8	157	Lahti	25	52.5	4,434	Berlin	8.0	277.8	1,080	Cartagena	1.0
FRANCE											
49.2	7,463	Lyon (PTT)	10.0	52.5	4,434	Berlin	8.0	324.3	925	Almeria (EAJ18)	1.0
45	6,666	Agen	0.25	52.5	4,434	Berlin	8.0	335	895	Sal Sebastian (EAJ8)	0.5
61.5	4,878	Radio LL (Paris)	1.0	52.5	4,434	Berlin	8.0	345.2	169	Barcelona (EAJ1)	3.5
158	1,899	Beziers	1.0	52.5	4,434	Berlin	8.0	375	160	Madrid (EAJ7)	2.0
176	1,700	Tourcoing	0.3	52.5	4,434	Berlin	8.0	400	750	Cadiz (EAJ3)	0.5
210	1,428	Chambery	0.5	52.5	4,434	Berlin	8.0	422.6	745	Salamanca (EAJ22)	0.55
228.4	1,313	Biarritz	0.25	52.5	4,434	Berlin	8.0	434.8	600	Seville (EAJ5)	1.0
2.0	1,301	Ste Etienne	0.25	52.5	4,434	Berlin	8.0	422	711	Bilbao (EAJ9)	0.5
538.1	1,200	Bordeaux (Radio Sud-Ouest)	2.5	52.5	4,434	Berlin	8.0	SWEDEN			
239.5	1,253	Nimes	1.0	52.5	4,434	Berlin	8.0	260.0	1,750	Malmö	1.0
145.7	1,221	Toulouse (PTT)	2.0	52.5	4,434	Berlin	8.0	278.8	1,076	Trollhattan	0.4
2.6	1,219	Juan-les-Pins	0.7	52.5	4,434	Berlin	8.0	216.7	947	Falun	0.5
253	1,165	Montpellier	0.5	52.5	4,434	Berlin	8.0	416.7	720	Goteborg	1.0
254.2	1,180	Rennes	0.5	52.5	4,434	Berlin	8.0	454.5	660	Stockholm	1.5
273.3	1,122	Lille (PTT)	0.7	52.5	4,434	Berlin	8.0	545.6	550	Sundsvall	1.0
HUNGARY											
555.5	540	Budapest	15.0	52.5	4,434	Berlin	8.0	720	416	Ostersund	2.0
ICELAND											
333.3	900	Reykjavik	1.0	52.5	4,434	Berlin	8.0	1,190	252	Boden	2.0
NETHERLANDS											
1,181	254	Stamboul	5.0	52.5	4,434	Berlin	8.0	1,380	217	Motala	30.0
1,818	165	Angora	7.0	52.5	4,434	Berlin	8.0	SWITZERLAND			
TURKEY											

K. RAYMOND

27 & 28a, LISLE ST., LONDON, W.C.2
Come to LEICESTER SQUARE TUBE.
This address is at the back of Daly's Theatre. Phone: Gerard 4637 and 2821

C.O.D. Orders despatched same day as received where possible. Send ORDER with instructions and pay Postman.
C.O.D. APPLIES TO UNITED KINGDOM ONLY.

WE ARE OPEN ALL DAY SATURDAY ALL DAY THURSDAY ALL DAY EVERY DAY
Hours 9 a.m. to 8 p.m. Sat. 9 a.m. to 9 p.m. Sunday morning 11-1

Ebonite cut while you wait at 1d. square inch, also 1/4 in. at 1d. Only the best supplied.

EELIX Terminals, Plugs, and Spades Stocked.

We stock Igranio, Gilmac, Ever-Ready, Hellesen, Siemens, Formo, Ferranti, Weartite, Ormond, J.B., Benjamin, Lotus, Mullard, Dubilier, Lissen, Lewcos, Utility, Magnum, Peto-Scott, Peerless, Burndept, Pye, Marconi, McMichael, Cosmos, Garborundum, R.L. Varley, Gambrell, Brown's, Sterling, Amplicons - in fact, everything it is possible to stock.

KITS of parts for all CIRCUITS. Make out LIST for keen quotation. DON'T worry, if it's Wireless WE HAVE IT.

COSSOR VALVES MULLARD VALVES SIX-SIXTY VALVES B.T.H. VALVES EDISWAN VALVES MARCONI VALVES
H.F., L.F., R.C., 10/6. Power 12/6. Super Power, 20/-, 2-v., 4-v., 6-v. Screen-Grid, 22/6.

LISSEN
Valveholders, 1/-; Fixed Con., 1/-; 1/6; Leaks, 1/-; Switches, 4/6; 2/6; Latest 2-way Cam Vernier, 4/6; Rheostats, 2/6; B.B., 1/6; Lissenols, 13/6; L.F. Transformers, 8/6; 100-v. H.T., 12/11; 60-v. H.T., 7/11; Coils, 00X, 6/3; 250X, 9/9; 60-v. H.T., 7/11; 110-v., 12/11; Super 60-v., 13/6; Grid Bias, 7/6; 4.5, 5d.

COSSOR MELODY MAKER

£4:10:0 kit. As COSSOR Specification
Leaffet free. (Wattet Choke included)
2 Ormond .0005, 2 Do. S.M. Dials, 6 T.C.C. Condensers, 2 B.B. Clips, 1 B.B. Rheostat, 3 Dubilier Leaks, 3 Lotus V.H., Ferranti A.F.3, 2 Switches, Cossor Wound Coil, Terminals, Glazite, Grid Bias, Wattet Choke.

FREE WITH PARTS
Drilled High-grade 21 x 7 Polished Panel and Strip, Wood Screws, Carriage 1-1, 20/- Carriage 2-2.

COSSOR VALVES 2, 4, or 6-Volt for above.
D., R.C., or H.F., 10/6 each. Power, 12/6 each.

OFFICIAL H.F. UNIT FOR THE MELODY MAKER.

Lotus D.P.D.T. Jack Switch, 2 on and off switches, Formo .0005 Log, Ormond S.M. Dial, Neutralising (Igranio) sprung V-holder, Magnum wound Coil, 01 mica R.F. Choke, Screen, 8 1/2 x 6, Crocodile Clip, strip and terminals. Send no money. We forward

C.O.D. U.K. post free for 35/-
2nd Selection of above.
Lotus D.P.D.T. Switch, 2 0/0 switches, Raymond .0005, S.M. Dial, Neutralising Condenser, Valve-holder, Strip, Terminals, Magnum wound Coil, T.C.C. 01 mica R.F. Choke, Crocodile Clip, Screen 8 1/2 x 6 Sent C.O.D. Post Free **30/-** Cabinet and Drilled Panel, with baseboard, 12/6, Carriage 1/3.

REDUCED PRICES RAYMOND

"DARIO" VALVES (Genuine Radio Micro)
Best in the World.

BIVOLT 2-v. .05, 5/6; Loud Speaker Valve 7/6; R.C. .05 1.8, 5/6; 3.5 .05, 5/6; Loud Speaker Valve, 7/6; 3.5 R.C. .07, 5/6. Post 6d. each.

No. 3 CONDENSERS. .00025, 5/6. .00035, 5/9. .0005, 6/- (With 4-in. Dial). Friction Geared, .0005, 15/- .0003, 14/6. .00025, 13/8. Straight Line Frequency Friction Geared, .0005, 20/- .00035, 19/6. S.L.F. .0005, 12/- .00035, 11/- Log .0005, 13/- .00035, 12/6. .00025, 12/- S.M. Dial, 5/-
All Components Stocked.

FIVE-POUNDER FOUR

(W.M. August, 1928.) SPECIFIED COMPONENTS
Two Raymond Special L.L. Condensers, .0005 (with 4-in. dials) (used in set), at 6/11 each, Bulgin .0001, 5/6. Lissen Pan. Rheo. 2/6, Coil Stand, 1/-, Bulgin Neutralising, 5/- Four Anti-micro. V.H. at 1/3; Six-pin Base, 2/- Lissen .0003 and 2-meg., 2/- Lissen H.F. Choke, 5/6. Do., R.C.C. Unit, 4/-, L.F. Transformer, Igranio, 16/- (or R.L. & Varley, 15/-). Ten Engraved Terminals at 6d. each. Drilled Strip, 1/3. Two Indicators, 4d. Ebonite Panel, 16 x 8, drill ed. 6/- Connecting Wire, Screws, and Baseboard, 2/6.

The above Lot **£3 6s. 6d. U.K.**
SEND NO MONEY. PAY THE POSTMAN C.O.D.
Coils for above, Lewcos 60 C.T., 3/6; 150 C.T., 5/3. Binocular Coils 6-pin S.P.H.F.T. BSP5, 15/- BSP20, 20/- Hand-made American-type Cabinet, 10 x 8 x 9, 12/6. Carriage 1/6. **CABINETS 7/6** If you buy components and 4 coils (Carriage 1/6)

LISTS FOR POSTCARD

CHIEF EVENTS OF THE WEEK

LONDON AND DAVENTRY (5XX)

Sept. 9 Concert from the Kursaal, Ostend.
" 12 A running commentary on the St. Leger.
" 13 Swiss national programme.
" 14 Prom. concert.
" 15 Tommy's Tours. Tommy Handley and Company.

DAVENTRY (5GB)

Sept. 10 *The Two Talismans*, an Eastern comedy by George Calderon.
" 11 *King Lear*.
" 13 Symphony concert from Winter Gardens, Bournemouth.
" 15 Prom. concert.

CARDIFF

Sept. 9 A service in Welsh from Ebenezer Welsh Congregational Church.
" 11 *Romance Unlimited* (Second Edition).
" 13 *Autumn Follies* Concert Party

MANCHESTER

Sept. 10 Bert Feldman's *White Blackbirds*, from Central Pier, Blackpool.
" 11 Prom. concert.

NEWCASTLE

Sept. 10 Prom. concert.
" 11 Municipal Orchestral concert from Whitby.
" 15 *Tommy's Tours*.

GLASGOW

Sept. 13 Scots vaudeville programme.

ABERDEEN

Sept. 13 A programme by the Scottish National Players.

BELFAST

Sept. 13 *The Mystic Trumpeter*, words by Walt Whitman, music by Sir Hamilton Harty.

A new super-heterodyne receiver with only three valves has been designed and patented by Major Edwin H. Armstrong, the famous radio engineer.

“DEVELOPMENT IN VALVE DESIGN” (Continued from page 265)

and results in a materially improved performance. It suffers from the disadvantage, however, that the capacity between anode and grid is somewhat higher. Precautions are taken by completely closing the top of the grid and by extending its base in a flare, as indicated in the diagram; but, nevertheless, the capacity is definitely higher, which tends to make the valve less stable, particularly where more than one stage is adopted.

Conventional Construction

This form of construction enables the valve to be finished in a somewhat more conventional form. The filament and grid connections can be brought down to the customary pins on the valve base and the screen grid can be taken to the anode pin. The anode terminal proper, which must be kept away from the grid terminal as far as possible, can then be taken to a separate terminal at some other suitable part of the valve, and in the type which will appear on the market this autumn the anode is brought out to a small insulated terminal on the top of the valve itself. Thus, a standard valve holder may be used with a flexible connection to the anode terminal. It is desirable, however, to take the same trouble with screening these valves as with the S625 type and to arrange to insert them through holes in the screening in exactly the same way. In fact, this precaution is definitely more desirable than before, because the valve is so much livelier, owing to its higher internal capacity. The development of the single-ended type of valve, as it is called, arises from the consideration of filament emission, and not from any desire to simplify the constructional work.

In this connection some figures showing the actual amplification obtained with a valve of the three-electrode type, a double-ended screen-grid valve, and a single-ended screen-grid valve will be of interest. These figures show the amplification at various wavelengths in a tuned circuit adjusted to give equivalent selectivity in all cases. The

curve indicates that the amplification obtainable with the double-ended type of valve is of the same order as that with a good triode, but with the single-ended type of valve the amplification is definitely superior. Many readers will have noticed that the amplification with a single screen-grid valve of the older type was not strikingly better than with a good valve of the ordinary three-electrode pattern, but it is clear that with the later pattern of single-ended valve this state of affairs will no longer be the case, and our experiments on advance samples of these valves have borne out this theoretical conclusion. Set designs including screen-grid stages, therefore, should be given serious consideration this autumn.

The Pentode

The pentode has already been referred to earlier in this article. This valve is a development of the standard screen-grid valve, an additional grid electrode being introduced in order to overcome the secondary emission effects obtained with the standard tetrode. Unless this is done, the valve cannot handle any appreciable output, and would obviously be of no use for low-frequency work. The additional electrode overcomes this effect, and the result is a valve having an amplification considerably higher than the normal type, yet which will handle the low-frequency output required. The auxiliary electrode is connected internally, so that there are still only four connections, and as we are dealing with low frequencies, there is no necessity for the careful and elaborate screening required with the screen-grid H.F. valve.

The valve is, therefore, connected up in the normal manner, the grid and anode pins being in their usual positions, while the screen-grid is connected to a terminal on the side of the base. This terminal is connected to a suitable point on the high-tension battery to apply the steady positive voltage to the screen, as is the case with the normal tetrode.

There is, therefore, every indication of a very interesting season when the new valves become available for public use. With the improvements in the screen-grid valve itself and the extension of its sphere of operation to low-frequency work, it becomes possible to achieve results with three valves which have hitherto only been possible with five. Against this one must offset the fact that the valves cost nearly twice as much as the ordinary type, but there can be no doubt that considerable interest will be aroused in these developments.

TUNEWELL COILS



as always
RECOMMENDED
in this
JOURNAL

Note Accessibility of Terminal

SIZES AND PRICES			
Standard.	25, 35, 50, 75 each		1/6
"	30, 40, 60, 100 "		1/8
"	125, 150 "		2/3
"	175 for 5XX "		2/6
"	200, 225 "		2/9
"	250 "		3/3
"	300 "		3/9
"	400 "		4/3

Centre tapped 9d. each extra, X type 1/- extra
TURNER & Co., 54 Station Rd., London, N.11

THE ONLY BRITISH VALVE WITH A WRITTEN GUARANTEE AS TO PERFORMANCE AND LIFE.

AMATEUR WIRELESS, 14/3/28, says: "The characteristics of this Valve compare favourably with many well-known makes."

Type	Fil. Volts	Amp.	imp. Ohms.	Amp. Fac.	
PR 1	2	.095	30,000	14	I.F.
PR 2	2	.095	28,000	13	Det.
PR 3	2	.095	15,000	8	L.F.
PR 4	2	.095	120,000	32	R.C.
PR 8	3.5-4	.063	23,000	15	H.F.
PR 9	3.5-4	.063	18,000	14	Det.
PR10	3.5-4	.063	10,000	8.7	L.F.
PR11	3.5-4	.063	38,000	40	R.C.
PR16	5-6	.1	19,000	18	I.F.
PR17	5-6	.1	18,000	17	Det.
PR18	5-6	.1	9,500	9	L.F.
PR19	5-6	.1	80,000	40	R.C.
PR20	2	.15	7,000	6	Power
PR40	2	.15	7,000	6	"
PR60	6	.1	5,000	6	"

WHAT OTHERS SAY of P.R. VALVES

"Unsurpassed for purity of tone and selectivity—the equal of any," is the opinion expressed in hundreds of letters from satisfied users—the originals can be seen at our offices.

Tell us your set—we will send correct Valves. Matched Valves 1/- extra.



7/6 Each Post 4d. P.R. VALVES

NOW ONLY **3/6** C.O.D. Phone: City 3788 Post 4d.

2 Valves for 6/9 Post 4d.
3 Valves for 10/- Post 4d.
4 Valves for 13/- Post 4d.

All orders executed by return of post.

GUARANTEE. All valves despatched Money Back in Full if not satisfied. All valves are carefully packed and breakages replaced.

17/1, Paternoster Square, LONDON, E.C.4.

Player's "Medium" Navy Cut Cigarettes 10 for 6d. 20 for 11½d.



Pleasure realised because—

*Player's
please*



"It's the Tobacco that Counts"

N.C. 0515

TRIX Certified FIXED CONDENSERS

have been tested by Faraday House Laboratories and are fully guaranteed for capacity, insulation, and voltage tests. Capacity is clearly engraved on the case as shown. TRIX Fixed Condensers possess real ruby mica insulation and copper foil built into Trixite moulded cases. Complete with terminals and soldering tags. Retail prices from 1/- each. ERIC J. LEVER (TRIX) LTD., 8/9, Clerkenwell Green, E.C.1. Phone: Clerkenwell 3014/5.

From **1/- each**



0005 MF.

Full details on request

PERTINAX PANELS

SUPER BAKELITE BOARD

UNBREAKABLE UNFADABLE

	Nat.	Col.
7x14	4/10	5/8
7x18	6/11	7/11
7x21	7/11	8/4
8x12	4/7	5/5
8x20	7/9	9/-
8x26	10/-	11/8
8x33	11/6	13/7

3/16" Thick.

Made in the following colours—natural brown, black walnut and mahogany. Natural brown 1d. per square inch. Other surfaces 1d. per square inch. Send postal order to GEO. L. SCOTT & CO. LTD., Morris House, 60-66 Rochester Row, S.W.1. Money ret. if not satisfied.

ASTONISHING BARGAINS

in our **NEW CATALOGUE**

72 pages, well illustrated and offering the greatest choice obtainable in radio products.

Get a copy. Post free 4d.

ELECTRADIX RADIOS

218 UPPER THAMES ST., LONDON, E.C.4

USE **ELEX**

TREBLE DUTY TERMINALS

AND OTHER WIRELESS ACCESSORIES

J.J. EASTICK & SONS,
ELEX HOUSE, BUNHILL ROW, LONDON, E.C.1.

USE ETON AND AVOID EATEN CELLS

Eton Primary H.T. Battery. Pl Porous Pot Cells, S1 and S2 Sac Cells. All complete for assembly.

	1-cell.	6-cell.	12-cell.	30-cell.
P1	6d.	5/3	5/9	14/-
S1	6d.	3/-	5/3	12/-
S2	4d.	2/6	3/10	9/6

Send 1d. stamp for booklet giving full particulars to—
THE ETON GLASS BATTERY Co.
46 ST. MARY'S ROAD - LEYTON - E.10

WET H.T. BATTERIES

Solve all H.T. troubles

SELF-CHARGING, SILENT, ECONOMICAL

JARS (waxed) 2 1/2" x 1 1/2" sq. 1/3 doz.
Zincs, New Type, 11d. doz. SACS 1/2 doz.
Sample doz. (18 volts), complete with bands and electrolyte 4/3, post 6d. Sample unit, 6d. Illustrated booklet free. Bargain list free.

AMPLIFIERS, 30"- 2-Valve Set, 2s.

A. TAYLOR, 57 Studley Rd., Stockwell, London.

"THE RADIO 'SLEUTH'"

(Continued from page 273)

and headphones may be tested for continuity of winding; anode resistances and grid leaks may be tested for continuity and variable and fixed condensers for faulty insulation.

A sound condenser may be identified by



The Interior of the Radio "Sleuth"

the fact that only one loud click will be heard in the phones, even if contact is made with it several times; this is because the first contact charged up the plates.

To discharge the condenser the switch on the panel should be pushed in and contact again made to the condenser terminals, when a click will be heard in the phones, due to the release of the charge.

Scottish listeners on September 16 will again hear the Church Parade Service of the Boys' Brigade to be held in the Music Hall at Aberdeen. Amongst well-known men taking part in the service are Sir George Adam Smith, Principal of the Aberdeen University; the Rt. Rev. the Bishop of Aberdeen and Orkney; and the Very Rev. Dr. Harry Miller, Moderator of the United Free Church of Scotland.

On September 17 the Aberdeen station will give a novel broadcast in the form of a musical tour of London by the Station Octet, conducted by Mr. Arthur Ketelbey. A "State Procession," Lambeth Walk, the Cenotaph, and Hampstead Heath on Bank Holiday will be "witnessed" by listeners, after which they will, in company with M. Jalowicz, visit Rotten Row and the banks of the Serpentine.

On September 18 another ladies' programme will be broadcast from the Glasgow station. The artistes will include Edith James (entertainer) and Eileen Andjelkovich (violin).

Mr. Gordon Baker is to give a talk on the new sport, dirt-track racing, from Glasgow on September 22.

Although a wavelength of 297 metres has been allotted to the San Sebastian broadcasting station, transmissions are still being carried out on 335 metres.

PREPAID ADVERTISEMENTS.

Advertisements under this head are charged **THREEPENCE PER WORD**, minimum charge **THREE SHILLINGS.**

DEPOSIT SYSTEM

As the Publishers cannot accept responsibility for the bona fides of advertisers in this publication, they have introduced a system of deposit which it is recommended should be adopted by readers when dealing with persons with which they are unacquainted. It is here explained.

Intending purchasers should forward to the Publishers the amount of the purchase money of the article advertised. This will be acknowledged to both the Depositor and the Vendor, whose names and addresses must necessarily be given. The Deposit is retained until advice is received of the completion of the purchase, or of the article having been returned to and accepted by the Vendor. In addition to the amount of the Deposit, a Fee of 6d. for sums of £1 and under, and 1s. for amounts in excess of £1, to cover postage, etc., must be remitted at the same time. In cases of persons not resident within the United Kingdom, double fees are charged.

The amount of the Deposit and Fee must be remitted by Postal Order or Registered Letter (Cheques cannot be accepted), addressed to

"AMATEUR WIRELESS," ADVERTISEMENT DEPARTMENT,
58/61, FETTER LANE, LONDON, E.C.1.

WOOD HORNS for all gramophone units, etc.; List, Maidson, 1 Chapel St., Edgware Rd., N.W.1. Manufacturer of THE ALLWOODORNS.

MOVING COIL LOUD SPEAKERS—10/- and 19/- monthly. COSEOR MELODY MAKER and all accessories, 5/- and 15/6 monthly. Everything wireless on easy terms. Lists free—World's Wireless, Wallington.

CDM THE CHOKE OF THE FUTURE 4!



Glass-protected Choke, Upright type, 5/-

Why wait for Olympia? Two components will be included in all Sets—The screened-grid Valve and the "Clip In" Chokes, thus improving range and embracing Short-wave Reception. CDM Chokes are months ahead—we know this fact, and want you to know it as well, as it is your best investment to improve reception on your Set. Universal from 15 to 2,000 metres gives highest Self Inductance and lowest Self Capacity, and is especially recommended for those who contemplate a second stage H.F.

CDM Fixed mica Condensers individually tested. 50,000 users have assured satisfaction.

.00025 to .002, 1/8
.0025 to .006, 2/-
.0065 and Grid
Leak - - 2/-

CDM
"The UNIVERSAL CHOKE"

C. D. MELHUISE (Dept.)
8 Gt. Sutton Street, Goswell Road, E.C.1
Telephone: CLERKENWELL 7474.

PAREX products PAR EXcellence

THE SCREENED-GRID H.F. AMPLIFIER

described in this issue uses a "PAREX" SCREEN

Highly polished and Mottled Copper drilled as specified and ready to fix, 4/6.

VISIT OUR STAND No. 272

E. PAROUSSI

10, Featherstone Bldgs., LONDON, W.C.1.
Phone: Chancery 7010.

REPAIRS

Any make of L.F. Transformer, Loud-speaker or Headphones repaired and dispatched within 48 HOURS—TWELVE MONTHS' GUARANTEE with each repair. 4/- Post Free. Terms to Trade

TRANSFORMER REPAIR CO.

"Service" Dept.
214 High Street, Colliers Wood, London S.W.19

Amateur Wireless

Available until Saturday,
SEPTEMBER 15th, 1928

Relay for L.T. & H.T. sets. Also supplied for L.T. & H.T. Eliminator and All-Mains sets.

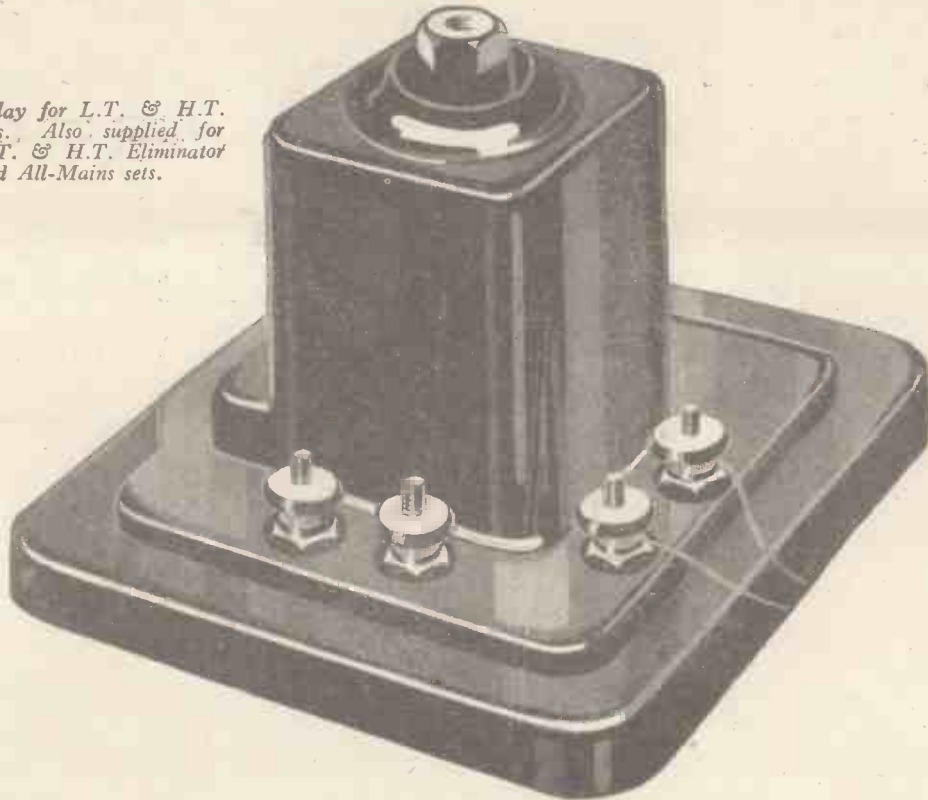

This component brings you wireless all over the house

Increase the enjoyment and comfort of good reception. Don't have a good set and restrict it to one room. Reception from your set can take place in every room in the house, independently, simultaneously, without interference if you fit a Lotus Remote Control.

You can wire two rooms yourself in half an hour at a cost of a few shillings. Ask your retailer for a **FREE BLUEPRINT** or send a postcard to the makers.

Prices :

Complete outfit for 2 rooms for a set using L.T. Accumulator and H.T. Battery, including 1 Lotus Relay, 2 Filament Control Wall Jacks, 2 Jack Plugs and 21 Yards Special 4-strand wire ... **30/-**

Complete outfit for 2 rooms for set using L.T. Accumulator and H.T. Eliminator ... **45/-**

Complete outfit for 2 rooms for any make of circuit using All from the Mains set ... **47/6**

In each case, each additional room, 7/6 extra.

All radio dealers sell the

**LOTUS
REMOTE CONTROLS**

Made by the makers of the Lotus Buoyancy Valve Holder, Lotus Vernier Coil Holder, Lotus Jacks, Switches and Plugs.

GARNETT, WHITELEY & CO., LTD., Lotus Works, Broadgreen Road, LIVERPOOL.

To Ensure Speedy Delivery, Mention "A.W." to Advertisers

"TAKE MY TIP!"

Use Mullard Valves.
You will find that
stations come in
clearer and stronger
and that tone is
improved. Mullard
P.M. Valves put
new life into any set!

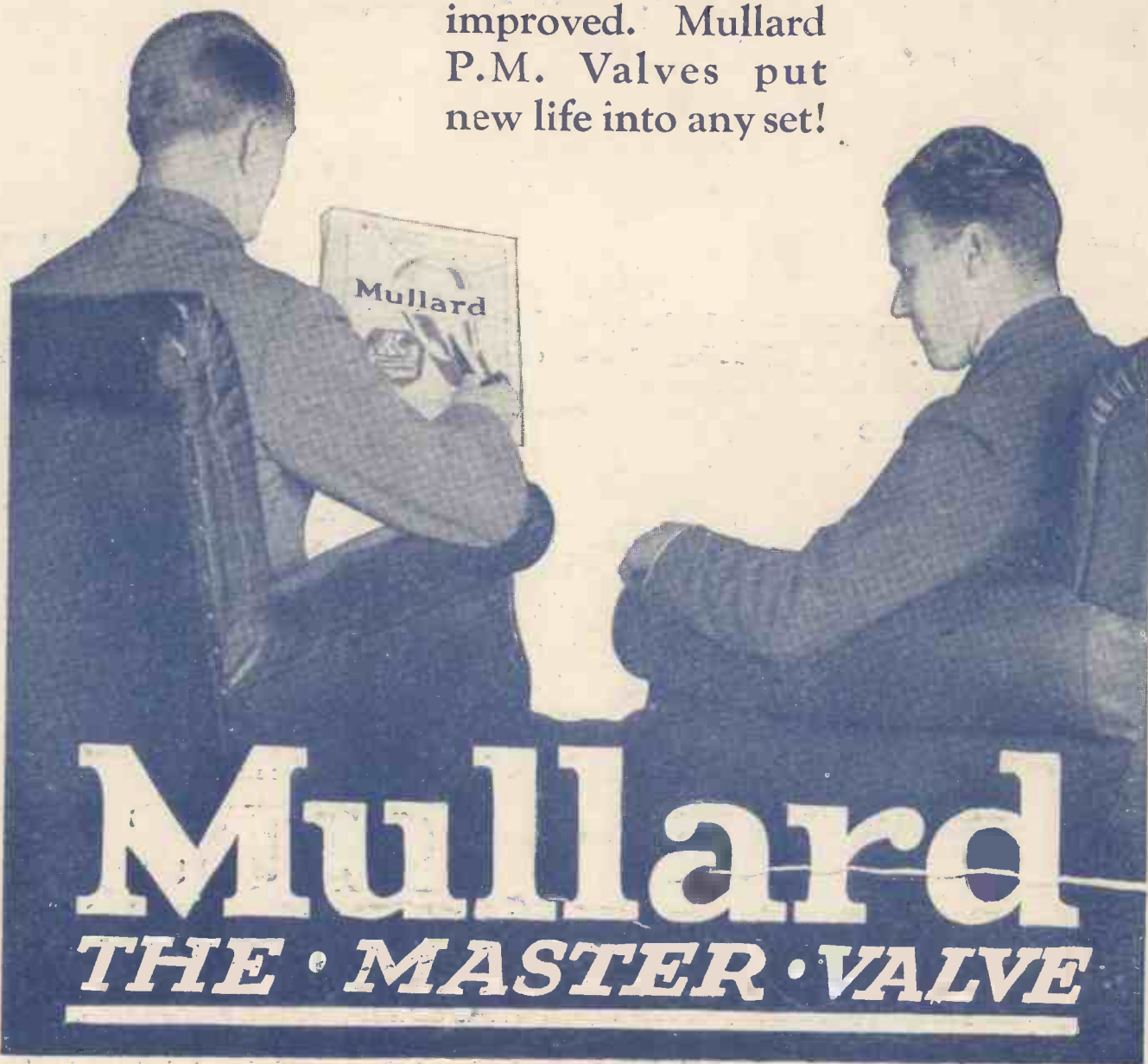

Mullard

THE • MASTER • VALVE