

FOR NEXT WEEK'S FREE GIFT, see page 601

STUNTS WITH AERIALS

Amateur Wireless And Electrics

Vol. IV. No. 102.

SATURDAY, MAY 17, 1924

Price 3d

PRINCIPAL CONTENTS

POWER THROUGH THE
ETHER

A PORTABLE ALL
STATION RECEIVER

GETTING DOWN TO
THE VERY SHORT
WAVES

PROTECTING HIGH-
RESISTANCE PHONES

LOUD SPEAKERS AND
THE CRYSTAL

A NOVEL TUNER

INTERFERENCE ELIMI-
NATION

A MICA VARIABLE
CONDENSER

EXPERT REPLIES TO
READERS' QUESTIONS

WELL ILLUSTRATED

Registered at G.P.O. as a Newspaper



BROADCASTING THE BOURNVILLE CARILLON

The photograph shows the operating keyboard of the Bournville Carillon. The Carillon was broadcast recently from 5 IT as described on page 602.

ECONOMIC ELECTRIC LTD.



SIR!
WANT
PROOF?
HERE IT IS!

YOU

7,000 MILES TELEPHONY RECEPTION WITH ONE "XTRAUDION" VALVE

UNSOLICITED TESTIMONIAL from Messrs. Dowson & Dobson, Ltd., JOHANNESBURG, South Africa.

Messrs. Economic Electric, Ltd. March 26th, 1924.
Dear Sirs,
For your information we would like to add that Mr. Pleese, a local amateur, has had one of your "XTRAUDION" valves in constant use for 18 months and has heard Bournemouth's programme on one valve only. This is absolute fact; not fiction.

The PRICE of the "XTRAUDION" VALVE is 12/6 and the current consumption is only .4 amp. at 4 volts, with a potential of 30-75 volts. If you write us to-day, enclosing 4d. in stamps we will mail you, post free, our 40-page Radio Catalogue, which gives full particulars of the "XTRAUDION" Valve and hundreds of other "E.E.C." high efficiency instruments.

Head Office: 10, FITZROY SQUARE, LONDON, W.1 Showrooms: 303, EUSTON ROAD, N.W.1 Branch and Works: TWICKENHAM

Manufactured Entirely by BRITISH LABOUR in our own works.

The SECURITY BEHIND BONTONE

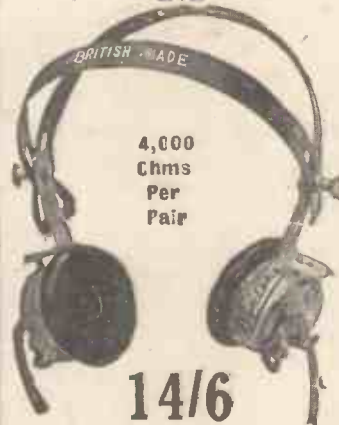

4,000 Chms Per Pair

14/6 POST FREE

Have you recognised all the better qualifications which make BONTONE the distinctive type? Mainly, they are backed by a most generous guarantee.

Sensitive! Why? Simply that the magnets are made in our own works under our own supervision.

BONTONE will respond to the weakest signals. Durability? BONTONE are made of the best materials procurable, and their beautiful finish is highly creditable to skilled craftsmanship.

Comfort? Throughout exhaustive tests we have worn BONTONE and known comfort, a point mechanically successful. BONTONE are easily adjusted.

See you buy BONTONE Generously Guaranteed

If you prefer lightweight, use BONTONE post LIGHTWEIGHT 15/6 free These Headphones are similar in construction to the standard BONTONEs and are guaranteed.

Insist on receiving BONTONE. If your dealer cannot supply, send direct, giving your dealer's name to:

GUARANTEE. We agree to replace or return cash if Phones do not give complete satisfaction, subject to Phones being returned to us within 7 days of purchase, undamaged.

B. D. & Co. (Edward A. Boynton)

Offices: 167-173 GOSWELL RD., LONDON, E.C.1.

Works: GOSWELL RD. & CITY RD., LONDON, E.C.1.

Admiralty, War Office and India Office Contractors.

Sole Distributing Agent for Scotland: J. W. Gordon, 98 Sauchiehall St., Glasgow.

LIVERPOOL WIRELESS AUCTION MAY 20th

An excellent opportunity of securing bargains in Wireless Sets and Accessories. At this Auction all goods will be offered in suitable quantities for purchase by both Public and the Trade.

Do not fail to attend this Auction at

OUTHWAITE & LITHERLAND

Auctioneers and Appraisers,

49/51 SOUTH CASTLE ST., LIVERPOOL TUESDAY, MAY 20th, 1924, at 12.30 o'clock

On View Monday, May 19th, from 10 a.m. to 6 p.m.

Catalogues on Application.

WIRELESS BARGAINS by post

ALL PARTS SUPPLIED Send for List

A.I. TWO VALVE CONSTRUCTOR'S SET

Comprising handsome polished oak cabinet with ebonite top and nickel plated fittings, two-way coil holder and set of five basket coils. The panel has tuning condenser with full reaction, and the transformer used is the well-known "Energol." Complete with Marconi Osram Valves, Batteries, Headphones, and all other accessories for complete installation. Price, including carriage - **£10-0-0**

CARRIAGE PAID.

ALLIED INDUSTRIES 93/94 Chancery Lane, LONDON, W.C.2

TUNGSTALITE'S TRIUMPH

ANOTHER RECORD

(COPY.)

13, Fairbairn Road, Waterloo, Nr. LIVERPOOL. 30 April, 1924.

Messrs. Tungstalite Ltd., 47, Farringdon Road, LONDON, E.C.1.

Dear Sirs,
Please send me by return two of your Tungstalite crystals. It might be of interest to you to know that I have tried a good many crystals. I find that yours is by far the best. Please find enclosed P.O. for 2/-.

Yours truly,
(Signed) JAMES F. JOHNSTON.

Guaranteed more sensitive than any other crystal. Ideal for long-distance work. Absolutely non-fading. Unaffected by heat. A genuinely synthetic sulphide.

Ask your Dealer for it or send 1/- P.O. for Sample Tube to:

TUNGSTALITE LTD.,

Electric Lamp House, 47, FARRINGTON ROAD, LONDON, E.C.1

Phone: Holborn 2557. Grams: Tungslamp, Smith, London.

DON'T ASK FOR CRYSTAL ASK FOR TUNGSTALITE!



1/-

Amateur Wireless

and Electrics

Vol. IV, No. 102

May 17, 1924

POWER THROUGH THE ETHER

An article on the Wireless Transmission of Power, by Marcus J. Martin, author of "Electrical Transmission of Photographs."

ALTHOUGH, as every wireless worker knows, the transmission of energy through space is an accomplished fact, yet the transmission of power in bulk which can be utilised for industrial or other purposes is a problem that still remains to be solved.

A Fascinating Problem

The idea of a central transmitting station from which power could be radiated through space over a large area, tapped by an unlimited number of receivers and utilised for the thousand and one purposes of domestic and business requirements, is certainly a very fascinating one and if ever realised would have far-reaching effects.

Although in the opinion of several of our leading scientists a solution of the problem is by no means impossible, yet the difficulties to be overcome are enormous. The great expense entailed in experiments of this description has been mainly responsible for the lack of practical effort, although several suggestions, well worth trying out, have been put forward at various times. Quite recently a syndicate has been formed in America with the object of carrying out extensive experiments.

When energy is radiated from an aerial the waves set up and transmitted, although to a small extent directional, are spread out through space in all directions, the result being that only a very small percentage of the energy transmitted is available at a particular receiving station.

Loss of Energy

As every wireless worker knows, the amount of energy available at the receiver, even when situated within a short distance of the transmitting station, is very small indeed, and only capable of actuating the most delicate of instruments. The ratio between the power transmitted and that received varies inversely as the square of the distance between the stations. This loss of energy (lost as far as the subject under discussion is concerned) is not confined entirely to the waves travelling through space. Even in a well-designed transmitting station the energy delivered to the aerial is only 60

per cent. to 70 per cent. of the total energy generated.

This radiation of energy in all directions, while practically essential for purposes of telegraphy, constitutes, where the transmission of power is concerned, one of the greatest difficulties. A solution of the problem of directional wireless is obviously a step in the right direction.

If we could devise the means of so controlling the radiations that they could be focused and transmitted in whatever direction desired as an intense beam, in a similar manner to light, then a solution of the problem of the wireless transmission of power would not be very far distant.

During his early researches Prof. Hertz, by using large mirrors with a parabolic

section, was able to reflect the waves radiated from an oscillator placed at the focal point of one mirror upon a second mirror placed some distance away. To concentrate all the energy available, even with the shortest of wireless waves, mirrors of gigantic dimensions would be necessary.

A Lighting Experiment

In the following experiment, which was the outcome of some brilliant research work in high-frequency electrical discharge, a practical attempt was made to illuminate a room by means of vacuum tubes which were rendered luminous by means of a high-frequency discharge. The arrangement of the experiment is shown in the diagram, Fig. 1.

The two metal plates P, which are well insulated and placed well away from each other, are connected on to each end of the secondary winding of the Tesla transformer S. The primary current generated by the alternator G is supplied to the circuit, which includes the condenser C and the primary winding B of the transformer. When working, vacuum tubes will become luminous when placed anywhere between the plates, this action being due to the constantly surging electrostatic strains between the two plates.

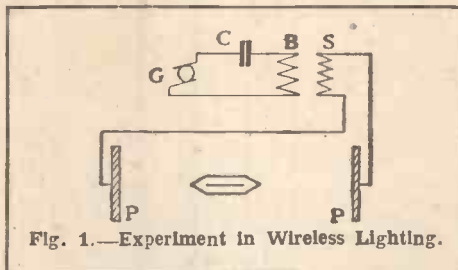

Fig. 1.—Experiment in Wireless Lighting.

Results

This experiment depends for its success upon the use of alternating currents of high potential and high frequency. In ordinary alternating-current machines the frequency very rarely exceeds 100 per second, and as the frequency depends upon the number of field magnet poles, Tesla, with specially constructed machines having 400 poles, was able to obtain a frequency of 20,000 alternations of current per second, and by the use of step-up transformers he was able to drive his pressure up to very high voltages.

The rapidly alternating electrostatic fields produced in the dielectric are capable of reaching out into space far beyond the region situated within the area of the two metal plates, and if these are placed one at each end of a large room sufficient energy will be transmitted and delivered by induction to vacuum tubes to render them brilliantly luminous.

(To be concluded)



Lissen Inductances.

COMPONENTS YOU CAN RELY UPON

INDUCTANCE COILS.—II



Chakophone Inductances.

The Lissen Inductances

THESE coils are wound in the way which has already been referred to. It might be thought from the diagram, Fig. 5, that coils made in this way would be flimsy. Such, however, is not the case, for I have submitted two of these coils to the extremely rough test of trying to break them by squeezing the windings together. No ill effects resulted from the application of quite heavy pressure. Under it the windings came rather close together, but as soon as it was released they sprang apart again to their original positions. I should say, in fact, that these coils are as nearly unbreakable as coils can be. In these coils again efficiency upon the short waves is produced by their large air spacings between the layers. In the No. 25, which is the smallest coil of the series, the distance between the points A and B in Fig. 3 is nearly $\frac{1}{8}$ in. High-frequency resistance is kept down by the use of heavy wire even in the largest sizes. The windings of No. 300, which tunes up to 4,600 metres with an average aerial with a .001 microfarad condenser in parallel, appear to consist of No. 26 wire, and those of the No. 28, whose maximum wavelength in the same conditions is 350 metres, of No. 16. It is impossible to measure them exactly without pulling the coils to pieces. Owing to the method of winding self-capacity is low, and it was found in actual test that the losses were small. When tried upon the two test sets in turn the results obtained with these coils were extremely satisfactory. Signal strength even upon the most distant transmissions was exceedingly good, and there was little inclination on the part of the set to become unstable.

The Lissen inductances are well made, well designed and robust. They are very efficient, the results obtained with them being immeasurably superior to those given by the basket coils used as standards

for the test. It was noticed, too, that much greater selectivity became possible when the Lissenagon coils were in use. Taken all round these are thoroughly good inductances, which will give every satisfaction to the amateur.

The Cosmos Coils

These coils are made on an entirely new principle, being wound with a patent strip of prepared paper in which are incorporated from three to seven wires well separated from one another. When the strip has been wound into a spiral upon a circular ebonite former the outer end of the first wire is connected to the inner of the second and so on. A very efficient form of multi-layer winding is thus produced with good spacings between the turns and, with an accompanying small self-capacity. Recent National Physics Laboratory tests show that the distributed capacity of the smaller Cosmos coils is only 10 micro-microfarads. This strip

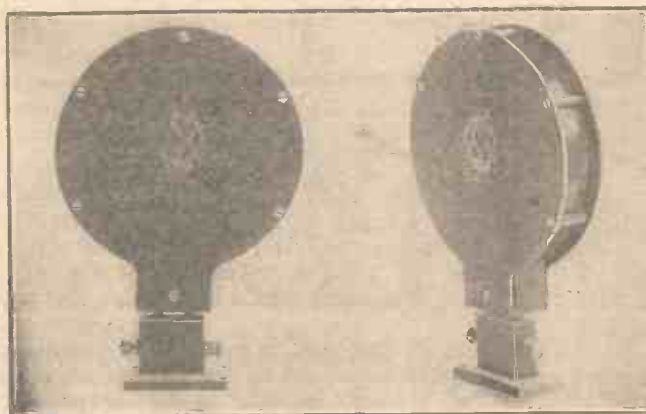

A Pair of Cosmos Coils.

wire, by the way, can be purchased separately at very low prices—that containing three wires costs 4d. per dozen feet, whilst that with seven wires sells at 10d. per dozen feet—and it will be found most useful by those amateurs who prefer to wind their own inductances, for there is probably no other method by which a well-spaced coil of small self-capacity can be wound so easily or so quickly. One great advantage of the system is that the spacing

increases as the wavelength of the coil decreases. The Cosmos inductances have their windings entirely encased in insulating covers, which are strongly put together with screws and metal spacing pieces. So strong are they that it is quite impossible to damage them by any reasonable pressure or by an ordinary bending strain.

The results obtained in practical tests were first-rate. With the single-valve set transmissions that were weak with the original basket coils became much stronger when these were exchanged for the Cosmos set, and signals which had previously been out of range now came in faintly. On the five-valve set the results were again good, there being a distinct gain in signal strength, the coils showing no tendency to produce self-oscillation. A complete set of Cosmos coils consists of seven, which, if a series-parallel switch is used, will enable the set to be tuned from about 100 metres to 4,500 metres, which is quite as high as most amateurs wish to go, since it brings in all the telephony that is available. Considering their sound construction and good finish these coils are remarkably cheap, ranging in price from 4s. 6d. for the smallest to 8s. 9d. for the largest. I do not think that there is another set on the market as reasonably priced which will give anything like such good results.

The Chakophone Coils

The Chakophone coils are made by the Eagle Engineering Co., of Warwick. They are a broadcast set of four coils, tuning from about 300 to 2,000 metres when used at A.T.I. with a .001 condenser in parallel. They form an excellent set for use at A.T.I., secondary, tuned anode, inductance and reaction coil for all broadcast wavelengths. These again are single-layer coils, the windings being placed upon a stout former and protected by an outer covering of Empire tape. Practical tests showed that they were very good indeed for broadcast reception, the signal strength being excellent and the selectivity good. The Chakophone set provides exactly what the broadcast man requires.

J. HARTLEY REYNOLDS.

(To be continued)

GETTING DOWN TO THE VERY SHORT WAVES

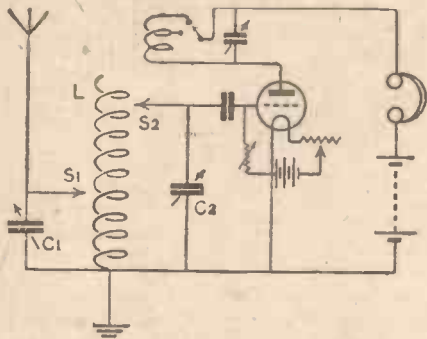

Circuit Diagram of Short-wave Receiver.

ONE of the most constantly changing ideas in wireless is the definition of "short waves." Three years ago there were few experimenters who troubled to go below the lower shipping wave of 300 metres, and even as recently as a year ago 150 metres was the lowest limit of the majority of experimental sets. To-day there are a considerable number of stations working on from 60 to 120 metres; the American amateurs have crowded down there, and a number of British and French amateurs have followed suit.

Aerial Length

It seems to be a prevalent idea amongst many amateurs that, unless one works on an aerial of about 20 ft. in length or uses a supersonic receiver, it is exceedingly difficult to get down to these very short waves. The usual method tried employs a very small condenser in series with the aerial together with an inductance of a few turns loosely coupled to a secondary circuit. This arrangement renders quick searching a somewhat difficult matter and tuning is apt to be rather critical. The small series condenser in the aerial circuit also results in loss of efficiency.

A Good Circuit

A circuit which gives excellent results on both short and very short waves is given in the accompanying illustration. It certainly deserves to be more widely used than it is. As will be seen, it is very similar to the ordinary single-valve regenerative circuit. The inductance L is wound with No. 22 d.c.c. wire on a 3-in. former and is tapped at every five turns, each tapping being brought out to two switches, S1 and S2. It is important that the inductance be wound with a heavy-gauge wire; if too fine a wire is used difficulty may be experienced in getting the set to oscillate at the lower limit. The turns should also be spaced in order to obtain the maximum number of turns on the very short waves. In the case of the author's set, each turn is spaced from the next by a winding of thick wool, giving nine turns to the inch. The reaction coil is wound on a ball former which rotates inside the A.T.I. and has thirteen turns of spaced wire on each side. A two-stud switch is employed to enable either thir-

teen or twenty-six turns to be used. The A.T.C. (C1) is .0005 microfarad and the C.C.C. (C2) .0003 microfarad. A small five-plate condenser across the reaction coil is of great help in obtaining fine adjustment of reaction.

Tuning

For reception of waves above the fundamental of the aerial, the aerial circuit and grid circuit may both be tuned to the desired wave in the same manner as if the set were a loose-coupled circuit, or for medium waves the aerial circuit only may be tuned, the switch S2 being placed at some point on the inductance higher than S1. For reception of waves below the fundamental of the aerial the aerial circuit is tuned to a wavelength equal to double the wavelength it is desired to receive; the inductance in the grid circuit is then adjusted by varying S2 so that the grid circuit is approximately tuned to the desired wave; the final adjustment is made by means of C2.

It might at first be thought that quick tuning is not possible, but once the approximate wavelengths for different settings of S1 are known, all tuning can be carried out by varying C1 and C2. If

simplicity of tuning at the expense of slight efficiency is of primary importance, searching can be carried out by varying either C1 or C2, preferably the former, since as this condenser is only across a few turns of the grid circuit, which governs the frequency at which the set oscillates, tuning becomes very broad, and if the moving vanes are earthed there is an entire absence of hand capacity usually so noticeable when using a series condenser on short waves. Distinctly better results are, however, obtained, both as regards signal strength and selectivity, if the grid circuit is tuned accurately to the first harmonic of the aerial circuit. With this arrangement there is a much greater transfer of energy to the grid circuit than in systems in which an untuned aerial circuit is employed.

As regards results, the writer's set will easily go down to 60 metres with five turns in the aerial circuit and fifteen in the grid, and regeneration is perfectly smooth over the whole range. 2L O's harmonic on 90 metres is quite strong with the addition of a stage of L.F., whilst KDKA and two or three French telephony stations on about 110 metres come in very well.

5 G F.

A "Home-made" Set

SIR,—I enclose photo of my wireless set, using Coalite Crystal and Shaving Catwhisker. I can't get KDKA nor 2LO, though very early the other morning I distinctly heard 2CATS calling. I noticed a curious phenomenon, for by quickly oscillating small pieces of Coalite through the window, all sounds quickly ceased. Why is this?
—F. E. M. (Harrow).

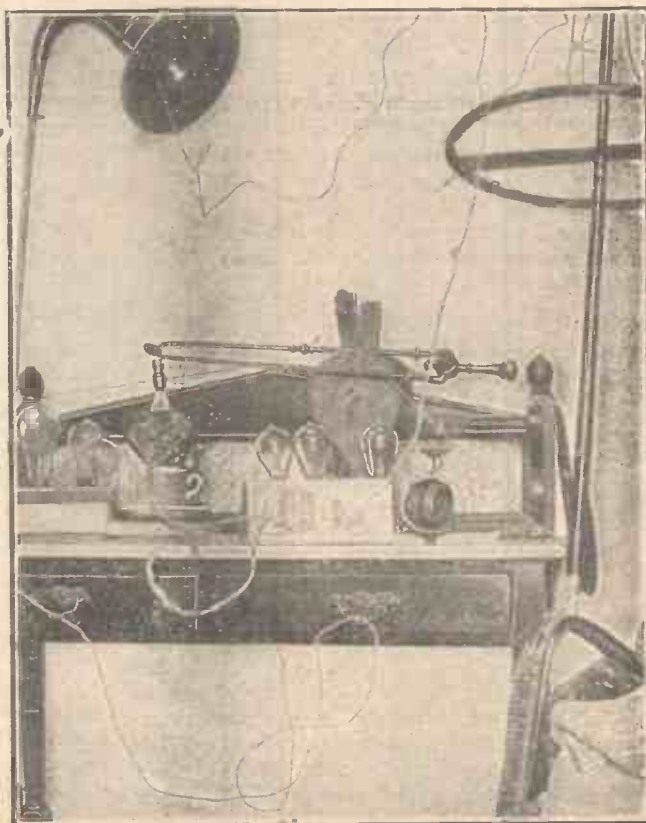

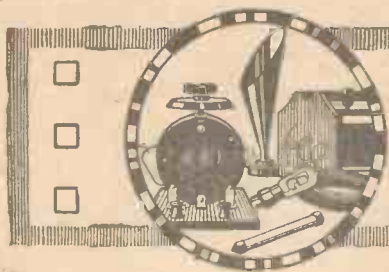

PRACTICAL ODDS AND ENDS

Honeycomb-coil Former

A NEAT honeycomb-coil former can be made by cutting from a piece of ebonite or wood two circles 2 in. in diameter by $\frac{1}{4}$ in. thick. To these are

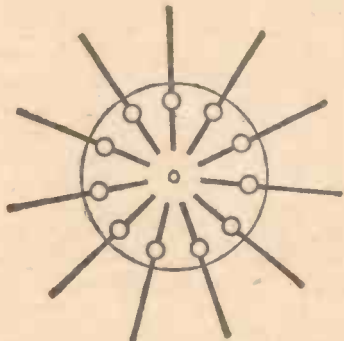

Honeycomb-coil Former.

fastened an odd number of phone terminals arranged as in the sketch. In each terminal is held a metal rod about $\frac{1}{8}$ in. in diameter and long enough for the largest coil that will be required. Obtain a cardboard tube 2 in. internal diameter by 1 in. wide. To assemble the whole device, put the two discs into the ends of the tube and clamp with a piece of 2 B.A. rod. S. W.

An Umbrella Aerial

A N efficient and inexpensive portable aerial may be made from an old umbrella. Take any old umbrella and attach to each of its steel stays (there are usually eight) a piece of string to which is attached an ebonite insulator.

On the main centre piece place a block of wood as shown. Attach eight more

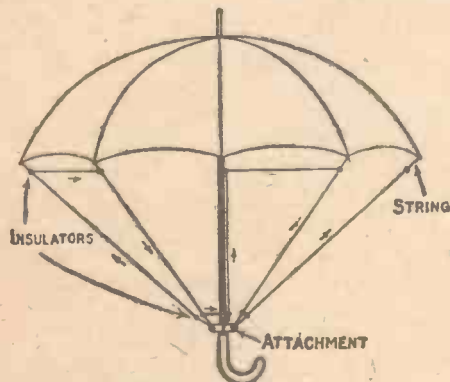

Arrangement of Umbrella Aerial.

pieces of string at this point with eight insulators. Commence wiring the aerial with the umbrella quite fully open. Make the wire firm at the commencement, and finish off the winding by twisting. J. O.

Wooden Panels

THAT one of the best-known wireless firms mounts its phone transformers on wooden bases, with the terminals fixed in the wood, seems to indicate that this material is not nearly so bad an insulator as is generally supposed.

Of course, for mounting apparatus any wood is not suitable. It must be well-seasoned, hard and dry; soft wood is not to be recommended. Some amateurs boil wooden panels in molten paraffin-wax, but if the wood is really dry and well-seasoned it is doubtful whether the wax is any advantage.

There are on the market a series of components mounted on small pieces of ebonite so that they can be easily fixed to wooden panels by cutting a number of holes. S.

Making a Variometer

A TYPE of variometer that deserves the attention of British amateurs is shown in the diagram. For broadcast reception the rotor should be about 3 in. in diameter and the stator 5 in. in dia-

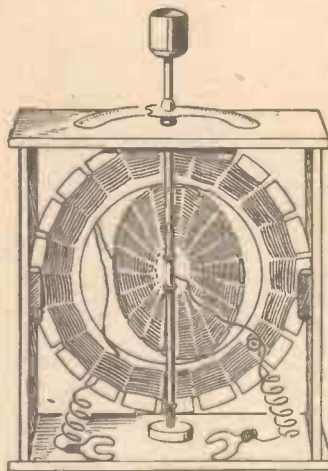

Simple Variometer.

meter, wound with 60 and 24 turns respectively of No. 28 d.c.c. on any odd number of segments. Both formers can be cut from the same piece of card, about $\frac{1}{8}$ in. clearance being allowed between them.

Small brass eyelets can be fixed in the top and bottom of the stator and in the rotor to act as bearings for the spindle. When completed the instrument can be mounted in a wooden frame as shown, a piece of cork keeping the bottom of the spindle in position. This variometer is of

American origin, being described in *Popular Radio*. R.

Phone Hook and H.T. Switch

THOSE who have sets with vertical panels can easily make a combined phone hook and H.T. switch. The idea is shown by the diagram. A brass or copper bridge, provided with a hook, is

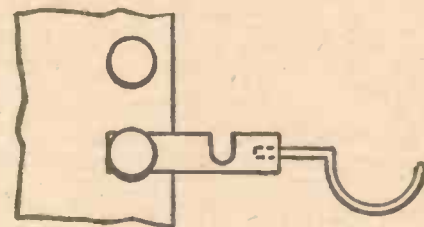

Phone Hook and H.T. Switch.

pivoted to a terminal in the anode circuit of the last valve.

This terminal should be so connected that when the hook is in the position shown the H.T. circuit is broken. Then when the set is in use and the phones are taken off the hook, the bridge is connected to the terminal above, thus completing the circuit. G. H. H.

Plug-in Crystal Detector

NEAT plug-in crystal detectors can be made from the threaded valve pins now sold for making connections. Each pin is provided with two brass washers, held in place by small nuts (see Fig. 1).

With a fine saw two cuts are made at right angles down the threaded portion of the valve pin to accommodate brass cross pieces as shown in Fig. 2. Thus four

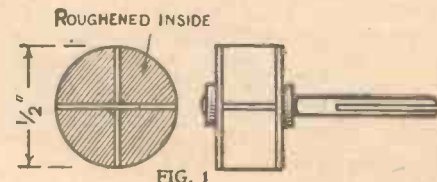

FIG. 1



FIG. 2

Figs. 1 and 2.—Plug-in Detector.

small compartments are available for mounting crystals. This should be done with Wood's metal. The cross pieces are held in place by the washers and nuts as shown in Fig. 1. F. G. G.

STUNTS WITH AERIALS

It is a fascinating hobby to take note of the peculiarities of the many types of aerial that have reared themselves throughout the country and, by a careful study of their design and the manner in which they are assembled, to form a shrewd opinion of the character of their owners.

Some Types

First we come to the "any-old-thing-will-do" type—the man who slings a wire without thought as to screening, insulation, etc. etc., and so long as he gets his local broadcast station, which is almost at his back door, he is happy.

Next we have the artistic aerial with an appearance pleasing to the eye, which harmonises with its surroundings; this usually belongs to the man of particular habits, the man who values appearance before efficiency.

And lastly we come to the "utility" aerial which has a stature and a stateliness that command awe and respect. There are, of course, many intermediate grades and freak concoctions of varied shapes and sizes.

Perhaps the twin variety leads the way in order of popularity, and yet hardly one per cent. of the proud possessors of them are aware of the latent possibilities of the material at their command.

Think of the avenues of experimenting which lie at our door! Think of the varied ways in which we can connect such an acquisition to our set. Let us examine a few of them.

Aerial Leads

The most commonly accepted method is to lead down from the extreme end of the two arms, finally joining the two wires together and bringing the single lead thus formed to the aerial terminal of the set. This is quite good, and, provided the single lead is fed by two collector wires of exactly equal length, one can tune in sharply on reasonable wavelengths. But should the two arms vary in their relative lengths, trouble is bound to be experienced in the reception of signals of quality.

Again, we have the T aerial—a modification of the inverted L above described. With this type three important points have to be watched to secure best results. Besides the fact that the two collector wires must be equal in length, we now have to consider carefully the point of attachment of the down leads, as these must be joined exactly to the electrical middle of each of the arms if perfect tuning is to result.

Here are a few stunts which will afford much food for reflection to the serious-minded.

(1) Join the free ends of the arms of the

inverted L with a cross wire and note differences in reception, if any.

(2) Try a similar experiment with the two free ends of the T type.

(3) Take a separate lead-in (separating the Y down-lead)—one leg to the aerial and the other to the earth terminal of the set (the ordinary "earth" wire, of course, being disconnected from the set).

(4) Try experiment No. 3 with a cross wire linking up the free end to form a loop.

(5) Connect one leg to a crystal set and the other to a valve set, using a common earth.

Doubtless numerous other experiments

will suggest themselves and much valuable data and experience will be gained.

Here are the writer's experiences with No. 5.

With the two sets tuned to London (the nearest broadcast station) a marked falling off in signal strength was experienced on the valve set, whilst the crystal functioned normally. It was found, however, that, contrary to all laws of interference, all the other B.B.C. stations, Radiola and Eiffel Tower could be brought in on the valve set without affecting the reception of 2 L O on the crystal; in fact, one could listen to London with one ear and Paris with the other.

W. J. T. C.

GIVEN AWAY FREE
with next week's "Amateur Wireless"
A SIXPENNY BOOKLET
ENTITLED
"Wireless Troubles and How to Remedy Them"
By OSWALD J. RANKIN and the
Technical Staff of "Amateur Wireless"

36 pages :: Full of Helpful Information :: Over 60 Illustrations

<p>Get your friends to order their copies of "A.W." immediately or disappointment may await them!</p>	<p>PRICE 3d. AS USUAL</p>	<p>THE DATE: Next Thursday, May 22nd.</p>
---	--	--

Marking Basket-coil Formers

THE following method of marking-off basket-coil formers gives at a glance the necessary measurements for stepping-

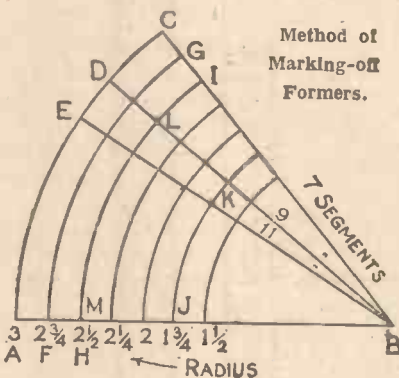

compasses set at $2\frac{1}{4}$ -in. radius describe an arc at C from the point A; again set the compasses to 3-in. radius and describe AC, then join CB. Proceed to subdivide the segment by reducing the radius $\frac{1}{4}$ in. at a time as shown.

Then AC gives the distance to which the compasses must be set when marking-off segments around the circumference of a 6-in. diameter former; FG gives the size for a $5\frac{1}{2}$ -in. diameter former, HI for a 5-in. diameter former and so on, these being for seven segments. For nine and eleven segments mark off AD $2\frac{3}{8}$ in. and AE $1\frac{1}{2}$ in. respectively and draw a line from each point to B.

The following two examples will make the above quite clear. If the compasses be set to points JK the size will be given for marking-off a $3\frac{1}{2}$ -in. diameter former with eleven segments. LM gives the dimension for a 5-in. diameter former with nine segments.

Draw a line AB 3 in. long and with

C. H.

PROTECTING HIGH-RESISTANCE PHONES

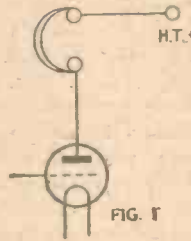

FIG. 1

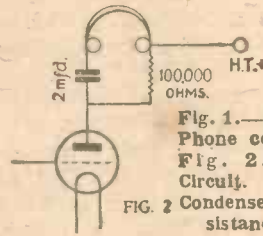

FIG. 2

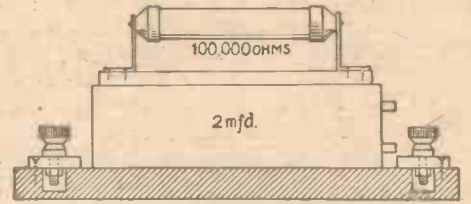

FIG. 3

Fig. 1.—Phone and Phone connections. Fig. 2.—Filter Circuit. Fig. 3.—Condenser and Resistance Unit.

IN connecting up an ordinary set the steady current of the high-tension battery passes straight through the windings of the high-resistance phones. These connections are shown in Fig. 1 for reference. This steady current is not necessary for the working of the phones, which are actuated by the fluctuations caused by the rectified signals or speech. Moreover, the current, which in multi-valve sets may be of the order of 8 to 10 milliamperes, is liable to damage the windings on the magnets, causing them to "burn out."

By connecting a filter in the circuit, consisting of a condenser and a resistance,

as shown in Fig. 2, the steady plate current cannot pass through the phone windings because it is blocked by the condenser; it has to pass through the resistance. The signal fluctuations, however, pass readily through the condenser and actuate the phone magnets. This filter device often improves reception, particularly if a loud-speaker is being used. If the components are properly chosen there should be no loss of signal strength.

Fig. 3 shows the complete unit made up, the wiring being left out for the sake of clearness. The base is of wood, with ebonite strips fixed to each end to take the terminals. These are four in number, the

input from the set being at one end and the output to the phones or loud-speaker at the other. The condenser can be of the Mansbridge type and the resistance be fixed to the top of its ebonite base. It can be anything between 70,000 and 100,000 ohms. In connecting up the unit it is convenient to mark the H.T. input and output terminals, which are linked by a lead, so that no mistake is made in regard to them. Most phones and loud-speakers have one tag marked to indicate that it should be connected to the H.T. positive. This connection should always be made, even when the filter is in use.

5 Y M.

BROADCASTING THE BOURNVILLE CARILLON

ON May 1 an interesting ceremony took place at the village school at Bournville. In the school belfry there has been installed since 1906 a carillon of twenty-two bells; these have recently been added to by Alderman George Cadbury, junr., in memory of his father, the donor of the original bells. The completed carillon of thirty-seven bells—covering three full chromatic octaves—was formally inaugurated on May 1, when M. Nauwelaerts, the official carillonneur of Bruges, gave two recitals on the bells. Both recitals lasted about an hour, and were broadcast from the Birmingham station of the B.B.C.

M. Nauwelaerts belongs to a family, members of which have been carillonneurs for more than a century past. Born at Lierre, he first played the bells at the age of fifteen, and succeeded his father as carillonneur in his native town in 1908.

The word carillon is defined as meaning "a series of bells so hung and arranged as to be capable of being played as a musical instrument either by means of machinery or by a keyboard." It should be noted that a carillon is always spoken of as being "played" and not "rung." It is essentially a musical instrument, as distinct from a set of bells hung for change-ringing. The bells are stationary in position, and are struck by hammers

which are connected by wires to the clavier, or keyboard at which the player sits; the clavier is fitted with pedals like those of an organ, but in place of notes the carillonneur strikes projecting keys. A photograph of the carillon appears on the cover.



LOUD-SPEAKERS AND THE CRYSTAL

IT will be of interest to readers who have constructed the loud-speaker-crystal set described in No. 73 to know of the following experiment which has been carried out.

An ordinary single-circuit crystal receiver was coupled to the phone terminals of the loud-speaker set. These terminals (phone) were coupled to the A and E terminals of the simple set and the loud-speaker was connected to the phone connections of the simple set. The signals with these two connected together were audible all over the room with a loud-speaker, whereas formerly the signals of the loud-speaker set were just audible five feet from the loud-speaker.

The aerial used was about 70 ft. long and 20 ft. high, rather badly screened at the house end; the loud-speaker was a small 4,000-ohm Brown. If the contact on the crystal of the second set is broken signals are still audible, but very faint.

E. G. B. C.

POWER OF THE B.B.C. RELAY STATIONS

A MISCONCEPTION seems to exist in the minds of many listeners as to the actual power used by the B.B.C. stations. A report appeared in a Sheffield paper to the effect that the Plymouth relay station was using a power of 200 watts, whereas Sheffield was still using only 100 watts (this has now been increased to 200 watts). If this were true Sheffield, as the city possessing the first relay station, would have a distinct grievance. However, it has been explained by an official of the B.B.C. that Plymouth is actually using 200 watts *input* to the transmitting set, but as this is made up of 100 watts to the oscillator valve and 100 watts to the control valves, it is precisely half the power that is being used at present by the Sheffield station.

Similarly it is very frequently stated that the power of the main stations is 1½ kilowatts. This is output, the transmitters being rated by the makers as 6-kilowatt sets. In this case the power to the oscillator valve is 1½ kilowatts, which has apparently been confused with the actual input power. Thus the power used is much greater than is at first apparent.

From these remarks it is clear that there are two systems of rating the power of a transmitter, either *input* or *output*—the Post Office rate by input and the B.B.C. by output.

Brandes

The Name to Know in Radio.



*Result of
15 years'
experience*

—for the Lady

You are familiar with that charming gesture which captures a rebellious curl, deftly adjusting it to the owner's satisfaction. Brandes, having the same consideration for the lady's coiffure, gain much feminine appreciation. A gentle pressure on the crown of the head, a firm clasp to the ears and the rest of the headband is held well away from the hair. Try the "Matched Tone" Headphones as a means to perfect reception and absolute comfort—*every good Dealer has them.*

PRICE
25/-

BRITISH MANUFACTURE
(B.B.C. Stamped) and
conform to all new
licensing regulations.

Manufactured at Slough, Bucks, by
Brandes Limited, Walmar House, 296 Regent Street, W.1.
Glasgow—47, Waterloo Street. Newcastle—5/6, Post Office Chambers.

Matched Tone

TRADE MARK

Radio Headphones

Telephone—
Mayfair 4208-4209
Trade enquiries invited



HULLO EVERYBODY!!

Post Free Column

- Valve Windows 3/-
- Twin Flex for Leads, 12 yds. 7/-
- Bell Wire, D.C.C., I.R.O., 10 yds. 10d.
- 100 ft. Aerial, 7/22 3/3
- Rubber Lead-in, 10 yds. ... 1/6
- Basket Coil Holder and Plug 1/9
- Do., 2-way on Stand 6/9
- 2-way for Igranio Coils 4/11
- Various Designs, 5/11, 6/11, 7/-
- Shaw's Genuine Hertzite ... 1/3
- Spade Screw Terminals doz. 1/3
- Pin do. doz. 1/-
- Ebonite Dial and Knob ... 1/4
- Do., Extra Quality 1/8
- Ebonite Valve Holders ... 1/3
- Do., Cut from Solid 1/6
- Valve Sockets, Best, doz. 1/3
- Do., Plain doz. 1/-
- Terminals, Telephone, doz. 1/6
- Do., Pillar doz. 1/6
- Do., Small Pillar doz. 1/4
- Do., W.O. Patt. doz. 1/6
- (All above with Nut.)
- Insulating Sleeving, 3 yds. 1/3
- Tinned Copper, 3 yds., 14 or 16 gauge 9d.
- Do., 3 yds., 18 or 20 gauge 6d.
- Ebonite Coil Plugs, 2 for Do. on Stand 1/9
- 100,000 ohm Resistance ... 2/6
- Switch Arm, 12 Studs and Nuts 1/8
- Ormond Fil. Resistance ... 2/6
- Fixed Condensers, .001 ... 1/2
- Do., .001 to .0005 1/2
- Do., .002 to .005, 1/3; .006 (Above best quality).
- Grid Leak and Condenser, .0003 2/6
- Ebonite Vario, D.S.C., 250-260 4/11
- Do., D.C.C. Ball Rotor ... 6/9
- Ebonite (Inside Winding) Variometers 13/6
- Contact Stops doz. 1/-
- Battery Clips doz. 1/6
- Coil, 28 tpgs., 1,600 M 2/6
- 4 Whiskers, 1 Gold 6d.
- Spear Point Whisker 6d.
- 12 yds. Empire Tape 1/-
- Plugs and Sockets doz. prs. 1/6
- Cocoonite Crystal 1/6
- Minicap Switch 8/-
- Radio Ins. Transformer ... 25/-
- Igranio Shrouded, L.F. 5-1 Formo Shrouded, do. 18/-
- Formo Open Type, do. 12/6
- Royal, do. 20/-
- Tested on Aerial, do. 12/6
- Raymond, do. 12/6
- Ormond Filis Rheostat ... 2/6
- Raymond, do. 2/6
- Rheostat and Dial 2/6
- Ajax Rheostat, 25.5 ohms ... 4/-
- Ajax with Vernier, 30.5 ohms 5/-
- Ajax Potentiometer, 464 ohm 6/6
- Igranio Rheostat, 4/6
- Peerless Rheostat, 6 ohms 4/6
- Peerless " 15 ohms 4/9
- Peerless " 30 ohms 5/-

RAYMOND VARIABLE CONDENSERS

Our Air Dielectric Condensers are the simplest and MOST efficient on the market. Lowest in price, highest in quality, made for panel mounting, and are the most suitable condensers for Broadcasting or Amateur work. They have passed THE TEST for guaranteed capacities, are scientifically accurate and built for durability

NEW MODEL

Cap.	Plates	Price.
.001	49	6/11
.00075	37	5/11
.0005	25	4/11
.0003	15	4/6
.0002	11	4/-
.0001	5	3/6
.00005 (Vernier)	3	3/-

Prices DO NOT include Dial. This is 9d. extra with Condenser.

Trade dis. on Condensers 20% plus postage. Good terms for quantities.

POST 6d. SET 3 Sets post free.



Owing to the thousands of testimonials received for our New Model Variable Condenser we are discontinuing "A" type and selling New Model only.

Specially Recommended by *Wireless Weekly* and *Modern Wireless*

BUY RAYMOND GOODS

NATIONAL LABORATORY CERTIFICATE

Above new model specially adapted for taking up minimum amount of space. All parts nickelled. PASSED NATIONAL LABORATORY TEST. One hole fixing.

- ### HEADPHONES.
- Sterling B.B.O. high-class (4,000) 25/-
 - B.T.H., B.B.O. None better (4,000) 25/-
 - Brunel. Very fine valuc (4,000) 16/6
 - Brunel, for Crystal Sets (8,000) 19/11
 - N. & K., genuine (4,000) 12/9
 - Slidpe, 4,000 ohms ... 12/9
 - Premier B.B.C. Full of music. (4,000) ... 17/6

CRYSTAL DETECTORS.

- Post 9d. each.
- Glass enclosed Whisker, Brass Fittings, 1/6, 2/3 & 1/-
- Glass enclosed Perlkon, with Zincite and Bornite 1/8 & 2/2
- Nickel enclosed, 3/8, 2/6, 1/11
- Edison Bell Twin 5/6
- Burndept 5/-

- Post 3d. each.
- Lissen Grid Leak (Var.) 2/6
- Lissen Anode Resist-ance 2/6
- Lissen T1 Transformer 30/-
- Lissen T2 " 25/-
- Lissen T3 " 16/6
- Lissen Series " Parallel Switch 3/9
- Lissen Two-way 2/6
- Lissenstat Minor 3/11
- 100,000 ohm Resistance 1/8
- Edison Bell Fixed .001 1/3
- Do. .0001 to .0005 ... 1/3
- Do. .002 to .006 ... 2/-
- Do. .0003 and Grid Leak 2/6
- Raymond Fixed .001 ... 10d.
- Do. .0002 to .0005 1/1
- Do. .002 to .005 1/6
- Do. .006 1/6
- Do. .0003 and Leak ... 1/10
- Dubliler Fixed .001 3/-
- Do. .002 to .006 3/-
- Do. .0001 to .0005 ... 2/6
- Do. .0003 and Grid Lk. 5/-
- 'Phone Cords, 54 In. ... 1/3
- Do. 72 In. Double 1/9
- Variometer 250/650, 3/-, 3/6
- Do. Ebonite 250/650 3/11

- ### M.T. BATTERIES.
- 30 v. 4/8, 4/6
 - 36 v. 4/8, 5/6.
 - 60 v. 7/6, 8/6, 10/6.
 - Post 1/- extra.

- ### D.C.C. WIRE
- S.W.G. 1 lb.
 - 18 " 9d.
 - 20 " 10d.
 - 22 " 10d.
 - 24 " 1/-
 - 26 " 1/1
 - 28 " 1/3
 - 30 " 1/6
 - Post 6d. reel.

- ### ERICSSON E.V. type, World Famous Continental Head-phones, 4,000 ohms.
- 12/6
- Post 1/- per pair.

- ### VALVES.
- Marconi R. Ediswan Mullard O. Cossor P.1. Cossor P.2. Post 1/- each. 12/6
 - Phillips R. 7/11
 - French R. 6/11
 - No post Orders.

- ### SNIPS! EBONITE VARIOMETER
- 250/260, Ball Rotor. wound D.C.C. with knob 6/11
 - Post 1/-.

- ### VALVES.
- Phillips R. 7/11
 - French R. 6/11
 - No post Orders.

- ### SNIPS! EBONITE VARIOMETER
- 250/260, Ball Rotor. wound D.C.C. with knob 6/11
 - Post 1/-.

- ### SNIPS! EBONITE VARIOMETER
- 250/260, Ball Rotor. wound D.C.C. with knob 6/11
 - Post 1/-.

- ### N. & K. (The Goods)
- Best. Genuine.
- 4,000 ohms 12/9 Pair
- Post 1/- pair.

Super Condenser with Three Plate Vernier



"IT" for very fine tuning.

- .001 12/6
- .0005 10/6
- .0003 8/6

Registered Post. 6d. Set.

- ### FILOSTAT FOR D.E. & R. VALVES
- 2 v 40 a. ... 10/6 & 11/6
 - 4 v 40 a. ... 17/6 & 19/6
 - 4 v 60 a. ... 19/6 & 23/-
 - 6 v 60 a. ... 28/- & 33/-
 - 6 v 80 a. ... 35/- & 39/-
 - Post 1/8 each.

- ### LOUD SPEAKERS
- Sterling Baby 55/-
 - Sterling Floral 60/-
 - Amplion Junior 42/-
 - Slidpe Loud-Speaker, complete, 25/-
 - Post free.

- ### SNIPS! COIL HOLDERS
- Plug-in type, Ebonite, Brass fittings on base. 3/3
 - Two-way ... 4/6
 - Three-way ... 4/6
 - Post 1/- each.

- ### SNIPS! COIL HOLDERS
- Plug-in type, Ebonite, Brass fittings on base. 3/3
 - Two-way ... 4/6
 - Three-way ... 4/6
 - Post 1/- each.

- ### BASKET COILS
- Set of 6 ... 1/11
 - Set of 7 ... 2/3
 - 200/3,600 metres. Post 6d. set.

- ### WAXLESS.
- Set of 5 ... 1/11
 - Set of 6 ... 2/3
 - 200/3,600 metres. Post 6d. set.

- ### DULL-EMITTERS
- All makes in stock.

CALLERS ONLY

ALL POST ORDERS FROM OTHER COLUMNS

- Telephone, large each 1/6d.
- Telephone each 1d.
- Pillar 1d. & 1/6d.
- W.O. Patt. 2 for 2/6d.
- Large size each 3d.
- Various doz. 1/- & 1/6
- Valve Sockets doz. 10/6d. & 1/6
- Contact Studs doz. 4d.
- 2, 3, 4, 5, 6 B.A. Nuts 3 doz. 6d.
- 2 B.A. Rod foot 3d.
- 4 B.A. Rod foot 2/6d.
- Valve Pins 2 a 1d.
- Brass Bushes 1d.
- Spade Tags, best quality doz. 3d.
- Screw Spade Terminals ... 3d.
- Pin Sorew do. 4 for 3d.
- Stop Pins 2 a 1d.
- Plug and Socket pair 1/6d.
- Easifix Cup 1/6d.
- Switch Arms, with 12 Studs, Nuts and Washers 10/6d.
- English Flash Lamp Batt. doz. 4/-
- H.T. Batteries, 36 v. 4/9
- H.T. Batteries, 60 v. 8/6 & 10/6
- Filament Res., with Dial Set of Names (12) 5d.
- 0-300 Dial 5d.
- Scale (Engraved 0-180) ... 3d.
- Multiphone Terminals 9d. & 1/-
- Insulators, Egg 6 for 6d.
- Aerial Wire, 100 ft. 1/10
- Extra Hard Drawn, 7/22 100 ft. 2/4
- Valve Windows 7d.
- Res. Dials 0-100 4d.
- Ebonite Dial and Knob, 0-180 1/1 & 1/3
- Filament do. and Knob ... 9d.
- Filament Dial, 0-10 6d.
- Fixed Condensers to .001 10d.
- Do., .002 to .005, .006 1/6
- Ins. Sorew Eyes 1d.
- 4 Cats Whiskers (1 gold) 3d.
- Gold Whisker 1/6
- Shaw's Hertzite 1/-
- Zincite, 6d.; Bornite 6d.
- Coil Holders 1/1 & 1/3
- Coil Plugs, Ebonite ... 7d. & 9d.
- Do., on Base 1/- & 1/3
- Best Valve Holders 1/3
- 3 makes, above, 10d., 1/- & 1/3
- Tinned Copper, 16, 18, 20g. Sieeving, best 3 yds. 1/-
- Copper Foil ft 3d.
- Filament Res., good 1/6
- Rubber Lead-in 10 yds. 1/- & 1/3
- Bell Wire, D.C.C., I.R.O., 10 yds. 5d.
- Twin Flex 12 yds 1/6
- Heavy Rubber Lead-in yd. 2d. & 3d.
- Waxless (s) 200/3,500 1/9
- Basket Coils (6) 200/3,500 1/9
- D.P.D.T. Switches for Panel S.P.D.T. do. 1/8
- Telephone Cords 1/6 & 8d.
- Grid-Leak (2 meg.) 1/9
- Do., and Condenser .0003 1/-
- Empire Tape doz. yds. 9d.
- Adhesive do. roll 4d.
- A.A. Earth Clips 7d.
- Washers, 3 and 4 B.A. 3 doz. 2d.
- 100,000 ohms Res. 1/6
- Fine Variometers 2/6
- Engraving Set 7d.
- Enclosed Detectors 11d.

THIS LIST subject to alteration without notice.

RIGHT OPPOSITE DALY'S GALLERY DOOR

K. RAYMOND

27, LISLE STREET, W.C.2

PHONE: GERRARD 4637

HOURS OF BUSINESS: DAILY - - 9 to 7.45 SUNDAYS, 10.30 to 1

On Your Wavelength!

Lightning

IN my part of the world there has been thunder hanging about for the last four or five days, with vivid lightning flashes at times. For this reason I have not made much use of the receiving set, for, quite apart from any question of danger, there is not much pleasure in any reception which is drowned by a crackling roar of atmospherics. Atmospherics, as a matter of fact, seem to have come in patches. I mean to say that there were times when there was no sign of them, and then a little later they were tremendously powerful. Another curious thing is that they seem to have been very local in their effects. Possibly you were not worried by them at all, for a friend who lives in another part of the country tells me that there they have had hardly any.

If atmospherics are not strong it is generally a sign that they are fairly distant. In that case it pays often to lop off a high-frequency stage from your receiver, for if they are a long way off they may then be outside the range altogether and you will not hear anything of them. We get them at all times of the year, as you have probably noticed—they are sometimes particularly bad during a snowstorm; but the hot weather of summer-time is, of course, the chief season for them.

Be Wise

There is probably little or no danger of the aerial being struck by lightning even if a thunderstorm is raging right overhead; in fact, it is usually held that a properly earthed aerial is actually a form of protection against the effects of lightning. But this does not mean that it is advisable to use the receiving set when thunderstorms are near. When electrical disturbances are about, the aerial, if connected to the receiving set, is apt to become charged to a very high potential, and the passage of high-voltage currents through the inductances and condensers of the receiving set may do a great deal of damage.

There is one other point that is not always realised. When you sit with a pair of telephones on your head you are earthed, but they are not, and if they are of the high-resistance variety you can receive a pretty hefty shock from them should the aerial become highly charged up. In my young and foolish wireless days I had that experience once, and I certainly do not want it again. It felt exactly as if one had been hit on the head with a mallet.

The wise man, if he knows that there is thunder about, or if he finds upon switch-

ing on that atmospherics are frequent and powerful, switches off at once and earths his aerial. This is a simple precaution, but it is sometimes neglected. In the great thunderstorm which raged last year one or two idiots actually tried to use their sets, which in most cases were burnt out. The best way of earthing the aerial is to provide a large well-insulated switch outside the house. Another method is simply to hook the lead-in and earth wire together and to let them swing clear of the building.

The B.B.C.'s Experimental Station

If all goes well you will probably have heard something of the B.B.C.'s experimental transmissions from Chelmsford by the time that these notes appear in print. The wavelength is to be in the neighbourhood of 1,600 metres and the power used, I am told, will be round about 25 kilowatts. This being the case, I make bold to say that you will have very little difficulty in tuning in no matter where you live, provided that your set is so built that it can be loaded up to this wavelength. My only fear is that our old and tried friend Radiola will be blotted out whenever Chelmsford is working. I hope that this will not be the case, for Radiola's programmes are always thoroughly good, and one often turns to him for a change. However, we shall very soon know. Radiola, by the way, is also increasing his power, so that we shall possibly have a kind of battle of the giants in the ether.

This reminds one somehow of what took place in the States when broadcasting first started there. Every big firm wanted to have a broadcasting station, and most of them rigged up transmitters of some kind and put on programmes. Several towns had half a dozen or more, and as there was only one wavelength it was a case of shouting the other fellow down if you wanted your own transmission to be heard. American ships using spark transmitters used to work on the same lines, and when you heard signals like bugle notes drowning everything else on 600 metres you could be pretty sure that it was one of Uncle Sam's mercantile marine desiring to make its voice carry above the general din.

Picnic Sets

There will be a great demand this summer for the light portable set which can be taken about easily. Things happen so quickly in wireless that we are apt rather to lose count of time. How many people, for example, remember that last summer we had neither the "06" valve nor the Wecovalve. There was, in fact, no valve on the market advertised to work

off dry cells. Hence, if you wanted to enliven your picnic party with wireless music you had to take a 30-lb. accumulator along with you. These things are bad enough, to carry even when it is cool, but on a hot day their weight seems more like 300 lb. than 30 lb. if you have to lug them any distance from a car or from the carrier of a motor-cycle to the spot chosen for the picnic.

Now that dry-cell valves are available you can rig up quite a big set which will not be at all heavy. With a frame aerial or, better still, with a piece of insulated wire attached to a near-by tree, such a set will give you all the broadcasting that you want on a small loud-speaker. With a couple of stages of high-frequency you can do without the aerial altogether within a dozen miles of a broadcasting station, which is a still further convenience.

American Reception

I think we may say good-bye for a few months to most of the U.S.A. broadcasting stations, for light evenings do not go well with Transatlantic reception, and atmospherics are likely to grow worse and worse as the summer draws on. KDKA, however, the powerful East Pittsburg station, still comes in pretty well, though one is beginning to notice a good deal of wobbliness in his transmissions, due probably to electrical disturbances.

The great thing about KDKA is his enormous strength on 100 metres. If the outside aerial is bringing in lots of atmospherics and mush from big stations, you can generally get KDKA on a piece of bell wire stretched across the room provided that you use two efficient stages of high-frequency amplification. KDKA's power is 15 kilowatts, so that he will be quite outclassed by Chelmsford's transmissions. I cannot somehow think that Uncle Sam will consent for long to the biggest broadcasting station in the world being situated in some other country. I expect that we shall hear shortly of a new 100-kilowatt transmitting station, and when that happens the complaints about American jamming on our own broadcast wavelengths will be heard everywhere: "I simply could not hear a thing from 2LO last night on account of that wretched Yank, who simply drowns him!"

Amateur's Successes

Some weeks ago I mentioned that amongst other amateurs 2KF had gone to the British Broadcasting Company. I now learn that 2KF did a large amount of work in connection with the relaying of the King's speech at the opening of the

On Your Wavelength! (continued)

British Empire Exhibition. We all know how successful was this experiment.

2 E H, the Edinburgh station of the B.B.C., carried out certain tests recently, and a number of London amateurs were asked to furnish reports on the transmission. The signature at the foot of the postcard addressed to these amateurs was that of Mr. B. Honri, better known as Harry Why, whose station is well known. He is now development engineer to the B.B.C.

Amateur Musical Transmissions

The amateur since the advent of broadcasting has been in the background as regards musical transmissions, with the exception of a few misguided persons who have attempted the impossible by means of ordinary carbon-granule microphones. Lately, however, one or two amateurs have devoted more attention to this part of transmission, and the result is that from one or two stations music has been transmitted almost equal to that of the B.B.C. In the pre-broadcast days we sat and gloated over any scratchy old gramophone record which condescended to beat against our aerial, but now we have become very much more critical. The music of 2 M T, of Writtle fame, would not now please our critics, although in those days it was one of the "star" turns of the week—the evening on which our catwhiskers were tickled up to the last micro-microampere and our valves and tuning coils pressed to their utmost. Most, if not all, of these transmissions were put into the ether via an ordinary Peel-Connor solid-back microphone. These things happened only a matter of two years ago, and now we are content only if we do not detect any resonance, etc. etc. in the transmission.

Research and Experiment

There is a belief that a tremendous amount of expensive research and experiment are necessary before the amateur can transmit passable music. Now whilst we hear stories of a supersensitive magnetophone and ten to twenty stages of low-frequency amplification, hot-wire microphones, condenser microphones and what not, I suggest that most amateurs have in their possession a music microphone which will, with the aid of certain additions, transmit quite good music. I refer to the Brown A-type receiver earpiece. This with the addition of a suitable low-frequency amplifier and the addition of a paper diaphragm, as referred to in my recent notes on loud-speakers, will transmit music and speech of a very excellent quality. There is ample room for experiment with a transmitting microphone built on these lines, and the possibilities are sufficiently tempting to justify the expenditure of time and money on the necessary gear.

The Amateurs

Amongst those who have recently achieved a certain amount of success with musical transmissions are 2 Q C and 5 F L and 5 D T. 2 Q C, by the way, appears to be somewhat of a mystery station, as his call sign does not appear in the directories of signs (B.B.C. experimental station, Hendon.—ED.). 5 F L increases in volume as time goes on and becomes more noticeable week by week. 5 Q V also appears to increase in volume week by week.

Now that the Post Office has put aside 115 to 130 metres for amateur use, those transmitters who have devoted so much time to this band of wavelengths will have the laugh over those who have so rigidly adhered to the 440-metre wave. It is comparatively easy to transmit on short waves, of course; the difficulty lies in the reception, and those who have persevered with 100-metre reception will have cause to feel pleased with themselves at no distant date.

Abolishing the A.T.I.

An inquiring mind may often be a source of trouble to its possessor. The other day your THERMION asked himself why it was necessary to use two or even three tuned circuits in an ordinary tuned-anode set. If the tuned coil connected in the plate circuit of the first valve is a rejector of all signals to the wavelength of which it is not tuned, why was it necessary to tune the aerial as an acceptor of the wanted signals?

Obviously the answer was "Try it out and see for yourself." Following up the idea, the aerial lead-in was connected straight to the grid of the first valve with no intervening inductance or capacity. The earth lead-in was connected to the negative side of the filament. The set oscillated readily and strong C.W. and spark signals were easily tuned in on 600 metres. Tuning seemed rather more critical than usual. Experiments on higher and lower wavelengths gave equally satisfying results. I saw myself taking rank as one of the great scientific discoverers of the day.

Anxiously I awaited a broadcast transmission, and when it came eagerly tuned in. Hurray! There it was. Good, clear speech. Then music. But tuning was very critical and oscillation gave some trouble. However, it was a relief to find that by none of the usual tests was there any indication that the aerial was being energised. But broadcasting was not so strong as with the usual aerial tuning. The idea is there. You have a present of it, you people who have the experimental bias. It can be done, and it may be capable of being worked up into something good. I suggest a variable grid leak and a variable grid condenser as one line of

inquiry. I have no time to work at it myself, but I hope someone will tackle it and let me know the results. I have raised the hare. Someone else can chase it.

The Wind on the Aerial

Experimenting with very small coils the other day with the idea of getting the 50- and 25-metre tests that are being sent out by F L at the end of the month, I had an experience which may, possibly, have come to others, but which I have never had before. I actually heard in the phones the sound of the wind in the aerial. There wasn't the slightest doubt about it. I couldn't hear it without the phones, and I couldn't hear it with the aerial cut out or with the set cut out. In some mysterious way that beats me altogether the audio-frequency oscillations, or vibrations, of the aerial wire caused by the wind pressure were clearly to be heard. The sound came in only so long as the set was not oscillating. Radio-frequency oscillation seemed to kill it at once.

The Worship of the Foreigner

It must be admitted that no other country worships the foreigner in its midst like England. Notwithstanding the fine singing of all the British opera companies during these last few years, it is humiliating to think that our national opera house was not filled until German singers were to be heard again. Though comparisons are odious, we believe that when listeners-in hear both companies, as they are likely to do over the ether, they will prefer the "home-made supply."

It is good to know that the British National Opera Company will be at His Majesty's Theatre from June 5 and that many of their performances will be broadcast again.

Query Night at 2 L O

I should imagine that the prize offered by the B.B.C. (free admission to the studio) for guessing a missing programme was quite safe in the hands of the awarders. A plebiscite programme is one thing, but the ability to guess over such a wide field as music offers would demand second sight. Why not find out how many of the interminable "talks" could be cut out. That would be really useful.

Old Memories Revived

These were pleasant and unpleasant. 2 L O recently gave us the inimitable comedian, Charles Coborn, whose songs, "Two Lovely Black Eyes" and "The Man Who Broke the Bank at Monte Carlo," were the outstanding music-hall favourites of Victorian days. Aberdeen went to the other extreme by including the "Carillon" (1914) of Elgar and in closing down for "one minute" to mark the torpedoing of the *Lusitania*, May 7, 1915. THERMION.

A BROADCAST RECEIVER WITH "EVER-SET" CRYSTAL.—III

WIRING up, using the No. 22 enamelled-copper wire covered with insulated sleeving, may now be proceeded with. Connections should be as short as possible consistent with keeping the wires a reasonable distance apart; care should be taken that no wires foul either the tuning-coil slider or the potentiometer slider.

Fig 17 shows the actual connections at the back of the panel, while the theoretical circuit diagram of the set is shown by Fig. 18. For the convenience of readers who have difficulty in understanding either of the diagrams mentioned the following list of connections will simplify the work:

- (1) Aerial terminal to (a) crystal cup of detector, (b) clamping arm end of tuning coil winding.
- (2) Earth terminal to (a) one connecting screw of loading coil holder, (b) one phone terminal, (c) one terminal of fixed condenser.
- (3) One of tuning-coil slider spindle bushes to remaining connecting screw of loading-coil holder.
- (4) Potentiometer slider spindle bush to (a)

panel to the containing box and test as follows: Place the loading-coil short-circuiting plug in the coil holder as shown in Fig. 14. Connect a pair of high-resistance (4,000 ohm) phones, aerial, earth and the 4½-volt dry battery to their respective terminals, the positive lead of the battery being joined in the first place to the terminal in the near left-hand corner of the panel. Turn the tuning-coil slider-control knob in an anti-clockwise direction until the slider is at the end of its travel away from the panel, and adjust the needle of the detector so that a firm but not too heavy contact is made with the crystal.

Switch on the current and begin to turn the tuner-slider knob in a clockwise direction; at every few turns of the tuner knob move the potentiometer control slowly from 0 degrees to 100 degrees on its scale. Continue these operations until signals are heard and brought to their loudest in the phones. If tuning has been adjusted to its maximum without signals being heard the whole procedure as outlined above should

found no more adjustments will be required, and all that is required when using the set at future times is to switch on the battery current. Do not forget to switch off when leaving the instrument.

When tuning in signals on long wavelength the loading-coil holder short-circuiting plug should be removed and a plug-in basket or honeycomb coil of suitable size inserted; fine tuning is then carried out as before by adjustment of the tuner control knob.

A. P.

(Conclusion)



CRYSTAL RESULTS

USING a crystal set consisting of a variometer in series with a tapped coil, and a hertzite crystal in conjunction with a No. 40 s.w.g. copper catwhisker, the writer has received concerts from Newcastle, Birmingham, Eiffel Tower, Radiola, l'Ecole Supérieure and Lympne. The speech is distinct, and concerts from the Radiola and Eiffel Tower can be heard

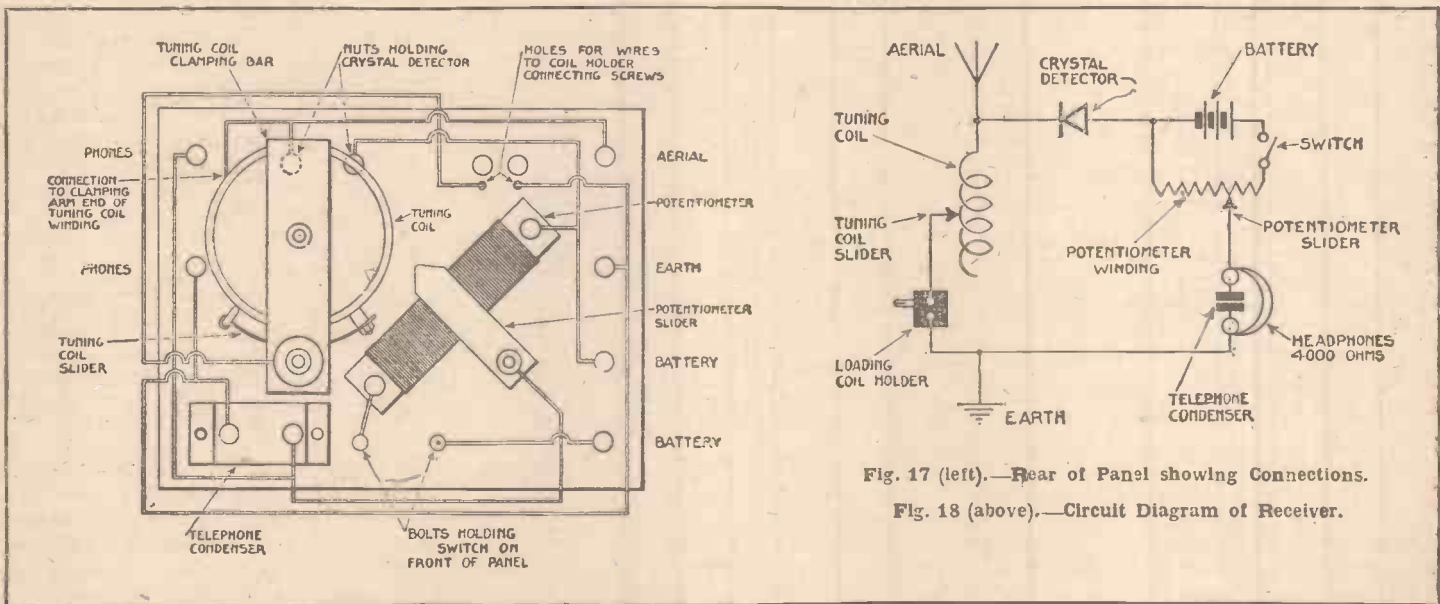

Fig. 17 (left).—Rear of Panel showing Connections.

Fig. 18 (above).—Circuit Diagram of Receiver.

- (5) Post of crystal detector to (a) one battery terminal, (b) terminal clamping end of potentiometer winding farthest from tuning coil.
 - (6) Terminal clamping remaining end of potentiometer winding to one contact plate of switch.
 - (7) Remaining contact plate of switch to remaining battery terminal.
- On completion of the wiring fasten the

be gone over a second time but with the battery connections reversed; although most carborundum detectors work best with a positive connection to the crystal it is quite likely that the reader may have obtained a crystal requiring a negative connection. Once the correct tuning adjustment has been determined experiments may be made with the detector—in conjunction with the potentiometer—to find the best setting for the particular crystal and needle contact; when this has been

with the phones 6 in. from the head. The aerial is 50 ft. high and the earth consists of three 7/22 wires leading to a zinc plate measuring 4 ft. by 6 ft. at the bottom of a well.

E. A. G.

We Give Away a Sixpenny Booklet
Next Week

Tell Your Wireless Friends.

Perikon Detector with Inter-changeable Cups

A SOMEWHAT novel feature is introduced in the simple perikon detector described below, namely, the interchangeable and adjustable crystal cups. The design permits of a variable selection of "points" over a large area of crystal surface, and the mounted crystals can be disconnected and replaced by others without the least trouble or delay.

The materials and parts required to build the instrument comprise a few pieces of brass and odd fittings. It is advisable to have at least four crystal cups so as to

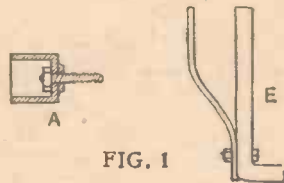
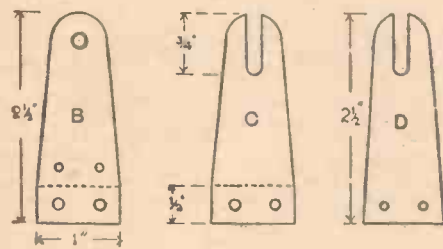

FIG. 1

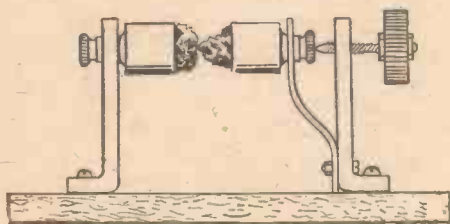

FIG. 2

Fig. 1.—Parts of Detector. Fig. 2.—The Complete Detector.

have a spare of each as a stand-by. The crystals recommended for use with this detector are copper-pyrites and zincite; a point of the pyrites should engage a flat face of zincite. Mount the crystals in the usual way, but first remove the screw from the base of the cup and substitute a small terminal as shown at A in Fig. 1, locking it on the outside with the collar and on the inside with a small nut.

Obtain a piece of sheet brass not less than 1/8 in. in thickness, cut out the two pillars B and C (Fig. 1), and bend at right angles at the dotted lines.

The holes at the base should be drilled to take round-headed wood screws and the two smaller holes in B to take two small bolts or ordinary contact studs. The hole at the top must be tapped to take the

detector screw, which is usually a 2 B.A. thread. An alternative method is to drill the hole slightly larger than the diameter of the detector screw thread and solder on a nut previously filled with clay to prevent the solder adhering to the thread. Cut out the slot in C, and see that the terminal shank can slide freely in it. D is similar to B, but it must be of thin spring brass; the two small bolt holes must correspond with the two small holes in B. The base of D should be flush with the dotted line. Bolt D firmly to B and bend to the shape shown at E. Next slide in the crystal cups and mount the two parts on a suitable base.

Connections

The connections are made from the wood screws (Fig. 2), or the wire leads can be soldered to any convenient part of the pillars—one from each. Terminals can be mounted on the base if required, but if the instrument is to be permanently installed on a receiving set they would be an unnecessary expense.

Exploratory movements of one or both crystals are obtained by slacking back the milled terminal nuts and revolving or sliding the crystal cups either up or down. The success of this detector depends upon the correct pressure being applied to the crystals, and with careful handling the results should be thoroughly satisfactory.

O. J. R.

A NOVEL TUNER

THE following particulars of a tuner that is operated on rather unusual lines may be of interest. The objects that dominated the design were efficiency combined with ease of manipulation and construction.

The circuit employed, an experimental licence permitting, was the ordinary autodyne, which is as capable of use as of abuse, although we hear most of the latter.

The A.T.I. is of basket coils which combine a very high degree of efficiency with cheapness.

The writer has always found that the great objection to this form of inductance is the risk of fracture of the fine composing wire and a certain difficulty of becoming aware of the breakage.

The method is as follows:

The tuner is composed of a wooden cabinet of the following dimensions that are useful but not arbitrary.

Depth, 8 in.; length, 15 in.; breadth, 10 in.

One end, lengthwise, of the cabinet is slotted vertically in the manner of a photographic dark slide. The top also slides in grooves. The top is further slotted to within 1/2 in. of each end, the purpose of

which will be explained later (Fig. 1 and Fig. 2).

The basket coils are then mounted, and this is conveniently done with a circle of cardboard and a small wood screw, on a wooden slide that is eventually to fit the slots made in the end of the box. The wood slide on which the basket coil is mounted thus forms the slide of the photographic simile. The ends of the basket coil are connected through the back of the slide to the wall-plug socket as used in electric lighting. The coil of the A.T.I. is then self-contained, while the leads from the aerial and earth of the wireless set are connected to a wall plug (Figs. 3 and 4). Thus all that is necessary is to slide in the coil and plug in the leads from the instrument.

Now for the reaction coil. The best results are obtainable from a suitably wound hard-wood former as used for the inner part of the variometer. In fact, this

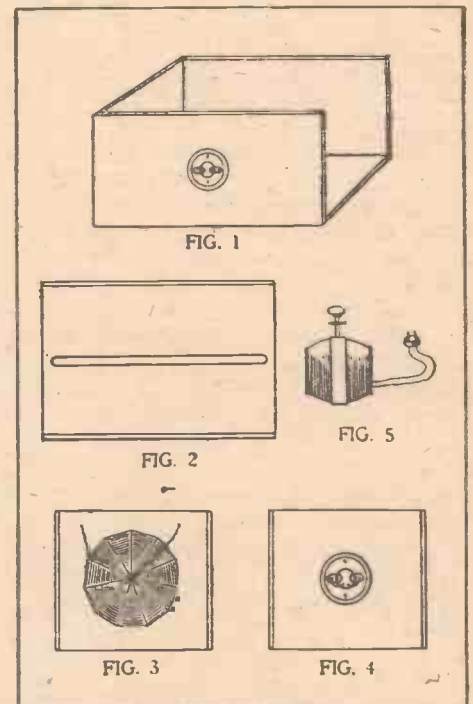

Fig. 1.—Case. Fig. 2.—Lid of Case. Fig. 3.—Basket Coil. Fig. 4.—Mounted Socket. Fig. 5.—Reaction Coil and Plug.

form of tuning is preferable (Fig. 5). The purpose of the slot in the cover is to permit the reaction former to travel nearer to or farther from the A.T.I.

In this way the coarser tuning may be effected and the finer by revolving the reaction former.

The two terminal wires of this former are similarly attached, an ample length of flex permitting, to another wall-plug socket mounted on the outside of the cabinet. The reaction leads are incorporated in a wall plug. It will be seen that, if by chance the A.T.I. and reaction coils are mounted in the wrong relative sense, it is merely a matter of seconds to change by withdrawing the reaction plug and re-plugging the other way up.

WALTER MEADE.

INTERFERENCE ||| ITS ELIMINATION IN LONG-DISTANCE RECEPTION

NO other phase of wireless science has received such concentrated attention during the last few months as has the problem of interference and measures to reduce or eliminate it. In the quest of making receivers more selective the skill of the foremost wireless men has been enlisted, and the gratifying results of their investigations are shown in the greatly improved receivers of to-day.

Types of Interference

There are several types of interference, ranging from that caused by ship-to-shore communications and radiating receivers down to inductive interference caused by other electrical apparatus operating near the receiver. There is one aspect of the interference situation, however, which does not seem to have engaged the attention of many amateurs themselves, yet it is a very serious one.

It is quite safe to assume that fully 50 per cent. of the wireless enthusiasts in this country are fascinated by the lure of DX, or long-distance reception. They are not all content to listen to the local programme, but—sighing for fresh worlds to conquer—they reach out for the elusive distant stations. A large number of them even disdain the regular distant transmissions, which can be obtained with a certain degree of regularity and ease, and are only content with those which are less often received.

To accomplish this they find it necessary to get their sets into the most sensitive condition possible, irrespective of the type of receiver they may be using, and they concentrate to the utmost in bringing in anything which they may happen to hear.

Directional Effects

In these circumstances it is quite possible that they may obtain the carrier wave of a station fully 2,000 miles away. On regenerative sets the presence of the carrier wave is readily detected, although the amount of energy that is picked up may not be sufficient to enable them to bring in the modulated current accompanying the carrier wave.

This is all very well, but they overlook one thing: They do not take into consideration the fact that while they have placed their receiver in this supersensitive condition to respond to the carrier wave which is being generated 2,000 miles away in a certain direction, the set is also in a condition to receive from an equal distance on the same or an approximating wavelength in any other direction. This is assuming, of course, that an outside aerial is in use; a frame aerial with its more pronounced directional properties would make a great difference. But until the

actual receiver is made directional the foregoing effect must naturally continue to obtain.

Thus it may happen that a ship 2,000 miles away, conversing with another station by means of code on a wavelength similar to that to which the receiver has been adjusted, will also be received and will cause the interference complained of. If the ship happens to be using a spark transmitter, interference will be more pronounced and may, if the frequency of the spark is very low, be put down by the operator of the receiving set to atmospheric or to noises in his set, when in reality they are signals coming from a station 2,000 miles away. Of course the ability to read Morse would quickly determine which is the real fact, but only a small percentage of present-day amateurs can boast of that accomplishment.

Similarly, another source of interference under these conditions may readily come

from another broadcasting station widely separated from the one which the operator is trying to receive but working on a wavelength close to it. Transmitting stations which in themselves are separated by 3,000 miles of territory may in this manner cause interference in a receiving set.

All these conditions should be taken into consideration by the amateur who aspires to receive the distant stations. He should also recognise the fact that no set is really "foolproof." If a receiver is capable of bringing in signals over long distances, it is also capable of radiating to the annoyance of his wireless neighbours. To obtain the supersensitive condition referred to, the valves must necessarily be on the brink of oscillation, and the slightest adjustment of reaction or tuning may cause them to overstep the margin. The motto is therefore obvious—use a little intelligent discrimination when searching for DX.

A. J. B.

BOSPHOR PRONZ BROADCASTS ON LIGHTNING

LIGHTNING, ladies and gentlemen, was originally a term of endearment applied to messengers in Government offices. The word, however, is no longer applicable in this sense, and it is at present used solely to denote a visible or invisible discharge of electricity through the air. Most frequently, this electrical discharge takes place between two clouds, the silver linings of which act as the plates of a large condenser. Less frequently a lightning discharge takes place from a cloud to the earth, and on such an occasion it is advisable to make use of the most rapid means of transport to the next parish.

The chief interest with regard to lightning and wireless lies in the noises which lightning is supposed to cause in our telephone receivers and loud-speakers. Distant lightning and faulty batteries both make the same kind of banging and crackling noises in our telephones. Most listeners-in, however, prefer to put the blame on lightning and so save the cost of new batteries.

In my professional capacity, three-nights-three-variable, I have often been asked what would really happen if lightning struck a wireless aerial fairly and squarely. My reply has always been that, if such a thing did actually happen, there

would be no aerial left to tell the tale. The aerial wire would undoubtedly fuse, refuse and end in smoke. The spreaders would go off like Chinese crackers, and the insulators would come undone in the manner of eggs in an incubator. Viewed from the safe distance of a couple of suburban gardens, an aerial struck by lightning would be a pleasant spectacle.

The noises made in our telephones, ladies and gentlemen, by distant lightning are officially divided into three kinds, known and distinguished from each other by the names clicks, hisses and grinders. The first kind, clicks, are similar to clicks in other branches of life, but they are not to be connected in any way with clix. The second type, hisses, may possibly be confused with the curious noises made by an audience when expressing strong disapproval of the efforts of an artiste. The third kind, ladies and gentlemen, are, like bananas, of tropical origin.

"Wireless Telegraphy :: and Telephony" ::

The most Practical Handbook for the Amateur. The price is 1/6 net.

Cassell & Co., Ltd., La Belle Sauvage, London, E.C.4

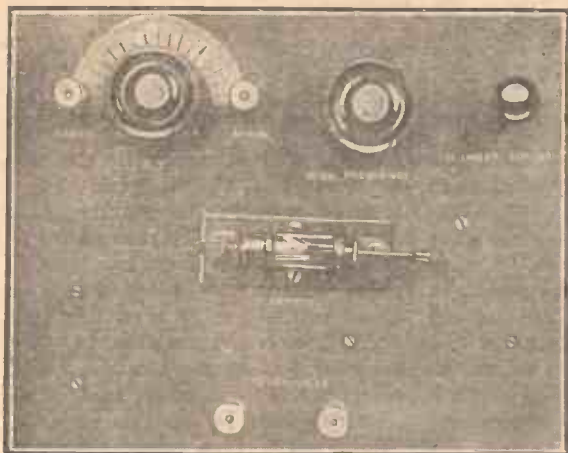

Front View of Panel.

A PORTABLE ALL-S

This set has been specially designed for those readers of "A.W." who desire a receiver for outdoor use. Some of



View showing Arrangement

IN view of the approaching fine summer weather, with its attendant open-air picnics and other festivities, the writer set to work to design a valve receiver, inexpensive in first cost and upkeep, portable, easy to manipulate, and sufficiently sensitive to receive a B.B.C. station within a 30-mile radius without a really good aerial or earth. The set about to be described is the result. With it all British broadcasting stations, the Ecole Supérieure concerts and much shipping and other traffic has been received on an open aerial 32 ft. high, situated 10 miles from 2 L O. 2 L O was received at good strength on a loud-speaker consisting of a Brown 4,000-ohm earpiece screwed into the base of a composition trumpet. It was also loudly and clearly received in the phones with an aerial 10 ft. long strung up indoors and an earth connection, and also with an aerial 7 ft. 6 in. high and 40 ft. long strung up outdoors with no earth connection. The set was taken 15 miles out, and an insulated wire with a weight attached to the free end flung over a tree by the side of the road, and an earth connection made by driving an iron peg 3 ft. into the ground; 2 L O was still received at excellent strength in the phones. A portion of a barbed-wire fence was utilised as an aerial at the same spot, and loud signals were also received on this.

For the Picnicker

The set, therefore, is an ideal one for people of limited means who indulge in country rambles, or who possess a motorcycle and make a habit of picnicking during the summer months. It is also useful to those people who desire only to listen-in to occasional concerts, perhaps once or twice in a week and to whom accumulators are a worry. The circuit, unlike the Flewelling or other regenerative circuits, is easy to manipulate, and the veriest novice will find it within his powers.

The valve used on the set is a Weco-valve, but other dull-emitter valves would

serve equally well. The first cost is high, but the economy in current and long life of this type of valve (approximately 1,300 hours) make it an economical proposition.

Protecting the Valve

As considerable jolting is probable with a portable set, some precautions have to be taken in order to protect the delicate valve filament from sudden jolts and jars. Suspending the valve in the case by means of elastic was first tried, but this took up rather a large amount of room, and it was found that an extra hard jolt caused the valve to rebound on to the side of the case, with disastrous results. The method finally adopted was to make a small stiff cardboard box sufficiently large to take the bulb of the valve and a portion of the cap (Fig. 1). The box was almost filled with cotton-wool, comfortably and yet not tightly packed, and the valve was forced into this pip first, the pins projecting from one end. The cardboard was then fixed to the panel by means of a thin fillet of ebonite, as shown in the illustration; the valve socket was fitted to the pins, and a small retaining strip of fibre or cardboard passed over the end between the valve pins, and glued to the side of the cardboard box, in order to prevent the valve from slipping. Flexible leads were carried to the legs on the valve sockets, and the result was a shock-proof valve, which nothing short of a deliberate drop on to a hard floor will break. The fact that the valve is enclosed in the wool has no detrimental effect upon it, as there is very little heat generated when the filament is glowing. The question of inspection of the filament does not arise, as with the resistance to be described and a dry battery there is no danger of over-running the valve, so that even the beginner need not worry over this point.

Photographs of the front and rear of the panel are shown. In these photographs the shock absorber has been detached, and the valve fixed to the panel in a normal manner. It will be noted that the H.T. and L.T. terminals are fitted to an ebonite strip, which is screwed to the under side of the panel.

The Panel

A piece of ebonite $\frac{3}{8}$ in. thick is prepared and drilled in accordance with the sketch (Fig. 2). Should it be desired to engrave the panel, this should be done before the components are mounted; alternatively very good transfers are now available, which are readily fixed with a little care. These are used in the set shown in the photograph.

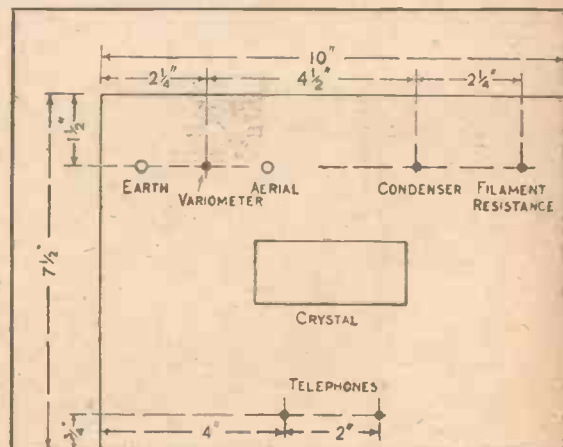

Fig. 2.—Lay-out of Panel.

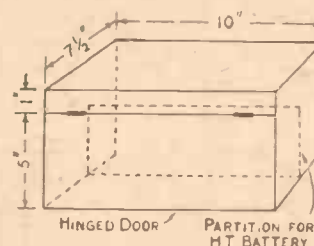

Fig. 3.—Details of Case.

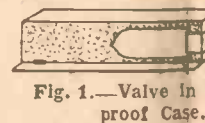
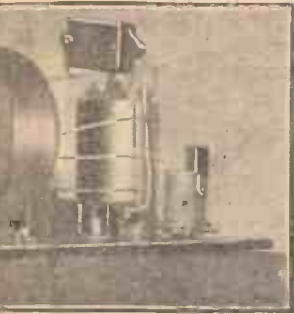
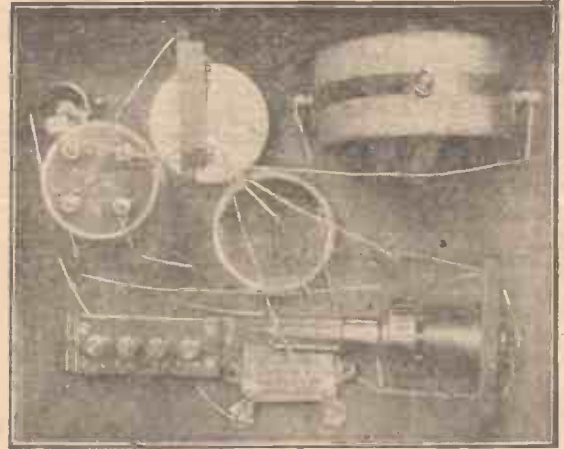

Fig. 1.—Valve in proof Case.

STATION RECEIVER



its features of advantage are portability, low cost, robustness, long range, stability and easy operation.



Rear View of Panel.

Arrangement of Components.

The Case

Details and the dimensions of the case of the instrument are given in Fig. 3. These are inside measurements. The door is provided on the front of the instrument, so that the high-tension battery may be placed inside. The low-tension battery is not placed inside, as this is easily carried in the pocket or picnic basket.

The Variometer

Particulars of the dimensions of the formers, etc., are as follow: Stator (outside coil), 3 in. in diameter by 1½ in. wide; rotor (inside coil), 2¾ in. in diameter by 1 in. wide.

Coil Winding

Stator, 42 turns of No. 28 d.c.c. wire

wound each side, with space of ⅝ in. in centre; rotor, 24 turns of No. 28 d.c.c. wire wound each side, with space of ⅝ in. in centre.

Both coils are wound in the same direction, and the end of the stator coil is joined to the beginning of the rotor via the spindle. The end of the rotor coil is joined to the remainder of the circuit in the instrument via the other spindle. A phosphor-bronze spring, which makes a bearing contact on a washer, with a strip of copper-foil with a hole in its centre, is placed between it and the ebonite panel.

The variometer is secured to the panel by means of two strips of brass, which are screwed to the ebonite stator former and the panel (see centre photograph).

ever, that these are now unobtainable except in certain districts where a stock remains, a new type having been introduced. This new type is larger, so that it will be necessary for the constructor to make one himself if he is unable to obtain one of the old type.

A sketch of a modified design is shown by Fig. 4. The ebonite former is a piece of ⅞-in. tube 1¾ in. long. It is wound with 22 turns of No. 20 bare Eureka resistance wire in a spiral groove cut in the ebonite tube.

Fixed Condensers

Dubilier .002-mfd. condensers are used.

Crystal Detector

A suitable detector may be purchased quite reasonably. A good piece of hertzite should be used in conjunction with a piece of Eureka or similar resistance wire. It should be noted that the moving parts of the detector are light.

Phones

Good-quality phones of about 4,000 ohms resistance should be used. Those used by the writer were ordinary phones which have been rendered supersensitive by the simple expedient of adjusting the packing washers until the diaphragm is very close to the magnets. Should adjustable phones such as the Brown A-type be obtained, this procedure is unnecessary, but it will generally be found that the common non-adjustable type can be considerably improved in sensitiveness by resorting to the simple expedient above mentioned.

Circuit

The circuit used is shown by Fig. 5. It will be noted that it is of the dual or reflex type with crystal rectification. No intentional reaction is embodied in the instrument, but a certain amount may be obtained by placing a .002-mfd. fixed condenser in series with the earth lead.

The cost of this set, using purchased components throughout, inclusive of the valve and dry batteries (40 to 60 volts H.T.), need not exceed £4. A. J. C.

Tuned-anode Coil

This H.F. coupling device consists of a coil of 70 turns of No. 36 s.s.c. on a 2-in. diameter cardboard or ebonite former.

H.F. Tuning Condenser

This is the Baly type, and may be purchased for two or three shillings; alternatively it may be built from two 2-in. discs of sheet aluminium. A thin piece of mica is fixed to one of the plates by means of some adhesive, in order to insulate the plates one from another when they are adjusted in close proximity and also to increase the capacity.

Intervalve Transformer

The transformer shown in the photograph is a G.R.C. "Audio-former," and this has been found to give excellent results in the circuit used. Others may function equally well.

The Filament Resistance

The resistance shown in the photographs is a Mullard resistance, made specially for use with the Wecovalve. It is understood, how-

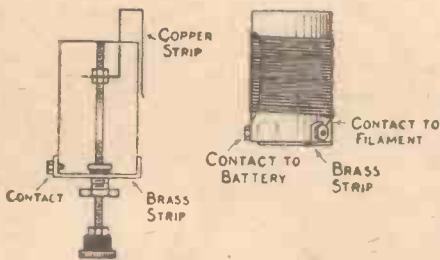

Fig. 4.—Filament Resistance.

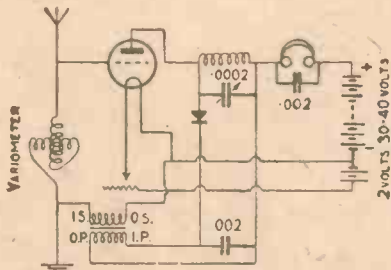

Fig. 5.—Circuit Diagram.



Shock-

AROUND THE SHOWROOMS

Vernier Crystal Detector

DELICACY of adjustment and cheapness are two great points about the new "Maxwellton" vernier crystal detector. As can be seen from the photograph, the cat-

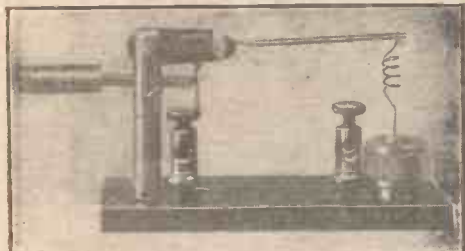

"Maxwellton" Crystal Detector.

whisker arm has attached to it vertically a small projection against which an adjustable screw presses. Any movement of the screw results in fine adjustment of the catwhisker pressure.

It will be seen that the catwhisker-arm supporting pillar is divided in the middle; the whole arm turns from this point, as it simply plugs into the part attached to the base. Altogether a very neat job. Each detector is supplied in a box, complete with crystal, for as little as 3s. 6d., by the Maxwell Radio and Optical Co., of 61, New Oxford Street, W.C.1.

Brighter Loud-speakers

THERE is no doubt that from an æsthetic point of view the average loud-speaker leaves a great deal to be desired, although many improvements have been made in this respect during the past few months.

Evidently the Western Electric people have realised this shortcoming, and as a result have standardised eight decorative designs, these being as follows: Chinese pagoda, peacock, Eastern spiral, nasturtium, sunflower, Chinese dragon, carnival and grape vine.

Loud-speakers are only finished in these designs to order, each instrument being hand-painted. The range has been designed to provide a pattern that will



Loud-speaker in Peacock Design.

harmonise with almost any existing style of furnishing. The Western Electric Co., Ltd., of Connaught House, Aldwych,

W.C.2, publish a fine brochure containing reproductions of these designs in colour.

Another Crystal Detector

THE photograph shows the method adopted by Burndept, Ltd., of Aldine House, Bed-

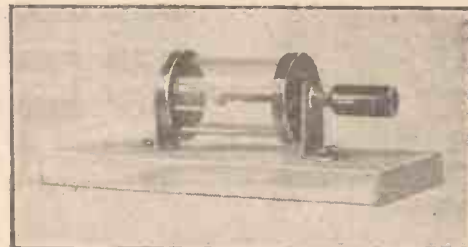

Burndept Crystal Detector.

ford Street, Strand, W.C.2, in sending out their crystal detectors. Each instrument is fixed to a wooden base and packed in a carton; a paper drilling template is also provided, thus saving the amateur a great deal of time and bother. A special form of catwhisker adjustment is used.

Fine-tuning Device

WHILST out the other afternoon I came across a neat little vernier device, suitable for use with a bevelled dial, in the wireless department of the Service Co., Ltd., of 273-274, High Holborn, W.C.1. It is similar to the circular-eraser type of vernier used by some amateurs, and is known as the "Fynetune" adjuster (price 2s. 6d.). As it can be fitted to existing sets without any difficulty, it should be appreciated by many amateurs.

VANGUARD.

PROGRESS AND INVENTION

Variometers

THE greatest drawback to the more extensive use of variometers is their somewhat limited tuning range. But now

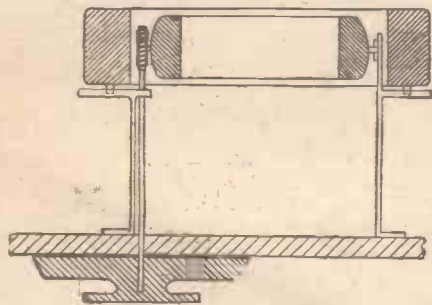

Interchangeable Variometer (No. 213,069/24)

even that difficulty has been overcome, for Patent No. 213,069/24 (W. H. Hunter, of Holywood, Ireland) proposes the con-

struction of variometers and variocouplers in which both coils are interchangeable. The principle of the arrangement is clear from the diagram. Any convenient method of adjusting the moving coil can be used; a suitable form of control is shown.

Improved Circuit

OF especial interest is a proposed arrangement for applying reaction without any possibility of re-radiation. A form of three-coil tuning is employed, the secondary being untuned. The primary and reaction coils are arranged with their axes at right angles to one another so that there is no coupling between them. The secondary is so adjusted that it is coupled to both primary and reaction, but

no re-radiation takes place. The circuit arrangement for one stage of H.F. amplification is shown. Combined electrostatic and electromagnetic coupling is used, reaction being controlled by a variable condenser in series with a resistance. This

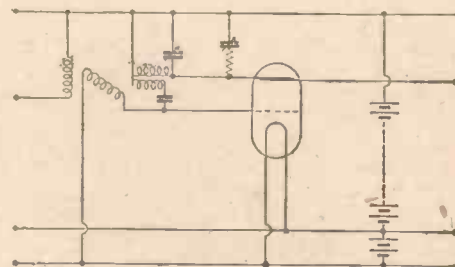

Improved Circuit (No. 213,699/24)

arrangement is the subject of Patent No. 213,699/24 (P. G. A. H. Voigt, of London, S.E.23).

Ask "A.W" for List of Technical Books

Crystals in Valve-crystal Sets

QUITE a lot could be written about crystals and their relative qualities in valve-crystal sets, and it is surprising that discerning amateurs do not more frequently put on record their observations of the functioning of various crystals in valve-crystal circuits, especially in view of the great help such data can be to others.

Variation

As examples, the writer will state briefly a few observations he has made during the last few months. It may not, for instance, be generally known that a really good crystal that gives excellent results in a simple crystal-detector receiver may be almost useless on a valve-crystal set. Some crystals that give only mediocre results in the plain crystal set will give excellent results following a stage or two of H.F. amplification, while others will function equally well in either kind of receiver. There are still further varieties which, while functioning well if following one stage of H.F., will become unstable if a second stage of H.F. is imposed on them.

Certain crystals will give good results only in a "straight" circuit set, some only when rectifying in "reflex" receivers, and still others only when used in sets employing reaction; but these latter seem to be few. This dividing and subdividing can go even further, for it is often the case that two crystals of the same make, possibly of the same batch, will function differently in the same circumstances. Some varieties seem to vary but little, while others do so to a considerable degree.

Increased Volume

Users of valve-crystal sets would be well advised, if they have not already done so, to try a number of crystals of different makes, and even of the same make. The catwhisker also may be varied and the changes of a number of different contacts rung on each crystal.

Apart from the fact that a crystal which, although it is "sensitive all over" in a simple crystal set, seems to have only one really sensitive spot in ten when used on a valve-crystal receiver, a striking illustration of the difference that exists between crystals is that of two now in use on a two-valve reflex set. This set is so arranged that reaction on the A.T.I. can be employed in DX work (other than B.B.C. stations, of course), and the difference between these two crystals is remarkable. Receiving the local station,

either crystal gives good service, though one is, perhaps, slightly more efficient than the other. This difference, however, can be made good by retuning very slightly, after which it is hardly apparent. Using reaction, however, on weak distant stations it was found that what was a sensitive spot for a local station was not necessarily a good one for a distant station brought in by reaction; it became clear that the crystal that needed the finer tuning gave infinitely better results in these circumstances. But, curiously enough, when the reaction was uncoupled, the tuners changed, and the local station brought in, the crystal adjusted for the distant station (Radiola in this case) with reaction gave only very poor results. Further tests showed that the better the adjustment of this particular crystal to DX conditions (with reaction), the weaker were the signals from the local station (without reaction) for the same adjustment of the contact. Here one sees that the value of alternative detectors is of no little importance and not so visionary as some appear to believe.

J. D. S.

A Mica Variable Condenser

THE photograph and sketches show a simple, compact and efficient mica variable condenser which should not cost more than two shillings to construct.

The parts necessary for its construction are: one piece of ebonite and one piece of wood, each about 1/4 in. thick; one piece of 16-gauge copper, and one piece of ruby mica, all 3 1/4 in. by 3 1/4 in.; a circular piece of 16-gauge copper 3 in. in diameter; one 2 B.A. screwed rod about 2 3/4 in. long; one bush to clear 2 B.A., with bolts and nuts for securing; one 2 B.A. screwed collar; three pieces of dowelling each 1 1/2 in. long; one ebonite



Photograph of Variable Condenser.

knob; two small terminals; three 2 B.A. nuts; some brass wood screws and two short pieces of copper wire.

The screwed collar should be soldered to the exact centre of the circular piece of copper, the rod inserted in the collar, and a nut screwed down to lock it (see Fig. 1).

Next solder two nuts on to the clearance bush (Fig. 2). This is best done with the rod passed through the bush and the nuts, care being taken that the rod will turn in either direction while the nuts are stationary.

The ebonite should now be drilled for the 2 B.A. rod, bolts for the bush, and three wood screws as shown in Fig. 3. Next drill the wooden base, the square piece of copper, and the mica for the screws as shown in Fig. 4.

The clearance bush (with nuts soldered) must now be secured by means of the bolts and nuts to the centre of the ebonite.

The condenser is now ready for assembling; the dowelling is used for three of the corner supporting posts, the fourth corner being reserved for a terminal, to the under side of which is soldered a copper wire. This wire is also soldered to the copper base plate, a triangular portion of the mica being cut away to allow of this being done. Another copper wire is to be soldered to the bush and under side of the other terminal. Care must be taken that both the circular and the square copper plates are perfectly flat or the tuning will be uneven. The complete condenser is shown by Fig. 5.

Tuning is effected by screwing down the circular plate, and *vice versa*, the maximum capacity occurring when the two plates are together. The capacity will probably be about .001 microfarad maximum, but this will depend upon the thickness of the mica used.

A. W. X.

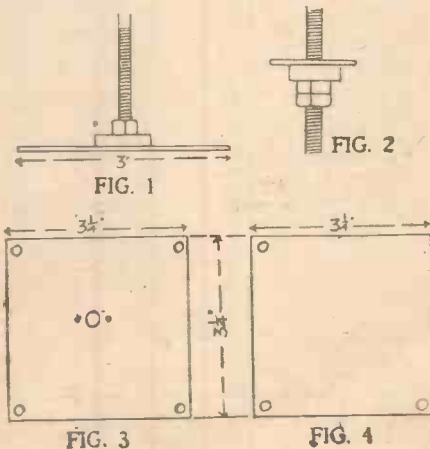

Fig. 1.—Movable Plate. Fig. 2.—Bush, Spindle and Nuts. Fig. 3.—Top Plate. Fig. 4.—Base Plate. Fig. 5.—Complete Condenser.



RULES.—Please write distinctly and keep to the point. We reply promptly by post. Please give all necessary details. Ask one question at a time to ensure a prompt reply, and please put sketches, lay-outs, diagrams, etc., on separate sheets containing your name and address. Always send stamped, addressed envelope and Coupon (p. 623.)

Difference between Variometer and Varlocoupler

Q.—What is the difference between a variometer and a variocoupler?—H. F. P. (London).

A.—A variometer is a tuning arrangement by means of which two coils connected in series, and of which one rotates within the

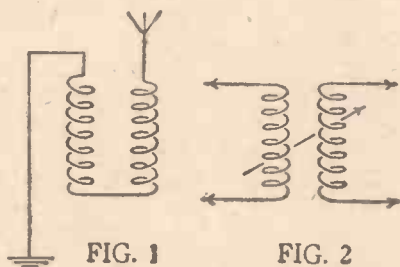

Figs. 1 and 2.—The Electrical Connections of a Variometer and Variocoupler.

other, will make changes in the wavelength of a circuit. This arrangement is usually employed to take the place of an inductance coil and variable condenser. A vario-coupler consists of two coils, quite distinct and not connected together except by magnetic induction between the two windings. This instrument, which often takes the same outward appearance as the variometer, is used for inductively coupling two circuits. Figs. 1 and 2 show the electrical connections of a variometer and variocoupler respectively.—P.

The Edison Accumulator

Q.—Can you give me any information concerning the Edison accumulator, and can it be used for wireless work?—F. J. D. (Manchester).

A.—The Edison accumulator differs from the usual type in several ways. In the first place, the electrolyte used is an alkali; there are no lead or paste plates, but nickel plates instead. The E.M.F. is 1.5 volts per cell. This battery is very suitable for all purposes, especially where a very heavy rate of discharge is required. It is practically indestructible, and cannot be harmed by shorting its terminals or excessive rates of charge and discharge. Two of these cells would be excellent for use with dull-emitter valves, especially of the .06-ampere type.—B.

Increase in Volume by Using Several Loud-speakers

Q.—If I used a number of loud-speakers, all connected to the same set, should I get an increase in the volume of sound heard?—A. T. F. (Bath).

A.—You would certainly get an increase in the volume of sound, for one reason which will be explained. If the volume of sound received from one pair of telephones could be represented by a certain value, this value would decrease by a certain amount per pair for each pair of telephones added. This also applies to loud-speakers as far as the "earpiece" portion of the loud-speaker is concerned. But we must take into con-

sideration the amplifying value of the horn of the loud-speaker, which would more than make up for the reduction in volume caused by adding another loud-speaker to the circuit. It must not be assumed from the foregoing that the number of loud-speakers which may be used to get increased volume is unlimited, but it may be taken that up to five or six loud-speakers may be operated from a powerful set with good results.—B.

Increasing Capacity of Condenser

Q.—How can I increase the capacity of a variable condenser, value .0005 microfarad, without mechanically altering it?—H. C. (Aylesbury).

A.—There are two methods of increasing the capacity without actual mechanical alterations to the condenser, one of which is to immerse the condenser in a jar of oil. The condenser will then have oil dielectric, instead of air, and its capacity will be considerably increased. Or you may connect a fixed condenser of .0005 microfarad in parallel with the variable, to be used in conjunction with a switch. If the switch is opened, the capacity in the circuit, as represented by the variable condenser, may be varied from approximately zero to .0005 microfarad by rotating the variable condenser over the whole range of its scale. If the condenser is now set to its minimum position and the switch closed, a new value of capacity of .0005 microfarad is brought into circuit by the fixed condenser. If the variable condenser is now rotated through its range to its maximum, the total value of capacity will be twice .0005 microfarad, or .001 microfarad in all. Thus with this arrangement it is possible to get any value of capacity up to .001 microfarad.—B.

Calculating Capacity of Accumulators

Q.—Can you supply me with any formula, etc., for calculating approximately the capacity of an accumulator?—N. H. B. (Cardiff).

A.—The capacities of accumulators vary considerably with the make, size, etc., but an average value for pasted plates is about 10 ampere-hours per square foot of positive plate surface, reckoning both sides of the plates. Thus, taking a cell containing eight positive plates, each 9 in. by 4 in., a rough estimation of the capacity can be obtained in the following way. Find the total area of the positive plates in square inches, remembering that each plate has two sides and that there are eight plates. Divide by 144 to bring to square feet, and multiply by 10 to give the capacity in ampere-hours. That is, in the case quoted, $\frac{(9 \times 4 \times 2) \times 8}{144} \times 10 = 40$ ampere-hours.—Q.

False Results with Frame Aerial

Q.—Would an aerial above my roof affect the signal strength of my receiver when used in con-

junction with a frame aerial?—W. M. (London, S.W.)

A.—If the outside aerial is connected to a receiver, which is tuned to the same wavelength as that which you are receiving on the frame-aerial set, and the lead-in from the outside aerial passes within a few feet of the frame aerial, your reception will be affected. Reception with a frame aerial under the conditions mentioned above is apt to give false results, for the reason that the frame will pick up re-radiation from the outside aerial, and signals received on the frame set will be several times louder than would be the case if the outside aerial was removed or connected direct to earth.—P.

Variometer Reaction Coil

Q.—Is there any advantage in using a variometer in place of the reaction coil?—C. W. R. (Salford).

A.—There is no advantage, but there are one or two disadvantages. Firstly, if the plate circuit in which the variometer is connected is tuned to the wavelength of the aerial circuit (as it should be for loudest results), the receiver will break into oscillation. To stop the set oscillating, the variometer must be slightly mistuned, resulting in a reduction in signal strength. Secondly, if it is wished to tune the aerial circuit to longer wavelengths than those which the variometer is wound to cover, some provision must be made to change the variometer for one of a larger size, or to arrange a plug-in coil in series with the variometer.—B.

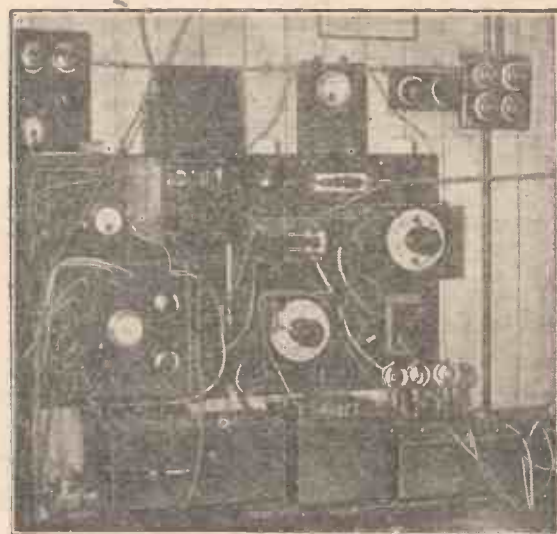

The very efficient Transmitting Station of 2 PX (Mr. H. H. Lassman, of Barking). 2 PX has been particularly successful in DX work. Speech from this station was received in Stonehaven, Scotland, recently, on three valves. Mr. Lassman has also established two-way communication on C.W. with 2 CE of Montreal, Canada, and worked with him intermittently for a fortnight. 2 CE, it is understood, was receiving on a one-valve super-regenerative circuit and his transmitter radiated 2½ amperes at 500 volts.



AN item that will intrigue all inquisitive minds is a talk from 2LO on "Bus-baiting," by Captain Grierson, on Tuesday, May 20. Presumably this is a new game invented by Captain Grierson in the hope that it will usher in a brighter London.

There should be no more cause for complaints from Sheffield listeners. Even at the time of going to press the power is being increased to 200 watts. In future the London programme will be relayed instead of that of Birmingham.

"Nothing is so amusing as someone else's misfortune," says Dr. L. du Garde Peach, who will speak on "The Misfortunes of Max" from 2LO on May 16. He himself is the unfortunate Max!

Once again we would remind listeners of the Gilbert and Sullivan programme to be broadcast simultaneously on May 17. The artistes are Mr. Joseph Farrington (bass) and Miss Doris Vane. The former will render the popular "Ho Jolly Jenkin" and that fine aria "Woo Thou Thy Snowflake." Rebecca's song from *Ivanhoe* will be included amongst the items rendered by Miss Doris Vane.

Barbers may start putting up their poles again so that they can fix aërials to them. Receivers have been installed in an American hair-dresser's for the amusement of customers whilst waiting. But they have to put a coin in the slot before anything happens!

Sir William Henry Bragg, K.C.B., D.Sc., F.R.S., will speak at 9.10 p.m. on Monday, May 19, on "The Nature of Liquids."

That the Chelmsford high-power station will be in operation in about a fortnight's time is the hope of the B.B.C., and to this end work is being pushed forward rapidly. How about those 1,600-metre coils?

Arrangements for moving the 2LO transmitter have now practically passed out of the hands of the B.B.C., for the *pros* and *cons* of putting it on the roof of a West-end store are being considered by the Postmaster-General's Advisory Board.

2QC, as to the ownership of which speculation has been rife, is a B.B.C. experimental station at Hendon, and is not Capt. Eckersley's private transmitter.

The programme for Sunday, May 18, includes an organ recital by Mr. Reginald

Goss Custard in the afternoon and the ever-popular R.A.F. band (under Flight Lieut. J. Amers) in the evening. The problem of getting the R.A.F. band back to Uxbridge on a Sunday evening has previously caused some trouble, which on this occasion has been successfully overcome; listeners will therefore be pleased to know that the programme will continue until 11 p.m.

"On a three-valve set I heard clearly the speech of King Edward VII at the opening of the British Empire Exhibition," says a letter sent from Norway to the B.B.C. Some set, that!

Formerly an assistant to Mr. L. Stanton Jefferies at 2LO, Mr. H. W. Braithwaite has been appointed musical director of the Cardiff station. Mr. Braithwaite has a number of musical compositions to his credit, including two piano sonatas, and is now writing an opera.

Probably one of the most interesting personalities of the present time is Sir Arthur Conan Doyle, M.A., LL.D., who will speak on "Psychic Development" at 9 p.m. on Tuesday, May 20.

American advertisements certainly stir the imagination. One firm says: "You don't know how thrilling radio reception can be until you've used — standard radio products."

The bright music and witty dialogue of *Paul Jones*, one of the comic operas so carefully produced by Mr. L. Stanton Jefferies, will delight listeners on Wednesday, May 21.

Capt. Eckersley says that in about a fortnight's time it is hoped that listeners will be able to hear the experiments in connection with the high-power station at Chelmsford.

Mr. H. C. Vernon, chairman of the organising committee of the International Advertising Convention, will speak on the convention simultaneously from all stations at 9.15 p.m. on Wednesday, May 21.

An interchange of greetings by wireless took place between Mr. Franklin Roosevelt, head of the New York Boy Scouts, and Sir Robert Baden-Powell, Bt., the Chief Scout, recently during the American Boy Scouts Week.

Everything is not entirely satisfactory at the new Edinburgh station. It has been very difficult to get a really good earth connection, and the aerial is not all that

might be desired. Mr. Kirk has gone to Edinburgh, and will remain there until everything has been put right. If all else fails, he may even go to the length of looking for a new site.

On Thursday, May 22, a two hours' symphony programme will be given under the conductorship of Mr. Percy Pitt, commencing at 7.30 p.m. "Wagnerian Plums" will be given, including the Prelude to *Lohengrin*, a beautiful study from *Tristan and Isolde*, and the music portraying Siegfried's journey to the Rhine.

When the Liverpool station opens on June 4 the programmes from London will be relayed for an experimental period. The studio is to be in Lord Street. The station director will be Mr. H. C. Pearson, at present assistant director at Birmingham.

Music direct from the bands playing in the parks will be broadcast from 2ZY (Manchester) in a week's time.

Speeches by the Duke of York and the Rt. Hon. J. H. Thomas, M.P., will be broadcast from all stations at 9.15 p.m. on Friday, May 23. The speeches will be made at the Empire Day annual dinner of the Royal Colonial Institute at the Hotel Victoria.

Capt. Eckersley is to give a lecture entitled "Technical Troubles of Broadcasting" before the Liverpool Wireless Society on May 15.

A special Empire Day programme is being prepared for Saturday, May 24. The band of the Grenadier Guards will play, while representatives of our overseas Dominions will each say a few words.

In accordance with their policy of endeavouring to keep alive wireless interest this summer, the B.B.C. will make several alterations to the programmes from provincial stations on and from June 1. Particulars of these changes are as follow: The evening programme will start and end half an hour later. From 6 p.m. to 6.45 p.m. the Children's Hour will be given, followed by news and the first talk at 7 p.m. An interval will occupy half an hour from 7.30 p.m. to 8 p.m., when the evening concert will begin; this will continue until 11 p.m. On Monday and Wednesday the Savoy bands will play from 10.30 p.m. to 11.30 p.m., and on Saturday until 12 p.m. There will be an additional two-hour concert on Saturday afternoon from 4 p.m. to 6 p.m., composed chiefly of light music. The second news bulletin will be given at 10 p.m.

The Brussels broadcasting station was temporarily closed last week before starting on a new wavelength of between 220 and 280 metres; the exact wavelength has not been decided on as we go to press.

Act II. of the Strauss opera *Ariadne*, as produced at Covent Garden, will be broadcast at 10 p.m. on May 23.



Crystal Reception

SIR,—I have a crystal set, loose-coupled, tuned by studs in units and tens up to a hundred turns.

I get loud results from London (twenty-five miles), but also get spark jamming when 2 L O is broadcasting. The curious part is that as soon as 2 L O closes down I do not get the spark signals, unless I tune them in on quite different studs. As this jamming is a great nuisance, I have been trying a hook-up of a basket coil and condenser, but I still get the sparks if I use a basket coil of the usual size. Latterly I have apparently quite eliminated the spark signals in the following way: I took one turn of wire off at a time until I found I was below the London wavelength, and then put part of the condenser in, and cannot now tune in the sparks even if I try, while the broadcast comes in splendidly.

The following is a description of the arrangement: A basket coil of 36 turns of No. 24 d.c.c. wire and a .0003 variable condenser about half-way in; full length aerial, average height 25 ft. The original basket coil was of 40 turns, $1\frac{1}{4}$ in. centre, and eleven slots. I should like to hear of anyone trying this if their experience is the same as mine.—B. F. (Godstone).

Appreciation from New Zealand

SIR,—In "A.W.," No. 66, Fig. 45, "150 Receiving Circuits in Diagram and Picture," is a circuit diagram of a "Voigt" double-amplification circuit. I have been experimenting for some time, and one day came across this circuit. I made a bench hook-up, and was successful in receiving KFFA, California. Tuning was rather critical, but not excessively so. My aerial is a T-type, about 45 ft. high; the two arms of the T are together about 75 ft. The valve was an "Ora," with 31.5 volts on the plate. I have subscribed to "A.W." since it started, and I must congratulate you. It is to me the most practical guide to amateur reception and general information on sale in New Zealand. I am very interested in the Transatlantic tests, but it seems to me that New Zealand is much better placed than England for American telephony. I recently made inquiries from various clubs, and found that the majority of long-distance records in reception were held by operators of one- or at most two-valve sets. Hamilton is 400 miles from Wellington, and yet a simple variometer crystal set picks up concerts regularly. Component parts are very expensive in this country. With one H.F. valve I can

get nearly every high-power Continental station; Bordeaux and Nauen are very powerful; Long Island, New York, sounds as if he were only a few miles away. Dozens of New Zealand amateurs are getting the same stations with but one or two valves.—H. V. P. (Hamilton, New Zealand).

Primary Cells for Valves

SIR,—I notice that it was stated recently that primary cells are unsuitable for heating valve filaments.

It will interest readers to know I have been running a single-valve set from "Economic" light cells for eight weeks without any trouble whatever. For the country dweller there is nothing to beat them. I have five cells in a corner cupboard, and the leads are brought to a two-pin plug beside the bench.

The valve is a Penton HE4 low-consumption type. The cells give a constant supply, and I can thoroughly recommend them. The supply is so good I am going to have another valve. I am sure it would pay readers to write to the Economic Co., 10, Fitzroy Square, W.

I may add I have no interest in the firm, except as a satisfied customer.—T. H. (Willington).

What Station?

SIR,—On page 522, No. 99, THERMION refers to a transmission received from Radiola. (What was it?)

I received this transmission every evening between 9 and 10 p.m. on Radiola's wavelength, and at the same time the Frenchman was speaking. The first time it was received was April 15 and the last Sunday, April 20, and since then nothing has been heard. The first time I heard cheering, then a band playing, pause, more cheering, and band playing a lively air; every evening the same thing happened. I tried longer and shorter wavelengths, but this cut out the French station and also the other station. It seemed to be a distant station brought in by Radiola's carrier, as immediately Radiola shut down the whole business ceased. I came to the conclusion that it was from Spain and thought it may have been a bull fight. Possibly someone may be able to solve the mystery.—T. W. DE L. (London).

Crystal Experiences

SIR,—I was very interested in a recent article entitled "Some Experiences with a Crystal," by L. A. J. My own experiences may be of interest and are as follow:

I constructed a simple slider-coil crystal set, and the results were clear, but faint and badly jammed by Morse. I needed a large amount of inductance, which fact puzzled me greatly. I found I got better results by having a 10-ft. length of flex attached to the earth terminal of the set instead of to the proper buried earth, and still better results if I held the end farthest from the set in my fingers. I knew that something was wrong. For convenience in wiring, and not anticipating any trouble, I had connected the catwhisker to the earth terminal and the crystal cup to the aerial terminal.

As soon as I had reversed this connection, whisker to aerial side and crystal cup to phones and earth, everything was altered. I required only about one-third the amount of inductance, the earth freaks disappeared and also the Morse jamming. R. K. (Clacton).

Frame Aerials

SIR,—"Thermion's" recent remarks on the above matter confirm my experience that frame aerials function better in some places than others. At my house (about six miles from 2 L O), using a three-valve set (H.F., detector and L.F.), London does not come in on the frame with the strength which one would expect as compared with Birmingham, Manchester or Bournemouth. This effect has been noticed in several other places using the same set and frame. On the occasion of the broadcasting of the King's speech, using the same gear in the basement (well below ground level) of a big building in this district, the results were remarkable.

I would urge your readers who are badly situated so far as outdoor aerials are concerned to try the experiment of a frame, which is not at all a costly affair. There is an ulterior motive behind my suggestion: some of these "dud" outdoor aerials seem to require so much use of reaction that they radiate more than they receive.—2 A J P (Leytonstone).

Other Correspondence Summarised

"Annoyed" (Harringay, N.4) writes to say that reception is almost impossible in his vicinity owing to the continuous transmission of an amateur who is using a flat-tuned single-circuit transmitter.

J. McC. (Leachkin, Inverness) heard a station (presumably foreign) on 1,100 metres on Sunday, May 4, at 8.40 (B.S.T.). Sounds which were like a church clock chiming the four quarters were heard and then the hour. The difference in time seems to suggest a Dutch station. Can any reader oblige?

A Swansea listener recently heard the throbbing of a man's heart in America by wireless quite plainly. It was during the testing of a particularly sensitive microphone. The difference between the throbbing of a man's pulse and that of a young girl could easily be detected. KDKA carried out these experiments.

EDISWAN



The machinery behind the Valve

When you consider the perfected machinery at the well-equipped Ediswan factory, the elaborate precautions taken to ensure unfailing reliability, allied to the wealth of 43 years' manufacturing experience, the obvious conclusion is, that Ediswan Valves *must* be better. And actual results quickly prove the truth of this natural deduction. *Merit* is the secret of "Ediswan" popularity—that is why we unhesitatingly advise you to ask the man who uses one.

Have you had your free copy of booklet, entitled "The Thermionic Valve"? If not, send to-day.

Also Manufacturers of "Toovee" and other Receiving Sets, "Televox" Loud Speaker, Headphones, Accumulators, Batteries and Accessories. Write now for descriptive leaflets. If your dealer does not stock, send us his name and address.

The safety cap (Prov. Pat.) which is now fitted to all Ediswan Valves. The filament pins are shorter in length than the plate and grid pins, thus avoiding any chance of making surface contacts with the wrong sockets.

THE EDISON SWAN ELECTRIC CO., LTD.,

(Contractors to H.M. Admiralty, War Office, Royal Air Force.)
123/125, Queen Victoria Street, E.C.4, and 71, Victoria Street, S.W.1.

Works: Ponders End, Middlesex.
Branches in all Principal Towns.



BUY BRITISH

GOODS ONLY

WIRELESS IN PARLIAMENT



From Our Own Correspondent.

IN the House of Commons last week the Postmaster-General informed Mr. Sturrock that prior to May 1 the Leaffield wireless station was reserved for a short period daily for the transmission of urgent Press telegrams to India on behalf of certain newspapers and news agencies. This service, which occupied a time totally incommensurate with its value to the Post Office or the senders, had lately fallen into disuse and had accordingly been suspended.

Capt. Wedgwood Benn asked the President of the Board of Trade whether he was in a position to furnish information as to existing direction-finding facilities for ships approaching the coasts of the British Isles; what new wireless direction-finding stations were contemplated and might be expected in the near future? Also whether seeing that at present an official charge of 5s. was made for each message sent to a ship indicating her bearing from a wireless direction-finding station, whereas similar information was given to ships of all nationalities from wireless direction-finding stations in Canada, the United States, France and elsewhere entirely free of charge, he would consider the desirability of abolishing the charges for such information given to ships in this country?

Mr. Alexander, Under-Secretary to the Board of Trade, said that there were at present direction-finding stations at Berwick, Flamborough and Lizard, and new stations were contemplated in South Wales and at Niton, Isle of Wight. He was aware that in certain countries no charge was made for bearings given by direction-finding stations, but in view of the cost of the service in this country it was not considered that the whole of the cost should be borne by the Exchequer.

Mr. Baker asked the Postmaster-General whether he would inform the House of the nature of the report of the Broadcasting Board on the proposal to construct the

London broadcasting station on the roof of a West-end store?

Mr. Hartshorn said that this question had been referred to the Broadcasting Board, but the Board had not yet reported on it.

PRIZES FOR RECEPTION

LAST year Mr. McMillan, an American, set out from New York in the schooner *Bowdoin* for the Arctic regions. On the *Bowdoin* there was installed a 100-watt transmitter and a multi valve receiver, with which the ship kept in constant communication with WGN, a Chicago broadcasting station.

The *Bowdoin* is now ice-bound within 11 degrees of the North Pole, and nothing has been heard of the expedition for several weeks. While this is causing no great uneasiness, as it is at present almost continuous daylight at the Pole and therefore wireless signals are much weaker, two prizes are being offered to the amateurs who first pick up any of the ship's messages, which, it is assumed, are being sent out nightly. During the winter signals were received from the schooner in all parts of the world.

WNP, the call sign of the *Bowdoin*, will be heard only in the Morse code, of course, although WGN's nightly talks to the ship are by wireless telephony.

The first prize is one hundred dollars in gold and the second a multi-valve receiver the exact duplicate of that on board the *Bowdoin*. These prizes will be awarded respectively to the first and second amateurs informing Mr. U. J. Herrmann, National Radio Manufacturers' Show Association, 127, N. Dearborn Street, Chicago, by telegram and giving the text of any message received from Mr. McMillan.

Do You ALWAYS

mention "A.W." when writing to Advertisers?

PLEASE DO !!

Next Week's Broadcasting

May 18-24

Items Simultaneously Broadcast*

Sunday. The Rev. H. E. Fosdick.
Monday. Sir William Bragg. The Savoy Bands.

Tuesday. French Talk. Sir Arthur Conan Doyle. The Savoy Bands.

Wednesday. B.B.C. Dramatic Critic. Mr. H. C. Vernon. Royal Horticultural Society Talk.

Thursday. Radio Society of Great Britain Talk. The Savoy Bands.

Friday. B.B.C. Film Critic. Speeches from Royal Colonial Institute.

Saturday. Colonel Philip Trevor. "A Pageant of Empire" Night.

* Except where otherwise stated, all items simultaneously broadcast originate from the London studio.

London (2 L O)

Sunday. Organ Recital. R.A.F. Band. The Mayfair Singers.

Monday. British Living Composers Night.

Tuesday. Miscellaneous Programme.

Wednesday. Comic Opera Night.

Thursday. Wagner Programme.

Friday. Request Programme.

Saturday. Empire Day Programme.

Your Wireless Troubles! Have you seen the announcement of the sixpenny booklet that will be given away free with next week's issue, on page 601? Sooner or later every amateur will have trouble with his set, and this booklet, which is entitled "Wireless Troubles and How to Remedy Them," shows how to find and put right faults with the minimum of trouble. Don't forget to order your copy for next week. It is published on Thursday, May 22.

Apparatus capable of producing 3,000,000 volts is being installed by the Edison Company in a new laboratory at Pasadena, in California. Scientists believe that much will be discovered relating to electricity and matter.

TRY THE **GNEISS** AND YOUR SEARCH FOR THE PERFECT CRYSTAL WILL BE REWARDED.
NOW AVAILABLE TO THE PUBLIC

It is the only Crystal with a Rectifying Efficiency Approaching 100%

The Gneiss is a Natural Crystal, having its origin in the rich deposits of Mexico, and it SHOULD IMPROVE ANY SET.

Scientifically embedded in a Brass Cup, ready for instant use, the Gneiss Crystal may be obtained

From **RADIO ACOUSTICS Ltd.**
Electrical Engineers and Manufacturers of Wireless Apparatus
175 a Peckham Park Road, Peckham, LONDON, S.E.15

Wireless is attracting all men. The Amateur is entering the field in great numbers, and he wants to know all about it. He will require Materials, Parts, Tools. He will also want to sell surplus material.

"AMATEUR WIRELESS"

is out to cater for this class of reader, who will be eager for knowledge and bargains. To meet him, use the Sale and Exchange columns, which he is sure to search. Rate 3d. per word, 3s. minimum, prepaid. Latest date Thursday mornings.

Address:
The Advertisement Manager,
"Amateur Wireless,"
La Belle Sauvage,
Ludgate Hill, London, E.C.4



The times given are according to British Summer Time.

London B.B.C. Station (2 L O), 365 metres. Weekdays, 3.30 p.m. to 4.30 p.m., concert. Children's concert from 5.30 p.m. to 6.15 p.m.; 7 p.m. to 7.30 p.m., news bulletin and talk; 8 p.m. to 11 p.m., concert, except on Savoy Band nights, when the band will play from 10.30 p.m. to 11.30 p.m. (on Saturdays until midnight). Concert from 1 p.m. to 2 p.m. on Tuesdays, Thursdays and Fridays.

Manchester B.B.C. Station (2 Z Y), 375 metres. Weekdays, 3.30 p.m., concert; 5 p.m., women's half-hour; 5.25 p.m., farmers' weather report; 5.30 p.m., children's hour; 6.20 p.m. to 7.15 p.m. and 7.45 p.m. to 10.30 p.m., concert and news. Sundays, 8.30 p.m. to 10.25 p.m.

Birmingham B.B.C. Station (5 I T), 475 metres. Weekdays, 3.30 p.m. to 4.30 p.m., concert; 5.30 p.m. to 6 p.m., women's half-hour; 6 p.m. to 6.45 p.m., children's hour; 7 p.m. to 10.30 p.m., concert and news. Sundays, 8.30 p.m. to 10.30 p.m.

Newcastle B.B.C. Station (5 N O), 400 metres. Weekdays, 3.45 p.m., concert; 4.45 p.m., women's half-hour; 5.15 p.m., children's hour; 6 p.m., scholars' half-hour; 7 p.m. to 10.30 p.m., concert, news. Sundays, 8.30 p.m. to 11 p.m.

Bournemouth B.B.C. Station (6 B M), 385 metres. Weekdays, 3.45 p.m. to 4.30 p.m., concert; 5.15 p.m. to 10.15 p.m., concert and news. Sundays, 8.30 p.m. to 10.15 p.m.

Cardiff B.B.C. Station (5 W A), 350 metres. Weekdays, 3.30 p.m. to 4.30 p.m., concert; 5.30 p.m. to 6 p.m., women's half-hour; 6 p.m. to 6.45 p.m., children's hour; 7 p.m. to 10.30 p.m., concert and news. Sundays, 8.10 p.m. to 11 p.m.

Glasgow B.B.C. Station (5 S C), 420 metres. Weekdays, 3.30 p.m. to 4.30 p.m., concert; 5 p.m. to 5.30 p.m., women's half-hour; 5.30 p.m. to 6 p.m., children's hour; 7 p.m. to 10.30 p.m., concert and news. Sundays, 8.30 p.m. to 10.45 p.m.

Aberdeen B.B.C. Station (2 B D), 495 metres. Weekdays, 3.30 p.m. to 4.30 p.m., concert; 5 p.m. to 6 p.m., women's half-hour and children's corner; 7 p.m. to 10.30 p.m., concert and news. Sundays, 8.30 p.m. to 10.30 p.m.

Sheffield (Relay) B.B.C. Station (6 F L), 303 metres. Programme relayed.

Plymouth (Relay) B.B.C. Station (5 P Y), 330 metres. Programme relayed.

Edinburgh (Relay) B.B.C. Station (2 E H), 325 metres. Programme relayed.

Königswusterhausen (L P), 2,800 metres. Sundays and public holidays, 11.50 a.m. to 12.50 p.m., concert. Berlin concert relayed daily on 680 metres at 8.30 p.m. Transmissions throughout day on 4,000 metres.

Croydon (G E D), 900 metres. Daily.

Eiffel Tower (F L), 2,600 metres. Daily, 6.40 a.m. to 7 a.m., weather forecast; 11 a.m. to 11.30 a.m., weather forecast; 3.40 p.m., Stock Exchange news; 5.30 p.m. (Saturdays excepted), Bourse closing prices; 6.10 p.m., 7 p.m., and 7.20 p.m. (Sundays only), concert and news; 10 p.m., weather forecast.

Paris Concerts Radiola (S F R), 1,780 metres. Daily, 12.30 p.m., concert and news; 1.45 p.m., first Bourse report; 4.30 p.m., Bourse closing prices; 4.45 p.m., concert and news; 6.45 p.m., news; 8.30 p.m. to 9.30 p.m., concert; also concert from 2 p.m. to 3 p.m. 10 to 10.45 p.m. on Sundays.

Rome (I C D), 3,200 metres. Daily, 11 a.m. **Ecole Supérieure des Postes et Télégraphes, 450 metres.** 3.30 p.m. to 4 p.m. (Wednesday and Friday), 7.45 p.m. to 10 p.m. (Tuesday and Thursday), 2.30 p.m. to 7.30 p.m. (Saturday), concerts.



Music at its best.

THE very first Loud Speaker ever designed for Wireless use was a product of S. G. Brown, Ltd. The experience gained in those early days (for it was before wireless telephony became commercially practicable), has been of great value in maintaining the prestige enjoyed by the **BROWN** Loud Speaker.

Much of the distortion prevalent in Loud Speaker use to-day is due to forcing the instrument to produce a greater volume of sound than it is capable of—to overloading it, in other words. The **BROWN** is so sensitive that the radio enthusiast will find that he obtains such a volume of sound that "forcing" is quite unnecessary.

An actual test will prove that if the **BROWN** is com-

pared with any other loud Speaker on the same Receiving Set, it will give a very much greater volume due to the unique design of its aluminium diaphragm and tuned reed.

It is this reserve of power that enables any **BROWN** user to obtain those results that are the envy of his friends and which help to confound sceptics who have previously maintained that all Loud Speaker music is distorted.

PRICES:			
Type H.1, 21 in. high	120 ohms	£5 5 0	Type H.2, 12 in. high
	2,000 ohms	£5 8 0	120 ohms
	4,000 ohms	£5 10 0	2,000 ohms
			4,000 ohms
			£2 5 0
			£2 8 0
			£2 10 0

S. G. Brown Ltd.—Victoria Rd., N. Acton, W.3.

Retail: 19, Mortimer Street, W.1, and 15, Moorfields, Liverpool.



THE KING'S WEMBLEY SPEECH IN ESPERANTO

REPORTS have been received to the effect that the King's Wembley speech, which was broadcast from the London station on April 23, was heard clearly and distinctly, every word being understood, by listeners in the following countries: Finland, Tunisia, Switzerland, Germany, Hungary, Belgium, Holland, Spain, France, Denmark, Sweden, Norway, Yugoslavia. A report of the speech, translated from the Esperanto version, was published in the Geneva newspapers the morning after the opening of the Exhibition and before the arrival of the official version of the speech.

DISCOUNT SALE

of Cabinets, Transformers, Variometers, Terminals, Phones, and other Wireless Components. List post free.

KENITE FOR RADIO PANELS

Half the price of Ebonite. Twice the efficiency. Panels 6 x 6 x 1/8, 1-; 9 x 6, 1/8; 12 x 10, 3/4, post free. Larger and intermediate sizes at proportionate prices. Black only. Matt finish, 1/2 in. 25% extra.—CRAWFORD, 9, Coleman St., London, E.C.2. Telephone: London Wall 9730

TELEPHONES RE-WOUND

to 4,000 ohms. Guaranteed. All makes 5/-, except Brown "A" 3/- and Sullivan, Wax filled, 2/0, per pair. Ex-army converted to high resistance, 2/6 each earpiece. Re-magnetsing 9d. per earpiece. Postage extra 6d. per pair.

JOHN W. MILLER, 70-71, FARRINGTON STREET, E.C.4
Phone: CENTRAL 1950



CABINETS YOU WANT

PICKETT'S CABINETS—they're good value, from 1.6 each, highly polished. Cabinet (A.M.) Works, Albion Rd. Bexley Heath, S.E. Write for lists

RADIO KENITE PANELS

The only Satisfactory Panel Sold at a really Low Price.

IMMEDIATE DELIVERIES

Trade enquiries to Sole Manufacturers:—
H. D. DOUGLAS & CO.
32, Queen Victoria St., LONDON, E.C.4

SPENCER'S STORES

4-5, MASON'S AVENUE,
BASINGHALL ST., LONDON, E.C.2
TELEPHONE:—LONDON WALL 2322

VALVES REPAIRED

6/6. Post free.
4,000 ohms, VERY SENSITIVE, GUARANTEED 12/-

5 volts
6/6

R.A.F. "C" Valves made by the Marconi-Osram Valve Co., Ltd., and Ediswan Co., are the finest H.F. and Det. Valve ever offered under 13-. The most suitable for vertical panels or portable sets. Fit Mullard "Ora B" sockets. Adaptors for "R" valves supplied at 1/- each.



"C" British Made "C"

1/2 amp.
6/6

"C" Valves were made under Government Supervision for W/L of the Broadcast bands and there is no valve to touch them under double the price.

Limited number delivered from stock.
Trade supplied.

LESLIE DIXON & CO.,

9, COLONIAL AVENUE, MINORIES, LONDON, E.1.

VALVES 5/9

POST FREE

A Limited Quantity of new Telefunken E.V.N. 171 Valves, Upright Pattern (The Long Distance Valves), 5/9 each, while they last. Fil. 2.3—5 volts. Plate 50 to 150 volts. Current consumption approximately .45 amp. SEND NOW.

ELEFACTORS, Ltd.,

86, Cranville Road, Child's Hill, N.W.2
Phone: Hampstead 7919. Nearest station, Golders Green

SKINDERVIKEN MICROPHONE

(THE SMALLEST IN THE WORLD)

TO THE GENERAL PUBLIC

If you cannot obtain this device from your local dealer write to the head office:
MIKRO Ltd, 32a, Craven St., STRAND, W.C.

The new type Skinderviken Microphone with Carbon Electrodes only are obtainable at 5/- each.

Write for illustrated booklet:

"THE MARVELS OF THE MICROPHONE,"

which gives full details how to make your own amplifier for crystal sets. Price 6d. post free 6d.

Send P.O. (not stamps) to-day.

MIKRO Ltd., 32a, Craven St., STRAND, W.C.

Fix your crystal in



GOLD SEAL PLASTIC METAL the best contact possible, and get LOUDER AND CLEARER SIGNALS.

Contains no mercury. 6d. per packet. Of all Enough for 8 cups. 6d. Wireless Stores. Wholesale enquiries (or sample packet 6d.) to: S. LEVY, 53, Ben Jonson Rd., LONDON, E.1

Please your home with the Tone

Now the call of the open: the river, the garden and the picnic, with all their attendant pleasures. But what of Broadcast Music's merry accompaniment? And remember, conditions compel you to employ apparatus of proven pre-eminence. For instance, truthful reproduction limits your choice of a loud-speaker to the—

BARNES MINORPHONE MODEL NO 2

Mark the volume, purity and richness of tone, free from all inherent resonance. The BARNES is the remarkable reward of patient and scientific research.

The BARNES MINORPHONE No. 2 merits your distinction—and your ultimate choice—by virtue of its reasonable price. It is an instrument with a strong, distortionless output obtainable at the minimum expense.

Price £2.5.0

Arrange a demonstration at your dealers. If he cannot supply write us, when we will direct you to the nearest selling agent.

L. B. TICKLE & CO.,

Government Contractors,
61 Borough Road, London, S.E.1

Phone: Hop 3874. Grams: Elbeetickl, Sedist.

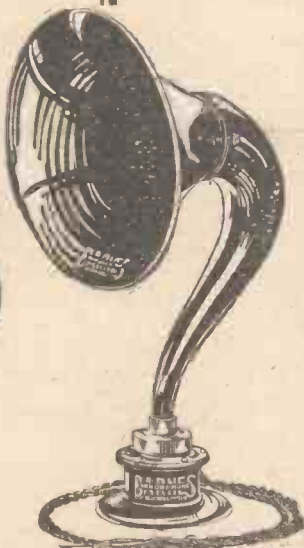

For large rooms and all that Summer Radio demands, its power is equally as noteworthy as its acoustic properties—ample for universal use.

Of robust construction with large adjustable diaphragm and detachable horn dull-black in finish. The well-designed base is also dull black with polished aluminium top. Resistance 2,000 ohms.

Profit

by the experience of others.

The **BRITISH EBONITE Co. Ltd.**
Hanwell, London, W.7

EXTRACTS FROM RECENT TESTIMONIALS

"Our client is very pleased with the panel. One of our staff who has been associated with the manufacture of ebonite for nearly 20 years considers it the finest piece of polished ebonite he has seen."

"We are immensely pleased with the panels supplied, the good effect of which is already felt."

Look for Mark on **BECOL** this Trade all Panels

WE SUPPLY THE BEST COMPONENTS for CONSTRUCTORS

And the Most Efficient Complete Sets

Hot Wire Ammeters 0 to .5, new	12/-
Intervalve Transformers	16/6
Variabls Condensers, .0003	7/8
" " .0005	9/-
" " .001	12/6
Filament Rheostats	2/6
Super Phones, 4,000 ohms	17/6
Valve Holders	1/-
Fixed Condensers, .0001 to .001	1/6
Ebonite Panels, 12" x 8 1/2" x 1/2"	4/6

or cut to your own size. Price on application.

1 Valve L.F. Amplifiers, £2 2 0

BUY BRITISH COMPONENTS—always the best—from

RADIO SUPPLIES LTD., 234, HIGH HOLBORN, London, W.C.1.

Phone: Holborn 2188.

ESTABLISHED 1920.

"FAITHFUL REPRODUCTION BY BROADCAST"

CAPTAIN P. P. ECKERSLEY, chief engineer of the B.B.C., lectured in his characteristically clear and witty style before the Radio Society of Great Britain on April 30, 1924, choosing as his subject "Faithful Reproduction by Broadcast."

The dominant theme of the lecture, which proved absorbingly interesting, was that present imperfections in the art of broadcasting were due, for the most part, to faults in loud-speaker and telephone design, and not to shortcomings at the transmitting end. In reception much depended, he said, upon the mental attitude of the listener.

Captain Eckersley then approached the subject from a technical point of view, discussing the relationship between amplitude and equal audibility of all tones in the musical scale.

To demonstrate the ideal form for producing electrical vibrations representing sound waves, the lecturer illustrated on the blackboard a large paper diaphragm "of infinite size" connected in circuit with a receiving diaphragm of equal proportions, both suspended in space. Such a device, he maintained, would reproduce practically the whole range of tones in human audibility without distortion. It was, however, impracticable, and Captain Eckersley then explained how the difficulties had been met by the B.B.C. and to a very large extent overcome. Trigger methods of transmission, however suited to the purposes of experts, were useless for ordinary broadcast reception by the general public; experiment had shown that the only method adaptable to broadcasting was that of varying the power supplied to the system.

Captain Eckersley was emphatic in his denunciation of present-day loud-speakers and telephones. Manufacturers had been catering for the craze for noise at the expense of purity of tone. The great fault in loud-speakers and telephones was, he considered, that they failed to give equal sound for equal signal amplitude.

In the lively discussion following the lecture several speakers expressed doubt as to whether all the blame should be levelled at loud-speakers and telephones. Mr. Phillip R. Coursey suggested that inefficient L.F. amplifiers were frequently responsible for distorted reception, and other speakers supported this view.

In his reply Captain Eckersley referred to the merits of resistance-capacity coupling in the elimination of distortion, and had some amusing things to say on loud-speaker design. At present, he remarked, he was experimenting with a hose-pipe and a good deal of hope!

A warm vote of thanks was accorded Captain Eckersley at the conclusion of the meeting.



*"and let the sounds of Music
creep in our ears."*

ALTHOUGH it is generally acknowledged that Radio exercises its greatest influence on the home during the winter months, yet even keen music lovers feel ill-disposed to pay the price of remaining within-doors to continue its pleasures.

Happily most Receiving Sets can be carried into the garden and operated from a temporary aerial (of insulated wire) slung over the bough of a convenient tree and an earth provided by an iron peg driven into the ground.

If you are using a Cossor H.F. Valve (with red top) reception will be almost as loud and quite as enjoyable. It is when the conditions are difficult and abnormal that the Cossor Valve proves its real worth. For although any Valve can give results when conditions are favourable, yet for summer use, when the ether is heavily

charged with atmospherics, when long distance Stations become increasingly difficult to receive—when fading becomes more and more pronounced—you will find that the only Valve which can render you faithful and unvarying service, week in, week out, is the Cossor.

There is no magic in this—sound scientific tests have proved that Cossor valve design and construction (fully patented) makes use of a far larger proportion of the electron stream than any other Valve in the world, with a resultant increase in efficiency.

Next time you buy a valve, remember that in summer Radio conditions are not so good as during the winter, therefore counteract this by obtaining the highest efficiency in valve design—a Cossor.

Sold in two types:
P. 1. (For Detector and L.F. use) 12/6
P. 2. (with red top) for H.F. 12/6
From all Dealers.



Cossor Valves



Eccles and District Radio Society

Hon. Sec.—G. R. NOKES, 3, Cleaveley Street, Winton, Patricroft.
Full information concerning the society may be obtained on application to the secretary.

City of London Phonograph and Radio Society
Hon. Sec.—J. W. CRAWLEY, 27, Horsham Avenue, N.12.

At the meeting held on April 24 the secretary submitted a paper on "Low-frequency Transformers," paying particular attention to distortionless amplification. Mr. R. Allison (5NP) gave a splendid demonstration of loud-speaker work, using a loud-speaker of his own make with a straight circuit.

Dulwich and District Wireless and Experimental Association

Hon. Sec.—H. KING, 2, Henslowe Road, East Dulwich, S.E.22.

On April 28 a very interesting lecture was given by Mr. P. Falkner entitled "A Transatlantic Receiver." Mr. Falkner's special design of receiver, which he demonstrated, was particularly suitable for this class of reception.

Croydon Wireless and Physical Society

Hon. Sec.—H. T. P. GEE, 51 and 52, Chancery Lane, W.C.2.

Mr. L. F. FOGARTY delivered a lecture on "Distortion in the Reception and Transmission of Speech and Music" on May 5. He dealt with the subject both in its technical and practical aspects, describing the construction of microphones, amplifiers and receiving sets, and his review of the various appliances and their shortcomings showed some of the problems still awaiting solution by experimental work, in which amateurs are playing a large part.

Tottenham Wireless Society

Hon. Sec.—S. J. GLYDE, 137, Winchelsea Road, Bruce Grove, Tottenham, N.17.

A SECOND talk on "Workshop Practice" was given by Mr. Tracey on April 30. Advice as to types of tools to buy was given and their several uses explained. A new and notably neat method of tapping a solenoid coil was explained. Several

"special-use" tools, devised and made by the lecturer, were passed round for inspection by the members.

Nottingham and District Radio Experimental Association

Hon. Sec.—A. S. GOSLING, 63, North Road, West Bridgford, Notts.

At the meeting on May 1 Mr. W. H. Burtoa (5UG) demonstrated a portable dual-amplification receiver of his own design. A new French dult-emitter valve of the .06 type was used.

North Middlesex Wireless Club

Hon. Sec.—H. A. GREEN, 100, Pellatt Grove, Wood Green, N.22.

At the meeting held on April 30 Mr. A. V. Ballhatch delivered a lecture on "Crystals Used in Wireless Reception." Discussing the theories of the rectifying action of the crystal, the lecturer mentioned several problems which so far have not been solved. For instance, two pieces of crystal may be chemically identical and may look exactly similar under the microscope, and yet one may be very good for wireless purposes and the other quite useless. The lecturer was able, however, to give some very valuable hints on choosing crystals.

RADIO SOCIETY OF GREAT BRITAIN

AN informal meeting of the Transmitter and Relay Section of the Radio Society of Great Britain will be held at the Institution of Electrical Engineers, Savoy Place, W.C.2, on Friday, May 16, at 6.30 p.m. Mr. T. E. Goldup will open a discussion upon the "Design of Transmitting Valves."

From such places as Pennsylvania, Arizona and Montana come complaints that electric smoke-precipitating systems cause interference with broadcast reception within a radius of about twenty miles.

A garden shed of the sectional type, apart from the question of portability, possesses many advantages, and an article describing such a useful structure appears in the current issue of "Work" (3d.). Other articles in this number are: "Renovating a Kitchen Clock"; "Colour Photography: The Autochrome"; "Building a One-valve Amplifier"; "A High-back Settee Built in Oak"; "An Opera Glass Made at Home"; "Melting Metals on a Forge Fire"; "Re-covering a Motor-car Hood"; "Slotting and Light Gear-cutting in the Lathe"; "An Adjustable Spanner"; "Embellishing Wrought Ironwork"; "Repairing an Iron Bedstead."

A wireless club has been formed in connection with the Board of Trade.

ANNOUNCEMENTS

"Amateur Wireless and Electric." Edited by Bernard E. Jones. Price Threepence. Published on Thursdays and bearing the date of Saturday immediately following. It will be sent post free to any part of the world—3 months, 4s. 6d.; 6 months, 8s. 9d.; 12 months, 17s. 6d. Postal Orders, Post Office Orders, or Cheques should be made payable to the Proprietors, Cassell & Co., Ltd.

General Correspondence is to be brief and written on one side of the paper only. All sketches and drawings to be on separate sheets.

Contributions are always welcome, will be promptly considered, and if used will be paid for.

Queries should be addressed to the Editor, and the conditions printed at the head of "Our Information Bureau" should be closely observed.

Communications should be addressed, according to their nature, to The Editor, The Advertisement Manager, or The Publisher, "Amateur Wireless," La Belle Sauvage, London, E.C.4.



"A topping detector"

-better than the best
at ONE THIRD the price

"Gentlemen,
"No doubt you are aware for many months I have been on the look out for a satisfactory Detector Valve for my large Receiving Set supplied by you. I have tried almost every valve on the market (for some of which I paid as much as 35/-), but have not been satisfied until I tried the Thorpe at 10/-. It just does what I want, and makes no fuss about it.
"It is A TOPPING DETECTOR, bringing in all Stations of the B.B.C. Loud Speaker Strength without reaction. I am sorry to confess that I kept off it for a time thinking it could not be much good at the price.
"Thanking you in bringing it to my notice.
"I am, yours faithfully,
"B. H. BRITAIN."

Copy of testimonial sent to a well-known Provincial Factor.



Sole Agents:
BOWER ELECTRIC LTD., 15 Grape St., Shaftesbury Avenue, W.C.2

S. G. BLAND

A.C.G.I., B.Sc.

Wireless and Photographic Dealer

	£	s.	d.
Zola Crystal Set (B.B.C.)	1	2	6
Regophone C.V. Set. Range 500 miles. Price includes all Taxes	5	2	6
Rees Maxe Portable (No Aerial) complete	12	12	0
B.T.H. Phones	1	5	0
Telefunken, Adjustable Lightweight	1	1	0
Bull Phone	17	6	
N. & K. Pattern (Guaranteed)	12	0	
Claritone Loud Speaker	2	15	0
Gramophone Attachment	3	3	0
100 ft. Hand Drawn Aerial Wire	1	7	
Crystal Detector, with two Crystals	1	0	
Broadcast Coils			each 6
Variometer, with brackets	2	9	
60 V.H.T. Battery (Guaranteed)	9	6	
Columbia Cell for .06 Valves	2	6	
Regophone 3½ to 1 Transformer	15	0	
Telefunken Dull Emitter Valve	12	6	
C.H. Valve (Phillip Type)	8	6	
Soft Dutch Valve	5	6	
.001 Variable Condenser, with knob and dial	7	6	
Wave Trap	1	15	0

Postage Extra Trade Supplied

82a Queen St., London, E.C.4



THE "NATIONAL" SUPER CRYSTAL SET

RECEIVES BROADCAST TELEPHONY UP TO 110 MILES AND IS GUARANTEED TO DO SO

PRICE 32/6 Including B.B.C. Royalty.

Recd. G.P.O. Design No. 441
Price of complete Set including Brown "F" Phones, 100 ft. 7/22 Aerial Wire, 4 Insulators. £3-0-0 Postage 1/6.
In Large Handsome Polished Mahogany Case, 5/- extra.

"NATIONAL" SUPER CRYSTAL

We are SELLING OVER 1,000 PER WEEK as fitted to our Super Crystal Sets. Price per specimen above, complete with our Special Contact 1/9. Post 2d.

We guarantee there is nothing as good on Market

ALL ENGLAND & PARIS ON A CRYSTAL

In an article on the above, "Amateur Wireless" (April 12) says:—
... the crystal was a "National Super Crystal." ... Results due to ... Sensitive crystal. ...

A LARGE STOCK OF THE FINEST COMPONENTS AND SETS CAN BE SEEN AT OUR RETAIL DEPOT:

THE NATIONAL WIRELESS & ELECTRIC CO.,
79, CANNON STREET, E.C.4.

Address all Correspondence and Post Orders to our Works:

7a, CHURCH ROAD, ACTON, LONDON, W.3.

Telephone No.: CHISWICK 2266.

Manufacture of Broadcasting Apparatus.

USE OF PATENTS

THE pioneer work of the Marconi Company in connection with wireless telegraphy and telephony is well-known, and as the result of many years of research work and considerable expenditure, the Company controls numerous patents relating to the manufacture or use of wireless telegraph and telephone apparatus.

The Company is prepared to grant a licence for the use of its patents in connection with the manufacture of broadcasting apparatus to any member of the British Broadcasting Company, Limited.

A large number of firms (including the principal manufacturers) are already so licensed and pay royalty for the use of these patents, and all apparatus manufactured under licence is so marked.

Any persons or firms manufacturing or offering for sale valve apparatus embodying patents controlled by Marconi's Wireless Telegraph Company, Ltd., without its permission, render themselves liable to legal proceedings for infringement.

Whilst hoping that it will not be forced to take legal proceedings, the Marconi Company wishes to give notice of its intention to protect its own interests and those of its licensees, and in cases of infringement the Company will be reluctantly compelled to take such steps as may be necessary to defend its patent rights.

Marconi's Wireless Telegraph Co., Ltd.,

Marconi House, Strand, London, W.C.2.

Sweeter Music & POUNDS in POCKET



FROM the minute you fit Radion Valves your pleasure goes up and your expenses go down. Your accumulator lasts three times as long, for Radion Valves

Use only .25 amps. at 3.5 to 4 volts.
Anode volts 30 to 90.

On all normal plate voltages no grid bias is needed.

Two Types:

A.2 for Amplifying. D.4 for Detecting. Same price for each. Same filament and anode current also. If your dealer does not stock this efficient and economical valve write direct to us and we will see that you are immediately supplied.

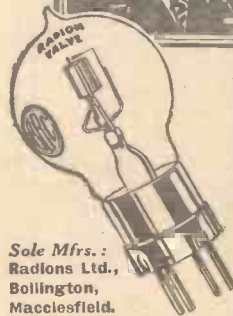

Sole Mfrs.:
Radlons Ltd.,
Bollington,
Macclesfield.

Valve Repairs.
(Most makes). Valves repaired by us are guaranteed: (1) Not to consume more current. (2) To have the same amplification. (3) To give the same radiation. Ordinary types. Price 5/6. Post extra. Trade enquiries invited.



fit the New
RADION VALVES LOW CONSUMPTION

and amplify enjoyment!

Amateur Wireless

COUPON
Available until Saturday,
May 24, 1924

THE "BREAK-NOT" HYDROMETER

7/6

ALL PARTS REPLACEABLE at SMALL COST

LIST ON REQUEST



Everyone who uses an accumulator needs a Battery tester, and it must be a strong, accurate instrument and not a toy.

The "BREAK-NOT" is the ideal for all purposes, and is the only practical instrument for keeping in the Tool Box without danger of breakage.

Your local dealer can supply you, but if any difficulty send us your order and we will arrange for same to be executed.

For Trade Terms write

S. GUITERMAN & Co., Ltd. 35/6 ALDERMANBURY LONDON, E.C.2

ACCUMULATORS

C.A.V. Fullers, etc. Guaranteed brand new and perfect but slightly soiled. We refund cash with carriage both ways if returned within 7 days.

Table with columns for model numbers (IV-40a, 4V-60a, etc.) and prices (17/-, 21/6, etc.).

Special Line. Best English Make, 6v. 60 amp. hour, 22/9 each MAUDE RUBBER CO., 58, Praed St., W.2.

START RIGHT-BY WRITING

Get this list of components which are all tested before despatch. Reliable parts ensure successful sets. Every description of component in stock as used and recommended by foremost workers.



Why hump your Radio Battery to a Service Station when you can charge it at home more carefully for 3d. or 4d. The HOMCHARGER connects to any lamp-socket or wall-plug—A.C. and D.C. types available. AT ALL DEALERS. THE CARPAX CO., LTD., 312, DEANSGATE, MANCHESTER.

AMANITE

The Best Super Crystal SENSITIVE ALL OVER KNOWN ALL OVER SOLD ALL OVER Price 1/- each, 1/2 post free. Trade Supplied. Amalgamated Manufacturers, 94, Aston Road, Birmingham

ORIGINAL POST PAID HOUSE WE APPRECIATE POST ORDERS

SCREW SPADES 1/3 per doz. TINNED COP. PER WIRE 24" x 1/16" x 1/16" square, 1/6 per doz. MARK OF RELIABILITY

Headphones 450 Ohms 650 Ohms Potentiometers Rheostat Type Superior Quality 3/9

H.T. Batteries With Wander Plugs 60v. 8 1/2 30v. 4 1/2 80v. 4 1/2 15v. 2 1/2 4v. P.L. Btry. 6d. 66v. Ever-Rdy. 13/6 86v. 8 1/2 16v. 3/6 Siemens same price

Ebonite Panels Matt ground edges 9" x 6" x 3/16" 1/10 9" x 6" x 1/8" 2/8 12" x 9" x 1/16" 3/6 12" x 9" x 1/8" 4/6 12" x 12" x 3/16" 5/6 15" x 12" x 1/8" 6/6 6" x 6" x 1/8" 5/6

Coll Plugs Moulded type 5d. Ebonite 1/3 Superior 1/3 Narrow type 6d. Basket 1/3 Coll Formers, 2d.

Switches Superior quality D.C.O. 3 1/2 S.C.O. 2/3 D.P.B.T. 2/8 R.P.B.T. 1/10 Ebonite S.C.O. 1/8 Tumbler 1 1/2 Series parallel Double-arm 2/8 Devar D.G.O. 2/8 Utility 2-way 2/8 3-way 4v. 6v. 8v. 12

Aerial Wire/22's 100' Bright... 2/9 100' Enam'd... 3/9 1/4 strd. brd-ld 1/1 1/2 str. 1d. 5d 9d

Insulators Shell, 2 1/2 x 2 1/2 6d. Steel, 2 1/2 x 1 1/2 2d. Crystal type 9d. Lead-in 4/- Lead-in Tubes 4" and 6" 6d. 9" 1 1/2, 12" and 15" 1/3 Simplex Type 1/6

Valve Holders Type A 6d. Type B 8d. Flash legs 6d. Screwed 2 nuts 8d. Ebonite 2 10d. Polar type 1/3

Write for "Complete Supplementary Price List of Exceptional Values," sent Post Free, (9XL—New Issue.) J. H. TAYLOR & CO., Electrical and Radio Engineers, Macaulay Street, Huddersfield. Telephone: 341. Telegrams: "Thorough," Huddersfield

BEGINNERS' GUIDE TO WIRELESS BEST BOOK OBTAINABLE

If you wish to make your own receiver, or to improve the set you already have, you cannot do better than obtain this book. How to ERECT, CONNECT, AND MAKE Aerials, complete crystal and valve receivers, coils, tuners, etc.; also the latest two and three valve tuned anode receivers and one and two valve amplifiers 144 pages (including 23 diagrams). 1/3 post free SAXON RADIO CO. (DEPT 12), SOUTH SHORE, BLACKPOOL

MAGNIPLEX AERIAL MEANS 40 PER CENT, INCREASED AERIAL EFFICIENCY

The Range, Strength and Clearness of Signals is increased up to 40 per cent. by installing a MAGNIPLEX AERIAL. This applies to both Valve and Crystal Sets. Made of Special Woven Wire Gauze of High Tensile Strength and Conductivity. Patent Applied for. Prices: 1/4 in. wide 3d. per ft.; 1/2 in. wide 2d. per ft. Supplied in lengths of 50, 75 and 100 feet, including fittings, viz: End Terminal for Down Lead and Insulators ready for erecting. For lengths under 50 ft. fittings charged 1s. 3d. extra. Postage & Packing 1s. extra. HELIXO LTD., HENRY BUILDINGS, GRESSE STREET, RATHBONE PLACE, LONDON, W.1. Phone: Museum 5039

ADVERTISEMENT INSTRUCTIONS FOR "Amateur Wireless" are accepted up to first post on Thursday morning for following week's issue, providing space is available.

PREPAID ADVERTISEMENTS.

Advertisements under this head are charged THREEPENCE PER WORD, minimum charge THREE SHILLINGS.

DEPOSIT SYSTEM.

As the Publishers cannot accept responsibility for the bona fides of Advertisers in this publication they have introduced a system of deposit which it is recommended should be adopted by readers when dealing with persons with whom they are unacquainted. It is here explained.

Intending purchasers should forward to the Publishers the amount of the purchase money of the article advertised. This will be acknowledged to both the Depositor and the Vendor, whose names and addresses must necessarily be given. The Deposit is retained until advice is received of the completion of the purchase, or of the article having been returned to and accepted by the Vendor. In addition to the amount of the Deposit a Fee of 6d. for sums of £1 and under, and 1s. for amounts in excess of £1, to cover postage, etc., must be remitted at the same time. In cases of persons not resident within the United Kingdom, double fees are charged.

The amount of the Deposit and Fee must be remitted by Postal Order or Registered Letter (Cheques cannot be accepted), addressed to "AMATEUR WIRELESS."

ADVERTISEMENT DEPARTMENT.

PATENTS and Trade Marks obtained.—H. T. P. Gas, Patent Agent, Member R.S.G.B., 51/52, Chancery Lane, London, W.C.1. Phone: Holborn 3255. HEADPHONE REPAIRS.—Rewound, remagnetised and readjusted. Lowest prices quoted on receipt of telephons, delivery three days.—The Varley Magnet Co., London, E.C.18. ACCUMULATORS.—New and reliable repairs a speciality. Special terms to trade.—Lanham Accumulator Service, 2, Lenham Road, Lee, S.E.

STRONG WOOD POLES FOR WIRELESS, painted, 2 1/2 in. long, in 3 sections, fitted with improved strong galvanized iron sockets, 10s. complete. Satisfaction guaranteed. Prompt delivery. Cash with order. (Extra length 9 ft. 9 in. long, 8s. 6d. each with socket).—J. Byfield, Bridge Foot, Warrington. TOPICAL ARTICLES ON WIRELESS SUBJECTS (not home constructional) wanted. Must be bright and well informed.—Apply Box 46, Cassell's Advertisement Offices, La Belle Sauvage, London, E.C.4.

13/- CRYSTAL SET 1-VALVE AMPLIFIERS.—Pledge Bros., 28, Woodstock Road, Oxford. ACCUMULATORS REPAIRED, Moderate charges. Pack your defective accumulator in a box and send it to us for repair or a free report and quotation.—The Electric Accumulator Company, 114, Stocks Street, Chetham, Manchester. 1/16-in. SQUARE TINNED COPPER WIRE, finest quality at cheapest price, 1s. 8d. per dozen 2 ft. lengths. Postage, 4d. extra. Special terms to the trade.—Bowyer Lowe Co., Ltd., Leitchworth, London Retail Stockists—Hamley's, 200, Regent Street, W. Bonds Ltd., 254, Euston Road.

TELEPHONE RECEIVERS & LOUD SPEAKERS, rewound, 2,000 ohms, 3s. 6d.—M. E. Hampshire, 159, Spydham Road, S.E.25. VARIOMETER FORMERS, stator and rotor, hard-wood close coupled, 15s. dozen sets. Sample set, 1s. 6d. delivered.—Sleighthorne, 4, Ingham Street, South Shields. CRYSTAL USERS.—1-valve amplifiers, assembled, guaranteed, 12s.—D. Walters, 23, Marchell Road, London, S.E.15. INSULATED SPRING for fixing phone to horn, with instructions, 6d., post free.—Hildur, 14, Daftoddl Street, Hammer-smith, London.

3-VALVE SET, in new condition, complete with all accessories, receives all stations, and work loud speaker; an absolute bargain, 47 10s. for quick sale, worth double.—C. W. E., 59, Cronin Road, Beckham, London. WIRELESS INVENTORS.—Patents and Trade Marks advice. Handbooks and Consultations free.—King, Regd. Patent Agents, 146a, Queen Victoria Street, London, E.C.4. FALGNE NATURAL CRYSTAL.—Unsurpassed for wireless reception, exceptional results, 1s., post free.—Constans & Co., 81, Amothill Square, N.W.1.

AMPLIFYST (permanently energised), guaranteed 100 per cent. louder than other crystals. Price with catwhisker, 3s. 6d., or particulars Ledham & Co., 297, King Street, Hammer-smith. SWITCHES, "27 point," 4s. Brown's Microphone Amplifiers, 2,000—120, 23 15s. Moving Coil Milliammeters, 25s., new. Edison-Bell Variometers, 12s.—Newells, 74, Claverdon Street, Victoria, S.W.1. VALVES, "Dutch R" type, astounding offer, receives most stations without reaction, 6s. 9d., postage 6d.—68, Springfield Place, Leeds. FREE EBONITE PANEL to purchasers of component parts from us. This week's special offer. Four-valve Family Receiver, complete components and Free Panel, 28 10s. Lists free.—British & Continental Industries, Chancery Lane, London, Staffs.

RADIO "KENITE" PANELS All sets should be built on "Kenite." Highest dielectric strength, rigid, thoroughly insulated. Black matt finish. 6" x 6", 4" x 7" x 5", 1 1/2" x 8" x 5", 1 1/2" x 9" x 5", 1 1/2" x 9", 2 1/4" x 14" x 12", 4", 1 1/2" thick. Post free. Trade quoted. CROXSONIA COMPANY, 10 SOUTH STREET, E.C.2

GAMAGES

of Holborn

Since the movement was in its veriest infancy, Gamages have always been right to the fore as the Premier Wireless Supply House. Experimenters know that at Gamages they can get exactly what they want - and at the price they want to pay! Let us help YOU.

Write to day for your copy of Gamages' Fully Illustrated **WIRELESS CATALOGUE** Just published, it contains everything from a complete set to the smallest accessory



Morse Signalling Apparatus (1316 Improved Model)

Fitted with Flashing Apparatus and High note Buzzer, with terminals for connecting wires for Line Telegraphy. Polished Mahogany Case, with hinged lid and sliding bolt m. Size 5 1/2 x 3 1/2 x 3 1/2. Weight, 1 lb. 3 oz. Complete with battery ready for work. Extra batteries, 9d. ea. Post 4d.

16/6
Post 1/-

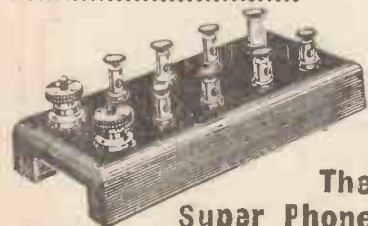

The Super Phone DISTRIBUTOR BOARD

A beautifully made component with lacquered terminals. To take 4 pairs of phones. Size 5 x 2 x 1 1/2 in. Write for yours to-day. Satisfaction or money refunded. Price post 4d. extra

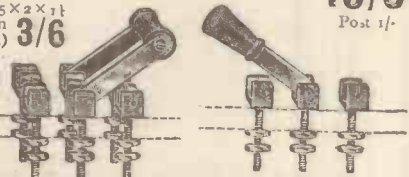

SMALL UNMOUNTED SWITCHES

Nickel-plated, Double Switch Arm with small black handle and contact parts complete with fixing nuts. Single Pole, change-over. Price ... **1/6** Double Pole Price ... **2/3**

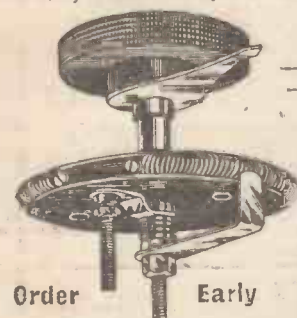

Order Early

Get this Velvet FILAMENT RESISTANCE

A High-class Variable Resistance for one or two valves, with a perfect movement. Similar to illustration, but with many improvements in details. Price **2/6**

Post 4d.



FULLER'S BLOCK ACCUMULATORS

Special offer of ex-Govt. stock, but absolutely unused.

2 volt 40 amp. ... **10/6**
Post 1/-
4 volt 40 amp. ... **21/-**
Post 1/-
6 volt 40 amp. ... **31/6**
Post 1/6

Boxes to hold 5 of these, fitted with lid and carrying strap. Each ... **1/6**
post extra

6 Accumulators sent post free.

PERMANITE

Regd. No. 438341
Highly sensitive. Clear, powerful results. Remains in adjustment longest. Get a piece to-day and notice the improvements in your results. Peel large piece

1/6

Post Free



"Homefect," Northdown Way, Margate.

It may be of interest to you to know that I am receiving 2 L O regularly on a crystal set, with single slider tuning and a piece of your crystal "Permanite." The name could not have been more aptly chosen, as this piece of crystal was purchased at the exhibition and has been lying idle until about a month ago. My "Cat's whisker" is a piece of electric main fuse wire, and my phones a pair of Brown's "A" type of 4,000 ohms resistance.

I am more than delighted with this excellent performance, and you are at liberty to use this letter in any way you may wish. Yours faithfully, ARTHUR O. MILNE.



WE must be amused— We can have too much excitement; but we never laugh too much. Bad headphones are past a joke. If you have a Fellows Set you know its value. Get Fellows Headphones too, and hear every word clearly.

The "Lightweight" Headphones weigh under 6 ozs., and are extremely comfortable. With the special spring adjustment the ear-pieces may be moved into any desired position or separated without the use of adjusting nuts. This fitting is specially designed not to tear the hair. Wound to 4,000 ohms, they are very sensitive and well made, with duralumin headbands, stalloy diaphragms, etc.

: Price **18/6** :

FELLOWS MAGNETO CO., LTD.
PARK ROYAL, N.W. 10 Phone: Willesden 1260

FELLOWS

E.P.S. 58.

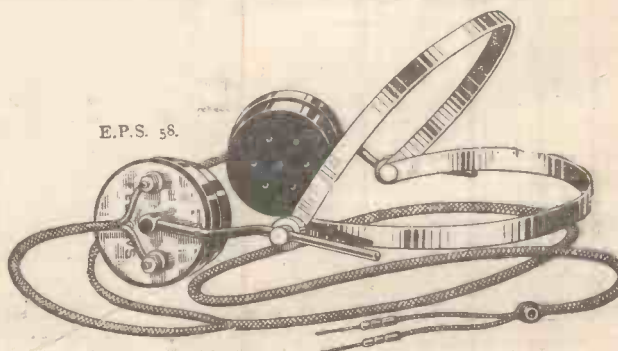

GAMAGES, Holborn, LONDON, E.C.1

Cheapside House: BENEFINKS

LISSENIUM

Lighting the Valve Filament

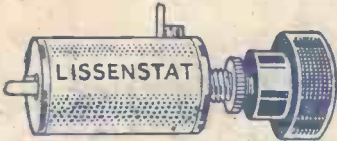

The days are gone when mere lighting of the valve filament was called filament control. The successful tuning of the detector and H.F. valves is a critical thing which largely depends upon the proper regulation of electron emission. Filament temperature must be exactly right for

each station tuned in—especially is this important on long distance work. The introduction of LISSENSTAT control has shown what unique filament control can do to improve fine detection of long distance telephony. The difference it makes to tuning is a revelation. There are three types to choose from. Each is suitable for dull emitter and all valves:

- LISSENSTAT (prov. pat.).—This is the super filament control—brings in stations which have previously eluded every other control of the receiver **7/6**
- LISSENSTAT MINOR (prov. pat.).—There must be hundreds of thousands of inefficient rheostats in use. The LISSENSTAT MINOR has been introduced to provide something of the beautiful LISSENSTAT control at a popular price. It is well worth while discarding any existing rheostat and replacing it with this perfect little control. **3/6**
- LISSENSTAT UNIVERSAL (prov. pat.).—Gives full LISSENSTAT control, and by means of an ingenious arrangement a minimum resistance can be left in circuit to protect expensive valves while zero resistance can also be obtained when full battery pressure is required **10/6**

Cutting Out Station after Station



Start with any station you please, and you can go right round them all if you use the LISSENCEPTOR and a separate tuning condenser. In turn you can cut out any of the stations you do not want—Morse interference also. Users on the coast say they can now enjoy broadcasting in a way impossible before. Some type of Morse interference calls for somewhat more skill, but 95% of Morse is cut out easily. Even the more difficult Morse, however, can be sufficiently subdued so that it ceases to be troublesome.

- LISSENCEPTOR Mark 1 type, for broadcasting... **7/6**
- LISSENCEPTOR Mark 1 type, for 600 metres... **7/6**
- LISSENCEPTOR Mark 2 type for broadcasting and 600 metres combined (with tuning) **15/6**

LISSENCEPTOR Mark 2 switch for more selective tuning)
THE LISSENCEPTOR ACTS AS A SENTINEL BESIDE YOUR RECEIVER.

Stronger Light and Fading Signals. The Need for Radio Frequency Amplification

Have you yet noticed how signals which used to come in strongly are now more difficult to tune in while daylight lasts? No sooner has darkness set in, however, than signals seem to come in strongly again. Summer shows up any weakness in your set if it is without proved radio frequency amplification. Build up wave energy with the aid of LISSEN radio frequency amplification. Then see how strongly your signals are received, and with what certainty they come in. There are three well known types of LISSEN radio frequency parts:—When to use the LISSEN Selective H.F. Transformer. In some dual and reflex circuits transformer coupling of H.F. valves is essential, and even where it is not indispensable many still like to use transformer coupling. The advantage the LISSEN H.F. Transformer has over all others is that it makes a receiver exceedingly sensitive—it is also very stable and as many stages of H.F. as desired can be introduced into a receiver. 150-4,000 metres... **19/6**

Blue print with each shows easy connections.

When to use Lissen Reactance (prov. pat.)

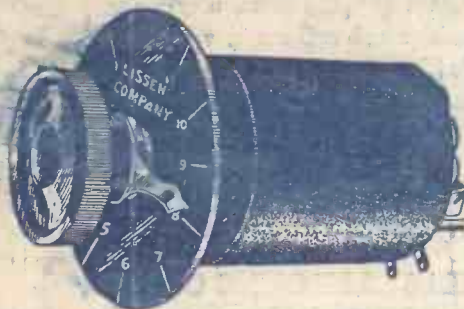

If you desire great purity of reception, a high degree of amplification, and extreme sensitivity, the LISSEN REACTANCE should be introduced into the H.F. valve. Diagram with each shows how. It gives greater amplification than any other H.F. coupling, and it will amplify even the loudest of signals almost as much as a good audio frequency transformer. Recommended for one or two stages H.F., for which it is easy to control. Beyond two stages some

little skill is required. It is widely used, and has done much to popularise radio frequency work. Gives its best results with aerial 150-10,000 metres **19/6** 150-600 metres **17/6**

The LISSEN REACTANCE AND LISSEN H.F. TRANSFORMER have the same outward appearance—latter has four connections instead of two, however.

Successfully Used in the Reception of American Telephony

No aerial reaction need be used for the LISSEN REGENERATIVE REACTANCE (prov. pat.) will take its place. It is non-radiating—replaces plug in coils—it is lower in cost than a set of coils to cover the same wide range; it is easier to handle, one knob controls tuning and reaction; reception is often possible with both aerial and earth connections dispensed with; cuts out the local station and tunes in the others with full built up strength. Continental stations come in easily. Introduced into the anode circuit it forms an unequalled first stage of radio frequency. Blue print with each shows easy connections—unbroken regeneration possible over the whole range—150-4,000 metres **£2/12/6**

Tune always with a vernier—preferably the LISSEN Vernier, which is specially designed for fine tuning in H.F. circuits, **12/6**.

NOTE.—LISSEN H.F. Transformer and LISSEN REACTANCE are self-contained and no separate condenser is essential, but the aid of a vernier will oftentimes be an advantage, and the LISSEN VERNIER is recommended. All these parts have LISSEN ONE HOLE FIXING, OF COURSE. And the radio frequency parts are complete with internally connected switch, so that drilling and soldering are avoided.



The Loud Speaker's Voice

You have no doubt heard that blurred, woolly reproduction which is more jarring than beautiful. More often than not such reproduction comes from a badly designed transformer. Not all high priced transformers are well designed. If you would have beautiful tone quality, crystal-clear music, perfect in every detail of light and shade, song and speech that come through with absolute fidelity of tone, you will fit LISSEN Audio Frequency Transformers, at the price you choose.



MAKES A WHISPER LOUD.—The LISSEN T₁ has a coil with over 8-ozs. of copper in the coil—the coil would amplify by itself without any iron core at all—for immediately after the detector valve always, throughout when superlative amplification is desired, and especially for **POWER WORK** also... **30/-**

AUDIO FREQUENCY IN REFLEX CIRCUITS.—An all purpose transformer is the LISSEN T₂, and it has been found an excellent transformer in dual and reflex circuits, where it will yield pure and powerful amplification. May be used for all stages, and recommended to follow the LISSEN T₁ where multiple stages of audio frequency are used... **25/-**

SKILFULLY BALANCED DESIGN.—Many expensive transformers are not so good as the LISSEN T₃—it is one of the best light transformers made. **16/6**

Switching that is Helpful to Regeneration

When working on the lower wavelengths perhaps the set will just oscillate with the condenser in parallel. If the LISSEN Series-Parallel switch were fitted you could immediately try the effect of putting the condenser in series, and so seeing whether the increased regeneration obtained would more than compensate for the slight damping of signals consequent upon the changing over of the condenser. The LISSEN Series-Parallel switch is easy to fit—takes up little room—LISSEN ONE HOLE FIXING, OF COURSE **3/9**



Make Your Batteries Last Longer

In the case of dull emitters, the current taken per valve is small, but there is a drain on the batteries all the same. If the dry cells used are given the opportunity to recuperate the voltage which has dropped when the cells are in use will rise again. Two cells, for instance, which are worked alternately throughout will last a great deal longer than twice as long as one cell which is worked continuously. Apart from the economy of introducing a switch to change over to alternate batteries, the voltage will be steadier and the efficiency of the set improved. The best switch to use is the LISSEN two-way switch—easy to fit—hardly any room is taken up—LISSEN ONE HOLE FIXING, OF COURSE **2/9**



What would Happen to the Negative Charge?

If you had an unreliable grid leak in your receiver, the negative charge left on the grid of the valve by each radio frequency oscillation of a radio wave would leak away too quickly, with the result that it would be impossible to regulate the charge that should accumulate on the grid. When the LISSEN Variable Grid Leak (prov. pat.) is used it is possible to select the exact value of leak resistance, and to obtain correct grid potential under all conditions of valve and circuit. An interesting alternative use is across the secondary of a transformer or across the loud speaker itself, when it will suppress any tendency for the high notes of the musical scale to be amplified disproportionately to the lower notes.



LISSEN Variable Grid leak has positive stops both ways—continuously variable $\frac{1}{2}$ to 6 megohms—LISSEN ONE HOLE FIXING, OF COURSE **2/6**

LISSEN Variable Anode Resistance, 20,000 to 250,000 ohms continuously variable, same outward appearance as the LISSEN Variable Grid Leak **2/6**

WHY USE MIXED PARTS?—You can be sure that your receiver built with all LISSEN Parts will give results which would never be possible with a receiver built with mixed parts.

LISSEN LIMITED

16-20, Woodger Rd., Goldhawk Rd., Shepherd's Bush, London, W.12.

Telephones—Hammersmith 3380, 3381, 3382, and 1072.
Telegrams (Inland) "Lissenium, Shepherds, London."
" (Foreign) "Lissenium, London."

BUILD—WITH LISSEN MASTER PARTS