

2047

A UNIVERSAL CRYSTAL-VALVE RECEIVER

Amateur Wireless And Electrics

Vol. IV. No. 99.

SATURDAY, APRIL 26, 1924

Price 3d

PRINCIPAL CONTENTS

A TELEPHONE DIS-
TRIBUTION BOARD

THE CHEAPEST LOUD-
SPEAKER

POPULARISING OPEN-
AIR WIRELESS

A VARIABLE-CIRCUIT
VALVE SET

PRACTICAL PHONE
POINTS

THE NEWEST DULL-
EMITTERS

A PAGE OF PRACTICAL
ODDS AND ENDS

ON YOUR WAVE-
LENGTH

WELL ILLUSTRATED

Registered at G.P.O. as a Newspaper



BROADCASTING THE TIME SIGNALS

The apparatus shown in the photograph relays the signals from Greenwich for retransmission by wireless.

ECONOMIC ELECTRIC LTD.



ENGRAVED WHITE IVORINE DIAL
3 in. diam.
Price 6d.



100 yd. COILS
Stranded copper wire consisting of 4 wires, 25 gauge.
Price 1/6



BASKET COIL FORMER with plug mounting to fit either Basket or Honeycomb coil holders 1/9



CRYSTAL DETECTOR COMPONENTS for panel mounting 1/6



POTENTIOMETER
250 or 450 ohms.
5/6



NEW 40-page RADIO LIST mailed post free, 4d.



FILAMENT RHEOSTAT With engraved bevelled dial 3/6

Head Office: 10, FITZROY SQUARE, LONDON, W.1
Showrooms: 303, EUSTON ROAD, N.W.1
Branch and Works: TWICKENHAM

The **ML ANODE CONVERTER**

BANISHES one of the most troublesome components of the set, namely, the High Tension Battery.

It is worked from the ordinary 6 volt accumulator used for your filaments at a consumption of only 1.15 amperes.

The M-L Anode Converter completely smooths out the ripple that is so noticeable with direct current machines, and the current supply is as perfectly continuous as that from a battery.

"AMATEUR WIRELESS" says — "... one of the most remarkable appliances yet brought out for the benefit of the amateur Wireless enthusiast."

The machine is supplied for the following standard voltage ranges, but special machines can be made to order.

- Type A, 6-70 volts. For general reception,
- Type B 6-120 volts } For two stage power amplification.
- Type C 12-300 volts }
- Type D 12-500 volts. For low power transmission.

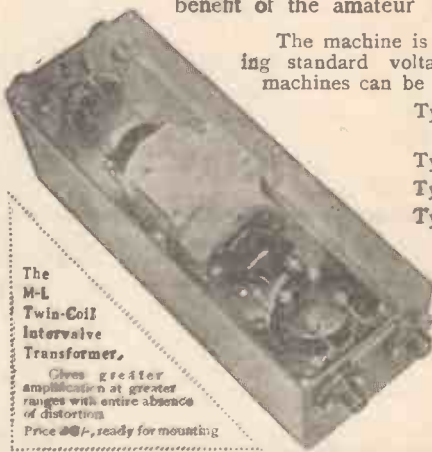

The M-L Twin-Coil Interval Transformer. Gives greater amplification at greater ranges with entire absence of distortion. Price 2/6, ready for mounting.

Write to-day for full particulars.

The M-L Magneto Synd. Ltd., Wireless Department, Victoria Works, COVENTRY

TUNGSTALITE'S TRIUMPH

A GREAT ACHIEVEMENT

The Eaves, Woodplumpton, Nr. PRESTON.
April 14, 1924.
Messrs. Tungstalite, Ltd.
Dear Sirs,
I am in receipt of your second sample of "Tungstalite" Crystal which you forwarded me recently, and I am firmly of the opinion that it is impossible to obtain a clearer crystal, both for loudness and long-distance reception. I am 33 miles by air from Manchester, which I received perfectly, and also Newcastle, which is 90 miles. You may make use of this letter as you wish.
Wishing your crystal every success, I remain,
Yours faithfully,
E. MORTON.

Guaranteed more sensitive than any other crystal. Ideal for long-distance work. Absolutely non-fading. Unaffected by heat. A genuinely synthetic sulphide.

Ask your Dealer for it or send 1/- P.O. for Sample Tube to:

TUNGSTALITE LTD.,
Electric Lamp House,
47, FARRINGTON ROAD, LONDON, E.C.1
Phone: Ho. born 2557.
Grams: Tungstamp. Smith, London.

YOU HAVE TRIED THE REST NOW TRY THE BEST!



1/-

AMATEURS and EXPERIMENTERS ALL OVER THE WORLD

The "MAXWELLTÖN" Vernier Crystal Detector is the only crystal detector which will positively increase your range and signal strength **100 per cent.**

Fitted with Radial-arm and the most delicate and sensitive adjustment possible. A great scientific achievement. Try it on your Reflex circuits.

Complete with "MAXWELLTÖN" Crystal on Ebonite Base. Price within reach of all. Can be Panel mounted by detaching from Ebonite Base. Post Free, British Isles.

Send at once for sample, and after proving its superiority and efficiency tell your friends.

Postal Orders to the **MAXWELL RADIO & OPTICAL CO.,**
61, NEW OXFORD ST., LONDON, W.C.1.

Remember always that your set is only as good as its poorest PART

Amateur Wireless

and Electrics

Vol. IV, No. 99

April 26, 1924

"POPULARISING OPEN-AIR WIRELESS"

Dancing Couples

PLENTY of fine weather will mean either open-air wireless or no wireless at all; the latter alternative is, of course, inconceivable to any wireless enthusiast.

The chief means of popularising open-air wireless lies in the possibilities of the portable set, whose performance has been brought to a high degree of efficiency and reliability by the use of the various super-circuits which have lately come to the fore. Since the advent of the latest types of dull-emitter valve there has been no difficulty in constructing portable multi-valve sets.

Open-air wireless will be popularised mainly through the facilities offered by loud-speakers to dancing couples, in the park, on the pier, or perhaps on a yacht. Weather reports will tell us when to go home to avoid getting our frocks and flannels soaked through. The occasional butting-in of some powerful Morse station will provide a fine opportunity for the ex-service signal officer to "swank" and tell the latest news to his partner.

A portable set will accompany every picnic party, perhaps fixed to the Rolls-Royce (?). At home some music will be appreciated by the open-air "fiends" whilst having tea in the garden or taking a respite from the tennis-court. In fact, when father goes out in the canoe for a day's fishing, he might try a few wireless tunes to lure his wary quarry—customarily so apathetic to the bait—before visiting the local fishmonger on the way home.—A. B. DEERE (Mumbles).

In the Parks

OPEN-AIR wireless, like most other things, can be popularised by bringing it before the public eye and installing a confidence in the people as regards its national importance.

Perhaps the most universally-needed use to which open-air wireless should be put is the transmission of talks and debates of national interest. Some of the open parks which are dotted all over the country would afford excellent sites for the erection of large loud-speakers, and there is no doubt that large numbers of people would congregate, especially during the dinner-hours, to hear these talks. One

has only to look about and see the numbers of men who are loafing around to feel the need of something to interest them during the present hard times of unemployment. Surely open-air wireless is the solution to this universal problem.

One form of open-air wireless which would be sure of a tremendous following

Efficient Sets and Aerials

THE influence of the portable receiver in promoting outdoor wireless is so great that more attention might be paid by manufacturers to developing this type of set. By marketing it at reasonable cost the public would be encouraged to take their wireless outdoors with them.

An aerial which would be more efficient than the frame type and much more compact could be made in the form of a copper ribbon, which would roll up after the style of a surveyor's tape-measure. The increase in signal strength would enable less valves to be used, and now that dull-emitters have reached perfection, wireless sets can be really self-contained and easily portable without sacrificing efficiency in any way.

Broadcasting stations, by extending their afternoon programmes on certain days, say, from 2 p.m. to 4.30 p.m., and dispensing popular music only, would enable organisers of outdoor parties to provide an additional attraction. In this connection wireless societies could do a great deal by equipping themselves with a really powerful receiver, enabling loud-speakers to be used. Considering that a four-valve set with one power valve will be satisfied with less than .45 ampere, batteries need be no inconvenience.

This summer will no doubt see a great increase in the use of wireless receivers on occasions when hitherto the gramophone held pride of place.—G. PERCY (Bridge of Weir).

What is Needed

IN my opinion a great deal has to be done before wireless will be really popular in the open-air.

To obtain really good results in the open-air one must employ at least three valves, unless one uses a reflex or super circuit. Both the latter types of circuit are usually unstable and also very often call for a certain amount of experience.

The set that would really popularise open-air wireless would be one that gave sufficient volume to operate a loud-speaker. It would also weigh only about 10 lb. and would occupy the space of an average attaché case. Adjustments would be simple, and it would have the necessary mechanical strength.

THIS IS OUR DISCUSSION PAGE

READERS are here given an opportunity of contributing their opinions on topics of the day. Mr. A. B. Deere, 3, Oakland Road, Mumbles, is the writer of the letter placed first on this page, and we shall send him one guinea in due course. The writers of the other letters printed will each receive 7s. 6d.

In continuation of the idea we invite any reader to send us by first post

Next Wednesday, April 30

a bright, non-technical, interesting letter of not more than 250 words (written on one side of the paper) on the subject mentioned below.

We shall publish as soon as possible about five or six of the letters and for the one placed first shall pay one guinea, whilst for any other letter published on the page we shall pay 7s. 6d.

Envelopes should be addressed: *Discussion Page, Editor, "Amateur Wireless," La Belle Sauvage, London, E.C.4.*

"Discussion Page" letters not printed will be destroyed. No correspondence on the subject can be entered into.
The next subject is:

"If I Were the B.B.C."

is the broadcasting, by means of large loud-speakers, of popular music. The need is greatly felt in this country for more open-air entertainment in this direction. During the summer months especially this form of entertainment would be very popular amongst those on holiday, who are always seeking some new outdoor amusement.

In conclusion, taking into account the widespread interest which is taken in wireless, I would venture to vouch that, carried out in the proper manner, open-air wireless would become one of the most popular forms of entertainment.—A. C. HILCOMBE (Rock Ferry).

A TELEPHONE DISTRIBUTION BOARD

Preferably there would be no batteries, but if these were necessary they would be dry and of very small dimensions. It would only require a small frame aerial incorporated in the lid of the case. Valves (if used) would have to be practically unbreakable.

Until these conditions are possible, I do not think that open-air wireless will be really popular. Of course, we always have the type of enthusiast who is willing to carry a large cabinet filled with apparatus, a 6-volt 100 ampere-hour accumulator, a loud-speaker, and a 6-ft. square frame aerial, but he is only one in a thousand.
—A. S. BROWN (S.E.16).

Light Apparatus

WITH the rain hissing against the windows and the thermometer registering but 40 degrees, it is not too easy to think and write of outdoor pastimes. But when summer does come eventually, I think outdoor listening will be far more popular than it was last year.

Experience has enabled us to obtain greater service from a smaller amount of apparatus, and the dull-emitter dispenses with the need of an accumulator—heavy, cumbersome and acid filled. For portable work the filament current can be obtained from a pocket-lamp battery, whilst the H.T. supply can be built up with similar batteries to the exact voltage requirements of the valve or valves used.

The high-power station, if and when it materialises, will do much towards making outdoor listening more popular, because much simpler, and consequently lighter, sets will be suitable.

The listener in the garden, on the river, at a picnic, or in a char-à-banc, is in a lighter and less serious mood and has more to distract him than was the case during the winter months when he sat by the fireside.

Consequently heavy, classical music should give place to lighter and jollier music and songs requiring less thought and attention for their appreciation. Lectures such as "How to Become a Solicitor" and "The Training of a Dentist" should stand over until the winter evenings are with us again.—R. H. BRADLEY (Hanwell).

THE writer being called upon to give a village demonstration of wireless required a neat and quick way of connecting six pairs of phones to the two

number of phones it will be required to accommodate. As a guide the panel illustrated measures 12 in. by 3 3/4 in. The depth of the cabinet is 4 in.

It is not advisable to use more than four pairs of H.R. phones in series. Fig. 1 shows the connections on the under side of the panel.

Stout flexible wire should be used for the leads marked "input," and two holes are drilled in the back of the cabinet for them to pass through. Two inches of stout brass wire or two spade terminals should be soldered to their ends and then bound with red and black silk to distinguish them and make a neat joint.

Switching

The key to the switching was painted on the panel (see Fig. 2). The centre was lightly scratched and the four sets of five points to represent terminals were marked out with dividers and recessed with a small drill. These recesses were then filled with white enamel and allowed to dry, the lines representing connecting bars being filled in afterwards. The tops of the terminals should be painted with red and black enamel to ensure correct connection of the phones.

It was found that there was no diminution in signal strength with both sets of phones in series, but with both sets in parallel the low-resistance phones were slightly louder. The writer intends to fit a G clamp to the cabinet so that it can be clamped to the table.

The constructional details are shown by Fig. 3. The cabinet bottom is cut away to allow the clamp to lie flush with

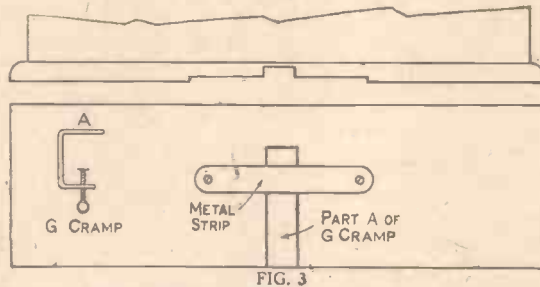
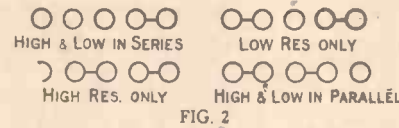
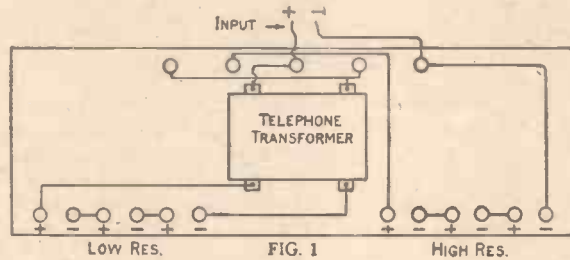

Fig. 1.—Connections on Under Side of Panel. Fig. 2.—Key to Switchboard. Fig. 3.—Constructional Details of Cabinet.

terminals of the receiver. To complicate matters, three pairs of the phones were of high resistance and the others of low resistance. The following is a description of the arrangement used.

When recording Morse the relay can be connected to the L.R. terminals and one pair of phones to the H.R. terminals. By means of the novel "switch" the relay

bars being filled in afterwards. The tops of the terminals should be painted with red and black enamel to ensure correct connection of the phones.

It was found that there was no diminution in signal strength with both sets of phones in series, but with both sets in parallel the low-resistance phones were slightly louder. The writer intends to fit

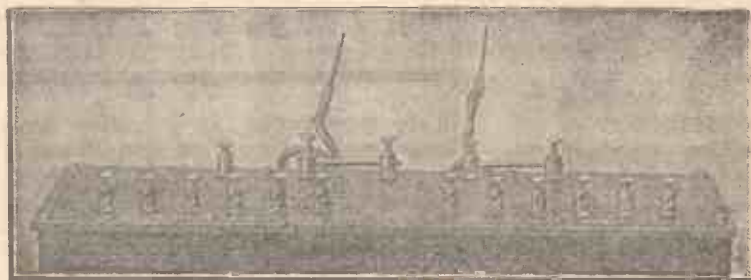

Photograph of Distribution Board.

can be put in circuit and the phones out immediately the station is tuned. There are numerous other uses which will suggest themselves.

The size of the panel and the depth of the cabinet will be decided by the size of the telephone transformer used and the

the table. A thin metal strip is then cut to size, let in flush with the cabinet bottom, and fastened with countersunk screws. With this addition there is no fear of the "D.B." and perhaps the set being pulled off the table by a sudden movement on the part of one of the listeners. A. J.

THE "WORK" HANDBOOK

WIRELESS TELEGRAPHY AND TELEPHONY

TELLS YOU HOW wireless works, and how to make a complete range of crystal and valve receiving apparatus.

IT IS ONLY EIGHTEENPENCE, But it is the Best Yet!

CAMELL & COMPANY, LIMITED, LA BELLE SAUVAGE LONDON, E.C.4.



Fig. 1.—Top View of Receiver without Coil-holder, Valves, etc.

FOR certain experimental work the writer required a receiver which, while being compact enough to be easily portable, would at the same time be so arranged that any circuit, either standard or freak, could be used. The accompanying photographs show how these requirements were met.

The set is contained in a box measuring 12 in. by 9 in. by 5½ in., with ebonite top and front. The chief point of interest is that practically the only internal wiring consists of the connections between the A.T.C., the aerial and earth terminals, and the series-parallel switch (seen on left centre of top panel) and those of the filament sockets, via the resistances, to the L.T. terminals on the right. All the other components are wired directly to sockets on the face of the panel, circuit connections being made as required by short insulated leads with a plug at each end.

An Experimenter's Variable-circuit Valve Set

latter has further sockets mounted in its base, by means of which connections from either the aerial or closed-circuit coils are taken to the first valve, etc.

Above the three filament resistances are the sockets for the valves and their connections, and also those for the grid condenser; the latter can be plugged in on the left of any valve, and the grid leak can be placed either across the condenser or between the grid and L.T. positive or negative. Additional sockets are provided to allow of the connection of the H.T. negative to the positive or negative L.T., and of the earth to either side of the filament of any valve.

Above the valves are eight sockets connected to the two intervalve transformers. The top row sockets are wired to the positive H.T. A 30-volt battery is contained inside the case, and the two terminals at the top right-hand side are for additional H.T. supply. The latter can be used either instead of, at the same time as, or in series with the internal battery.

The sockets for the valves themselves have been drilled right through, so that the set can, if required, be used with the valves inside the case.

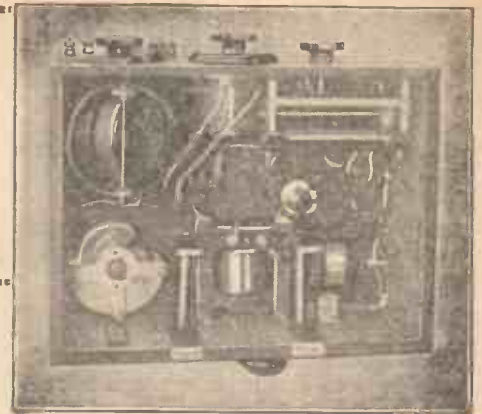

Fig. 4.—Interior View showing One Valve in Position.

were cut off and connecting wires soldered in their places. These wires are carefully spaced, and though it may be thought that the wiring system employed would give rise to unwanted capacity effects, this does not appear to be the case in practice. As far as the exterior wiring is concerned, if any particular connection appears to give trouble it can be bent into a new position, some of the connectors being made of fairly stiff wire for this particular purpose.

It will be seen that the components and their sockets are placed as nearly as possible in the positions that they usually occupy in conventional circuit diagrams. This simplifies the wiring and also makes it possible to tell at a glance whether the connections for any particular circuit have been correctly made. The latter advantage is particularly apparent, for example, when one has been using some special

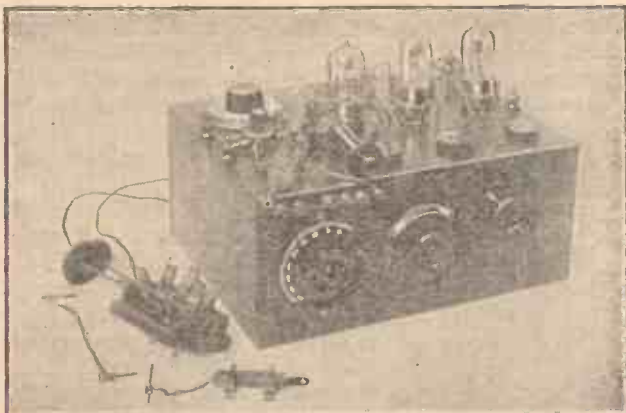

Fig. 2.—Receiver Arranged for Detector Valve, (variometer-tuned), followed by L.F. Valves.

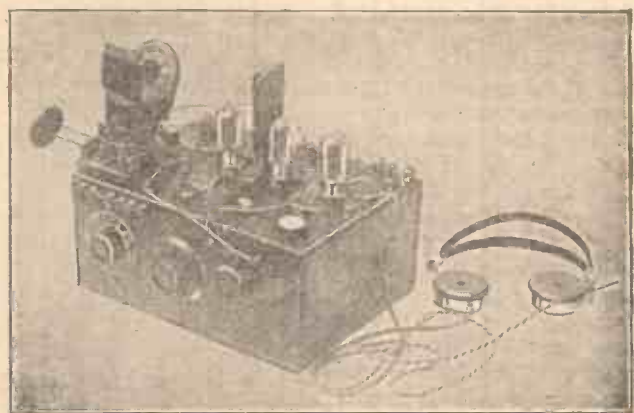

Fig. 3.—Receiver Arranged for 1 H.F., Detector and 1 L.F. Valves.

Referring to the photograph of the top of the set (Fig. 1), above the series-parallel switch is the H.F. condenser, which is connected to the two sockets on its immediate right, into which fits the anode-coil holder; the latter makes its own connections with H.T. positive and plate and so, when removed, the condenser is isolated and can be used elsewhere in the circuit.

Near the lower left-hand corner are two sockets (connected to the series-parallel switch) for the three-coil holder. The

On the front panel are fitted the A.T.C. and a potentiometer, and a variometer with the rotor and two halves of the stator wired to separate terminals. A third condenser for the closed circuit is at present used externally, but there is room for it inside the case.

Valve sockets were used throughout. The top ends were tapped ¼-in. Whitworth and screwed from the under side into tapped holes in the ebonite, and then countersunk from the top with a left-hand drill. The screwed parts of the sockets

circuit and a rapid change back to a normal receiving set is required.

The set is thus seen to yield, in many respects, greater advantages than given by switching arrangements, and is specially convenient for circuits which require some alteration from standard, as, for example, the earthing of positive instead of negative L.T., etc., as mentioned above. At the same time the set is particularly suitable for use either as a whole or in any particular part, with other apparatus for experimental purposes.

L. F. I.

PRACTICAL PHONE POINTS

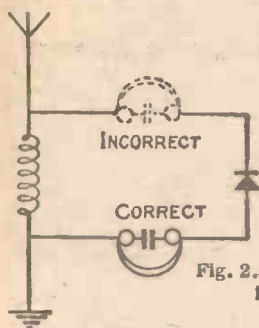

Fig. 2.—Position of Phones in Crystal Set.

THERE are probably very few people to-day who do not know how the head-phone works; but for the sake of these few people the following may prove of interest.

To commence with, the incoming wireless signal, which is in reality a series of small impulses of high-frequency energy, is converted into direct current by the rectifier, whether it is a crystal or a valve. These impulses travel through many turns of wire wound round a permanent magnet which has a metal diaphragm in its field. These impulses, although very minute, are sufficiently strong to vary the strength of this field and thus vary the pull exercised on the diaphragm. As these impulses vary, so does the speed at which the diaphragm is vibrating vary, and thus the air is set in motion and the signal is made audible. Loud-speakers work, as a rule, on the same principle.

For wireless purposes various kinds of phones are used. The most usual type is perhaps that known as the high-resistance phone. This simply means that the resistance of the windings are relatively high—perhaps 2,000 or 4,000 ohms. They may even be as high as 8,000 or more.

Failures

Causes of failure in this type of head-phone are numerous.

First we have ordinary mechanical breakage.

Then there is a failure which is generally called "burn out." Do those who say that they have burnt out their phones think exactly what this means? It must mean that sufficient current has been passed through the windings actually to burn the insulation or melt the wire. Now, although the wire is extremely fine, it will pass a considerable current without melting. The current passing in a single-valve set is seldom more than 2 or 3 milliamperes, and this would not be nearly sufficient to burn out the windings. Even on a dead short with the H.T. they will survive. Take the following example: An enthusiast owns a pair of phones with a total resistance of 4,000 ohms. One day he accidentally connects them across his high-tension battery of 60 volts. What happens? There is a deafening crash and the owner is deafened for a minute or so. But the current flowing will be 1½ milliamperes! Surely this wire will stand that amount! Then what is the cause of this failure through "burning out"?

It is simply this: The small impulses of current passing through the windings set the diaphragm in vibration as explained above. At the same time they tend to make the windings vibrate. Now should the windings be badly wound excessive vibration will take place and after a while the wire becomes very brittle. When a very loud signal comes in the

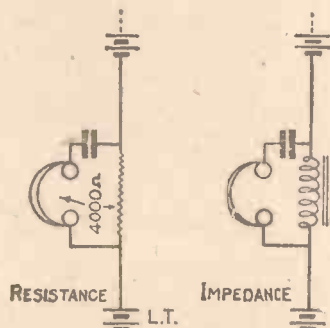

Fig. 1.—Resistance and Impedance Methods.

vibration becomes so pronounced that it breaks the wire. This is the explanation of a great many cases of "burning out."

It is possible to burn the insulation off should there be a great deal of high-frequency energy passing, and this is one reason why a condenser should be bridged across phones in valve circuits. The other reason does not concern us here.

There are several methods of using H.R. phones for wireless purposes. The most usual is to connect them in series

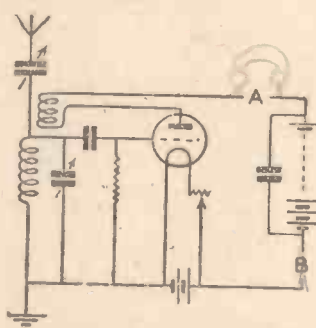

Fig. 3.—Position of Phones in Valve Set.

with the H.T. circuit in a valve set or in series with the crystal if a valve is not used.

One method which is sometimes adopted is to connect in a one-to-one ratio transformer; that is, a transformer having an equal number of turns on both primary and secondary both wound to the same resistance as the telephones. There is only one advantage to the writer's knowledge and several disadvantages. The advantage is in the fact that the wearer

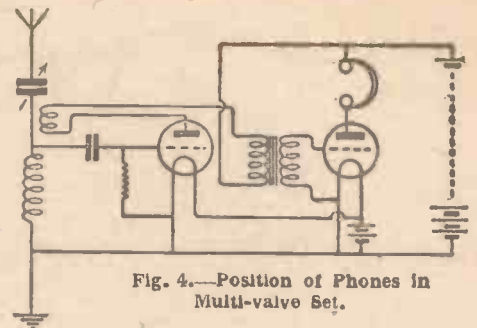

Fig. 4.—Position of Phones in Multi-valve Set.

of the phones is immune from shocks due to high-tension leakage to earth through the ears and body of the operator. One disadvantage is that there must always be a loss of efficiency even in the best transformers, and this always tends to reduce signal strength.

The resistance and condenser method comes next. (See Fig. 1.) The advantage of this method lies in the fact that there is no current passing through the phones and therefore they are not likely to "burn out." Again, there must be a loss, and there is not much to choose between this and the foregoing method.

Then there is the impedance method, which is similar to the resistance and condenser system but, probably more inefficient.

Correct Position

The correct position for phones in various sets is often a cause of much worry.

Let us take a common crystal set as shown in Fig. 2. The phones should be placed as shown and not on the other side of the crystal, for this reason: when the headphones are being worn there is a considerable capacity, due to the operator's body, to earth, and the incoming signal would much rather go through him than through the high resistance of the crystal. Thus much energy is lost and the signals in the phones are not as loud as they might be.

Fig. 3 shows a straightforward single-valve set. Do not put the phones in at A for the same reason as with the crystal set. The effect is even more pronounced in this case and shows itself in the form of very unstable tuning. Just as the very faint signal has been tuned in and the operator clutches the phones in each hand in order to hear better, the signal vanishes! This can easily be overcome by putting them in position B.

In a multi-valve set as shown in Fig. 4 there is no alternative but to put them as shown and trust to luck that the capacity effect is not too noticeable. This is automatically controlled by the fact that not much high frequency has got through the transformers, and therefore the phones can generally be handled in comfort from the tuning point of view. A. G. W.

(More Phone Points next week)

Wireless is revolutionising exploration and survey work in the Far North.

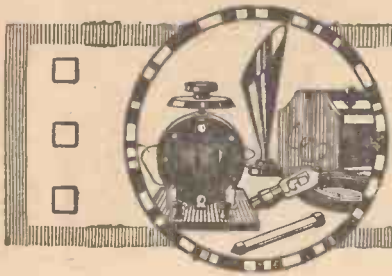

PRACTICAL ODDS AND ENDS

Improved Indoor Aerial

ORDINARY indoor aerials are not very efficient unless they are directional, and the same limitation applies to frame aerials. The proposal comes from Germany that two aerials should be used together, as shown in the diagram.

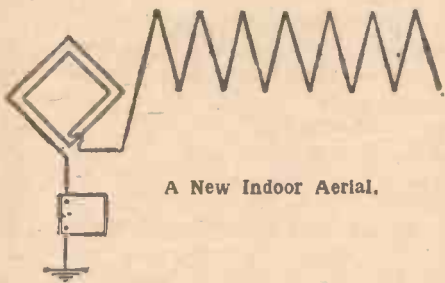

A New Indoor Aerial.

In this case a zigzag-type of aerial is connected in series with a frame, which is in turn connected to the receiver. An ordinary earth connection is used. The frame apparently helps to give better results owing to its easily-adjustable directional properties. D.

Quick Crystal Comparison

IN crystal sets employing two detectors it is not essential to have a switch to change from one to the other. Connect the detectors in parallel, then to change from one to the other simply lift the catwhisker. C. P.

Using Lighting Mains as Aerial

A SIMPLE method of using the electric-light mains as an aerial is to take a lead from one prong of a tumbler switch through a small condenser to the aerial

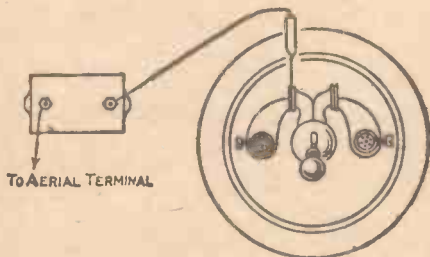

Using Lighting Mains as Aerial.

terminal of the set. The writer uses as an adaptor a small piece of brass strip to which a wire is soldered. This strip is inserted into the bent prong of the switch, and makes a reliable contact, especially when the light is "on."

The condenser is made of four foils and three (.002 in.) micas, the foils having an overlap of $1\frac{1}{4}$ sq. in. It is found that no earth is necessary with this adaptor. A. L. R.

Tinsel Catwhiskers

TINSEL, such as used on crackers, can be used successfully as the contact in crystal detectors. A strand of brass tinsel from a "pan cleaner" (composed of wire interwoven in cloth) makes a better catwhisker than that of any the writer has tried. R. W.

Spring-mattress Aerial

AN efficient connector for using a spring mattress as an aerial can be made from two copper strips, each measuring about 5 in. by $\frac{1}{2}$ in., arranged as shown by the photograph.

The two strips should be placed one above and one below that particular part



Mattress Used as Aerial.

of the mattress from which the best results are obtained and a terminal firmly screwed into position. Another terminal is now fixed into the opposite end, thus drawing the strips into intimate contact with the wire intersections of the improvised aerial. W. A. A.

Polarity of Phone Leads

IN a valve set one of the phone tags should always be connected to the same phone terminal, otherwise the permanent magnets may be weakened.

When extension leads are used, to discover which is which of the two wires, one should be connected to a low-voltage battery and the other battery terminal connected to earth.

A pair of phones is then taken into the other room and one tag earthed. The remaining tag is touched on to each of the extension leads and the one on which a loud click is obtained is the one connected to the battery and should be suitably marked in each room. R. H. B.

The "Phantom" Circuit

THE circuit shown by the diagram comes from America and is of interest because no aerial is used with it. A variometer is used for fine tuning, in series

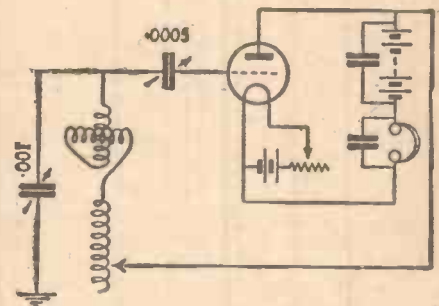

The "Phantom" Circuit.

with it being placed a 54-turn coil, tapped at every sixth turn. Tuning is carried out by means of the .001-microfarad condenser, the variometer and the tapped coil. Oscillation is controlled by the variable grid condenser. No grid leak is used. D.

Soldering Tinfoil

AN effective flux for soldering tinfoil can be made by heating and mixing together equal parts of vaseline and paraffin. While still hot half the total volume of sal-ammoniac is added. Leads can best be soldered to tinfoil by placing the job on a sheet of copper. S.

A Novel Basket Coil

SHOWN by the diagram is a novel type basket coil, known as the "bean" pattern. The method of winding is the same as that used in making ordinary circular coils. An advantage claimed for the "bean" type is that a comparatively large inductance is obtained within a

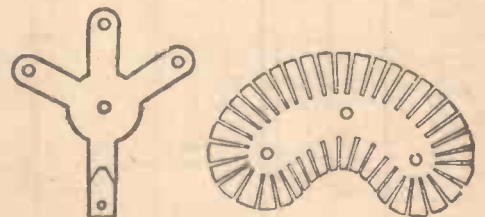

"Bean" Pattern Basket Coil.

small space; they should therefore be of value in constructing portable receivers. Should it be desired to make a variometer with two of these coils, the moving "bean" can be mounted on a piece of stiff cardboard of the shape shown. S.

ELECTRICAL BENCHWORK

BRASS FINISHING.—II

AS to the method of producing a straight-grain finish, other than by hand with emery-paper, for quite small surfaces a lap may be used to advantage. This is an iron or wooden disc, on which emery-paper is stuck with Chatterton's compound or marine glue, and which can be mounted in the lathe. A table, fixed to the lathe bed, may be used in conjunction with the lap. The curvature of the grain produced is not noticeable if the surface is small, and is no objection for large areas unless the final surface is being given. A more useful tool still is a machine known as a finisher, in which a roll of emery-cloth revolves stretched on a flat table between two rollers. This machine is indispensable in a brass-worker's shop of any size.

Small Parts

Small brass turned parts, especially those made with forming tools, such as terminals, knobs and studs, are usually left as they are and lacquered or plated, but to make this possible the front of the forming tool should be smoothed on an Arkansas stone slip.

Most readers have, no doubt, had at some time or other to finish small parts the shape of which renders it impossible to grip them in the vice while filing or papering them. Typical examples of this kind of work are crystal detector springs, buzzer blades, bars for connecting terminals, pointers, switch blades, washers and all parts cut out of sheet. The best method of holding these is to knock a few small nails into a block of wood in such a way as to prevent the job slipping off. If this is held in the vice the parts may readily be placed in position. Another simple method is to place one of the parts, together with a piece of soft wood, in the vice and squeeze up tightly. The work makes an impression which will hold any similar part for filing.

Draw-filing

When it is desired to finish a job with the file, the method known as "draw-filing" is suitable in many cases. A dead-smooth file is held in both hands, like a spokeshave, and worked to and fro over the surface in a direction perpendicular to itself. This is quite a good way of finishing anything in the nature of an edge, but for broad surfaces is not so successful.

The principal methods of protecting the surface from the action of the atmosphere are plating and lacquering. About plating little can be said in this article. It is, however, a useful process to have at one's disposal, and does not require an expensive plant to carry out in a small way.

With an accumulator, a small tank or jar, a supply of the necessary chemicals, and a reliable book on the subject, a lot can be done. Plating brass parts with nickel or silver is an excellent finish for wireless parts.

Lacquering

Lacquering is a process which is more popular amongst amateurs than plating. It is, however, an art which takes years of practice to accomplish to perfection. This applies more especially to large work, as any amateur with care can produce tolerable results with such small parts as screws and terminals provided the following instructions are adhered to.

Assuming that a number of small parts have just been turned in the lathe, they will in general be covered with grease and brass dust. To clean them, they are first placed in a tin with enough paraffin to cover them and shaken for about half a minute. The paraffin is then drained off, and they are placed in a wire or zinc sieve with a quantity of coarse, clean sawdust and shaken until all the sawdust has passed through and there is none left clinging to the parts. This should take about a minute; if the sieve is coarse the sawdust will pass through more quickly, and it would be as well to repeat the process. The parts are then ready for lacquering, and should not be touched with the fingers.

Some articles, such as screws and studs, may be easily held in the hand while lacquering them, as the shank is left unlacquered, so may be touched with the fingers. Those which cannot, such as terminals and collars, may be picked up by inserting a small round pair of tweezers in the hole in the centre.

Methods of Lacquering

There are two methods of lacquering, namely, cold and hot, according to whether the articles are cold or hot actually at the time of applying the lacquer. In either case they are baked afterwards. The easiest method, and that preferred by the writer, is cold lacquering. The lacquer is laid on with a soft, flat camel-hair brush, which must be dipped in the lacquer and squeezed once against the edge of the vessel. The great aim is to get every part of the surface covered, and not to leave too much lacquer on in any place. In the case of small turned parts the brush is held against the part, and the latter revolved slowly on its axis once, taking care to lift the brush off in such a way as to soak up all superfluous lacquer. The parts are then placed in a

tray and placed in an oven at a rather lower temperature than that used for baking cakes for a few minutes; or, alternatively, held over a gas-ring on a tray. Care must be taken not to burn the lacquer. A convenient way of heating screws, studs or terminals is to place them in the holes in a fish-slice and hold them over a gas-ring. The object of heating the parts is to melt the lacquer and leave it adhering to the surface in an even layer. At the correct temperature the odour of hot shellac is easily distinguishable, and if this is exceeded the lacquer is observed gradually to darken in colour and finally turn black. M. S. S.

THE B.B.C. AT WEMBLEY

ALTHOUGH small in size, there is no doubt that the B.B.C. kiosk will attract as much attention as anything else in that wonderful exhibition at Wembley. It is situated in a central position near the main Stadium entrance. Three private lines run from the kiosk to Savoy Hill. The chimes of Big Ben will be received at every quarter-hour. One of the private lines will be used for this, the other two being for music and control respectively. Concerts will be received at Wembley weekly (not daily, as stated in some quarters), and interesting transmissions, such as special bands and conferences, will be made from Wembley as opportunity arises.

Telephone lines connect the kiosk to various vantage points in the grounds. Under the Stadium gallery will be placed a six-way exchange and line amplifier for the microphone in the Stadium. This will be connected to the main kiosk. The microphone into which the King was to have spoken is connected to another telephone box. In the Royal Tunnel there will be a kiosk from which the microphone picking-up massed bands will be controlled.

In the main kiosk is a transmitter of the type used at the various relay stations. A single-wire T-aerial will be used, and the earth connection consist of buried copper plates. Items from Wembley will probably be transmitted to Savoy Hill (in a similar way to the Old Vic transmission) by wireless and then relayed in the ordinary way. Transmissions can be made to Savoy Hill by wireless or land line at will.

Brandes

The Name to Know in Radio



Result of
15 years'
experience

Grandpa a Defaulter

A running fire of comment on Grandpa's continued absence from the Club. Truth to tell, he is finding that a variation of his habitual custom provides a welcome diversion—he is finding that there are other things beside being lost in a fierce argument. Brandes are convincing him that his appreciation of good music has not deteriorated and that the "Matched Tone" brings perfect reproduction of the broadcast programme. His smoke-room friends deplore this back-sliding, but Grandpa knows he's "on" a good thing. Try Brandes—your Dealer has them.

PRICE
25/-

British manufacture (B.B.C. Stamped) and conform to all new licensing regulations.

Manufactured at Slough, Bucks, by

Brandes Limited, Walmar House, 296, Regent Street, London, W.1.

Glasgow—47, Waterloo Street.

Newcastle—5/6, Post Office Chambers.

Matched Tone

TRADE MARK.

Radio Headphones

Telephone—Mayfair 4208-9.

Trade enquiries invited.



GAMAGES

Prices Lower—Quality Better!

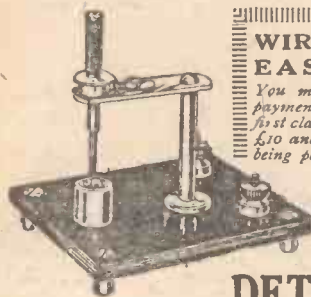

WIRELESS ON EASY TERMS

You may now secure on payment of first deposit a first class Radio Set (value £10 and upwards) balance being payable in monthly instalments.

Two Splendid CRYSTAL DETECTORS

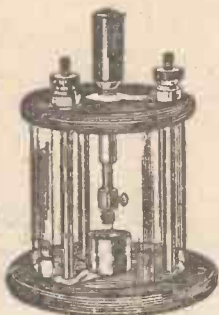

COMPLETE WITH "PERMANITE" CRYSTAL
CRYSTAL DETECTOR DUSTPROOF DETECTOR

Lacquered brass, mounted on ebonite, ball joint and cat's whisker. A beautifully made component supplied complete with our famous "Permanite" Crystal. Price Order by post **2/6** Post 6d.

A beautifully made piece of apparatus, very efficient in use. The transparent cover protects the "Permanite" Crystal from dust. Price, complete with crystal Get one to-day **3/9** Post 4d.



FULLER'S BLOCK Wireless Accumulators

The Ideal Accumulator for Dull - Emitter Valves, etc.

Special offer of Ex-Government Stock but absolutely unused.

- FULLER'S BLOCK ACCUMULATOR 2 VOLT. 40 AMP. Post 1/- **10/6**
- FULLER'S BLOCK ACCUMULATOR 4 VOLT. 40 AMP. Post 1/- **21/-**
- FULLER'S BLOCK ACCUMULATOR 6 VOLT. 40 AMP. Post 1/6. **31/6**

Boxes to hold 5 of these fitted with lid and carrying strap 1/6, post extra. Five Accumulators and Box sent post free.

Gamages FAMOUS "PERMANITE"

Read this extract from a letter from Mr. F. S. FENNELL, 18 Burmas Road, PLUMSTEAD—and we have many others like it!

A few days ago I purchased a piece of Gamages "Permanite" Crystal. . . I gave this crystal a good test, and to my astonishment was able to work a Loud Speaker without using any amplification whatever. Thinking it might be in the nature of a freak, I tried again, and again had the satisfaction of hearing the music and speech from a L O through the Loud Speaker. Considering I am from 10 to 15 miles from the London Broadcasting Station I don't think the results have been too bad. Yesterday I had a further remarkable experience. By adding a 2 L.F. amplifier I was able to get 2 Z Y and also Paris. In conclusion I have no hesitation in saying that in my opinion Gamages "Permanite" is far and away the best crystal on the market.



Always use Gamages "Permanite" Crystal. With it you'll always get the best results, wherever the Broadcasting Station. Highly sensitive and remains in adjustment longest. Clear powerful results. Price per large piece. Post free **1/6**

GAMAGES, HOLBORN, LONDON, E.C.1

Chepside House : Benetfinks

YOU SAVE 33 1/3% ON ALL WE ADVERTISE

FILOSTAT for D.E. VALVES 0 to 30 ohms	2/6	VARIOMETER	2/6
GABINET & EBONITE PANEL, 6 in. by 6 in. each	6/-	BASKET COIL HOLDERS	1/3
VARIABLE CONDENSERS, '007, 8/6; '0003, 5/6; '0005, 6/-; '00075, 7/6		VARIOMETER I ALL RDTOR	3/6
FILAMENT RESISTANCE, 7 ohms	1/6	DIAL AND KNOBS 7d, 10d., 1/-	9d.
'PHONES, 4,000 ohms	12/6	SWITCH ARM, 1st quality	
L.F. TRANSFORMER Energy	12/6	TRANSFORMERS, H.F. PLUG-IN TYPE. Ranges from 150 to 5,000. 3/6, 4/6, 5/- and 6/- each.	
		COIL HOLDERS.	
		1-way	1/-
		2 "	4/-
		3 "	5/6

Ask for our price list B, of British Made Components and you will save money.

MAIL ORDERS ONLY.

Postage one penny in the shilling. Special terms to the Trade.

RADIO MAIL ORDER CO.,
5, Upper Charles Street, London, E.C.

The New "BELLING-LEE" Wireless INDICATING TERMINALS

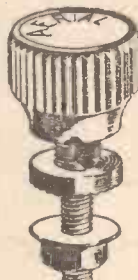

Tops engraved "Aerial," "Earth," "Phones," "Input," "Output," "L.T.+", "L.T.-", "H.T.+", "H.T.-", etc. Tops cannot come off. Grips a phone tag, spade terminal, or any wire. Serrated seating prevents working loose. Gives just the expert finish to your set.

Price **3D** each

"ASK YOUR DEALER FOR THEM"

Made by BELLING & LEE, LTD.
Queensway Works, Ponders End, Mdx.

Pat. No. 5807/24

FIRST ANNOUNCEMENT The "FELLOPHONE" PORTABLE 3 RECEIVER

To take with you anywhere—for Car, Boat, Train, Seaside, River, Bungalow, your friend's house—where you will. Always ready for listening-in. Complete with

Aerial, phones, batteries enclosed in handsome case for carrying like a suit case. Easily portable. Loud-speaker results from broadcasting station. Extended payments. Deposit, £4 : 5 : 6 and 12 monthly payments £1 : 9 : 11. This super receiver and all other well-known makes stocked.

£21 : 7 : 6
or
£4 : 5 : 6
Down

Call and Hear them at—
THE SERVICE CO. LTD.
273-274, HIGH HOLBORN, W.C.1.

A Complete Wireless Department. Send for Catalogue and bargain List.

THE "BROWNIE WIRELESS"

THE MOST EFFICIENT OF CRYSTAL RECEIVERS

THE new improved "Brownie Wireless" with its solid moulded ebonite cap and highest grade nickel fittings, coupled with its tested merits endorsed by nearly twenty thousand users, makes it the most attractive crystal set on the market in respect of price.



Now supplied erected and with B.C.C. stamp. Requires :: 10 - licence only ::

Endorsed by Editors of "Popular Wireless," "Amateur Wireless," "Electricity," etc. Trade Enquiries Invited.

7/6

Plus B.C.C. Royalty, 1/-

By post 6d. extra

THE J.W.B. WIRELESS CO.,
310a-312a, Euston Road, N.W.1
(Facing Warren Street Tube Station)

On Your Wavelength!

Service

IN my opinion the ever-increasing section of the community who motor will soon have a parallel in the hundreds of thousands who nightly listen-in to the broadcast programmes of the British Broadcasting Company. The motor trade is at once the most cosmopolitan and co-operative of world industries. The keynote of its success is service and co-operation. When one stops to consider that it is possible to-day to obtain supplies of petrol, oil and spares at even the smallest country village, it is hard to believe that this wide-world organisation has only developed within the last twenty years or so.

The Wireless Trade

Compare this scheme of service with the conditions existing to-day in the wireless trade. Apart from a few of the better-class makers, the majority of manufacturers are quite content to concentrate on turning out wireless sets or components and to leave it to the local dealer to not only sell the goods but to answer all questions and deal with complaints and grievances as best he can. In the case of the larger electrical houses, who are able to employ an expert to help and advise on the selection of a set, everything runs smoothly, but what of the chemist, draper or music dealer who run wireless sets and components as a side line? In the majority of cases the customer is sold the most expensive set his purse will stand without consideration as to its suitability under the conditions the customer intends to use it. The result is that, in cases where failure or only partial success is met with, the set is blamed, and if it carries the name of the maker his goodwill is damaged and a possible enthusiast is lost to the wireless world. Even should the disappointed purchaser return it to the seller he will in many cases be met with a shrug of the shoulders and the intimation that the seller was not there for the purpose of giving technical information, but to sell the instruments, which, of course, had never been complained about "by anyone else."

Extreme Cases

The above remarks are, if anything, a little on the severe side, and do not imply any real lack of willingness to serve on the part of the dealer but rather a lack of ability to do so. On the other hand, there are certain enterprising firms who will install a set, erect the aerial and obtain satisfactory results before requesting payment. This, of course, indicates a progressive spirit.

As I have pointed out previously,

complaints and dissatisfaction on the part of customers recoil eventually on the manufacturer of the set and in time will affect seriously the goodwill built up from perhaps years of trading. This, in spite of the fact that the set as turned out may be perfectly satisfactory and efficient.

In nine cases out of ten failure to obtain the desired result is due to some trivial defect.

How can the manufacturer help, then? First of all in the matter of instruction books; a well-illustrated booklet of a dozen pages or so will go far to keep the purchaser in a contented frame of mind. Then, again, in the matter of answering inquiries; even many manufacturers of repute are vague when giving technical information. Fullest details should be given, remembering that most men to-day are sufficiently interested in the hobby they take up, be it wireless or anything else, to want to know as much about it as possible in a non-technical way with the minimum of trouble.

Repair Service

While admitting that many so-called "defective" instruments are defective as a result of the handling received from the purchaser, in these days of mass production it does happen that an improperly assembled piece of apparatus sometimes gets into circulation; every repair job should therefore be considered on its merits and if a free replacement is warranted it should be given without hesitation.

Spanish Broadcasting

I ought to write a paragraph on how I tuned in Madrid the other night and heard the address by General Primo de Rivera. It would be seemly if I added that the transmission came in very well indeed and that but for a little interference at times it was most successful. I would like to be able to write of this, but unfortunately I cannot, for the plain truth is that though I firmly intended to turn to 2,000 metres at the appointed time, I was so absorbed in the doings of our own broadcasting stations that I forgot all about it. Still, I hope to have a go at Spain one evening soon, then I will let you know what happens. I can, however, record one quite successful evening or, rather, late night with KDKA and an early morning with WGY. Atmospherics have been rather troublesome of late, but on these occasions nature very kindly relented and there was practically no trouble of any sort. For the 100-metre station I was using a new kind of tuner, which is very easily made. It consists of a short piece of 4-in. cardboard tube upon

which are wound 15 turns of No. 18 insulated wire, the turns being well spaced. Over this are wound five turns of the same wire. The five-turn winding forms the primary, and its ends are connected directly to aerial and earth without the interposition of any variable condenser. The fifteen turns form the secondary, which is tuned by a .0005 variable condenser with a three-plate "vernier" in parallel. If you have not yet tried 100-metre reception, you might find it worth while to make up one of these simple tuners. It is an improvement, by the way, to make the primary and secondary loose-coupled, winding the former on a 4-in. tube and the latter on a 3½-in. tube, so that one slides within the other. The aerial should in either case be untuned or aperiodic.

Standardisation

I was delighted to hear during the official wireless talk the other night that the Radio Society of Great Britain is to give the question of standardisation its august attention. It is high time that something was done in the matter, for things really seem to be getting worse and worse. About the only two components now on the market of which all makes will fit into the same holders are valves and plug-and-socket coils. I really do not know why, for instance, the mushroom type of high-frequency transformer should not be standardised. It seems ridiculous that makers cannot agree to adopt, say, the "grid" and "plate" legs for the primary and the "filament" legs for the secondary. At present if you wire your set to suit a transformer of one make you will probably find that you have to alter everything if you purchase one of another make. Screw threads should be properly cut, and there is no reason why the odd B.A. sizes should not disappear once and for all so far as wireless goods are concerned. The question of quality is perhaps rather a difficult one. I wish it were possible that some means could be found of obliging makers to state the exact capacities of their condensers or the resistances of their grid leaks.

It seems to me, too, that there should be a standard bright-emitter rheostat. I do not mean that the pattern should be similar in all cases, but I contend that the resistance of the windings should be standardised at, say, 7 ohms. At present rheostats even of the best makes vary from 4 to 7 ohms.

2ZY

It was reported some time ago that 2ZY was raising his aerial. I do not

:: :: *On Your Wavelength (continued)* :: ::

remember seeing any account of his having completed the feat, but he seems to have done it all the same, to judge by the difference in his signal strength. When I first tried to tune him in he was very small beer even with the headphones, but the other night when turning from London to Bournemouth I came across, to my great surprise, a new and quite powerful 2ZY. If you have not tried him lately you will be astonished when you do so. It is not easy to separate him from London, since there are only 10 metres between the two. Still, it can be done if you use a loose-coupled tuner and make your adjustments carefully. I am very glad to welcome Manchester into the ranks of the B.B.C. stations that can be heard in the south of England. Often have I looked at some particularly attractive programme of his that was going and bemoaned my inability to tune him in. But now all is well, and if he continues to be as strong as he is at present he will soon become well known in the south. My only fear is that with the coming of the longer days and of drier weather he may fade away, as so many stations do in the summer-time. If Manchester has gained in strength, 5IT has lost. He used to be very nearly as good as 2LO down here; in fact, though he is over seventy miles away he was regularly received on crystal sets. Now he is little more powerful than Newcastle and certainly not so strong as Cardiff. Glasgow, too, seems to have lost some of his carrying power, in fact he requires a second stage of low-frequency amplification to make him really good on the loud-speaker.

Frame Aerials

One is often asked the question, "What difference will it make to reception if I use a frame aerial instead of the outdoor wire?" The answer is that as a general rule it will cut down the signal strength and range by quite 50 per cent., sometimes more. I say, as a general rule, because there are places in which the frame is actually better than the outside aerial. In my own case I find that when a frame is used the five-valve set is very little more efficient than a two-valver on the big aerial. This particular house seems to be quite unsuited to frame reception, and there are many in which the same is the case.

I was trying round last night with a frame which I know to be very efficient if used in a suitable spot. London, of course, I got, but so weakly that to bring him up to loud-speaker strength I had to use far too much plate voltage and to run the filaments of the valves more brightly than is good for their health. Bournemouth I managed to pick up at respectable phone

strength, and Cardiff was just a little better, but of the rest of the stations I could get absolutely nothing at all even though I had an accurate wavemeter to guide me in tuning. You will gather that I am not at present thinking of installing a frame aerial. However, those whose minds are set in this direction must not be discouraged by these sad words of mine. It may be that your house is one in which this kind of aerial works extremely well. All you can do is to try it and see.

What Was It?

I turned to Radiola the other night for a few minutes just before his transmission came to an end. It appeared that he was relating an account of a cycle race which

give us more of this kind of thing and that we shall have due warning so that we may get on to 1,780 metres in time. The transmission of accounts of sporting events has been done quite a lot in America, but in this country, so far as I can remember, the aerial Derby was the only one to be so treated.

KDKA

My remarks a week or so ago on the subject of getting KDKA direct seem to have caused a certain amount of interest. I have noticed several letters about this low-wave reception. The suggestion of one correspondent that those copper spirals out of old R.A.F. spark transmitters might make good coils for 100 metres is a very good one.

Howling Again

The outburst of howling which broke out at the end of the year, when thousands of happy folk were rejoicing in the possession of the new sets which had come to them at Christmas-time, died away towards the end of January, as users became more expert and perhaps as their friends rubbed in the iniquity of squeaking, chirping and the like. But of late there has been a terrible fresh chorus of yells, screams and moans. Ham-handed Henry and Oscillating Oswald seem to have got that spring feeling. Possibly the coming of the longer days and of warmer weather has driven them to seek their workshops more and to prepare the brand-new receivers which they are now engaged in trying out, whilst the rest of us tear our hair in impotent wrath. Everyone makes up new appliances for his set, and they must, of course, be tried out. It is grossly unfair to do so on broadcast transmissions, especially during the evening hours, and it is a great shame to spoil the pleasure of the children whilst the "Uncles" and "Aunts" are doing their best to entertain them. I wish that the B.B.C. would consider the possibility of instituting a testing half-hour during one of the evening intervals. It would be an excellent idea if they would turn on gramophone records, have passages of the newspaper read, and run down the piano note by note from top to bottom at such a time. This would give all of us an opportunity of seeing that our sets were up to the mark. I wish, too, that the B.B.C. would let us have every now and then a series of calibrated waves so that we could check the tuning of sets and wavemeters. I am quite sure that any move in this direction would be very popular.

THERMION.

Next Week's Broadcasting

April 27—May 3

Items Simultaneously Broadcast.*

Sunday. Children's Corner. Time Signal.
Monday. B.B.C. Literary Critic. The Savoy Bands.
Tuesday. The Savoy Bands.
Wednesday. Time Signal and News Bulletin.
Thursday. B.B.C. Music Critic. Radio Society of Great Britain Talk.
Friday. Sixth Symphony Concert.
Saturday. The Savoy Bands.

* Except where otherwise stated, all items simultaneously broadcast originate from the London studio.

London (2 L O)

Sunday. Organ Recital. The Rev. P. T. R. Kirk. The De Groot Orchestra.
Monday. Chamber Music Evening.
Tuesday. Play Evening.
Wednesday. Popular programme.
Thursday. Operatic Night.
Friday. Sixth Symphony Concert.
Saturday. Scenes from "Hiawatha."

was taking place in one of the big halls in Paris, though I cannot be absolutely certain, for what with a band and the cheers, jeers, whistles and plaudits of the audience it was very difficult to catch what the announcer said. I heard him say "So-and-so is now coming up to the front. He passes." (Pause.) "He is leading by about forty metres." From this I deduced, after the manner of Sherlock Holmes, that it was a cycle race—but it may, of course, have been a macaroni eating competition! I only wish that I had tuned in earlier, for it all sounded most exciting and the crowd was certainly fired with the wildest enthusiasm. Let us hope that Radiola will

From America: Radio will not appeal to most orators until it can send back the applause.

THE CHEAPEST LOUD-SPEAKER

AMATEURS who possess a receiver of three valves or more, by spending an hour or two with a cardboard tube and a glue-pot may possess what can be described as a very good substitute for the orthodox type of loud-speaker. In effect, this loud-speaker consists of a V fitting over which are placed a pair of headphones, while on the stem a horn of any suitable material, such as cardboard or tinfoil, is fixed.

From Fig. 1 it will be seen that the construction is extremely simple, the body part being cut from a tube $1\frac{1}{4}$ in. outside diameter and $\frac{1}{8}$ in. thick. In spite of the fact that it is a parallel tube, the expansion of the sound waves is provided for by fitting into each arm a truncated cone of suitable dimensions.

Construction

First of all cut two lengths of tube A and B at the required angle and smooth the ends of each piece. Glue A and B together as shown in Fig. 2 and secure the joint by covering it with a length of linen tape. Next cut off the portion C about 2 in. long and shape one end with a sharp penknife in such a manner that it will seat snugly over the lower end of the V piece just made. When the joint in the latter is quite dry, make a pencil line where the part C blends with it, cut off the portion that falls inside it (below the line x x in Fig. 1), and finish shaping the ends to obtain a good joint. Glue as before, and secure by covering with glued linen tape.

In order to ensure a substantial construction a stiffener D of cardboard is cut to fit the angle between the two arms A and B, glued thereto, and further secured by linen tape on each side.

The ends of the tube are closed by two cardboard discs, elliptical in shape, to conform to the end of the tube, but having a hole $\frac{7}{8}$ in. in diameter in the centre into which is fitted a cone of stout drawing paper. This cone G should, of course, be made, in the first place, larger than the finished size so that it can be cut down gradually until the large end is the correct diameter to enter the tube and the small end the right dimensions for the $\frac{7}{8}$ -in. hole in the disc. When this is done, glue the cone and disc firmly in position as in Fig. 3, allow to dry, and smooth over the whole of the fitting with fine sandpaper.

As a last operation, cut out two rubber washers $1\frac{1}{4}$ in. outside diameter, $\frac{7}{8}$ in. inside diameter and $\frac{1}{8}$ in. thick to form seatings for the phones, glue them concentrically over the hole in the disc, and

when the joint is hardened round off the edges of the rubber with fine sandpaper. When completed the width over the rubber cushions should be $6\frac{3}{4}$ in., or just sufficient to allow the phones to be sprung into position.

This construction, although of cardboard, results in a very strong and rigid fitting on which to affix a horn of the desired length and shape; the web D is strong enough to hold a bracket or any other means employed to maintain the complete instrument in any desired position.

As regards the finish, a coat of dull black paint is all that is required, and the cost is the modest sum of threepence.

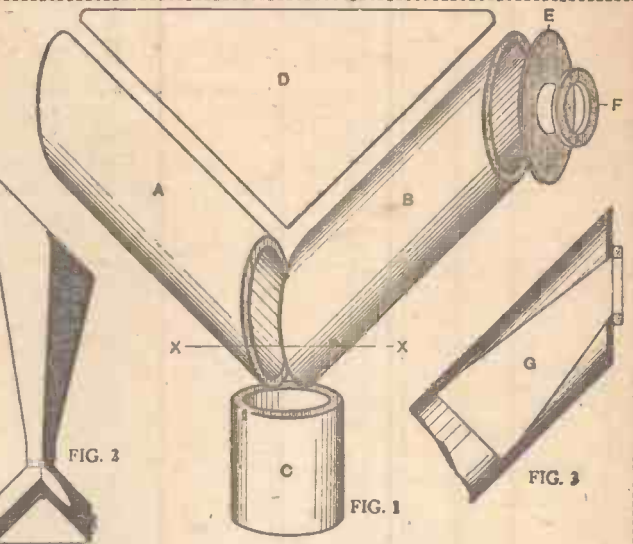

Figs. 1 to 3.—Constructional Details of Loud-speaker.

wire to be wound on the ebonite barrel. After completing the winding a coat of shellac varnish should be given to keep the wire in place, and when this is thoroughly dry a contact line for the slider

Type	Gauge	Turns	Le-gth of Winding
Dull-emitter Resistance	32	83	1 inch
Potentiometer	40	190	1 inch

H. J. T.

A RESISTANCE FOR DULL-EMITTERS

THE resistance or potentiometer shown in the illustrations will be very suitable for panel mounting, as the rotary control can be carried right through the ebonite and fitted with a dial or scale. The area occupied at the back of the panel is only $1\frac{1}{2}$ in. by $\frac{3}{4}$ in., which compares favourably with any other type of variable resistance or potentiometer.

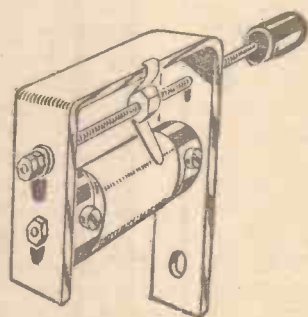

Fig. 2.—Perspective View of Resistance.

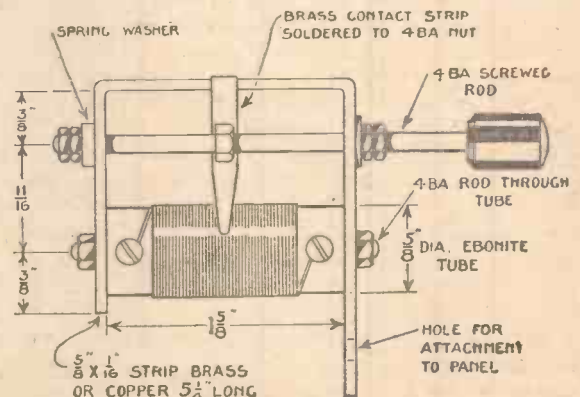

Fig. 1.—Elevation of Resistance.

Fig. 1 shows the necessary constructional details and is self-explanatory. The following table of windings gives the amounts of Eureka enamelled resistance

should be made by careful scraping. Fig. 2 shows the completed instrument.

C. A. I.

THE NEW RELAY STATIONS

OWING to certain circumstances which have presented themselves it will be impossible to have the Leeds station open as soon as was hoped.

It is hoped to have the new stations open on the following dates: Edinburgh,

May 1; Liverpool, June 1; Leeds and Bradford, July 1; Hull, August 1.

It is understood that the Leeds station will require special consideration.

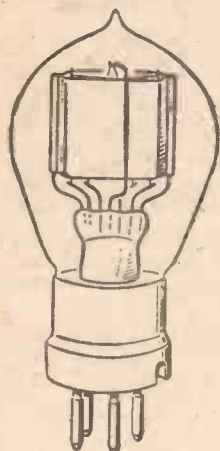

The B.T.H. B4 Valve.

THE NEWEST DULL-EMITTERS.—IV

SMALL POWER VALVES

The B.T.H. B4
VALVE



The COSSOR
WUNCCELL
VALVE

be used on the L.F. side of the set even with only one stage of note-magnification. The makers' figures for the amount of negative potential required at various plate voltages are as follows:

Plate Volts.	Negative Grid Volts.
50	1.0
70	1.5
90	2.0

THE Wecovalve was described in detail some weeks ago in the pages of AMATEUR WIRELESS. It has been improved since the article was written, and those now available can be relied upon to give excellent results. It should be noted that this valve is now supplied with a standard four-pin base so that it can be used on any existing set. The Mullard One-volt Ora, whose internal arrangements are very similar to those of the Wecovalve, may be described as a standard English valve with a special filament. The plate is slightly larger in diameter than that of the Wecovalve, but the grid is made of the same wire and has a similar number of turns. The bulb and cap are similar to those of the well-known Bright-emitter Ora.

One-volt Ora Tests

When tested on the bench the results obtained were excellent. The curves were straight and steep, such, in fact, that would lead one to expect distortionless working with a high degree of amplification. At 50 volts with zero potential on the grid the plate current was .5 ampere, whilst an output of nearly two milliamperes was reached with a plate voltage of 100. The magnification factor is extraordinarily high, working out at about 10, as compared with between 4 and 5 for the Wecovalve. The valve is very hard; in fact, it appears to stand up well to 100 volts when used in the capacity of an L.F. amplifier.

For high-frequency amplification purposes I find that about 65 volts is the most suitable working potential, whilst as a rectifier the valve does best with about 50. On the low-frequency side of the set excellent results were obtained with voltages between 50 and 100. When used on a three-valve set (H.F., D., L.F.) the One-volt Ora gave excellent results with a high-tension supply of 50 volts on a busbar connection to all valves. Still better results were obtained by adding a further 50 volts to the extra-high-tension terminals connected to the low-frequency amplifier. The valve is thus eminently suitable for general-purpose work.

It should be noted that it is most important that a grid-biasing battery should

These were found to correspond very well with the actual requirements of the valve when in use. The valve did excellently in any position in the set. Perhaps its greatest feature is to be found in its large emission, which makes it particularly suitable for low-frequency amplification. A fault with some dull-emitters is that the emission is so low that they will not supply current enough to work a small loud-speaker. The One-volt Ora was tried and did very well indeed on all broadcasting stations, bringing in speech and music with good strength and without a sign of distortion.

The One-volt Ora is one of those excellent constructional jobs that one has come to expect from the Mullard Company. It is well designed, well made and robust. Those who wish to use valves which operate off one cell cannot use a better.

Cossor Wuncell

I understand that the new Cossor Wuncell is to be placed upon the market very shortly. It may even have appeared before this article is in print. Though I have not yet had an opportunity of testing this valve, I have heard something about the experiments that have been made and the results that have been achieved. One hesitates to prophesy in wireless, but if what I have heard of the Wuncell is to be relied upon, we may expect to find in it a valve which is quite as good in its class as are the famous P1 and P2.

The latest application of the dull-emitter principle is to the small power amplifying valve, which is intended for use with loud-speakers or where more than one stage of L.F. amplification is employed. Telephones and loud-speakers are *current-operated* devices; that is, they require for efficient working a fairly large normal current with considerable changes in it produced by the variations in the grid voltage.

In order to be able to deal with big variations in the grid voltage, the straight portion of the curve must be as long as possible. In valves of the ordinary type the straight portion is not very long in many cases, and distortion may be caused in two ways when a strong signal is com-

ing in. Should the positive half-waves take the working point of the valve up to beyond zero grid potential the grid current will flow, which causes a damping effect, flattening the tops of the waves as they are passed on from the plate of the valve. This causes speech to become harsh and nasal and music to sound metallic. It also gives rise to very discordant sounds upon loud signals. Distortion, too, will be noticeable when an orchestra containing much brass is playing.

Still worse effects will be noticeable if a positive cycle upon the grid is sufficient to reach the saturation point of the valve owing to the shortness of the straight portion of the curve. When this happens all the effects previously mentioned are noticed, but to a very much greater extent, for the wave forms delivered by the plate are badly mutilated and therefore give rise to all kinds of unpleasant effects in the receiver. These things being so, it is desirable by means of a suitable negative biasing potential upon the grid to keep the working point entirely upon the negative side; that is to say, upon that part of the straight portion of the curve which comes below the zero point. This is possible only if the curve is a steep and long one crossing the vertical zero line at a point at which there is a considerable amount of plate current. Power amplifiers are specially designed to have curves so shaped that distortion will not be produced even by very considerable voltage changes upon their grids.

Small Power Valves

Until recently the small power amplifier has been rather out of the range of the majority of amateurs on account of the voltage and the current required by its filament. Earlier types required an 8-volt accumulator and consumed from 1 to 2 amperes of current. This was all very well so long as one had a large 8-volt accumulator and could get charging done easily and cheaply, but in other circumstances it made their use out of the question.

With the coming of the dull-emitter filament it became immediately possible to design power amplifiers with quite reasonable requirements in the shape of voltage and current. I have just been testing one of the dull-emitter power valves, the B.T.H. B4, which works with a filament voltage of six and takes only .25 ampere. It can thus be used on sets worked from an ordinary 6-volt accumulator. This is a first-rate valve for power amplification purposes, giving a large volume of pure and undistorted sound. It is, unfortun-

ately, quite impossible to photograph it, since the glass has a reddish tint which makes it appear coal black on a photograph.

M.O. LS4

Another is the M.O. LS4, which will work quite well with only 4 volts on the filament; in fact I have one upon my set at present in combination with three dull-emitters, all of which are worked from a two-cell accumulator, the total current required being less than 1 ampere. The Mullard Company make a small power valve, the PA3, which consumes .67 ampere at 4 volts. This is not strictly a dull-emitter, but it is a good valve and very economical to use. I understand that

the same firm may place on the market a dull-emitter power valve with very small requirements indeed.

Those who are not satisfied with their low-frequency amplification cannot do better than obtain a small dull-emitter valve, for they will probably find that it makes all the difference in the world to the purity of reception. When the ordinary valve is made to give anything like loud reception it has usually to be forced, with the result that it cannot do its best. The power amplifier, however, is always working within its limits, so that the quality of speech and music are as near perfection as the loud-speaker will permit.

J. H. R.

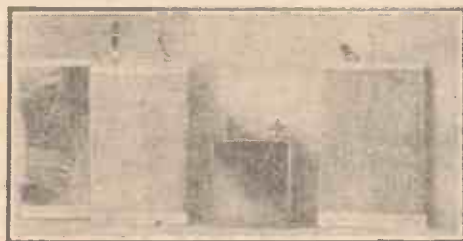

Parts of Mansbridge Condenser.

THE MANSBRIDGE CONDENSER

PROBABLY no piece of apparatus used in wireless looks quite so uninteresting as a Mansbridge condenser. There is so little about it to excite your curiosity. A green or grey metal case with two tags protruding from a protective pitch coating—that is all. No knobs to twist, nothing to get out of adjustment, nothing at which to grumble! But although uninteresting in appearance, there are quite a number of curious points about the manufacture of Mansbridge condensers, some parts of which are shown by the photograph.

Tin Precipitated on Paper

They are not, as many amateurs suppose, made up with alternate strips of tinfoil and waxed paper. Tin is actually precipitated on the paper by a special process, but at this stage the particles are not conductive. The strips are calendered by being pressed between two rollers moving at different speeds. Here a difficulty is encountered. So great is the pressure that particles of tin are forced right through the paper, which is then useless for making a condenser, of course. These particles are got rid of by burning them away.

Finishing the Paper

What actually happens in one works is that a 2,000-volt supply is connected across the rollers, with a condenser of about 20 microfarads capacity in parallel. At any point where tin has been forced through the paper it is promptly burnt away. This leaves small pin-holes, which can be seen by holding the paper up to the light, but they do not affect the insulation resistance to any extent that matters.

The method of construction of a Mans-

bridge condenser is clear from the photograph. Two strips of the specially-prepared tin-coated paper already mentioned are rolled up with interleaving strips of pure cellulose paper (as seen on the left), connecting tags being slipped in. In a condenser of 2-microfarad capacity the strips are each about 40 yd. long. After having been rolled the condensers are covered with wax under high pressure (right). The complete condenser appears as in the centre of the photograph.

Insulation Resistance

During a visit that the writer recently paid to Fuller's United Electric Works, Ltd., of Chadwell Heath, Essex, that firm's technical manager expressed the opinion that Mansbridge condensers were perhaps the most interesting things they made there. Take insulation resistance, for instance. Normally this is somewhere in the region of 2,000 to 3,000 megohms, but may fall, for no apparent reason and whilst still in storage, to five or ten megohms. A week later it may have gone back to its original 2,000 or 3,000 megohms!

D. S. R.

This year's wireless exhibition will be held at the Albert Hall and will be open for ten days during September and the beginning of October. It will be held under the auspices of the National Association of Radio Manufacturers.

A company, called the Broadcasting of Australia Proprietary, Ltd., is starting operations in Melbourne. Its station will probably use 5 kilowatts and the aerial will be 300 ft. high.



Some of these transmissions are commercial or official. Wavelengths and times are liable to alteration without notice. The times given are according to British Summer Time.

London B.B.C. Station (2 L O), 365 metres. Weekdays, 3.30 p.m. to 4.30 p.m., concert; 5 p.m. to 5.30 p.m., women's half-hour; 5.30 p.m. to 6.15 p.m., children's stories; 7 p.m. to 10.30 p.m., concert and news. Sundays, 3 p.m. to 5 p.m., concert; 8.30 p.m. to 10.30 p.m., concert and news. Concert from 1 p.m. to 2 p.m. on Tuesdays, Thursdays and Fridays.

Manchester B.B.C. Station (2 Z Y), 375 metres. Weekdays, 3.30 p.m., concert; 5 p.m., women's half-hour; 5.25 p.m., farmers' weather report; 5.30 p.m., children's hour; 6.20 p.m. to 7.15 p.m. and 7.45 p.m. to 10.30 p.m., concert and news. Sundays, 8.30 p.m. to 10.25 p.m.

Birmingham B.B.C. Station (5 I T), 475 metres. Weekdays, 3.30 p.m. to 4.30 p.m., concert; 5.30 p.m. to 6 p.m., women's half-hour; 6 p.m. to 6.45 p.m., children's hour; 7 p.m. to 10.30 p.m., concert and news. Sundays, 8.30 p.m. to 10.30 p.m.

Newcastle B.B.C. Station (5 N O), 400 metres. Weekdays, 3.45 p.m., concert; 4.45 p.m., women's half-hour; 5.15 p.m., children's hour; 6 p.m., scholars' half-hour; 7 p.m. to 10.30 p.m., concert, news. Sundays, 8.30 p.m. to 11 p.m.

Bournemouth B.B.C. Station (6 B M), 385 metres. Weekdays, 3.45 p.m. to 4.30 p.m., concert; 5.15 p.m. to 10.15 p.m., concert and news. Sundays, 8.30 p.m. to 10.15 p.m.

Cardiff B.B.C. Station (5 W A), 350 metres. Weekdays, 3.30 p.m. to 4.30 p.m., concert; 5.30 p.m. to 6 p.m., women's half-hour; 6 p.m. to 6.45 p.m., children's hour; 7 p.m. to 10.30 p.m., concert and news. Sundays, 8.10 p.m. to 11 p.m.

Glasgow B.B.C. Station (5 S C), 420 metres. Weekdays, 3.30 p.m. to 4.30 p.m., concert; 5 p.m. to 5.30 p.m., women's half-hour; 5.30 p.m. to 6 p.m., children's hour; 7 p.m. to 10.30 p.m., concert and news. Sundays, 8.30 p.m. to 10.45 p.m.

Aberdeen B.B.C. Station (2 B D), 495 metres. Weekdays, 3.30 p.m. to 4.30 p.m., concert; 5 p.m. to 6 p.m., women's half-hour and children's corner; 7 p.m. to 10.30 p.m., concert and news. Sundays, 8.30 p.m. to 10.30 p.m.

Sheffield (Relay) B.B.C. Station (6 F L), 303 metres. Programme relayed.

Plymouth (Relay) B.B.C. Station (5 P Y), 330 metres. Programme relayed from London station daily.

Königsusterhausen (I. P), 2,800 metres. Daily, 8 a.m. to 9 a.m., Stock Exchange news; 12 noon to 1.30 p.m., news and concert; 5 p.m. to 6.30 p.m., Stock Exchange news.

Croydon (G. E. D), 900 metres. Daily.

Eiffel Tower (F L), 2,600 metres. Daily, 6.40 a.m. to 7 a.m., weather forecast; 11 a.m. to 11.30 a.m., weather forecast; 3.40 p.m., Stock Exchange news; 5.30 p.m. (Saturdays excepted), Bourse closing prices; 6.10 p.m., 7 p.m., and 7.20 p.m. (Sundays only), concert and news; 10 p.m., weather forecast.

Paris Concerts Radiola (S F R), 1,780 metres. Daily, 12.30 p.m., concert and news; 1.45 p.m., first Bourse report; 4.30 p.m., Bourse closing prices; 4.45 p.m., concert and news; 6.45 p.m., news; 8.30 p.m. to 9.30 p.m., concert; also concert from 2 p.m. to 3 p.m.; 10 to 10.45 p.m. on Sundays.

Rome (I C D), 3,200 metres. Daily, 11 a.m. Ecole Supérieure des Postes et Télégraphes, 450 metres. 3.30 p.m. to 4 p.m. (Wednesday and Friday), 7.45 p.m. to 10 p.m. (Tuesday and Thursday), 2.30 p.m. to 7.30 p.m. (Saturday), concerts.

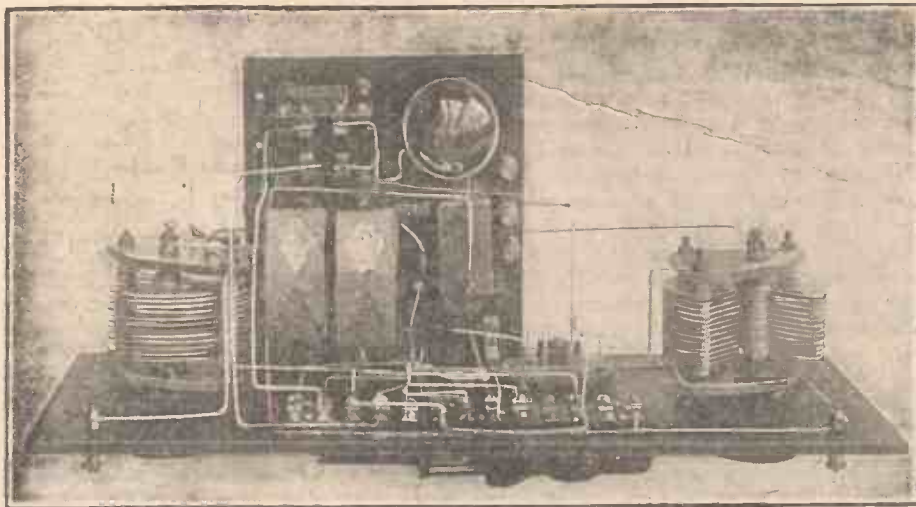

Fig. 1.—Top View of Back of Panel.]

THE crystal-valve receiver shown by the photographs Figs. 1 to 3 is unique, and has been specially designed for the ever-widening circle of AMATEUR WIRELESS readers who wish to construct a crystal-valve set which can be used as a simple crystal set or as an H.F. or L.F. amplifier and crystal. The set functions as an easily-tuned crystal receiver intended for use by the younger members of the family who cannot be trusted to handle a valve set. With a near-by local station reception on headphones with crystal only is obtained and the batteries need not be used. When a number of friends are gathered together, however, the necessity of several headphones is avoided by the addition of the valve and a stage of L.F. amplification for use with a loud-speaker.

Three-in-ones Set

For those who wish to listen to most of the distant broadcasting stations, the receiver, by one movement of the plug, can be changed from a crystal-L.F. valve combination to an H.F. valve-crystal combination. The receiver is a three-in-one set, and can be constructed at a little more than the cost of one. The total cost of the components is about £2 10s.

Figs. 1 to 3 show the appearance and make-up of the set. The cabinet encloses the batteries, and also the phones when they are not in use. Fig. 4 shows the circuit and the switching arrangements employed in its control.

Each circle represents a plug-in contact, each of which is located on a switch-board attached to the front upper part of the panel. The function of these plug-in contacts is to cut in or to disconnect various portions of the circuit, so changing it from a simple crystal set to H.F. amplification and a crystal detector, or to a crystal detector followed by L.F. amplification. The change from one circuit to either of the other two is accomplished

by merely altering the position of a single special telephone plug having five separate contacts attached to it.

The shape of the plug is such that it cannot be used in any other than the proper combination of contacts. When it is at the right-hand side of the panel the circuit is a plain crystal receiver; in the central position it is an H.F. amplifier; and at the left a crystal detector with L.F. amplification.

The Cabinet

The first steps in the construction are to make a full-size drawing of the cabinet and panel. The cabinet is not difficult to make if ordinary deal is used and all joints are made in a simple manner with fine screws and nails. The inside dimensions of the case are 15½ in. high, 15 in. wide and 8 in. deep over all. The shelf is fixed at 7 in. from the under side of the top and projects ¼ in. in front of the face of the side pieces and is finished in a half-round shape. The panel is fitted from the back of the case and presses against a simple moulding attached to the inner sides of the case at a distance of 1½ in. from the front.

The two doors are hung on small hinges; the door at the upper part of the back is similarly fitted and a slip of wood is fixed at the lower part to act as a stop. The three-ply backing at the lower part is permanently fixed with screws or brads. Four thin strips of wood about 2 in. wide and ⅛ in. thick, to fit inside the case at the back of the panel to keep it in place, are prepared, but not fixed until the panel is finally in place. The whole of the case should be stained and polished.

The panel is made from ebonite ⅜ in. thick and should be an easy but not too slack a fit into the upper part of the case. The nominal size is 15 in. long and 7 in. high. The separate ebonite valve panel measures 6 in. long and 5½ in. wide by ⅜ in. thick. Both should be squared up

THE UN CRYSTAL-VAL

This Set has three functions:

(1) H.F. Amplifier and Crystal Detector

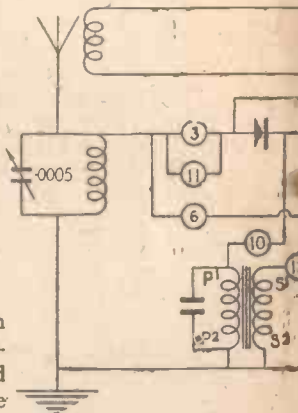

Fig. 4.—Circuit Diagram

and the location of the components marked on them. The two variable condensers are fixed on the centre line of the panel at a distance of 2 in. from either end. The aerial terminal is at the right-hand corner and the earth terminal is similarly placed at the opposite corner. Between them is the special switchboard.

Located symmetrically are the knobs controlling the filament resistance and the reaction coil respectively (see Figs. 5 & 6).

The following are the components needed: Two variable condensers, each



Fig. 3.—The Cabinet

UNIVERSAL VALVE RECEIVER

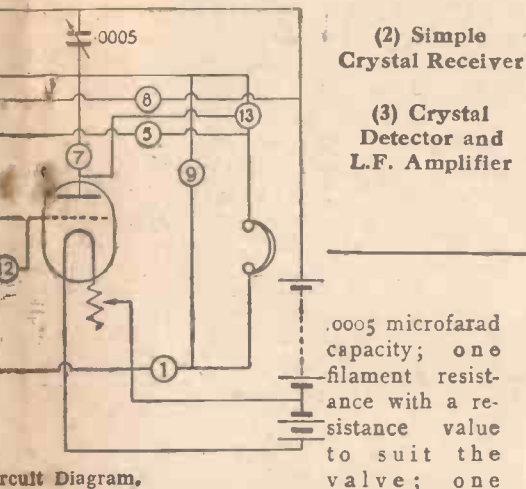

(2) Simple
Crystal Receiver

(3) Crystal
Detector and
L.F. Amplifier

.0005 microfarad
capacity; one
filament resist-
ance with a res-
istance value
to suit the
valve; one two-

coil holder with a vernier action or gear
wheels for making a slow-motion device,
as explained later; one valve holder; one
fixed condenser, value .001 microfarad;
one complete crystal detector; one L.F.
transformer of good quality; three tele-
phone terminals; two plain terminals; a
quantity of No. 4 B.A. screws; thin brass
strip for contacts, about 15 in. long, $\frac{1}{4}$ in.
wide; square tinned-copper busbar for

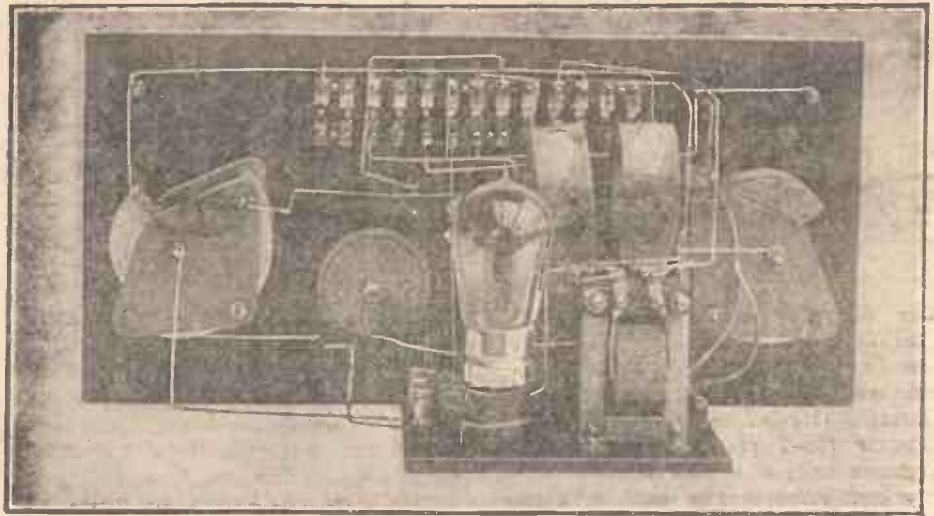

Fig. 2.—Another View of Back of Panel.

wiring; a few pieces of flexible wire; two
brass angle pieces for attaching the base to
the panel; ebonite for switchboard, two
pieces $1\frac{1}{4}$ in. wide and $7\frac{1}{2}$ in. long; three
pieces each 1 in. wide and $2\frac{3}{4}$ in. long for
the plug.

The base is attached to the back of the
panel by the angle pieces and should be
fixed about $\frac{1}{4}$ in. up from the bottom edge
so that the wiring does not touch the
wooden shelf.

If the coil holder has a vernier device
the spindle merely passes through a hole
in the panel. If not, a slow-motion device
is easily made up by attaching a large
gear wheel to the spindle of the moving
coil holder and a small separate gear to
the control spindle, which turns in a bush-
ing in the panel. The inner end of this
spindle is supported by a brass plate
drilled to receive it and screwed to the
face of the coil-holder stand. The wheels
used in the present example were taken
from a Meccano set and answer the pur-
pose very well. A fine adjustment for the
reaction coil is essential.

The Switchboard

The base of the switchboard is made of
ebonite. It is squared up, a central line
being scribed, and a series of thirteen
divisions very accurately marked out at
equal spaces of $\frac{3}{8}$ in. apart. Lines are
squared off at these points right across the
ebonite, with a steel point and not with a
pencil. Two other lines are scribed
parallel to the centre line at $\frac{1}{8}$ in. from
each edge. The two outer rows are drilled
and tapped No. 4 B.A.; the inner row are
drilled $\frac{1}{8}$ in. There will thus be thirteen
holes in each row, or thirty-nine in all.
Other holes are drilled for fixing this part
to the back of the panel.

Twenty-six brass contacts are made from
 $\frac{1}{4}$ -in. strip brass, each $\frac{5}{8}$ in. long,
rounded at one end, and the rounded end
is bent to a curved shape with round-nosed
pliers. Holes are drilled to suit the fixing

screws, corresponding holes being drilled
in the outer holes on the ebonite plate to
which they are then fixed by screws as
shown in Fig. 7.

The plug is made by cutting three pieces
of ebonite to shape as shown in Fig. 5,
pointed at one end and rounded at the
other. At the pointed end a projection is
formed on either side to fit into regis-
tering holes cut in the outer guide plate.

The lower of the three pieces has five
holes drilled and tapped No. 2 B.A., and
these have to register with the central
holes in the switchboard. Plugs made
from $\frac{1}{8}$ in. brass rod are fitted to these
holes and secured with lock-nuts at the
back. The second ebonite plate is cut out
in the middle to clear the nuts. The third
plate is slightly recessed to allow space for
the telephone cords. The latter pass
through a hole at one end of the outer
plate and are connected to the outer pair
of plugs, and the other end to the tele-
phone distribution board seen in Fig. 3.
When completed all three pieces are held
together with small brass screws.

The switchboard should be tested with
the plug in each combination of five con-
tact holes, any needful adjustments made,
and then screwed to the back of the panel.
Holes are drilled through it to clear the
plugs and the hollowed guide plate is
screwed to the front of the panel, being
adjusted to the guides on the plug, which
should be placed in position first and the
guide fixed accordingly.

Wiring

The wiring is carried out as follows:
First connect the outer of the three tele-
phone-pattern terminals on the base to the
outer filament terminal on the valve
holder. Connect the earth terminal to the
second telephone terminal and to the fila-
ment resistance coil. The contact arm
connection on the filament resistance is
connected to the second filament terminal
on the valve holder.

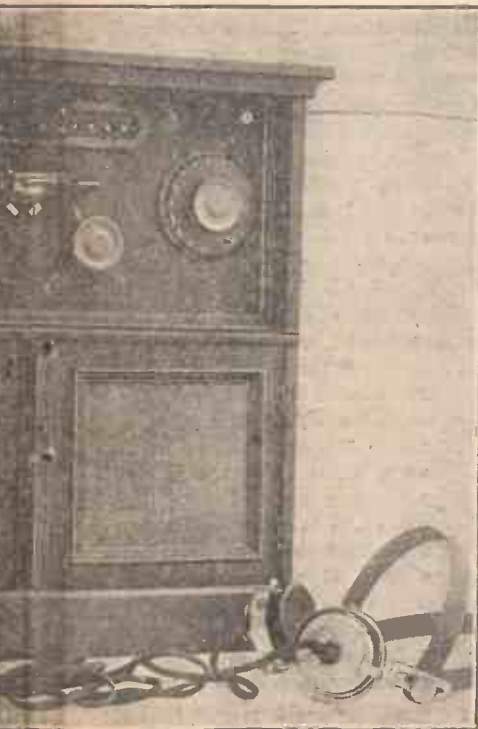

Complete Receiver.

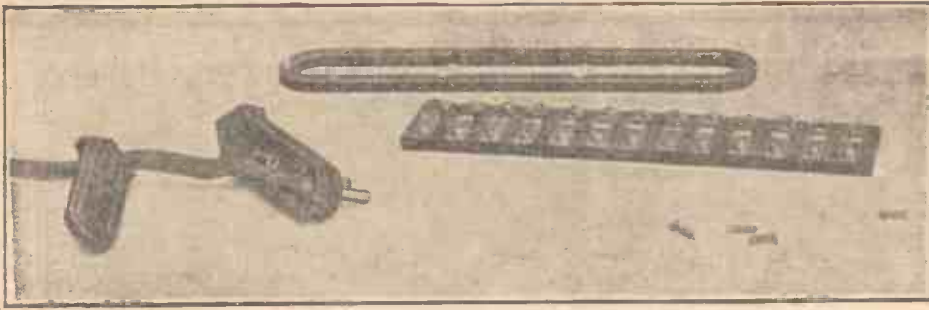

Fig. 7.—Details of Switch.

The following connections are then made: Third telephone terminal (H.T. +) to moving plates of anode-tuning condenser and to one side of anode-reaction coil; aerial terminal to one side of aerial condenser (fixed plates) and to aerial-inductance coil; other side of aerial condenser and inductance to earth terminal. A branch from this wire is connected to one side of the secondary and to one side of the primary of the L.F. transformer. The terminals on the fixed condenser are connected to those on the primary of the transformer. This constitutes the fixed circuit which is common to all three combinations.

The remaining connections are made to and from the switchboard. This should be numbered as follows and connected accordingly. Looked at from the back of the panel, the left-hand pair of terminals are numbered 1 and the next 2 and so on to 13. Connections are made as follows. There are two contacts for each number, an upper and a lower one.

No. 1 to earth terminal; No. 2 blank; No. 3 lower contact to aerial and to lower contact of 11 and upper of 6, upper contact to crystal and upper contacts of 8 and 11; No. 4 blank; No. 5 lower contact to opposite crystal terminal to that already wired and to lower of 10; No. 6 upper contact to aerial, lower to grid and lower of 12; No. 7 upper contact to anode coil and to one side of anode condenser and upper contact of 9, lower to 13 and to plate of valve; No. 8 lower to H.T. +; No. 9 already connected (to 7 and anode coil and condenser); No. 10 upper to primary of transformer, lower to crystal; No. 11 already connected (upper to 3 and 8, lower to aerial and lower 3); No. 12 upper to secondary of transformer, lower to lower

contact of 6; No. 13 lower to lower contact of 7.

Wired in this way the work is robbed of its terrors and, although it may sound complicated, really the work is easy and all the wires are short and readily attached by soldering. The complete wiring is shown in Figs. 1 and 2. A No. 50 Igranic or similar coil is used in the aerial-coil holder and a No. 75 Igranic in the anode or moving-coil holder. The panel is secured in the case with fillets or strips. The wires to the telephone-type terminals are attached as follows: Outer to L.T. positive, middle to L.T. negative and H.T. negative, inner to H.T. positive.

Operation

To tune, first of all place the plug in the crystal sockets, that is, the right-hand side set Nos. 1 to 5, and connect the aerial and earth wires. The reaction-coil holder knob is turned to the uncoupled position. Tune in a signal by carefully turning the A.T.C. knob and bring up the signal strength by adjustment of the crystal. Place the plug in the left set of sockets, turn on the filament, and the signals should be greatly increased in strength. Adjust the reaction by bringing it about half-way towards the aerial coil until maximum signal strength is obtained. Critical adjustment of the crystal will probably result in doubling the signal strength.

The H.F. connections are made with the plug in the centre, using contacts Nos. 5 to 9. Tuning will be found quite critical. If the signals are tuned in on the crystal only and then the plug is removed to the H.F. side, adjustment of the anode-coil coupling with simultaneous movements of the anode-tuning con-

denser will result in the station being picked up. Build up the greatest signal strength by adjusting the two condensers and the coupling.

At thirty miles from 2 L O, using an ordinary outdoor aerial about 25 ft. high, the following stations were tuned in at good readable strength on the headphones. 2 L O at loud-speaker strength, audible some four or five feet from the loud-speaker (6 volts on the filament circuit, 120 volts on the anode with an M.O. R valve); 6 B M came in at loud headphone strength; 2 Z Y about the same strength as 2 N O, which was the next station to be picked up. 5 W A came in rather weak but readable; Paris and Brussels were quite strong; Glasgow (5 S C) and Aberdeen (2 B D) were also heard. The whole were picked up during one hour's trial.

TESSET.

SELECTIVE TUNING

WHEN tuned to any given frequency the product of the circuit inductance and capacity is a constant. Either of these quantities can be varied so long as their product remains the same. Therefore when the tuned-circuit inductance is high the capacity value must be correspondingly low, and vice versa. This may appear fairly obvious, but a curious difference exists between the two alternative methods of tuning. The impedance of a circuit increases with increase of inductance, and it also increases as the capacity is diminished. Therefore a tuned circuit containing a large amount of inductance and a small value of capacity possesses as a whole a high impedance value. For this reason it is said to be "heavily" tuned, and is highly selective; that is, it will not readily respond to frequencies other than that to which it is definitely tuned.

On the other hand, a tuned circuit in which the inductance is small and the capacity large has a comparatively low total impedance. In other words, it is said to be "lightly" tuned, and does not so effectively bar out frequencies other than that to which it is definitely in resonance. The inference is that when you are trying to tune out 2 L O in order to listen to a distant station, the best chance of success is to increase the normal amount of inductance (by plugging in a higher value of coil) and striking the critical point on a low reading of the tuning condenser.

M. A. L.

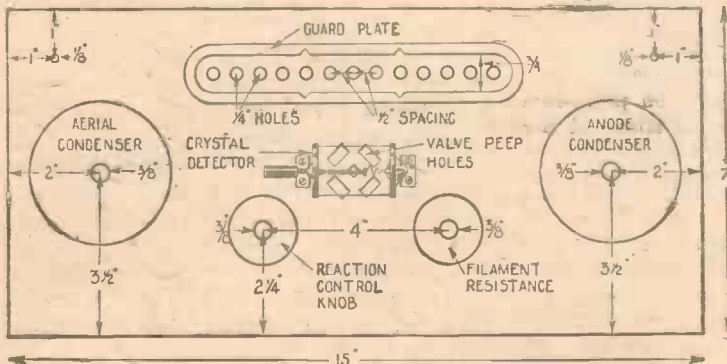

Fig. 5.—Lay-out of panel

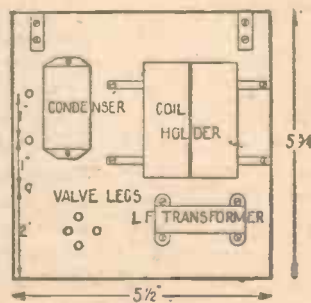

Fig. 6.—Plan of Valve Panel.

Ask "A.W." for list of Technical Books.



RADIOGRAMS

PLANS for the Liverpool station are going ahead. As far as it has been decided at present, the transmitter will be situated in Smithdown Lane and the studio in Lord Street. Capt. P. P. Eckersley guarantees that the station will be open by June 1. Now then, Liverpool enthusiasts, what of those sets you are going to make?

It was stated in the Irish Dail that the P.M.G. would have the right to censor programmes intended to be broadcast.

Listeners who intend taking their sets with them during the summer holidays must remember that the post office where the licence was taken out, or the G.P.O. in the case of experimental licence holders, should be notified. Particulars as to the locality where the set will be used, etc., should be supplied.

It is likely that portions of the Welsh National Eisteddfod will be broadcast from the Cardiff station.

The Edinburgh relay station, which is due to start operations on May 1, will be opened formally by Lord Provost Sleight. Mr. G. L. Marshall, a graduate of both Oxford and Edinburgh Universities, has been appointed station director. At 8 p.m. speeches will be simultaneously broadcast.

Just lately calls broadcast from London and Manchester were the means of finding two witnesses whose attendance was required at court. All other means of tracing the persons had failed.

The naval wireless stations at Aden and Matara now broadcast weather bulletins on 2,000 metres at 0945 and 1745 Greenwich mean time. Aden is BFZ, and Matara, Ceylon, BZE.

A site in East Bridge Street has been offered the B.B.C. by the Belfast Corporation for the broadcasting station.

The Fifth Symphony Concert (on April 22) was to have been conducted by the B.B.C.'s own musical director, Mr. L. Stanton-Jefferies, popular with listeners all over the country. He studied the organ (at the Royal College of Music) with Sir Walter Parratt and Sir Frederick Bridge—both now dead. Mr. Stanton-Jefferies made his first public appearance at the age of eight, when he played Liszt's *Liebestraum*.

To send a message to the Pope within a few weeks is the hope of the B.B.C. With his new receiver the Pope listens regularly to the 2LO transmissions. It is hoped that the Archbishop of Westminster will broadcast this message.

The B.B.C. are going to adapt themselves as well as possible to Summer Time. Schemes are in hand for later programmes, and the times of transmissions generally may be revised.

Listeners may expect some extra specially interesting transmissions now that Major Corbett-Smith has come to Savoy Hill. His work will chiefly be working up "event" and "stunt" programmes.

Mr. William Wolstenholme, the famous blind organist, will be responsible for the recital on Sunday afternoon (April 27).

Selections by the De Groot Orchestra are relayed from the Piccadilly Hotel.

From 2LO on May 1 will be given a complete production of *Faust*, conducted by Mr. L. Stanton-Jefferies. The cast will include Miss Beatrice Miranda, Miss Constance Willis, and Messrs. Joseph Farrington, John Perry, William Michael and John Huntingdon.

The plays to be broadcast on April 29 are the productions of Mr. Lewis Casson.

The next transmission of the fortnightly poetry reading will be made on April 28. The programme for that evening is very varied, including two instrumental septets by Beethoven and Saint-Saëns, a "bright and breezy" entertainment by Miss Gladys Seymour and Mr. Robert Sturtivant, and two groups of art songs by Miss Elsie Suddaby—to say nothing of that inimitable humorist, Mr. Ronald Gourley.

Some people are of the opinion that wireless is a winter "pastime," but the B.B.C. hope to prevent any falling-off in interest during the summer by means of specially interesting programmes. These and the wider use of sets out of doors should keep listeners "up to scratch"!

Sir Edward Elgar will conduct the last of the present series of B.B.C. Symphony Concerts on May 2. Consisting entirely of his own compositions, the programme will include the most attractive numbers from the "Wand of Youth" suite, two of the "Pomp and Circumstance" marches, and the "Enigma Variations."

For the broadcasting on May 3 of scenes from *The Song of Hiawatha*, Dr. Henry Coward is bringing to London his famous Sheffield choir. The transmission will begin at 7.15 p.m.

There are at present only about 2,000 broadcast licences issued in the area covered by the Leeds Post Office. Licences are being issued at a rate of about fifty a week, but a rush is expected in the near future. There are some fifty experimental licence-holders in the district.

It seems apparent from local opinion in Liverpool that the London programme is favoured for the relay station. A suggestion has been made that the Manchester and London programmes should be relayed in turn.

A considerable amount of impatience is being manifested in South Africa owing to the delay in the commencement of a broadcasting service. Three amateurs are carrying out quite an efficient service, however, in the meanwhile.

Experts of the Radio Corporation of America recently measured the velocity of wireless signals. It was found that it took an impulse transmitted from Warsaw (Poland) to the corporation's station at New Brunswick, 8,000 miles away, 0.054 second. This corresponds to 170,000 miles per second and is only approximately correct.

Voice amplifiers and carefully camouflaged loud-speakers have been placed in Westminster Abbey. A small microphone is concealed in the pulpit.

The committee of the British Association, appointed a few years ago to consider the practicability of an international auxiliary language, has finally decided to recommend the adoption of Esperanto.

Listening-in one night, an American thought he heard his brother, whom he had not seen for five years, singing a selection from *Carmen*. On inquiry at the broadcasting station he found that the artiste was his brother, who had left home because his father would not allow him to take up professional singing. Thanks to broadcasting, the family is re-united.

The Durban (South Africa) borough surveyor, who has just returned from a European tour, states that he thinks it highly desirable that a municipal wireless service be inaugurated in Durban.

It is now possible to send a message to Sydney, Australia, without rehandling on the way. Under a new system the message is received from England in India and automatically re-transmitted from there to Australia.

European manufacturers are invited to show their apparatus at the First International Radio Exhibition, which is to be held at Madison Square Garden, New York, from September 22 to 28.

With reference to an application for permission to place an aerial across a road, the town clerk of Droitwich told the Council that they had no power to consent or refuse provided the surveyor was satisfied as to the possibility of danger due to a wire across a road, and providing that the consent of the owners on each side of the road had been obtained.

Time signals received by a mapping expedition in French Equatorial Africa, combined with various astronomical observations, enabled the position of the Nile-Congo watershed to be accurately determined. This is the first time that wireless has played an "official" part in mapping expeditions.

There is at least one man who is profoundly thankful for broadcasting but never listens-in. He is a corrector of examination papers, and lives in the suburbs. A year ago he had to stuff cotton-wool into his ears to keep out the sounds of neighbouring pianos. Now the daughters of his neighbours are all listening-in.

(Continued on page 532)

AN UNUSUAL METHOD OF VALVE COUPLING

FOR some months the writer has been experimenting with a well-known form of resistance coupling, namely, that employing a resistance of the order of 50,000 ohms in the plate circuit of the second and each succeeding valve. It was found that the value of this anode resistance may be varied very considerably and widely differing results may be obtained by this means. Whilst using a resistance of 80,000 ohms the results may be quite good, but unless the high-tension battery is increased accordingly great difficulty will be experienced in coaxing the set to oscillate below a wavelength of about 600 metres.

Anode Resistance

By reducing the anode resistance to about 30,000 ohms the set has been induced to oscillate on a wavelength as low as 250 metres, using only 45 volts high-tension. To get the best results on long waves it is again necessary to increase the anode resistance. There seemed no alternative but to buy a number of resistances and join them to a multi-point switch so that the desired one could be selected by turning the handle. As this was a somewhat expensive method an alternative was sought.

It is well known that a valve has a pretty high internal resistance between filament and plate when the former is incandescent. Why not use that? Experiments were made with a two-valve circuit, employing a separate Mullard-type valve to operate for the resistance employed. It worked excellently with 4 volts on filament and 45 volts on the plate. Of course a separate filament battery is required for the resistance valve, and this must be kept well insulated. A common plate battery was used, and the variation in the internal resistance of the valve was effected by varying the filament brilliancy.

Using the Grid

Nor was this all; so far the grid of the resistance valve had not been utilised. A zero potential relative to filament did not appreciably affect signals. At 2 volts negative the signals came up in strength, and at 4 volts negative the results were quite equal to if not better than the two-valve coupling employing the fixed resistances.

The valve used was an ordinary Mullard Ora with 4 volts for the filament and .7 ampere current, thus giving the filament an apparent resistance of 5.7 ohms whilst incandescent. When cold the resistance of the same filament was only .87 ohms. It is rather difficult to understand

why the resistance should increase so greatly, but these are actual readings. With the grid potential at zero in relation to the filament the resistance between filament and grid was 50,000 ohms and filament-plate current 1.5 milli-amperes and filament-grid current 2 milli-amperes.

Results

With the grid 2 volts negative in relation to the filament, the filament-plate current was 1.5 milliamperes and the resistance between the two 30,000 ohms. No readings were taken on the grid on this and the next test as the potential cannot be maintained whilst the tests are made. With the grid 4 volts negative in relation to the filament the internal resistance was

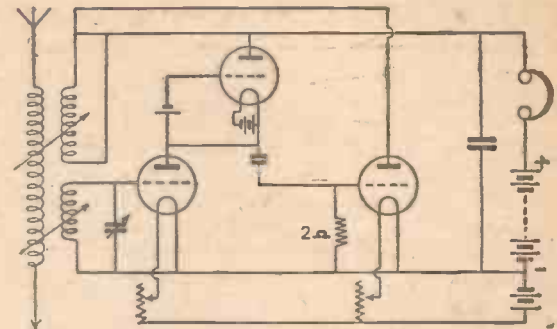

Diagram of Circuit with Valve as Anode Resistance.

40,000 ohms and the plate current 1.5 milli-amperes.

As has been remarked previously, there are two ways of varying the internal resistance of the valve, one apparent from the figures just quoted, that is, varying the grid potential, and the second by adjusting the brilliancy of the filament to suit requirements, it being borne in mind that the brighter the filament the greater the electronic emission, hence the less the resistance. The accompanying diagram shows the arrangement of the circuit.

F. T. G. T.

AROUND THE SHOWROOMS

Multi-crystal Detector

SEVERAL combinations are possible in perikon detectors, and, of course, any one catwhisker can be used with a multi-



"Service" Multi-crystal Detector.

tude of crystals. A neat detector with which you can try any number of perikon combinations is shown by the photograph. Five crystals are accommodated in a holder that can be rotated; this is on the left. A catwhisker can be easily substituted for the crystal mounted on the adjusting arm. These detectors are made by the Northern Radio Service Co., of 67, Church Street, N.16.

Easy Payment Terms

FROM the popular point of view, the cost of a two-valve set has up to now discouraged many of small means from buying anything more ambitious than a

crystal set. This is changed, for I note that the Marconiphone people are offering the "V2" on easy payment terms.

Filament Resistances

FILAMENT resistances can now be made specially for use with different types of valve. The idea is clearer from the photograph, which shows two filament resistances made by Fuller's United Electric Works, Ltd., of Woodland Works, Chadwell Heath, Essex. That on the left is of the usual pattern, whilst that on the right has the wire arranged in a special way. This gives the best variations over certain parts of the valve's characteristic. Two interesting points about these resist-

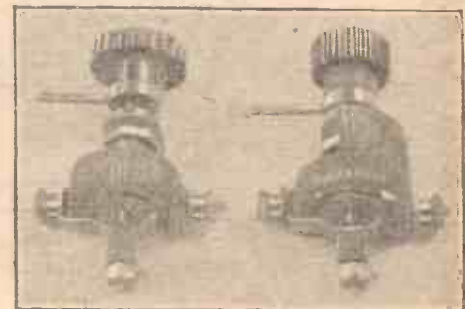

Fuller Filament Resistances.

ances are that the control turns through only 180 degrees and the resistance turns are not spaced, the wire being oxidised.

VANGUARD.

Quality guaranteed

Practically every article shown in this advertisement is manufactured by ourselves in our own factories. We can, therefore, guarantee its quality. Purchasers who cannot call at one of our Branches can have every feeling of confidence in sending their orders by post and know that their instructions will be correctly interpreted and the goods sent without delay. All orders of £2 and over sent post free, otherwise postage should be included (any excess will be returned.)



Max-Amp. Transformer

A high grade intervalve Transformer of proved performance. Fully guaranteed and tested to 500 volts between windings. Outer winding protected by cord. Primary winding silk covered 18/6

Crystal Detectors

As illustrated. Glass enclosed, solid brass end pieces, superior finish. For panel mounting ... 2/-
If mounted on ebonite 2/6
Other patterns, 4/-, 5/6, and 8/6.

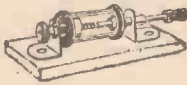

Fixed Condensers

Very large capacity, specially made for bridging the terminals of the H.T. battery. Sealed in metal case with two soldering tags. Tested and guaranteed ... 1/6



Special for Portable Sets

Rechargeable Batteries for Dull-Emitter Valves

The latest battery specially designed for the new Dull Emitter Valves. These batteries will give a continuous output of .5 to .8 amperes for a period of three to five hours at a voltage of 1.5 per cell. To start the battery working it must be filled with water and allowed to stand for two hours before using. Owing to the heavy discharge which can be taken from these cells without any drop in voltage, four of them can be used in series to operate any ordinary valve. In length of life they will be found to outlast at least three of the ordinary dry cells recommended for use with Dull Emitters. Special price, each in ebonite case 7/6



Coil Holders

Well designed, solidly constructed and finished in a superior manner. Fitted with long handle (to eliminate body capacity). For panel mounting can be used in either vertical or horizontal position. Also for 3 coils ... 7/6

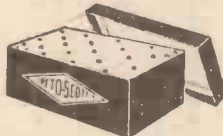

H.T. Batteries

The Sphinx

Specially made to our own specification, very silent and thoroughly reliable. Fitted with 2 Wander Plugs.
15 volts 3/-
36 volts 7/-
60 volts 12/6
100 volts 21/-
18 volts for grid bias 3/9

The "Filtophone"

Specially constructed to eliminate noises in the Loud-speaker and to improve tonal quality. Merely connect between Set and Loud-speaker. In polished mahogany case 8/6



Multi-wave Amplifier

For H.F. Amplification on all wavelengths above 1,000 metres. Simply plug in—no tuning with variable condenser required. No. 1 for coupling between H.F. and Detector and No. 2 for use where more than one stage of H.F. Amplification is used. Prices: No. 1, 8/6. No. 2, 12/6



Variable Condensers

Approx. Capacity in Micro-farads.	Ready to assemble for Panel Mounting.	Price assembled for Panel Mounting.
.0015	10/8	14/6
.001	7/8	9/-
.00075	6/8	7/6
.0005	5/8	6/11
.0003	4/3	5/11
.0002	3/8	4/11
.0001	3/2	4/6
.00005	—	2/6



Tunode Plug

Permits the usual type of plug-in coil being used as a tuned anode coil in any set designed for use with transformer H.F. coupling. All connections made internally ... 3/6
No. 2. For use with second stage of H.F. amplification 7/-



Fixed Condensers

In genuine moulded ebonite cases, sealed against dampness. Ready for fitting to panel by means of two screws.
.0001-.0005 ... 1/3 .001-.002 ... 1/6

Send 3d. for 48-page illustrated Catalogue, the largest and best in the trade. Peto-Scott's Wireless Book (post free, 1/3) contains over 60 circuit diagrams and much useful information on how to build and operate Receiving Sets.

A Valve for Every Wireless Circuit

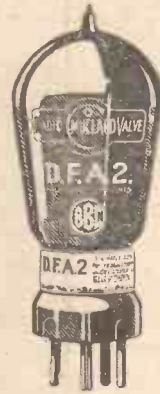

You wouldn't

be satisfied to overload a one-horse power engine to try and make it give ten-horse power.

Don't use ordinary bright filament valves to give you loud speaker volume, use

THE NEW D.F.A.

the Mullard dull filament MASTER valve, specially designed to give volume without distortion.

If you have bright filament valves working on 4 or 6 volts, replace the last valves with D.F.A.'s—you will be delighted with the increase in volume and clarity.

The same battery will do and it will last you longer.

D.F.A.'s are new dull filament amplifying valves made in two types, the D.F.A.1 for 6 volt batteries and the D.F.A.2 for 4 volt sets, as follows:—

	D.F.A.1	D.F.A.2
Filament volts	5.5	3.3
Filament amps.	0.23	0.25
Anode volts	50-100	50-100
Negative Grid volts	2.6	4.8
Price:	35/-	30/-

Ask your dealer or write to us today (Dept. A.W.) for leaflet V.A.3, giving full particulars.

Mullard

THE MASTER VALVE

Advt.—The Mullard Radio Valve Co., Ltd., Nightingale Works, Nightingale Lane, Balham, S.W.12. E.P.S. 131

Peto-Scott Co., Ltd., HEAD OFFICE: 64 High Holborn, W.C.1

Demonstration Lounge: 99 High Holborn, W.C.1

Branches: LONDON, 3, Wellington St., Strand, W.C.2.
LIVERPOOL: 4, Manchester Street.
PLYMOUTH: 4, Bank of England Place.
CARDIFF: 94, Queen Street.
WALTHAMSTOW: 230, Wood Street.

G. A., Ltd., 761.

RADIOGRAMS (continued from page 529)

The assistant editor of an American newspaper, who refused to tell a grand jury where he obtained a certain news item, was sent to prison for thirty days. He said he was quite happy in gaol, as he had his wireless outfit.

A report states that a Bill will come before the Greek National Assembly, by which the installation of wireless receivers will be permitted on payment of a licence fee.

Arrangements are being made between an American broadcasting station and gramophone company for artistes to broadcast and make records simultaneously.

When you want to get a servant through a registry office nowadays you have to say whether or not she will be allowed to listen in. One girl asked at a registry office whether her prospective employers had a crystal or valve. She declined to have anything to do with a common crystal, saying she had an offer from a house where a four-valve set was installed. As she was "interested in science," she thought she would go there!

The Austrian Government is undertaking the formation of a company called Broadcasting A.G. It has been decided not to grant a wireless monopoly to any private concern.

American broadcasting stations have decided to limit the duration of all political speeches to ten minutes. But during an electoral campaign the rate for broadcasting is ten dollars a minute!

Mr. J. L. Baird, of Hastings, is reported to have advanced so far in television that his experiments have attracted the attention of a number of cinema magnates.

General Ferrie and his colleagues at the French centre of military wireless telegraphy have invented a system of transforming luminous signals into audible signals.

Sir Oliver Lodge is soon to speak from 2 L.O. His subject will probably be astronomy.

Concert artistes are finding that broadcasting is an effective form of advertisement, and it is stated that there are artistes, unknown before broadcasting, who can now make successful concert appearances.

Manchester is said to have a larger circle of listeners than any other provincial station. Nearly 100 licences are issued there daily.

At Morecambe a local firm is considering asking permission from the Council to run open-air concerts on the front with loud-speakers during the summer.

A letter sent by the B.B.C. to boys of the Oakbank Industrial School who recently sang from the Aberdeen station says that they gave great delight to the children who listened.

WIRELESS AT THE BRITISH EMPIRE EXHIBITION

AT the British Empire Exhibition wireless exhibits are included in the electrical engineering section of the Palace of Engineering. In all there are about thirty firms exhibiting things of particular interest to amateur enthusiasts. Below we give a list of exhibits that are mainly "wireless" in nature. The positions of all stands are determined by numbered avenues and bays, of which we shall give a plan in a future issue.

List of Exhibitors

- Automatic Telephone Manufacturing Co., Ltd., Norfolk House, Norfolk Street, W.C.2. (Avenue 14. Bay 14-15.)
- British Electric Transformer Co., Ltd., Hayes, Middlesex. (Avenue 10. Bay 5-7.)
- British Thomson-Houston Co., Ltd., Rugby. (Avenue 9-10. Bay 11-15.)
- S. G. Brown, Ltd., Victoria Road, North Acton, W.3. (Avenue 14. Bay 6-7.)
- Burndep, Ltd., Ariel Works, Blackheath, S.E. (Avenue 13. Bay 13.)
- Chloride Electrical Storage Co., Ltd., Clifton Junction, near Manchester. (Avenue 13. Bay 7-8.)
- City Accumulator Co., Ltd., 10, Rangoon Street, Crutched Friars, E.C.3. (Avenue 15. Bay 12.)
- D. P. Battery Co., Ltd., Bakewell, Derbyshire. (Avenue 13. Bay 5.)
- Ebonestos Insulators, Ltd., Excelsior Works, Rollins Street, Canterbury Road, S.E.15. (Avenue 11-12. Bay 20-21.)
- Edison Swan Electric Co., Ltd., 123-125, Queen Victoria Street, E.C.4. (Avenue 11-12. Bay 15-16.)
- Electrical Installations, Ltd., 27, Martin Lane, Cannon Street, E.C.4. (Avenue 14. Bay 15-16.)
- Ever-Ready Co. (Great Britain), Ltd., Hercules Place, Holloway, N.7. (Avenue 14. Bay 7-8.)
- Falk, Stadelman and Co., Ltd., Efesca Electrical Works, 83-87, Farringdon Road, E.C.1. (Avenue 14. Bay 9-11.)
- Ferranti, Ltd., Hollinwood, Lancs. (Avenue 15. Bay 16.)
- Fullers United Electrical Works, Ltd., Woodland Works, Chadwell Heath, Essex. (Avenue 14. Bay 10-11.)
- General Electric Co., Ltd., Magnet House, Kingsway, W.C.2. (Avenue 11-13. Bay 11-15.)
- Alfred Graham and Co., St. Andrew's Works, Crofton Park, S.E.4. (Avenue 11. Bay 11-13.)
- Hart Accumulator Co., Ltd., Marshgate Lane, Stratford, E.15. (Avenue 13. Bay 10-11.)
- London Electric Wire Co. and Smiths, Ltd., 7, Playhouse Yard, Golden Square, E.C.1. (Avenue 9. Bay 18.)
- L. McMichael, Ltd., Providence Place, West End Lane, Kilburn, N.W.6. (Avenue 13. Bay 13-14.)
- M.O. Valve Co., Ltd., Osram Works, Brook Green, Hammersmith, W. (Avenue 11-13. Bay 11-15.)
- Marconi's Wireless Telegraph Co., Ltd., Marconi House, Strand, W.C.2. (Avenue 11. Bay 9-11.)
- Metropolitan-Vickers Electrical Co., Ltd., Trafford Park, Manchester. (Avenue 8-10. Bay 7-11.)
- Mullard Radio Valve Co., Ltd., 45, Nightingale Lane, Balham, S.W.12. (Avenue 14. Bay 13.)
- Radio Communication Co., Ltd., 34-35, Norfolk Street, Strand, W.C.2. (Avenue 15. Bay 9-10.)
- Siemens Bros. and Co., Ltd., Caxton House, Westminster, S.W.1. (Avenue 11. Bay 15-17.)
- Sterling Telephone and Electric Co., Ltd., 210-212, Tottenham Court Road, W.1. (Avenue 15. Bay 11-13.)
- A. J. Stevens and Co. (1914), Ltd., Walsall Street, Wolverhampton. (Avenue 14. Bay 9-10.)
- Telephone Manufacturing Co., Ltd., Hollingsworth Works, Martell Road, S.E.21. (Avenue 11. Bay 6-7.)
- Tudor Accumulator Co., Ltd., 2, Norfolk Street, Strand, W.C.2. (Avenue 14. Bay 13.)
- C. A. Vandervell and Co., Ltd., Acton, W.3. (Avenue 14. Bay 11-12.)
- Western Electric Co., Ltd., Connaught House, Aldwych, W.C.2. (Avenue 9-10. Bay 18-20.)
- Wireless Lights Syndicate, Ltd., Moorgate Hall, Moorgate, E.C.2. (Avenue 15. Bay 15-16.)

FOUR
"AMATEUR WIRELESS"
HANDBOOKS - 1s. 6d. EACH

WIRELESS TELEPHONY
EXPLAINED.

SIMPLE CRYSTAL
RECEIVING SETS
WIRELESS COMPONENT
PARTS

SIMPLE VALVE
RECEIVING SETS

CASELL & CO., LTD.,
LA BELLE SAUVAGE, E.C.4.

MARCONI v. MULLARD

The House of Lords' Decision.

THE recent House of Lords' judgment in favour of the Mullard Radio Valve Co., Ltd., and against Marconi's Wireless Telegraph Co., brings to a close one of the most bitterly contested actions in the history of patent law.

The first step was taken in July of 1922, when the Marconi Co. sued Mullards for alleged infringement of their patent rights in the thermionic valve. The point in dispute was whether the use of a straight filament surrounded by an open spiral wire grid and an open-ended cylindrical plate was permissible in view of the existing patents held by the plaintiff company.

In the High Court, Mr. Justice Lawrence considered the scope of the two Marconi patents relied upon, and decided that one of them merely covered a particular method of mounting the electrodes inside the valve, whilst the other did not clearly describe the open spiral grid and cylindrical plate used in the Mullard valve. He therefore decided that no infringement had taken place and dismissed the action with costs.

The plaintiffs appealed against this decision, but without success. Lords Justices Younger and Warrington in the Court of Appeal on March 3, 1923, upheld the findings of the Lower Court in every respect, and confirmed the right of the Mullard Co. to manufacture the type of valve in dispute.

Undeterred by these rebuffs, the Marconi Co. took their case before the highest tribunal in the land—the House of Lords—only to suffer a final defeat.

In his judgment Lord Dunedin confirmed the decisions previously given. Although the law was ready to afford the utmost protection to inventors who produce new and valuable devices, it was manifestly unfair to others to extend a patent monopoly beyond the invention actually and clearly described in the patent specification. The principal Marconi patent claimed the use of a "closed" grid, whereas in the Mullard valve an open spiral grid was employed. Lord Buckmaster and Viscount Cave concurring, the appeal was dismissed with costs.

BARRISTER-AT-LAW.

"Restoring an Easy Chair" is the title of a useful article (illustrated by photographs) appearing in the current issue of "Work" (3d.). Other articles appearing in the same number are: "A Cheap Primary Cell"; "A Home-made Refuse Destructor"; "A Pedestal Music Cabinet"; "Marking Chemical Bottles"; "Making a String Box"; "Incandescent Oil and Petrol Lamps"; "Gauge for Setting Tool to Diameter"; "Grinding, Sharpening and Setting Razors"; "Tool-holder for Lathe"; "Hanging a Door"; "Making a Decorative Table Fountain"; "Using Up Broken Hacksaw Blades."



Choose a Loud Speaker to suit your room

Just as for the small room the piano requires careful and deliberate selection—not only on account of its size but also by reason of its volume of tone—so the choice of a Loud Speaker requires just as much care and discrimination.

A large Loud Speaker such as the Brown H.1 is so powerful and produces such a large volume of sound that in a small room its true-to-life reproduction may be impaired.

For this reason, therefore, it is obvious that there is a very real need for a Loud Speaker capable of giving a medium volume of clear, mellow tone sufficiently loud for fireside use. Considerable improvements have now been effected in the new Brown H.2, which render it ideal for use in the small room.

Mechanically the identical principles which have proved so successful in the large model are used, but the whole instrument—its shape and size—is the direct result of a careful study of the actual requirements.

If your room has an equivalent area of, say, 3 yards by 5 yards, then the purchase of a Brown H.2 will add considerably to the pleasure you are at present obtaining from Radio.

PRICES:

Model H.2, 12 in. high:	
120 ohms	£2 5 0
2,000 ohms	£2 8 0
4,000 ohms	£2 10 0
Model H.1, 21 in. high:	
120 ohms	£5 5 0
2,000 ohms	£5 8 0
4,000 ohms	£5 10 0

S. G. BROWN, LTD.
 Wholesale:
 Victoria Road, North Acton, W.3.
 Retail:
 19, Mortimer St., W.1.
 15, Moorfields, Liverpool.





Wireless in Germany

SIR,—Since my letter concerning wireless conditions in Germany, which was published in No. 95, several important changes have been made.

From April 1 users of crystal sets have had their share of the programmes free of charge, no licence of any sort being required. Valve users have the option of paying G.M.2 (gold marks) monthly or G.M.24 per annum. As there was only one licence previously, costing 50 G.M. (£3 5s.), this should increase the craze which is raging over the whole of Germany. This step appears to have been taken on account of the large number of unlicensed sets in use.

Experimental licences (corresponding to English constructors' licences) must be ob-

tained through the medium of a wireless club, an easy examination having to be passed by applicants.

The following stations are now working: Berlin (Vox Haus), 415 metres; Leipzig, 450 metres; Munich, 450-500 metres; Frankfurt, 460 metres. Königswusterhausen has now a wavelength of 475 metres. Most of the stations work at the following times, which are British summer time:

8 a.m., market reports; 10.45 a.m., exchange and news; 2.30 to 4 p.m., music; 5.30 p.m. talks (not daily); 6.15 p.m., concert (Sundays and holidays, 3 to 4 p.m.); 8 to 9 p.m., dance music (once weekly: Berlin Thursdays; other stations irregularly).

Regarding the reception of British stations, Newcastle is best, Bournemouth next. Cardiff used to be much stronger than it is at present. London is not too good, and Birmingham is very hard to tune with Königswusterhausen on the same wavelength. Glasgow and Aberdeen are

both very good. Several times I have received Glasgow (670 miles), Newcastle (550 miles) and Bournemouth (490 miles) on a crystal set (aerial, one end 8 ft. from the ground, other end 25 ft.). Using a parrot's cage as an indoor aerial, with one H.F. and a crystal, the British stations are quite good.—F. H. S. (Oberschmitten).

Continental Stations

SIR,—In answer to a question asked by your correspondent F. G. S. (Theydon Bois) in No. 96, the station which he heard is probably Königswusterhausen, near Berlin, on a wavelength of 475 metres. The official wavelength of the Munich station is at present unknown, but experience shows that it is between 475 and 480 metres. Another station working on a wavelength close to that heard by F. G. S. is Frankfort-on-Main, 460 metres. This station has already been heard at a distance of 1,000 miles. Königswusterhausen is the most likely in view of the hours in which it was heard. It has a power of 4 kilowatts.

E. P. (Hartest, Suffolk) inquires about a French station heard, giving the call letters PRL. Might these letters be the call sign of the new French station owned by the newspaper *Le Petit Parisien*, wavelength 340 metres, 300 watts? If the station was heard on a Saturday night, about 10.30 p.m., it was most likely *Le*

(Continued on page 536)

WATMEL VARIABLE GRID LEAK

Constantly variable. Silent in operation. Constant in any temperature. Dust and damp-proof. Each tested and guaranteed. Neat and well made.

SEND P.C. FOR DESCRIPTIVE FOLDER
Beware of imitations, see the name Watmel on every Grid Leak

WATMEL WIRELESS
Connaught House, 1a, Edgware Rd., Marble Arch, W.2
Telephone: 4575 Paddington.

Patent No. 206698

.5 to 5 megohms ... 2/6
50,000 to 100,000 ohms 3/6

ASK
"A.W."
for List of
Technical
Books

TO THE TRADE

Send Your Enquiries to
LONDON METAL WAREHOUSES Ltd.

For BRASS and COPPER, TUBES, SHEETS, RODS, WIRE, ANGLES, Etc. ALUMINIUM and BRONZE PULLEYS, AERIAL WIRES, ENAMELLED and D.C.C. COPPER WIRE, CONSTANTAN RESISTANCE WIRE, SCREWS, NUTS, WASHERS, Etc. :: :: ::

Write for Price List

THE FOUNDRY, HILL STREET, Blackfriars Road, S.E.1

Telephones: HOP 6196 and 1913.

Telegrams: STEBRAWARE, SEDIST, LONDON

TOOLS

HAND DRILL. Takes up to 1/2 in. diameter powerful 3-jaw chuck. Postage 9d. extra. **5/9**

SET of SIX TWIST DRILLS ... Post Free ... **2/-**

MAKE UP YOUR OWN WIRELESS SETS

EBONITE
Any size cut to your requirements.

The IDEAL SOLDERING LAMP for Wireless Amateurs.
Postage 6d. extra. **4/6**

Straight or hatched shaped Soldering Irons to use with above. 1/6 extra. Postage 3d. extra.

RICHARD MELHUISS, LTD.,
Tool, Machine and Electrical Experts,
50, 51 & 54, FETTER LANE, HOLBORN CIRCUS, LONDON, E.C.1
Established 1828

DRY CELLS
For D.E. VALVES

Take Our Advice.

With D.E.3 Valves and similar types, use two cells in series.
With Weco valves, Wuncel and similar valves use two cells, in parallel.

USE RADIAX SUPER-CELLS AND AVOID DISAPPOINTMENT. PRICE 2/3 EACH.
Postage, 2, 9d., 4, 1/3, 6, 1/3.

RADIAX S.S. HEADPHONES
REALLY SUPER-SENSITIVE

And will almost double the strength of reception, having adjustable diaphragms and are absolutely unbearable.

4,000 ohms Price 19/6

H.T. BATTERIES

With Sockets and Wander Plugs. 54 volt, 9/9; 66 volt, 11/9; 108 volt, 17/9.

RADIAX SPECIALITIES ARE OBTAINABLE FROM ALL REPUTABLE DEALERS. Send Stamp for List.

RADIAX, LTD.

20, RADIO HOUSE, PERCY ST., TOTTENHAM Ct. Rd., LONDON, W.1
(7 min. Tott. Ct. Rd. or Goodge St. Tube).
Museum 490.

WE SATISFY YOU

No. 1 of a series dealing with Edison Swan Valve manufacture.

Reasons why EDISWAN VALVES Are Better

Glass

Glass plays an important part in the construction of a Valve. The *quality* of the glass has a definite bearing upon its span of life—the thickness of the bulb must be regulated to a minute degree of accuracy. One important reason for the superiority of Edison Swan Valves is the fact that the whole of the glass required is manufactured at their Ponders End Factory. From the preparing and heating to 1,200° C. of the mixture which produces the molten glass, to the blowing and finer moulding, each stage of the process is carefully supervised. In this way, from the outset, extreme measures are taken to ensure Edison Swan efficiency.



Prices:

"R." ... 12/6
 "A.R." 12/6
 "A.R.D.E." 21/-
 Dull Emitter.
 "A.R. .06" 30/-

Latest Dull Emitter.
 Current consumption
 at 2.5 volts .06 of an
 ampere.

Have you had your **FREE** copy of Illustrated Booklet "The Thermionic Valve"? If not, send a postcard to-day. Your dealer holds stocks to supply you. If not, write us direct giving his name and address

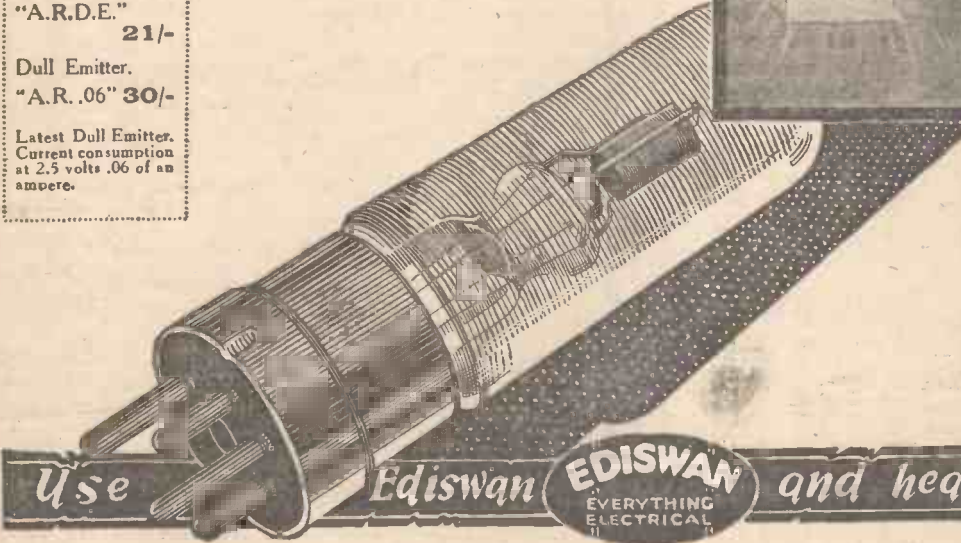

**THE EDISON SWAN
ELECTRIC CO., LTD.,**

*Contractors to H.M. Admiralty
War Office, Royal Air Force,*

123-5, Queen Victoria St., E.C.4.
and 71, Victoria Street, S.W.1.

Branches in all Principal Towns.
Works: Ponders End, Middlesex.

Use **Ediswan** **EDISWAN** and hear Everything
EVERYTHING ELECTRICAL

Buy British

Goods Only.

CORRESPONDENCE (continued from page 534)

Petit Parisien. This station has not yet started regular programmes. With one H.F. and crystal I receive this station well.

At the Frankfort fair one was impressed by the number of English loud-speakers on the various stands. The Brown was foremost, the Amplion being a good second. The Magnavox was also making its presence heard on one stand. On the whole, the standard of the apparatus was pretty good, although some of the operators sacrificed quality for quantity.—F. H. S. (Oberschmitten).

[We are obliged to numerous other readers who have indicated the station in question.—ED.]

Amateur Transmitters

SIR,—May I be allowed a little of your valuable space to appeal to amateur transmitters? I have been listening-in over the week end, and the state of things has prompted me to make this appeal.

On Sunday, April 13, I worked a station I had not worked before, and his call sign is not in the lists. At the end of each short message I sent "QRA?" which means nowadays, "Where are you situated?" but each time he ignored my query. Then my accumulators suddenly ran down, so I don't know now where he is situated.

Another point is, why do people insist on readjusting their receivers during a transmission and then ask for a repeat? I heard two telephony stations working recently. Station A asked a question. Station B replied. But although A was receiving B at strength R7, B had to reply three times before A got the remarks. At last he got them and said: "Sorry, old man; I was just fiddling about with my receiver."—6 GM (London, N.W.).

Other Correspondence Summarised

B. D. (Stock, Essex) has received a station (foreign, but not French or Belgian) daily from 5-6 p.m. and 9-10.15 p.m. Wavelength appears to be between 500 and 600 metres. Speech is not very distinct using a five-valve set. Can any reader identify it?

J. J. (Billericay, Essex) states that he has received all the B.B.C. stations, Brussels, Eiffel Tower, and L'Ecole Supérieure on a crystal set.

H. C. C. (Southampton) received Glasgow on March 17 using a crystal set. Newcastle, Manchester and Cardiff are received fairly regularly.

G. A. (Birmingham), using the set mentioned by J. S. W. (Correspondence, p. 343) in "A.W.," No. 93, has received 5 IT (Birmingham), 6 BM (Bournemouth), 5 NO (Newcastle) and 2 BD (Aberdeen).

A communication addressed to 6 OH has been sent us. Will this transmitter kindly send us his name and address?

WIRELESS IN PARLIAMENT

From Our Own Correspondent

ACCORDING to a statement made by the Postmaster-General in the House of Commons recently the total number of wireless receiving licences in existence on March 31 last was approximately 720,000.

The question of broadcasting matters of a political nature was raised by Mr. Baker, who asked the Postmaster-General whether he was aware that Mr. B. H. Morgan, chairman of the British Empire Producers' Organisation, recently broadcast from 2 LO several addresses on British Empire trade, in which he advocated the development of Empire tariff preferences; and whether, since the broadcasting of such addresses was not in accordance with the understanding on this subject, he would undertake to apply the regulations?

Mr. Hartshorn, in reply, said he understood that the addresses to which the hon. member referred were broadcast in June and July, 1923, and that no complaints were received that they were of a political or controversial character. In the circumstances he did not propose to take any action.

In reply to a question by Capt. Viscount Curzon, Mr. Webb, President of the Board of Trade, said that representations had been made to the Board on the subject of wireless direction-finding stations, and this subject had for some considerable time been under the close consideration of the departments concerned. Under present financial conditions expenditure must in any case be limited, and invention was proceeding so rapidly that it was difficult to say at present which system would ultimately be best suited to the needs of the mercantile marine. The Board was watching this question closely and proceeding as far as circumstances would permit.

The question of providing further broadcasting relay stations is being considered. Mr. Hartshorn informed Mr. Gavin-Duffy that applications had been received for the establishment of broadcasting relay

(Continued on page 538)

WE REGRET

That, owing to pressure on our space this week, we are compelled to hold over the "Information Bureau" page. All queries addressed to us are answered by post providing that coupon (p. 539) and stamped addressed envelope are sent us.

Ask "A.W." for
A LIST OF
Practical Money-making Books

DISCOUNT SALE

of Cabinets, Transformers, Variometers, Terminals, Phones, and other Wireless Components. List post free.

KENITE FOR RADIO PANELS

Half the price of Ebonite. Twice the efficiency. Panels 6 x 6 x 1/4, 1/2; 9 x 6, 1/8; 12 x 10, 3/4, post free. Larger and intermediate sizes at proportionate prices. Black only. Matt finish, 1/2 in. 25% extra.—CRAWFORD, 9, Coleman St., London, E.C.2. Telephone: London Wall 9738

YEARS OF ENTERTAINMENT FOR 10/6



SELMO (Regd.)

Wireless Crystal Set. Solid Mahogany, Polished Casca. Maximum signal strength. Reception Clear and Distinct for 25 miles. 14 days' trial given. Money refunded if not satisfied.

MERCURY Square Type 10/6 ea.	MARS Slope Type 14/6 ea.	VENUS Lid Type 16/6 ea.	ROLL TOP DESK Type 45/- ea.
------------------------------------	--------------------------------	-------------------------------	-----------------------------------

Plus 1/- B.B.C. Royalty. Liberal Trade Discount
CHEAPEST HOUSE FOR COMPONENTS.

Ask your local dealer or write direct to manufacturers.
SIMONS (Dept. A.W.), 100 HOUNDSDITCH, LONDON, E.1

VALVES 3/9 POST FREE

A limited quantity of new K.T.D. Telefunken Valves recently received offered at 3/9 each until supplies are exhausted. Fil. 2—3.5 Volts. Plate 50—150 Volts. Current consumption approx. .45 Amps. SEND NOW.

ELEFACTORS, Ltd.,
86, Cranville Road, Child's Hill, N.W.2
Phone: Hampstead 7919. Nearest station, Golders' Green

SKINDERVIKEN MICROPHONE

(THE SMALLEST IN THE WORLD)

TO THE GENERAL PUBLIC

If you cannot obtain this device from your local dealer write to the head office:
MIKRO Ltd. 32a, Craven St., STRAND, W.C.
The new type Skinderviken Microphone with Carbon Electrodes only are obtainable at 5/- each.

Write for illustrated booklet:

"THE MARVELS OF THE MICROPHONE,"

which gives full details how to make your own amplifier for crystal sets.
Price 6d. post free 6d.
Send P.O. (not stamps) to-day.

MIKRO Ltd., 32a, Craven St., STRAND, W.C.

RIFANCO PHONES and PARTS

4,000 ohms tested Headphones, 2/6 pair. Cabinets, Pedestals, Sideboards for Wireless and Gramophones. Motors, Tonearms, Soundboxes, Horns, Springs, Needles, Hinges cheap. 32 pages, illus. Catalogue telling how to make Gramophones, etc. 24 types of Motors from 6/- cart. paid. Gramophones from 50/-
Trade discount to regular dealers
The REGENT FITTINGS Co. (Dept. A.W.)
120, Old Street, London, E.C.1
Est. 90 years. Tel.: Clerkenwell 29 23



TO GET BEST POSSIBLE RESULTS...

be sure not to buy stale, shop-soiled crystals when you can be supplied post free direct from fresh Importers' stock, at the same time saving at least 50%.

The genuine American "Extra-Loud All-Over" "SOLO" CRYSTALS, proven Best by America's Oldest Radio School, will be sent to you against 9d. each (value 1/6).

Your money back if not satisfied.

F. WALSER, 18, WELL COURT, QUEEN ST., LONDON, E.C.4

HULLO EVERYBODY!!

Post Free Column

- Valve Windows 1/-
- Basket Coils (6) 200/3,600 2/6
- Waxless (5), 200/2,000 M. 2/6
- Twin Flex for Leads, 12 yds. 2/-
- Bell Wire, D.C.C., I.R.O., 10 yds. 10d.
- 100 ft. Aerial, 7/22 3/3
- Rubber Lead-in, 10 yds. ... 1/6
- Basket Coil Holder and Plug 1/6
- Do., 2-way on Stand 5/6
- 2-way for Igranic Coils ... 4/11
- Various Designs, 5/11, 6/11, & 7/-
- Shaw's Genuine Hertzite ... 1/3
- Spade Screw, Terminals doz. 1/6
- Pin do. doz 1/3
- Ebonite Dial and Knob ... 1/4
- Do., Extra Quality 1/8
- Ebonite Valve Holders ... 1/3
- Do., Cut from Solid 1/6
- Valve Sockets, Best, doz 1/3
- Do., Plain doz 1/-
- Terminals, Telephone, doz. 1/6
- Do., Pillar doz 1/6
- Do., Small Pillar doz 1/4
- Do., W.O. Patt. doz 1/6
- (All above with Nut.)
- Insulating Sleeving, 3 yds. 1/3
- Tinned Copper, 3 yds., 14 or 16 gauge 9d.
- Do., 3 yds., 18 or 20 gauge 6d.
- Ebonite Coil Plugs, 2 for Do. on Stand 1/9
- 100,000 ohm Resistance ... 2/6
- Switch Arm, 12 Studs and Nuts 1/6
- Ormond Fil. Resistance ... 2/6
- Fixed Condensers, .001 ... 1/2
- Do., .001 to .0005 1/2
- Do., .002 to .005, 1/3; .006 1/6
- (Above best quality.)
- Grid Leak and Condenser, .0003 2/6
- Ebonite Vario, D.S.C., 250-260 4/11
- Do., D.C.C. Ball Rotor ... 6/9
- Ebonite (Inside Winding) Variometers 13/6
- Contact Stops doz 1/-
- Battery Clips doz 1/-
- Coil, 28 tpgs., 1,600 M 2/6
- 4 Whiskers, 1 Gold 6d.
- Speart Point Whisker 4d.
- 12 yds. Empire Tape 1/-
- Plugs and Sockets doz. prs. 1/6
- Cecocite Crystal 1/6
- Minicap Switch 8/-
- Radio Ins. Transformer 25/-
- Igranic Shrouded, L.F. 5-1 21/-
- Formo Shrouded, do. 18/-
- Formo Open Type, do. 12/6
- Royal, do. 20/-
- Tested on Aerial, do. 12/6
- Raymond, do. 12/6
- Ormond Filis Rheostat ... 2/6
- Raymond, do. 2/-
- Rheostat and Dial 2/6
- Ajax Rheostat, 25.5 ohms ... 4/-
- Ajax with Vernier, 30.5 ohms 5/-
- Ajax Potentiometer, 464 ohm 6/6
- Igranic Rheostat 4/6
- Peerless Rheostat, 8 ohms 4/6
- Peerless " 15 ohms 4/9
- Peerless " 30 ohms 5/-

RAYMOND VARIABLE CONDENSERS

Our Air Dielectric Condensers are the simplest and MOST efficient on the market. Lowest in price, highest in quality, made for panel mounting, and are the most suitable condensers for Broadcasting or Amateur work. They have passed THE TEST for guaranteed capacities, are scientifically accurate and built for durability.

NEW MODEL

Post 6d. per set .073 In Spacers.

Cap.	Plates	Price.
.001	49	7/11
.00075	37	6/11
.0005	25	5/11
.0003	15	5/3
.0002	11	4/11
.0001	5	4/3

Vernier 3/11

PASSED NATIONAL LABORATORY TEST

Above new model specially adapted for taking up min. amount of space. All parts nickelled. One hole fixing.



One Hole Fixing Prices include Knob and Dial. without Dial 6d. set less.

Trade discount on Condensers 20% plus postage Good terms quantities.

"A" TYPE

Post 6d. per set .088 In Spacers.

Cap.	Plates	Price.
.001	57	6/6
.00075	43	5/9
.0005	29	5/-
.0003	19	4/6
.0002	13	4/-
.0001	7	3/6

(Vernier, 2/6.) No dial.

Above "A" type is a wonderfully cheap and reliable condenser. One hole fixing. Thousands of testimonials from satisfied users.

CALLERS ONLY

ALL POST ORDERS from OTHER COLUMNS

- Telephone, large each 1/4d.
- Telephone each 1d.
- Pillar 1d. & 1 1/2d.
- W.O. Patt. 2 for 2 1/2d.
- Large size each 3d.
- Various doz. 1/1 & 1/6
- Valve Sockets doz. 10d. & 1/-
- Contact Studs doz. 4d.
- 2, 3, 4, 5, 6 B.A. Nuts 3 doz. 6d.
- 2 B.A. Rod foot 3d.
- 4 B.A. Rod foot 2 a 1d.
- Valve Pins 2 a 1d.
- Brass Bushes 1d.
- Spade Tags, best quality doz. 3d.
- No dial. 1d.
- Screw Spade Terminals ... 1d.
- Pin Screw do. 4 for 3d.
- Stop Pins 2 a 1d.
- Plug and Socket pair 1 1/2d.
- Easyfix Cup 1 1/2d.
- Switch Arms, with 12 Studs, Nuts and Washers 10 1/2d.
- English Flash Lamp Batt. doz. 4/-
- H.T. Batteries, 36 v. 5/-
- H.T. Batteries, 60 v. 8/6 & 10/6
- Filament Res., with Dial 2/-
- Set of Names (12) 5d.
- 0-300 Dial 5d.
- Scales (Engraved 0-180) ... 3d.
- Multiphone Terminals 9d. & 1/-
- Insulators, Egg 6 for 6d.
- Aerial Wire, 100 ft. 1/30
- Extra Hard Drawn, 7/22 100 ft. 2/4
- Valve Windows 7d.
- Res. Dials 0-100 4d.
- Ebonite Dial and Knob. 0-180 1/1 & 1/3
- Filament do. and Knob ... 9d.
- Filament Dial, 0-10 6d.
- Fixed Condensers to .001 10d.
- Do., .002 to .005, .006 1/6
- Ins. Screw Eyes 1d.
- 4 Cats Whiskers (1 gold) 3d.
- Gold Whisker 1 1/2d.
- Shaw's Hertzite 1/-
- Zincite, 6d.; Bornite 6d.
- Coil Holders 1/1 & 1/3
- Coil Plugs, Ebonite ... 7d. & 9d.
- Do., on Base 1/- & 1/3
- Best Valve Holders 1/6
- 3 makes, above, 10d., 1/1 & 1/3
- Tinned Copper, 16, 18, 20g. 1/3
- Sleeving, best 3 yds. 1/-
- Copper Foil ft. 3d.
- Filament Res., good 1/6
- Rubber Lead-in 10 yds. 1/1 & 1/3
- Bell Wire, D.C.C., I.R.O., 10 yds. 5d.
- Twin Flex 12 yds 1/6
- Heavy Rubber Lead-in yd. 2d. & 3d.
- Basket Coils (6) 200/3,500 1/9
- Waxless (5) 1/11
- D.P.D.T. Switches for Panel 1/6
- S.P.D.T. do. 1/3
- Telephone Cords 1/6 & 8d.
- Grid-Leak (2 meg.) 1/-
- Do., and Condenser .0003 1/9
- Empire Tape doz. yds. 9d.
- Adhesive do. roll 4d.
- A.A. Earth Clips 7d.
- Washers, 2 and 4 B.A. 100,000 ohms Res. 2d.
- Fine Variometers 1/6
- Nugraving Set 2/6
- Enclosed Detectors 11 1/2d.

THIS LIST subject to alteration without notice

HEADPHONES.

- Sterling B.B.O. high class (4,000) 25/-
- B.T.H., B.B.O. None better (4,000) 25/-
- Brunet, Very fine value (4,000) 17/6
- Brunet, for Crystal Sets (8,000) 19/11
- N. & K., genuine (4,000) 12/9
- Slpde, 4,000 ohms ... 12/9
- Premier B.B.C. Full of music. (4,000) 17/6
- Post 1/- pair.

CRYSTAL DETECTORS.

- Post 9d. each.
- Class enclosed Whisker, Brass Fittings, 1/6, 2/3 & 1/-
- Class enclosed Perikon, with Zincite and Bornite 1/8 & 2/2
- Nickel enclosed, 3/8, 2/6, 1/11
- Edison Bell Twin 5/6
- Burndept 5/-
- Post 3d. each.
- Lissen Grid Leak (Var.) 2/6
- Lissen Anode Reel-stance 2/6
- Lissen T1 Transformer 30/-
- Lissen T2 " 25/-
- Lissen T3 " 16/6
- Lissen Series " Parallel Switch 3/6
- Lissen Two-way 2/9
- Lissenstat Minor. Out of Stock.
- 100,000 ohm Resistance 2/6
- Edison Bell Fixed .001 1/3
- Do. .001 to .0005 ... 1/3
- Do. .002 to .006 2/-
- Do. .0003 and Grid Leak 2/6
- Raymond Fixed .001 1/1
- Do. .0002 to .0005 ... 1/1
- Do. .002 to .005 1/5
- Do. .006 1/6
- Do. .0003 and Leak ... 1/10
- Dubiller Fixed .001 3/-
- Do. .002 to .006 3/-
- Do. .0001 to .0005 ... 2/8
- Do. .0003 and Grid Lk. 5/-
- 'Phone Cords, 54 in. ... 1/3
- Do. 72 in. Double ... 1/9
- Variometer 250/650, 3/-, 3/6
- Do. Ebonite 250/650 3/11

H.T. BATTERIES.

- 30 v. 4/3, 4/6.
- 36 v. 4/9, 5/6.
- 60 v. 7/6, 8/6, 10/6.
- Post 1/- extra.
- Discount to Trade and Members of Radio Clubs.
- All Proprietary articles stocked.
- Var. Condensers, brass goods, etc.

ERIOSSON E.V. type, World Famous Continental Head-phones, 4,000 ohms.

13/9 Post 1/- per pair.

VALVES.

- Marconi R. Ediswan 12/6
- Mullard O. Cossor P.1. Cossor P.2. Post 1/- each.

VALVES.

- Phillips R. 7/8
- French R. 6/11
- No post Orders.

SNIPSI

- EBONITE VARIOMETER 250/260, Ball Rotor, wound D.C.C. with knob 6/11
- Post 1/-

N. & K. (The Goods)

Best. Stamped Genuine

4,000 ohms 12/9 Pair Post 1. pair.

Super Condenser with Three Plate Vernier

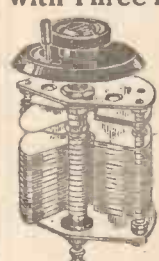

"IT" for very fine tuning.

IMPORTANT: Vernier is an Independent Control.

- .001 - 12/6
- .0005 10/6
- .0003 - 8/6

Registered Post. 6d. Set.

FILOSTAT FOR D.E. & R. VALVES

- Post 6d. each 2/6

LOUDSPEAKERS

- Sterling Baby 55/-
- Sterling Floral 60/-
- Amplion Junior 42/-
- Slpde Loud-Speaker, complete, 25/-
- Post free.

SNIPSI

- COIL HOLDERS Plug-in type, Ebonite, Brass fittings on base. 3/3
- Two-way ... 4/6
- Three-way ... 4/6
- Post 1/- each.

ACCUMULATORS

- 2 v 40 a. ... 10/6 & 11/6
- 4 v 40 a. ... 17/6 & 19/6
- 4 v 60 a. ... 19/6
- 4 v 60 a. ... 23/-
- 6 v 60 a. ... 28/- & 33/-
- 6 v 80 a. ... 35/- & 39/-
- Post 1/6 each.

EBONITE.

- 3/16 in. 6 x 6 ... 1/6
- 8 x 6 ... 2/-
- 9 x 6 ... 2/3
- 12 x 9 ... 4/6
- 12 x 12 ... 6/-

BASKET COILS

- Set of 6 ... 1/11
- Set of 7 ... 2/3
- Post 6d. set. 200/3,600 metres

WAXLESS.

- Set of 5 ... 1/11
- Set of 6 ... 2/3
- Post 6d. set. 200/3,600 metres.

DULL-EMITTERS

All makes in stock.

RIGHT OPPOSITE DALY'S GALLERY DOOR

K. RAYMOND

27, LISLE STREET, W.C.2

PHONE: GERRARD 4637

HOURS OF BUSINESS: DAILY - - 9 to 7.45 SUNDAYS, 10.30 to 1

"WIRELESS IN PARLIAMENT" (continued from page 536)

stations at Whitehaven and other towns. He was consulting the Broadcasting Board on the question whether further relay stations beyond those already authorised should be established, and, if so, on what terms.

Sir Harry Brittain asked the President of the Board of Education to what extent, if any, broadcasting as a medium of education was being used in British schools.

Mr. Trevelyan said it was too early to make any estimate of the value of broadcasting as a means of education. Listening-in sets had been installed in a certain number of schools. At present a series of experimental lectures had been organised by the British Broadcasting Company. He had arranged for reports to be made to him on the results of this experiment.

The broadcasting of the House of Commons debates was suggested by Mr. Mills, who asked the Prime Minister whether this could be done, in view of the public interest taken in such debates and of the importance of increasing a general knowledge of the work of the House.

Mr. Ramsay MacDonald, however, said he did not think the proposal practicable.

A London evening paper says that in thousands of houses where phones are used for receiving people sit together for hours without exchanging more than a few words!



Sale and District Radio Society

Hon. Sec.—H. FOWLER, A.M.I.E.E., "Alston," Old Hall Road, Sale.

On March 20 Mr. Dan Godfrey (junr.), director of the Manchester broadcasting station gave a lecture on the management and programmes of the 2ZY station. The president, Mr. J. U. Thornton, was chairman, and a vote of thanks was proposed by the hon. sec., Mr. H. Fowler, and seconded by Mr. W. R. Burne (2KW of Transatlantic fame). The lecture-room was filled to the door and many were unable to get in.

Dulwich and District Wireless and Experimental Association

Hon. Sec.—H. KING, 2, Henslowe Road, East Dulwich; S.E.22.

On March 24 the above association was favoured with an interesting lecture by Mr. H. J. Camplin on "Neon Lamps," with particular reference to the application of these lamps for wireless work. After the lecture the agenda for the forthcoming month was considered. The association has arranged for a full programme of lectures on all branches of wireless science for every Monday up to May 5, after which the meetings will be held on the first Monday in every month up to the beginning of October, when the usual weekly meetings will be resumed.

Radio Association of Ireland

Hon. Sec.—, 3, Bolesworth Street, Dublin.

At a meeting held on March 20 the Rev. Father Gill, S.J., M.A., B.Sc., lectured on "Electrons and Their Radio Possibilities." He showed how the study of electrons has progressed, and said that for a long time there were two different opinions held as to the nature of the rays in a vacuum tube, the German scientists holding that the rays were caused by wave motion and the English scientists, on the other hand, believing that they were caused by a bombardment of negative electrons. The English view, said Father Gill, is the one now universally held to be correct.

Battersea and District Radio Society

Hon. Sec.—T. M. NORRIS, 39, Warriner Gardens, Battersea, S.W.1.
On March 27 Mr. Carriett, of the General Electric Co., Ltd., gave a most interesting lecture and demonstration on a "Gecophone" set, comprised of their well-known crystal set, power amplifier, and loud-speaker. During the demonstration various points were discussed on the reproduction of speech and music, and it was finally acknowledged that the results were as good as any yet heard, and infinitely better than some. The sets were then dismembered and passed round for inspection, while the lecturer gave blackboard illustrations of the more intricate parts.

Leeds Radio Society

Hon. Sec.—D. E. PETTIGREW, 37, Mexborough Avenue, Leeds.
THERE is room for more members in this society. Applications are invited by the secretary.

Westminster Wireless and Experimental Association

Hon. Sec.—J. DOVE, 77, Pimlico Road, S.W.1.
On April 1 Mr. W. D. Gwynne delivered a lecture on "Valves." About fifty different valves were dealt with, from the Fleming two-electrode to the modern transmitting valve. Dull-emitters were dealt with and also the four-electrode valve.

ANNOUNCEMENTS

"Amateur Wireless and Electric." Edited by Bernard E. Jones. Price Threepence. Published on Thursdays and bearing the date of Saturday immediately following. It will be sent post free to any part of the world—3 months, 4s. 6d.; 6 months, 8s. 9d.; 12 months, 17s. 6d. Postal Orders, Post Office Orders, or Cheques should be made payable to the Proprietors, Cassell & Co., Ltd.

General Correspondence is to be brief and written on one side of the paper only. All sketches and drawings to be on separate sheets.

Contributions are always welcome, will be promptly considered, and if used will be paid for.

Queries should be addressed to the Editor, and the conditions printed at the head of "Our Information Bureau" should be closely observed.

Communications should be addressed, according to their nature, to The Editor, The Advertisement Manager, or The Publisher, "Amateur Wireless," La Belle Sauvage, London, E.C.4.

FINE RESULTS FROM FINE COMPONENTS

Where FALLON products are used there are no failures

This is our NEW Model A II Condenser

right up to FALLON standard and will appeal to thousands of constructors who prefer the following points, which are included in same:—

- One-Hole fixing.
- Tag Connections.
- Heavy Aluminium Top and Bottom Plates.

The Best, and nothing but the best, British material and workmanship are put into this New Fallon Condenser.

Metal-to-metal adjustable bearings. Stout, well-cut aluminium vanes. Complete in every respect and exactly as illustrated.

Plates	Price	Plates	Price
.001	57	.002	13
.005	29	Vernier	5
.003	19	Vernier	8
.0025	15		

To those who prefer our type A II Condenser with Ebonite top and bottom and Aluminium Screening Disc, which, besides enhancing the appearance of the dial as it lies flush with the panel, prevents the hand of the operator producing capacity, can still obtain same, prices as above. BRITISH REPUTATION.—Your condenser is not a Fallon unless the name Fallon appears on same.

THE "DUANODE" CONDENSER

was the first popularly priced Twin Condenser placed on the market. There are many imitators, but there are no superiors. Amateurs now receive America every night in the week with the "Duanode." In a recent article in "Modern Wireless" on the subject Mr. Percy Harris gave very favourable reference to the "Duanode." The "Duanode" consists of Two matched Condensers operated by one knob. Thus, by using matched COILS, it is possible to tune BOTH Circuits perfectly with one operation only. This Condenser can be used for other purposes. The two halves (each of .00025 mfd.) can be used in series or parallel, giving capacities of .000125, .00025 and .0005.....Price 17/6

Variometer

The finest Variometer on the market at ANY price. Inside winding. Suitable for broadcast reception on any P.M.G. Aerial extraordinary close coupling, ensuring large tuning range. On a 30 ft. indoor aerial the max. wavelength exceeds 420 metres and the min. on a 100 ft. aerial is below 350 metres. The max. on a full size outdoor aerial is 700 metres, and the min. on a 30 ft. is 200 metres. Inductance, the highest possible, 9.5 to 1. Metal feet can be adjusted to four different positions. Price 15/-



Fixed Condensers

Highest Quality Mica and Copper Foil. Fitted with soldering tags and nuts for connections. Capacities up to .001, 1/3; .0015 and .002, 2/- Guaranteed Neatly Boxed.



STOCKISTS EVERYWHERE—too numerous to mention in this space. Our motto is "Quality First," and every article carries our money-back guarantee. Insist upon your local dealer supplying you with FALLON products. If he will not, send cash with order direct to us. The name FALLON guarantees satisfaction.

WRITE DIRECT FOR TRADE TERMS

FALLON CONDENSER CO., LTD.

"The Condenser People"

WHITE RIBBON WORKS, Broad Lane, N.15

Phone: Tottenham 1932

ELECTRADIX RADIO STOCK

We have by far the largest stock of High Grade Ex-Govt. Apparatus in Great Britain, both in value and quantity.

As Electrical Engineers of 30 years' experience we are able to discriminate in our purchases and stock quality goods only selected by Mr. H. L. Dixon, M.Inst. Elec. Eng. You will find these reliable and prices exceedingly low.

PORTABLE SETS are increasing in popularity. We stock cabinets with ebonite panel at 10/-, or can supply the famous R.A.F. "10" 5-Valve Set, brand new for £5 5 0. 3-Valve Mk. III, £3 15 0 (See leaflet), and others as per list.

AMPLIFIERS in great variety, see last week's "Wireless World." 3-Valve High Frequency, only £2 10 0, suitable for Super Hetrodynes.

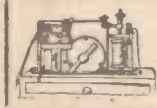

RECORDERS. The demand for these wonderful bargains has been so great that we have few left now. Makers, Silvertown, Siemens, etc. Cost £40. All are guaranteed O.K. Full instructions with each. A bargain at £6 10 0. See leaflet.

TRANSMITTER RECEIVER COMBINED. The Celebrated Marconi Trench Set, totally enclosed in polished Mahogany Case is a bargain for Home Experiments or for use on Motor Boats, etc. Cost £40. Brand new, platinum contacts, £4 only.

VALVE TRANSMITTERS. One-Valve Mk. III, £5 10 0. Two-Valve R.A.F. Mk. II, £3 10 0. Earth control panel, 17/6.

WAVEMETERS. The best selection of high-grade sets ever offered. Long range Townsends, 120/4,000 metres, £6. Broadcast range, £3. Hetrodynes, £6 10 0. 3 range Paul, 100/3,500 metres, £5 10 0. 120/1,200 metres, £4 10 0. Wavetraps, 30/-. See leaflet.

ILLUSTRATED CATALOGUE. For fuller details see special leaflets on request or our April edition of our Illustrated Catalogue and Price List which every experimenter should have. Special attention to Foreign and Mail Orders if you cannot call at our Showrooms in Colonial Avenue. It will save you 50% to place your enquiries for anything Radio or Electrical with—

LESLIE DIXON & CO.

9, Colonial Avenue, Minories, E.1.

Telephone: Ave 4166.

Telegrams: "Electradix, Ald, London."

Colonial Avenue is the first turning on the left in Minories from Aldgate Station, Met. Ry. Buses pass close by from Tower and Bank.

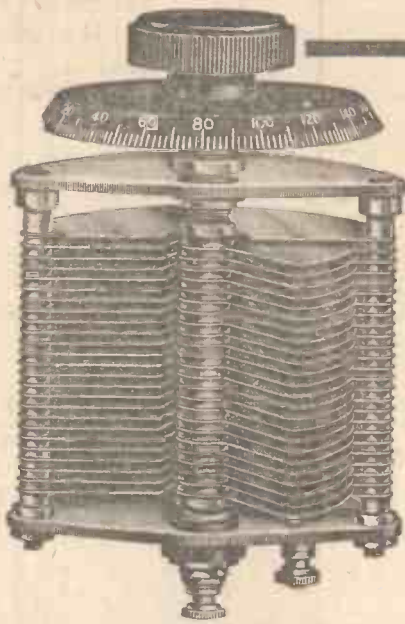

IMPERIAL VARIABLE CONDENSERS

Where accuracy is essential, "Imperial" is always first choice. The following range of Variable Condensers will particularly appeal to the discriminating Experimenter. Every Condenser is carefully packed and delivered in neat, dust-proof cardboard container.

Write to-day for details of our valve renewal service, home accumulator charging apparatus and general wireless accessories.

G.W.I. Ltd.,

The Original Valve Repairers
Imperial Works, Shanklin Road, Brough End, London, N.8.

Telephone: Hornsey 3065.
Telegrams: White, Hornsey 3065.

PRICES.—No. 2. Fitted with aluminum top and bottom plates, ebonite bushes, knob and dial complete, centre hole fixing spacers .073 in. Vanes 24 gauge, capacity guaranteed.

'001 ... each	8/-	'0003 ... each	4/6
'00075 ... "	7/-	'0011 ... "	4/-
'0105 ... "	5/-	'00005 ... "	4/-
'0003 ... "	5/6	'00025 x '00025 ... "	17/6

FIXED CONDENSERS

'0001 to '0015 ...	1/6	1 Microfarad ...	4/6
'002 to '008 ...	2/-	2 " ...	5/6
'01 ...	4/6		

Delivery by return of post. Please remit ample postage. Excess refunded.

THE JIFFY-LINK INSULATED CONNECTOR.

The Quickest, Neatest, and Most Efficient Wiring System for Wireless Instruments and Electrical Apparatus of every Description, manufactured in lengths from 1/4 inch to 50 inches advancing by quarters of an inch. Solid or Flexible Conductors, 2 or 4 B.A. Terminal Eyes and in various colours. Any assortment supplied.

Used by the Leading Wireless Manufacturers

Length	Per Doz.	Length	Per Doz.	Length	Per Doz.	Length	Per Doz.
1"-1"	1/4	2"-5"	2/8	8"-9"	2/8	12"-13"	4/8
1"-2"	1/2	5"-8"	3/8	9"-10"	4/2	13"-14"	5/2
2"-3"	1/10	6"-7"	2/10	10"-11"	4/4	14"-15"	6/4
3"-4"	2/2	7"-8"	3/4	11"-12"	4/6	16"-18"	6/10
						19"-20"	7/1
						17"-18"	2/4
						18"-20"	7/6
						20"-22"	8/4

Note: When ordering state size of Terminal Eye and colours required. Postage and packing extra.

LOVELAND BROTHERS & SONS
CRESCENT ELECTRI- CARS, NORBURY, LONDON
PHONE, STREATHAM 138

I Told You So—

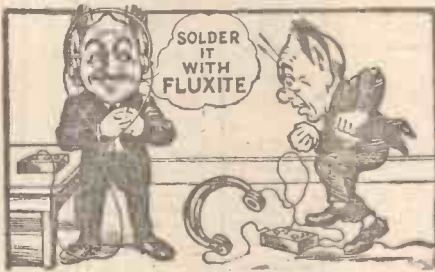

How you hate him for reminding you of that—yet you know that if you had taken his advice in the first case your set would not be suffering from "dead ear-phones." The golden advice in wireless reception is the scrupulous attention to details—they are the things that matter. We mean this—if the wind blows your aerial down, the cause of no reception is rather obvious, but if a little connection

comes "unstuck" somewhere in the vitals of your instrument the seat of trouble needs hunting for (and just when America is coming through). So save yourself further annoyances by carefully overhauling your connections and fix them with solder and FLUXITE. Soldering is the easiest thing in the world to do when FLUXITE is at hand to assist you.

FLUXITE SOLDERING SET.

It is perfectly simple to use, and will last for years in constant use. It contains a special "small-space" Soldering Iron with non-heating metal handle, a Pocket Blow-lamp, FLUXITE, Solder, etc., and full instructions. Price 7/6. Write to us should you be unable to obtain it.



FLUXITE SIMPLIFIES SOLDERING

All Hardware and Ironmongery Stores sell FLUXITE in tins, price 8d., 1/4, and 2/8.

For the tool-kit of your car or motor cycle or any soldering jobs about the house.

Buy a Tin Today.
FLUXITE LTD., 326, Bevington Street, Bermondsey, England

HESTAVOX "D" CRYSTAL SET

Well constructed in every detail, contained in polished mahogany Cabinet, ebonite top, machine engraved, glass enclosed crystal detector, wavelengths 300 to 600 metres. Range 20 to 25 miles.

Price, including B.B.C. tax, **30/-**

HESTAVOX ONE VALVE AMPLIFIER for addition to same, including all Royalties and taxes **£3 17 6**

WRITE FOR OUR LISTS. Subject to trade discount. Special discount for quantities.

Hestavox Limited 32, Palmerston Road, ACTON, W.3
2 minutes South Acton Station. Phone: Chiswick 586.

Amateur Wireless

COUPON
Available until Saturday,
May 3, 1924

THE "BREAK-NOT" HYDROMETER

7/6

ALL PARTS REPLACEABLE at SMALL COST

LIST ON REQUEST



Every one who uses an accumulator needs a Battery tester, and it must be a strong, accurate instrument and not a toy.

The "BREAK-NOT" is the ideal for all purposes, and is the only practical instrument for keeping in the Tool Box without danger of breakage.

Your local dealer can supply you but if any difficulty send us your order and we will arrange for same to be executed.

For Trade Terms write

S. GUITERMAN & Co., Ltd. 35/6 ALDERMANBURY LONDON, E.C.2

Advertisement for 'Say' brand crystal sets, featuring a logo and text: 'to your dealer you'll get the Best Crystal Sets'.

Advertisement for 'Fix your crystal in' featuring a logo and text: 'GOLD SEAL PLASTIC METAL the best contact possible, and get LOUDER AND CLEARER SIGNALS'.

Advertisement for 'Use Tested Parts' featuring a logo and text: 'The foremost experimenters use and recommend Bowyer-Lowe Components'.

Advertisement for 'TELEPHONES RE-WOUND' with text: 'to 4,000 ohms. Guaranteed All makes 5/6, except Brown "A" 6/6'.

Advertisement for 'EBONITE' with text: 'Sheet, Rod and Tubing in all sizes kept in stock and cut to any required size'.

ORIGINAL POST PAID HOUSE WE APPRECIATE POST ORDERS

SCREW SPADES 1/3 per doz. TINNED COP. PER WIRE 24" x 1/16" x 1/16" square. 1/6 per doz.

Headphones B.B.O. Mark, 4,000 ohms. Sterling "P" 25/- Brown's "P" 25/- Flows 19/6 Siemens 25/- Brandes 25/- 120 ohms ex-Govt. Sullivan's 10/-

H.T. Batteries With Winder Plug 60v. 8- 30v. 4/10 80v. 4- 15v. 2/- 4v. P.L. Bury. 6d. 60v. Ever-Rdy. 13/6 30v. 8- 15v. 3/6 Siemens same price

Ebonite Panels Matt ground edges 8"x6"x3/16" 1/3 12"x6"x3/16" 2/6 9"x6"x1/4" 4/6 12"x6"x1/4" 4/6 12"x12"x1/4" 6/6 15"x9"x1/4" 6/6 6"x6"x1/4" 10d

Coll Plugs Moulded type 8d Ebonite 1/6 Superior 1/6 Narrow type 8d Basket 1/3 Coil Formers, 2/4

Switches Superior quality D.C.O. 3 & S.C.O. 2/3 D.P.S.T. 2/6 S.P.S.T. 1/10 Ebonite S.C.O. 1/6 Tumbler 1/6 Series parallel Double-arm 2/6 Dewar D.G.O. 2/6 D.P.S.T. 2/6 Utility 2-way 4/- 2e R. 4v R. 2e 8/-

Aerial Wire 7/22's 100 Bright 2/6 100 Enam. 2/6 4 strd. bright 1/4 Rubr. id.-in. 6d yd Insulators shell, 2 1/2" x 2 1/2" 6d Beel, 2 1/2" dia. 2d Crystal type 8d Lead-in 4/-

Lead-in Tubes 4" and 5" 9d 9" 1", 12" and 15" 1/3 Simplex type 1/6 Valve Holders Type A 8d Plain legs 8d Screwed 8 nuts 8d Ebonite 1/10 Polar type 1/6

Write for "Complete Supplementary Price List of Exceptional Values," sent Post Free. (9XL--New Issue.) J. H. TAYLOR & CO., Electrical and Radio Engineers, Macaulay Street, Huddersfield. Telephone: 342. Telegrams: "Thorough," Huddersfield

Advertisement for 'A BOOK BARGAIN' Technical Instruction for Wireless Telegraphists. A Handbook by HAWKHEAD & DOWSETT.

ADVERTISEMENT INSTRUCTIONS for "Amateur Wireless" are accepted up to first post on Thursday morning for following week's issue, providing space is available.

PREPAID ADVERTISEMENTS. Advertisements under this head are charged THREEPENCE PER WORD, minimum charge THREE SHILLINGS. DEPOSIT SYSTEM.

As the Publishers cannot accept responsibility for the bona fides of Advertisers in this publication they have introduced a system of deposit which it is recommended should be adopted by readers when dealing with persons with whom they are unacquainted. It is here explained.

Intending purchasers should forward to the Publishers the amount of the purchase money of the article advertised. This will be acknowledged to both the Depositor and the Vendor, whose names and addresses must necessarily be given. The Deposit is retained until advice is received of the completion of the purchase, or of the article having been returned to and accepted by the Vendor. In addition to the amount of the Deposit, a Fee of 6d. for sums of £1 and under, and 1s. for amounts in excess of £1, to cover postage, etc., must be remitted at the same time. In cases of persons not resident within the United Kingdom, double fees are charged.

The amount of the Deposit and Fee must be remitted by Postal Order or Registered Letter (Cheques cannot be accepted), addressed to

"AMATEUR WIRELESS," ADVERTISEMENT DEPARTMENT, LA BELLE SAUVAGE, LONDON, E.C.4

PATENTS and Trade Marks obtained.—H. T. P. Gee, Patent Agent, Member R.S.G.S. 61/62, Chancery Lane, London, W.C.1. Phone Holborn 15/5.

HEADPHONE REPAIRS.—Rewound, remagnetised and readjusted. Lowest prices quoted on receipt of telephones delivery three days.—The Vary Magnet Co., London, S.E.15.

AMPLITONE CRYSTAL permanently energised, no battery required, guaranteed 100 per cent. greater volume of sound than other crystals. Price, including catwhisker and postage, 8s. 6d. or particulars Ledsham & Co., 27, King Street, Hammersmith, London.

VARIOMETER, dry beech stator and rotor, close coupled 126 dozen sets. Complete sample, 1s. 9d.—Slaight-Holmes, Wholesale Turners, Ingham Street, South Shields.

CRYSTAL SET 1-VALVE AMPLIFIERS.—Pledge Bros., 28, Woodstock Road, Oxford.

BROWN'S A 5,000 HEADPHONES.—Few pairs ex W.L., guaranteed O.K. 35s. pair. Registered post, 6d.—Williams, 99, Rought Road, London, E.15.

ACCUMULATORS.—New and reliable repairs a speciality. Special terms to trade.—Lenham Accumulator Service, 2, Lenham Road, Lee, S.E.

BROADCAST VALVOMETERS, 2s. 6d., post free. Slide valve set, less phones, 4s.—Dudley, Bridge Square, Burnham.

COMPLETE WIRELESS EQUIPMENT, including super quality 4,000 ohms six magnet headphones, flat coil, ebonite panel, Plug-in Detector, mahogany case and complete Aerial equipment, delivered 8/6. Particulars, stamp.—Holmes, 608, Leadon Road, Bradford.

ASTOUNDING OFFER.—D.E. Valves, Filament 1 1/2 to 2 volts, Plate 80-90 volts, anode 225 1/2a. 6d. each. Double Grid Valves, 8/6-9/6 volts guaranteed, 6s. each. Post free.—Wireless, 104, Long Acre, London.

TRINO WOOD POLES FOR WIRELESS, painted, 20 ft 8 in. long, in 3 sections fitted with improved strong galvaniz'd iron sockets, 10s. complete. Satisfaction guaranteed. Prompt delivery. Cash with order. (Extra lengths 9 ft 9 in. long, 8s. 6d. each with socket.)—J. Byfield, Bridge Foot, Warrington.

Advertisement for 'CABINETS YOU WANT PICKETT'S CABINETS—they're good value, from 16 each, highly polished. Cabinet A.M.J. Works, Alton Rd, Boxley Heath, S.E. Write for lists'.

Advertisement for 'ACCUMULATORS' O.A.V. Fullers, etc. Guaranteed brand new and perfect but slightly soiled. We refund cash with carriage both ways if returned within 7 days.

Advertisement for 'SPENCER'S STORES' 4-5, MASON'S AVENUE, BASINGHALL ST., LONDON, E.C.2. VALVES REPAIRED 6/6. Post free. PHONES 4,000 ohms, VERY SENSITIVE, GUARANTEED 12/-



is essentially light and care-
less. The spirit of it is lost if
one has to go abroad to find it.
Now, in these evenings when
the weather is still treacher-
ous, a little music and enter-
tainment are best of all at
home. Do not spoil your
pleasure by an inferior loud-
speaker. The new Volutone
Loud Speaker gives a really
large volume of sound, com-
bined with a richness of tone,
that is so essential for good
music. In price it compares
favourably with any other
loud-speaker on the market.
Wound to 2,000 ohms; adjust-
able diaphragm.

Fellows Magneto Co., Ltd.,
Park Royal, N.W.10. Phone: Willesden 1560-1

Price
£4 10 0



FELLOWS
VOLUTONE
Loud Speaker

E.P.S. 62

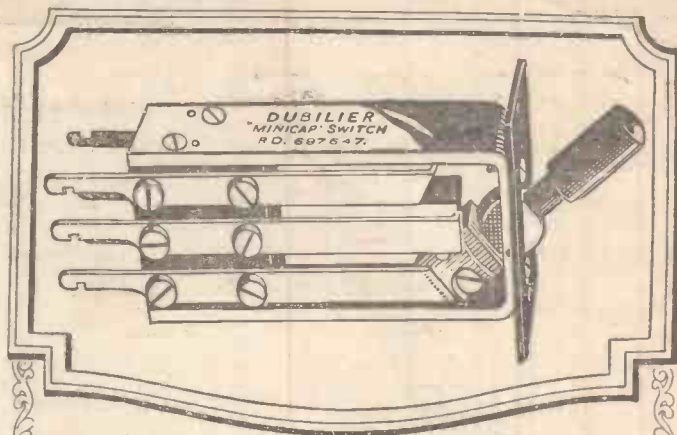

The Minicap Switch

“Capacity” is necessary in some parts
of Radio receiving circuits, in other
parts capacity effects are undesirable.

The Dubilier “Minicap” Switch, as
its name indicates, is one in which the
capacity between the contacts is re-
duced to a minimum. This makes it
greatly superior to the ordinary type
of key for switching in and out amplifying
valves, whether high or low fre-
quency.

In addition the “Minicap” can be used
as a series-parallel switch, and, in fact,
wherever a double pole, double throw
switch is now employed.

The design and workmanship are in
keeping with that of other Dubilier
products, and the price is

8/-

Write to department A for list A 9,
which gives full details and diagrams
showing the Minicap Switch incor-
porated in various wireless circuits.

The **DUBILIER CONDENSER CO.**
(1921) Ltd.
Goldhawk Road, Shepherds Bush,
LONDON, W.12

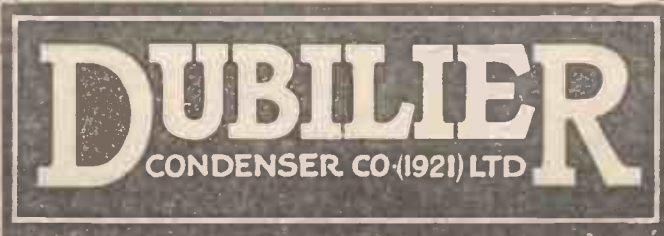

E.P.S. 47.

BUILD!

—With LISSEN Master Parts

Your New Station—Build it with LISSEN master parts throughout.

Your Radio Frequency Amplification—Certainly LISSEN master parts.

Your tuning—LISSEN master parts.

Your Fixed Condensers—ALL LISSEN master parts.

Your Audio Frequency Amplification—LISSEN master parts here.

Your Filament Control—A LISSEN master part, too.

Your Variable Grid Leak—Also a LISSEN master part.

LISSEN MASTER PARTS—ALL BEHIND YOUR PANEL!

Whether you are building our new station, re-making your old one, or adding to your existing receiver, there is a

LISSEN MASTER PART for your every need.

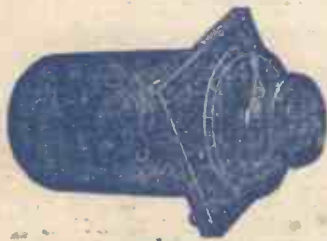

1. The unequalled first stage of Radio Frequency—LISSEN REGENERATIVE REACTANCE—strikingly sensitive—selects with accuracy 52/6



3. LISSEN TUNER—tunes high, tunes low, tunes sharply! 22/6



5. LISSEN VERNIER—for fine tuning in H.F. circuits ... 12/6



7. LISSEN T₂ TRANSFORMER—for reflex circuits and 2nd and 3rd stages L.F. ... 25/-



11. LISSEN VARIABLE GRID LEAK—for clear signals (neat and nicely finished, no thicker than a pencil, usual LISSEN ONE-HOLE FIXING, of course!) 2/6

LISSEN MASTER PARTS INCLUDE EVERYTHING YOU NEED TO GO UNDERNEATH YOUR PANEL

LISSEN PARTS are the largest selling parts—they are supreme in their efficiency, supreme in their unique design, supreme in their ease of fitting—their rigid inspection during the making and their triple testing after ensure permanent satisfaction for everyone who buys.

AMATEURS—All good dealers sell LISSEN PARTS—take no substitute—order direct if any difficulty, and your need will be immediately filled, post free.

DEALERS—LISSEN PARTS soon sell—keep a stock ready, claim your maximum discount for stocking—ask your Factor or direct—order ahead, if you please.

The trade should apply now for new LISSEN list—ready shortly—interesting details of LISSEN parts.

LISSEN LIMITED

16-20, Woodger Rd., Goldhawk Rd., Shepherd's Bush, London, W.12.

Phone. 1072 Hammersmith.
N.B.—Close to Goldhawk Road (Met) Station, Shepherd's Bush (Central London) or Hammersmith Tube. Busses 11 and 32.

BUILD—with LISSEN Master Parts!

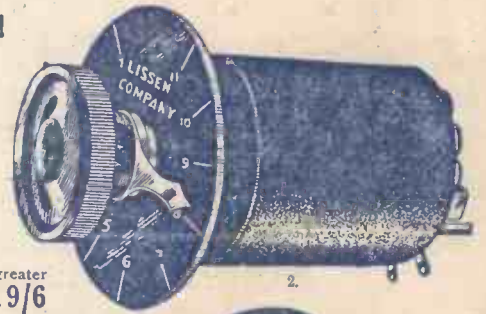

2. For 2nd (and or 1st stage) Radio Frequency—LISSEN REACTANCE—for still greater range and power. 150 to 10,000 metres ... 19/6
150 to 600 metres ... 17/6



4. LISSEN MICA VARIABLE CONDENSER—Mark 2 type—tunes through 710 degrees of scale—low resistance—minimum capacity, maximum 'oor 17/6

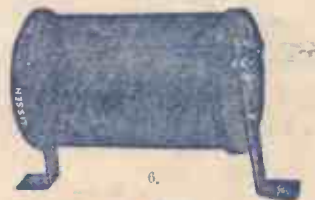

6. LISSEN T₁ TRANSFORMER—for immediately behind the detector valve—an incomparable transformer ... 30/-

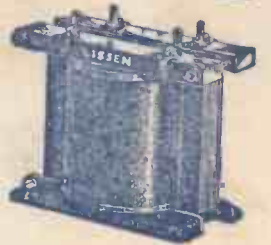

8. LISSEN T₃—the popular transformer—actually compares in performance with many expensive transformers—described as the best light transformer made ... 16/6



10. LISSEN FIXED CONDENSERS—they deliver all their stored-up energy! ... '0001 to '0009 2/-
'001 to '003 2/6
'004 and '005 3/-