

# Amateur Wireless And Electrics

No. 26

SATURDAY, DECEMBER 2, 1922

Price 3d.

## Regular Features

■ ■ ■

RADIOGRAMS

■ ■ ■

ON YOUR WAVE-  
LENGTH

■ ■ ■

INFORMATION  
BUREAU

■ ■ ■

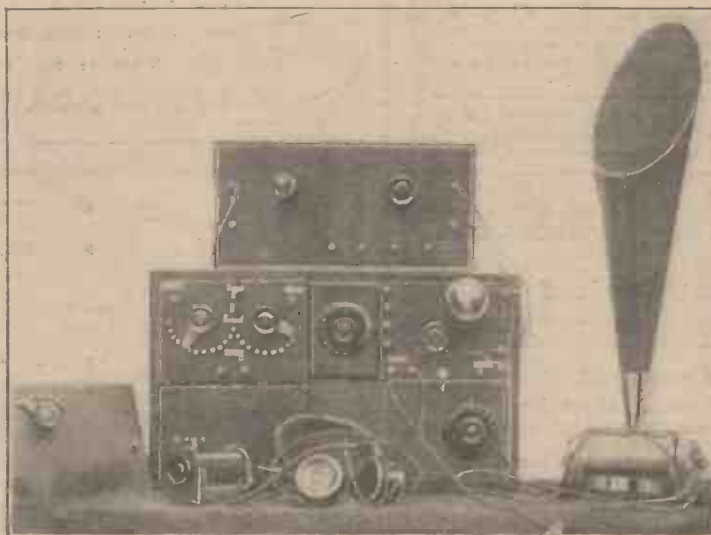

Photograph of a Single-circuit One-valve Set constructed by  
Mr. A. W. Owen, of Walthamstow

## Regular Features

■ ■ ■

TELEPHONY  
TRANSMISSIONS

■ ■ ■

CLUB EVENTS

■ ■ ■

LETTERS  
ETC. ETC.

■ ■ ■

## SPECIAL ARTICLES

Atmospherics or Statics

A Basket-coil Type Tuner

Shall We Ever See by Wireless?

Telephone Winding

Loose-coupler Device

Amateur Transmissions and the  
G.P.O.

A Novel Utility Aerial

All About the Valve

Rectifying Panels for Unit Set

Interference Prevention

# ECONOMIC ELECTRIC LTD.



## Have YOU tried the "XTRAUDION" VALVE ?

the latest and best development of the 3 Electrode Valve.

**RECTIFIES, OSCILLATES  
AMPLIFIES**

Its Mechanical Construction makes it a stronger and more lasting valve than any other.

The Filament consumes well under half - an - amp. at 4 volts. Anode Potential, 50 volts.

Its Amplifying Properties are wonderful and its freedom from noises a revelation. Send for Descriptive Leaflet.

15/-  
PRICE



15/-  
PRICE

We publish the most complete Wireless Catalogue obtainable. 38 pages, profusely illustrated, and many useful circuits for experimental work. Mailed to any address on receipt of four penny stamps.

Head Office 10, FITZROY SQUARE, LONDON, W.1.

Showrooms : 303, EUSTON ROAD, N.W.1.

Telephone : MUSEUM 1055

Branch Showrooms & Works : TWICKENHAM

## An Auction of Interest to Amateurs

### Included in this important Sale of Ex-Government Wireless Apparatus

there will be a large number of **SMALL LOTS** eminently suited for purchase by Wireless Experimenters

THE TRADE will also have an excellent opportunity of securing: New Mark III Tuners, Mark III C.W. Transmitters and Receivers, B. Mark II 2-Valve Detector Amplifiers, 50 Watt Spark Trench Sets for Receiving and Transmitting.

C. Mark III 3-Valve Amplifiers (low frequency) in new condition.

Brown's Head Telephones, Reed Type, 120 to 8,000 ohms in new condition.

Valve Boxes, Teak Instrument Cases, a quantity of 13 ft. Masts, and a large quantity of Miscellaneous WIRELESS GEAR.

## STEVENS' AUCTION ROOMS LTD.

(Established 1760)

Will sell the above by Auction  
:: at their Great Rooms ::

38, King Street, Covent Garden,  
W.C.2.

WEDNESDAY, December 6th, 1922,  
At 12.30 o'clock precisely

On View: Monday, 4th December, from 12.30 to 5.30, Tuesday from 9.30 to 5.30, and on morning of sale from 9.30 to 12 o'clock

CATALOGUES ON APPLICATION.

Telephone—1824 GERRARD.

Telegrams—"AUKS, RAND, LONDON."

## MITCHELFONES

Are not a spasmodic production to meet a sudden demand, but have been on the market for over three months, and during this period 27,000 have been distributed to the trade, and consequently we have not been able to offer them direct to the retail buyer.

1,000 per week are now available, and we announce

### DELIVERY FROM STOCK

You post your order, or call at our premises and get them at once. Think what this means to you—you, perhaps, who have been waiting and are still waiting.

Standard resistance 4,000 ohms, double headgear with double headstraps, comfortable, highly efficient, and foolproof

25/- per pair.

Special Terms to Traders and deliveries that will surprise you.

### MITCHELLS Electrical & Wireless Ltd.,

Postal Address: McDermott Road, Peckham, S.E.15.  
Retail Address: 188, Rye Lane, Peckham, S.E.15.

Phones: New Cross 1540/1541

### GREAT BRITAIN'S GREATEST WIRELESS STORE



## "PERRYPHONES"

HEAD SETS FOR WIRELESS TELEPHONY  
4,000 ohms;

21/-

Every Set Guaranteed. Beautifully finished, highly sensitive, detachable receivers,

### IMMEDIATE DELIVERY

! Illustrated Wireless Catalogue now ready, post free, 3d.

### THE JEARY ELECTRICAL CO., LTD.,

8, LAMBETH HILL, and 97, QUEEN VICTORIA ST., LONDON, E.C.4.

And at Glasgow, Birmingham, etc.

## COMPLETE and EFFICIENT AERIAL SETS

### For Single Wire Aerial

100 feet 7/22s Copper Wire  
2 Shell Pattern Insulators, which guarantee High Insulation  
2 Wall Fixtures  
1 Wall Fixture and 1 Mast Pulley  
10/- complete

### For Double Wire Aerial

140 feet 7/22s Copper Wire ;  
4 Shell Pattern Insulators  
2 Hard Wood Spreaders, 6 feet long  
2 Wall Fixtures  
1 Wall Fixture and 1 Mast Pulley  
16/6 complete

Delivered Free from Stock. Cash with Order  
Please state clearly whether you require 2 Wall Fixtures or 1 Wall Fixture and 1 Mast Pulley

THE SOUTH WESTERN WIRELESS SUPPLIES CO.  
382a, Merton Road, — Southfields, — London, S.W.



# Amateur Wireless

## and Electrics

No. 26

December 2, 1922

## ATMOSPHERICS OR STATICS

OF late we have had several pessimists in our midst who have been preaching disaster by the mighty hand of static. They tell us that when the big broadcasting stations begin on their long-delayed programmes we shall begin to see how undeveloped the science is as yet. They tell us to wait until we are listening-in on one of our favourite pieces, and in the midst of our enjoyment are suddenly enraged by a discordant jargon of sound—static interference again.

Most probably you have met one of these pessimists. He gives one the impression that our receiving sets will be useless until some method is found of eliminating the disastrous static. In fact, static is the big boggy of the wireless world.

But up to the present we have not suffered so badly from it, I think. Let us see what static is and how it behaves, and perhaps we may pick up a hint or two so that we may be able to combat its effects.

### How Static Behaves

First we must realise that broadcasting is not a new thing; the only new thing is the public interest which is now being taken in it. Ever since the development of the wireless telephone to a point of good performance, amateurs have been broadcasting to one another, and they have done it very well. Static has not seriously inconvenienced them so far.

The best way to explain static simply is that it is lightning in the making. It consists of accumulated charges of electricity which are stored in the atmosphere, not large enough in capacity to break down the air resistance and find a way to the earth. These charges are stored up just like charges on the plates of a condenser, and, like the latter, some of the charge leaks across the dielectric, or air.

In the case of static, this leakage takes place along the aërials of wireless stations wherever they are erected, and the

The elimination of atmospheric or statics is one of the most pressing needs of modern wireless. This article explains the effects and gives some simple hints that may provide a key to the problem.

passage of the charge is recorded in the telephone receivers. These static charges are so broad and cover so many different wave-lengths that they penetrate almost all turning adjustments, this being, perhaps, their most annoying characteristic.

The peculiar thing about static is that it is most prevalent in tropical countries. In northern latitudes it is most prevalent in summer, and always worse during the night than during the daytime. Its effect upon the telephones ranges from harsh, rasping sounds to mushy squeaks, and when it is really bad it continues uninterruptedly. Such are the conditions of static.

between the dots and dashes, making it almost impossible to distinguish them.

So far as wireless telephony is concerned, however, I do not think that static will be found nearly as serious. In the first place wireless telephony is conducted by means of

continuous waves, and where these are used in the ether we get sharp tuning, which is in itself extremely helpful.

Then again, we are dealing now with voice and music sounds, and these vary in pitch and amplitude, so that the hearer does not have to concentrate on one pitch and pick up dots and dashes. I believe that with careful tuning the voices and music will ride clear above the static, but of course, the tuning must be very discriminate, and that only comes with experience.

### Some Hints

Here are a few suggestions for use where static comes in very badly. If you are using a two- or three-stage amplification in connection with a loud speaker, forgo that pleasure for a little while and cut out the whole lot. By listening-in direct from the detector you will necessarily sacrifice some degree of volume of sound, but you will gain much in the clarity of the signals from the headphones. Remember that the amplifying valves extend their power to all currents that come in, and that static, being stronger than the radio-frequencies, is amplified to a greater volume than the signal sounds.

Another hint is to reduce the amount of current passing through the valve filaments to the lowest possible amount consistent with the result of static, because the

more current passed through the valve the more the static is increased in intensity as compared to the music.

Above all, make all tuning adjustments carefully and very slowly. A. J. B.



Photograph of Four-valve Set of the Small Cabinet Type.  
(Telephone Manufacturing Co., Ltd.)

### Static and Telegraphy

To wireless telegraphy static offers a very serious opposition. The sounds of the code are very constant, and this allows the atmospheric interference to get

# A Compact Tuner

A Neat Efficient Tuner of the Basket-coil Type

THE following is a description of a tuner of a neat and compact type and remarkable efficiency.

The apparatus is mounted on an ebonite panel 9 in. long by 5 in. wide and  $\frac{1}{4}$  in. thick (see Fig. 1). This is screwed on to a mahogany box of the same size as the panel and 4 in. deep made from  $\frac{1}{4}$ -in. wood.

The aerial tuning condenser of a capacity of .001 microfarad and a small three-plate vernier condenser connected in

half inches for wave-lengths from 600 to 1,100 metres. The holders are made from ebonite  $\frac{1}{4}$  in. thick, and are 3 in. long by  $1\frac{1}{2}$  in. wide (see Fig. 3). Each has a slot  $\frac{3}{32}$  in. wide cut lengthwise through the thickness of the ebonite (see Fig. 4). The slot has a depth equal to the radius of the coil intended for it, and is made by first cutting two slots  $\frac{3}{32}$  in. apart with a fine stiff-back saw and then cutting out the ebonite in between with a fret-saw. The coil fits tightly in the slot in its holder.

near its pin, as shown in Fig. 5. The reaction coil consists of a small slab coil mounted in the same manner as the basket coils, and is sufficiently small to prevent the set from oscillating, while large enough to magnify the telephony or signals considerably. The two-way switch at the back of the panel reverses the direction of the current flowing in the reaction. This has been found very useful, particularly when using high-frequency amplification with the plug-in type of transformers,

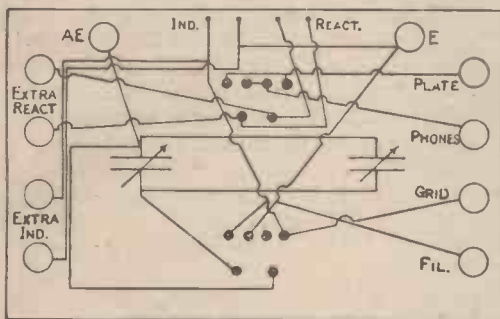

Fig. 6.—Diagram of Connections.

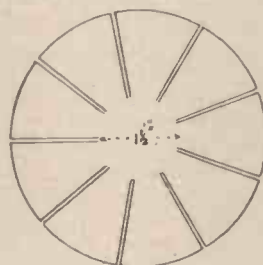

Fig. 2.—Coil Former.

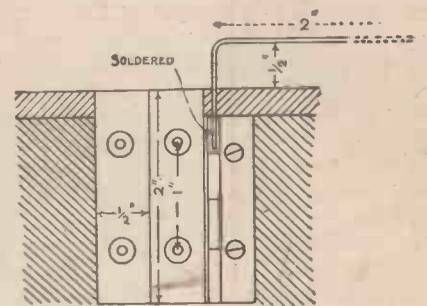

Fig. 5

*These illustrations show the details of a remarkably efficient apparatus of simple construction*

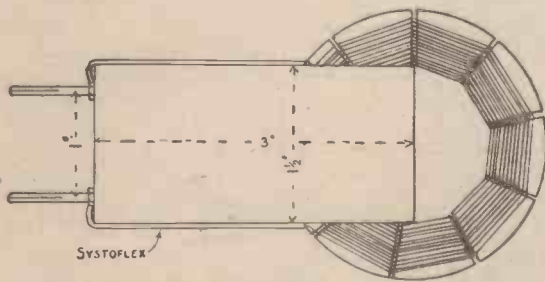

Fig. 3.—Coil Holder with Coil in Position.

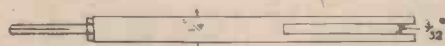

Fig. 4.—Side View of Coil Holder.

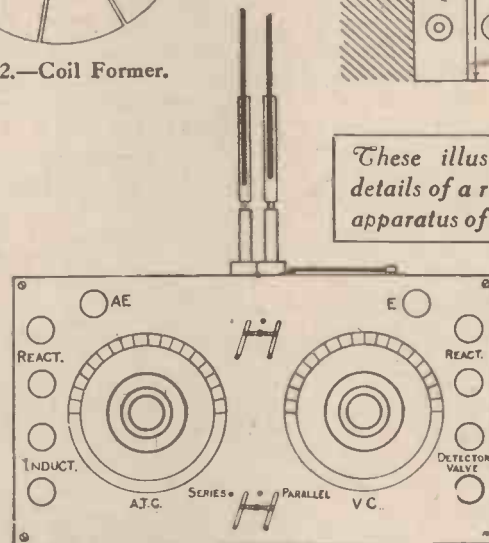

Fig. 1

Fig. 5 (above).—Detail of Holder for Reaction Coil.

Fig. 1 (left).—The Complete Tuning Unit.

parallel with the larger one are mounted on the panel. The two-way switch on the front of the panel enables these condensers to be placed in series with the aerial for short wave-lengths, say, 180 metres to 500 metres, or in parallel with the inductance for higher wave-lengths.

The actual tuning coils and their holders are of rather novel design. They consist of basket coils wound with 26-gauge enamelled copper wire on thin cardboard formers of the shape shown in Fig. 2. These are well dried, shellacked, and then baked. A depth of wire of half an inch is suitable for wave-lengths from 180 to 300 metres, three-quarters of an inch from 300 to 400 metres, one inch from 400 to 600 metres, and about one and a

The holders are each fitted with two ordinary valve legs 1 in. apart, and these plug into valve sockets on the back of the tuner.

The sockets are 1 in. apart and are mounted on a piece of ebonite  $\frac{1}{4}$  in. thick and 2 in. long by  $\frac{1}{2}$  in. wide. This latter is screwed on to the back of the mahogany box. A similar piece of ebonite with two valve sockets 1 in. apart is mounted by its side on an ordinary brass hinge, which is fastened on to the box. This holds the reaction coil and is capable of swinging through an angle of 90 deg. (see Fig. 5). A long handle made out of a piece of right-angled stiff brass wire with an ebonite knob on one end is soldered on to the top movable part of the brass hinge,

whose windings are not always in the same direction.

The four terminals on the left of the panel are to enable an ordinary solenoid type of inductance coil with reaction to be used for longer wave-lengths than 1,000 metres, in which case the short-wave coil and reaction are removed from their holders. An alternative would be to wind the basket coils with more turns of finer wire, but this would mean loss of efficiency.

Fig. 6 shows the internal connections of the tuner.

This tuner has been found to give excellent results with telephony, its chief advantage being the ease with which any station can be tuned in. H. B.



## Television.—VI Shall We Ever See by Wireless (conclusion)

### The Application of Wireless to Television

WITH the problem of television still in the experimental stages, and with no system sufficiently developed to be capable of working successfully over even a short length of metallic circuit, any suggestion regarding wireless television may, perhaps, be considered mere speculation. This, however, is not the case, for even with the introduction of a practical system of television there are certain features inherent in all telegraph and telephone lines that would prevent transmission over any but exceedingly short distances.

### Possible Speed

The rate at which separate telegraph signals can be transmitted is dependent upon the resistance and capacity of the circuit. Over a very short length of line where the capacity and resistance effects are slight, signals can be transmitted at the very high rate of several thousands per second, but this speed is not possible with much increase in the length of the line. When a brief current of electricity is sent over a line of considerable length a portion of this current is abstracted, and, by virtue of the capacity of the line, retained as a charge upon its surface. This induced charge, or "extra" current as it is termed, makes itself manifest in two ways. It delays the appearance of the current at the receiving end (known as retardation) and increases the period of discharge of the current after arrival (known as prolongation). This retardation and prolongation of the current has a material effect upon the rate at which separate signals can be transmitted.

In ordinary telegraphy a working speed of 10,000 signals a minute has been obtained over an aerial line 500 miles in length and about 6,000 signals over a line of 1,000 miles. These figures, however, only represent the practical limit of working; in practice signals cannot succeed each other at intervals more frequent than the time taken to affect the receiving instrument. As the capacity of one mile of submarine cable is equal to about twenty miles of aerial line, it is evident that the effective signalling speed will be greatly reduced on any circuit which includes any great length of submarine cable. Over the Atlantic cables the current is retarded four-tenths of a second, the working speed being about 1,500 signals per minute. Compare these figures with the 100,000 signals per minute that are required for a successful television system, and it will be perfectly obvious that line transmission is totally out of the question. Wireless,

however, remains, and indeed its use seems essential in considering any attempt to deal with such a large number of signals.

### Synchronism

The use of wireless, although practically overcoming one difficulty, introduces another of even greater importance. This is the question of synchronism. In ordinary photo-telegraphy, where no time limit is set for the reproduction of the secondary pictures, the limit of error in synchronism requires to be at least 1:500 in order to obtain results at all suitable for publication. Even where the two stations are connected by a metallic circuit, maintaining this degree of accuracy over a protracted period is no easy matter. A limit of error in synchronism as high as 1:800 or 1:1,000 will at least be necessary in the case of television, but even this degree could no doubt be obtained by the use of alternating currents in the manner already explained.

### The Future

In any wireless system of transmission the difficulty arises from the fact that the two stations have to run independently, the one link that at present makes synchronism possible—the connecting wires—being non-existent. It is this problem that also prevents the successful application of wireless transmission to any of the systems of photo-telegraphy that have been designed for working over metallic conductors. Some adaptation of the alternating-current method of synchronism suggested in connection with the two recent systems of television just described seems possible, as it is a comparatively easy matter to arrange for the two sets of alternators to run at similar speeds and to deliver current at the same frequency. What is required is either some arrangement whereby the two stations are set to work at the same instant and kept in synchronism during the period of operation, or some arrangement whereby the picture thrown upon the screen at the receiver can be synchronised by the operator after reception has commenced.

From the results of experiments that have taken place there is every reason to believe that a reliable working method will eventually be found.

We can say, then, that although television working over metallic circuits is almost out of the question, wireless television is not only possible but probable. Whilst the difficulties to be overcome are enormous and cannot be overrated they are by no means insurmountable, and should readily yield to organised research. They are no greater in comparison than the difficulties that had to be met and overcome by the pioneer workers in other field of invention.

M. J. M.

Ask "Amateur Wireless" to send you a list of practical books. Sent gratis and post free.

## A Simple Device for Operating the Loose-coupler

THE accompanying diagram shows a device for operating the secondary coil of a loose-coupler, such as that of the short-wave set described in the Handbook

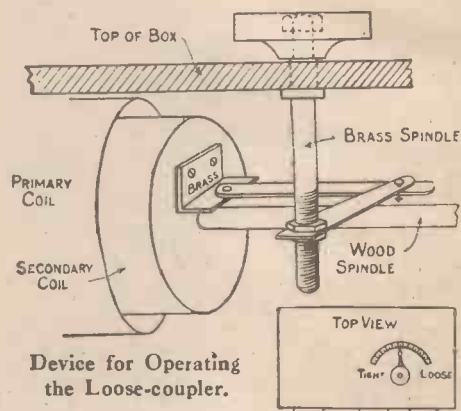

Device for Operating the Loose-coupler.

"Wireless Telegraphy and Telephony." The exact measurements are immaterial, as they would probably have to be modified with different apparatus, but the sketch is self-explanatory, and no difficulty should be met with in making the arrangement.

H. A.

## A Telephone Winding "Tip"

THE following tip may be of use to amateurs who desire to re-wind their telephones.

If one has access to a gramophone the matter will be found quite simple. Obtain an empty cotton reel which has a hole through its centre just large enough to fit

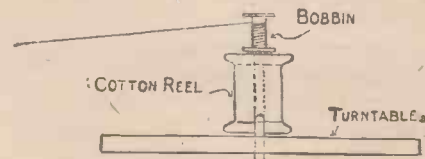

Winding Telephone Bobbins.

over the projecting portion of the spindle of the gramophone turntable. Then take the bobbin which is to be wound and fix it to the top of the reel by means of a spot of glue or sealing-wax. The wire can then be attached to the bobbin and the turntable allowed to revolve. The speed at which it revolves can, of course, be regulated by the controller which is fitted to most gramophones.

R. A. F.

# All About the Valve.—VII

## The Valve as Detector and Amplifier

WHERE one valve is utilised both as a detector and amplifier, it is generally in practice worked on the straight-line part of the characteristic curve ob-

But as the characteristic curve shows, it commences to pass a certain amount of current when the grid builds up a positive voltage. Accordingly as this happens, the shunt path across the grid and filament no longer offers an infinite resistance to the signal voltage on the inductance L, but opens up so as to by-pass through the tube a part of the positive half of each high-frequency impulse impressed upon the grid circuit.

As a result, the positive pulses applied to the grid lose some of their effect, and give rise to a net increase in the plate current which is less than the theoretical value by an amount that represents the loss in grid voltage arising from the shunt grid current. Meanwhile no corresponding effect takes place so far as the negative halves of the high-frequency signal waves are concerned. These exercise their full effect in reducing the plate current.

As the resultant increase in plate current under these circumstances is not symmetrical with, but is less than, the resultant decrease throughout the duration of a wave train, the upshot is to cause the value of the mean plate current to fall during that period, and this variation is duly recorded by a click in the phones.

Meanwhile the existence of a grid current also indicates that electrons have been carried from the filament to the grid in pulses or gushes which correspond to each positive half-wave of the applied high-frequency signal impulses.

Each such pulse of electrons charges the grid negatively, and at the end of a wave train there exists accordingly a considerable accumulation of negative electricity upon the grid and the associated plate of the condenser C. Unless a relief path is given to enable this charge to escape, it will impede the main electron flow from the filament to the plate and so clog up the normal operation of the tube.

The high resistance R of one or two megohms is shunted across the condenser plates in order to supply this means of relief. The normal interval between the end of one series of spark wave trains and the beginning of the next is anything from ten to twenty times longer than the actual duration of any one train.

Therefore, although the pulses of electrons forming the grid current follow each other so rapidly during the actual persistence of a wave train that they have no time to escape completely through the high-resistance path of the leak R, yet in the ensuing comparatively long period of quiescence before the next wave train arrives, there is ample time for the accumulated charge to traverse the leak and so re-establish the normal grid voltage, leaving the tube ready to receive and rectify the next oncoming train of waves.

The actual condition of the grid voltage during this sequence of events is clearly shown in the group of curves set out in Fig. 14. It will be observed that the grid voltage sinks in a series of small curves of increasing depth during the actual reception of a wave train. This is due to the fact that during the actual period of the impact of the wave train a certain amount of the accumulating grid charge manages to escape through the leak resistance. Before all of it has succeeded in getting away the next pulse of electrons arrives and sends the voltage a stage lower.

This alternation of the grid voltage is important, as it throws light on the manner in which one valve can function to generate local oscillations for receiving C.W. by the heterodyne method and at the same time serve to detect the combined "beat" effect. The sinusoidal form of the voltage variations represents the high-fre-

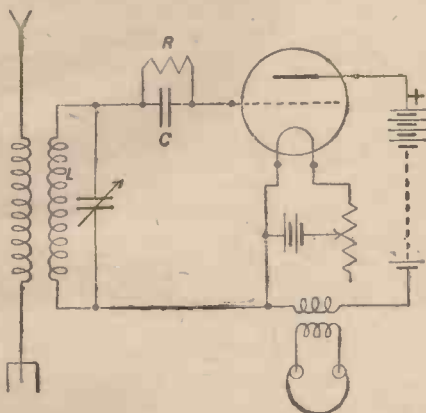

Fig. 13.—Diagram showing Rectification by Means of Grid Leak.

tained as explained in the preceding article.

The usual potentiometer employed for setting the grid at the "bend" points is dispensed with, and the necessary rectification is secured by the use either of a simple grid condenser or more usually of a condenser shunted by a high resistance, the combination being known as the grid leak.

### How Impulses are Rectified

Such a circuit arrangement is shown in Fig. 13. In order to understand clearly the manner in which the signal impulses are rectified by means of the grid leak it is necessary to refer back to the characteristic curves shown in Fig. 11, p. 538. As previously explained, the lower set of curves represents the relation that exists between the grid voltage and the grid current—the current which flows through the grid-filament space and around the external grid circuit. These grid currents are usually very small in magnitude, particularly in "hard" valves, but they play an extremely important part in the process of rectification, particularly when this takes place, as in the present case, off the "bend" points in the characteristic curve.

As the grid voltage swings up from zero potential to a positive value, a current starts to flow in the grid circuit, which, in the case of the French valve, reaches a value of about 40 micro-amperes for a grid voltage of + 2.

Now a glance at the circuit shown in Fig. 13 will make it clear that the internal grid-filament space of the valve is in shunt to the main grid inductance L, on which the applied signal energy is building up. Normally this shunt path has an infinite resistance for zero potential on the grid.

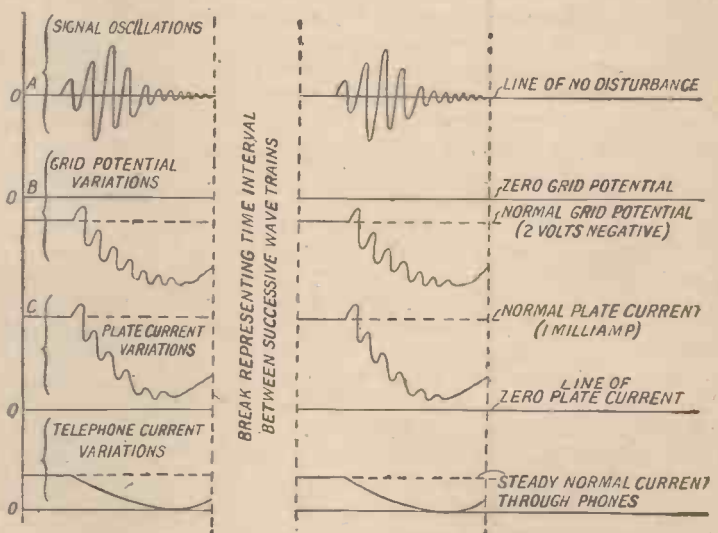

Fig. 14.—Diagram Illustrating the Mechanism of Grid-leak Rectification.

quency interaction between the plate and the grid circuits by means of which the local self-oscillation is maintained. In the case of a heterodyne receiver the right-hand side, or "recovery" part of the curve, would also be sinusoidal.

D. ALCASE.

(To be continued)



# Build your own set with Mullard Accessories



22/23

The wireless components with a world-wide reputation of many years standing. They will ensure your getting a set which looks well, works well and speaks well. For receiving vocal and instrumental items you must have the

## MULLARD "ORA" Valves

to get the best results.

### Oscillates—Rectifies—Amplifies

Specially recommended where good amplification is required. The "Ora" Valve requires about 3.8 volts on the filament and 30 volts or over between the anode and filament for efficient results.

15/- each

### IMPORTANT NOTICE

The great demand for Mullard "ORA" Valves and other accessories has compelled us to open much larger works. A greatly increased output is now available.

The MULLARD "R" Valve is now reduced in price from 22/6 to 17/6

# Mullard Radio Valve Co. Ltd.

45, Nightingale Lane, Balham, S.W.12.

Contractors to H.M. Admiralty,  
War Office, Royal Air Force & Post Office,

Telephone:  
Battersea  
1068

Codes:  
ABC (5 Ed)  
Bentley's

Telegrams:  
'Radiovalve, Hammer'  
London.



Name and Address		Quantity	Description	Price	
To the MULLARD RADIO VALVE CO. LTD 45, Nightingale Lane, Balham, S.W.12.			Telephone Head Sets	High Grade 35/-	per set
			"ORA" Valves	15/-	each
			Grid A Resistances	5/-	"
			Anode A or B Resistances	2/6	"
			RA Condensers, .0003 mfd.	7/6	"
			Combined Resistance and Condensers with Terminals	5/-	"
			Valve Bases with Terminal Clips	1/3	"
			Valve Sockets	9d.	per pair
			Terminal Clips		
			Valve Sockets		
Name of usual Wireless Dealer				1 enclose (Cheque, Money Order, P.O.) value to cover the cost	

SEND THIS TO-DAY



**IMPORTANT NOTICE** to all Amateurs, Experimenters, Manufacturers and Retailers

We have completed the purchase of the largest stock of

## Ex-Govt. WIRELESS MATERIAL

ever handled by an individual firm, and it is our intention to offer the same for re-sale at astonishingly low prices in accordance with our inevitable rule to

**SHARE OUR BARGAINS WITH OUR CUSTOMERS**

We would again emphasise the fact that

**IT IS UNNECESSARY TO PAY FANCY PRICES FOR EX-DISPOSAL BOARD WIRELESS APPARATUS**

As an example of the bargains that are to follow, we are offering the following preliminary items:

### RECEIVERS, C.W. MARK III

This set comprises a complete 2-valve Receiving Set, with a wave-length range of 350—1,800 metres. The addition of High and Low Tension Batteries, valves, and 'phones completes the entire receiving station. For the reception of Broadcast concerts this set is ideal, the strength and clarity of the signals being absolutely wonderful. London readers should take the opportunity of hearing this set working at our Showrooms. **Only 200 left. Price £9 9 0**

Complete with 4-volt 40-amp. Fuller Block Accumulator, 60-volt H.T. Battery, 2 Mullard "ORA" Valves, and pair of Brown "A" Type Headphones, complete with cords ... .. **£15 10 0**

### AMPLIFIERS, C. MARK IV

This instrument is a complete three-valve low-frequency amplifier, and can be used in many ways without modification.

The C. Mark IV. Amplifier is an improvement on the C. Mark III. (the latter being sold by other dealers at £6 5s. 0d. each without cases), inasmuch as the C. Mark IV. contains terminals and change-over switch, allowing the use of the instrument for either High- or Low-Frequency amplification.

The price at which we are offering these Amplifiers is less than the actual value of the transformers contained in the instrument. **Price, Complete in Mahogany Case ... .. £4 5 0**

### INSULATED AERIALS

40-feet **£0 1 0** 60-feet **£0 1 6**

Kindly note that the above prices do not include Packing and Carriage. Please add, therefore, an appropriate amount to cover this. Any surplus will be refunded.

### C.W. TRANSMITTERS, MARK III, 30 WATT

For two valves. Complete, with aerial, ammeter, platinum-pointed Morse Key, in Mahogany case. Wave-length range 300—1,800 metres.

NOTE.—This set can be conveniently converted into a 2-valve Detector-Amplifying Receiver. **Price ... .. £3 5 0**

### B MARK II RECEIVERS

Vertical pattern. Can be easily converted to any wave-length ... .. **£3 15 0**

Above, fitted with Variable Air Condenser, .0005 mfd., in place of change-over switch **£4 15 0**

### HETERODYNE WAVEMETERS. 500-3,000 METRES

For Receiving, without Gal.

vanometer ... .. **£2 0 0**

For Transmitting and Receiving, containing Weston Galvanometer ... .. **£3 0 0**

### AERIAL MASTS AND EQUIPMENT

15-feet Steel Masts in Sections, each 2 ft. 8½ in., complete with Halyard, Pulley, and Stays. Can be erected by one man, and are portable. The height can be increased up to 30 feet by the use of extra stays. **Per Set Complete ... .. £0 15 0**

30-feet DITTO, in SECTIONS, each 4 ft. 3 in. (without stays). **Per Set Complete £0 17 6**

### SULLIVAN HEADPHONES

120 ohms ... .. **£0 12 6**

### SULLIVAN HEADPHONES

120 ohms complete with new Telephone Transformer (value 25s.) in iron case ... .. **£1 10 0**

## The City Accumulator Co.

79, MARK LANE, — LONDON, E.C.3

\*Phone: Avenue 1316

Wholesale and Retail Distributors for Messrs. BURNDIPT, Ltd. Same Trade Discount Allowed as by Manufacturers.

#### AGENTS.

London: H. V. ALBROW, 56, George Street, Portman Square, W.1.

Glos.: BRISTOL WIRELESS CO., 52, Cotham Hill, Bristol.



S. Wales: SOUTH WALES WIRELESS INSTALLATION CO., LTD., 18, West Bude Street, Cardiff.

N. Wales, Lancs., Ches. & I.O.M.: THE "ALL-BRITISH" WIRELESS MANUFACTURES CO., LTD., 18, Vauxhall Road, Liverpool.



# Oh You Waverer!

## Those Troublesome Cracklings

### Election Night and 2 L O

#### Sunday Morning

one may put it so, on the lips of my loud-speaker thought that the rest would shortly be arriving thick and fast. "Closing down for five minutes" said the voice. Feverishly the minutes were ticked off; then, with ten good seconds to go, the switches were put over. "No more news; closing down for another five minutes." We agreed that results couldn't after all be expected before half-past ten; later we made it half-past eleven, and later still we fixed half-past twelve as the likely zero hour for the great rush. It never came. Results, quite a number of them, trickled in, but the man with the pencil was never really overworked. However, we heard a great many long before lesser men relying on the "land line" could possibly do so, and the half-hourly *resumés* of the state of the parties provided both the optimist and the pessimist present with all the material that they needed to prove that their fondest hopes or worst fears were in process of realisation. What an evening out it must have been for 2L O's announcer. News at six, more news at nine, and election results from then till one in the morning. His microphone did not seem to be quite so good as usual, for it was inclined to blur s's and f's. Possibly it, too, felt the strain a little. The new chimes which strike the fourth quarter and then the hour are quite a feature. Phones and loud-speakers reproduce them with amazing clearness.

\* \* \* \*

Curious that the non-technical papers have been almost as silent as the grave over the broadcast licence question. Is it that they do not realise what has been done? The position is utterly ridiculous when you come to think of it. "A," who is keenly interested in wireless, wishes to make some experiments which may lead to a useful discovery. He is told that as he cannot show a satisfactory record of previous experience he must content his soul with a broadcast licence. He obtains a "hall-marked" set, but finds that if he tinkers about with its circuits he is guilty of an illegal act. Exasperated, he applies again to be ranked as an experimenter, only to learn that the fact that he possesses and works a broadcast set is not regarded as giving him the necessary qualifications. "B," again, has designed an original set. Unless he makes

**ELECTION** night was really most exciting. When the first result came in at about 10 o'clock the little crowd hanging,

and uses it he cannot qualify for the experimenter's ticket; but the regulations say that he may neither make nor use it! At any rate he must not be found with it in his possession. How is either "A" or "B" ever to gain the status of an experimenter? "There," in the words of a famous character, "there you 'ave me." All wireless men should take the first opportunity of approaching both the correspondence columns of the press, and the M.P.s whom their votes have just sent to Westminster. Something must be done, and that right soon.

\* \* \* \*

Sunday morning. I ought really to be going to church; in fact I'd practically said I would, but we've got some people coming this afternoon to listen to the Dutch Concert and one wants to get the thing all right. Yes, I know I did say practically; but practically's not absolutely definitely, and—hand me the small screwdriver, there's a dear, and—confound this infernal nut, rolled under the table, dear. . . . Thanks. Haven't seen my soldering-iron lately, I suppose? Is that the last bell? Well, that settles it; I can't possibly go now. I've got a mouthful of nuts. Not that I don't want to go; I do, but with all these people coming this afternoon I feel I ought to— They're not coming? Well, now I've wasted the whole morning, missed church and everything. Of course, you go, dear. It wouldn't do for both of us to stay at home. . . . Good-bye!

Now. Round about 1,000 metres, I should think. Hallo, who's this? "Abide with me." Yes, I ought to have gone to church. Who's 2NP, or is it MP? Rag-time now. Riddles, rather an amusing cove, this. I'll just push the condenser back a bit. Le Bourget talking to St. Inglevert. "The President of the Republic wants to talk to St. Inglevert." President's a bit sticky at the microphone. Croydon as loud as ever and Pulham excellent. I'll keep the same coils on and switch the condenser in series. Here's somebody on about 400. I can hear what he says but I can't catch his call sign. Wonderful difference a condenser across the reactance makes on short waves. 2LO was good last night, by the way, though the items were rather on the gloomy side. I think I've found the ideal combination now, and that is basket coils for the A.T.I. and one of Tingey's A\* coils in the reactance with a large capacity variable condenser across it. This reactance coil, if adequate use is made of the three tapping studs and of the variable condenser across it, does excel-

lently for all telephonic wave-lengths from Paris downwards and renders coupling far more manageable and less susceptible to body capacity than the ordinary methods. At least I find it so.

\* \* \* \*

We have not yet had the wireless limerick, or at any rate if any have been perpetrated they have not come Thermion's way. Let us invoke the Muse:

A young man who lived in an attic  
Had a set that was strangely erratic.  
When sparks flew from the phones  
He would stifle his groans  
And put the whole thing down to static.

Sorry to use an Americanism ("static" is merely our old friend—or enemy—atmospherics), but there did not seem to be anything to rhyme with atmospherics. Still, on second thoughts, how's this?

A wild man who lived close to Berwick's  
Fine town was renowned for homerics;  
When he wirelessed his speeches  
His screams and his screeches  
Were mistaken for strong atmospherics.

\* \* \* \*

Are you troubled at times with cracklings in your receivers which cannot be due to the baleful influence of atmospherics? Most of us are. As a rule the H.T. battery is the culprit, especially when it is no longer in its first youth. The remedy is to use a far larger by-pass condenser across its terminals than is usually recommended. Most writers lay down that from .05 to .3 mfd. is the most suitable capacity. As a matter of fact I never use less than 1 mfd., and frequently double this capacity when the battery is growing old. You will find, too, that if you employ low-resistance telephones it pays to shunt across them something much bigger than the .0005 or .001 condenser of convention. If the phones are of the high-resistance type the larger condenser does no good at all, but with low-resistance gear capacities up to .025 mfd. may be used with advantage. Tests with various condensers will soon show which capacity is best suited to the phones.

\* \* \* \*

Answer to Correspondent: No, Harold, we can see no use in the wireless set for the valve which your dear little boy connected to the high-tension battery "to see the pretty fireworks." However, the missis will find it most useful to push inside socks when she is darning them.

THERMION.

## The Wireless Limerick

### The Experimenter and His Licence

# A Novel Utility Aerial

UNTIL such time as aerials as we know them to-day are no longer necessary, even with comparatively simple sets, the

in mind, Chambers and Ellis, of Craven House, Kingsway, London, W.C.2, have put on the market what they term the "Esi-Fix" aerial.

and another adjustable insulator is provided by means of which the necessary length of span easily can be secured. The



Photograph of Aerial on Chimney.

task of fixing those of the orthodox type will always be a troublesome matter in the case of seventy-five per cent. of would-be wireless enthusiasts, and, therefore, any idea that tends to reduce the trouble will always be welcome. With this idea

The claims made for the aerial, and there is no reason that they should not be substantiated in actual practice, are that it can be simply thrown up anyhow and anywhere, over a roof, for instance, or over a tree, without any precaution being necessary with regard to insulation. Also, there is no necessity to cut the aerial to an exact length as it is made adjustable. The lead-in can be made through any open window, and it is immaterial whether the wire touches external objects such as window frames, masonry, etc. No insulators or supporting wires are required.

This all seems very wonderful, not to mention the convenience, but the result is obtained in a very simple way though the invention is none the less of value because of this. The aerial is composed of 40 strands of No. 30-gauge wire with an outer covering of a patented tough rubber compound which is impervious to wet and will not rot or corrode. It will be apparent that the combined construction provides at one and the same time an aerial and the necessary insulation. One end of the wire is fitted with a porcelain insulator to provide a means of attachment rather than to act as an insulator,



Photograph showing Down Lead and Adjusting Device.

aerial is made in lengths of 100 ft., 75 ft. and 50 ft.; additional cable can be had if required.

The two photographs show the aerial in use under different conditions.

# An Interference-prevention Circuit

EXPERIMENTERS who are troubled with interference should try the circuit shown below (Fig. 1), as it has proved very selective in use. As will be seen the

ductance variably coupled to the two primaries.

Coils of the honeycomb and basket types are particularly suitable for this circuit on

the secondary circuit should be tuned until the desired signals are heard at their strongest. Then the condenser of the other circuit is varied until interfering signals are cut out. It will probably be found that the coupling between the three coils has to be carefully set completely to cut out the interference.

For receiving C.W. signals by the reaction method it is advisable to split the secondary inductance, using one half in the interference-prevention circuit and the other half coupled to a reaction coil in the plate circuit (Fig. 2). In this case the reaction-coupling coils should be far enough away from the primary circuits to prevent energy being returned to the aerial.

L. A. W.

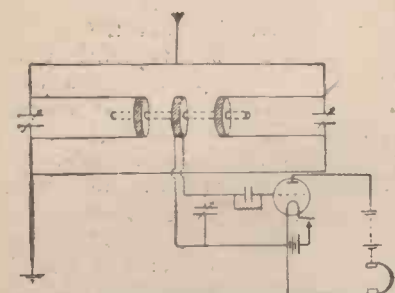

Fig. 1.—Interference-prevention Circuit.

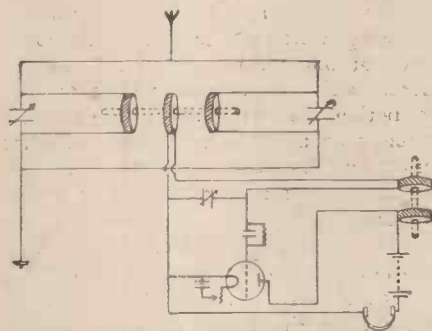

Fig. 2.—Modified Interference-prevention Circuit.

primary circuit is divided, and each half contains an inductance and a condenser. The inductances should have similar values. The secondary circuit has an in-

account of their compactness. The requisite sizes will, of course, depend upon the wave-length to be received.

In operation the primary circuit and

The Western Telegraph Co. have lodged a claim with the Irish Provisional Government for the destruction of the Valentia Cable station.



## The Experimenter's Licence for the Home-made Set

WE print below a copy of a letter that has been received by an amateur from the Secretary of the General Post Office in response to an application for a receiving licence. The letter is self-explanatory and needs no comment, beyond pointing out that it endorses the advice that we have consistently given to those who have made their own sets to apply for an experimenter's—and not a broadcast receiving—licence.

P.O. Ref. No. 147990/22.

GENERAL POST OFFICE,  
LONDON, E.C.1.

16th November, 1922.

"With reference to your application of the 6th November, I am directed by the Postmaster-General to say that licences for wireless apparatus for the reception of broadcast matter are confined to apparatus which is manufactured by members of the British Broadcasting Company, and which bears the registered trade-mark of that company, indicating that the apparatus is of a type approved by the Postmaster-General. The range of reception in the case of such apparatus will not be limited to a particular band of wave-lengths, and in view of this fact it is thought that a licence of this kind will probably meet your requirements. If not, the alternative would be a licence for the use of

receiving apparatus for *experimental* purposes; and such licences are now only issued to persons who make their own sets, or to persons who produce evidence that they have in view some object of scientific value or public utility, and that they are qualified to make proper use of the facilities they desire. If you wish for a licence of this description, it will be necessary to ask you to produce such evidence.

"With reference to the broadcast licence above referred to, I am able to explain that the British Broadcasting Company is an association of manufacturers who have combined to erect stations for broadcast transmission, and to arrange for the broadcasting by means of those stations of regular and suitable programmes of music and other matter. The company is open for fair and easy terms to every *bona-fide* British manufacturer of wireless apparatus, and every set bearing their trade-mark contributes by a suitable percentage of the sale-price to the heavy expenditure of the company in the erection of suitable stations or programmes. I am to add that the approval given by the Postmaster-General to sets manufactured by members of the company indicates only that such sets comply with his technical requirements, and is no guarantee of efficiency or workmanship."

## Wireless Society of London (The Radio Society of Great Britain)

### Change of Name

AT the special general meeting held on November 22nd, the name of the society was officially altered and henceforth will be called "The Radio Society of Great Britain."

**Amateur Transmissions.**—The committee which was appointed at the meeting of those holding transmitting licences in the London district have unanimously arrived at the following suggestions and these will be submitted to the next meeting.

(1) It is agreed that a voluntary arrangement be made to stop broadcast music transmissions except where special permission has been obtained from the G.P.O., in which case this should be stated before, during and after the transmissions. Music transmissions (either

gramophone or otherwise), not exceeding five minutes in duration, to be permitted for testing purposes, and a total transmission at one time of not more than 10 minutes, with a total transmission of four such periods (40 minutes) in all, during any one evening from 6 to 11 p.m.; other hours of the day being free except that the five minutes' limit of music transmission shall apply.

(2) These arrangements only to apply to working in the 440-metre wave-length.

(3) Holders of transmitting licences are reminded of the terms of their licence whereby they must use their call sign before and after each transmission.

(4) The use of spark transmissions by amateurs on all wave-lengths and tonic train on 440-metre wave-length should be abolished.

**Transatlantic Tests.**—The London Electric Supply Company have kindly allowed the use of their premises for one of the transmitting stations. A 200-ft. chimney is available for running up an aerial. Operators willing to assist and who do not mind sitting up between 12 midnight and 6 a.m. should write to the hon. secretary.

**Prizes for Armstrong Regenerative Circuit Sets.**—A first prize of £15 and the second prize of £10 is being presented by two members of The Wireless Society of London (who desire to remain anonymous) for the best instrument employing the principles of the Armstrong super-regenerative circuit. The conditions are:

(1) The ruling of a special sub-committee of the Wireless Society of London will be final.

(2) No more than three valves shall be used, and the set must work on a loop aerial which must accompany the instrument when it is sent in for judging, together with a diagram and what is claimed for the instrument as to performance.

(3) Those desiring to enter the competition must be members or associate members of the Wireless Society of London, or members of an affiliated society. The competition will close December 10th. All apparatus must be sent in to the hon. secretary before that date.

(4) Each competitor will be allowed to demonstrate his own instrument if he desires, or he may depute someone to do this, failing which the committee will make their own tests according to written instructions. Some constant source of transmission will be arranged for all of the tests. In all probability it will be arranged that the prize winners will exhibit their sets at a meeting of the Wireless Society of London if they agree to do so.

The following points will be taken into consideration in judging:

- (a) General design.
- (b) Adjustment in minimum time to maximum efficiency.
- (c) Resultant signal strength.

Note: External finish will not be taken into consideration.

### A Historic Event

WE have received from Marconi's Wireless Telegraph Co. a copy of the souvenir that has been prepared and sent to persons who reported on the transmission of H.R.H. the Prince of Wales's speech to the Boy Scouts on October 7th. This souvenir, which is very attractively got up, gives H.R.H.'s speech in full, and a list of the persons who heard it. 2L O employed on this occasion a twin-wire aerial, the wave-length being 360 metres. The power used was 1½ kw., and the transmission was heard on a crystal set at Cambridge, 50 miles from Marconi House, and on a 4-valve set at Newquay, 240 miles away.

# "AMATEUR WIRELESS" ID

## Rectifying Panels

WHETHER it is intended that the first unit of the apparatus shall be a crystal detector or a valve rectifier, the reader is strongly advised to begin by making the terminal panel, which is the foundation of the whole set. Once it is

in place certain leads can be attached permanently to it, so that the connection and disconnection of wires are reduced to a minimum.

## Terminal Panel

The photograph (Fig. 1) shows the panel with four terminals, and the same number appears on all the other units. Since the photographs were taken an additional one has been added throughout the set, which is found to serve a variety of useful purposes. It is always handy to have an extra terminal, particularly when experimenting with new circuits. For this reason the reader will do well to adopt five-terminal units rather than those with four only. One set of terminals will normally not be in action, but we shall see later how they may be used to advantage when we come to discuss possible refinements of the circuits shown.

For the terminal panel we require a strip of ebonite measuring 8 in. by 1 in. by  $\frac{3}{16}$  in. or  $\frac{1}{4}$  in. thick. This should be bored as shown in Fig. 2. All the holes are  $\frac{3}{16}$  in. The two nearest the ends are for the screws which fix the strip, and the wood block upon which it rests, to the table. The remaining five are for the 3 B.A. terminals, whose heads should be as large as possible, with good flat contact surfaces. As all the ebonite strips used are identical, except that for those fitted to the unit panels the screw holes should be only  $\frac{1}{8}$  in. in diameter, it is a good plan to make a number at once. They can conveniently be trimmed up and

This is the second article of the series writing by special request. This article deals with rectifying panels.

drilled in batches of three or four at a time.

The block for the terminal panel should be of hard wood of exactly the same height and length as the unit-panels. Clamp the strip on to it and make a prick in the wood exactly in the centre of each terminal. Next remove a strip and bore a  $\frac{1}{2}$ -in. hole about  $\frac{1}{4}$  in. deep at each mark. Fit the terminals to the strip and put it in place, seeing that the nuts or bolt-heads on the under side are quite clear of the wood. If there is any contact the offending hole or holes must be slightly enlarged. Cut a small notch in the wood leading to each hole, as shown in Fig. 3. These should be just large enough to take comfortably the insulated wire that you propose to use for your battery and other leads. If it is intended to proceed straight away with the construction of the valve rectifying panel, these leads may now be attached to the lower ends of their respective terminals, and the strip and its block can be fixed to the table. If, however, the crystal detector is to be the next step, no wires need be attached before the panel is screwed down.

## The Crystal Unit Panel

The crystal unit does not actually require the full number of terminals, but



Fig. 10.—Photograph of Accumulator with Valve Sockets Fitted to Terminals.

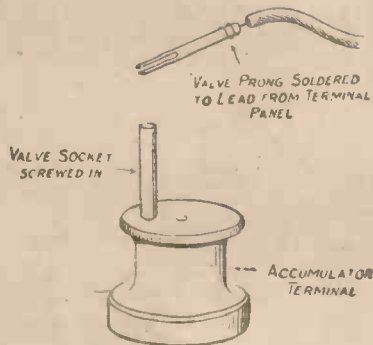

Fig. 11.—Detail of Accumulator Terminal with Valve-socket Connector.

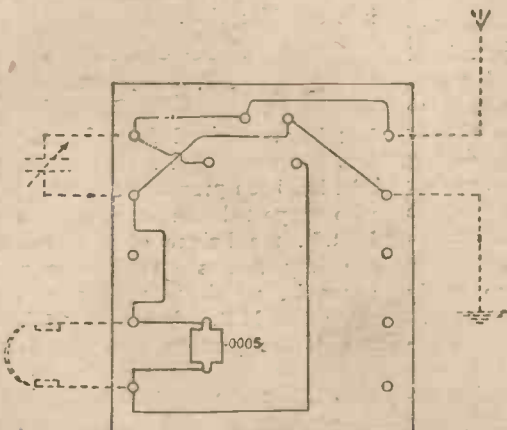

Fig. 5.—Wiring Diagram of Crystal Unit Panel.

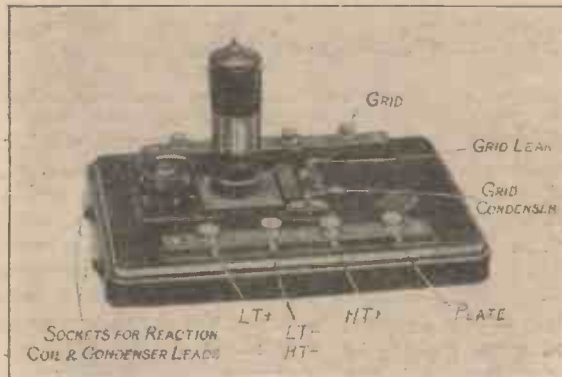

Fig. 7.—Photograph of Valve Rectifying Panel.

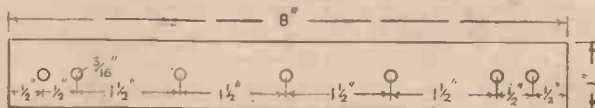

Fig. 2 and 3.—Details of Ebonite Strips and Wood Block.

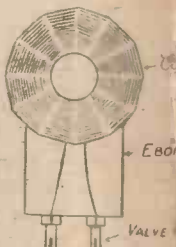

Fig. 6.—Detail of Coil with Valve.

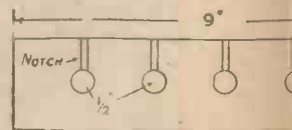

Fig. 3



# REAL UNIT RECEIVING SET

series that Mr. R. W. Hallows  
The instalment given in this issue  
rectifying panels,

as we shall see later how to convert it  
into a combined high-frequency valve and  
detector panel, it is just as well to provide  
it with them when it is first made up.

Prepare two strips as before, but bore  
the 1/2 in. holes beneath them right  
through the wood of the panel. Now take  
a piece of ebonite measuring 2 in. by 1 in.  
and mount on it a pair of valve-sockets  
1 in. apart from centre to centre. Bore  
1/2 in. holes through the wood to take  
their lower ends, and fix the block quite  
close to the top edge of the panel (Fig. 4).  
Another strip to take the detector is fitted  
as shown in the drawing. Place it quite  
near the piece containing the valve-  
sockets, so that plenty of room may be  
left on the panel for the valve-holder and  
rheostat which will be added later when  
we come to make the conversion. Mount  
the detector on this strip, boring 1/2 in.  
holes as before below the crystal-cup and  
the pillar.

The wiring may now be carried out as  
shown in Fig. 5. Use fairly stout wire,  
about No. 24 S.W.G., and pass each piece  
through a length of insulating tubing.  
Each end of all wires should be soldered  
to a 3 B.A. washer, as described in the  
last article; these can then be clamped  
tightly by the lower nuts of the terminals.

If now the aerial lead-in is taken to terminal 1  
and the lead from the earth is

fastened to No. 2 of the terminal panel,  
the detector unit can be connected to it  
by means of two notched brass strips. The  
telephones and variable condenser are  
wired up as shown, and as soon as we have  
made some kind of inductance coil to fit  
the valve-sockets the unit is complete.  
You cannot do better than use a set of  
basket coils, seven of which, tuning from  
250 to 4,000 metres with a .001 mfd.  
variable condenser, can be bought for  
about 6s. Make sure that your coils are  
heavily shellacked and not merely dipped  
in paraffin wax, otherwise they will not last  
long. Mount each on an ebonite block as  
shown in Fig. 6, provided with a pair of  
valve prongs spaced to fit the sockets.  
This is done most easily by sandwiching  
the coil between the ebonite block and a  
strip or disc of the same material held in  
place by a screw.

### The Valve-rectifying Panel

The valve-rectifying panel is not at all  
difficult to make. Figs. 7 and 8 show its  
appearance when seen from above and  
from below. To fix the valve-holder in  
place bore a hole 1 1/4 in. in diameter in  
the panel, which will give the legs plenty  
of clearance, and then fasten with screws.

The rheostat should have a maximum  
resistance of about 8 ohms. Several excel-  
lent types are on sale now very cheaply.  
Three of those used in the set which  
appears in the photographs cost only  
2s. 6d. each, and nothing could be more  
satisfactory, for their action is silent and  
perfectly smooth.

The way in which the rheostats are fitted  
to the panel depends entirely upon their  
design. It is necessary, as a rule, to let  
them into the wood for 1/4 in. or so in  
order to allow plenty of clearance below  
the end of the spindle, but this is a matter  
that presents little difficulty if a chisel or

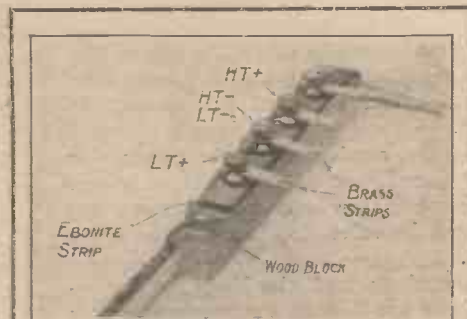

Fig. 1.—Photograph of Terminal Panel.

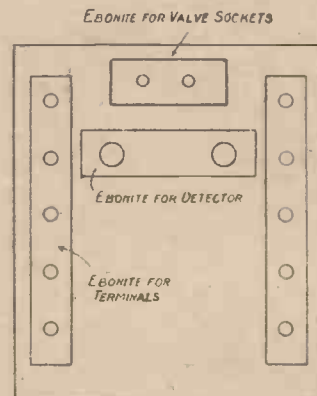

Fig. 4.—Diagram showing Positions of Ebonite Strips.

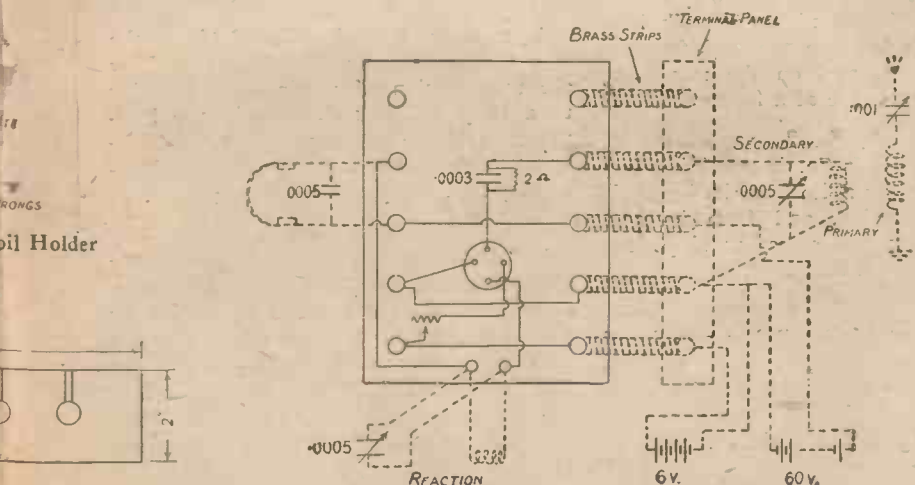

Fig. 9.—Wiring Diagram of Valve Rectifying Panel.

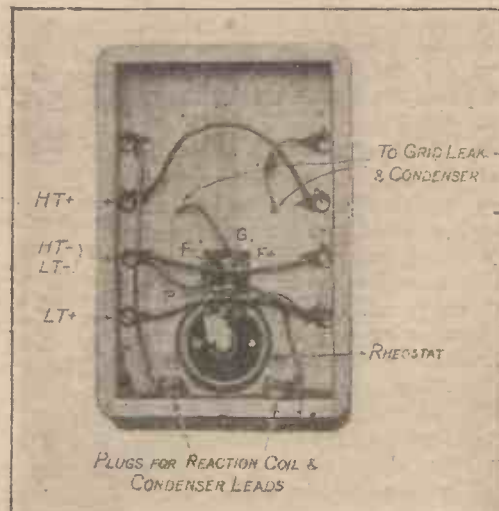

Fig. 8.—Under-side View of Valve Rectifying Panel.

gouge is available. If the spindle passes through a brass bush, it is best to make in the wood a hole big enough to clear it entirely. The bush is then passed through a thin piece of ebonite, which is screwed down to the top of the panel.

#### Don't Economise on the Grid Condenser

There is one direction in which it is folly to economise when building a valve set. A cheap, badly-designed grid condenser and leak will often be responsible for poor and irregular results. The condenser is about the only one in the whole set whose value is critical, and it must be well made. Cheap grid-leaks are sometimes made of hygroscopic material, which causes the resistance to drop enormously in damp weather, often to the entire mystification of the user, who cannot understand the poor performance of his set.

Place the condenser on the upper side of the panel just in front of the valve. The leak can then be changed without any trouble if its valve does not suit the valve in use.

In the photograph the leads for the reaction coil are shown as running to a pair of sockets at the lower end of the panel. This is a convenient arrangement, for it enables the coil and the condenser to be plugged in in a moment, whilst if reaction is not in use the sockets are short-circuited by means of a pair of plugs mounted on a brass strip. Possibly, however, it would be even better to take these leads to terminals standing on the surface of the panel, shorting being done when necessary by means of a swinging hook, made of sheet brass, attached permanently to one of the pair.

The valve used for the rectifying panel should be preferably of the rather soft type. It is possible to use the same valves for both amplifying and rectifying, but better results will be obtained if the rectifier is provided with a valve with not a very high degree of vacuum, hard valves being used on the remaining panels.

Fig. 9 shows the wiring of the panel, which should not present any great difficulty. See that all wires on the under side of the panel are a little slack.

#### Accumulator Connections

A useful tip for making accumulator connections is shown in Figs. 10 and 11. A valve-leg is screwed into the top of each terminal, a prong being soldered to each lead running from the low-tension battery to the terminal panel. This saves all the bother of unscrewing and screwing down terminals when the accumulator is being connected up, but the presence of the valve-legs in no way interferes with the free movement of the milled-headed nuts, which can be used in the ordinary way when the battery is sent to be re-charged.

Any type of three-coil inductance will work well with this set. For short-wave reception basket coils mounted as already described are particularly recommended

owing to their low self-capacity. It is not difficult to make an adapter which will allow them to be used on holders designed to take honeycomb or lattice-wound coils. A very cheap set of coils can be made by mounting a set of seven baskets and the five largest of a set of eight slabs in the way mentioned. The baskets will attune to 4,000 metres, beyond which wave-length the slabs can be used for receiving any existing stations. Even Bordeaux's 23,450 metres are not too much for the largest of the coils. Slabs are not so efficient as baskets, but they will be found quite good for the longer waves, on which, after all, one rarely listens in. Such a set of coils, complete with their mountings, will not cost much more than a sovereign all told, and with them one covers the whole range from 200 to 30,000 metres.

R. W. HALLOWS.

## Radiograms

AT the annual dinner of the Society of Authors, Playwrights and Composers, held on November 21st, Major Ian Hay Beith, who presided, mentioned the fact that any question of licensing an agency which was going to broadcast music without payment to those immediately concerned, should be left to the society to decide upon.

It is stated that the call letters 5H X have been allocated to an experimenter for the purpose of carrying out experimental transmissions from racing cars on Brooklands motor track.

The Territorial Signalling Section in Glasgow is giving wireless amateurs in the district excellent Morse practice every night. Morse is transmitted by the territorials between 7 p.m. and 8 p.m. on 1,900 metres. Three nights a week it is sent at speeds between ten and fourteen words a minute, and on the remaining nights the signals are at a faster rate.

The United Fruit Co. is providing free medical service by radio from its hospitals in Central America, and from its passenger ships at sea to other ships not having a doctor on board.

The President of Brazil has sanctioned the installation of high power wireless stations, and the establishment of a wireless telephone service on Brazilian territory by the Agencia Americana.

The following alterations have been made in the broadcasting times of the Eiffel Tower: The concerts given at

3.30 p.m. are discontinued, and the transmission that was given at 5.10 p.m. is now sent out at 6.20 p.m.

A number of Glasgow and district amateurs report that when receiving they are greatly troubled by the phenomena known as "fading." One amateur puts it down to the erratic running of the generator at the transmitting station, while another thinks that it is wholly due to atmospherics. In next week's issue we hope to have an article on the subject.

A wireless telegraph station is to be erected at Gremeton, near Varberg, Sweden, for communication with America.

Good reception of Marconi House is reported in the Glasgow district using only a single valve, the distance being nearly 400 miles. At Bridge of Allan, still farther away from the transmitting station, loud speech is received on a small two-valve "Marconiphone," which has a guaranteed range of only 50 miles, while similar experiences are obtained in Glasgow, using two valves of an "Ethophone III," guaranteed range 80 miles, and with pairs of phones fitted.

In a letter to the "Aftenposten," a Norwegian paper, dated August, 1922, Captain Amundsen says: "The wireless functions brilliantly. We hear Stavanger Radio clearly and distinctly every day at the appointed hour."

The United States Army Air Service is experimenting with a kite balloon which carries a camera controlled by wireless. By this means, during war, it will be possible to photograph large tracts of land without any of the usual danger associated with aerial photography.

A novelty was introduced into the Devonshire House election-night ball by the transmission of music from a cellar to a lacquered box situated in the ballroom where the guests were dancing. The box, which was a cleverly concealed receiver, took the place of the orchestra.

In Scotland tenement dwellings are very numerous, and many difficulties have been experienced in the erection of aërials by residents therein. A novel suggestion has been made that a stout cable should be stretched parallel to a tenement and at some distance from it, the ends being attached to the chimney stacks of adjacent tenements running at right angles to the one which is to be served. This cable could be used to support any number of aërials running from it to the various houses in the tenement.



# OUR INFORMATION BUREAU

Expert Replies to Readers' Questions. Hundreds of Replies are sent by Post.

TO ENSURE A PROMPT REPLY PLEASE OBSERVE THE FOLLOWING RULES

Write distinctly, give all necessary details and keep to the point. Ask one Question at a time—never more than two. Send a Stamped and Addressed Envelope. Send the Coupon cut from page 598.

## Flickering Valve.

Q.—Can you explain the reason why my valve occasionally flickers and the light ceases momentarily and then lights up again for no apparent reason?—P. G. K. (Bristol) (4312).

A.—Provided you are positive that your connections are quite in order and that your variable arm fits tightly on your rheostat, we can only suggest that possibly one set of the accumulator plates is broken internally from one of the accumulator terminals. It may be making contact ordinarily, but any slight jar or vibration will cause the broken connection to jump apart and thus cause your valve to go out. Any loose matter between the plates would also cause the trouble.—L. C.



## BROADCAST TELEPHONY

Some of these transmissions are commercial or official. Wave-lengths and times are liable to alteration without notice.

- London B.B.C. Station (2L O), 365 metres. Daily, usually 6 p.m. to 10 p.m.  
 Manchester B.B.C. Station (2Z Y), 385 metres. Daily, usually 6 p.m. to 9 p.m.  
 Birmingham B.B.C. Station (2W P), 425 metres. Daily, usually 6 p.m. to 9 p.m.  
 Croydon (G E D), 900 metres. Daily.  
 Writtle (2M T), 400 metres. Tuesdays, 8 p.m.  
 Eiffel Tower (F L), 2,600 metres. Daily, 5.20 p.m. to 7 p.m.  
 The Hague (P C G G), 1,085 metres. Sundays, 3 p.m. to 5 p.m.  
 Rome (I C D), 3,200 metres. Daily.  
 Königswusterhausen (L P), 2,800 metres. Daily, 4 p.m. to 5.30 p.m.  
 Amsterdam (P C A), 1,800 metres. Daily, 1.10 p.m.  
 Haren (O P V H), 900 metres. Daily, every hour from 11.20 a.m. to 4.20 p.m.

## CORRESPONDENCE

### Berkhamsted Wireless Society and the Broadcast Licence

SIR,—I should esteem it a favour if you would draw the attention of wireless societies to the following resolution passed at a meeting of the above society and forwarded to the various officials immediately concerned:

"That this representative meeting of the society views with the gravest apprehension the inclusion of condition No. 2 on the broadcast licence, holding that it establishes a monopoly of the worst type, that it is a menace to both the industrial and the scientific sides of wireless, and that it is a gross and unconstitutional interference with the liberty of the subject."

—W. F. EAGER, *Hon. Secretary.*

### Crystal Reception

SIR,—I have read with interest the letters relating to crystal reception that have appeared from time to time in the

correspondence column, and think the results I have obtained would be of some interest to other amateurs. I am using a 60-ft. twin-wire aerial 34 ft. high, an inductively-coupled tuner with condensers, and a "Hertzite" crystal with fine copper wire contact. Ship and coast stations come in very strongly, and clear signals are received from Harwich, Niton, North Foreland, Sheerness and the Continental stations at Boulogne, Dunkirk, Le Havre, Ostend and Scheveningen. The commercial stations, Paris and Naucn, are always loudly received, and I have also heard Karlsborg, Madrid, Moscow and Petrograd. Telephony between Croydon, which is 17 miles away, and aeroplanes on the London-Continental route is always very loud. Speech from Marconi House five miles away, can be heard 2 ft. from the 'phones and can still be loudly received when a frame aerial is substituted for the ordinary one. The concerts from Writtle, 35 miles away, are very good, every word being clearly heard. On one occasion I was surprised to hear faint telephony from the Eiffel Tower station. With regard to the transmission of telephony by amateurs, I have received speech and music from the following: 2B Z, 2L U, 2L V, 2L W, 2M I, 2O M, 2O N, 2Q Q, 2S I, 2S W, 2U V, 2W P, 2X X, 5C P. I should be pleased to hear if any other reader has had results equal to mine in the reception of low-power amateur telephony.—W. E. N. W. (Harlesden, N.W. 10).

### Experimenting with a Crystal

Sir,—With regard to your correspondent's letter *re* my article published November 4th, I agree with him that the current passed by a crystal is not directly proportional to the applied voltage, but there are ways (as no doubt your correspondent is aware) of increasing the applied voltage by means of local potential. I did not show potentiometers and batteries in my diagrams in order to simplify matters. I should like to point out that a stable crystal such as carborundum, in a well-designed detector, should rarely require adjustment.

I should also like to mention that which it seems I did not make clear enough in my article, that the "multi-crystal circuit" was only a suggested line for experiments, and was not a full tested instrument.

R. W. E. (Tamworth).

The "Work" Handbook "Wireless Telegraphy and Telephony" is the best value obtainable.

## CLUB DOINGS

### Lambeth Field Club and Morley College Scientific Society

Hon. Sec.—MR. W. RIVERS, Morley College, Waterloo Bridge Road, S.E. 1.  
 THE Hon. Sec. invites application for membership of the above society.

### Sale, Altrincham and District Radio Society

Hon. Sec.—MR. H. FOWLER, Alston, Oldhall Road, Sale.

A SOCIETY has now been formed called the Sale, Altrincham and District Radio Society, with headquarters at the Reform Club, Sale. It is proposed to form a ladies' section and also a junior section. Full particulars can be obtained from the hon. secretary.

### Plymouth Wireless and Scientific Society

Hon. Sec.—MR. G. H. LOCK, 9, Ryder Road, Stoke, Devonport.

ON Oct. 31st a meeting of the Society was held, at which a lecture was given by Mr. G. H. Lock on "Wireless Reception." Dealing with the subject historically to begin with, the lecturer referred to the pioneer work of Hertz, Branley and others, carrying the audience up to the point where Marconi came upon the scene. The principles of tuning were then explained, and then magnetic and crystal detectors dealt with. The Edison effect, the Fleming two-electrode valve and ultimately the three-electrode valve followed. A typical characteristic curve was shown, and the rectifying and amplifying points explained. Magnetic reaction and the reception of continuous waves completed the lecture. A demonstration followed, during which, by means of a seven-valve set, the lecturer was able to show practically the principles of beat reception.

### Coventry and District Wireless Association

Hon. Sec.—J. E. BOLUS, "Iona," 14, Coundon Road, Coventry.

AT a meeting of the above association on Nov. 1st, Mr. Sidley gave a short address on general subjects connected with wireless telegraphy. Mr. Sidley commenced his address by an appeal to all members using reactance to revise their circuits with a view to bringing them strictly within the P.M.G.'s regulations, both on their own account and with a view to avoiding annoyance to other listeners-in by causing oscillation of their aeriels. He pointed out that the prevailing practice of coupling the reception coil to the aerial coil was forbidden, and that the only permissible arrangement was to couple the reactance coil with a secondary coil of a closed circuit inductively coupled to the aerial coil, and that although this might seem to involve additional difficulty in tuning, yet in practice the difficulties were not nearly so great as might appear. Also that while critical tuning was as necessary as ever in the secondary circuit, considerable latitude was



obtained in the aerial circuit, and in general with a given coil in the latter the aerial condenser might be varied throughout its whole range without losing a station which has been tuned-in.

**Portsmouth and District Amateur Wireless Society**

Hon. Sec.—MR. R. G. H. COLE, 34, Bradford Road, Southsea.

A MEETING of this association was held on Nov. 1st. The speaker for the evening was Mr. Harrold, A.M.I.R.E., his subject being "Wireless Telegraphy, Telephony and Broadcasting." Unfortunately time did not permit Mr. Harrold to go as fully into the subject as he wished, but he conveyed to the members the system of the earliest forms of transmitters. Mr. Harrold explained what civilization owes to wireless telegraphy, and although at the present time wireless is being boomed by the daily press, in a few years time it will be a part of our daily existence.

**Thames Valley Radio and Physical Association**

Hon. Sec.—ERIC A. ROGERS, 17, Leinster Avenue, East Sheen, S.W.14.

FULL particulars of this society will gladly be sent on application by the Hon. Secretary.

**Hackney and District Radio Society**

Hon. Sec.—MR. E. R. WALKER, 48, Dagmar Road, Hackney, E.9.

AN informal meeting of the above society was held on Nov. 2nd. The first unit of the society's wireless set was installed. It permits of the use of valve or crystal detection. Further units are in course of preparation. With the aid of a 3-valve Mk. III L. F. amplifier, kindly lent by a member, telephony was very well received. It is worthy of note that the society's set is as far as possible being built without recourse to the ordinary funds but

by means of contributions in the form of money or apparatus.

**Manchester Wireless Society**

Hon. Sec.—MR. Y. W. P. EVANS, 2, Parkside Road, Princess Road, Manchester.

ON Nov. 1st Mr. Y. W. P. Evans gave his first of a series of elementary lectures intended for the novice and dealt thoroughly with simple crystal circuits and also combinations of crystal and valve. All technical matter was entirely eliminated, and the various actions explained in everyday language much to the benefit and interest of those present who were just taking up wireless experimenting.

**Hornsey and District Wireless and Model Engineering Society**

Hon. Sec.—MR. H. DAVY, 134, Inderwick Road, Hornsey, N.8.

ON Oct. 23rd a short lecture was given by Mr. Hunting on "The Morse Code," dealing in detail with its many and varied uses.

**Bromley Radio and Experimental Society**

Hon. Sec.—J. FERGUSSON-CROOME, "Gowrie," Wendover Road, Bromley, Kent.

At a meeting on Nov. 1st the secretary stated that the present meeting place had been secured as a permanent headquarters and that the future meetings would be held there regularly on every Monday at 7.30. He then introduced Mr. L. Stopes (chairman of the Society), who gave an interesting and instructive lecture on "Primary Cells and Accumulators." The lecturer described the various types of cell, their chemical action, and their use with special reference to wireless purposes. The second half of the lecture was devoted to secondary cells, both the Planté and Edison form being dealt with, and charging methods described. A representative collection of cells, kindly loaned by Messrs. Siemens Bros., of

Woolwich, showed the practical application of the lecturer's remarks.

**East London Radio Society**

Hon. Sec.—MR. W. G. SIMMONDS, 60, East Ferry Road, E.14.

THE secretary of this society will cordially welcome intending visitors and do everything in his power to make them enjoy their visit.

**Bromley Radio and Experimental Society**

Hon. Sec.—J. F. CROOME, 26, Wendover Road, Bromley, Kent.

At a meeting of the Society held on Nov. 13th, Mr. Allen demonstrated and explained his five-valve receiving set. The H.F. valve is arranged with tuned anode circuit, and he showed with diagrams the functioning of this and other parts of the apparatus. Telephony and music specially transmitted by 2 L.W. were afterwards successfully and clearly received on a loud speaker.

**Streatham Radio Society**

A LECTURE meeting of the above society was held on Nov. 8th. After the routine business had been carried through, a lecture was given by Mr. A. G. Wood, the subject being "Tuned

(Continued on page 598)

"Piano-tuning and Repair" is an important article in this week's issue of "Work" (3d.) Other articles are: "Making a Leather-covered Footstool," "Hints on Grafting Soles on Boots," "Wrought-iron Boot-scraper," "Bedroom Curb and Fire-screen," "Mending Pots and Pans," "A Fitment for the Scullery," "Close-annealing Furnaces," "Metal Draining Rack for Photographic Plates."

**BROADCASTING RECEPTION SETS**

ONE VALVE SET COMPLETE FOR WORKING, £7 - 10 - 0

INCLUDING ALL ACCESSORIES

G.P.O. Prov. No. 1027.



**DESCRIPTION**

Single valve, mounted on polished 1-in. ebonite panel with variable condenser, smooth acting resistance, grid leak and condenser and all terminals clearly engraved in white, in a mahogany polished cabinet, 9 in. by 5 in. by 5 in. ... £3 - 15 - 0

A TAPPED COIL for wave-lengths up to 900 metres with 2 Terminals for coils for any higher wave-lengths.

The coil is enclosed and the tappings are brought out to an 8-way switch mounted in the front of the cabinet.

**ACCESSORIES INCLUDED**

Siemens 54 volt high-tension Battery with plugs for altering the voltage ... ..	15 - 0
4 volt 50 amp. hour low-tension Accumulator in case with carrying strap ... ..	1 - 4 - 0
One pair of Sensitive Head Phones of 4,000 ohms resistance ... ..	1 - 1 - 0
One Mullard "Ora" Detecting Valve ... ..	15 - 0
<b>TOTAL</b>	<b>£7 - 10 - 0</b>

**WIRELESS INSTALLATIONS LIMITED,**

15 ALDERSGATE STREET, LONDON, E.C.





**25/-** POST FREE

4000 ohms total Resistance.  
Double Headband.

Guaranteed highly efficient. Complete with Cords. Ball and socket joints; highly polished nickel cases; best Tungsten steel magnets.

**BEAVER Complete CRYSTAL SETS** ALL POST FREE

**Beaver "MIDGET" Crystal Set.**

The Ideal Xmas Present. Length 6 3/4 in. x 4 in. Absolutely guaranteed. 18/-; complete with 4000 ohm ear-piece, 36/-.

**No. 1** unassembled 20/- **No. 2** unassembled 25/-

**No. 3** assembled 27/6 ready for use  
Complete with Splendid Tested and Guaranteed 4000 ohm Phones, 50/-

**No. 4** unassembled 35/-  
Complete with Splendid Tested and Guaranteed 4000 ohm Phones, 57/6

**De Luxe Set No. 5** assembled 66/- ready for use  
Complete with Splendid Tested Guaranteed 4000 Phones, 84/-

(Passed by Postmaster-General)

**BEAVER Complete Set of CONDENSER**

**PARTS**

contains:

- Ebonite Top and Bottom Plates, Machined
- Aluminium Moving Plates
- Aluminium Fixed Plates
- 1 Square Centre Spindle
- 3 Stay Rods, screwed both ends
- Large Spacing Collars
- Small Spacing Collars
- Bronze Coil Spring
- Ebonite Knob, drilled and screwfitted
- Brass Nuts for Centre Spindle
- Small Nuts
- \*0005 MF. ... .. 10/-
- \*00075 MF. ... .. 12/6
- \*001 MF. ... .. 14/-
- \*0015 MF. ... .. 15/-

Post Free

**Splendid Crystal Detector**

Mounted on Ebonite.

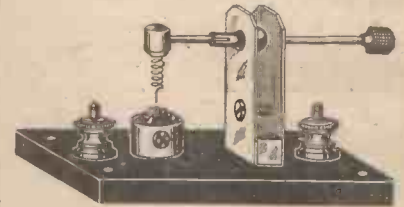

POST FREE **2/9**

**Solid Brass and Ebonite Lead in Tubes**

6 in. ... ..	2/-
9 in. ... ..	2/2
12 in. ... ..	2/6
15 in. ... ..	2/9
18 in. ... ..	3/-

**Ebonite Valve Holders 1/6 and 1/9**

*0002 Condensers	1/6
*003 ... ..	2/9



**BEAVER ELECTRICAL SUPPLY CO.**

Telephone: GERRARD 1900.

109, REGENT STREET, LONDON, W.1.

Special Terms to Trade. All Cheques and Postal Orders to be crossed London Joint City and Midland Bank.



**BEGINNER'S GUIDE TO WIRELESS**

Explains in plain, everyday language, everything beginners wish to know about Wireless Telegraphy.

**HOW TO ERECT, CONNECT, AND MAKE**

all the apparatus required for reception of telephony or Morse, and full instructions and diagrams for making coils, tuners, and complete valve and crystal sets. 112 pages, price 1/- post free.

**SAXON RADIO CO.** (Dept. 12), South Shore, BLACKPOOL

32 page Catalogue of Wireless Apparatus, 3d. post free.

**DO YOU READ PRACTICAL BOOKS?**

See Cassell's List of Technical, Practical and Money-saving Books. A p.c. will ensure your receiving it.

**CASSELL & Co., La Belle Sauvage, LONDON, E.C.4.**

**AMATEURS! Don't Work in the Dark.**

You can acquire a thorough knowledge of the Scientific Principles which govern the working of your apparatus quickly and easily by our system.

**PLEASANT LESSONS BY POST AT YOUR LEISURE.**

Our Course of individual tuition is certain to appeal to you, whatever previous knowledge you may have or if you have none. Among our students we number highly trained scientists with University Degrees, as well as those with no scientific knowledge whatever.

Special fee for the Course—30/- cash, or 6/- upon enrolment and five monthly payments of 5/-.

**THIS IS JUST THE THING YOU NEED—BEGIN TO-DAY**

Write for full particulars to—

**THE NATIONAL INSTITUTE OF APPLIED SCIENCE,**  
3, 5 & 7, OLD QUEEN STREET, LONDON, S.W.1.

**WORK HANDBOOKS**

The best series of Practical Books for Practical Men

Complete Lists free from:—

**CASSELL & CO.**  
Limited  
La Belle Sauvage  
LONDON, E.C.4

**J. L. CARTWRIGHT & Co.**

24, London Road, Manchester.

Phone: CENTRAL 4203. Grams: "PLADURAM," MANCHESTER  
Works - - BERRY STREET

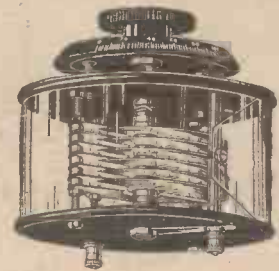

As our special offer of 'PHONES is now closed, we are offering

**CONDENSERS**

(complete and parts) at considerably reduced prices. Get our lists—3d., post free.

Our Standard Prices for 'Phones are now—

140 ohms .. ..	30/-
4000 .. ..	32/-
8000 .. ..	33/-

Special terms to the trade.

Sole Distributing Agents for Scotland: **J. GORSTON SINCLAIR & Co.,** 47, Waterloo Street, Glasgow.  
Retail Agents for Blackburn: **THOS. BARTON & Co.,** The Electric Works, Blackburn.

# HALL'S

## WIRELESS ACCESSORIES

HIGHEST QUALITY ———— LOWEST PRICE

### SPECIAL OFFER!

## 4,000 ohms BRITISH HEADPHONES

Very Light. Beautifully Finished  
(COMPLETE WITH CORDS)

# 19/6

POSTAGE 9d.

These phones, sold almost exclusively elsewhere at 35/., will be supplied at 19/6 (below cost price) to all customers purchasing within the next fourteen days.

### GUARANTEED GOODS

Value with Quality. DISPATCH BY RETURN.

Capacity	VARIABLE CONDENSERS:		
	Complete Parts	Mahogany Cabinet	
.001	7/-	3/6	
.0075	6/-	3/3	
.0005	5/3	3/-	
.0008	3/3	2/9	
.0002	2/3	2 6	
.0001	2/-	2/3	
Ebonite top and bottom, 1/6 pair extra			
Interval Transformers.—Ratio 5 to 1	...	12/9	
Crystal Sets ... 15/-, 35/- and	...	23	
Aluminium Vanes ... 1d. pair; fixed and moving, doz.	...	6d	
Spacers, large, 3d. doz.; small, doz.	...	1d	
Ebonite Knobs for centre spindle; each, 2d., 4d. and	...	5d	
Aerial Wire, 100 ft. in length, 7/22 copper	...	2/8	
Valve Legs, with nuts and washers	...	1d	
Insulating Sleeving	...	4d	
Two Coil Holders, solid ebonite mounted on mahogany	...	5/-	
Three	...	9/6	
Crystal Detectors, adjustable in every way, turned brass on ebonite	...	2 10	
Slider Rods, drilled	...	5d	
Instrument Wire, all gauges.	...		
Engraved Ivory Scales, 0-180	...	4d	
Filament Resistances, splendid value	...	2/4	
Switch Arms, complete with knob, collar, nuts, etc., 10d. and	...	1/6	
Valve Holders	...	1/6	
Crystal Cups ... plain 1d.; 2 screw 2d.; 3 screw	...	3d	
Large Terminals, all types. Extraordinary value, 2d. each	...	1d	
with nut and washers, 1 9 doz. Small type	...	5d	
Contact Studs, 1/2 x 1/4, with nuts	...	3d	
Insulators, 2 in. porcelain. Reel, shell or egg type	...	3d	
Brass Nuts, 2 B.A., 4 B.A. and 5 B.A.	...	3d	
Ebonite Sheet, cut to any size	...	3 6	
Fixed Condensers, any capacity	...	1/8	
Grid Leak Condensers	...	2/9	
Ebonite Slider Plunger complete	...	5d	
Mica, 4d. large sheet, Copper and tinfoil, 8 in. wide, foot	...	4d	
Crystals, Borate, Carborundum, Galena, Silicon	...	4d	
Zincite	...	1/-	
Hertzite	...	1/9	
Screwed Brass Studding, 2 B.A., 4 B.A.	...	4d	
Inductances Wound 22/24 gauge wire	...	3/6	

Orders under 30/- kindly remit  $\approx$ mple postage  
Balance refunded if excess sent. Send for FREE Catalogue

TRADE SUPPLIED **HALL'S** DISPATCH BY RETURN

PHONE: REGENT 1282  
71, Beak Street, Regent Street, London, W.1

Between Piccadilly Circus and Oxford Circus  
Buses 3, 6, 12, 13, 15, 32, 51, 53, 59 and 88 pass

"Dispatch by return!"

OUR LATEST BATCH

DARLINGTON,  
20th November, 1922.  
Messrs. Hall's.  
DEAR SIR,  
... "I am greatly satisfied and pleased with the articles already sent." W. H. S.

HERTS,  
20th November, 1922.  
Hall's.  
DEAR SIR,  
... "All the goods are to my entire satisfaction," etc.  
A. BEADLE.

CHESHIRE,  
19/11/22.  
Hall's.  
DEAR SIR,  
... "Goods received safely and am very pleased with same."  
B. B.

MANCHESTER,  
14/11/22.  
Hall's.  
DEAR SIR,  
... "We thank you for prompt delivery," etc. A. V. W.

PAISLEY,  
Scotland.  
Hall's.  
DEAR SIR,  
... "Safely received parcel. Delighted with quality of contents," etc. R. B. E.

All originals are at our office, and can be seen on request.

"Dispatch by return" is no idle boast.

Our Stock of Wireless Equipment and Accessories is such that we can supply every Wireless need at once and at lowest prices. If you do not see what you want in our list, please write us.

CLUB DOINGS (continued from page 596)

Anode Circuits." Mr. Wood gave details of his new "Vim" apparatus, and after the lecture gave a demonstration with it. The next "lecture" meeting is on Dec. 13th, when Mr. C. H. Roddis will give a demonstration of Transmission and Reception of Infra-red rays.

#### Leeds and District Amateur Wireless Society

Hon. Sec.—MR. D. E. PETTIGREW, 37, Mexborough Avenue, Chapelton Road, Leeds. At the general meeting held on Nov. 10th, Mr. G. P. Kendall, B.Sc., gave a paper on the subject of "Some Gadgets of a Faddist." Mr. Kendall kept the meeting highly interested for more than an hour, with explanations as to the use of innumerable gadgets which were embodied in his experimental receiving installation. Devices to ensure security of an aerial to maintain an efficient earth were examined closely. Paying particular attention to preserving valves, Mr. Kendall submitted various means to prolong the life of a valve. Switching arrangements of circuits enabling a combination of valves to be used were explained briefly and clearly. Many other gadgets including smoothing devices for rough anode potential, shock protectors, variometers, use of potentiometer for regenerative purposes, plugs and jacks, etc., were described and various components submitted to the meeting for examination.

#### Hornsey and District Wireless Society

Hon. Sec.—MR. H. DAVY, 134, Inderwick Road, Hornsey, N.8. A MEETING of the above Society was held on Nov. 3rd. A lecture was given by Mr. H. J. Pugh, who demonstrated a crystal detector and 2-valve amplifier. Persons desiring to join a society in the above-mentioned district should write to the secretary for full particulars.

#### Lambeth Field Club and Morley College Scientific Society

Hon. Sec.—F. W. LING, Physics Laboratory, Morley College, Waterloo Road, S.E. ON Nov. 11th Mr. R. F. Cosser gave a lecture before the members of the above society entitled "The Making of a Two Valve Set."

#### Oldham Lyceum Wireless Society

Hon. Sec.—GRAHAM HULBERT, ESQ., 16, South Hill Street, Oldham. PARTICULARS of this society can be obtained on application being made to the secretary.

### ANNOUNCEMENTS

"Amateur Wireless and Electric." Edited by Bernard E. Jones. Price Threepence. Published on Thursdays and bearing the date of Saturday immediately following. It will be sent post free to any part of the world—3 months, 4s. 6d.; 6 months, 8s. 9d.; 12 months, 17s. 6d. Postal Orders, Post Office Orders, or Cheques should be made payable to the Proprietors, Cassell & Co. Ltd.

General Correspondence is to be brief and written on one side of the paper only. All sketches and drawings to be on separate sheets.

Contributions are always welcome, will be promptly considered, and if used will be paid for.

Communications should be addressed, according to their nature, to The Editor, The Advertisement Manager or The Publisher, "Amateur Wireless," La Belle Sauvage, London, E.C.4.

Amateur  
Wireless  
(And Electric)

Querist's Coupon Available until Saturday, Dec. 9, 1922



# WIRELESS PARTS

and ACCESSORIES at  
MANUFACTURERS' PRICES

Terminals, solid brass, knurled, large	2/- doz. : gross	21/-
" " " " small	1/5 " : "	15/-
Valveholders, best finish	... .. each	1/-
Porcelain Insulators	... .. "	6d
Filament Resistances, with special stop stud	... .. "	4/-
Brass Rod, square, 13-in.	... .. "	6d
Slider and Plunger	... .. doz.	7/6
Switch Arms, best Ebonite Knob, 4-leaf contact	each	2/6
Contact Studs	... .. doz.	1/-
100 ft. Aerial Wire, 7/22s best copper, enamelled	...	3/11
Crystal Detec'or, mounted on ebonite base, ebonite handle, universal joint, heavy brass terminals	... each	4/6
Accumulators, 4 volt 40 amps...	... .. "	20/9
" " 6 " 40 " ...	... .. "	29/6
Volt and Ammeters, Flush or Raised Fitting:—		
Plated	... .. each	10/6
Back Enamel	... .. "	10/-

**SPECIAL TERMS TO THE TRADE**

We shall be glad to quote for all components of the first quality at equally low prices to the above selection from our list. Every article tested before leaving our Warehouse. Money returned if not satisfied.

Terms: Cash with order. Orders over 20/- carriage paid

For a short period only we are offering  
**HANDY BENCH VICE**  
Specially suited for the Wireless Workshop. 2-in. jaws, all steel. Sheffield make. The tool you have been looking for. Carr. paid **6/11**

## The ABRO Motor Company

WIRELESS DEPARTMENT

194 and 186, London Road, Manchester

WORKS: 73 and 75, Downing Street and Hague Street. PHONE: Central 6143

# OUR PRICES SIMPLY STAGGERING

<b>Buzzer Sets</b> complete with Ear-piece, Tapping Key, Buzzer, Induction Coil, in case 7/6 (Postage 1/- extra)	<b>Switch Arms</b> , heavy type 2/3
<b>Single Ear Phones</b> (150 ohms) ... .. 2/9	<b>Large Spacer Washers</b> per doz. ... .. 4d
<b>Brass Formers</b> each 2/6	<b>Small Spacer Washers</b> per doz. ... .. 3d
<b>Brass Nuts</b> , 2, 3, 4, 5 or 6 BA. ... per dozen 3d	<b>Switch Knobs</b> 1 1/2 Dia. Knurled Edges, Tapped 2 BA each ... .. 2d
<b>2 BA 12" Screwed Rods</b> ea. 4d	<b>Filament Resistances</b> , best quality ... each 2/6
<b>Brass Rods</b> , 13" x 1/4" x 1/2" each ... .. 5d	<b>Aerial Wire</b> 7/22 per 100 ft. 3/3
<b>Condenser Vanes</b> per doz. 6d	<b>Aerial Wire Silicon</b> , per 100 ft. ... .. 2/6
<b>Contact Studs</b> with Nut and Washer per dozen 6d	<b>Lightning Arresters</b> each 2/0
<b>Copper Foil</b> 4" x .002; lb. 2/8	<b>Valve Holders</b> with nuts and washers ... each 1/0
<b>Crystal Detectors</b> complete with best quality Crystal 3/6	<b>Valve Legs</b> with Nut and Washer ... each 2d
<b>Crystal Cups</b> , each 2d & 6d	<b>Valve Pins</b> with nut, each 2d
<b>Crystal Detector Parts</b> per set ... .. 1/9	<b>Ebonite Sheets</b> , 1/4 thickness any size cut; per lb. 4/6
<b>Egg Insulators</b> each 3d or per dozen ... .. 2/6	<b>Terminals</b> , small or medium, with nut and washer, per dozen ... .. 1/6
<b>Shell Insulators</b> , each 7d	<b>Terminals</b> large, with nut and washer, per dozen ... 2/0
<b>Mica</b> , 3" x 2 1/2" ... each 1d	<b>Centre Condenser Rods</b> , each from ... 3d to 1/0
<b>Mica Washers</b> per doz. 3d	
<b>Switch Arms</b> , best quality each ... .. 1/0	

CASH  
REFUNDED  
IF NOT  
SATISFIED

**GEORGE PALMER**  
47, GERRARD STREET, LONDON, W.1.  
1 Minute from LONDON HIPPO-  
DROME and DALY'S THEATRE

WHOLESALE  
TRADE  
SUPPLIED

# Dr. J. A. Fleming

F. R. S.

## THE INVENTOR OF THE VALVE

Who is a well-known writer in *THE WIRELESS WORLD & RADIO REVIEW* is now contributing a series of articles entitled

# ELECTRONS ELECTRIC WAVES AND WIRELESS TELEPHONY

which covers the whole field of WIRELESS TELEPHONY TRANSMISSION including the principles and application of the Thermionic Valve.

¶ The subject of Valves and their application is too great to be completely dealt with in one article.

¶ The first article appeared in the Oct. 7th issue (No. 164, Vol. XI), and is continued each week.

¶ Since the commencement of this series, over fifty pages of the WIRELESS WORLD AND RADIO REVIEW have been devoted to thorough explanations, which can be easily grasped, and which Dr. Fleming has personally written.

¶ As a result of the introduction of Broadcasting, thousands are seeking a lucid explanation of the principles of Broadcasting and how it is done. The exact answers will be found in these articles.

¶ There have been many contributions to wireless literature dealing with the subject of Wireless Telephony, but never before has it been treated in a manner so well calculated to absorb the attention and interest of every class of reader.

### Remember

If you want full information covering the whole field of Wireless Telephony Transmission read these articles in:

# The Wireless World and Radio Review

Of all Newsagents and Booksellers  
PRICE 6d. EVERY THURSDAY

# HULLO EVERYBODY!

**Do YOU Know US? If not, why not?**  
**COMPARE PRICES! COMPARE QUALITY!!**

## Complete Sets of PARTS for Making Variable Condensers

Approx. Capacity in Microfarads	No. of Plates	Price
•0015	85	10/-
•001	57	7/6
•00075	43	6/9
•0005	29	5/6
•0003	19	3/-
•0002	13	2/3
•0001	7	2/-
Vernier	3	1/9

Everything ready to assemble and consist of the following: Accurate Aluminium Fixed and Moving Vanes, Large and Small Spacer Washers, Centre Square Spindle (Screwed Ends 2 BA), 3 Side Rods, 12 Nuts and 12 Brass Washers (2 BA), Pointer—scale 0-180, Terminals, 3 Bushes, Spring Coil Washers, Best Quality Knob with 2 BA Nut in Centre.  
**ALL HIGHEST QUALITY GOODS**

**EBONITE TOP and BOTTOM PLATES SUPPLIED (Drilled) Free of Charge with**

**SETS: •0015, •001, •00075, •0005**

(If wanted for any other set include another 1/-)

Postage, Packing, etc., 1/- per set extra      Packing and Postage for 2 sets, 1/3

### UNSOLICITED TESTIMONIALS

**A. J. POOK, Esq.,**  
 101, Day's Road,  
 Barton Hill,  
 Bristol.

17/11/22

Enclosed 6s. 6d. for .0005 condenser parts. Two I had previously (.001 and .0005) have drawn admiration from all my friends. Remarkable value, they say.

**SYDNEY J. ASHWORTH, Esq.,**  
 9, Paradise Place,  
 Stoke,  
 Devonport.

13th November, 1922.

The quality, price, and the dispatch of your high-class goods leave nothing to be desired. I am still able to profit by sending to you for them, especially when quality is considered.

**W. J. CORLESS, Esq.,**  
 5, Whatman Road,  
 Forest Hill, S.E.23.

2/10/22.

I received the set of condenser parts quite safely and thank you for the careful packing. As regards the parts themselves, they fitted together splendidly, making a neat instrument, and I consider them the best condenser value on the market.

## ALL the following GOODS POST FREE at the SPECIAL PRICES attached for POST ORDERS

*If you are not satisfied with value, return goods and we will refund all charges*

Filament Resistances. Most wonderful value in the wireless trade. Each 2/6 and 3/6. By Post, 3/- and 4/-.

Switch Arms, with polished knob, bushed 2 BA nut, laminated blade, spring coil washer, nuts and bush, 10½d. and 1/6 each. By post, 1/3 and 2/1 each.

Crystal Detectors on Ebonite. Simply marvelous value. Each 2/-. By post, 2/8.

Fixed Condensers, with terminals on ebonite, .0003, .0005, .001, .002, .003, 1/8; by post, 1/9; .004, 1/9; by post, 2s.

Oojah Basket Coils, 7 in set, 5/- set. By post, 5/6.

Lead-in Tubes, ebonite, brass ends, 9 in., 1/2. By post, 1/6. 12 in., 1/4. By post, 1/8.

Good Condenser Knobs, tapped 2 B.A., at 2/- doz. By post, 2/6.

Knobs, with brass nut (2 B.A.) in centre, high-class quality, 4½d. each. By post, 7d. 6 for 2/-. By post, 2/6.

Crystal Detector, cups enclosed with glass cover, dust proof, 4/6. By post, 5/3.

Aerial Wire, 7/22 bare copper, stranded, first class quality, not a substitute. Price per 100 ft., 2/10. By post, 3/10. Price per 150 ft., 4/3. By post, 5/3.

Reel Insulators, 1d. each, 11d. doz. Cannot be sent by post.

Hertzite Crystal, per piece 1/3 and 1/6. By post, 1/6 and 1/9.

Pericon Crystal Detectors, 4/-. By post, 4/9.

1½ mm. Insulating Sleeving, 6 yds. for 2/2. By post, 2/6. 12 yds. for 4/-. By post, 4/6.

Slider and Plunger, 5d. By post, 8d.

Slider Knob, plunger and 13 in. rod. The lot, 8d. Cannot be sent by post.

War Office Pattern Terminals, complete with nut and washer, 1/8 doz. By post, 2/2 doz.

Splendid Line in 5-piece Terminals, complete with nut and washer, good size, 1/- doz. By post, 1/6.

Interval Transformers. Each, 14/-. By post, 15/-. (Low frequency.)

Aluminium Vanes, 2 doz. 1/- By post, 1/6.

Triple Coil Holders, handsome design on Ebonite, 10/-. By post, 11/-.

Large Spacer Washers, 3 doz. 9d. By post, 1/-.

Small Spacer Washers, 6 doz. 1/- By post, 1/4.

**NEW TRADE LIST NOW READY. WE LICK CREATION ON PRICES AND QUALITY.**

## To Callers: We Sell All Component Parts CHEAP!

Brass Rods, Nuts, Washers, Screws, Valve Sockets, Valve Pins, Stop Pins at wholesale prices.

## HEADPHONES

We don't sell cheap and nasty telephones. Try our best French make. Guaranteed quality.  
 4,000 ohms, 21/-, 25/- (Double). Single, 4,000 ohms, 10/-  
 8,000 ohms, 25/- (Double). Post, 1/-.

*NOTE! My terms are strictly cash with order. All orders by post are despatched at the earliest possible moment, as we have great pressure just now on the postal department.*

**M. RAYMOND, 27, LISLE STREET, W.C.2.**

RIGHT OPPOSITE DALY'S GALLERY DOOR:

Phone: Gerrard 4637

To avoid mistakes, this address is close to Charing X Road and Leicester Square Tube.



Your Guarantee.



Your Guarantee.

## BROADCAST RECEIVING SETS

(One, two, three or four Valves)

Our receiving sets will bear the guarantee mark of the Postmaster-General, and are fully licensed under Marconi Patents.

**EFFICIENT SETS AT REASONABLE PRICES.**

Full details and quotations upon application.

Besides complete sets we supply numerous component parts for those wishing to build their own sets.

Price Lists 3d. post free.

Advice and assistance freely given.

**HAMBLING, CLAPP & Co., 110, Strand, London, W.C.**

Phone: Gerrard 8806.

## "OOJAH" HIGH FREQUENCY TRANSFORMERS

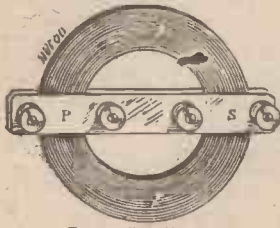

PATENTED  
IN  
THE U.K.

PATENTS  
PENDING  
ABROAD.



FIG. 2

FIG. 1. Reg. No. 685488

These H.F. Transformers have been designed to meet the growing demand of the Wireless Experimenter for a cheap and efficient H.F. Transformer.

**They were used successfully in the recent Transatlantic Tests.**

All Transformers are wound with D.S.C. paraffin-waxed copper wire (affording the highest degree of insulation) of a gauge far thicker than transformers now upon the market.

No.	Min. W/L	Max. W/L	Unmounted	Fig. 1	Fig. 2	
No. 1	300	to 800	1/3	3/9	4/6	
No. 2	600	to 1,400	1/6	4/-	4/6	
No. 3	900	to 1,900	2/6	5/-	5/6	Postage extra
No. 4	1,800	to 4,000	3/-	5/6	6/-	
No. 5	3,000	to 5,000	4/-	6/6	7/-	

**GREENSLADE & BROWN, Lansdowne Rd., Clapham, S.W.9**  
Telephones: Brixton 639. Brixton 3251.

A NEW

## Selector Switch



The ideal Tuning Device—Makes your Set complete and finished—A perfectly insulated 10 stud switch, contacts covered and numbered—Fire proof—Advantageous when Soldering—Difficult to make but easy for you to acquire.

PRICE **4/6** EACH

8/6 per pair

Cash with Order. Packing and Postage Free  
TRADE SUPPLIED

**E. & D. MANUFACTURING CO.**  
112a, Queen Victoria St., London, E.C. 4

# Clarophon



"Clear as a Bell"

## BROADCASTING RECEPTION SETS

\* CRYSTAL SETS

ONE TO FOUR VALVE SETS

P.O. Licence No. 0124

\* We have prepared a range of Broadcasting Reception Sets conforming to P.M.C.'s Regulations, and manufactured under Patentee's Licence.

We invite applications for our "R" List, giving full particulars and prices. We are also prepared to offer special terms to Dealers in Districts where Agencies have not yet been fixed.



## RELIABLE RECEIVING HEADPHONES

4,000 ohms, double bands, complete with flex and tags, at 20s. each, post free

Cash with order. Ex stock. Every instrument guaranteed.

**THE SOUTH WESTERN WIRELESS SUPPLIES CO.,**  
382a, Merton Road, SOUTHFIELDS, LONDON, S.W.18

HEADPHONES, 4,000 ohm, English make, guaranteed . . .	£ 1 5 0
FELLOPHONE 2-VALVE RECEIVER, in Oak Cabinet, with Headphones, Batteries, Accumulator, Aerial and Insulators	£ 9 0 0
2-VALVE AMPLIFIER, in Oak Cabinet (for loud speaker)	£ 5 0 0
SUPER CRYSTAL SET, with double Headphones, Aerial and Insulators	£ 4 0 0
Superior Resistances, 5/-; L.F. Transformers, 21/-; Knobs, 5d.; Condenser Dials, 1/9; Mullard "Ora" Valves, 15/-; Mullard Grid Leaks, 5/-; Ebonite Block Condensers, '0003, 2/9; Switch Arms, 3/6.	
F. N. GOUVY & CO., Ltd., 31, Upper Brook Mews, Lancaster Gate, near Paddington Station.	

# WIRELESS FOR THE HOME

By **NORMAN P. HINTON, B.Sc.**

Written by an Expert for the Amateur, this book is intended as a guide for all who have installed or who contemplate installing wireless apparatus. It tells the amateur how to install the apparatus and gives the best advice on its selection and purchase. The style is simple, technicalities are avoided, and everything that will smooth the way for the amateur and help him to grasp the main principles of wireless, so as to be able, after perusal, to receive messages, etc., has been included.

"WILL BE FOUND INVALUABLE."—*The Broadcaster.*

Price

**2/=**  
net.

Of all  
Booksellers

Price

**2/=**  
net.

Of all  
Booksellers

**PITMAN'S** — Parker Street, Kingsway, London. W.C.2.



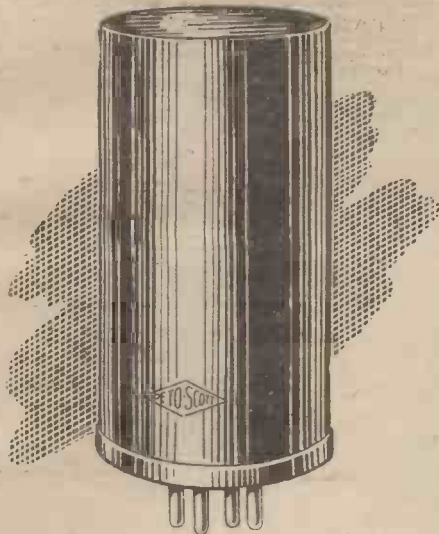

INTRODUCING THE

# For all wave lengths over 1000 MULTI-WAVE AMPLIFIER

(Made throughout by Peto Scott Co.)

HERE is a new plug-in Amplifier being offered with absolute confidence after the most exacting tests. For use on all wave-lengths over 1,000 metres.

No condenser or other critical tuning is required—merely plug in and be assured of the best possible results. Made in two styles in solid ebonite throughout. No. 1 for use with one H.F. Valve, and No. 2 for more than one stage of H.F. amplification (in this case No. 2 is used as coupling between first and second Valves and No. 1 between second Valve and Detector).

No. 1—  
for use with  
one H.F. Valve **8/6**

No. 2—  
for more than  
one stage of H.F.  
amplification **12/6**

Send 6d. for RADIO BOOKLET showing HOW to build up your own Receiving Set with Standard Radio Parts. Full description of principles involved in plain language. 32-PAGE CATALOGUE—FREE

All Peto Scott Radio Instruments sold under Licence from Marconi Co.



Offices and Showrooms:

64, HIGH HOLBORN, W.C.1

**3/9**  
POST  
FREE

**A PERFECT DETECTOR  
FOR WIRE CONTACT  
CRYSTALS**

DOUBLE BALL JOINT  
Reg. Design No. 691368

MICKELWRIGHT, Ltd.  
ALPERTON, WEMBLEY, MX.

## FREE SERVICE

Have you any queries? We answer them FREE. THE RIGHT GOODS AT THE RIGHT PRICE. Single valve sets complete from aerial to earth, £6 10s. Two valve, £8. Three valve, £11 5s. Four valve, £14 10s. Five valve, £18 10. Crystal Sets, 60s. Lists 2d.

Dept. "A"  
SIMPOLIA WIRELESS CO., 170, West Green Rd., Tottenham, N.15  
*15 Years' practical wireless experience.*

## PORTLAND'S PARTS BY POST

# "EBONITE"

	£	s.	d.		£	s.	d.
4 X 4	...	...	1 3	12 X 7	...	...	5 2
7 X 5 1/2	...	...	2 8	12 X 8 1/2	...	...	6 5
8 X 6	...	...	3 0	12 X 10	...	...	7 6
9 X 6	...	...	3 5	15 X 8 1/2	...	...	8 0
10 X 6	...	...	3 9	12 X 12	...	...	9 0
12 X 5 1/2	...	...	4 2	15 X 8 1/2	...	...	9 6
9 X 8 1/2	...	...	4 10	18 X 12	...	...	10 5
17 X 5	...	...	5 3	18 X 18 (Half sheet)	...	...	12 10
7 lb.	...	...	1 3 0	36 X 18	...	...	1 3 0

28 lb., £4

No charge for cutting, waste or postage  
Delivery by return of post

Quality A1. DRILLING, Manufacture, BRITISH  
Thickness, one Quarter—Surface, Mat

## JAMES PORTLAND,

39, SINCLAIR ROAD, OLYMPIA, W.14  
N.B.—Mr. Portland Stocks 200 Wireless Parts

SCIENTIFIC APPLIANCES (Dale & Hollins). Electrical, Magnetic, Optical and ALL RADIO WIRELESS PARTS and Materials at Lowest Prices. Call and see our immense stock or write for Information and Prices. In Centre of London, Top of Kingsway. SCIENTIFIC APPLIANCES, 11 and 29, Sicilian Avenue, London, W.C.1.

## CRYSTAL SETS IN CABINET

Complete with 4,000 ohms Phones, Aerial, etc., £4, cash with order.  
Without Phones, £2 10s. " " " " " "  
Or on easy payments, £1 with order and 5s. per week  
VARIABLE CONDENSERS, any capacity or type.  
COIL HOLDERS, CRYSTAL DETECTORS,  
FILAMENT RESISTANCES, INDUCTANCE  
STUD BASES, SWITCH ARMS, etc.  
Send Stamp for Lists. Our Prices will astound you.  
Save money by dealing direct with the Manufacturers.  
Trade only supplied on small Brass Parts.

T. W. HALL & CO., Manufacturers,  
58, HARDMAN ST., MANCHESTER.

## CRYSTAL SETS

### SPECIAL OFFER

12 in. coil, double slider, oak base, fixed condenser. Hertzite detector, complete with 4,000 ohm head phones, aerial and insulators. **55/-** Cash with order.  
Cash returned if not satisfied. DELIVERY FREE.  
EMANCO, 18, CASTLE STREET, LONG ACRE, W.C.2

## EBONITE!!

SHEET—1 in., 3/6; 1 1/2 in., 5/6; 1 in., 9/- square foot. Any Size Cut. Best "A" Quality.  
Reel Insulators, 3d. each. Aerial Wire, 7/22 Enamel, 5/6 100 ft. Velvet Filament Resistances, with Knobs and Pointer, 3/8 each. Switch Arms, Laminated, 3/3 each. Condenser Dials, with Set Screw, 0°—180°, 3/6 each. High Note Transmitting Buzzers, 3/6. Valve Holders, 1/3 & 1/9. Delivery per return. Enclose Postage, balance returned.  
Houghton's Wireless & Electrical Supplies, High Street, Blackwood, Mon.

**CRYSTAL BROADCASTING RECEIVER**

PASSED BY G.P.O.  
Totally enclosed in highly polished Cabinet, with accommodation for Phones. Mounted on Ebonite plate.

Price - £2 10 0  
With 4,000 ohms phones, 100 ft. aerial, insulators and lead-in tube. Carriage paid U.K. £4 0 0.  
ACCESSORIES & SMALL PARTS SUPPLIED. LIST FREE.

Our Motto:  
"EFFICIENCY with CHEAPNESS"

C. S. MILLS,  
135, High Street, Notting Hill Gate, LONDON.

## Notice to Advertisers

ADVERTISEMENT INSTRUCTIONS and copy for "Amateur Wireless" should be at the office by First Post on FRIDAY morning at the latest.

## PREPAID ADVERTISEMENTS.

Must Sell. Complete crystal set. Nothing to buy. 45 or offer.—Lovell, Wraybury, Bucks. [1 s  
Make Your Own Sets. Working drawings supplied. Write to-day—Puckle, Buckhurst Hill, Essex. [23 r  
25. Nearest offer. Experimenter's crystal set, 8,000 ohm. phones. Particulars, photo sent; seen evenings.—Baverstock, 70, Strode Road, Portsmouth. [3 s  
Wireless.—New 2-valve experimental set, complete; worth £20.—Write Goodacre, Gosberton. [4 s  
Instrument Wire, 46 gauge (.0024) single silk wire, 10s. 6d. 1/2 lb., post free.—Radi Arc Co., 1, Warwick Street, W.1. [5 s  
Accumulators, plates, parts, accessories. Expert repairs.—Barnard, 45, Great Ormond Street, W.C.1. [12 r  
Wireless Dealers throughout Great Britain are strongly advised to stock parts for making up wireless sets. Buy your parts direct from the factory at wholesale prices.—Newtonia Wireless Factory, 13 and 15, Whitcomb Street, London, W.C.2.  
Huge Purchase of ex-Government Wireless Stock. Write for list giving full details. 150-watt dynamo, £1; hedgehog coils, 3s. 6d.; loud speakers, 200 ohms, 7s. 6d.; 1-in. spark coils, 10s.; 1 1/2-in. spark coils, 12s. 6d.; Morse tapping keys, 3s., etc. etc. etc. Three days' approval against cash, or please call. Write for detailed price list of all goods.—E. J. Galpin, 16, Loampit Hill, Lewisham, S.E.13, London. [2 s  
B.A. Screws, Nuts, and Washers, assorted gross; 2s.; list, 2d.—J. H. Bennett, Station Road, Willesden Junction. [17 r  
All About Wireless.—Send for Booklet, 64 pages, with many illustrations, "Wireless Made Easy." Simple, concise explanation of wireless worder. How to make and fit up at home. Post free, 6d. stamps.—The City Wireless and Electrical Depot (Dept. J), 17, Hatton Garden, London, E.C.  
Five Wireless Sets Given Away! Particulars, 3d.—Hinks' Wireless Department, Hardington, Yeovil. [20 r  
The Latest Invention. Steam rotary engine, reg. patent. The finest scientific working steam engine ever invented. 1s. each, 3 for 2s. 6d.—Alan Hitchen, Patentee and Manufacturer, Dept. 17, Burnley. [22 r  
Wires, all gauges; rock bottom prices. Send for list.—Empire Wire Company, 52, May Road, Gillingham, Kent. [15 r

## EASY TERMS OR CASH

Further reduction. No extra charge for extended payments. L.F. Transformers, 15/6 & 20/6. Mullard Or Valves 15/6. Double Headphones, Brown's, Serling's 4,000 ohms, 52/6. Mullard's 4,000 ohms, 30/6. Best French 4,000 ohms, 25/6 & 30/6. British 4,000 ohms, highly sensitive, 20/6 & 22/6. 3 way Coilholders, 13/6 & 17/6. 2 wa., 7/6. Single Holder 2/6. Honeycomb 4-gis list, price according to wavelength. Variable condensers, complete sets of 50 ris, top and bottom, coil 8/-, cap 6/6. Accumulator, 4 volt 20 amps, 17/6. 30 amps, 20/6. 80 amps, 40/6. H. F. Battery, 30 volt 7/6, 60 volt 15/6. Polished Mahogany Cabinet, with Ebonite Panel, drilled, for Single Valve Set 8 by 6, 10 by 8, 15 by 6, three Valves 14 by 12; 2 1/2 and terminals. Terms: One-third with order, balance in six fortnightly payments. Carriage paid on all orders over 40/6. Money returned in full if not completely satisfied. Other accessories for cash at lowest prices.  
G. BUSH, 119, Sutherland Avenue, London, W.9.

## Genuine "Brunet" phones.

Extremely sensitive, as used exclusively by French army and navy, 6 tungsten steel poles each earpiece, 4,000 ohms, limited number at 25/-

## Intervalve Transformers.

Guaranteed highest efficiency, suitable for super regenerative sets. Ratio, 4 1/2 to 1. £1.

CONDENSERS, the last word in efficient design, aluminium frames, all vanes rounded and polished edges, 4" aluminium earthing plate to avoid hand capacity, 3" bevelled and engraved dial for panel mounting, £1.

ACCUMULATORS, 6v. 60 AMP. Celluloid Cases, 37/6, carriage free.

INDUCTANCES, wound 22 or 24 gauge, 12 X 4, 4/6.

BASKET COILS, set of 7. 200/30,000 metres, 6/9.

3-COIL HOLDERS, long handles avoiding capacity, 13/6 each.

Every other accessory stocked.

SEND FOR LIST.

PAGET, 32, Glenythorne Road, Hammersmith.



## A RECEIVING SET WITHOUT 'PHONES IS LIKE A SHIP WITHOUT A RUDDER

### The "Brown" Super-Sensitive Telephones

These Telephones are unquestionably the clearest and most sensitive made, and, consequently, increase the distance over which wireless can be heard. BROWN'S are recognised as the most comfortable to wear, due to their extreme lightness in weight and adaptable adjustment. There is no wireless headphones in the world to compare with BROWN'S.



**"A" TYPE**  
Low Resistance  
58/-

High Resistance  
62/- to 66/-

**"D" TYPE**  
Low Resistance  
48/-

High Resistance  
52/-

(Above Prices include cords.)

Wireless Instruments and parts manufactured by and bearing the name "BROWN" can still be bought with absolute confidence in their quality, value, and efficiency, because throughout this period of increasing wireless activity S. G. BROWN, Ltd., have wisely refused to lower their high standard of quality.

**IMPORTANT NOTICE.**—When purchasing BROWN'S, you should see that the name BROWN is stamped on the back of each ear-piece.

IN UNIVERSAL USE, AS SUPPLIED TO BRITISH, ALLIED AND FOREIGN GOVERNMENTS.

ILLUSTRATED CATALOGUES POST FREE

Head Office & Works—  
Victoria Rd., NORTH  
ACTON, LONDON, W.3.



London Showrooms—  
19, MORTIMER STREET,  
LONDON, W.1.

## THAT BOOK YOU WANT ON WIRELESS OR ANY OTHER TECHNICAL SUBJECT

Foyles have it or will quickly obtain it. 1,000,000 Vols. (Second-hand and New) on Technical and every other conceivable subject in stock. Books sent on approval. Write for Catalogue 104 (free) mentioning requirements. Books Purchased.

**FOYLES, 121, Charing Cross Rd., London.**

### 24-HOUR SERVICE

We make it our boast that every letter received has attention within twenty-four hours. Send your inquiry along and test our service for yourself.

**ELECTRICAL SUPPLY STORES,**  
5, Albert Terrace, King Cross, Halifax, Eng.

New Lists Now Ready.

### 24-HOUR SERVICE

## RELIABLE APPARATUS AT POPULAR PRICES

CRYSTAL SETS, VALVE SETS, etc. EVERY NECESSITY & LUXURY FOR THE WIRELESS EXPERIMENTER.

Fully Illustrated List of Wireless Goods, post free, 4d.

## H. D. BUTLER & CO., LTD.

Office: BANK BUILDINGS, 222, CT. DOVER ST., S.E.1  
(Opposite Boro Tube Station).

Works: CANONBURY, LONDON, N.1.

Telephone: Hop 3029.

Teleg.: "Ingenuity," Phone London."



### STARTLING REDUCTIONS

Ebonite Condenser Dials; Engraved 0-180° and filled white with Knob, Brass Bush and Set Screw 2/6  
Dial only ... 1/6  
Aluminium Condenser Vanes per doz. ... 6d.  
Spacer Washer, small 3d. 6bz.; large 4d. doz.

Knobs, with 2 BA Brass Inset ... 3d.	A.E.G. and Halske Valves for rectifying and amplifying (tested) ... 7/6
Grid Leaks (enclosed), 2 meg. ... 1/6	Crystals (special selected), Bornite, Zincite, Galena, Silicon, Carborundum, Copper Pyrite, Graphite, Tellurium, etc. ... 6d.
Grid Condensers ... 1/6	Egg Insulators, Green ... 4d.
Filament Resistances ... 3/6	Reel " best quality ... 3d.
Crystal Cups with Screw ... 3d.	Hellesen 36 v. Batteries with Tappings and Wander Plug ... 8/6
Fusible Alloy, per stick ... 4d.	Essex 15 v. H.T. Batteries ... 3/6
Inductance Tubes, 12" X 3" ... 6d.	Ebonite Leading In Insulators ... 1/6
" " 12" X 4" ... 9d.	Perikon Detectors on Ebonite Complete with Crystals ... 4/6
" " 12" X 5" ... 1/-	"Ubique" Crystal Set Complete ... 15/6
" " 12" X 6" ... 1/3	
Sliders and Plungers ... 5d.	
Sq. Brass Rod, 12" X 1/4" X 1/4" ... 4d.	
Enamelled Wire, 23 gauge, lb. ... 2/-	
Aerial Wire, 7/25, Stranded, 100' ... 3/-	
Valve Holders, Screwed Legs ... 6d.	

DELIVERY BY RETURN GUARANTEED Postage extra.

THE **ESSEX WIRELESS CO.** 499, GROVE GREEN RD., LEYTONSTONE, E.11.  
Telephone—WANSTEAD 749. (1 min. from Station, G.E.R.)

## GENTS' "DISCOL" H.F. TRANSFORMER

HAS BECOME A  
STANDARD FITTING  
IN THE



RADIO WORLD and IS IN  
LARGE DEMAND BY EVERY CLASS  
OF USER—ASK YOUR DEALER FOR  
GENTS' "DISCOL" TRANSFORMER—6/8 EACH.

**GENT & Co., LTD., FARADAY WKS., LEICESTER**

London: 25, Victoria St., S.W.1.  
Newcastle-on-Tyne: "Tangent House," Blackett St.

## Exide BATTERIES

H.T.  
Batteries  
for  
Valve Sets



24v. 28v. 32v.  
Type B.K.

Owing to the demand for these batteries, all orders will be dealt with in strict rotation. Prices approximately one shilling a volt. :: Ask for Leaflet 4030 ::

THE **Chloride** ELECTRICAL STORAGE COMPANY LIMITED.

CLIFTON JUNCTION, Nr MANCHESTER.

219/229, SHARTESBURY AVENUE, W.C.2.

PRICES AND PARTICULARS ON APPLICATION.

# "LISTEN-IN" ON THE STERLING No. 1 CRYSTAL RECEIVING SET



**Immediate  
Delivery**

The Sterling No. 1 Crystal Receiver has been specially designed for use in connection with the Wireless Telephony Broadcasting Scheme and is suitable for a range of about 25 miles.

The set comprises:

1. **TUNER.**—This consists of an inductance which can be varied by means of tappings taken to stud switches. Two of these are fitted, one for coarse and the other for fine adjustment. A separate coil is provided which can be plugged into a fitting at the back of the instrument (as illustrated) for reception of time signals, etc., from Eiffel Tower.

2. **DETECTOR.**—This is of the crystal type, requiring no battery, and is designed to give universal adjustment over all parts of the crystal.

The apparatus is mounted on ebonite panel and fitted in polished walnut case.

The equipment includes one pair of No. R1258 DOUBLE HEAD TELEPHONES wound to a total resistance of 2,000 ohms the pair.

To be obtained from all dealers or direct from—

**Sterling Telephone and Electric**  
TELEPHONE HOUSE, Co., Ltd.,  
210/212, Tottenham Court Road, London, W.1.

We guarantee that all Radio apparatus sold by us conforms with the Postmaster-General's Broadcasting Licence.

Telephone No. 4144 Museum (7 lines). Telegrams: Cucumis, Wesdo, London.

Works: DAGENHAM, ESSEX.

BRANCHES: NEWCASTLE-ON-TYNE: 9, Clavering Place.  
CARDIFF: 8, Park Place.

**PRICE - £7 12 6**

## LOW PRICES !!!

Purely for the purpose of bringing to your notice our New Show-rooms & Demonstration Lounge, all our small parts are marked at practically Cost Price. Below are a few samples of our prices.

Moulded Valve Holders, Polished, with Flange and 3 screw holes ...	6d	Aluminium Condenser Plates, fixed or moving, per doz. ...	5d
Moulded Polished Slider with Spring and Plunger ...	3d	Ebonite Condenser Ends ...	1/-
Moulded Polished Knobs 1½ in. Blind nut inlaid ...	3½d	Bright Valve Sockets, Best Quality ...	2d
Moulded Condenser Ends drilled ...	5d & 8d	Sensitive French Phones with Leads, 4,000 ohm, pair ...	18/-
Egg Insulators ...	3d	British Made Ditto ...	21/-
Switch Arms with Knob complete ...	1/-	Heavy Teak Base Boards 9½ × 9½ × ¾ ...	1/-
Mahogany Boxes, High Class Polished, 9½ × 6½ × 5 ...	7/-	Ditto, 4½ × 7 × ¾ ...	4d
Ebonite Panels, Best Matt finished, 9 × 6 × ¼, fit neatly into above boxes ...	2/-	Crystal Receivers (Two kinds) ...	25/-
Ditto Panels, 5 × 7 × ¼ ...	1 6	New (ex-Govt. Stores) Brown Phones (type A) H.R. ...	49 6
Ditto ditto 4½ × 4½ × 1½ ...	8d	Ditto, L. R. ...	42 6
		Telephone Cords, Best Make, pair ...	3 6

All kinds of Valves, Phones, Valve and Crystal Sets. Amplifiers, and Hundreds of other Wireless Lines.

These absurd Prices are merely to induce you to give us a call. Terms nett cash with order, incline sufficient for postage. Orders of £1 and over post free.

AT THE BACK OF SELFRIE'S **H. V. ALBROW** 'PHONE NO. 56, GEORGE STREET, MAYFAIR BAKER STREET, W.1 5842

## Wireless Headphones



THIS High Grade Instrument fitted with Aluminium Adjustable Diaphragms is acknowledged by leading experts to be the finest yet placed before the Public. Wound to a total resistance of 2,000 ohms, their sensitivity is equal to most others on the market of 4,000 ohms. Specially shaped Ear Pieces are designed so that all outside noises are excluded. Headbands are extremely light and covered with the finest quality Ebonite.

2,000 Ohms  
**45/-** POST FREE

Special Terms to Trade

**The BRITISH DOMINIONS TRUST Ltd.**  
161, New Bond Street,  
LONDON, W.1. Phone: Gerrard 3438  
B.P.S.



What the Broadcast Licence Covers (p. 616)

# Amateur Wireless And Electrics

ENLARGED  
NUMBER

No. 27

SATURDAY, DECEMBER 9, 1922

Price 3d.



Adjustable Headpiece Set  
(Automatic Telephone Manufacturing Co., Ltd.)

### REGULAR FEATURES

- On Your Wave-length Radiograms
- Correspondence
- Information Bureau
- Club Doings, etc., etc.

### SOME OF THE CONTENTS

- Amateur Experimental Transmitters
- Why do Signals Fade?
- Legal Position of the Wireless Amateur
- Regulation Aerials
- Magnification Units
- How to Obtain a Good Earth
- Reaction and the Valve
- Loud Speakers

# ECONOMIC ELECTRIC LTD.



## Have YOU tried the "XTRAUDION" VALVE?

the latest and best development of the 3 Electrode Valve.

**RECTIFIES, OSCILLATES AMPLIFIES**

Its Mechanical Construction makes it a stronger and more lasting valve than any other.

The Filament consumes well under half-an-amp. at 4 volts. Anode Potential, 50 volts.

Its Amplifying Properties are wonderful and its freedom from noises a revelation. Send for Descriptive Leaflet.

15/-  
PRICE



15/-  
PRICE

We publish the most complete Wireless Catalogue obtainable. 36 pages, profusely illustrated, and many useful circuits for experimental work. Mailed to any address on receipt of four penny stamps.

Head Office 10, FITZROY SQUARE, LONDON, W.1

Showrooms: 303, EUSTON ROAD, N.W.1.

Telephone: MUSEUM 1055

Branch Showrooms & Works: TWICKENHAM

# MITCHELFONES

Are not a spasmodic production to meet a sudden demand, but have been on the market for over three months, and during this period 27,000 have been distributed to the trade, and consequently we have not been able to offer them direct to the retail buyer.

1,000 per week are now available, and we announce

## DELIVERY FROM STOCK

You post your order, or call at our premises and get them at once. Think what this means to you—you, perhaps, who have been waiting and are still waiting.

Standard resistance 4,000 ohms, double headgear with double headstraps, comfortable, highly efficient, and foolproof

25/- per pair.

Special Terms to Traders and deliveries that will surprise you.

## MITCHELLS Electrical & Wireless Ltd.,

Postal Address: McDermott Road, Peckham, S.E.15.  
Retail Address: 188, Rye Lane, Peckham, S.E.15.

Phones: New Cross 1540/1541.

## GREAT BRITAIN'S GREATEST WIRELESS STORE

# "HERTZITE"

OUR GREAT CRYSTAL FOR BROADCASTING  
SIMPLE TO USE. NO BATTERY REQUIRED

Price 2/6 post free

Mounted in our Patent Detector, 5/6, post free

See you get our "Hertzite" and not some substitute

"HERTZITE" and "PERIKON" DETECTOR, 6/6, post free.

We can give the best Wholesale Terms for all Crystals

VALVES: "ORA," "XTRAUDION," "C.V.C.," & "R.M.R." 15/- each

## RUSSELL-SHAW,

38, Great James Street, Bedford Row, W.C.1.

### STARTLING REDUCTIONS

Ebonite Condenser Dials, Engraved 0-180° and filled white with Knob, Brass Bush and Set Screw	2/6
Dial only	1/6
Aluminium Condenser Vanes per doz.	6d.
Spacer Washer, small 3d. doz.; large 4d. doz.	
Knobs, with 2 BA Brass Inset	3d.
Grid Leaks (enclosed), 2 meg.	1/-
Grid Condensers	1/6
Filament Resistances	3/6
Crystal Cups with Screw	3d.
Fusible Alloy, per stick	4d.
Inductance Tubes, 12" x 3"	6d.
" " 12" x 4"	9d.
" " 12" x 5"	1/-
" " 12" x 6"	1'3
Sliders and Plungers	5d.
Sq. Brass Rod, 12" x 1/2" x 1/2"	4d.
Enamelled Wire, 23 gauge, lb.	2/-
Aerial Wire, 7/25, Stranded, 100'	3/-
Valve Holders, Screwed Legs	9d.
A.E.G. and Halske Valves for rectifying and amplifying (tested)	7/6
Crystals (special selected), Bornite, Zincite, Galena, Silicon, Carborundum, Copper Pyrite, Graphite, Tellurium, etc.	6d.
Egg Insulators, Green	4d.
Reel " best quality	3d.
Hellesen 36 v. Batteries with Tappings and Wander Plug	8 6
Essex 15 v. H.T. Batteries	3/-
Ebonite Leading In Insulators	1/6
Perikon Detectors on Ebonite Complete with Crystals	4/-
"Ubique" Crystal Set Complete	15/-

DELIVERY BY RETURN GUARANTEED Postage extra.

THE ESSEX WIRELESS CO. Office & Showrooms: 499, GROVE GREEN RD., LEYTONSTONE, E.11. Telephone-WANSTEAD 749. (1 min. from Station, G.E.R.)



A good judge

JAN. 15<sup>TH</sup>

ON THIS DATE WILL APPEAR

No. 1 of a GREAT NEW MONTHLY JOURNAL

Entitled

"MODERN WIRELESS"

It will be edited by John Scott-Taggart, F.Inst.P., M.I.R.E., assisted by Paul D. Tyers and E. Redpath, well-known contributors to "Amateur Wireless."

A good judge of wireless literature will insist on getting this first number.

Order from your newsagent. It is published by RADIO PRESS LIMITED.

JUST OUT

## Wireless Handbook & Diary, 1923

Price 2/6 net

A complete Letts' Diary with 40 pages of valuable wireless information and the usual pages of useful general information. Beautifully bound in leather, it will form an ideal Xmas gift. Get someone to buy you one.

Obtainable through all Booksellers or direct post free 2/8 from

RADIO PRESS LTD., DEVEREUX COURT, LONDON, W.C.2.



# Amateur Wireless

## and Electricians

No. 27

December 9, 1922

### FADING ||| A PROBLEM STILL TO BE SOLVED

ONE of the outstanding problems of the day with which both amateurs and professional men are faced is the finding of a cure for that very prevalent malady in wireless communication known as fading. Nothing is more common; nothing is more difficult to eradicate; and nothing is more heartily annoying than the coming and going of signals in more or less regular waves of sound.

#### Telegraphy and Telephony

It was bad enough for the enthusiast when Morse was the sole mode of conversation, but now that broadcast telephony is in operation the position becomes more serious, and affects an immeasurably larger number of people. It would be hard to discover anything more likely to raise the choler of a listener than, after getting a charming singer or a delightful orchestral selection nicely tuned in, to hear the volume of sound gradually die away without apparent cause until it becomes almost or quite inaudible. At such times the set has a dead feeling for a few seconds. Such happenings are of frequent occurrence among amateurs, and there seems to be no certain remedy at the present stage of wireless development.

So far, the cause of the trouble has not even been definitely ascertained. Probably in different instances there are varying reasons, but, at any rate, the signals of no station appear to be absolutely immune from attack, though with some transmitting sets the phenomenon seems to be more noticeable.

In dealing with the puzzle, the first question that naturally arises is to what stage

of the communication can the trouble be traced. Is it in the receiving set, is it in the transmitting station, or must we look elsewhere for an answer? Each shade of opinion has numerous adherents, and the experts are far from unanimous in their views.

By those who believe that the receiver is to blame, it is suggested that irregular working of the leak across the grid condenser, or irregular discharge of the battery, is responsible. Possible faults at the transmitter which have been mentioned are variations in the source of power, or heat set up in the valves, causing expansion and contraction of the plate and consequent lack of uniformity in the output. It is also thought that persons moving about in the operating room and

coming close to the transmitter have the effect of altering the wave-length.

#### Theories

A great body of opinion, however, attributes fading to defects in the ether itself, or whatever medium it is by which wireless waves are carried. There is much to be said for this theory, as even the most thorough overhaul of apparatus by experienced men usually fails to locate any satisfactory explanation of the interruption in the signals.

When the apparatus is suspected it is almost always some part of the valve, transmitting or receiving, of which the investigator challenges the efficiency, but with the crystal, and also long ago in the days of the magnetic detector, one of the bugbears of an operator's life was this selfsame fading.

The subject is one that needs very full and careful inquiry, but it may be pointed out that there is already proof that in certain parts of the world there are clearly defined and continuous dead spots through which no wireless message may pass. Is it not possible, and even feasible, that when the cause of the existence of one is discovered, the problem

of the other will at the same time find a solution?

In some tests carried out by a number of amateurs living in the same town, and within a distance of a mile or two of each other, it was found with regard to reception from a selected broadcasting station that fading was experienced at approximately the same moment by each of the experimenters. Further investigations along these lines may lead to an understanding of the character of this obstacle and its subjection. G. A. F.

### EXAMPLES OF UNIT CONSTRUCTION

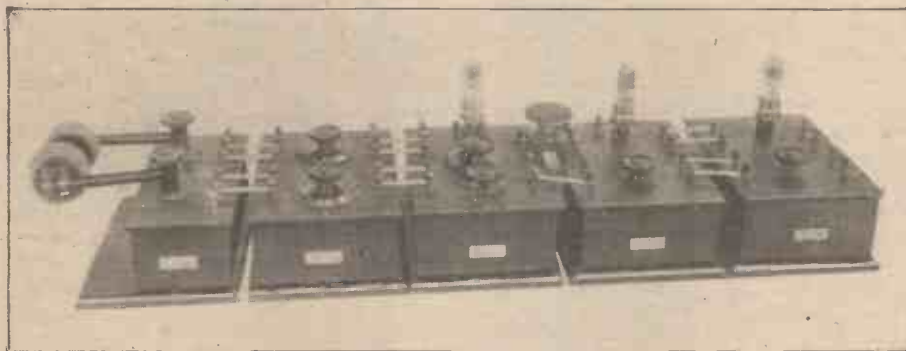

Five-part Unit Set (Fleet Radio Co.)

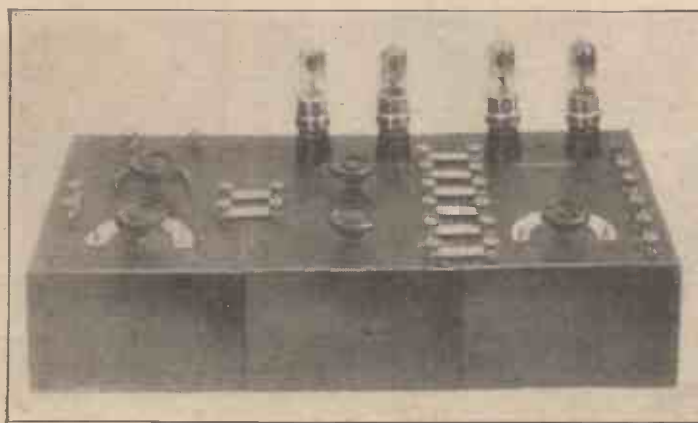

Four-valve Unit Set (Consolidated Trading Co.)

# Amateur Experimental Transmitters

An Article Describing the Various Methods and Apparatus Used in Amateur Transmissions

MANY beginners perhaps think that a continuous-wave transmitter is expensive or complicated; the object of this article is to show that such a belief is

useful in this connection. Terminals **K** are for use when transmitting C.W.; when telephony is required these terminals are short-circuited, and a low-resistance microphone is connected to terminals **M** in the earth lead.

negligible wattage absorbed by the set; its transformation ratio may conveniently be of the order of 1 : 1. The apparatus shown in Fig. 2 will not be suitable for telephony transmission, but only "tonic train," and therefore terminals **M** and **K** should be shorted.

The Morse key for connection in the grid circuit may be of quite light construction, as the power of the set is so low.

With the second arrangement a small

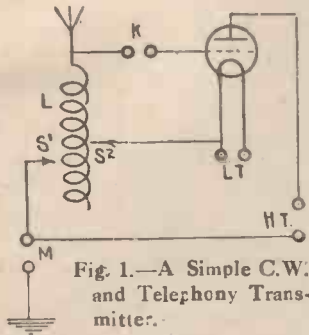

Fig. 1.—A Simple C.W. and Telephony Transmitter.

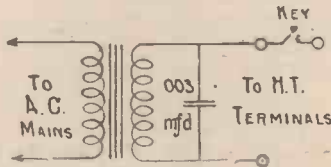

Fig. 2.—Method of Using A.C. Mains for H.T. Supply.

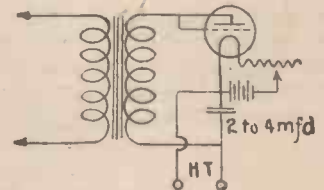

Fig. 3.—Rectified A.C. for C.W. and Telephony Transmission.

erroneous, and that most probably a low-power set may be assembled from material in the reader's possession without any monetary outlay whatever. It must be understood, however, that before any transmitting set can be operated a transmitting licence must be obtained.

In Fig. 1, from which all unnecessary components have been omitted, the coil **L** is a small double-slide tuning inductance, of the type used for crystal reception, the size of which is unimportant, provided it is capable of tuning the experimenter's aerial to 440 metres. Most amateurs who have taken up valve work will have such a coil left over from their crystal days, but for those who wish to make one, a coil 3 in. diameter by 4 in. long wound full of 22-gauge enamelled wire is recommended, as this will easily reach the standard 440-metre wave-length with a small aerial.

For the valve an ordinary R type may be used, or alternatively an ES2, B, or AT25; to increase the power several tubes of the same type may be connected in parallel. The low-tension voltage will

The microphone carries the oscillating antenna current, and therefore should have as little metalwork in it as possible; very short leads are desirable, and it should preferably be fixed to the set instead of being held in the hand. If

transformer of the "bell ringing" type may replace the filament battery of the rectifying valve; this valve may be an ordinary R type or a special rectifier, such as a Cossor; its filament must not be fed from the same source as the main oscillatory valve. If there is no electricity laid on in the house and it is not convenient to use a 100—200-volt dry-cell battery, the arrangement sketched in Fig. 4 may be used. It is particularly suitable for portable sets, and enables tonic-train transmission to be obtained when terminals **M** and **K** (Fig. 1) are shorted.

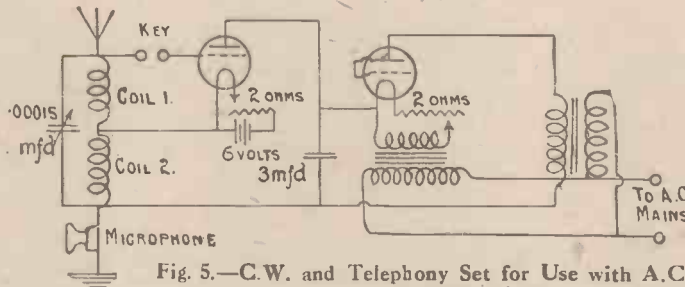

Fig. 5.—C.W. and Telephony Set for Use with A.C.

several microphones are to hand, all should be tried in turn, as one will usually give distinctly better results than the rest.

The best type of high-tension supply for use with this set is the D.C. house-lighting mains, at from 80 to 600 volts; it is possible that some fortunate amateurs may have current at the latter pressure laid on for power purposes, and if so, quite a good range may be expected. Should the light-

The induction coil used must be very small, with a very thick (comparatively) secondary. The capacity of the condenser across this will depend on the size of the coil; it should be extremely well insulated, and large enough to enable a potential of about 400 volts R.M.S. to be obtained across the anode and filament of the transmitting valve.

In "tuning-up" these transmitters for best results the following procedure should be adopted:

1. Connect up all component parts with the shortest possible leads, making sure

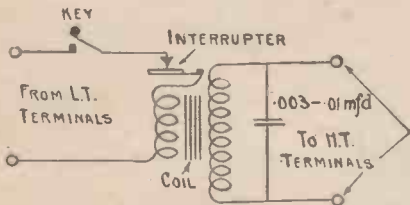

Fig. 4.—Connections of Induction Coil for Supplying H.T. Current.

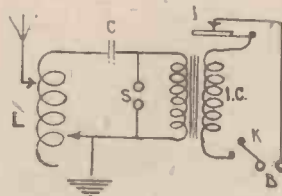

Fig. 6.—Standard Spark Transmitter.

depend on the type of valve, but it should be as high as may safely be applied; a low-resistance, close-regulation rheostat in series with a 6-volt accumulator is very

ing circuit be A.C., the arrangements shown in Figs. 2 and 3 may be used. The size of the transformer is quite immaterial, as it draws upon the meter only for the

that every connection is clean and bright. Terminals **K** should be shorted.

2. Listen in on a wave-meter set to 440 metres, adjusting wave-length by **S**<sup>1</sup> (see

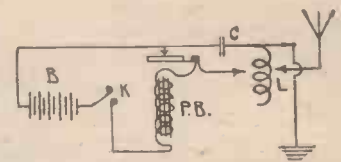

Fig. 7.—Power-buzzer Transmitter.



Fig. 1), and oscillation point, by  $S^2$  and filament rheostat. Unless the set is arranged for T.T. a heterodyne wave-meter is required, which makes adjustment rather difficult; alternatively, a clock may be arranged to tick in front of the microphone, and an ordinary spark wave-meter employed.

3. If a tonic-train induction-coil set has been assembled, adjust break and reverse secondary leads once or twice to obtain best results.

4. When using rectifying valve, adjustment of filament brilliancy may be made with advantage.

5. If using a microphone with "variable damping" device, adjust this for loudest speech on a crystal set arranged near by.

If the set should break down from some obscure cause, one of the following faults may be the cause, and the suspected part should be tested thoroughly:

1. Microphone granules fused. Remedy: Replace with larger ones.
2. Plate potential reversed.
3. Disconnection.
4. Condenser shorted internally.
5. Lighting-main fuse blown.
6. Valve filament touching grid.

Sometimes, on this short wave-length, a difficulty is experienced in making a set oscillate. This trouble can be overcome by replacing the two-slide tuner by two pancake coils, each of thirty turns of 22-gauge d.c.c. wire wound on a nine-peg former with an internal diameter of  $1\frac{1}{2}$  in. A very small variable condenser (not exceeding .00015 mfd. maximum capacity) is used to tune the aerial. The windings of the two coils should be arranged to run all in one direction, and the coupling between the coils should be tight but variable.

Fig. 5 shows the connections when using these coils and rectified A.C. Any other circuit required may be arranged, of course, by reference to preceding diagrams.

It is recommended that the apparatus described above be mounted on a base-board of ample size rather than in a cabinet, as the experimenter will probably, when he has gained experience with these simple circuits, desire to make improvements, such as replacing the present tuning arrangements by coupled circuits with separate reaction coil, or elaborating the radiophone into a choke-control set.

**Spark Transmitters**

To turn from these valve circuits to the interesting, though fast disappearing, spark transmitter, we find that the usual arrangement of circuit is as in Fig. 6, where L is the tuning coil, of about six turns of copper strip wound pancake fashion with  $\frac{1}{4}$  in. between turns, and with a mean diameter of 6 in.; C is a very well-insulated condenser of .0025 mfd. capacity; S the spark gap, variable up to  $\frac{1}{2}$  in.; IC an ordinary induction coil, of which I is the break; K a Morse key with heavy contacts; and B the battery terminals.

It is not intended to go at all thoroughly into the construction of spark sets, as this type of transmitter is becoming rarer as the numerous advantages of C.W. on the score of efficiency, close tuning, and ability to transmit speech are becoming more apparent.

**Power Buzzers**

In the category of spark transmitters is the so-called "power-buzzer," which has not in this country received the attention which its efficiency on very low powers warrants. The customary circuit arrangement is as in Fig. 7. The buzzer consists of a core, similar to that of an induction coil, about 6 in. long, wound with about 2 lb. of 20-gauge d.c.c. copper wire, with an interrupter arranged as for a spark coil. Such a buzzer will take about .3 to .5 amperes at 20 volts from a battery of large dry cells.

The tuning inductance, which should be accessible to the clips at almost all points,

may be as described for an ordinary spark set above. The best capacity for the condenser is found by trial, .005 mfd. being a very usual value. The best value for this condenser is shown by minimum sparking with best tone at interrupter.

**Practical Advice**

In conclusion, the author would recommend to the intending experimenter the following:

1. Always use a wave-meter.
  2. Strictly observe the regulations appertaining to amateur transmitters.
  3. Experiment thoroughly for maximum range with minimum power.
  4. Speak clearly and loudly, frequently giving your "call" when radiotelephoning.
  5. Lastly, never rest content with usual or ordinary results—always expect your set to be capable of improvement to such an extent as to make it more efficient than any other.
- T. W.

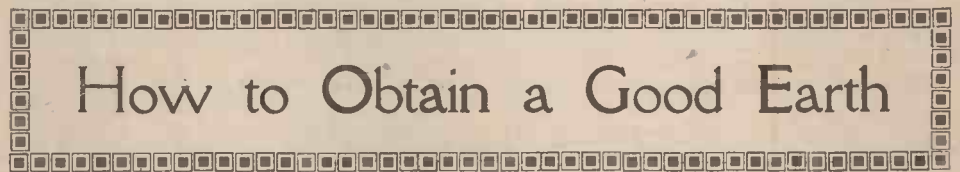

# How to Obtain a Good Earth

**A**N earth is necessary for all wireless sets before signals can be sent or received, and it is important that a good earth should be obtained, for it can just as easily be the cause of poor signals as a bad aerial can. Great care should therefore be taken to make sure that the earth connection is a good one.

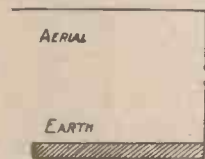

Fig. 1—Earth Arrangement for Spark Transmitting.



Fig. 2.—Earth Arrangement for Continuous-wave Transmitting.

There are several methods of making an earth, and one of the following can be made use of wherever the reader may be situated:

- (1) A connection made to a water-pipe (preferably the main feed pipe to the cistern) as near the ground as possible.
- (2) A sheet of metal about a yard square buried a few feet deep in the ground.
- (3) A network of wires buried under the ground or grass.
- (4) A metal gauze mat laid upon the grass or damp soil.

**Selection**

I have enumerated them in the order in which I should select them, but what would prove satisfactory in one place

might not be so successful in another, as much depends upon local conditions. The reader, if in difficulty, can try each of the above in turn, or a combination of any, and note which gives the best results.

It should be borne in mind that an earth should be made in a place where the soil is as moist as possible and not in dry places. For that reason the water-pipe earth is usually a very good one, because it is bound to reach damp soil somewhere.

The connection to the sheet of metal, if in suitable damp soil, should prove just as satisfactory as the water-pipe. The network of wires spread out and buried under the soil or grass can also prove a very satisfactory earth, for there is usually a fair amount of moisture under grass.

The metal gauze mat lying on the grass is more or less the same as the network of wires just described.

The reader must remember that in gas-piping there is often a coating of paint in the joints which may greatly reduce the efficiency of the earth, and then there is the risk of lightning, the likely consequences of which do not need to be mentioned.

In some cases water-pipes may have painted joints, but in the majority of cases the joints are soldered.

It may not be known to some that the best place for the earth for transmitting, if employing methods 2, 3 or 4, is for it to run parallel to and directly under the aerial (Fig. 1) if using spark sets, and parallel to the aerial, but running behind it (Fig. 2), if using continuous-wave sets.

C. E. B.

# All About the Valve.—VIII

## How Reaction Takes Place

It should be mentioned that in the case of soft tubes, such as the Round valve and the early Audion type, a small condenser inserted in the external grid path is sufficient to ensure rectification without the use of a leak resistance. In this case the grid charge accumulated as the result of an incident wave train is relieved by being transferred to the positive ions of the residual gas contained in the tube.

### Retroaction

An important step in the evolution of the thermionic tube was the discovery about 1913 of the principle of retroaction. This development appears to have been made almost simultaneously by Franklin and Round in England, by Armstrong in America, and by Meissner in Germany. It consists essentially in so linking together the input or grid and the output or plate circuits that they interact by mutual stimulation until, in the limiting case, the tube is set into continuous oscillation.

This new characteristic opened out many fresh fields of utility. Thermionic tubes, as generators of continuous waves, are displacing the older systems of C.W. and telephony transmitters, such as the high-frequency alternator and the arc, owing to their superior advantages as regards compactness, simplicity, regularity in operation, and portability.

Among other things the thermionic generator rendered it possible to equip our scouting aircraft during the war with a light-weight wireless telephony outfit of remarkable efficiency and range. Similarly small- and large-powered valve transmitters for C.W. and tonic-train telegraphy were rapidly developed, and proved themselves superior in many respects to the various types of rotating-gap, quenched-spark, and similar transmitters previously in use.

Fig. 15 shows a typical circuit arrangement for a back-coupled valve as applied to receive C.W.

### Its First Uses

Before discussing the electrical action of such a circuit, it should perhaps be mentioned that back-coupling was first used simply and solely as a means of amplifying incoming signals to a greater extent than was previously possible. It was only subsequently discovered that the ultimate result of the interaction between the grid and plate circuits was to set the whole system into a state of self-oscillation. Further, although as shown in Fig. 15 the connection between the two circuits arises from the magnetic linkage across the coils A and B, other means of electric coupling, such as by the electro-static action of a condenser, are equally effective

in producing the regenerative action desired.

When the coils AB, Fig. 15, are loosely coupled together, the first impact of signal energy upon the aerial is transferred to the grid. Suppose the first result to be that the grid voltage is made more positive. This is reflected in an immediate rise in the value of the plate current, which in turn increases the magnetic flux through the coil A. The new lines of force link with the coil B, and so induce a transient voltage which is in phase with the plate current. This, on being superposed upon the existing grid voltage, tends to augment the first effect—that is, it boosts the plate current upwards, beyond the value it would have reached without the back-coupling action.

### Self-oscillation

Now if the reaction is set below the

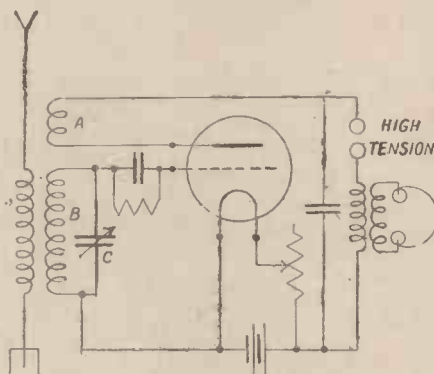

Fig. 15.—Retroactively-coupled Tube.

point at which self-oscillation occurs (as where the tube is being used purely as an amplifier for increasing signals), the upward growth of the plate current is ultimately arrested by the impact of the next half-wave of signal energy, which this time throws the grid voltage in the negative direction.

The resulting drop in the plate current reduces the value of the magnetic linkage between the coils AB, and this time the resulting transient E.M.F. induced in the coil B is in the opposite direction (again in phase with the current) and tends to throw the grid voltage still more negative, so that the drop in the plate current is again greater by the effect of this transferred voltage.

The dropping current in turn is again arrested by the ensuing half-wave of signal energy, and is turned upwards by the change in grid voltage, and so the process goes on so long as the signal impulses are being received. The net effect is, of course, to increase the energy changes in the plate current so as to give amplified effects in the phones.

### A Simple Explanation

A simple way of viewing this action is to regard it as a mode of lessening the damping of the applied signals. It is obvious that when a signal "impulses" the tuned circuit BC the resultant oscillation should persist indefinitely if it were not for the reactance or resistance of the circuit itself, which in actual practice rapidly damps out the effect of each impulse. If, however, an electro-motive force were to be applied in phase with the current and equal in value to the product of the current and the resistance, the effect of the damping resistances would be cancelled, and the implied oscillation would persist, theoretically for ever, at a constant amplitude. In a retroactively coupled tube the additional electro-motive force so required is transferred from the plate circuit to the grid, with the result that the applied signal impulses are maintained by reducing the damping of the grid circuit.

A critical point is reached when the transferred E.M.F. is just sufficient to counteract entirely all the damping effects of the grid circuit. At this point the first signal impulse would set the grid circuit BC, continuously oscillating.

This is not desirable in practice when receiving damped signals, as it would result in a steady current through the phones which would persist after the cessation of the signal itself.

Accordingly the regenerative coupling is set just below this critical point, so that the maximum amplification is attained whilst keeping the plate circuit responsive to the impact and cessation of each signal.

D. ALCASE.

(To be continued)

## Regulation Aerials

A CONSIDERABLE amount of uncertainty exists regarding the conditions that must be fulfilled for an aerial to comply with the official regulations. The following are the conditions as communicated by the Secretary of the General Post Office: It is necessary that the aerial of a station for the reception or transmission of wireless signals shall not exceed a combined height and length of 100 ft. The height is regarded as the vertical height from the leading-in point to the level of the highest point of the aerial, and the length as the length of the span. Provided the foregoing limit is observed there is no restriction as to the number of wires which may be used in the aerial. Authority to use an aerial in excess of the standard limit is only granted where special justification is shown.



# "ORA"

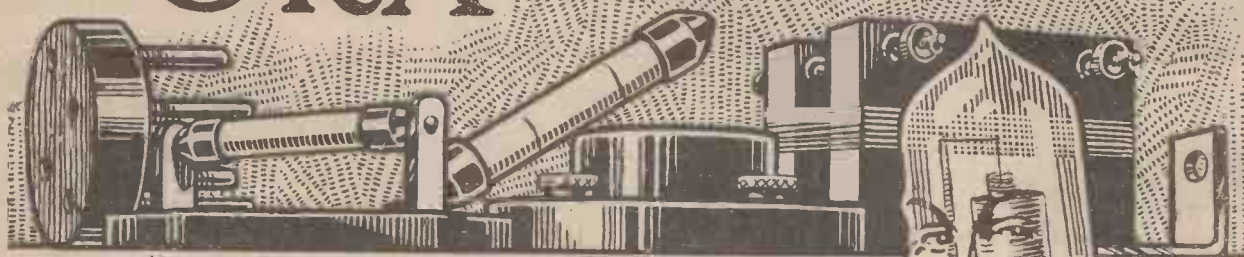

*for Perfect Reception*

For receiving vocal and instrumental items you must have

## MULLARD "ORA" VALVES

to get the best results.

**O**scillates **R**ectifies **A**mplifies.

Specially recommended where good amplification is required.

The "Ora" Valve requires about 3.8 volts on the filament and 30 volts or over between the anode and filament for efficient results

**15/-** each

### IMPORTANT NOTICE

The great demand for Mullard "ORA" Valves and other accessories has compelled us to open much larger works. A greatly increased output is now available.

The Mullard "R" Valve is now reduced in price from 22/6 to 17/6.

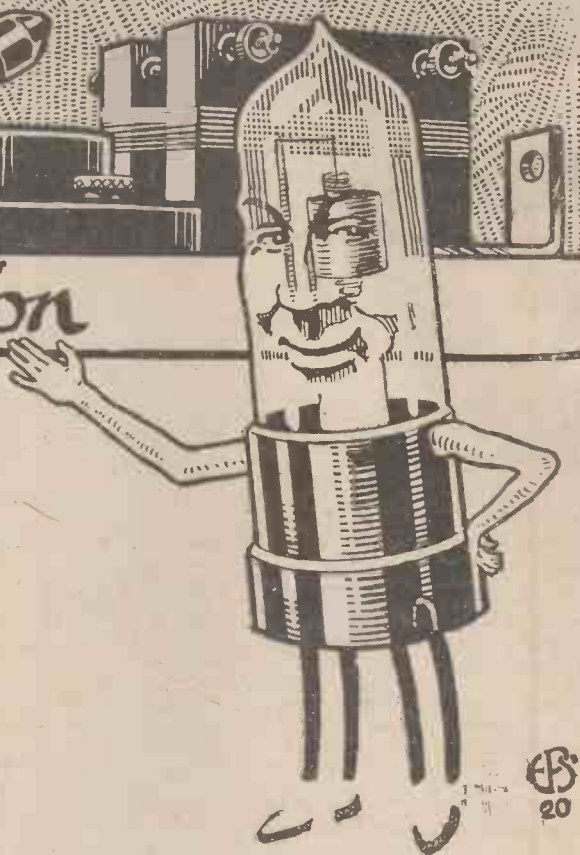

## Mullard Radio Valve Co. Ltd.

45, Nightingale Lane, Balham, S.W.12.

Contractors to H.M. Admiralty,  
War Office, Royal Air Force & Post Office.

Telephone:  
Battersea  
1068

Codes:  
ABC (5 Ed)  
Bentley's

Telegrams:  
'Radiovalve, Hammer'  
London.



Name and Address .....		Please send me post free		1 enclose (Cheque, Money Order, P.O.) value	
Quantity	Description	Price	Quantity	Description	Price
.....	Telephone Head Sets	35/- per set	.....	Telephone Head Sets	35/- per set
.....	"ORA" Valves	15/- each	.....	"ORA" Valves	15/- each
.....	Grid A Resistances	5/- "	.....	Grid A Resistances	5/- "
.....	Anode A or B Resistances	2/6 "	.....	Anode A or B Resistances	2/6 "
.....	BA Condensers, .0003 mfd.	7/6 "	.....	BA Condensers, .0003 mfd.	7/6 "
.....	Combined Resistance and Condenser	5/- "	.....	Combined Resistance and Condenser	5/- "
.....	Valve Bases with Terminals	1/3 "	.....	Valve Bases with Terminals	1/3 "
.....	Valve Sockets	9d. per pair	.....	Valve Sockets	9d. per pair
.....	Terminal Clips	.....	.....	Terminal Clips	.....

To the  
**MULLARD RADIO VALVE CO. LTD**  
45, Nightingale Lane,  
Balham,  
S.W.12.

Name of usual Wireless Dealer

**SEND THIS TO-DAY**

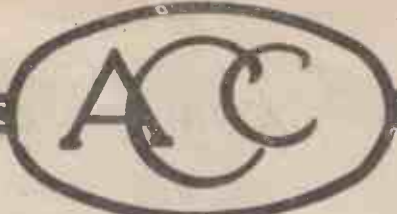

Unprecedented Offer of—

# Ex-Govt. WIRELESS MATERIAL

## AN APOLOGY.

Owing to the overwhelming number of orders received by us for this Ex-Government apparatus, we have been unable to cope with the tremendous number of enquiries as expeditiously as we would wish.

We respectfully ask the indulgence of readers, and assure them that we will reply to their queries at the earliest possible moment.

In the meantime we are despatching all orders in strict rotation, and guarantee delivery within 48 hours of receipt.

### RECEIVERS, C.W. MARK III

This set comprises a complete 2-valve Receiving Set, with a wave-length range of 350—1,800 metres. The addition of High and Low Tension Batteries, valves, and 'phones completes the entire receiving station. For the reception of Broadcast concerts this set is ideal, the strength and clarity of the signals being absolutely wonderful. London readers should take the opportunity of hearing this set working at our Showrooms.

Only 100 left **£9 9 0**

Complete with 4-volt 40-amp. Fuller Block Accumulator, 60-volt H.T. Battery, 2 Mullard "ORA" Valves, and pair of Brown "A" Type Headphones, complete with cords ...

**£15 10 0**

### AMPLIFIERS, C. MARK IV

This instrument is a complete three-valve low-frequency amplifier, and can be used in many ways without modification.

The C. Mark IV. Amplifier is an improvement on the C. Mark III. (the latter being sold by other dealers at £6 5s. od. each without cases), inasmuch as the C. Mark IV. contains terminals and change-over switch, allowing the use of the instrument for either High- or Low-Frequency amplification.

The price at which we are offering these Amplifiers is less than the actual value of the transformers contained in the instrument. Limited number only left subject to being unsold.

Complete in Mahogany Case

**£4 5 0**

### INSULATED AERIALS

40-feet **£0 1 0**

60-feet **£0 1 6**

### C.W. TRANSMITTERS, MARK III, 30 WATT

For two valves. Complete, with aerial ammeter, platinum-pointed Morse Key, in Mahogany case. Wave-length range 300—1,800 metres.

Note.—This set can be conveniently converted into a 2-valve Detector-Amplifying Receiver. **£3 5 0**

### B MARK II RECEIVERS

Vertical pattern. Can be easily converted to any wave-length ... **£3 15 0**

Above, fitted with Variable Air Condenser, .0005 mfd., in place of change-over switch ... **£4 15 0**

### HETERODYNE WAVEMETERS. 500-3,000 Metres

For Receiving—without Galvanometer ... **£2 0 0**

For Transmitting and Receiving, containing Weston Galvanometer ... **£3 0 0**

### AERIAL MASTS AND EQUIPMENT

15-foot Steel Masts in Sections, each 2 ft. 8½ in., complete with Halyard, Pulley and Stays. Can be erected by one man, and are portable. The height can be increased up to 30 feet by the use of extra stays ... Per Set Complete **£0 15 0**

30-foot DITTO, in SECTIONS, each 4 ft. 3 in. (mast only) ... Per Set Complete **£0 17 6**

### SULLIVAN HEADPHONES

120 ohms ... **£0 12 6**

### SULLIVAN HEADPHONES

120 ohms complete with new Telephone Transformer (value 25s.) in iron case ... **£1 10 0**

Kindly note that the above prices do not include Packing and Carriage. Please add, therefore, an appropriate amount to cover this. Any surplus will be refunded.

## The City Accumulator Co.

79, MARK LANE, — LONDON, E.C.3

Phone: Avenue 1316

Wholesale and Retail Distributors for Messrs. BURNDEPT, Ltd. Same Trade Discount Allowed as by Manufacturers.

### AGENTS.

London: H. V. ALBROW, 56, George Street, Baker Street, W.1.

Glos.: BRISTOL WIRELESS Co., 52, Cotham Hill, Bristol.

Leicester: WALTER ROWE, LTD., 96, Granby Street, Leicester.

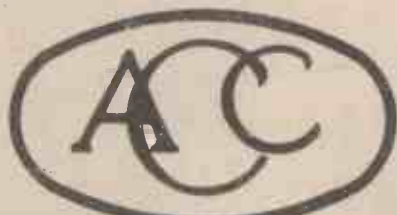

S. Wales: SOUTH WALES WIRELESS INSTALLATION Co., LTD., 18, West Bude Street, Cardiff.

N. Wales, Lancs., Ches. & L.O.M.: THE "ALL-BRITISH" WIRELESS MANUFACTURES Co., LTD., 18, Vauxhall Road, Liverpool.



# Oh You Wavelength!

## Too Much Condenser

## 2L O, 2W P and Radiola

## A Wireless Miracle

you possibly can in the primary of the aerial tuning inductance? Coils are often stated to tune from 400 to 1,000 metres *with a .001 condenser*; they will do so, but every extra degree over about .45 marked by the condenser pointer means a loss in efficiency. If you wish your set to be really efficient you should not use a variable condenser in the primary bigger than .0005 mfd. The A.T.C. should be wired in series for all wave lengths under 1,000 metres. It is difficult to realise the almost infinite smallness of the impulses brought in by the aerial to the set. Certainly the current is a million times too weak to light even a pocket flash-lamp. There is absolutely nothing to play with, and if we reduce the efficiency of the set by adding capacity, simply because we are too lazy to put on a bigger set of coils, we must not be surprised if we do not get the best results. The moral of all this is: Always use the largest possible coils for any given wavelength, and tune them by adding as little capacity as you can.

\* \* \* \*

Here is a tip that may save quite a number of shillings over the lead-in and the earth wire. If you buy heavy rubbered cable for the purpose it will cost from 6d. to 1s. a foot. But there is some excellent stuff used by electricians for wiring heavily-loaded household circuits which will answer admirably. It consists of seven strands of 18 or 22-gauge copper wire with an insulation whose resistance is 8 megohms. This wire, which costs about 7d. a yard, will do all that is needed.

\* \* \* \*

2L O's new orchestra is a great feature. At their first performance on Saturday, November 25th, they had a *succès fou*. So many congratulatory calls were received on the "land-line" that the announcer had to issue a C.Q. message begging admirers to send postcards instead of telephoning in order to prevent the one operator on duty at the exchange from being snowed under. The orchestra's performance of part of the "Peer Gynt" suite was magnificent, and the dance music to which they treated us at intervals must have set hundreds of couples a-fox-trotting in all parts of the country.

The news bulletins are not exactly striking. There is, of course, the weather forecast, followed by cricket and billiard scores and market reports, all of which will be greatly appreciated by those who do not see the evening paper. But the rest of the programme consists too much of police court news of no particular interest, and of "snippy bits" of the kind which harassed sub-editors generally use for filling up gaps into which nothing else will fit. You know the sort of thing: Mr. Blank Dash, aged 103, has just made a flight in an aeroplane. A deported tom-cat has arrived home after a journey of empty miles, and so on.

\* \* \* \*

There is one thing about it all, however: if you do not like what London is transmitting you can always turn on Birmingham, and *vice versa*. Birmingham's transmissions are amazingly good. Though he is three times as far from my aerial as is 2L O, he comes in every bit as strongly. It is a pity that he puts on so many gramophone records. After all, if one wants to hear gramophone music one can do so without using a wireless set. Records undoubtedly do not sound well in wireless transmissions; one can tell them in a moment. If the broadcasting stations are going to make extensive use of what the Americans call "canned stuff" they will not encourage the popularity of wireless.

\* \* \* \*

On the whole, our broadcasting programmes are quite good, but they cannot compare with the Concerts Radiola, transmitted by the Société Française Radio-électrique, whose station is at Levallois-Perrett, near Paris. Next time you are listening-in between 8 and 9 p.m., or between 2 and 3 o'clock on a Sunday afternoon, tune to 1,500 metres, and you should have no difficulty in picking up this station, for its transmissions come in very strongly. On November 26th the *matinée* performance consisted of orchestral pieces, all beautifully rendered, by Weber, Mozart, Gluck and Greig, a humorous turn by one of the most popular music-hall stars—his topical song, with its reference to Lloy' Jorge, would have brought down any French house—and songs and instrumental solos by artistes of distinction from the Opéra and the Conservatoire. Every item was a little gem. Not the least attractive part of the programme lay in the short chats on the various composers given by the announcer before the performance of pieces by them: "*Morceau par Weber, compositeur allemand—mais rappelez-vous y'aît mourut il-y-a plus d'un siècle!*" Nothing Hunnish is yet very popular in

France. This, mark you, is done every evening and twice on Sundays, by a company which receives no share of licence fees, for the benefit of listeners-in who are not compelled to use hall-marked apparatus. There is a moral in this somewhere.

\* \* \* \*

Perhaps the greatest miracle that has ever happened in wireless was announced by 2L O with his 9 p.m. bulletin on Monday, November 27th. The entire programme of an American broadcasting station was heard that morning in Croydon. It appears that Mr. J. H. Ridley, of Messrs. Burndept, was listening-in on 325 metres for American amateurs, when he suddenly heard strains of music. Sharpening the tuning, he was amazed to pick up the call letters W J2, which are those of the Newark, New Jersey, broadcasting station. For a whole hour he listened to the programme, every item of which was clear and distinct. This opens up an entirely new field in wireless. At no far distant time we shall be able to listen in our own homes to telephony transmissions from all parts of the world.

\* \* \* \*

It is to be hoped that amateurs are not going to take the broadcast licence lying down. If they make a determined and combined effort they can ensure the modification, if not the complete suppression, of the odious condition No. 2 on the back. If, however, they are content to do nothing they will have themselves to blame if the monopoly, having become firmly established, proceeds to treat them as monopolies usually do.

\* \* \* \*

Did you hear that delightful jester, the O.C. Writtle transmission, in his burlesque of 2L O's new chimes? 'Twas done, so 'tis said, with two biscuit tins and an empty soda water bottle.

\* \* \* \*

Overheard Conversation: "Yes, isn't this wireless a wonderful thing! So romantic, too, to think of messages coming like that through space. My daughter's fiancé, a *charming* man, my dear, always says good-night to her by wireless. He failed to do so the other night and we couldn't think why until he sent a note to say that his osculation transformer had broken down!" Well! Well! Well!  
THERMION.

## The Broadcast Licence

## 2M T's Burlesque

## A New Transformer!

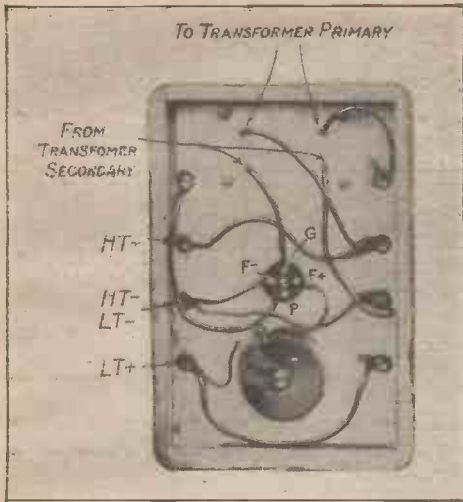

Fig. 9.—Under Side of Low-frequency Panel.

# “Amateur Wireless” Ideal Unit Receiving Set

The Third Article by Mr. R. W. Hallows on the Construction of a Complete Unit Set.

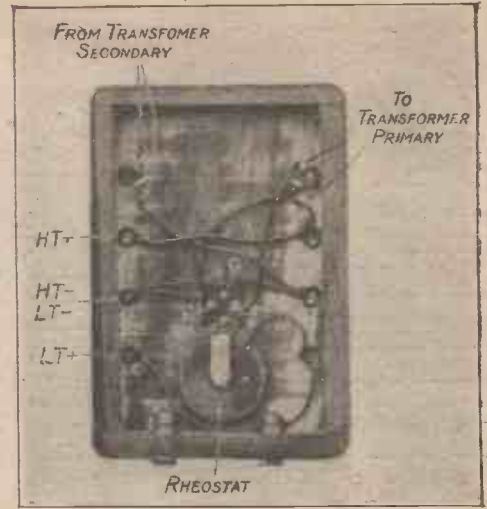

Fig. 7.—Under Side of High-frequency Panel.

MOST of those who use multi-valve sets will agree that if there are to be several steps of amplification the majority of them should be of the high-frequency type. Note magnification, though it gives a much greater volume of sound in the receivers, has several serious drawbacks. Amongst other things it always gives rise to a certain amount of distortion. This, if only one low-frequency valve is used, is not as a rule serious, but if there are several stages, it may become bad enough to spoil most of one's pleasure in using the set. There is also the further disadvantage that the slightest parasitic noise in the set is enormously magnified. The reader will therefore do well to begin with three panels—one radio-frequency

amplifier, a rectifier and one note-magnifier—and to add to his set by fitting up some further high-frequency units rather than those which amplify at audio frequency.

The two types of panels differ considerably since their tasks are quite unlike. The radio-frequency unit receives the rapidly oscillating waves that are delivered to it either by the secondary of the tuning inductance or by the plate of a previous valve. These are complete waves, and if the wave-length is 400 metres 750,000 undulations occur in each second of time. When the waves have passed through the detecting valve they are delivered by it to the note-magnifier in a very different form. In the first

place, one-half of each has been filtered out, so that it consists now of either a crest or a trough; in the second, the waves have now been marshalled into groups, and, as it were, fused together, so that several hundreds of them combine to produce one movement of the telephone-receiver diaphragms.

The high-frequency impulses may be passed on in several ways, two of the best of which for short wave reception, the tuned plate and the air-core transformer, are shown diagrammatically in Figs. 1 and 2. A third method, the resistance-capacity coupling, though excellent for wave-lengths of over 1,000 metres, does not give very good results with the shorter waves.

For the conversion of the original

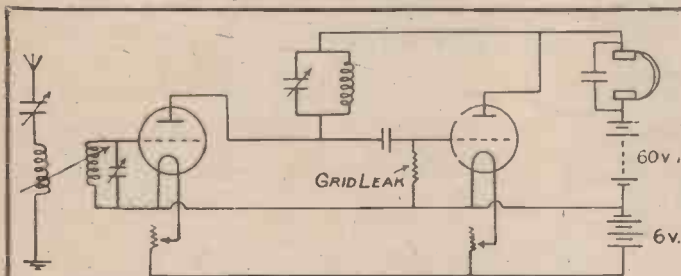

Fig. 2.—Tuned-plate Coupling of H.F. Unit to Rectifying Valve.

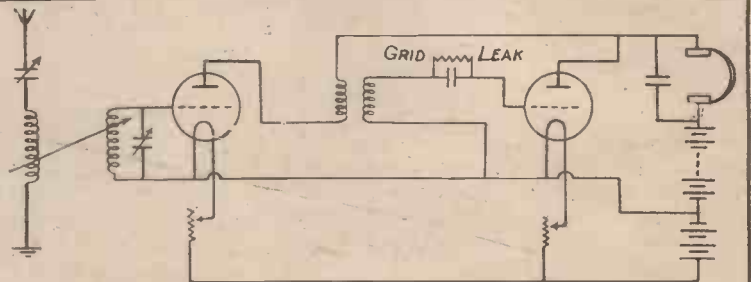

Fig. 1.—High-frequency Air-cored Transformer Coupling.

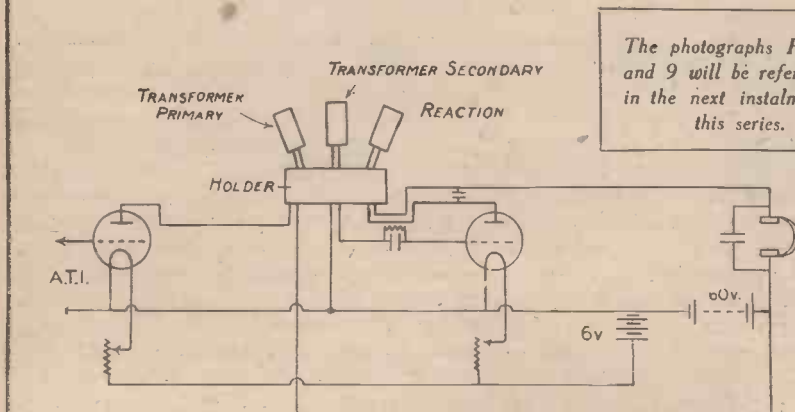

Fig. 4.—Diagram of Coil Holder used as H.F. Transformer.

The photographs Figs. 8 and 9 will be referred to in the next instalment of this series.



Fig. 8.—Photograph of Low-frequency Panel with Iron-core Transformer.



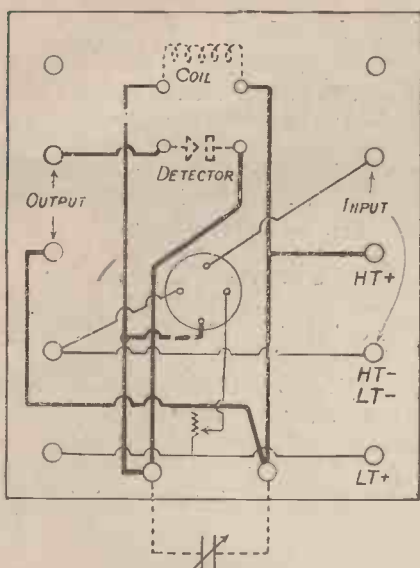

Fig. 3.—Wiring Diagram of H.F. and Detector Panel.

crystal detector panel we make use of the first of these methods, using the basket coil originally mounted for the aerial tuning inductance as the coil in the tuned-anode circuit.

Fig. 4 (p. 568) shows the finished panel. The valve-holder and filament rheostat are mounted as before, and two extra terminals are required at the lower ends of the panel. These are to take the leads from the variable condenser which tunes the anode inductance. About .0006 mfd. will be found to be a suitable value for this condenser.

The wiring, which is shown in Fig. 3, looks at first sight rather a formidable undertaking, but actually it does not present any great difficulty, especially if the anode circuit, shown in heavy black lines, is completed first. It is a good tip when making up any of the panels described in these articles to draw pencil lines on the under side of each corresponding to the leads themselves. The wiring, having been first mapped out in this way, is then quite an easy task; further, if at any time temporary changes are made in the circuits, the pencilled lines showing the original positions of the wires are always there to act as guides and time-savers when the connections come to be remade. Records of several circuits can be kept by using pencils with different coloured leads.

With some kinds of crystals it will be found advantageous to place a small fixed condenser between the detector and the top output terminal; this acts as a block, preventing any of the high-tension current from passing through the crystal.

The panel can now be used with any kind of two-coil tuning inductance as a complete receiving unit by clipping it to the terminal panel and attaching the head-telephones to the output terminals on the other side. Those who have previously used only the unaided crystal will be surprised at the increase in both range and volume of sound which follows on the addition of even one high-frequency valve. Great care should be taken to find the most sensitive spot on the crystal and to get the pressure of the contact exactly right. To do this you cannot do better than adjust the set to 600 metres, on which wave-length there is always something to hear at any hour of the day or night. When you have made signals as loud as possible by means of the tuning inductance, and the variable condenser of the plate circuit, turn your attention to the detector and adjust it so that you are getting the best out of it.

**High-frequency Panel**

The high-frequency panel containing a valve alone is most conveniently made with transformer coupling. A high-frequency transformer consists of two coils of equal, or almost equal, size coupled together. The primary receives the output of the valve, inducing in the secondary a current which is passed on to the grid of the succeeding valve. A perfectly efficient transformer can be made by using two basket coils which are simply laid one on top of the other, the upper one being moved about until the most effective degree of coupling has been found. With this type of transformer it is an advantage, though it is not absolutely necessary,

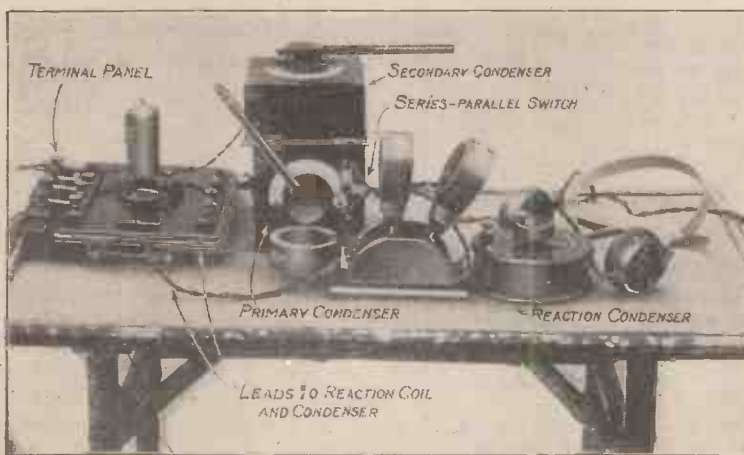

Fig. 6.—Photograph of Rectifying Panel in Use as "Single-valver."

to tune one of the coils with a variable condenser. Fig. 4 shows how a three-coil holder may be used as a high-frequency transformer, the reaction coil from the rectifying panel being coupled in this case to the secondary of the transformer, a method which entirely eliminates the risk of causing annoyance to others by re-radiation from one's own set.

Either of these improvised instruments can be mounted on the high-frequency

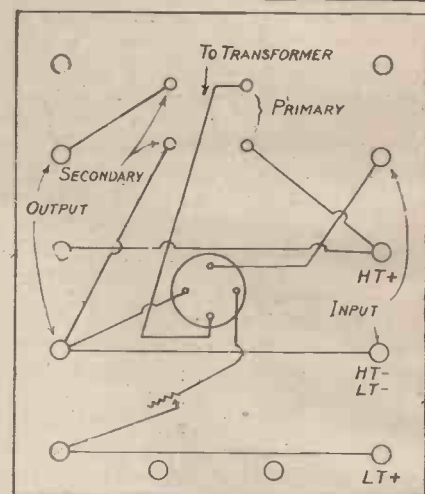

Fig. 5.—Wiring Diagram of H.F. Transformer Panel.

panel in the place occupied by the transformer shown in the photograph (Fig. 6, p. 569). There are two main types of transformer on the market to-day, the "plug-in" and the tapped. The former are small mushroom-shaped affairs provided with four prongs (one pair for the primary and the other for the secondary turns) which fit into an ordinary valve holder. Their great advantage is their cheapness, for they can be bought for about 5s. each. They have, however, one serious drawback, which is that each covers a very limited range of wave-lengths, so that a set of eight or so is necessary in order to receive all transmissions from 250 to 25,000 metres. If the set is to be used only for the reception of broadcasting the plug-in transformer will answer admirably; but if you wish to be able to receive everything that is going in

the way of both telephony and telegraphy, you will find the tapped transformer much more convenient. Those the author uses are provided with a rotary switch and four studs. The first is tuned to wave-lengths from 200-400 metres, the second 400-1,000, the third 1,000-3,000, and the last to those over 3,000. Whichever type it is decided to use see that they are well made, and remember that if two or more transformers are used, their electrical values must be identical, otherwise they will work against instead of with each other.

The high-frequency panel differs from the valve rectifying unit in that it has only the ten terminals arranged in two rows of five on the long ebonite strips. The input or primary side of the transformer receives impulses from the plate circuit of the valve, which makes it in some cases rather difficult to mount it so that the lead to the grid of the valve shall not run near that going from its plate to the transformer. It is important to keep

these wires as far apart as possible, otherwise the set may be noisy when high-frequency amplification is in use owing to capacity and induction effects between them. Care must be taken that these wires are not parallel to each other and close together.

Fig. 7 shows the under side of the panel, whilst Fig. 5 shows the wiring diagrams, which is applicable to any type of transformer.

**Valve for Amplification**

Though a soft valve may be used with advantage as a rectifier, this type will not give good amplification. A really hard valve, that is one with a high degree of vacuum, will give by far the best results, but care should be taken to select one which works best with the same plate potential as the valve used on the rectifying panel. If amplifying and rectifying valves require quite different voltages on their plates, the unit system becomes unsatisfactory unless a potentiometer is used in the anode circuit of the rectifier, since normally the H.T. leads supply the same potential to each valve.

When the high-frequency unit has been completed it should be tested in conjunction with the rectifying panel. Fig. 6 shows the rectifying panel used alone as a complete receiver. The H.F. panel is simply inserted in front of it. You cannot go wrong in the connections, since the correct pairs of terminals come opposite each other when the units are placed side by side. It will probably be found that the tuning of the aerial and secondary inductances alters considerably as a high-frequency valve is added. As soon as signals are coming in as well as it is possible to get them turn to the filament rheostats; and adjust them, moving at the same time the wander-plugs of the high-tension battery until the best combination of filament current and plate potential has been found. In both cases use the least amount of "juice" consistent with good signal strength.

**Self-oscillation**

Each additional step of high-frequency amplification increases the tendency of the set to fall into self-oscillation. The signs of this can be readily recognised: signals become "woolly," and if the aerial terminal is touched with a wet finger a distinct "tap" is heard in the phones. The question of eliminating self-oscillation will be dealt with fully in a later article; for the present it will suffice to say that it can usually be prevented in small sets (1) by using the smallest efficient reaction coil; (2) by lessening filament current or anode potential; (3) by working always with the loosest possible coupling.

The set that is being described is remarkably quiet in its working, but parasitic noises may make their unwelcome appearance at odd times in any set. If they occur, suspect the batteries first, and if they prove blameless look for loose connections.

R. W. HALLOWS.

A Broadcast Licence  
Covers a Built-up  
Set

BY the courtesy of Messrs. Peto Scott we are able to publish the following correspondence:

*Applicant's Letters to the Postmaster-General*

"DEAR SIR,—I beg to apply for an experimental licence to enable me to use a home-constructed Peto Scott installation for receiving at my private residence. I have already a broadcasting licence, but realise that this will be useless for the apparatus I desire to use and the field I wish to cover."

*The Reply*

"DEAR SIR,—With reference to previous correspondence, I am directed by the Postmaster-General to forward a licence for the reception of broadcast messages, and to say that, as it is understood that you have already purchased your apparatus, no objection will be raised to its use provided that it was purchased from a British manufacturer, and that it complies with the technical conditions of the licence. The requirements in regard to the apparatus bearing the registered trade mark of the British Broadcasting Company will not in the circumstances be enforced as far as the set in question is concerned. I am to add that when this licence is renewable an account will be rendered by the local postmaster.—I am, your obedient servant,

"G. E. P. MURRAY."

*Our Comment*

Taken in conjunction with the correspondence which we published last week, it is evident that there has been a very significant change of front on the part of the Post Office during recent weeks. We very heartily congratulate the Post Office officials on having taken such a wide and generous view of the situation.

It follows from last week's correspondence that the Post Office recognises that experimental licences are for those *who make their own sets*, or for persons who produce evidence that they are qualified to conduct experiments.

That is a great point. The correspondence that we print above establishes another one.

In the present case the applicant had a Peto Scott set which he had built up from parts purchased from the manufacturers. Evidently the Post Office did not think that this was a case for an experimental licence; but, inasmuch as the set had been built up from parts supplied by a British manu-

facturer, they took the view that the set could properly be used under the terms of the ordinary broadcast licence. This will be splendid news for the thousands of wireless enthusiasts who have been placed in a state of difficulty during the last few weeks, and also for that body of manufacturers which, since the issue of broadcast regulations, have simply not known where they were.



**The British Radio Manufacturers' and Traders' Association, Limited**

WE learn that a company, limited by guarantee and bearing the above name, has now completed its legal formation. It takes over the members of the Wireless Manufacturers' and Traders' Association of Great Britain and also the members of the Trade Section of the recently-formed Radio Association. There is not much doubt that it will be able to do its work in a far more thorough and efficient manner than was possible for either of the two associations from which it draws its original members. Its executive council, which will not exceed twenty, already contains fifteen representatives of firms every one of which is well known to readers of this journal. The registered office of the association is Dundee House, 15, Eastcheap, London, E.C.3; and the secretary is Mr. Charles Latham, A.L.A.A., A.I.A.R.

Membership of this association is open to any British firm in the wireless industry, the annual subscription being two guineas. The principle of alternative representation has been adopted so that any one of a firm's chief officials may represent it in the meetings of the association. There are also to be honorary members, and in the case of these no subscription will be payable.

Among the many objects of the association are the promotion, encouragement and protection of the manufacturers' and traders' interests; the guidance of public opinion in matters that vitally concern the wireless trade; the establishment of a patent bureau (the very first duty of which will be to investigate the present patent position); the compilation and distribution of statistics of the industry; and the formation of a court of arbitration to which differences and disputes can be referred.

We are informed that the association has already entered into communication with the British Broadcasting Company, and also with the Postmaster-General on matters of immediate concern to the industry, and from our acquaintance with the trade generally we are of opinion that the association will supply "a long-felt want." It would be well for all interested members of the trade to put themselves into communication with the secretary, whose name and address we give above.



# Radiograms

THE Right. Hon. F. G. Kellaway, P.C., has been appointed a director of Marconi's Wireless Telegraph Company, Limited. This appointment was the subject of questions in the House of Commons on November 30.

The Cunard Steamship Company have decided to maintain its own wireless service instead of employing Marconi operators.

It is stated that Mr. R. E. Williams, of Holyhead, employing only three valves, has received a concert broadcast from America.

A pilotless biplane was successfully directed and controlled by wireless at Etampes on November 24.

Telephony was received from Newark (W J Z), United States, 3,750 miles from London, on November 27, by Mr. Frank Phillips, chief engineer of Messrs. Burndept, Limited. This is the first time on record that a wireless concert has been received in England from America. A special note appears in another column.

The proprietor of the Wilton Arms, Thornton Heath, has a wireless receiver in his saloon-bar, and customers are entertained with concerts from the various broadcasting stations.

Capt. J. W. Moore, Huddersfield's chief constable, has received permission to install wireless apparatus at the central police offices. This is the second of its kind, the first being at Middlesbrough.

A noticeable omission in the programme of the London Broadcasting station is that so far little has been transmitted of the nature that appeals to children.

Letters from two South African correspondents state that the conditions for receiving are very bad. Only telegraphy can be heard, and atmospheric are very bad. AMATEUR WIRELESS has to be ordered in advance, and costs 6d.

The only drawback at the Glasgow and District Radio Club's wireless exhibition was that the accommodation in the hall was quite inadequate. Two thousand persons paid for admission, but owing to the congestion at the show many more had to

be denied entrance. One gratifying result has been the greatly increased membership. At the subsequent meeting of the club no fewer than sixty-nine new applications were submitted.

The British Broadcasting Co. has decided that the temporary Birmingham district broadcasting station is to be at the General Electric Works, Witton, Birmingham.

At the special request of the King, whilst on an unofficial visit to the Marine and Small Craft Exhibition on November 22nd, a message was sent through by wireless from Buckingham Palace to illustrate to His Majesty how H.R.H. the Duke of York opened the exhibition.

Walsall Education Committee has sanctioned a grant of thirty shillings towards the cost of installing wireless apparatus in a Council school, provided that it is for the use of the children. The teachers and scholars have agreed to find the remainder of the apparatus.

President Harding's speech to the Senate on the Ship Subsidy Bill on November 21 was broadcast to the country.

The Detroit Police Department has been issued with the call letters KOP. Pure genius on somebody's part.

In a lecture and demonstration on "Broadcasting" the lecturer, Mr. Anthony Harkey, mentioned that an ether wave could travel seven and a half times round the world in a second.

The missionaries of the Methodist Episcopal Church have decided to use wireless telephones as well as aeroplanes as an aid to carrying missionary work into the inaccessible parts of China.

A suggestion is made that buses and trams should be equipped with receiving apparatus for the entertainment of passengers.

Scottish amateurs must be amongst the smartest going. The latest report—from the Ayrshire coast—is that Birmingham and The Hague have both been excellently heard on a rubber-covered 40-ft. aerial only 18 ft. from the ground. The music was audible at a distance of 6 ft. from the phones. The set was quite an ordinary one, with two stages of amplification.

The P.M.G. of New Zealand has stated that he is in favour of New Zealand having direct wireless communication with the world instead of the chain system. Two

companies have been negotiating for rights, but the Government is unable to move, owing to the fact that Great Britain has not yet come to a decision.

It is stated in certain official quarters in Glasgow that under the broadcasting scheme the station for the Lowlands of Scotland, which was provisionally fixed for either Edinburgh or Glasgow, will be established in the latter city. At one time a town midway between the two big centres was suggested.

## BROADCAST TELEPHONY

- Some of these transmissions are commercial or official. Wave-lengths and times are liable to alteration without notice.*
- London B.B.C. Station (2L O), 369 metres. Daily, usually 5 p.m. to 10 p.m.
  - Manchester B.B.C. Station (2Z Y), 385 metres. Daily, usually 5 p.m. to 10 p.m.
  - Birmingham B.B.C. Station (2W P), 425 metres. Daily, usually 5 p.m. to 10 p.m.
  - Croydon (G/E D), 900 metres. Daily.
  - Writtle (2M T), 400 metres. Tuesdays, 8 p.m.
  - Eiffel Tower (F L), 2,600 metres. Daily, 6.20 p.m. to 7 p.m.
  - The Hague (P C G G), 1,085 metres. Sundays, 3 p.m. to 5 p.m.
  - Rome (I C D), 3,200 metres. Daily, 10 a.m.
  - Königswusterhausen (L P), 2,800 metres. Daily, 4 p.m. to 5.30 p.m.
  - Amsterdam (P C A), 1,800 metres. Daily, 1.10 p.m.
  - Haren (O P V H), 900 metres. Daily, every hour from 11.20 a.m. to 4.20 p.m.

# "WORK" CHRISTMAS NUMBER

GREATLY ENLARGED  
USUAL PRICE — 3d.

This week's issue is a special number and contains over a dozen articles of a seasonable nature in addition to the regular features

### PRINCIPAL CONTENTS

- Amateur Wireless at Christmas
- Easily-made Chinese Lanterns
- A Cliff Tramway: A Working Toy that will stand hard use
- Parlour Tricks for Christmas Parties
- "Making-up" for Amateur Theatricals
- On the Rise of the Curtain: an Illusion in which the Conjuror Introduces Himself
- Making Christmas Cards at Home
- A Santa Claus Sleigh
- Standing Figure Calendars
- Home Decorations and Illuminations
- The Master Puzzle
- Some New Conjuring Tricks for the Amateur
- Preparing for the Christmas Party
- The Parlour Stage and Its Arrangement

40 pages 3d. Fully Illustrated.

THE Postal Service, which covers the collection, transmission and delivery of written communications generally, has always been a State monopoly, and is at present vested in the Postmaster-General.

The introduction of the telegraph as a new mode of communication was followed in 1869 by the passing of the Telegraph Act which gave the Postmaster-General the exclusive privilege (with certain exceptions in favour of railway companies, etc.) of transmitting telegrams and of performing all the incidental services of receiving, collecting and delivering them.

**Government Monopoly**

When in the year 1880 the telephone made its appearance as a commercial proposition, the Postmaster-General claimed that its use was an infringement of his monopoly rights under the above-mentioned Act. This view was upheld by the courts, and in consequence it became necessary for each telephone company to hold a licence, and to pay a royalty of ten per cent. on its gross revenue to the Post Office—a state of affairs that lasted until the National Telephone Company was bought out by the State. Now practically all existing public telephone systems have passed into the hands of the Post Office.

**The Introduction of Wireless**

The invention of wireless signalling, in turn, opened up a fresh avenue of possible encroachment upon the postal preserves. The new development was accordingly met by the passing in 1904 of the Wireless Telegraph Act, under which the present W.T. Broadcast and Experimental Licences are issued.

Originally the life of this Act was limited to a period of two years, from the 15th of August, 1904, to the 31st July, 1906.

Possibly the authorities thought the newfangled wireless contrivance would be dead and forgotten by then. Curiously enough, it survived and flourished, and it therefore became necessary to pass a new Act in 1906, which in one curt paragraph extended the provisions of the former Act until the 31st December, 1909.

Since then the original statute has been extended from time to time up to the present day in a somewhat furtive manner, and in company with sundry other minor legislation, by means of a succession of Expiring Laws Continuation Acts.

**THE LEGAL THE WIRELE**

An Authoritative article, spe of the Editor of "A.W

For good or ill, then, the Act of 1904 governs the position to-day, and determines the relation in which the would-be user of wireless apparatus finds himself situated, both as regards the law generally and the Postmaster-General in particular.

**Restrictions**

In these circumstances it is most important that every owner of a wireless set should have a clear idea of what restrictions and duties the statute imposes.

The first section of the Act lays down that no person shall establish any wireless telegraph station or install or work any apparatus for wireless telegraphy in any place except under and in accordance with a licence granted to him by the Postmaster-General for that purpose.



"Broadcast De Luxe" (T. H. Isted).



"Aero" Adapter (J. A. Coomes, Ltd.).



"Gramaphix" Loud-speaker.

**Loud Speake**

THE first photograph shows a lo in conjunction with a 5-valve am that amplifies the sound is shown in being simply slipped on to a special principle is made with the arrangem this case the sound chamber of the the sound. The next photograph sh contained type, whilst the last pict in cabin



# POSITION OF WIRELESS AMATEUR

Originally written at the request  
of the Postmaster-General by a Barrister-at-law.

It goes on to declare that a licence shall be in such form and for such period as the Postmaster-General may determine, and shall contain the terms, conditions and restrictions on and subject to which the licence is granted. The fees payable for a licence are to be determined by the Postmaster-General with the consent of the Treasury.

## An Explanation

The expression "Wireless Telegraphy" is laid down to cover any system of communication (in the nature of telegraphy) without the aid of any wire connecting the transmitting and receiving ends. The definition covers wireless telephony.

It will be observed that the effect of the above paragraphs is to prohibit in the

widest possible manner the installation or use of any wireless set, either for reception or transmission, by anyone who has not fortified himself by a licence from the Postmaster-General. Further, the Postmaster-General is given entire discretion as to what terms he

may impose as a condition for granting the licence.

Section 2 sets out that where an applicant for a licence furnishes satisfactory proof to the Postmaster-General that his sole object in obtaining the licence is to enable him to conduct experiments in wireless work, a licence for that purpose shall be granted, subject to such special terms, conditions and restrictions as the Postmaster-General may think proper, but shall not be subject to any rent or royalty.

## The Rights of the Experimenter

The purport of the above paragraph is to exempt a genuine experimenter from the monopoly powers of the Postmaster-General. Provided that he can prove that his only object is to carry out wireless in-

vestigations, the Act entitles him to have a licence, as a matter of right. But it is still left to the Postmaster-General to say what constitutes a satisfactory proof that the applicant is in fact an experimenter. Further, the licence may be hedged in with whatever restrictions the Postmaster-General may think proper.

The average amateur probably thinks that this concession practically amounts to nothing, as it leaves too much to the discretion of the authority in power at the Post Office. To a certain extent this criticism is true enough. If, however, the administrative official in practice abuses his authority to such an extent as to evade the spirit of the Act, it is always open to an aggrieved applicant who is a bona-fide experimenter to appeal to the High Court for a mandamus to compel the Postmaster-General to carry out the provisions of the Act, and to grant a licence upon reasonable terms.

## Licence Fees

The statement that such licences are free from any payment in respect of rent or royalty requires some little explanation. The Postmaster-General's monopoly in wireless signalling is analogous to the position a patentee occupies in respect of a protected invention, and the rent or royalty here referred to is a monetary

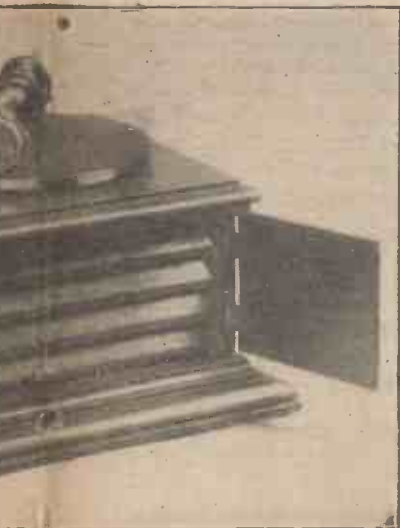

Attachment for Gramophone.

Examples of some  
Usual Types

loud speaker of the self-contained type amplifier. An attachment for the phones in the next picture, the usual ear-pieces of a self-contained horn. Use of the same attachment shown in the third photograph, in a gramophone being utilised to amplify the sound. Shows another loud speaker of the self-contained type. The picture is that of a loud speaker arranged in a self-contained form.



"Magnavox."



"Radio Teleola."

payment as consideration for the privilege of sharing the monopoly. The fee of ten shillings actually charged for an experimental licence is not a rent or royalty proper, but merely covers the administrative charges connected with the examination, grant and registration of such licences.

It should be pointed out that licences to receive broadcast matter do not fall under the above-mentioned section of the Act. They are not to be obtained as a matter of right under the statute, nor are they necessarily free from the duty to pay rent or royalty. In fact, however, as is well known, such licences are being granted under certain conditions to all who care to apply for them.

The fee charged, namely ten shillings a year, happens to be the same as that levied upon the experimenter, but the Postmaster-General would be within his powers in charging any fee he might consider reasonable, purely as compensation for sharing his monopoly rights, apart from any sum due to the purveyors of the Broadcast Service, music, news, etc. As is now well known, the licence fee is to be shared between the Broadcasting Company and the Postmaster-General, the latter's portion being probably just sufficient to cover registration and general administration expenses.

#### Penalties

The Act lays down some very severe penalties for any infringement of its provisions.

Any person installing or using wireless apparatus without a licence is guilty of a misdemeanour. If charged before a magistrate he is liable to a penalty of £10. He may also be brought before Quarter Sessions or the Assizes on indictment, and, if convicted there, may be fined anything up to £100, or be sentenced to a maximum term of imprisonment of 12 months, with or without hard labour. In either case he is also liable to have his set confiscated.

A saving clause, however, says that no prosecution shall be launched against any offender except by order of the Postmaster-General, the Admiralty, the Army Council, or the Board of Trade.

Finally, a further sub-section states that any magistrate (if he is satisfied that there is reasonable ground for believing that any apparatus for wireless telegraphy has been installed or worked in any place without a licence having been obtained), may grant a search warrant to any police officer or other properly accredited official, authorising him to enter and inspect the installation and to seize any apparatus which appears to him to be used or intended to be used for the purpose of wireless signalling.

#### Out-of-date Regulations

These regulations were framed at a time when wireless was practically in its infancy, long before the present type of compact apparatus was even dreamt of.

Since then the phenomenal developments that have taken place in radio science promise to make a wireless receiver most certainly an asset, if not an absolute necessity in every home in the country.

Under such circumstances how can one contemplate without amusement the case of some respectable householder, or the still harder case of his youthful but impecunious son and heir, being solemnly threatened by an irate P.M.G. with the horrible fate laid down by the Wireless Telegraph Act of 1904 for those who neglect to procure or renew the necessary licence. In all seriousness, the law should command respect, not provoke a grin.

In effect the 1904 Act with its absurdly drastic powers and penalties is completely out of touch with present facts. The sooner it is replaced upon the Statute Book by a measure more in accordance with public approval the better for all concerned.

## CORRESPONDENCE

### Motor Racing and Wireless

SIR,—We have pleasure in informing you that our experiments on Brooklands with a wireless equipped car were entirely successful, and we succeeded in transmitting speech, whilst the car was circling the track, to a station situated at the top of the members' hill. At high speed a slight muffling of speech was noticeable owing to the vibration of the microphone and swaying of the aerial wires, but these are technical details which can soon be overcome. The receiver, operated by Mr. Partridge (2KF), of Merton, was of the four-valve type—one H.F., one rectifier, and two note-magnifying; the receiving aerial was approximately 60 ft. long, supported by two trees at a height of about 25 ft. Earth was obtained by pushing a screwdriver down a wet drain. Three pairs of telephones were in use. We hope to continue these experiments at an early date.—ELECTRICAL DISPOSALS SYNDICATE.

### Filament Fuses

SIR,—I have noted the article in your recent issue dealing with the above, and think the following suggestion from my own experience may prove of interest to your readers. I think more valves are spoilt by hastily replacing them without switching off the H.T. battery than from any other cause. At least that is my own experience; others may have different ways of being reckless. A ½-amp. "Cozwhy" fitted in a holder against the negative end of the H.T. battery may be relied on to blow first in such cases. If the negative terminal is used to vary grid potentials, that is, is a wander-plug, the fuse-holder can be conveniently fitted close by, and a lead of sufficient length to allow for the variation connected between it and the plug. This precaution also serves to prevent the battery from being run down by accidental short cir-

cuits. Incidentally, why do the makers of valve-holders design them so that such troubles are possible? If the brass sockets are well sunk in the ebonite there is no risk. One would have expected it to be the first thing a designer would think of, but so far I have only met one case in which this point has received attention on a standard design.—C. B. (London, S.W.).

## CLUB DOINGS

### Ilkley and District Wireless Society

Hon. Sec.—E. STANLEY DOBSON, Lorne House, Richmond Place, Ilkley.

A MEETING of the society was held on Nov. 6, when Dr. J. B. Whitfield gave a lecture on "The Relation Supposed to Exist between Electricity and Matter." The lecturer commenced by giving a short account of the various states in which matter can exist, and the means by which it may be transformed from one state into another.

The division of matter by mechanical means was explained, showing how the smallest particle into which matter can be divided retains all the chemical properties and composition of the substance in bulk. The theory of the subdivision of the molecule in atoms was explained, and the difference between the properties of the constituent elements and the composite substance after chemical action takes place, was dealt with by reference to salts such as common table salt, with which everyone is familiar. The discovery of radio-active elements and the electronic emissions in a vacuum tube were then traced out, and the modern electron theory and its explanation of these phenomena was explained. The lecturer then gave an interesting demonstration of the action of these electronic emissions, by means of a very fine X-ray outfit.

### Hartlepool and District Wireless Society

Hon. Sec.—MR. A. BROWN, 62, Grange Road, West Hartlepool.

VISITORS are invited to any of this society's weekly meetings, excepting on the first Friday of each month, which is devoted to the society's business. Full particulars may be obtained on application to the secretary.

### Ilford and District Radio Society

Hon. Sec.—A. E. GREGORY, 77, Khedive Road, Forest Gate, E.7.

UNDER the auspices of the above society, demonstrations of wireless telephony were given in aid of church funds at the Seven Kings Baptist Church on Nov. 2nd, 3rd, and 4th. Telephony was successfully received from Marconi House, 2 O N and 2 J X, and was reproduced on a loud speaker loaned by Messrs. Radio Instruments, Limited.

(More "Club Doings" on page 622)

### "All-on" Two-valve Receiving Set.—

On the first page of our last issue a photograph of a valve-receiving set of the small self-contained cabinet type was shown and was there inadvertently described as being a production of the Telephone Manufacturing Co., Ltd. The makers of this, however, are Messrs. Rogers, Foster & Howell, Ltd., Edward Road, Birmingham, and the set is styled the "All-on Two-valve Receiver."



# OUR INFORMATION BUREAU

Expert Replies to Readers' Questions. Hundreds of Replies are sent by Post.

TO ENSURE A PROMPT REPLY PLEASE OBSERVE THE FOLLOWING RULES

Write distinctly, give all necessary details and keep to the point. Ask one Question at a time—never more than two. Send a Stamped and Addressed Envelope. Send the Coupon cut from this page.

## 5-Valve Amplifier with Switches.

Q.—Will you please give me a circuit diagram of a 5-valve amplifier with only one pair of telephones and with switches instead of jacks, the switches to allow of any combination of valves to be used without disconnecting leads or 'phones.—J. H. A. (3940)

A.—The circuit shown will be suitable. The secondary-tuning coil should be connected between G and F. When wishing to use all valves, the switches should be arranged as follows. Switch at G is put to the grid of the first valve. The grid switches of the second and third valves should be put to the left, and

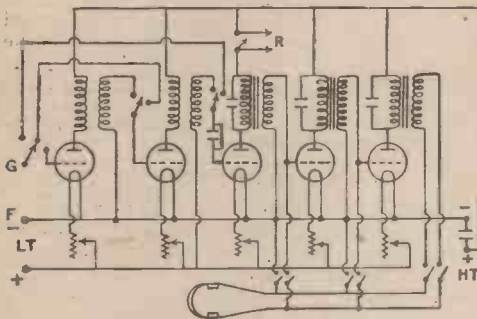

Five-valve Amplifier with Switches.

the right-hand telephone switch down and the other two up. To cut out the last I.F. valve, simply raise the last telephone switch and push down the centre telephone switch. To cut out the two I.F. valves, raise both the centre and end telephone switches and push down the first telephone switch. To cut out the first H.F. valve, put switch G on the centre stud and the second grid switch to the right, keeping the third grid switch to the left. To cut out two H.F. valves put the switch G to the left-hand stud, and the third valve grid switch to the right.—I. C.

The largest and most powerful transmitter, it is claimed, has been built on the roof of the Æolian Hall, New York.

## Reception of American Signals

THE following American signals were received on a Burndept Ultra 111, to which was coupled an extra stage of high-frequency amplification, making four valves in all.

From 1.5 a.m. to 3.31 a.m. G.M.T. on Sunday morning, November 26, WJZ New York Broadcasting Station, the entire programme was heard and understood. From 3 a.m. to 3.15 a.m. the strength of the signals gradually increased until they were eventually audible about 12 ft. from the telephones.

The following stations were also heard very strongly: 1CMK, 1XU, 2AWL (who was calling 5LV and 9ZY), 2LM, 8BPL (who was calling 4XY, sent him a message and signed off), CUL, GM, 73GN, 8ATF, 8AQO (who was calling 5MS Manchester Wireless Society), his message reading, "Signals faint. Nearly QRZ," 8XAK (who sent a weather report), 9LG.

These signals were all received on the same set by the chief test room assistant of Messrs. Burndept, Ltd., Mr. J. H. D. Ridley, who lives at Norwood, near Croydon, and whose aerial is 180 ft. long and 37 ft. high.

## "B.B.C."

A SOMEWHAT curious position seems to have developed with regard to the use of the above letters. As everybody knows, Condition 2 of the Broadcast Receiver Licence states that "Any receiving

set, or any of the following parts, namely, amplifiers (valve or other), telephone head receivers, loud speakers and valves, used under this licence must bear the mark "B.B.C." The only firms allowed to affix this mark to their goods are those who are members of the British Broadcasting Company, but as at the time of writing this company has not yet been registered and, therefore, we presume, has not yet any legal existence, it is difficult to see how it can have any members. In spite of this anomaly many firms are already using the "B.B.C." mark, but apparently there are many others who wish to be able to use it and do not appear to have authority to do so.

## ANNOUNCEMENTS

"Amateur Wireless and Electric." Edited by Bernard E. Jones. Price Threepence. Published on Thursdays and bearing the date of Saturday immediately following. It will be sent post free to any part of the world—3 months, 4s. 6d.; 6 months, 8s. 9d.; 12 months, 17s. 6d. Postal Orders, Post Office Orders, or Cheques should be made payable to the Proprietors, Cassell & Co. Ltd.

General Correspondence is to be brief and written on one side of the paper only. All sketches and drawings to be on separate sheets.

Contributions are always welcome, will be promptly considered, and if used will be paid for.

Communications should be addressed, according to their nature, to The Editor, The Advertisement Manager or The Publisher, "Amateur Wireless," La Belle Sauvage, London, E.C.4.

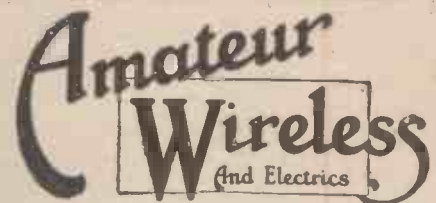

Querist's Coupon Available until Saturday, Dec. 16, 1922

# INVINCIBLE

(cannot be beaten)

IN QUALITY AND PRICE

## L.F. INTERVALLE TRANSFORMERS

These transformers are of the upright pattern, and are manufactured throughout at our own works. Several well-known wireless manufacturers are using our transformers in their sets, and we guarantee you complete satisfaction or refund full payment by return post.

Type A. 17/6 Type B. 16/- post free.

Type A is fitted with brass connectors for wiring to the external circuit.

Type B is not. Otherwise both types are identical.

Terms and samples sent to Manufacturers and Traders on application.

WOODMASON, St. John's St., COLCHESTER.

## SPLENDID Christmas PRESENTS

ESTABLISHED **ALLISON & CO.** 20 YEARS

"SETS" Crystal, £3 } With 4,000 ohms  
Valve, £5 } DOUBLE Headphones

All Sets will be marked **BBC** and **PMG**

Send for particulars and testimonials

46, 46a, 50 and 50a, CHURCH RD., ACTON

## MORE CLUB DOINGS

(See also page 620)

## Manchester Wireless Society.

*Hon. Sec.*—Y. W. P. EVANS, 2, Parkside Road, Princess Road, Manchester.

SENDAY, Nov. 19.—At 1 a.m. the members commenced a special series of tests with a 1,000-watt valve transmitter, calling 2FP and 1AW, two American amateur stations. Transmission lasted for fifteen minutes, and consisted of test messages referring to the work in hand. These were repeated every hour until 6 a.m., the intervening 45 minutes of each hour being devoted to listening for replies from the above-mentioned stations. The power was derived from D.C. generators in series, with a total output of 2,500 volts, and using two 450-watt Marconi valves, a maximum radiation of 12 amps was attained on the last transmission.

As regards the reception, although twenty-three American amateur stations were registered, there was no acknowledgment of our transmissions. One special record was an amateur as far west as California, who was only using about 750 watts and radiating about 7 amps. Comparatively speaking, with our 12-amp. radiation our messages ought to have been received quite easily by the American amateurs.

Cables are being exchanged between the American Radio Relay League and the society with a view to boosting up the enthusiasm which has been aroused on both sides of the Atlantic, and the Manchester amateurs are working day and night improving their apparatus with a view to eventually establishing direct interchange of messages, to be followed by a special test of telephony, subject to the approval of the P.M.G.

## Peckham Wireless and Experimental Association.

*Hon. Sec.*—G. SURTON, 18, Melford Road, S.E. 22. As was previously announced, this association had determined to give their vice-president, Sir Fred. Hall, K.B.E., D.S.O., all the wireless assistance they could in the general election they might be allowed by the authorities to give, and had instructed their secretary, who on Oct. 28 made the pro-forma application to the Post Office for the requisite permission. This was not forthcoming, and the project had regrettably been abandoned. Late in the afternoon of the polling day, Nov. 15, a telephone message was received that the petition was granted, and that formal permission would follow. It was too late then to put into train all the elaborate scheme which had been mapped out, but an old Army rubber-covered aerial was hoisted up the flagstaff at the committee rooms at 17, Grove Vale, Camberwell, and another length of the same material stretched on the other shorter flagpoles

round the front of the building and used as an earth or, more properly speaking, a balancing capacity, and with the secretary's three-valve receiving set, supplemented by batteries, amplifiers and a loud-speaker kindly loaned by Messrs. Mitchell, of Rye Lane, all the results broadcasted by 2LO were made known to the occupants of the crowded committee rooms, and it is feared that some of them became known to the crowd outside in the street. From 6 p.m. to 1.30 next morning, when 2LO closed down with a notice that they did not know how Mr. Bonar Law had fared, the secretary stuck to his post to see that none of the terms of the non-arrived permit had been infringed.

## Manchester Radio Scientific Society.

*Hon. Sec.*—H. D. WHITEHOUSE, 16, Todd Street, Manchester.

A GENERAL MEETING of the above society was held on Nov. 16. Mr. J. W. Hand opened a discussion on "The Construction of Wireless Sets, with special reference to the three-valve set in operation at the meeting." Mr. Hand spoke briefly about crystal sets for short-distance "broadcast" reception, and followed this up with an outline of the working and construction of the home-made set which was on view. Then followed a demonstration of telephony reception from 2ZY.

## Hackney and District Radio Society.

*Hon. Sec.*—E. R. WALKER, 48, Dagmar Road, E. 9. ON Nov. 9th the chairman read a letter he had received from the Wireless Society of London with regard to the position of amateurs under the new broadcasting regulations; and although some very strong opinions were voiced against the restrictions to be imposed on amateurs, the Wireless Society's reply was considered satisfactory, it being felt that the Hackney Society would be able to fight harder on behalf of the amateurs within the ranks of the national society than outside.

Nov. 16th.—Two home-made sets of three valves each were on exhibition, loaned for the occasion by two members of the society, and with the aid of a Brown's loud-speaker the latest news of the day, as broadcasted by the London Broadcasting Station, was heard loudly and clearly by all present. The society meets every Thursday at 7.30 p.m., and visitors are always welcome.

## Plymouth Wireless and Scientific Society.

*Hon. Sec.*—G. H. LOCK, 9, Rydef Road, Stoke, Devonport.

At a meeting of the above society, held on Nov. 7, a lecture on "High-frequency Amplification" was given by Mr. L. J. Voss. Starting with an explanation of the amplifying region of the characteristic curve of a normal valve, the lecturer proceeded

to describe the various methods of communicating the amplified impulses to the grid of the succeeding valve. Transformer, resistance-capacity and reactance-capacity couplings were dealt with in a way which enabled even the beginners to understand. Practical hints given as to the methods of eliminating self-oscillation and "howling" were particularly valuable.

On Nov. 14 a lecture was given by Mr. E. W. Penney on "Valves and Valve-receiving Circuits." The lecturer dealt first with the electron theory, more particularly in its application to valve-working. He then briefly described the typical construction of valves and their classification into hard and soft open and closed grid types.

## Liverpool Wireless Society.

*Hon. Sec.*—C. L. LYONS, 76, Old Hall Street, Liverpool.

ON Nov. 16 a very interesting demonstration was given by Mr. J. H. Swift, who had brought his exceedingly well made five-valve receiver, consisting of two H.F. detector and 2 L.F. valves. A special transmission was given to the society by 2ZY, and both the speech and the musical items were very loudly and clearly received. The Birmingham Broadcasting station was also picked up (2ZP) very clearly. Some little trouble was caused by unwanted interference from Seaforth G.P.O. station, and in a rather amusing duel between this station and the Metro-Vickers station the latter easily came out on top.

All interested persons desirous of joining the society should apply to the secretary.

## Portsmouth and District Amateur Wireless Society.

*Hon. Sec.*—R. G. H. COLE, 34, Bradford Road, Southsea.

A MEETING of the above association was held on Nov. 8, when an interesting talk was given by the secretary, Mr. R. G. H. Cole. Mr. Cole chose as his subject "Valves," and fully explained the actions of these frail members. Mr. Cole explained the two-electron and three-electron valves, and dealt with the action of the grid and plate. Mention was made of the various kinds of valves and how they rectified speech in telephony.

## South Shields and District Radio Club.

*Hon. Sec.*—J. A. SMITH, 66, Salmon Street, South Shields.

A NEW aerial has recently been erected, and this was tried out on Nov. 7 with a four-valve Burdett set in conjunction with a Brown's microphone relay and loud-speaker. Among the telephony stations heard were the new broadcasting stations at London and Manchester.

## BROADCASTING RECEPTION SETS

ONE VALVE SET COMPLETE FOR WORKING, £7 - 10 - 0

SEND FOR CATALOGUE

Passed for  
Broadcasting  
Licence

G.P.O. No. 1038.



INCLUDING ALL ACCESSORIES

## DESCRIPTION

Single valve, mounted on polished 1/4-in. ebonite panel with variable condenser, smooth acting resistance, grid leak and condenser and all terminals clearly engraved in white, in a mahogany polished cabinet, 9-in. by 5 in. by 5 in. ... £3 - 15 - 0

A TAPPED COIL for wave-lengths up to 900 metres with 2 terminals for coils for any higher wave-lengths.

The coil is enclosed and the tapings are brought out to an 8-way switch mounted in the front of the cabinet.

## ACCESSORIES INCLUDED

Siemens 54 volt high-tension Battery with plugs for altering the voltage	...	...	15 - 0
4 volt 50 amp. hour low-tension Accumulator in case with carrying strap	...	...	1 - 4 - 0
One pair of Sensitive Head Phones of 4,000 ohms resistance	...	...	1 - 1 - 0
One Detecting Valve	...	...	15 - 0

Satisfaction guaranteed  
or money refunded.

TOTAL £7 - 10 - 0

WIRELESS INSTALLATIONS LIMITED,

15, ALDRSGATE STREET, LONDON, E.C.



# It Speaks for itself—

and in no uncertain voice

## THE WORLD'S STANDARD LOUD SPEAKER

# AMPLION

WIRELESS  
LOUD  
SOUNDING  
RECEIVERS  
are supplied in  
a series of

### Ten Models

Suitable for  
every service:

**The Home,  
Laboratory  
and the  
Concert Hall**



### At Prices

ranging from

**£2 : 10 : 0**

to

**£15 : 15 : 0**

DAILY  
DEMONSTRATIONS  
at the

**GRAHAM  
SHOWROOMS**

The  
**ALGRAPHONE  
SALON**

25-26 Savile Row,  
Regent Street, W.1

#### "MUSIC MASTER" HORN

Type AR 13, 120 ohms	...	£6 : 0 : 0
Type AR 15, 2,000 ohms	...	£6 : 2 : 6

"Graham" Wireless Pro-  
ductions include "High  
Efficiency" Telephone  
Headsets of improved  
design and construction.  
The "Graham" is the  
best Head Gear money  
can buy.

Full particulars forwarded upon  
request. Ask for Folder A. W.

Patentees and Manufacturers :

## ALFRED GRAHAM AND COMPANY

St. Andrew's Works, Crofton Park  
LONDON - - - S.E.4

SCOTLAND :

Mr. F. M. Milligan,  
25 Renfrew Street,  
GLASGOW.

IRELAND :

Mr. Alex. R. Munday,  
41, Chichester St.,  
BELFAST.



# GREAT REDUCTION IN PRICES

All Goods Sent POST FREE.

4000 ohms total Resistance. Double Headband.

Guaranteed highly efficient. Complete with Cords. Ball and socket joints; highly polished nickel cases; best Tungsten steel magnets.

## BEAVER Complete CRYSTAL SETS

### Beaver "MIDGET" Crystal Set.

The Ideal Xmas Present. Length 6 3/4 in. x 4 in. Absolutely guaranteed. 18/-; complete with 4000 ohm ear-piece, 36/-.

No. 1 unassembled 20/- No. 2 unassembled 25/-

No. 3 assembled 27/6 ready for use Complete with Splendid Tested and Guaranteed 4000 ohm Phones, 50/-

No. 4 unassembled 35/- Complete with Splendid Tested and Guaranteed 4000 ohm Phones, 57/6

De Luxe Set No. 5 assembled 66/- ready for use Complete with Splendid Tested Guaranteed 4000 Phones, 84/- (Passed by Postmaster-General, G.P.O. Regd. No. 198)

## BEAVER Complete Set of CONDENSER PARTS

contains:

- Ebonite Top and Bottom Plates, Machined
- Aluminium Moving Plates
- Aluminium Fixed Plates
- 1 Square Centre Spindle
- 3 Stay Rods, screwed both ends
- Large Spacing Collars
- Small Spacing Collars
- Bronze Coil Spring
- Ebonite Knob, drilled and screwfitted
- Brass Nuts for Centre Spindle
- Small Nuts
- 0005 MF. ... 8/6
- 00075 MF. ... 9/6
- 001 MF. ... 11/6
- 0015 MF. ... 13/-

## Splendid Crystal Detector

Mounted on Ebonite.

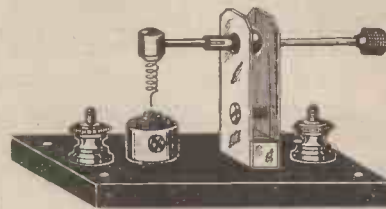

2/9

- High-class Filament Resistances 4/-
- 100 ft. Aerial Wire 7/22 S.randed
- H.D. Copper the best ... 3/10
- Best Quality Switcharms ... 1/6
- Ebonite Valve Holders Best Quality 1/6
- Best Insulating Composition ... 10d.
- 0002 Condensers 1/6
- 003 ... 2/9



# BEAVER ELECTRICAL SUPPLY CO.

Telephone: GERRARD 1900. 109, REGENT STREET, LONDON, W.1.

Special Terms to Trade. All Cheques and Postal Orders to be crossed London Joint City and Midland Bank.



## Indoor Aerials will give splendid results



No. 4 Detector Panel (without valve)

If you cannot erect an Aerial out of doors, don't worry. Fasten duplicate Wires (stranded copper or insulated Pertinax) across the room, three inches below the ceiling, insulate them from the walls, and connect to your Set. You will get results which will surprise you. If you have an upstairs landing or passage, four wires stretched 12 inches apart, and connected in pairs—each about 30 feet long—will give you practically a P.M.G. Aerial.

Use a Peto Scott No. 4 Unit, and you will receive excellent speech and music without atmospheric disturbances.

The usual earth lead to water-pipe is required.

Adding a No. 3 H.F. Unit will enable you to pick up long-distance Broadcasting stations with ease.

All Peto Scott Units are sold in sets of parts for home construction. Detailed instructions render Radio knowledge unnecessary.

All Peto Scott Apparatus is manufactured under license from Marconi Co. Catalogue free.



Offices and Showrooms: Featherstone House, 64, HIGH HOLBORN, W.C.1.

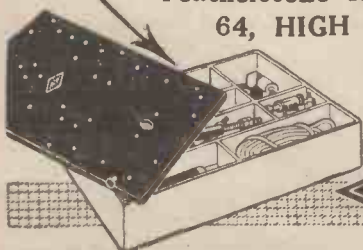

## WILTON

# B.B.C. RECEIVERS

Approved by Postmaster-General.

Complete Outfit No. 1.—Comprising Cabinet, Crystal Receiver, with tapped inductance and enclosed detector, fitted special Hertzite Crystal, one Pair "Supreme" Headphones, 4,000 ohms, 100 feet Aerial Wire, Insulators, in strong box. An Ideal Christmas Present.

Post free £3 10 0

Loud Speakers—"Clarivox," £3 0 0. "Amplions," £2 5 0

Splendid Line of 4,000 ohms Headphones ... 19s. 6d.

Detectors—On Ebonite, Special Crystal ... 2s. 9d.

C.A.V. Accumulators, 4 v. 40 amp. ... 18s. 6d.

4 v. 60 amp. ... 26s.

Brown's 4 000 ohms Headphones ... 30s.

3 Coil Holders—With Extension Handles ... 10s. 6d.

Basket Coils—200-3,000 Metres, for Telephony ... 4s. 6d.

2 Valve Receiving Outfits comprising Receiver-Valves, Loud Speaker, Aerial Equipment, with instructions. Made specially for Broadcasting £20 0 0

Interval Transformers ... 15s.

B.B.C. Crystal Sets ... 35s.

Everything for Wireless — Despatch by Return

Trade Supplied.

WILTON WIRELESS CO., LTD.,

120-124, HIGH ST., TOOTING, S.W.17.

Phone—STREATHAM 533.



The **Universal Electric Supply Co. Ltd.**  
 4 BROWN STREET  
 ONE DOOR FROM MARKET ST  
**MANCHESTER**  
 Telephone: 3409 CITY  
 Established 1892.  
 G.P.O. Box No. 519.

All Radio Requisites Promptly Supplied.  
 Complete Valve and Crystal Sets for  
 Broadcasting Reception, P.O. Licensed.  
 Fully Illustrated Catalogue, post free, 6d.

**COIL HOLDER**  
 Excellent finish.  
 Three Coil Type, price 18/-  
 Mounted on polished base.  
 Price 21/-

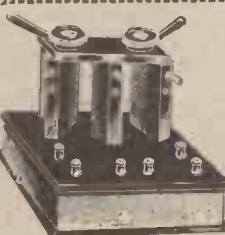

**HONEYCOMB COILS**  
 Excellent Results.  
 Wave Lengths.  
 180 4/8 800 5/2  
 300 4/6 1,000 5/6  
 450 5/- 1,500 7/-  
 600 5/- 2,000 7/10

**LAMINATED SWITCH ARM**  
 Radius 3/4 in.  
 Complete as  
 illustrated.  
 Price 2/-



**FILAMENT RHEOSTAT**  
 Best Value. Ready for  
 mounting. Price 3/6

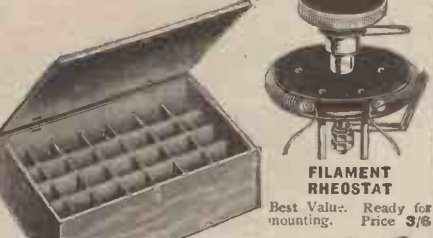

**Strong Wood CONTAINER**  
 to hold up to 35 Sac Leclanche  
 Cells. Price 1/6



**TERMINALS.**  
 Make up your own H.T.  
 Batteries.  
 Easily attached to  
 Pocket Lamp Batteries.  
 Price 1/6 doz.

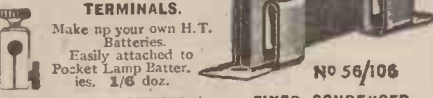

**NEW MODEL CRYSTAL DETECTOR**  
 All capacities from .001 to .0005.  
 Complete with clips. Price 3/6



**FIXED CONDENSER**  
 No 56/106

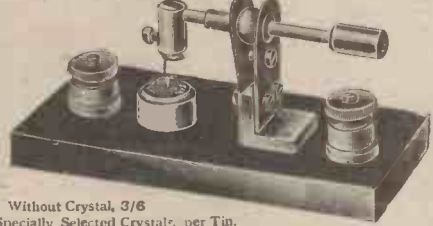

Without Crystal, 3/6  
 Specially Selected Crystals, per Tin.  
 Boronite, 1/- Copper Pyrites, 1/- Galena, 1/- Manganese, 1/-  
 Carborundum, 1/- Fused Silicon, 1/6 Iron Pyrites, 2/-  
 Nickel Filling, 1/6

**CONDENSER PARTS**  
 Fixed and Movable  
 Vanes.  
 3/4 in. x 9/10 in.  
 Price 1/6 doz.  
 Centre Rod, 1/4 in. overall.  
 Fitted with  
 Indicating  
 Finger and  
 extra large  
 handle.  
 Price 4/6  
 Screwed Rod,  
 7/10 in. per ft.  
 Ivory  
 Condenser  
 Scales,  
 Accurately  
 Marked,  
 1/- each.



Dec. 9 to 24 ONLY **SALE!** Dec. 9 to 24 ONLY

Great Clearance Xmas Sale of Wireless Instruments and Accessories

... AT ... **HALL'S**

A perusal of a few of the items below will shew that unapproachable value and prices are listed. Purchasers are advised to secure while stocks exist, as a rush will undoubtedly be experienced and replacements at the figures shewn will not be possible. Another opportunity like this will never be presented.

OUR GOODS ARE GUARANTEED!  
 "Dispatch by return!"  
 OUR LATEST BATCH

DARLINGTON,  
 20th November, 1922.

Messrs. Hall's.  
 DEAR SIR,  
 "I am greatly satisfied and pleased with the articles already sent."  
 W. H. S.

HERTS,  
 20th November, 1922.

Hall's.  
 DEAR SIR,  
 "All the goods are to my entire satisfaction," etc.  
 A. BEADLE.

CHESHIRE,  
 19/11/22.

Hall's.  
 DEAR SIR,  
 "Goods received safely and am very pleased with same."  
 B. B.

MANCHESTER,  
 14/11/22.

Hall's.  
 DEAR SIR,  
 "We thank you for prompt delivery," etc.  
 A. V. W.

PAISLEY,  
 Scotland.

Hall's.  
 DEAR SIR,  
 "Safely received parcel. Delighted with quality of contents," etc.  
 R. B. E.

All originals are at our office, and can be seen on request.

"Dispatch by return" is no idle boast.

Our Stock of Wireless Equipment and Accessories is such that we can supply every Wireless need at once and at lowest prices. If you do not see what you want in our list, please write us.

**BRITISH HEADPHONES**

4000 ohms. Very Light. Beautifully Finished. Stalloy Diaphragms. Complete with Cords. Adjustable Earpieces.  
 (Sold elsewhere almost exclusively at 35/-)

**19/6** Postage 9d.  
 Only 530 left.

Every type of instrument and accessory from Mercury Condensers to Double Slider Tuners at ridiculously low prices can be seen at our showroom. Space naturally precludes complete list

**VARIABLE CONDENSERS:**

Capacity	Complete Parts	Assembled for Panel Mounting
.001	6/9	11/9
.0075	5/-	11/-
.0095	4/9	9/9
.0098	3/3	7/-
.002	2/3	5/9
.001	2/-	4/-

Top and Bottom Circular Drilled Ebonite Plates, 1/3 extra Vernier, 3/-

- Interval Transformers, Ratio 5 to 1, finest manufacture 11/9
- Crystal Sets ... from 15/- to £3
- "Royal Phone" Loud Speakers, 4000 ohms resistance, ebonite horn giving clarity of tone and freedom from distortion. Stock of 72 only ... each 28/9
- Aluminium Condenser Vanes, fixed and moving, 22-24 gauge ... each 1d
- Spacers, true to .001 ... small, doz. 1d; large, doz. 2d
- Ebonite Knobs, tapped 2 B.A. with brass nut—  
 1st quality, 4d; 2nd quality 2d
- Aerial Wire, 7/22 hard drawn copper, in 100 ft. lengths ... 2 6
- Valve Legs, with nuts and washers ... 1d each; doz. 9d
- Two Coil Holders, solid ebonite mounted on mahogany ... 4/6
- Three " " " with long arms to avoid capacity effects ... 8/9
- Crystal Detectors, adjustable in every way, turned brass on ebonite ... 2 6
- Slider Rods, 12-in. or 18-in. 1/4-in. square brass, drilled both ends 4d
- Engraved Ivory Scales, 0-180°, round or square ends ... 3 6
- Filament Resistances, extraordinary value, velvet action 2/4
- Switch Arms, complete with knob, collar, washers, bush nuts, etc. ... 1st quality, 1 3; 2nd quality 9d
- Valve Holders, turned ebonite, complete with nuts, 1/-; 2nd qual., 8d
- Crystal Cups ... plain 1d; one, two, or three screw 2d
- Large Terminals, complete with nut and washer ... each 1d
- Contact Studs, 1/4-in. x 1/4-in., or 3/16-in. x 1/4-in., complete with nut and washer ... doz. 4d
- Insulators, 2-in. reels—  
 1d each; white egg, 3d; green egg, 4d; green shell, each 3d
- Brass Nuts, 2, 3, 4, 5, 6 B.A., 2 1/2 doz.; Washers, doz. 1 1/2
- Ebonite Sheets, 1/4, 1/2, 3/4, 1 lb. 3 3
- Fixed Condensers, any capacity ... each 1 3
- Grid Leak and Condensers combined ... each 2 9
- Slider Plunger complete ... each 4d
- Hertzite, 1 6. Boronite Carborundum, Galena, etc. each 4d
- Screwed Brass Lengths, 12-in. 2 or 4 B.A. ... each 3d
- Inductances, wound 22/24 enamelled wire ... each 3/-

Orders under 30/- kindly remit postage

Balance refunded if excess sent. Send for FREE Catalogue

TRADE SUPPLIED **HALL'S** DISPATCH BY RETURN

PHONE: REGENT 1282  
 71, Beak Street, Regent Street, London, W.1  
 Between Piccadilly Circus and Oxford Circus  
 Buses 3, 6, 12, 13, 15, 32, 51, 53, 59 and 88 pass

# HULLO EVERYBODY!

**Do YOU Know US? If not, why not?**  
**COMPARE PRICES! COMPARE QUALITY!!**

## Complete Sets of PARTS for Making Variable Condensers

Approx. Capacity in Microfarads	No. of Plates	Price
·0015	85	10/-
·001	57	7/6
·00075	43	6/9
·0005	29	5/6
·0003	19	3/-
·0002	13	2/3
·0001	7	2/-
Vernier	3	1/9

Everything ready to assemble and consist of the following: Accurate Aluminium Fixed and Moving Vanes, Large and Small Spacer Washers, Centre Square Spindle (Screwed Ends 2 BA), 3 Side Rods, 12 Nuts and 12 Brass Washers (2 BA), Pointer—scale 0-180, Terminals, 3 Bushes, Spring Coil Washers, Best Quality Knob with 2 BA Nut in Centre.

**ALL HIGHEST QUALITY GOODS**

**EBONITE TOP and BOTTOM PLATES SUPPLIED (Drilled) Free of Charge with**

**SETS: ·0015, ·001, ·00075, ·0005**

(If wanted for any other set include another 1/-)

Postage, Packing, etc., 1/- per set extra

Packing and Postage for 2 sets, 1/3

## UNSOLICITED TESTIMONIALS

A. J. POOK, Esq.,  
101, Day's Road,  
Barton Hill,  
Bristol.

17/11/22

Enclosed 6s. 6d. for .0005 condenser parts. Two I had previously (.001 and .0005) have drawn admiration from all my friends. Remarkable value, they say.

SYDNEY J. ASHWORTH, Esq.,  
9, Paradise Place,  
Stoke,  
Devonport.

13th November, 1922.

The quality, price, and the dispatch of your high-class goods leave nothing to be desired. I am still able to profit by sending to you for them, especially when quality is considered.

W. J. CORLESS, Esq.,  
5, Whatman Road,  
Forest Hill, S.E.23.

2/10/22.

I received the set of condenser parts quite safely and thank you for the careful packing. As regards the parts themselves, they fitted together splendidly, making a neat instrument, and I consider them the best condenser value on the market.

## ALL the following GOODS POST FREE at the SPECIAL PRICES attached for POST ORDERS

*If you are not satisfied with value, return goods and we will refund all charges*

Filament Resistances. Most wonderful value in the wireless trade. Each 2/6 and 3/6. By Post, 3/- and 4/-.

Switch Arms, with polished knob, bushed 2 BA nut, laminated blade, spring coil washer, nuts and bush, 10½d. and 1/6 each. By post, 1/3 and 2/1 each.

Crystal Detectors on Ebonite. Simply marvelous value. Each 2/-. By post, 2/8.

Fixed Condensers, with terminals on ebonite, .0003, .0005, .001, .002, .003, 1/6; by post, 1/9; .004, 1/9; by post, 2s.

Oojah Basket Coils, 7 in set, 5/- set. By post, 5/6.

Lead-in Tubes, ebonite, brass ends, 9 in., 1/2. By post, 1/6. 12 in., 1/4. By post, 1/8.

Good Condenser Knobs, tapped 2 B.A., at 2/- doz. By post, 2/6.

Knobs, with brass nut (2 B.A.) in centre, high-class quality, 4½d. each. By post, 7d. 6 for 2/-. By post, 2/6.

Crystal Detector, cups enclosed with glass cover, dust proof, 4/6. By post, 5/3.

Aerial Wire, 7/22 bare copper, stranded, first class quality, not a substitute. Price per 100 ft., 2/10. By post, 3/10. Price per 150 ft., 4/3. By post, 5/3.

Reel Insulators, 1d. each, 11d. doz. Cannot be sent by post.

Hertzite Crystal, per piece 1/3 and 1/6. By post, 1/6 and 1/9.

Pericon Crystal Detectors, 4/-. By post, 4/9.

1½ mm. Insulating Steeving, 6 yds. for 2/2. By post, 2/6. 12 yds. for 4/-. By post, 4/6.

Slider and Plunger, 5d. By post, 8d.

Slider Knob, plunger and 13 in. rod. The lot, 8d. Cannot be sent by post.

War Office Pattern Terminals, complete with nut and washer, 1/8 doz. By post, 2/2 doz.

Splendid Line in 5-piece Terminals, complete with nut and washer, good size, 1/- doz. By post, 1/6.

Interval Transformers. Each, 14/-. By post, 15/-. (Low frequency.)

Aluminium Vanes, 2 doz. 1/-. By post, 1/6.

Triple Coil Holders, handsome design on Ebonite, 10/-. By post, 11/-. Large Spacer Washers, 3 doz. 9d. By post, 1/-. Small Spacer Washers, 6 doz. 1/-. By post, 1/4.

**NEW TRADE LIST NOW READY. WE LICK CREATION ON PRICES AND QUALITY.**

**To Callers: We Sell All Component Parts CHEAP!**

Brass Rods, Nuts, Washers, Screws, Valve Sockets, Valve Pins, Stop Pins at wholesale prices.

## HEADPHONES

We don't sell cheap and nasty telephones. Try our Best French make. Guaranteed quality  
 4,000 ohms, 21/-, 25/- (Double). Single, 2,000 ohms, complete  
 8,000 ohms, 25/- (Double). with cord, 9/-. Packing and post 1/-.

*NOTE! My terms are strictly cash with order. All orders by post are despatched at the earliest possible moment, as we have great pressure just now on the postal department.*

**M. RAYMOND, 27, LISLE STREET, W.C.2.**

RIGHT OPPOSITE  
DALY'S GALLERY DOOR.

Phone:  
Gerrard  
4637

To avoid mistakes, this address is close to  
Charing X Road and Leicester Square Tube.



# A BALD STATEMENT

## The NEW "POLAR"

Earth-Screened

### VARIABLE CONDENSER

Range from .0001 to .001 mfd.

Costs only **14/9** Post Free.

Measures 3 in. x 3½ in. x 1 in. only.

Is Now Available from Stock.

Is made and guaranteed for 12 months by

**THE RADIO COMMUNICATION CO., LTD.**

Direct from 34, NORFOLK STREET, LONDON, W.C.2.

Or at **NEWCASTLE**: 17, Sandhill, **LIVERPOOL**: 67, Dale St. **CARDIFF**: Atlas Chambers, James St.  
**Branches**: **SOUTHAMPTON**: 19, Queen's Terrace. **GLASGOW**: 10, Blythswood Square.

# — THAT MAKES YOU THINK —

E.P.S. 18.

### Crystal Receiver

Range 25 to 30 miles

This Model is a cheap and efficient receiver

**SPECIFICATION.**—Tuning Coil wound on an insulated former with 24 S.W.G. enamelled H.C. Wire, having a wave length range of 130 to 1,000 metres. Tappings taken off to 10 studs. Variable Condenser. .0003 Mfd. tuning in series. .001 Mfd. Blocking Condenser across telephone terminals. The whole is mounted on an Ebonite Panel, 7½ in. x 5½ in. x ½ in., engraved and mounted in Polished Mahogany Case, 5 in. deep. Complete with Sterling Phones, Aerial Wire, Insulators, Lead-in Tube. **CASH PRICE £3 10 plus Royalties, 7/6**

### Note Magnification Panel

**SPECIFICATION.**—Low Frequency Transformer, Ratio 5½ to 1, wound with S.S.C. Copper Wire. Filament Resistance of 5 ohms. Mounted on an Ebonite Panel, 7 in. x 6 in. x ¾ in. in Polished Mahogany Case. **PRICE 45/- CASH plus Royalties.**

These can be supplied up to 3 stages of Note Magnification from a Broadcasting Station.

### 4-Valve Receiver

1 Detector. 3 Low Frequency Amplifiers

**SPECIFICATION.**—As preceding models, but with 3 stages of Note Magnification for Loud Speaker reception. Mounted on Panel, 16 in. x 14 in. x ½ in., in sloping Mahogany Desk-shaped Cabinet. All Valves are sunk in panel, visible from front.

### 4-Valve, 1 H.F., 1 D., 2 L.F.

As above, but with one stage of Radio Frequency Amplification, and two stages of Note Magnification. .0002 Mfd. Variable Condenser tuning Primary Winding of H.F. Transformer. This model is strongly recommended for reception over long distances.

All the above Models are Approved

**H. A. WHITE & SON, ELECTRICAL ENGINEERS.**

229, Pentonville Road, KING'S CROSS, LONDON, N.1.

Telephones: CENTRAL 3045. HAMPSTEAD 7872. HAMPSTEAD 648.

### 2-Valve Receiver

1 Detector. 1 Low Frequency Amplifier

Range, 60 to 80 miles

Tuning Coil wound on an insulated former with 24 S.W.G. Enamelled Wire with 5 tappings to studs. Wave length range, 130 to 900. Variable Condensers. .0005 Mfd. Main Tuning Condenser. Single Moving Plate Vernier Condenser. .0003 Mfd. Grid Condenser. 2 V. Grid Leak. .001 Mfd. Fixed Condenser across Primary of Low Frequency Transformer. .001 Mfd. Fixed Condenser across Telephones. Low Frequency Transformer, Ratio 5½ to 1, Mounted on 8 in. x 12 in. x ½ in. Ebonite Panel, engraved and in Mahogany Case 4½ in. deep. With Sterling Telephones, Aerial and Insulators, etc. **£10 10 plus Royalties.**

### 3-Valve Receiver

1 Detector. 2 Low Frequency Amplifiers

As above but with extra stage of amplification on Panel 14 in. x 12 in. x ½ in., engraved and in Mahogany Case 4½ in. deep.

### [3-Valve Receiver

1 High Frequency. 1 Detector. 1 Low Frequency

**SPECIFICATION.**— .0002 Variable Condenser Tuning Primary of H.F. Transformer. Tuning Coil wound on insulated former with 24 S.W.G. Enamelled Wire. Wave-length range 130 to 1,200 metres tapped off to 10 studs. Mounted on Ebonite Panel 12 in. x 14 in. x ½ in., engraved and in Mahogany Case 4½ in. deep. This model is recommended for use when the situation is 30 miles or farther from a Broadcasting Station.

**MANUFACTURERS OF COMPLETE WIRELESS INSTALLATIONS**



## THE MECCANO RADIO Crystal Receiving Set

for Broadcasting and Morse Reception

The Meccano Crystal Receiving Set will receive Telephony (i.e. music and speech) from distances of 20 to 30 miles. It is a piece of scientific apparatus with which anyone may spend hours of delight and enjoyment, "listening in" to broadcasting stations and other telephony transmissions. It has been thoroughly tested and has received with great clearness broadcast music and speech in London, Paris, New York and elsewhere.

The Meccano Receiving Set is low in cost and is complete in itself, ready to be connected to any aerial. A complete Aerial Set is sold separately.

The Meccano Radio Receiving Set makes an ideal present for Christmas. Give one to your boy and make him happy.

### Send for this Book

Our new booklet, *The Meccano Crystal Receiving Set*, explains Radio so that everyone is able to understand how simple is the reception of broadcasting, telephony and Morse messages. This booklet will be mailed free on request.



Start Radio Now in an Efficient and Inexpensive Way

### PRICES

Meccano Crystal Receiving Set, complete, price 55/-

" Aerial Set (including antenna, lead in and aerial wires and insulators) " 12/6

**MECCANO Ltd Binns Road LIVERPOOL**



## For the first time a wireless Xmas

Xmas 1922 is the first time you will be able to give a really novel present :

### A Wireless Set

A present in which the fascination and enjoyment never fails.

We offer a complete range of wireless receivers from simple crystal sets to cabinets de luxe.

All T.M.C. wireless receivers are fully approved by the P.M.G. and give maximum results from the British broadcasting.

The illustration shows the T.M.C. Crystal Set No. 2, with Patent Everset Crystal which needs no adjusting.

**£5 - 17 - 6 each**

Come and choose your present to-day.

If you cannot call, full particulars will be sent on request.

**The Telephone Manufacturing Co., Ltd.**  
**68, Newman Street, W.1**

Telephone

Museum 5581

BRANCHES IN EVERY LARGE TOWN

# T.M.C.

makes Wireless worth while.

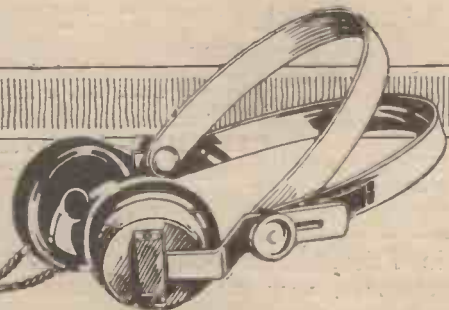
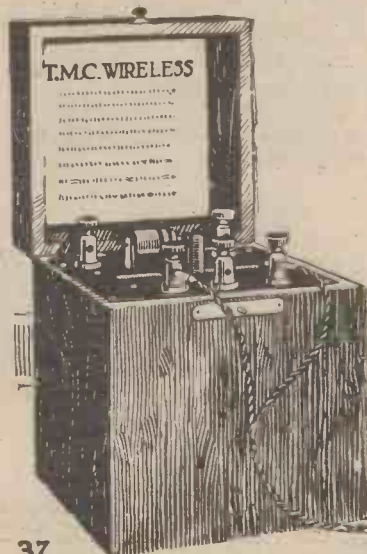



**BROADCASTING  
HAS NOW BEGUN!**

*Have you obtained your Set yet?*

OUR No. 1 CRYSTAL DETECTOR SET is suitable for reception of all broadcast matter for a range of 20-30 miles. Type approved by P.M.G. Reg. No. 126. Price **35s.** plus 7s. 6d. Broadcasting royalty. With Phones. British made, wound to 4,000 ohms. Price **60s.** and Broadcasting royalty. Aerial equipment comprising 100 ft. 7/22 Stranded Aerial wire and 2 Insulators, 4s. extra.

Everything complete **£3 3 0** plus Broadcasting royalty, 7/6. All accessories and component parts.

*Write for Illustrated Catalogue*

**BOWER ELECTRIC LTD.,**  
15, GRAPE STREET,  
SHAFTESBURY AVENUE, London, W.C.2

**GENTS' "DISCOL" H.F. TRANSFORMER**

HAS BECOME A  
STANDARD FITTING  
IN THE  
RADIO WORLD AND  
IS IN LARGE DEMAND  
BY EVERY CLASS OF USER.



ASK YOUR DEALER FOR  
GENTS' "DISCOL" TRANSFORMER — 6/8 EACH.

**GENT & Co., LTD., FARADAY WKS., LEICESTER**

London: 25, Victoria St., S.W.1.  
Newcastle-on-Tyne: "Tangent House," Blackett St.

**BEGINNER'S GUIDE TO WIRELESS**

Explains in plain, everyday language, everything beginners wish to know about Wireless Telegraphy.

**HOW TO ERECT, CONNECT, AND MAKE**  
all the apparatus required for reception of telephony or morse, and full instructions and diagrams for making coils, tuners, and complete valve and crystal sets. 112 pages, price 1/- post free.

**SAXON RADIO CO. (Dept. 12), South Shore, BLACKPOOL**

32 page Catalogue of Wireless Apparatus, 3d. post free.

**HEADPHONES, 4,000 ohm, English make, guaranteed . . . £1 5 0**

**FELLOPHONE 2-VALVE RECEIVER, in Oak Cabinet, with Headphones, Batteries, Accumulator, Aerial and Insulators £9 0 0**

**2-VALVE AMPLIFIER, in Oak Cabinet (for loud speaker) £5 0 0**

**SUPER CRYSTAL SET, with double Headphones, Aerial and Insulators . . . £4 0 0**

Superior Resistances, 5/-; L.F. Transformers, 21/-; Knobs, 5d.; Condenser Dials, 1/9; Mullard "Ora" Valves, 15/-; Mullard Grid Leaks, 5/-; Ebonite Block Condensers, .0003, 2/9; Switch Arms, 3/6.

F. N. GOUVY & CO., Ltd., 31, Upper Brook Mews, Lancaster Gate, near Paddington Station.

**How did YOU receive the  
ELECTION RESULTS?**

**BROADCAST RECEIVING SET**

Price complete with British made headphones, aerial and everything ready for fixing—

**£5 0 0**

Plus 7/6 Broadcasting Fee. Low Frequency Amplifiers for use in conjunction with this set having special transformers—Price

**£5 0 0**

Two of these amplifiers are capable of working a loud speaker with excellent results within a distance of 20 miles from London.

Filament Resistances . 3/9  
"Ideal" Valve Accumulator in case

4-Volt 50 amp. . 25/-

(Carriage 2/-)

6 " 50 amp. . 35/-

(Carriage 3/-)

Variable Condensers (of various capacities)

From 6/-

Fixed Condensers . " 2/6

3-Coil Holder, complete

Unit for use with Standard Coils . . 20/-

IT can be confidently said that all who were listening in with a Wates Set were very pleased with the reception when the Election results were broadcasted.

The reception was good—not only because Wates Sets are perfect in manufacture, but also because purchaser can avail themselves of the free advice of our technical experts, who can help them to get the best possible results under varying circumstances.

Not only do we manufacture complete receiving sets of the best quality, but also all component parts.

The illustration is that of the PYRAMID H.T. Battery, which we can confidently recommend to help you to get better results. It is priced as follows:—

15-Volt - - - 3/6

With variable plug connection

30-Volt - - - 7/6

Send 3d. stamps for our Illustrated Catalogue.

List of H.T. Batteries or Accumulators free.



**Exide  
BATTERIES**

**H.T.  
Batteries  
for  
Valve Sets**

24v. 28v. 32v.

Type B.K.

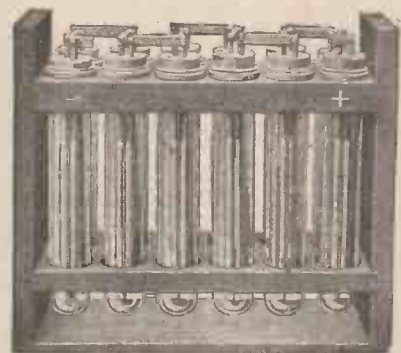

Owing to the demand for these batteries, all orders will be dealt with in strict rotation.

Prices approximately one shilling a volt.

:: Ask for Leaflet 4030 ::

**THE Chloride ELECTRICAL STORAGE COMPANY LIMITED.**

CLIFTON JUNCTION,  
Nr MANCHESTER.

219/229, SHAFTESBURY  
AVENUE, W.C.2.

PRICES AND PARTICULARS ON APPLICATION.

Call at our Showrooms—they will interest you  
**Wates Bros.** 13/14, Great Queen Street,  
KINGSWAY, LONDON, W.C.2.





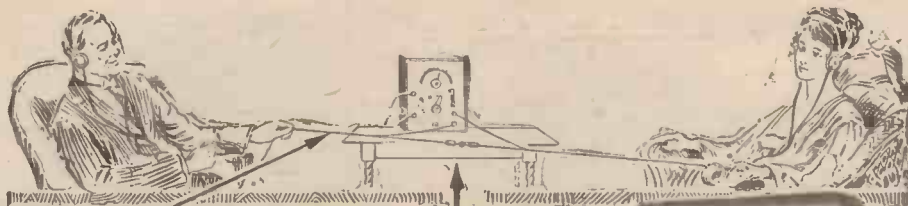

38

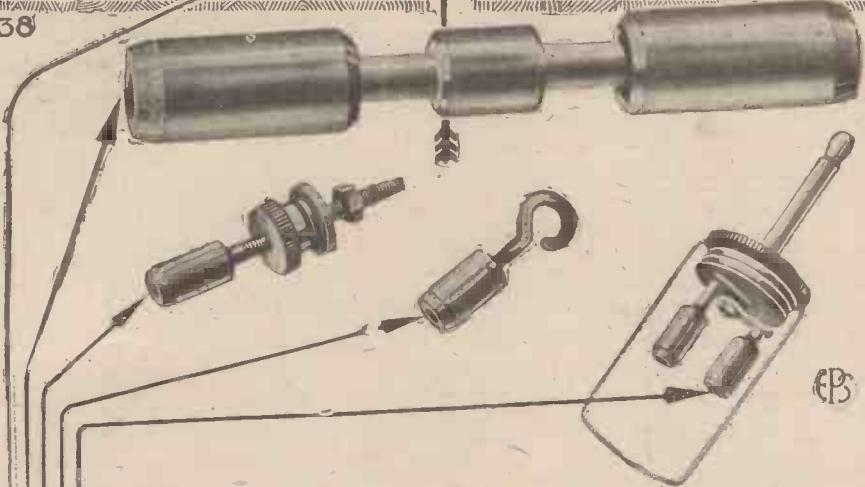

- (1) The self-tightening bull-dog grip fitted to the Elwell plug enables telephones or loud speaker connections to be changed in a moment.
- (2) By the terminal adaptor, the bull-dog grip connector can be added to any existing terminals.
- (3) For fitting to the face of a panel this pattern is recommended. It combines a standard terminal for fixed connections with a bull-dog fitting for connections which you require to change.
- (4) A series connector with a bull-dog grip at each end. Invaluable for connecting telephones in series.
- (5) The series connector in use. Telephones can be connected in series in an instant. No amount of pulling can break the connection. It thus avoids those annoying interruptions caused by involuntary movements.

## BULL-DOG GRIP CONNECTORS

Elwell patented self-tightening grip fittings are a big convenience. Without soldering, tightening of nuts or screws or the use of any tools whatever, electrical connections can be made, broken or changed in a moment.

Moreover, the connections when made are electrically perfect and self-tightening. The more you pull them the tighter they grip. But they can be released in a moment when desired.

Ask to see them at your wireless dealer or write for descriptive leaflet.

**C. F. ELWELL, LTD.,** Radio Engineers,  
 CRAVEN HOUSE, KINGSWAY, LONDON, W.C.2.

Telephone: REGENT 421



Radio brings it: **MAGNAVOX** tells it

# MAGNAVOX

## THE WORLD'S FINEST LOUD SPEAKER

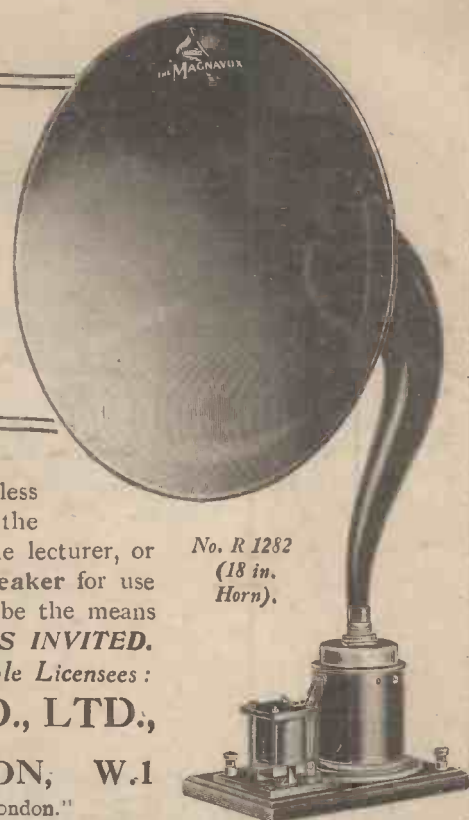

No. R 1282  
(18 in.  
Horn).

To enjoy and obtain the greatest possible satisfaction from your Wireless Receiving Set, equip it with a **Magnavox Loud Speaker**. Hear the voice of the singer faithfully reproduced, the perfect intonations of the lecturer, or the natural sound of music. The introduction of the **Magnavox Loud Speaker** for use with Radio Receiving Sets marks a most important development, and will be the means of making broadcasting extremely popular.

**INQUIRIES INVITED.**

To be obtained from all Dealers or direct from the Manufacturers and Sole Licensees:  
**STERLING TELEPHONE & ELECTRIC CO., LTD.,**  
Telephone House,  
210/212, TOTTENHAM COURT ROAD, LONDON, W.1

Telephone: Museum 4144 (7 lines).  
NEWCASTLE-ON-TYNE:  
9, Clavering Place.

Telegrams: "Cucumis, Wesdo, London."

WORKS:  
Dagenham, Essex.

CARDIFF:  
8, Park Place.

**IMMEDIATE  
DELIVERY**

We guarantee that all Broadcast Radio Apparatus sold by us conforms with the conditions of the Broadcaster's licence issued by the Postmaster-General.

## Where there's Electric Light there's Wireless



Your electric light catches the wireless exactly as an aerial does.

Plug a "Ducon" into any lamp holder or wall socket, connect it to your wireless receiver and you will receive the broadcasting perfectly.

USE A "DUCON"  
and you don't need an aerial

"Ducons" are perfectly safe—each one is tested to 1,000 volts, **they consume no current** and do not affect the electric light in any way.

## The DUCON 10/-

is obtainable from leading wireless dealers, electrical contractors and stores, or direct from the makers.

Dealers not yet stocking are invited to write for Trade Terms  
Over 50,000 in use

**The Dubilier Condenser Co. (1921) Ltd.**  
Ducon Works, Goldhawk Road, Shepherds Bush, London  
Telephone—Hammersmith 1084. Telegrams—Hivoltcon, Phone, London



Forming a Wireless Association (see page 645)

# Amateur Wireless And Electrics

Thirty-  
Two  
Pages

No. 28

SATURDAY, DECEMBER 16, 1922

Price 3d.

## CONTENTS

How to Record  
    Signals  
    "                      "  
Coil-winding  
    Apparatus  
    "                      "  
Making Contact  
    Studs  
    "                      "  
Wireless as a  
    Profession  
    "                      "  
Radiograms  
    "                      "  
On Your Wave-  
    length  
    "                      "  
Telephony  
    Transmissions

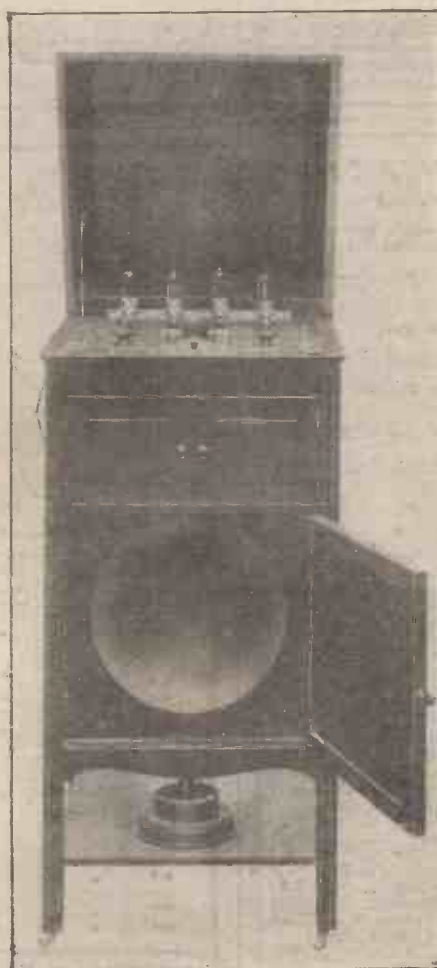

Four-valve Cabinet Receiving Set  
(W. R. H. Tingey)

## CONTENTS

Rectification by  
    Crystal  
    "                      "  
The Valve as a  
    Generator  
    "                      "  
Low-frequency  
    Amplifying Sets  
    "                      "  
Bending of Wireless  
    Waves  
    "                      "  
Club Doings  
    "                      "  
Correspondence  
    "                      "  
Information Bureau

# ECONOMIC ELECTRIC LTD.



**Have YOU tried the  
"XTRAUDION" VALVE ?**

the latest and best development of  
the 3 Electrode Valve.

**RECTIFIES, OSCILLATES  
AMPLIFIES**

Its Mechanical Construction  
makes it a stronger and more lasting  
valve than any other.

The Filament consumes well under  
half - an - amp. at 4 volts. Anode  
Potential, 50 volts.

Its Amplifying Properties are  
wonderful and its freedom from noises  
a revelation. Send for Descriptive Leaflet.

**15/-**

PRICE



**15/-**

PRICE

We publish the most complete Wireless Catalogue obtainable. 36 pages, profusely illustrated, and many useful circuits for experimental work. Mailed to any address on receipt of four penny stamps.

Head Office: 10, FITZROY SQUARE, LONDON, W.1

Showrooms: 303, EUSTON ROAD, N.W.1

Telephone: MUSEUM 1055

Branch Showrooms & Works: TWICKENHAM

# MITCHELFONES

Are not a spasmodic production to meet a sudden demand, but have been on the market for over three months, and during this period 27,000 have been distributed to the trade, and consequently we have not been able to offer them direct to the retail buyer.

*1,000 per week are now available, and we announce*

## DELIVERY FROM STOCK

You post your order, or call at our premises and get them at once. Think what this means to you—you, perhaps, who have been waiting and are still waiting.

*Standard resistance 4,000 ohms, double headgear with double headstraps, comfortable, highly efficient, and foolproof*

### 25/- per pair!

Special Terms to Traders and deliveries that will surprise you.

## MITCHELLS Electrical & Wireless Ltd.,

Postal Address: McDermott Road, Peckham, S.E.15.  
Retail Address: 188, Rye Lane, Peckham, S.E.15.

Phones: New Cross 1540/1541

## GREAT BRITAIN'S GREATEST WIRELESS STORE

# "HERTZITE"

**OUR GREAT CRYSTAL FOR BROADCASTING**  
SIMPLE TO USE. NO BATTERY REQUIRED

**Price 2/6 post free**  
Mounted in our Patent Detector, 5/6, post free

This Crystal was named and introduced by us. See you are not taken in with some substitute.

*We can give the best Wholesale Terms for all Crystals*

VALVES: "ORA," "XTRAUDION," "C.V.C.," & "R.M.R." 15/- each

## RUSSELL-SHAW,

38, Great James Street, Bedford Row, W.C.1.

### STARTLING REDUCTIONS



Ebonite Condenser Dials, Engraved 0-150° and filled white with Knob, Brass Bush and Set Screw 2/6  
Dial only ... 1/6  
Aluminium Condenser Vanes per doz. ... 6d.  
Spacer Washer, small 3d. doz.; large 4d. doz.

Knobs, with 2 BA Brass Inset ... 3d.  
Grid Leaks (enclosed), 2 meg. ... 1/-  
Grid Condensers ... 1/6  
Filament Resistances ... 3/6  
Crystal Cups with Screw ... 3d.  
Fusible Alloy, per stick ... 4d.  
Inductance Tubes, 12" x 3" ... 6d.  
" " 12" x 4" ... 9d.  
" " 12" x 5" ... 1/-  
" " 12" x 6" ... 1/3  
Sliders and Plungers ... 5d.  
Sq. Brass Rod, 12" x 1" x 1/8" ... 4d.  
Enamelled Wire, 23 gauge, lb. ... 2/-  
Aerial Wire, 7/25, Stranded, 100' ... 3/-  
Valve Holders, Screwed Legs ... 9d.

A. E. G. and Halske Valves for rectifying and amplifying (tested) ... 7/6  
Crystals (special selected), Bornite, Zincite, Galena, Silicon, Carborundum, Copper Pyrites, Graphite, Tellurium, etc. ... 6d.  
Egg Insulators, Green ... 4d.  
Reel " best quality ... 3d.  
Hellesen 36 v. Batteries with Tappings and Wander Plug ... 8/6  
Essex 15 v. H.T. Batteries ... 3/-  
Ebonite Leading In Insulators ... 1/6  
Perikon Detectors on Ebonite Complete with Crystals ... 4/-  
"Ubique" Crystal Set Complete ... 15/-

**DELIVERY BY RETURN GUARANTEED** Postage extra.

**THE ESSEX WIRELESS CO.** Office & Showrooms: 499, GROVE GREEN RD., LEYTONSTONE, E.11. (1 min. from Station, G.E.R.)  
Telephone—WANSTEAD 749.

# HEADPHONES!!

## Buy French Headphones Now and Save £ s. d.



Headphones of French manufacture are seldom equalled for sensibility and workmanship. Efforts are being made to prohibit importation. Therefore buy now.

Owing to the present favourable rate of exchange, we can offer various makes at the following extraordinary prices:

List No.	Make.	Total Res in ohms.	Brief Specifications.	Retail price.	Postage.
201	Picard	4,000	Moulded ebonite receivers, double duralium straps, fully adjustable ...	21/-	9d.
202	"	8,000	Ditto ...	22/6	9d.
203	"	2,000	Single Receivers only, complete with cords ...	8/-	5d.
204	Brunet	4,000	Aluminium receivers, double oxidised steel straps, fully adjustable, extra long cords ...	23/6	9d.
205	Thomson-Houston	3,000	Highly polished detachable receivers, single nickel-plated light wide steel spring strap. Particularly suitable for ladies ...	23/6	9d.
206	"	"	As above, but with double straps, fully adjustable ...	24/6	9d.
207	"	4,000	As above, single strap ...	24/6	9d.
208	"	"	As above, double straps ...	25/6	9d.

Satisfaction Guaranteed. Liberal Trade Terms. Send for List to-day, (PARIS and LONDON.)

## W. JOANES, 42, JENNER ROAD, STOKE NEWINGTON, LONDON, N.16



# Amateur Wireless

## and Electrics

No. 28

December 16, 1922

## Recording Wireless Signals

Constructing a Simple Device for Printing Morse

THE inability to read Morse places many amateurs under a great disadvantage, for many of the important communications are carried on in the code, as for long-distance communication telephony is out of the question. The difficulty is in memorising the code, and long practice is required in order to be able to take down the signals as rapidly as an expert operator transmits them.

To obviate these difficulties, and also to keep records of press, etc., the writer uses the instruments shown in the diagrams, which automatically prints the received signals on the familiar Morse tape, when they can be decoded slowly. The apparatus can easily be made with few tools, and the necessary components may be purchased for a comparatively small sum. It is easy to adjust, and if not disturbed will go on working until the paper is exhausted. Its only disadvantages are that unless the signals are very strong it will not work with less than three valves,

terminals Y by a piece of very thin coiled copper wire. The other contact C (also preferably of carbon) is mounted in a small cup, its pressure on B being regulated by

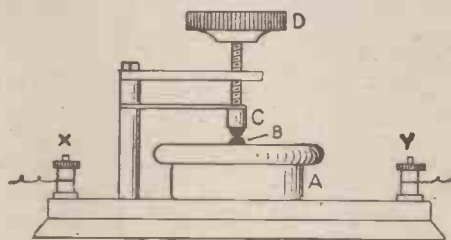

Fig. 1. Dancing-contact Relay.

a screw fitted with the knob D, the whole arrangement being similar to a crystal detector. Contact C is connected to the other terminal Y.

Across these two terminals is connected a Weston moving-coil relay in series with a small dry cell and rheostat. The Weston

wheel by a pinion and large gear wheel. The pen consists of a short length of glass tubing drawn out into a fine point; the upper part holds a small quantity of ink, and is therefore fitted with a cork.

If the moving parts are made light and little friction is allowed, the inker can record automatic transmissions at quite a good speed.

Fig. 4 shows the method of connecting up the apparatus which will work quite smoothly, provided it is kept free from vibration.

The signals from the receiver on passing through the telephone vibrate the diaphragm and contact B. Contact C is adjusted so as to keep a light contact with B, and the rheostat varied until just sufficient current is allowed to pass the contacts in order to keep the relay contact on the spacing stop, that is so that the 4-volt battery does not actuate the inker.

On the arrival of the signal the diaphragm vibrates, moving the contacts and

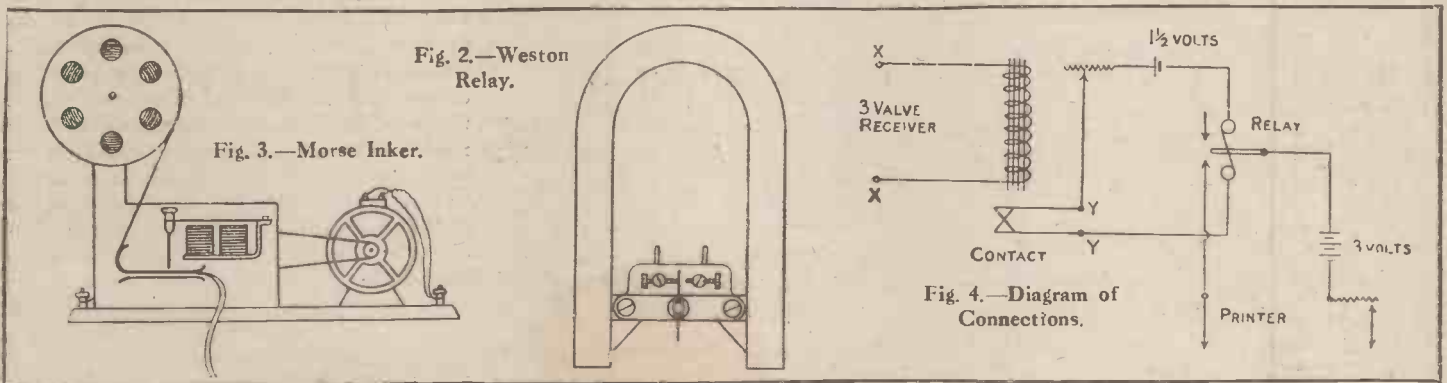

and as it is very sensitive to vibration it is not portable.

Fig. 1 shows the dancing-contact relay that controls the current supplied by a small dry cell operating the Weston relay. This dancing contact is the essential part of the apparatus and is used by many American amateurs for similar purposes, although the arrangement is different. A is an ordinary telephone ear-piece mounted on a suitable base, and leads from its terminals are taken to the two terminals X. B is a light carbon contact, the smaller the better, fixed on to the telephone diaphragm and connected to one of the

relay (shown in Fig. 2) was purchased for thirty shillings, and it has now been working satisfactorily for nearly a year. The small current from the dancing contact controls the current supplied by a 4-volt accumulator actuating the Morse inker shown in Fig. 3.

The inker is of the usual type, driven by a small electric motor, but any type of inker will answer provided the magnets are wound to a suitable resistance. The one shown is home-constructed. In order that the tape wheel may revolve sufficiently slowly, the belt drive from the motor works a separate shaft driving the

thus increasing the resistance between them. The decreased current not being sufficient to hold the contact arm of the Weston relay back, the arm flies over to the marking stop, allowing the 4-volt accumulator to pull down the pen on to the tape, thus recording the signal.

Once adjusted the instrument works well, but as before mentioned, it is very sensitive to vibration from traffic, etc., and must therefore be installed in a quiet part of the house.

The small expense and trouble incurred in its construction is amply repaid by the results obtained.

K. U.

# Rectification by Crystal



B. I. - H. Crystal Receiver (British Thomson-Houston Co., Ltd.).

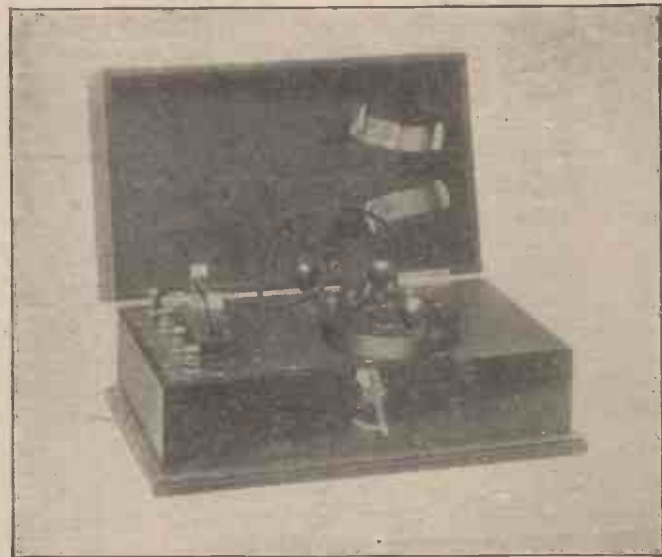

Empire Crystal Receiving Set (A. C. Cossor, Ltd.).

THERE are many types of crystals, but they can all be divided into two distinct classes. Firstly, those through which an increase in flow of current is proportionate to an increase in potential difference across the crystal. Secondly, those through which, after a certain voltage has been applied, the increase of current is out of proportion with the increase in potential difference. Hence it is said that those crystals in the first class obey Ohm's law, which states: "The current

flowing in any circuit is equal to the potential difference between the ends of that circuit divided by the total resistance of the circuit; and that those in the second class do not obey Ohm's Law.

Included in the first class are such combinations as bornite-zincite (perikon), silicon, whilst the carborundum-steel combination is included in the second class.

These crystals in the first class being more easily explainable than that employed with those in the second class will be dealt with first.

All crystals have the property—exactly why is not known—of allowing a large amount of current to pass through them in one way and only a very little in the other way.

To explain the result of this phenomenon a graph of the current-voltage curve of a typical crystal is shown (see

ing from zero and rising to their maximum values.

Now considering one train of oscillations, we will suppose that the first alternation rises in value to .3 volts, so plotting this on the graph, as in Fig. 1, we see that it causes a current rising in value up to 60 micro-amps to pass through the crystal. The next alternation being negative in direction causes current rising to only .5 micro-amps to flow in the opposite direction. The next positive alternation causes a current to flow rising up to 50 micro-amps. The following alternation being again negative in direction causes only .4 micro-amps to flow, whilst the next positive one produces a current rising up to 40 micro-amps. And so on to the last positive pulse which makes a varying current, having a maximum value of 60 micro-amps, to flow through the crystal. For one train of oscillations we thus have pulses of current of a large value in a positive direction and of a very small value in a negative direction.

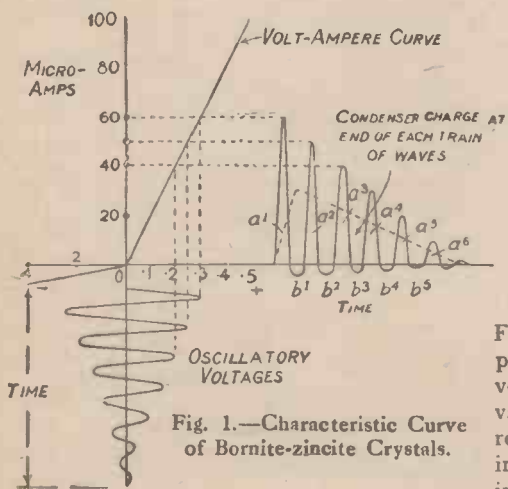

Fig. 1.—Characteristic Curve of Bornite-zincite Crystals.

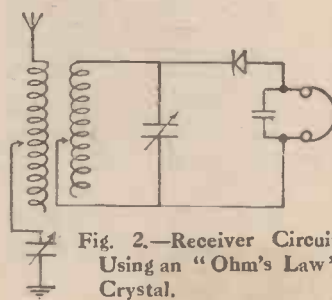

Fig. 2.—Receiver Circuit Using an "Ohm's Law" Crystal.

Fig. 1). Along the horizontal axis are plotted values of E.M.F., measured in volts, and along the vertical axis current values measured in micro-amps. The resultant graph will be one showing the increase in current for a certain increase in voltage, and will be in the form of a straight line because an increase in one is proportionate to an increase in the other. The type of crystal we are considering is used in a circuit such as is shown in Fig. 2, where it is seen that no steady voltage is placed across the crystal. Therefore the alternating voltage due to the oscillation in the aerial is the only voltage which affects the crystal, so they must be plotted on the graph, start-

### The Blocking Condenser

In a circuit employing the ordinary types of detector a blocking condenser is placed across the telephones as in the circuit shown graphically in Fig. 2. This condenser will be charged positively and negatively by the rectified current. Owing to the high frequency of the alternations the condenser will only be able to discharge at the end of each train; this discharge, being the net result of the positive and negative alternations, will be positive in value. This will be seen to be so on studying the graph, Fig. 1, where the rectified current is plotted against time.

(Continued on page 651)

flowing in any circuit is equal to the potential difference between the ends of that circuit divided by the total resistance of the circuit; and that those in the second class do not obey Ohm's Law.

Included in the first class are such combinations as bornite-zincite (perikon), silicon, whilst the carborundum-steel combination is included in the second class.

The method of detecting employed with



# A Coil-winding Apparatus

THE apparatus shown by Figs. 1 and 2 was designed for amateurs who desire to wind cylindrical coils easily and have not access to a lathe.

Procure an old highly-varnished thin cardboard advertisement which is roughly 9½ in. by 14 in. Bind lengthwise in a circle, glazed side out, and glue a butt-strap inside along the seam, leaving the latter ½ in. short of each end for the insertion of the circular end pieces of hard wood.

To wind 24 S.W.G. enamelled wire the following material will be required: one rod screwed 4 BA 12 in. long; one spindle 12 in. long passing through the coil holder; three large size "Meccano" wheels; two wood end pieces 7 in. by 5 in.; two pieces of wood for the base—one 3 in. wide and the other 1½ in. wide.

Take the 7-in. by 5-in. pieces and bore two holes in them about 2¾ in. apart to take the traveller spindle and coil spindle.

Screw a thread at each end of the coil spindle. Bore a hole in the centre of the

coil ends to take the spindle. Insert the spindle in the coil and screw up tight, using two nuts each end (one nut acting as lock-nut).

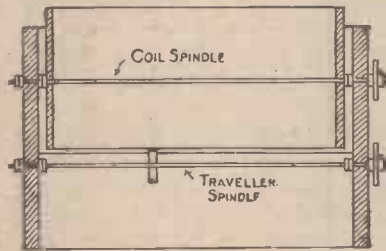

FIG. 1

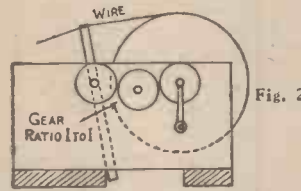

FIG. 2

Figs. 1 and 2.—Plan and End Elevation of Coil Winding Apparatus.

For the traveller a piece of ¼-in. square rod 5 in. long is required. Make a hacksaw cut at the top end, to run the wire through, and tap it 4 BA about 3 in. from the bottom end.

Screw the traveller on to its spindle and add two nuts to each end. Insert the traveller spindle and spindle with the coil holder between the two end pieces and then screw the end pieces on to the two bottom pieces.

Place one gear wheel on each spindle, securing them by the small set screw provided, and then mesh the third gear wheel loosely on a wood screw and tighten up all round with double nuts. Attach a handle to coil spindle and the apparatus is complete.

The sizes of the coverings on wire vary with different makers, but almost any wire can be wound by first winding 1 in. of turns on a lead pencil and counting the number of turns and selecting the thread giving that number or nearest less to the inch.

J. M. W

# A Cheap Variable Condenser

THE accompanying drawings illustrate the method of constructing a simple variable condenser which, besides being easy to construct, will be found to be equally as useful as the expensive bought

The capacity is varied by sliding the part C over or away from D (see Fig. 1). The measurements shown in the drawings have been found the most convenient by the writer, but, of course, these may be

each side of the wooden strip. A spring letter clip is then connected by a short piece of flexible wire to terminal B and clipped on to that part of the tinfoil which passes over the wooden or ebonite strip G. In this way electrical contact with the moving plate of the condenser is easily made.

The fixed part D of the condenser is tin-

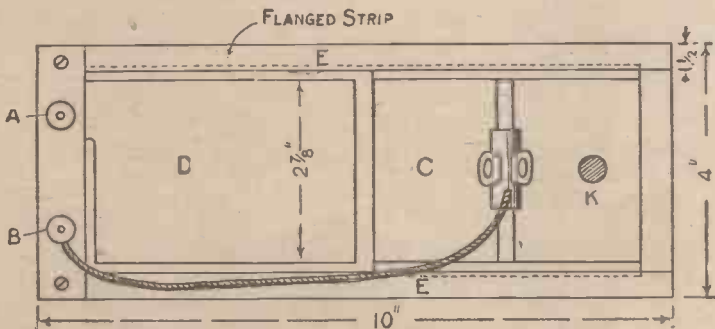

Fig. 1.—Top Elevation of Condenser.

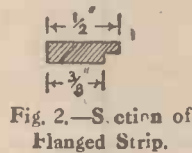

Fig. 2.—Section of Flanged Strip.

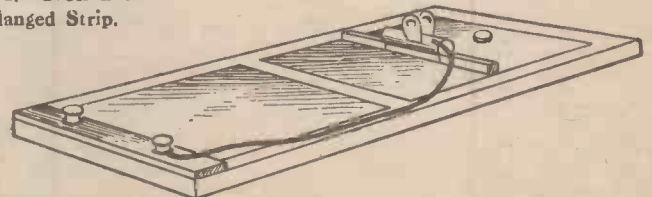

Fig. 4.—Complete Condenser.

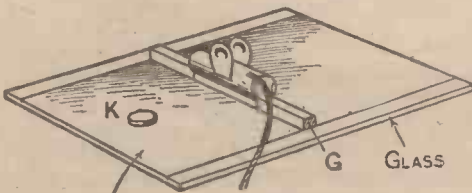

Fig. 3.—The Moving Plate.

modified. The base and flanged strips marked E (Fig. 1) are made quite smooth with glasspaper. The section of the flanged strips is shown by Fig. 2. The construction of the moving plate C may be seen from Fig. 3. For the dielectric a ¼-plate glass negative (which has been thoroughly cleaned) is used. G (Fig. 3) is a small strip of wood or ebonite and is glued on to the glass. A piece of tinfoil is laid over this and attached to the glass at

foil glued smoothly to the base and covers the area shown. This tinfoil is connected to terminal A.

The flanged strips E are so fixed as to allow the moving plate and glass to slide easily backwards and forwards. K is a small ebonite knob for moving the plate.

The terminals A and B are mounted on ½-in. ebonite screwed down at each end to the strips E. The complete instrument is shown by Fig. 4.

F. D. C.

variety. A brief description only is necessary, as the sketches explain themselves.

# All About the Valve—IX

## AS A GENERATOR

IT is frequently desirable that the tube should generate sustained oscillations—for example, when it is used as a transmitter or as a receiver of undamped or C.W. signals by the heterodyne method. The coupling of the coils A and B (see Fig. 15, p. 610) is then increased until the reaction is sufficient to set the plate current surging continuously (see Fig. 16).

### Interchange of Energy

The action is precisely the same as that previously described, except that in this case the upward growth of the plate current is limited, not by the imposition of each successive signal half-wave, but by the physical dimensions of the tube itself. Theoretically the interchange of energy between the grid and plate circuits should continually increase, and in time become sufficient to create oscillations of infinitely large amplitude in the plate circuit. In practice, however, the plate current cannot exceed the saturation value of its characteristic curve (see Fig. 16), nor can it sink below zero value, and so the extent of the plate variations is limited by these factors.

It may perhaps be asked why the first impulse on the grid does not thrust the plate current up to its maximum value and keep it there. The answer to this is that the value of the E.M.F. transferred from the plate to the grid is measured by the rate of change of the magnetic flux. This is a maximum at the steepest part of the plate current curve. As the curve approaches the apex, this rate of change diminishes, whilst at the moment it is actually at the apex the current is momentarily steady (there is no rate of change),

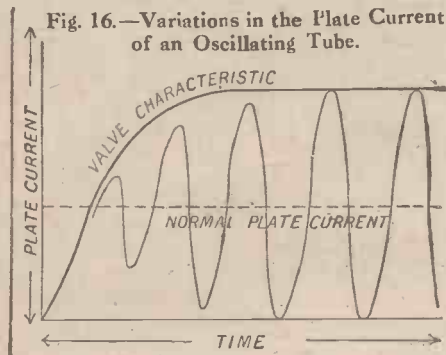

Fig. 16.—Variations in the Plate Current of an Oscillating Tube.

so that the transfer of energy ceases and the plate current commences to fall to its normal value (as shown in dotted lines). Immediately this reversal sets in, however, a new magnetic linkage-variation is created between the coils AB (Fig. 15) which sets up a reverse E.M.F., and this

increases the downward thrust of the plate current and so carries it past the normal, down to the lowest limit or zero. Then again the transfer of energy ceases and the current commences accordingly to regain its normal value (corresponding to the filament current and the high-tension on the plate), and so the process continues.

In reception by the heterodyne method the local oscillations so created interact

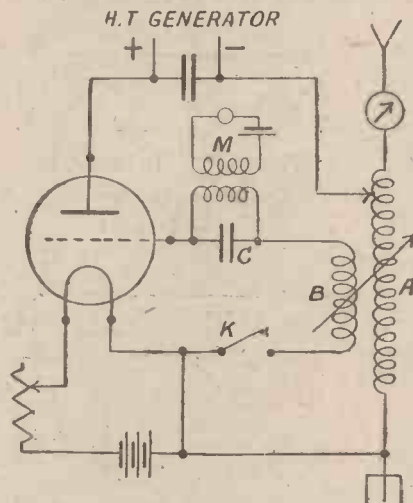

Fig. 17.—Thermionic High-frequency Generator for Telephony or C.W. Transmission.

with the incoming signal oscillations so as to create a "beat" effect of audible frequency. This is rectified by the grid leak and is detected in the phones.

### The Thermionic Generator

Fig. 17 shows a thermionic generator for use as a telephone transmitter or for C.W. telegraphy. The regenerative action takes place through the tightly-coupled coils A B. The plate and aerial inductances form an auto-transformer.

The action is precisely similar to that described in the heterodyne receiver, except that greater energy variations are naturally concerned in the case of transmission. The plate tension is supplied from a D.C. generator of suitable voltage (say 1,200 volts). Signals are sent by means of a key K in the grid circuit, which starts and stops the oscillations, the duration of each C.W. wave train radiated from the aerial corresponding to the Morse intervals.

For transmitting speech, a microphone circuit M is connected through a transformer to the grid circuit as shown, a condenser C forming a shunt for the high-frequency currents. The action of the circuit is to superpose on the grid, voltage-variations corresponding to the low-frequency current-variations created by speaking into the microphone. These are reflected in the plate circuit and cause the amplitude of the continuous waves fed to the aerial to vary. At the receiving end these "carrier waves" are rectified, and the superposed voice-form variations are revealed in the phones.

D. ALCASE.

(To be continued)

# Contact Studs Made from Screws

WHEN it is desired to make up one's own contact studs the following idea will be of service. Cheese-headed screws must, of course, be used, and, as the sizes of these vary greatly, no definite dimensions can be given for making the jig. It is thought, however, that the diagrams Figs. 1 to 3 will give a clear impression of what is required.

Referring to the illustrations it will be seen that the jig is composed of three portions. The material used throughout is mild steel. A and B (Fig. 1) should be slightly less in thickness than the distance between the base of the screw-head and the bottom of the screw-slot. Two fixing-screw holes are drilled in each in the position shown, and these are countersunk so that the heads of the fixing-screws will be slightly below the surface. When completed both pieces are case-hardened. The reason why the jig has only been designed to take two screws at a time is because, if A and B were made longer unevenness of surface might be caused by the metal warping during the case-hardening. C should be at least 1/4 in. thick, so that the jig may have a firm foundation. The holes for the fixing-screws are drilled and tapped, so that, while being coincident with those in A and B, they are at such a distance apart that the slot formed between the plates A and B will be just equal to the diameter of the heads of the screws to be made into studs. The holes for the reception of the shanks of the screws are drilled in the centre of the slot, and should be clearance for the size of the screws used.

### Using the Jig

When in use the jig is held in the vice. The screws are inserted in the holes in the slot, and, after making sure that they

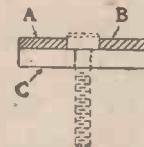
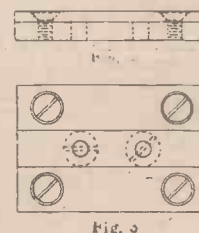

Fig. 1

Figs. 1 to 3.—Making Contact Studs from Screws.

are firmly seated, are filed off flush with the surfaces of the hardened plates. The latter will not be "touched" with the file, and uniformity of contact surfaces will be the result. An old file should be used as the hardened surfaces would soon ruin the teeth of a new one.

J. MCG.



# The World listens in on MULLARD PHONES

Specially made for the reception of wireless broadcasting, Mullard 'phones are thoroughly well made and fit comfortably to the head, etc.

### British Manufacture

The two high resistance ear-pieces (4,000 ohms total) are flexibly attached to the fully adjustable, double head bands. The set is nicely finished in nickel-plate and supplied complete with standard flexible cords.

Send the coupon to-day to secure immediate delivery.

These telephones are made by the makers of the famous "ORA" valve and Mullard valve accessories.

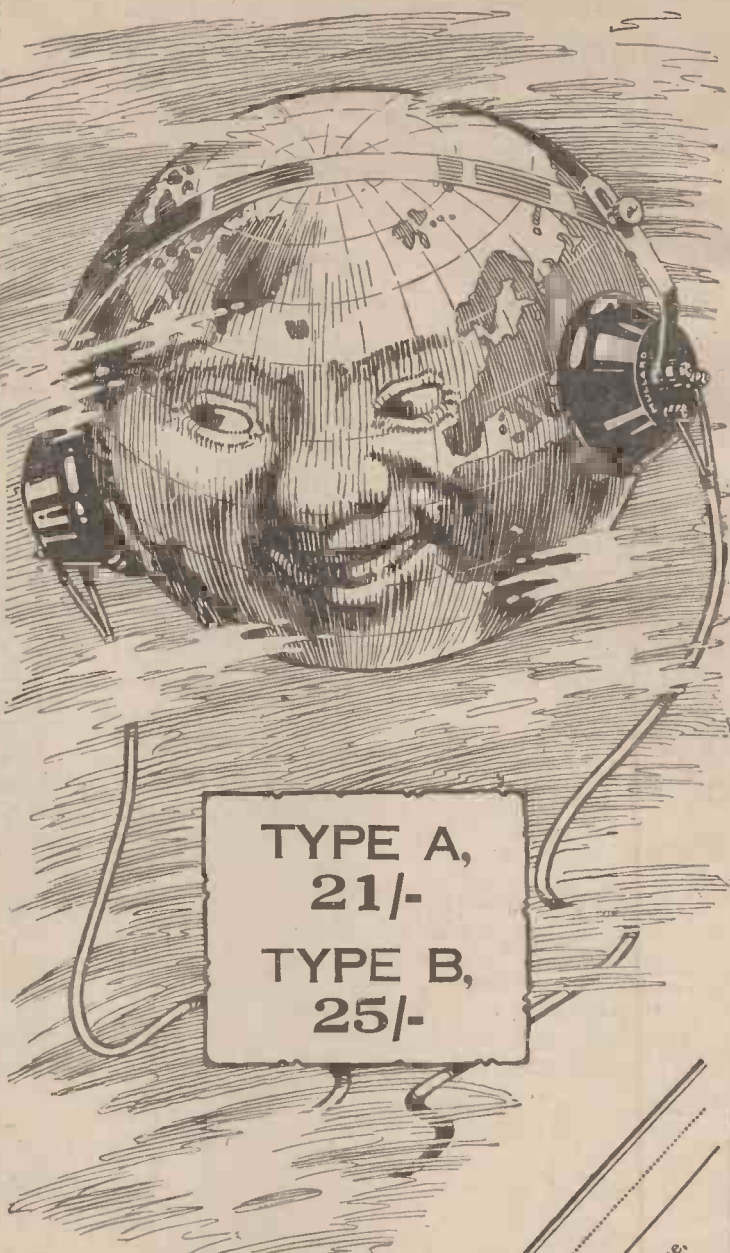

TYPE A,  
21/-  
TYPE B,  
25/-

## MULLARD "ORA" VALVES

We hope to get a greatly increased output of these famous valves at our large new factory.

Meanwhile ORDER AT ONCE

## Mullard Radio Valve Co. Ltd.

45, Nightingale Lane, Balham, S.W.12.

Contractors to H.M. Admiralty,  
War Office, Royal Air Force & Post Office,

Telephone: Codes: Telegrams:  
Battersea ABC (5 Ed) 'Radiovalve, Hammer'  
1068 Bentley's London.



Name and Address .....		Please send me post free	
Quantity	Description	Price	
.....	Telephone Head Sets	Type A, 21/-	1 enclose (Cheque, Money Order, P.O.) value to cover the cost.
.....	"ORA" Valves	Type B, 25/-	
.....	Grid A Resistances	15/- each	
.....	Anode A or B Resistances	5/- "	
.....	BA Condensers, 0.002 mfd.	2/6 "	
.....	Combined Resistance and Condensers	7/6 "	
.....	Valve Bases with Terminals	5/- "	
.....	Valve Sockets	1/3 "	
.....	Terminal Clips	9d. per pair	

Name of usual Wireless Dealer .....

**SEND THIS TO-DAY**

# T.M.C. Wireless



“My Xmas present”

Make it a T.M.C. Wireless Receiver and strike a new note. T.M.C. offers you a wide selection of fully approved, British Broadcasting Receivers, from simple Crystal Sets to Cabinets de Luxe

The illustration shows the—

**T.M.C. CRYSTAL SET NO. 2**

with

**PATENT “EVERSET” CRYSTAL**

which needs no adjusting. Call and choose your Present to-day. If you cannot call, full particulars will be sent on request.

The Telephone Manufacturing Co.,  
Limited,

68, Newman Street, London, W.1.

Tel.: Museum 5581

We have engineers in every large town, who install the wireless to your satisfaction.

London, Manchester and Birmingham are Broadcasting Now.

# T.M.C

makes Wireless worth while



# BUY YOUR XMAS GIFTS NOW!

## FURTHER GREAT REDUCTIONS IN PRICES

ALL GOODS SENT POST FREE

### Headphones



**21/-**

4000 ohms total Resistance.  
Double Headband.

Guaranteed highly efficient. Complete with Cords. Ball and socket joints; highly polished nickel cases; best Tungsten steel magnets.

### BEAVER Complete Set of CONDENSER PARTS

contains:

- Ebonite Top and Bottom Plates, Machined
- Aluminium Moving Plates
- Aluminium Fixed Plates
- 1 Square Centre Spindle
- 3 Stay Rods, screwed both ends
- Large Spacing Collars
- Small Spacing Collars
- Bronze Coil Spring
- Ebonite Knob, drilled and screwfitted
- Brass Nuts for Centre Spindle
- Small Nuts

•0005 MF. ... ..	8/6
•00075 MF. ... ..	9/6
•001 MF. ... ..	11/6
•0015 MF. ... ..	13/-

### Splendid Crystal Detector

Mounted on Ebonite.

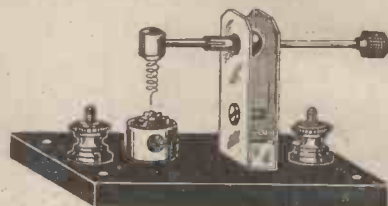

POST FREE **2/9**

- High-class Filament Resistances 4/-
- 100 ft. Aerial Wire 7/22 Stranded
- H.D. Copper—the best ... 3/10
- Best Quality Switcharms ... 1/6

#### Valve Holders

- Best Quality Ebonite ... .. 1/6
- Best Insulating Composition ... 10d.
- Condensers •0002 ... .. 1/6
- .. .. •003 ... .. 2/9
- Chemically engraved Scales 0-180°, 3½d.

## BEAVER COMPLETE CRYSTAL SETS

### Beaver "MIDGET" Crystal Set

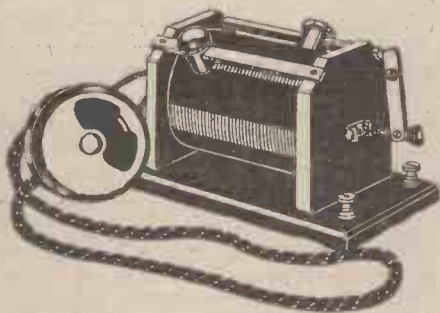

The Ideal Xmas Present. Length 6½ in. X 4 in. Absolutely guaranteed. 15/-; complete with 4000 ohm ear-piece, 30/-.

**No. 1** unassembled 15/- **No. 2** unassembled 20/-

**No. 3** assembled 24/- ready for use  
Complete with Splendid Tested and Guaranteed 4000 ohm Phones, 45/-

**No. 4** unassembled 30/-  
Complete with Splendid Tested and Guaranteed 4000 ohm Phones, 50/-

### No. 5 De Luxe Set

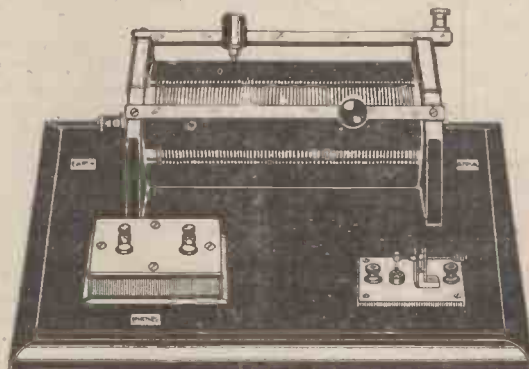

Comprises Inductance Coil 9" X 3½", with waxed interior to prevent sweating, wound 24-Standard Wire Gauge, Bronzed Wire, heavily shellaced and varnished. Beaver de Luxe Crystal Detector with Crystal, Highly efficient Blocking Condenser, 2 Brass Rods. Special pattern Slider and Plunger, concealed Insulated Wiring, all necessary Terminals and Tabs, the whole mounted on polished Mahogany base, with fluted edges. A Highly Efficient and Guaranteed Set.

Assembled 50/- ready for use  
Complete with Splendid Tested Guaranteed 4000 Phones, 70/-  
(Passed by Postmaster-General, G.P.O. Regd. No. 198)

## BEAVER ELECTRICAL SUPPLY CO.

Telephone: GERRARD 1900. 109, REGENT STREET, LONDON, W.1.

Special Terms to Trade. All Cheques and Postal Orders to be crossed London Joint City and Midland Bank.





An Ideal

Xmas Gift

ORDER NOW.

The Best Value in Single Valve Panel Sets on the market

No Finer Set could be built if 20 times the price were paid

30/-

Complete

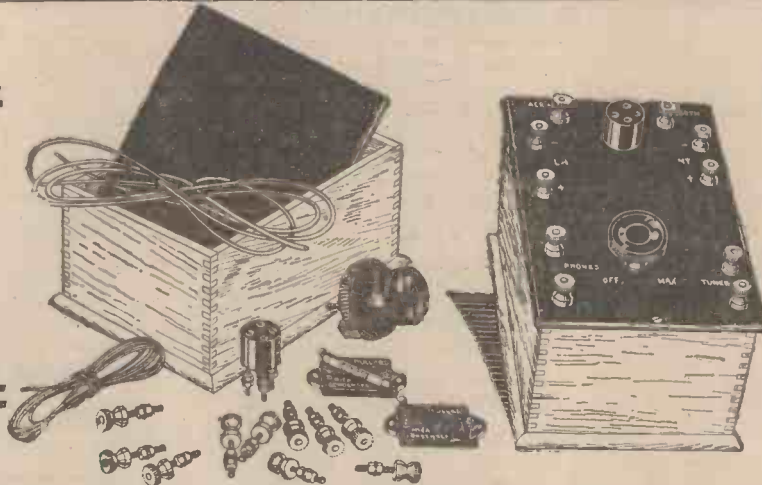

30/-

Complete

Comprising: Handsome polished mahogany cabinet, panel of best quality ebonite, well finished and bevelled edges, valve holder, filament resistance, 2 Mullard's Condensers, '001 and '0002 mfd. Mullard's Grid Leak, 10 Terminals, 10 engraved terminal tablets, coloured systoflex and copper wire, blue print with full instructions. Hundreds of these sets have already been sold. As will be observed, **ONLY THE VERY BEST COMPONENTS ARE SUPPLIED.** This is the secret of the success and popularity of this panel.

**EVERY WIRELESS ACCESSORY IN STOCK**

Coil Holders, 25/-; "Ora" Valves, 15/-; Marconi "R" Valves, 17/6; Valve Holders, 1/9; Variable Condensers '0005 mfd. £1; '001 mfd. 26/6; Filament Resistances, 4/-; Mullard Condensers '0002 and '0003 mfd. 2/6; '001 mfd. 3/-; Mullard Grid Leaks, 5/-; Transformers, intervalve, 25/-; High Tension Batteries complete with Wander Plugs, 36 volts, 8/6, 60 volts, 14/-.

**FREE GIFT**

A useful Case containing 3 padded compartments free to every purchaser of 3 valves



**BROWN HEADPHONES, "A" Type, 120 ohms. £2 2 6**  
 " 8000 " £2 9 6  
**SULLIVAN HEADPHONES** (Complete with 25/- Transformer) 120 ohms - - £1 10 0  
 " HEADPHONES 8000 ohms - - £1 16 6

All brand new and unused, and sold under express guarantee that we will refund full amount paid if not absolutely satisfied and goods are returned within 7 days

**The City Accumulator Co.**

79, MARK LANE, — LONDON, E.C.3

Phone: Avenue 1316

Wholesale and Retail Distributors for Messrs. BURNDIPT, Ltd. Some Trade Discount Allowed as by Manufacturers.

AGENTS.

London: H. V. ALBROW, 56, George Street, Baker Street, W.1.

Glos.: BRISTOL WIRELESS Co., 52, Cotham Hill, Bristol.

Leicester: WALTER ROWE, LTD., 96, Granby Street, Leicester.



S. Wales: SOUTH WALES WIRELESS INSTALLATION Co., LTD., 18, West Bude Street, Cardiff.

N. Wales, Lancs., Ches. & I.O.M.: THE "ALL-BRITISH" WIRELESS MANUFACTURES Co., LTD., 18, Vauxhall Road, Liverpool.



# On Your Wave-length!

**My Favourite Valve**

**Non-stop Seven-hours' Concert**

**Vics**

as G N P and G B<sub>2</sub>, are powerful enough to make the headset uncomfortable whenever quite a small number of valves is in use. But if ever your ears are suddenly blasted into temporary deafness by a call that seems to come from a million kilowatt station situated in your own back garden, you can be pretty certain that you are listening to the gentle cooing of one of Uncle Sam's mercantile marine. If American land stations are of anything like the same calibre it is no wonder that Congress is taking measures to suppress spark transmissions.

\* \* \* \*

My rectifying valve blew out on Sunday. On any other day of the week it would be the simplest matter to obtain another that would have done the work in some kind of fashion. But I fear that I shall never be able to replace that old friend, the best rectifier that ever was. The secret of its excellence lay in its slightly soft character. With it mounted on the big set one could search round with a clear conscience amongst telephony transmissions until one found what was wanted, for there was never a sign of a chirp or a squeak whilst searching was being done. Your hard valves are all very well in their way, but for rectification purposes they cannot hold a candle to those of the open grid type with a small residue of air left within the glass. My late lamented was not, I regret to say, of British make; in fact, had any member of the B.B.C. seen it I should probably have been hanged, drawn and quartered; but it did the work as no other has ever done it, giving a far greater volume of perfectly pure sound than can be obtained with any that has since been tried. If one of our home makers will try placing on the market a valve designed specially for rectifying, softish, yet able to withstand 60 volts on the plates without blue-glowing, he will find that it will command a ready sale.

\* \* \* \*

Let me tell you of a non-stop seven-hour concert. The fun started at 5.15 with F L booming through as though he was in the same room. Weather report first, as usual, and then an excellent musical programme; vocal and orchestral, mostly

the very best modern stuff. F L ended at 5.50 with his customary "Bon soir, mesdames; bon soir, messieurs." Ten minutes interval to adjust a high-tension connection which showed a disposition to crackle.

At 6 p.m. to the minute, 2L O's chimes announced that he was on the spot. Only the first news bulletin from him, but the promise of a concert later. 6.15.—Manchester, in full song. More good music until an entertainer with some sort of a recitation came on. I couldn't get him very well—Manchester is 200 miles away—so went fishing. Surprised an amateur announcing that he was coming on at 11 p.m. with music. Our old friend 2O M this was. Are we going to get to bed at all to-night?

Birmingham was going strong at 7 o'clock. Transmission excellent, but still that hollow sound, as though the room from which the speech and music comes was absolutely bare. Why does Birmingham say he is going to switch off for three minutes and then be away five or eight? It wastes our "juice." But we don't have to listen to Birmingham, do we? That he was good enough is evidenced by the fact that I stuck to him till 8 p.m.

London again at 8 o'clock. Very good indeed, and punctual. When Burrows of the clear articulation says that he is having a three minutes' interval, it is a three minutes' interval, except when he makes it two minutes fifty-seven seconds. Violin and piano and some excellent contralto and tenor songs from London. At 8.45 we decide that London may be very good, but it isn't the only pebble on the beach. What about that new French station on 1,500? Perhaps there won't be so many fellows using reactance on the aerial and flashing condensers on that wave-length. Something has got to be done about these ether-hogs. They aren't getting much fun themselves because their instruments aren't properly tuned, and they spoil the pleasure of everyone for miles around.

Yes, the Radiola people were there, and no interference at all. Instrumental music to start with, then some songs, and an excellent 'cello solo. More orchestral work. Radiola ended at 10.5, and it was curious to hear F L's time signals butting in on the last item, though he is 1,000 metres higher up on the wave-length scale.

At 10.25 the amateurs were getting busy. They kept it up until midnight, with speech and music. A seven-hour run, practically non-stop.

\* \* \* \*

Amateur transmitters have been rather put in the shade of late by broadcasting.

Some have taken to the shorter waves, others have changed their times. One no longer hears the pleasant buzz of conversation that

used to take place every evening and most of the day on Sundays on round about 400 metres. We all of us owe these enthusiasts a deep debt of gratitude for what they have done for us in the past. But for them there would, on most evenings, have been nothing at all to listen to in the way of telephony.

\* \* \* \*

It is reported that hundreds of amateurs, fired by what has been done at Croydon, Nottingham, Bridgend, Brighton and Holyhead, are now burning the midnight therm or watt, as the case may be, whilst endeavouring to pick up dulcet strains from broadcasting stations across the Herring Pond. They should remember, however, that others are engaged just now in trying to hear American amateur transmissions; it is therefore very important that no set should be allowed to oscillate on short waves during the night hours, for interference of this kind might easily spoil important experiments. It must be rather a blow to Uncle Sam that we have heard his music before he has managed to listen-in to ours. Don't worry about that, though. It won't be long before American papers report, with headlines of vast size, that Abinadab P. Joskins, the thirteen-year-old son of the Sheriff of Slossville, Pa. (or perhaps Va. or possibly Ga.), has been hearing 2MT for weeks on a home-made crystal set that cost exactly 37 cents to construct.

\* \* \* \*

The Morse instructor was warming to his work with the beginners' class. "The letter v, or vic," he thundered, "which you will hear used a great deal on Sunday afternoons during The Hague concert, is made up of three dats and a dosh!"

\* \* \* \*

Did you hear, by the way, of the post-card received at Writtle from an admirer who had been motoring that way? "I had hoped to call," so he wrote, "but when we got to Writtle it was an hour past lunch time and I was 2MT to CQ." Too bad; still Writtle was asking for trouble after his spoof chimes on a biscuit tin and 2MT bottles!

THERMION.

**Amateur Transmissions**

**Oscillation and the American Tests**

**2MT to CQ**

# "A.W." Ideal Unit Receiving Set.—IV

## THE LOW-FREQUENCY PANEL

A PASSING reference was made in the last article to some of the drawbacks that attend the use of low-frequency amplification; though these are serious, it must not be imagined that this form of wave

of them can be relied upon to eliminate entirely the unwanted effects, but they certainly make a great improvement. You

sion, for a certain amount of distortion will hardly affect spark or continuous wave signals, though it mars the distinction of speech and spoils the tone of a musical item. Gramophone records, by the way, are not ideal for testing purposes, since if the receiving set is perfectly in tune the scratching of the needle on the surface of the record can be heard, and may be mistaken for the hissing that often betokens a faulty grid-leak or the presence of self-oscillation.

Should interaction effects be noticed, try soldering a wire to each iron core and taking it to earth. This will sometimes work a cure; but if it fails, the best thing to do is to enclose each low-frequency transformer in an iron case, which will confine the greater part of its magnetic field to its own immediate neighbourhood.

### What the Transformer Does

The chief duty of the low-frequency transformer is to act as a "booster" to the impulses supplied by the plate of the preceding valve. When two coils are coupled, breaks or changes in the current flowing in the primary will cause spurts of current to occur in the secondary. The secondary terminals of a transformer therefore deliver electrical impulses which correspond exactly with those that enter those of the primary. But if the windings of the secondary are more numerous than those of the primary the current will be so altered by it that its voltage is increased. We do not obtain more current, for the step-in in voltage is accompanied by a corresponding loss in amperage; but as the operation of the amplifying valve depends upon potential changes in the grid circuit, this is exactly what we require. The increase of potential is almost in proportion to the number of turns in the primary and secondary coils respectively. Hence, if the latter contains five times as many turns as the former, the potential will be raised by about five times. This ratio of five to one has been found to give the most satisfactory results for the low-frequency trans-

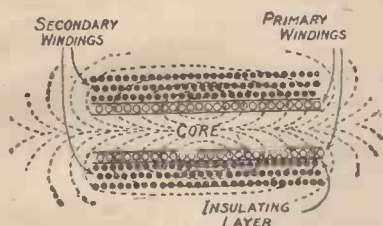

Fig. 1.—Diagram of Open-core Transformer.

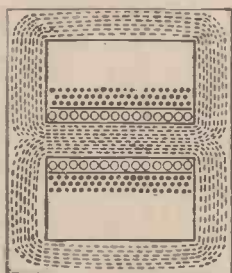

Fig. 2.—Diagram of Closed-core Transformer.

magnification is altogether to be condemned. On the contrary, it has its own uses, performing tasks that the high-frequency system cannot accomplish, and it is usually desirable to have certainly one stage of audio-frequency amplification available in the multi-valve set. Thanks to the unit system it can always be thrown out of action in a moment when it is not wanted.

### Note-magnifiers in Cascade

It is, of course, possible to use two or more note-magnifiers in cascade, but unless the set is required to operate a loud speaker giving a volume of sound sufficient to fill a large hall, it is better not to employ more than one. High-frequency transformers can be placed quite close together without undesirable results, but with the iron-core instruments needed for dealing with audio-frequency impulses the case is different. Unless they are widely separated a certain amount of interaction takes place, which gives rise to distortion and sometimes to an orgy of howls, in comparison with which the mightiest vocal efforts of a pair of warring tomcats are mere dulcet flutings.

The low-frequency unit used with the set under description is shown in Figs. 8 and 9 in the article on page 614, which give the details of its economy both above and below the panel. It will be noticed that the transformer is so arranged that its windings are at right angles to the long side of the panel. If the reader contemplates the employment of more than one such unit he is advised to mount the transformer with its coils parallel to the ebonite strip, otherwise its effects upon its next-door neighbour may be so serious as to impair the working of the set.

### Interaction Effects

There are several ways of minimising the interaction effects of low-frequency transformers mounted in cascade. None

can test the set for interaction effects by using flexible leads, say a yard in length, instead of the short brass strips, to connect two low-frequency panels. Before switching on move the panels away from each other to the fullest extent of the wires. Now turn on the current, tune into a

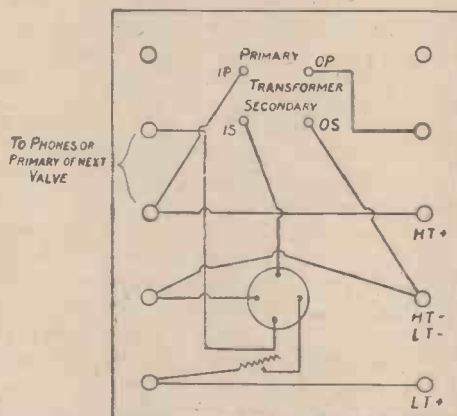

Fig. 3.—Wiring Diagram of Low-frequency Panel.

strong signal and listen carefully. Slide the outlying panel gradually towards the other, remaining at the same time on the look out for any change in the quality of the signals. If they become blurred or accompanied by outside noises as the dis-

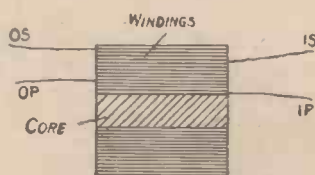

Fig. 4.—Leads of Low-frequency Transformer.

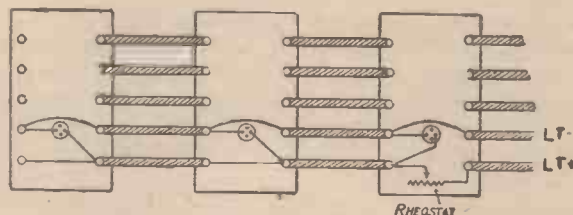

Fig. 5.—Diagram showing Control of Three Low-frequency Panels with One Rheostat.

tance between the panels is decreased, then interaction is present. It is best to make the test also with a telephonic transmis-

sioners used in the receiving set, providing always that the primary is large enough to give the necessary factor of impedance.



The function of the iron core is to act as a path for the electro-magnetic lines of force set up by currents flowing through the windings. In order to compel as many of them as possible to do useful work the core is of what is known as the closed type; that is, instead of being simply a straight bundle of iron wires it is shaped into what may be termed a "square 8," both primary and secondary coils being wound on the middle bar. Figs. 1 and 2 illustrate the effects of this arrangement.

Fig. 1 shows an imaginary section of an open-cored transformer. All of the lines of force from the primary move along the straight core, but many escape at the ends without ever having passed through the secondary. In Fig. 2 the working of the closed-core type is seen diagrammatically. The iron offers far less opposition to the passage of the lines of force than does air; hence all but a very few of them move round the core, passing on their way through to windings of the primary, and doing useful work.

The rectifying valve does not function quite perfectly, for it allows a number of high-frequency pulsations to pass through it, and these go on to the transformer mingled with low-frequency impulses. Their presence in audio-frequency circuits is undesirable, and some means of getting rid of them must be found. This is done by providing a capacity in the primary of the transformer which will act as a by-pass for them. It usually takes the form of a fixed condenser of .001 mfd. shunted across the primary terminals, but some transformers, such as the type shown in Fig. 1, are so wound that their own self-capacity is sufficient for the purpose. The low-frequency panel, when made up, should be tested with and without such a condenser in order to see which gives the best working.

Low-frequency condensers range in price from 14s. to £2. A small type used during the war in army receiving sets can be bought at the lower figure mentioned. I cannot claim to have tried them, but some who have done so give good reports of them. In this type the core is provided with a lead ready fixed for earthing purposes. Remember that the success of your audio-frequency panel depends very largely on the design and finish of the transformer. A badly made instrument can never do good work; it pays therefore to buy a kind that is guaranteed by the makers to have been thoroughly tested before leaving the factory.

Fig. 3 gives a wiring diagram of the panel. In it the transformer is shown mounted as seen in the photograph; do not forget to make the necessary change in its position if you intend to have two or more note-magnifiers.

There is one point of importance in the wiring up of the transformer. Some of them have the input and output terminals of primary and secondary marked 1 P, 0 P, 1 S, and 0 S, but others are merely lettered "primary" on one side and "secondary"

on the other. The input and output terminals can, however, be readily found if you remember that the input lead will always come from a point nearer the centre of the coils than the output lead. Fig. 4 makes this quite plain. In connecting up the wires join the terminal leading from the plate of the preceding valve to 0 P, and 1 P to H.T+. 1 S is joined to the grid, and 0 S to L.T-. If the connections are not made as shown the transformer will not work properly.

Valves of the type used on the high-frequency panels will be found to answer admirably for note magnification. There is no need, by the way, to have a separate

filament rheostat for each low-frequency unit, for since the valves are doing the same work they will require the same amount of current. Fig. 5 shows how one resistance may be made to control all of them. If a single rheostat is used it must be capable of carrying 2½ amperes.

In the next article we shall describe the construction of the end panel, on which are mounted both loud speaker and telephones, a switch enabling either to be thrown in or out of operation. We shall also discuss some possible refinements, and see how to make profitable use of the fifth terminal, which so far has been allowed to remain idle.  
R. W. HALLOWS.

## Forming a Wireless Association

AN amateur wireless society may consist of three or more members, and if the three are respectively the chairman, the secretary and the treasurer, with power to add to their number, you have an ideal nucleus round which to gather and to work. However small your town, it surely will contain three people who are interested in wireless matters. A Post Office permit is not necessary before you can hold a meeting, but you will find that few meetings will have taken place before most of the members are in possession of the necessary permit to receive wireless signals.

The authorities are invariably well disposed toward the *bona-fide* wireless experimenter, and if you have given proof by banding together into a society, the Post Office can hardly go back on its word and refuse to listen to the appeal for experimental licences when they are backed up by the signature of your elected secretary on club notepaper and concurred in by the other members of the committee.

In order to justify the good opinion which the authorities have, the writer suggests a definite course of elementary study beginning with an easily-made tuning inductance, passing on to a crystal detector, the telephones and the aerial, and by the time you have studied these theoretically, by the aid of the cheap and good literature now on the market, you will be quite ready and capable of putting your so acquired knowledge to the test of experiment and, as before said, will probably have received the official sanction to do so.

Let it be clearly understood that if you purchase a broadcasting licence at your Post Office you will not be permitted to perform any experiments other than turning the various knobs on your dearly-bought apparatus, and hoping that something will happen as a consequence. The only thing you will be allowed to do on your own will be the erection of your aerial. If, on the other hand, you obtain an experimental licence, you can con-

struct your own set from home-made or bought parts.

The matter of forming an association is not quite so easy if a large membership is probable. You have now a more diverse standard of attainment and the capacity to attempt greater things.

To meet such a case the formation of a special committee is advised whose sole function is to find out the requirements of individual members and recommend to the chairman and the secretary that the discussions and instructions should follow a course best designed to meet the individual need. Everything else which you may do must be subservient to this. Where the plan outlined above has been adopted it has worked admirably. Meetings, however large or small, must be conducted on parliamentary lines. The speakers must address the chairman, who must be selected on account of his suitability for the post.

The secretary also will either make or mar the society, but he has to be more or less of an opportunist, and though he cannot be all things to all men, he has to trim his course by the wishes of the majority.

An expert visitor who can appreciate your needs and meet them in a talk or lecture is a very desirable person, but one who cannot get down to your level is a drawback rather than a help. He will talk over your heads and you will go away confused rather than edified.

Don't stint yourself in stationery. You will often be judged by your letters. Publicity is good. It keeps you up to the mark and brings in new blood, without which no society can progress.

Read the reports of the doings of other societies and try at least to equal their doings.

Nearly all newly-joined members will be most diffident as to their worthiness of belonging to your society. Do your best to put them at their ease, and thaw them out of their reserve.  
SIGMA.

# The Bending of Waves

An Entertaining Article by Mr. Robert G. Lunnon, M.A., B.Sc., on an Abstruse Question

HOW can wireless waves bend half-way round the world? The question is a very puzzling one, and the scientist is not yet certain of its complete answer, although his knowledge of other kinds of waves goes some way towards it. Consider, for example, how sound waves bend. We all know that sound can pass round corners, and there are three ways in which it does so. If a band is playing in front of a house it can be heard at the back, although not all the notes are equally audible; the low notes travel best, and the high-pitched instruments may scarcely be heard. Again, in a whispering gallery even a faint sound can be carried round a large part of a circular gallery. And thirdly, the sounds from some powerful source, such as gunfire or an explosion, are sometimes heard at great distances when they have not been audible at all at nearer places; they have travelled up into the air and have been bent down again in an arc. Is it by methods similar to one or all of these that electric waves are curved?

## Three Effects

These three effects are classified as cases of diffraction, reflection and refraction respectively. In the last case the air is of different densities and temperatures at different places in the path of the sound, so that some parts of the wave travel more quickly than others, and its path is no more a straight line than the path of a squad of soldiers would be if the men on one side marched more quickly than those on the other. The whispering gallery is a case of reflection—the feeble sound waves from a whisper are not allowed to waste their energy by spreading out in all directions, but by repeated reflections they are kept going for a long distance round the narrow gallery. The method of diffraction is harder to understand. The sound waves from the band travel round the house because every part of each advancing wave sends on the sound as, if it were itself a new centre for the wave. That is to say, it sends on the wave in all directions, and not only forward in its original direction. In the same way if a noise comes into a room through a keyhole it spreads out inside the room in all directions to various degrees—most strongly, of course, in the line of the hole.

## The Behaviour of Ether Waves

But sound waves are entirely different in character from electromagnetic waves—they are waves in air, not in ether—and these analogies may be misleading. Con-

sider the behaviour of those ether waves which are visible as light. They can be reflected and refracted easily; do they show diffraction? They certainly do not bend far round the earth, for a ship's sails soon disappear on the horizon. If light rays enter by a keyhole they do not appear to spread out in the least. Sound waves, however, are very much longer than light waves, being commonly 3 ft. or 4 ft. in length, whereas the longest waves of light are less than one thirty-thousandth part of an inch. By suitable methods the bending of light can be made clear. If a small pinhole be placed in front of a strong light, and a threepenny-piece be hung at about six yards distance, then at the very centre of its shadow, at the same distance on the other side, a tiny bright spot may be seen and photographed. The light has not come through the centre of the coin; it has been able to bend through the very small angle, less than twenty minutes ( $\frac{1}{3}^\circ$ ) of arc, involved in passing round the edge. Similarly if the edge of a knife blade be held in a suitable beam of light, it is possible to see with a microscope that the clear edge of the shadow seen with the naked eye does not exist, but some light bends round the edge, the shadow only gradually deepening into complete darkness.

## Characteristics of Long and Short Waves

The shortest waves bend least. An average X-ray is a wave 5,000 times shorter than red light, and until 1912 it had not been discovered that X-rays could curve at all, so that it was doubted whether they were really waves. But the electric waves that Hertz discovered in 1888 were several feet long, and it was not surprising therefore to find that such waves could diverge widely from a straight line path. Now we use waves far longer than any Hertz could produce, and they can very easily curve round ordinary obstacles. An experiment of Campbell Swinton's is one of many that show this clearly. He enclosed a wireless receiving apparatus in a large covered tin with one side cut out. When this open side was pointed directly away from the sending apparatus the signals were received perfectly clearly, so that the waves had been able to bend right back round the edges. Even with the side almost closed again, and only a narrow slit left, the waves could penetrate. Sir Oliver Lodge has found that if a small round hole is left instead of a slit the signals received inside are very much weaker, and he also found that they may be strengthened by holding a short piece of wire through the hole.

Is this phenomenon of diffraction sufficient to account for the fact that with a wave-length of ten miles we can communicate with the Antipodes? The answer is that the waves would indeed bend so far by diffraction, but they would be far weaker on arrival than is actually the case.

## A Problem Solved

It was in 1918 that G. N. Watson solved the problem which had baffled many leading mathematicians, and calculated how far the wave should bend round the earth. Actual measurements of the strengths of signals over very long distances were made by the Radio Department of the U.S. Navy in the years before the war, and one of Austin's actual measurements of reception at 6,000 miles was seven thousand times greater than Watson's formula could explain. So the theory, long thought to be the only possible one, has failed, and physicists' thoughts have been seeking other channels. The most fruitful result has been due to a suggestion made by Oliver Heaviside many years ago, based on the whispering gallery analogy. If the waves do not spread out freely upwards from the generating station, but are reflected downwards and outwards by some upper layer of the atmosphere, then they will travel very much farther round the earth. Such an upper layer would make the whole earth one vast whispering gallery for electric waves by preventing the great waste of wave energy sent out into the interstellar spaces. The theory would be admirable if we could understand how such a "Heaviside layer," with a definite reflecting inner surface, could be produced.

## A Reflecting Layer

Now electric waves are only reflected from conductors of electricity—even for the short light waves metals are the best reflectors. Air is a non-conductor—if it were otherwise wireless could never exist—but it can be made into a conductor; that is, it can be ionised by passing X-rays, or ultra-violet light, or strong electric charges through it, and in certain other ways. Professor Fleming therefore suggests that this invisible reflecting layer is simply the boundary of a great, permanently ionised portion of the atmosphere. It may be about 50 miles above the surface of the earth, where the atmosphere is chiefly hydrogen, and the ionisation is due to strongly electrified particles of dust sent into our atmosphere by the sun. It is known that dust particles of a certain size will be repelled by the pressure of sunlight, and Fleming calculates



that this dust will be unable to fall farther towards the earth because of the viscosity of the gas around it. Some particles will be positively charged with electricity and some negatively, but they do not recombine for two reasons: they are different in size, which makes them fall to different levels, and they are drawn in opposite directions by the earth's magnetism. And so a great fixed wall is hung above the earth, and continually renewed by vast streams of two kinds of dust thrown off from the sun. It is a daring suggestion, but its deductions seem to be perfectly in accord with facts, for a calculation of the strength of signal to be expected has been made and agrees with experiments. It has some support, too, from the meteorologists, for they can only explain phenomena like aurora borealis by means of similar theories.

There is, however, a difference in the amount of curvature which electric waves can accomplish in daytime and in nighttime. This is readily understood as the effect of the shortest invisible waves of sunlight, for in the daytime these rays ionise the atmosphere for some miles beneath the Heaviside layer, and so the surface of the layer becomes less clear and sharp for reflecting purposes. Daylight hangs curtains round the walls of the world's vast whispering gallery, and by dulling the reflections makes the signals less audible. Besides this, the upper parts of the waves must travel more quickly in this partly ionised air, and so the waves come down again to earth more quickly before they have travelled so far as they can do at night. At sunset and sunrise, too, and at times of heavy thunderstorm, the rapid changes in the atmospheric ionisation produce other strange variations in the paths of the waves. They become locally distorted, and not only is the distances of their travel irregular, but they may be changed in direction. This side-wise bending of the wave is a serious hindrance when the wave is being used for direction finding, and the best modern apparatus for these purposes is unreliable at times.

Wireless waves curve round the earth, therefore, under the influence of all the three tendencies which waves possess. They are diffracted, their diffraction is very much helped by reflection in the great whispering gallery of the atmosphere, and lastly, their paths suffer further distortion, and that harmfully, from refraction. These are the outlines of the answer to our question.

R. G. L.

"Using a Gramophone as an Orchestra" is one of the articles in this week's issue of "Work" (3d.). Other articles include: "Making Toys from Waste Tins," "A Simple Magnetic Fishpond," "Two Clothes-airing Devices," "Easy but Effective Conjuring," "The Pin-wheel Clock Escapement," "Amateur Wireless at Christmas," "How to Grind Glass," "Decorations in Strip Tinplate."

# RADIOGRAMS

CHRISTMAS greetings will be sent on Christmas-eve by wireless to the small colony of workers at King's Bay, Spitzbergen. Spitzbergen is 1,500 miles from London.

A Lincoln hairdresser has installed a receiver in his shop, and customers are invited to be "shaved by wireless." The *Daily Telegraph* asks, "Who would choose to sit beneath the barber's steel at the moment when the artist heard that the horse which carried his money or the candidate of his affections had been the last of the field?"

An Australian amateur has succeeded in transmitting speech, using only 3.2 watts in power, from Strathfield to Sydney, Melbourne, a distance of 420 miles.

Captain W. G. R. Hinchliffe, pilot of the London to Amsterdam air mail, was in constant communication with Croydon aerodrome whilst circling over Amsterdam. This is a new record in wireless telephony.

Control of wireless telephony by the Provincial Governments is recommended by the Canadian telephone departments.

Australia is to have a radio concert service, in addition to an up-to-date commercial wireless telegraph service.

It is probable that wireless telegraphy stations will be erected at Julianchaab, Godthaab, Godhavn, and Angmagssalik, in Greenland.

An electric power company in Japan has asked for permission to link up its various generating stations by wireless.

It is hoped that the broadcasting stations at Newcastle and Cardiff will be in operation by the end of the year.

A broadcasting company is being formed in Sweden.

Ten thousand experimental licences have been issued during the last seven months, which now make a total of 18,000.

Letter messages can now be sent at week-ends to America via Marconi for 3d. per word.

A new wireless station is being erected at Gothenburg, and one of the many uses

to which it will be put will be to send out reports of shoals of fish to fishing boats.

Dr. Lee de Forest will be able for the first time to manufacture his own invention, as the Fleming patent, which was owned by the Marconi Telegraph Co., expired in the United States on Nov. 7.

A particularly neat receiver has been produced by using plate glass panels.

Mr. F. G. Kellaway took over his new duties as director of Marconi's Telegraph Co. on Dec. 4.

A number of trained canaries supplied the entertainment of a programme broadcast from San Francisco recently.

There has been some difficulty in finding a suitable site for the Glasgow broadcasting station, but when it is opened—which may possibly be before the end of the year—it is thought that there will be a rearrangement of the wave-lengths in use to allow of the Scottish transmissions being given somewhere between the mean time limits of 360 metres at Marconi House and 420 at Birmingham. The Glasgow station, by the way, will cater for the whole of Scotland at first, as well as the North of Ireland. It will be run on the same lines as the three in service in England.

There is quite a probability that once broadcasting gets into its stride the power all round will be raised to the neighbourhood of 3 kw.

In the United States broadcasting is enjoyed every night by between half and three-quarters of a million of people. It is fully believed that similar huge audiences will be obtained in this country within a very short period, in which case the Broadcasting Company gives the assurance that it will be able to get the very finest artistes, teachers, and preachers—in fact, everyone who has a worthy message to give.

Further proof that Scottish amateurs can bear comparison with their English brethren is given by the reports of two enthusiasts north of the border as to hearing telephony in which the voices had an undoubtedly American twang. The source of the transmissions was not ascertained, but one of the experimenters was of opinion that what he heard was someone speaking to a passenger on a liner.

AS a natural sequence to the amazing progress made in the science of wireless within the last few years, many people are considering the suitability of wireless as a means of livelihood, and we are constantly being asked for information as to how the profession may be entered and what prospects it offers. This article, written by a Post Office operator, explains exactly the present-day position, and it will be seen that the immediate prospects are none too bright; in fact, the author practically gives the same advice as did Mr. Punch to those about to marry—"Don't."

A GREAT many people, fascinated by the wonders of wireless telegraphy and telephony, seriously contemplate taking up the science as a profession and a means of livelihood. The great difficulty they experience, however, is the lack of useful information which will give them a true perspective of things and help them to gauge the possibilities of success.

Generally speaking, the profession is divided into two separate and distinct branches—the engineering branch and the manipulative or administrative branch, each of which has its own particular class of work to perform. The former is responsible for the production of apparatus and the erection of wireless stations, but it is the work of the latter branch to operate them and to make the necessary arrangements for handling wireless traffic.

#### The Engineering Branch

So far as this branch is concerned the only position of importance is that of the radio engineer. He is the man who has made the science of wireless and electrical engineering a life study. His work is primarily that of designing apparatus and stations and for seeing that his specifications are properly executed. The actual work of manufacturing the many component parts of the apparatus is undertaken by various firms who specialise in these matters. The radio engineer, therefore, is in a class of his own, whose numbers are very small. His training necessitates the possession of brains and a goodly supply of cash, and in most cases he is found to be a man who has had a university education. The field of employment for such a man is not very large, being practically confined to the service of large firms of wireless manufacturers.

More than this need not be said with regard to this branch, where it is not difficult to see that the prospects of obtaining lucrative employment are very remote.

# WIRELESS AS

#### The Manipulative Branch

This is the branch which will undoubtedly appeal more strongly to the aspirations of young people. It is to this branch that the wireless operator belongs, whose position and the means of obtaining it will now be analysed.

There are two distinct branches of operators—each of which have their own particular sphere of activity, and who belong to two separate and independent services.

First of all there is the sea-going operator, the majority of whom constitute the staff of the Marconi International Marine Communication Company; and secondly, there is the land-station operator, who, in most cases, is a member of the Post Office wireless service.

#### The Sea-going Operator

The Marconi operator is the individual with whom we are most familiar. His sphere of duty is aboard ship—a fact which forces him to lead a seafaring life. His position is attained in one of two ways. He may either pay a fee and receive his training at one of the many wireless schools established throughout the country, or he may be chosen by the Marconi Company to attend their school of instruction, for which, it is believed, no fees are required. Whichever be the plan chosen the object is the same, namely, that of qualifying for the Postmaster-General's certificate of proficiency in wireless telegraphy. This certificate must be held by everyone desirous of taking up wireless duties afloat, and it usually takes a person of average intelligence at least a year of conscientious work and study under the tuition of experienced teachers in which to gain it. Having secured it and obtained a position with the company, the young operator is soon detailed for sea duties. Obviously the choice of a ship cannot be given him, but it is generally the case for him to spend the first years of his career aboard ships of the cargo type. Naturally, positions aboard the best ships are reserved for the senior and more experienced operators.

The next question to be considered is the interesting one of pay. So many adjustments have recently been made, due to

adverse economic conditions, that the exact scales cannot be stated. However, it will not be far out to put the limits between a minimum of £2 and a maximum of £5 per week. Rations aboard are, of course, supplied at the expense of the shipping companies.

With regard to promotion the sea-going operator has small prospects. So much so, indeed, that his job can undoubtedly be classed as one of the "blind-alley" type. The company to which he belongs has no suitable positions for him ashore. In the case of the Marconi Company a limited

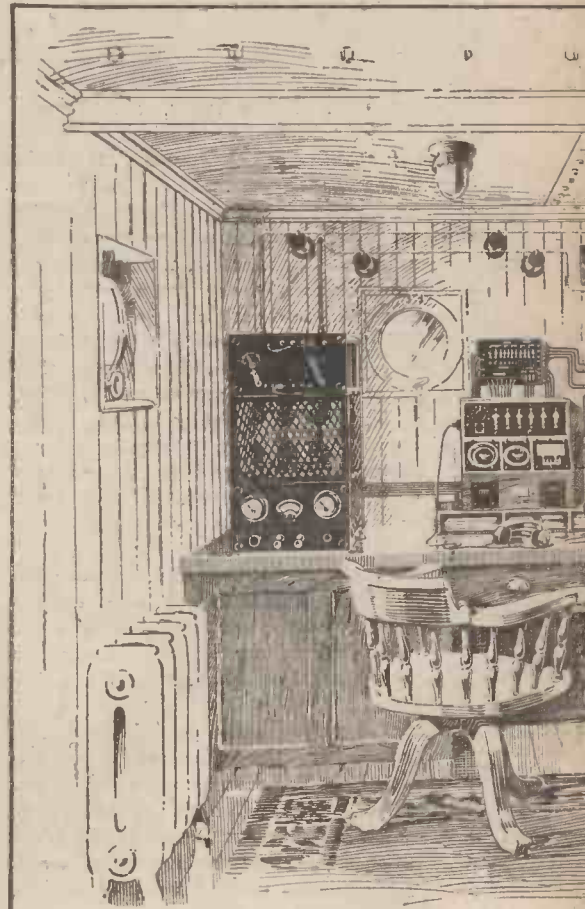

Sketch of Interior of Wireless Cabin of

number of inspectorships are available to their operators, but the number of appointments are so small compared to the large number of operators, that the chances of securing one are infinitely small. Moreover, this particular class of operator has little hope of serving at one of the company's high-power stations, because the nature of the work they do at such places



# A PROFESSION

demand the services of specially-trained operators. It will therefore be seen that the prospects of a sea-going operator cannot be considered alluring, especially when it is remembered that the position entails many years at sea with its dull monotony and the lack of homely comforts and associations. This is a point upon which too much emphasis cannot be placed, because so many people have learnt this truth too late.

## The Land-station Operator

The lot of this operator will now be con-

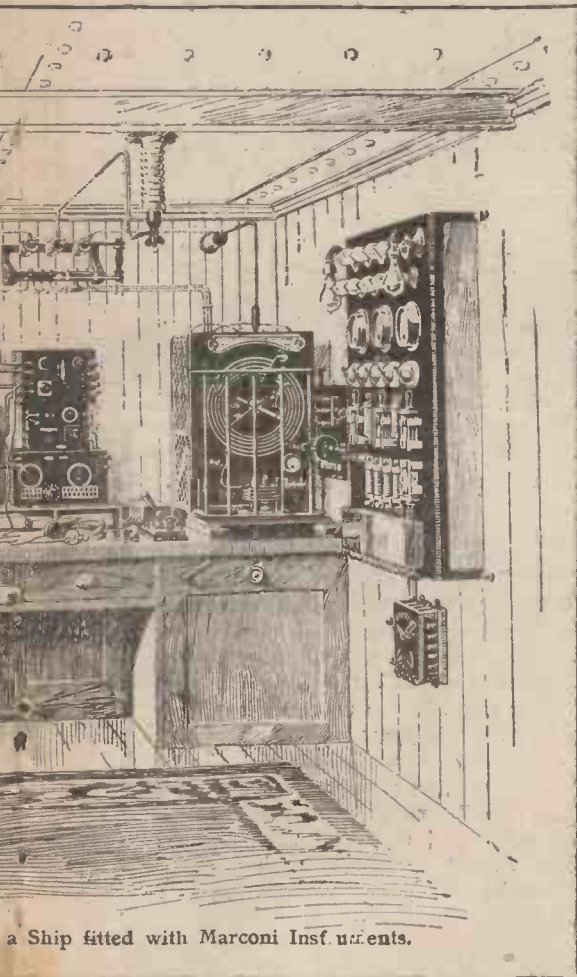

a Ship fitted with Marconi Insf. uents.

sidered. He is the man who performs his duty at one or other of the Post Office land stations, through which the sea-going operator sends and receives his messages. The service to which he belongs is the Post Office Wireless Service, the supreme head of which is the Inspector of Wireless Telegraphy. Recruits for this service are exclusively drawn from the ranks of

established Post Office telegraphists, so that anyone wishing to enter this service must first obtain a position in the Post Office Telegraph Service. Once there, several years of manipulation work will follow, during which time he will become thoroughly acquainted with the different systems of telegraphy, and finally emerge a first-class operator. It is at this stage of his career that he may secure a transfer to the wireless branch of the service, in which case a new phase of life will be entered upon. His new work will probably take him to one of the lonely spots of the country where a station is situated, but he will have plenty to occupy his mind for the first two years. During this period of time he will be compelled to study hard in order to pass the required departmental examinations in French, German, and technical wireless telegraphy. Failure to accomplish this will probably result in his re-transfer to the telegraph service. Success, however, means his acceptance on the permanent wireless staff as an operator, after which he will be liable for duty at any of the Post Office stations within the British Isles (Ireland excepted).

The pay of these operators ranges from a minimum of 38s. to a maximum of 75s. per week, plus the Civil Service cost-of-living bonus, which is rapidly falling. The working week is one of forty-five hours spread over six days; the time being divided between day and night in the ratio of about three to one.

The prospects of promotion are not very bright in normal times, as it is usually a case of waiting for dead men's shoes. The rank above that of an operator is an overseer or supervising officer, and when a vacancy for such occurs the senior operator in the service is selected for promotion, providing his official record is clean and he has passed the necessary qualifying technical examination. Men of this rank take duty as officers in charge of stations, or perform Government ship inspection duties at one or other of the large ports. They may also be called upon to examine candidates for the P.M.G.'s certificates, or to work as clerical officers on the headquarters staff at the G.P.O.

The constitution of the Post Office wire-

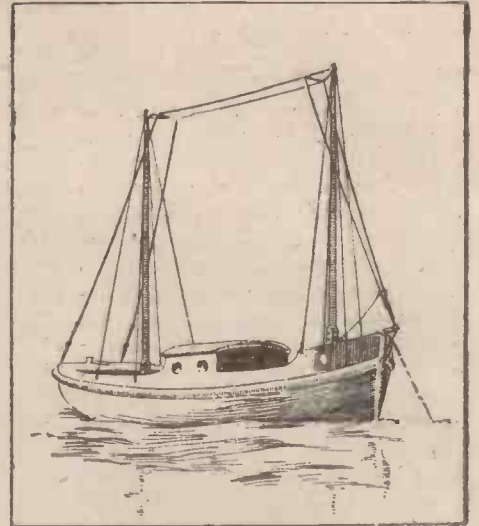

Lifeboat Fitted with Wireless.

less service beyond this point need not be pursued, enough having been said to show the difference between the two classes of operators.

It is hardly necessary to point out that neither class can be accused of making fortunes out of wireless. The only people who are able to do that are those whose interest in the science does not extend beyond the number of shares they hold in the various wireless companies.

The business of the operator is the serious one of dealing with the messages of the public and of carrying out the provisions of international wireless laws, without which the ether would be in a perpetual state of pandemonium and chaos. Furthermore, he must be very watchful for signals of distress and ready at all times to carry out the "safety at sea" regulations.

Such men have little time for the pleasures of wireless telephony, their duty compelling them to listen for hours at a time to the ceaseless buzz of dot and dash.

S. W. G.

## A List of Addresses

useful to any candidate for the Wireless Profession.

Amalgamated Wireless (Australasia), Ltd., "Wireless House," Clarence Street, Sydney, New South Wales.

Marconi International Marine Communication Co., Ltd., Marconi House, Strand, London, W.C.2.

Marconi's Wireless Telegraph Co., Ltd., Marconi House, Strand, London, W.C.2.

Radio Communication Co., Ltd., 34/35, Norfolk Street, London, W.C.2.

R.M. Radio, Ltd., 5, Regent's Square, Gray's Inn Road, W.C.1.

Chinese National Wireless Telegraph Co., 5, Peh Ch'a Ta Fu Ssu, Peking.

Compania Marconi de Telegraphia Sin Hilos del Rio de La Plata, Calle Lavalla, 544, Buenos Aires, Argentina.

Companhia Radiotelephica Brasileira, 107, Rua 1º de Marco, Rio de Janeiro.

# A Tuning Hint

If you are troubled with a set that asks for exceedingly delicate tuning on short wave-lengths, try putting a blocking condenser of about 0.001 mfd. in series with your aerial tuning condenser. This broadens tuning very considerably and you will find it difficult to miss signals it was almost impossible to find previously without a deal of luck. The best way to put it in is to insert it between the output terminal of the aerial tuning condenser and the input of the aerial tuning inductance.

Such a condenser can easily be made for a few pence at home. Cut eight pieces of the thinnest copper foil to dimensions of 2 in. by 2½ in. Each piece should have a tongue on the end for connection purposes. About twenty pieces of stout blotting paper should next be cut to 2¼ in. by 2¾ in. These should be thoroughly soaked in wax that is nearly at boiling point. Ordinary candle-wax will serve the purpose. Five sheets of waxed paper are used as a foundation and then alternate copper sheets and papers are laid on one another, like a Victoria sandwich. The connection tongues project first on one side and then on the other. Five more pieces of waxed paper on top finish it off. Whilst the wax is hot the whole should be pressed into a solid lump. Pierce the tongues at each end and insert small terminals through each of the bundles of four. Wrap the whole in stout brown paper and the job is finished. To make a very complete job of it put the finished condenser in a small box, bend the tongues so that the terminals stick up, and pour wax, just in the running condition, over the whole, so that the condenser is embedded in wax.

Don't forget that on short wave-lengths you get maximum efficiency by using your aerial tuning condenser in series with your inductance (coil) and not in parallel.

ERNEST LANGMEAD.

# The Broadcasting Company

IN the House of Commons this week Capt. W. Benn, Liberal member for Leith, asked the Postmaster-General the names of the various firms which were members of the Broadcasting Company and the amount of their holding. He inquired whether the terms of the agreement between the Post Office and the company could be published.

Mr. Neville Chamberlain, in reply, said that six firms had guaranteed the capital

of the British Broadcasting Company, each holding an equal number of shares up to a total for the six companies of 60,000 £1 shares. No further capital could be issued without the Postmaster-General's consent. The six firms were: The Marconi Wireless Telegraph Company, the Metropolitan Vickers Electrical Company, the Radio Communication Company, the British Thomson-Houston Company, the General Electric Company, and the Western Electric Company. Any other British manufacturer of wireless apparatus might become a member of the company, subject to certain terms and conditions already agreed to by the guaranteeing companies. He saw no objection to publishing the terms of the agreement between the Post Office and the company if there was a general demand for it.

# The Radio Society of Great Britain

(The Wireless Society of London)

ON December 20, at 6 p.m., Lieut. Duncan Sinclair, of the Air Ministry, will lecture at the Institute of Electrical Engineers on "Direction Finding in Airships." As Lieut. Sinclair was present on the voyages of several airships and personally assisted in carrying out tests, the lecture should prove of great interest.

During the past month 50 new members have been elected, and there are now upwards of 150 societies and clubs affiliated. The total membership of the whole society will soon reach the 1,000 mark.

# CORRESPONDENCE

## Calibration

SIR,—It has often occurred to me that many amateurs are at a loss to calibrate their apparatus, owing to the fact that a wave meter is not, in general, within everybody's reach. I give the following for what it is worth to those who use fixed inductances (such as slab, honeycomb, etc.) and tune with variable condensers. It is only necessary that a numbered and divided dial be used with the condenser, such as may be bought for a few pence. The principle is as follows: The capacity of any variable condenser is directly proportional to the overlap of the plates, and therefore proportional to the amount swung in as indicated by the pointer on the dial; that is, a condenser having a maximum of, say, 0.001 mfd. with the plates right in (that is 180 deg. on dial) will have 0.0005 mfd. at 90 deg. and 0.00033 at 60 deg., etc. The wave-length for any set is given by:

$\lambda = k \sqrt{C \times L}$ , where  
 $\lambda$  = wave-length.  
 $k$  = some constant.  
 $C$  = capacity.  
 $L$  = inductance.

Squaring both sides we have  $\lambda^2 = k^2 L \times C$ . Now since  $k$  is a constant and  $L$  is also constant (a fixed inductance coil) the expression  $k^2 L$  is also a constant, and may be noted by  $K$ , when the expression becomes

$$\lambda^2 = K C$$

It is necessary to pick up and tune to the loudest possible point some station whose wave-length is constant and well known, say, Marconi House, Croydon, etc., and to note the condenser reading in degrees. We are now in a position to calculate  $K$  in terms of wave-lengths and condenser degrees. Thus, suppose a transmission occurs on 360 metres and the condenser reading is 40 deg., we have

$$360^2 = K \times 40$$

$$360 \times 360 = K \times 40$$

$$\text{therefore } K = 9 \times 360$$

and our equation becomes  $\lambda^2 = 3240 C$  (in degrees). By interposing for  $\lambda$  any values within the range of the coil we can readily calculate condenser reading corresponding to this wave-length. I applied this method for tuning in The Hague after getting Croydon. I set the condenser and waited for The Hague and got him, it requiring only very little fine tuning. This method should be used with the fine tuning condenser (if used) connected up, but at 90 deg. It will be observed that the constant  $K$  must be calculated for each instrument by observation on a known wave-length, and will, of course, vary considerably. The method lends itself very readily to the construction of a curve for each coil used, and I may say that I have found it very useful.—F. G. F.

## With a Single Valve

SIR,—The article "All on a Single Valve," in No. 18, has prompted me to forward you the following description of my home-made single-valve set on which I receive the Dutch concert regularly and also F L and 2MT telephony. I also get all the usual Morse transmissions covered by my tuning apparatus. The set is rather roughly constructed, and the total cost was £2 12s., as under:

"Magnos" valve and holder	
(9s. 6d. and 1s. 6d.)	11 0
Second-hand double head-phones	
(total resistance 2,000 ohms)	6 6
Second-hand accumulator (Fuller block)	10 0
H.T. battery (flash-lamp refills, Siemens)	7 6
Wire for tuning coil (No. 22 s.c.c.), etc.	2 6
Condenser material and parts	6 0
Aerial wire (18 gauge), insulators and poles (2 in. by 2 in.)	6 9
Terminals and sundries	1 9
	<hr/>
	£2 12 0

(Continued in third column of next page)



# OUR INFORMATION BUREAU

Expert Replies to Readers' Questions. Hundreds of Replies are sent by Post.

TO ENSURE A PROMPT REPLY PLEASE OBSERVE THE FOLLOWING RULES

Write distinctly, give all necessary details and keep to the point. Ask one Question at a time—never more than two. Send a Stamped and Addressed Envelope. Send the Coupon cut from page 654.

## Oscillating and Heterodyning

Q.—Is the oscillation of one's valve during the reception of C. W. necessarily radiating energy from one's aerial, and if so, is it audible to neighbours, or is one creating a nuisance only on those occasions when too tight coupling causes a hooting audible in one's own phones.—T. K. S. (3029).

A.—Various notes have been published concerning the re-radiation of wireless waves when using reactance in conjunction with valve sets. These notes have been somewhat misleading owing to the contributors being at a loss to explain a difficult subject in terms that could be readily understood by the amateur. When a valve set is in operation, and is receiving signals of any category, the valve itself is really oscillating. Keep this in mind from the outset, and a better understanding of the subject will be formed. By oscillating it is not intended to convey that the valve is re-radiating. It simply means that the incoming signal which forms an oscillatory current functions between the grid and the filament of the receiving valve. This in turn causes variations of current in the plate circuit of the valve. These variations are occurring at exactly the same frequency as the incoming oscillations, but instead of alternating positively and negatively above and below the filament potential line, are alternating consistently at a positive potential to the filament. These variations in plate current are rectified by adjusting the steady grid potential in the usual way to enable the current to operate the telephone receivers. Now, when a reactance coil is inserted between the plate of the valve and the positive terminal of the plate circuit battery, an extra duty is performed. By coupling this reactance coil in such a manner to the oscillatory circuit or aerial tuning circuit, the variations in the plate current caused by the valve oscillating, induce a corresponding variation into the oscillatory circuit. This induced variation from the reactance into the oscillatory circuit may be termed a super-imposed oscillation. This operation causes the valve to maintain a self-oscillation in the oscillatory circuit. Before proceeding further, an analogy will serve as a simple explanation. Imagine two men walking along the road together. One is tall and takes long strides, the other is short and consequently takes short strides. At one moment each man will be correctly in step; a short time later the men will be out of step. Possibly

a dozen or more steps will be taken and then the men will be in opposite step. That is, one man places his right foot down whilst the other his left foot. Again they will fall out of step, and so on until exactly in step as when first they started walking. This state of affairs occurs in a valve circuit when employing reactance. The reactance coil forming a circuit, which is not tuned resonantly to the aerial oscillatory circuit, causes the variations in anode current to alternate best at the tuned frequency of itself. These variations being slightly out of tune with the incoming oscillations cause a "beat" effect such as illustrated by the analogy. When the reactance and aerial oscillatory circuits are functioning thus, the circuits are said to be heterodyning. If the reactance coupling to aerial is tight, oscillations induced into the aerial are strong. Only a small percentage of this oscillatory strength is required to make up for the resistance losses in the circuit to maintain a self-oscillation and consequently the surplus is radiated away between aerial and earth. It is noticed when a very tight coupling is employed the valve starts to "hoot" or "howl." An explanation of this is, the super-imposed oscillation from the reactance is so powerful that it causes the valve to generate its own oscillations. If amateurs understood that the valve howling for only a few moments causes greater loss than burning the valve in an ordinary manner for several hours, the howling of valves would be reduced to a minimum. C.

## Particulars of Tuning Coils.

Q.—Please give a list which will enable me to build up a complete set of coils constituting primary, secondary and reactance to tune between 100 and 6,000 metres.—F. B. (South Wales) (5148).

A.—The following lists may be taken as approximate when used in conjunction with variable condensers as follows:—.001 mfd. for the primary tuning coils, and .0005 mfd. for the secondary tuning coils.

200 to 600 metres, 70 turns of No. 26 s.w.g. d.c.c. copper wire.

600 to 1,000 metres, 110 turns of No. 26 s.w.g. d.c.c. copper wire.

1,000 to 1,700 metres, 170 turns of No. 26 s.w.g. d.c.c. copper wire.

1,700 to 2,500 metres, 235 turns of No. 28 s.w.g. d.c.c. copper wire.

2,500 to 4,000 metres, 370 turns of No. 28 s.w.g. d.c.c. copper wire.

4,000 to 6,000 metres, 550 turns of No. 30 s.w.g. d.c.c. copper wire.

The above will be suitable to use as primary tuning coils.

200 to 600 metres, 150 turns of No. 30 s.w.g. d.c.c. copper wire.

600 to 1,000 metres, 230 turns of No. 30 s.w.g. d.c.c. copper wire.

1,000 to 1,700 metres, 350 turns of No. 32 s.w.g. d.c.c. copper wire.

1,700 to 2,500 metres, 480 turns of No. 32 s.w.g. d.c.c. copper wire.

2,500 to 4,000 metres, 750 turns of No. 32 s.w.g. d.c.c. copper wire.

4,000 to 6,000 metres, 1,100 turns of No. 32 s.w.g. d.c.c. copper wire.

These will be suitable for a set of secondary tuning coils. A set of four reactance coils will be quite suitable for the above range of wave-

lengths. Up to 600 metres 50 turns of No. 36 s.w.g. d.s.c. copper wire. 600 to 2,000 metres 100 turns of No. 36 s.w.g. d.s.c. copper wire. 2,000 to 6,000 metres, 170 turns of No. 36 s.w.g. d.s.c. copper wire. All of the above coils should be wound on a 2-in. former and may be of the honeycomb coil type.—L. C.

## BROADCAST TELEPHONY

Some of these transmissions are commercial or official. Wave-lengths and times are liable to alteration without notice.

London B.B.C. Station (2L O), 369 metres. Daily, usually 5 p.m. to 10 p.m.

Manchester B.B.C. Station (2Z Y), 385 metres. Daily, usually 5 p.m. to 10 p.m.

Birmingham B.B.C. Station (2W P), 425 metres. Daily, usually 5 p.m. to 10 p.m.

Croydon (G E D), 900 metres. Daily.

Writtle (2M T), 400 metres. Tuesdays, 8 p.m.

Elfiel Tower (F L), 2,600 metres. Daily, 6.20 p.m. to 7 p.m.

The Hague (P C G G), 1,085 metres. Sundays, 3 p.m. to 5 p.m.

Rome (I C D), 3,200 metres. Daily, 10 a.m.

Königswusterhausen (L P), 2,800 metres. Daily, 4 p.m. to 5.30 p.m.

Amsterdam (P C A), 1,800 metres. Daily, 1.10 p.m.

Haren (O P V H), 900 metres. Daily, every hour from 11.20 a.m. to 4.20 p.m.

## CORRESPONDENCE (continued from page 650)

In addition to the foregoing is the licence of 10s. My aerial of twin wires is slung from a 15-ft. pole (2 in. by 2 in. red deal, planed and painted) on to the back kitchen chimney, total height from ground about 30 ft. The far end is to a similar pole 20 ft. high. Length of aerial about 36 ft., and down lead about 15 ft. 1 in.; bamboo spreaders, 4 ft. 6 in. long, are used at each end of aerial with reel insulators. My valve panel is constructed from two 7-in. gramophone records and is still going strong after six months' service. The records require just ordinary care in drilling, and can be held down for this operation by a screw through centre holes. I am using discarded fountain pens for extensions and tuning handles on condensers. A week or two ago I heard part of the Teddy Tail story-reciting, "Three Blind Mice," etc., also announcements of the items. Needless to say I also hear from some of the local atmosphere disturbers, whose howls are anything but welcome on these occasions. I have also been experimenting with a home-made loud speaker, constructed from a microphone and earpiece belonging to a house telephone set. With the horn of a gramophone attached, and placing one of the H.R. earpieces over the microphone, I get

## "RECTIFICATION BY CRYSTAL" (cont. from p. 636)

The area of the positive half-cycles,  $a^1-a^6$  are very much larger than the area of negative half-cycles  $b^1-b^5$ , and the discharge of the condenser is due to the difference between  $a^1-a^6$ , and  $b^1-b^5$ , because the charge due to the latter annuls some of the charge due to the former.

Thus each wave train sets up a uni-directional rise and fall of current through the telephones, which will result in the diaphragm being attracted and released once for each wave train. C. E. N. R.

(To be concluded)



Paris clock ticking just like a grandfather clock, also Leafield on CW ("harmonic" about 2,000 metres).—V. E. M. (Shrewsbury).

**Experimenting with Crystals**

SIR,—With reference to the articles on experimenting with crystals in the issue of November 4, I should like to point out the following: assuming the resistances of the crystals are to be of equal value =  $x$ . Let  $y$  represent the resistance of the remainder of the circuit. The current through one crystal can be taken as pro-

portional to  $\frac{I}{x + y}$ , because the fact that it increases out of proportion with increase of E.M.F. does not interfere with the calculation, as each transmitting station will be sending on a definite and not varying pressure. For two resistances in parallel the total resistance is equal to

$$\frac{R_1 \times R_2}{R_1 + R_2}$$

If we consider the four crystals in Fig. 1 (page 487) in pairs in parallel the resistance of the crystal circuit alone is equal to

$$\frac{2x \times 2x}{2x + 2x} = \frac{4x^2}{4x} = x$$

so that it will be seen from this that the current through the whole is proportional to

$\frac{I}{x + y}$ , the same as for a single crystal, and there is apparently no advantage at all to be gained by this method of connection. If, however, we consider the case of two crystals in parallel (Fig. 2, page 487) we have

$$\frac{x \times x}{x + x} = \frac{x^2}{2x} = \frac{x}{2}$$

and the current is proportional to  $\frac{I}{\frac{x}{2} + y}$

$$= \frac{2}{x + 2y}, \text{ or } C_1 : C_2 :: \frac{1}{x + y} : \frac{2}{x + 2y}$$

$\therefore C_2 = C_1 \frac{2(x + y)}{x + 2y}$  If we give values as before  $x = 100,000, y = 4,000 = C_1$

$$\frac{2(104,000)}{108,000} = 1.9. \text{ Or we may say that the current through two crystals in parallel is twice that of one.—J. T. B.}$$

reception of the special transmissions from Paris and Northolt, and these came through at 4 and 7 p.m., both wishing the club every success. The set used for the reception of these messages was unique, same having been built by one of the club members who is totally blind. It is in the form of a bureau with lid, and has a three-valve set containing one H.F., one detector, and one L.F. The workmanship and general finish of the set is splendid, and gives particularly good signals. Concerts were transmitted at regular intervals all day from an adjoining hall, and received in loud-speakers and headphones at a number of the exhibitors' stands in the main hall. By three o'clock the hall was so packed that it was found necessary to stop admitting visitors for a short time, but after the lecture by Professor Howe on "Wave Transmission," which was enjoyed by the few who managed to squeeze into the lecture hall, those who had been in for some time, and had been satisfied in what they had seen, were asked to kindly make room for the queue which was lined up outside. Not the least successful part of the exhibition was the fact that arrangements had been made for the taking of the names of new members for the club. During the day about one hundred names were taken, practically doubling the club membership. All things considered, the show was an undoubted success, and gives the club great encouragement for holding a similar exhibition at some future date, when no doubt the experience gained at this their first exhibition will be valuable.

**Croydon Wireless and Physical Society.**

Hon. Sec.—B. CLAPP, Meadmoor, Brighton Road, Purley.

At a meeting of the above society, held on Nov. 4, Mr. S. H. Naylor gave a most interesting lecture on "Hints to the Student and Teacher of Wireless Telegraphy." Mr. Naylor explained the easiest ways to study the subject, and emphasised his points with several analogies and demonstrations with simple models. The secretary will be pleased to give particulars of membership to intending members.

**Fulham and Chelsea Amateur Radio and Social Society.**

Hon. Sec.—R. Wood, 48, Hamble Street, Fulham, S.W.6.

At a meeting held on Nov. 7 the members, with the aid of a five-valve set loaned by one of them, attempted a pleasant and instructive evening, but owing to severe disturbances from a local generator it was found impossible at the time to get at all clear signals.

Mr. Whittis in the meantime read and lectured from one of R. D. Bangay's books.

**Streatham Radio Society.**

Hon. Sec.—S. C. NEWTON, "Compton," Pendennis Road, S.W.16.

On Nov. 15, Mr. Bevan Swift gave the first of a series of lectures specially arranged for the younger amateur. Some of the more experienced, however, received an excellent "brushing up" on the less complicated fundamental wireless laws, such as the relation of wave-length to frequency, etc.

**North London Wireless Association.**

Hon. Sec.—V. J. HINKLEY, Northern Polytechnic, N.1.

On Nov. 20 Mr. H. Norman Wilson delivered a lecture on the construction of telephones. Mr. Wilson had actually constructed his own phones, and was therefore well able to speak on the difficulties to be overcome by anyone desiring to undertake the job. The main difficulties, he stated, were to obtain sufficiently strong permanent magnets and to wind and solder the extremely fine wire on the bobbins. In his case, to make the permanent magnet he had wound the hardened steel with several turns of wire and magnetised it by connecting it to a charging dynamo.

(Continued on page 654)

**EXTRA 'PHONES FOR CHRISTMAS YOU CAN AFFORD THEM AT THIS PRICE**

All your friends will want to "listen in." Snap this special offer now. Three pairs for price of one!

Genuine Sullivan Headphones, Double, complete with double adjustable headbands and cords, 120 ohms. Perfectly new. Each pair in box. Ideal present for "Wireless" friends.

POST 12/6 Or 3 PAIRS FOR 35/- FREE Cash with Order. While stock lasts.

F. HARRISON, 46 Brooke Road, WALTHAMSTOW, E.17

**ACCUMULATORS**

4 volt 20 amp. ... 14/-	6 volt 20 amp. ... 22/-
4 " 40 " ... 19/-	6 " 40 " ... 27/6
4 " 60 " ... 27/-	6 " 60 " ... 37/6
4 " 80 " ... 33/-	6 " 80 " ... 52/-

(Carriage Paid) (Carriage Paid)

These accumulators are brand new, guaranteed and specially recommended. Terms Cash with Order.

BASTONES, 228, PENTONVILLE RD., KINGS CROSS, LONDON, N.1.

**OFFER OF GUARANTEED GOODS**

Everything for Wireless

Combined Crystal and Valve set B.R.C. stamped 70 mile range, with phones, valve, batteries, 100 ft. aerial wire, insulators, lead-in tube, earthing clamp and including all royalties, £9. Accumulators 4, 20, 15/6, 4/40, 20/6, 4/60, 25/6, 6/30, 28/6, 6/60, 31/6, 6/60, 39/6. H.T. Batteries 15 v. Multi-Plug, 35 v. 6/6, 6 v. 10/6. Aerial wire 7/22, 4/3, 3/22, 3/3. Double headphones 4,000 ohm. 27/6. All instrument wires Hertzite, 1/6. Zincite, Galena, Carborundum, Boronite, etc. 6d. each. THE LIVERPOOL WIRELESS CO., 105, MOUNT PLEASANT, LIVERPOOL.

**EASY TERMS OR CASH**

Further reduction. No extra charge for extended payments. L.F. Transformers, 15/6 & 20/6. Mullard Ora Valves 15/6. Double Headphones, Brown's, Sterling's 4,000 ohms, 52/6. Mullard's 4,000 ohms, 30/6. Best French 4,000 ohms, 25/6 & 30/6. British 4,000 ohms, highly sensitive, 20/6 & 22/6. 3 way Coilholders, 13/6 & 17/6. 2 way, 7/6. Single Holder 2/6. Honeycomb Coils list, price according to wave-length. Variable Condensers, complete sets of parts, top and bottom, 008 8/6, 0005 6/6. Accumulator, 4 volt 20 amps, 17/6, 20 amps, 20/6, 80 amps, 40/6. H.T. Battery, 30 volt 7/6, 60 volt 15/6. Polished Mahogany Cabinet, with Ebonite paper, drilled, for Single Valve Set 8 by 5, 10/6, two Valves, 20 by 8, 15/6, three Valves 24 by 12, 21/6 and terminals. Terms: One-third with order, balance in six fortnightly payments. Carriage paid on all orders over 40/6. Money returned in full if not completely satisfied. Other accessories for cash at lowest prices.

G. BUSH, 119, Sutherland Avenue, London, W.9.

**—XMAS POST FREE OFFERS.—**

CABINET CRYSTAL RECEIVER, OAK CASE, 35/11.

Baby Crystal Receiver, 19/11. 4,000 Double Headgear, 31/11.

30 v. H.T. Unit, 7/11. 60 v., 14/11.

6 v, 60 amp. Accumulator, 40/11. 100' 7/22 Copper Wire, 5/6.

Aerial Insulators, each 6d.

IVEL WIRELESS SUPPLIES, 33 Middle Street, YEOVIL.

**ALL REQUIREMENTS FOR THE EXPERIMENTER OR BEGINNER.**

AT MOST REASONABLE PRICES. COMPLETE SETS OF PARTS SUPPLIED. FROM CONDENSERS TO SUPER-REGENERATIVE SETS (IN STOCK). EXPERIENCED RADIO ENGINEER IN ATTENDANCE. INSTRUMENTS REPAIRED, ETC.

**JOHN BANKS & SONS,**

14-15 Duke Street, LIVERPOOL (5 minutes from CENTRAL STN.)

Phone 4424 Royal.

(See WINDOWS.)

**LIVERPOOL**

**CLUB DOINGS**

**Glasgow and District Radio Club.**

Hon. Sec.—W. YULL, 93, Holm Street, Glasgow. A highly successful exhibition was held by the club in the McLellan Galleries, Sauchiehall Street, on Nov. 4. The special features were the large trade show, all the latest in wireless being exhibited by about twenty firms, the local firms being very prominent. The club members' show was also fairly large, all types of ancient and modern apparatus being on view, and the workmanship of some was of high order. Arrangements had been made for the

**HIGHEST EFFICIENCY CRYSTAL RECEIVING SET for BROADCASTING**

1 (Range over 20 miles)

Coil wound on Ebonite, polished mahogany base. Dust proof sensitive detector, condenser, spare crystal in cap. Approved by P.M.G., PRICE COMPLETE incl. royalties, 33/6 (highest grade). Headphones, 4,000 ohms, single 10/6; double, 20/6 and 32/6. COMPLETE OUTFITS (incl. 100 ft. 7/22 wire,

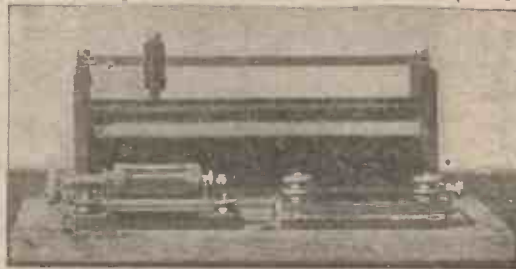

insulators, lead-in tube) with single phone 50/-, with double, 60/- & 70/- all post free.

**SPLENDID testimonials.**

All sets tested.

Immediate delivery from workshop.

W. J. PDLYDOROFF, A.M.I.E.E. 298, KILBURN LANE, W.10

Phone: Willesden 2071.



# The Marconiphone Will Bring Joy To Your Home This Xmas.

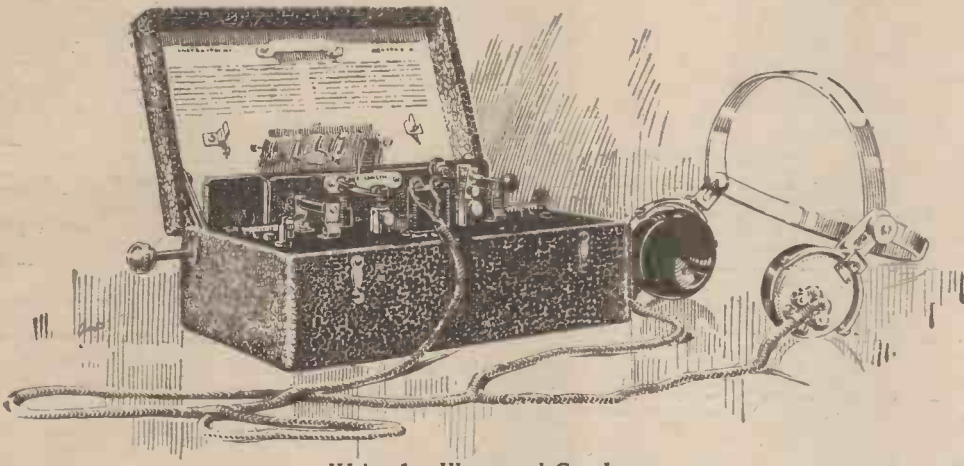

Write for Illustrated Catalogue.

## THE CRYSTAL JUNIOR

Wireless Receiving Set with double earpiece Telephone :

**£6 6 0**

With single earpiece Telephone :

**£5 15 0**

## CRYSTAL "A" WIRELESS RECEIVING SET

With double earpiece Telephone :

**£9 10 0**

Write for Illustrated Catalogue.

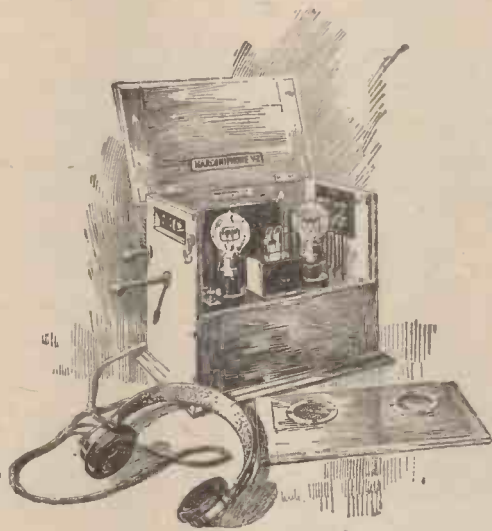

## THE V.2 WIRELESS RECEIVING SET

One of the most popular models which gives full efficiency over long distances (up to 50-100 miles) and is at the same time simple to operate :

**£25 0 0**

Write for Illustrated Catalogue.

Our Stock of the above Models has been replenished especially for the Xmas Rush. Prompt Dispatch Guaranteed.

All Models can be Inspected and Heard at the Head Office and Branches of **THE WALTURDAW CO., LTD.**

MARCONIPHONE DEPT.:

46 GERRARD ST., LONDON, W.1.

BIRMINGHAM. LEEDS. MANCHESTER. LIVERPOOL. CARDIFF. NEWCASTLE-ON-TYNE. SCOTLAND.

**SOLE AGENTS IN THE UNITED KINGDOM**

For all Places of Public Entertainment.

**CLUB DOINGS (continued from page 652)**

**Oldham Lyceum Wireless Society.**

*Hon. Sec.*—GRAHAM HULBERT, 16, South Hill Street, Oldham.  
ON Nov. 16 Mr. J. Holden lectured on "Recording Wireless Signals." In his lecture Mr. Holden went right back to the beginning of wireless, and explained how a recorder could be used and had been used with such old friends as coherers. The next step was the crystal, and the lecturer showed how a recorder could be brought satisfactorily into this type of detector circuit. He then went on to explain in great detail the theory and action of most present-day recording machines.

**Wireless Society of Hull and District.**

*Hon. Sec.*—H. NIGHTSCALES, 79, Balfour Street, Holderness Road, Hull.  
A MEETING of this society was held on Nov. 13. Mr. G. H. Strong read a paper entitled "The Calculation of Capacity," in which the lecturer described the way to calculate the capacities of many different types of condensers and gave many useful formulae.

**Plymouth Wireless and Scientific Society.**

*Hon. Sec.*—G. H. LOCK, 9, Ryder Road, Stoke, Devonport.  
ON Nov. 22 a demonstration of telegraphy and telephony was given at a bazaar and fête in aid of the funds of the Service Men's Y.M.C.A. With a seven-valve set and Magnavox belonging to Mr. S. F. Heal the 5.10 concert and weather forecast from Paris were made audible to a large audience. In the main hall of the building, through the kindness of Messrs. Tregilgas, Gundry, Brand and Lock, quite a good exhibition of modern wireless receiving apparatus was given.

**Ipswich and District Wireless Club.**

*Hon. Sec.*—H. E. BARBROOK, 49, Foundation Street, Ipswich.  
PARTICULARS of this society can be obtained from the secretary.

**South London Wireless and Scientific Club.**

*Hon. Sec.*—W. G. ANSELL, 69, Larcom Street, S.E.17.  
ON Nov. 20 Capt. de Villiers discoursed on his seven weeks' experience in the provinces with his wireless controlled airship. He started by describing the difficulty he had experienced in various towns in arranging suitable aerials and the marked contrast in the results on aerials arranged under varying local conditions and his methods of overcoming same.

**Durham City and District Wireless Club.**

*Hon. Sec.*—G. BARNARD, 3, Sowerby Street, Sacriston, Durham.

THE secretary will be very glad to hear from intending members. All ladies and gentlemen interested are made welcome to the meetings, which are held every Friday evening in the Y.M.C.A., Claypath, Durham, at 7.30 p.m.

**Ilkley and District Wireless Society.**

*Hon. Sec.*—E. S. DOBSON, "Lorne House," Richmond Place, Ilkley.  
ON Nov. 20 Mr. D. E. Pettigrew, secretary of the Leeds and District Amateur Wireless Society, gave a lecture on "Maritime Radio Communication." The lecturer commenced by tracing the development of wireless as applied to ship practice from the earliest experiments of Marconi. The utility of wireless as a means of communication between ships and from ship to shore was explained, and also the method of handling messages. Mr. Pettigrew then proceeded to describe in detail the various types of transmission and receiving gear to be found on ships, from the magnetic detector and plain aerial spark transmitter to the modern multi-valve receiver and C.W. transmitter.

**Blackpool and Fylde and Lytham St. Annes Wireless Societies.**

*Hon. Sec.*—R. S. DOEG, "The Poplars," 6, Seventh Avenue, South Shore, Blackpool.  
PERSONS interested in the above society are invited to write to the secretary.

**Tottenham Wireless Society.**

*Hon. Sec.*—R. A. BARKER, 22, Broadwater Road, Bruce Grove, N. 17.  
ON Nov. 22 a lecture on "Aerials" was given by Mr. Hall. The lecturer fully explained how to make a substantial mast, also how to erect it correctly, after which he went into the smaller but important details.

**Fulham and Putney Radio Society.**

*Hon. Sec.*—J. WRIGHT DEWHURST, 52, North End Road, West Kensington, London, W.14.  
ON Nov. 24 Mr. S. G. Calver gave a lecture on "Accumulators and Secondary Cells." He started with the earliest form of this type of battery, and went carefully through the various types up to Edison's nickel accumulator. Mr. Calver had on exhibition a number of accumulator parts.

**Ilford and District Radio Society.**

*Hon. Sec.*—A. E. GREGORY, 77, Khedive Road, Forest Gate, E.7.  
ON Nov. 16 Mr. A. E. Gregory delivered a lecture on the "Elementary Principles of the Valve." Explaining briefly the electron theory and the emission of electrons from hot bodies, the lecturer proceeded to the theory of the two-electrode valve

and its application as a detector. Next, the controlling effects on the electron stream, obtained by the insertion of the "grid," were shown, and the increase in efficiency and range of application pointed out.

**Stoke-on-Trent Wireless and Experimental Society.**

*Hon. Sec.*—F. T. JONES, 360, Cobridge Road, Hanley.  
THE secretary of the above society will be glad to hear from intending members.

**Walthamstow Amateur Radio Society.**

*Hon. Sec.*—R. H. COOKE, Ulverston Road, E.17.  
ON Nov. 15 Mr. Cooke gave a lecture, illustrated by many diagrams, on "Radiating and Non-radiating circuits." He drew several non-radiating circuits, including circuits conforming to the P.M.G.'s regulations.

**ANNOUNCEMENTS**

"Amateur Wireless and Electrica." Edited by Bernard E. Jones. Price Threepence. Published on Thursdays and bearing the date of Saturday immediately following. It will be sent post free to any part of the world—3 months, 4s. 6d.; 6 months, 8s. 6d.; 12 months, 17s. 6d. Postal Orders, Post Office Orders, or Cheques should be made payable to the Proprietors, Cassell & Co. Ltd.

General Correspondence is to be brief and written on one side of the paper only. All sketches and drawings to be on separate sheets.

Contributions are always welcome, will be promptly considered, and if used will be paid for.

Communications should be addressed, according to their nature, to The Editor, The Advertisement Manager or The Publisher, "Amateur Wireless," La Belle Sauvage, London, E.C.4



Querist's Coupon Available until Saturday, Dec. 23, 1922

**BROADCASTING RECEPTION SETS**

ONE VALVE SET COMPLETE FOR WORKING, £7 - 10 - 0

SEND FOR CATALOGUE

Passed for  
Broadcasting  
Licence

C.P.O. No. 1038.

AGENTS  
WANTED



INCLUDING ALL ACCESSORIES

**DESCRIPTION**

Single valve, mounted on polished 1/2-in. ebonite panel with variable condenser, smooth acting resistance, grid leak and condenser and all terminals clearly engraved in white, in a mahogany polished cabinet, 9 in. by 5 in. by 5 in. ... £3 - 15 - 0

A TAPPED COIL for wave-lengths up to 900 metres with 2 terminals for coils for any higher wave-lengths.

The coil is enclosed and the tapings are brought out to an 8-way switch mounted in the front of the cabinet.

**ACCESSORIES INCLUDED**

Siemens 54 volt high-tension Battery with plugs for altering the voltage	...	15 - 0
4 volt 50 amp. hour low-tension Accumulator in case with carrying strap	...	1 - 4 - 0
One pair of Sensitive Head Phones of 4,000 ohms resistance	...	1 - 1 - 0
One Detecting Valve	...	15 - 0

SATISFACTION GUARANTEED  
OR MONEY REFUNDED

TOTAL £7 - 10 - 0

**WIRELESS INSTALLATIONS LIMITED,**

15, ALDERSGATE STREET, LONDON, E.C.



# WIRELESS BROADCASTING



For best results "listen-in"  
on a

## GECOPHONE

GECOPHONES are "Listening-in" sets manufactured by the G.E.Co. (The General Electric Co. Ltd.) and are the result of many years research and manufacturing experience in both Telephone and Wireless practice. It is due to this unique experience that GECOPHONES give such perfect results.

## GECOPHONE

("LISTENING-IN" SETS)

are devoid of technical complications. Simplicity is their keynote! They can be installed and operated with the utmost ease—a child can handle them.

## GECOPHONE

("LISTENING-IN" SETS)

are unequalled in their perfect reception of speech and music, and ensure for every user the very best possible broadcasting results.

Fully approved by H.M. Postmaster-General  
Comply in all respects with Broadcasting Regulations



**GECOPHONE**  
**CRYSTAL SET No. 1**  
Approx. range (with standard  
P.O. Aerial) 25 miles.  
Price Complete £5 10 0

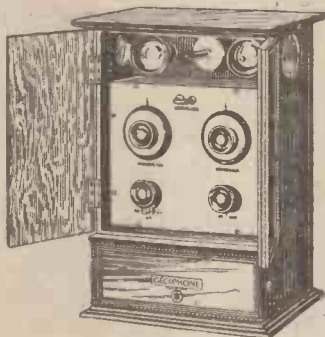

**GECOPHONE**  
**2 VALVE CABINET SET DE LUXE**  
Approx. range (with standard  
P.O. Aerial) 100 miles.  
Price Complete £25 0 0

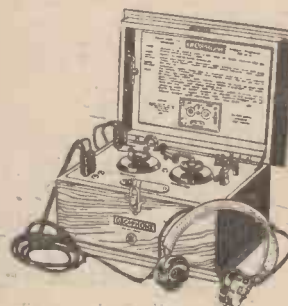

**GECOPHONE**  
**CRYSTAL SET No. 2**  
Approx. range (with standard  
P.O. Aerial) 30 miles.  
Price Complete £9 15 0

# GECOPHONE

(REGISTERED TRADE MARK)

SOLD BY PRINCIPAL ELECTRICIANS, STORES and IRONMONGERS

Manufacturers (Wholesale only) THE GENERAL ELECTRIC CO., LTD., Magnet House, Kingsway, London, W.C.2.

# IMPORTANT

**WE HAVE OPENED VERY COMMODIOUS PREMISES AT  
54, Gracechurch Street, E.C.3**

for the demonstration and sale of all types of Wireless Receiving Sets and "Claritone" Loud Speakers.

Amateurs and Experimenters will be able to obtain every part required for any type of Set including :

- Transformers, L.F. and H.F.
- Headphones, all types, all resistances
- Condensers, variable and fixed, all capacities
- Vario-Couplers and Variometers
- Coil-Holders and Coils
- Anti-capacity Switches, all types
- Rheostats, all types
- Radial Switches, 5, 10 and 15 way
- Ebonite Valve Holders, Dials, Scales, other parts and in sheet

- Valves, M.O. and Mullards
- Brass W.O. and Telephone type Terminals,
- Nuts, Washers, Contact Studs and all other parts
- Accumulators
- Dry Batteries
- Aerial Wire
- Insulators
- Hertzite and Galena Crystals
- Cotton and other Tubings, all colours
- Etc. etc.

**PRICE LIST ON APPLICATION**

**PETTIGREW & MERRIMAN, Ltd., 122-124, Tooley Street, London, E.C.1**

*Note: 54, Gracechurch Street is a few minutes from Monument, Eastcheap, Bank, Cannon Street & London Bridge*

TELE. : HOP 134

## "A HAPPY RADIO CHRISTMAS" for those who buy our B.B.C. Sets.

**No. 1 Receiving Outfit**, comprising Crystal Receiver (P.O. No. 269), fitted in handsome sloping cabinet with finely tapped inductance coil, enclosed detector fitted with the wonderful HERTZITE CRYSTAL, certain results; one pair splendid 4,000 ohms 'Phones, Aerial Wire, Insulators, in strong box, and instructions. **POST FREE £3 10s.**

### THIS WEEK'S SPECIAL BARGAINS.

- (1) **Enclosed Crystal Detector**, ball action, Hertzite Crystal ... .. **4s. 6d.**
- (2) **Broadcast Receiving Unit**, Tapped Inductance on Panel ... .. **12s. 6d.**
- (3) **Splendid Variable Condenser**, .0003... **7s. 6d.**  
(The Three make a Splendid Receiver.)

**Brown's 4,000 ohms 'Phones, Special, 30s.**  
L.F. Interval Transformer ... 15s. 3 Coil Holders, Extension Hand-  
10s. 6d.  
3 Coils on Plugs for Broadcast, 7s. 6d. H.F. Broadcast Transformers, 3s. 6d.

**PARTS FOR AMATEUR WIRELESS.  
IDEAL UNITS. TRADE SUPPLIED.**

**Wilton Wireless Co., Ltd.**

**120-124 HIGH STREET, TOOTING, S.W.17**

'PHONE: STREATHAM 533.

### Crystal Receiver

Range 25 to 30 miles  
This Model is a cheap and efficient receiver

**SPECIFICATION.**—Tuning Coil wound on an insulated former with 24 S.W.G. enamelled H.C. Wire, having a wave-length range of 130 to 1,000 metres. Tappings taken off to 10 studs. Variable Condenser, .0003 Mfd., tuning in series. .001 Mfd. Blocking Condenser across telephone terminals. The whole is mounted on an Ebonite Panel, 7 1/2 in. x 5 1/2 in. x 1 1/2 in., engraved and mounted in Polished Mahogany Case, 5 in. deep. Complete with Sterling 'Phones, Aerial Wire, Insulators, Lead-in Tube. **CASH PRICE £3 10 plus Royalties, 7/6**

### Note Magnification Panel

**SPECIFICATION.**—Low Frequency Transformer, Ratio 5 1/2 to 1, wound with S.S.C. Copper Wire. Filament Resistance of 5 ohms. Mounted on an Ebonite Panel, 7 in. x 6 in. x 1 1/2 in. in Polished Mahogany Case. **PRICE 45/- CASH plus Royalties.** Supplied up to 3 stages of Note Magnification.

### 4-Valve Receiver

**1 Detector, 3 Low Frequency Amplifiers**  
**SPECIFICATION.**—As preceding models, but with 3 stages of Note Magnification for Loud Speaker reception. Mounted on Panel, 16 in. x 14 in. x 1 1/2 in., in sloping Mahogany Desk-shaped Cabinet. All Valves are sunk in panel, visible from front.

### 4-Valve, 1 H.F., 1 D., 2 L.F.

As above, but with one stage of Radio Frequency Amplification, and two stages of Note Magnification. .0002 Mfd. Variable Condenser tuning Primary Winding of H.F. Transformer. This model is strongly recommended for reception over long distances.

All the above Models are Approved

**H. A. WHITE & SON, ELECTRICAL ENGINEERS.**  
**229, Pentonville Road, KING'S CROSS, LONDON, N.1.**

Telephones: CENTRAL 8045. HAMPSTEAD 7872. HAMPSTEAD 648.

### 2 Valve Receiver

**1 Detector, 1 Low Frequency Amplifier**  
Range, 60 to 80 miles

Tuning Coil wound on an insulated former with 24 S.W.G. Enamelled Wire with 5 tappings to studs. Wave-length range, 130 to 900. Variable Condensers, .0005 Mfd. Main Tuning Condenser. Single Moving Plate Varner Condenser. .0003 Mfd. Grid Condenser, 2 V. Grid Leak. .001 Mfd. Fixed Condenser across Primary of Low Frequency Transformer. .001 Mfd. Fixed Condenser across Telephones. Low Frequency Transformer, Ratio 5 1/2 to 1, Mounted on 8 in. x 12 in. x 1 1/2 in. Ebonite Panel, engraved and in Mahogany Case 4 1/2 in. deep. With Sterling Telephones, Aerial and Insulators, etc. **£10 10 plus Royalties.**

### 3-Valve Receiver

**1 Detector, 2 Low Frequency Amplifiers**  
As above but with extra stage of amplification on Panel 14 in. x 12 in. x 1 1/2 in., engraved and in Mahogany Case 4 1/2 in. deep.

### 3-Valve Receiver

**1 High Frequency, 1 Detector, 1 Low Frequency**

**SPECIFICATION.**—.002 Variable Condenser Tuning Primary of H.F. Transformer. Tuning Coil wound on insulated former with 24 S.W.G. Enamelled Wire. Wave-length range 130 to 1,200 metres tapped off to 10 studs. Mounted on Ebonite Panel 12 in. x 14 in. x 1 1/2 in., engraved and in Mahogany Case 4 1/2 in. deep. This model is recommended for use when the situation is 80 miles or farther from a Broadcasting Station.

**MANUFACTURERS OF COMPLETE  
WIRELESS INSTALLATIONS**

Agent:

W. A. MAGGARD, 53, Charles St., CARDIFF.



# A BALD STATEMENT

## The NEW "POLAR"

Earth-Screened

### VARIABLE CONDENSER

Range from .0001 to .001 mfd.

Costs only **14/9** Post Free.

Measures 3 in. x 3½ in. x 1 in. only.

Is Now Available from Stock.

Is made and guaranteed for 12 months by

## THE RADIO COMMUNICATION CO., LTD.

Direct from 34, NORFOLK STREET, LONDON, W.C.2.

Or at NEWCASTLE: 17, Sandhill, LIVERPOOL: 67, Dale St. CARDIFF: Atlas Chambers, James St.  
Branches: SOUTHAMPTON: 19, Queen's Terrace. GLASGOW: 10, Blythswood Square.

# — THAT MAKES YOU THINK —

E.P.S. 18

## WIRELESS ACCESSORIES

POSTAGE AND PACKING EXTRA

FILAMENT RESISTANCES	...	...	3/9	each
FIXED CONDENSERS '0 02 or 3	...	2/6	.001	3/-
DOUBLE THROW SWITCHES S. POLE	...	3/-	Double	4/6
SINGLE THROW	...	2/6		3/6
GRID L A.K.S 2 MEGS	...	1/3	WITH CONDENSER	4/6
CRYSTAL DETECTORS, Small	...	3/6	Large	4/6
BASKET COILS (SET OF 9 WL 180 to 3500)	...	4/9		set
PLUG IN COILS (2) AND H.F. TRANSFORMER WOUND FOR B.B.C. BROADCASTING	...	18/-		
SINGLE SLIDER CRYSTAL S.T. (B.C.C. AND P.O.)	...	42/-		
DOUBLE SLIDER CRYSTAL SET (FULLY LICENCED)	...	63/-		
INDUCTANCE COILS WOUND 22/24 WIRE	...	4/-		each

Special Quotations to Trade and Factors on Application.

THE LONDON & COUNTY SPORTS CO., 10, WOODFORD ROAD, E.7.

## QUALITY "NATIONAL" EFFICIENCY

### ANOTHER OF OUR BROADCAST RECEIVERS

Approved by P.M.G.

TYPE N. MK.1\*

Guaranteed by Us.

THE N. Mk.1\* is an extraordinarily efficient r-Valve Set, our tuning device giving great selectivity and sharpness. Jamming of Signals is greatly eliminated. This Set will receive the Broadcasting up to a distance of 100 miles and the Wave-length Range is 330 to 930 metres. It will therefore receive ships and Croydon as well as the Broadcasting.



ALL INSTRUMENTS are tested and calibrated by us before leaving the works, and a calibration card supplied. The Panel is of ¼ in. Ebonite, highly polished, and all lettering is engraved. The cases are very handsome, being of special Ebonite Black finish, highly polished, size 9 in. by 7 in. by 3½ in. Only the very best materials are used in the manufacture of our sets, and we do not sell rubbish.

G.P.O. Regd. No. 1042.

PRICE of Receiver, excluding Valve, Royalty, and Accessories, **£4 15 0**

Mullard ORA Valve, 15/-; Broadcast Royalty, 20/-.

ACCESSORIES (best quality), 4 v. 60 a. Accumulator (Hart's), 36 v. H.T. Battery with Wander Plugs, 1 pair Brown's Phones 4,000 ohms, 100 ft. Aerial Wire 7/22, 4 Insulators, and Coil of Earth Wire.

PRICE of Complete Installation, including Valve, Royalty, and Accessories, **£9 15 0.**

TERMS: Cash with order **AGENTS WANTED.** Carriage Free.  
We are Actual Manufacturers. Come and see our Stock and Works!  
Advice free with pleasure. Send for our complete List of SETS AND PARTS.

**THE NATIONAL WIRELESS AND ELECTRIC CO.,**  
Tel. Chiswick 2266. 7a, Church Road, ACTON, LONDON, W.3.

## Make it a Radio Christmas

Crystal Receiver, Tapped Inductance-Hertzite Detector in Handsome Cabinet, results without trouble	...	27/6	
4,000 ohms Headphones	19/6	Concert Basket Coils, per pair	2/-
Intervalve Transformers	15/-	Crystal Detectors	2/9
3 Coil Holders	10/6	H.F. ditto	3/6
Note Magnifiers, for adding to existing sets	...	45/-	
Hertzite Crystal in Cup—Tested	...	2/-	
Single 2,000 ohms Earpiece, with cord	...	9/6	
Set of 7 "Trinity" Basket Coils	...	4/6	

STAMP FOR LISTS : ADVICE FREE

A. S. A. RADIO, 33, Trinity Road Tooting, S.W.17.

## BUY HIM A WIRELESS SET

Crystal receiver, which will pick up anywhere within a 20-mile radius of Charing Cross. Passed by Post Master and Broadcasting Co., £3 7s. 6d. Phones extra, single, 12/6 each, or with headpiece £1 10s. per pair (better quality, £1 15s.), materials for oval, 8/- to 10/-, according to requirements. Any handy man can erect by following instructions in 6d. Booklet "WIRELESS MADE EASY." The whole outfit at less than five pounds. You can then listen-in to Concerts, Lectures, Sermons, and general news at home in your favourite chair.

### ELECTRIC NOVELTIES AT MODERATE PRICES.

Beautiful Tlepins that light up at will, 18 each (large assortment to choose from).

SHOCKING COILS, 6/6, 8/6, 10/6 each.

MOTORS to drive Meccano sets, on card for home erection, 5/-.

DITTO, complete, 8/-, 10/6.

AS ILLUSTRATED, 15/-.

PARTLY PHONE SETS, 30/- pair.

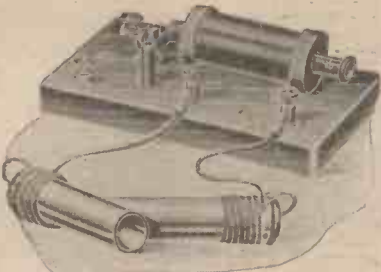

HAND LAMPS, as illustrated, small, 6/6; large, 10/6.

LIGHTNING SETS on card, all ready to fit up, 5/- Battery, 6d.; bulb, 7d. extra.

ACCUMULATORS, switches of all kinds.

BULBS, various, special, for lighting your Xmas Tree, small stock only. Order early. In fact, everything electric. Write for Book, 6d. Or Catalogue, only 2d.



**THE CITY WIRELESS AND ELECTRICAL DEPOT,**  
17, Hatton Garden,  
London, E.C.1.

## THE XL 'PHONE

Comprising a Crystal Receiving Instrument that tunes to 1,500 metres and containing micrometer detector.

Price **£2 15** complete  
Smaller size, price **£2 10**



All mounted on solid ebonite base and stamped BBC and approved by the Postmaster-General for the reception of concerts. One pair of Phones and one Aerial.

We would state that all our instruments are fitted with

**HERTZITE**  
the supersensitive Crystal.

Cash with order. Delivery in strict rotation. Send your order immediately to

**BAKER, JARROLD & CO.,** 97, QUEEN VICTORIA STREET, LONDON, E.C.4.

TELEPHONE: CITY 2972

## A. MUNDAY, Ltd.,

59, WATLING ST., E.C.4, :: 45, EASTCHEAP, E.C.3  
(One door Queen Victoria Street, :: One door Queen Street)

French Head Phones, 4,000 ohms	£1 0 0
Brown's Head Phones, 4,000 ohms	£1 10 6
Sullivan's Head Phones, 120 ohms	12 6
Low Frequency Transformers .....	12 6
Aerial Wire, per 100 ft. 7/22 .....	2 9
Egg Insulators, each .....	3
Terminals from, per doz. ....	1 3

# MATERIALS, TOOLS, AND WORKSHOP SUNDRIES

OUR 1923 LIST of above (64 pages) is now ready. Wireless experimenters cannot afford to be without a copy. SENT POST FREE on receipt of Post Card. Ask for List No. SM/1.

**GEORGE ADAMS (Dept. A.W.),** 255-6, HIGH HOLBORN, LONDON, W.C.1.

## Extracts from our Catalogue.

3d. post free



LOUD SPEAKER

Aerial Insulators, Shell Type, 2 1/2" x 2 1/2" approx., best glaze finish .....	each	1/3
Aerial Insulators, Reel Type, 2 1/2" dia. approx. ....	each	3d
Aerial Insulators, Strainer, 2 1/2" x 1 1/2" approx. ....	each	8d.
Aerial Leading in Tubes, sturdy ebonite, 6" overall, each 1/8, 1 1/2" overall, each .....	each	2/-
Aerial Pulleys, large 5 1/2" with tackle, hook and bucket .....	each	2/6
Aerial Pulleys, small 2 1/2" .....	each	1/-
Accumulators (Oldham's Special Process) —		
4 volt 40 amp. I.C. ....	each	20/-
4 volt 60 amp. I.C. ....	each	22/6
6 volt 80 amp. I.C. ....	each	27/6
6 volt 6 amp. I.C. ....	each	32/6
Brass Rod, screwed, 2 B.A. in 12" lengths .....	each	5d.
3 B.A. in 12" lengths .....	each	4 1/2d.
4 B.A. in 12" lengths .....	each	4d.
5 B.A. in 12" lengths .....	each	3 1/2d.
Brass Washers, 2, 3, 4 or 5 B.A. ....	doz.	2d.
Brass Nuts, 2, 3, 4 or 5 B.A. ....	doz.	4d.
Batteries, flash Lamp .....	doz.	5/-
Terminals to fit contacts of flash lamps .....	doz.	2/-
Condenser Vanes, 2 1/2" diam., in .002" hard drawn aluminium .....	doz.	9d.

Condenser Vanes, other sizes see list.	
Condenser Spacing Washers. Accurate, large 6d. doz., small .....	doz. 4d.
Condensers, fixed, .0001 to .0005 .....	each 2/-
.001 to .002 .....	each 2/3
.003 to .004 .....	each 2/6
Crystal Cups (with screw to fix crystal) .....	each 3d.
Contact studs (superior finish, 1/4" x 1/4", with nut and washer) .....	doz. 1/-
Copper Foil Sheets (uniform thickness, 12" x 3") .....	each 3d.
Core Wire, soft iron in straight lengths .....	lb. 2/4
Coil Mounting Plugs, with screw connections .....	each 1/6
3 Coil Holders for panel mounting .....	each 12/6
Ebonite Engraved Dials .....	each 1/6
Ebonite Sheet, best quality, light not loaded .....	lb. 5/-
Filament Rheostats for Panel Mounting, the best offered .....	each 3/6
Grid Leaks and Condensers (tested with proper Instruments) .....	each 5/6
Instrument Wires. Hundreds of miles in stock, competitive prices.	

Please include ample postage, balance will be returned

**J.L. Cartwright & Co.**

(Dept. A), 24, London Rd., MANCHESTER.  
Works: BERRY STREET.

Phone: Central 4209. Grams: "Pladuram, Manchester."

Insulated Sleeving, 1 1/4 m.m. ....	yard	6d.
Inductance Sliders, with spring and plunger .....	each	6d.
Inductance Slider Rod, in 13" lengths .....	each	4d.
Ivory Scales, engraved, not printed .....	each	10d.
Knobs, Ebonite, 1 1/4" diam. ....	each	5d.
Low Frequency Transformers, 24v. each. For description see catalog		
Paraffin Wax .....	lb.	1/-
Resistance Wires, 22 and 24 S.W.G. and enamelled 28 S.W.G. ....	yard	1d.
Screws (brass) .....	from 2d. doz.	
Terminals .....	from 1/9 doz.	
Telephone Transformers, 20v. each. For description see catalogue.		
Tin Foil, free from lead, sheets 26" x 13" .....	each	4d.
Valve Pins, complete with nut and washer .....	doz.	1/3
Valve Sockets, complete with nuts and washer .....	doz.	1/3
Valve Holders, complete with nuts and washer .....	each	1/-
Valves. Huge stocks B.T.H., 15/-, Mullard Ora, 15/-, Marconi Osram .....		17/6



HEAD PHONES

Wholesale Distributing Agents for Scotland:—  
**J. GORSTON SINCLAIR & Co.,**  
47, Waterloo St., Glasgow.

Retail Agents for Bradford:—  
**THE GRAMOPHONE STORES,**  
Bowling Old Lane.



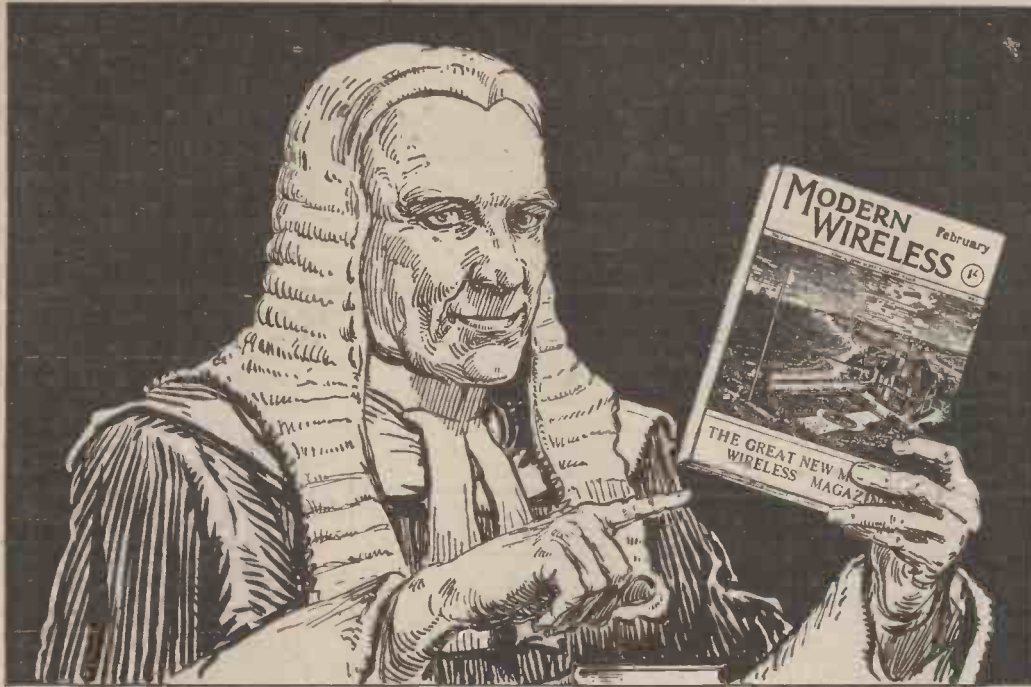

**JAN. 15th**

On this day will appear the great new Monthly Wireless Magazine "MODERN WIRELESS"

**ORDER NOW**

From your Newsagent.

**1/- net.**

This Magazine will be written by Wireless Engineers, edited by Wireless Engineers, and published by Wireless Engineers.

Edited by

**JOHN SCOTT-TAGGART**

(F. Inst. P., M.I.R.E.),

assisted by

**PAUL D. TYERS**

Author of "Construction of Wireless Receiving Apparatus,"

and

**E. REDPATH,**

late Wireless Expert of "Work," and author of Cassell's "Work" Handbook "Wireless Telegraphy and Telephony."

*A good judge* of a wireless periodical will not fail to buy the brilliant First Number of this Magazine, published by **RADIO PRESS, Ltd., Devereux Buildings, Strand, London, W.C.2.**

**BEGINNER'S GUIDE TO WIRELESS**

Explains in plain, everyday language, everything beginners wish to know about Wireless Telegraphy.

**HOW TO ERECT, CONNECT, AND MAKE**

all the apparatus required for reception of telephony or morse, and full instructions and diagrams for making coils, tuners, and complete valve and crystal sets. 112 pages, price 1/- post free.

**SAXON RADIO CO. (Dept. 12), South Shore, BLACKPOOL**

32 page Catalogue of Wireless Apparatus, 3d. post free.

**BUTLER'S BRITISH BROADCASTING CRYSTAL RECEIVERS FOR WIRELESS TELEPHONY, ETC.**

Dimensions: 6 1/2 x 6 1/2 x 5 1/2

Approximate Weight 3 lb.

Approved by Postmaster-General.



**A RELIABLE INSTRUMENT AT A LOW FIGURE**

Double Slide Tuning Coil, Spring Contact Crystal Detector, Engraved Ebonite Panel, Lacquered Terminals, the whole fitted into solid, well seasoned, polished mahogany Cabinet.

**AS ILLUSTRATION**

Approximate range 3,000 metres  
**£2 - 7 - 6** POST FREE

**IF FITTED WITH VARIABLE CONDENSER**

Approximate range 3,000 metres  
**£2 - 15 - 0** POST FREE

Overseas Postage Extra.

All that is necessary with these sets is to connect up the aerial and earth and telephones and with small adjustment signals should be received.

**EXTRAS.**—Double Telephone Head Gear, Insulators, Aerial and Earth Wire.

ILLUSTRATED LIST POST FREE 4d.

**H. D. BUTLER & COMPANY, LIMITED,**

Office: BANK BUILDINGS, 222, GT. DOVER ST., S.E.1. Works: CANONBURY, LONDON, N.1. (Opposite Boro Tube Station) Phone: Hop 3029. Teleg: "Inventivity, Phonis London."

**IMPORTANT NOTICE**

TO THE PUBLIC AND TRADE

**Wireless Sets and Accessories**

Our policy has always been one of individual attention and promptness of delivery. Owing to the enormous increase in business we are now greatly extending our organisation :: :: :: ::

This is to give notice of the following changes of address:

**HEAD OFFICE & WHOLESALE SHOWROOMS** are now located at—

**Hastings House,**  
Norfolk Street, Strand,  
London, W.C.2.

to which address all correspondence should be sent.

**DEMONSTRATION & RETAIL SHOWROOMS** are now located at—

**179, Strand (Corner of Norfolk St.),**  
London, W.C.2.

All goods are to be sent to our  
**WAREHOUSE & WORKS—**

**Providencé Place,**  
West End Lane, Kilburn,  
London, N.W.6.

**LESLIE McMICHAEL Ltd.**

# HULLO

Do YOU Know Us? If not, why not?

## COMPLETE SETS of PARTS for MAKING VARIABLE CONDENSERS

*EVERYTHING READY to ASSEMBLE and  
CONSISTS of the FOLLOWING:*

Accurate Aluminium Fixed and Moving Vanes, Large and Small Spacer Washers, Centre Square Spindle (Screwed Ends, 2 B.A.). 3 Side Rods, 12 Nuts and 12 Brass Washers (2 B.A.), Pointer—scale 0-180, Terminals, 3 Bushes, Spring Coil Washers, Best Quality Knob with 2 B.A. Nut in Centre.

**ALL HIGHEST QUALITY GOODS**

### REVISED PRICES, WITHOUT EBONITE

Approximate Capacity in Microfarads	No. of Plates	Price
.0015 .....	85 .....	9/-
.001 .....	57 .....	6/6
.00075 .....	43 .....	5/6
.0005 .....	29 .....	4/6
.0003 .....	19 .....	3/-
.0002 .....	13 .....	2/3
.0001 .....	7 .....	2/-
Vernier .....	3 .....	1/9

PLEASE NOTE

### DRILLED EBONITE ENDS

1/- per pair extra

Postage and Packing, 1/- per set. Two sets, 1/3

Owing to the extraordinary value given in above Condenser Sets, we are compelled to make these charges for packing, postage, etc.

## Unsolicited Testimonials

G. H. FRASER, Esq.,  
169, Maxwell Road,  
Shillshall,  
Glasgow.

1/12/22.

The condenser parts to hand, and I desire to thank you for the very prompt attention to my order. The condensers themselves are of an excellent quality.

T. BROWN, Esq.,  
2, St. Clair Terrace,  
Annan Road,  
Dumfries.

6/12/22.

Received goods this morning. Am highly pleased with them, especially condenser parts.

G. W. DUFFIN, M.P.S.,  
15, Silver Street,  
Wakefield.

2/12/22.

I am very pleased with condensers. They are wonderful value.

NORMAN E. CARVILL, Esq.,  
Feroze Hall,  
Tonbridge.

I purchased some variable condensers of you some time ago, and I should like you to know that I am very pleased indeed with them. They are really worth double, and the finish is excellent.

RIGHT OPPOSITE  
DALY'S  
GALLERY DOOR

## M. RAYMOND

27, LISLE STREET, W.C. 2

'Phone : \_\_\_\_\_ GERRARD 4637

To avoid mistakes,  
this address is close  
to Charing X Road  
and Leicester  
Square Tube



# EVERYBODY

We do not offer you "something for nothing," nor is this advertisement a catchpenny one. Goods supplied are value for money, both as to quality and price. We leave our customers to be the best judges. 'Nuff said!

## ALL the following GOODS POST FREE at the SPECIAL PRICES attached for POST ORDERS

*If you are not satisfied with value, return goods and we will refund all charges*

**Filament Resistances.** Most wonderful value in the wireless trade. Each 2/6 and 3/6. By post, 3/6 and 4/6.  
**Switch Arms,** with polished knob, bushed 2 BA nut, laminated blade, spring coil washer, nuts and bush, 1/6, 1/6, 2/6 each. By post, 1/3, 1/9, 2/3.  
**Crystal Detectors on Ebonite.** Simply marvellous value. Each 2/6. By post, 3/6. Also 3/3; by post, 3/9.  
**Fixed Condensers,** with terminals on ebonite, .0003, .0005, .001, .002, .003, 1/6; by post, 1/9; .004, 1/9; by post, 2/6.  
**Oojah Basket Coils,** 7 in set, 5/6 set. By post, 5/6.  
**Lead-in Tubes,** ebonite, brass ends, 9 in., 1/2. By post, 1/6. 12 in., 1/4. By post, 1/8.  
**Good Condenser Knobs,** tapped 2 BA, at 2/6 doz. By post, 2/6.  
**Knobs,** with brass nut (2 BA) in centre, high-class quality, 4 1/2 d. each. By post, 7d. 6 for 2/6. By post 2/6.  
**Crystal Detector,** cups enclosed with glass cover, dust proof, 4/6. By post, 5/3.  
**Aerial Wire,** 7/22 bare copper, stranded, first class quality, not a substitute. Price per 100 ft., 2/10. By post, 3/10.  
**Reel Insulators,** 1d. each. Cannot be sent by post.  
**1 1/2 mm. Insulating Sleeving,** 6 yds. for 2/2. By post, 2/6. 12 yds. for 4/6. By post, 4/6.  
**Slider and Plunger,** 4d. By post, 7d.  
**Slider Knob,** plunger and 13 in. rod. The lot, 8d. Cannot be sent by post.  
**Aluminium Vanes,** 2 doz., 1/6. By post, 1/6. 5/6 gross; by post, 6/6.

**War Office Pattern Terminals,** complete with nut and washer, 1/8 doz. By post, 2/2 doz.  
**Splendid Line in 5-piece Terminals,** complete with nut and washer, good size, 1/6 doz. By post, 1/6.  
**Large Spacer Washers,** 3 doz., 9d. By post, 1/6.  
**Small Spacer Washers,** 6 doz., 1/6. By post, 1/4.  
**Terminals (very large),** magnificent quality, aerial and earth, complete with 2 nuts and 2 washers (2 BA stems), 2 for 8d. By post, 1/6.  
**Interval Transformers (low frequency),** high class, tested, and guaranteed 5-1; 14/6 each. By post, 15/6. Smaller size, 10/6; by post, 11/6.  
**Hertzite Crystal,** per piece, according to size, 1/3 and 1/6. Cannot send by post.  
**Ebonite Dials,** bored in centre with engraved scale 0-180, 1/6 each. By post, 1/6.  
**Egg Insulators,** 4 for 9d.; 2/6 per doz. Not sent by post.  
**Grid Leak and Condenser,** .0003, very high quality and appearance, 3/9. By post, 4/3.  
**Inductance Coils Wound Enamel Wire,** 12 by 4, 3/6. Not sent by post.  
**Filament Resistance, "Thor" pattern,** suitable for one, two or three valve sets, 4/6. By post, 4/6.  
**Terminals, telephone,** highly finished, with nut and washer, 2/6 dozen. By post, 2/6.  
**War Office Pattern Terminals,** extra special quality, with nut and washer, 2/6 dozen. By post, 2/6.

## WE BEAT CREATION ON PRICES AND QUALITY

## HEADPHONES.

*We Don't Sell Cheap and Nasty Telephones*

**Genuine "Brunet" French Telephones,** most sensitive obtainable, 6 Tungsten steel poles in each earpiece. 4,000 ohms, with cords (Double Receivers) **25/- post free**  
**French Receivers, 8,000 ohms, double Receivers with cords** **25/- post free**

**Single Receivers (French) with cord** 2,000 ohms **9/- (post 1/- extra)**  
**High Class British Receivers, double,** complete with cords and headband **21/- to 25/- (post 1/- extra)**

## To CALLERS: We Sell All Component Parts CHEAP!

Brass Rods, Nuts, Washers, Screws, Valve Sockets, Valve Pins, Stop Pins at wholesale prices

*NOTE! Terms strictly cash with order. All orders by post are despatched at the earliest possible moment, as we have great pressure just now on the postal department*

RIGHT OPPOSITE  
**DALY'S**  
 GALLERY DOOR

**M. RAYMOND**  
 27, LISLE STREET, W.C.2

'Phone : \_\_\_\_\_ GERRARD 4637

To avoid mistakes, this address is close to Charing X Road and Leicester Square Tube

**DEC. 30**

**ISSUE**

**GOES TO PRESS**

**DEC. 20**

**PREPAID ADVERTISEMENTS.**

The Latest Invention. Steam rotary engine, reg. patent. The finest scientific working steam engine ever invented. 1s. each, 3 for 2s. 6d.—Alan Hitchen, Patentee and Manufacturer, Dept. 17, Burnley. [22r  
Accumulators, plates, parts, accessories. Expert repairs.—Barnard, 45, Great Ormond Street, W.C.1. [12r

Wireless Dealers throughout Great Britain are strongly advised to stock parts for making up wireless sets. Buy your parts direct from the factory at wholesale prices.—Newtonia Wireless Factory, 13 and 15, Whitcomb Street, London, W.C.2.

**S.A. Screws, Nuts, and Washers**, assorted gross, 2s.; list, 2d.—J. H. Bennett, Station Road, Willesden Junction. [17r

All About Wireless.—Send for Booklet, 64 pages, with many illustrations. "Wireless Made Easy." Simple, concise explanation of wireless wonder. How to make and fit up at home. Post free, 6d. stamps.—The City Wireless and Electrical Depot (Dept. J), 17, Hatton Garden, London, E.C.

**Ebonite Sheet**, post free, any size cut, 1/2 in. thick, 1d. per sq. in.; 1/4 in. thick, 3d. per sq. in.—Warren and Clark, 11A, Sidney Avenue, London, N.13. [1s

Look at This.—Loud speakers, ex-Government 200 ohms, fitted on ebonite base, with high-class 24-in. detachable aluminium horn; bargain, 30s.; carriage and packing extra.—White, 121, Adelaide Road, Chalk Farm. [13s

**L.B. Automatic Morse Senders** will send any message any speed and will last a lifetime. Makes the Morse code a pleasure to learn. Price only 6s., post free. Further particulars 3d. stamped envelope. Satisfaction guaranteed.—Grimshaw's (Dept. A.W.), Lugh Street, Golborne, Lancs. [4s

**Huge Purchase of ex-Government Wireless Stock.** Write for list giving full details. 150-watt dynamos, £1; hedgehog coils, 3s. 6d.; loud speakers, 200 ohms, 7s. 6d.; 1-in. spark coils, 10s.; 1 1/2-in. spark coils, 12s. 6d.; morse tapping keys, 3s., etc. etc. etc. Three days' approval against cash, or please call. Write for detailed price list of all goods.—E. J. Galpin, 16, Loampit Hill, Lewisham, S.E.13, London. [2s

**Scientific Appliances** (Dale & Holmes). Electrical, Magnetic, Optical and **ALL RADIO WIRELESS PARTS** and Materials at Lowest Prices. Call and see our immense stock or write for Information and Prices. In Centre of London, Top of Kingsway. [27  
**SCIENTIFIC APPLIANCES,**  
11 and 29, Sicilian Avenue, London, W.C.1.

**ELECTRADIX RADIOS.**

**IMMEDIATE DELIVERY FROM OUR HUGE STOCKS**

Everything from a Recorder to an Earth Clip.

The best equipped City depot.

**COME AND SEE US**

9, COLONIAL AVENUE, is first opening on left in the Minories, nr. Aldgate Station, Metropolitan Railway.

**LESLIE DIXON & CO.,** Tel: Avenue 4166,  
9, COLONIAL AVENUE, MINORIES, E.1.

**THE MARK OF RELIABILITY**

**FILAMENT RESISTANCES**  
2/- Each  
Panel Type with Knob and Pointer.

**POTENTIAL-METER**  
300 ohms.  
4/6 Each  
Panel type on Ebonite.

1 to 12 volts      1 to 35 amps

**VOLT & AMMETER**

Combined Dead Beat Pocket Type. New and not German. Splendid Instrument in Nickel-plated Case. Ideal for Testing Cells & Filament Current

**POST PAID 5/6 LIMITED NUMBER**

**OTHER EXCEPTIONAL VALUES**

Aerial Wire. Bright Hard Drawn, 7/22 Copper, 3/6 per 100 ft.; same enamelled, 5/-  
Aerial Insulators. 2 x 2 1/2 ins. Shell type, 9d. each; 2 in. Reel Type, 2/- each.  
Telephone Transformers. (Army Type.) 9/- each; L.F. Transformers, 15/- each.  
Vernier Condenser. 5 Plate for Panel mounting, 4/- each. '001, 16-', '0005, 12' each.  
Wireless Jacks. With Plugs, 1/- the pair.  
High Note Buzzer. (Army Type.) Worth treble, 3/- each; Tapping Keys, 5/6 each.  
Dewar Switches. D.P. Change over, panel type, 2/- ea. h. Small Switch Arms, 6d. each.  
Write for "Complete Supplementary Price List of Exceptional Values," sent Post Free. All goods sent Carriage Paid, but with orders under 5s. 6d. add 6d. for postage.

**J. H. TAYLOR & CO.,**  
ELECTRICAL AND RADIO ENGINEERS.  
**Macaulay St., HUDDERSFIELD.**  
Telephone 341. Telegrams: "Thorough," Huddersfield.

**3/9**  
POST FREE

**A PERFECT DETECTOR FOR WIRE CONTACT CRYSTALS**

DOUBLE BALL JOINT  
Reg. Design No. 691568

**MICKELWRIGHT, Ltd.,**  
ALPERTON, WEMBLEY, MX.

**PORTLAND'S PARTS BY POST**

**"EBONITE"**

	£	s.	d.		£	s.	d.
4 x 4	...	1	3	12 x 7	...	5	2
7 x 5 1/2	...	2	8	12 x 8 1/2	...	6	5
8 x 6	...	3	0	12 x 10	...	7	6
9 x 6	...	3	5	15 x 8 1/2	...	8	0
10 x 6	...	3	9	12 x 12	...	9	0
12 x 5 1/2	...	4	2	17 1/2 x 8 1/2	...	9	6
9 x 8 1/2	...	4	10	14 x 12	...	10	5
17 x 5	...	5	3	18 x 18 (Half sheet)	...	12	10
7 lb.	...	1	3	36 x 18	...	1	3

28 lb., £4

No charge for cutting, waste or postage  
Delivery by return of post

Quality A1. **DRILLING**, Manufacture, **BRITISH**  
Thickness, one Quarter—Surface, Mat

**JAMES PORTLAND,**  
39, SINCLAIR ROAD, OLYMPIA, W.14  
N.B.—Mr. Portland Stocks 200 Wireless Parts

**JUST OUT**

**WIRELESS HANDBOOK & DIARY, 1923**

The ideal gift to all interested in Wireless. Show this advertisement to your friend who was going to buy you an ordinary diary.

**PRICE 2/6 net (post free 2/8).**

A Charles Letts' Diary with 34 pages of general and 40 special pages of wireless interest. Beautifully bound in real leather.

**HANG IT**

from your table

**Radio Press Wireless Directory**

12,000 amateur, ship and land station call signs. As indispensable as a telephone directory.

**PRICE 2/6 net (post free 2/8).**

All our publications obtainable through booksellers, or direct from:

**RADIO PRESS Ltd.,** Devereux Buildings, Strand, London, W.C.2.

**CRYSTAL BROADCASTING RECEIVER**

PASSED BY G.P.O.

Totally enclosed in highly polished Cabinet with accommodation for Phones. Mounted on Ebonite plate.

**Price - £2 10 0**

With 4,000 ohms phones, 100 ft. aerial, insulators and lead-in tube. Carriage paid-U.K. **£4 0 0.**

2 Valve Broadcast Receiving Set. Passed by P.M.G. Tax paid. **£9 0 0.**

3 Valve Cabinet Receiving Set. Passed by P.M.G. Tax paid. **£15 0 0.**

**ACCESSORIES & SMALL PARTS SUPPLIED. LIST FREE.**

**Our Motto: "EFFICIENCY with CHEAPNESS."**

**C. S. MILLS,**  
135, High Street, Notting Hill Gate, LONDON.

**WIRELESS BARGAINS.**

**PHONES, 21/-** SUPERSENSITIVE ALL-BRITISH, 4,000 ohms, POST FREE.

**ALL WIRELESS PARTS & SETS,** Trade supplied. **CRYSTAL DETECTORS, 2/6.**

Illustrated Catalogue A, including list of Stations, 6d. post free.

**EONS WIRELESS SUPPLY CO.,**  
115, Fleet Street, E.C.4.

**FEL OPHONE 2-Valve RECEIVER** for plug in coils in Oak Cabinet, Headphones, Batteries, Accumulator, Aerial and Insulators (Including Tax) **£12**

**FELLOPHONE 2-Valve AMPLIFIER** in Oak Cabinet (for Loud Speaker), Including Tax **£7**

**SUPERCRYST**, Complete with Aerial, Insulators and Headphones, Including Tax **£4 7 6**

**HEADPHONES, 4,000 ohms £1 1**

**LOUD SPEAKERS, MULLARD and COSSOR VALVES, GRID LEAKS.** Variable and Block Condensers, Telephone Transformers. **£1 1**

DEMONSTRATIONS. 9 a.m. to 5.30 p.m. 8 to 9.30 p.m.  
SATURDAYS. 9 to 1 p.m. 8 to 9.30 p.m. SUNDAYS by appointment.

**F. N. GOUVY & CO., Ltd.,** 31, Upper Brook Mews, Lancaster Gate, near Paddington Station.

**RELIABLE RECEIVING HEADPHONES**

4,000 ohms, double bands, complete with flex and tags, at 20s. each, post free

Cash with order. Ex stock. Every instrument guaranteed.

**THE SOUTH WESTERN WIRELESS SUPPLIES CO.,**  
382a, Merton Road, SOUTHFIELD, LONDON S.W.18



**H.C. CO.**

Your Guarantee. Your Guarantee.

## BROADCAST RECEIVING SETS

(One, two, three or four Valves)

Our receiving sets will bear the guarantee mark of the Postmaster-General, and are fully licensed under Marconi Patents.

**EFFICIENT SETS AT REASONABLE PRICES.**

Full details and quotations upon application.

Besides complete sets we supply numerous component parts for those wishing to build their own sets.

Price Lists 3d. post free. Advice and assistance freely given.

**HAMBLING, CLAPP & Co., 110, Strand, London, W.C.**  
Phone: Gerrard 8806.



## "PERRYPHONES"

HEAD SETS FOR WIRELESS TELEPHONY  
4,000 ohms.  
**21/-**

Every Set Guaranteed. Beautifully finished, highly sensitive, detachable receivers.

**IMMEDIATE DELIVERY**

Illustrated Wireless Catalogue now ready, post free, 3d.

**THE JEARY ELECTRICAL CO., LTD.,**  
8, LAMBETH HILL, and 97, QUEEN VICTORIA ST., LONDON, E.C.4.  
And at Glasgow, Birmingham, etc.



## THE MECCANO RADIO Receiving Set

for Broadcasting and Morse Reception

**THE Meccano Crystal Receiving Set** has been thoroughly tested and has received with great clearness, broadcast music and speech up to 30 miles of London, Birmingham and Manchester.

**EACH SET IS TESTED AND GUARANTEED EFFICIENT ON A P.M.G. AERIAL**

An ideal present for Christmas. Give one to your boy and make him happy. It is low in cost and complete in itself, ready to be connected to any aerial.

**Send for this Book**  
Our new booklet, *The Meccano Crystal Receiving Set*, explains Radio so that everyone is able to understand how simple is the reception of broadcasting, telephony and Morse messages. This booklet will be mailed free on request.



*Start Radio Now in an Efficient and Inexpensive Way*

**PRICES**

Meccano Crystal Receiving Set, complete, price 55/-  
" Aerial Set (including antenna, lead-in and aerial wires and insulators) " 12/6

**MECCANO Ltd Binns Road LIVERPOOL**

We reply by return

## CRYSTAL DETECTOR

Lacquered Brass on Ebonite, Ball and Socket movement. Suitable for Silicon, Galena, etc.

Our money-back guarantee accompanies ALL our goods

**PRICE 3/- POST FREE**

Two Cup Pattern, for Zincite-Bornite, etc., etc., Lacquered Brass on Ebonite, post free 3/6

Complete Wireless Lists post free

**ELECTRICAL SUPPLY STORES,**  
5, Albert Terrace, King Cross, Halifax

## GENTS' "TANGENT" FILAMENT RHEOSTAT

**STURDY, SOUND AND RELIABLE**



SEND FOR LATEST PRICES OF  
Gents' "TANGENT" Filament Rheostat  
Gents' "TANGENT" L.F. Transformer  
Gents' "DISCOL" H.F. Transformer and other fittings

**GENT & CO., LTD., "Radio Dept., FARADAY WORKS," LEICESTER**

LONDON: 25, VICTORIA ST., S.W.1.  
NEWCASTLE-ON-TYNE: TANGENT HOUSE 11 BLACKETT ST.

# Exide BATTERIES

## H.T. Batteries for Valve Sets



24v. 28v. 32v.  
Type B.K.

Owing to the demand for these batteries, all orders will be dealt with in strict rotation. Prices approximately one shilling a volt.

:: Ask for Leaflet 4030 ::

---

**THE Chloride ELECTRICAL STORAGE COMPANY LIMITED.**

CLIFTON JUNCTION, N<sup>r</sup> MANCHESTER. | 219/229, SHAFTESBURY AVENUE, W.C.2.  
PRICES AND PARTICULARS ON APPLICATION.

# RADIO CHRISTMAS GIFTS



### Sterling No. 1 Crystal Receiving Set

Specially designed for Broadcast reception, very selective and simple to operate. Complete with one pair of Double Head Telephones and with special coil for Paris Time Signals. Range about 25 miles.  
*Write for Leaflet No. 324.*



### Radio Head Phones

*(Manufactured under Brown's Patent  
No. 134353/18 by Sole Licence)*

Of the highest efficiency. Constructed on the most scientific principles and to give a comfortable fit to the ear of the user.

*Write for Leaflets Nos. 321 and 325.*

*To be obtained from all Dealers or direct from*

## STERLING TELEPHONE & ELECTRIC CO., LTD.,

Telephone House, 210/212, TOTTENHAM COURT ROAD, LONDON, W.1.

Telephone: Museum 4144 (7 lines.)

Telegrams: "Cucumis, Wesdo, London."

NEWCASTLE-ON-TYNE:  
9, Clavering Place.

WORKS:  
Dagenham, Essex.

CARDIFF:  
8, Park Place.

**WE GUARANTEE**  
that all Broadcast Radio  
Apparatus sold by us conforms  
with the conditions of the  
Broadcasters' Licence issued by  
the Postmaster-General.

Introducing the

# B Registered No. 1045 B Passed by P.M.C. BROADCAST BABY

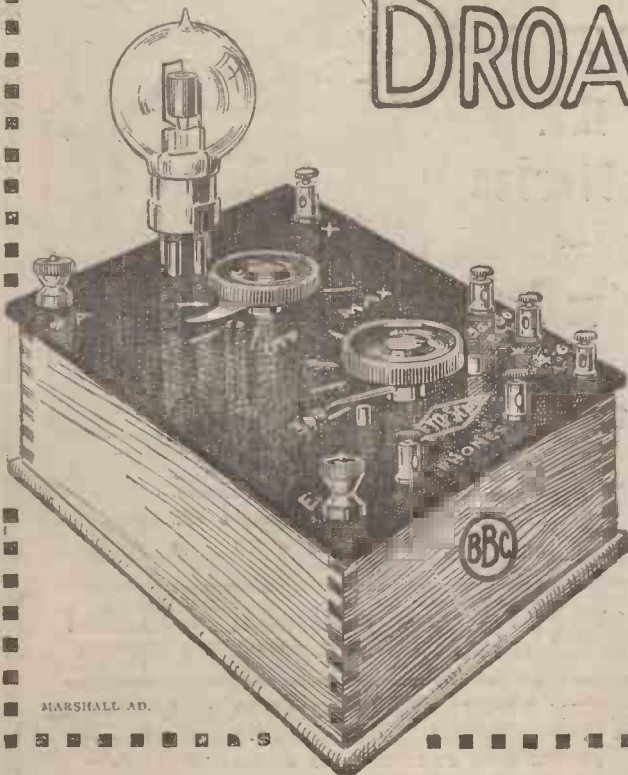

Here's an ideal Xmas Gift—one all the family can enjoy 365 days in the year. Receives speech and music perfectly, and is tuned by one knob only—no irritating adjustments to make. Further Valves can be added to enable a Loud Speaker to be used. In addition, by the aid of a special Loading Panel—to be attached to terminals A and E—its present wave-length limits of 300 to 500 metres can be increased to receive Paris and Hague Concerts. Every Instrument accurately tested on an Aerial before dispatch & a signed Certificate attached to each.

Size 7 in. by 5 in., mounted on polished mahogany Cabinet, complete as illustration but without Valve. Catalogue of phones, loud speakers, batteries and other components sent post free.

OFFICES & SHOWROOMS:  
FEATHERSTONE HOUSE,  
64, HIGH HOLBORN, W.C.1.

# 50/-

If for use with Broadcast Licence each instrument must be stamped B.B.C. at an extra cost of 32/6.



MARSHALL AD.



A "Christmassy" Number

A Visit  
to  
2 L O

# Amateur Wireless And Electrics

No. 29

SATURDAY, DECEMBER 23, 1922

Price 3d.

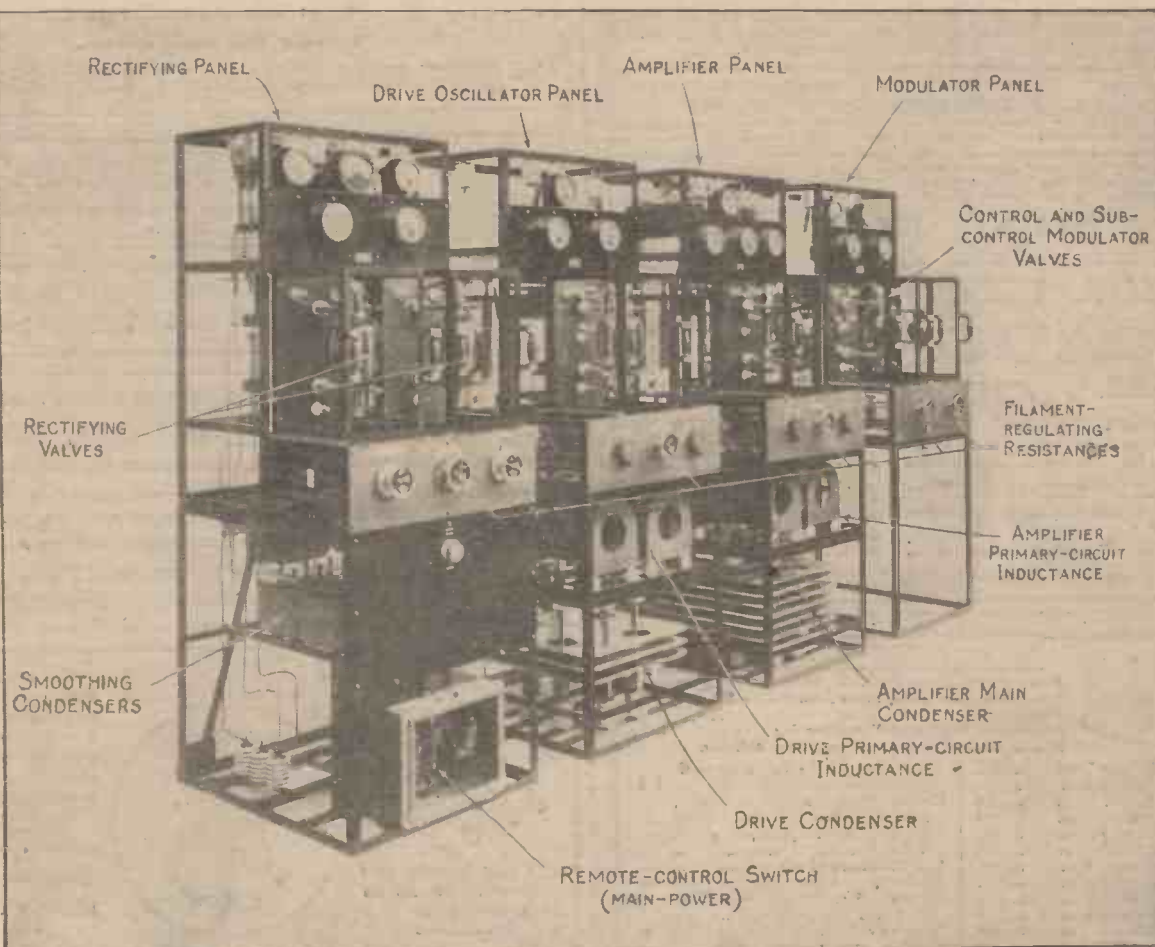

BROADCASTING APPARATUS AT 2 L O. (See Special Article on pages 678 and 679.)

# ECONOMIC ELECTRIC LTD.



## Have YOU tried the "XTRAUDION" VALVE?

the latest and best development of the 3 Electrode Valve.

**RECTIFIES, OSCILLATES AMPLIFIES**

Its Mechanical Construction makes it a stronger and more lasting valve than any other.

The Filament consumes well under half - an - amp. at 4 volts. Anode Potential, 50 volts.

Its Amplifying Properties are wonderful and its freedom from noises a revelation. Send for Descriptive Leaflet.

15/-  
PRICE



15/-  
PRICE

We publish the most complete Wireless Catalogue obtainable. 36 pages, profusely illustrated, and many useful circuits for experimental work. Mailed to any address on receipt of four penny stamps.

Head Office 10, FITZROY SQUARE, LONDON, W.1.

Showrooms: 303, EUSTON ROAD, N.W.1.

Telephone: MUSEUM 1055

Branch Showrooms & Works: TWICKENHAM

## No Set to Equal Our Great "HERTZITE" CRYSTAL RECEIVING SET FOR BROADCASTING

Including B.B.A. Commission **67/6** Carriage and Packing Free  
SINGLE CRYSTALS, 2/6 Post Free.  
VALVES: "ORA," "XTRAUDION," "C.V.C.," & "R.M.R." 15/- each

**RUSSELL & SHAW,**  
38, Great James Street, Bedford Row, W.C.1.

### STARTLING REDUCTIONS

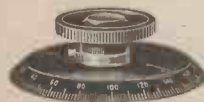

Ebonite Condenser Dials, Engraved 0-180° and filled white with Knob, Brass Bush and Set Screw Dial only ... 2/6  
Aluminium Condenser Vanes per doz. ... 1/8  
Spacer Washer, small 3d. doz.; large 4d. doz. ... 6d.

Knobs, with 2 BA Brass Inset ... 3d.  
Grid Leaks (enclosed), 2 meg. ... 1/-  
Grid Condensers ... 1/8  
Filament Resistances ... 3/8  
Crystal Cups with Screw ... 3d.  
Fusible Alloy, per stick ... 4d.  
Inductance Tubes, 12" x 3" ... 6d.  
" " 12" x 4" ... 9d.  
" " 12" x 5" ... 1/-  
" " 12" x 6" ... 1/3  
Sliders and Plungers ... 5d.  
Sq. Brass Rod, 12" x 1/2" x 1/2" ... 4d.  
Enamelled Wire, 23 gauge, lb. ... 2/-  
Aerial Wire, 7/25, Stranded, 100' ... 3/-  
Valve Holders, Screwed Legs ... 9d.

A.E.G. and Halske Valves for rectifying and amplifying (tested) ... 7/8  
Crystals (special selected), Bornite, Zincite, Galena, Silicon, Carborundum, Copper Pyrites, Graphite, Tellurium, etc. ... 6d.  
Egg Insulators, Green ... 4d.  
Reel " best quality ... 3d.  
Hellesen 36 v. Batteries with Tappings and Wander Plug ... 5/8  
Essex 15 v. H.T. Batteries ... 3/-  
Ebonite Leading In Insulators ... 1/8  
Perikon Detectors on Ebonite Complete with Crystals ... 4/-  
"Ubique" Crystal Set Complete ... 15/-

DELIVERY BY RETURN GUARANTEED Postage extra.

THE **ESSEX WIRELESS CO.** Office & Showrooms: 199, GROVE GREEN RD., LEYTONSTONE, E.11.  
Telephone—WANSTEAD 749. (1 min. from Station, G.E.R.)

# MITCHELFONES

Are not a spasmodic production to meet a sudden demand, but have been on the market for over three months, and during this period 27,000 have been distributed to the trade, and consequently we have not been able to offer them direct to the retail buyer,

1,000 per week are now available, and we announce

## DELIVERY FROM STOCK

You post your order, or call at our premises and get them at once. Think what this means to you—you, perhaps, who have been waiting and are still waiting.

Standard resistance 4,000 ohms, double headgear with double headstraps, comfortable, highly efficient, and foolproof

**25/- per pair.**

Special Terms to Traders and deliveries that will surprise you.

## MITCHELLS Electrical & Wireless Ltd.,

Postal Address: McDermott Road, Peckham, S.E.15.  
Retail Address: 188, Rye Lane, Peckham, S.E.15.

Phones: New Cross 1540/1541.

## GREAT BRITAIN'S GREATEST WIRELESS STORE

## ONE VALVE BROADCAST SET

Registered No. 1062. Very compact, of finest British workmanship, and the price includes all accessories. ... Price, £10 0 0

Send for lists, post free, of other sets, amplifiers, components, etc.

**WIRELESS COMPONENTS LTD.,**  
16, Manette Street, Charing Cross Road, London, W.C.2.

## DO YOU READ PRACTICAL BOOKS?

See Cassell's List of Technical, Practical and Money-saving Books. A p.c. will ensure your receiving it.

**CASSELL & Co., La Belle Sauvage, LONDON, E.C.4.**

SEE OPPOSITE PAGE,  
LAST WEEK'S ISSUE,  
ON RECORDING

### SPECIAL OFFER



The most sensitive Relay made. Real Platinum Contacts. Eminently suitable for Wireless work. Perfectly new as received from makers.

Price **20/-** each  
Postage and packing, 1/8.  
DELIVERY PER RETURN.

NOTE:—Originally cost the Trade £8 to £10 each.

## WESTON MOVING COIL RELAYS

**THE GRAFTON ELECTRIC COMPANY,**  
54, Grafton Street, Tottenham Court Road, LONDON, W.1.

Telephone: Museum 241.

Telegrams: Grafetric Eusroad London.



# Amateur Wireless and Electrics

No. 29

December 23, 1922

## No Re-radiation this Christmas! Ensure Peace and Goodwill to Your Brother Experimenters

THERE are complaints in all parts of the country just now about the amount of interference caused, particularly on wave-lengths in the neighbourhood of 400 metres, by those who allow their sets to oscillate. One thing is quite certain about wireless enthusiasts, experimenters and broadcast receivers alike, and that is that not one of them wishes to spoil the pleasure of others by interfering with their reception. Where re-radiation occurs it is due usually to carelessness, lack of skill, or insufficient knowledge of the way in which a receiving set works. In some cases it is no doubt attributable to the faulty design of the set itself. If any reader is not satisfied that his set cannot cause interference when it is carefully handled the best way of making sure is to arrange a series of tests with a friend whose aerial is near his own. After comparing watches he arranges to use the set for five minutes at certain hours of the day. The friend should listen-in on the agreed wave-length and be on the look out for the slightest sign of re-radiation.

If it is found to take place during the test periods and not at any other time, then the set is most certainly at fault.

### Official Regulations

The Postmaster-General's regulations now prohibit the use of a reaction coil coupled directly to the primary or aerial inductance. There are still hundreds of sets in use which do not conform to this requirement, and their owners should lose no time in having them altered. It is, as a rule, quite a simple business. If there is no secondary coil the existing primary may be converted into the secondary by making its leads run direct to the grid and the negative terminal of the valve holder; a new primary coil can then be fitted loosely coupled to the secondary. Some sets which have already a trio of coils do

not comply with the regulations, because the primary coil is the middle one of the three and is thus directly coupled to the reaction. In this case the remedy is as simple as it can be, for it is merely a matter of altering the wiring.

But the amateur whose inductances are properly coupled must not be lulled into a false sense of security, for though this arrangement reduces re-radiation to a great extent it does not by any means prevent it entirely from occurring.

### Searching

Interference with telephony takes place



Operating a Four-valve Set.

*With care, a receiver with any number of valves may be operated without causing annoyance to others. That care we enjoin upon all readers, particularly at this season of goodwill.*

most commonly whilst the searching for the desired station is in progress. Both secondary and reaction couplings are altered as the user tries to pick up the first faint sounds, with the result that the set is continually being thrown into oscillation for brief periods. The most sure way of avoiding this is to put the reaction coil out of action, either by short-circuiting it or by moving it to the most loosely-coupled position, until the transmission has been picked up. Tuning should be done with the primary and secondary circuits until the signals are at their maximum strength; then, and not till then, the coupling of the reaction coil should be gradually

tightened, watch being kept for that peculiar tinny sound which betokens that the set is about to oscillate.

Reaction well used is a splendid thing and one of the greatest helps to the reception of distant signals. Badly used it is a curse, not only to the user himself, but to his friends and neighbours. Too often one meets an enthusiast who, with the best intentions in the world, boasts of the wonderful loudness of the signals which his apparatus brings in.

When he demonstrates its powers one discovers that he had made a fetish of strength and pays little or no attention to clearness and lack of distortion. Reaction is pushed to its limits, with the result that words are inaudible, whilst music is full of weird, discordant noises. Your set is not properly tuned unless speech and music are received distinctly and with good tone. Overdone reaction makes the loud speaker perform worse than a badly designed gramophone using worn-out records and a blunt needle; if the amount of reaction is correct, a good set will give nothing but sounds that are absolutely pure.

### Some Advice

Never use too large a reaction coil. This is an

error into which many amateurs fall, imagining that the more the impulses are "gingered up" the stronger will the signals be. You may increase their strength a little, but you will also increase distortion and the possibility of re-radiation. The reaction coil should be the smallest consistent with good results. Use a small variable condenser shunted across it, but keep the capacity as low as possible.

If you start your tuning-in when a concert has been in progress for some minutes, still greater care is called for

*(Continued at bottom of first column on next page)*



# Practical Aerial Hints

Single-wire Aerial and the Down Lead  
 Short Double-wire Aerial Pole and Spreaders  
 Insulators  
 Aerial Wires

THE most common fault of an otherwise well-arranged single-wire aerial is the position of the lead-in from the horizontal part. Some amateurs seem to think that it matters very little where the lead-in wires are attached, and that the middle or the end are the only possible places if good work is to be expected. It is extremely difficult to arrange a lead-in from the electrical middle point of the horizontal wire, for ever so little deviation from the centre point means that the two halves are at variance with one another. Even if it has been measured off carefully to the nearest fraction of an inch, one half, perhaps suspended over the house, has quite different characteristics from the other half, suspended over the garden with 20 ft. or 30 ft. more clear space between it and the nearest level.

It is, of course, not always possible to arrange that the lead-in can come straight from the pole at either end, and if not, some sort of a compromise must be made.

This would be the case in Fig. 1, where the lead-in, to get the best results, would

probably have to come from the top of the pole at A, but if the position of the receiving room was low it would be quite im-

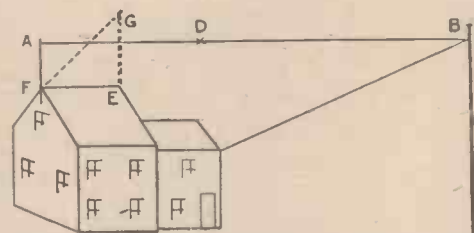

Fig. 1.—Diagram Explanatory of Aerial Erection.

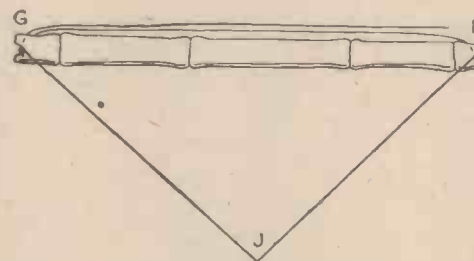

Fig. 2.—Bamboo Spreader.

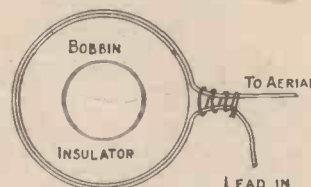

Fig. 4.—Attachment of Insulator.

AVOID RE-RADIATION (continued from the preceding page)

in searching, otherwise you may spoil others' reception of most of one item. It would be a good thing if the Broadcasting Company could arrange to have the customary three minutes' intervals at certain stated times, continuing to send out a wave whilst they lasted. Late-comers could then tune in without fear of causing interruption, and those whose tuning was not perfect for earlier items could make final adjustments.

There is one case in which it is difficult to avoid re-radiation, and that is when strong continuous-wave signals are coming in on almost the same wave-length as a telephony transmission. This is particularly liable to occur in the case of the concerts from Paris and The Hague. The set, though perfectly adjusted to the telephonic transmission, oscillates in response to the C.W. signals. The only thing to do in this case is to short-circuit the reaction coil, sacrificing signal strength in order not to offend. H. R. W.

possible to arrange a good straight lead-in from the point A.

Similarly from the point B, even if the lead-in, together with the aerial, did not exceed 100 ft. in length, the angle at B made between the aerial and the lead-in would reduce the efficiency of reception considerably.

In such a case perhaps a piece of strong, light bronze wire from A to D might be used with a light insulator at D, and the lead-in be dropped from this point. Even if the aerial were shortened by a few feet these few feet might well be sacrificed.

### Restricted Space

But supposing that your garden is a short one, then this construction would not

make the best of the space available. In such a case it would be better to erect the mast on the house at E (Fig. 1) and run a double wire aerial from G to B, with a lead-in from G.

Measure off the wire carefully, and so arrange the spreaders that they can be pulled to the top of the poles without unduly straining them.

The pole at E can probably be stayed by a fine bronze wire at F against the pull of the aerial. If you have light aerial wires you can have light bamboo spreaders, and the "flogging about" in a gale of wind will not be so likely to cause damage.

### Joints

Avoid joints in the aerial if possible, making the aerial all in one piece with the lead-in wire. If you must have joints, see that they are properly soldered and that the jointed-up lengths of wire are all of the same size and material. "Egg" insulators are generally light and look neat when up. "Shell" insulators are also very light and have a greater protective surface.

### Spreaders

Choose a light bamboo stick about 3 ft. long, not less, and not a great deal more than 1 in. thick. See that it has a knot near each end. Then in the open reedy part outside the knots, cut grooves across the bamboo as at G and H (Fig. 2.)

Take three pieces of No. 20 bronze or copper wire, each about 12 ft. long, and fasten them at one end to something solid, such as a screw eye in a door post. Take



Fig. 3.—Photograph showing Wiring of Insulators and Spreader.



the three other ends and stretch the wires out equally tight, fix them to the "chuck" of a carpenter's brace, and, keeping them stretched out tight, twist them up tightly into a stranded cable. Take one end of the cable when completed and place it at C, running the stranded wire along the bamboo into the notch at H, carrying the stranded wire out and back again into the notch at C with the other end at H.

You should now have two strands lying along one side of the spreader, and a loose loop extending outwards from the other side from the notches at G and H. Now take about a yard of No. 20 copper—bronze is rather too brittle for this operation—wind three turns round each end of the spreader so as to bind down the ends of the stranded slings, but leaving the sling on the other side of the spreader, as shown in the photograph (Fig. 3). These slings should not make a much more acute angle, and may be less acute than that of an equilateral triangle—that is, GJ and HJ should not be longer than GH. The ends of the binding wire, after the three turns have been made, should be twisted together and passed through the eye of the bobbin insulator and brought back to G and H, each single wire end being bound round twice again and finished off by twisting together.

The example shown by the photograph has been made with large cotton-covered wire so as to show how the spreader should be wired, and the loose ends sticking up at the right of the print are the free ends of the binding wire after they have been twisted round the sling to prevent it riding out of the notch. Two bobbin insulators are shown making a "shackle," which is quite a good way of making up aerial insulators. A double loop of wire is passed round the grooves of the bobbins and then the bobbins are twisted in opposite directions, so that the double loop is twisted into a strand as shown, while the two free ends are then twisted over on top as shown near the larger of the two bobbins.

**Aerial Wire**

The aerial wire is passed through the eye of the second bobbin and the tail end twisted round the straight run, so that no twist is put into the run of the aerial wire to weaken it. If stranded wire is used for the aerials the wires may be unstranded and then twisted one at a time round the straight run to make off.

The lead-in should be a continuation of the straight run of the aerial. If it is passed round a bobbin insulator and tied up tightly with a piece of string, this will avoid a joint and allow for subsequent alteration in length if found necessary (Fig. 4).

This bobbin necessarily makes the third in the chain, being additional to the two shown in the photograph, and would be better able to take the strain, as the aerial would thus have no sharp edges to bend over as it would if wired to the eye of the bobbin.

GAMMA.

# Another Phone Dodge

LADIES often complain of the phone head-band disarranging their hair. This state of affairs need not exist if the phones are simply disconnected from the head-band and attached to short wooden handles, as shown in the accompanying sketches. A length of good hard dry wood and a few screws and washers are all that is required, the sketches being self-explanatory. Smooth all edges off the wood with glasspaper and give it two or three coats of shellac varnish, or it may be

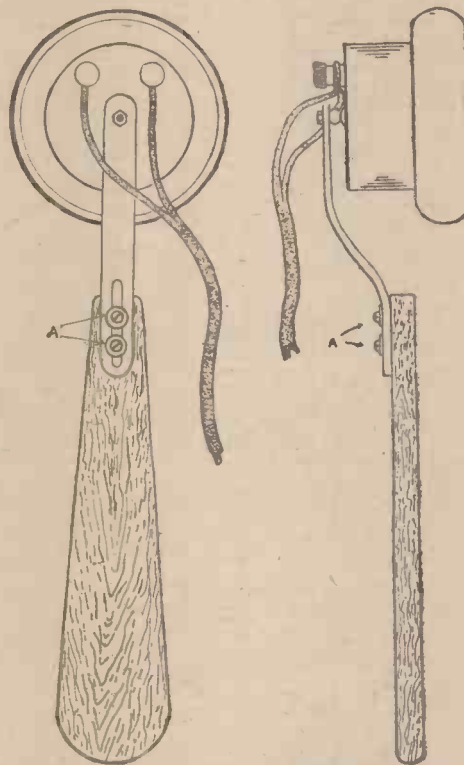

Figs. 1 and 2.—Telephones Fitted with Handles.

finished in black enamel or in any other way desired. Fig. 1 shows a back view of the phone and link connected to the wooden handle by the screws and washers A, and the side view and general arrangement is clearly shown in Fig. 2.

O. J. R.

# High-tension Battery Tips

THE socket connections of the ordinary 36-volt plug-in type of H.T. battery sometimes come adrift from their soldered connections to the cells. As they are embedded in wax they are somewhat difficult

to repair. Soldering is almost an impossibility unless the whole of the wax is removed, but by the following method batteries with loose sockets can easily be repaired and put into a condition in which they will give excellent service with a little care. The cell connection should be first scraped clean of any wax, and then a stiff amalgam of zinc and mercury should be prepared and a little run into the hole. The loose socket should now be put down into the amalgam and held upright whilst a little melted wax is run round it, filling the hole. When the wax is set the socket should be quite firm and making excellent electrical connection with the cell. Unless it is very roughly handled it will stay in position.

When making up batteries with the "flash-lamp" type of battery as units the connections from unit to unit are more easily made with copper foil than with wire. Each unit should be separated from the next by a sheet of waxed blotting paper, and the whole battery should be placed in a box with well-waxed bottom and sides or stood on a sheet of glass.

For "plugging in" with batteries made of flash-lamp units nothing is better than a spring tie-clip soldered to the end of the lead from one of the H.T. terminals of the set.

ERNEST LANGMEAD.

# Winding Inductances

WHEN winding an inductance or other coil some means of supporting the full spool is necessary, and the illustration shows a simple method of effecting this without fixing up a special frame or other spindle arrangement. Procure two hooks of the size and shape shown, and screw hook A in any wooden fixture. Do not screw it right home, but just so that it can be turned either way without undue effort. Hold the spool in position almost touching the vertical portion of hook A. The position of hook B can now be marked on the wooden support, allowing only just

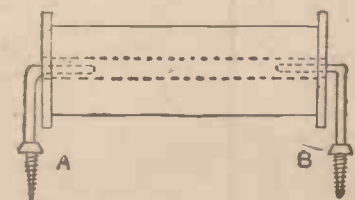

Simple Winding Devices.

enough of the horizontal part to enter the spool and support it, say 3/8 in. Screw in hook B level with A. Now if the two hooks are turned slightly backwards, the spool pushed over A, it will be found quite easy to insert B, as there is sufficient clearance.

MICJAR.

# Rectification by Crystal

The Conclusion of the Article on the Theory of Crystal Rectification

HAVING studied the rectification by a crystal which obeys Ohm's law, we will consider the manner in which rectification is obtained by such a combination as that of the carborundum-steel, which does not obey Ohm's law.

## Carborundum Crystals

Fig. 3 is a characteristic curve of a carborundum crystal. The curve and the

The most common type of potentiometer used for this purpose is shown in Fig. 5, where the terminal D is joined to one side of the crystal combination and terminal F to one terminal of the telephones. The left-hand cell is trying to force current through the part AE of the resistance AB through the outside circuit in the direction of F to D. The right-hand cell is trying to force current through the outside circuit in

half-cycle rising to .3 volts causes a current of 10 plus 52 micro-amps (=62 micro-amps) to flow. The negative half-cycle rising to .3 volts causes a current of 10 minus 2.5 micro-amps (= 7.5 micro-amps) to flow. The next positive alternation, or half-cycle, produces a current of 10 plus 43 micro-amps (= 53 micro-amps), and the next negative alternation one of 10 minus 2 micro-amps, or 8 micro-amps, and so on.

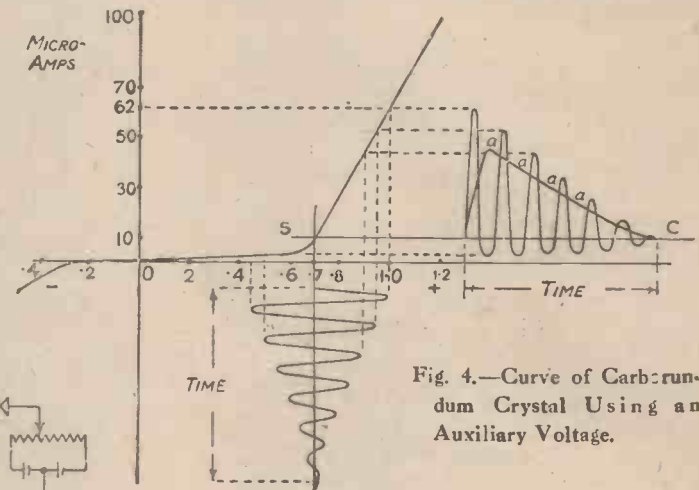
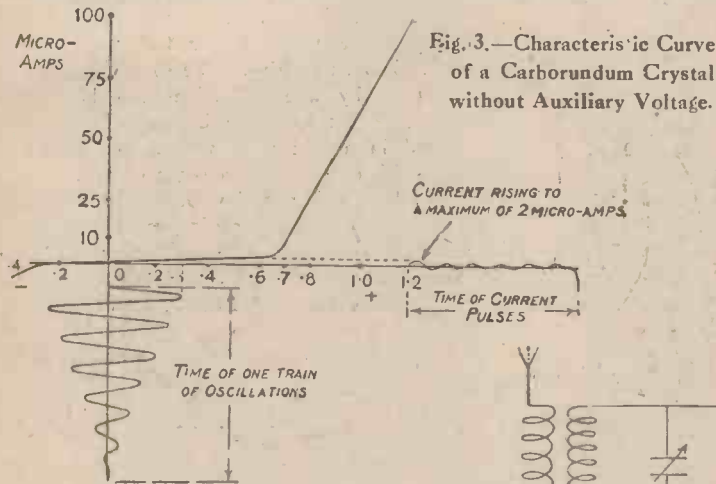

oscillating voltages plotted thereon are drawn in the same way as the characteristic curve of the Ohm's-law crystal, with the oscillatory voltages applied across it. It can be seen that unless the voltage applied is greater than .7 volts only very little current will flow in a positive direction; and unless the voltage applied is less than minus .3 volts in a negative direction practically no current will flow, and even after minus .3 volts only a very little flow.

Now the E.M.F. of the received oscillations will never rise to as much as .7 volts, so unless some extra potential is placed across the crystal, rectification by a carborundum crystal is of no practical use. This fact can be made clear by studying the graph, Fig. 3, of the characteristic curve of a carborundum crystal where there is no extra voltage across the crystal, the received oscillations being therefore plotted on the curve at zero potential, with the result that maximum rise in current—due to the greatest half-cycle of oscillatory voltage rising to .3 volts—is only 2 micro-amps. The extra voltage is applied by means of a potentiometer and battery.

## The Potentiometer

The potentiometer enables one to apply that voltage after which the current suddenly increases out of proportion with the increase of voltage. In the case of the crystal whose characteristic curve is drawn in Fig. 3, this value is .7 volts.

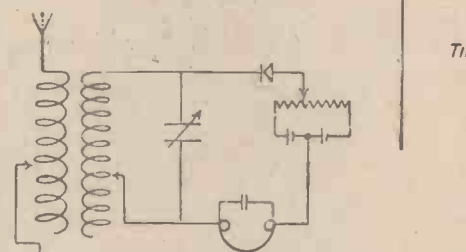

Fig. 6.—Receiver Circuit Using Carborundum Crystal.

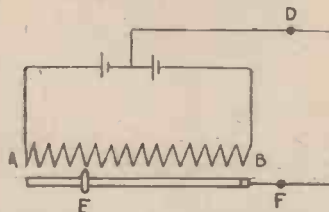

Fig. 7.—Diagram of Potentiometer and Battery.

the direction of D to F and through the part EB of the resistance. The resultant current will be the difference between the two. If, therefore, the slider E is at the centre point of AB no current will flow. If AE is less than EB, F will be positive to D, and if AE is greater than EB, D will be positive to F. A detector circuit employing a potentiometer and battery is shown in Fig. 6.

Supposing, then, we apply across the crystal a steady potential of .7 volts (see Fig. 4), so that each positive half-cycle of an applied oscillatory E.M.F. acts in the same direction as the potentiometer voltage, and each negative half-cycle acts in opposition to it. Now the potentiometer voltage causes a steady flow of current of 10 micro-amps, so that the first positive

The charges put in the telephone condenser will be, as before, the charges put in during the positive half-cycle less those put in during the negative half-cycles.

The steady current of 10 micro-amps always causes a certain pull on the telephone diaphragm. Therefore the diaphragm will be deflected by an amount proportional to the pull caused by that current which is due to the difference between the steady current of 10 micro-amps—as shown by the line SC on the graph, Fig. 4—and the current aaaa, which is due to the combined effects of the potentiometer voltage and that rectified by the crystal.

Thus by means of the potentiometer we have adjusted the crystal to its most sensitive point where the latter suddenly becomes unidirectionally conductive, and have thus been able to rectify the oscillatory potentials, picked up by the receiving aerial and transmitted by a spark transmitter by means of a carborundum crystal.

C. E. N. R.

**Stage Illusions and Entertainments:** This is the title of a new "Work" Handbook of special interest to all amateur entertainers. In the large variety of subjects included are Stage Carpentry; Scene Painting; Stage Effects; Making-up; Black Art; Making a Manikin Theatre; A Marionette Theatre; Making Ventriloquist Dolls; Illusions; Smoke, Rag and Sand Pictures; Paper Manipulation; Making and Working a Punch-and-Judy Show, etc. etc. Price 1s. 6d. from all booksellers, or 1s. 8d., post paid, from Cassell & Co., Ltd., La Belle Sauvage London, E.C.4.



# ORA

## The Valve for perfect reception

Mr. "ORA" wishes his many friends and supporters a Happy Xmas and a very Prosperous New Year. He looks forward to spending many delightful hours in their company during the festive season.

For receiving vocal and instrumental items you must have

### MULLARD "ORA" VALVES

to get the best results.

**O**scillates **R**ectifies **A**mplifies.

Specially recommended where good amplification is required.

The "Ora" Valve requires about 3.8 volts on the filament and 30 volts or over between the anode and filament for efficient results.

**15/-** each

The Mullard "R" Valve is now reduced in price from 22/6 to 17/6.

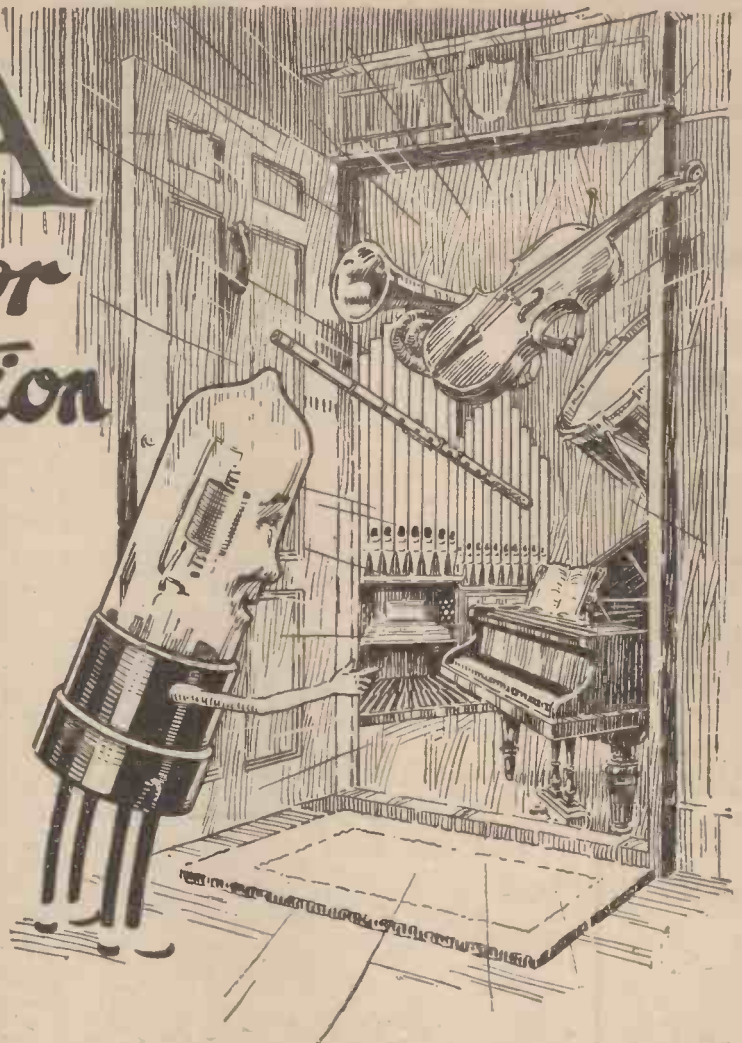

## Mullard Radio Valve Co. Ltd.

45, Nightingale Lane, Balham, S.W.12.

Contractors to H.M. Admiralty,  
War Office, Royal Air Force & Post Office,

Telephone: 1068      Codes: ABC (5 Ed) Bentley's      Telegrams: Radiovalve, Wandscom, London.



Name and Address	Quantity	Description	Price	Total
To the MULLARD RADIO VALVE CO. LTD 45, Nightingale Lane, Balham, S.W.12.		Telephone Head Sets	Type A, 21/- Type B, 25/-	
		"ORA" Valves	15/- each	
		Grid A Resistances	5/- "	
		Anode A or B Resistances	5/- "	
		BA Combined Resistance and	2/6 "	
		Valve Bases with	7/6 "	
		Terminal Clips	5/- "	
		Valve Sockets	1/3 "	
		Terminal Clips	9d. per pair	

Please send me post free

1 enclose (Cheque, Money Order, P.O.) value to cover the cost.

Name of local Wireless Dealer

**SEND THIS TO-DAY**

# IMPORTANT

WE HAVE OPENED VERY COMMODIOUS PREMISES AT  
**54, Gracechurch Street, E.C.3**

for the demonstration and sale of all types of Wireless Receiving Sets and "Claritone" Loud Speakers.

Amateurs and Experimenters will be able to obtain every part required for any type of Set including :

- |  |  |
|--|--|
| Transformers, L.F. and H.F.                                    | Valves, M.O. and Mullards                          |
| Headphones, all types, all resistances                         | Brass W.O. and Telephone type Terminals,           |
| Condensers, variable and fixed, all capacities                 | Nuts, Washers, Contact Studs and all other parts   |
| Vario-Couplers and Variometers                                 | Accumulators                                       |
| Coil-Holders and Coils   | Dry Batteries                                      |
| Anti-capacity Switches, all types                              | Aerial Wire  |
| Rheostats, all types   | Insulators   |
| Radial Switches, 5, 10 and 15 way                              | Hertzite and Galena Crystals                       |
| Ebonite Valve Holders, Dials, Scales, other parts and in sheet | Cotton and other Tubings, all colours<br>Etc. etc. |

PRICE LIST ON APPLICATION

**PETTIGREW & MERRIMAN, Ltd., 122-124, Tooley Street, London, E.C.1**

*Note: 54, Gracechurch Street is a few minutes from Monument, Eastcheap, Bank, Cannon Street & London Bridge*

TELE.: HOP 134



## Congratulations on the Success of the

# MULTI-WAVE AMPLIFIER

(Made throughout by the Peto Scott Co.)

For H.F. amplification above 1,000 metres, you will find the Multi-wave Amplifier absolutely ideal. There is no tuning required: simply plug it into its socket and immediately you will begin to pick up Stations which have previously been out of your reach. Excellent telephony is being transmitted daily from Paris and Berlin and the Multi-wave will enable you to hear them with the greatest ease.

In this letter, Mr. J. K. P. admits that his Multi-wave does not work quite as well on The Hague wavelength as on the others. Every set has peculiarities of its own, and perhaps in this particular case, for 1050 metres (the wavelength used for The Hague) transformer coupling is to be preferred. But for the Paris and Berlin concerts, the Multi-wave stands alone . . . its results are almost unbelievable.

Made in two styles in solid ebonite throughout. No. 1 for use with one H.F. Valve and No. 2 for more than one stage of H.F. amplification (in this case No. 2 is used as coupling between first and second H.F. Valves and No. 1 between second H.F. Valve and Detector).

No 1— for use with one H.F. Valve **8/6** No 2— for more than one stage of H.F. amplification **12/6**

Thinking of building your own Set? Send 6d. for a copy of "RADIO," which gives full descriptions of home-constructed Radio Sets. Fully illustrated and well written. Thirty-two page Catalogue free with Booklet.

**FEATHERSTONE HOUSE, 64, HIGH HOLBORN, W.C.1.**

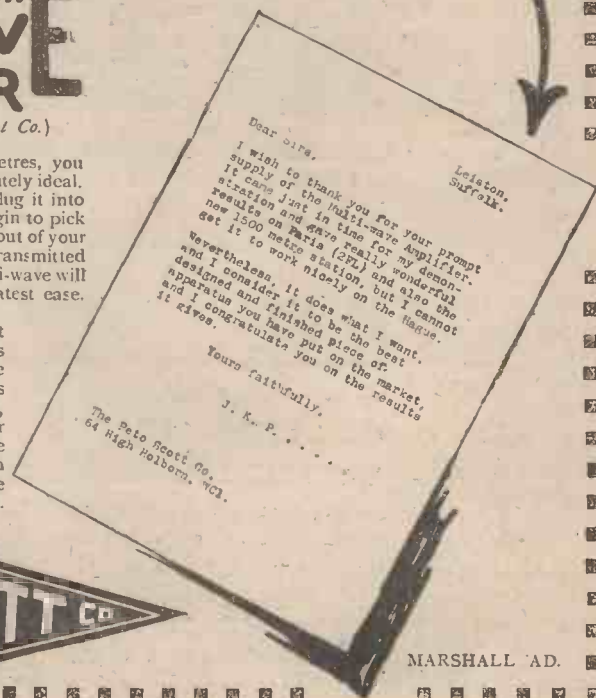

MARSHALL AD.



# T·M·C· Wireless.



## “A Merry Xmas” Say it with wireless

and give a Present, which is new and brings continuous enjoyment. T.M.C. offer you a complete range of wireless receivers from simple crystal receivers to cabinets-de-luxe. The illustration shows a

**T.M.C Crystal Set No. 2** with patent Everset Crystal which needs no adjusting  
**£5:7:6 each** (plus Broadcasting Royalty)

T.M.C. Wireless Receivers give vocal, orchestral and dance music from the British Broadcasting and ensure

### A Merry Xmas.

Call and choose your present to-day. If you cannot call, full particulars will be sent on request.

**The Telephone Manufacturing Co., Ltd.**  
**68, NEWMAN STREET, W.1**

Telephone ————— Museum 5581

We have engineers in every large town who install the wireless to your satisfaction.

LONDON, MANCHESTER & BIRMINGHAM ARE BROADCASTING NOW!

# T·M·C

makes Wireless worth while

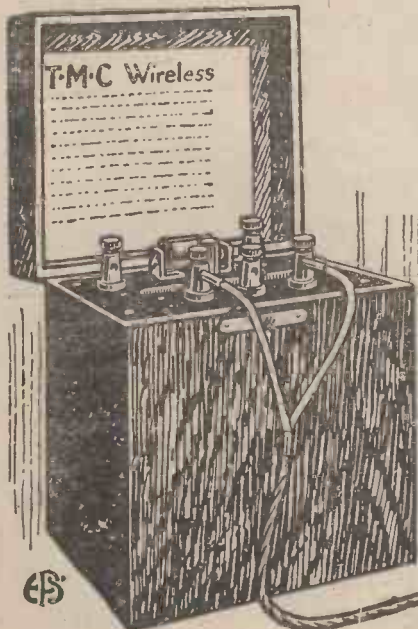

# A Seasonable Gift which will be appreciated

BUILD YOUR OWN SET FROM THE BEST MATERIALS OBTAINABLE

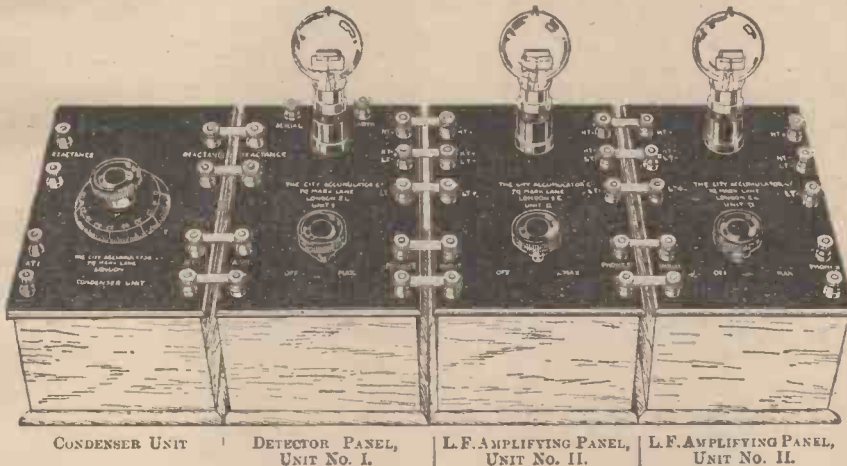

No finer Set could be obtained if 20 times the price were paid.

Illustration shows:—

Three Valve Detector-Amplifying Set, built up on the Unit system.

### Condenser Unit.

Handsome polished mahogany Cabinet. Panel of best quality ebonite, matt finish, bevelled edges. Variable Condenser '0005 mfd. Condenser Scale, with knob, engraved. 8 Terminals. 4 Engraved tablets. Coloured Systoflex, copper wire and BLUE PRINT.

**37/6** each

### Detector Panel, Unit No. I.

Handsome polished mahogany Cabinet. Panel of best quality ebonite, matt finish, bevelled edges. Valve holder. Filament resistance. 2 Mullard Condensers, '0003 and '001 mfd. Mullard's Grid Leak. 11 Terminals. 12 Engraved tablets. Coloured Systoflex, copper wire and BLUE PRINT.

**30/-** each

### L.F. Amplifying Panel, Unit No. II.

Handsome polished mahogany Cabinet. Panel of best quality ebonite, matt finish, bevelled edges. Valve holder. Filament resistance. Intervalve transformer in iron case. Mullard Condenser '001. 10 Terminals. 12 Engraved tablets. Coloured Systoflex, copper wire and BLUE PRINT.

**50/-** each

## READ THIS TESTIMONIAL from WALLSEND-ON-TYNE—271 MILES from LONDON

"With reference to the set of parts I bought from you a short while ago for building A SINGLE VALVE PANEL, allow me to tell you that it has proved a great success. Whilst listening in the other night, I could plainly hear telephony from 2 L O London. Please forward parts for a L.F. Amplifying Panel to add to your Detecting Panel . . ."

SUCH A RESULT CAN ONLY BE MADE POSSIBLE BY USING THE VERY BEST COMPONENTS OF CORRECT VALUES. WE SUPPLY ONE QUALITY ONLY—THE BEST OBTAINABLE: Inferior qualities lead only to disappointment.

## SPECIAL OFFER OF EX-GOVT. SULLIVAN HEADPHONES.

*Absolutely New. Thousands Sold. Cannot be repeated.*

120 Ohms, **12/6.** 120 Ohms (complete with Transformer, value 25/-), **30/-.**  
8,000 Ohms, **36/6.** Best quality Cords, **3/6.** Postage, registered, 1/- extra.

## The City Accumulator Co.

79, MARK LANE, — LONDON, E.C.3

Wholesale and Retail Distributors for Messrs. BURNDEPT, Ltd. Same Trade Discount Allowed as by Manufacturers.

#### AGENTS

London: H. V. ALBROW, 58, George Street, Baker Street, W.1.  
Glos.: BRISTOL WIRELESS Co., 52, Cotham Hill, Bristol.  
Leicester: WALTER ROWE, LTD., 96, Granby Street, Leicester.

Phones: AVENUE 1316, 91, 92, 93 and 9936.  
Telegrams: "TYCHE FEN, LONDON."  
Codes: A.B.C. (5th Edition) and LIEBER'S.

#### AGENTS

S. Wales: SOUTH WALES WIRELESS INSTALLATION Co., LTD., 18, West Bude Street, Cardiff.  
N. Wales, Lancs., Ches. & I.O.M.: THE "ALL-BRITISH" WIRELESS MANUFACTURES Co., LTD., 18, Vauxhall Road, Liverpool.



# Oh Your Wavelength!

**A Wireless Christmas**

**Christmas Programmes**

**Luck!**

**A MERRY CHRISTMAS** to all good and true wireless men. May their signals never grow less!



This is going, when you come to think of it, to be one of the most wonderful Christmases in the history of the world. One can safely say that every available wireless receiving set will be in action, which means that the world over three or four millions of people will be listening in their own homes to greetings and music sent out to them by distant stations. It is safe to prophesy that in the next few days the great army of British wireless enthusiasts will be largely augmented. Every schoolboy home for the holidays will want one Christmas present above all others; and so, amidst feverish excitement, new crystals and valves will be giving their maiden performances in all parts of the country. Paterfamilias will readily fall in with little Tommy's suggestion that a wireless set is the one thing needed to make life worth living, for all of us are wondrous wishing to give a present with which we can play ourselves! You remember the old story of the small boy who saved up to give his sire a clock-work engine in order that he might be allowed to enjoy the performances of his own in peace?

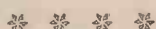

There are rumours that the broadcasting stations are concocting something very special in the way of Christmas programmes. Let us hope that we shall be treated to the playing of those excellent orchestras which we have heard from time to time.

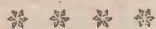

Which instrument do you think comes out best in wireless transmissions? I should plump for them in the following order: 1, clarinet; 2, 'cello; 3, banjo; 4, violin; 5, piano. The difficulty with the piano, one imagines, is that the microphone, wherever it is placed, must always be nearer to some strings than the others. Hence certain parts of the register are unduly emphasised, whilst others are almost swamped.



It is amazing that the microphone and the receiver can deal at all with such complex wave forms as those set up by even a common chord of three notes. When we are describing the way in which the carrier wave is modulated we speak

lightly of a sound wave superimposed upon it. As a matter of fact, the most simple of sound waves is really a very complicated affair, consisting of dozens of ripples of different lengths and amplitudes woven together like threads in a skein. If you have ever seen photographs of waves made by the human voice you will realise what extraordinary compounds of different curves they are. When an orchestra of several performers is playing, the microphone has to respond simultaneously to innumerable impulses of varying strengths, and, of course, the receiver, perhaps hundreds of miles away, must do the same. That the stallo or aluminium disc of a loud speaker can become by turns a violin, a cornet, a human throat, or a whole band of musical instruments is really one of the most perplexing of modern miracles.



Many thanks to 2WD and 2OH for giving me a call. Both transmissions, though on small power, were excellent. Neither, I believe, used more than 5 watts, which shows how much can be done nowadays with a tiny expenditure of power. 2WD's first call was unfortunately interfered with badly by some condenser wangler in the neighbourhood, who produced cat calls in the loud speaker that could be heard in the next room. However, the second attempt was most satisfactory, the after-mentioned disturber of the peace being probably engaged in a Sunday afternoon nap. Few of those who offend realise that they are interfering with others. Most of the elementary books lead beginners to believe that unless the set actually howls no harm can be done; as a matter of fact, many instruments, if they are oscillating at all, send out a heterodyne wave that is audible two or three miles away. The only sure test for oscillation is to touch the aerial terminal with a wet finger. Clicks, taps or pops in the receiver as the finger makes and breaks its contact are a sure proof that your set is causing interference. I make no apology for returning to this old topic for the sake of the new hands who will be operating sets for the first time at Christmas. There are even "hall-marked" sets that will oscillate if badly handled.



Superstitious? No, of course not. Nor am I. Still . . . Anyhow, listen to this. A new set had just been completed, and after a few adjustments was giving wonderful results. "Absolutely perfect," quoth I to the partner of my joys and sorrows; "if you'd paid £100 for it it

couldn't be better." Saying which I touched wood, to wit the painted mantelpiece. Within an hour a short burnt out two expensive valves.

Then something went wrong, and hours of investigation have not yet disclosed what it is. The performances of the set are now far from good, and it has suddenly become possessed of an evil spirit. I have just discovered that that mantelpiece is not wood at all, but marble painted over by some Vandal in bygone days!

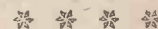

Of course you have noticed how often the receiving set lets you down when you have invited friends to come round and listen to some particularly delectable concert! As a rule it is some silly little thing, such as a loose connection, which defies detection at the time but leaps to the eyes in a moment when it's too late. On such occasions the wise man tests through half an hour before his guests are due to arrive; he sees carefully that all connections are tight, that the lead in is attached and that everything is above suspicion. He searches for and obtains clear, strong signals. He greets his friends with a quiet smile of assurance—and then the accumulator "conks out." At least that's what mine did last night!



What a pity it is that the harmonics of Learfield and Northholt come in so badly in some places on the broadcasting wavelengths. Northholt especially often interferes seriously with 2LO's programme, making it difficult to keep the set from oscillating. The elimination of harmonics will be one of the big wireless problems of the future, for the ether will soon be so full that it will be impossible to allow one station to occupy two wave-lengths at the same time.

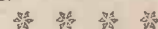

It would be interesting if readers in various parts of the country would report how they receive the broadcasting stations now in operation, for some curious freaks are occurring. The Manchester air station, for example, comes in strongly in Hertfordshire, whilst the broadcasting station is very faint. Birmingham is almost as strong as Marconi House, though three times as far away. On the south coast Manchester is received in several places much better than Birmingham.

THEMION.

**Instrumental Transmissions**

**Harmonics**

**Blind-spots**

# The Wonderful Future of Wireless

Prophecies of Many Applications of Wireless in the Service of Mankind

SOMETHING less than thirty years ago the idea of using ether waves for signalling purposes was a mere possibility slowly taking shape in the minds of one or two leading physicists.

## 1900

In 1900, four years after Marconi's pioneer invention of the extended aerial, wireless telegraphic messages were being sent across one hundred miles of intervening space. Speech had also been successfully transmitted over shorter ranges through the same medium. In short, the new art of wireless communication had been established on a sound practical footing and was preparing to enter into commercial competition with the older wire and cable systems.

## Rapid Expansion

Since then the progressive expansion of wireless has been without parallel in the history of invention. Even at the present day we have merely opened up the fringe of the subject, and the possibilities of further development in the future appear to be inexhaustible.

Quite apart from the enormous growth in popularity that is bound to follow the introduction of broadcasting, the new principles and apparatus utilised and developed by the wireless engineer are continually finding new and wider fields of utility.

It would be impossible within the scope of the present article to deal with these innovations in any great detail, but it is proposed to indicate briefly some of the more important directions in which wireless is rapidly making itself indispensable.

## Applications

In the first place, a broad division may be made into those applications which have a special value, (a) at sea, (b) in the air, and (c) on land. In the second place, it should be borne in mind that to a large extent these special uses have been made possible by the internal development of two main factors: (1) the introduction of the thermionic valve as a supersensitive receiver and as the most convenient and reliable generator of high-frequency oscillations yet discovered, and (2) the progress that is being made towards the ultimate perfection of directional methods of transmission and reception.

## Marine Uses

At sea, quite apart from its value as the only possible means of keeping passengers in constant touch with their business and private affairs *en route*, and in addition to the unique part it has played in saving countless lives through the S.O.S. appeal

in time of peril, wireless gear is gradually displacing the compass, the sextant, and the chronometer, and is substituting for them a new system of navigation.

## Direction Finding

By means of the radiogoniometer, or wireless direction-finder, a ship at sea is able to ascertain its precise location. This may be done on board by analysing the direction of the incoming signals from two or more coast beacon stations in turn, or alternatively, by sending out a call from his own wireless set, the ship's wireless operator can obtain in reply precise details of his bearings as determined by the loop aerials at the shore station.

Such a method is particularly useful in foggy weather where the ordinary difficulties of navigation are enormously increased. A high percentage of sea casualties arise from the prevailing danger of wreck or collision during fog, owing to the difficulty of ascertaining the true position of the ship relatively to a dangerous coast or a neighbouring vessel.

A wireless direction-finding set provides the most reliable means at present known of meeting such a situation with confidence.

In addition it is probable that particularly dangerous coast lines will in future be provided with a chain of automatic wireless "beam" or directional transmitters to supplement the present lighthouses and foghorns which are found in practice to be almost useless, if not actually misleading, in foggy weather. The French Government actually installed a series of "radiophares," as such automatic transmitters are called, around portions of the coast of Brittany just before the outbreak of war.

## Locational Uses

In the case of submarines, the wireless equipment is indispensable and has served many other purposes than the primary one of receiving official instructions from the "proper quarters." For example, one of the secret applications of wireless during the war consisted in the use of what was termed "leader gear," whereby a fairway through a mined area was indicated by laying down along each border of the channel a cable fed by alternating current. The radiations from these marginal cables were picked up by suitable receiving sets on board a submarine or ship and formed a safe guide by means of which such vessels could thread their way through waters that meant sudden death for the crew of an enemy craft. By means of the same device vessels can enter a port with safety in the thickest fog.

The general use of wireless as a means of keeping in touch with land, previously referred to in connection with ships, applies with particular force in the case of aircraft. Once the aviator has taken wing he is in a peculiarly isolated situation without the aid of his wireless set.

In the war, aircraft wireless enabled the flying scout to send down to headquarters a prompt report of his observations. When employed in co-operation with a firing battery, the result of each shot could be recorded from aloft, and the necessary directions transmitted to correct the gunner's aim when necessary.

Again the development of the double-loop direction finder enabled a pilot to navigate his machine by taking readings from a ground beacon station, and so facilitated long-distance flying at night. The armistice came at a time when a flight to Berlin and back had just been rendered feasible by the aid of wireless as an auxiliary means of aerial navigation.

## In Aviation

In civil aviation, where the safety of the machine and its freight, both passengers and cargo, is of primary importance, the provision of wireless equipment has now been rendered compulsory by legislation. As previously stated, it affords the only reliable means of keeping the pilot in touch with his base for receiving essential instructions either as to the route to be taken or as to the weather conditions that he may expect to meet ahead.

## Distant Control

The application of wireless methods to the automatic control or steering both of aircraft and of ships or submarines is already well known. Many alternative systems have been suggested. According to one method the steering gear is controlled by means of relays actuated by tuned circuits energised through wavelengths of a particular frequency. In another a two-anode valve is employed, and the electron current is automatically diverted to one or other of two separate control circuits, according as a compass needle deviates to one side or the other.

## Divining

Turning to new developments of general application on land, we find wireless being used as a method of prospecting or discovering mineral deposits. In this connection it may be mentioned that in a recent test of the directional properties of a particular aerial, it was discovered that a peculiar asymmetry in its radiation curve was caused by the presence of a metal drainage pipe buried in an adjacent field.

(Continued on page 680)



# Charging Accumulators from Alternating-current Mains

ONE of the many troubles of the amateur is getting his accumulators charged satisfactorily. For those who have direct-current electric-light mains the matter is fairly simple. It is only necessary to connect the cells up with a variable resistance and ammeter and leave

(3) the rotary converter; (4) an alternating-current motor driving a D.C. generator.

### The Electrolytic Rectifier

This has two outstanding advantages where a small current only is needed. It is easy and cheap to make and can be left on for any length of time; it makes no noise and requires no attention while in use. If 200-volt mains are available a transformer or choking coil should be obtained to reduce the voltage to a reasonable amount, say 25. Most electrolytic rectifiers will not work on high voltages, but they are always satisfactory for any voltage below 40. If a transformer is not available a choke coil may be used, but it is not nearly so satisfactory, and suitable transformers are fairly cheap to buy now. For charging accumulators up to 12 volts the secondary winding of the transformer should give 25, as there is a certain amount of resistance loss in the rectifier itself. The type of rectifier described in the following notes has been used for a considerable time by the writer with satisfactory results for charging a 12-volt 20-amp. hour accumulator battery.

The container is a 2-lb. glass jam jar 6 in. high (see Fig. 1), and is filled within an inch of the top with a nearly saturated solution of ammonium phosphate. The pure salt, and not the commercial, should be used, as it lasts very much longer and justifies the extra cost. The writer has experimented with sodium bicarbonate, sodium phosphate, and borax (sodium baborate), but the ammonium phosphate has been found to give better results than any of these.

Two plates, one of lead and the other aluminium, each  $5\frac{1}{2}$  in. by  $1\frac{1}{2}$  in. and about  $\frac{1}{8}$  in. thick, are required, and these



Glass-cell 2-volt Accumulator (E. G. Lind & Co.)

are screwed to a hard-wood block, as shown in Fig. 2. The wood must be soaked in paraffin wax or painted with brunswick black or shellac varnish, and two terminals screwed in and connected to the plates. This will complete the rectifier, and when placed in series with a low-voltage source of alternating current it will only allow the current to flow in one direction.

If the voltage used is above 30 it may be necessary to treat the aluminium plate before it will function properly. To do this it may be immersed for a few moments in a strong and boiling solution of washing soda. This will render the surface matt. For lower voltages, however, the rectifier will always work as soon as it is put into the circuit. To preserve the life of the plates they should always be taken out of the solution when not in use, and if necessary scrubbed after each charge.

The size of rectifier described above will pass half an ampere without heating too much. It should not be overloaded, or the solution will get too hot and eat away the plate. Of course, with a charging current of only this amount it takes three days continuous running to charge a 40 ampere-hour battery, but this is not usually a dis-

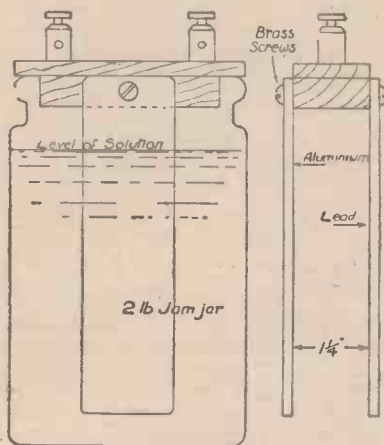

Fig. 1.—Electrolytic Rectifier. Fig. 2.—Method of Mounting Plates.

them until they are charged. This, of course, is very wasteful if there is only a 4-volt cell to charge, as the remaining voltage is lost in the resistance. Low-voltage cells can be connected in series with the lights of the house without making very much difference to the intensity of the latter, and provided the lights pass enough current there is no trouble.

To charge accumulators from alternating current mains is quite a different matter, however. There are four methods which are suitable for the amateur to use, and these are by means of: (1) The electrolytic rectifier; (2) the mechanical rectifier;



R.A.F. WIRELESS OFFICERS' REUNION DINNER.

Amongst the readers of "Amateur Wireless" there are certainly many thousands who during the war served in the Royal Air Force. How many of these, we wonder, recognise any of the former officers shown in the photograph above?

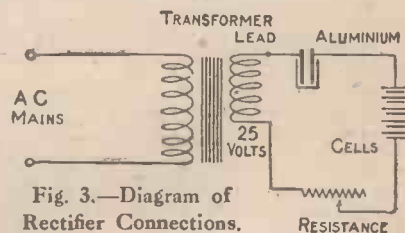

Fig. 3.—Diagram of Rectifier Connections.

advantage and will certainly not do the cells any harm. Two or more rectifiers might be connected in parallel if desired, but it is doubtful whether this would be better than using one of the other methods of charging available.

A diagram of connections for charging accumulators from mains through a transformer is shown in Fig. 3. J. F. S.

EVERYONE knows the familiar words "Hullo, hullo, hullo, 2LO, the London Broadcasting Station calling," and most of us have tried at one time or another to imagine what sort of a place a big transmitting station must be. You can believe, therefore, how delighted I was when, the other day, the telephone brought an invitation to spend an evening at Marconi House with Mr. A. R. Burrows, the announcer, who up till then had been "a voice but nothing more."

**The Broadcasting Room**

The broadcasting room is on the seventh floor, but fortunately there is a lift. Imagine a mixture of a large drawing-room, an office and a tent, and you have some idea of what 2LO looks like. The furniture consists of a grand piano, a number of comfortable chairs for the artistes who are awaiting their turns, music stands, a filing cabinet and a large desk. The floor is covered with a thick, sound-deadening carpet, whilst walls and ceiling are draped with hangings in order to do away with the curious resonant sound that accompanies transmissions from a room whose sides and top are bare.

Near the piano are the famous chimes, clearly seen in the photograph. They are operated by Mr. L. Stanton Jefferies, the accompanist, who puts real soul into the work! In the middle of the room is a pedestal supporting the microphone which is used by the announcer as well as by singers. A second microphone hangs from

**"A.W's" Special Representative Visits 2LO**

the open top of the piano, and others are at hand, adjustable to various heights.

**The Change-over Switch**

The change-over switch seen on the pedestal actuates a remote control in the instrument room which throws into action the whole of the transmitting gear. At one side of the concert room is a bracket which contains a tell-tale lamp, whose steady glow shows the announcer that the transmitter is working. This bracket also supports a pair of head phones connected to a receiving set working on a small frame aerial in a distant part of the building. He is thus able to listen-in and can signal to a singer to come nearer to the microphone or to move farther away from it.



SENATORE GUGLIELMO MARCONI, G.C.V.O., LL.D., etc., of world renown, who made wireless broadcasting possible.

**The Chimes**

As the clock nears the hour Mr. Jefferies takes up his position at the chimes, whilst Mr. Burrows stands at the central microphone. "Quiet, please," says the announcer—a necessary warning, since others in the room often do not realise that anything that they say may be heard even in Shetland! The long hand touches the hour; over goes the switch and the chimes ring out. Mr. Burrows gives the general call and announces the first item. Then the switch is opened again whilst the first performer is getting into position. "Ready?" Singer and pianist nod; the



Mr. L. Stanton Jefferies, A.R.C.M. Mr. John Llanthigou, baritone. Miss Olive Sturges, contralto.

**Transmission:** Photographed in the Broadcasting Room at 2LO.

**Hullo C Q, "Amateur A Happy Christmas"**

little light on the wall bracket flashes on, and in a moment the first song is on its way to listeners in all parts of the country.

**The Apparatus**

So much for the concert room; and now for the apparatus. This is housed in a room some distance away and does the actual work of transmitting. Large notices outside the door give all and sundry warning that the place is dangerous. When you realise that the secondary winding of the main transformer gives a working potential of 22,500 volts you will see that such a warning is not out of place.

The transmitter (a photograph of this is





MR. ARTHUR R. BURROWS,  
2 L O'S ANNOUNCER,

to so many thousands just "a voice"—and a clear voice, too.

## A Broadcasting Station at Christmas

duce between them a direct current with a "ripple" of 600 per second. This is smoothed out by a double filtering system which actually makes the current more even than that supplied by a direct-current generator. One can understand now why 2 L O's transmission are so completely free from humming.

The filaments of the valves of the three remaining panels are lit by a 40-volt 330-ampere-hour accumulator. The drive oscillator receives its anode potential from the rectifier, its grid being connected to earth, which at 2 L O means the lead roof and the steel framework of the building. The valve of the next panel is a transmitter, whose grid potential is controlled, by means of reaction coils, by both the drive and the amplifier. In the positive

high-tension lead is a "speech-choke" connected to a large inductance which varies the potential on the anode of the oscillator valve. Each variation is carried to the aerial and so helps to produce the complex ripple which, superimposed on the carrier wave, conveys every modulation of speech or music.

### The Modulator Panel

The modulator panel has two valves, a control and a sub-control. The plate of the first is connected through a high resistance to the speech-choke, which is also connected to the positive high-tension lead. Its grid is joined through a condenser to the anode of the second valve. When the microphone is spoken into, the varying resistance produced by the vibration of its diaphragm causes a variation to take place in the current flowing through the speech transformer. This produces changes in the potential on the grid of the sub-control valve, which then causes still larger variations on the grid of the main-control valve. This in turn varies the anode potential of the amplifier, and so the speech ripple is suitably built up.

My thanks are due to Mr. Burrows, who was kindness itself; and to Mr. R. H. White, M.I.E.E., M.I.R.E., whose explanations of the complex mechanism of the transmitting set made everything clear even to one who has had little practical experience of the transmitting and broadcasting side as distinct from the receiving side of wireless.

LAMBDA.

shown on the cover) consists of four panels. That on the left is the rectifier, next come the drive oscillator and the amplifier; on the extreme right is the modulator.

Power comes from the ordinary supply mains, but a special arrangement is provided so that either of two entirely different sets of mains can be utilised. It is delivered in the basement of the building to a 10-h.p. motor coupled direct to a 6-kw. alternator which supplies current at 500 volts. From the alternator a cable runs to the transmitting room at the top of the building, where it is connected to the primary of a 6-kw. transformer, whose

## "Wireless" speaking: Christmas to You!

secondary winding gives out the terrific voltage already mentioned.

### The Rectifying Panel

The function of the rectifying panel is to convert alternating current to direct at a pressure of 10,000 volts. The filaments of its valves are lighted from a transformer whose primary is connected to the main 500-volt alternating supply. Thus the filaments of these huge valves—they are as big as Rugby footballs—become the positive high-tension pole of the wireless circuit. Each valve deals with 300 alternations a second, and as they are so arranged that each of them deals with one side of the alternating waves, they pro-



Reception: A Typical Drawing-room Scene this Christmas.

"THE WONDERFUL FUTURE OF WIRELESS"  
(continued from page 676).

Similarly, in another set of experiments, a rubbish heap containing a number of empty tin cans and biscuit cases made its presence felt in quite a decisive fashion.

#### Subterranean Uses

The application of wireless signalling to mines has shown that subterranean communication is perfectly feasible. Here again the new science will show its value as a saver of human life in time of accident or emergency.

#### Television

The transmission of pictures over telegraph wires is a problem that has long exercised the minds of inventors. Recent inventions go to show that a solution of the problem may be found by means of wireless methods. The prospect of seeing the latest cinema films broadcasted is certainly attractive and will form a welcome addition to the present fare of song and music.

#### Wired Wireless

Wired wireless, as applied to existing telephone lines, will enable more than a dozen independent conversations to take place over a single pair of wires without the slightest interference or confusion. This will result in greatly reducing the cost of the existing telephone service, more particularly in the case of long-distance work, where the expense of laying down and maintaining the trunk lines is at present enormous.

#### Valve Development

The development of the thermionic valve has resulted in a great extension of its original purpose. The valve is now employed in practice for rectifying high-power alternating current, as an automatic controller for dynamos and motors, and as a regulator in electric power supply and distribution circuits generally. It threatens, in fact, to replace the dynamo itself. A thermionic tube capable of developing 200 kw. is already in use, and the manufacture of a 1,000-kw. tube has been reported from America.

#### Power Supply

Finally it is possible that we may yet collect our electric power supply through an aerial system erected upon the domestic roof. The problem of distributing power by radiation through the ether appears at first sight to be impracticable on account of the waste involved, but the further perfection of a strictly directional system of transmission may quite conceivably result in bringing this scheme within the limits of practical application. D. A.

**Notes on Oxy-acetylene Welding** is an important feature in the current issue of "Work" (3d.). Other articles include: "Improving a Spring Letter-balance," "A Handy Pair of Steps," "Silver Work for Amateurs," "Making Toys from Waste Tins."

# RADIOGRAMS

It is stated that the Bar and Formby Lightships are to be placed in wireless-telephone communication with the Liverpool Dock Offices.

America is to have a national radio week.

It is stated that the Cardiff broadcasting station will be completed by Christmas.

Another amateur, Mr. J. Jardine, reports on hearing WJD, United States, early in the morning of Dec. 2.

The Attorney-General of New York State has declared that marriages by wireless are illegal.

The Japanese Government has decided to assist in the proposed formation of a Japanese-American Radio Corporation.

A song in Esperanto, sung by Miss Gladys Cosmetto, was broadcast from 2 L O on Dec. 8.

Barnes District Council has refused permission to allow householders to fix aerials to street trees.

Schools for training the voices of singers for broadcasting were declared necessary by Professor Fleming at a demonstration at Trafford Park on Dec. 16.

The new P.M.G. is opening up negotiations with the Marconi Co. with a view to settling its long-standing claims with the Government.

The news that music broadcast from Newark, U.S.A., has been heard in England occasions no surprise in the States. It is understood that all the items mentioned have been verified except one.

The claims under Wireless Inventions were found to have been adjourned generally when the second report of the Royal Commission on awards to inventors was issued on Dec. 15.

Work on the South African Wireless station is to be started at once, as the agreement with the Marconi Company has been ratified by Parliament. This station will be the biggest in the world, giving direct service practically to every country.

The premises of the Co-operative Wholesale Society in Blandford Street have been selected for the Newcastle broadcasting station. The aerial is to be attached to the boiler-house chimney, 150 ft. high.

Further investigations of fading are being carried out by the Glasgow and District Radio Club. Members situated in different parts of this locality are making tests with the broadcasting stations whereby a certain station is selected for a particular night, and each member listens in to the entire programme. Detailed reports as to reception are prepared, and these are called at the subsequent meeting of the club. It is hoped to secure valuable data in this way.

Valves do not have to be approved by the Postmaster-General for use under a broadcast receiver licence; they must bear the stamp of the British Broadcasting Company. In this connection it may be stated that Mullard valves (used by the winner of the first Transatlantic test) are stamped with the B.B.C. mark and can be used freely for broadcast reception.

Don't expect a special Christmas concert from Radiola, the French broadcasting station. Like the Scots, the French reserve their celebrations for New Year's Eve, the Reveillon festivities being amongst the gladdest of the year. Therefore, though no announcement has been made yet, we may look for something even better than usual if we tune to 1,550 metres on the evening of Dec. 31.

Directional wireless experiment tests on less than 10 metres (!) will probably take place between London and Birmingham at Christmas time. It is stated that the signals cannot be picked up by stations lying more than half a mile or so off the direct line. It is not an easy business to receive them in any case; still, it can be done by cunning work with a separate oscillator circuit tuned to provide the necessary heterodyne.

Wireless Catalogues are often mines of information, and in this respect we particularly direct our readers' attention to a catalogue just issued by the Economic Electric, Limited, of 10, Fitzroy Square, London, W.1. It is primarily intended for the experimenter, to whom it makes a special appeal, for every requirement is catered for, from odds and ends of material to complete apparatus.



# OUR INFORMATION BUREAU

Expert Replies to Readers' Questions. Hundreds of Replies are sent by Post.

TO ENSURE A PROMPT REPLY PLEASE OBSERVE THE FOLLOWING RULES

Write distinctly, give all necessary details and keep to the point. Ask one Question at a time—never more than two. Send a Stamped and Addressed Envelope. Send the Coupon cut from page 682.

## Units of Capacity

**Q.** Can you tell me of a unit of capacity for calculation purposes in receiving sets which eliminates the use of so many decimal figures. Decimal figures are often regarded as very small quantities and neglected.—F. C. (Windsor) 5998

**A.** A unit of capacity which is invariably used for tuning receiving circuits by calculation is the jar. One jar equals  $\frac{1}{100}$  part of a microfarad and the formula for calculating the wavelength in metres is:  $62.8\sqrt{LC}$ , when L equals the inductance in micro-henries and C, the capacity in jars.—L. C.

## Imported Wireless Parts

**L**AST week, in the House of Commons, Major McKenzie Wood asked the Postmaster-General what arrangements, if any, had been made with the Broadcasting Company or the British Radio Apparatus Manufacturers' Association for notifying the electrical trades as to the admissibility of imported parts in wireless apparatus approved for Post Office licence; whether he was aware that leading British import houses who had hitherto sold parts to wireless manufacturers were finding the greatest difficulty in securing the information necessary to guide them in considering forward contracts; and whether he would consider the issue of a detailed statement on the subject?

Mr. N. Chamberlain, in reply, said that the receiving apparatus which might be used under broadcast receiving licences would be limited to types submitted for the approval of the Post Office by members of the Broadcasting Company and found to conform with certain technical standards. It would be a condition during a period of two years that such apparatus must be made in this country, with the exception of certain parts which for the present were confined to batteries, accumulators and outside aerial equipment. These conditions had been announced by his predecessor, but he would endeavour to secure publicity for them in the technical press.

"The Modern Boy's Library" is the title of a new series announced for publication this season by the House of Cassell. The aim of the books, which are well and fully illustrated, is to meet the needs of the many boys who are keen to obtain knowledge of "useful" things. The first volumes, published at 5s. net each, are "Something to Make," "The Outdoor Boy," "Hobbies," and "The Boy's Workshop," and these will be followed by others.

## CORRESPONDENCE

### Fading

**SIR**,—Attention was drawn in a recent number of your paper to the excellent results obtained by amateurs in the North of Scotland who, using comparatively few stages of amplification, received clear telephony from London and even Paris. This seems to suggest that wireless impulses tend to travel along the meridian rather than across the lines of the terrestrial magnetic force. It would be interesting to know if any of your other readers can throw any further light on this subject.—H. A. B. (London, W.).

### Insulated Aerials

**SIR**,—Some correspondence took place a few weeks ago in the pages of your journal on the subject of insulated aerials, and the following experience may be of interest to your readers. At a demonstration given by the Radio Society of Highgate on Saturday, Nov. 25, an indoor aerial was used, consisting of a single length of rubber-covered cable such as is used for house-lighting installations. The aerial was 40 ft. long and ran parallel to and 3 ft. away from the wall and 2 ft. below the steel girders supporting the roof. The earth connection was made to a rusty gas bracket. It is evident from this that the conditions were not favourable for the reception of signals, but amateur telephony and other stations came in well on a single valve, and three valves worked a loud speaker sufficiently well to enable a hundred people to dance to the orchestral music from Marconi House.—J. F. S. (London).

### Reception in Cheshire

**SIR**,—In reading your issue of Nov. 25 I notice that Thermion asks for the experiences of those living in Cheshire as regards reception. My station is situated at Hewall-on-Dee in the Wirral Peninsula; it is badly screened on the N.E. and W., but not on the S.E. or S.W. The aerial lies north and south. As to reception, I fail to get Marconi House (2 L O) during the day, using five valves (two H.F. reactance coupling and two L.F.) and he is very weak during the evening. A friend living about two and a half miles away at West Kirby gets him very loud, using reactance and two L.F. valves, his aerial being screened on the south. Some

amateurs report that they cannot get 2 M T in parts of Cheshire, but I have no difficulty at all, using one rectifying and two L.F. valves. I may say that Paris and P C G G are excellent on five valves, so there is nothing wrong with the set. Another of my friends, about three miles away (Hoylake), reports that he cannot get P C G G at all, but Paris is louder with him than with me. It seems strange that these stations should be so weak at these certain spots; I also fail to get Königswusterhausen, yet in Liverpool he is quite clear on one H.F., one rectifying, and one L.F. valves.—I. A. (Wellington).

## CLUB DOINGS

**Stoke-on-Trent Wireless and Experimental Society.**  
*Hon. Sec.*—F. T. JONES, 360, Cobridge Road, Hanley. The secretary will be pleased to forward particulars to intending members.

**Hackney and District Radio Society.**  
*Hon. Sec.*—E. R. WALKER, 48, Dagmar Road, E.8. ON Dec. 7 a lecture on "Insulators and Insulating Materials" was given by Mr. Sandford. In the course of the lecture Mr. Sandford demonstrated the insulating qualities of various materials.

**Burnham, Highbridge and District Wireless Society.**  
*Hon. Sec.*—L. LOTT, 52, High Street, Burnham-on-Sea. The secretary will be pleased to forward particulars of the above society to persons interested.

**Fulham and Putney Radio Society.**  
*Hon. Sec.*—J. WRIGHT DEWHURST, 52, North End Road, West Kensington, W.14. ON Dec. 8 Mr. Calver brought to the club-room a very compact portable three-valve set fitted with special low-frequency transformers, and the members present had a very pleasant evening "listening in." The speech and music were very loud and clear and free from the usual disturbances, this being due to the design of the transformers and type of circuit used.

**Chorleywood and District Wireless Society.**  
*Hon. Sec.*—A. G. S. RICHARDS, Hillbrow, Haddon Road, Chorleywood. This society meets every Monday evening, and all interested are invited to communicate with the secretary.

**Coventry and District Wireless Association.**  
*Hon. Sec.*—H. H. THOMPSON, 44, Northumberland Road, Coventry. PARTICULARS of the above society may be obtained on application being made to the secretary.

**Stratford-on-Avon and District Radio Society.**  
*Hon. Sec.*—E. W. KNIGHT, 17, Park Road, Stratford-on-Avon. THE secretary invites application for membership of the above society.

**Manchester Wireless Society.**  
*Hon. Sec.*—Y. W. P. EVANS, 2, Parkside Road, Princess Road, Manchester. Nov. 26.—After having dismantled the transmitting set used the previous week for the Transatlantic test, and substituted A.C. for D.C. supply, the work of installing the transformers and rectifying valves was commenced on Saturday afternoon at 2 p.m., and the first tests were made at 11.50 p.m., everything working well. At 1 a.m., the circuit was still being adjusted and tuned, but insufficient radiation as reached to justify a call to I A W and 2 F B,



# SALE!

## Great Clearance Xmas Sale of Wireless Instruments and Accessories

— AT —

# HALL'S

A perusal of a few of the items below will show that unapproachable value and prices are listed. Purchasers are advised to secure while stocks exist, as a rush will undoubtedly be experienced, and replacements at the figures shown will not be possible. Another opportunity like this will never again be presented.

**BRITISH HEADPHONES**  
4,000 ohms. Very Light. Beautifully Finished. Stalloy Diaphragms. Complete with Cords. Adjustable Earpieces.

(Sold elsewhere almost exclusively at 35/-)

**19/6** Postage 9d.  
Only 530 left.

Every type of instrument and accessory from Mercury Condensers to Double Slider Tuners at ridiculously low prices can be seen at our showroom. Space naturally precludes complete list.

**VARIABLE CONDENSERS:**

Capacity.	Parts Complete	Assembled for Panel Mounting.
.001	6/9	11/9
.0075	5/-	11/-
.005	4/9	9/9
.003	3/3	7/-
.002	2/3	5/9
.001	2/-	4/-
Top and Bottom Circular Drilled Ebonite Plate, 1/3 extra. Vernier, 3/-		
Interval Transformers, Ratio 5 to 1, finest manufacture		
Crystal Sets	from 15/-	to £3
"Royal Phone" Loud Speakers, 4,000 ohms resistance, ebonite horn giving clarity of tone and freedom from distortion. Stock of 72 only		
Aluminium Condenser Vanes, fixed and moving, 22/24 gauge		1/6
Spacers, true to .001. Small, doz. 1 1/2d.; large, doz.		2d.
Ebonite Knobs, tapped 2 B.A., with brass nut—1st quality, 4d.; 2nd quality		2d.
Aerial Wire, 7/32 hard drawn copper, in 100 ft. lengths		2/6
Valve Legs, with nuts and washers, 1d. each; doz.		9d.
Two Coil Holders, solid ebonite mounted on mahogany		4/6
Three Coil Holders, solid ebonite, with long arms to avoid capacity effects		8/9
Crystal Detectors, adjustable in every way, turned brass on ebonite		2/6
Slider Rods, 12-in. or 13-in. 1/2-in. square brass, drilled both ends		4d.
Engraved Ivory Scales, 0-180°, round or square ends		3 1/2d.
Filament Resistances, extraordinary value, velvet action		2/6
Switch Arms, complete with knob, collar, washers, bush nuts, etc. 1st quality, 1/3; 2nd quality		9d.
Valve Holders, turned ebonite, complete with nuts, 1/-; 2nd quality		8d.
Crystal Cups. Plain 1d.; one, two, or three screw		2d.
Large Terminals, complete with nut and washer		1d.
Contact Studs, 1/2 in. by 1/2 in., or 1/4 in. by 1/2 in. complete with nut and washer		4d.
Insulators, 2-in. reels—1d. each; white egg, 3d.; green egg, 4d.; green shell		3d.
Brass Nuts, 2, 3, 4, 5, 6 B.A., 2 1/2d. doz. Washers, doz.		1 1/2d.
Ebonite Sheets, 1, 1 1/2, 1 1/4		3/3
Fixed Condensers, any capacity		1/3
Grid Leak and Condensers combined		2/9
Slider Plunger complete		4d.
Hertzite, 1/6. Boronite, Carborundum, Galena, etc.		4d.
Screwed Brass Lengths, 12-in. 2 or 4 B.A. each		3d.
Inductances, wound 22/24 enamelled wire, each		3/-

Orders under 30/- kindly remit ample postage. Balance refunded if excess sent. SEND FOR FREE CATALOGUE

TRADE SUPPLIED **HALL'S** DISPATCH BY RETURN

PHONE: REGENT 1282  
71, Beak Street, Regent Street, London, W.1

Between Piccadilly Circus and Oxford Circus  
Buses 8, 6, 12, 13, 15, 32, 51, 53, 59 and 88 pass

the two American stations with whom the society were working. At 2 a.m. a maximum radiation of about 9 amperes was registered, and a fifteen minutes' call was given, and repeated at 3 a.m. Several American amateur stations were heard working, and a few references were made to our transmissions, which started the idea that we had been heard. A special survey was undertaken with the idea of getting the utmost output at the 4 a.m. transmissions, and a few preliminary trials showed a little improvement and the call was commenced, but at two minutes past the hour the fuses were blown, and after examination it was found that the transformer supplying one of the rectifying valves was shorting across the primary winding. No spares being at hand, we made a desperate effort to overcome the difficulty by putting 5,000 volts A.C. direct on to the plates of the power valves. This method only gave a radiation of about 3 amps., but a call was made and a list of stations received repeated. After listening in for another hour it was decided to abandon the tests until the following week.

Dec. 3.—The temporary arrangement of the circuit, as used at the Transatlantic transmitting station for the tests on Sunday, Nov. 23, was replaced on the 2nd inst. for a more efficient one by mounting the valves, switches, meters, etc. on a specially prepared panel about 8 ft. by 6 ft. erected on insulators. Owing to a slight error in the transformer adjustment of the power valve filaments one valve was burnt out. Two members, however, went to a dealer and obtained a spare, arriving back at 2.30 a.m. Meantime a test had been carried out on the one valve, resulting in excellent radiation, and this, coupled with the second, gave a fairly good output, which, by means of a few extra adjustments, was increased considerably, and finally, at 5, 6 and 7 a.m., the set was worked at its maximum efficiency with the material in hand. The reception was very poor indeed owing to local conditions, with the result that only about three American amateur stations were heard. SAQO (N.Y. district) was heard calling Manchester 5 MS.

**East London Radio Society.**

Hon. Sec.—L. E. LUBBOCK, Lecture Hall, Woodstock Road, Poplar, E.14.  
The secretary will be very glad to hear from intending members.

**Radio Society of Tavistock.**

Hon. Sec.—A. E. GRAVES, 2, Parkwood Road, Tavistock.  
The above society is in process of formation. Will any gentlemen who are interested in the science kindly communicate with the secretary?

**Wolverhampton and District Wireless Society.**

Hon. Sec.—J. A. H. DEVEY, 232, Great Brickkiln Street, Wolverhampton.  
ON Nov. 28 the above society held several experiments with regard to the reception of broadcast music. The experiments were made on crystal and valve sets, including an Armstrong super-regenerative set, telephony and music being distinctly heard with the use of a frame aerial and a loud speaker.

Dec. 6.—A short paper was given by Mr. G. W. Jones explaining the usefulness of various home-made contrivances for the testing of sets and the obtaining of good results.

**Mount Pleasant Radio Society.**

Hon. Sec.—W. R. FLEMING, 156, Upton Park Road, Forest Gate, E.7.  
At a meeting on Nov. 17 Mr. W. E. F. Corsham, president, gave his experiences in communicating with American amateur stations. He stated that he found that the best signals were received during storms over the Atlantic. American stations, he said, could be received on two valves. Mr. W. D. Keiller lectured on simple receiving sets. On Nov. 24 Mr. W. A. J. Smith gave a demonstration with a Mark III tuner lent by the vice-president, Mr. W. Beaton.

**Leeds and District Amateur Wireless Society.**

Hon. Sec.—D. E. PETTIGREW, 37, Mexborough Avenue, Chapeltown Road, Leeds.  
At a general meeting on Nov. 24 Mr. F. C. F. Phillips gave a lecture and demonstration relating to "Burndept" apparatus. He explained how efficient reception of the shorter waves, as used for broadcasting and amateur experimental transmissions, may be obtained by using certain tuning arrangements and certain modes of intervalve coupling. As regards tuning, the use of loosely-coupled circuits with variometer tuning was advocated. For intervalve coupling of H.F. valves, the "reactance-capacity" coupling has been proved as the best for short wave work. Musical selections and speeches by the hon. treasurer and hon. secretary were transmitted with a "Burndept" transmitter, using one watt of power and a frame aerial erected in another building.

**Proposed Feltham, Ashford and District Radio Club.**

Will all persons in these districts who are interested in wireless please communicate either with Mr. Nettleton, "St. Albans," Feltham, Middlesex, or with Mr. H. G. Moss, 48, High St., Feltham, with a view to forming the above club?

**Hornsey and District Wireless Society.**

Hon. Sec.—H. DAVY, 134, Indezwick Road, Hornsey.  
INTENDING members should send stamped envelopes for particulars of membership to the secretary.

**Wireless Society of Hull and District.**

Hon. Sec.—H. NIGHTSCALES, 79, Balfour Road, Holderness Road, Hull.  
At a meeting of the above society on Dec. 11 Mr. J. Nicholson gave a lecture on "The Construction of Inductance Coils." The lecturer gave much valuable information and many useful hints to amateurs intent on making their own coils.

**BROADCAST TELEPHONY**

Some of these transmissions are commercial or official. Wave-lengths and times are liable to alteration without notice.

- London B.B.C. Station (2L O), 369 metres. Daily, usually 7 p.m. to 10 p.m.
- Manchester B.B.C. Station (2Z Y), 385 metres. Daily, usually 6 p.m. to 10 p.m.
- Birmingham B.B.C. Station (2W P), 425 metres. Daily, usually 6 p.m. to 10 p.m.
- Croydon (G E D), 900 metres. Daily.
- Writtle (2M T), 400 metres. Tuesdays, 8 p.m.
- Eiffel Tower (F L), 2,600 metres. Daily, 5.20 p.m. to 7 p.m.
- The Hague (P C G G), 1,085 metres. Sundays, 3 p.m. to 5 p.m.
- Rome (I C D), 3,200 metres. Daily, 10 a.m.
- Königswusterhausen (L P), 2,800 metres. Daily, 4 p.m. to 5.30 p.m.
- Amsterdam (P C A), 1,800 metres. Daily, 1.10 p.m.
- Haren (O P V H), 900 metres. Daily, every hour from 11.20 a.m. to 4.20 p.m.

Radio Components Ltd. are issuing their catalogue on the loose leaf principle, and we have received copies of the sheets already issued. These include rheostats, duo-lateral inductance coils, triplug tuners, micro-tuners, intervalve transformers, accumulators, condenser and other component parts for wireless apparatus.

**ANNOUNCEMENTS**

"Amateur Wireless and Electric." Edited by Bernard E. Jones. Price Threepence. Published on Thursdays and bearing the date of Saturday immediately following. It will be sent post free to any part of the world—3 months, 4s. 6d.; 6 months, 8s. 6d.; 12 months, 17s. 6d. Postal Orders, Post Office Orders, or Cheques should be made payable to the Proprietors, Cassell & Co. Ltd.

General Correspondence is to be brief and written on one side of the paper only. All sketches and drawings to be on separate sheets.

Contributions are always welcome, will be promptly considered, and if used will be paid for.

Communications should be addressed, according to their nature, to The Editor, The Advertisement Manager or The Publisher, "Amateur Wireless," La Belle Sauvage, London, E.C.4.



Querist's Coupon Available until Saturday, Dec. 30, 1922

"All About the Valve" and "The 'A. W.' Ideal Unit Receiving Set"—Owing to the special demands upon our space it has been necessary to hold over the instalments of these two articles this week.



# BUY YOUR XMAS GIFTS NOW!

## FURTHER GREAT REDUCTIONS IN PRICES

ALL GOODS SENT POST FREE

### Headphones



**21/-**

4000 ohms total Resistance.  
Double Headband.

Guaranteed highly efficient. Complete with Cords. Ball and socket joints; highly polished nickel cases; best Tungsten steel magnets.

### BEAVER Complete Set of CONDENSER PARTS

contains:

- Ebonite Top and Bottom Plates, Machined
- Aluminium Moving Plates
- Aluminium Fixed Plates
- 1 Square Centre Spindle
- 3 Stay Rods, screwed both ends
- Large Spacing Collars
- Small Spacing Collars
- Bronze Coil Spring
- Ebonite Knob, drilled and screwfitted
- Brass Nuts for Centre Spindle
- Small Nuts

·0005 MF. ... ..	8/6
·00075 MF. ... ..	9/6
·001 MF. ... ..	11/6
·0015 MF. ... ..	13/-

### Splendid Crystal Detector

Mounted on Ebonite.

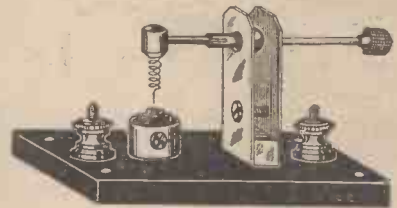

POST FREE **2/9**

- High-class Filament Resistances 4/-
- 100 ft. Aerial Wire 7/22 Stranded
- H.D. Copper—the best ... 3/10
- Best Quality Switcharms ... 1/6

#### Valve Holders

- Best Quality Ebonite ... .. 1/6
- Best Insulating Composition ... 10d.
- Condensers ·0002 ... .. 1/6
- " " ·003 ... .. 2/9
- Chemically engraved Scales 0-180°, 3½d.

## BEAVER COMPLETE CRYSTAL SETS

### Beaver "MIDGET" Crystal Set

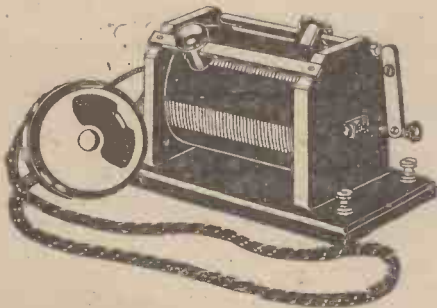

The Ideal Xmas Present. Length 6½ in. × 4 in. Absolutely guaranteed. 15/-; complete with 4000 ohm ear-piece, 30/-.

No. 1 unassembled 15/- No. 2 unassembled 20/-

No. 3 assembled 24/- ready for use  
Complete with Splendid Tested and Guaranteed 4000 ohm Phones, 45/-

No. 4 unassembled 30/-  
Complete with Splendid Tested and Guaranteed 4000 ohm Phones, 50/-

### No. 5 De Luxe Set

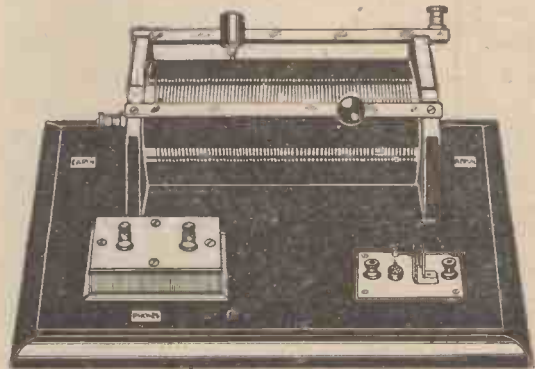

Comprises Inductance Coil 9" × 3½", with waxed interior to prevent sweating, wound 24-Standard Wire Gauge, Bronzed Wire, heavily shellaced and varnished. Beaver de Luxe Crystal Detector with Crystal, Highly efficient Blocking Condenser, 2 Brass Rods, Special pattern Slider and Plunger, concealed Insulated Wiring, all necessary Terminals and Tabs, the whole mounted on polished Mahogany base, with fluted edges. A Highly Efficient and Guaranteed Set.

Assembled 50/- ready for use

Complete with Splendid Tested Guaranteed 4000 Phones, 70/-  
(Passed by Postmaster-General, G.P.O. Regd. No. 198)



## BEAVER ELECTRICAL SUPPLY CO.

Telephone: GERRARD 1900. 109, REGENT STREET, LONDON, W.1.  
Special Terms to Trade. All Cheques and Postal Orders to be crossed London Joint City and Midland Bank.



# Wireless Receivers

**BRITISH  
MADE  
HEAD-  
PHONES**

Leather  
Covered—  
of the Highest  
Efficiency.

4,000 ohm pair,  
only

**25/6**

Postage 9d.

Approved by P.M.G.  
and bearing B.B.C.  
stamp.

Also single 4,000 ohm Phones, with flex  
and handle holder ... .. **12/6**  
each—postage extra

DEPT. A.W. 2.

**THE CITY WIRELESS & ELECTRICAL DEPOT,**  
17, HATTON GARDEN, E.C.1.



**Standing alone**

## “ WIRELESS VALVES SIMPLY EXPLAINED ”

By JOHN SCOTT-TAGGART, F.Inst.P.

Whether you buy a complete receiving  
set or design it yourself, this book at 2/6  
will save you *time, trouble and money.*

**GET IT TO-NIGHT AS YOU GO HOME**

Obtainable from all newsagents and bookstalls,  
or send us P.O. for 2/8 and your copy will  
reach you in two days.

**Radio Press, Ltd.,** { Devereux Buildings,  
Strand,  
London, W.C.2.

## A. MUNDAY, LTD.,

59, WATLING ST., E.C.4 :: 45, EASTCHEAP, E.C.3  
(One door Queen Victoria Street. :: TELEPHONE: CITY 2972)

CONTACT STUDS ... ..	per doz.	5d
AERIAL WIRE, 7/22 Stranded Copper, 100 ft.		2/9
CRYSTAL DETECTORS ... ..	each	2/5
FILAMENT RESISTANCE ... ..	each	2/6
SWITCH ARMS ... ..	10d and 1/-	
BROWN'S 4,000 OHM PHONES ...		30/-
BEST FRENCH 4,000 OHM PHONES		20/-
” ” 8,000 ” ”		22/6
LOW FREQUENCY TRANSFORMERS		12/6

Wireless is attracting all men. The Amateur is entering  
the field in great numbers, and he wants to know all  
about it. He will require Materials, Parts, Tools. He  
will also want to sell surplus material.

## “ AMATEUR WIRELESS ”

is out to cater for this class of reader, who will be eager  
for knowledge and bargains. To meet him, use the Sale  
and Exchange columns, which he is sure to search. Rate  
3d. per word, 3s. minimum, prepaid. Latest date  
Friday mornings.

Address: The Advertisement Manager,  
“Amateur Wireless,”  
La Belle Sauvage,  
Ludgate Hill, London, E.C.4.

## WILTON

### Wireless Outfits and Parts

All Sets Approved by P.M.G.  
Members of the British Broadcasting Co., Ltd.

**WILTON No. 1 OUTFIT—**  
Cabinet Crystal Receiver,  
Hertzite Detector. 4000 ohm  
Phones, Aerial Wire, Insulators,  
etc. £3 2 6  
Plus B.B.C. royalties 7 6  
**£3 10 0**

**WILTON No. 2 OUTFIT—**  
Cabinet Valve Receiver, tapped  
Inductance, 4000 ohm Phones,  
Valve, H.T. Battery, Accumu-  
lator, Aerial Fittings, Instruc-  
tions. Designed by experts for  
Telephony Price £6 17 6  
Plus B.B.C. and Marconi  
royalties 1 12 6  
**£8 10 0**

L.F. Intervalve Trans-  
formers ... .. 15 0  
H.F. Broadcast Trans-  
formers ... .. 3 6  
Set of 7 Basket Coils ... 4 6  
Grid Leak and Condenser 2 6  
Fixed Condensers .001, .002 2 6  
Loud Speakers, 2000 ohms 45 0

Skeleton Variable Condensers  
'0003 '0005 '001  
8/- 10/- 16/6  
Switch Arms laminated ... 2 0  
Velvet Filament Rheostats 3 0  
3 Coil Holders ... .. 10 6  
Honeycomb Coils 1/3, 1/9 2 6  
Tapped Inductance Coils,  
300-900 metres, 9 tap-  
pings ... .. 7 6  
Ivory Scales ... .. 0 8  
Engraved Dial and Knob 2 6  
Enclosed Detectors, Ball  
Action, Hertzite Cryst-  
tals ... .. 4 9

Note Magnifier—Set of Parts  
to make yourself, designed on  
the “Radiocamo” principle,  
loud signals when attached to  
any make of receiver. Exceed-  
ingly easy to make. Complete  
with Cabinet and Instructions.  
**£1 17 6**  
Making a 3-guinea Instrument.

Get our 14-page List. Trade Supplied.

**WILTON WIRELESS CO., LTD.,**  
120—124, HIGH ST., TOOTING, S.W.17.  
Phone—STREATHAM 533.



# A BALD STATEMENT

## The NEW "POLAR"

Earth-Screened

### VARIABLE CONDENSER

Range from '0001 to '001 mfd.

Costs only **14/9** Post Free.

Measures 3 in. x 3½ in. x 1 in. only.

Is Now Available from Stock.

Is made and guaranteed for 12 months by

### THE RADIO COMMUNICATION CO., LTD.

Direct from 34, NORFOLK STREET, LONDON, W.C.2.

Or at **NEWCASTLE:** 17, Sandhill. **LIVERPOOL:** 67, Dale St. **CARDIFF:** Atlas Chambers, James St.  
**Branches:** **SOUTHAMPTON:** 19, Queen's Terrace. **GLASGOW:** 10, Blythswood Square.

# THAT MAKES YOU THINK

E.P.S. 18

## RADIO FOR 45/-

CONSTRUCT IT YOURSELF  
COMPLETE SET FOR WIRELESS MUSIC  
NO COIL WINDING TO DO

Polished Cabinet, Drilled Ebonite Top, Double Phones,  
4,000w. Detector and Terminals, Hertzite Crystal,  
Aerial and Insulators, with Best Quality Phones **50/-**

**ELEC. SERVICE. 12., KIRKDALE, S.E.26**  
Cheques and P.O.'s crossed BARCLAYS BANK

## POPULAR 2 VALVE RECEIVER

P.O. Regd. No. 2011



This is sure to please you.

Price excluding value **£9**

So simple that a child can operate it.

Full station price **£14 : 10 : 0**

Send for our full list

**T. H. ISTD, RADIO WORKS, TERLING, ESSEX.**

## BUTLER'S BRITISH BROADCASTING CRYSTAL RECEIVERS FOR WIRELESS TELEPHONY, ETC.

Dimensions : 6½ x 6½ x 5½

Approximate Weight 3 lb.

Approved by Postmaster-General.

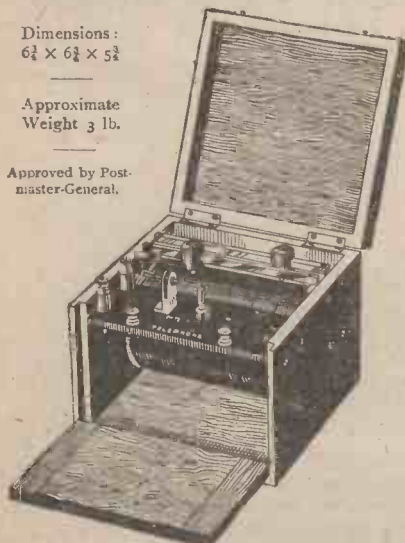

A RELIABLE INSTRUMENT AT A LOW FIGURE

Double Slide Tuning Coil, Spring Contact Crystal Detector, Engraved Ebonite Panel, Lacquered Terminals, the whole fitted into solid, well seasoned, polished mahogany Cabinet.

AS ILLUSTRATION  
Approximate range 3,000 metres  
**£2 - 7 - 6** POST FREE

IF FITTED WITH VARIABLE CONDENSER  
Approximate range 3,000 metres  
**£2 - 15 - 0** POST FREE  
Overseas Postage Extra.

All that is necessary with these sets is to connect up the aerial and earth and telephones and with small adjustment signals should be received.

EXTRAS.—Double Telephone Head Gear, Insulators, Aerial and Earth Wire.

ILLUSTRATED LIST POST FREE 4d.

**H. D. BUTLER & COMPANY, LIMITED,**  
Office: BANK BUILDINGS, 222, GT. DOVER ST., S.E.1. Works: CANONBURY, LONDON, N.1.  
(Opposite Boro Tube Station) 'Phone: Hop 3020. Teleg.: "Duzemulky," Phone London.



L.F. Transformer  
Price 22/6 each

## GENTS' MAKE FITMENTS

Send for our sundries pamphlet, make use of our stocks, ask us to quote for your wholesale requirements :: ::

**GENT & CO., LTD.,**  
Radio Dept., Faraday Works, LEICESTER

London 25, Victoria St., S.W.1.  
Newcastle-on-Tyne: "Tangent House," Blackett St.



This is to announce that on  
**JAN. 15th**

RADIO PRESS LTD., the well-known publishers of authoritative wireless books, will publish a new monthly wireless Magazine entitled:



**MODERN WIRELESS**

**1/- NETT**

Every reader of "Amateur Wireless" should obtain the brilliant first number. The Magazine is edited by John Scott-Taggart, F.Inst.P., assisted by E. Redpath, Author of Cassell's "Work" Handbook "Wireless Telegraphy and Telephony," and by Paul D. Tyers, Author of "Construction of Wireless Receiving Apparatus," both well-known contributors to the pages of "Amateur Wireless."

Order your copy from your newsagent, bookseller, from a railway bookstall, or direct (1/3 post free) from

**Radio Press Ltd., DEVEREUX BUILDINGS, STRAND, LONDON, W.C.2.**



**FILAMENT RESISTANCES**  
for Panel Mounting, 3/6



**Top and Bottom CONDENSER BUSHES**  
9d. per doz.



**SLIDER KNOBS**  
6d. each



**TERMINALS**  
No. 1  
1/9 Per doz.



**VALVE LEG**  
at 1/3 per doz.

**SEND FOR OUR SPECIAL WIRELESS LIST POST FREE**



**SPACERS**  
guaranteed within limits of .001  
LARGE 3/- per gross  
SMALL 2/- per gross

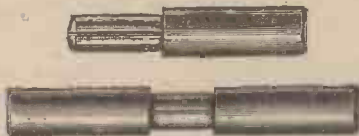

**COIL PLUGS AND SOCKETS**  
1/9 per doz. pairs



**SWITCH ARMS**  
1/6 each

**ORMOND ENGINEERING CO., 199, Pentonville Rd., N.1**

Telegrams: "ORMONDENGI, KINCROSS."

Telephone: HOLBORN 1812.



# It Speaks for itself

and in no uncertain voice

## THE WORLD'S STANDARD LOUD SPEAKER

# AMPLION

WIRELESS  
LOUD  
SOUNDING  
RECEIVERS  
are supplied in  
a series of

### Ten Models

Suitable for  
every service:

**The Home,  
Laboratory  
and the  
Concert Hall**



At Prices  
ranging from  
**£2 : 10 : 0**  
to  
**£15 : 15 : 0**

**DAILY  
DEMONSTRATIONS**  
at the  
**GRAHAM  
SHOWROOMS**  
The ALGRAPHONE  
SALON  
25-26, Savile Row,  
Regent Street, W.1  
Phone: Regent 1075

### "MUSIC MASTER" HORN

Type AR 13, 120 ohms ... £6 : 0 : 0  
Type AR 15, 2,000 ohms ... £6 : 2 : 6

"Graham" Wireless Productions include "High Efficiency" Telephone Headsets of improved design and construction. The "Graham" is the best Head Gear money can buy.

Full particulars forwarded upon request. Ask for Folder A.W.

Patentees and Manufacturers :

## ALFRED GRAHAM AND COMPANY

St. Andrew's Works, Crofton Park  
**LONDON - - - S.E.4**

Phone: Sydenham 952. Grams: Navalhada, Brock, London

SCOTLAND :

Mr. F. M. Milligan,  
25, Renfrew Street,  
GLASGOW.

IRELAND :

Mr. Alex. R. Munday,  
41, Chichester St.,  
BELFAST.

# HULLO EVERYBODY!

## Do YOU Know US? If not, why not?

We do not offer you "something for nothing," nor is this advertisement a catchpenny one. Goods supplied are value for money, both as to quality and price. We leave our customers to be the best judges. 'Nuff said!

## Complete Sets of PARTS for Making Variable Condensers

REVISED PRICES, without Ebonite

Approx. Capacity in Microfarads	No. of Plates	Price
•0015 ...	85 ...	9/-
•001 ...	57 ...	6/6
•00075 ...	43 ...	5/6
•0005 ...	29 ...	4/6
•0003 ...	19 ...	3/-
•0002 ...	13 ...	2/3
•0001 ...	7 ...	2/-
Vernier ...	3 ...	1/9

EVERYTHING READY TO ASSEMBLE and CONSISTS of the FOLLOWING:

Accurate Aluminium Fixed and Moving Vanes, Large and Small Spacer Washers, Centre Square Spindle (Screwed Ends, 2 B.A.), 3 Side Rods, 12 Nuts and 12 Brass Washers (2 B.A.), Pointer—scale 0-180, Terminals, 3 Bushes, Spring Coil Washers, Best Quality Knob with 2 B.A. Nut in Centre. **ALL HIGHEST QUALITY GOODS.**

PLEASE NOTE

**DRILLED EBONITE ENDS - 1/- per pair extra**

Postage and Packing, 1/- per set extra. Two Sets, 1/3. Three Sets, 1/6. Owing to the extraordinary value given in above Condenser Sets, we are compelled to make these charges for packing, postage, etc.

## ALL the following GOODS POST FREE at the SPECIAL PRICES attached for POST ORDERS

*If you are not satisfied with value, return goods and we will refund all charges*

Filament Resistances. Most wonderful value in the wireless trade. Each 2/6 and 3/6. By Post, 3/- and 4/-.  
 Switch Arms, with polished knob, bushed 2 BA nut, laminated blade, spring coil washer, nuts and bush, 1/-, 1/6, 2/- each. By post, 1/3, 1/9, 2/-.  
 Crystal Detectors on Ebonite. Simply marvellous value. Each 2/6. By post, 3/-. Also 3/3; by post, 3/9.  
 Fixed Condensers, with terminals on ebonite, .0003, .0005, .001, .002, .003, 1/6; by post, 1/9; .004, 1/9; by post, 2s.  
 Oojah Basket Coils, 7 in set, 5/- set. By post, 5/6.  
 Lead-in Tubes, ebonite, brass ends, 9 in., 1/2. By post 1/6. 12 in., 1/4. By post, 1/8.  
 Good Condenser Knobs, tapped 2 B.A., at 2/- doz. By post, 2/6.  
 Knobs, with brass nut (2 B.A.) in centre, high-class quality, 4½d. each. By post, 7d. 6 for 2/- . By post, 2/6.  
 Crystal Detector, cup enclosed with glass cover, dust proof, 4/6. By post, 5/3.

Aerial Wire, 7/22 bare copper, stranded, first class quality, not a substitute. Price per 100 ft., 2/10. By post, 3/10.  
 Reel Insulators, 1d. each. Cannot be sent by post.  
 1½ mm. Insulating Sleeving, 6 yds. for 2/2. By post, 2/6. 12 yds. for 4/-. By post, 4/6.  
 Slider and Plunger, 8d. By post, 7d.  
 Slider Knob, plunger and 13 in. rod. The lot, 8d. Cannot be sent by post.  
 Aluminium Vanes, 2 doz. 1/- . By post, 1/6. 5/- gross; by post, 6/- .  
 War Office Pattern Terminals, complete with nut and washer, 1/8 doz. By post, 2/2 doz.  
 Splendid Line in 5-piece Terminals, complete with nut and washer, good size, 1/- doz. By post, 1/6.  
 Large Spacer Washers, 3 doz. 9d. By post, 1/- .  
 Small Spacer Washers, 6 doz. 1/- . By post, 1/4.  
 Terminals (very large), magnificent quality, aerial and earth, complete with 2 nuts and 2 washers (2 B.A. stems), 2 for 8d. By post, 1/- .

Interval Transformers (low frequency), high class, tested, and guaranteed 5-1, 14/- each. By post, 15/- . Smaller size, 10/6; by post, 11/6.  
 Hertzite Crystal, per piece, according to size, 1/3 and 1/6. Cannot send by post.  
 Ebonite Dials, with engraved scale 0-180, 1/- each. By post, 1/6.  
 Egg Insulators, 4 for 9d.; 2/- per doz. Not sent by post.  
 Grid Leak and Condenser, .0003, very high quality and appearance, 3/9. By post, 4/3.  
 Inductance Coils Wound Enamel Wire, 12 by 4, 3/-. Not sent by post.  
 Filament Resistance, "Thor" pattern, suitable for one, two or three valve sets, 4/- . By post, 4/6.  
 Terminals, telephone, highly finished, with nut and washer, 2/- doz. . By post, 2/6.  
 War Office Pattern Terminals, extra special quality, with nut and washer, 2/- doz. By post, 2/6.

WE BEAT CREATION ON PRICES AND QUALITY.

## HEADPHONES. We don't sell cheap and nasty telephones.

Genuine "Brunet" French Telephones, most sensitive obtainable, 6 Tungsten poles in each earpiece. 4,000 ohms with cords (Double Receivers) ... .. 25/- post free  
 French Receivers, 8,000 ohms, double receivers with cords ... .. 25/- post free

Single Receivers (French) with cord, 2,000 ohms ... .. 9/- (post 1/- extra)  
 High Class British Receivers, double, complete with cords and headband ... .. 21/- to 25/- (post 1/- extra)

## To Callers: We Sell All Component Parts CHEAP!

Brass Rods, Nuts, Washers, Screws, Valve Sockets, Valve Pins, Stop Pins at wholesale prices.

NOTE! My terms are strictly cash with order. All orders by post are dispatched at the earliest possible moment, as we have great pressure just now on the postal department.

IMPORTANT! The postal department will be closed December 25, 26 & 27th.

**M. RAYMOND, 27, LISLE STREET, W.C.2.**

RIGHT OPPOSITE DALY'S GALLERY DOOR.

Phone: Gerrard 4637

To avoid mistakes, this address is close to Charing X Road and Leicester Square Tube.



THE  
**MECCANO**  
RADIO  
Receiving Set



for Broadcasting and Morse Reception

THE Meccano Crystal Receiving Set has been thoroughly tested and has received with great clearness, broadcast music and speech up to 30 miles of London, Birmingham and Manchester.

**EACH SET IS TESTED AND GUARANTEED  
EFFICIENT ON A P.M.G. AERIAL**

An ideal present for Christmas. Give one to your boy and make him happy. It is low in cost and complete in itself, ready to be connected to any aerial.

**Send for this Book**

Our new booklet, *The Meccano Crystal Receiving Set*, explains Radio so that everyone is able to understand how simple is the reception of broadcasting, telephony and Morse messages. This booklet will be mailed free on request.



Start Radio  
Now in an Efficient  
and Inexpensive Way

**PRICES**

Meccano Crystal Receiving Set, complete, price 55/-  
" Aerial Set (including antenna, lead-in and aerial wires and insulators) " 12/6

**MECCANO Ltd Binns Road LIVERPOOL**

**BROADCASTING RECEPTION SETS**

One-Valve Set Complete for Working, £7 10s.

Passed for  
Broadcasting  
Licence G.P.O.  
No. 1038.

SEND FOR  
CATALOGUE

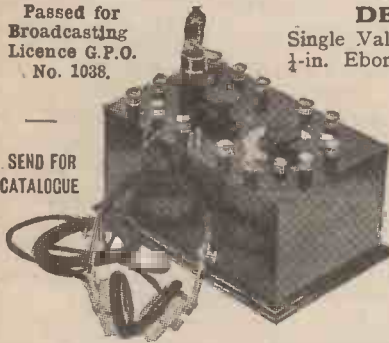

**DESCRIPTION :**

Single Valve, mounted on polished 1/2-in. Ebonite Panel with Variable Condenser, smooth acting resistance, grid leak and Condenser and all terminals clearly engraved in white, in a Mahogany Polished Cabinet 9 in. by 5 in. by 5 in. **£3 15 0**

A TAPPED COIL for wave-lengths up to 900 metres with 2 terminals for coils for any higher wave-lengths.

The coil is enclosed and the tappings are brought out to an 8-way switch mounted in the front of the cabinet.

**ACCESSORIES INCLUDED :**

Siemens' 54-volt high-tension Battery with plugs for altering the voltage	15 0
4-volt 50-amp.-hour low-tension Accumulator in case with carrying strap	1 4 0
One pair of Sensitive Head Phones of 4,000 ohms resistance	1 1 0
One Detecting Valve	15 0
<b>Total</b>	<b>£7 10 0</b>

Satisfaction Guaranteed or Money Refunded.

**WIRELESS INSTALLATIONS Ltd.**  
15, Aldersgate St., London, E.C.

AGENTS WANTED.

**BROWN'S**  
*"Featherweight"*  
**HEADPHONES**

**BRITISH  
AND BEST  
THE FINEST  
HEADPHONES  
PROCURABLE for**

**30/-**

This price is for one pair of either 120 or 4000 ohm phones, including cords — of good quality. —

Catalogue, post free, gives you details of our Wireless Headphones, Loud Speakers, and Amplifiers



Type F "Featherweight." Actual weight, including cords, is 6 oz. only.

Obtainable from all Wireless Dealers

**S. G. BROWN, LTD.**

London Showrooms :

19, MORTIMER STREET, LONDON, W.1

Head Office and Works: Victoria Road, North Acton, W.3

**'SHUN !**

MARK TIME before you spend your money on expensive wireless sets. Look at these prices and see what you save.

		Average range in miles for telephony.	
Crystal Sets	... 12/6, 30/- and 50/-.		
Single Valve Sets	... ..	50	£6 10 0
Two Valve Sets	... 1 detector, 1 L.F.	50	£8 0 0
Two Valve Sets	... 1 H.F., 1 detector	150	£9 10 0
Three Valve Sets	... 1 detector, 2 L.F.	50	£11 5 0
Three Valve Sets	... 1 H.F., 1 detector, 1 L.F.	150	£12 15 0
Three Valve Sets	... 2 H.F., 1 detector	450	£14 5 0
Four Valve Sets	... 1 detector, 3 L.F.	50	£14 10 0
Four Valve Sets	... 2 H.F., 1 detector, 2 L.F.	150	£16 0 0
Four Valve Sets	... 2 H.F., 1 detector, 1 L.F.	450	£17 10 0
Four Valve Sets	... 3 H.F., 1 detector	1350	£19 0 0
Five Valve Sets	... 1 detector, 4 L.F.	50	£18 10 0
Five Valve Sets	... 1 H.F., 1 detector, 3 L.F.	150	£20 0 0
Five Valve Sets	... 2 H.F., 1 detector, 2 L.F.	450	£21 10 0
Five Valve Sets	... 3 H.F., 1 detector, 1 L.F.	1350	£23 0 0
Five Valve Sets	... 4 H.F., 1 detector	4050	£24 10 0

The above sets are complete with valves, phones, accumulator, H.T. battery, aerial and insulators. They are built with sloping panel and have a finish as good as sets costing three times as much. Every set is guaranteed and sent on approval for four days against cash.

We have a practical wireless experience of fifteen years at your service. Write for our list, 2d., it will save you pounds.

**SPECIAL TERMS TO THE TRADE**

**SIMPOLIA WIRELESS COY.**

(Dept. A), 170, West Green Road, Tottenham, N.15



The **Universal Electric Supply Co. Ltd.**  
 4 BROWN STREET  
 ONE DOOR FROM MARKET ST  
**MANCHESTER**  
 Telephone: 3409 CITY  
 Established 1892  
 G.P.O. Box No. 519.

Our Large Illustrated Catalogue gives a wide range of Radio Requisites, and complete Crystal and Valve Receiving Sets for Broadcast Reception. Post free 6d.

**SINGLE VALVE RECEIVING SET.**  
**P.O. Licensed.**  
 Highly efficient. Comprises Polished Case with Ebonite Panel fitted with Variometer Tuner, Filament Rheostat, and all necessary Terminals, etc. etc.



**£3 10s.**  
**Broad-casting Fee extra.**  
 Fully Illustrated leaflet of Crystal & Single Two, Three and Four Valve Receiving Sets, post free on request.

**FILAMENT RHEOSTAT.**  
 Complete for Panel Mounting. Price **3/9.**



**"RADIO" DOUBLE HEAD RECEIVERS.**  
**British Made.** Complete with Cords, 4,000 ohms, 28/- pair

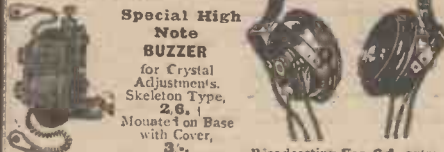

**SPECIAL HIGH NOTE BUZZER** for Crystal Adjustments. Skeleton Type, 2/6. Mounted on Base with Cover, 3/-.  
 Broadcasting Fee 6d. extra.



**CRYSTAL SET AMPLIFYING PANEL**  
 Increasing the strength of Signal's to a remarkable extent. Can be readily attached to any good type of Crystal Set. Comprises polished hardwood Case with Ebonite Panel. Fitted with Valve Holder, Filament Resistance, Low Frequency Transformer and all necessary Terminals, Labels and Connections. Price, including all Broadcasting Fees, **£5 5 0** Marconi-Osram "R" type Valve, including Broadcasting Fees, **17/8.**



THE MARK OF RELIABILITY



FILAMENT RESISTANCES **2/-** Each  
 Panel Type with Knob and Pointer.

POTENTIOMETER **4/6** Each  
 Panel type on Ebonite.

1 to 12 volts  
**VOLT & AMMETER**  
 1 to 35 amps

Combined Dead Beat Pocket Type. New and no German. Splendid Instrument in Nickel-plated Case. Ideal for Testing Cells & Filament Current

POST **5/6** LIMITED PAID NUMBER

**OTHER EXCEPTIONAL VALUES**  
 Aerial Wire. Bright Hard Drawn, 7/22 Copper, 3/6 per 100 ft.; same enamelled, 5/-  
 Aerial Insulators. 2 x 2 1/2 ins. Shell type, 9d. each; 2 in. Reel Type, 2/- each.  
 Telephone Transformers. (Army Type.) 9/- each; L.F. Transformers, 15/- each.  
 Vernier Condenser. 5 Plate for Panel mounting, 4/- each. '001, 16/-; '005, 12/- each.  
 Wireless Jacks. With Plugs, 1/- the pair.  
 High Note Buzzer. (Army Type.) Worth treble, 3/- each; Tapping Keys, 5/6 each.  
 Dewar Switches. D.P. Change over, panel type, 2/- each. Small Switch Arms, 6d. each.

Write for "Complete Supplementary Price List of Exceptional Values," sent Post Free. All goods sent Carriage Paid, but with orders under 5s. 6d. add 6d. for postage

**J. H. TAYLOR & CO.,**  
 ELECTRICAL AND RADIO ENGINEERS.  
**Macaulay St., HUDDERSFIELD.**  
 Telephone 341. Telegrams: "Thorough," Huddersfield.

SCIENTIFIC APPLIANCES (Dale & Hollins). Electrical, Magnetic, Optical and ALL RADIO WIRE LESS PARTS and Materials at Lowest Prices. Call and see our immense stock or write for Information and Prices. In Centre of London, Top of Kingsway.

**SCIENTIFIC APPLIANCES,**  
 11 and 29, Sicilian Avenue, London, W.C.1.

PORTLAND'S PARTS BY POST

**"EBONITE"**

8 x I	...	...	...	7
4 x 4	...	...	...	1 3
7 x 5 1/2	...	...	...	2 8
10 x 6	...	...	...	3 9
17 x 5	...	...	...	5 8
12 x 10	...	...	...	7 6
17 1/2 x 8 1/2	...	...	...	9 6
18 x 18	...	...	...	12 10
36 x 18	...	...	...	1 3 0
7 lb.	...	...	...	1 3 0

QUARTER, MAT. BRITISH  
 Postage Free—Any Size Cut

**JAMES PORTLAND,**  
 39, SINCLAIR ROAD, OLYMPIA, W.14  
 N.B.—Mr. Portland Stocks 200 Wireless Parts

**ELECTRADIX RADIOS.**

IMMEDIATE DELIVERY FROM OUR HUGE STOCKS

Everything from a Recorder to an Earth Clip.  
 The best equipped City depot.

COME AND SEE US  
 9, COLONIAL AVENUE is first opening on left in the Minories, nr. Aldgate Station, Metropolitan Railway.

**LESLIE DIXON & CO.,** Tel: Avenue 4166.  
 9, COLONIAL AVENUE, MINORIES, E.1.

**PREPAID ADVERTISEMENTS.**  
 The Latest Invention. Steam rotary engine, reg. patent. The finest scientific working steam engine ever invented. 1s. each, 3 for 2s. 6d.—Alan Hitchen, Patentee and Manufacturer, Dept. 17, Burnley, 130 r

Wireless Dealers throughout Great Britain are strongly advised to stock parts for making up wireless sets. Buy your parts direct from the factory at wholesale prices.—Newtonia Wireless Factory, 13 and 15, Whitcomb Street, London, W.C.2.

**Huge Purchase of ex-Government Wireless Stock.** Write for list giving full details. 150-watt dynamos, £1; hedgehog coils, 3s. 6d.; loud speakers, 200 ohms, 7s. 6d.; 1-in. spark coils, 10s.; 1 1/2-in. spark coils, 12s. 6d.; Morse tapping keys, 3s., etc. etc. etc. Three days' approval against cash, or please call. Write for detailed price list of all goods.—E. J. Galpin, 16, Loampit Hill, Lewisham, S.E.13, London.

Telephone Receivers Rewound up to 1,000 ohms, 5s. each; 2,000 ohms, 7s. 6d.; cash with order.—M. E. Hampshire, 139, Sydenham Road, S.E.26. [4 s

Buzzers.—Specially constructed instruments by which crystals can be set for reception, 2s. 6d., post free.—Frank Hooydonk, Hornsey Rise, N.19. [28 r

B.A. Screws, Nuts, and Washers, assorted gross, 2s.; list, 2d.—J. H. Bennett, Station Road, Willesden Junction. [32 r

New Low-resistance Telephone Earpieces for valve sets, 10s. 6d. pair; 6s. single; 12 for 54s.; quantities cheaper. Quadruple cords, 1s. 6d. Second-hand chloride accumulators, 90 amp. 2 volt, 10s.; carriage extra. Satisfaction or money back.—140, Grosvenor Road, E.7. [1 s

Telephone Jack and Plug, nearly new, 3s. each., post free.—M., 51, Meath Road, Ilford. [3 s

**EASY TERMS OR CASH**

Further reduction. No extra charge for extended payments. Double Headphones, Brown, Sterling 4,000 ohms, 52/-. Mullard's Type A, 21/-. Type B, 25/-. Best French "Brunet" 4,000 ohms, 25/-. & 30/-. British 4,000 ohms, 20/-. & 22/6. Mullard Ora Valves 15/-. L.F. Transformers, 15/6 & 20/-. 3 way Colloidors, 13/6 & 17/6. 2 way, 7/6. Honeycomb Coils at list prices, according to wavelength. Variable Condensers, complete sets of parts, top and bottom, .001 8/6, .0005 6/6. Accumulators, 4 volt 20 amps, 17/6, 30 amps, 20/6, 80 amps, 40/6. H.T. Battery, 30 volt 7 1/2, 60 volt 16/6 (variable with plugs). Maltagony Cabinets, Ebonite Panel, drilled, for Single Valve Set 2 by 6, 10/6, for two Valves, 10 by 8, 15/6, three Valves 14 by 12, 21/6 with terminals. Money returned in full if you are not completely satisfied. Carriage paid on all orders over 40/-. Terms: One-third with order, balance in six fortnightly payments.

**G. BUSH, 119, Sutherland Avenue, London, W.9.**

**ACCUMULATORS**

4 volt 20 amp.	...	14/-	6 volt 20 amp.	...	22/-
4 " 40 "	...	19/-	6 " 40 "	...	27/6
4 " 60 "	...	27/-	6 " 60 "	...	37/6
4 " 80 "	...	33/-	6 " 80 "	...	52/-

(Carriage Paid)

These accumulators are brand new, guaranteed and specially recommended. Terms Cash with Order.  
**BASTONES, 228, PENTONVILLE RD., KINGS CROSS, LONDON, N.1.**

**WIRELESS BARGAINS.**  
**PHONES, 21/-** SUPERSENSITIVE ALL-BRITISH, 4,000 ohms, POST FREE.  
 ALL WIRELESS PARTS & SETS. Trade supplied. CRYSTAL DETECTORS, 2/6.  
 Illustrated Catalogue A, including list of Stations, 6d. post free.

**EONS WIRELESS SUPPLY CO.,**  
 115, Fleet Street, E.C.4.

**NOTICE**

The **SIMPOLIA WIRELESS Co.**, having re-designed their wireless sets, have a small stock of their older type to dispose of at less than cost price.  
 20 Single Valve Receiver Panels at 12/- each or £10 the lot. 12 Two Valve Receiver Panels with tuners, low frequency, at 40/- each or £21 the lot.  
 Simpolia Wireless Co., 170, West Green Rd., Tottenham, N.15

**SOLVES THE AERIAL PROBLEM**

You can support your aerial indoors one foot from walls on the insulated arm of the **IND-AERIAL HOOK.**



These hooks can be attached (and taken down) in a second, to the picture rail of any Room, Hall, Lobby, Passage, Office, Nursery, etc. Almost any length of Aerial can be arranged by hanging aerial round walls or across room. No screws or nails required. Makes any set portable, astonishing results being obtained. TRY IT.

**IND-AERIAL CO. (Dept. A),**  
 47, VICTORIA STREET, S.W.

PRICES  
 2/9 each  
 Set of four  
**10/6**  
 post free  
 Send P.O.  
 to-day and  
 secure yours.



# Exide BATTERIES

H.T.  
Batteries  
for  
Valve Sets

24v. 28v. 32v.

Type B.K.

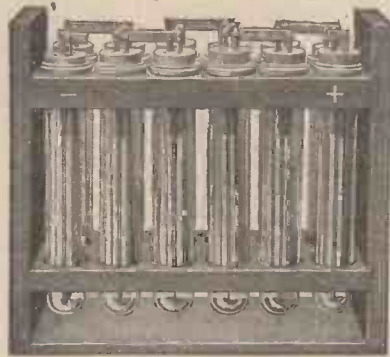

Owing to the demand for these batteries, all orders will be dealt with in strict rotation. Prices approximately one shilling a volt. :: Ask for Leaflet 4030 ::

**THE Chloride** ELECTRICAL STORAGE COMPANY LIMITED.

CLIFTON JUNCTION, N<sup>r</sup> MANCHESTER. | 219/229, SHAFTESBURY AVENUE, W.C.2.  
PRICES AND PARTICULARS ON APPLICATION.

## The Battery with 40 years' manufacturing experience behind it

THE finest quality materials and experienced workmanship go to make this a battery to be absolutely relied upon to give the steady high voltage so necessary to ensure the best results in Wireless Reception.

### PYRAMID H.T. Battery

15 Volt ... 3/6  
30 Volt (with variable plug connection) ... 7/-  
(POST ORDERS DELIVERED WITHIN 24 HOURS)

We also manufacture complete Wireless Sets and all component parts, of which the following is a much abbreviated list.

### Broadcast Receiving Set

Price complete with British made headphones, aerial and everything ready for fixing—£5 0 0 plus 7/6 Broadcasting Fee.

Low Frequency Amplifiers for use in conjunction with this set having special transformers—Price £5 0 0

Two of these amplifiers are capable of working a loud speaker with excellent results within a distance of 20 miles from London.



Filament Resistances . . .	3,9
"Ideal" Valve Accumulator in case	
4-Volt 50 amp. . . . .	25/- (Carriage 2/-)
6 " 50 amp. . . . .	35/- (Carriage 3/-)
Variable Condensers (of various capacities)	From 6/-
Fixed Condensers . . . . .	2/6
3-Coil Holder, complete Unit for use with Standard Coils. . . . .	20/-

Illustrated Lists free on Request, or Visit our Showrooms

**Wates Bros.** 13/14, Great Queen Street, KINGSWAY, LONDON, W.C.2.

## ALL REQUIREMENTS FOR THE EXPERIMENTER OR BEGINNER.

AT MOST REASONABLE PRICES. COMPLETE SETS OF PARTS SUPPLIED, FROM CONDENSERS TO SUPER-REGENERATIVE SETS (IN STOCK). EXPERIENCED RADIO ENGINEER IN ATTENDANCE, INSTRUMENTS REPAIRED, ETC.

**JOHN BANKS & SONS,**  
14-18 Duke Street,  
(5 minutes from CENTRAL STN.)  
\*Phone 4424 Royal.  
(See Windows.) Catalogue Post Free.

# LIVERPOOL

### BEGINNER'S GUIDE TO WIRELESS

Explains in plain, everyday language, everything beginners wish to know about Wireless Telegraphy.

### HOW TO ERECT, CONNECT, AND MAKE

all the apparatus required for reception of telephony or Morse, and full instructions and diagrams for making coils, tuners, and complete valve and crystal sets. 112 pages, price 1/- post free.

**SAXON RADIO CO.** (Dept. 12), South Shore, BLACKPOOL

32 page Catalogue of Wireless Apparatus, 3d. post free.

## An Ideal Xmas Gift

JUST OUT

# WIRELESS HANDBOOK & DIARY 1923

Price 2/6 net

A complete Letts' Diary with 40 pages of valuable wireless information and the usual pages of useful general information. Beautifully bound in leather, it will form an ideal Xmas gift. Get someone to buy you one. Obtainable through all Booksellers or direct post free 2/8½ from

**Radio Press Ltd.,**

DEVEREUX BUILDINGS, STRAND, LONDON, W.C.2

## BROADCASTING HAS NOW BEGUN!

### Have you obtained your Set yet ?

Our No. 1 CRYSTAL RECEIVING SET is suitable for reception of all broadcast matter for a range of 20-30 miles.

TYPE APPROVED BY P.M.G. Reg. No. 126.

Price **35s.**

Plus 7s. 6d. broadcasting commission.

'PHONES. British made, wound to 4,000 ohms.

Price **25s.**

AERIAL EQUIPMENT, comprising 100 ft. 7/22 S.W.G. Stranded Aerial Wire and Insulators, 4/- extra.

COMPLETE EQUIPMENT, ready to "Listen-

in." Price **£3 3 0**

Plus 7/6 broadcasting commission.

"Excellent Results."

"Costs Nothing."

West Kensington, 18th Nov., 1922.  
"You might like to know that in spite of the fact that I have a 3-valve Set, I prefer listening-in on the Broadcasting Co.'s Transmission of your No. 1 Crystal receiver, which gives excellent results, and unlike Valves costs nothing to run."

Write for Illustrated Catalogue of all Radio Accessories

**BOWER ELECTRIC LTD.,**

15, GRAPE STREET,  
SHAFTESBURY AVENUE, London, W.C.2

# RADIO CHRISTMAS GIFTS



**Sterling No. 1  
Crystal  
Receiving  
Set**

Specially designed for Broadcast reception, very selective and simple to operate. Complete with one pair of Double Head Telephones and with special coil for Paris Time Signals. Range about 25 miles.  
*Write for Leaflet No. 324.*



**Radio Head  
Phones**

*(Manufactured under Brown's Patent  
No. 134353/18 by Sole Licence)*

Of the highest efficiency. Constructed on the most scientific principles and to give a comfortable fit to the ear of the user.

*Write for Leaflets Nos. 321 and 325.*

*To be obtained from all Dealers or direct from*

**STERLING TELEPHONE & ELECTRIC CO., LTD.,**  
Telephone House, 210/212, TOTTENHAM COURT ROAD, LONDON, W.1.

Telephone: Museum 4144 (7 lines.)

Telegrams: "Cucumis, Wesdo, London."

**NEWCASTLE-ON-TYNE:**  
9, Clavering Place.

**WORKS:**  
Dagenham, Essex.

**CARDIFF:**  
8, Park Place.

**WE GUARANTEE**  
that all Broadcast Radio Apparatus sold by us conforms with the conditions of the Broadcasters' Licence issued by the Postmaster-General.

## Where there's Electric Light there's Wireless



Your electric light catches the wireless exactly as an aerial does.

Plug a "Ducon" into any lamp holder or wall socket, connect it to your wireless receiver and you will receive the broadcasting perfectly.

**USE A "DUCON"**  
and you don't need an aerial.

"Ducons" are perfectly safe—each one is tested to 1,000 volts, *they consume no current* and do not affect the electric light in any way.

The **DUCON 10/-**

is obtainable from leading wireless dealers, electrical contractors and stores, or direct from the makers.

*Dealers not yet stocking are invited to write for Trade Terms.  
Over 50,000 in use.*

**The Dubilier Condenser Co. (1921) Ltd.**  
Ducon Works, Goldhawk Road, Shepherd's Bush, London.

Telephone—Hammersmith 1054. Telegrams—Hivoltcon, Phonic, London.



A COMPLETE VALVE SET FOR £4

# Amateur Wireless And Electrics

*Put Your  
Difficulties  
to Us*

No. 30

SATURDAY, DECEMBER 30, 1922

Price 3d.



Manchester Broadcasting-station Studio (See page 707)

SINGLE-VALVE REGENERATIVE CIRCUIT	::	WIRELESS FROM CLOUDLAND
MORSE MADE EASY	::	CRYSTAL MOUNTING
MANCHESTER BROADCASTING STATION	::	THE DYNATRON
	::	IMPROVING A UNIT SET

# ECONOMIC ELECTRIC LTD.



**CRYSTAL DETECTORS, 5/6**



**HEAD RECEIVERS  
From 12/6**



**ENCLOSED CRYSTAL DETECTOR, 12/6**



**INDUCTANCES, 50/-**



**VALVE HOLDERS, 1/9**

Head Office 10, FITZROY SQUARE, LONDON, W.1.

Showrooms:  
303, EUSTON ROAD, N.W.1.

Telephone:  
MUSEUM 1055

Branch Showrooms & Works:  
TWICKENHAM

Write  
To-day for 40-  
Page WIRELESS  
List Post Free  
4d.  
250 Illustrations.

## MITCHELFONES

Are not a spasmodic production to meet a sudden demand, but have been on the market for over three months, and during this period 27,000 have been distributed to the trade, and consequently we have not been able to offer them direct to the retail buyer.

*1,000 per week are now available, and we announce*

### DELIVERY FROM STOCK

You post your order, or call at our premises and get them at once. Think what this means to you—you, perhaps, who have been waiting and are still waiting.

*Standard resistance 4,000 ohms, double headgear with double headstraps, comfortable, highly efficient, and foolproof*

## 25/- per pair.

Special Terms to Traders and deliveries that will surprise you.

### MITCHELLS Electrical & Wireless Ltd.,

Postal Address: McDermott Road, Peckham, S.E.15.  
Retail Address: 188, Rye Lane, Peckham, S.E.15.

Phones: Now Cross 1540/1541.

## GREAT BRITAIN'S GREATEST WIRELESS STORE

## An Ideal New Year's Gift

JUST OUT

### WIRELESS HANDBOOK & DIARY

1923

Price 2/6 net

A complete Letts' Diary with 40 pages of valuable wireless information and the usual pages of useful general information. Beautifully bound in leather, it will form an ideal New Year's gift. Get someone to buy you one. Obtainable through all Booksellers or direct post free 2/8½ from

## Radio Press Ltd.,

DEVEREUX BUILDINGS, STRAND, LONDON, W.C.2

### STARTLING REDUCTIONS

<p></p> <p>Ebonite Condenser Dials, Engraved 0-180° and filled white with Knob, Brass Bush and Set Screw 2/6 Dial only ... 1/6 Aluminium Condenser Vanes per doz. ... 6d. Spacer Washer, small 3d. doz.; large 4d. doz.</p>	<p>A.E.G. and Halske Valves for rectifying and amplifying (tested) 7/6 Crystals (special selected), Bornite, Zincite, Galena, Silicon, Carborundum, Copper Pyrites, Graphite, Tellurium, etc. ... 6d. Egg Insulators, Green ... 4d. Reel " best quality ... 3d. Helleisen 36 v. Batteries with Tappings and Wander Plug ... 8/6 Essex 15 v. H.T. Batteries ... 3/- Ebonite Leading In Insulators ... 1/6 Perikon Detectors on Ebonite Complete with Crystals ... 4/- " Ubique" Crystal Set Complete ... 15/-</p>
<p>Knobs, with 2 BA Brass Inset ... 3d. Grid Leaks (enclosed), 2 meg. ... 1/- Grid Condensers ... 1/6 Filament Resistances ... 3/6 Crystal Cups with Screw ... 3d. Fusible Alloy, per stick ... 4d. Inductance Tubes, 12" x 3" ... 6d. " " 12" x 4" ... 9d. " " 12" x 5" ... 1/- " " 12" x 6" ... 1/3 Sliders and Plungers ... 5d. Sq. Brass Rod, 12" x 1/4" x 1/4" ... 4d. Enamelled Wire, 23 gauge, lb. ... 2/- Aerial Wire, 7/25, Stranded, 100' ... 3/- Valve Holders, Screwed Legs ... 9d.</p>	

**DELIVERY BY RETURN GUARANTEED** Postage extra.

**THE ESSEX WIRELESS CO.**

Telephone—WANSTEAD 749.

Office & Showrooms:  
499, GROVE GREEN RD.,  
LEYTONSTONE, E.11.  
(1 min. from Station, G.E.R.)

# AT LAST!!!

## Really Efficient B.B.C. Sets at LOW PRICES

**COMPLETE OUTFITS** Ready to "listen-in."

Complete with Tuner, etc.	{	One Valve	£9 9 0	Including all Royalties
		Two "	13 17 6	
		Three "	16 16 0	
		Four "	19 19 0	

*Packing and Carriage free in Great Britain.*

Accessories are: 1 pair 4,000 ohms Double Headphones; 1 Accumulator; 2 H.T. Batteries; Aerial Wire; Insulators; Lead-in Rod and necessary Earth and Connecting Wire; and Valves.

NOTE!!! We are 45 miles from Writtle, 70 from Marconi House, 130 from Birmingham, and 170 from Manchester, and get all these stations on any of these sets, *Verb. sap.*

WRITE:

## Cook's Wireless Depot

61 and 63, St. Matthew's Street,  
IPSWICH—SUFFOLK.

:: Wholesale only:—9, Bedford St. ::



# Amateur Wireless

## and Electrics

No. 30

December 30, 1922

## Wireless from Cloudland

It is truly a wonderful experience to travel above the clouds, out of sight of the earth, at a speed of 80 or 90 miles an hour, and carry on a communication with an invisible wireless station some hundreds of miles away. Flying is in itself a most exhilarating mode of travelling, and when to this is added the excitement of trying to keep in touch with Mother Earth by wireless there is no more interesting and fascinating experience to be found.

Needless to say, aircraft wireless forms a specialised branch of science to-day, although eight years ago practically nothing had been done towards the development of this method of signalling from cloudland. The late war gave the first impetus in this direction, when some of the greatest scientific minds of the day set themselves to conquer the many difficult problems which impeded the application of wireless principles to aircraft.

### Weight and Efficiency

The greatest of these problems—and it is one which continues to exist to-day in no small measure—had reference to the need for reducing the weight and size of aerial wireless instruments to a minimum. It must be remembered that when aircraft wireless began to develop, aeroplanes and airships were themselves in no very advanced state of development. This, of course, led to a conflict of interests between those who were responsible for the efficiency of the aircraft itself and those whose task it was to make the wireless gear as efficient as possible. On the one hand the efficiency of the aircraft depended largely upon its lightness and its amount of available space for passengers and cargo. The efficiency of the wireless gear, on the other hand, depended to an almost equal degree upon its heaviness and the amount of space it occupied.

### Power

In those days the power for the transmitter was always taken from accumulators. This meant that the greater the power used the greater the total weight and the space occupied by the wireless installation. Another disadvantage from which the pioneers of aircraft wireless suffered emanated from the slight danger

AIRCRAFT WIRELESS :: WEIGHT AND EFFICIENCY  
POWER :: EARTH :: ENGINE NOISES :: VIBRATION  
THE "HEAVISIDE" LAYER

that was incurred by the presence of a "spark" in any kind of aircraft. Needless to say, this danger was frequently exaggerated to a ridiculous degree at first, until it became demonstrated in the course of time that, with proper precaution, it constituted as unlikely a source of danger as any other part of the machine's equipment—which, of course, was not saying a great deal in those days!

### Earths

A point which seems of particular interest to many amateurs in reference to aircraft wireless is that of making a connection to earth. How is it possible to connect an aeroplane instrument to earth? Well, the answer is that the function of an "earth" with any "open" aerial is to serve as a capacity, to balance that of the aerial itself. The aerial-earth system thus acts as a condenser, between the two sides of which the received or transmitted impulses oscillate. The first attempts to provide a suitable earth on an aeroplane took the form of long condenser tubes which were carried in a separate part of the machine. It was found later that the metal bed of the aircraft engine afforded a still more satisfactory earth. A number of leads are usually taken to this from the earth connection on the wireless instrument.

### Engine Noise

Another important problem in receiving on board all types of aircraft is that of engine noise. The roar of an aero-engine at close quarters is terrific, though, strangely enough, one can become so accustomed to it during flight as to be almost unconscious of it. To-day, of course, with valve amplification, its effect is practically negligible. At that time the only thing to be done was to lock it out by shutting your head up in the best fitting flying helmet that could be procured. How one's ears used to ache after a long flight under such conditions!

Then there was the difficult problem of vibration. When an aeroplane is "under

way" it is vibrating throughout its whole structure. Nothing could be more injurious, of course, to crystal reception. In order to keep the contact point

steady it was often necessary to screw it hard down upon the crystal itself, thus reducing the sensitivity of the latter. Magnetic relays were extensively used in those days to procure signal amplification in aircraft. The adjustment of these, however, was even more sensitive than of crystals, and they were usually carried in the "tail" of the machine where the least amount of vibration was experienced.

### Bumping

The tuner, of course, could not be carried in this position because of the need for periodical readjustment of the condenser, etc. When the relays "conked," it was impossible to get them going again during flight because of their inaccessibility in the tail of the machine. This was often responsible for a number of false starts at the commencement of a flight. If the aerodrome happened to be a bit "bumpy" at all, it was an even chance as to whether the relays would or would not be thrown out of action in the course of "taking off."

### Valve Troubles

With the advent of the transmitting and receiving valve, of course, the aerial wireless operator began to look forward to a life of luxury and ease. But if valves brought advantages they also brought troubles. From the first they never seemed to take kindly to the air. Valves which were quite well-behaved on the ground always "howled" on being put into an aeroplane. Moreover, high-tension leads were tricky things to "mess about with" in the limited space at one's disposal in the cock-pit of a machine. And if valves amplified signals, they also amplified other things, such as the "ripple" produced in the phones by induction from the magneto of the engine.

But fresh troubles are, alas! rising up to meet the new generation of aircraft observers. There is, for instance, that important problem of the "Heaviside layer." Now, if that could only be lifted a little. . . .

AIRCRAFT OBSERVER.

# A Dutch Amateur Wireless Station



**A**MATEUR interest in wireless is now universal, and we are constantly receiving particulars of installations from all

parts of the globe. The Dutch amateur station (Noordwyk Aan Zee, Holland), owned by an enthusiastic amateur, Mr.

W. Tappenbeck, and shown in the accompanying photographs, is of special interest owing to the wide variety of apparatus

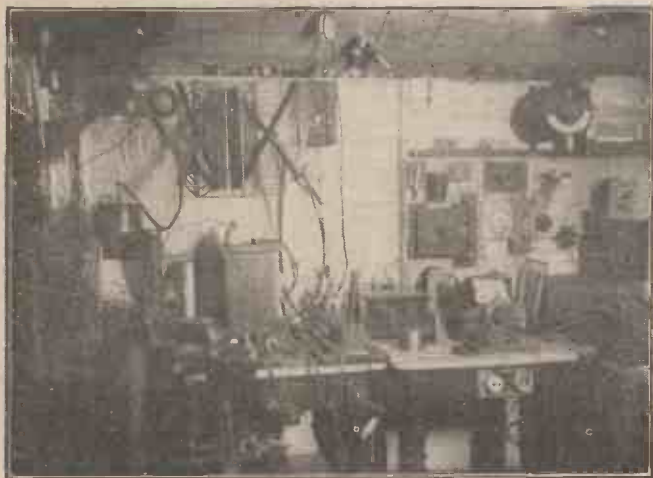

Transmitting Apparatus.



Receiving Apparatus.

displayed, much of which is of an experimental nature. The photograph on the left shows a spark transmitter with a

range of 200 miles and apparatus for experiments with very short wave-lengths. The second photograph shows the receiver,

which has honeycomb coils, amplifiers and four-electrode valves, together with a quantity of accessory apparatus.

## Single-valve Regenerative Circuit

**T**HE query "How can I get more volume from my single valve?" is causing much racking of brains amongst experimenters. How many have thought of employing variometers? These wonderful little components are perhaps not too widely known in this country, but in America, the Land of Hook-ups, they are extensively used.

The variometer, what it is and what it is not, was fully described in a recent issue of *AMATEUR WIRELESS*, and the purpose of this short article is to give an example of one of its many useful adaptations. In the very simple circuit shown in the accompanying illustration, it is possible to obtain both detecting and amplifying from one single valve almost equal to results obtained from two valves

arranged as detector and amplifier in the usual way. The function of the variometer in the plate circuit (plate variometer) is to tune in and feed back into the grid the added voltage of the plate circuit.

For simplicity and ease in operation this circuit has a distinct advantage over any other type of regenerator, and the experi-

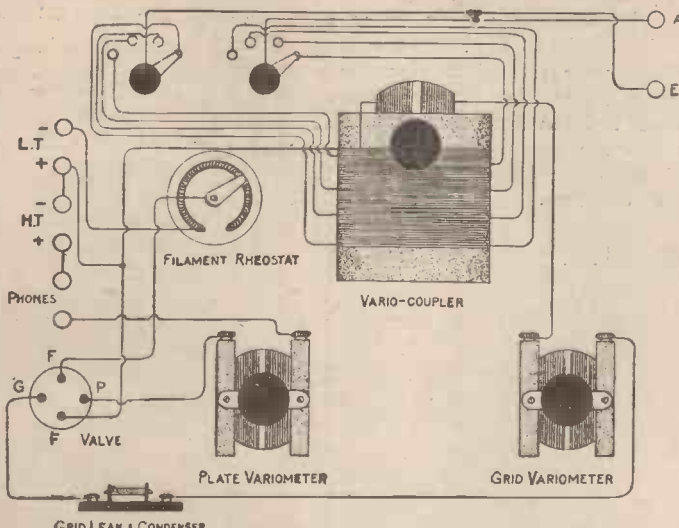

Single-valve Detecting and Amplifying Variometer Circuit.

menter will find it well worth trying out. "OH-JAY-AH."

Please mention "Amateur Wireless" in replying to advertisements.

## Morse Made Easy The Group Method

**M**ANY amateurs seem to think that the Morse code is very difficult to learn, but anyone following the advice given below will find it quite easy.

The code should be learned in four different groups, the easiest signs being in the first group, which should be learned thoroughly.

### FIRST GROUP.

- E . — is opposite T —
- I .. " " M — —
- S ... " " O — — —
- H ....

### SECOND GROUP.

- A . — is opposite N — .
- U .. — " " D ...
- V ... — " " B — ....

### THIRD GROUP.

- W . — — is opposite G — — .
- R . . . " " K . . .
- P . — . . " " X — . . .
- L . — . . " " Y . . . —
- F . . . . " " Q — . . . .

### FOURTH GROUP.

- C — . . . . } No opposites
- J . — — — . }
- Z — . . . . }

C. F.



# "A.W." Ideal Unit Receiving Set.—V

## SOME ADDITIONS AND IMPROVEMENTS

WITH even a single stage of high-frequency amplification the set may be found liable to oscillate when it is least wanted to do so. We must therefore check this tendency by devising some means of controlling the potentials supplied to the grids of the valves which are amplifying at radio-frequency, otherwise the set may be very difficult to handle satisfactorily.

### Self-oscillation

Though slight self-oscillation is unlikely to cause re-radiation or interfere with other people, so long as the reaction coil is loosely coupled to the secondary it will make the reception of telephony very indistinct. On music its effects are appalling; singers seem to be hoarse and not quite true to pitch, whilst instruments may produce discordant sounds. The most distinct of speakers appears to be having trouble with a half-swallowed potato. The presence of self-oscillation makes itself felt even when spark signals are coming in, depriving them of their sharpness and causing a mixture of rushing, rustling and hissing noises when the coupling between the primary and the secondary coils is tightened.

If the set is properly controlled there should be none of the squeaks and squeals

taken in fitting up a means of controlling the grid potentials, for nothing is more annoying than to find that big variations in the tuning occur whenever the hands

of potentiometer can be bought cheaply from those firms which deal in Army surplus stores.

With high-frequency valves the tendency

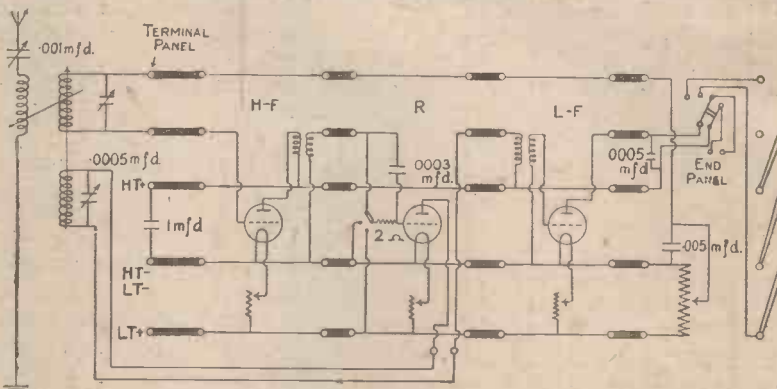

Fig. 1.—Wiring Diagram of Three-valve Unit Set with Terminals, H.F. Rectifying, L.F. and End Panel.

approach or leave condenser knobs and inductance handles.

Many owners of receiving sets suffer from self-oscillation troubles without recognising them or knowing that they can be cured. Comparatively few "ready-made" sets have any form of grid control, but it is luckily not a difficult matter to add it to most types of apparatus.

to oscillate is at its strongest when the grids are supplied with a negative potential. As this potential is reduced towards zero the oscillation noises die down, ceasing altogether when the potential becomes slightly positive. The simplest and most obvious solution of the difficulty would be to alter the wiring of the panels so that the secondaries of the tuning inductance and the high-frequency transformers are connected to the plus leg of the filament instead of to the minus. This, however, has serious drawbacks, since a positive potential has a damping effect, and we must, if we are compelled to use it at all, make it as small as possible.

The way in which the problem is solved will be seen from a study of Fig. 1, which shows the wiring diagram of a small complete unit set consisting of three valves, a radio-frequency amplifier, a rectifier and a note-magnifier. The fifth terminal, which hitherto we have left neglected, is now brought into play, and an end-panel, whose details will be described later, has been fitted.

### Grid-voltage Control

If you trace out the course of the grid potential of the H.F. valve, you will see that before reaching its destination it must pass through a variable amount of the resistance windings of the potentiometer, whence it travels by way of the fifth terminals and their connections to the secondary coil of the tuning inductance. After passing round this coil it arrives on the grid of the high-frequency valve. Thus the potentiometer controls the grid voltage, but does not interfere with the passage of high-frequency oscillations in the circuit, a by-pass for them being pro-

Fig. 2.—Grid-control Circuits of Three High-frequency Valves.

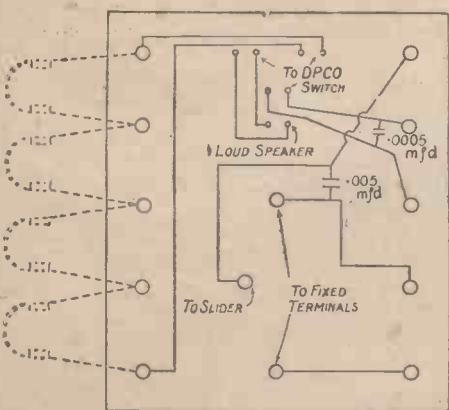
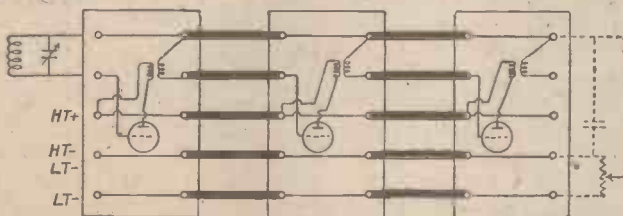

Fig. 4.—Wiring of End Panel with Four Pairs of Phones in Series.

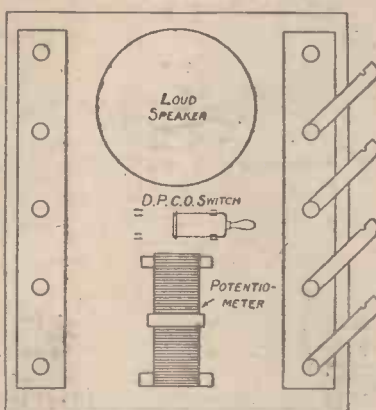

Fig. 3.—Upper Side of End Panel.

that commonly occur when searching for telephony transmissions. Further, capacity effects will be reduced to a minimum even if they are not altogether absent. This in itself is an ample repayment for the trouble

The apparatus required is simple and inexpensive, consisting of a condenser of about .005 mfd. capacity and a potentiometer with a maximum resistance value of from 300 to 450 ohms. Quite a good type

vided in the .005 bridging condenser, which, by the way, should have mica, not paper, as its dielectric.

Let us suppose that when full negative potential is being supplied the set shows signs of unwanted oscillation. The slider of the potentiometer is moved towards the middle, increasing the resistance and reducing the negative value. Oscillation may cease before the mid-point is reached, but if it does not we continue the move-

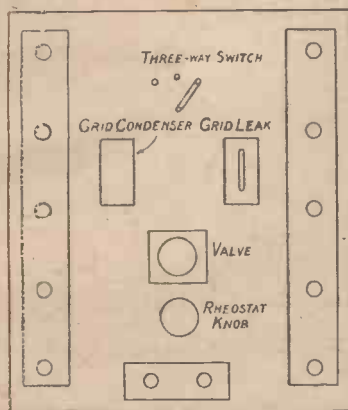

Fig. 5.—Upper Side of Improved Detector Panel

ment of the slider, thus giving the potential a slight positive value. Experiment will show the adjustment that gives the most satisfactory results.

Do not forget, by the way, that so long as the low-tension battery is connected a current of 30 milliamps or so is flowing through the potentiometer. This is a small amount, but if the battery is not disconnected when the set is out of use its charge will gradually leak away.

When two or more high-frequency valves are in use the wiring of their panels is as shown in Fig. 2. In this way the grids of all of them are controlled by the potentiometer, and it is not as a rule difficult to eliminate self-oscillation altogether with a minimum loss of amplification.

#### End Panel

Details of the end panel are given in Figs. 3 and 4, which show respectively its upper and under sides. Made in this way, it becomes a neat and handy addition to the set, which well repays by its usefulness and the time that it saves the trouble taken in putting it together. The loud speaker is fastened down near the top of the panel; if its base is too large to fit comfortably, a small pedestal should be made for it. Immediately below it is a double-pole change-over switch, by means of which either loud speaker or head telephones can be put in and out of operation in a moment.

Below this again is the grid-control potentiometer. If it is desired to use low-resistance phones and loud speaker, the telephone transformer should be mounted on this panel. It is possible without any difficulty to make use of such mixed gear as high-resistance phones and low-resistance loud speaker. In this case the trans-

former is connected to the leads shown running from the double-pole change-over switch to the loud speaker.

The terminals on the right of the panel are for the telephones. When more than one pair is in use receivers should always be connected in series, not in parallel as is often done. The swinging hooks enable any number of head-sets up to four to be used with a minimum of trouble. Most people prefer to turn on the loud speaker when friends come to listen-in, but there is no doubt that the sounds produced by telephones are clearer and freer from distortion; hence many amateurs never employ a loud speaker. Though there are many excellent types on the market none of them probably is perfect in its performances; the loud speaker has, however, one distinct advantage if you are using the set for long periods: it relieves you of the pressure caused by the heat-bands which, to me at any rate, becomes intolerable in time even with the lightest makes of receivers. With this panel the telephones can be used normally for delicate work, the loud speaker being switched on at intervals to give the head a rest.

#### Improvements

Let us now see how the existing set can be improved. The high-tension battery should be bridged by a by-pass condenser as shown in Fig. 1. Besides providing a free path for oscillating currents this condenser serves to eliminate battery noises by keeping the H.T. current constant. It should be of large capacity—a 1 mfd. Mansbridge condenser will do admirably. Convenient places for mounting it are either below the top of the table or on the outside of the terminal panel.

Figs. 5 and 6 show how the valve-rectifying panel may be improved by the addition of a three-way switch, which can be made up on a small ebonite base, by using three of the studs made for the selector switches of tapped inductances and a laminated arm.

Valves of different types vary considerably in their working. Some do best with the grid-leak in parallel with the grid condenser, others with it placed between the grid and the minus leg of the filament, others again with it connected to the positive low-tension lead. Experiment will show which is the best position for any valve, and this switch provides a handy way of making the necessary wiring changes without any trouble. Very soft valves do not require a grid-leak; these may be catered for by providing a fourth neutral stud for the switch-arm.

In making up this arrangement grid-leak and condenser are separated, the former being mounted on its own ebonite block. The condenser is wired as before between the grid and the input terminal. A second lead is taken from the grid to the leak, and thence to the switch arm. The studs are wired respectively to the input terminal, low-tension negative and low-tension positive. If a fourth stud is

fitted it has no connection, merely serving as a cut-out for the leak. This stud will not be needed if the grid-leak is of the cartridge pattern, in which case one throws the leak out of action simply by removing it altogether.

#### Other Modifications

Other modifications and improvements will no doubt suggest themselves to

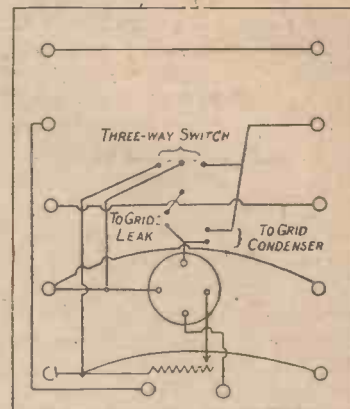

Fig. 6.—Wiring Diagram of Under Side of Improved Detector Panel.

readers who make such a unit set as that which has been described in these articles. The keen amateur is never quite satisfied with his set as it stands, but is always thinking out some way in which it may be made to give better performances. In this lies perhaps one of the chief delights of wireless, for there is no thrill to equal that which one experiences when a change of wiring or the addition of some carefully thought-out "gadget" is found to give an increase in efficiency.

If the set is carefully made up it will be found to give first-rate results. The working is quiet, and signals come in with good quality and strength. With only three valves arranged, as shown in Fig. 1, broadcasting stations within a reasonable radius come in with sufficient power to enable a loud speaker to make speech and music pleasantly audible to everyone in a good-sized room. With two or three stages of high-frequency, telephony should be heard not only from any of our broadcasting stations, but also from most, if not all, of the European centres. The reception of very long-range telephony depends, however, largely on the quality used, to say nothing of the skill of the individual operator, which counts for a great deal. Practice makes perfect; you will be surprised to find how greatly your receptions improve as you gain familiarity with the set and its working.

The last article of the present series will deal with the operation of a multi-valve set.

R. W. HALLOWS.

*Erratum.*—A misprint occurred in Article IV. in the first line of paragraph 4 on page 645. Low-frequency condensers should read low-frequency transformers.



# I've got Mullard Accessories



The wireless components with a world-wide reputation of many years standing. They will ensure your getting a set which looks well, works well and speaks well.

For receiving vocal and instrumental items you must have

## MULLARD "ORA" VALVES

to get the best results.

**O**scillates **R**ectifies **A**mplifies.

Specially recommended where good amplification is required.

The "Ora" Valve requires about 3.8 volts on the filament and 30 volts or over between the anode and filament for efficient results.

Standard Price **15/-** each

### IMPORTANT NOTICE

The great demand for Mullard "ORA" Valves and other accessories has compelled us to open much larger works. A greatly increased output is now available.

The Mullard "R" Valve is now reduced in price from 22/6 to 17/6.

## Mullard Radio Valve Co. Ltd.

45, Nightingale Lane, Balham, S.W.12.

Contractors to H.M. Admiralty,  
War Office, Royal Air Force & Post Office,

Telephone: Codes: Telegrams:  
Battersea 1068 ABC (5 Ed) Bentley's Radiovalve, Wandsworth, London.



Name and Address	Quantity	Description	Price		
To the MULLARD RADIO VALVE CO. LTD., 45, Nightingale Lane, Balham, S.W.12.	.....	Telephone Head Sets	Type A, 21/- Type B, 25/-	I enclose (Cheque, Money Order, P.O.) value	
	.....	"ORA" Valves	15/- each		to cover the cost.
	.....	Grid A Resistances	3/-	Name of usual Wireless Dealer	
	.....	Anode A or B Resistances	2/6		
	.....	Combined Resistance and Valve Bases with Terminal Clips	5/6	5/-	
	.....	Valve Sockets	1/3	9d. per pair	

Please send me post free

SEND THIS TO-DAY



# THE IDEAL ACCUMULATOR FOR WIRELESS FULLER "BLOCK" Type ACCUMULATOR

The only Accumulator which will hold its charge from 12 to 18 months when not in use  
**Fool-proof :: Non-Sulphating :: Unaffected by Short Circuits**

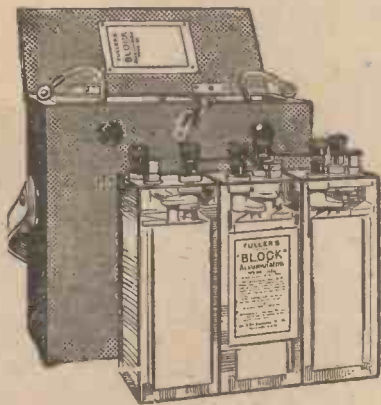

Type 640, complete in Teak Case

**A Summary of the Principal Advantages of Block Accumulators.**

Instead of using thin plates, with their liability to buckle, the Cells are constructed with electrodes in which segmental blocks of active material are carried on small grids and wrapped in porous material. The result is that the electrodes are free from the possibility of injury either by vibration, short circuiting, or sulphating. They also have the special feature that they will hold their charge from 9 to 18 months without the E.M.F. falling below 2 volts.

The Cell is constructed of two or more segments. The grid being buried in the Block is not acted upon by the electrolyte, and consequently there is no fear of trouble from "growth."

Some of the advantages of the Block accumulators are:—

- (1) They are "fool-proof."
- (2) There are no plates to buckle.
- (3) It is impossible for the cells to be spoiled through accidental short circuiting, and even if the terminals are joined by a metal bar, the cells will not be spoiled or seriously injured.
- (4) They will retain their charge for many months.
- (5) Sulphating cannot occur to any serious extent, as this is mostly caused through cells standing in a discharged state or being discharged through accidental short-circuits.
- (6) The Blocks are so constructed that they cannot swell or grow, and this prevents the external box or container being cracked or broken.
- (7) If the cells are neglected, or left in charge of inexperienced hands, no serious harm can be done, as even when discharged down to 1.5 volts, they recover their voltage and maintain their recovery, thereby preventing sulphate forming.
- (8) They are lighter and have a higher capacity per pound weight than ordinary plate accumulators, and can be re-charged an indefinite number of times.

TYPE.	VOLTS.	Intermittent Capacity at 20-hours Rate.*	Makers' Price.	Our Price.
440	4	40	£ s. d.	£ s. d.
640	6	40	2 15 0	1 12 6
			4 2 6	2 8 9
B L 440	4	80	3 10 0	2 8 0
B L 640	6	80	5 5 0	3 12 0
B L 455	4	110	4 1 0	2 15 0
B L 655	6	110	6 1 6	4 2 6
B J 4120	4	120	4 8 0	2 16 0
B J 6120	6	120	6 12 0	4 4 0
B L 480	4	160	4 9 0	3 4 0
B L 680	6	160	6 13 6	4 16 0
B L 4110	4	220	6 1 0	4 0 0
B L 6110	6	220	8 9 0	6 0 0

\*NOTE: For 12-volt batteries, double the price of the 6-volt.  
The Ignition Capacity is double the Actual Capacity taken at the 20-hour rate.  
Price for Teak Carrying Crates or Cases on application.  
The name "FULLER" is behind every one of these batteries, a certain guarantee of quality, for nothing but the best and purest materials are used in the manufacture of their products.

## DO NOT MISS THIS SPECIAL OFFER

We have made a special purchase of 1,000  
**POLISHED TEAK CASES**  
(as illustrated)

to take Type 640 (6 volts 40 ampere hours) complete with outer terminals brass hinges and fastener, and solid leather strap.  
We offer one of these cases, as long as the stock lasts.

## ABSOLUTELY FREE of CHARGE

to all purchasers of this particular battery at 22 8s. 9d. The value of the case alone is 15s. Please add 3s. 6d. to cover cost of carriage by passenger train.

# The City Accumulator Co.

79, MARK LANE, — LONDON, E.C.3

Wholesale and Retail Distributors for Messrs. BURNDEPT, Ltd. Same Trade Discount Allowed as by Manufacturers.

**AGENTS —**

Phones:  
AVENUE  
1316, 91, 92, 93  
and 9976.

London: H. V. ALBROW, 56, George Street, Baker Street, W.1.  
Glos.: BRISTOL WIRELESS Co., 52, Cotham Hill, Bristol.  
Leicester: WALTER ROWE, LTD., 96, Granby Street, Leicester.

S. Wales: SOUTH WALES WIRELESS INSTALLATION Co., LTD., 18, West Bude Street, Cardiff.  
N. Wales, Lancs., Ches. & I.O.M.: THE "ALL-BRITISH" WIRELESS MANUFACTURES Co., LTD., 18, Vauxhall Road, Liverpool.

Telegrams:  
"TYCHE  
FEN.  
LONDON."

Codes: A.B.C. (5th Edition) and LIEBER'S





# On Your Wavelength!

Receiving America

Blind Spots

Low-temperature Valves

PROBABLY none but those whose aerials are high and situated in open positions have much chance of hearing amateur or broadcast-

ing transmissions from the United States. It is not, however, at all difficult to pick up some of the big American stations provided that you have a set of inductances sufficiently large to reach the great wave-lengths that they use. Tuned by a .001 mfd. condenser in parallel, a honeycomb coil of 1,250 turns will be able to deal with most of them, and on these long waves a fair amount of capacity in the primary circuit does not greatly matter. If you have a coil-winding machine you can make these big fellows for the cost of the wire, which is not a big item; or you can purchase the inexpensive but not very efficient slabs. These last are not too easy to use owing to their large self-capacity. Annapolis (NSS) works on 17,000 metres, sending at 1.30 a.m., 1.30 p.m., 4.55 p.m. and 10 p.m. G.M.T. Marion (WSO) is engaged almost continuously on Transatlantic traffic, working on 11,500 metres, and Tuckerton (WGC), whose wave-length is 16,100 metres, is seldom silent for long.

\*\*\*

I. A. has sent a most interesting letter with reference to the paragraph on blind spots which appeared in "On Your Wavelength" a week or two ago. It was mentioned then that parts of Cheshire were reported to be bad for wireless reception. I. A., whose station is in the Wirral Peninsula, cannot get 2LO at all in the daytime even with five valves; at night-time he comes in faintly. Considering that this station is heard in Shetland on a single valve this is extraordinary, and seems to point to the presence of a small blind spot, especially as a friend of I. A.'s, living only two and a half miles away, receives the transmissions very strongly with a rectifying valve and two note magnifiers. Matters are complicated by the fact that I. A. can receive 2MT on three valves, whilst friends near by cannot get him at all. Again, he receives both PCGG and FL strongly, though friends fail to get the former and receive weak telephony from the latter. It looks as though some underground vein of metallic ore were causing the waves to deviate from their courses in curious ways. Will other readers who have come across similar instances of the vagaries of ether waves please send in brief reports? They

would make most interesting reading. The direction of the aerials concerned should be mentioned, as well as any screening of them that may exist.

\*\*\*

Have you ever wrestled with a set that refused to work until your head buzzed, your brain reeled and your heart was sick within you? Have you ever traced out the wiring and found it all correct; thought of every possible fault, looked for it and found it not? Have you ever in blank despair resolved to give up wireless and take to knitting? Of course you have, or if you haven't you will some day. 'Tis a thing that happens to every amateur wireless man sooner or later. My time of trial came a day or two ago. Signals, if they were there at all, were so faint that they were barely audible. Nothing appeared to be wrong anywhere in the inner parts of the set, still something was very obviously amiss. Take three guesses. Give it up? Well, the grid condenser of the rectifying valve had broken down in some mysterious way, and that was that. You'll agree that it was about the last thing that one would look for.

It is curious to observe how often the obvious will escape one's notice when one is looking for faults. A friend not long ago spent the best part of the day in taking his set to pieces and putting it together again in the hope of finding out what was wrong with it. And all the time the filament of one valve was resting gently upon the grid. Another friend was about to hurl his disembowelled set through the window when something suggested that he should test his accumulators—you really can't expect much from about 2 volts!

\*\*\*

Speaking of small voltage, though, have you tried one of the low-temperature valves that are now on the market? Some of them work on as little as 1.8 volts with a current of only .11 of an ampere. In fact their requirements are so small that they can be run quite well from any primary battery that will give a steady current. The great thing against them is their high initial cost, but this is counter-balanced by their long life and the saving in the cost of recharging batteries. As they work with the filament only just red-hot, they will outlast three or four ordinary valves. The low temperature of the filament does away with the crackling that is too often associated with a brightly glowing valve. For some reason these low-temperature valves are a little micro-

Problems in Wireless

The Oscillators

Micro

phonic, producing a slightly metallic tone in the receivers, but this is not bad enough to be unpleasant. There is no doubt that when they can be manufactured and sold at a reasonable price they will displace all other kinds for receiving purposes.

\*\*\*

Interference from sets, whose owners will allow them to oscillate in spite of prayers and threats, is becoming beyond a joke. There are times when re-radiation is so bad that one switches off in disgust. Anyone who has a valve set containing only primary and reaction coils should realise that he is about as popular with wireless users as a mad dog is amongst ordinary men. There are three people near me who deserve to be hanged from their own aerials. I do not know their names, but I can always recognise them by their peculiar methods of tuning. Ham-headed Henry moves his condenser knobs with great majestic sweeps—SQUEEEEEEEAL. Timid Thomas, on the other hand, prefers the method of rapid jerks from side to side—squeak-squawk, squeak-squawk, squeak-squawk. But the worst of all is Oscillating Oswald, who is never quite satisfied with his tuning; he is always giving things a touch here and a poke there. Could I but find a good, sound, old-fashioned witch I would have the evil eye put upon the lot of them. If only they and others of their kidney would reduce their filament current by means of the rheostat before starting their condenser-wangling, there would be a great peace in the land. It is a simple matter to increase the resistance a little during searching, which prevents oscillation, and then to brighten the filament once the desired station has been found. Meantime, if any out-of-work enchanter wants the job of turning Henry and Thomas and Oswald into lop-eared rabbits with pink eyes let him apply without delay to me.

\*\*\*

"If you see the prefix *micro*-tacked on to any electrical term you know at once that it means millionth of." So says an American text book, but our microphone simply won't believe it! THERMION.

A deputation representing the Empire Press Union will wait upon the P.M.G. early in January to get from him a declaration of policy regarding the Empire Wireless Chain.

# All About the Valve.—X

This Article Concludes the Series Describing the Principles and Action of the Thermionic Valve

If an alternating current of audible frequency is supplied to the plate in place of the steady voltage from the D.C. generator, the stream of C.W. radiations is broken up into audible groups or trains and may be received without heterodyning—for example, by a crystal detector. Such signals are called tonic train. The pitch

Fig. 18.—The Dynatron or Negative-resistance Tube Oscillator.

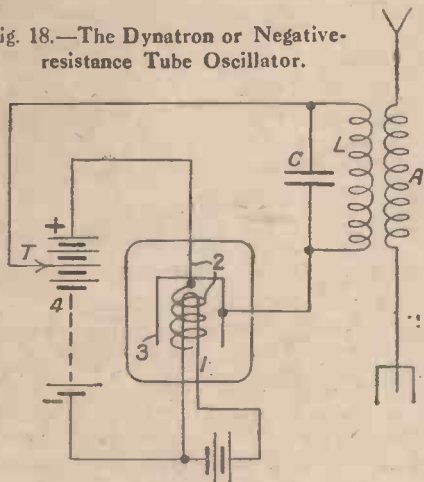

of the note in the receiving phones corresponds to the frequency of the alternating current applied to the plate of the generating valve. For long-range transmission it is usual to employ a number of tube-generators connected in parallel.

## Modifications of the Valve

There are at present in existence many ingenious modifications of the three-electrode tube. These are too complex and varied to be dealt with in the present article, but it may not be out of place to refer very shortly to one remarkable variety called the dynatron.

A diagrammatic sketch of the dynatron is shown in Fig. 18. It consists of a filament 1, surrounded by a spiral wire 2, which in this case forms the anode and carries a high voltage from the battery 4. Surrounding both these is a third electrode consisting of the metal cylinder 3 containing in its external circuit a condenser C and inductance L, which determine the frequency of the oscillations generated. The three elements are enclosed in an evacuated globe. The potential of the cylinder 3 is derived from a tapping point on the battery 4.

As there is a high positive potential on the spiral 2 there will be a considerable flow of electrons from the filament to the spiral. If the cylinder is kept at the same potential as the filament practically none of the electron stream will reach it. If, however, a small positive potential is

applied to the cylinder, more of the electron stream will impinge upon it after passing through the spaces between the spiral electrode.

By increasing the positive potential on the cylinder by means of the adjustable tapping T it will receive an increasing number of electrons, and owing to their velocity under the added attraction of the static field they will strike it with a considerable impact.

## Electronic Velocity

Ultimately the velocity may be increased to such an extent that the force of the impact is sufficient to "knock off" secondary electrons from the substance of the cylinder itself. These secondary electrons will thereupon be attracted by the more positive charge on the spiral element, and thereby will form a second current flowing from the cylinder 3 to the spiral 2.

At first only a few of such secondary electrons are liberated, but soon there are as many set free as are received by the cylinder. In other words, each received electron upon impact liberates a secondary electron which passes to the spiral electrode. At this stage no current is being received by the cylinder.

If the cylinder potential be still further increased the number of secondary electrons liberated exceeds the number received—that is, some of the electrons on impact release two or more secondary electrons. As a result the cylinder circuit supplies current to the spiral circuit instead of receiving current.

This is clearly shown in Fig. 19. The part AB of the curve represents the increasing current in the cylinder circuit. From B to C shows a lessening of current, until at C as many secondary electrons are released as there are primary electrons received, and there is zero current in the cylinder circuit.

From C to D the number of secondary electrons liberated continues to increase and the reverse current grows in value. The point D is finally reached, however, at which the potential of the cylinder so closely approaches that of the spiral that the number of secondary electrons lost by the cylinder again begins to decrease, as there is no longer a sufficient static attraction towards the spiral element. This process continues until, at the point E, the number of secondary electrons which leave the cylinder and do not return has again become equal to the number of primary electrons received, and the net current is again zero.

By suitably adjusting the initial voltage

applied through the tapping T to the cylinder 3, continuous oscillations may be set up in the cylinder circuit, the voltage variations arising from each pulse of current being sufficient to maintain the circuit in a state of persistent oscillation.

The frequency of these oscillations is adjusted by means of the inductance L and condenser C, and they may be fed to

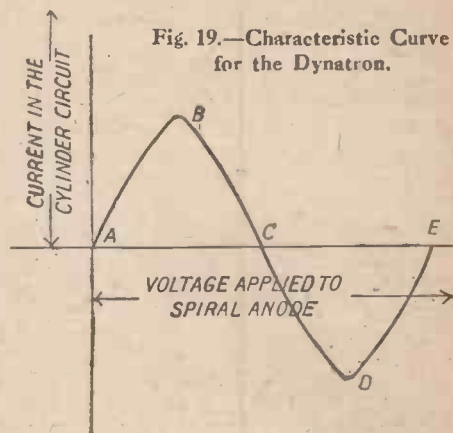

Fig. 19.—Characteristic Curve for the Dynatron.

a transmitting aerial A (Fig. 18) in the ordinary way.

The dynatron is a typical example of a thermionic device possessing a "negative resistance" characteristic. There are many other varieties having this feature, and in general all such arrangements may be utilised to generate continuous electrical oscillations.

D. ALCASE.

## Amplifying Buzzer Tones

WHEN making detector adjustment tests, ordinary magnetic buzzers are generally used. Although quite convenient, the faint tone emitted is not as desirable a signal as could be wished for.

The tone can be raised by simply placing tightly-folded strips of paper between the magnet core and armature and between the armature and contact spring. The requisite thickness of paper may be determined by experiment.

Instead of the paper, rubber bands may be used if they are wound tightly round the buzzer in such a manner as to occupy the same position as the paper.

In further adjusting the buzzer for a higher tone, the contact screw must also be regulated.—Radio Digest.



# A Page in Holiday Mood

## "Blenny"

IF there is one thing more than another I admire about Blenny it is the fine fresh enthusiasm with which he greets the advent of any new hobby. When the hand camera first made its appearance he became one of the pioneers of semi-libellous portraiture, and many of his efforts are still unsurpassed as trick-takers when our little circle indulges in the joyous game of photo-bridge.

With bicycles, motor-cycles and cars it was just the same. When the safety bicycle arrived Blenny discarded his bone-shaker and demonstrated the wonders of the new machine before an admiring group of friends. His disappearance into the nettlebed and the subsequent lament, which made the finest outbursts of the Greek tragedians seem but poor, feeble things, are still remembered. And there was the adventure with the little pigs in the narrow country lane. He was fortunate, we told him, in choosing animals so well upholstered—might they not have been goats?

He pitched Mrs. Blenny out of trailers, upset her in side cars, and left the pair of them stranded miles from anywhere. His motor-cycles could be counted on to convert themselves into the push variety on the hottest of days. Shortly after

acquiring his first car he developed bed-sores on his back. He diabolized most of Mrs. Blenny's best china into the ashpit, and pogoed through the nursery floor.

You will not be surprised then if I tell you that when I boarded the five-forty-five a few nights ago I found Blenny immersed in a work entitled "The Ether's Wondrous Waves" or something of that kind.

He looked up as I entered and began immediately to attempt to fire me with enthusiasm for his newest love. Had I a set? No? Then I was missing the most splendid kind of entertainment that there had ever been.

As the train slowed down he urged me to come in that very evening to hear my first wireless concert. Knowing that it would have to be done sooner or later, I accepted.

When I entered Mrs. Blenny's drawing-room after dinner I found that the attack of wirelessmania was more acute even than I had at first suspected. The polished surface of her best table was covered with an array of queer things, some with little knobs for tuning, and others that shut up or extended like telescopes. The name wireless seemed a misnomer, for between the instruments lay one of the most fascinating entanglements that I have ever seen. The room was strewn with batteries, coils, bits of wire and miscellaneous tools.

Blenny moved to the table and turned on a row of quite pretty little lights. They were not, he informed me rather testily in reply to my inquiry, the footlights. He began to twiddle the knobs and to push things in and out. His brow grew wrinkled. He made little impatient noises from time to time. The set made none.

He twiddled something else, and the cry of the amorous tomcat filled the room.

"Splendid!" I cried. "I love animal imitators. I do hope he'll do the sea-lion—through a lamp glass, you know."

Blenny explained, a little wearily I thought, that this was not really an item of the programme. It was merely misbehaviour on the part of the set. If you let it continue you were liable to have your licence endorsed for furious howling or something of that kind. I do not wonder.

He fiddled with something else. There was another howl, louder and more melancholy than the first. "Must be the thing-mejig that's wrong," he sighed. "We'll see."

He laboriously disembowelled one of his contraptions with a screwdriver and a pair of pliers, but found it all as it should be. The thingmebob and the what's its name were also above reproach. He replaced his bits and pieces and tried once more.

The thing howled again.

"If this was anybody else's set," said Blenny wildly, "I'd say that the aerial wasn't connected."

"Is yours, dear?" asked Mrs. Blenny. "The window cleaners were here to-day."

With a groan Blenny flung open the french windows and strode out into the night. . . .

He sat down once more to the set, moving things feverishly about.

Suddenly the horn began to pipe like a canary.

"Here it is," cried Blenny.

"Is that the concert?" I asked.

"No, the carrier-wave, you idiot. Now we'll see."

The chirpings grew shriller and yet more shrill, then settled down to a hoarse rasping.

Then the thing found voice.

"Hullo, hullo, hullo!" it said.

"There we are," said Blenny, beaming.

" . . . 2 LO speaking," the voice continued. "We are now closing down. Good night, everybody."

\* \* \* \*

This is almost a true story. Let me make its veracity perfect. It was I who enacted the part of Blenny. H. R.

## An Amateur's A.B.C.

- A is for AERIAL, ever so high.
  - B is for BATTERY, usually dry.
  - C for CONDENSER, which stores up a charge.
  - D the DETECTOR, finds signals at large.
  - E is for EBONITE, good as a base.
  - F for the FORMER, each turn in its place.
  - G is for GRID-LEAK, 2 megohms or so.
  - H is for HOLDER, whose function you know.
  - I for INDUCTANCE, to tune in the set.
  - J for the JAMMING we usually get.
  - K for the KEY with a delicate touch.
  - L for the LEADERS who teach us so much.
  - M for MARCONI, the man of the year.
  - N is for NAUEN, whose signals we hear.
  - O is for ORA, its value well known.
  - P is for PARIS, heard clear in the phone.
  - Q is the QUESTION we ask you to state.
  - R the REPLY at the earliest date.
  - S for the SPARK, that is often so clear.
  - T for the TELEPHONE, held to the ear.
  - U for UNITED, by wireless speech.
  - V for the VALVE, that has brought it in reach.
  - W for WAVE-LENGTH, on which the signal's sent.
  - X is for X'S; we all know what is meant!
  - Y is for something that's not seen in the set;
  - Z is another one, I haven't found it yet!
- VECTOR.



Something New in Fancy Dress Costumes. The photograph shows Mr. H. V. Batton, Hampstead, as "Amateur Wireless." The costume gained him the first prize.

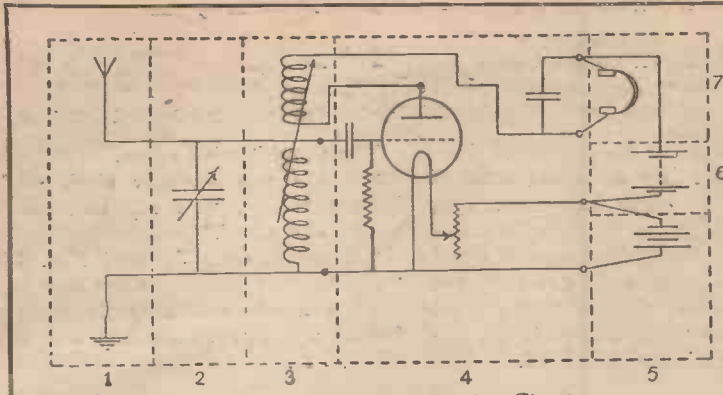

Fig. 1.—Single Valve Receiving Circuit.

A Complete  
Valve Set  
for £4



Fig. 1b

MANY amateurs, while fully realising the many advantages of a valve over a crystal receiver, are deterred from adopting the former by reason of its greater expense. It is hoped that this article may be useful to such in indicating how a complete valve set may be constructed at a comparatively low figure. This set is built on the "unit" system, so that from time to time improvements may be made in one component without inter-

6. High-tension supply ... ..	0	4	0
7. Phones ... ..	1	12	6
			£3 19 6

**Aerial and Earth**

	s.	d.
1 lb. (about 140 ft.) No. 18 S.W.G. bare copper wire ... ..	2	0
4 reel insulators ... ..	1	4
9 in. thick rubber tubing for lead-in ... ..	0	4
	3	8

capacity across T<sub>1</sub> and T<sub>2</sub>, but if A and C be rotated through 180 deg., A becomes opposite to D, and C opposite to B, and a condenser is formed, since A is connected to one terminal and D to the other. By rotating the plates A and C various capacities may be obtained.

A simple variable condenser on this principle can easily be constructed. A box 4 in. by 4 in. by 1 in. should be made out of cigar-box wood, and to the under side of the top two pieces of tinfoil (such as is used for wrapping chocolates, etc.), should be attached by means of shellac varnish. The shape of the tinfoil is shown in Fig. 3. Two tags protrude through which two terminals pass. A piece of thin mica about 0.004 in. thick is then placed over

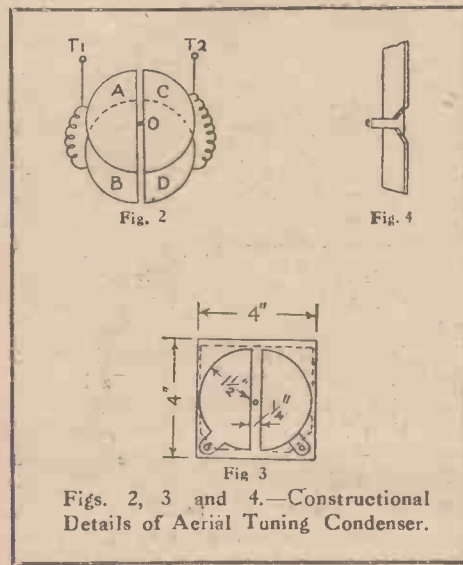

Ordinary bare copper wire makes a very good aerial. Stranded wire is stronger but something of a luxury. A single-wire aerial is easier to erect than a double one, and is preferable in every way if the full length can be obtained (100 ft., including lead-in). The aerial may be slung between two chimney-stacks and should be as high as possible, one end being led in through the rubber tube insulation in a hole in the framework of the window. To ensure good insulation two insulators of the reel type are recommended at each end of the aerial. The earth-lead should be as short as possible and should be soldered to a water-pipe connected directly with the main (not to a cistern). Some of the wire left over from the aerial may be used for this purpose. If a water-pipe is not available plates may be sunk into the ground and the earth-lead attached thereto.

fering with the others, and additional amplifiers may be added at will without any internal alterations to the existing set.

Fig. 1 shows a simple valve receiver, and the dotted lines divide it up into seven components, each of which will be described separately. The following list will give some idea of the cost of the material for each component:

	£	s.	d.
1. Aerial and earth ... ..	0	3	8
2. Aerial tuning condenser ... ..	0	2	0
3. Aerial tuning inductance and reactance ... ..	0	5	4
4. Valve panel and valve (15s.) ... ..	1	5	0
5. Low-tension supply ... ..	0	7	0

**Aerial Tuning Condenser**

	s.	d.
1 Knob and pointer with set screw ... ..	1	0
Mica ... ..	0	6
2 Terminals ... ..	0	6
	2	0

Four semicircular plates, A B C D, are arranged as shown in Fig. 2. A and C are insulated from one another and are mounted together so that they can rotate about O, and the plates AB and CD are connected by two flexible wires. In the position shown there is a negligible

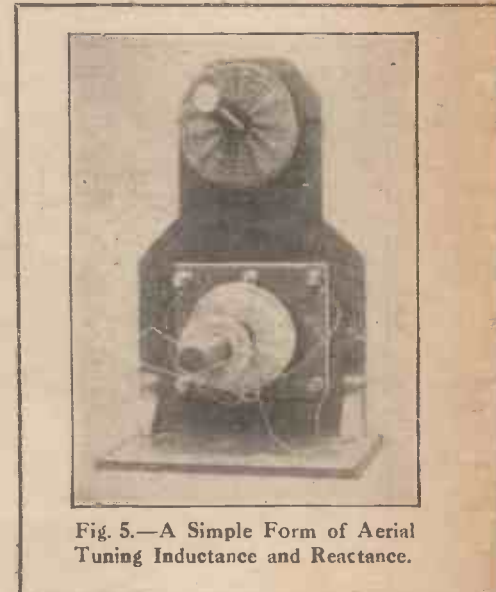
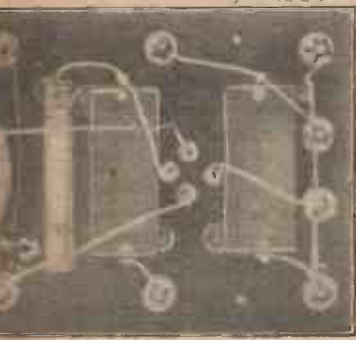

Fig. 5.—A Simple Form of Aerial Tuning Inductance and Reactance.

the tinfoil, as shown by the dotted line. This may be obtained from the mica supplied by ironmongers for oil stoves. It may be split by burring over the edge and inserting the finger-nail, and the piece used should be the thickness of this paper. A piece of cigar-box wood should then be cut into a circle of 3 1/4 in. diameter and a





—Inside of Valve Panel.

**Specification :**

- Aerial
- Aerial Tuning Condenser
- Aerial Tuning Inductance and Reactance
- Valve Panel, Valve Batteries, Telephones

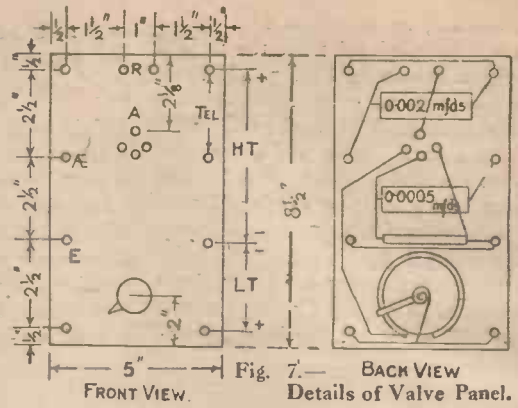

$\frac{3}{16}$ -in. centre hole drilled, two small countersunk holes being made at each side of this. Two semicircles of tinfoil,  $1\frac{1}{2}$  in. radius, should then be cut out and shellacked to the disc of wood on the side on which the holes are countersunk, the semicircles being separated by  $\frac{1}{4}$  in., as in the case of the tinfoil-fixed to the top of the box. A screw is then pushed through the tinfoil covering each of the countersunk holes, and screwed right into the wood, so that it protrudes at the other side, and the flat head of the screw is below the surface of the tinfoil (Fig. 4). Contact is thus made between the brass screw and the tinfoil. On the other side of the disc a small brass bridge is placed over the centre hole with a  $\frac{3}{16}$ -in. hole drilled in it.

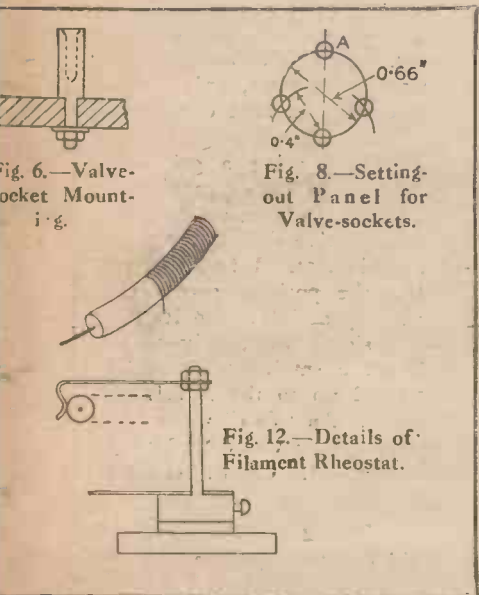

Fig. 6.—Valve-socket Mounting.

Fig. 8.—Setting-out Panel for Valve-sockets.

Fig. 12.—Details of Filament Rheostat.

The surface of the mica is then rubbed with a piece of cloth damped with olive oil. This is to ensure the smooth working of the condenser.

The disc is placed over the mica with the tinfoil side next to it, and a short  $\frac{3}{16}$ -in. spindle screw at one end is placed through the centre hole of the top of the disc and

a nut placed on each side of the bridge to prevent the spindle rotating without the disc. The knob may then be attached to the other end of the spindle. Each of the pieces of tinfoil on the rotating disc is connected to one of the pieces fixed to the top by means of a spiral coil of No. 28 d.c.c. copper wire.

A condenser such as described has been used with very satisfactory results and was found to have a maximum capacity of 0.00035 mfd. This value is somewhat small, but the maximum capacity can be increased if desired by providing one or more fixed condensers of about 0.00035 mfd. (such as used in the valve panel), which may be placed in parallel with the variable condenser by means of a plug or switch.

**Aerial Tuning Inductance and Reactance**

- |                                 |       |
|---------------------------------|-------|
|                                 | s. d. |
| 1 lb. No. 28 d.c.c. copper wire | 4 4   |
| 4 terminals                     | 1 0   |

For those just commencing to use a valve set it is a good plan to make a very simple form of A.T.I. and reactance. A number of coils of the slab and basket type should be made from No. 28 d.c.c. wire. One of the coils may be used as a reactance and another for the A.T.I., and coupling produced by resting one flat on the table and sliding the other over the top. Large wave-lengths may be obtained by connecting two of the larger coils in series with each other to form the A.T.I.

An improvement is shown in the photograph (Fig. 5), where the coils may be moved about on a horizontal spindle, the upper spindle being a holder for spare coils. The four corner terminals are connected to the A.T.I. and reactance terminals of the valve panel respectively. The middle one is used as a common terminal when two of the coils are being connected in series. The ebonite is not a necessity, for if a piece of dry wood is well treated with shellac varnish it may be dispensed with. It is not suggested that this is as good as the more elaborate tuners,

but it is less expensive and simpler for a beginner. Telephony can be received quite satisfactorily.

**Valve Panel**

- |   |       |
|---|-------|
|   | s. d. |
| 1 piece of ebonite about 5 in. by 8 1/2 in. | 3 6   |
| 4 valve sockets                             | 1 0   |
| 1 ebonite knob with pointer and set screw   | 1 0   |

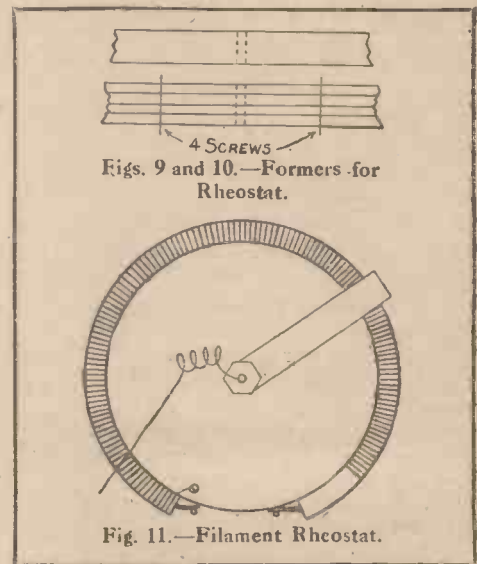

Fig. 11.—Filament Rheostat.

- |  |     |
|--|-----|
| 1 piece of mica  | 0 6 |
| 10 terminals No. 4 B.A.  | 2 6 |
| 1 cigar-box (about 8 in. by 5 in. by 2 in.)  | 0 1 |
| 1 reel of flower wire  | 0 1 |
| Pieces of cigar-box, small brass screws, length of H.T. rubber cable, tinfoil, scrap ebonite, brass wire, slate pencil, glass tubing | 1 4 |

The valve panel contains a valve holder, filament rheostat, grid leak and condenser, and telephone condenser. These may all be bought or made at home.

The valve holder is made by fixing the four valve sockets to the ebonite panel, as shown in Figs. 6 and 7. The panel should be drilled, as shown in Fig. 8, the ebonite being marked off with the hole A in the position shown in Fig. 7. If there is any serious difficulty in inserting the valve it is a good plan to slacken the nuts of the sockets, then insert the valve and tighten them up again. The valve should then take in and out quite easily; if not, the holes in the ebonite should be slightly enlarged.

For the filament rheostat a former about 2 in. in diameter is required to be turned, as shown in Fig. 9. If a lathe is not available a good former may easily be made by cutting out four circles of cigar-box wood with a fretsaw, two 2 in. in diameter and two 2½ in. in diameter. These should be fixed together, as shown in Fig. 10. A length of rubber high-tension cable (such as is used to connect the sparking plug of an engine to the magneto) is then cut so that it will almost reach round the circumference of the former. Round this is coiled the flower wire, each turn being wound as closely as possible to its neighbour without touching it. The winding should not be taken right to the end of the cable in one case, but to within about ⅜ in. of the end. The ends may be secured by slipping them underneath the previous turn. The H.T. cable is then mounted on the former, as shown in Fig. 11, being fixed by attaching the two ends of the inner stranded wire of the cable to screws in the former.

A short length of brass rod about ⅛ in. in diameter screwed at one end is required this is inserted through a hole in the centre of the former and the ebonite knob attached to the unscrewed end by means of its set screw. A contact arm is then required, and may be made out of a piece of hard, springy brass or copper, or better, phosphor-bronze strip. This should be about ¼ in. by 1¼ in., and should have a hole drilled in one end, so as to be attached to the brass spindle between the two nuts. The other end is bent so as to make contact (Fig. 12) with the flower wire. Two small screws are then fixed to the former to serve as stops for the moving arm, and to one of these the end of the flower wire from the end which is wound to the end of the H.T. cable should be soldered. The rheostat is then ready for mounting on the ebonite panel. It may be fixed by a countersunk wood-screw, a small tapered hole being first made in the ebonite, but not right through. An ordinary countersunk bolt and nut may be used, but the wood-screw method avoids showing any bolt heads on the top side of the panel.

A photograph of the near side of the valve panel is shown by Fig. 13.

(To be concluded)

## Radiograms

IT is suggested that a band of amateurs should be formed in Glasgow with the object of searching out the operators of valve sets who are allowing them to interfere with the reception of their neighbours. Like other congested areas Glasgow suffers considerably from this nuisance; one prominent experimenter has offered the use of a direction finder and a motor car in tracking down the offenders.

A directional wireless station has been erected at Hallo, in Sweden, with the call letters SAM. This station will give ships calling within 150 miles their bearing. The charge for each bearing given is placed at 5s. 9d.

The British Broadcasting Company was duly registered as a limited company on December 15th.

An agreement has been made by the British Broadcasting Co., Ltd. with the following press agencies: Reuter's, the Press Association, the Central News and the Exchange Telegraph Company for the supply each day of a summary of the world's news.

It is probable that the Savoy Havana Band will play part of the Christmas broadcast programmes, so that the dancers at the Savoy will have the novel experience of listening to their usual orchestra by wireless.

A Committee of the Cabinet has been set up for the purpose of once again going into the question of the Imperial wireless chain.

At the general meeting of the Gramophone Company, Ltd., held recently, the chairman explained that wireless telephony and broadcasting in its present state was not likely to affect the company's business.

A steam locomotive was recently successfully controlled by wireless in America.

A new Belgian wireless company has been formed under the title of La Société Belge Radio Electrique.

## CORRESPONDENCE

### Fading

SIR,—I have read with interest the article in a recent issue on "Fading Signals," and suggest that experiments should be carried out. By obtaining the co-operation of your readers and choosing a certain evening (correct time to be taken as the first stroke of the hour from Marconi House) observations could be readily made and results forwarded to you by the observers. The details of organisation, I feel sure, are best left to you, although I am willing to help in compiling the data into a form for easy analysis.—H. V. M. (Plumstead).

[We shall be glad of other readers' opinions.—ED.]

### 5 H Y and 5 H Z

SIR,—Can any of your readers inform me who 5HY and 5HZ are? I have heard very loud telephony from both these stations when I have been listening to the Birmingham Broadcasting Station. Someone has suggested that 5HY is a station on one of the islands off the extreme north coast of Scotland. Is this so?—S. W. (London).

### P C G G on the Valve

SIR,—I think it may interest some of your readers to hear that P C G G was received by me on Sunday 3/12/22 using the single-valve detector panel described in the "Work" Handbook. The music came in quite clearly, although it was difficult to follow the announcements, only words here and there coming in loud enough to hear.

In my panel I am using a grid-leak consisting of a piece of slate pencil with graphite lines, and it is placed across from the grid condenser (valve side) to the positive side of the filament. I find this an improvement on the position across the grid condenser. My aerial is 100 ft. (including lead-in), single wire, only 20 ft. above ground, but a small indoor aerial was also connected up to the A.T.I. on the above occasion. An "Ora" valve was used, and the fine tuning was done by the filament resistance.—H. C. B. (Forest Hill).

### 5 G B

SIR,—I should like to register a protest through the medium of your paper of the use of my call-sign, 5GB, being made by some other amateur in Liverpool or district. Naturally, I have strong objections to such a practice.—L. HUMPHRIES, 61, Geraint Street, Liverpool.

### "Wireless Telegraphy and Telephony"

The most Practical Handbook for the Amateur. The price is 1/6 net.

Our gratis list of Technical Books contains particulars of this splendid little work.

The Prince of Wales listened in to a wireless message broadcast from 2LO on Dec. 13 by Sir William Noble whilst he was on a visit to Devonshire House.



# Manchester Broadcasting Station

THE Manchester Broadcasting Station (2ZY) has established a reputation for the excellence of both its transmission and its programmes.

## The Station

The station is situated in the research department buildings of the works of the Metropolitan Vickers Electrical Company, Ltd., Trafford Park, Manchester. This company is technically very closely associated with the Westinghouse Electrical and Manufacturing Company, who were the pioneers of broadcasting in the United States, and has had at its disposal the whole of the experience and experimental work of that company.

Since its inception 2ZY has been working on 800 watts, but by the time this description of the plant and methods of the

commutator. In this case it is very efficiently done by passing the current through a filter circuit consisting of in-

*A fortnight ago the Metropolitan Vickers Electrical Co., Ltd., entertained a party of journalists at Trafford Park, Manchester. Among the party was a representative of "Amateur Wireless." Here is his description of the broadcasting station and of the small experimental station at Hale, six miles distant.*

ductances in series, shunted with condensers. Fig. 1 shows the two generators together with the control panel.

## Transmitter Panel

The transmitter panel, shown in Fig. 2, was installed by the Radio Communica-

are necessary to retain all the real brilliance of tone whilst cutting out echo. A great deal of experimental work has had to be done to determine both the right size for the chamber and the most suitable material for the draping.

A switchboard (to be seen on the left side of the photograph) connects the various microphones with the transmitting set. All the circuits are run in separate cables to avoid inductive effects. On the panel is a lamp which is used for signalling that the transmitting set is working, and when the lamp is glowing no sounds must be made other than those to be transmitted.

## Musical Equipment

The equipment of the studio consists of a Steinway grand piano to which can be

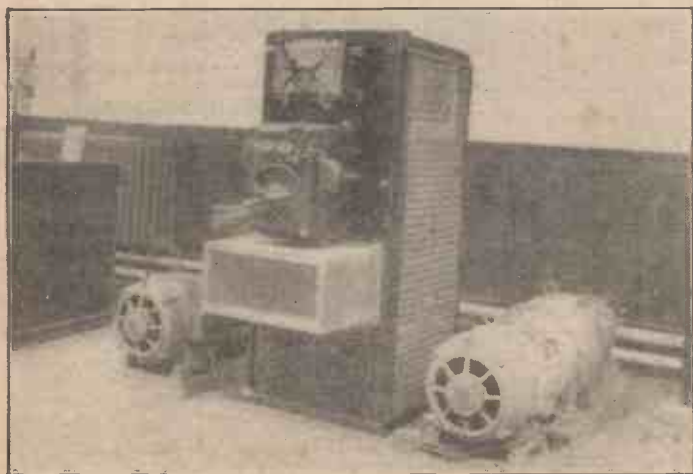

Fig. 1.—Generators and Control Plant.

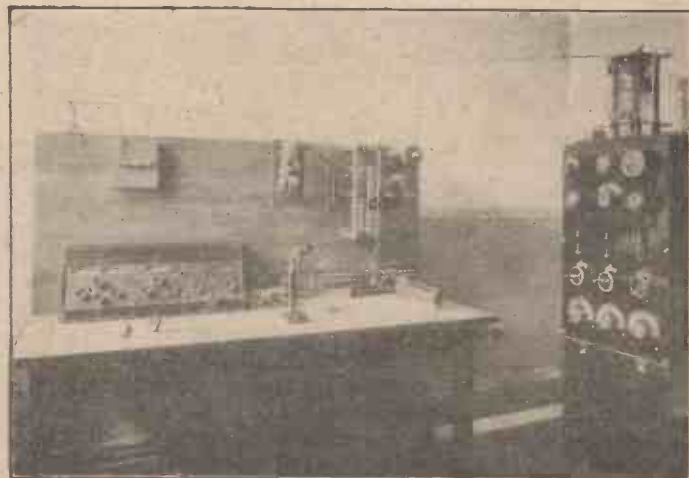

Fig. 2.—Transmitter Panel.

station is in print it should be using the full 1,500 watts for which it is licensed. It started on the lower power in order that the many problems to be solved should not be unduly complicated.

## Power

The power for the transmitting set is supplied by a small 50-cycle 3-phase generator in the works power-house. This delivers 440 volts and is employed to drive a triple set consisting of an induction motor, high-tension generator and exciter supplied by Newton Bros., Derby. The high-tension generator is rated at 2.5 kw. at 5,000 volts and runs at 1,500 revolutions per minute. Two of these sets are installed, and a complete changeover of drive and supply can be effected in emergency by throwing a single switch from one side to the other. One of the problems of transmission is that of getting rid of the noises, or "ripple," caused by the very rapid make-and-break of the generator

tions Company of London, and employs three Mullard 0-500 valves. The high-tension direct-current supply at 5,000 volts is supplied direct to the plates, and a suitable protective gear is provided to protect the generating set against short circuits. The filaments of the transmitting valves are heated from a 30-volt battery. The character of the modulation given by the transmitting set can be checked in the small transmission room by means of either a set of headphones or a loud speaker.

## Studio

The studio, in which are given the concerts that are broadcasted, is a draped-off portion of a spacious room adjoining the transmission room. A photograph of this is shown on the cover. It is arranged to give the utmost acoustic efficiency and to eliminate all resonance and echo. Resonance is not desirable, and the carpeting of the floor and draping of the room

is fitted a Welte player attachment. In addition, there is an Edison diamond-disc gramophone and an Æolian "Vocalion Graduola" gramophone. The ordinary desk telephone on the table beneath the control switches is used for announcing the items and for the broadcasting of news.

## Microphones

The speech and music to be broadcast is picked up by microphones supported on convenient adjustable stands. One of these stands, with the microphone hanging from it, is seen on the right of the picture. The sound energy, having been translated into electrical energy by the microphones, is given preliminary amplification through three to five valves before it is passed to the transmitting set.

The placing of the microphones in relation to the performers is a matter in which constant experimental work is being carried out. The distance depends entirely on the character of the sounds that are to

be transmitted, and the whole question is one of considerable difficulty. The choosing of suitable performers is also of more difficulty than outsiders would suppose. Some voices and instruments that are excellent for chamber or concert-hall work transmit very badly, whilst others that are not nearly so successful in the ordinary way transmit very well. In this matter unceasing experimental work is being done at all the other broadcasting stations.

In the case of singers the problem is not only one of quality of voice. The ideal is to find vocalists and speakers who can, so to speak, project their personality into the microphone. Such people may or may not be rare; the difficulty is to find them. The quality is elusive, but when it is found it is welcomed by thousands of listeners-in. The "Uncle Humpty-Dumpty" who tells the children's stories at Manchester is a case in point. Already he is "snowed under" with letters from little friends he has made. Some of the letters have come from places over 300 miles from Trafford Park.

The aerial used by 2ZY is of the cage type, consisting of six wires supported by hoops. The average height is 160 ft.

In connection with the Trafford Park station is a small experimental station at Hale. This is used for both transmission experiments and as a "control" for the quality of the transmission from the main station. It has a small transmitting set of 100 watts, and is very completely equipped for listening-in. The aerial at Hale is 150 ft. long, triple wire, and is placed at a height of 75 ft. Most reception experiments, however, are done on a small subsidiary aerial within the limits set by the Post Office for those taking out broadcast reception permits.

The outstanding feature of 2ZY is the enthusiasm of all those connected with it. They are just as "wireless-mad" as the many thousands who nightly listen to their work. E. L.

**Wireless Handbook and Diary.**—A neat pocket diary for wireless amateurs has been published by the Radio Press, Ltd., of Devereux Court, Strand, London, W.C.2. In addition to the usual features of a diary a considerable amount of information and data of value to the experimenter is given. Its price is 2s. 6d.

**"Notes on Supersensitive Microphones"** is the title of an article that will be of special interest to wireless amateurs in the present issue of "Work." Other articles include: "Simple Repairs to Blowlamps," "A Pair of Wrought-iron Fire-dogs," "Finding Steam-engine Horse-power," "Keeping a Small Gate Shut," "Spoons, etc., Fusible in Hot Water," "The Saltosphere. A Suspended Cork Ball" (illustrated), "Some Novelties in Metal" (illustrated), "A Table-chair." Fully illustrated, price threepence, weekly.

## Improved Broadcasting Service

WHEN the regular service of broadcasting was first begun it was understood, of course, that the broadcasts were to be of an improvised and temporary nature, until such time as detailed arrangements could be made and the British Broadcasting Co. was formally registered. This latter event has now been accomplished and we are informed that at a very early date the programmes of the stations now operating will be considerably extended. Permanent stations are to take the place of the temporary ones with, it is hoped, a general all-round improvement. Stations at Newcastle, Cardiff and Glasgow are to begin working at an early date. In a recent interview Sir William Noble, chairman of the broadcasting committee, said, "May I ask the public not to judge of broadcast by the present service at the three temporary stations." Actual details of the programmes are not yet available, but they will include high-grade concerts, three news summaries from four British press agencies, and three daily weather reports.

### BROADCAST TELEPHONY

*Some of these transmissions are commercial or official. Wave-lengths and times are liable to alteration without notice.*

**London B.B.C. Station (2 L O),** 369 metres. Daily, usually 7 p.m. to 10 p.m.

**Manchester B.B.C. Station (2 Z Y),** 385 metres. Daily, 4.30 p.m. to 5 p.m., concert; 6 p.m. and 6.15 p.m., kiddies' corner; 6.30 p.m. to 7 p.m., reproducing-piano recital; 7 p.m., news bulletin; 8 p.m. to 9.10 p.m., concert; 9.15 p.m., second news bulletin; 9.30 p.m. to 10 p.m., miscellaneous concert.

**Birmingham B.B.C. Station (2 W P),** 425 metres. Weekdays, 6.30 p.m. to 6.45 p.m., children's stories; 7 p.m., news bulletin; 7.15 p.m. to 8.30 p.m., concert; 9 p.m. to 9.45 p.m., concert; 9.45 p.m., second news bulletin. Sundays, 8 p.m., news bulletin; 8.15 p.m. to 9.45 p.m., concert; 9.45 p.m., second news bulletin.

**Croydon (G E D),** 900 metres. Daily. Writtle (2 M T), 400 metres. Tuesdays, 8 p.m.

**Eiffel Tower (F L),** 2,600 metres. Daily, 5.20 p.m. to 7 p.m.

**The Hague (P C G G),** 1,085 metres. Sundays, 3 p.m. to 5 p.m.

**Rome (I C D),** 3,200 metres. Daily, 10 a.m.

**Königswusterhausen (L P),** 2,800 metres. Daily, 4 p.m. to 5.30 p.m.

**Amsterdam (P C A),** 1,800 metres. Daily, 1.10 p.m.

**Haren (O P V H),** 900 metres. Daily, every hour from 11.20 a.m. to 4.20 p.m.

### CATALOGUES RECEIVED

**Sterling Telephone and Electric Co., Ltd.**—Loud Speakers and Power Amplifiers.

**G. Z. Auckland & Son.**—Component Parts. **Wireless Supplies Co.**—Valve Sets and Crystalphone Complete Outfits.

**Saxonia Electrical Wire Co.**—Flexible Wires, Cables, Cords, etc.

**Medical Supply Association.**—Crystal and Valve Sets and Component Parts.

**Radiophones, Ltd.**—Valve Sets and Component Parts.

**T.V. Electrical and Wireless Supplies.**—Component Parts.

**Jeary Electrical Co., Ltd.**—Valve Sets and Component Parts.

## CLUB DOINGS

**Thames Valley Radio and Physical Association.**  
*Hon. Sec.*—E. A. ROGERS, 17, Leinster Avenue, East Sheen, S.W.14.

The secretary will be pleased to give full particulars of the above society to all interested.

**Croydon Wireless and Physical Society.**  
*Hon. Sec.*—B. CLAPP, Meadmoor, Brighton Road, Purley.

A most interesting lecture was delivered by L. F. Fogarty on "Different Methods of Charging Accumulators from A.C." The lecture was illustrated by a number of very clear drawings depicting the different methods, and was demonstrated by a large number of instruments including electrolytic, vibrating reed, and vacuum tube rectification, by which Mr. Fogarty charged accumulators at various rates up to 5 amperes.

**Birmingham Experimental Wireless Club.**  
*Hon. Sec.*—A. L. LANCASTER, Lancaster Bros., Shadwell Street, Birmingham.

The secretary will be glad to furnish particulars to intending members.

**Redditch and District Radio Society.**  
*Hon. Sec.*—A. W. REEVES, The Elms, Alvechurch, near Redditch.

PARTICULARS regarding membership may be obtained from the secretary.

**Bath Radio Club.**  
*Hon. Sec.*—G. J. CURTIS, 6, Pierrepont Street, Bath. APPLICATION for membership to be made to the secretary.

**Ashton-under-Lyne and District Radio Society.**  
*Hon. Sec.*—J. H. MARSHALL, 22, Warrington Street, Ashton-under-Lyne.

PARTICULARS of the above newly-formed society can be obtained from the secretary.

**Fulham and Putney Radio Society.**  
*Hon. Sec.*—J. WRIGHT, DEWHURST, 52, North End Road, West Kensington, W.14.

ON Dec. 1 Mr. Houstoun gave his experiences and described some wiring experiments he had made with the four-electrode valve. Mr. Calver described the results of trials he had made of various Armstrong circuits as published, and also mentioned that he had wired up a new circuit which gave good results.

**West London Wireless and Experimental Association.**  
*Hon. Sec.*—H. W. COTTON, 19, Bushey Road, Harlington.

At a meeting held on Nov. 24 Mr. C. A. Hillyer gave Part II of his paper entitled "Electrical Measuring Instruments," and everyone was deeply interested both with the data placed before them and the manner in which the paper was rendered. The secretary will have much pleasure in replying to inquiries respecting the objects and terms of subscription to this association.

**Chesterfield and District Radio Society.**  
*Hon. Sec.*—J. HANBIDGE.

The secretary will be pleased to hear from persons intending to become members of the above society.

**Wolverhampton and District Wireless Society.**  
*Hon. Sec.*—J. A. H. DEVEY, 232, Great Brickkiln Street, Wolverhampton.

THE weekly meeting of the above society held on Dec. 13 took the form of an exhibition of wireless sets, the chief object of the meeting being to show the various efforts made by members at building their own sets. The exhibits, which ranged from the simplest form of crystal set to the elaborate valve panel, were distinctly creditable. At intervals those present were entertained by the Birmingham broadcasting items, a loud speaker being in use.

**Leeds and District Amateur Wireless Society.**  
*Hon. Sec.*—D. E. PETTIGREW, 37, Mexborough Avenue, Chapelton Road, Leeds.

AN exhibition of apparatus and demonstration of wireless telephony was held on Dec. 1. Telephony transmissions were received from Mr. H. F. Yardley's experimental station 2LB on 400 metres. Broadcast items were also received. During the course of the exhibition numerous lectures were delivered by members of the society and others.

At a general meeting held on Dec. 8 the chairman called upon the president to give a lecture and demonstration of recording apparatus. The president outlined the work done on recording devices, paying particular attention to tuned trigger valve relays. The whole system of reception using a single valve receiver with a tuner trigger relay was clearly described, and with the aid of diagrams the action of the magnetic relay in controlling the valve relay oscillations described. The lecturer showed

(Continued on page 710)



# How the Telephone Receiver Works

THERE are a large number of beginners who, although making frequent, if not daily, use of that humble instrument the telephone receiver in some

ceased to flow the magnetic field vanished. Here then was a means of creating a magnet at will. It was then found that by making the wire into the form of a

transmitter flow round the coil the magnetic effect being made intermittently greater or less, the diaphragm will be made to vibrate between the three dotted lines as shown in Fig. 2. The vibrations thus produced will correspond exactly with the vibrations originally set up at the transmitting end.

The type of telephone receiver used in wireless is called the watch receiver, and although constructed in a slightly different manner, it works in exactly the same way. Figs. 3 and 4 show sections of a watch receiver.

R. A. F.

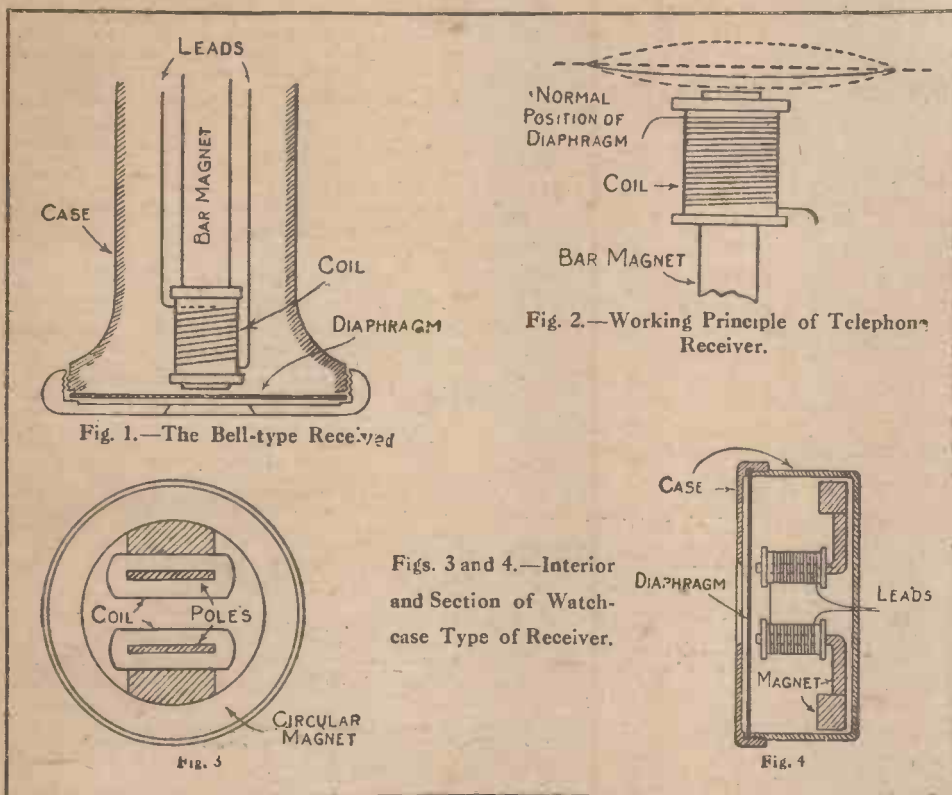

## Valve made from Motor-lamp Bulb

A VERY good thermionic valve can be made at the cost of about five shillings, according to a writer in *Radio Digest*. The necessary parts are: one Ford double-filament electric lamp, one strip of pure tin 3 in. long, 8 in. of adhesive tape, and one piece of copper wire about 6 in. long. On the base of the lamp bulb are two contact points. One leads to the dim filament and the other to the bright filament.

Twist a wire round the brass part of the globe and connect the other end to one side of a 6-volt accumulator. A wire from the other battery terminal is touched to each lead contact point to determine which filament is the dim one. When the dim filament is found, burn it out. This may be accomplished by applying a large voltage.

Attach the piece of tin on the outside surface of the bulb with adhesive tape as shown in the sketch, and solder wires to A, B, C and D. The burnt-out filament A

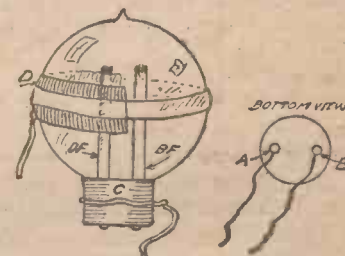

Valve Made from Motor Lamp and Detail of Connections.

form or another, have only a vague idea of the principle underlying it.

### Early Receivers

The receiver in the form that we have it when attached to the ordinary house telephone is practically identical to that which Dr. Bell first designed. If we opened a Bell receiver we should find inside just an ordinary bar magnet with a coil fixed round one end (Fig. 1). Against the end where the coil is and close up to it we should find a soft-iron diaphragm which is clamped at its edges by the case surrounding the receiver.

### Working Principle

The principle underlying the telephone receiver underlies almost every electrical instrument we have, that of electro-magnetism.

Early experimenters discovered that when a current of electricity was made to flow along a wire, that wire assumed the properties of a magnet during the time that the current was flowing. In other words the current set up round the wire magnetic lines of force, the space occupied by these lines being known as the magnetic field. When the current

coil the magnetic effect was much greater. This, of course, is obvious, for without going into technical reasons it will be quite plain that the lines of force, instead of being distributed throughout the length of one long piece of wire, are now linked up and thus concentrated in a small space.

To return to Fig. 1 it will be seen that the coil has two leads coming from it, and these are connected up with the transmitter at the other end of the circuit. The transmitter is made to send out electric currents of varying strength, which, when they reach the coil, make the latter into an electro-magnet, the strength of which varies in accordance with the currents flowing through it. We have seen that this coil is fastened to the end of a permanent magnet, so that the electro-magnet will be able to vary the total strengths of the two combined fields.

### Diaphragm

It has already been stated that the diaphragm is clamped to the edges, therefore the centre, being opposite to the pole of the magnet, will be attracted and cause the diaphragm to be slightly curved as shown in Fig. 2, this being its normal position. When the currents from the

is the grid. The wires B and C are the filament leads and D is the plate.

Extreme care should be taken to see that the "plate" is attached on the "grid" side of the globe.

These valves are cheap, efficient, and will last for a considerable length of time.

# OUR INFORMATION BUREAU

Expert Replies to Readers' Questions. Hundreds of Replies are sent by Post.

TO ENSURE A PROMPT REPLY PLEASE OBSERVE THE FOLLOWING RULES

Write distinctly, give all necessary details and keep to the point. Ask one Question at a time—never more than two. Send a Stamped and Addressed Envelope. Send the Coupon cut from page 714.

## Tuning Devices.

Q.—Will you explain the respective advantages and disadvantages of the many types of tuning devices at present in use, with their suitability both for crystal and valve apparatus.—H. C. (London) (5,997).

A.—There are various kinds of inductances for tuning purposes all of which should have a variable condenser in conjunction with them for fine tuning. Briefly slab, honeycomb and the basket coils have the advantage of giving the required inductance and yet being very compact and simple of construction. One great disadvantage with this type of coil is that the difference of potential between neighbouring turns is often greater than is desirable. In the case of cylindrical or single-layer coils the difference of potential between adjacent turns is practically nil, and there is little impedance to current flowing through the wire. The disadvantage of single layer coils is, that to receive any high wave-length it is necessary to build a large instrument. Maximum results with minimum selectivity are obtained with the single coil tuner. It is practically impossible, however, with single-coil tuners to tune out interference from any station near-by and consequently a two coil or loose-coupled tuner is necessary. This type of apparatus allows of very selective tuning for any wave-length. Variometers give fine tuning over a limited range of wave-lengths without the use of a tuning condenser and

provide a means of obtaining very fine tuning with a minimum of adjustments. They have the drawback, however, that selectivity of reception cannot be obtained; with vario-couplers the range of wave-lengths is very limited unless a massive instrument is constructed.—L.C.

**Removing Enamel from Wire.**—There is difficulty in scraping off enamel without breaking the wire. One way of removing the enamel is to pass the wire over a bunsen gas flame several times, until the enamel melts and drops off. If it is impossible to do this because of circumstances; the same result, says *Radio Digest*, may be secured by dissolving the enamel in amyl alcohol.

## CLUB DOINGS (continued from page 708)

the necessity of an "uprighting" magnetic relay before describing the pointer. A demonstration of the apparatus on view took place, signals being printed up to fifty words a minute.

### Sutton and District Wireless Society.

Hon. Sec.—E. A. PYWELL, Stanley Lodge, Rosebery Road, Cheam.  
ON Thursday, Dec. 14, a successful demonstration of wireless reception was given, and during the evening over 150 people were able to enjoy music transmitted from London, Birmingham and Manchester.

### Portsmouth and District Amateur Wireless Association.

Hon. Sec.—S. G. HOGG, 5, Pelham Road, Southsea. ALL inquiries may be sent to the secretary, who would specially welcome new members.

### Proposed Lee and District Amateur Wireless Society.

Will all persons interested communicate with A. H. Kidd, "Woodlands," 39, Burnt Ash Road, Lee, S.E.12, with a view to the formation of the above society.

### Sunderland Wireless and Scientific Association.

Hon. Sec.—A. RICHARDSON, Westfield House, Sunderland.

ON Dec. 16 Mr. A. J. C. Davis, of Marconi's Wireless Telegraph Co., lectured on "Wireless Direction Finding." The lecture was illustrated by excellent lantern slides. The lecturer said that before the development of the thermionic valve it was not possible to compress the large aerials then necessary for direction-finding into the limited space afforded by a ship. Such stations in those days were therefore situated in coastal positions. In an early German method a kind of umbrella aerial was employed, and a rotary switch was provided whereby various portions of the aerials were used in succession. This method was improved upon by using two triangular aerials at right angles to one another. The bases of the two triangles were made to include respectively two coils whose axes were also at right angles one to the other. A rotating "search coil," the secondary of the receiving set, was made to turn within these former coils and so give maximum and minimum strength of signals corresponding to the direction of the transmitting station. The advent of the thermionic valve made it possible for the two "loop" aerials to be small enough to be installed upon ships, and the arrangement described was used extensively by the Marconi Com-

(Continued on page 714)

# The Famous "WORK" Handbooks

Each 160 Pages. 1/6 net each; 1/8 post free.

Basket Making. With 151 Illustrations.  
Beehives and Beekeepers' Appliances. With 155 Illustrations.  
Bent Iron Work. Including ELEMENTARY ART METAL WORK. With 269 Illustrations.  
Bookbinding. With 125 Illustrations.  
Boot Making and Mending. Including REPAIRING, LASTING, and FINISHING. With 179 Illustrations.  
Building Model Boats. With 168 Illustrations.  
Camera Making. With 245 Illustrations.  
Clay Modelling and Plaster Casting. With 153 Illustrations.  
Clock Cleaning and Repairing. With 97 Illustrations.  
Conjuring Apparatus. With 167 Illustrations.  
Cycle Repairing and Adjusting. With 79 Illustrations.  
Domestic Jobbing. With 157 Illustrations.  
Dynamo and Electric-motor Building. With 145 Illustrations.  
Dynamo and Motor Erection and Management. With 94 Illustrations.  
Dynamos, Small. MAKING SMALL DYNAMOS AND MOTORS. With 132 Illustrations.  
Electric Accumulators. With 57 Illustrations.  
Electric Apparatus, Small. With 132 Illustrations.  
Electric Bells and Telephones. With 144 Illustrations.  
Electric Clocks. PRINCIPLES, CONSTRUCTION AND WORKING. With 213 Illustrations.  
Electric Lighting. With 65 Illustrations.

Electric Primary Batteries. With 91 Illustrations.  
Electro-plating. With 77 Illustrations.  
Fishing Rods and Tackle. With 199 Illustrations.  
Furniture Repairing. With 178 Illustrations.  
Gilding, Silvering and Bronzing. With 27 Illustrations.  
Glass Writing, Embossing and Facula Work. With 129 Illustrations.  
Gramophones and Phonographs. With 103 Illustrations.  
Household Repairs. With many Illustrations.  
House Painting and Decorating. With 74 Illustrations.  
Incubators and Chicken Rearing. With 124 Illustrations.  
Induction Coils. With 82 Illustrations.  
Knotting and Splicing Ropes and Cordage. With 208 Illustrations.  
Lathes, Small. With 214 Illustrations.  
Magnet Repair and Adjustment. With 104 Illustrations.  
Miniature Electric Light. With 141 Illustrations.  
Model Aeroplanes. With 190 Illustrations.  
Motor Cycles and Side-Cars. With 70 Illustrations.  
Mounting and Framing Pictures. With 240 Illustrations.  
Oxy-acetylene Welding. With 43 Illustrations.  
Patents, Designs and Trade Marks.  
Photography Simplified. With Frontispiece and 63 Illustrations.

Pianos: Their Construction, Tuning, and Repair. With 74 Illustrations.  
Poultry Houses and Appliances. With 226 Illustrations.  
Pumps and Hydraulic Rams. With 171 Illustrations.  
Rustic Carpentry. With 194 Illustrations.  
Sewing Machines: Their Construction, Adjustment, and Repair. With 177 Illustrations.  
Soldering, Brazing and Welding. With 78 Illustrations.  
Tailoring: How to Make and Mend Trousers, Vests, and Coats. With 134 Illustrations.  
Taxidermy: Skinning, Mounting and Stuffing Birds, Mammals, and Fish. With 108 Illustrations.  
The Handyman's 1,000 Practical Receipts.  
Ticket-writing and Sign-painting. With 154 Illustrations.  
Tinplate Work. With 230 Illustrations.  
Toy Making. With 237 Illustrations.  
Watch Cleaning and Repairing. With 78 Illustrations.  
Wireless Telegraphy and Telephony. With 100 Illustrations.  
Wood Finishing. Comprising STAINING, VARNISHING, and POLISHING. With 12 Illustrations.  
Workshop Appliances, Small. BUILDING MACHINES AND APPLIANCES USED IN WOODWORKING AND METALWORKING. With 232 Illustrations.  
Workshop Arithmetic.  
Workshop Hints for Metal Workers. With numerous Illustrations.



# Proclamation



This is to announce that on  
**JAN. 15th**

RADIO PRESS LTD., the well-known publishers of authoritative wireless books, will publish a new monthly wireless Magazine entitled:

## MODERN WIRELESS

**1/- NETT**

Every reader of "Amateur Wireless" should obtain the brilliant first number. The Magazine is edited by John Scott-Taggart, F.Inst.P., assisted by E. Redpath, Author of Cassell's "Work" Handbook "Wireless Telegraphy and Telephony," and by Paul D. Tyers, Author of "Construction of Wireless Receiving Apparatus," both well-known contributors to the pages of "Amateur Wireless."

Order your copy from your newsagent, bookseller, from a railway bookstall, or direct (1/3 post free) from

**Radio Press Ltd.,** DEVEREUX BUILDINGS, STRAND, LONDON, W.C.2.

## "Wemco" Wireless Receiving Sets

Specially designed for Broadcasting under British conditions, and approved by the Postmaster-General.

UNIT SYSTEM.



See Postmaster-General's conditions, and note that this Crystal Detector or Rectifier Panel need not be scrapped at any future date should it be desired to add High or Low Frequency Amplification.

**No. 1 (Crystal Detector) SET. £4 15s. Od.**

Including 4,000 ohm Double Head Gear Receivers.

This set is sufficient to receive (within a range of about 20 miles) all concerts, etc., under Broadcasting arrangements. Within the limits of these wave-lengths (300 to 500 metres) it is more efficient than similar apparatus which covers an unnecessarily wider range.

All prices include free packing and free delivery in Great Britain, and provide for Patent Royalties and Manufacturers' payments to the British Broadcasting Co.

*Send us a Post Card and ask for our List No. 122 A.W.*

Manufactured by: **WALTERS ELECTRICAL MANUFACTURING CO., Ltd.,**  
**KENSAL ROAD and CONLAN STREET, LONDON, W.10.**

Telephone: **PARK 653.**

ESTABLISHED 1880. INCORPORATED 1907.

Manufacturers and Contractors to the Post Office, War Office, Admiralty, etc. etc. Members of the British Broadcasting Company.

# HULLO EVERYBODY!

**Do YOU Know US? If not, why not?**

We do not offer you "something for nothing," nor is this advertisement a catchpenny one. Goods supplied are value for money, both as to quality and price. We leave our customers to be the best judges. 'Nuff said!

## Complete Sets of PARTS for Making Variable Condensers

REVISED PRICES, without Ebonite

Approx. Capacity in Microfarads	No. of Plates	Price
•0015 ...	85 ...	9/-
•001 ...	57 ...	6/6
•00075 ...	43 ...	5/6
•0005 ...	29 ...	4/6
•0003 ...	19 ...	3/-
•0002 ...	13 ...	2/3
•0001 ...	7 ...	2/-
Vernier ...	3 ...	1/9

**EVERYTHING READY TO ASSEMBLE and CONSISTS of the FOLLOWING:**

Accurate Aluminium Fixed and Moving Vanes, Large and Small Spacer Washers, Centre Square Spindle (Screwed Ends, 2 B.A.), 3 Side Rods, 12 Nuts and 12 Brass Washers (2 B.A.), Pointer—scale 0-180, Terminals, 3 Bushes, Spring Coil Washers, Best Quality Knob with 2 B.A. Nut in Centre. **ALL HIGHEST QUALITY GOODS.**

**PLEASE NOTE**  
**DRILLED EBONITE ENDS - 1/- per pair extra**

Postage and Packing, 1/- per set extra. Two Sets, 1/3. Three Sets, 1/6. Owing to the extraordinary value given in above Condenser Sets, we are compelled to make these charges for packing, postage, etc.

## ALL the following GOODS POST FREE at the SPECIAL PRICES attached for POST ORDERS

*If you are not satisfied with value, return goods and we will refund all charges*

Filament Resistances. Most wonderful value in the wireless trade. Each 2/6 and 3/6. By Post, 3/- and 4/-.

Switch Arms, with polished knob, bushed 2 B.A. nut, laminated blade, spring coil washer, nuts and bush, 1/-, 1/6, 2/- each. By post, 1/3, 1/9, 2/-.

Crystal Detectors on Ebonite. Simply marvelous value. Each 2/6. By post, 3/-. Also 3/3; by post, 3/9.

Fixed Condensers, with terminals on ebonite, .0003, .0005, .001, .002, .003, 1/6; by post, 1/9; .004, 1/9; by post, 2s.

Oajah Basket Coils, 7 in set, 5/- set. By post, 5/6.

Lead-in Tubes, ebonite, brass ends, 9 in., 1/2. By post 1/6. 12 in., 1/4. By post, 1/8.

Good Condenser Knobs, tapped 2 B.A., at 2/- doz. By post, 2/6.

Knobs, with brass nut (2 B.A.) in centre, high-class quality, 4d. each. By post, 7d. 6 for 2/- . By post, 2/6.

Crystal Detector, cup enclosed with glass cover, dust proof, 4/6. By post, 5/3.

Aerial Wire, 7/22 bare copper, stranded, first class quality, not a substitute. Price per 100 ft., 2/10. By post, 3/10.

Reel Insulators, 1d. each. Cannot be sent by post.

1 1/2 mm. Insulating Sleeving, 6 yds. for 2/2. By post, 2/6. 12 yds. for 4/-. By post, 4/6.

Slider and Plunger, 5d. By post, 7d.

Slider Knob, plunger and 13 in. rod. The lot, 8d. Cannot be sent by post.

Aluminium Vanes, 2 doz. 1/-. By post, 1/6. 5/- gross; by post, 6/-.

War Office Pattern Terminals, complete with nut and washer, 1/8 doz. By post, 2/2 doz.

Splendid Line in 5-piece Terminals, complete with nut and washer, good size, 1/- doz. By post, 1/6.

Large Spacer Washers, 3 doz. 9d. By post, 1/-.

Small Spacer Washers, 6 doz. 1/-. By post, 1/4.

Terminals (very large), magnificent quality, aerial and earth, complete with 2 nuts and 2 washers (2 B.A. stems), 2 for 8d. By post, 1/-.

Interval Transformers (low frequency), high class, tested, and guaranteed 5-1, 14/- each. By post, 15/-. Smaller size, 10/6; by post, 11/6.

Hertzite Crystal, per piece, according to size, 1/3 and 1/6. Cannot send by post.

Ebonite Dials, with engraved scale 0-180, 1/- each. By post, 1/6.

Egg Insulators, 4 for 9d.; 2/- per doz. Not sent by post.

Grid Leak and Condenser, .0003, very high quality and appearance, 3/9. By post, 4/3.

Inductance Coils Wound Enamel Wire, 12 by 4, 3/-. Not sent by post.

Filament Resistance, "Thor" pattern, suitable for one, two or three valve sets, 4/-. By post, 4/6.

Terminals, telephone, highly finished, with nut and washer, 2/- doz. By post, 2/6.

War Office Pattern Terminals, extra special quality, with nut and washer, 2/- doz. By post, 2/6.

**WE BEAT CREATION ON PRICES AND QUALITY.**

## HEADPHONES. We don't sell cheap and nasty telephones.

Genuine "Brunet" French Telephones, most sensitive obtainable, 6 Gangsten poles in each earpiece. 4,000 ohms with cords (Double Receivers) ... .. 25/- post free

French Receivers, 8,000 ohms, double receivers with cords ... .. 25/- post free

Single Receivers (French) with cord, 2,000 ohms ... .. 9/- (post 1/- extra)

High Class British Receivers, double, complete with cords and headband ... .. 21/- to 25/- (post 1/- extra)

## To Callers: We Sell All Component Parts CHEAP!

Brass Rods, Nuts, Washers, Screws, Valve Sockets, Valve Pins, Stop Pins at wholesale prices.  
*NOTE!* My terms are strictly cash with order. All orders by post are dispatched at the earliest possible moment, as we have great pressure just now on the postal department.

**M. RAYMOND, 27, LISLE STREET, W.C.2.**

RIGHT OPPOSITE DALY'S GALLERY DOOR.

Phone: Gerrard 4637

To avoid mistakes, this address is close to Charing X. Road and Leicester Square Tube.



# IMPORTANT

**WE HAVE OPENED VERY COMMODIOUS PREMISES AT  
54, Gracechurch Street, E.C.3**

for the demonstration and sale of all types of Wireless Receiving Sets and "Claritone" Loud Speakers.

Amateurs and Experimenters will be able to obtain every part required for any type of Set including :

- |   |   |
|---|---|
| Transformers, L.F. and H.F.<br>Headphones, all types, all resistances<br>Condensers, variable and fixed, all capacities<br>Varío-Couplers and Variometers<br>Coil-Holders and Coils<br>Anti-capacity Switches, all types<br>Rheostats, all types<br>Radial Switches, 5, 10 and 15 way<br>Ebonite Valve Holders, Dials, Scales, other parts and in sheet | Valves, M.O. and Mullards<br>Brass W.O. and Telephone type Terminals,<br>Nuts, Washers, Contact Studs and all other parts<br>Accumulators<br>Dry Batteries<br>Aerial Wire<br>Insulators<br>Hertzite and Galena Crystals<br>Cotton and other Tubings, all colours<br>Etc. etc. |
|---|---|

PRICE LIST ON APPLICATION

**PETTIGREW & MERRIMAN, Ltd., 122-124, Tooley Street, London, E.C.1**

*Note: 54, Gracechurch Street is a few minutes from Monument, Eastcheap, Bank, Cannon Street & London Bridge*

TELE.: HOP 134

## BROADCASTING RECEPTION SETS

**One-Valve Set Complete for Working, £7 10s.**

Passed for  
Broadcasting  
Licence G.P.O.  
No. 1038.

SEND FOR  
CATALOGUE

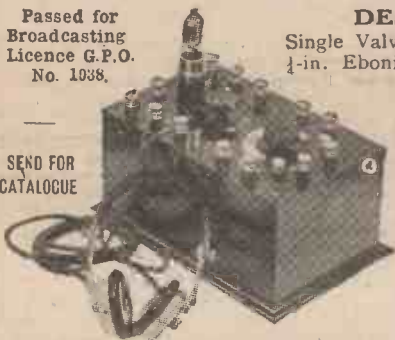

**DESCRIPTION :**

Single Valve, mounted on polished 1/4-in. Ebonite Panel with Variable Condenser, smooth acting resistance, grid leak and Condenser and all terminals clearly engraved in white, in a Mahogany Polished Cabinet 9 in. by 5 in. by 5 in. **£3 15 0**

**A TAPPED COIL** for wave-lengths up to 900 metres with 2 terminals for coils for any higher wave-lengths.

The coil is enclosed and the tappings are brought out to an 8-way switch mounted in the front of the cabinet.

**ACCESSORIES INCLUDED :**

Siemens' 54-volt high-tension Battery with plugs for altering the voltage	15 0
4-volt 50-amp.-hour low-tension Accumulator in case with carrying strap	1 4 0
One pair of Sensitive Headphones of 4,000 ohms resistance	1 1 0
One Detecting Valve	15 0

Total **£7 10 0**

*Satisfaction Guaranteed or Money Refunded.*

**WIRELESS INSTALLATIONS Ltd.**

**15, Aldersgate St., London, E.C.**

AGENTS WANTED.

## Exide BATTERIES

**H.T.  
Batteries**  
for  
**Valve Sets**



24v. 28v. 32v.  
Type B.K.

Owing to the demand for these batteries,  
all orders will be dealt with in strict rotation.  
Prices approximately one shilling a volt.  
:: Ask for Leaflet 4030 ::

**THE Chloride ELECTRICAL STORAGE  
COMPANY LIMITED.**

CLIFTON JUNCTION, | 219/229, SHAFTESBURY  
Nr MANCHESTER. | AVENUE, W.C.2.  
PRICES AND PARTICULARS ON APPLICATION.

CLUB DOINGS (continued from page 710)

pany. The bearings obtained by such apparatus did not give the absolute direction of the transmitting station. Thus the latter might equally well be either due north or due south of the receiving station. This difficulty had, however, been overcome by an ingenious arrangement.

West London Wireless and Experimental Association.

Hon. Sec.—H. W. COTTON, 19, Bushey Road, Harlington.

ANY gentleman desiring to take up wireless either for experimental work or entertainment can obtain full particulars of the association's objects by communicating with the secretary.

Redditch and District Radio Society.

Hon. Sec.—A. W. REEVES, "The Elms," Alvechurch. A public demonstration and exhibition of wireless equipment was held on Dec. 13. The demonstration was given by Mr. A. W. Reeves and Mr. Entwistle, both of the Western Electric Co. Mr. Entwistle explained the various units and their use in a very able manner. The Birmingham Concert Party gave an excellent programme from Witton, the reception of which was very much appreciated by the large audience.

Hornsey and District Wireless Society.

Hon. Sec.—H. DAVY, 134, Inderwick Road, Hornsey. ON Dec. 11 Mr. Fleet gave a demonstration with a 3-valve amplifier of his own construction. The reception of musical items from 2LO and 2WP were heard quite clearly, also some telephony from the Hague (PCGG) proved interesting to those unfamiliar with that station.

Hackney and District Radio Society.

Hon. Sec.—E. R. WALKER, 48, Dagmar Road, E.9. At the weekly meeting of the above society on Dec. 14 a very interesting discussion took place on radio subjects in general. The secretary invited questions, and replied to all and sundry in a most satisfactory manner.

ANNOUNCEMENTS

"Amateur Wireless and Electrics." Edited by Bernard E. Jones. Price Threepence. Published on Thursdays and bearing the date of Saturday immediately following. It will be sent post free to any part of the world—3 months, 4s. 6d.; 6 months, 8s. 6d.; 12 months, 17s. 6d. Postal Orders, Post Office Orders, or Cheques should be made payable to the Proprietors, Cassell & Co. Ltd.

General Correspondence is to be brief and written on one side of the paper only. All sketches and drawings to be on separate sheets.

Contributions are always welcome, will be promptly considered, and if used will be paid for.

Communications should be addressed, according to their nature, to The Editor, The Advertisement Manager or The Publisher, "Amateur Wireless," La Belle Sauvage, London, E.C.4.

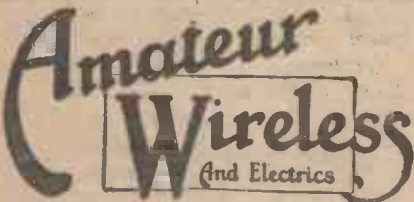

Querist's Coupon Available until Saturday, Jan. 6, 1923

Hullo! 15/- KING'S FOR VALUE Hullo! 15/-  
IN 20 MINUTES can be assembled IN 20 MINUTES.

ALL BRITISH MANUFACTURE. Can be used with Broadcast Licence. Full Set of Parts for Broadcast Reception, wave-length 300-300 metres. King's No. 2 Parts consist of Mahogany Base and Ends, 9 x 3 1/2 Inductance Mounted, Crystal Detector, Blocking Condenser, Terminals, Ivorine Tablets, Slider Rod and Plunger. Assembled and tested, 4/- extra.

One Pair of Headphones Given Away FREE with every 20th order received. Cash with Order. Post 1/6. Stamp for List.

HAMMOND & KING, 51, Berwick St., W.1. Phone: Gerard 6753

BEGINNER'S GUIDE TO WIRELESS

Explains in plain, everyday language, everything beginners wish to know about Wireless Telegraphy.

HOW TO ERECT, CONNECT, AND MAKE

all the apparatus required for reception of telephony or morse, and full instructions and diagrams for making coils, tuners, and complete valve and crystal sets. 112 pages, price 1/- post free.

SAXON RADIO CO. (Dept. 12), South Shore, BLACKPOOL

32 page Catalogue of Wireless Apparatus, 3d. post free.

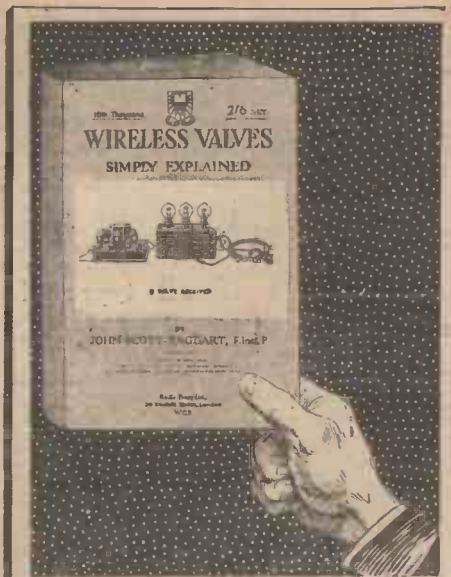

Whether you buy a complete receiving set or design it yourself, this book at 2/6 will save you time, trouble and money.

GET IT TO-NIGHT AS YOU GO HOME

Obtainable from all newsagents and book-stalls, or send us P.O. for 2/8 and your copy will reach you in two days.

Radio Press Ltd. Devereux Bldgs., Strand, LONDON, W.C.2.

PORTLAND'S PARTS BY POST

"EBONITE"

8 x 1	...	...	5.	7	12 x 10	...	...	7	6
4 x 4	...	...	1	3	17 1/2 x 8 1/2	...	...	9	6
17 x 5 1/2	...	...	2	8	18 x 18	...	...	12	10
10 x 6	...	...	3	9	18 x 18 1/2	...	...	1	3
7 x 5	...	...	5	3	7 1/2	...	...	1	3

QUARTER, MAT. BRITISH Postage Free—Any Size Cut

JAMES PORTLAND,

39, SINCLAIR ROAD, OLYMPIA, W.14

N.B.—Mr. Portland Stocks 200 Wireless Parts

Notice to Advertisers

ADVERTISEMENT INSTRUCTIONS and copy for "Amateur Wireless" should be at the office by First Post on FRIDAY morning at the latest.

PREPAID ADVERTISEMENTS.

The Latest Invention. Steam rotary engine, reg. patent. The finest scientific working steam engine ever invented. 1s. each, 3 for 2s. 6d.—Alan Hitchen, Patentee and Manufacturer, Dept. 17, Burnley. [30 r Wireless Dealers throughout Great Britain are strongly advised to stock parts for making up wireless sets. Buy your parts direct from the factory at wholesale prices.—Newtonia Wireless Factory, 13 and 15, Whitcomb Street, London, W.C.2.

B.A. Screws, Nuts, and Washers, assorted gross, 2s.; list, 2d.—J. H. Bennett, Station Road, Willesden Junction. [32 r

Cabinets and Cases, in polished mahogany or teak. Quotations per return.—Lancasters, 87, Parade, Birmingham. [33 r

WIRELESS BARGAINS.

PHONES, 21/- SUPERSENSITIVE ALL-BRITISH. 4,000 ohms, POST FREE.

ALL WIRELESS PARTS & SETS. Trade supplied. CRYSTAL DETECTORS, 2/6.

Illustrated Catalogue A, including list of Stations, 6d. post free.

EONS WIRELESS SUPPLY CO., 115, Fleet Street, E.C.4.

SCIENTIFIC APPLIANCES (Dale & Hollins). Electrical, Magnetic, Optical and ALL RADIO WIRELESS PARTS and Materials at Lowest Prices.

Call and see our immense stock or write for Information and Prices. In Centre of London, Top of Kingsway.

SCIENTIFIC APPLIANCES, 11 and 29, Sicilian Avenue, London, W.C.1.



PICK UP AMERICA

if you can on your outdoor aerial, but hook up an indoor aerial on

IND-AERIAL HOOKS

and let the family get the broadcasting. Ind-Aerial Hooks go on the picture-rail and support aerial one foot from the wall. Results will charm you!

P.O. for 10/6 brings four, post free.

IND-AERIAL CO. (Dept. A1) 47, VICTORIA STREET, S.W.1

ELECTRADIX RADIOS.

IMMEDIATE DELIVERY FROM OUR HUGE STOCKS

Everything from a Recorder to an Earth Clip.

The best equipped City depot.

COME AND SEE US.

9, COLONIAL AVENUE is first opening on left in the Minorities, nr. Aldgate Station, Metropolitan Railway.

LESLIE DIXON & CO., 9, COLONIAL AVENUE, MINORITIES, E.1.

ASK "A. W." for List of Technical Books.

THAT BOOK YOU WANT ON WIRELESS OR ANY OTHER TECHNICAL SUBJECT

Foyles have it or will quickly obtain it. 1,000,000 Vols. (Second-hand and New) on Technical and every other conceivable subject in stock.

Books sent on approval. Write for Catalogue 10s. (free) mentioning requirements. Books Purchased.

FOYLES, 121, Charing Cross Rd., London.



## Wireless Supplies

Order at Once if you require Prompt Delivery

### Q61 Headphones

4,000 ohms **21/-** per pair

Every Set Guaranteed. Beautifully finished, highly sensitive, detachable receivers.

**IMMEDIATE DELIVERY**

Illustrated Wireless Catalogue now ready, post free, 3d.

**THE JEARY ELECTRICAL CO., LTD.,**

8, LAMBETH HILL, and 97, QUEEN VICTORIA ST., LONDON, E.C.4.

And at Glasgow, Birmingham, etc.



**FELLOPHONE 2-Valve RECEIVER** for plug in coils in Oak Cabinet, Headphones, Batteries, Accumulator, Aerial and Insulators (Including Tax) **£12**  
**FELLOPHONE 2-Valve AMPLIFIER** in Oak Cabinet (for Loud Speaker), including Tax ... .. **£7**  
**SUPERCRYST**, Complete with Aerial, Insulators and Headphones, including Tax ... **£4 7 6** **HEADPHONES**, 4,000 ohms **£1 1**  
**LOUD SPEAKERS, MULLARD and COSSOR VALVES, GRID LEAKS,** Variable and Block Condensers, Telephone Transformers, **£1 1**  
**DEMONSTRATIONS.** 9 a.m. to 5.30 p.m. 8 to 9.30 p.m.  
**SATURDAYS.** 9 to 1 p.m. 8 to 9.30 p.m. **SUNDAYS** by appointment.  
**F. N. GOUVY & CO., Ltd.,** 31, Upper Brook Mews, Lancaster Gate, near Paddington Station.

## DO YOU READ PRACTICAL BOOKS ?

See Cassell's List of Technical, Practical and Money-saving Books. A p.c. will ensure your receiving it.

**CASSELL & Co., La Belle Sauvage, LONDON, E.C.4.**

"We reply by return"

## Apparatus at YOUR Price

The following are a few items from our lists, and should interest you. Every article carries our money-back guarantee with it.

Filament Resistance Panel Mounting ... ..	2/6	Brass Rod, square, 1/4 in. x 1/4 in., per foot ... ..	6d.
Crystal Detector single cup ...	2/9	Brass Rod, round, 1/4 in., per ft.	6d.
Ditto double cup ... ..	3/6	Ditto, 3/8 in., per foot ... ..	5d.
Crystals, all kinds, per pkt. ...	6d.	Ditto, 1/2 in., per foot ... ..	3d.
Wood's Metal, per stick ... ..	8d.	Strip Brass, 1/2 in. x 1/4 in., per ft.	6d.
Buzzers for testing Crystals ...	2/6	Aerial Wire, 7/22 Stranded	
Inductance Sliders to fit 1/4-in. rod ... ..	9d.	Copper, per 100 ft. ... ..	4/6
		Insulators, egg pattern, each	3d.
		Voltmeter, 0-6 volts ... ..	6/6

Postage extra on all above. Send to-day for your copy of our Free List.

**ELECTRICAL SUPPLY STORES,**  
**5, Albert Terrace, King Cross, Halifax, Eng.**



## GENTS' MAKE FITMENTS

Send for our sundries pamphlet, make use of our stocks, ask us to quote for your wholesale requirements :: ::

**GENT & CO., LTD.,**  
**Faraday Works, LEICESTER**

L.F. Transformer  
 Delivery from Stock

London 25, Victoria St., S.W.1.  
 Newcastle-on-Tyne: "Tangent House," Blackett Street



Every Instrument tested on an Aerial before despatch and a signed Certificate attached to each.

## Registered N° 1045 Passed by P.M.C. BROADCAST BABY

HERE'S just the Set you want to enable you to enjoy the splendid Concerts now being broadcast from four centres. An excellent Instrument, moderately priced—and so simple to operate. One knob controls the whole of the tuning; there are no irritating adjustments to make. Further Valves can be added at any time, so that at any future date you can add a Loud Speaker and enable everyone in the room to hear in comfort. In addition, by the aid of a special Loading Panel, to be attached to terminals A and E, its present wave-length limits can be increased to include the Paris, Hague and Berlin Concerts.

Size 7 in. by 5 in., mounted on polished mahogany Cabinet, complete as illustration but without Valve. Catalogue of 'phones, loud speakers, batteries and other components sent post free. :: ::

**50/-**

If for use with Broadcast Licence each instrument must be stamped B.B.C. at an extra cost of 32/6. :: ::

The PETO SCOTT Co.,  
 Radio Headquarters,  
 64, HIGH HOLBORN, W.C.1.



# It's the results that count.



No. R1238  
**STERLING HEAD 'PHONES**  
*(Manufactured under Brown's Patent No. 154253 '18 by Sole Licence)*

**I**N choosing your Broadcast Receiving Set or Head 'Phones do not be tempted by cheap apparatus. You would probably get results, but of a crude and uncertain nature. Get the full measure of enjoyment by using apparatus which can be relied upon.

*Before deciding on your purchase write for our literature or call at our showroom for free advice.*



**STERLING No. 1 CRYSTAL RECEIVING SET.**

Complete with one pair of Double Head Telephones and with special coil for Paris Time Signals. Ranged 25 miles.

To be obtained from all dealers or direct from—

**Sterling Telephone and Electric Co., Ltd.,**  
210/212, Tottenham Court Rd., London, W.1.

Telephone No. : 4144 Museum (7 lines). Telegrams : Cucumis, Wesdo, London.

Works : **DAGENHAM, ESSEX.**

BRANCHES : **NEWCASTLE-ON-TYNE**: 9, Clavering Place.  
**CARDIFF**: 8, Park Place.  
**MANCHESTER**: 14, St. Peter's Square.

**We Guarantee** that all Broadcast Radio Apparatus sold by us conforms with the conditions of the Broadcaster's Licence issued by the Postmaster-General.

## BROADCASTING HAS NOW BEGUN!

*Have you obtained your Set yet ?*

Our No. 1 CRYSTAL RECEIVING SET is suitable for reception of all broadcast matter for a range of 20-30 miles.

TYPE APPROVED BY P.M.G. Reg. No. 126.  
Price **35s.**

Plus 7s. 6d. broadcasting commission.

'PHONES. British made, wound to 4,000 ohms.  
Price **25s.**

AERIAL EQUIPMENT, comprising 100 ft. 7/22 S.W.G. Stranded Aerial Wire and Insulators, 4/- extra.

COMPLETE EQUIPMENT, ready to "Listen-in." Price **£3 3 0**  
Plus 7/6 broadcasting commission.

"Excellent Results."

"Costs Nothing."

West Kensington, 13th Nov., 1922.

"You might like to know that in spite of the fact that I have a 3-valve Set, I prefer listening-in on the Broadcasting Co.'s Transmission of your No. 1 Crystal receiver, which gives excellent results, and unlike Valves costs nothing to run."

Write for Illustrated Catalogue of all Radio Accessories

**BOWER ELECTRIC LTD.,**  
15, GRAPE STREET,  
SHAFTESBURY AVENUE, London, W.C.2

## Headphones



**21/-**

4,000 ohms total Resistance.  
Double Headband.

Guaranteed highly efficient. Complete with Cords. Ball and socket joints; highly polished nickel cases; best Tungsten steel magnets.

## Splendid Crystal Detector

Mounted on Ebonite.



## Beaver Complete Crystal Sets

No. 1 unassembled ... **15/-**  
No. 2 unassembled ... **20/-**  
No. 3 assembled, ready for use ... **24/-**

Complete with Splendid Tested and Guaranteed 4,000 ohm Phones ... **45/-**

**ALL GOODS SENT POST FREE**



**BEAVER ELECTRICAL SUPPLY CO.**  
109, REGENT STREET, LONDON, W.1  
Telephone : **GERRARD 1900**

Special Terms to Trade. All Cheques and Postal Orders to be crossed London Joint City and Midland Bank

