

**BROADCASTING-DEFINITE NEWS**

# Amateur Wireless And Electrics

Second  
Exhibition  
Number

No. 18

SATURDAY, OCTOBER 7, 1922

Price 3d

## CONTENTS

---

THE MINER'S S.O.S.

THE B.T.H. PORTABLE  
RECEIVER

ALL WITH A SINGLE  
VALVE!

VARIOMETERS: THEORY  
AND CONSTRUCTION

THE WIRELESS SOCIETY  
AND THE P.M.G.

A GENERAL IMPRESSION OF  
THE EXHIBITION

THE NEWLY-FORMED RADIO  
ASSOCIATION

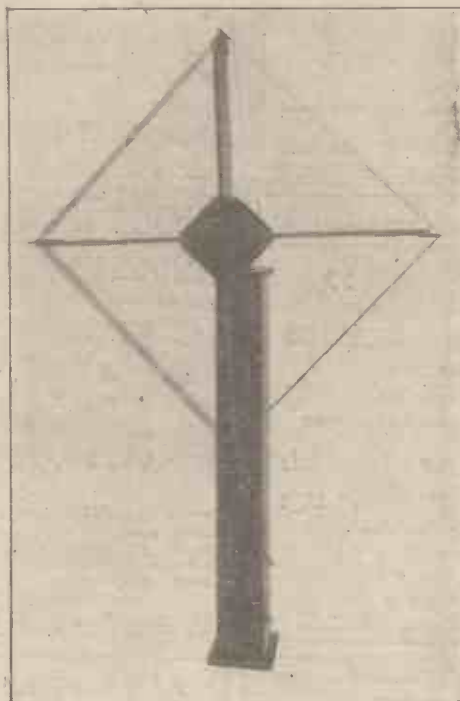

A SIMPLE TYPE OF FRAME AERIAL

## CONTENTS

---

MEANING of ELECTRICAL  
UNITS

WIRELESS, "WIRED"  
AND "PIPED"

SOME AMERICAN HINTS  
AND TIPS

THE TELEPHONE TRANS-  
FORMER

PORTABILITY

EXHIBITION NOTES

SIR HENRY NORMAN'S SPEECH  
ON BROADCASTING

THE P.M.G. AND AMATEUR-  
MADE RECEIVERS

Radiograms. Club Doings. Information Bureau. Forthcoming Events, etc. etc.

# ECONOMIC ELECTRIC LTD.

WHOLESALE, RETAILERS  
and the PUBLIC, are requested  
to TAKE NOTICE that this ad-  
vertisement is to introduce the

PRICE **15/-** PATENTS PENDING **15/-** PRICE

## THERMIONIC TRIODE

the latest and best development  
of the three electrode valve.

**RECTIFIES, OSCILLATES,  
AMPLIFIES**

**Unique Construction and High  
Amplification Characteristic.**

Filament current 5 amps at  
4 volts. Anode potential 50 volts.

Obtainable from the patentees, ECONOMIC ELECTRIC  
LTD., and all dealers in Wireless apparatus.  
Wholesale enquiries should be sent to the paten-  
tees or to Mr. H. S. TYLER, 23b, Balham Hill,  
London, S.W.11.

Head Office: 10, FITZROY  
SQUARE, LONDON, W.1

INFRINGES NO  
PATENTS!  
Illustration Full Size

New Showrooms:  
303, EUSTON ROAD, N.W.1.

Telephone:  
MUSEUM 1055

Branch Showrooms:  
TWICKENHAM



# MITCHELFONES

Are not a spasmodic production to meet  
a sudden demand, but have been on the  
market for over three months, and during  
this period 27,000 have been distributed  
to the trade, and consequently we have  
not been able to offer them direct to the  
retail buyer.

1,000 per week are now available, and we announce

## DELIVERY FROM STOCK

You post your order, or call at our  
premises and get them at once. Think  
what this means to you—you, perhaps, who  
have been waiting and are still waiting.

Standard resistance 4,000 ohms, double headgear with  
double headstraps, comfortable, highly efficient,  
and foolproof

**35/-** per pair.

Special Terms to Traders and deliveries  
that will surprise you.

## MITCHELLS Electrical & Wireless Ltd.,

Postal Address: McDermott Road, Peckham, S.E.15.  
Retail Address: 188, Rye Lane, Peckham, S.E.15.

Phones: New Cross 1540/1541

GREAT BRITAIN'S GREATEST WIRELESS STORE

## THE WIRELESS CRYSTAL OF TO-DAY AND THE FUTURE

# "HERTZITE"

SIMPLE TO USE. NO BATTERY REQUIRED

Price 2/6 post free

Mounted in our Patent Detector, 5/9, post free

See you get our "Hertzite" and not some substitute

We can give the best Wholesale Terms for all Crystals

VALVES:—"R.M.R." 15/-; "ORA" 15/-; "XTRAUDION," 15/-;  
DOUBLE HEADPHONES, 4,000 ohms, 22/- post free

## RUSSELL-SHAW,

38, Great James Street, Bedford Row, W.C.1.

## Get Your TOOLS from us

We specialise in Electricians' Requirements. Write or call. The Chancery  
Lane Tube Station gives all London access to us, and is only one minute away,  
just across the road to Chancery Lane and a few doors down brings you to

# POND TOOL CO

67, 69, 70 CHANCERY LANE, W.C.2.

### SPECIAL LINES IN

Wire Gauges, 0 to 26, S.W.G.; 2/9; Hand Vices, 4 in., solid steel, 2/-; Hand  
Drill, taking all drills, 0 to 1/2 in., 8/-; Combination Pliers, 6, 7 or 8 in., 2/-;  
Hack Saw, with 2 blades, 1/6; Measuring Slide Rules, 3 in., 2/-; Blow-  
lamps from 2/6; all post free. We have a large stock of Drills, Files, Taps,  
and Dies, Bolts and Nuts, Wood Screws, Solder Irons, etc. All goods  
sent on approval against cash, money returned if not satisfied.

Write for our List 6d., refundable on first order.

## I PAY POSTAGE

### HEAD PHONES

Best Quality, French, 4,000 ohms,  
Double Receiver.

**20/9**

Postage paid.

### INDUCTANCE COILS

Wound with 24 S.W.G. Enamelled  
Wire, 12" x 4", 12" x 3 1/2", 12" x 3".

**3/9**

Postage paid.

### CRYSTAL DETECTOR

Two-in-one, Universal, Adjustable  
and Locking.

**5/-**

Postage paid.

All packing and postage free. Mail order only.

New Price Sheets sent free.

**JACKSON,** 7, BLAKE ROAD, FULHAM,  
LONDON S.W.6.



## "PERRYPHONES"

HEAD SETS FOR WIRELESS TELEPHONY

4,000 ohms.

**21/-**

EVERY SET GUARANTEED.  
Beautifully finished, highly  
sensitive, detachable receivers.

**IMMEDIATE DELIVERY**

## THE JEARY ELECTRICAL CO., LTD.,

8, LAMBETH HILL, and 97, QUEEN VICTORIA ST.,  
LONDON, E.C.4

And at Glasgow, Birmingham, etc.

**SPECIAL OFFER — LAST WEEK  
HEADPHONES!!**

We have just received another 1,000 'phones which we are offering at the following keen prices:

- 4,000 ohms, **20/6**, POST FREE
- :: :: (usual price 24/6) :: ::
- 8,000 ohms, **22/6**, POST FREE
- :: :: (usual price 26/6) :: ::

These 'phones are of **FIRST QUALITY FRENCH MAKE** and of Higher Sensibility than many others at 35/- or more. Duralium Headstraps, fully adjustable, complete with 6 ft. Flex.



**The ECCENTRO Crystal Detector**



This is without doubt the Finest Crystal Detector yet on the market. By means of two eccentric movements the whole face of the crystal is quickly explored. When the most sensitive point is found the pressure can be regulated with micrometer precision, and **no jolt or jar will shift it.** It is perfectly simple.

**RIGID, DUSTPROOF & FOOLPROOF  
:: A BOON TO CRYSTAL USERS ::**

Complete with selected Galena Crystal,  
**1 1/6 POST FREE** (usual price 13/6)

**DEAL DIRECT WITH THE SOLE IMPORTERS. SATISFACTION GUARANTEED**

*Trade Supplied*  
**- LIST FREE -**

**W. JOANES** (Paris and London)  
42, JENNER ROAD, STOKE NEWINGTON, LONDON, N.16

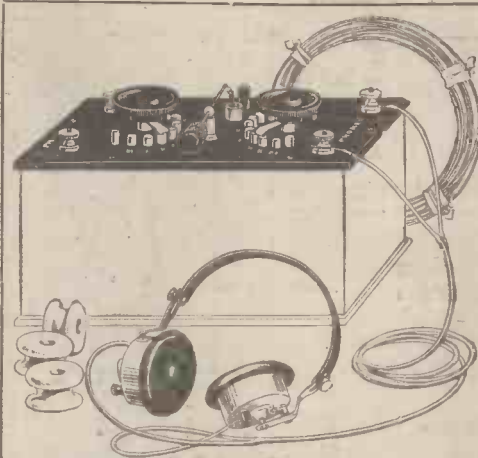

THE  
**"SELECTAPHONE"  
CRYSTAL  
RECEIVING SET  
FOR  
WIRELESS  
CONCERTS**

Receiver range 300/1000 metres, and special device for Paris Time Signals. Each set tested and guaranteed to receive Telephony.

*As Efficient as a  
Crystal Set can be.*

ABOVE SET COMPLETE WITH PHONES, AERIAL, INSULATORS: **£3/17/6** RECEIVER ONLY **47/6**  
*Post and Packing, 2/- extra.*



**ARE YOUR SIGNALS  
LOUD ENOUGH?  
MAGNIFY THEM WITH THIS  
INTERVALVE TRANSFORMER**

PRICE ONLY **19/6** PRICE ONLY  
*Postage 6d. extra.*

Made with genuine Stalloy Stampings, solid Ebonite Bobbins, perfect insulation. Very efficient and silent. Tested and guaranteed. Money refunded if not satisfied.

**THE B. & A. WIRELESS Co.,  
ST. ALBANS.**

*The discerning Amateurs and Experimenters require apparatus and parts of the highest quality and efficiency. These can be obtained only from:*

**Radio Supplies** (Established 1920) 236, High Holborn, London, W.C.1.

*The firm with a long-standing reputation for Superior Wireless Apparatus.*

**ECONOMIC**  
Head Office: 10, FITZROY  
SQUARE, LONDON, W.1.

**ELECTRIC**  
New Showrooms:  
303, EUSTON RD., N.W.1.

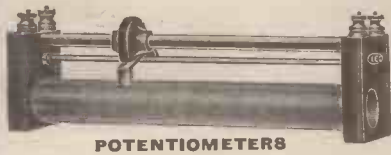

POTENTIOMETERS



Valve  
Sockets



Terminals



TELEPHONE INDUCTION COILS

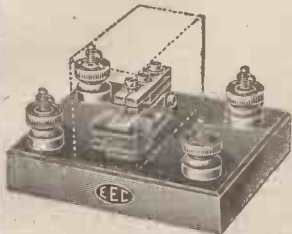

THE "MOSQUITO" BUZZER

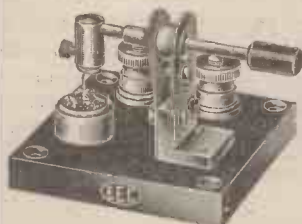

CRYSTAL DETECTORS



PILE WOUND INDUCTANCES

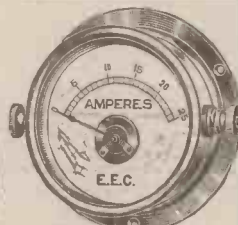

Voltmeters  
Ammeters

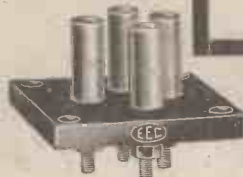

VALVE HOLDERS



ENCLOSED  
CRYSTAL  
DETEC-  
TORS



CRYSTAL  
SETS FOR RECEPTION  
OF  
BROADCAST  
TELEPHONY  
Etc.

**YOU!**

**WILL  
THIS**

THE  
**'XTRAUDION'**  
PRICE 15/-

If you have tried  
of three electrode  
not satisfied,  
'Xtraudion,' and  
ably surprised with  
Filament current,  
Anode potential,



**WANT  
VALVE**

THE  
**'XTRAUDION'**  
PRICE 15/-

all other makes  
valves and are  
purchase an  
you will be agree-  
is performance.  
.5 amps at 4 volts,  
50 volts.

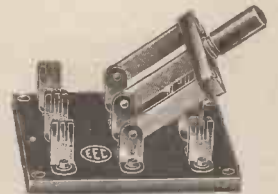

KNIFE SWITCHES



AMPLIFIERS



BALANCED  
VARIABLE  
CONDENSERS



CRYSTAL RECEIVER



HEAD  
PHONES  
FROM  
21/-

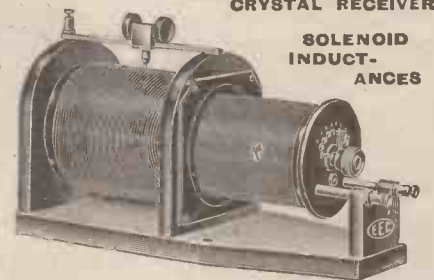

SOLENOID  
INDUCT-  
ANCES



COIL HOLDERS



Write  
To-day for 36-  
Page WIRELESS  
List Post Free  
4d.  
240 Illus-  
trations.

# Amateur Wireless

## and Electrics

No. 18

October 7, 1922

## THE MINER'S S.O.S.

How Entombed Miners Can Signal Their Whereabouts :: Wireless in Life-saving

THE use of wireless as a means of saving life in the mine has received little attention yet in the minds of those who are busy developing the science; nevertheless it would be of great value in reducing the appalling death roll in the coal industry of this country.

The catastrophe in a Cumberland colliery recalls an experience in France during the war which was very significant of the possibilities of wireless communication in this direction.

A party of British mining engineers engaged in detecting enemy mining operations suddenly found themselves entombed by the explosion of one of the objects of their quest. The working behind them was blocked by an impenetrable wall of fallen earth. They were hundreds of yards out beneath no-man's land, completely cut off, it seemed, and without hope of rescue.

One of the party had in his possession a portable spark-transmitting set of the army field pattern. It had been used experimentally below the ground, though for what purpose the writer cannot quite remember. As a last resource it was decided to "broadcast" a message on this, and it was done with but little hope of response.

To the intense relief and surprise of the entombed engineers a reply was almost immediately received. The message had been clearly heard and read by an operator in an aeroplane which was passing at a high altitude at the time.

It was re-transmitted from the aeroplane to a land station, whence help was quickly sent to the trapped men, all of whom were rescued.

This remarkable experience was by no means a freak result in wireless reception.

Experiments were carried out a short time ago by a small party of Birmingham amateurs, the results of which suggest that a new and fascinating field for research awaits experimenters in this direction.

The scene of their tests was the Baggeridge Colliery, near Willenhall, South Staffs, and with the assistance of the chief electrical engineer of the pit-head staff the experiments were made of a very comprehensive nature. The Baggeridge Colliery was particularly suitable, for the main shaft is nearly 700 yards deep, one of the deepest in the country. A special permit, by the way, had to be obtained from the Postmaster-General for the underground transmissions.

The apparatus used was quite of the usual type. The receiving set was a 3-valve reaction circuit with one rectifier

The transmitting set was of the usual portable type and embodied only one feature "out of the ordinary." About this, at present, it is not permissible to write anything. The valves were operated with a plate voltage of 180. The set was installed first in the cage, and it is interesting to note that this was of all-steel construction. An aerial was made by winding copper wire lattice-wise across the roof, care being taken to insulate it well from the steel.

For some considerable distance down the shaft steel supporting-girders had been built in, and it was expected that these, together with the steel of the cage, would have a bad screening effect upon the transmission.

Transmission was commenced while the cage slowly descended from the top, and it was quickly found that there was an appreciable amount of screening, making the signals weak and "chirrupy." Soon, however, they grew stronger, and when the cage was about half-way down and well past the steel girders, signals reached their maximum strength, which was easily readable. This was maintained until the cage approached the bottom, where there was more steel work. Here they commenced rapidly to fade, and when bottom was reached, became practically negligible.

Accordingly the transmitting set was taken out and set up alongside. The aerial was slung between two pit-props, and the earth made by laying a length of cable along the ground. This arrangement led to no improvement, and the set was conveyed for several hundred yards along the workings. It was set up at a point directly beneath the engine-house, which would, of course, have a screening effect, and the distance, measured transversely through solid earth, was nearly three-quarters of a mile from the receiving set. A new aerial was 90 ft. of cable stretched along the ground.



Photograph that Illustrates the Need of Signalling Arrangements that will not be Affected by Roof Falls and Explosions.

valve and one low-frequency amplifier. An aerial was made by suspending a 40-ft. length of copper wire from a point on the steel hoisting gear above the shaft, about 100 ft. high, to an adjacent railway bridge. The earth was made by taking a wire to one of the rails in the permanent way and clamping it there. As a preliminary test for the aerial the experimenters listened-in and were gratified to hear Bordeaux, whose signals were so loud as to be audible with the 'phone 6 ft. away.

Transmission of Morse code was received with wonderful strength above, every signal being clearly readable. Thus encouraged, the experimenters attempted telephony transmission. This was received fairly loudly, the carrier wave being very strong. Articulation was, however, indistinct, only a few words being distinguishable; and no amount of manipulation in the receiver brought any improvement.

It was particularly noticeable in transmitting that the high-tension current was susceptible to heavy leakage into the surrounding air, a fact which was responsible for deterioration in signal strength: This curious phenomenon was due probably to the presence in the atmosphere of heavy carbon elements, which, like metal, would have an extensive screening effect.

Despite this, however, the results were remarkable and proved that wireless communication in the mine presents no insuperable difficulties, and has at least one definite advantage over the ordinary telephone—the absence of intervening wires, which in the event of a disaster are easily destroyed.

It would not be costly to install, and by its means rescuers could be acquainted immediately with the exact position to which their efforts should be directed, and by the saving of time loss of life might be avoided.

What is needed is a cheap, fool-proof set which will transmit telephony efficiently over short ranges without necessitating skilful manipulation. It ought not to be difficult to produce such a set, which could be standardised. L. B. P.

## The B.T.H. Portable Receiver

### An Advanced Type of Apparatus with Very Long Range

IN the Exhibition pages of last week's issue reference was made to a portable receiver of a most advanced type and for which some special claims are made. We are now enabled to give some constructive

details of this receiver which is the production of the British Thomson-Houston Co., Ltd., of Rugby. The photograph (Fig. 1) shows the receiver in conjunction with a 2-valve amplifier and loud speaker,

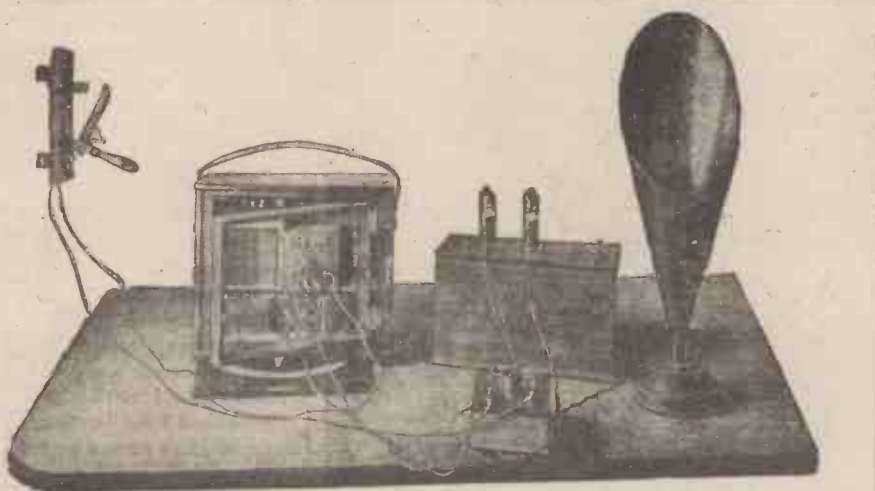

Fig. 1.—The B.T.H. Portable Receiver with Loud-speaker.

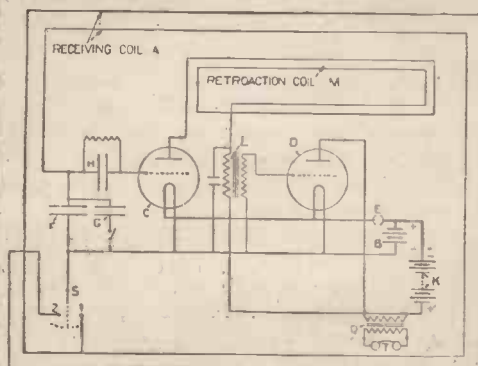

Fig. 2.—Circuit Diagram.

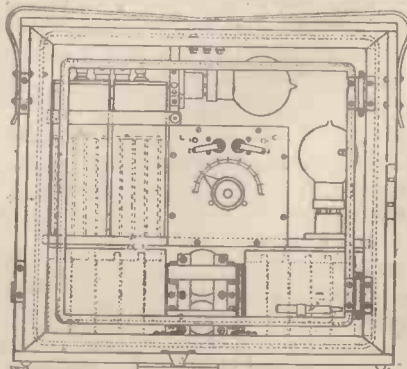

Fig. 3.—Diagram of Apparatus.

but of course it may be used as an entirely self-contained unit.

The entire apparatus is contained in a polished wood case measuring about 13 in. by 14 in. by 5 in., and weighing under 20 lb. complete. The cover, upon being opened, can be lifted off its hinges, and has fixed to it a central pivot. The case is fitted with a corresponding socket in the base which fits over the pivot and so allows the whole set to be turned round a vertical axis to any desired position. A pointer, hinged to the base of the case, indicates on the circular scale the direction from which the signals come.

A receiving coil, adjustable condenser, two valves, accumulator for heating the valve filaments, dry cells for the telephone circuits, two small transformers, and a hinged frame which carries a second coil are contained in the case.

In use the case is set upon the pivot and the telephone connections made. A plug is inserted in a socket, when the filaments of the valves light up. The case is then rotated on its pivot until the pointer indicates on the compass scale the direction of the station it is desired to hear. The condenser is then turned until its pointer indicates the wave-length of the desired station as shown on tabulated data supplied, and the hinged coil is moved outwards until the station is heard.

#### The Apparatus in Use

Diagrams of the parts and connections of the instruments are shown in Figs. 2 and 3. The receiving coil A, which is acted upon by the passing waves, is wound on a frame surrounding the apparatus, there being an air space between the coil and outer case. An accumulator B, of an unspillable type, heats the filaments of the two 3-electrode valves C and D when the plug is inserted at E. A battery K provides an E.M.F. for the plate circuits of these two valves.

The receiving coil is tuned by means of the condensers F and G, the latter being inserted for high wave-lengths, with switch S on contact 2. A small capacity condenser H, shunted with a high resistance, enables the high-frequency E.M.F. generated by the coil A to charge the grid of valve C negatively. The detecting valve C receives pulses of high-frequency E.M.F. from the receiving coil and transforms them into low-frequency pulses passing to transformer L, which in turn transforms this low-frequency E.M.F. up to a suitable value to apply to the amplifying valve D, where it is amplified and transmitted to the telephone transformer Q. The telephone receiver T is connected to the secondary of this transformer.

The hinged reaction coil M enables detector C to maintain self-oscillation by reaction on coil A. By adjusting the amount of this reaction, when moving M in or out, the best conditions of oscillation and loudest signals are obtained.

Rome, Nauen and Lyons can easily be heard without the use of an aerial.

# All With a Single Valve!

I HAD not attended many meetings of our wireless association before I discovered that whenever there was a lull in the general conversation the chairman would say "Anything new, Mr. Bateman?" And it was generally found that Mr. Bateman had, in the course of his experiments, made a discovery of some sort. He was anything but garrulous, but he was extremely interesting. His reticence arose, too, not from any desire to keep his discoveries to himself, but from a modesty of which he obviously found it hard to divest himself. I began to pay considerable attention to Mr. Bateman. His results with a single valve, be it noted, were remarkable, so remarkable that I felt I should like to see this set in operation. The owner was agreeable, and at six o'clock one windy and rainy Tuesday evening I found my way to Cadman, a little village about nine miles west of Southampton, where Mr. Bateman lives.

## The Apparatus

I had scarcely arrived when I was invited to listen to FL's evening weather report and music. The clarity and volume of sound were quite astonishing, every word and note being clearly heard. Between the time that FL broke off till seven p.m., when we were due to hear 2IL, a local amateur, I was at liberty to examine the apparatus. I may mention here that Mr. Bateman, then serving in the Royal Engineers, lost his right hand in 1914. Knowing this, I was far from being prepared for the really exquisite winding of his basket coils and the generally ingenious way in which he had made commonplace things serve his turn. The coil-holder, working on the hinge principle, was made of stout wood well waxed; the coils were hung on brass nails—in fact, on one of the three coil-holders an old gramophone needle served as the suspending medium!

I noticed, too, a most ingenious method of rapid fixture of various coils. The ends of the wires of each coil were attached to a stout metal washer. The coil-holder was provided with that brass or copper-type of spring in which the connecting arms of a tumbler switch rest, or those used for fuses. The washers were conveniently inserted, and almost instantaneous attachment was the result.

The method of fine tuning for FL was entirely novel. The normal autodyne circuit was employed, but on the coil-holder arm next the A.T.I. was mounted a circular metal disc about the same size as the basket coil. This disc was merely suspended to the arm, and

otherwise had no connections whatsoever. By bringing this metal disc nearer to or farther from the A.T.I. coil remarkably fine tuning was effected. Mr. Bateman attributes this to a species of magnetic refraction, but has a sufficiently open mind to accept other explanation.

## Unorthodox Methods

And for the apparatus itself and taken as a whole, there was nothing about it that was ordinary. There was not an inch of ebonite throughout the set. The telephone condenser was made of two pieces of zinc separated by paraffin-waxed paper. The tubular condensers, both A.T.C. and reaction, were made of test tubes and a wooden slider with a maximum capacity of .0003. There were no variable plate condensers at all. The valve was a Dutch one, purchased for 8s. 6d. The H.T. battery consisted of ninepenny dry cells connected in series, and the aerial of twelve strands of 28 d.c.c. stranded together. The far end was 60 ft. high, attached somewhat precariously to a pole sticking out of an oak tree. The height of the lead-in end was about 25 ft., and the earth consisted of a small-gauge wire attached to a metal plate thrown down the well.

The only things one could definitely



A Single-valve Receiver.

associate with wireless telegraphy were the telephones, which were Brown's best, with a total resistance of 8,000 ohms and adjustable diaphragms. Mr. Bateman winds his coils with 28 d.c.c. on bicycle spokes. The coils when complete are placed in the oven, still on the spokes, and baked till the characteristic smell of shellac is noticed. They are then extracted and the spokes removed. The result is a peculiarly effective and substantial type of coil. By the way, Mr. Bateman, when winding these baskets, instead of missing one spoke in the ordinary way, misses two. He is thus able to get twice the amount of winding on the same former, a tip worth mentioning.

## 2MT.

It was now time for us to listen to the local amateur. He was tuned in punctually on time, and reception was almost incredibly good. And then we passed at eight o'clock to the test of the evening—2MT. Let me say at once that was so clear that every word of the transmitter's voice was clearly audible. Every word could have been logged with ease, and not a note was missed of the music. Now think of it! Cadman is rather over a hundred miles from Writtle; Mr. Bateman has lost his right hand; his whole apparatus, with the exception of the essentials of 'phones, valve, accumulator and high-tension battery, is home-made; he has but the single valve, and yet he can get these stations, and get them as many with multivalve sets do not. And he has got the Dutch concert on Sunday afternoons.

## An Amateur

You will perhaps say, "He is an expert." He is; but an amateur expert whose wireless experience is a matter of a few months. Mr. Bateman is employed in Southampton during the day, so he has only his after-work hours and holidays to spend on his hobby. Think where he is; try and conjure up from this very imperfect description of a set lacking in almost everything that the majority of us are wont to regard as essentials; think again of these more than remarkable results.

That's what can be done with a single valve!

WALTER MEADE.



SLATE has good insulating qualities, can be cut with a carpenter's saw, and is drilled as easily as iron. It may be secured to a cabinet containing radio instruments in the same way as any of the other panel materials. The common grade school slate that can be purchased cheaply may be used with good results.—*Radio Digest*.

## "Wireless Telegraphy and Telephony" ::

The most Practical Handbook for the Amateur. The price is 1/6 net.



Unit Cell of the Wet Type

# Variometers: Theory and Construction

WHEN receiving either spark, C.W. or telephony on crystals or valves maximum signals result when the capacity across the receiving or aerial coil is as small as possible. Crystals and valves are potential-operated devices, that is, voltage operated. Energy or power =  $\frac{1}{2}KV^2$ , where K = capacity, V = voltage, therefore the potential across the valve or crystal for a given signal will be three times as large, provided the capacity can be decreased nine times. The signal will be more than three times as strong because the efficiency of rectification increases as the voltage is increased up to a certain point.

To get maximum signals it is necessary to keep the capacity across the tuning coil as low as possible and do without a condenser. There will still be the self-

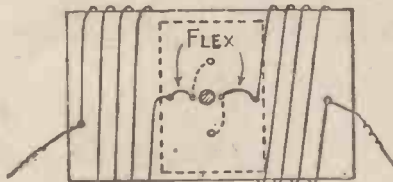

Fig. 1.—Details of Connections.

capacity of the windings, but no added capacity.

The most efficient method of varying the wave-length is by a variometer. A variometer consists of two inductance coils connected in series electrically, but they can be magnetically coupled in opposition or in the same direction. The inductance can thus be varied continuously from the difference between the two inductances to twice the sum of the two. If the two inductances are equal, it is from  $L - L = 0$  to  $(L + L) \times 2 = 4L$ , where L stands for inductance.

The variometer about to be described is easy to construct and will give very good results.

Two formers will be required, of sizes to be decided by the wave-lengths it is desired to receive.

If the outside former is 6 in. in diameter and the inside former is 5 in. in diameter, the length of the inside one cannot be longer than  $\sqrt{6^2 - 5^2}$ , that is  $\sqrt{36 - 25} = \sqrt{11} =$  about  $3\frac{1}{2}$  in., otherwise it will not turn. Any diameter of former can be used if the following be acted upon.

The length of the inside former must be a little less than the square root of the difference between the diameter of the outside former squared minus the squared diameter of the inside former.

The number of turns on either former will depend upon the minimum and maxi-

imum wave-lengths it is desired to receive. If the range desired is from 2,000 to 3,000, then the inside former will only have about one-third the length of wire on the outside one. If the range desired is from the

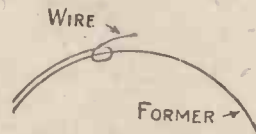

Fig. 2.—Finishing Off End of Winding.

natural wave-length of the aerial, say 200 metres up to 500 metres, then the two coils must be equal, so that  $L - L$  will equal 0.

The inductance of the two coils can be made about equal if the length of wire on both formers is equal; the length of wire on the outside former is  $\pi dN$ , where  $\pi = 3.1416$ ,  $d =$  diameter of former, and  $N =$  number of turns on former.

As the inside diameter is small,  $N$  must be larger to make the length of wire the same.

The relation between turns outside and turns inside will be  $\frac{(\pi d) \text{ outside}}{(\pi d) \text{ inside}} \times \text{turns outside} = N \text{ inside}$ , or  $\frac{(\pi dN) \text{ outside}}{(\pi d) \text{ inside}} = N \text{ inside}$ .

To get more turns inside than outside, either wind with thinner wire inside or have a longer former inside.

A drawback to a simple home-made variometer is that it is often difficult to connect the movable and fixed windings together. This difficulty can be overcome by the method shown in Fig. 1.

The outside former is wound in two halves, sufficient distance being allowed

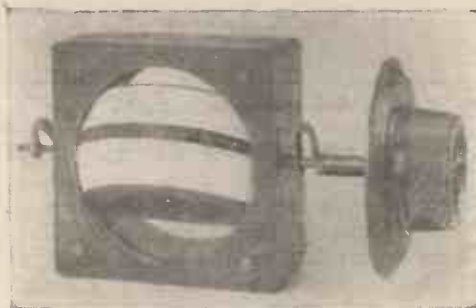

Variometer with Shaped Formers.

between for the width of the spindle. Finish off the four ends of the outside former and the two ends on the inside one, as shown in Fig. 2, to prevent the coil unwinding. If the holes are slightly larger than the wire and shellac is dropped in the insulation will be sufficient.

A soft, flexible rubber-covered flex is

then fastened between the two inner ends of the outside former and the two ends of the inner coil, but the holes through the two formers must be copied as shown in Figs. 1 and 3; the rubber flex passes through both formers.

With this method of connecting there is only about  $\frac{1}{4}$  in. difference between the outside and inside former holes when at right angles or when parallel to each other, therefore the leads do not become entangled or rub on the turns. The two ends of the outside former are now the terminals, as the inside coil has been added in the middle of the outside one.

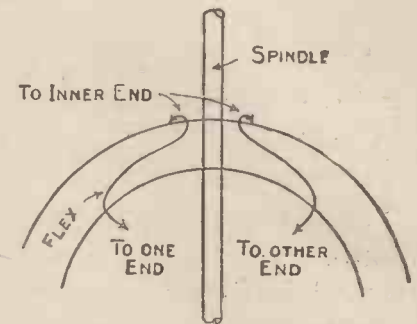

Fig. 3.—Method of Making Connections.

For mounting, secure the outside former to the ebonite or wooden panel as shown in Fig. 4, or else mount it on two wooden supports.

Place a pointer on the spindle so that it cannot pass the supporting terminal heads; this will prevent the inner coil turning through more than 180 deg.

If a wooden panel, the wires should be connected to terminals on an ebonite bush. The spindle can be a piece of thin round wood projecting 6 in. or 7 in. so that the capacity of the hand will not have any effect when tuning. It should move just freely, the inside former being fastened to it with wax or something similar.

For use as a variable inductance in the aerial circuit the wire should be about No. 20 or 22 gauge, particularly for short waves, but on account of bulk it will be necessary to use No. 26 for long waves. The wire can be either enamelled, silk-covered, or, if shellacked afterwards, cotton-covered. Using a variometer as a tuned reactance (without coupling) No. 30 wire can be used. In all cases, if it is possible, space the wires apart a little, say ten turns to an inch instead of twenty; it will decrease the self-capacity and increase the efficiency. The circuits will usually oscillate without coupling, if the reaction coil has exactly the same wave-length as the aerial circuit. If fitting a high-frequency valve, good results will be

(Continued on page 391)



# The World listens in on MULLARD PHONES

Specially made for the reception of wireless broadcasting, Mullard 'phones are thoroughly well made and fit comfortably to the head, etc.

*British Manufacture*

The two high resistance ear-pieces (4,000 ohms total) are flexibly attached to the fully adjustable, double head bands.

The set is nicely finished in nickel-plate and supplied complete with standard flexible cords.

Send the coupon to-day to secure immediate delivery.

These telephones are made by the makers of the famous ORA valve and Mullard valve accessories.

## MULLARD "ORA" VALVES

We hope to get a greatly increased output of these famous valves at our large new factory

Meanwhile - - - ORDER AT ONCE



## Mullard Radio Valve Co. Ltd.

45, Nightingale Lane, S.W.12.

Contractors to H.M. Admiralty,  
War Office, Royal Air Force & Post Office.

Telephone : Codes : Telegrams :  
Battersea ABC (5 Ed) 'Radiovalve Hammer,  
1068 Bentley's London.



Name and Address.....

To the MULLARD RADIO VALVE CO. LTD.,  
45, Nightingale Lane,  
London, S. W. 12.

Quantity	Description	Price
.....	Telephone Head Sets	30/- per set
.....	ORA Valves	15/- each
.....	Grid A Resistances	5/- "
.....	Anode A or B Resistances	5/- "
.....	BA Condensers, .003 mfd.	2/6 "
.....	Combined Resistance and Condensers	7/6 "
.....	Valve Bases with Terminals	5/- "
.....	Valve Sockets	1/3 "
.....	Terminal Clips	9d. per pair

I enclose (Cheque, Money Order, P.O.) value..... to cover the cost.

Name of usual Wireless Dealer.....

**SEND THIS TO-DAY**



# BEAVER



## HEADPHONES

4000 Ohms total Resistance. Double Headband, each Receiver Detachable Instantaneously. Guaranteed highly efficient ; Complete with Cord and ready for use.

*Every pair tested and guaranteed*

**25/-**  
**POST**  
**FREE**

## COMPLETE SETS

### NO. 1 "BEAVER" CRYSTAL SET

*Unassembled*

Inductance Coil 7 x 3½, wound 24 Enamelled Wire. Blocking Condenser .0003 between Ebonite Sheets. Crystal Detector, Complete with Special Crystal. 1 Brass Rod Cut and Drilled. Slider and Plunger. 1 Pr. Wooden Ends. Wooden Base 10 x 9. 3 Reel Insulators.

**20/-**  
**POST FREE**

### NO. 2 "BEAVER" CRYSTAL SET

*Unassembled*

Inductance Coil 9 x 3½, wound 24 Enamelled Wire. Blocking Condenser, capacity .0002 between Ebonite Sheets. Crystal Detector. 2 Brass Rods Cut and Drilled to fit. All Necessary Terminals. Two End Boards. Wooden Base 15 x 12. 100 ft. 7/22 Stranded Aerial Wire (Best Quality). 6 Reel Insulators. 2 Sliders and Plungers. Ivoryne Tabs, Earth, 'Phone and Aerial.

**25/-**  
**POST FREE**

### NO. 3 "BEAVER" CRYSTAL SET

*Assembled ready for use*

Splendid Crystal Detector fitted with Special Crystal, and mounted on Ebonite Base. Blocking Condenser .0005, mounted between Ebonite. Inductance Tube 12 in. x 4 in., wound 24 gauge Enamelled Wire, Waxed Interior to prevent sweating. Fitted 2 Brass Rods complete with 2 Sliders and Plungers. All necessary Terminals marked with Ivoryne Tabs. The whole mounted on Solid Mahogany.

**27/6** POST FREE  
 Complete with Splendid Tested and Guaranteed 4000 ohm 'Phones, **50/-**

### NO. 4 "BEAVER" CRYSTAL SET

*Unassembled*

Inductance Coil, 12 x 4, wound 23 gauge Bronzed Wire, Beaver Variable Condenser .0005, as sold for 10/-. Crystal Detector complete with Special Crystal. 2 Brass Rods Cut and Drilled to fit. 6 Splendid Terminals. 1 pr. End Pieces of Mahogany, Solid Varnished Mahogany Base. 100 ft. 7/22 Stranded Aerial Wire. 6 Reel Insulators. One 6 in. or 9 in. Leading-in Tube of Solid Ebonite and Brass. Ivoryne Tabs for Terminals. 2 Sliders and Plungers.

**35/-** POST FREE  
 Complete with Splendid Tested and Guaranteed 4000ohm 'Phones **57/6**

*Ask your Wireless Dealer for these sets ; if he does not stock them, write direct to :—*

**BEAVER ELECTRICAL SUPPLY CO.,**  
 Telephone : **GERRARD 1900**      **109, REGENT STREET, LONDON, W.1.**  
*Special Terms to Trade. All Cheques and Postal Orders to be crossed London Joint City and Midland Bank.*

VARIOMETERS (continued from page 388)

obtained with the reactance-capacity coupling, using a variometer as tuned reactance.

To prepare the formers, dry them thoroughly in a moderately warm oven, then shellac them, drying again slowly in the oven; wind and reshellac them, then

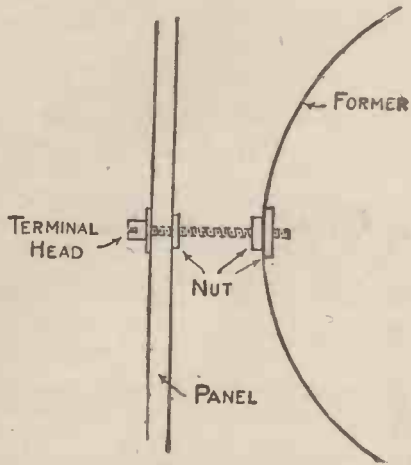

Fig. 4.—Method of Mounting.

dry very slowly so as not to shrink the formers.

The following tables are a rough guide for sizes of former and wire for different wave-lengths.

	FORMER				Wavelength
	Turns (spaced)	Wire	Diameter	Length	
Outside ...	40	No. 20	4 in.	5 in.	} 200-700
Inside ...	40	No. 22	3 in.	2½ in.	
Outside ...	200	No. 26	6 in.	10 in.	} 2000-2800
Inside ...	90	No. 26	4½ in.	4 in.	

List of wires and weights in oz. (to nearest oz.) sufficient to fill 6 in. of various size formers.

If Closely Wound	Enamelled Wire						
No. of Turns to 6 in.	166	215	288	335	415	485	550
Gauge of Wire	20	22	24	25	28	30	32
Diameter of Former	4 in.	5 in.	6 in.	7 in.	8 in.	9 in.	10 in.
Weight (oz.)	7	7	6	5	5	4	3
	0	8	8	6	6	5	4
	11	10	9	8	8	6	5
	13	11	11	9	9	7	5
	14	14	12	10	10	8	6

G. H. W.

"Working Diagrams of Valve Amplifying Receiver Circuits," a very valuable little book already in its fourth edition, has been received from Mr. H. W. Sullivan, Winchester House, Old Broad Street, London, E.C.2, the price being 1s. The book contains about thirty-three diagrams of different circuits, and these circuits can be so modified as to avoid any reactance on coupling direct to the aerial. Diagrams explain how to vary the number of valves in circuit without unduly disturbing the connections, and how to add, at will, a note-magnifying valve to most of the circuits shown. The final plate shows various components in two ways, as they are and in symbolic form.

# Meaning of Electrical Units

## Some Introductory Remarks

THERE will doubtless be many readers to whom it has occurred to wonder why so many different units are constantly being referred to, why this array of ohms, volts, henrys and farads. A few words on their origin and meaning will therefore be useful.

### Indiscrimination

The tendency of the "lay mind" is to regard these units as so many synonymous terms to be used indiscriminately as the memory serves, or as the avoidance of repetition of expression requires. This was well illustrated lately when a daily newspaper announced that a large new power concern in America was to use "the largest current ever—1,000,000 volts"—apparently missing the point that the reason for attempting to use this extremely high voltage for transmission purposes was to reduce the current in the line as much as possible.

When we buy a tennis ball we usually judge it by the price and our knowledge of the previous performance of the brand. If we are particular we may pinch it or bounce it, but beyond that we do not trouble, for we know that the chances are overwhelmingly in favour of it giving satisfaction. After a period of service, depending for length on whether we play at Wimbledon or in a public park, we decide, likewise by its appearance, that its useful life is over. And so it is with most commodities in familiar everyday use. The superficial test of appearance, together with, perhaps, measurement on the household scales or by the foot-rule, will give us a sufficient idea of whether anything is lacking.

### Non-apparent Qualities

But when we begin to deal with things electrical we must be prepared to narrow down our ideas of what will and what will not give satisfaction to infinitely smaller limits. So small is the difference between, say, an inductance which will just "tune in" certain signals which we wish to hear and one which is useless to us, that we must be able to adjust its dimensions one turn at a time, and if we wish to convey to others what the amount of inductance actually is we shall have to measure it in millionths of a henry. In addition, of course, we are usually dealing in quantities which are not apparent to the naked eye. For example, one dry cell may look just like another, may have cost as much and may have been made at the same time, yet the electromotive force it is capable of exerting may, through some defect in the manufacture or subsequent ill-use, have

dropped till the cell is an actual hindrance in the plate circuit of a valve instead of a useful unit of the battery. Our readiest means of rendering this apparent is to test the cell with a suitable instrument, and in order to compare one cell with another and estimate its value we calibrate that instrument in suitable and mutually understood units. Thus we are enabled to say that it has an electromotive force of so many volts, and immediately to realise from that, by our previous experience, of course, whether it will give satisfactory service or not.

### Requirements

The growth of the table of units at present in use in electrical measurements, although it has been so much more rapid, resembles that of the "tables" we learnt to be so fond of in our youth. As the existence of some new property of matter became evident the desirability of comparing it quantitatively became important, and a suitable unit was devised and christened.

It is related of a certain English king that upon being informed that trade was becoming impossible because of the multitude of different measuring rods which were being used to estimate length, he gave instructions that the length of the royal foot was in future to be the standard. Although somewhat arbitrary, this method for dealing with what has frequently since that day proved to be a knotty point, had in its favour the fact that it was a royal decree and in no way open to question.

The requirements of electrical science have increased so rapidly that in some cases different workers suggested and used different names for the same unit, but the uncertainty which this threatened to create was satisfactorily dealt with by the appointment of an international committee of scientific men who drew up a list of units with their definitions, and instituted a system of symbols to represent them. We propose to discuss those quantities which are of greatest use to the wireless experimenter, to state the units in which they are measured, and to give a list of the accepted symbols. All such units are ultimately based on the standards of length, mass and time, and may be expressed in terms of these fundamental conceptions. In England the fundamental units are the foot, the pound and the second, while on the Continent, and almost universally among scientists, the centimetre, the gramme and the second are used. Much confusion would be avoided if the latter were made the legal standards in England.

SIGMA.

(To be continued)

# The All-British Wireless Exhibition

## Sir Henry Norman's Opening Speech

THE first All-British Wireless Exhibition and Convention was opened at the Royal Horticultural Hall, Vincent Square, Westminster, London, S.W.1, on Saturday, September 30, by Sir Henry Norman, who, as chairman of the Imperial Wireless Telegraphy Committee, and as a member of the Post Office Telegraph Organisation Committee and of the British Association Committee of Radio Telegraphic Investigation, was able, at the conclusion of the inaugural lunch, to make a speech of first-class importance. We present here its main points which will be found to have especial interest in their relation to broadcasting.

Sir Henry congratulated the organisers on their system of having stands of uniform design which gave the exhibition a neat, businesslike appearance. Wireless-telephony would be an integral part of our social life in the very early future, and he spoke of broadcasting being a commonplace in a month or two.

The hold-up of broadcasting had been blamed to the Postmaster-General and to the companies, but this was a complete misapprehension. There had not been an hour's avoidable delay in bringing broadcasting into being. No less than twenty firms had applied for permission to broadcast—big firms, little firms, old firms, new firms—and it had been a delicate and difficult task to co-ordinate all the interests

Closes on  
**Saturday,  
October 7th.**

10 a. m. to  
10 p. m.



concerned. What delay there had been was all to the advantage of the public. He thought they had now arranged an admirable scheme. A broadcasting company had been formed on lines approved by the Postmaster-General. Its capital of £100,000 had been guaranteed by six companies (see p. 334 of AMATEUR WIRELESS, dated September 23), and any genuine British firm could join by taking one share and by paying 10 per cent. of its sale price to the company. (In another part of his speech Sir Henry announced that users of Marconi patents would pay the Marconi company a royalty of 10 per cent.)

A broadcasting receiving licence would be obtainable in due course at any post office.

The cost of broadcasting was chiefly that of the high-class professional programme—the very best of its kind in the world—which the broadcasting company

regarded as the very foundation of success of the whole scheme. Broadcasting would begin within a week or two from Marconi House and Trafford Park, the remaining six broadcasting stations which had been arranged for coming into operation as soon as ready. The desirability of increasing the power of the broadcasting stations from 1½ kilowatts to 2½ and 3 kilowatts was being seriously considered. The broadcasting of news was only possible with amicable accord between the Broadcasting Company and the news agencies and newspapers.

He expected that no less than 500,000 receiving sets would be wanted in this country and that great developments with regard to amplification might be expected.

Sir Henry closed a notable speech with the hope that 'broadcasting would soon make it possible for His Majesty the King to address simultaneously the Parliaments of the Empire.

Mr. F. Hope-Jones, the chairman of the Wireless Society of London, in moving a vote of thanks to the chairman, said that Sir Henry's statement with regard to broadcasting was definite and authoritative, that it had silenced our doubts and removed our difficulties.

## A General Impression of the Exhibition

IN our last issue we gave illustrations and advance particulars of many of the more prominent exhibits. Such a brief interval elapsed between the opening of the exhibition and our going to press that it is impossible for us to present here a complete account of all there is on view, and we propose to content ourselves for this week by giving our readers the result of our impressions gained by a general glance at the exhibition.

We must say at once that the exhibition is good and comprehensive, and it is no exaggeration to say that its chief interest is for the amateur. True, there are a

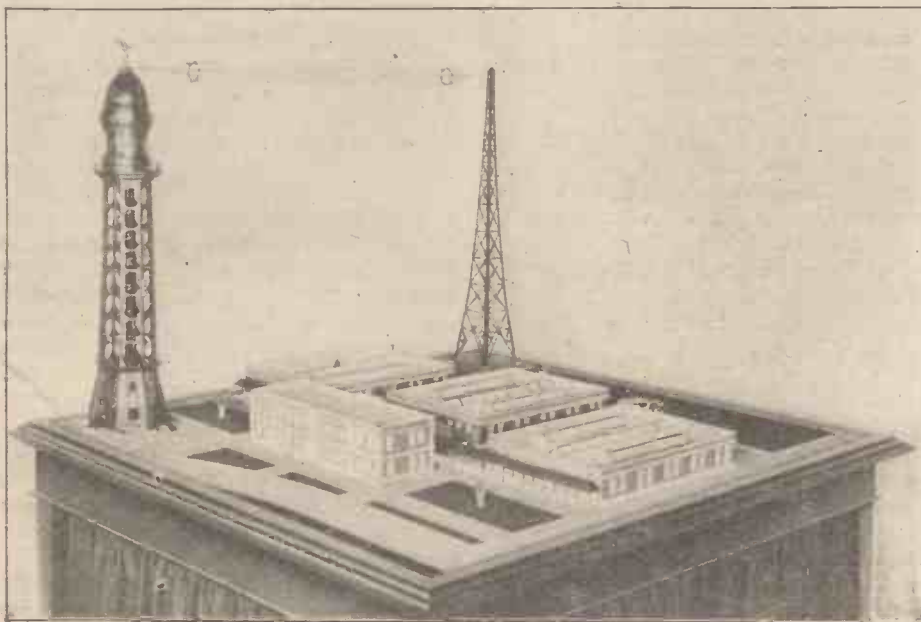

Scale Model of Metropolitan-Vickers Broadcasting Station and Research Department at Trafford Park.

multitude of sets with prices in the region of a hundred guineas which, from a constructional point of view, the amateur cannot hope to emulate, but there are also studs, knobs, switches, inductances, transformers, condensers and a host of other sundries, and these and the examples of complete apparatus are to the keen amateur the potentials of his receiving set.

For the apparatus shown we have nothing but praise, and it may be said at once that it is distinctly improved compared to that which was on the market within even the last few months. This is particularly the case with those parts which are ordinarily out of sight, and a very cursory examination makes it obvious that makers are now as anxious to show the interiors of their apparatus as the exteriors. This perhaps is the most evident feature of the show.

The next most prominent feature is the elaborateness of the complete receivers combined with the most simple means of

Trafford Park, Manchester. The coil machines on the stand of Igranic Electric Co., Ltd., are equally interesting, providing as they do an indication of the progress that the science is making when elaborate constructional plant is being devised. As stated in another column, we are promised broadcasting within the next two weeks, and as an almost continuous programme of concerts has been arranged for the present week, this exhibition may almost be said to mark its inception. Loud-speakers are reproducing the broadcasting in the exhibition hall, but this is a feature in which, frankly, we were most disappointed; we were concerned to think that the impression upon the minds of many thousands of visitors who previously have not heard any broadcasting could not be favourable. We have heard better music and speech, though less noise, on a simple crystal set. The fact is that present-day loud-speakers of the more powerful type leave much to be desired.

production of the Economic Electric, Ltd., 10, Fitzroy Square, London, W.1. (Stand 51.)

The telephone transmitting set of a capacity of 10-15 watts, on the stand of H. W. Sullivan, of Old Broad Street, London, E.1, which comprises a completely self-contained transmitting set suitable for small range. The exhibits of this firm are of a very varied nature both for transmitting and receiving purposes, and include, of course, the well-known Sullivan patent telephone head-sets. The range of apparatus shown is one of the most extensive on view in the exhibition. (Stand 49.)

The patented inductances, the exhibits of Gambrell Bros., Ltd., Merton Road, London, S.W.18. The special claims made for these inductances are very low effective resistance, low self-capacity, great mechanical strength, and an extensive

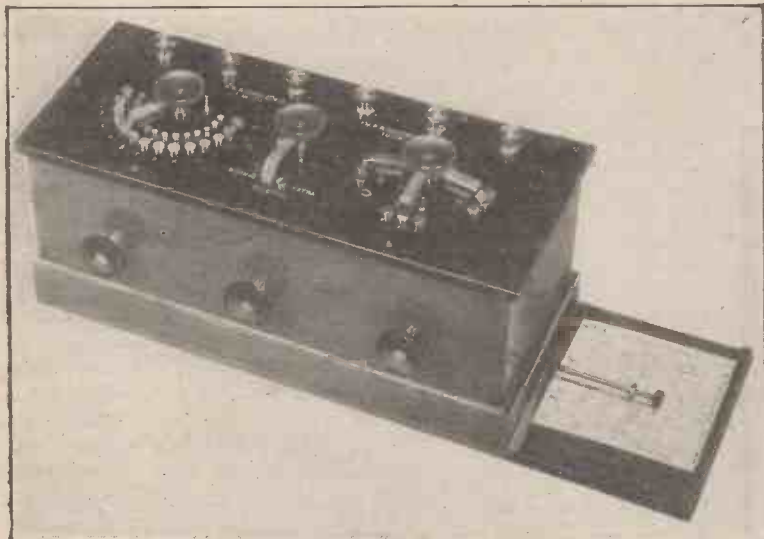

The H.P.R. Universal Tuner.



Metropolitan-Vickers Crystal Set.

control., To-day at the Horticultural Hall there are dozens of receivers of most complicated construction, but which, it is not too much to say, could be efficiently operated by a child. This is all to the good, for it is not to be expected that the average receiver of broadcast will be a wireless expert, though no doubt the amateur will still have his maze of wires.

Feature number three may be said to be the relatively large number of new devices that are exhibited either as component parts or included in the make-up of complete apparatus. It is not proposed to describe any of these here; some have already been described, and others will be featured in later issues. Particular ingenuity is evident in the construction of basket-coil holders.

Mention must be made of one or two exhibits that are a little out of the ordinary run. One of these is the collection of historical apparatus on the Marconi stand, and another is the model of the broadcasting station shortly to start transmitting at

The visitor's to the show were no less interesting than the exhibits, for they may be deemed to be representative of the present-day wireless enthusiasts. There was the schoolboy and there was the man on the wrong side of sixty, and there were many of the gentler sex too—all apparently very keen on the new science of amateur wireless.

### "What to See" (continued from last week)

**Ex-Government wireless apparatus,** a feature on the stand of L. McMichael, Ltd., Providence Place, Kilburn, London, N.W.6. The firm are offering as a prize a B Mark II two-valve detector-amplifier for the best conversion of this particular piece of apparatus. In addition, they are exhibiting a large range of general apparatus. (Stand 38.)

**The E.E.C. oscillator,** an instrument for reproducing oscillations in a receiving circuit without the use of a reaction coil, a

range of wave-lengths. On this stand are also to be seen a number of broadcast receivers of interesting design. The inductances will be described and illustrated in a later issue. (Stand 47.)

The film entitled "The Audio," which illustrates and describes the operation of the thermionic valve, shown by the Western Electric Co., Ltd., Finsbury Pavement, London, E.C.2. This company is one of the largest engaged in the production of wireless apparatus, in which they have done a vast amount of pioneer work. In this regard it may be mentioned that the experimental apparatus of Dr. Alexander Graham Bell, the inventor of the telephone in the year 1876, was made by them. Their exhibits cover a very wide range, from the simplest crystal receiver to the most elaborate cabinet valve sets, some of which we hope to describe and illustrate in a later issue. Special claims are made for their loud-speaking equipment, in which distortion is said to be a minimum. (Stand 39.)



Fig. 1.—Two Patterns of Intervalve Transformer:



Fig. 3.—Method of Bringing Out Wire Between Paper Washers.

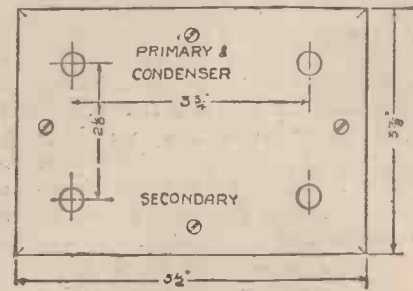

Fig. 5.—Plan of Lid.



Fig. 4.

IN the single-valve set described in No. 5 of AMATEUR WIRELESS the telephones are connected in series with the high-tension battery in the plate circuit. The negative end of the high-tension battery is connected to the filament which is earthed, as will be observed from the diagram of connections (p. 91). This means that the windings of the telephones are at

a potential of about 50 volts above the surrounding objects. It may be assumed that the human body is earthed, although it is a poor conductor. Now, since the

windings have to be of high-resistance to get satisfactory results when connected in series with the plate circuit, the wire must necessarily be very fine and the insulation must be thin, so that there is no likelihood of it being strained. The fact that the ears are continually giving off moisture, which finds its way on to the diaphragm, does not assist matters. The telephones being shunted by a condenser does not make any difference.

To overcome the above difficulties a telephone transformer may be used. It consists of an iron core, closed or open, on which is wound two separate coils, well insulated from one another. They may be wound side by side or one over the other. If the telephones are of high-resistance, say 4,000 ohms, the windings may each have the same number of turns, but there is no reason why low-resistance 'phones should not be used, in which case the ratio of the number of turns on primary and secondary should be between 5 and 20 to one.

Of course, in a crystal set there are no high potentials, and therefore no necessity for a transformer except if it is desired to use low-resistance telephones. The amateur should be warned against buying low-resistance telephones simply because they are cheap. The difference in price between new 150-ohm and 4,000-ohm 'phones of a good make will be found to be only about four or five shillings. Of course, if the reader has a good pair of low-resistance 'phones it would certainly pay to make a transformer rather than discard the old ones and get a new pair.

**The Iron Core**

The most satisfactory form of iron core is undoubtedly the one shown in the photograph (Fig. 1), in which both of the transformers shown are of the intervalve type. The cores of the smaller one are made up from stampings which are difficult to obtain, and not worth the trouble of cutting out.

The following notes describe a telephone transformer for a pair of 300-ohm 'phones which was made by the writer. It includes a condenser across the primary, so that there is no need to use an external condenser (see Fig. 2).

The core is made of a bundle of iron wires; about ¼ lb. No. 20 S.W.G. would be ample. The wire is straightened out and cut into 10-in. lengths. The quickest way of straightening it is to cut the wire first into lengths of about 5 ft., grip one end in the vice and the other end in a pair of pliers and jerk it straight, as though one were trying to snap it. This process will take all the bends out. A piece of ½-in. diameter fibre tube 3 in. long should then be obtained and two pieces of ebonite 1½ in. square and ¼ in. thick. Holes ½ in. in diameter are to be drilled in the centre of each end, and they are driven over the ends of the tube to make a bobbin. If it is not possible to

# THE TELEPHONE TR

## PORTABILITY



THE great advantage of the crystal type of receiver is its portability, owing to the fact that no extraneous batteries or accumulators are required, the instrument being complete in itself. The photograph shows the "Multum in parvo" crystal receiver fitted with a leather handle, the whole being no more cumbersome than the average attaché case. The makers are the Consolidated Trading and Manufacturing Co., Ltd., Fulwood Place, London, W.C.2.

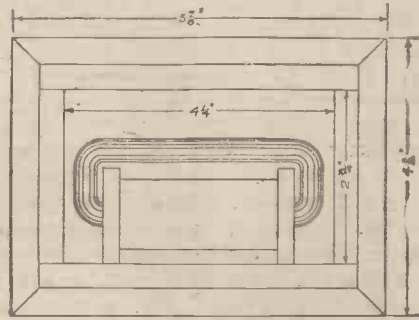
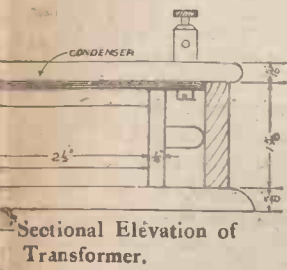

Fig. 6.—Diagram showing Position of Transformer in Case.



Fig. 2.—A Telephone Transformer Complete.

## TRANSFORMER

### Its Use and Construction

obtain these materials the tube may be made of good drawing-paper wrapped round the bundle of iron wires and well glued.

The bundle should be  $\frac{3}{8}$  in. in diameter. Bobbin ends of three-ply wood may be used, but it must be remembered that it is much more difficult to make a good job out of makeshift materials than it is out of the proper stuff.

#### The Windings

The secondary winding is wound first. It should be noted that in a step-down transformer the high-resistance winding will be the primary and the low-resistance the secondary. It is more convenient to wind the secondary on first, as the wire is thicker and there is not so much likelihood of a breakdown when the outer winding is laid on.

In the writer's case the secondary winding consists of 1 oz. of No. 32 S.W.G. enamelled wire. Single-cotton-covered would do. This makes about 1,000 turns. The ends of the wire are brought out through little holes in the cheeks of the bobbin, and two layers of paraffin-waxed paper are put over the winding. The wax should not be hot enough to smoke, but it should make the paper fizz when it is immersed. The covering round the secondary is well smoothed down with a piece of warm brass strip.

The primary winding consists of about 14,000 turns of No. 42 S.W.G. single-silk-covered wire (weight about  $1\frac{1}{2}$  oz.) or 2 oz. of No. 40. The ends of the wire are soldered to pieces of No. 26-gauge wire to make strong leads. About 2 ft. of wire should be used for the inside end. When this has been soldered it should be wound once or twice round the bobbin and then another piece of paper laid on. The end can be brought out through a hole in the cheek of the bobbin or between two cut paper washers, which are slipped on the

core and pressed against the cheek as shown in Fig. 3. The wire is then wound on the core evenly and carefully from end to end.

When finished, the end of the wire is joined to a piece of No. 26 as before and the whole covered with a layer of paraffined paper. The coil wires are then placed in position and bent round the sides of the bobbin to overlap. They can either be spread out evenly all round, umbrella fashion, or all kept together; it makes no difference to the final result. If they are bent round all in the same direction, as in the photograph, they can be tied together and bound round with tape to make them tight. The transformer is now complete, and the windings should be tested for continuity.

To do this each winding is connected in series with a telephone and a dry cell. When the circuit is made and broken a loud click should be heard in the telephone. Both primary and secondary should be tested this way, and then the insulation between windings is checked. This is done by connecting one lead from the telephone to the cell, the other to an end of the secondary, and the other terminal of the cell to the prim-

ary. No noise should now be heard. The condenser, which is connected across the primary, consists of twenty sheets of tinfoil 3 in. by  $1\frac{1}{2}$  in. and twenty sheets of thin white paper  $2\frac{1}{2}$  in. by  $\frac{1}{2}$  in. Typing paper is convenient for this purpose. It is cut up into strips 2 in. wide and soaked in wax. The strips are then hung up to

(Continued on page 397)

### PORTABILITY



THIS photograph shows another crystal receiver designed for portability, being the well-known "Aerowave" receiver of Henry J. Brewster & Co., 11, Queen Victoria Street, London, E.C.4. The construction is on similar lines to that of the instrument in the opposite illustration. In this case the top and front are made to open as shown, compactness being the keynote.

# Wireless: "Wired" and "Piped"—III

The Third Article on the Use of Electric-light Mains and Pipes as Aerials

### Other Methods

FIG. 8 shows another method of arranging the circuit. In this case only one of the fixed condensers (L) was connected to the series variable condenser, this being the unearthed side of the main. Signals

noticed. The variable condenser in series could be operated over its whole range without seriously interfering with reaction, and gave very sharp tuning. However, at any value above its minimum the generator hum increased in strength.

generator hum was extremely loud. However, as signals showed a slight increase in strength when compared with Fig. 8, the writer intends to devise some means of reducing generator noises, and to report the result at a later date.

Fig. 10 shows a scheme of connections which produced signals of almost half-strength. In this case the unearthed side of the main was connected through fixed condenser (L) to two series variable condensers of .0015 and .0005 micro-farads, with the usual earth connection to the receiver. Signals were easily tuned in and reaction was easily controlled. In fact, the only way to stop oscillations was to reduce the high tension to about ten volts. The wave-lengths to which given coils would tune were found to be practically the same as with the previous circuits, but it is curious to note that the two series condensers made practically no difference to tuning even when rotated through their whole range. It was found, however, that best reception was obtained when these condensers were set at about their minimum positions; any increase in their value made the generator hum slightly more pronounced and served no useful purpose.

P. T. B.

(To be concluded)

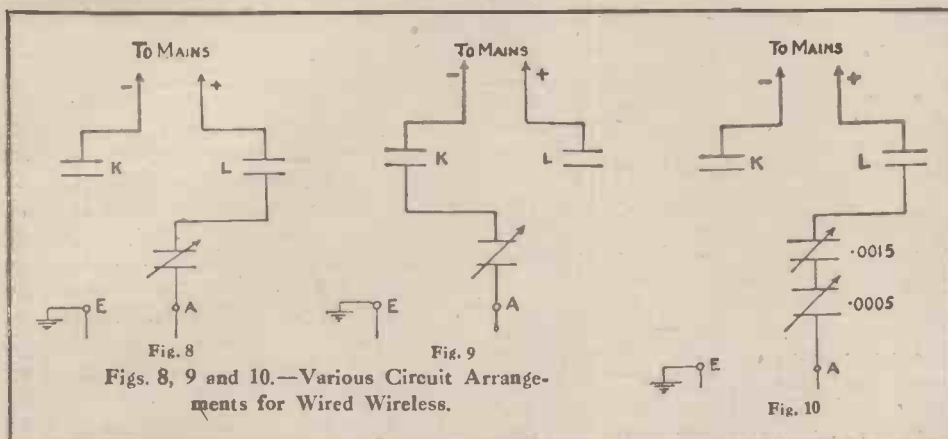

Figs. 8, 9 and 10.—Various Circuit Arrangements for Wired Wireless.

were much louder with this arrangement, being about half-strength as compared with an outside aerial. Generator hum was slightly less, and in all respects this circuit was an improvement on the last, but a slight lowering of the wave-length was

In Fig. 9 the unearthed side was disconnected and the other fixed condenser K placed in circuit with the series variable condenser. This method of connection is practically useless when operating on mains having one side earthed, as

## Some American Hints and Tips

### Spider-web Coil Formers

ON the periphery of an old gramophone record find nine equidistant points and draw a line from each point to the centre. With a hack-saw cut slots  $\frac{1}{2}$  in. wide along these lines to about 2 in. from the centre. Then weave the wire between the slotted pieces. By making several coils of varying sizes, a wide range of wave-lengths can be covered. Another way is to mount a multi-tap switch in the centre of the record and bring down taps to it from the winding. The circuits in which these coils are used are the same as those for De Forest honeycomb coils.—*Radio Digest*.

### A Tuning Coil Slider

A SIMPLE method of making a tuning coil slider is shown in the accompanying illustrations. The materials required are a round brass rod of any length and about  $\frac{3}{8}$ -in. diameter; one piece of sheet copper  $3\frac{1}{2}$  in. by  $\frac{1}{2}$  in. of sufficient springiness

to suit; one steel ball about  $\frac{3}{8}$ -in. diameter.

First hammer the copper to make it

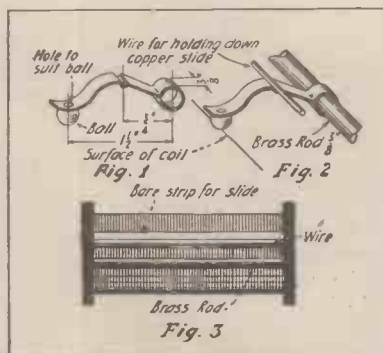

Tuning Coil Slider

springy, then bend it round the brass rod (see Fig. 1).

Fasten a wire along the length of the coil to keep the slider on to the polished surface of the wire, as shown in Fig. 2.

Bore a hole in the copper at one end (see Fig. 3) a little smaller than the ball, so that the ball will revolve without slipping through. An insulated handle may be attached to the slide.—*Radio News*.

### Insulating Tubing

HAVE you ever been in need of some use for cambric insulating tubing and discovered that there was none at hand? If this happens to you at any time, just hunt up a round shoelace used on ladies' shoes, and you will find that this makes good insulation for small wire. Just push the wire through the centre.—*Radio Digest*.

### Fixed Detector Adjustment

IN order to keep a crystal detector in perfect adjustment, drop some hot beeswax around the wire. In practice this has kept the whisker in place for months; it eliminates the necessity of seeking the elusive spot every time the set is used.—*Radio Digest*.



"THE TELEPHONE TRANSFORMER"—(continued  
from page 395)

cool and cut into 3-in. lengths. The condenser is built up to allow  $\frac{1}{4}$  in. space for the paper to overlap the foil. When finished the condenser should be pressed with a hot iron to squeeze out the surplus wax. The iron must not be hot enough to burn the wax or it will lose its insulating properties.

A few words on calculating the capacity of such a condenser may not be out of place here. The effective size of the plates is 2 in. by  $1\frac{1}{2}$  in., and there are twenty sheets. This is equivalent to two sheets 2 in. by 15 in., separated by paraffin equal to the thickness of the paper (0.003 in.). Bringing these dimensions to centimetres (2.54 cm. = 1 in.), 30 sq. in. =  $60 \times 2.54^2 = 387$  sq. cm. Distance apart =  $2.54 \times .003 = .0076$  cm.

Now C in micro-farads =  $\frac{K \times A}{11,300,000 \times d}$   
where A = area of plate, sq. cm.  
d = distance apart.

K = a constant depending on the material.

For air K = 1.

For paraffin K = 2.

The above, therefore, is:

$$\frac{2 \times 387}{11,300,000 \times .0076} = .009 \text{ micro-farads.}$$

The box for the transformer measures  $4\frac{1}{4}$  in. by  $2\frac{3}{4}$  in. by  $1\frac{5}{8}$  in. internally. It should preferably be made of mahogany or teak, but soft wood will do. The top, if made of soft wood, should be thoroughly dried and soaked in paraffin wax. The transformer, after it has been tested, may be fixed in place in the box by pouring wax in to a depth of about  $\frac{1}{4}$  in.

The connecting wires are cut to about 4 in. long, and pieces of rubber tubing are slipped over them for protection against short circuiting. This can be stripped off rubber-covered cable. The condenser is fastened under the lid of the box and clamped down with the primary terminals as shown in the drawing, Fig. 4. The rest of the wires can then be connected up, and after the complete transformer has been tested the connections may with advantage be soldered to the terminals. The diagram (Figs. 5 and 6) showing details of construction is self-explanatory.

J. F. S.

## ANNOUNCEMENTS

"Amateur Wireless and Electrics." Edited by Bernard E. Jones. Price Three-pence. Published on Thursdays and bearing the date of Saturday immediately following. It will be sent post free to any part of the world—3 months, 4s. 6d.; 6 months, 6s. 9d.; 12 months, 12s. 6d. Postal Orders, Post Office Orders, or Cheques should be made payable to the Proprietors, Cassell & Co. Ltd.

General Correspondence is to be brief and written on one side of the paper only. All sketches and drawings to be on separate sheets.

Contributions are always welcome, will be promptly considered, and if used will be paid for.

Communications should be addressed, according to their nature, to The Editor, The Advertisement Manager or The Publisher, "Amateur Wireless," La Belle Sauvage, London, E.C.4.

# Broadcasting: The Situation

## The Wireless Society Sends a Deputation to the P.M.G.

IMPORTANT announcements were made at the last meeting of the Wireless Society of London. By the way, the committee has decided, subject to the approval of the annual meeting, to alter the title of the society to the "Radio Society of Great Britain"—in our opinion a very proper change.

Admiral of the Fleet Sir Henry B. Jackson, the society's president, accompanied by Mr. F. Hope-Jones and other officials of the society, had formed a deputation to the Postmaster-General, on whose behalf they were received by the Secretary of the General Post Office, by Capt. F. G. Loring, R.N., and by Mr. E. H. Shaughnessy, the interchange of opinion being on very amicable and courteous lines. Messrs. Loring and Shaughnessy were present at the meeting of the Wireless Society, and in their speeches made clear the difficulties involved in the question of broadcasting.

From the statements made at the meeting we gather that the licence position, in its essence, is as follows: In the past licences have been granted freely to all serious experimenters, and the same will apply in future, but every possible care must be taken to prevent amateur experimenters interfering with the pleasure and convenience of other people. Apparently the broadcasting receiving licence will cost 10s., of which the Broadcasting Company will take half. The holder of such a licence will purchase his set, and this must

amateur 15s., and he will be free to use apparatus that has been bought, made from bought components, or made at home.

Of course, certain regulations made by the P.M.G. would have to be observed. Mr. Shaughnessy said that if the state of affairs now existing among many skilled amateurs continued, broadcasting would be a failure because of the interference which the amateur sets give rise to. The Post Office intended to test every type of broadcast receiver sold, and only the harmless (that is, non-re-radiating) types would be licensed. According to the *Times* report Mr. Shaughnessy proceeded:

"In future the Post Office would stipulate that during broadcasting hours and between the wave-lengths of 300 and 500 metres no valve with an adjustable reaction on to the aerial should be used. If the condition were loyally observed by the amateur experimenters, the authorities would not be inclined to say that no reaction whatever might be used at any wave-length. The authorities wanted to give serious experimenters every opportunity of experimenting with the view of improving the listening-in conditions. The authorities were compelled to examine all applications for licences, but their attitude was not one of opposition to the experimenters. They had always taken a very generous view of applications for receiving licences, and there had been no change in that attitude. Personally, he felt that those people who were earning their living by the art of wireless telegraphy often had not time to trouble about the inventive side of the question. It frequently happened that the man of leisure, who took up an art as a hobby, was able to pursue some particular point which might yield very valuable results."

## Broadcasting: The Situation

Readers should see also Sir Henry Norman's speech, reported on p. 392

be of British manufacture. Any company will be able to join the Broadcasting Company and to make and sell apparatus; according to Capt. Phillips, a member of the new Broadcasting Company, a genuine applicant could not be refused. The fact that a broadcasting licensee must buy his set does not rule out amateur-made sets. Licences will be granted to amateurs who make their own sets, but the General Post Office will more or less assume that anyone capable of building his own set can be regarded as a true amateur as distinct from a mere broadcast "listener-in"; and it is therefore felt that, as he would enjoy an entertainment for which he had not paid anything, he should pay a little more for his licence, so that the fifty per cent. paid over to the Broadcasting Company should realise a little more than in the case of the 10s. licence of the "listener-in." The proposal, therefore, is to charge the

## The P.M.G. on Amateur-made Receivers

THE P.M.G. has addressed the following letter to Colonel L'Estrange Malone, F.R.Ae.S., M.P. It appears to be slightly at variance with the statements (as reported elsewhere on this page) made at last week's meeting of the Wireless Society of London:

September 26, 1922.

DEAR MR. MALONE,

In reply to your letter of the 8th instant, in regard to the position, under the broadcasting scheme, of persons who desire to make their own receiving sets, I would refer you to the answer which I gave in the House of Commons on the 27th July last, in which I stated *inter alia*, that provision would be made under which amateurs who construct their own

receiving sets would be allowed to use them. To this statement I adhere.

The question, however, is not without difficulty. The proposed Broadcasting Company (of which every *bona-fide* British manufacturer of wireless apparatus may become a member on fair and easy terms) will be put to heavy expense in erecting transmitting stations and providing suitable and regular programmes of broadcast matter. It is proposed that half of the annual fees collected for licences in respect of receiving sets should be handed over to the funds of the company. But, so far as can be judged, this will only go a little way towards meeting their expenditure. The greater part will have to be met by means of a contribution by the manufacturers to the company upon each set sold to them—a contribution which has been fixed at 10 per cent. of the price. The person who makes his own set will, under these arrangements, contribute half his licence fee towards the funds of the company, but he will be relieved of the other and more important contribution, and it hardly seems fair that he should have the same facility to listen to the broadcast programmes as the person who buys his set from a manufacturer who is a member of the Broadcasting Company.

In these circumstances suggestions have been made in the Press and otherwise that persons who make their own receiving sets, or obtain them from other sources than firms who are members of the Broadcasting Company, should pay a somewhat higher licence fee, with a view to a larger contribution being made out of the licence fee to the funds of the Broadcasting Company. It would, however, be difficult to distinguish this class of persons from *bona-fide* experimenters who may have no wish to receive the broadcast programmes; and if the fees paid by the latter were increased as well as those paid by the former class, this might be regarded as putting a financial handicap upon experimentation and research. In these circumstances I am disposed to retain in all cases the present fee of 10s. for a receiving licence, and to require from the person who does not propose to buy his set from a member of the Broadcasting Company some evidence that he has a sufficient knowledge of the subject to justify his being granted an experimental licence. The term "experimenter" will be interpreted in a liberal sense, and will, I think, adequately

cover the class of persons whom you have in mind. You must not, however, regard me as pledging myself against a higher fee should experience show that the end in view can be better reached in that way than on the lines which I propose to adopt in the first instance.

Yours faithfully,  
(Signed) F. KELLAWAY.

## The Newly-formed Radio Association

AT the inaugural meeting held at the Hotel Cecil, Strand, London, W.C.2, on Wednesday evening, September 27, the chair was taken by Prof. Low, and a message of good wishes came from Sir Oliver Lodge expressing his belief that the work of so many amateurs must lead to important developments in wireless. The secretary spoke on the objects of the association. These are adequately explained by reproducing here the list of the aims which the association has issued:

1. To further the development of radio-telephony and other forms of radio science.
2. (a) To co-operate with the authorities to secure the utilisation of the facilities afforded in conformity with the regulations; (b) To protect the interests of licence-holders from onerous or restrictive legislation and to make recommendations to the competent authorities whenever necessary for this purpose.
3. To protect the interests of licence-holders and manufacturers of radio instruments and component parts.
4. To provide expert technical advice for members.
5. To establish a Fellowship of the Radio Association and to elect as fellows duly qualified members of the association.
6. To protect members by the provision of expert legal and technical advice on questions of patents, infringements and licences.
7. To establish relations and to co-operate with kindred associations in this and other countries.
8. To disseminate by means of lectures and publications information regarding all forms of radio science.
9. To act as a bureau and a central source of information, and to establish a library dealing with all aspects of radio science.

Colonel L'Estrange Malone, F.R.Ae.S.,

M.P., moved the following resolution (ultimately carried unanimously): "This meeting, realising the need for organisation among the radio licence-holders, manufacturers, operators, and others interested in the development of radio science, welcomes the formation of the Radio Association."

Colonel Malone announced that there would shortly be called a general meeting to draw up the constitution, and expressed his own view that broadcasting must ultimately include far more than music and mere entertainment. It would have to embrace a full news service—politics, Stock Exchange, racing, etc. etc. There would be a broadcast receiver in every home, in a sense the poor man's tape machine.

The resolution was seconded by Major Phillips, who gave some interesting information—gleaned from the P.M.G.—with regard to the use of wireless-controlled toy mechanisms. These, if officially approved and marked to that effect (the General Post Office would require particulars and diagrams to be submitted to them before approval would be granted), could be used without licence, providing the wireless range did not exceed fifty yards. In the discussion which followed, the difficulty of one association attending to the needs of both amateur and trader were referred to, the chairman replying to the effect that he thought the association might become a go-between to link up the two classes.

Major Beaumont spoke on the present very curious patent position, and said that wireless telephony was "the youngest sister of all the daughters of science, and should be the handmaiden of every householder."

Colonel Malone submitted a further resolution, deploring the delay in concluding the broadcasting arrangements and expressing regret that the negotiations have been conducted in secrecy. This was carried unanimously, the meeting closing with a vote of thanks to the chairman, proposed by Mr. William Le Queux.

~~~~~

A NEW crystal detector, in which the known properties of galena are employed in a novel manner, has been patented in France. The device consists of a container partly filled with mercury and hermetically closed by a plug of insulating material through which pass two terminals on the inner ends of which are carried galena crystals, which dip into the mercury.

## OUR INFORMATION BUREAU

Expert Replies to Readers' Questions. Hundreds of Replies are sent by Post.

TO ENSURE A PROMPT REPLY PLEASE OBSERVE THE FOLLOWING RULES

Write distinctly, give all necessary details and keep to the point. Ask one Question at a time—never more than two. Send a Stamped and Addressed Envelope. Send the Coupon cut from page 400.

*Our system of business is to put money into the pockets of those who deal with us.*

We are supplying



# BROWN RADIO HEADPHONES

(“A” Type, Reed Pattern, Aluminium Diaphragms)  
at much below makers’ prices.

120 ohms, **42/6**, cords 2/9 extra, makers’ price 58/-. Reg. Post 1/-  
8,000 ohms, **49/6**, “ “ “ “ 66/-. ditto  
SULLIVAN 8,000 ohms, **36/6**, ditto

**Guaranteed Brand New Condition and exactly as delivered direct from the makers.**

Every order despatched within 4 hours of receipt.

## A GILT-EDGED GUARANTEE WITH EVERY RADIO HEADPHONE

**IMPORTANT.**—In order to settle, once and for all, the prolonged controversy at present being carried on by certain firms through the medium of a section of the Wireless Press, we now make the following addition to our original guarantee, which entirely disposes of the arguments put forth by our competitors.

**IF ANY BROWN OR SULLIVAN ‘PHONE PURCHASED FROM US, WHEN TESTED AGAINST SIMILAR ‘PHONES OF SAME MAKE MANUFACTURED DURING THE LAST YEAR, DO NOT SHOW A MARKED SUPERIORITY IN EFFICIENCY,**

**— WE WILL RETURN THE FULL AMOUNT PAID. —**

Every pair of our ‘phones were originally made to the order of His Majesty’s Government, and bears the examiner’s mark that they have passed the strictest test. This mark alone is sufficient guarantee that the ‘phones are the best that money can buy.

*The following Testimonial is typical of many :*

“ . . . We may add that the ‘phones we had from you at the beginning of this month were perfect. One customer has written saying that he finds these SO-CALLED OBSOLETE AND INSENSITIVE HEADPHONES far more efficient than those with the new type of aluminium diaphragm.”

30th August, 1922.

“ MASCO PATENTS MANUFACTURING Co., Newcastle-on-Tyne.”

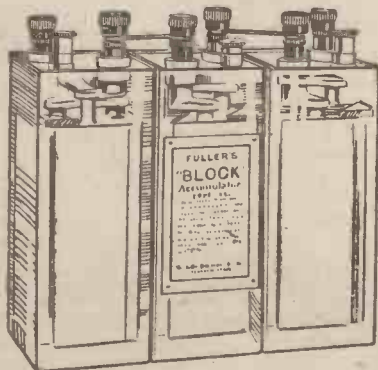

### FULLER “BLOCK” ACCUMULATORS

are the only practical proposition for wireless use. They will hold their charge from 12 to 18 months, and are FOOL PROOF.

All capacities up to 220 amp.-hours in stock. Do not risk failure and disappointment by using the plate type battery with your wireless set.

Send at once for our pamphlet. Our prices are much below those of the makers.

### The “PARLIPHONE”

LOUD SPEAKER (Prov. Patent No. 21967)

Instantaneous success of our effort to provide a reliable loud speaker at a fair price.

SOLID EBONITE. NO METAL. ENSURING PERFECT CLARITY AND ABSOLUTELY NO DISTORTION, 25 inches high, 6½ inch base.

The interior is screwed and made to receive a Brown’s Patent Standard Receiver. Order early if prompt delivery is required.

**32/6**

Carr. 1/3 extra



# The CITY ACCUMULATOR CO.

79, Mark Lane, London, E.C.3. Phone: AVENUE 91

Agents: LONDON: A. W. GAMAGE, LTD., Holborn, E.C. SELFRIDGE & Co., LTD., Oxford Street, W. RICHFORD & Co., 153, Fleet St., E.C.4.  
YORKS: BARNSELY BRITISH CO-OPERATIVE SOCIETY, LTD., Barnsley.  
GLOS: BRISTOL WIRELESS Co., 52, Cotham Hill, Bristol.  
S. WALES: SOUTH WALES WIRELESS INSTALLATION Co., LTD., 18, West Rute Street, Cardiff.  
N. WALES, LANCs. CHES. & L.O.M.: THE “ALL-BRITISH” WIRELESS MANUFACTURERS Co., LTD., 70, Central Bldgs., 41, N. John Street, Liverpool.

**OUR NEW SHOWROOMS—THE LARGEST AND MOST UP-TO-DATE IN THE CITY OF LONDON—ARE NOW OPEN, AND THE PUBLIC ARE CORDIALLY INVITED.**

## Radiograms

A COMPANY of interested persons assembled at Selfridge's, Oxford Street, London, W., last Sunday morning at 5.30, to await a wireless-telephony message from Sir Thomas Lipton, who would be sending a message from New Jersey, U.S.A., between 6 and 7 o'clock. As we go to press we do not know whether Sir Thomas Lipton actually sent his message, but we do know that it was not received, and that the little company at Selfridge's cheerfully contented itself with a very good breakfast but no message.

The Mullard Radio Valve Co., Ltd., inform us that they are just removing to their large new works, which is fully equipped with the most up-to-date plant for producing their well-known specialities. These new works, covering many thousand square feet, will enable a much greater output of the famous Mullard "Ora" valves to be maintained. At the same time facilities will be available to cope with the enormous demand for other Mullard products such as valve sockets and bases, grid leaks, telephones, etc.

Scotland is still in ignorance as to whether Glasgow or Edinburgh is to get preference as the site of a broadcasting station. The latest rumour is to the effect that the station will not be located in either city, but in a town about midway between them.

Employees of the electricity department of Glasgow Corporation are setting up a powerful installation in their club premises. It is hoped to interest the members of the Town Council in broadcasting by inviting them to the demonstrations.

The Reparations Commission having ratified the Austrian Government's concession to Marconi's Wireless Telegraph Company, the final documents relating to that concession have been signed and are now in London. By this concession the Marconi Company is given the sole right to erect, and to work for thirty years, wireless stations for public traffic between Austria and all other countries.

## FORTHCOMING EVENTS

**Glasgow and District Radio Club.** Oct. 5. First ordinary meeting of winter session.

**Hounslow and District Wireless Society.** Oct. 5, 8 p.m. Lecture by Mr. S. H. Nayler on "Wireless for the Man in the Street."

**Borough of Tynemouth Y.M.C.A. Radio and Scientific Society.** Oct. 9, 8 p.m. Lecture by W. G. Dixon, Esq., on "Short Wave Receivers." Buzzer practice at 7.30 p.m.

**Ilkley and District Wireless Society.** Oct. 9, 7.30 p.m. General meeting, and lecture by Mr. E. Stanley Dobson on "Capacity and Condensers."

**Redhill and District Y.M.C.A. Wireless Society.** Oct. 11. Lecture by Mr. Edwards on "Condensers."

**Portsmouth and District Wireless Association.** Oct. 11. Lecture by Mr. R. Cole on "Charging Accumulators by the Noden Valve off A.C. Mains."

**Stockton and District Wireless Society.** Oct. 11, 7 p.m. General meeting.

## TELEPHONY TRANSMISSIONS

**Eiffel Tower (F L),** 2,600 metres. Each afternoon (Saturdays excepted).

**The Hague, Holland (P C G G),** 1,085 metres, B.S.T. Oct. 5, 8, 12, 8-9 p.m.

**Marconi House (2 L O),** 360 metres. The Prince of Wales to the Boy Scouts of Great Britain. Oct. 7, 7.30-8 p.m.

**Writtle (2 M T),** 400 metres. Oct. 10, 8 p.m.

## CLUB DOINGS

### Huddersfield Radio Society

**Hon. Sec.—C. DYSON,** 14, Y.M.C.A. Buildings, John William Street, Huddersfield.

A SOCIETY has been formed with headquarters at the above address. The secretary will be glad to hear from persons desiring to become members.

### Rhyl and District Amateur Wireless Society

**Hon. Sec.—C. MITCHELL,** 24, East Parade. A DEMONSTRATION was very recently given on a two-valve receiving set. The instructions on putting a small receiving set together for practical use were of great interest. Each part was shown in detail, and advice given on every point possible.

Owing to very great pressure on our space we are compelled to hold over many reports.—ED.

## CORRESPONDENCE

### Telephony Reception on a Single Valve Set

SIR,—The tests referred to in my article in the issue of AMATEUR WIRELESS for September 23 were carried out some time ago. In order to bring the last paragraph up to date I recently made some further tests with one valve and should like to say that I received the Paris

telephony very much better. Croydon and Writtle were good when the set was very carefully adjusted, but it was only under favourable conditions that I could get P.C.G.G. The type of circuit described is not now allowed by the P.M.G., but with a "loose-coupler" added the remarks about the adjustments still apply.—HERBERT H. DYER.

## PREPAID ADVERTISEMENTS.

**Morse Code** easily mastered with the "L.B." Morse sender. Sends any message any speed, and will last a lifetime. Price complete, 6s., post free. Further particulars stamped envelope.—Grimshaw (Dept. A.W.), Legh Street, Golborne, Lancs. 15s

**B.A. Screws, Nuts, and Washers,** assorted gross, 2s.; list, 2d.—J. H. Bennett, Station Road, Willesden Junction. 1348

**Wireless Dealers** are advised to stock parts for making radio apparatus, as so many amateurs prefer to make their own instruments; there is also the additional profit in making your own sets from stock parts. Raw materials and partly machined parts can be had direct from the factory at the right price.—The "Newtonia" Wireless Factory, 13/15, Whitcomb Street, London, W.C.2. Regent 643 and 5469.

**Huge Purchase of ex-Government Wireless Stock.** Write for list giving full details. 150-watt dynamos, £1; hedgehog coils, 7s. 6d.; potentiometers, in case, with battery, 12s. 6d.; loud speakers, 200 ohms, 7s. 6d.; 1-in. spark coils, 10s.; 1½-in. spark coils, 12s. 6d.; Morse tapping keys, 3s., etc. etc. Three days' approval against cash, or please call. Write for detailed price list of all goods.—E. J. Galpin, 16, Loampit Hill, Lewisham, S.E.13, London. 1348

**Sets Designed,** concert coils and H.F. transformers wound to order, condensers and coils calibrated, faults righted, etc.—Walker, 23, Little Chester Street, S.W.1.

**Brass Foil,** .001 in. thick, suitable for condensers, 8d. per square foot, post free.—Davies, 39, Dresden Road, London, N.19. 1348

**Cozwhy Filament Fuses** will protect your valves from burn-outs. ¼ or ½ amp., 10d. each, 8s. per doz. Polished ebonite fuse-holders, plated Ph-Br. springs, 2s. 6d. each, 11s. set of five, post free. Cash with order.—Beswinning's, Cowley Road, Ilford, E. 1348

**Govt. new Aerial Insulators** by De La Rue's. Finest made, worth 3s. 6d., post free 1s. 3d.; money back if not approved.—Veda Co., Pawson's Rd., W. Croydon.

**Crystal Set** with 12 X 4 coil, detector, condenser, on polished base pr. 4,000 French phones, all brand new. Owner gone in for valve set. Accept £4 5s. complete, or 50/- without phones. 9" Crystal set complete 25/-.—Wireless, 48, Pawson's Rd., Croydon.

## AERIALS.

7/22 Copper Strand. 100 feet lengths.  
4/-

## CRYSTAL DETECTORS.

Copper Standard, Brass Arm, Detector Spring, Ball and Socket Joint, Ebonite Thumb-piece, Crystal Cup with Side Screw, two 2 B.A. Terminals, all on Ebonite Base. 3/6

## LEADING-IN TUBES.

Brass Rod screwed 2 B.A. and fitted with Nuts, Washers and Terminals, and 6 in. Ebonite Tube. 1/6

POST FREE, CASH WITH ORDER.

**JAMES EDGAR,**  
3, CLOAK LANE, E.C.4.

**Amateur Wireless**  
And Electrics

Querist's Coupon Available until  
Saturday, Oct. 14, 1922

ASK  
"A.W."  
for list of  
Technical  
Books.

## MAXEY'S Wireless Bureau

The Firm with a Reputation for Dispatch

### MAKE YOUR OWN SET

Special Offer This Week: former 9½ x 5 or 12 x 4, ½ lb. Enamel Copper Wire S.W.G. 22, 24 or 26 and bottle of Hellac Varnish, 4/- Post Free. Fixed Telephone Condenser 1½ x 2½. Mica Dielectric, 2/6 Post Free.

Call and Inspect Our Quality

28, Ludgate Hill, E.C.4, and Market Hall, London Road, Brighton.

## See These on Stand No. 15!

Among the many exhibits that will hold your intense interest on our Stand at the Wireless Exhibition will be found the

### "MASTERPIECE" Complete Wireless Cabinet

A highly efficient 3 Valve Receiving Set—Complete with all accessories, such as Loud Speaker, Microphone Amplifier, Headphones, eight-day luminous clock, etc., contained in a cabinet that is a handsome piece of furniture in itself and which can be supplied to harmonise with any style or period of decoration. It is, in fact, a "masterpiece" as its name implies.

The illustration is of a **Wates Condenser**—low priced—but of exceptional quality. Stout aluminium vanes are used in its construction and the special bearings allow of very smooth adjustment.

#### PRICES:—

| Capacity    | Mounted | Unmounted |
|-------------|---------|-----------|
| *001 ...    | 24/-    | 20/-      |
| *0005 ...   | 22/-    | 17/6      |
| *0003 ...   | 20/-    | 15/-      |
| Vernier ... | 10/-    | 6/6       |

**Do not fail to  
Visit our Stand**

**It will prove  
worth while**

## WATES BROS.,

13-14, GT. QUEEN STREET,  
KINGSWAY, W.C.2.

Telegrams: Zywatereng, Westcent.  
Telephone: Gerrard 576.

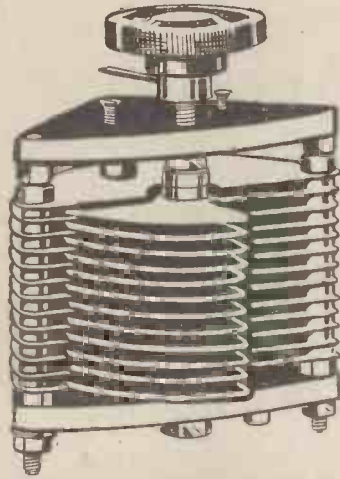

## Why bother about Aerials?

### The "SANS-AERIAL"

will give you perfect reception by connecting to your electric light mains by means of an adapter in a lampholder only, and consumes no current.

It can be used with either Valve or Crystal Receivers.

**Demonstration by appointment.**

Price, with flex and adapter ready for use, **10/6** POST FREE.  
Orders dispatched by return.

With this little fitting telephony has been clearly received on the

## HODGSON RADIOPHONE No. 1

which has a crystal detector

This latter instrument is a complete receiver with sensitive 'double head' phones enclosed in a walnut cabinet and aerial, and earth wires, also insulators, are supplied. The detector, which is of the "Perekon" type with crystals in a dust-proof glass tube, is capable of extremely sensitive adjustment and is constant.

The tuner is designed for the most efficient reception of Broadcasting.

All metal parts are heavily plated.

PRICE—COMPLETE £5 : 10 : 6, Carriage Paid in the U.K.

Valve amplifier for attaching to Crystal Set, making it equal to a 2-valve Set. Complete with Transformers, etc., 70s.

LIBERAL TERMS TO THE TRADE

## HODGSON (London), Ltd.,

NOTE NEW ADDRESS—

Archer Street Works, PICCADILLY CIRCUS, W.1.

(At back of Apollo Theatre)

Phone: Gerrard 4461

### A BRITISH INVENTION TRIUMPHS AGAIN!

## The Wonderful New Wireless Set that is Astonishing the Wireless World.

Everybody can afford to buy it. Get yours NOW.



JUST think of a Wireless Set with an ultra-efficient capacity, with remarkable sensitivity and selectivity—the Complete Receiver (Detector, Tuning Coils, Lead in, Aerial, Insulators, etc.) for ... **15/6**

Isn't that a remarkable offer? Perhaps you think the instrument is too cheap to be worth having? There you are mistaken.

### THE CLAUDE WIRELESS CRYSTAL SET

is a NEWLY INVENTED INSTRUMENT, an important development in construction of the Wireless Receiving Apparatus, greatly simplifying manufacture and economising costs. It is simply and strongly made, the parts mounted on special solid hard wood base. No batteries, no cylinder, no renewals or maintenance necessary. It cannot get out of order—difficult even to damage; so compact you can put it in your pocket; set up in a few minutes anywhere by any schoolboy. It is no experiment—no toy. Sound received with absolutely the same clearness as with

the most elaborate set of any kind manufactured.

Study that statement. It is a true one. This instrument enables you to enjoy broadcasting concerts, speeches, Morse signals, etc., with the best. All your friends will want one when they have heard yours. "I set my watch from Paris (Eiffel Tower) signals frequently. I get either Marconi concerts from Chelmsford or other entertainment every evening. Have just listened-in to the reports of the Aeroplane Race round England. Heard the announcements splendidly throughout the progress of the race. I am used with delight, and thank you." This is from a London purchaser of the little Claude Wireless Set. Why spend Pounds when you can get such an efficient instrument for 15/6? Or, complete with one Headphone 25/6, or with two Headphones (4,000 ohms) 35/6. Carriage and packing 9d. extra without phones, 1/- extra with phones. You cannot buy these "broadcast," therefore don't wait for the Waiting List. Orders will be executed strictly in rotation. Your money will be willingly returned if you are not satisfied. Cross Postal Orders, and make them payable to—

**THE CLAUDE WIRELESS MANUFACTURING CO.,**  
RNRC: 52, Stoke Newington Rd., London, N.16.

## THERE IS MONEY IN WIRELESS

Big incomes for those who start in NOW

Learn at home all about this fascinating science and earn from £5 to £10 weekly

There is big money to be made in Wireless Telephony for those who step in now, when thousands upon thousands of amateurs are buying Wireless Sets which will need constant attention and repair.

## IN YOUR SPARE TIME

you can learn all about Wireless Telephony by following the simple, complete and intensely interesting McGrath course. You can enjoy the wonders of this modern marvel yourself, and under the guidance of our Wireless experts make a big income out of others.

The McGrath Course starts you in the new, not overcrowded profitable profession of a Wireless expert. We teach you how to install and correctly tune any sets to proper wave-lengths, to alter and replace parts, or make your own outfits. Think of the enjoyment you get, and think of the money you can earn, when, as Lord Northcliffe said, "A Wireless Set will become indispensable to every home."

Be among the first in the new profession; you should earn easily from £5 to £10 Weekly. The McGrath course teaches you how to earn whilst you learn. Pupils are amazed at their rapid success.

### Let us send you particulars of MONEY-MAKING WIRELESS FREE

It costs you nothing to know all about this simple, fascinating Course. The knowledge we give will make you independent. Write now and enrol while the business is in its infancy.

All applications should be addressed to—

**The Secretary, Wireless Dept. 10, McGRATH INSTITUTE, 20, Southampton St., Holborn, W.C.1.**

# HULLO EVERYBODY!

Call Here and **SAVE 10/-** in the £

**HEADPHONES.** Very special offer of French Headphones. Highly sensitive, very light, tested and guaranteed. All complete with double headband and cords. All 4,000 ohms

**21/- 22/6 25/- 30/-**

**NOTHING BETTER OBTAINABLE**

## COMPLETE SETS OF PARTS FOR MAKING VARIABLE CONDENSERS

| Approx. Capacity in Micro-farads | No. of Plates | Price |
|----------------------------------|---------------|-------|
| .001                             | 57            | 7/6   |
| .00075                           | 43            | 6/9   |
| .0065                            | 29            | 5/6   |
| .0003                            | 19            | 3/6   |
| .0002                            | 13            | 2/6   |
| .0001                            | 7             | 2/3   |
| Vernier                          | 3             | 1/9   |

These sets are complete ready for assembling and consist of the following parts: Necessary Aluminium Vanes (fixed and moving), all standard size, large and small Spacer Washers, Centre Square Spindle with Knob screwed 2 BA, 3 round screwed Rods for sides, necessary Nuts and Washers, Brass Pointer, Engraved Scale, 2 Terminals, Lock Nuts, bush and 2 bronze coil Spring Washers. Every part guaranteed best workmanship and quality.

Postage and packing 1/3 per set.

Contact studs,  $\frac{1}{2} \times \frac{1}{2}$ , complete with nut, 8d. doz.; 3 doz., 1/8.

Interval Transformers, 18/6, 21/-.

Insulated Sleeving, all colours, 5d. piece (1 yard) 4/9 doz.

Aluminium Vanes, best quality, fixed or moving, 1 doz. 8d.; 6 doz. 3/-.

Large Spacer Washers, 2 doz. 8d., 6 doz. 1/10. Small ditto, 3 doz. 8d. 6 doz. 1/3.

Knobs,  $1\frac{1}{2}$  in. diameter, 4d., 5d., 6d. (latter with 2 BA nut in centre). All best quality.

'Phone Condensers, extra quality, 1/6, 1/8.

Aerial Wire, 7/22 stranded copper, 100 ft. banks, 3/6. Postage and packing, 1/3.

Centre Spindles for Condensers,  $\frac{1}{4}$  square, screwed both ends 2 BA, 3d., 4d., 5d. and 6d.

Valve Holders, 11d. each, with 4 nuts.

Please include sufficient for packing and postage. The above prices are too low to admit of being sent otherwise. Trade Supplied.

For Special Bargains see Windows. Always Something at Attractive Prices.

## M. RAYMOND,

### 27, LISLE STREET, W.C.2.

Right Opposite Daly's Gallery Door.

To avoid mistakes, this address is close to Charing-X Road and Leicester Square Tube

'Phone: Gerrard 4637.

## ELECTRADIX RADIOS.

IMMEDIATE DELIVERY FROM OUR HUGE STOCKS

Everything from a Recorder to an Earth Clip.

The best equipped City depot. COME AND SEE US

9, COLONIAL AVENUE is first opening on left in the Minorities, nr. Aldgate Station, Metropolitan Railway.

LESLIE DIXON & CO., Tel: Avenue 4166.  
9, COLONIAL AVENUE, MINORITIES, E. 1

**FELLOWS HEADPHONES,** 4,000 ohms, 30s.; "Ora" valves, 15s. Fellophone 2 valve set, £9, complete. **Crystal Set,** £3 7s. 6d., complete. **Grid Leaks,** "Mullard," 5s.; Valve holders, panels, aeriels, condenser vanes, washers, tops and bottoms, sealed tops, switch arms, headphone cords, resistances, etc. Everything for amateurs. Trade supplied.

F. N. COUVY & CO., Ltd., 31, Upper Brook Mews, Craven Rd., W.2. Nr. Padd. Station. Padd. 5743

## HIGH CONDUCTIVITY SOFT COPPER INSTRUMENT WIRES. PRICES AT PER LB.

| S.W.G. | S.C.C. | D.C.C. | S.S.C. | D.S.C. | ENAM'D |
|--------|--------|--------|--------|--------|--------|
| 18     | s. d.  | s. d.  | s. d.  | s. d.  | s. d.  |
| 20     | 2 0    | 2 2    | 2 7    | 2 10   | 2 2    |
| 22     | 2 2    | 2 3    | 2 10   | 3 7    | 2 3    |
| 24     | 2 5    | 2 6    | 3 4    | 4 3    | 2 5    |
| 26     | 2 11   | 3 1    | 3 7    | 4 6    | 2 8    |
| 28     | 3 4    | 3 8    | 4 5    | 5 6    | 3 0    |
| 30     | 3 10   | 4 2    | 5 0    | 6 6    | 3 3    |
| 32     | 4 6    | 5 0    | 6 3    | 7 0    | 3 6    |
| 34     | —      | —      | 7 3    | 8 0    | 3 11   |
| 36     | —      | —      | 8 3    | 9 6    | 4 2    |
| 38     | —      | —      | 9 9    | 11 9   | 4 6    |
| 40     | —      | —      | 13 0   | 15 6   | 5 0    |
| 42     | —      | —      | 15 6   | 19 0   | 6 6    |
| 44     | —      | —      | 20 0   | 25 6   | 8 0    |
| 46     | —      | —      | 40 0   | 57 6   | 12 6   |
| 48     | —      | —      | 85 0   | 132 6  | 19 6   |
| 47     | —      | —      | 115 0  | 160 0  | 30 0   |

## H.D. COPPER AERIALS

PLAIN  $\frac{7}{22}$  4/-  $\frac{7}{20}$  5/- per 100 ft. coil  
ENAM'D, 5/- 6/6 " " " " " "

ENAMELLED AND D.C.C. BELL WIRE.)  
205 SINGLE 1d. per yd.  
205 TWIN 2d. " "

Terms: Cash with Order. Postage Extra. Special Prices to Trade for Quantities.  
**HORROCKS AND ASPIN,**  
12, SCHWABE ST., RHODES, MANCHESTER.

SCIENTIFIC APPLIANCES (Dale & Hollins), Electrical, Marine, Optical and ALL RADIO WIRE. LESS PARTS and Materials at Lowest Prices. Call and see our immense stock or write for Information and Prices. In Centre of London, Top of Kingsway.

SCIENTIFIC APPLIANCES,  
11 and 29, Sicilian Avenue, London, W.C.1.

## VARIABLE CONDENSERS

Complete with Knob, Scale and Pointer.

|         | Unassembled for panels. | Assembled for panels. | In Celluloid Cases. |
|---------|-------------------------|-----------------------|---------------------|
| .001    | 16/-                    | 19/-                  | 25/6                |
| .00075  | 13/6                    | 15/6                  | 21/-                |
| .0005   | 10/-                    | 12/-                  | 17/-                |
| .0003   | 8/6                     | 10/6                  | 15/6                |
| .0002   | 6/6                     | 8/6                   | —                   |
| .0001   | 5/6                     | 7/6                   | —                   |
| .000075 | —                       | 4/6                   | —                   |
| .00005  | —                       | 4/3                   | —                   |

Trade supplied with above.

CONDENSER VANES, Aluminium, 20G, 7d. dozen, 6/- gross.  
Large Spacers, 8 1/2d. " 4/- " "  
Small " 2 1/2d. " 2/- " "

**R. DOUGHTY & SON,**  
COOKE STREET, WOLVERHAMPTON.

Ask "A.W." for list of Technical Books

**HERE'S THE RECEIVING SET  
:: YOU ARE LOOKING FOR ::  
The R.S. No. 1 CRYSTAL SET**

**Price £6 6s. complete,  
including 4,000 ohms 'Phones Aerial Outfit**

You can pay more money for a Receiving Set—if you want to—but you can't get any better results or greater satisfaction at any price.

Since we put this set on the market we've been literally swamped with orders. The Trade, Amateurs—everybody who has tried the instrument has become a booster for it. The range or distance from which signals are received, and the clear sharp tones are a revelation to the experienced radio man as well as to the person who "listens in" for the first time.

If you are looking for 100% satisfaction ask your dealer to show you this set. He may be temporarily out, but it's well worth waiting for, or you can write us direct.

This set is quite different from any set on the market, and the design is registered. We will take proceedings against any person trying to infringe our design. All our sets are guaranteed, money refunded if not satisfied.

Our factory is now working in full swing, and we are in a favourable position to accept contracts for the manufacture of wireless sets, etc., to your own specification.

VISIT OUR STAND

**No. 6**

All-British Wireless Exhibition,  
Sept. 30—Oct. 7.



Send for Price List.  
Write for Trade Terms.

The Crystal of the Moment—"HERTZITE," price 2s. 6d. for large piece, post free.

We also stock all Crystals. Write for Trade Discounts.  
Sterling 'Phones 4,000 ohms, 32s.; 2,000 ohms, 31s.

Our own make High Resistance 4000 ohms Double Head Phones, beautifully finished complete, 25s. pair. Money returned if not completely satisfied. Postage 1s.

**THE SERVICE AMPLIFYING TRANSFORMERS.**

The SERVICE TRANSFORMERS are the result of exhaustive tests of every kind, and are positively unequalled for audibility and amplifying power.

If you are not getting maximum amplification try it and note the improvement, the absence of distortion and the clearness of tone.

**RADIO SERVICE CO., LTD., 62, OXFORD STREET, W.1.**

(Dept. D.)

Branch: 143, CHURCH STREET, STOKE NEWINGTON.

'Phone: Museum 2136.

FOLLOW THE CROWD  
TO  
**STAND NO. 1.**  
AT THE  
ALL BRITISH  
WIRELESS EXHIBITION  
AND INSPECT  
*The Crystophone*  
COMPLETE OUTFITS

It will be to  
- your own -  
interest and  
future satisfac-  
tion to visit our  
stand before  
deciding on  
your wireless  
- - outfit -

**THE  
LATTIKONE**

(REGISTERED)

(Lattice-wound Cone Coil—patent pending)

Combines in itself the functions of a Variometer and Variable Condenser while yet possessing the body and strength of a direct-coupled Inductance.

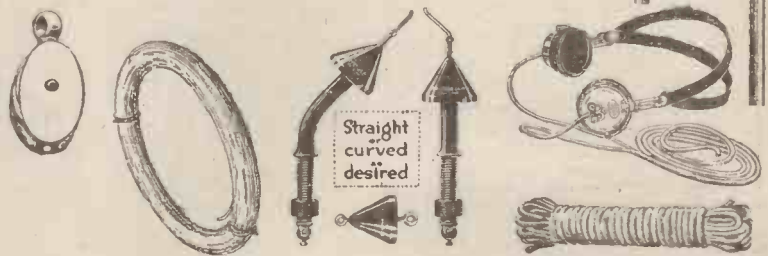

**Outfit No. 1.**—Crystophone Receiver Type 20 T.T., Crystor Aerial Outfit, a pair of Sterling Headphones, 4,000 ohms, packed in suitable box. £7 12s. 6d.

**Outfit No. 2.**—Crystophone Receiver Type 21 T.T., Crystor Aerial Outfit, a pair of Sterling Headphones, 4,000 ohms, packed in suitable box. £6 15s. 6d.

**Outfit No. 3.**—Crystophone "Scout" Receiver, Crystor Aerial Outfit, a pair of British Headphones, 4,000 ohms, packed in suitable box .. £5 12s. 6d.

**THERE IS A CRYSTOPHONE TO SUIT  
EVERY PURSE AND PURPOSE**

**WIRELESS SUPPLIES CO.,  
64, Mortimer Street, London, W.1.**

'Phone: Museum 2572.

'Grams: "Adragonax, Wesdo, London."

# BROADCASTING IN A FORTNIGHT THE GOODS!!!

**HAVE YOU A GRAMOPHONE?  
THEN GET A  
GRAMAPHIX LOUD SPEAKER**

THE GRAMAPHIX multiplies sound! THE GRAMAPHIX fits any gramophone! HAVE YOU HEARD THE GRAMAPHIX?

It produces full volume of sound without distortion and makes your gramophone a **RADIO LOUD SPEAKER**.

The Gramaphix is the result of considerable time and expense which has enabled us to offer a **Loud Speaker** with exclusive features at a price within the reach of all.

The Gramaphix utilises the scientifically designed tone amplifier of the gramophone to secure mellowness and Beauty of Tone, therefore doing away with all that metallic sound, scratching and "ring" associated with other loud speakers. The Gramaphix is the talk of the wireless world.

Adjusted in a Minute by a child. **LATEST and LOUDEST.**

Why pay pounds when a better instrument can be secured for

**APPLY FOR TRADE TERMS** **10/6** **IMMEDIATE DELIVERY**

Postage 9d.

Be ready for the Broadcasting and get our **B.N.B. CRYSTAL SET £7 10 0** complete, with **TWO SETS OF DOUBLE HEADPHONES**. Sold under the **SPECIFIC GUARANTEE** to receive telephony from a **MAXIMUM** distance of 25 miles.

**LACLAND ELECTRICAL MANUFACTURING AGENCY (Dept. A),  
68, GREAT QUEEN STREET, KINGSWAY (Holborn End), W.C.2 Gerrard 5341.**

**WILL BE OFFICIALLY PERMITTED IN THE U.K.!!!**  
SIR HENRY NORMAN (representing the Post Office) made the above important announcement at the opening of the Exhibition.

## DON'T BE CAUGHT!!! FROM FACTORY TO YOU

**NO WAR** We are really actual manufacturers. Deal direct and don't waste money. Why pay middlemen's profits? reap the benefit yourself.

**P**Articularly note our sets are guaranteed absolutely complete. Don't rush and buy a supposed cheap set and find your extras exceed your original cost. Take our advice, buy from factory. **Save saving of money.**

*Our Sets guaranteed by experts who are holders of degrees, We Guarantee all parts new*

### NO WAR STOCK USED

We cannot sell our sets on the gradual payment system or sell at half price during Exhibitions. Look at our prices and you have the reason

#### WE SELL COMPLETE SETS

"LACLAND" 1 Valve Set £12 0 0 "LACLAND" 3 Valve Set £19 10 0  
" 2 " " £16 10 0 " 4 Valve Set £22 5 0

**CARRIAGE PAID IMMEDIATE DELIVERY**

Sets can be erected by an expert and put in actual working order before being handed over. **DEMONSTRATIONS** at any time by appointment.

**AGENTS WANTED** for (parts of) the following Counties:  
*Kent, Surrey, Essex, Herts, Bucks and Middlesex*

## A RECEIVING SET WITHOUT 'PHONES IS LIKE A SHIP WITHOUT A RUDDER

### The "Brown" Super-Sensitive Telephones

These Telephones are unquestionably the clearest and most sensitive made, and, consequently, increase the distance over which wireless can be heard. BROWN'S are recognised as the most comfortable to wear, due to their extreme lightness in weight and adaptable adjustment. There is no wireless head-phones in the world to compare with BROWN'S.



(Above Prices include cords.)

Wireless Instruments and parts manufactured by and bearing the name "BROWN" can still be bought with absolute confidence in their quality, value, and efficiency, because throughout this period of increasing wireless activity S. G. BROWN, Ltd., have wisely refused to lower their high standard of quality.

**IMPORTANT NOTICE.**—When purchasing BROWN'S, you should see that the name BROWN is stamped on the back of each ear-piece.

**IN UNIVERSAL USE, AS SUPPLIED TO BRITISH, ALLIED AND FOREIGN GOVERNMENTS.**

Visit our Stand, No. 43, All-British Wireless Exhibition, Horticultural Hall September 30 to October 7

**ILLUSTRATED CATALOGUES POST FREE**

Head Office & Works—  
Victoria Rd., NORTH  
ACTON, LONDON, W.3.



London Showrooms—  
19, MORTIMER STREET  
LONDON, W.1.

# HEADPHONES

**FOR BROADCASTING AND ALL RADIO  
RECEPTION USE OUR HEADPHONES**

#### SPECIFICATION:

Fully wound to 4,000 ohms with high grade copper wire, laminated magnets, Stalloy diaphragm, 2 comfortable ear-phones with band, 6 foot cord and tap

**EACH 24/- DELIVERED**

*As used almost exclusively by the French Army, Navy and Air Service since 1913*

Cash returned if for any reason found unsuitable within 7 days

**"LIBERTY" HEADPHONES, H/R**

**EACH 27/6 EACH**

**DELIVERY FROM STOCK**

**BUCK, 14, THOMAS STREET  
WOOLWICH, S.E.18**



**COMPLETE AND EFFICIENT ONE-VALVE RECEIVING SET**

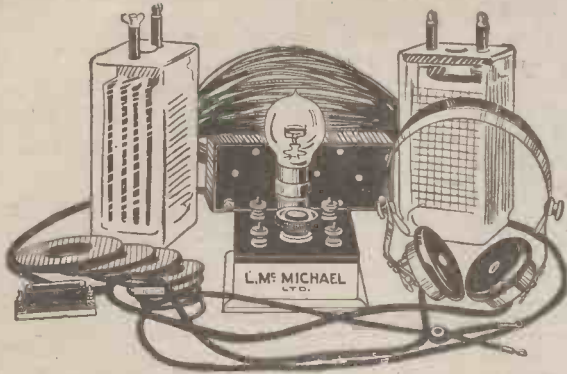

|                                                                              | £  | s. | d. |
|------------------------------------------------------------------------------|----|----|----|
| 1 Valve Panel in mahogany box with circular filament resistance              | 14 | 0  | 0  |
| 1 Variable Condenser                                                         | 1  | 0  | 0  |
| Complete set of slab coils for all wave lengths                              | 15 | 0  | 0  |
| 1 Valve (Ex-Government) if in stock                                          | 12 | 0  | 0  |
| 1 Battery, 72 volts tapped off every 4 Volts                                 | 15 | 0  | 0  |
| 1 4-volt Accumulator                                                         | 1  | 0  | 0  |
| 100 ft. Aerial Wire, best enamelled stranded Copper                          | 7  | 6  |    |
| 2 Insulators                                                                 | 2  | 0  | 0  |
| 1 pair Head Telephones                                                       | 1  | 10 | 0  |
| 60 ft. 19/30 tinned and rubber-covered Cable for earth connection and wiring | 1  | 6  |    |
|                                                                              | £6 | 17 | 0  |

VISIT OUR STAND No. 43, All-British Wireless Exhibition, Horticultural Hall, Sept. 30 to Oct. 7.

ILLUSTRATED CATALOGUE (A/W), post free 6d., 15 pages, 100 illustrations. When writing please mention this publication.

**LESLIE McMICHAEL, Ltd.**

Providence Place, West End Lane, Kilburn, N.W.6.  
 Bus Services 1, 8, 16, 28, 31, all pass West End Lane.  
 Telephone: HAMPSTEAD 1261. Nearest Tube Station: KILBURN PARK (Bakerloo.)

**BOWER'S**  
 HAVE GREATLY REDUCED THE PRICE OF THEIR  
**WIRELESS PARTS**

WORKMANSHIP ON EVERY ARTICLE IS STILL UP TO THE HIGHEST STANDARD

Write NOW for Comprehensive Money-saving Price List  
**POST FREE**

TRADE INQUIRIES RESPECTFULLY SOLICITED

|                                                                                               |              |
|-----------------------------------------------------------------------------------------------|--------------|
| Aerial Wire, 7/22 bare copper stranded in 100 ft. hanks                                       | 5/- per hank |
| Ring Pattern Insulators, 2 in. by 1 in., 4 in. hole                                           | 4d. each.    |
| 1/2 in. sq. Section Brass Rod for Sliders, cut in 13 in. lengths and drilled ready for fixing | 6d. each.    |
| Inductance Slider, complete with plunger                                                      | 3d. each.    |
| Cardboard Cylinders, 12 in. by 4 in. diameter                                                 | 8d. each.    |
| No. 24 Enamelled Wire, H.C., true to gauge                                                    | 2/8 per lb.  |
| Large or small Condenser Plates (Aluminium)                                                   | 1/- doz.     |
| Large Spacer Washers for condensers (cut true to 1,000th of an inch)                          | 7d. doz.     |
| Small " " "                                                                                   | 5d. doz.     |
| Ivory Scales                                                                                  | 9d. each.    |
| Condenser Box, in Polished Oak or Mahogany, 3 1/2 in. by 3 1/2 in. by 2 in.                   | 4/6 each.    |
| .0003 mf. Condensers, complete, assembled in Polished Mahogany or Oak Boxes                   | 15/- each.   |
| All necessary parts for above Condensers, no drilling or fitting required, but unassembled    | 12/6 each.   |
| Ditto, but without box                                                                        | 9/6 each.    |
| Ditto, but without box and Ebonite top, suitable for panel mounting                           | 8/6 each.    |
| Crystal Detector, mounted on Ebonite, complete with Crystal                                   | 4/6 each.    |
| Large or Small Contact Studs                                                                  | 9d. doz.     |
| Valve Legs, complete with nuts and washers                                                    | 2d. each.    |
| Government Surplus Accumulators, 16 volt 15 amp. hrs., in case complete (f.o.r.)              | 20/- each.   |
| Hart Accumulators, 4 volt 24 amp. hrs.                                                        | 14/9 each.   |
| Packing and postage for last item, 1/8 each.                                                  |              |

**J. B. BOWER & CO., LTD.**

WIRELESS APPARATUS MANUFACTURERS  
 15, Kingston Road, WIMBLEDON, S.W.19  
 Phone: WIMBLEDON 1030. Works: MERTON

**SELF CONTAINED OR UNIT SYSTEMS—  
 MARCONIPHONES, MARCONI SCIENTIFIC UNITS, WAVEORA UNITS, ETC.**

We give demonstrations to purchasers at our showrooms.  
 Tuners, Coils, Rectifiers, Amplifiers, Valves, Magnavox and Brown Loud Speakers, Microphone Amplifiers, H.T. and L.T. Batteries, and all Wireless Accessories.

Special quotations for Technical Colleges, Schools and Educational Institutions.

**THE RADIO WAVEORA CO., 168, REGENT STREET, LONDON, W.1.**

Telephones: Gerrard 3039; Western 847.

Telegrams: Wychwood, 'Phone, London.

**THAT'S BETTER.**

We were confident that when our friends were assured of the genuineness of our special offer of 'Phones we should be assailed with orders. We have already received very many repeat orders and orders emanating from the same districts, from which we may conclude that they are the result of recommendation. The full 1,000 have not been sold at the time of going to press, so that when this advertisement appears we shall still supply at our special prices below.

|                |      |
|----------------|------|
| 140 ohm.....   | 23/6 |
| 4,000 ohm..... | 25/- |
| 8,000 ohm..... | 27/6 |

Will those of our customers who have already received price lists please note that our Condenser Vanes are reduced to 9d. per dozen, fixed or moving.

PRICE LISTS 3d., post free.



FIXED CONDENSERS.

|                |     |
|----------------|-----|
| .0001 to .0005 | 2/- |
| .001 and .002  | 2/3 |
| .003 and .004  | 2/6 |

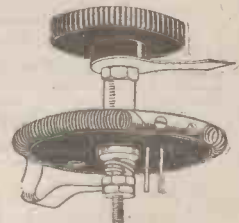

FILAMENT RHEOSTAT.  
 3/6 each.



Watch for the Name of our nearest Agent.

Bury: BENNETT & CO.,  
 12, Union Square  
 Bolton: J. S. McLEOD,  
 189, Blackburn Rd.  
 AGENTS WANTED.

**J. L. CARTWRIGHT & CO., Works:**  
 130-132, London Road, MANCHESTER.  
 Berry Street.

Telephone: CENTRAL 4209

Telegrams: "PLADURAM," MANCHESTER.

# T.M.C. Wireless

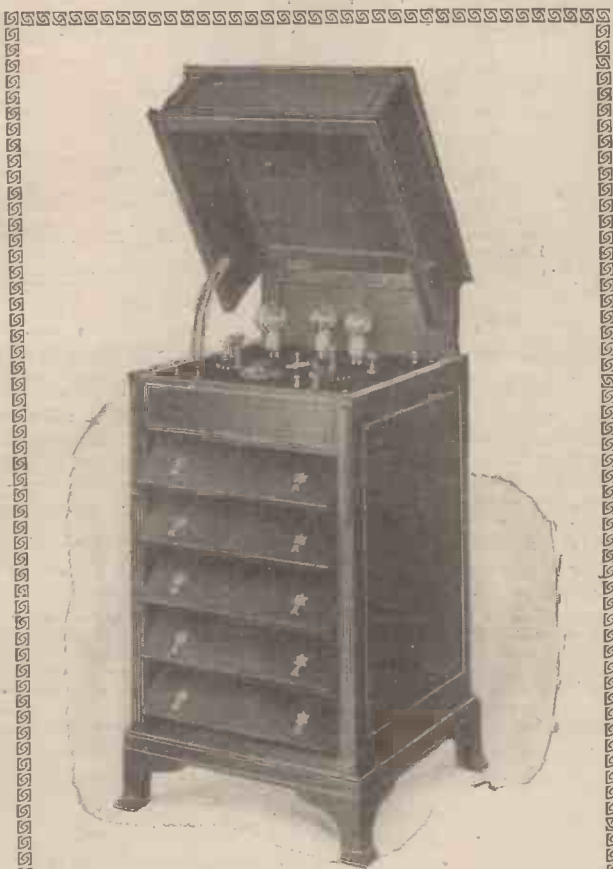

THE "DE LUXE" CABINET  
WIRELESS RECEIVING SET

THIS SET has been specially designed to meet the requirements of those who desire a Wireless Receiving apparatus of maximum efficiency, simplicity of control, and the whole self-contained in a "De Luxe" Cabinet, designed to harmonise with other pieces of artistic furniture.

THE INSTRUMENT comprises a Valve and Crystal Set so arranged that, by the manipulation of a simple switch, either can be brought into operation as may be desired, the reception being suitably amplified by means of a two-valve Audio Frequency combination.

OUR PATENTED form of permanent Crystal Detector—which entirely eliminates the usual troublesome setting—is fitted in duplicate as Standard.

ALSO MOUNTED upon the highly polished Ebonite Panel are the necessary Controls, carefully arranged for convenience of manipulation.

THE LOUD SPEAKER and requisite Batteries are mounted on the Cabinet, the front of which is provided with adjustable louvres.

TWO HEADSETS are included in the equipment, for use on such occasions as when the Loud Speaker may not be required.

WE CAN SUPPLY the Cabinet in any Finish to order, the overall sizes being 3 ft. high by 1 ft. 8 in. square. The workmanship and design of these Cabinets are exquisite specimens of the cabinet-makers' art.

**SPECIAL NOTE** Our Prices include the supply and erection of the Aerial in any part of Great Britain, and the handing over of the Set in thorough working order, and to our customers' entire satisfaction.

**The TELEPHONE MANUFACTURING Co.,**  
Hollingsworth Works, DULWICH, S.E. 21. LTD.

Telephone: SYDENHAM 2460-1

Telegrams: "BUBASTIS DULCROX, LONDON."



# Exide

## BATTERIES

**THE LARGEST SHIP IN THE WORLD**  
—the White Star Liner "Majestic"—uses Exide batteries for her wireless installation.

No finer testimony to the general reliability of Exides, and their particular suitability for wireless work, could be given.

---

**THE Chloride ELECTRICAL STORAGE COMPANY LIMITED.**

CLIFTON JUNCTION, Nr MANCHESTER. | 219/229, SHAFTESBURY AVENUE, W.C.2.

PRICES AND PARTICULARS ON APPLICATION.

## THAT BOOK YOU WANT

ON WIRELESS OR ANY OTHER TECHNICAL SUBJECT

Foyles have it or will quickly obtain it. 1,000,000 Vols. (Second-hand and New) on Technical and every other conceivable subject in stock. Books sent on approval. Write for Catalogue 104 (free) mentioning requirements. Books Purchased.

**FOYLES, 121, Charing Cross Rd., London.**



**THIS HIGH NOTE BUZZER IS INDISPENSABLE FOR SELECTING SENSITIVE SPOTS ON THE CRYSTAL, ALSO FOR USE WITH WAVEMETERS. REAL PLATINUM CONTACTS. PRICE 5/-.**

|                                                                                                                                                                                                                                                                                                                                                                                                                     |                                                                                                                                                                                                                                                                                                                                                                                               |
|---------------------------------------------------------------------------------------------------------------------------------------------------------------------------------------------------------------------------------------------------------------------------------------------------------------------------------------------------------------------------------------------------------------------|-----------------------------------------------------------------------------------------------------------------------------------------------------------------------------------------------------------------------------------------------------------------------------------------------------------------------------------------------------------------------------------------------|
| Crystals (special selected), Bornite, Galena, Silicoon, Carborundum, C. Pyrites, Graphite, etc. ... 6d.<br>Crystal Cups with Screw ... 4d.<br>Fusible Alloy, per stick ... 6d.<br>Inductance Tubes, 12" x 3" ... 6d.<br>" " 12" x 4" ... 9d.<br>" " 12" x 5" ... 1/-<br>" " 12" x 6" ... 1/3<br>Sliders, with Plungers ... 6d.<br>Sq. Brass Rod, 12" x 1/4" x 1/4" ... 4d.<br>Enamelled Wire, 23 gauge, lb. ... 2/- | Aerial Wire, 7/25 Stranded, 100' ... 3/6<br>Egg Insulators, Green ... 6d.<br>Reel " " best quality ... 3d.<br>Valve Holders, Screwed Legs ... 1/-<br>Hellesen 36 v. Batteries with Tappings and Plug ... 8/6<br>Essex 15 v. H.T. Batteries ... 3/-<br>Ebonite Lead Insulators ... 2/-<br>Perikon Detectors on Ebonite Complete with Crystals ... 4/-<br>"Ubique" Crystal Set Complete... 15/- |
|---------------------------------------------------------------------------------------------------------------------------------------------------------------------------------------------------------------------------------------------------------------------------------------------------------------------------------------------------------------------------------------------------------------------|-----------------------------------------------------------------------------------------------------------------------------------------------------------------------------------------------------------------------------------------------------------------------------------------------------------------------------------------------------------------------------------------------|

**HEADPHONES, EBONITE, CONDENSERS, Etc. Postage extra.**

---

**THE ESSEX WIRELESS CO.** Office & Showrooms: 499, GROVE GREEN RD., LEYTONSTONE, E.11.  
Telephone—WANSTEAD 749. (1 min. from Station, G.E.R.)

## BUTLER'S RELIABLE MANUFACTURES

HIGH FREQUENCY TRANSFORMERS TO FIT R. VALVE SOCKETS

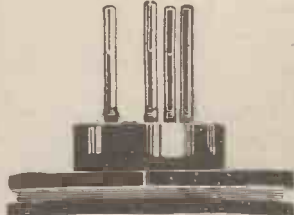
|                                                                                                                                                                                                                                                                                                                                                                                                                                                                                                                                                                                                                                                                                                                                                                               |       |       |            |            |      |     |     |    |   |     |   |     |     |    |   |     |   |     |     |    |   |       |   |     |     |    |   |       |   |     |     |    |   |       |   |     |     |    |   |       |   |     |     |    |   |       |   |      |     |    |   |        |   |      |                                                                                                                                                                                                                                                                                                                                                                                                                                        |
|-------------------------------------------------------------------------------------------------------------------------------------------------------------------------------------------------------------------------------------------------------------------------------------------------------------------------------------------------------------------------------------------------------------------------------------------------------------------------------------------------------------------------------------------------------------------------------------------------------------------------------------------------------------------------------------------------------------------------------------------------------------------------------|-------|-------|------------|------------|------|-----|-----|----|---|-----|---|-----|-----|----|---|-----|---|-----|-----|----|---|-------|---|-----|-----|----|---|-------|---|-----|-----|----|---|-------|---|-----|-----|----|---|-------|---|-----|-----|----|---|-------|---|------|-----|----|---|--------|---|------|----------------------------------------------------------------------------------------------------------------------------------------------------------------------------------------------------------------------------------------------------------------------------------------------------------------------------------------------------------------------------------------------------------------------------------------|
| <table border="0"> <tr><td>No. 0</td><td>..</td><td>Range</td><td>150 metres</td><td>..</td><td>5/6</td></tr> <tr><td>" 1</td><td>..</td><td>"</td><td>360</td><td>"</td><td>6/-</td></tr> <tr><td>" 2</td><td>..</td><td>"</td><td>600</td><td>"</td><td>6/3</td></tr> <tr><td>" 3</td><td>..</td><td>"</td><td>1,200</td><td>"</td><td>6/9</td></tr> <tr><td>" 4</td><td>..</td><td>"</td><td>1,800</td><td>"</td><td>7/6</td></tr> <tr><td>" 5</td><td>..</td><td>"</td><td>2,500</td><td>"</td><td>8/3</td></tr> <tr><td>" 6</td><td>..</td><td>"</td><td>6,000</td><td>"</td><td>9/9</td></tr> <tr><td>" 7</td><td>..</td><td>"</td><td>8,600</td><td>"</td><td>12/-</td></tr> <tr><td>" 8</td><td>..</td><td>"</td><td>24,000</td><td>"</td><td>14/3</td></tr> </table> | No. 0 | ..    | Range      | 150 metres | ..   | 5/6 | " 1 | .. | " | 360 | " | 6/- | " 2 | .. | " | 600 | " | 6/3 | " 3 | .. | " | 1,200 | " | 6/9 | " 4 | .. | " | 1,800 | " | 7/6 | " 5 | .. | " | 2,500 | " | 8/3 | " 6 | .. | " | 6,000 | " | 9/9 | " 7 | .. | " | 8,600 | " | 12/- | " 8 | .. | " | 24,000 | " | 14/3 |  <p style="text-align: center;">There is good Latitude on these Coils for Higher and Lower Ranges</p> <p style="text-align: center;"><b>H-B SUPER SLAB INDUCTANCES, 15/- per set of NINE, complete with set of curves Range 150 to 30,000 metres</b></p> <p style="text-align: center;">Fully Illustrated List of Wireless Goods, post free, 4d.</p> |
| No. 0                                                                                                                                                                                                                                                                                                                                                                                                                                                                                                                                                                                                                                                                                                                                                                         | ..    | Range | 150 metres | ..         | 5/6  |     |     |    |   |     |   |     |     |    |   |     |   |     |     |    |   |       |   |     |     |    |   |       |   |     |     |    |   |       |   |     |     |    |   |       |   |     |     |    |   |       |   |      |     |    |   |        |   |      |                                                                                                                                                                                                                                                                                                                                                                                                                                        |
| " 1                                                                                                                                                                                                                                                                                                                                                                                                                                                                                                                                                                                                                                                                                                                                                                           | ..    | "     | 360        | "          | 6/-  |     |     |    |   |     |   |     |     |    |   |     |   |     |     |    |   |       |   |     |     |    |   |       |   |     |     |    |   |       |   |     |     |    |   |       |   |     |     |    |   |       |   |      |     |    |   |        |   |      |                                                                                                                                                                                                                                                                                                                                                                                                                                        |
| " 2                                                                                                                                                                                                                                                                                                                                                                                                                                                                                                                                                                                                                                                                                                                                                                           | ..    | "     | 600        | "          | 6/3  |     |     |    |   |     |   |     |     |    |   |     |   |     |     |    |   |       |   |     |     |    |   |       |   |     |     |    |   |       |   |     |     |    |   |       |   |     |     |    |   |       |   |      |     |    |   |        |   |      |                                                                                                                                                                                                                                                                                                                                                                                                                                        |
| " 3                                                                                                                                                                                                                                                                                                                                                                                                                                                                                                                                                                                                                                                                                                                                                                           | ..    | "     | 1,200      | "          | 6/9  |     |     |    |   |     |   |     |     |    |   |     |   |     |     |    |   |       |   |     |     |    |   |       |   |     |     |    |   |       |   |     |     |    |   |       |   |     |     |    |   |       |   |      |     |    |   |        |   |      |                                                                                                                                                                                                                                                                                                                                                                                                                                        |
| " 4                                                                                                                                                                                                                                                                                                                                                                                                                                                                                                                                                                                                                                                                                                                                                                           | ..    | "     | 1,800      | "          | 7/6  |     |     |    |   |     |   |     |     |    |   |     |   |     |     |    |   |       |   |     |     |    |   |       |   |     |     |    |   |       |   |     |     |    |   |       |   |     |     |    |   |       |   |      |     |    |   |        |   |      |                                                                                                                                                                                                                                                                                                                                                                                                                                        |
| " 5                                                                                                                                                                                                                                                                                                                                                                                                                                                                                                                                                                                                                                                                                                                                                                           | ..    | "     | 2,500      | "          | 8/3  |     |     |    |   |     |   |     |     |    |   |     |   |     |     |    |   |       |   |     |     |    |   |       |   |     |     |    |   |       |   |     |     |    |   |       |   |     |     |    |   |       |   |      |     |    |   |        |   |      |                                                                                                                                                                                                                                                                                                                                                                                                                                        |
| " 6                                                                                                                                                                                                                                                                                                                                                                                                                                                                                                                                                                                                                                                                                                                                                                           | ..    | "     | 6,000      | "          | 9/9  |     |     |    |   |     |   |     |     |    |   |     |   |     |     |    |   |       |   |     |     |    |   |       |   |     |     |    |   |       |   |     |     |    |   |       |   |     |     |    |   |       |   |      |     |    |   |        |   |      |                                                                                                                                                                                                                                                                                                                                                                                                                                        |
| " 7                                                                                                                                                                                                                                                                                                                                                                                                                                                                                                                                                                                                                                                                                                                                                                           | ..    | "     | 8,600      | "          | 12/- |     |     |    |   |     |   |     |     |    |   |     |   |     |     |    |   |       |   |     |     |    |   |       |   |     |     |    |   |       |   |     |     |    |   |       |   |     |     |    |   |       |   |      |     |    |   |        |   |      |                                                                                                                                                                                                                                                                                                                                                                                                                                        |
| " 8                                                                                                                                                                                                                                                                                                                                                                                                                                                                                                                                                                                                                                                                                                                                                                           | ..    | "     | 24,000     | "          | 14/3 |     |     |    |   |     |   |     |     |    |   |     |   |     |     |    |   |       |   |     |     |    |   |       |   |     |     |    |   |       |   |     |     |    |   |       |   |     |     |    |   |       |   |      |     |    |   |        |   |      |                                                                                                                                                                                                                                                                                                                                                                                                                                        |

**H. D. BUTLER & CO. Ltd.** Office: BANK BUILDINGS, 222, CT. DOVER ST., S.E.1 (Opposite Bond Tube Station).  
Works: CANONBURY, LONDON, N.1. Telephone: Hop 3009. Telegrams: "Ingeni'y," Phone London."

## CRYSTAL SETS

|                                                                                                                                                                                              |   |
|----------------------------------------------------------------------------------------------------------------------------------------------------------------------------------------------|---|
| Single Slider... .. £0 18 6 unassembled<br>" " " " " 1 13 6 assembled<br>With Tapped Inductance £1 1 0 unassembled<br>" " " " " 1 15 0 assembled<br>With Loose Coupler ... £4 16 6 assembled | } |
|----------------------------------------------------------------------------------------------------------------------------------------------------------------------------------------------|---|

All Carriage Paid

Send for our Illustrated Catalogue for full particulars. Printed on Art Paper and profusely illustrated. Price 3d., returnable on first order of 5/-

**P. H. BOYS & CO., 187, GOSWELL ROAD, LONDON, E.C.1**

## FOR TOOL BARGAINS

CALL or WRITE TO-DAY to;

Before buying elsewhere compare our prices. Remember, we have the Largest Stock of Tools to select from in London. We guarantee you satisfaction, so you can safely shop by post. Bargain List sent Post Free.

**GEORGE ADAMS,** DEPT. A/W, 255-6, HIGH HOLBORN, LONDON, W.C.1.



## GENTS' MAKE FITMENTS

SEND FOR OUR SUNDRIES PAMPHLET, MAKE USE OF OUR STOCKS, ASK US TO QUOTE FOR YOUR WHOLE-SALE REQUIREMENTS.

**GENT & Co. Ltd., FARADAY WORKS, LEICESTER**

L.F. Transformer. Delivery from Stock  
London: 85, Victoria St., S.W.1. Newcastle-on-Tyne: "Tangent House," 52, Blackett St.

## GET OUR LIST—IT'S FREE

ELECTRICAL SUPPLY STORES  
5, Albert Terrace, King Cross,  
HALIFAX.

EVERYTHING FOR WIRELESS IN STOCK

# AERIALS

MASTS,  
SPREADERS, STAYS,  
PULLEY BLOCKS, EYEBANDS.

EVERYTHING FROM MAST TRUCK TO MOORING STAKE.

COMPLETE INSTALLATION OF AERIALS UNDERTAKEN.

ESTIMATES GIVEN for the SUPPLY and ERECTION OF MASTS and AERIALS.

**DYNE & EVENS, York Rd., Limehouse, E.14.**  
(Near STEPNEY STA. G.E.R.)

# "LISTEN-IN" ON THE STERLING No. 1 CRYSTAL W/T RECEIVING SET



Visit Our STAND  
**No. 34**  
ALL BRITISH WIRELESS  
EXHIBITION  
Horticultural Hall,  
Westminster, S.W. 1.  
Sept. 30—Oct. 7.

**Immediate  
Delivery**

*The Sterling No. 1 Crystal Receiver has been specially designed for use in connection with the Wireless Telephony Broadcasting Scheme and is suitable for a range of about 25 miles.*

The set comprises:

1. **TUNER.**—This consists of an inductance which can be varied by means of tappings taken to stud switches. Two of these are fitted, one for coarse and the other for fine adjustment. A separate coil is provided which can be plugged into a fitting at the back of the instrument (as illustrated) for reception of time signals, etc., from Eiffel Tower.

2. **DETECTOR.**—This is of the crystal type, requiring no battery, and is designed to give universal adjustment over all parts of the crystal.

The apparatus is mounted on ebonite panel and fitted in polished walnut case.

The equipment includes one pair of No. R1258 DOUBLE HEAD TELEPHONES wound to a total resistance of 2,000 ohms the pair.

**Sterling Telephone and Electric**  
TELEPHONE HOUSE, Co., Ltd.,  
210/212, Tottenham Court Road, London, W.1.  
Telephone No.: 4144 Museum (7 lines). Telegrams: 'Cucumis, Wesdo, London.'  
Works: **DAGENHAM, ESSEX.**  
BRANCHES: **NEWCASTLE-ON-TYNE: 9, Clavering Place.**  
**CARDIFF: 8, Park Place.**

**PRICE - £7 12 6**



## Shows you how to make your own Valve Set

This Booklet shows you how, with P. S. Standardised Radio parts, you can easily build a highly efficient Set with a screwdriver and a pair of pliers—and without previous electrical knowledge.

It explains how the Peto Scott Unit System permits you to add further Valves at any time at minimum cost.

Thousands of home constructed Peto Scott Sets are already giving splendid results all over the country.

Don't miss our Stand No. 16 at the Wireless Exhibition—it is sure to interest you.

post 6d. free

Our big 32-page Illustrated Catalogue sent post free with every Booklet.  
Address application "Sales Dept."



**Send To-day**

Showrooms and Offices:  
FEATHERSTONE HOUSE,  
64, HIGH HOLBORN, W.C.1.



**JUST PUBLISHED.**

## SIMPLIFIED WIRELESS

BY

JOHN SCOTT-TAGGART, F.Inst.P.

Author of

"Wireless for All," "Wireless Valves Simply Explained," etc. etc.

**An Entirely New Book for the Beginner.**

IT TELLS YOU—

- (1) All about elementary electricity.
- (2) What the different parts of wireless circuits are for.
- (3) How to erect your aerial.
- (4) How to make inductances, variable condensers, fixed condensers, crystal detectors, etc.
- (5) How to make several types of complete receivers out of the simplest materials.

WHY NOT MAKE YOUR OWN SET? THIS BOOK TELLS YOU HOW.

PRICE 1/-; postage 1½d. Get your copy to-day.

From all Booksellers, or by return post from

**Radio Press Limited,**

DEVEREUX BUILDINGS, STRAND, W.C.2.  
(Opposite the Law Courts.)

Our Stand at the Exhibition is No. 27.

PAY US A VISIT!

: THE P.M.G. AND LICENCES :

# Amateur Wireless And Electrics

ALL  
ABOUT  
THE  
VALVE

No. 19

SATURDAY, OCTOBER 14, 1922

Price 3d

## *This Week's Contents:*

WHAT DO WE GET OUT OF  
WIRELESS ?

AERIAL CONSTRUCTION FOR  
FLAT ROOFS

DETAIL EFFICIENCY: Obtaining  
Results with the Crystal

WIRELESS SOCIETY OF  
LONDON: NOTES

MECHANICAL  
MORSE

A NEW TYPE OF  
CONDENSER

EASILY-MADE  
COIL-HOLDERS

ALL ABOUT THE  
VALVE

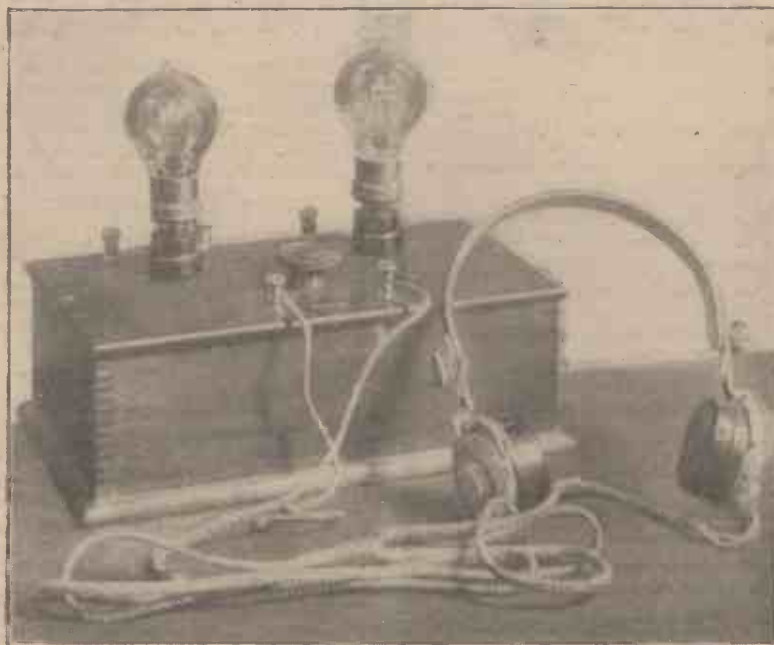

MEANING OF  
ELECTRICAL  
UNITS

MORE EXHIBI-  
TION PHOTO-  
GRAPHS

WIRELESS,  
"WIRED" and  
"PIPED"

A SIMPLE TWO-VALVE SET

Radiograms. Club Doings. Information Bureau. Transmissions, etc. etc.

E CONOMIC ELECTRIC LTD.

WHOLESALE, RETAILERS  
and the PUBLIC, are requested  
to TAKE NOTICE that this advertisement is to introduce the

PRICE

**15/-**



PRICE

**15/-**

THERMIONIC TRIODE

the latest and best development  
of the three electrode valve.

RECTIFIES, OSCILLATES,  
AMPLIFIES

Unique Construction and High  
Amplification Characteristic.

Filament current 5 amps at  
4 volts. Anode potential 50 volts.

Obtainable from the patentees, ECONOMIC ELECTRIC LTD., and all dealers in Wireless apparatus. Wholesale enquiries should be sent to the patentees or to Mr. H. S. TYLER, 29b, Balham Hill, London, S.W.11.



Head Office: 10, FITZROY SQUARE, LONDON, W.1.

INFRINGES NO PATENTS!  
Illustration Full Size

Branch Showrooms: TWICKENHAM

New Showrooms: 303, EUSTON ROAD, N.W.1.

Telephone: MUSEUM 1055

Branch Showrooms: TWICKENHAM

MITCHELFONES

Are not a spasmodic production to meet a sudden demand, but have been on the market for over three months, and during this period 27,000 have been distributed to the trade, and consequently we have not been able to offer them direct to the retail buyer.

1,000 per week are now available, and we announce

DELIVERY FROM STOCK

You post your order, or call at our premises and get them at once. Think what this means to you—you, perhaps, who have been waiting and are still waiting.

Standard resistance 4,000 ohms, double headgear with double headstraps, comfortable, highly efficient, and foolproof

25/- per pair.

Special Terms to Traders and deliveries that will surprise you.

MITCHELLS Electrical & Wireless Ltd.,

Postal Address: McDermott Road, Peckham, S.E.15.  
Retail Address: 188, Rye Lane, Peckham, S.E.15.

Phones: New Cross 1540/1541.

GREAT BRITAIN'S GREATEST WIRELESS STORE

FOR TOOL BARGAINS

CALL or WRITE TO-DAY to;

Before buying elsewhere compare our prices. Remember, we have the Largest Stock of Tools to select from in London. We guarantee you satisfaction, so you can safely shop by post. Bargain List sent post free.

GEORGE ADAMS, DEPT. A/W, 255-6, HIGH HOLBORN, LONDON, W.C.1.

CRYSTAL SETS

|                        |           |               |
|------------------------|-----------|---------------|
| Single Slider...       | ... £0 18 | 6 unassembled |
| " " " "                | 1 13      | 6 assembled   |
| With Tapped Inductance | £1 10     | 0 unassembled |
| " " " "                | 1 15      | 0 assembled   |
| With Loose Coupler     | ... £4 16 | 6 assembled   |
| All Carriage Paid      |           |               |

Send for our Illustrated Catalogue for full particulars. Printed on Art Paper and profusely illustrated. Price 3d., returnable on first order of 5/-

P. H. BOYS & CO., 187, GOSWELL ROAD, LONDON, E.C.1

EUREKA!! Drudgery Banished!

The "TURNNEY"

Automatic Morse Buzzer

(PATENT APPLIED FOR)

Transmits in a fascinating manner suitable signals, quickly training the ear to instinctively read the code as heard in the 'phones

You MUST Learn Morse. Why Wait for your Wireless Set?

30/- Post Free

Price Complete

W. PRESTON TURNBULL, 26, Cowper St., LEEDS

Hullo!!! C.Q.

WILL DAY CALLING

We must Broadcast the fact that we have purchased 1,000 Trench Buzzer Sets complete With Low Resistance 'Phone, Double Pole Buzzer with Heavy Platinum Contacts, Morse Key, Terminals, Head Band, etc. All fitted in Stout Teak Case with Canvas Top and Strap.

EACH COMPLETE 10/6 Postage 1/-

The Phones off these sets make wonderful Loud Speakers

|                                                                                                                  |                           |
|------------------------------------------------------------------------------------------------------------------|---------------------------|
| Best Quality Filament Resistances ...                                                                            | 2/9 each Postage 3d.      |
| Switch Arms with Laminated Blades...                                                                             | 1/- each " " "            |
| 3-Way Coil Stand for Panel Mounting                                                                              | 15/ " " " 6d.             |
| Best Ebonite Knobs with Brass Nut inserted 2 B.A. ...                                                            | 5d. each Postage extra    |
| Insulated Sleeving all colours ...                                                                               | 5d. yard Postage extra    |
| Brass Terminals with nut and washer                                                                              | 1/- doz. Postage 3d. doz. |
| Complete Set of Parts, including two Ebonite Plates 4" x 4" for making Best Quality Variable Condensers '001 ... | 10/- set                  |
| '0005 ...                                                                                                        | 8/- set                   |
| '0003 ...                                                                                                        | 6/- set.                  |

These are only a few of our bargains. Do not fail to send for our Price List giving the lowest prices for the best quality goods.

---

We always Stock the Famous HERTZITE CRYSTAL at 2/6 each, or mounted in Brass Cup 2/10 postage 3d. extra.

WILL DAY, Ltd.,

19, Lisle St, Leicester Square, London, W.C.2.

Phone: Regent 4577. Telegrams: Titles, Westrand, London.

# Amateur Wireless

## and Electrics

No. 19

October 14, 1922

## What Do We Get Out of Wireless?

Ranging the World for a Pound or Two :: The Magic Carpet

I READ a few days ago in a journal a letter from a gentleman who would only regard wireless as an intensely practical asset to his everyday life. He did not want "indifferent music" and "bedtime stories," nor was he intrigued by Croydon's conversation with aircraft or other aerodromes. He wanted news of the Stock Exchange and to know with certainty and celerity the winner of the 4.30.

To those of us—and I know there are so many, happily so many—whose spirits thrill to any whisper of the ether waves, this sounds remarkably like blasphemy. To us our apparatus is but the vehicle of romance, and by its aid we are wafted to regions hitherto unexplored and unexplorable. We can range the world for a pound or two. It is the nearest approach to the Magic Carpet, and so girt with mystery that, I think, no carpet were quite so magic.

Think of those days and nights when the amateurs of England sought the amateurs of America: that desperate feeling forth into the darkness to meet the far-off message. And still more wonderful that many who adventured did so with apparatus that would seem pitiful to this eminently practical man. Not the polished articles of shops and stores, but queer, jumbled things made with their own hands and crude, except that they were blessed by the creative genius of the maker, who knew each turn and twist of the thing he made.

We cannot welcome the day when wireless will be but a mechanical and automatic process; when all sets are calibrated and wavelengths but figures on a

chart; and in this case I cannot, will not, believe that when Science comes in at the window, Romance will flee by the door. For this wireless is a thing of dreams, a fantasy to which we all have access, those that buy and those that make with lathes, and those whose work-bench is the kitchen table and whose tools are pliers, gimlet and screwdriver. And I think these last

are the happiest; for obstacles are but met to be surmounted and with success, however ultimate, they must be so infinitely happy. There is no joy akin to the joy of creation, to know that this rough thing, devoid of anything that is unessential and of many things that the man who buys would deem essential, works.

This is the glamour of the thing, and is it a glamour that passes? I don't think so. There is no finality, no goal save an intermediate one. There are things, tremendous things, to find out. Because our apparatus is crude it does not mean that we are excluded from the quest.

There are steps onward and upward for all of us.

And now for this eminently practical man. He protests his practical mind. The curiously intangible thing we worship is not for him—not yet. But with Mark Sabre, "I can see what he means."

For my part I am not personally interested in the winner of the 4.30, but I can understand that others may be, and I know for certain that they are. Well, now, suppose that this very practical person had his eminently practical wish and could, by revolving certain definite handles through certain definite degrees, get all the winners and the rise and fall of, say, Mexican Eagles. Would he stop there? Why, no. He'd search round by revolving indefinite handles entirely unauthorised degrees, and he would find music that is no longer "indifferent" and eventually take his penitent seat with the rest of us on the Magic Carpet. Don't you think so? Where could not that Carpet transport him?

WALTER MEADE.

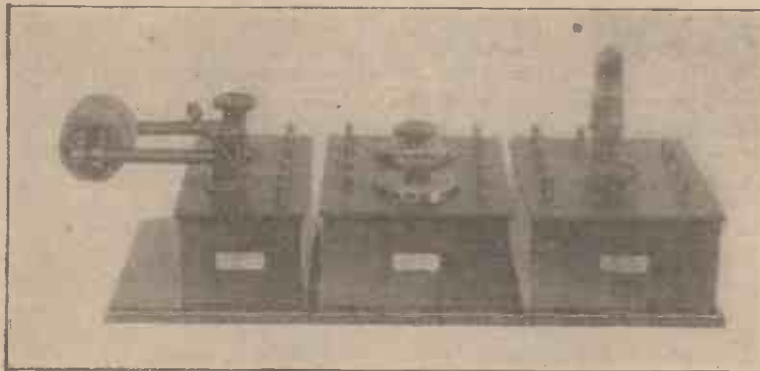

Single-valve Unit Set (Fleet Radio Co.).



Unit System Model with Loud Speaker (City Accumulator Co.).

The above photographs illustrate the advantages of the unit system by means of which receiving sets can be built progressively.

# DETAIL EFFICIENCY

How to Obtain the Best Results with the Crystal

IN spite of all the attractions of the valve set, with its greater power, its longer range, and its extraordinarily fine tuning, the crystal receiver has a certain fascination of its own which calls one irresistibly at times. The writer recently laid aside valves for a season and spent a whole fortnight with zincite, tellurium, perمانite, galena, carborundum and others of their kind; during that time he learnt a very great deal, and possibly the fruits of his experience may be of use to other experimenters.

## Valve versus Crystal

The greatest charm of the crystal lies in its wonderful efficiency. The valve, even if it is used for rectification alone, requires two separate currents to be applied to it. Except for carborundum and one or two others, crystals need no outside potential of any kind, yet they actually rectify more efficiently than the valve. Their only drawback is that so far no one has discovered any means of making them amplify. A fortune awaits the man who, by means of relays or possibly by the use of magnetic fields of force, discovers some way of enabling the currents in a detector set to be magnified at either radio-frequency or audio-frequency without the use of valves.

## Receiver Design

It has been said that the crystal is efficient; it is, provided that it is given a fair chance, which is very seldom the case. Many of the crystal receiving sets at present are badly designed, and often the workmanship is not all that it might be. But even if the set is perfect, it is often badly treated by its owner, who fails to realise with what tiny currents it has to deal. He erects a rough-and-ready aerial, twists his earth wire loosely round a water-pipe, uses unsoldered connections, and wonders why he can hear nothing but a few of the most powerful spark stations. With the crystal detector one has no margin of current to play with. The total amount delivered to the telephones, even under the best of conditions, is so small that none of it can be wasted. Every electron must be made to pull its weight.

A great many detectors are simply mounted on bases of wood, which is almost useless as an insulator of oscillating currents, especially if, as is usually the case, connections under the surface are made

with bare wires lying close together. This was brought home to the writer in rather a curious way. He was experimenting with a detector coupled up with a valve amplifying at audio-frequency. Whilst the spring was making no contact with the crystal he threw in the grid-leak, and the

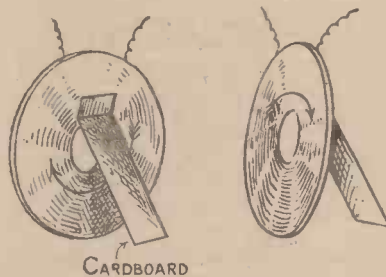

Simple Method of Using Inductance Coils.

valve at once began to rectify the currents which were making short circuits across the woodwork of the detector. On 600 metres any number of readable signals were obtained in this way.

## The Detector

The detector should always be mounted upon an ebonite base, and care should be taken that the wires joining the cup and wire contact to the terminals do not run parallel to each other a short distance apart; if they do so they will produce capacity effects which will seriously impair the working of the detector. If it is absolutely essential to adjust the detector by means of a buzzer—and there is a good deal more in this than one might believe

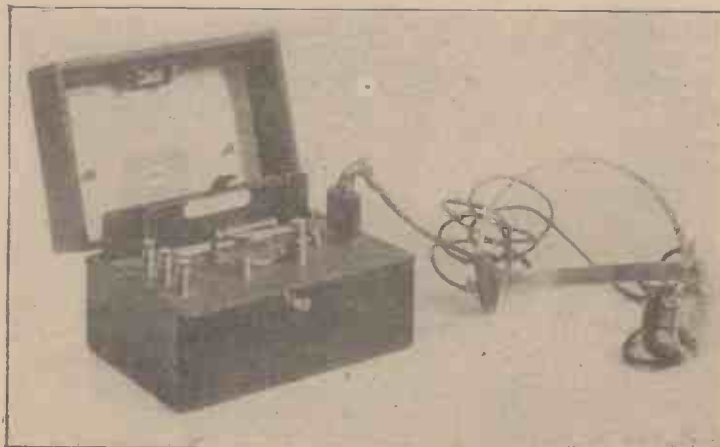

A Compact Receiving Set: the Marconiphone Crystal Junior.

at first sight—any kind of buzzer will do; even an electric bell with the gong removed answers quite well, but one that can be tuned to give a high-pitched note is preferable. It is a great mistake to use too much current on the buzzer. If quite

a weak E.M.F. is applied from, say, one dry cell much more critical adjustment is possible; with a more powerful current the crystal may seem to be giving good results in places which are not really very sensitive.

The buzzer should not be in the same room as the receiving set. The best way is to place it in another part of the house, connecting the pillar of the contact screw to a water-pipe by means of a wire. Search for the most sensitive spot on the crystal, then disconnect the buzzer from the water-pipe and continue to adjust until it can be distinctly heard in the telephones. Even then the adjustment should not be regarded as perfect. The next step is to tune the set to 600 metres, upon which wave-length there is usually a perfect chorus of Morse signals, and to obtain exactly the right contact between spring and crystal by means of the adjusting screw. The whole process does not take more than a quarter of an hour, and it is well worth the trouble. With a crystal tuned in this way the writer has on several occasions received clear telephony from Writtle and from Croydon, both nearly 40 miles from his aerial.

## Inefficient Circuits

Another important point brought to light in this series of experiments was the inefficiency of the single circuit with which nine detector sets out of ten are fitted. The loose coupler gave results at least 50 per cent. better, but it was eclipsed by basket and slab inductances so arranged that any degree of coupling could be obtained. There is no need to mount them at all. Simply provide each with a cardboard prop, shellacked on as shown in the sketch above, and manoeuvre them on a piece of ebonite. An arrow should be painted on each coil to show the direction of the windings.

The aerial has a great deal to do with the results obtained from a crystal set. It should be of stranded wire, and it is important that it should be as high and as long as possible. The writer obtained much better signals from a single aerial 100 ft. in length than from one with 70-ft. parallel wires.

## When a Receiver will not Work

When a friend complains that his detector set will not work, look first at his method of bringing the lead-in into the house. Even highly insulated wire will



part with some of its current, especially in wet weather, if it is simply brought in through the window, making contact on its way with brickwork, wood and possibly iron. A simple and perfectly satisfactory form of lead-in tube is shown in Fig. 2. This consists of a stout ebonite tube  $\frac{3}{16}$  in. in internal diameter, through which passes

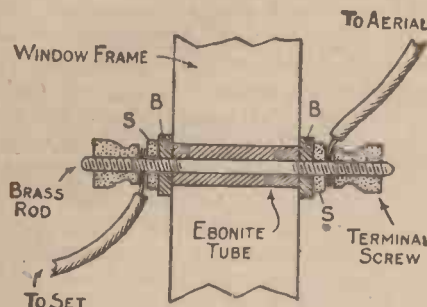

Fig. 2.—Simple Form of Lead-in.

a brass or copper rod threaded to take large terminal screws. A hole of just the right size is bored in the window frame, the tube is then inserted, and after being cut to the right length is firmly fixed in place by means of the screws S S, which are tightened against the ebonite blocks B B. When the set is not in use the aerial and earth leads are disconnected outside the window and hooked together, so that there is no danger from lightning.

With the crystal set a good earth is of paramount importance. Few wireless men realise how great a resistance even a good ordinary earth connection offers to the passage of currents. A test carried out recently on an earth which was suspected, in spite of the fact that its owner was perfectly satisfied with it, disclosed a resistance of nearly 3,000 ohms! A water-pipe is excellent provided that the earth wire can be made not more than 10 ft. or 15 ft. long, and it is desirable that the pipe should not rise to a higher level than that of the receiving set. The best earth of all

is made with a 7-lb. biscuit tin, as shown in Fig. 3.

The earth wire is unstranded for about a couple of feet, and the loose ends are soldered to various points at the top of the tin. A hole from 3 ft. to 4 ft. deep is dug immediately under the aerial, and the tin is placed in it and half filled with water. A

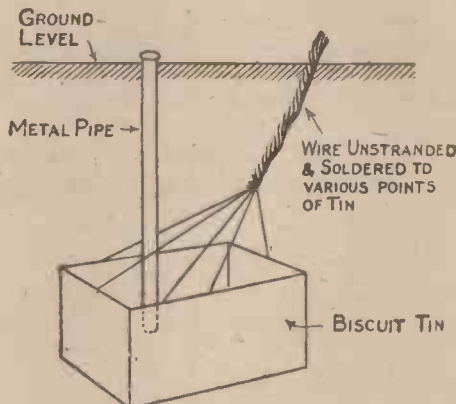

Fig. 3.—Earthing Arrangements.

metal pipe, whose top end has been slightly belled so as to form a funnel, is then placed in the tin and the hole is filled in. If very small holes are made in the tin the water in it is bound to leak out and to moisten the ground all round it. So long as the tube is filled up from time to time a wet earth of low resistance is assured.

It is just these little points of detail that make all the difference to the working of the detector set. If they are attended to excellent results will be obtained except when atmospheric conditions are not too favourable for reception. Given fair play, the simple crystal receiver will provide its owner with never-ending entertainment, but if it is regarded as a coarse instrument that can be connected to any kind of aerial and earth it will be a source of disappointment and of constant annoyance.

R. W. H.

The difficulty in the last course is that he knows what sound to expect before he hears it, and, though one might not at first realise it, this fact almost entirely vitiates the method as the means of recognising an unexpected signal. To avoid this difficulty there is needed some device whereby one can "buzz" letters in correct Morse without knowing what the letter will be before it is sounded. The problem may appear difficult, but it is quite easily solved by means of a thin card appropriately perforated which, lying on a sheet of metal, allows contact to be made through the perforations as the end of a piece of flex is drawn steadily across.

**Making the Cards**

Such cards can be readily made with either a hollow punch, as is used in leather working, or a pair of perforating pliers, such as used for punching the holes in papers for filing. I have found a convenient size for the hole to be about  $\frac{3}{16}$  in., and the letter X would appear as in the sketch. The dotted lines indicate the edges of strips of cardboard which are subsequently glued on to form grooves. These grooves allow one to use the device without looking at it; they should be about  $\frac{1}{8}$  in. wide, and should cover any points left by the intersecting circular holes which would otherwise interfere with clear sending. A single wire is not so good for making contact as the end of a heavy flex, which should be bared and then bound to within about  $\frac{3}{16}$  in. of the end. The cards should be of tough manilla paper or thin hard card. A convenient size is that of an ordinary post-card cut in half ( $2\frac{3}{4}$  in. by  $3\frac{1}{2}$  in.), which will comfortably accommodate six letters separated by strips of cardboard  $\frac{1}{4}$  in. wide.

**The System in Use**

Half a dozen such cards with the letters arranged in no special order, with the more difficult ones duplicated, will be found quite sufficient. It is not advisable to play straight through a card but to stroke off three letters at random and then pick up another card. The motion of the hand should be steady and rather slow. A beginner will almost certainly read a quickly stroked X and B, and in such a case it is well to pick out an X and a B and compare the two, both sent quickly and at the same speed. Still there is no advantage in running off the letters far quicker than is common in commercial messages, and quite a slow motion of the hand is enough.

An extension of this idea for use with two people is to punch out all the letters of the alphabet in their correct order on a sheet which need be no larger than 7 in. by 7 in. With this the veriest novice can send correctly, in fact the one whom you press into your service need not have any knowledge of the code whatever.

T. K. S.

# Mechanical Morse

THE novelty of listening to the spark, C.W., and an occasional Wheatstone soon wanes, and not a few develop an urgent curiosity as to the meanings behind the tantalising tic-tac. An endeavour to learn the code is often attended with further disappointment. By the aid of a mnemonic it is a simple matter to learn it in the direction letter-to-morse-signal; but what a difference when the reverse order is attempted.

There is no royal road. The one and only way is to achieve familiarity by constant reception at slow speeds until the letter is received as a whole, and not spelt into dots and dashes. Of course, those who are lucky enough to be in close con-

tact with an enthusiast at about their own stage will have no difficulty in getting their practice, though even so it is often impossible to arrange the few minutes each day which will make rapid progress



Diagram showing Method of Punching Card.

possible. But the lonely enthusiast finds himself in a far worse plight; he can occasionally victimise a friend, or he may resort to that brain-bewildering attempt to pick out a letter here and there from commercial messages, or he may try equally unsatisfactory "buzzing" to himself.

# Meaning of Electrical Units

Our Old Friends, Messrs. Volt, Ampère and Ohm

**E.M.F.**

**N**OW let us consider electromotive force. This is a form of strain set up most commonly either by chemical action or by the motion of a magnet relative to a conductor. It results in a difference of

is a battery, the chemical action in which has set up a difference of electrical potential between the two points A and B, the switch S being open. We may assume that this P.D. is two volts. When S is closed a current flows from A to B, and the

the E.M.F. of the battery maintains a P.D. of 2 volts between A and B, but that on closing the circuit the E.M.F. remains as before, while the P.D. between A and B drops to 1 volt.

This illustration will also serve to introduce us to the conception of current and resistance. We have already mentioned that a P.D. between any two points will tend to drive a current along any conductor joining them. The quantity of current thus set flowing, will depend on two factors—the resistance which the conductor offers to its passage and the magnitude of the P.D. overcoming that resistance.

The relationship between these three quantities is known as Ohm's Law, being named after the man who first put it in that definite form. It may be stated as follows: The current (measured in amperes) in any conductor is equal to the P.D. (in volts) between the ends of the conductor, divided by its resistance (in ohms).

Thus in Fig. 2 if the resistance between A and B is 1 ohm, the current flowing, both there and in the rest of the circuit, will be 1 ampere.

The quantities so far mentioned and the symbols used to represent them are given in the following table:

| Quantity.            | Unit.  | Symbol.      |
|----------------------|--------|--------------|
| Electromotive force  | Volt   | E. or E.M.F. |
| Potential difference | Volt   | V. or P.D.   |
| Current              | Ampere | I. (not C.)  |
| Resistance           | Ohm    | R.           |

Σ

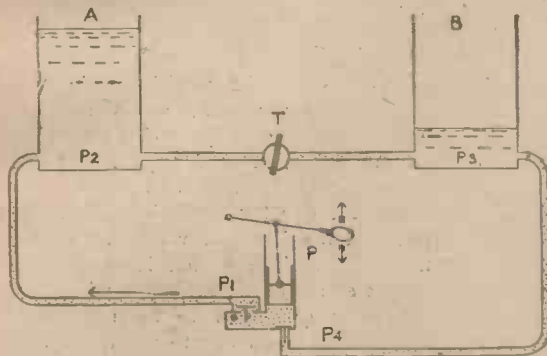

Fig. 1

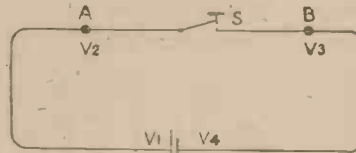

Fig. 2.

Fig. 1.—Water Analogy of an Electrical Circuit.

Fig. 2.—An Equivalent Electrical Circuit.

electrical potential between neighbouring points, which in turn drives or tends to drive a current along any conductor joining those points. In fact, electromotive force (E.M.F.) and potential difference (P.D.) may be considered as cause and effect. Both are measured in volts.

P.D. will then be less than it was before. Suppose it falls till  $V_1-V_2$  is only one volt. Thus we have a set of conditions very similar to those existing in the water circuit just described. To express them briefly we may say that on open circuit

**A Water Analogy—**

We can best make this matter clear, perhaps, by the use of the familiar water analogy. A and B are two vessels containing water connected together by a pipe which is a tap T. P is a small pump, by means of which the water may be transferred from B to A.

Let us close the tap and then work the pump till the water level in A is higher than that in B. The hydraulic pressure, which is measured in lb. per square inch, at the point P<sub>2</sub> in A is now greater than that at the corresponding point P<sub>3</sub> in B; in other words, we have set up a difference of potential. Let us suppose that the pump is only capable of maintaining a pressure of 2 lb. per square in. All the while the tap T is closed the pressure at P<sub>1</sub> and P<sub>2</sub> will be the same, and so will that at P<sub>3</sub> and P<sub>4</sub> (the difference between them being, of course, the 2 lb. just mentioned). If we open T slightly, however, the conditions will be materially altered. Water will flow from A to B, relieving the pressure somewhat and therefore decreasing the difference between P<sub>2</sub> and P<sub>3</sub>. The pump will see to it that P<sub>1</sub> is still 2 lb. greater than P<sub>4</sub>.

**—and its Electrical Equivalent—**

Now let us turn to an equivalent electrical circuit as shown in Fig. 2. Here

# Easily-made Coil Holders

A VERY useful coil-holder can be made with a minimum amount of labour and expense from an old electric-light plug and socket. Take the wooden plug and mark it so as to allow the maximum flat surface which can be filed at right angles to the terminal separator and then file it to the marks (see Fig. 1). This done, obtain two ebonite strips for coil supports, approximately  $\frac{3}{4}$  in. by  $\frac{1}{16}$  in. by 4 in. (no definite diameters can be given for these strips, as the plugs vary according to manufacture), and fit them on to the flats by means of glue and four small screws (see Fig. 1). The coil can be mounted between the two supports by means of an old bobbin and screw, as shown in Fig. 2. The socket is an ordinary light socket and can be fixed on to the baseboard by means of the two screw collars attached.

Suitable connections having been made to place same in circuit, the coil can now be plugged in ready for use.

A slight improvement can be made to

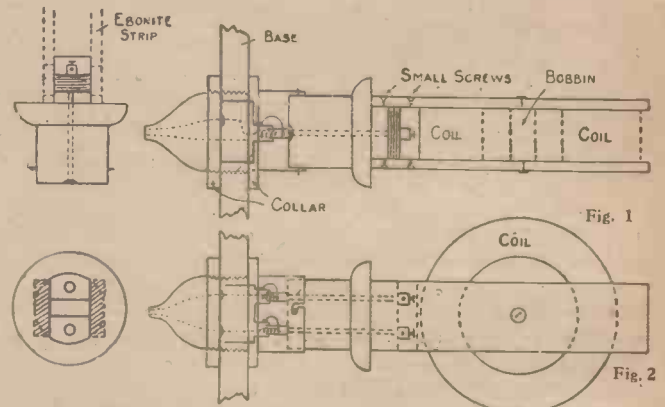

Figs. 1 and 2.—Plan and Elevation of Coil Holder.

the socket if two small pieces of flexible cord are soldered on to each section of the sliding spring contact, thus ensuring minimum resistance and also a very good connection.

S. W.

# ORA

## The Valve for perfect reception

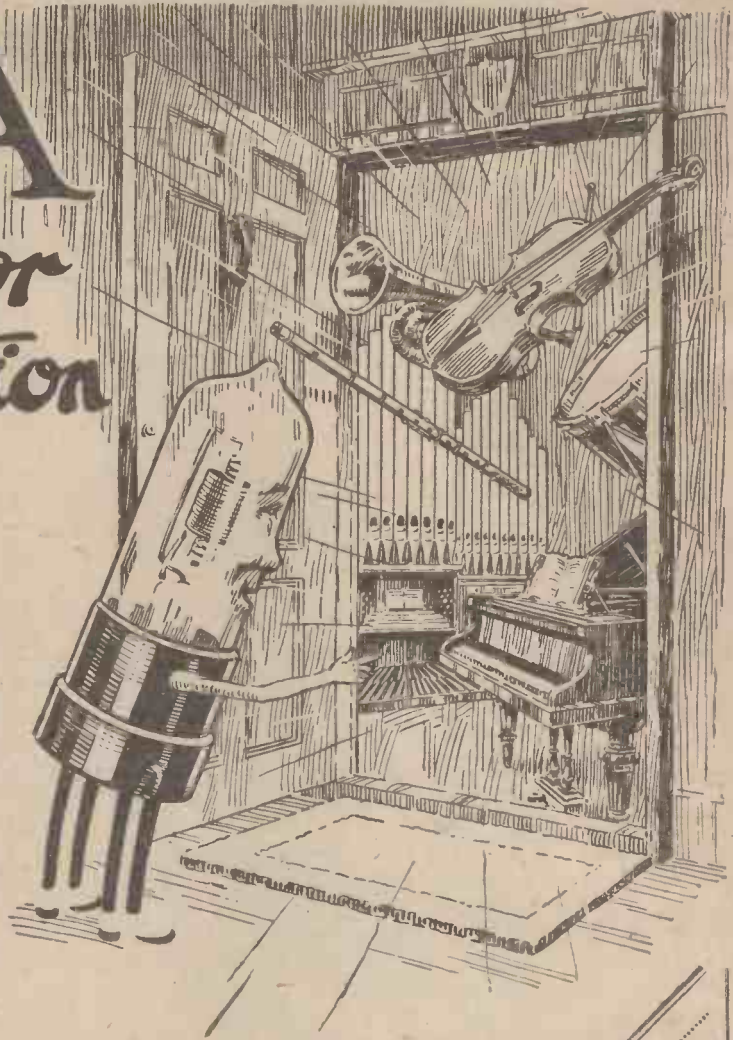

For receiving vocal and instrumental items you must have .

### MULLARD ORA Valves

to get the best results.

**Oscillates—Rectifies—Amplifies**

Specially recommended where good amplification is required.

**15/- each**

#### IMPORTANT NOTICE.

The great demand for Mullard ORA Valves and other accessories has compelled us to open much larger works. A greatly increased output is now available.

The MULLARD "R" Valve is now reduced in price from 22/6 to 17/6

## Mullard Radio Valve Co. Ltd.

Claybrook Road, Hammersmith, W.6.

Contractors to H.M. Admiralty,  
War Office, Royal Air Force & Post Office.

Telephone: Codes: Telegrams:  
Hammersmith 312 ABC (Ed) Radio Valve Hammer Lond



Name and Address .....

To the MULLARD RADIO VALVE CO. LTD.,  
35, Claybrook Road,  
Hammersmith,  
London, W.6.

| Quantity | Description                       | Price        |
|----------|-----------------------------------|--------------|
| .....    | Telephone Head Sets               | 30/- per set |
| .....    | ORA Valves                        | 15/- each    |
| .....    | Grid A Resistances                | 5/- "        |
| .....    | Anode A or B Resistances          | 5/- "        |
| .....    | BA Condensers, 0.003 mfd.         | 2/6 "        |
| .....    | Combined Resistance and Condenser | 7/6 "        |
| .....    | Valve Bases with Terminals        | 5/- "        |
| .....    | Valve Sockets                     | 1/3 "        |
| .....    | Terminal Clips                    | 9d. per pair |

Please send me post free

I enclose (Cheque, Money Order, P.O.) value .....

to cover the cost.

Name of usual Wireless dealer .....

**SEND THIS TO-DAY**

# T.M.C. Wireless



THE "DE LUXE" CABINET  
WIRELESS RECEIVING SET

THIS SET has been specially designed to meet the requirements of those who desire a Wireless Receiving apparatus of maximum efficiency, simplicity of control, and the whole self-contained in a "De Luxe" Cabinet, designed to harmonise with other pieces of artistic furniture.

THE INSTRUMENT comprises a Valve and Crystal Set so arranged that, by the manipulation of a simple switch, either can be brought into operation as may be desired, the reception being suitably amplified by means of a two-valve Audio Frequency combination.

OUR PATENTED form of permanent Crystal Detector—which entirely eliminates the usual troublesome setting—is fitted in duplicate as Standard.

ALSO MOUNTED upon the highly polished Ebonite Panel are the necessary Controls, carefully arranged for convenience of manipulation.

THE LOUD SPEAKER and requisite Batteries are mounted on the Cabinet, the front of which is provided with adjustable louvres.

TWO HEADSETS are included in the equipment, for use on such occasions as when the Loud Speaker may not be required.

WE CAN SUPPLY the Cabinet in any Finish to order, the overall sizes being 3 ft. high by 1 ft. 8 in. square. The workmanship and design of these Cabinets are exquisite specimens of the cabinet-makers' art.

**SPECIAL NOTE** Our Price includes the supply and erection of the Aerial in any part of Great Britain, and the handing over of the Set in thorough working order, and to our customers' entire satisfaction.

**The TELEPHONE MANUFACTURING Co.,**  
Hollingsworth Works, DULWICH, S.E. 21. LTD.

Telephone: SYDENHAM 2460-1.

Telegrams: "BUBASTIS DULCROX, LONDON."

# Wireless: "Wired" and "Piped"—IV

The Concluding Article on the Use of Electric-light Mains and Pipes as Aerials

FIG. 11 is a combination of Figs. 7 and 10. In this case both fixed condensers L and K are in circuit with the two series variables, the earth connection to the set being retained. This circuit was a slight improvement on the last as far as control was concerned, but no increase in strength of signals was noticed. The series condensers made greater differences in tuning than in the last case, but again it was found that any increase in their values

house circuit to receive signals, the tests were carried out afresh with the current switched off. It was found that signal strength in every case was slightly reduced, although quite good signals were received, and generator hum was practically non-existent except in the case of Fig. 9.

### Some Conclusions

To those who wish to experiment with

indoor aerial, but, of course, if it is at all possible to erect an outside aerial, however inefficient, it is preferable to do so. The lighting mains system, as well as the indoor aerial system, should only be resorted to when it is an absolute impossibility to erect an outdoor aerial.

### Gas Pipes Instead of Lighting Mains

Most readers probably have no lighting mains at their disposal, but the majority will have access to gas pipes. The writer tried one or two experiments on the lines indicated in Fig. 14, in which the house gas pipes were made to function as an aerial. For the first test a direct connection was made from the aerial terminal of the receiver to a screw on a gas bracket about ten feet away. Although it was found impossible to produce oscillations, Paris spark and many ship and coast stations came in quite well at about

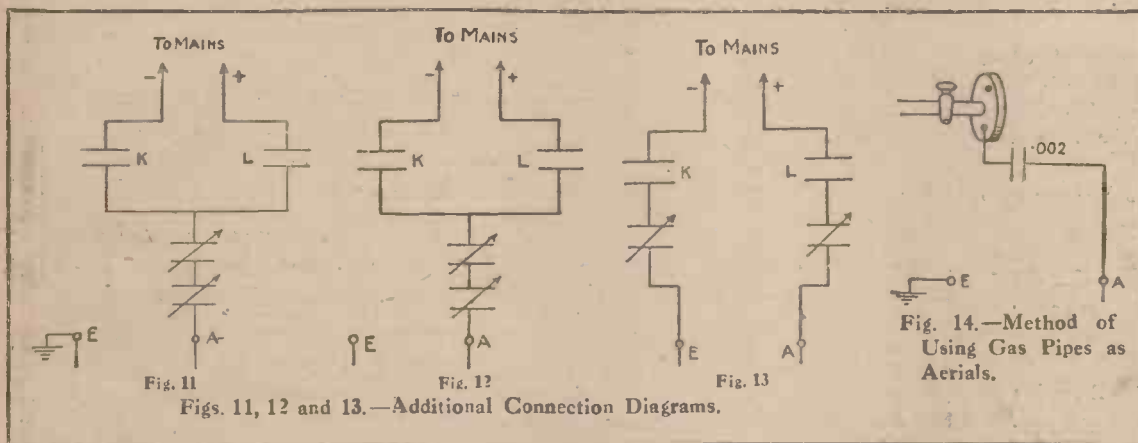

Figs. 11, 12 and 13.—Additional Connection Diagrams.

above about twenty degrees strengthened generator noises.

The same arrangement as shown in Fig. 11 was used for the next test, except that no earth connection was made to the receiver. Fig. 12 shows the circuit. A slight increase in signal strength over the last test was noticed, and generator hum was almost absent. For this reason this particular arrangement seems best adapted for use in cases where one side of the lighting mains is earthed. It should be mentioned that differences in tuning were approximately the same as in Fig. 7.

The next circuit to be tested is that shown in Fig. 13. The two fixed condensers K and L were used, each being connected separately to a variable condenser as shown. The opposite sides of the variables were taken to aerial and earth terminals on the receiver, and the usual earth connection was dispensed with. This circuit has nothing to recommend it. Signals came in very easily and the set was quite easy to control, but strength was lacking. In addition, generator noises were almost sufficiently loud to drown out the very weak signals obtained.

### Switching-off the Main Current

In all the experiments so far described the main current was switched on, and in order to ascertain whether or not it is necessary to have current flowing in the

high resistances, with or without condensers, the writer would mention that no good results can be obtained. Generator noises are extremely loud, and nothing else can be heard; besides which it is contrary to the rules of electric lighting companies to make any direct connection between their mains and earth.

The foregoing tests were carefully carried out and were checked by an independent person of considerable wireless experience, but naturally every experimenter will not experience the same results. Much will depend on the particular lighting system and the characteristics of the receiver. It is therefore impossible to recommend a suitable combination of condensers for every particular case, but in general the following note should form a fairly reliable guide: where neither side of the lighting system is earthed, both fixed condensers L and K may be used in conjunction with circuits shown in Figs. 7, 11, 12 and 13, and the fixed condensers may be used separately as in Figs. 8, 9 and 10. This means that all the circuits described should be suitable. In cases where one side of the mains is earthed, any circuit except Figs. 9 and 13 should give useful results.

To sum up, the writer is of opinion that the results obtained when employing lighting mains as a substitute for an outdoor aerial compare favourably with a good

one-tenth their usual strength. For the next test a condenser which may be fixed or variable was connected to the gas bracket as shown in the figure. Excellent signals were received, both spark and C.W., and telephony from a London amateur came in very weakly. Signal strength was quite equal to that obtained when using the electric lighting mains, and, of course, there were no external noises.

For the guidance of readers, it remains to be said that all the tests here described were carried out twenty-two miles north of London.

P. T. B.

## Making Inductance Tubes from Gramophone Records

INDUCTANCE tubes can be made from gramophone records in the following way. Suppose the tube is to be 6 in. long and 4 in. in diameter, procure two old gramophone records and first remove the paper label in the centre. Then mark out a rectangle 6 in. by 6 3/4 in. on each. Cut this out with a tenon saw; if the saw binds, lubricate with water.

Now obtain two 2-lb. stone jam jars (size 5 1/2 in. by 3 3/4 in.). Mark the pieces of record A and B, and place them in boiling water for a few minutes to render them pliable. Then take sheet A and bend it into a half cylinder round one of the jars.

fixing it securely with string, and allow to cool. Repeat the process with piece B. Then untie the string and let A remain on its jar; remove B and place it on the same jar as A, but make both the edges of B overlap A. It may need resoftening to do this.

Now take a soldering iron or poker and heat to redness. With this melt the composition where the two half-cylinders overlap, so as to join them together. Seal the other side in a similar manner. This will leave a very rough surface, so reheat the iron and, applying pressure, slide it

quickly backwards and forwards along the join with a smoothing action.

Next fill up the holes which were in the centres of the records with some small pieces of record fused in so as to make a smooth surface. Remove the jar from the tube, and with coarse glasspaper smooth both joints. Mark two points  $\frac{1}{2}$  in. apart and  $\frac{1}{2}$  in. from the end of the tube at both ends, and with a red-hot nail pierce holes for anchoring the wire.

The finished tube has the appearance of ebonite and is much smarter than the usual type. G. S. B.

fixing screws. E is a circular disc of mica  $2\frac{1}{4}$  in. in diameter and .002 in. thick, provided with a hole in the centre  $\frac{3}{4}$  in. in diameter. F is a circular piece of brass  $2\frac{1}{2}$  in. in diameter and  $\frac{1}{16}$  in. thick; the hole in the centre is  $\frac{1}{2}$  in. in diameter. G is an ebonite washer 1 in. in diameter and  $\frac{1}{4}$  in. thick and drilled through the centre to clear the spindle.

The arm (see Fig. 2) is a piece of brass 3 in. long and  $\frac{1}{16}$  in. thick,  $\frac{1}{2}$  in. wide at the nut end, and tapered off the whole length. A hole to clear spindle is drilled at the wide end, from the centre of which measure off  $2\frac{1}{4}$  in. and bend up remainder at right angles. A glass bead (about  $\frac{3}{8}$  in. in diameter) is fitted to allow of easy movement up and down the side of the box.

Fig. 3 shows a piece of brass 1 in. by  $\frac{1}{2}$  in. by  $\frac{1}{16}$  in. thick; a slot is cut in one side to fit the groove at the bottom of the spindle preventing up and down movement. Drill as shown and fix to wooden base with two wood screws.

The bead end of the arm (Fig. 2) rests in the corner of the box, and coming into contact with the sides, prevents the nut from revolving.

A flexible lead is soldered to the top of

## Aerial Construction for Flat Roofs

NO doubt many readers are so situated that they have to be careful when erecting the aerial that no damage is done to the premises with nails, etc. To obviate any trouble of this nature the following method can be adopted.

First obtain a rough strong wooden box,

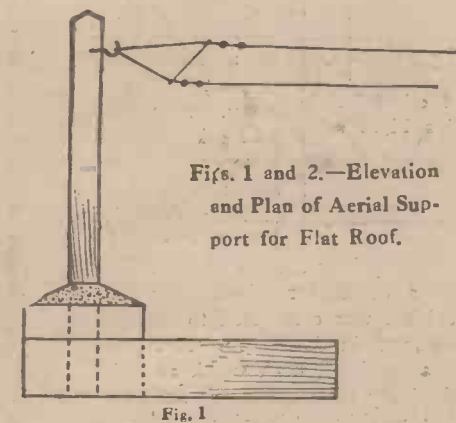

Figs. 1 and 2.—Elevation and Plan of Aerial Support for Flat Roof.



Fig. 2

size about 12 in. by 12 in. by 9 in. or more, one wooden post, approximately  $2\frac{1}{2}$  in. or 3 in. square and 8 ft. high, sufficient broken brick or stones, etc., portland cement and sand, and two pieces of board about 2 ft. 6 in. long by 6 in. wide by 1 in. thick.

Coat the wooden post with a wood preservative to lengthen its life, and from the bottom for a distance of 9 in. knock old nails, staples or the like into the post, leaving the heads protruding about  $\frac{1}{2}$  in., which will form a good key for the concrete in which it is to be mounted.

Erect the post upright inside the wooden box, then mix up the concrete as follows: 6 parts, by measure, of broken brick or stone, 3 of sand, and 1 of portland cement. Mix well in the dry state and then gradu-

ally add sufficient cold water to render the whole a thick creamy mass. Empty this into the box around the pole and ram well down until the whole is a solid, homogeneous mass. The concrete should then be allowed to dry for about fourteen days. The two 2 ft. 6 in. boards should be securely nailed or screwed to two opposite sides of the box flush with the bottom, as shown in Figs. 1 and 2. It will be seen that these boards will exert a leverage against the pull-in of the aerial.

If the aerial is to be erected entirely on a flat roof, two boxes and posts, etc., will be required; but if the roof is not sufficiently long, then one box and post should be erected thereon as already described and the other end of the aerial attached to a post or mast in the garden. (Note.—The weight of 1 cubic foot of concrete is about 112 lb.). R. B.

## A New Type of Condenser

THIS simple but highly efficient condenser can be made without the aid of expensive tools, the lack of which is so often a drawback to the amateur. The design allows for mounting on a panel, if preferred, when, of course, the box will hardly be necessary. Capacity varies from zero to .001 m.f., and the cost to make will be about two shillings.

In Fig. 1 A is a piece of brass rod screwed No. 0 B.A. (or near) and  $2\frac{1}{2}$  in. long. A groove is cut  $\frac{1}{8}$  in. from the bottom to fit into slot of I. BB are two nuts to fit A. One fitted into knob is soldered to spindle, the other acts as a carrier for opening or closing plate F. C shows one of four ebonite washers  $\frac{1}{2}$  in. in diameter and  $\frac{1}{4}$  in. thick (one at each corner of plate D); these are drilled through the centre. D is a brass plate  $\frac{1}{16}$  in. thick,  $2\frac{1}{2}$  in. by  $2\frac{1}{2}$  in. A hole  $\frac{1}{2}$  in. in diameter is drilled through the centre to clear the spindle, and a small hole at each corner,  $2\frac{1}{4}$  in. centres, for

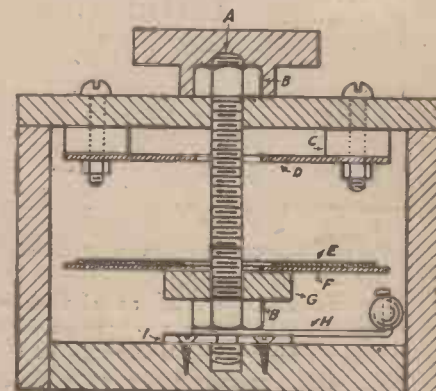

Fig. 1.—Section of Complete Condenser.

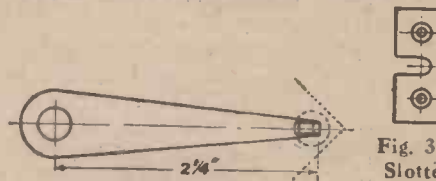

Fig. 2.—Brass Arm.

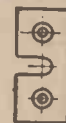

Fig. 3.—Slotted Plate.

the plate D, and another to the bottom of the plate F; these are taken through the top to terminals if and as required. Both plates D and F should be perfectly flat.

A piece of ebonite  $3\frac{1}{4}$  in. by  $3\frac{1}{4}$  in. by  $\frac{1}{4}$  in. thick forms the top. A hole is drilled through the centre to clear the spindle, and four holes at  $2\frac{1}{4}$ -in. centres for screws fixing the plate D. Terminals can be added as desired.

Overall height of box is  $2\frac{1}{4}$  in., sides being of  $\frac{1}{4}$ -in. material, and base of  $\frac{3}{8}$ -in. material. W. A. D.

## “Wireless Telegraphy and Telephony”

The most Practical Handbook for the Amateur. The price is 1/6 net.



This photograph shows what was probably the simplest receiving set in the Exhibition. The makers are Fellows Magneto Co., Ltd.

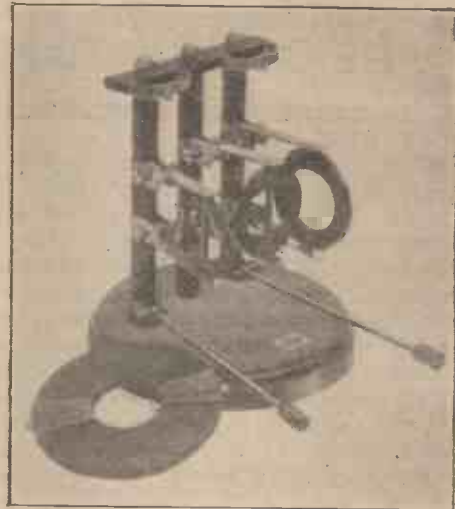

An ingenious method of mounting inductance coils, providing excellent insulation and double movement (Gambrell Bros., Ltd.).

More Exhibition Photographs  
Specially taken for "Amateur Wireless"

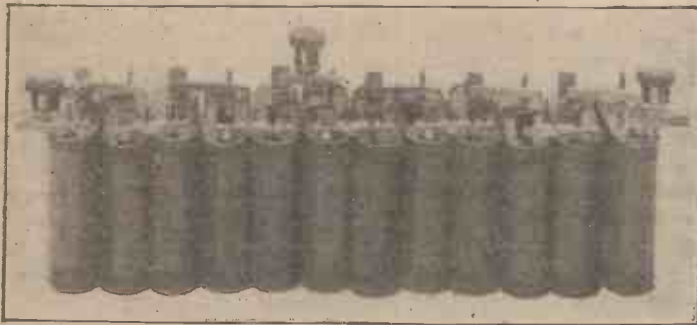

An assembly of dry cells connected up by means of the Harwell connectors. The plug holes allow of any voltage being tapped.



A variometer of unconventional type, by The Igranic Co.

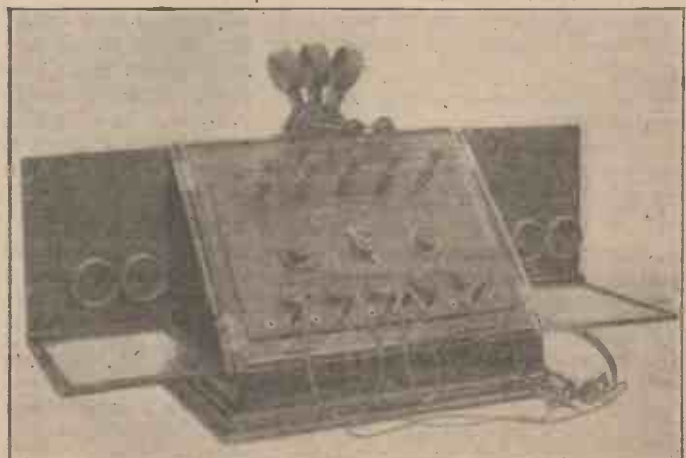

These photographs show the excellent arrangement of the "Fellophone Super Five," which makes the instrument so convenient in use; note the hinged covers and neat effect.

# The Wireless Tanks in France

THE war-time invention which most completely caught the popular fancy was undoubtedly the tank. The huge, cumbersome creature, with its elephantine antics, besides being a standing joke, was regarded by everybody as a marvellous piece of war machinery—which it was. But how many people know that some of these tanks were fitted with wireless, and boasted a wireless cabin much more elaborately fitted with apparatus than the Atlantic liner at that time? Yet such was actually the case, and the success of the British operations during the period of their use was due in no small measure to the wireless tanks; which were able to keep pace with the main attack and pass back regular reports which enabled the staff to prepare for counter-attacks or plan further forward movements.

The writer has dealt with the technical side of this subject in a previous article, and intends on this occasion to survey briefly the history of the wireless tanks on the western front.

## Means of Communication

Up to the end of 1916 there was no reliable means of communication between the front and headquarters during an attack. Runners, sometimes three or four, were dispatched with the same message, seldom reached their destination, and more often than not found themselves in a casualty clearing station or were picked up and buried after the action. Pigeons were fairly reliable if they could be kept intact until needed. Field telephones were useless owing to the impossibility of maintaining the lines in less than a hundred pieces. Flag and lamp signalling were out of the question on account of the dense smoke clouds caused by the guns and bursting shells. Portable wireless, or trench sets, generally managed to find a home for stray shrapnel, and were quickly put out of action. The result was that the attacking troops simply went out into the blue, and nothing more was heard of them until the attack had quietened down. It was a wonder they were not shelled by our own guns more often than they were.

## Mobile Wireless Stations

This state of affairs had to be remedied, and one can imagine that the staff spent many anxious hours until some bright person suggested that the tanks, in addition to running round with a battery of guns on board, might spare a little space to accommodate a wireless set. The idea found favour, and a feverish activity manifested itself at tanks headquarters. Twenty-four men were chosen from the whole of the Tank Corps, and were sent

to the Royal Engineers' wireless school, where they spent a glorious six weeks learning the mysteries of wireless. The course of instruction was an excellent one, embracing spark and continuous-wave transmitters, crystal and valve receivers, and amplifiers. A speed of twenty-five words a minute was easy to most of the operators at the end of the course.

## Preparation

From the wireless school the would-be operators went to the tank workshops, where six tanks had been fitted with soundproof cabins in the space previously occupied by two machine guns. Three weeks sufficed to equip the tanks with wireless, and they were then ready for the line.

Just as the finishing touches had been applied, Her Majesty Queen Mary visited the workshops, and the officer in charge of the wireless tanks, Captain Tingey, was very anxious that Her Majesty should hear some signals. He accordingly arranged that a near-by transmitting station should send V's during the time the Queen was paying her visit. That station transmitted for three hours without a break, so the Queen heard signals, and expressed her surprise at the progress which wireless was making. After the visit the writer endeavoured to obtain the telephones used by the Queen as a souvenir, but was half a minute too late—someone else had the same idea.

## Up to the Line

The wireless tanks moved up to the Ypres salient by train, the operators and crews riding on top of the tanks and making quick dives on to the trucks whenever the train neared a bridge, which cleared the tanks by about 6 in. Arrived at their destination, the tanks were hidden in the woods and the operators were given strict instructions not to depress their transmitting keys on any account. It was rightly thought that if Fritz heard a large number of new transmitting stations tuning up he would come to the conclusion that something was being prepared for his discomfort. Many anxious days were spent getting ready for action; batteries were charged, receiving apparatus tested. In one or two instances the transmitters were tested, one depression of the key being sufficient to show if the needle of the aerial ammeter flew over to a satisfactory distance.

## The First Day

At last the eventful day arrived, and on the evening of July 30, 1917, two wireless tanks, in company with a battalion of

fighting tanks, moved up to the line and stayed the night in the area occupied by our field guns. At dawn next morning the usual hell broke loose—guns of all sizes firing as fast as shells could be pushed into the breech, and the tanks moved forward just behind the infantry. This first occasion on which wireless tanks were used was disastrous to everyone taking part in the attack. The infantry had very hard going, and the writer had the experience of seeing the infantry battalion to which he originally belonged cut to pieces; the troops on their flanks had been unable to keep up. The fighting tanks, with their crews just out from England, seemed unable to keep out of the enemy barrage, and many of them were hit and set on fire very early in the day.

## Not a Message

The wireless tanks were ready for anything that came along, but not once during the attack did they have a message to send. Apparently no one knew why they were there, or, in fact, knew that there were such things as wireless tanks. We kept in touch with our directing station ten miles away, and were ready at any minute to deal with messages, but none was forthcoming. The only cheerful incident in the whole gloomy day happened on the way back. Wishing to make the return journey as quickly as possible, our tanks strolled across country along a beautiful carriage drive, nicely made of gravel and sand and perfectly level. After about a mile of easy travelling on this excellent track an officer appeared, and from his manner one could see that he was distinctly annoyed; in fact, his language was lurid. It transpired that the beautiful carriage drive was the foundation of a new light railway which the Engineers were pushing forward at the rate of several miles a day. Although about a mile of the track was ruined this incident cheered the crew somewhat, and the tank continued its way rearwards.

Then followed a series of attacks by infantry and tanks in various parts of the Ypres salient. On each occasion wireless tanks were made full use of, and the experiment justified itself. The country in that part of Belgium was very boggy, and many tanks endeavoured to emulate the submarine, and so far as the diving part was concerned were very successful. But unlike the submarine, they were unable to come to the surface again. When this happened the crew were usually able to save themselves from being buried alive by escaping through the manhole on the top of the tank, bringing with them as



much of the wireless apparatus as they were able to remove in the short time at their disposal.

#### **Portable Stations**

It was realised at this stage that the wireless apparatus was useless when the tank itself was put out of action either by engine trouble or through coming into contact with a stray shell, and the apparatus, which was previously a fixture in the tank, was remounted in portable form, so that everything was contained in a cabinet which could be removed bodily from the tank when occasion demanded. Two 30-ft. steel masts and large quantities of spare aerial wire were carried for use when the apparatus was moved into a dug-out or other convenient shelter. Results were better under this system, which proved very convenient in later actions in the Menin district where German pill-boxes were plentiful. These heavily protected structures made excellent wireless stations, although no protection could be provided for the aerial.

#### **Aerials**

It will be remembered that the spark system was in use at that time, and anything less than an aerial 30 ft. high made working at a twenty-mile range impossible.

The aerials were very conspicuous and were always very near the front of the attack, and it was not surprising that the stations came in for a lot of heavy shelling. Although on no occasion did a shell succeed in piercing the pill-boxes, which were of German make, the aerials were frequently blown away, and it was a record if one could be kept intact for as long as ten minutes. The operator engaged in mending the double-wire aerial, which at first was of 7/22 enamelled copper had a very thin time. Sometimes the masts had to be put in splints improvised from barbed-wire stakes. On several occasions the masts disappeared entirely and new ones had to be made from the aforesaid barbed-wire stakes.

The wireless tanks were used in various minor actions during the summer of 1917, but the event of the year, as far as they were concerned, was the battle of Cambrai in November. This attack was something of a farce; it was such an easy proposition that it could have been ably carried out by Girl Guides. The operators of the four wireless tanks were able to wash and shave while our preliminary barrage was going on, and they then strolled over with the infantry as easily as walking down the Strand. Not a shot of any description came from the enemy lines until late in the afternoon, when the Germans succeeded in recapturing a part of Bourlon Wood.

The stations were erected in various small villages along the front, and several days passed during which a large volume of messages was successfully dealt with. Then suddenly things became lively. The

Germans had been able to pull themselves together, and with the addition of several fresh divisions managed to break through our lines in several places. One wireless tank continued to transmit when the Germans had entered their village, but when the time came to withdraw it was found that a fighting tank had broken down the bridge over the river, and this bridge was the only exit from the village. However, after several adventurous days the operators arrived at headquarters with their apparatus on a small farm cart.

#### **New Experiments**

This was the end of the wireless tank programme for the year, and the operators moved back for experiments with the new valve transmitters which were to be used on the tanks in the following spring. The wireless men were not idle during the winter; they were spread over different sectors of the front with their new apparatus, and replaced the ordinary trench telephones.

#### **The 1918 German Offensive**

When the Germans broke loose in March, 1918, the writer had a station in a hut at Bapaume; the hut also sheltered the canteen. As we were doing nothing more important than take down English, French, Italian and German press for the benefit of local officers' messes, things looked very good, especially as it was rumoured that we should probably be there for some time. In fact, the writer had written home for some nasturtium seed to plant round the hut, but the letter had barely reached England when the storm broke. March 21 dawned on a heavy bombardment by the Germans, and by the evening it was easily seen that the next day would have to see a strategic retirement on our side. We moved back a few miles each day until we came to a village just behind Albert, where our troops checked the advance, and then things became quieter. Our wireless stations did some good work, although there were no tanks to carry the apparatus—a few excited people having burnt the petrol dumps while the tanks were fighting within the German lines. When their supplies of fuel were exhausted they were unable to replenish, and so the tanks had to be abandoned, and some of them were used against us in the second battle of Cambrai in the following September.

#### **The Allied Offensive**

Things continued quiet until August, when our side commenced a vigorous offensive in various parts of the line; the wireless tanks for the most part were operating in the Amiens district, later moving up to the Cambrai sector, where an almost continuous advance was kept up for some weeks. The wireless tanks were continually in action and did their part without a hitch, moving forward every day as the advance pressed on and handling an enormous number of messages. It

is impossible to detail all the adventures of the wireless tanks in an article such as this, so the writer will pass on to the happenings just before the Armistice.

#### **The Last Action**

The last real action of the war, which was fought in the Landrecies sector about a fortnight before the Armistice, was perhaps the worst of the whole war for us of the wireless. We had information that the Germans were trying to arrange for a cessation of hostilities, and consequently each one wondered if, after coming through the whole of the war in safety, he was to be killed in the last action. Our fears were nearly justified, for just after the attack commenced, and a gas shell attack was in progress, a shell struck the tank and smashed right through the apparatus without exploding. Nobody was hurt, but the wireless was a pitiful sight; the accumulators were smashed and the acid scattered far and wide, the high-tension batteries were burst open, and the cells hung round the tank like strings of sausages. Our work for the day was done, and the only thing to do was to get back as soon as possible, as we had no guns on board.

#### **The Armistice**

The week preceding the Armistice was an interesting one. All day long the tank operators were intercepting messages passing between the Eiffel Tower and the German station at Spa, in connection with the proposed Armistice. Everything seemed to be going well and everyone was in the best of spirits and thinking of marching through London in the near future. The German delegates came through the lines in motor-cars and the front remained comparatively quiet. However, the negotiations hung fire, and it was arranged that unless the Germans signed by November 11 a flying column composed of cavalry, horse artillery, whippet tanks and armoured cars was to break through and chase the Germans out of France and Belgium. This force was gathered round about Avesnes, in the Landrecies sector, all ready for a quick move on the 11th. The writer had a wireless station mounted in a light car attached to the armoured car squadron which was to lead the attack. However, this advance did not take place as it was planned, because during the night of the 10th a message from the German wireless station was intercepted, authorising the German delegates to sign the terms of the Armistice. After a day or two the armoured cars moved forward, accompanied by the station in the light car, and continued to advance a few miles each day, taking over dumps of guns and ammunition, aeroplanes, motor-lorries, etc., which were left behind by the Germans with an officer in charge. Immediately after handing over the dumps the German would make a swift retreat.

(Concluded on page 428)



An Ordinary Type of Thermionic Valve or Triode and its Component Parts.

Right:  
Photograph of Valve with Bulb Removed showing Filament, Grid and Plate.



Left:  
Another Photograph showing the Valve with the Plate Removed.



Right:  
Photograph showing the Filament only Remaining.



THE introduction by Professor Fleming in 1904 of the original two-electrode valve as a simple rectifier or detector of wireless signals was the practical outcome of a series of investigations, dating back to 1880, into the molecular and electrical phenomena associated with incandescent bodies when enclosed in an evacuated envelope.

**The Incandescent Glow Lamp**

Attention was first directed to this field of inquiry by certain peculiarities noticed in the behaviour of the (then) recently invented electric incandescent filament or glow lamp, to which even at the present day the ordinary type of thermionic valve bears a close outward resemblance. It was a common occurrence in such lamps for a fault to develop in the carbon filament, generally caused by some chemical impurity or physical irregularity. This gave rise to local over-heating, the visible result of which was to cause the inside of the glass globe to become sooted up. A close scrutiny showed that the defective point in the filament formed the source or origin of a continuous bombardment of carbon particles, as was evidenced by the fact that the blackened globe disclosed a clear-cut shadow effect SS, as shown in Fig. 1. This was obviously due to the opposite leg or branch of the filament

shielding the adjacent part of the globe from the point of origin A of the emitted corpuscles or particles.

The full inference to be drawn from this observation is that under the given circumstances an incandescent body is capable of emitting a stream of material particles, the individual units of which traverse the evacuated space in a path of travel which is a straight line. It should be borne in mind that such incandescent lamp globes were highly evacuated, otherwise the contained air or other gases would have impeded the free motion of the projected corpuscles. As a matter of fact, a degree of vacuum corresponding to an internal pressure of not more than one-millionth of the normal atmospheric pressure is required in order that the free path of the molecules contained within the bulb should extend to a distance of 4 in. in any direction.

**The "Edison" Effect**

Further light upon the subject resulted from an investigation of the electrical effects concerned. Edison about the year 1882 discovered that when a metal plate P is sealed into such an evacuated globe, between the legs of the filament, and is, in turn, connected to one or other of the filament terminals by means of an external circuit containing a sensitive galvanometer

# ALL ABOUT VALVES

The first of a series of articles in this series and also the method of action of the valve in simple but extremely

G, as shown in Fig. 2, then certain remarkable differences are made apparent.

If the terminal of the enclosed plate P is joined or tapped to the leg of the filament nearest the positive pole of the heating battery, a distinct current of electricity is recorded by the galvanometer G. On the other hand, if the same plate electrode is tapped on to the leg of the filament nearest the negative pole of the battery, no current is registered by the galvanometer.

Further experiment showed the strength of the galvanometer current to be independent of the nature of the metal plate. It increases, however, directly and rapidly with the heating voltage applied across the glowing filament. On the other hand, the current decreases in strength the farther the plate is removed from the immediate locality of the filament, and it can be stopped entirely by interposing a shield between the negative leg of the filament and the metal plate. Finally, a similar screen applied between the positive leg of the filament and the metal plate has no appreciable effect upon the current.

**Deductions**

The irresistible deduction from these facts is that the negative leg of the glowing

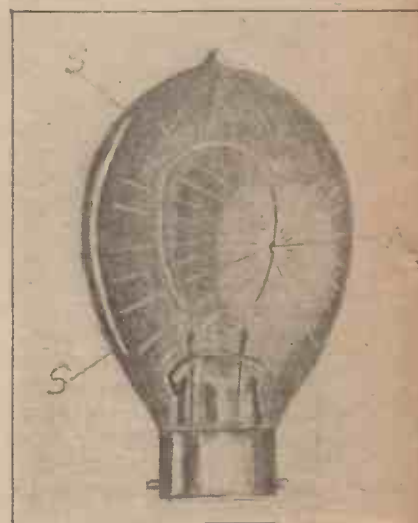

Fig. 1.—The Shadow Effect on a Lamp Bulb.

# OUT THE LVE

in which the underlying principles of the thermionic valve are explained in a complete fashion.

filament normally forms the seat or locus of an emission of negative charges of electricity which, like the material particles first mentioned, are capable of traversing the vacuous path between the filament and the interposed metallic plate.

In corroboration of these results Elster and Geitel, in a series of researches between the years 1880-89, had also demonstrated the fact that a white hot metallic wire or carbon filament, placed in close proximity to a metal plate, within an evacuated glass vessel, caused that metal plate to become charged up with an accumulation of negative electricity, the presence of which was disclosed by the application of a gold-leaf electroscope.

Having reached this point of experimental research, it will be necessary to make a slight diversion into previous knowledge concerning the facts associated with the passage of electricity through liquid conductors.

## A Faradic Law

Nearly a century ago Faraday enunciated and proved the electro-chemical law which has since borne his name. In this he states that whenever an electric current passes through a liquid solution the pas-

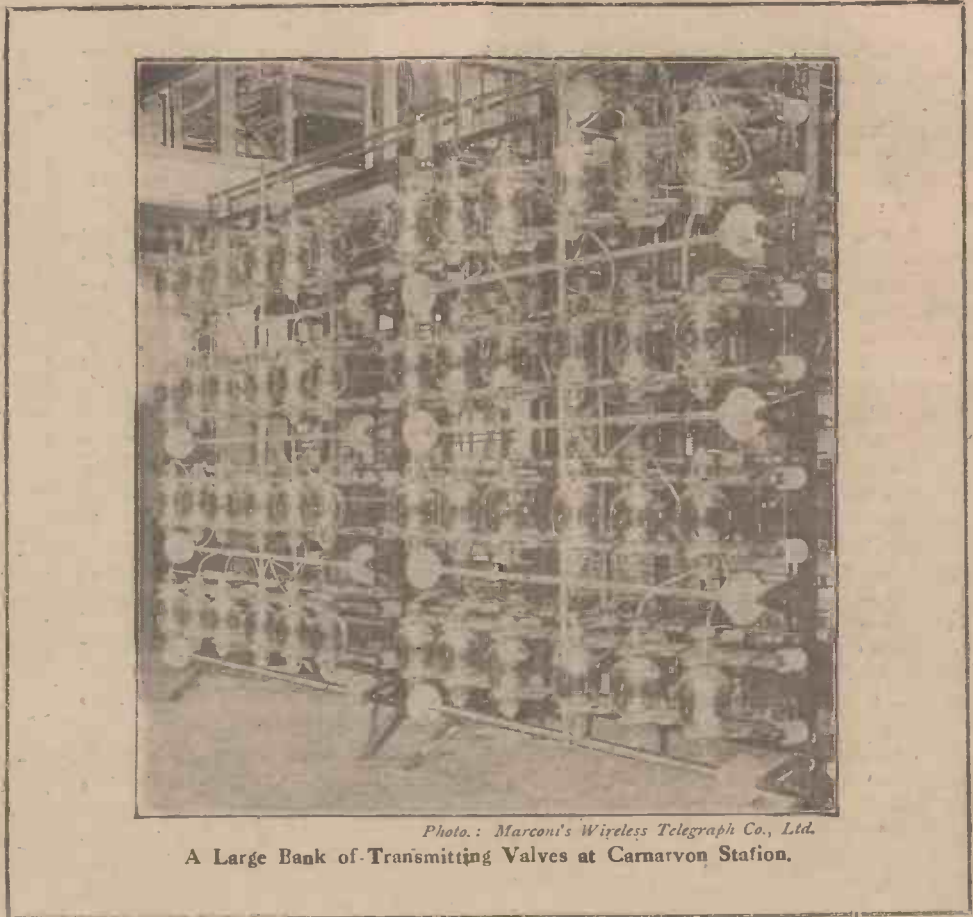

Photo: Marconi's Wireless Telegraph Co., Ltd.

A Large Bank of Transmitting Valves at Carnarvon Station.

sage of a given quantity of electricity invariably results in the deposition or liberation at the electrodes of a definite mass of the electrolyte employed. For example, 96,550 coulombs of electricity will always deposit 108 grammes of silver, or 31.5 grammes of copper, or 28 grammes of ferrous iron, or 1 gramme of hydrogen from solution, the different figures in each case being proportional to the respective atomic weights or valencies of the elements concerned.

Briefly stated, this implies that a definite electric charge is always associated with each individual ion or carrier mass in the electrolytic solution.

Some seventy-five years later, by a series of ingenious experiments and mathematical calculations, Sir J. J. Thomson demonstrated the fact that negative electricity, in its passage by conduction across a gaseous space, is likewise invariably associated with a definite mass or carrier of matter of some kind or other. By utilising cathodes made of different materials placed in high-vacuum tubes containing residual gases of various kinds he showed, in the first place, that in strict analogy with what occurs in the case of liquid solutions the proportion of the electric charge to the atomic weight or mass of the carrier is always constant.

In the second place, however, he found

that the fixed ratio ascertained for the cathode ray was nearly 2,000 times greater than the corresponding value for the hydrogen atom in the case of electrolysis.

This discrepancy at once raises the question as to whether the electric charge is 2,000 times greater, or the carrier mass 2,000 times smaller, in the case of the cathode particle as compared with the electrolytic hydrogen ion.

## Thomson's Vapour-cloud Experiment

By means of the now famous vapour-cloud experiment Thomson next succeeded in showing conclusively that the negative charge was precisely the same in both the liquid and gaseous results. From this it would appear in the first place that the uniform electric charge so identified most probably represents the ultimate unit of electricity, just as an atom in chemical science represents the ultimate particle capable of possessing the characteristic features of any given chemical element.

In the second place, it is obviously clear that the actual mass of the cathode-ray particle must be some 2,000 times smaller than the mass of the hydrogen atom, which previously had held the record in this respect.

## The Electron

The new unit is called the electron. In

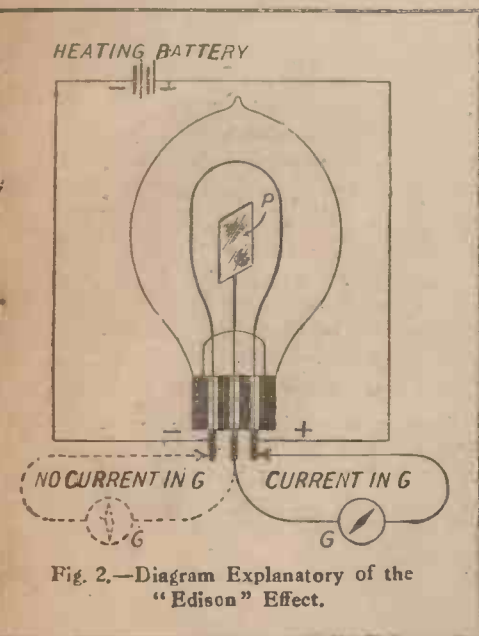

Fig. 2.—Diagram Explanatory of the "Edison" Effect.

absolute size it is approximately one ten-billionth of a centimetre in radius. It constitutes the smallest subdivision of matter known, and it is invariably associated with a fixed charge of negative electricity.

It may perhaps be of interest to mention that there is at present a considerable body of scientific opinion which inclines to the belief that the electron has in fact no real or substantial mass apart from that due to its own magnetic field, and that it therefore constitutes in itself the ultimate basis or foundation of all matter.

A less metaphysical and more generally accepted view is that the chemical atom, as heretofore recognised, constitutes a species of solar system, of which the central bond or sun is formed by one or more relatively massive positive ions.

To sum up, modern theory regards electricity as atomic in structure, the fundamental and indivisible unit being an electron. Such electrons are more or less closely associated with the atoms of molecules of all matter. The particle of matter itself is considered to be negatively or positively charged with electricity according as there is an excess, or deficit in its normal quota of electrons.

In the case of those substances usually termed conductors, a certain number of the electrons grouped about each atomic nucleus are very loosely held or bound to it, and can therefore be readily detached either by the application of an electro-motive force or by the effect of so-called chemical attraction existing between various elements. A current of electricity is the outward sign of a flow of electrons passing in succession between the adjacent atoms of a conductor. The practical unit of one ampere represents the continual passage of six million billion (6 followed by eighteen noughts) of electrons in each second across any section of the circuit.

D. ALCASE.

(To be continued)

## The P.M.G. and Licences

WE understand that the secretary to the Postmaster-General has written in the following terms to the Wireless Society of London: "Wireless receiving licences will in future be of two main classes, namely (1) for the reception of broadcast matter only and (2) for the reception of wireless signals for bona-fide experiments by persons qualified to conduct such experiments. As regards the first class, I am bound to say that the arrangements for broadcasting by wireless are not yet complete, and definite information as regards the precise conditions on which the relative receiving licences will be granted is not yet available. A reply given by the Postmaster-General in the House of Commons on the 27th of July gives some information on the subject; and it will be seen that, as

at present proposed, the apparatus to be used under the broadcast receiving licences will be limited to types submitted by members of the broadcasting company or companies and approved by the Post Office. The technical standards imposed as a condition of such approval will probably be as follows: (1) Any valve shall not be capable of oscillating in such a way as to energise the aerial; (2) As emissions from the broadcasting stations will be limited to the band of wave-lengths between 300 and 500 metres, the range of wave-lengths for receiving will also be restricted, and the apparatus must be so constructed that any extension of the range of reception will be a matter of some difficulty. Further particulars will be announced in due course."

## Radiograms

DR. C. F. JENKINS, a Washington inventor, is at work upon the transmission of moving pictures by wireless, or, in other words, television.

A wireless penny-in-the-slot machine has been invented in America. The invention consists of an automatic apparatus surmounted by a revolving loop aerial, and takes its power from a lighting circuit supply. When the coin is inserted in the slot two valves are switched on, and the music is heard through a large horn at the bottom of the instrument.

A racehorse in America has been equipped with a receiver and trained to race by commands from the trainer.

Complaints about the lack of telephony to be heard by amateurs in Scotland have led some of the leading firms in Glasgow to arrange for the establishment of small transmitting sets in their premises. Public demonstrations of speech and music are now being given.

The United States is divided into eight wireless districts with a wireless inspector under the Department of Commerce in charge of each district. Inspectors have offices in Boston, New York, Baltimore, Savannah, New Orleans, Detroit, Chicago and San Francisco.

Experiments to determine the feasibility of reception of wireless signals by the sense of taste have recently been carried out. Silver electrodes were used, one of which made contact with the inner part of the upper lip of the operator and the other with the tip of his tongue. Using four-stage amplification, it was found possible to detect signals and to tune in a station by noting when the intensity of the taste

sensation was a maximum. For messages to be read the speed must not be greater than ten words a minute.

The Department of Commerce of the United States has licensed about 20,300 wireless stations, and of this number 3,575 are ship and commercial land stations, 11 trans-ocean, 560 special land stations, such as colleges and experimental stations, 451 broadcasting stations, and 15,780 amateur stations.

The Government of New Zealand are considering whether to establish a wireless station relying upon the Imperial Wireless Chain or a station giving direct communication with Great Britain, the European Continent, and America. Negotiations with the British authorities are proceeding.

Every postal telegraph and cable company office in the United States will now accept messages for transmission to Great Britain by the Transatlantic wireless circuit conducted by the Radio Corporation of America and Marconi's Wireless Telegraph Company, Ltd.

In a letter to the *Times*, a correspondent suggests the substitution of "aerophone" and "aerograph" for "wireless telephone" and "wireless telegraph" respectively. What has the subject to do with air?

The wireless station on the Rundemanden, a mountain towering 2,500 feet above the city of Bergen, Norway, is being modernised and equipped with more powerful apparatus. As the new equipment has a radius of 3,000 kilometres, it is believed that direct communication with American stations will be possible. Wireless telephones with a 600 mile radius are also to be installed and connections with England and Continental Europe established.

Included in the Royal Air Force draft for Mesopotamia were 500 officers and men trained to operate the new armoured cars which are all equipped with wireless.

At the last meeting of the Newcastle Amateur Wireless Association it was decided to draw up a petition requesting the Postmaster-General to grant a broadcasting licence to the association.

Suggestions are made in the non-technical Press that by means of piezo-electric crystals London could be lighted by means of its noise. Piezo-electricity is the property possessed by certain crystals whereby they generate electricity when subjected to vibration.

Senatore Marconi paid a visit to the Wireless Exhibition last week.

A wireless exhibition is to be held in Manchester next April.

■ ■ ■ ■ ■

The Radio Company at Twyford Abbey Works are experimenting with the wireless transmissions of photographs, and although the invention is as yet only in the experimental stage remarkable results are said to have been obtained.

■ ■ ■ ■ ■

A new and powerful wireless telegraphy station will shortly be opened at Scheveningen for the sending of messages throughout the Continent.

■ ■ ■ ■ ■

During the whole of 1921 some 45,000 messages were dealt with on steamers of the White Star Line, but that figure will be almost doubled by this year's total. In the first six months alone nearly 40,000 have been handled. On one trip of the Olympic 1,572 separate messages, representing over 42,000 words, were sent and received.

■ ■ ■ ■ ■

Professor Michelsen (who performed the experiment which suggested the theory of relativity to Einstein) has just announced that he will shortly give the world decisive proof that curved space and bent light rays have no existence.

■ ■ ■ ■ ■

A wireless alarm clock has been constructed based on the principles of the calling-up apparatus described in a recent issue—that is, the clock responds to a call

consisting of a special series of signals, the correct combination operating a relay which closes a circuit and rings the alarm.

■ ■ ■ ■ ■

Glasgow Corporation is giving serious consideration to the question of broadcasting and its possibilities from a municipal point of view. It is proposed that a special sub-committee should be formed to investigate the matter thoroughly.

■ ■ ■ ■ ■

A motion is to be brought forward at the next meeting of the Glasgow Parish Council, that receiving installations should be set up in the various institutions—hospitals, poorhouses, and asylums—under the council's jurisdiction. It is urged that the reception of musical programmes would be a great boon to the unfortunate inmates.

■ ■ ■ ■ ■

A London motor-bus, which is being run by three ex-service men, was temporarily fitted out with a receiving set on Sunday last for the entertainment of wounded men. A four-valve amplifier with loud-speaker was used, the aerial being fitted on the top deck.

## CORRESPONDENCE

### Crystal Reception

SIR,—I read with interest the article on crystal reception and also letter relating to same in your issue of Aug. 26, and

think the following results obtained with a crystal receiver may be of interest to your readers. I have made up an inductively-coupled crystal set as described in "Wireless Telegraphy and Telephony," the only difference being the omission of the variable condenser and potentiometer, the latter being unnecessary, as I am using a "Hertzite" crystal with silicon bronze wire. I am getting quite good results with this set, coast and ship stations coming in quite clear and loud; but the best result I have obtained so far is the Writtle concert on Tuesday evenings. As Writtle is about 70 miles away, I think this is a wonderful result for a crystal receiver. Of course, it is very faint, but I distinctly heard "Hallo CQ! Hallo CQ! Hallo CQ! 2 Emma Toc speaking"; and later I heard several musical items. Since then I have added a two-valve note-amplifier, and now the reception of the concert is quite O.K., except when atmospheric intervene. My aerial is 100 ft. single wire attached to a flag-pole on the roof of the house, the highest point being 52 ft. from the ground, the lower end being fixed to a tree about 15 ft. up. It faces open country to the south, but is somewhat screened by trees. The lead-in wire is taken from the centre of the aerial. I may say I have also heard "2MT" on a single coil inductance, but not so good as the inductively coupled set.

I should be interested to know if any of your readers have heard Writtle a greater distance than this on a crystal receiver.—K. C. (Northampton).

# The Famous "WORK" Handbooks

Each 160 Pages. 1/6 net each; 1/8 post free.

Basket Making. With 151 Illustrations.  
 Beehives and Beekeepers' Appliances. With 155 Illustrations.  
 Bent Iron Work. Including ELEMENTARY ART METAL WORK. With 269 Illustrations.  
 Bookbinding. With 125 Illustrations.  
 Boot Making and Mending. Including REPAIRING, LASTING, and FINISHING. With 179 Illustrations.  
 Building Model Boats. With 168 Illustrations.  
 Camera making. With 245 Illustrations.  
 Clay Modelling and Plaster Casting. With 153 Illustrations.  
 Clock Cleaning and Repairing. With 97 Illustrations.  
 Conjuring Apparatus. With 167 Illustrations.  
 Cycle Repairing and Adjusting. With 79 Illustrations.  
 Domestic Jobbing. With 157 Illustrations.  
 Dynamo and Electric-motor Building. With 145 Illustrations.  
 Dynamo and Motor Erection and Management. With 94 Illustrations.  
 Dynamos, Small. MAKING SMALL DYNAMOS AND MOTORS. With 132 Illustrations.  
 Electric Accumulators. With 57 Illustrations.  
 Electric Apparatus, Small. With 134 Illustrations.  
 Electric Bells and Telephones. With 144 Illustrations.  
 Electric Clocks. PRINCIPLES, CONSTRUCTION AND WORKING. With 213 Illustrations.  
 Electric Lighting. With 65 Illustrations.

Electric Primary Batteries. With 91 Illustrations.  
 Electro-plating. With 77 Illustrations.  
 Fishing Rods and Tackle. With 199 Illustrations.  
 Furniture Repairing. With 178 Illustrations.  
 Gilding, Silvering and Bronzing. With 27 Illustrations.  
 Glass Writing, Embossing and Fascia Work. With 129 Illustrations.  
 Gramophones and Phonographs. With 103 Illustrations.  
 Household Repairs. With many Illustrations.  
 House Painting and Decorating. With 74 Illustrations.  
 Incubators and Chicken Rearers. With 124 Illustrations.  
 Induction Coils. With 62 Illustrations.  
 Knotting and Splicing Ropes and Cordage. With 208 Illustrations.  
 Lathes, Small. With 214 Illustrations.  
 Magneto Repair and Adjustment. With 104 Illustrations.  
 Miniature Electric Light. With 141 Illustrations.  
 Model Aeroplanes. With 190 Illustrations.  
 Motor Cycles and Side-Cars. With 70 Illustrations.  
 Mounting and Framing Pictures. With 240 Illustrations.  
 Oxy-acetylene Welding. With 43 Illustrations.  
 Patents, Designs and Trade Marks.  
 Photography Simplified. With Frontispiece and 63 Illustrations.

Pianos: Their Construction, Tuning, and Repair. With 74 Illustrations.  
 Poultry Houses and Appliances. With 226 Illustrations.  
 Pumps and Hydraulic Rams. With 171 Illustrations.  
 Rustic Carpentry. With 194 Illustrations.  
 Sewing Machines: Their Construction, Adjustment, and Repair. With 177 Illustrations.  
 Soldering, Brazing and Welding. With 78 Illustrations.  
 Tailoring: How to Make and Mend Trousers, Vests, and Coats. With 184 Illustrations.  
 Taxidermy: Skinning, Mounting and Stuffing Birds, Mammals, and Fish. With 108 Illustrations.  
 The Handyman's 1,000 Practical Receipts.  
 Ticket-writing and Sign-painting. With 154 Illustrations.  
 Tinplate Work. With 280 Illustrations.  
 Toy Making. With 237 Illustrations.  
 Watch Cleaning and Repairing. With 73 Illustrations.  
 Wireless Telegraphy and Telephony. With 100 Illustrations.  
 Wood Finishing. Comprising STAINING, VARNISHING, and POLISHING. With 12 Illustrations.  
 Workshop Appliances, Small. BUILDING MACHINES AND APPLIANCES USED IN WOODWORKING AND METALWORKING. With 232 Illustrations.  
 Workshop Arithmetic.  
 Workshop Hints for Metal Workers. With numerous Illustrations.

### Insulated Aerials

SIR,—I was rather interested in the remarks of a contributor to AMATEUR WIRELESS in a recent issue under the title of "A Practical Experiment," in which he states that insulation on a receiving aerial is detrimental to reception. This does not agree with my own experience, using a patented aerial which appears to be entirely insulated from start to finish, except where connected to my instrument. This somewhat unorthodox aerial does, however, certainly give excellent results, and the worst weather does not appear to affect its service in the least.

Also the peculiar method of construction enables one to ignore the usual precautions when fixing the aerial, and greatly simplifies this otherwise rather formidable problem.

In view of these facts it is difficult to appreciate the conclusions of the gentleman to whose remarks I refer, and the surprising thing to my mind is that more use is not made of this undoubtedly effective type of aerial, especially with such a damp climate as ours to contend with.—D. E. B. (Ilford).

## ANNOUNCEMENTS

"Amateur Wireless and Electric." Edited by Bernard E. Jones. Price Threepence. Published on Thursdays and bearing the date of Saturday immediately following. It will be sent post free to any part of the world—3 months, 4s. 6d.; 6 months, 8s. 9d.; 12 months, 17s. 6d. Postal Orders, Post Office Orders, or Cheques should be made payable to the Proprietors, Cassell & Co. Ltd.

General Correspondence is to be brief and written on one side of the paper only. All sketches and drawings to be on separate sheets.

Contributions are always welcome, will be promptly considered, and if used will be paid for.

Communications should be addressed, according to their nature, to The Editor, The Advertisement Manager or The Publisher, "Amateur Wireless," La Belle Sauvage, London, E.C.4.

### Ask "A.W." for list of Technical Books

## The Wireless Society of London

DURING the course of the next few weeks it is proposed to form a separate section of the society which will specially cater for the needs of the broadcaster. It is proposed to hold meetings and conduct special lectures so that the man who knows practically nothing about wireless can acquire sufficient knowledge so that later on he will be in a position to qualify for an experimenter's licence.

The Wireless Society of London contemplate in the near future carrying out tests between this country and America on amateur wave-lengths. The committee are making application to the Post Office, and are endeavouring to obtain a temporary licence, say on 1,250 watts, for this purpose. It is suggested that the wave-lengths should be 440 metres, and the transmissions will, of course, take place at times specified by the Post Office. The call letters and more details of the scheme will be given later.

## Around the Showrooms

AN ingenious earthing clip for the easy attachment of the earth wire to pipes, etc., has been put on the market by Leopard Bros., Nettleton Road, London, S.E.14. The clip consists of a band provided with a series of holes, and is so constructed that no soldering is necessary either for the attachment of the earth wire or for attaching the clip to the pipe. It is made in two sizes which provide a range for all pipes up to 2 in. diameter.

The "Whisperphone" is a small super-sensitive microphone which may be used as a detectaphone or as a microphone-

relay in wireless. In this latter capacity it is clamped upon one of the ear-pieces and is placed in series with an ordinary telephone receiver provided with an amplifying horn, a battery and a regulating existence. The makers are Adolph Taylor & Co., 12, Leverington Street, London, E.C.1.

That accumulators do not deteriorate quite so easily as many people suppose is proved by an experience of the Chloride Electrical Storage Co. with one of their famous "Exide" batteries. The company state that in June, 1911, a small 2-volt 10-ampere-hour accumulator in a celluloid case was returned by a customer to their London office. This accumulator remained undisturbed on a shelf until September, 1912, when it was found in good condition but almost without acid. It was refilled and recharged and has been standing on open circuit ever since, receiving a freshening charge about once a year. In February, 1919, it gave 10 ampere-hours at ½-ampere discharge rate; in February, 1920, it gave 17-ampere hours at 1-ampere discharge rate; and in 1922 it gave 19 ampere-hours, so that after remaining for eleven years on open circuit, with an annual recharge, it now gives 90 per cent more than its listed capacity.

Semaphore, Ltd., 28, John Street, London, W.C.1, are making up special 3-cell batteries for high-tension battery construction. These are of the same dimensions as the ordinary pocket lamp cells, but are of special construction, great attention having been paid to insulation.

For wireless there is a necessity for a type of accumulator that will provide a very steady current, and C. A. Vandervell & Co., Ltd., inform us that for some time  
(Continued on page 428)

## OUR INFORMATION BUREAU

Expert Replies to Readers' Questions. Hundreds of Replies are sent by Post.

TO ENSURE A PROMPT REPLY PLEASE OBSERVE THE FOLLOWING RULES

Write distinctly, give all necessary details and keep to the point. Ask one Question at a time—never more than two. Send a Stamped and Addressed Envelope. Send the Coupon cut from page 430.

### A New Use for Blocking Condensers

Q.—Please state the advantages and disadvantages of the following. Instead of using a '001 m.f. variable condenser, would it not be just as good to use a variable condenser of '00025 m.f. with four blocking condensers of '0002 m.f.d. in parallel operated by switches?—J. A. P. (2993)

A.—The idea you have conceived is quite good and the arrangement will function well in place of a larger and more costly variable condenser. However, it is not necessary to employ four condensers of '0002 m.f. A series as given below will be in order and give greater results. If you employ a

'00025 m.f. variable condenser, connect your blocking condenser in the following series: '00025 m.f., '0005 m.f., '001 m.f., '002 m.f., '004 m.f. This series of condensers should only be employed in a parallel circuit, that is to say, where the variable condenser is connected direct across the tuning coil as in the case of a secondary coil. If a coil of 100 mics is used, without a variable condenser, this coil would give a natural wave length of 630 metres approximately. Now a variable condenser of '0005 m.f. is joined across the coil, thereby reducing the wave length maximum to 315 metres. If a '001 m.f. variable condenser is employed the wave length remains

at 630 metres. By having a series of small condensers operated by switches to exceed '001 m.f. the wave length may be increased above the natural wave length of the coil simply and speedily without the use of large coils which are cumbersome and take a good time to make. Instructions for building these condensers are as follows:—

|             |                                |     |     |
|-------------|--------------------------------|-----|-----|
| '00025 m.f. | 2 pieces of tin or copper foil | 2½" | 2½" |
| '0005 m.f.  | 2 "                            | 2"  | 2"  |
| '001 m.f.   | 4 "                            | 2"  | 1½" |
| '002 m.f.   | 6 "                            | 2"  | 1½" |
| '004 m.f.   | 10 "                           | 2"  | 2"  |

The dielectric for the above should be mica with a thickness of 1-100 in.—L. C.



*We share our Bargains with our Customers*

We are supplying

# BROWN RADIO HEADPHONES

("A" Type, Reed Pattern, Aluminium Diaphragms) at much below makers' prices

120 ohms, **42/6**, cords 2/9 extra, makers' price 58/-. Reg. Post 1/-  
 8,000 ohms, **49/6**, " " 66/-, ditto  
 SULLIVAN 8,000 ohms, **36/6**, " " ditto

*Guaranteed Brand New Condition and exactly as delivered direct from the makers.*

Every order despatched within 4 hours of receipt.

## A GILT-EDGED GUARANTEE WITH EVERY RADIO HEADPHONE

**IMPORTANT.**—In order to settle, once and for all, the prolonged controversy at present being carried on by certain firms through the medium of a section of the Wireless Press, we now make the following addition to our original guarantee, which entirely disposes of the arguments put forth by our competitors.

**IF ANY BROWN OR SULLIVAN 'PHONE PURCHASED FROM US, WHEN TESTED AGAINST SIMILAR 'PHONES OF SAME MAKE MANUFACTURED DURING THE LAST YEAR, DO NOT SHOW A MARKED SUPERIORITY IN EFFICIENCY,**

**WE WILL RETURN THE FULL AMOUNT PAID.**

Every pair of our 'phones were originally made to the order of His Majesty's Government, and bears the examiner's mark that they have passed the strictest test. This mark alone is sufficient guarantee that the 'phones are the best that money can buy.

*The following Testimonial is typical of many:*

"... I am perfectly satisfied with them and think myself lucky to have got them at the price. I have compared them to-night with two other sets, also of Brown's make, and can say without hesitation that mine gave the best results."

(Mr.) G. WRAY, 19b, Ghurch Gate, Loughborough.

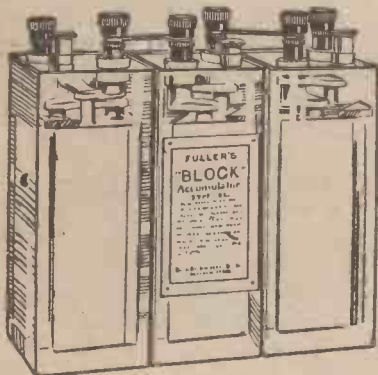

### FULLER "BLOCK" ACCUMULATORS

are the only practical proposition for wireless use. They will hold their charge from 12 to 18 months, and are FOOL PROOF.

All capacities up to 220 amp.-hours in stock.

Do not risk failure and disappointment by using the plate type battery with your wireless set.

Send at once for our pamphlet. Our prices are much below those of the makers.

### The "PARLIPHONE"

LOUD SPEAKER (Prov. Patent No. 21967)

Instantaneous success of our effort to provide a reliable loud speaker at a fair price.

SOLID EBONITE. NO METAL. ENSURING PERFECT CLARITY AND ABSOLUTELY NO DISTORTION, 25 inches high, 6½ inch base.

The Interior is screwed and made to receive a Brown's Patent Standard Receiver. Order early if prompt delivery is required.

**32/6**

Carr. 1/3 extra



Marconi "R" Valves, 17/6 each. Mullard "Ora" Valves, 15/- each. "Dewar" Switches, 5/- each. Valve Holders, best quality, 1/9. Variable Condensers, .0005 mfd., 18/6; .001, 24/6. Murdoch's Filament Resistances, 6/9. Dubilier Condensers, 2/6 and 3/- each. Mullard Grid Leaks, 5/- each.

**WE STOCK ONLY THE FINEST QUALITY OF ACCESSORIES. INFERIOR QUALITY ONLY LEADS TO DISAPPOINTMENT.**

Our Technical Experts always in attendance to give FREE ADVICE to Amateurs

# THE CITY ACCUMULATOR CO.

79, Mark Lane, London, E.C.3.

Phone: AVENUE 91

Agents: LONDON: A. W. GAMAGE, LTD., Holborn, R.C. SELFRIDGE & Co., LTD., Oxford Street, W. RICHFORD & Co., 153, Fleet St., E.C.4.  
 YORKS: BARNSLEY BRITISH CO-OPERATIVE SOCIETY, LTD., Barnsley.  
 GLOS: BRISTOL WIRELESS Co., 52, Cotham Hill, Bristol.  
 S. WALES: SOUTH WALES WIRELESS INSTALLATION Co., LTD., 18, West Bute Street, Cardiff.  
 N. WALES, LANCs. CHEs. & L.O.M.: THE "ALL-BRITISH" WIRELESS MANUFACTURES Co., LTD., 70, Central Bldgs., 41, N. John Street, Liverpool.

**OUR NEW SHOWROOMS—THE LARGEST AND MOST UP-TO-DATE IN THE CITY OF LONDON—ARE NOW OPEN, AND THE PUBLIC ARE CORDIALLY INVITED.**

AROUND THE SHOWROOMS (continued from page 426)

they have been giving this matter their close attention. As a result of their experiments they have placed upon the market an accumulator in which threaded rubber insulation has been adopted, one great claim for this construction being that there is the minimum internal activity while idle. The makers are C. A. Vandervell & Co., Ltd., Acton, London, W.3.

CATALOGUES

A USEFUL catalogue of crystal and valve receivers and component parts and sundries has been received from Radio Instru-

FORTHCOMING EVENTS  
TELEPHONY TRANSMISSIONS

Eiffel Tower (F L), 2,600 metres. Each afternoon (Saturdays excepted).

The Hague, Holland (P C G G), 1,085 metres, B.S.T. Oct. 12, 15, 19, 8-9 p.m.

Marconi House (2 L O), 360 metres. Oct. 12, 8-9 p.m. (in aid of the Warehousemen's, Clerks' and Drapers' Schools); Oct. 18, 5-5.30 p.m., 6-6.30 p.m. (in aid of the Gravesend Disabled Soldiers' and Sailors' Fund).

Writtle (2 M T), 400 metres. Oct. 17, 8 p.m.

ments, Ltd., 12, Hyde Street, London, W.1.

A catalogue received from Radio Teleola, 106, Great Portland Street, London, W.1, shows a very comprehensive range of cabinet apparatus.

A catalogue of special interest to the amateur constructor has been received from P. H. Boys & Co., 187, Goswell Road, London, E.C.1. The firm also supply complete valve and crystal receiving sets.

THE WIRELESS TANKS IN FRANCE (continued from page 421).

The Return

Each night, after days spent in passing under triumphal arches erected by every village in anticipation of our coming, the wireless station got into communication with its directing station at the rear and dispatched full particulars of the day's doings. Two hundred miles from the directing station proved to be the limit of the transmitter, and as the cavalry had by this time commenced to operate their powerful spark transmitters in our neighbourhood and on the same wave-length, our station returned from the borders of Germany to headquarters in France.

Nothing remained to do now but to return all apparatus and hope for demobilisation. It is true to say that there was no more interesting post in the army than that of TANK WIRELESS OPERATOR.

CLUB DOINGS

Beckenham and District Radio Society

Hon. Sec.—MR. BUTTERFIELD, 10, The Close, Elmers End, Beckenham.

ON Thursday, September 14, the second general meeting of the Beckenham and District Radio Society was held for the purpose of confirming proposed rules. Every encouragement is given to novice members, the general programme being that each week a certain part of a crystal set is thoroughly explained with a view to instructing those anxious to make their own sets. Up to the present, the progress of the society has surprised its founders. One junior member won the first prize in Selfridge's home-made set competition. He constructed a first-class crystal set, on which Writtle can be heard. Enquiries will be welcomed by the hon. secretary, and prospective members are asked to attend the weekly meetings held at the Dorothy Tea Rooms, High Street, Beckenham, each Thursday at 8.15 p.m.

Plymouth Wireless and Scientific Society

Hon. Sec.—G. H. LOCK, 9, Ryder Road, Stoke, Devonport.

THE second annual general meeting of the society was held on September 15. The reports of the secretary and treasurer, showing the society to be in a satisfactory and flourishing condition, were adopted unanimously. Election of officers for the coming year then took place. An extraordinary general meeting was held on September 26 to consider a complete revision of the rules.

(Continued on page 430)

WIRELESS SERVICE STATION

ALL ORDERS ARE S.O.S. TO US AND WE TRANSMIT IMMEDIATELY

- MARCONIPHONES ... £5 15, £9 10, £25, Etc.
- METROPOLITAN VICKERS SETS £4 10, £23 10, Etc.
- BRITISH THOMSON-HOUSTON SETS £7 7, £14, Etc.
- Q.E.C.O. PHONE SETS £5 10, £9 15, £25, Etc.
- STERLING SETS ... £7 12 6, Etc.
- Brown Loud Speakers ... 110/-
- Magnavox Loud Speaker, "Junior" type ... 210/-
- Magnavox Loud Speaker, "Senior" type ... £20
- 2-Valve Power Amplifier complete with valves, but less batteries (for Magnavox) ... £22 10
- 3-Valve Power Amplifier complete with valves, but less batteries (for Magnavox) ... £35
- Ebonite Sheets, various thicknesses (cut to any size), 4/6 per lb.
- Switch Arms, complete, 2/6.
- Fixed Condensers, 1/8 each.
- Condenser Vanes, 9d. per doz.
- Condensers Spacer Washers, large, 5d. per doz.; small, 3d. per doz.

- Aerial, Earth and Phone Labels, each, 3d.
- Aerial Wire, 100 ft. 7/22, with 2 insulators, each set, 4/6. [2/6]
- Aerial Silicon Bronze Wire, 18 gauge, per 100 ft.
- Wireless Masts, in 4 sections, totalling 11 ft., 4/9.
- Ebonite Valve Holders, 4 legs, with nuts and washers, 1/-.
- Ebonite Valve Holders, complete, best quality, 1/9.
- Ebonite Slider and Plunger, 8d.



- Insulators, porcelain, small egg shape, 3d.
- Insulators, porcelain, 2-in. reel, 2d.
- Insulators, large shell type, 8d.
- Ivory Scales, 6d.
- Crystal Cups (small and large), each 2d. and 6d.
- Crystal Detectors, 3s., 4s. 6d.
- Lightning Arresters, 2/-.
- High-Frequency Transformer Former (8 divisions), 4/6.
- Leading-in Tube, 6 in. long, 2/-.
- Copper Foli, 4 M. 002, per lb., 2/8.
- 2-Coil Holder, with extended arm, complete for panel mounting, 12/9.
- 3-Coil Holder, with extended arm, complete for panel mounting, 17/6.



- Condensers (Dubilier), 0.001, 0.002 and 0.003, 3/- each.
- Ditto ditto fitted with grid leaks, 7/6 each.

- Terminals, complete, small and medium, per doz. ... 1/6
- Terminals, complete, large, per doz. 2/0
- Square Brass Centre Rods for condenser 6d.
- 2 BA Brass Screwed Rods, 12 in. lengths 5d.
- Brass Nuts, 2BA, 4BA and 5BA, per doz. 4d.
- Tuning Bar, square, Brass rods in 13 in. lengths ... 5d.
- Filament Resistances 4/ and 7/6 each.

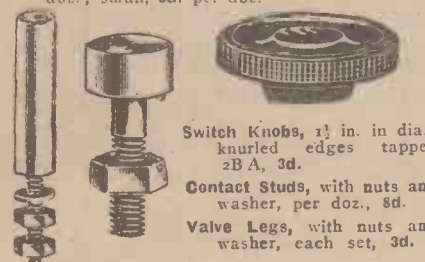

- Switch Knobs, 1 1/2 in. in dia., knurled edges tapped 2BA, 3d.
- Contact Studs, with nuts and washer, per doz., 8d.
- Valve Legs, with nuts and washer, each set, 3d.

CASH REFUNDED IF NOT SATISFIED

GREAT REDUCTION IN PRICE OF "PALMERPHONES" FROM 29/6 TO 25/-

GEORGE PALMER (OPPOSITE STAGE DOOR SHAFTESBURY THEATRE), 49, Gerrard Street, London, W.1.

WHOLESALE TRADE SUPPLIED



**Hundreds are Listening In on our Instruments and further—they Get Splendid Reception**

**WHY?**

**BECAUSE THE MANUFACTURE IS ON THE RIGHT LINES**

Place your order with us and FOR THE NEXT FOURTEEN DAYS we will supply an

**Extra Pair of Best Type H.R. Headphones (4,000 ohms)**

With every order received for an "AEROWAVE" CRYSTAL RECEIVER or a "RELIANCE" TWO-VALVE SET.

*Read the following Report on our Two-Valve Set recently received from one of our clients living in BRIGG, Lincolnshire:—*

"Last Sunday I wired up my set as a single-valve panel, and I am sure you will be interested to hear that using only one valve I got The Hague Concert very well indeed, without a single 'jam.' This, you will agree, speaks well for the goods. Of course, tuning was very fine."

*YOU can get the same results with one of our Sets.*



**SPECIFICATION**

- 1 Polished Mahogany Cabinet
- 1 10 in. by 8 in. Ebonite Panel complete with all Terminals
- 2 Filament Resistances giving separate control to each Valve.
- 1 Grid Leak and Condenser of improved design.
- 1 Fixed Phone Condenser.
- 3 Sockets (2 for Valves, 1 for H. F. Transformer).
- 1 H. F. Transformer.
- 1 Set Headphones, Best Type, High Resistance (4,000 ohms).
- 1 Accumulator (Hart), 4 vt., 40 amp. hrs.
- 1 H. T. Battery 36 vt.
- 1 Double-slide Tuning Inductance.
- 1 Variable Condenser, 005, Special Close Spacing.
- 1 Aerial Equipment, complete with Wiring-up Wire and Blue print.

**PRICE £12 10 0**

Above may be supplied with either a Loose Coupler or a set of 5 Coils and Two-way Coil Holder in place of 1 Double-slide Tuning Inductance at an extra cost of £1.

**READ THESE TESTIMONIALS**

- Norbury, S.W. "I heard Writtle and Marconi House, and Croydon very loud (Aerowave Crystal Set)."
- Nelson, Lancs. "Received Reliance 2-valve Set. Am very pleased with same."
- Huddersfield. "As regards quality of goods I am highly pleased. I shall not fail to urge my friends to obtain sets from you."

**A phenomenal record which speaks for itself**

At the recent International Wireless Exhibition every one of the "Aerowave" Crystal Sets exhibited on our stand received the Marconi Concert without Aerial or Earth Connection.

The instrument was simply held in the hands, the phones adjusted to the head, and those who were fortunate enough to get near the stand enjoyed the concert.

The names of many of the listeners were obtained and we have the actual signed papers in our possession.

**Facts like these prove Efficiency**

*If within easy radius of Broadcasting you do not require a Valve Set, the "Aerowave" Receiver will provide clear reception up to 30 miles.*

**SPECIFICATION**

- Polished Mahogany Cabinet with drop front.
- 2 Slider Inductance.
- Glass-enclosed Crystal Detector of improved design, with ball joint so that the whole of the Crystal may be swiftly and easily searched.
- Specially tested Crystal.
- Variable Condenser, 00015.
- Fixed Phone Condenser.
- Mounted on Sloping Ebonite Panel, engraved and fitted with all Terminals.
- 1 Pair Best Quality Headphones, High Resistance 4,000 ohms. Aerial Equipment.

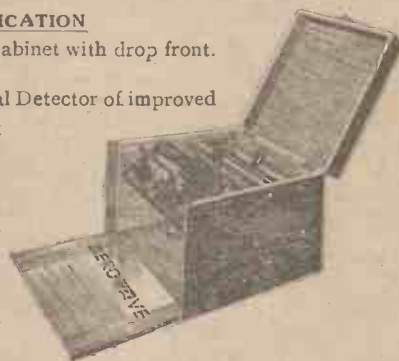

**READY FOR IMMEDIATE USE**

**PRICE £5 10 0**

**Post Your Order Now**

**HENRY J. BREWSTER & Co.,**

Makers of "Aerowave" Specialities,

11, Queen Victoria Street, London, E.C.4.

Phone: City 768.

Grams: "Aerowave, Phone, London."

NETT CASH WITH ORDER

CARRIAGE PAID

DELIVERY IN ROTATION

Letters containing cash should be registered. Cheques and Money Orders should be crossed and made payable to Henry J. Brewster & Co.

CLUB DOINGS (Continued from page 428)

### Glasgow and District Radio Club

**Hon. Sec.**—ROBERT CARLISLE, 40, Walton Street, Shawlands, Glasgow.  
This club resumed its activities with the annual general meeting, which was held at the club's new premises, 200, Buchanan Street, on September 27. In view of the interest in wireless, the club has arranged for a public exhibition and demonstration of wireless reception at the McLellan Galleries Hall, Sauchiehall Street, on November 4. The exhibition will commence at 12 noon, and will continue till 9 p.m. The committee hope to have a collection of both ancient and modern wireless apparatus. Trade firms who wish to be represented should send full particulars of offers to the hon. secretary as soon as possible. Two aerials will be available. Professor G. W. O. Howe, D.Sc., M.I.E.E., has kindly consented to deliver an address at 3 p.m. and special messages from Continental stations have been arranged for.

Tickets for admission are 1s. each (including tax), and can be had from all club members and wireless dealers in Glasgow. A syllabus for the ensuing session is in the course of preparation, and the secretary will be glad to have the name of any gentleman who can give a lecture or otherwise contribute to the winter's programme.

### Fulham and Putney Radio Society

**Hon. Sec.**—J. WRIGHT DEWHURST, 52, North End Road, West Kensington, W.14.  
At a meeting which was held on September 15 it was proposed a librarian be elected. Mr. S. W. Martin was elected to this post, and he will in due course notify the members as to the books available. The Morse buzzer class started on the 22nd ult. After the close of the business Mr. Calver introduced Mr. Adams of Wandsworth, the winner of Messrs. Selfridge's Wireless Competition. Mr. Adams had brought with him the apparatus which had won the prize; this consisted of a very small and compact three-valve set with specially wound transformers and coils, the whole being well made and finely finished. The time being limited, Mr. Adams could not go into much detail of construction, but the members present heard some signals which were rendered very loud and clear due to the special winding and wiring of the set. Mr. Adams has very kindly promised to explain the set in detail at a future meeting. Mr. N. A. Brown had with him a two-valve set also very neat and compact, which was also tried with very good results.

### Durham City and District Wireless Club

**Hon. Sec.**—GEO. BARNARD, 3, Sowerby Street, Sacriston.  
The last meeting was held on Sept. 15th, and was devoted chiefly to actual receiving sets. It was decided that the lecture on "Accumulators," by Mr. G. Barnard, should be held over for a more suitable occasion, the intention being to hold another open public meeting. The chairman opened the proceedings by requesting Mr. R. W. Holmes, M.I.M.E., to give a short address, which took the form of some carefully chosen queries, thereby opening quite a lot of discussion. Mr. R. W. Rush-

worth was then called upon to describe his set. While thoroughly appreciating the benefits of valve reception, he still had a great respect for the much-despised crystal, and pointed out the advantages of an ordinary crystal detector. Upon the invitation of the chairman, the hon. sec. answered questions spontaneously, during which he reviewed again the action and function of a condenser, also the spark method of producing high frequency oscillations. He drew and explained simple transmitting circuits on the blackboard. A question put to Mr. Barnard by the Rev. Bothamley regarding resistance offered by the insulation of an air-gap compared with the inertia of a strong inductive circuit was very ably explained diagrammatically.

It was shown and proved conclusively that although the resistance offered by an air gap was much greater than that of a large solenoid, yet this insulation was broken down, causing a spark at the gap terminals owing to the inertia, that is inductance of the solenoid. Mr. Barnard was requested to describe types of aerial insulators and lead in tubes. He handled this subject excellently and exhaustively, during which the types used in the R.A.F. and Navy were described fully. At the close of the question period the hon. sec. drew a diagram (his own arrangement) of a 2-valve receiver, which was copied by all present. The lecture on Oct. 1st by Capt. Donnisthorpe of the Marconi Co., will undoubtedly prove a great success. No efforts are being spared. Lantern slides and first class apparatus will be used. A special concert is to be transmitted at 9 p.m. from Newcastle for this event.

### East London Radio Society

**Hon. Sec.**—L. E. LUBBOCK, King George's Hall, East India Dock Road, Poplar, E.14.  
At a meeting held on Sept. 5th at the Lecture Hall, Woodstock Road, E.14, the matter of changing the society's meeting night was discussed at length.

After discussion it was decided to be necessary to have the society's accommodation and apparatus at the disposal of the members for at least two evenings every week, these to be Tuesday and Friday.

The management committee arranged the programme for the next month, reserving Tuesdays for lectures and debates and Fridays for experimental work.

On September 12th, the usual meeting of the above society was held at the Lecture Hall, Woodstock Road, E.14, when Mr. J. Keen commenced a series of lectures "How the Valve Works." Mr. J. Keen's knowledge enabled him to deal with his subject in a manner which is not too simple for the old hand and not too intricate for the beginner. He traced the history of the valve from the initial conception of the idea, and the original formation of the electron theory. After dealing very fully with the valve in all its aspects, Mr. J. Keen invited questions. The keenness of the questioning was ample proof of the attentiveness of the audience and of the interest created by the lecture. On September 18th the society's enthusiastic "Buzzerites" turned up in full force, and got so interested in their own doings that they rather overstepped the time allotted to them. So much so that listening-in did not commence until 9.15 p.m., and after various interesting experiments the meeting closed at 10.20 p.m.

### West London Wireless and Experimental Association

**Hon. Sec.**—HORACE W. COTTON, 19, Bushey Road, Harlington, Middlesex.  
The meeting held on September 14 was well attended by a large number of members. Mr. O. S. Pucker of the Wireless Society of London gave a lecture entitled: "The Lesser-known Forms of Telephone Receivers." This proved to be an interesting subject. The lecturer

divided telephone receivers into five sections, and in turn subdivided each section, upon which he gave a very fine detailed description as to their functions and results forthcoming from various experiments carried out by himself and others that he had seen done. By the kind permission of Major A. S. Angwin, D.S.O., M.C., the club meetings will in future be held at Stamford Brook Lodge, Ravenscourt Park, W.6., close to Stamford Brook (District Rly.) Station, and furthermore the weekly meeting will now be held on Friday evenings from 7 p.m. to 10 p.m., instead of Thursdays. The secretary will be glad to give full particulars of the association's objects and terms of subscription to all gentlemen who may feel interested and desire to seek membership.

### Wolverhampton and District Wireless Society

**Hon. Sec.**—F. A. H. DEVEY, 232, Gt. Brickkiln Street, Wolverhampton.

A MEETING of the above society was held on September 13 when a very interesting and instructive lecture was given by Mr. H. Taylor (2K Q) on "Hints and Tips on Receiving." The lecture was chiefly for beginners, and commencing with the correct method of using a single valve set, the lecturer (by means of diagrams) illustrated the importance of correct circuits. Mr. Taylor laid great stress on the fact of having a good and permanent grid leak of correct value, and also the advantages of grid batteries and their effect upon the circuit. Many questions were addressed to the lecturer whose expensive experience proved exceedingly beneficial and opportune to all present. One of the chief items of discussion was the question of grid batteries, and various opinions were expressed as to their importance, permanency and correct method of coupling.

### Swadlincote and District Radio Society

**Hon. Sec.**—MR. H. SHAKESPEARE, 46, High Street, Newhall, Nr. Burton-on-Trent.  
INAUGURATED at a meeting held on August 25, 1922, the above society is making rapid progress. A further meeting was held on August 30th in the Hastings Road Schools, Swadlincote, when a discussion took place on the rules framed at the last meeting. The decision of the sub-committee that the members construct their own apparatus was endorsed. Invitation is extended to all interested in wireless.

### PREPAID ADVERTISEMENTS.

3-Valve Receiver with valves, tunes 20,000 metres, condenser, phones, etc. £12.—Sloan, Windsor Avenue, Lurgan. 13s

Aircraft Receiving Sets, every description, £2 10s. upwards; also everything for wireless. Write your wants.—White, 121, Adelaide Road, South Hampstead. 12s

Valve Holders, plain legs, 1/2; screwed with nuts, 1/3; legs only with nuts, 7d. per set. Condenser vanes, 1/- doz. Ebonite knobs, 2 in., 4d.; 1 1/2 in., 5d.; tapped 2 BA. Ebonite sheet, 3/4 in., 3/6; 1/2 in., 3/3; 1/4 in., 7/-; 3/8 in., 10/6; 1/2 in., 14/-; any size cut. Coil plugs, 1/6 each. Ivoryine tablets, 1/- per set of 7.—J. B. Renshaw, 17, Old Chapel Street, Blackburn. 14s

B.A. Screws, Nuts, and Washers, assorted gross, 2s.; list, 2d.—J. H. Bennett, Station Road, Willesden Junction. 13d R

Wireless Dealers are advised to stock parts for making radio apparatus, as so many amateurs prefer to make their own instruments; there is also the additional profit in making your own sets from stock parts. Raw materials and partly machined parts can be had direct from the factory at the right price.—The "Newtonia" Wireless Factory, 13/15, Whitcomb Street, London, W.C.2. Regent 643 and 5469.

Sets Designed, concert coils and H.F. transformers wound to order, condensers and coils calibrated, faults righted, etc.—Walker, 23, Little Chester Street, S.W.1.

Cozwhy Filament Fuses will protect your valves from burn-outs. 1/4 or 2 amp., 10d. each, 8s. per doz. Polished ebonite fuse-holders, plated Ph.-Br. springs, 2s. 6d. each, 11s. set of five, post free. Cash with order.—Beswinning's, Cowley Road, Ilford, E. 14r

**Amateur  
Wireless  
And Electrics**

Querist's Coupon Available until  
Saturday, Oct. 21, 1922

**STARTLING OFFER**

As an advertising medium  
**For One Week only**

we offer 200 guaranteed 30/-  
Headphones 4,000 ohms at  
post 23/- free

Send P.O. to **BELL'S WIRELESS STORES,**  
18, De Crespigny Park, London, S.E.5.

Watch our Special Offer of  
— Crystal Set Next Week —

WE were overwhelmed with orders from our display advert. in A.W. of Sept. 23rd. Did you see it? Look it up—the prices will surprise you.



The **VEDA** Coy.  
48, Pawson's Road, Croydon.

**BUZZER SETS**

(Government Surplus)  
COMPLETE WITH EAR-PIECE,  
TAPPING KEY, BUZZER, INDUC-  
TION COIL, IN MAHOGANY CASE  
— LIMITED SUPPLY —  
8/6 CARRIAGE 1/3

**CONDENSERS**

VARIABLE, CIR: TYPE, CELL, CA'E  
·001 ·0005 ·0003  
24/- 19/6 16/-  
VERNIER TYPE FOR PANEL MTG.  
·0005 ·0003 ·0005 ·001  
6/6 9/6 12/6 15/-  
— WRITE FOR LIST —

**GRIFFIN'S**

80, NEWINGTON CAUSEWAY  
LONDON, S.E.1.

**PORTLAND'S PARTS BY POST**

All parts fit and match. Ebonite, by return, 4/-lb., any size.  
Generous trade discount. List free.  
PORTLAND, 39, Sinclair Road. Olympia, W.14.

**ELECTRADIX RADIOS.**

**IMMEDIATE DELIVERY  
FROM OUR HUGE STOCKS**

Everything from a Recorder to  
an Earth Clip.

The best equipped City depot.  
COME AND SEE US

9, COLONIAL AVENUE is  
first opening on left in the  
Minories, nr. Aldgate Station,  
Metropolitan Railway.

**LESLIE DIXON & CO.** Tel: Avenue 416.  
9, COLONIAL AVENUE, MINORIES, E.1

SCIENTIFIC APPLIANCES (Dale & Hollins). Electrical, Magne'tic,  
Optical and **ALL RADIO WIRE-**  
**LESS PARTS** and Materials at Lowest Prices.  
Call and see our immense stock or write for Information and Prices.  
In Centre of London, Top of Kingsway.  
**SCIENTIFIC APPLIANCES,**  
11 and 29, Sicilian Avenue, London, W.C.1.

**HEADPHONES**

THE CHEAPEST ON THE MARKET

4,000 ohms 20/- } POST FREE  
8,000 ohms 22/- }  
CASH WITH ORDER

As used in French Army and Navy.  
Complete with headbands and 6 ft.  
flex cord. Beautifully finished. Made  
from best materials. Satisfaction guar-  
anteed. Delivery by return. :: :: ::

**CITY TELEPHONE & ELECTRIC CO.,**  
10, CAXTON ROAD, LONDON, N.22.

**BROADCASTING**

RECEIVING SETS. ABSOLUTELY READY FOR USE, ONLY  
REQUIRE PUTTING UP. VALVE, 'PHONE, AERIAL  
AND EVERYTHING REQUIRED . . . . . **£5**

"**ALLISON'S,**" — Established 20 years —  
46-50, CHURCH RD., ACTON. 'Phone: 845 Chiswick

**ASK  
"A.W."  
for list of  
Technical  
Books.**

**MAXEY'S Wireless Bureau**

The Firm with a Reputation for Dispatch  
**MAKE YOUR OWN SET**

Special Offer This Week: former 9 1/2 x 5 or 12 x 4, 1/2 lb. Enamel Copper Wire  
S.W.G. 22, 24 or 26 and bottle of Shellac Varnish, 4/- Post Free. Fixed Telephone  
Condenser 1 1/2 x 2 1/2. Mica Dielectric, 2/6 Post Free.

Call and Inspect Our Quality

28, Ludgate Hill, E.C.4, and Market Hall, London Road, Brighton.

**GET OUR LIST—IT'S FREE**

ELECTRICAL SUPPLY STORES  
5, Albert Terrace, King Cross,  
HALIFAX.

EVERYTHING FOR WIRELESS IN STOCK

**BROADCASTING  
IS NOW ASSURED**

GET YOUR INSTALLATION BEFORE THE RUSH  
HOW TO BUILD THE FINEST RECEIVING STATION EXPANDING BY INSTALMENTS  
TO RECEIVE SIGNALS YOU MUST HAVE Aerial Wire, 150 ft. Silicon  
Bronze, 4/6; Insulators from 4d. each; Tuning Stand (3 coils), 30/-; Coils from  
1/3, according to W.L.; Detector Unit (valve), 37/6; Phones from 24/-; Con-  
densers, Variable, 5/- to 36/-; H.T. and L.T. Batteries, see our list. **5**  
TO INCREASE RANGE YOU REQUIRE 1 (H.F. Unit, 37/6, and so that  
your friends can hear add 1 L.F. Unit, 45/-.

Illustrated Catalogue, including list of stations, useful books, etc.,  
we can supply, 6d. post free.

**EONS WIRELESS SUPPLY COMPANY,**  
115, FLEET STREET, E.C.4.

Factories & Laboratories:  
King's Road, St. Pancras.

**ANODE**

**Wireless & Scientific Instruments, Ltd.**

All Communications to Registered Offices:

**265, STRAND, W.C.2**

ANODE PATENT VARIABLE FOIL  
CONDENSERS, Capacity ·0005 mf. 9/6 } Laboratory

ANODE PATENT VARIABLE FOIL  
CONDENSERS, Capacity ·001 mf. 10/6 } Tested

\*ANODE PATENT CRYSTAL SETS (Good  
Telephony up to 12 miles) . . . £3 9 6

\* " " SINGLE VALVE SETS  
(Patent Auto-transformer Circuit) 6 17 6

\*UNIT SYSTEM  
Unit 1. PATENT ANODE VARIOMETER  
TUNER (350-500 metres) . . . 4 17 6

" 2. HIGH FREQUENCY AMPLIFIER  
(One Valve) . . . . . 4 2 6

" 3. DETECTOR . . . . . 5 12 6

" 4a. LOW FREQUENCY AMPLIFIER  
(Two Valves) . . . . . 10 15 0

" 5. TELEPHONE TRANSFORMER  
(for Low Resistance 'Phones) . 2 15 0

Units 1 and 3 comprise a Receiving Set to which other  
Units can be added  
\* All Valves, 'Phones and Batteries extra

# HULLO EVERYBODY!

COMPARE PRICES! COMPARE QUALITY!!

## COMPLETE SETS OF PARTS FOR MAKING VARIABLE CONDENSERS.

| Approx. Capacity in Micro-farads | No. of Plates | Price |
|----------------------------------|---------------|-------|
| .0015                            | 85            | 10/-  |
| .001                             | 57            | 7/6   |
| .00075                           | 43            | 6/9   |
| .0005                            | 29            | 5/6   |
| .0003                            | 19            | 3/6   |
| .0002                            | 13            | 2/6   |
| .0001                            | 7             | 2/3   |
| Vernier                          | 3             | 1/9   |

These Sets are complete ready for assembling and consist of the following parts: Necessary Aluminium Vanes (fixed and moving), all standard size, large and small Spacer Washers, Centre Square Spindle with Knob Bushed 2 BA, 3 round screwed Rods for sides, necessary Nuts and Washers, Brass Pointer, Engraved Scale, 2 Terminals, Lock Nuts, 3 Bushes and 2 Bronze Coil Spring Washers. Every part guaranteed best workmanship and quality. Generous quantity of all spares supplied.

Packing and Postage 1/3 per set extra.

EASY TO ASSEMBLE. Every part of the Highest Possible Quality. TRADE SUPPLIED with above Sets.

Aerial Wire, 7/22 Stranded Copper, 3/3 per 100 ft. Postage 1/-.

Knobs, tapped, 2 BA, 1½ in. diameter, 2/- doz. Special clearing line. Doz. lots only.

Condenser Parts, Fixed and Moving Vanes, 7d. doz.; 6 doz. 3/-.

Small Spacers, ½ in., 3d. doz.; 6 doz. 1/6.

Large Spacers, ¾ in., 4d. doz.; 6 doz. 1/9.

Ebonite Bases, circular (drilled), 10d. each.

Drilled Squares, 4 by 4, 1/6 pair.

Brass Washers, 4 BA, 3 doz. 2d.

2 BA, 1 doz. 1½d.; 6 doz. 6d.

Contact Studs, high-class quality, 6d. per doz., with nut.

Spring Coil Washers (Bronze), 4d. per doz.

Crystal Cups, large, 4 screws, 4d. each; 3/6 per doz.

Small, 2d. each; 1/3 per doz.

Crystal Detectors, parts, 1/6; complete 3/6.

Terminals, W.O. Pattern with Nut and Washer, 2d. each; 1/10 doz.

Telephone Terminals, complete with Nuts and Washers, 2d. each; 1/10 per doz.

Varieties of Terminals, 1/-, 1/6, 1/6 doz.

Brass Hexagon Nuts, 2 BA, 4 BA, 5 BA, 3d. per doz.; 6 doz. 1/3.

Switch Arms, with Laminated Blade, 1/-, 1/3. Extra quality, 1/8.

Inductance Coils, Wound No. 24 Enamel Wire, 3/3 (not sent by post).

Ebonite Condenser Dials, with Scale 0-180, splendid value, 1/2.

Condenser Bushes, 1d. each; 10d. per doz.

Stop Pins, Brass, 3d. per doz.

Ebonite Leading-in Tubes, 12 in. 1/6. Postage, 9d. Other sizes as cheap.

Valve Sockets with Shoulder, extra quality, complete with Nuts, 1/1 doz.

Valve Pins, 8d. per doz. (with Nuts, 10d.).

Valve Holders, 11d. and 1/2 each. Complete with Nuts.

Sets of Basket Coils, seven in set, 6/- set.

Porcelain Insulators, Reel Type, 1/- doz. (not sent by post).

Transformers, L.F. Open-Type Intervalve, 15/6 each. Postage 1/-.

Knobs, 1½ in. diameter, Tapped, 2 BA, 3d. each. Also with 2 BA Nut, 5d. each.

Crystal Receiving Sets, Fitted with Blocking Condenser, Terminals and Special Detector, £1 2s. 6d. complete.

Ivory Scales, best quality, 6d. each.

Pointers, Brass or Aluminium, 4 for 3d.; 8d. doz.

Filament Resistances, 2/6, 3/6; "Thor," 4/6.

Insulating Sleeving, 1½ mm. hole, 5d. per yard length; 4/6 doz.

Block Condensers, .001, .002, .0003, 1/6, 1/8; .004, 2/-.

S.P.D.T. and other Switches on Ebonite Base, 1/9, 1/10, 2/6 each.

Inductance Silder and Plunger, complete with 13 in. Brass Rod, 9d. (not sent by post).

Laminated Blades for Switch Arms, 3d. each; 2/6 doz.

Ebonite. To Callers only. Cut to sizes required (1½ in. only) at the rate of 4/- lb. Cutting 3d. per piece (not sent by post).

## HEADPHONES

**21/-** Best French Manufacture, with Universal Joint. Equal to any other or more expensive 'phone on the market. Resistance 4,000 ohms,

**22/6** highest possible insulation, selected tungsten steel magnets, heavy insulated cords, polished aluminium case, oxidised copper headbands,

**25/-** Ebonite earcaps.

ALL ORDERS MUST BE accompanied by cash and sufficient enclosed to cover postage and packing—the prices quoted are too low to admit of being despatched except on above terms. TRADE SUPPLIED.

**M. RAYMOND,** 27, LISLE STREET, W.C.2.

RIGHT OPPOSITE  
DALY'S GALLERY DOOR.

Phone:  
Gerrard  
4637

To avoid mistakes, this address is close to  
Charing X Road and Leicester Square Tube.

# I PAY POSTAGE

## CRYSTAL SET, complete

Oak Case with Tuning Coll, Ebonite Panel on top mounted with Detector, Block Condenser and 4 stud Tuning Switch. One pair best French 4,000 ohm Phones, 100 feet 7/22 Aerial Wire and 4 Insulators.

**55/-**

Postage paid.

## HEADPHONES

Best Quality, French, 4,000 ohms, Double Receiver.

**20/-**

Postage paid.

## INDUCTANCE COILS

Wound with 24 S.W.G. Enamelled Wire, 12" x 4", 12" x 3 1/2", 12" x 1 3/4".

**3/9**

Postage paid.

All packing and postage free. Mail order only. New Price Sheets sent free.

**JACKSON,** 7, BLAKE ROAD, FULHAM, LONDON S.W.6.



TELEPHONE: CITY 2972

## A. MUNDAY, Ltd.,

59, WATLING ST., E.C.4, :: 45, EASTCHEAP, E.C.3

## RADIO HEADPHONES

4,000 ohms 22/6 pair } - Beautifully finished, Ebonite -  
8,000 ohms 27/6 pair } Knobs, etc., to cord connections.  
GUARANTEED.

AERIAL WIRE, 7/22, 2/9 100 ft.

H.T. BATTERIES ACCUMULATORS  
VARIABLE VOLTAGE READY CHARGED



## A RECEIVING SET WITHOUT 'PHONES

IS LIKE A SHIP WITHOUT A RUDDER

## The "Brown" Super-Sensitive Telephones

These Telephones are unquestionably the clearest and most sensitive made, and, consequently, increase the distance over which wireless can be heard. BROWN'S are recognised as the most comfortable to wear, due to their extreme lightness in weight and adaptable adjustment. There is no wireless headphones in the world to compare with BROWN'S.



"A" TYPE

Low Resistance

58/-

High Resistance

62/- to 66/-

"D" TYPE

Low Resistance

48/-

High Resistance

52/-

(Above Prices include cords.)

Wireless Instruments and parts manufactured by and bearing the name "BROWN" can still be bought with absolute confidence in their quality, value, and efficiency, because throughout this period of increasing wireless activity S. G. BROWN, Ltd., have wisely refused to lower their high standard of quality.

IMPORTANT NOTICE.—When purchasing BROWN'S, you should see that the name BROWN is stamped on the back of each ear-piece.

IN UNIVERSAL USE. AS SUPPLIED TO BRITISH, ALLIED AND FOREIGN GOVERNMENTS.

Visit our Stand, No. 43, All-British Wireless Exhibition, Horticultural Hall September 30 to October 7

## ILLUSTRATED CATALOGUES POST FREE

Head Office & Works—  
Victoria Rd., NORTH  
ACTON, LONDON, W.3.

London Showrooms—  
19, MORTIMER STREET  
LONDON, W.1.



## SELF-CONTAINED OR UNIT SYSTEMS MARCONIPHONES, MARCONI SCIENTIFIC UNITS, WAVEORA UNITS, ETC.

We give demonstrations to purchasers at our showrooms.

Tuners, Coils, Rectifiers, Amplifiers, Valves, Magnavox and Brown Loud Speakers, Microphone Amplifiers, H.T. and L.T. Batteries, and all Wireless Accessories.

Special quotations for Technical Colleges, Schools and Educational Institutions.

**THE RADIO WAVEORA CO., 168, REGENT STREET, LONDON, W.1.**

Telephones: Gerrard 3089; Western 847.

Telegrams: Wychwood, 'Phone, London.

## COMPLETE SETS OF PARTS

ready for assembling, for any component of Wireless Gear

Send 3d. for Illustrated Price Lists.

We are actual Manufacturers, and our prices will astound you.

MONEY BACK if not entirely satisfied

Watch for the name of our nearest agent.

BOLTON—J. S. McLEOD, 189, Blackburn Road.

BURY—BENNETT & Co., 12, Union Square.

WARRINGTON—ECONOMIC ELEC. Co., 64/66, Sankey Street.

### AGENTS WANTED.

The Actual Manufacturers:

**J. L. CARTWRIGHT & CO.,**  
LONDON ROAD, MANCHESTER.

Phone: Central 4209. Grams: "Fladram, Manchester."  
Works: Berry St., Manchester.

ALL THAT IS NECESSARY

PLIERS, SCREWDRIVER, SOLDERING IRON.

**"MAKE YOUR OWN"**

**WIRELESS APPARATUS**

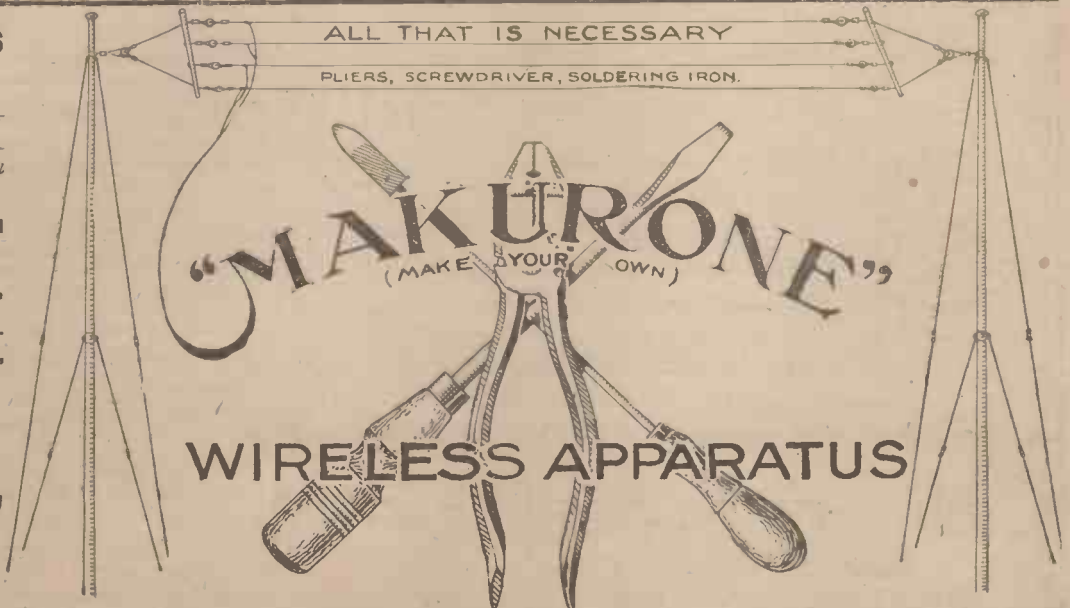

# BROADCASTING IN A FORTNIGHT

WILL BE OFFICIALLY PERMITTED IN THE U.K.!!!  
SIR HENRY NORMAN (representing the Post Office) made this important announcement at the opening of the Exhibition.

**THE GOODS THAT SELL!! DIRECT FROM FACTORY TO BUYER**

## HAVE YOU A GRAMOPHONE? THEN GET A GRAMAPHIX LOUD SPEAKER

THE GRAMAPHIX multiplies sound! THE GRAMAPHIX fits any gramophone! HAVE YOU HEARD THE GRAMAPHIX?

IT produces full volume of sound without distortion and makes your gramophone a RADIO LOUD SPEAKER.

The Gramaphix utilises the scientifically designed tone amplifier of the gramophone to secure mellowness and Beauty of Tone, therefore doing away with all that metallic sound, scratching and "ring" associated with other loud speakers. The Gramaphix is the talk of the wireless world.

Adjusted in a Minute by a child. LATEST and LOUDEST.

Why pay pounds when a better instrument can be secured for

APPLY FOR TRADE TERMS **10/6** IMMEDIATE DELIVERY  
Postage 9d.

Our Sets guaranteed by experts who are holders of degrees. We Guarantee all parts new  
**NO WAR STOCK USED**

We cannot sell our sets on the gradual payment system or sell at half price during Exhibitions. Look at our prices and you have the reason

**WE SELL COMPLETE SETS**

"LACLAND" 1 Valve Set £12 0 0 "LACLAND" 3 Valve Set £19 10 0  
" 2 " " £16 10 0 " 4 Valve Set £22 5 0

**HERE IT IS! SPECIFIC GUARANTEE TO RECEIVE TELEPHONY FROM A MINIMUM DISTANCE OF 25 MILES.**

**THE B.N.B. CRYSTAL SET £7 10 0**  
(With 2 Sets of Double Earphones)

Operates on Wave Lengths up to 1,000 Metres

Outstanding merits: simplicity, sensitiveness, efficiency and reliable audibility. Fitted with terminals for the adaption of honey-comb coils, thereby making it possible for performances broadcasted on longer wave-lengths to be received.

Each set is guaranteed to operate under normal conditions and is sold with this guarantee.

These sets have all been recently improved upon, consequently buyers will get the latest and most up-to-date instruments.

**LACLAND ELECTRICAL MANUFACTURING AGENCY (Dept. A), 68, GREAT QUEEN STREET, KINGSWAY (Holborn End), W.C.2 Gerrard 5341.**

# Build your own Variable Condenser

Our new Booklet explains the whole system

POST 6<sup>d</sup> FREE

With a screwdriver and a pair of pliers, you can quickly assemble your own Variable Condenser. Peto Scott sets of Condenser Parts are standardised throughout, all the drilling and tapping is done by machine, and the plates and washers are accurately cut to size. The whole neatly boxed with full instructions for building up.

Peto Scott Condenser Parts enable you to obtain a well-designed and accurate instrument at a very much lower cost than if you were to purchase ready-made.

### Sets of Parts for Panel Mounting

|       |           |      |
|-------|-----------|------|
| .0001 | 7 plates  | 6/-  |
| .0002 | 13 plates | 7/-  |
| .0003 | 19 plates | 9/-  |
| .0005 | 29 plates | 11/- |
| 1.001 | 57 plates | 18/- |

Mahogany Cabinets to fit extra.

Catalogue "A" free with each order for Booklet.

FEATHERSTONE BUILDINGS,  
64, HIGH HOLBORN, W.C.1.

Works: New Southgate  
and Tottenham, N.



JUST PUBLISHED.

## SIMPLIFIED WIRELESS

BY

JOHN SCOTT-TAGGART, F.Inst.P.

Author of

"Wireless for All," "Wireless Valves Simply Explained," etc. etc.

**An Entirely New Book for the Beginner.**

IT TELLS YOU—

- (1) All about elementary electricity.
- (2) What the different parts of wireless circuits are for.
- (3) How to erect your aerial.
- (4) How to make inductances, variable condensers, fixed condensers, crystal detectors, etc.
- (5) How to make several types of complete receivers out of the simplest materials.

WHY NOT MAKE YOUR OWN SET? THIS BOOK TELLS YOU HOW.

PRICE 1/- ; postage 1½d. Get your copy to-day.

From all Booksellers, or by return post from

**Radio Press Limited,**

Devereux Buildings, Strand, W.C.2.

(Opposite the Law Courts.)

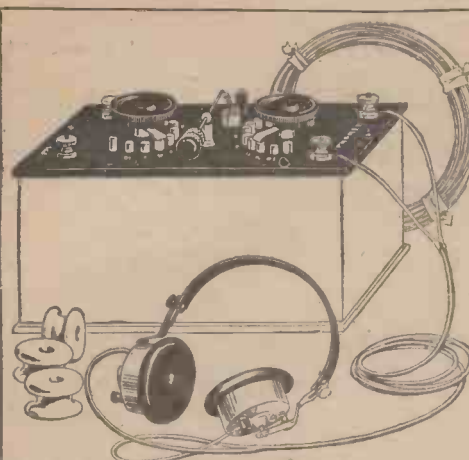

THE  
"SELECTAPHONE"  
CRYSTAL  
RECEIVING SET  
FOR  
WIRELESS  
CONCERTS

Receiver range 300/1000 metres, and special device for Paris Time Signals. Each set tested and guaranteed to receive Telephony.

As Efficient as a  
Crystal Set can be.

ABOVE SET COMPLETE WITH PHONES, AERIAL, INSULATORS: £3/17/6 RECEIVER ONLY 47/6  
Post and Packing, 2/- extra.



ARE YOUR SIGNALS LOUD ENOUGH?  
MAGNIFY THEM WITH THIS INTERVAL TRANSFORMER

PRICE ONLY 19/6 PRICE ONLY  
Postage 6d. extra.

Made with genuine Stalloy Stampings, solid Ebonite Bobbins, perfect insulation. Very efficient and silent. Tested and guaranteed. Money refunded if not satisfied.

THE B. & A. WIRELESS CO.,  
ST. ALBANS.



WHY PAY MORE?  
CRYSTAL DETECTOR MOUNTED ON EBONITE. Any part of crystal can be selected by the swivel movement. Complete with crystal. Price 4/-

Single Valve Detector Sets of complete parts, 17/6.  
Polished Mahogany Cabinets, 4/6.

Crystals (special selected), Bornite, Zincite, Galena, Silicon, Carborundum, C. Pyrites, Graphite, etc. ... 6d.  
Egg Insulators, Green ... 6d.  
Reel " best quality ... 3d.  
Valve Holders, Screwed Legs ... 1/-  
Helleseen 36 v. Batteries with Tappings and Plug ... 8/0  
Essex 15 v. H.T. Batteries ... 3/-  
Ebonite Lead Insulators ... 2/-  
Perikon Detectors on Ebonite Complete with Crystals ... 4/-  
"Ubique" Crystal Set Complete... 15/-

HEADPHONES, EBONITE, CONDENSERS, Etc. Postage extra.

THE ESSEX WIRELESS CO. 499, GROVE GREEN RD., LEYTONSTONE, E.11. (1 min. from Station, G.E.R.)  
Telephone - WANSTEAD 749.

GENTS' MAKE FITMENTS



Send for our Sundries Pamphlet  
Make use of our Stocks  
May we quote for your Wholesale Requirements

The 'Discol' H.F. Transformer  
Delivery from Stock

GENT & Co., Ltd., FARADAY WORKS, LEICESTER  
London: 25, Victoria St., S.W.1. Newcastle-on-Tyne: "Tangent House," Blackett St.

**BOWER'S**  
HAVE GREATLY REDUCED THE PRICE OF THEIR WIRELESS PARTS  
WORKMANSHIP ON EVERY ARTICLE IS STILL UP TO THE HIGHEST STANDARD  
Write NOW for Comprehensive Money-saving Price List POST FREE  
TRADE INQUIRIES RESPECTFULLY SOLICITED

|                                                                                                   |              |
|---------------------------------------------------------------------------------------------------|--------------|
| Aerial Wire, 7/22 bare copper stranded in 100 ft. hanks ...                                       | 5/- per hank |
| Ring Pattern Insulators, 2 in. by 1 in., 4 in. hole ...                                           | 4d. each.    |
| 1/2 in. sq. Section Brass Rod for Sliders, cut in 13 in. lengths and drilled ready for fixing ... | 6d. each.    |
| Inductance Slider, complete with plunger ...                                                      | 9d. each.    |
| Cardboard CyHinders, 12 in. by 4 in. diameter ...                                                 | 8d. each.    |
| No. 24 Enamelled Wire, H.C., true to gauge ...                                                    | 2/8 per lb.  |
| Large or small Condenser Plates (Aluminium) ...                                                   | 1/- doz.     |
| Large Spacer Washers for condensers (cut true to ...)                                             | 7d. doz.     |
| Small " " " " (1,000th of an inch) ...                                                            | 5d. doz.     |
| Ivoryne Scales " " " " ...                                                                        | 9d. each.    |
| Condenser Box, in Polished Oak or Mahogany, 3 1/2 in. by 3 1/2 in. by 2 in. ...                   | 4/6 each.    |
| .0003 mf. Condensers, complete, assembled in Polished Mahogany or Oak Boxes ...                   | 15/- each.   |
| All necessary parts for above Condensers, no drilling or fitting required, but unassembled ...    | 12/6 each.   |
| Ditto, but without box ...                                                                        | 9/6 each.    |
| Ditto, but without box and Ebonite top, suitable for panel mounting ...                           | 8/6 each.    |
| Crystal Detector, mounted on Ebonite, complete with Crystal ...                                   | 4/6 each.    |
| Large or Small Contact Studs ...                                                                  | 9d. doz.     |
| Valve Legs, complete with nuts and washers ...                                                    | 2d. each.    |
| Government Surplus Accumulators, 16 volt 15 amp. hrs., in case complete (L.O.R.) ...              | 20/- each.   |
| Hart Accumulators, 4 volt 24 amp. hrs. ...                                                        | 14/9 each.   |

Packing and postage for last item, 1/3 each.

**J. B. BOWER & CO., LTD.**  
WIRELESS APPARATUS MANUFACTURERS  
15, Kingston Road, WIMBLEDON, S.W.19  
Phone: WIMBLEDON 1080. Works: MERTON

**Exide BATTERIES**



THE LARGEST SHIP IN THE WORLD  
—the White Star Liner "Majestic"—uses Exide batteries for her wireless installation.  
No finer testimony to the general reliability of Exides, and their particular suitability for wireless work, could be given.

THE Chloride ELECTRICAL STORAGE COMPANY LIMITED.  
CLIFTON JUNCTION, N. MANCHESTER. | 219/229, SHAFTESBURY AVENUE, W.C.2.  
PRICES AND PARTICULARS ON APPLICATION.

Radio brings it: **MAGNAVOX** tells it

# MAGNAVOX

## THE WORLD'S FINEST LOUD SPEAKER

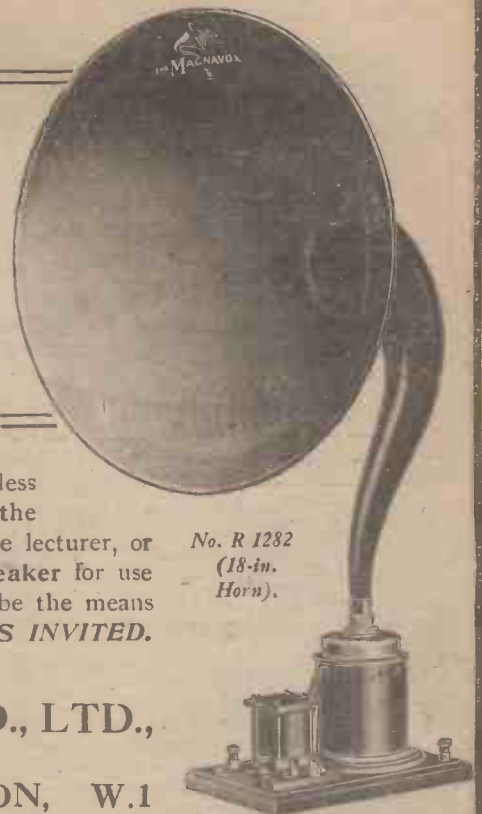

No. R 1282  
(18-in.  
Horn).

**T**O enjoy and obtain the greatest possible satisfaction from your Wireless Receiving Set, equip it with a **Magnavox Loud Speaker**. Hear the voice of the singer faithfully reproduced, the perfect intonations of the lecturer, or the natural sound of music. The introduction of the **Magnavox Loud Speaker** for use with Radio Receiving Sets marks a most important development, and will be the means of making broadcasting extremely popular.

**INQUIRIES INVITED.**

**SOLE AGENTS FOR THE UNITED KINGDOM:**

**STERLING TELEPHONE & ELECTRIC CO., LTD.,**

Telephone House,

**210/212, TOTTENHAM COURT ROAD, LONDON, W.1**

Telephone: Museum 4144 (7 lines).

Telegrams: "Cucumis; Wesdo, London."

**NEWCASTLE-ON-TYNE:**  
9, Clavering Place.

**WORKS:**  
Dagenham, Essex.

**CARDIFF:**  
8, Park Place.

**IMMEDIATE  
DELIVERY**

**ELWELL  
HIGH POWER  
WIRELESS  
STATIONS**

# AMPLIFYING MADE EASY

To the man who is:—

## BUILDING

Do not use intervalve transformers. Elwell Amplifying units replace them all on good sets. They save time, money and trouble.

## BUYING

See that the amplifying stages on valve sets are carried out by Elwell Amplifying Units. They enable the manufacturer to give you a better job at a lower cost.

## THE ELWELL AMPLIFYING UNIT

when provided with a valve and connected as marked, is all that is necessary to give a further stage of amplification to an existing set. No soldering. Easily mounted. Highest possible efficiency.

The self-contained permanent connections are embedded in compound, and, as shown in the diagram, are brought out to terminals. The perfect insulation of the grid connection cures "noise."

Two, three or more units may be coupled together to give as many stages of note magnification as required.

*Exclusive design covered by patents. British made and guaranteed throughout.*

**PRICE: 39/6 only,** for complete amplifying unit, less valve.

*Deliveries from Stock. Call and see it.*

A similar design of unit is now available as an oscillation amplifier, and a third design as a rectifying unit ::

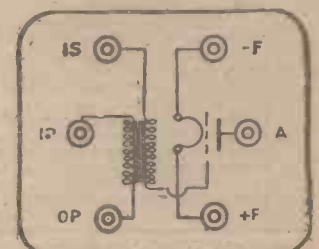

- OXFORD
- CAIRO
- NORTHOLT
- HORSEA
- EIFFEL TOWER
- LYONS
- NANTES
- ROME



**C. F. ELWELL, LTD., CRAVEN HOUSE, KINGSWAY, LONDON, W.C.2**

Telephone \_\_\_\_\_

[E.P.S., 36  
Regent 421



SHALL WE EVER SEE BY WIRELESS?

# Amateur Wireless And Electrics

Q.A.P.  
[QUERIES  
ANSWERED  
PROMPTLY]

No. 20

SATURDAY, OCTOBER 21, 1922

Price 3d

*Seeing by Wireless?*    *Recording the Prince's Scout Speech*    *Arranging The Den*

*Inductance  
Coil  
Holders*

*Joints  
in  
Wires*

*Using  
"Surplus"  
Gear*

*All about  
the Valve*



*Photo: Dorton  
Leigh, Ltd.*

*Screw-  
threading*

Prof. JOHN AMBROSE FLEMING, D.Sc., M.A., F.R.S.,  
in the Pender Electrical Laboratory, University College,  
London. Prof. Fleming is one of the greatest wireless  
authorities, and the inventor of the first thermionic valve

*Accumulator-  
charging*

# ECONOMIC ELECTRIC LTD.

WHOLESALE, RETAILERS and the PUBLIC, are requested to TAKE NOTICE that this advertisement is to introduce the

PRICE 15/- **EXTRA** PRICE 15/-  
**TRAJODION**  
 PATENTS PENDING

## THERMIONIC TRIODE

the latest and best development of the three electrode valve.

**RECTIFIES, OSCILLATES, AMPLIFIES**

**Unique Construction and High Amplification Characteristic.**

Filament current 5 amps at 4 volts. Anode potential 50 volts.

Obtainable from the patentees, ECONOMIC ELECTRIC LTD., and all dealers in Wireless apparatus. Wholesale enquiries should be sent to the patentees or to Mr. H. S. TYLER, 23b, Balham Hill, London, S.W.11.



Head Office: 10, FITZROY SQUARE, LONDON, W.1. INFRINGES NO PATENTS! Illustration Full Size

New Showrooms: 303, EUSTON ROAD, N.W.1.

Telephone: MUSEUM 1055

Branch Showrooms: TWICKENHAM

# MITCHELFONES

Are not a spasmodic production to meet a sudden demand, but have been on the market for over three months, and during this period 27,000 have been distributed to the trade, and consequently we have not been able to offer them direct to the retail buyer.

1,000 per week are now available, and we announce

## DELIVERY FROM STOCK

You post your order, or call at our premises and get them at once. Think what this means to you—you, perhaps, who have been waiting and are still waiting.

Standard resistance 4,000 ohms, double headgear with double headstraps, comfortable, highly efficient, and foolproof

**25/-** per pair.

Special Terms to Traders and deliveries that will surprise you.

**MITCHELLS Electrical & Wireless Ltd.,**

Postal Address: McDermott Road, Peckham, S.E.15.

Retail Address: 188, Rye Lane, Peckham, S.E.15.

Phones: New Cross 1540/1541

GREAT BRITAIN'S GREATEST WIRELESS STORE

# DUBILIER

**DUBILIER GRID LEAKS**  
 are like Dubilier Condensers —  
*the best.*

**2/6**  
Each.



**2/6**  
Each.

We have now got into full swing on the mass production of grid leaks, and in consequence have greatly reduced the manufacturing cost. We have, as usual, decided to reduce our price accordingly, and in future the Dubilier Grid Leaks will be sold at 2/6 each.

Dealers holding stocks of Dubilier Grid Leaks will be credited in full if they return their stocks to us.

*Dubilier Grid Leaks are Accurate, Constant, Guaranteed.*

TRADE TERMS ON APPLICATION.

**THE DUBILIER CONDENSER CO. (1921), LTD.,**  
**DUCON WORKS, Goldhawk Road, Shepherd's Bush, London, W.12**

Telephone—Hammersmith 1084.

Telegrams—HivoKoon, Phone, London.

Code—Marconi International

# Amateur Wireless

## and Electrics

No. 20

October 21, 1922

## ARRANGING A WIRELESS DEN

**T**HERE are many details coming under this heading which make all the difference between good and bad reception, and as it is not a matter of any extra expense it is worth attending to.

### The Room

Firstly, if there is any choice in the matter of what room to use, it is a mistake to pick on a small room with a low ceiling under the impression that it will be nice and snug. I remember listening-in on a friend's set in such a room, and owing to the capacity effects set up by the proximity of the walls and roof (it was in an attic), we found that every time we moved the tuning was altered; in fact, we found it impossible to do accurate tuning in the orthodox manner (we were listening to Writtle at the time), and had to do it by moving our bodies to or from the set. In the end, I remember, we obtained the best tuning by sitting with our heads under the table.

### The Position of the Receiver

The set should be arranged as near the window as possible, so that the wires from the earthing switch on the window frame may have a fairly direct path. These wires—or, at any rate, the aerial lead—which may be of motor-car H.T. wire, electric light flex, or even bell wire should not run close or parallel to the walls, ceiling or floor, and if they have to run any distance they should run diagonally across all corners. They can easily be kept away from the walls by wooden supports. On no account should the aerial and earth leads run near to each other; they should be kept quite apart.

### The Bench

With regard to a table on which to lay out the set, the size required will vary according to the ambition of the experimenter; for my own use I have one of

those big double washstands (*not* the type with holes for the basins) which has a vertical back board and two sides about eight inches or a foot high. If any ordinary table is used, it will nearly always be found worth while to attach a back and two sides, as these prevent any liability of apparatus being pushed over, and also come in useful for attaching switches, etc. Of course, if a bench is permanently fixed against the wall the matter is simplified. An ideal arrangement is to have this latter arrangement with a vertical wooden background; thus a room with wooden walls is a convenience.

If a back board is used the separate units of the apparatus should be screwed to it, so arranging them that the least used switches and controls are highest up, so that when you come to the final tuning (condensers, etc.) the hand is at the bottom, in which position it is least likely to affect tuning. The L.T. accumulator and H.T. batteries may be placed

out of sight under the table or on a high shelf; do not place the accumulator in such a position that the fumes from the acid can reach the set.

If the set must be laid out on a horizontal surface, arrange the units so that the fine tuning controls are the nearest, so that the hand will not have to pass over any part of the set when making final adjustments and produce capacity effects.

### Panel Mounting

There must be numerous amateurs who have built up a set-bit by bit, and which has become like a junk heap of mixed-up units

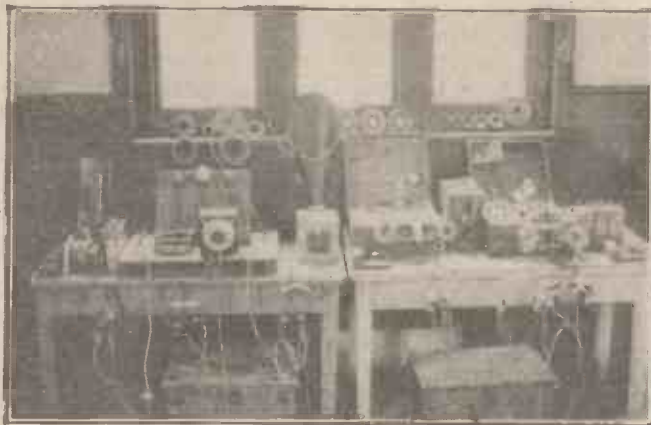

This photograph shows the well arranged wireless den of St. John's School, Leatherhead, Surrey. Two single-valve sets are to be seen on the right which can be coupled together by means of one of the sets of coupling coils as a high-frequency transformer, to form a complete 2-valve set. A 3-valve set is in the centre and the apparatus on the left is a separate heterodyne, the billi-condenser of which can be seen in the background. In the centre also is a loud-speaker and in front of it a special short-wave tuner.

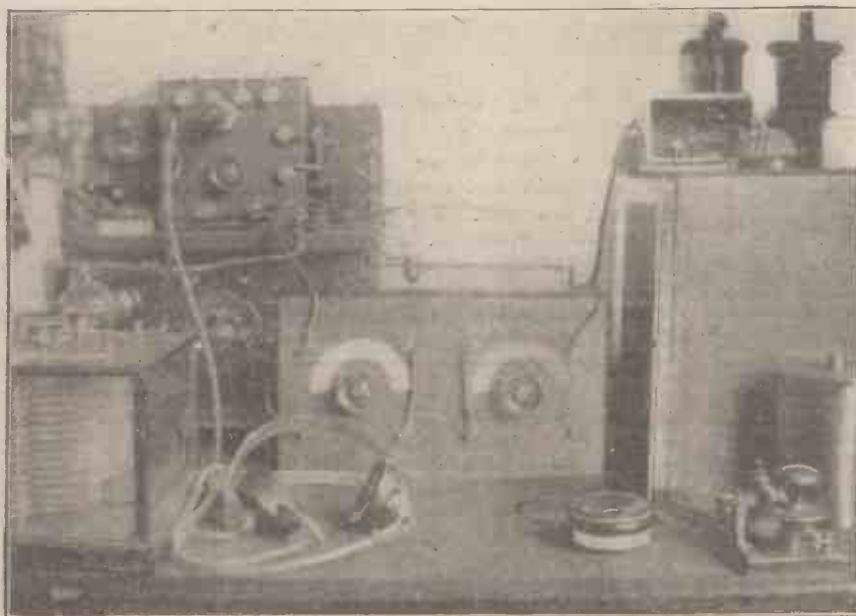

A photograph showing the bench arrangement of an amateur (Mr. George Grimmond), in which the convenient lay-out of the apparatus is apparent.

of all shapes and sizes. A simple, effective and inexpensive way of mounting these units in a neat manner is as follows: Obtain a mahogany board of suitable size and varnish it, then mount each unit on a separate ebonite panel and let these panels into holes cut in the board

to receive them; the units may be connected up by insulated wiring from the original terminals let back through holes in the board so, that the whole front looks neat. The whole set on its back board may now be fixed up in a suitable manner on the lid of a box or by brackets to a

wall, etc. The advantages of this system are that you have all the good features of an ebonite panel without the expense. After a time another junk heap will probably accumulate; this can then be mounted on a similar board and placed alongside of the first. B. M. W.

# Using "Surplus" W.D. Apparatus

The Triple-valve Relay. Type T.B.

THE T.B. three-valve relay, of which a circuit diagram is shown, was used during the war in conjunction with crystal receivers on aircraft. The relay was used in conjunction with various types of crystal receivers, and was intended as a substitute for Brown's relays. The apparatus is divided into two boxes clamped together, the connections between the two parts being effected by means of plugs and sockets.

dielectric, and is connected directly across the L and E terminals.

### Transformers

These have primary and secondary windings on closed cores composed of 56 E-shaped stampings of transformer iron, paper-covered. The primary is wound with 3,500 turns of No. 38 s.c.c. copper wire having a resistance of 272 ohms. The secondary has 18,000 turns of No. 47 s.c.c.

d.s.c. copper wire, and is connected in series with the positive terminal of the H.T. and the plate of the third valve.

The secondary has 4,800 turns of No. 42 d.s.c. copper wire, and is connected directly to the telephone terminals.

### H.T. Battery

This consists of 72 dry cells giving a potential at the battery terminals of 100 volts.

### Battery Condenser

This is of the Mansbridge type, having a capacity of 0.3 mfd.

### Safety Resistance

This consists of a bobbin wound with No. 40 "Eureka" wire, having a resistance of 2,000 ohms; it is connected in series with the battery to prevent undue discharge should the battery be accidentally shorted. A. C. D.

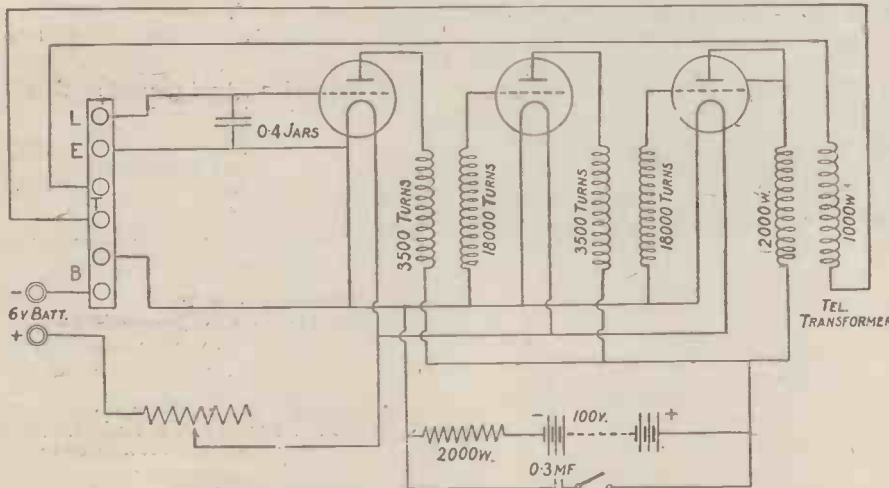

Circuit Diagram of Triple-Valve Relay.

### The upper box contains

1. Three valves (French pattern).
2. Three valve holders.
3. Filament rheostat.
4. Detector condenser.
5. Terminal board and filament terminals.
6. Transformer.
7. Transformer.
8. Telephone transformer.

These are sealed in the right-hand partition of box

### The lower box contains

1. High-tension battery.
2. Safety resistance.
3. Battery condenser.

### Filament Rheostat

This consists of a spiral of manganin wire, having a total resistance of two ohms.

### Detector Condenser

This has a capacity of 0.4 jms with mica

copper wire having a resistance of 10,510 ohms.

### Telephone Transformer

The primary and secondary are wound on a soft iron core. The primary consists of two coils connected in series and the secondary consists of a single coil sandwiched between the two primary windings. The primary has 9,600 turns of No. 42

# Tuning Cards

MOST, if not all, amateurs memorise the calibrations of their receiving sets or have to tune each time to the station it is desired to hear. It may not be generally known that the use of a tuning card would be of great assistance. These are used in just the same way as a business man uses a file index. An example of such a card is shown below, though, of course, this may be modified according to individual requirements.

| STN. | γ | A.T.I. | A.T.C. | C.C.C. | COIL NOS. |   |   | COUPLING | H.T. (volts) | STRENGTH | REMARKS |
|------|---|--------|--------|--------|-----------|---|---|----------|--------------|----------|---------|
|      |   |        |        |        | P         | S | R |          |              |          |         |
|      |   |        |        |        |           |   |   |          |              |          |         |

A. H. A. C. C.

# Good Joints Make All the Difference

All the Joints the Amateur Need Consider are Here Described and Illustrated

THESE lines are penned in the hope of assisting those who have not had a great deal of experience in handling wire, particularly those who are making their own apparatus.

When cleaning the ends of wire for

fore cutting it off. This prevents it fraying out and looking untidy.

Some wires (those which are rubber insulated) are tinned. In making joints in such wires endeavour not to scrape the tinning off, as the tinning makes soldering easier.

### Nib Joints

The illustrations show a few types of joints. Figs. 1, 2, 2a and 3 show the three stages of a nib-joint. This is used for fine and medium gauge wires. Slip a paper sleeve  $1\frac{1}{2}$  in. long over one end of the wire, cross the ends so they make an angle of 90 deg.; when the wire is fine, make two twists with the insulation on, then clean the ends and twist up. Trim up to form a nib about  $\frac{1}{2}$  in. long. When trimming off, as you feel the cutters bite turn them the same way as the wire is twisted; this tightens the joint. Press the nib down on the wire to point away from the sleeve. Now slip the sleeve over the joint and tie down at each end with thread. These sleeves may be manufactured at home with some notepaper, a knitting-needle and some gum. The method needs no explanation.

### Twist Joints

Fig. 4 shows a twist joint often used for open work, that is single-strand aeri-als, but it is sometimes used for internal work. Cross the two ends about half-way along the bared portion, which should vary according to the gauge of the wire. The two end angles should be about 60 deg., so that the twist in the joint may not have too sharp a lay. Make three alternate twists with each hand, then bind over as shown in Fig. 4 for about six turns. Trim off and tighten up the helix with the pliers. This joint may also be used for the finer strand wires, often for a T-joint. Fig. 4a needs no explanation.

### Stranded Wires

Another joint for stranded wires is shown in Figs. 5, 6 and 7 and is called the married joint. The wire is unravelled about 6 in. and frayed out. The two ends are then brought together so that the wires alternate. Now smooth down the ends, commencing from the middle. Take one wire and bind it round the others tightly for seven turns (Fig. 7) and cut off. Take another on the same side, and bind for six turns, and so on till four is reached, then bind the remainder three times each. Do the same the other side, tighten all ends with pliers. Stay wires are made off round a thimble or holdfast in the same manner (Fig. 8).

### T-joints

A T-joint in stranded wires is made as

follows (Fig. 9). Cut away the odd strand or turn it back and bind it down the cable for about six turns, open out the remaining two, four or six wires into V-shape with an equal number of strands on each side, and bind over (see Fig. 10) until the

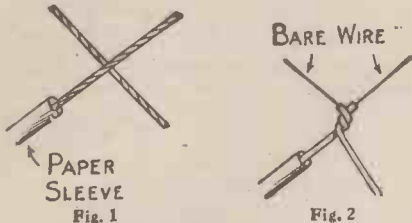

Figs. 1 and 2.—First and Second Stages in Making Nib Joint.

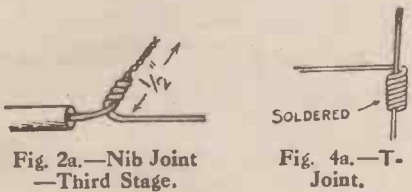

Fig. 2a.—Nib Joint—Third Stage. Fig. 4a.—T-Joint.



Fig. 3.—The Nib Joint Completed.

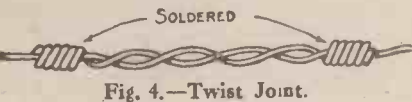

Fig. 4.—Twist Joint.



Fig. 5.—First Stage in Making Married Joint

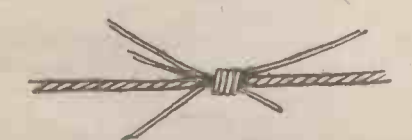

Fig. 6.—Second Stage in Making Married Joint.



Figs. 5, 6 and 7.—Married Joint Complete.

terminations or joints the greatest care must be taken not to nick the wire. If the wire be cotton- or silk-covered of a medium gauge, take the end of the silk or cotton strands and unwind them off the wire for a sufficient distance for the purpose in hand, then make the cotton off round the wire by a double half-hitch be-

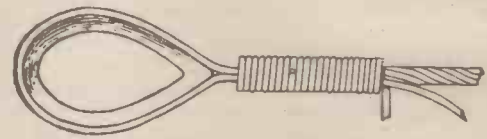

Fig. 8.—Method of Attaching Thimble.

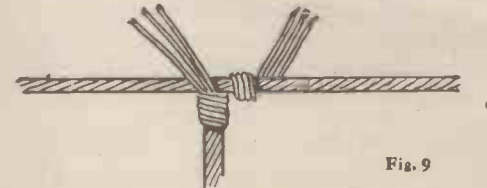

Fig. 9



Fig. 10

Figs. 9 and 10.—T-joint in Stranded Wire.



Fig. 11

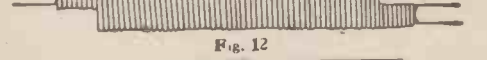

Fig. 12

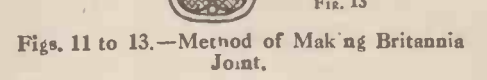

Fig. 13

Figs. 11 to 13.—Method of Making Britannia Joint.

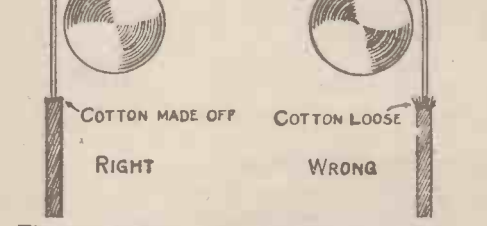

Fig. 14.—Diagrams showing Correct and Incorrect Attachment of Wires to Terminals.

overall length of the joint is about  $2\frac{1}{2}$  in. Trim off and tighten up.

### Britannia Joints

The britannia joint (Figs. 11, 12 and 13) is used for stout wires and is made as follows. Well clean the ends and overlay them as shown for about 2 in., take a piece

of copper wire, about 20 s.w.g., 30 in. long, and start binding in the centre of the joint with the centre of the binder. Make about three turns and then slip short pieces of copper wire the exact length of the overlay under the binder to occupy the position shown by X in Fig. 12, then complete the binding operation. To finish the joint it is necessary to solder it, using resin as a flux. Do not on any account use spirits of salts. Tin the bit well and

have it well heated so as to do the job quickly, wipe off the superfluous metal and let the joint cool in air.

When re-insulating joints give them at least one lapping of tape before rubbering up.

Always have the bit hot enough to do the job quickly to avoid damaging adjacent insulation.

Whenever possible lace internal wires into a small cable. This is conducive to

interior neatness. Macramé twine makes good lacing.

When dipping cables and wires into beeswax, be sure the wax is not too hot, or the insulation will fall off as soon as it is touched.

Fig. 14 shows the correct and incorrect ways of wiring terminals. Always put the wire so that the terminal nut tends to close the wire in under the terminal and not spread it out. A. S. M.

## All About the Valve.—II

The Second of a Series of Articles Explaining the Principles and Action of the Thermionic Valve

IF we consider for a moment the state of affairs in the case of a glowing filament, carrying a current of approximately half an ampere, enclosed in an evacuated vessel, we must picture a continual flow of billions of electrons jumping from atom to atom of the filament under the com-

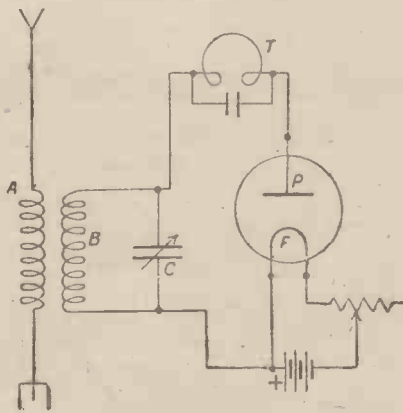

Fig. 3.—Circuit Employing 2-electrode Fleming Valve

pulsion of the electro-motive force applied by the heating battery. In addition, the molecules of the filament are in a state of intense vibration or activity, as is evidenced by the fact that the filament is raised to a white heat. In these circumstances it is not difficult to imagine that a considerable proportion of the loosely-bound electrons are thrown off from the substance of the filament into the surrounding space, which, it must be remembered, is practically a vacuum, so that there are no surrounding gas molecules to restrain or clog the emission.

If there were no relief path or exit provided for the electrons so flung off they would rapidly accumulate within the evacuated volume of the globe until a state of equilibrium would arise wherein as many electrons would re-enter the filament as were being projected from it.

Fleming, however, provided such a relief path by inserting a metal plate or shield in the globe and connecting it to an external circuit. Simultaneously, by means of this circuit, the alternating

signal currents flowing in a wireless receiving aerial are caused to impart corresponding potentials to the plate. When the applied potential is positive, the electrons emitted from the filament are attracted to the plate and find a relief path through the external circuit. When the plate potential is negative, the electrons instead of being attracted are repelled, and therefore no relief current can take place.

### The Original Fleming Valve

The original form of the Fleming valve is shown in Fig. 3. It functioned simply and solely as a rectifier or detector, or a one-way valve. In other words, it is purely a device which allows the passage of one half-wave of an alternating current but not of the other half. There is no auxiliary battery in the plate circuit, and consequently there is no amplification or relay effect.

In operation the grid circuit BC is tuned to the frequency of the oscillations received on the aerial A. The resulting current surge in the circuit BC throws the condenser plate connected to the anode P,

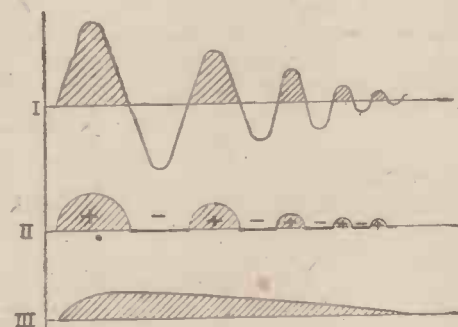

Fig. 4.—Diagram Illustrating Stages in Reception of Damped Train of High-frequency Waves.

alternatively positive and negative, relatively to the filament F.

### Reception of Damped Waves

Fig. 4 illustrates the separate stages in

the reception of a damped train of high-frequency waves, such as is emitted from a spark transmitter. The high-frequency ether pulses are represented by the top curves.

During each instant that the plate P is

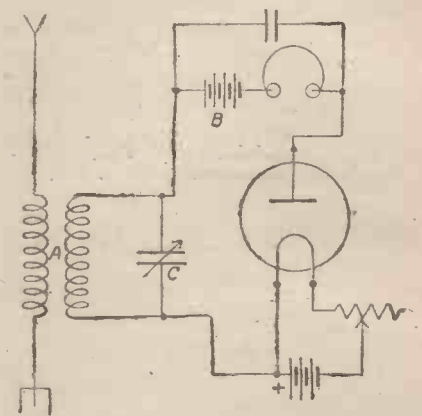

Fig. 5.—Diagram showing Circuit with Auxiliary Battery Added.

rendered positive, relatively to the filament, a small gush of electrons passes across the vacuous space between the plate and filament, and traverses the circuit containing the telephones T. These gushes of unidirectional current are represented by the second line of curves.

It must not be forgotten that these are still high-frequency pulses, and that they follow each other so rapidly that their effect on the phones is the same as the equivalent prolonged current-variation represented by the third curve. The duration of the telephone current therefore corresponds exactly to the effective duration of the wave-train emitted by each spark from the transmitter. Each such train gives rise to a single click in the phones, and the effect of the rapid succession of clicks is to create a telephone note of the same pitch as the spark-frequency at the sending end.

The transformation of the series of humps in the second line into the continuous hump of the third line curve is due to the fact that the high-frequency



# I've got Mullard Accessories

The wireless components with a world-wide reputation of many years' standing. They will ensure your getting a set which looks well, works well and "speaks" well.

For receiving vocal and instrumental items you must have the

## MULLARD "ORA" Valves

to get the best results.

**Oscillates—Rectifies—Amplifies**

Specially recommended where good amplification is required.

**15/-** each

### IMPORTANT NOTICE.

The great demand for Mullard ORA Valves and other accessories has compelled us to open much larger works. A greatly increased output is now available.

The MULLARD "R" Valve is now reduced in price from 22/6 to 17/6

## Mullard Radio Valve Co.Ltd.

45, Nightingale Lane, S.W.12

Contractors to H.M. Admiralty,  
War Office, Royal Air Force & Post Office,

Telephone: Codes: Telegrams:  
Hammersmith 312 ABC(5Ed) Radiovalve Hammer Lond?



| Name and Address.....              |                                         | Please send me post free                    |                                   |
|------------------------------------|-----------------------------------------|---------------------------------------------|-----------------------------------|
| To the                             | MULLARD RADIO VALVE CO. LTD.,           | Quantity                                    | Description                       |
|                                    | 45, Nightingale Lane, London, S. W. 12. | .....                                       | Telephone Head Sets               |
|                                    |                                         | .....                                       | ORA Valves                        |
|                                    |                                         | .....                                       | Grid A Resistances                |
|                                    |                                         | .....                                       | Anode A or B Resistances          |
|                                    |                                         | .....                                       | BA Condensers, 0003 mfd.          |
|                                    |                                         | .....                                       | Combined Resistance and Condenser |
|                                    |                                         | .....                                       | Valve Bases with Terminals        |
|                                    |                                         | .....                                       | Valve Sockets                     |
|                                    |                                         | .....                                       | Terminal Clips                    |
|                                    |                                         | Price                                       | 30/- per set                      |
|                                    |                                         |                                             | 15/- each                         |
|                                    |                                         |                                             | 5/- "                             |
|                                    |                                         |                                             | 2/6 "                             |
|                                    |                                         |                                             | 7/6 "                             |
|                                    |                                         |                                             | 5/- "                             |
|                                    |                                         |                                             | 1/3 "                             |
|                                    |                                         |                                             | 9d. per pair                      |
| Name of usual Wireless Dealer..... |                                         | 1 enclose (Cheque, Money Order, P.O.) value |                                   |
|                                    |                                         | to cover the cost.                          |                                   |
| <b>SEND THIS TO-DAY</b>            |                                         |                                             |                                   |

# YOU CANNOT OBTAIN BETTER QUALITY!

The "RELIANCE" VALVE RECEIVERS comprise the very best material and workmanship, and are giving wonderful results. Our aim is to GIVE YOU EVERY SATISFACTION, and with this policy in view we offer

## ONE LOUD SPEAKER FREE!

to every purchaser of one of these "RELIANCE" SUPER THREE VALVE SETS.



**"RELIANCE" SUPER THREE VALVE (1 Detector 2 H.F.)**  
**Specification:**—Three Best Ebonite Valve Holders; Three Separate First Grade Filament Rheostats; Two H.F. Transformer Sockets; Highly Efficient Grid Leak and Condenser; Telephone Condenser of correct capacity; Two Vernier Condensers across Transformer Primaries, with engraved dials 0-100; Twelve Brass Terminals, mounted upon Engraved Ebonite Panel, 14 in. X 12 in., and contained in highly polished sloping Mahogany Cabinet with sliding back.

**Equipment:**—4 vt. 60 amp. Hart Accumulator; 60 vt. H.T. Battery, with tappings; 3 Mullard "Ora" Valves or A.R. Special; Circular Tuning Condenser .0005 mfd.; 4 H.F. first quality Transformers (Plug in Type); 1 pair Best H.R. Headphones 4,000 or 8,000 ohms; Aerial Equipment and Wiring Diagram.

**Price**—With Loose Coupler Inductance, **£21.**

With Set Hoop Coils and 3-way Coil Holder, **£25.**

With Low Frequency Transformer in lieu of one of the H.F. Transformers, 20/- extra.



### READ THESE TESTIMONIALS.

- Norbury, S.W. "I heard Writtle and Marconi House, and Croydon very loud (Aerowave Crystal Set)."
- Nelson, Lancs. "Received Reliance 2-valve Set. Am very pleased with same."
- Huddersfield. "As regards quality of goods I am highly pleased. I shall not fail to urge my friends to obtain sets from you."
- Horsham. "I am well satisfied with set."
- Coventry. "Received Reliance No. 2 Set and am very well satisfied."
- Swindon. "I may say I am perfectly satisfied with the Set."
- Glasgow. "Received your Reliance Set to-day and am very pleased with same."

## HENRY J. BREWSTER AND CO.,

Makers of "Aerowave" Specialties,

11, QUEEN VICTORIA STREET, LONDON. E.C.4.

Phone: City 768

Grams: "Aerowave, Phone, London."

## COMPLETE AND EFFICIENT ONE-VALVE RECEIVING SET

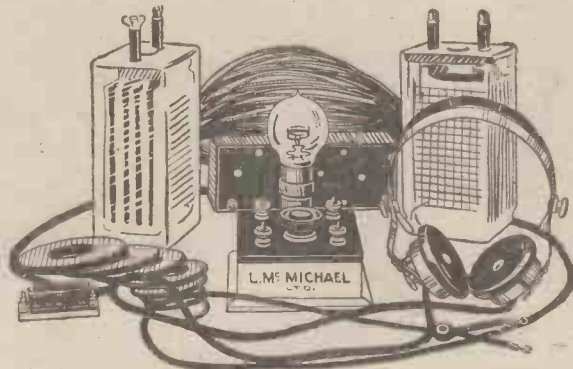

|                                                                              | £  | s. | d. |
|------------------------------------------------------------------------------|----|----|----|
| 1 Valve Panel in mahogany box with circular filament resistance              | 14 | 0  |    |
| 1 Variable Condenser                                                         | 1  | 0  | 0  |
| Complete set of slab coils for all wave lengths                              | 15 | 0  |    |
| 1 Valve (Ex-Government) if in stock                                          | 12 | 0  |    |
| 1 Battery, 72 volts tapped off every 4 Volts                                 | 15 | 0  |    |
| 1 4-volt Accumulator                                                         | 1  | 0  | 0  |
| 100 ft. Aerial Wire, best enamelled stranded Copper                          | 7  | 6  |    |
| 2 Insulators                                                                 | 2  | 0  |    |
| 1 pair Head Telephones                                                       | 1  | 10 | 0  |
| 60 ft. 19/30 tinned and rubber-covered Cable for earth connection and wiring | 1  | 6  |    |
|                                                                              | £6 | 17 | 0  |

VISIT OUR STAND No. 43, All-British Wireless Exhibition, Horticultural Hall, Sept. 30 to Oct. 7.

ILLUSTRATED CATALOGUE (A/W), post free 6d. 15 pages, 100 illustrations. When writing please mention this publication.

## LESLIE McMICHAEL, Ltd.,

Providence Place, West End Lane, Kilburn, N.W.6.

Bus Services 1, 8, 16, 28, 31, all pass West End Lane.

Telephone: HAMPS TEAD 1261. Nearest Tube Station: KILBURN PARK (Bakerloo.)

## A RECEIVING SET WITHOUT 'PHONES IS LIKE A SHIP WITHOUT A RUDDER

### The "Brown" Super-Sensitive Telephones

These Telephones are unquestionably the clearest and most sensitive made, and consequently, increase the distance over which wireless can be heard. BROWN'S are recognised as the most comfortable to wear, due to their extreme lightness in weight and adaptable adjustment. There is no wireless headphones in the world to compare with BROWN'S.



"A" TYPE

Low Resistance

58/-

High Resistance

62/- to 66/-

"D" TYPE

Low Resistance

48/-

High Resistance

52/-

(Above Prices include cords.)

Wireless Instruments and parts manufactured by and bearing the name "BROWN" can still be bought with absolute confidence in their quality, value and efficiency, because throughout this period of increasing wireless activity S. G. BROWN, Ltd., have wisely refused to lower their high standard of quality.

**IMPORTANT NOTICE.**—When purchasing BROWN'S, you should see that the name BROWN is stamped on the back of each ear-piece.

IN UNIVERSAL USE, AS SUPPLIED TO BRITISH, ALLIED AND FOREIGN GOVERNMENTS.

### ILLUSTRATED CATALOGUES POST FREE

Head Office & Works—  
 Victoria Rd., NORTH  
 ACTON, LONDON, W.3.

London Showrooms—  
 19, MORTIMER STREET  
 LONDON, W.1.





ALL ABOUT THE VALVE (continued from page 442.)

non-directional pulses occur so rapidly that they simply charge up the telephone condenser. This subsequently discharges in one surge through the phones (represented by the third curve) during the relatively long interval of time that elapses between one spark and the next.

It may be added that during the time when the plate P is charged negatively, the electrons emitted from the glowing filament merely describe a cyclic path in the internal space, and eventually return to the filament towards the positive leg without reaching the plate.

### The Ether-content

In order to present a clear mental picture of the sequence of events concerned in reception, we will assume a spark transmitter to be working on a wave-length of 3,000 metres. As the velocity of propagation of the signal energy is 300,000,000 metres per second, it follows that if there were a constant emission of waves from the transmitter, 100,000 waves would strike the receiver in each second. In fact, however, there is by no means a constant emission of energy. If the spark frequency is set at 500 per second, and if we assume that each spark gives out a damped series of waves of which, say, the first ten only are of sufficient amplitude to affect the receivers, then a very simple calculation will show that instead of 100,000 waves we have only provided 5,000 per second, or one-twentieth the number that would correspond to a continuous emission from the transmitter.

To gain an idea of their distribution throughout space the whole interval of one second must first be divided into 500 equal parts, and secondly, each of these parts must be again subdivided into two intervals, the first representing the time interval during which one train-wave (of ten alternations) strikes the aerial, and the second representing the interval during which the aerial is quiescent—that is, before the next wave-train comes along. As pointed out above, the second sub-interval must be nineteen times longer than the first or active sub-interval. This simple calculation gives some measure of the enormous rapidity of the high-frequency oscillations carried by the ether. It is during the longer subdivisions of the 1/500 part of a second that the telephone condenser (which has been charged up by ten rapid gushes in the first and shorter interval) has time to discharge, and so gives rise to the telephone click (see Fig. 4).

These clicks occur at the rate of 500 per second—a low or audible frequency, and the telephone note is of a pitch corresponding to that frequency; its duration corresponds to the time during which the transmitter key has been held down for a dot or dash Morse interval; and its loudness is proportional to the energy received by the aerial—that is, to the square of the amplitude of the ether wave at that point.

### Improved Fleming Valve

In its original form, the Fleming valve, as has already been pointed out, functioned purely as a rectifier, allowing the passage of one-half of an alternating impressed electro-motive force, but stopping the other.

The provision of a second, auxiliary battery B connected directly between the filament and plate, as shown in Fig. 5, imparted a new and valuable characteristic to the valve in operation. With the introduction of this battery the device acquired the characteristic of a true relay, although not to the same degree as it exhibits in the still later form in which the grid or control electrode is utilised.

### The Stream of Electrons

The regular stream of electrons which normally crosses the filament-plate space under the pressure of the auxiliary plate battery is found to respond in a marked degree to the application of signal voltage-variations on the plate through the circuit AC. That is to say, the small input of energy derived from the aerial circuit is utilised to create and control corresponding variations in a relatively heavy output current passing through the phones. The extent of these output variations (and therefore the degree of magnification involved) depends upon two factors, namely (1) the filament current and (2) the steady voltage applied to the plate by the battery B.

In other words, the advantage of this circuit over the original Fleming arrangement lies in the fact that it enables the valve to be operated at the most sensitive point on its characteristic curve.

As the principles here involved are of general application, particularly when we come subsequently to deal with the three-electrode tube, it is necessary to consider them in detail.—D. ALCASE.

(To be continued)

## More American Hints and Tips

### Strengthening Signals

ENTHUSIASTS having receiving sets employing only a single valve can strengthen the signals by taking the magnet poles from an old telephone receiver and placing them in different positions in front of the valve. Signals, ordinarily received very weakly, may be heard very clearly using this arrangement.—*Radio Digest*.

### Tuning

THE operation of changing the adjustment of a crystal often results in a slight change in the wave length of the circuit. This is caused by the relatively high internal resistance of the crystal. In view of this fact, slight readjustments of the tuning coil or of the variable condenser will be found advisable, after the detector has been adjusted.—*Radio Digest*.

### Use for Old Dry Batteries

DO not throw out your old dry cells.

The tar insulating material may be used; binding posts may be filed down and made into switch points.—*Radio Digest*.

### A Simple Variable Condenser

PROCURE two tin cans so that one will fit snugly into the other. Wash off all the labels, etc., and paste a piece of paper on the smaller can, to insulate it from the

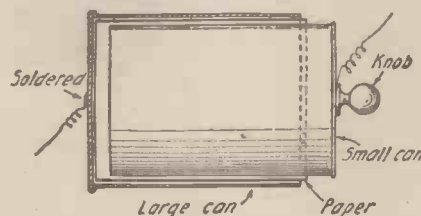

A Simple Variable Condenser.

larger one. Then give it two coats of shellac. Solder a wire to the larger can and fasten a binding post to the smaller (which also serves as a handle), and the

condenser is complete. It will add much to the appearance of the condenser if the cans are painted and mounted on a base, or if they are hidden in a box and a long rod projecting through the box is used for a handle.—*Radio News*.

### Mounting Jacks in Panels

WHEN mounting jacks in panels, the long sleeve support should be turned so that the contacts will extend beneath the jack. This will prevent the dust falling in between the contact points. It often happens that a small particle of dust will cause an open circuit, or at least noise in the receiving circuit.—*Radio Digest*.

### Fixed Condenser on 'Phones

VERY often the fixed condenser across the phones will have to be removed if one or more loud speakers is attached in addition to the phones. It is well, therefore, to have the phone condenser connected with a switch.—*Radio Digest*.

# Charging Accumulators from Small Batteries

And How to Make the Primary Cells

MANY amateurs have certainly been hindered by the question of producing the 4- or 6-volt current to feed the filament of their valves. It is well known that primary cells are not very suitable for this purpose. The best of this type is the bichromate battery; it is the only one which gives a large enough current to light the filament brilliantly, but the cur-

rent thus produced is not steady enough to get good results. The usual type of valve takes about half an ampere. With the new type of French low-consumption valve which has recently been placed on the market an attempt may be made with a large Leclanché-sack battery, as the filament of these new valves takes about 0.15 amperes only. But here also the current is not steady, and therefore the storage battery is universally adopted as being the best solution. For the amateur who has not the lighting supply at his disposal there is a choice between two suitable primary charging batteries—the bichromate cell and the

filaments take 6 volts, a 4-cell battery will give 8 volts and charge the 6-volt storage battery which is usually adopted with English valves. These bichromate batteries have been much used to charge ignition accumulators, but now bichromate of potash is costly, much more so than sulphate of copper, and they are tedious in the extreme to manage on account of dismantling, amalgamation of the zinc elements with mercury, preparation of solutions, etc.

Sulphate of copper cells are much more suitable for the purpose we have in view; the voltage that they give is much lower, being about 1 volt per cell instead of 2, and therefore twice the number of cells are needed—that is to say, 6 cells for a 4-volt and 8 or even 9 for a 6-volt accumulator.

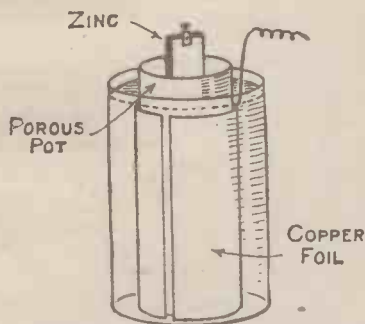

Fig. 1.—Diagram of Daniell Cell.

The current produced by such cells is quite steady; it is produced for a long time, week after week, without dismantling or the necessity of preparing another new solution.

In order to reach a sufficient charging rate large cells must be chosen; glass jars 8 in. high by 4½ in. in diameter, with 8 in. to 8½ in. high by 2½-in. porous pots, are very suitable. As a very steady current is a necessity, it is preferable to put the zinc element into the porous pots with the copper-foil into the outer glass jars. In order to have a low resistance the copper-foil which surrounds the porous pot must be kept as near as possible to it

ing to the desired voltage) are connected up in series and sulphate of copper has been poured into the glass jars the battery already gives a steady current and the accumulator can be put on charge. The current remains steady as long as there is zinc and sulphate of copper in the cells, and all that is needed is to add sulphate when the solution has lost its blue colour and to replace the zincs when they are eaten away. After some weeks the density of the solution will have increased too much, and it is advisable to remove a little of the concentrated liquid and replace it by pure water.

The accumulators remain continuously

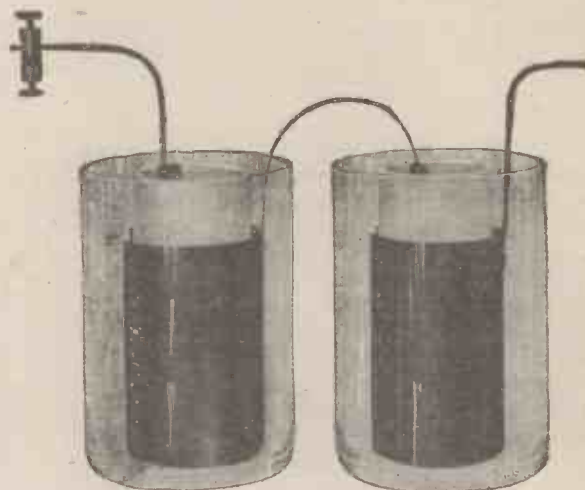

Two Daniell Cells in Series (Siemens Bros.)

The accumulators remain continuously

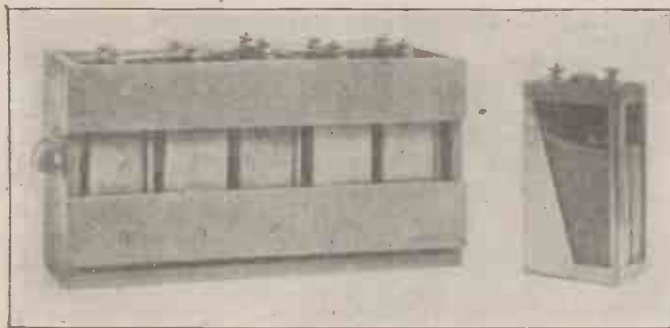

Alkaline Accumulator (E. G. Lind & Co.)

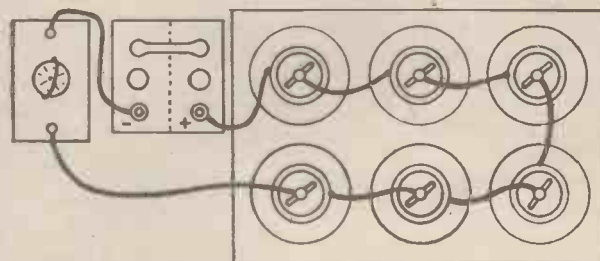

Fig. 2.—Arrangement of Cells, Accumulator and Ammeter for Charging.

Daniell sulphate of copper cell (Fig. 1). As stated, the former gives a heavy current, and thus can charge up an accumulator in a relatively short time. A 3-cell battery gives 6 volts and will charge up a 4-volt accumulator. If the

without actually touching. Further, instead of putting pure water into the jars, it is well to add to it a small quantity of salt. It will be useful to verify the density of the salt solution with a hydrometer, as the same degree must be kept in the com-

on charge day and night. An ammeter (0.1 ampere to 0.3 ampere) will be found very useful to show the amount of current which is passing through (see Fig. 2). An accurate, reliable and cheap ammeter can easily be made for a few pence with a

magnetic compass. First take a small piece of dry wood 6 in. long by 4 in. wide, fit a terminal at each end and the com-

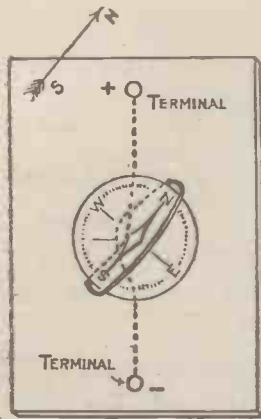

Fig. 4.—A Simple Ammeter.

pass in the centre. The greater the diameter of the compass dial the better, as readings will then be more accurate. Bore two small holes each side of the N.-S.

line in the wooden base and pass a heavy-gauge insulated wire through (Fig. 3). The wire must make a complete loop around the N.-S. line, the two ends being connected to the terminals. With this simple device it is necessary that the N.-S. line should be north and south. The deviation of the needle is proportional to some extent to the intensity of the current, and, if desired, the instrument can be compared with an accurate ammeter and calibrated against it. Inserted in series between the charging battery and the accumulators the instrument will indicate the amount of current passing.

A charging set built up on the above lines has been in use at my station (La Ferté St. Cyr, L. et Ch., France) for over two years, and the Daniell battery gives all the current I want to feed up either a single-valve set or a three-valve amplifier. On occasions I have found my accumulators overcharged and have had to switch off the battery. I find it most satisfactory, and I can thoroughly recommend it to my amateur friends as a battery which one can rely upon. MARIUS THOUVAIS.

rection of error takes the form of pulling the tap over in the required direction. Brass may be tapped dry, but it is better to use a spot of oil.

As the action of tapping raises a swel-

BRITISH ASSOCIATION GAUGE FOR SCREWS

| No. | Absolute Dimensions in Millimetres |       | Approximate Number of Threads per Inch | Approximate Dimensions in Inches |        |
|-----|------------------------------------|-------|----------------------------------------|----------------------------------|--------|
|     | Full Diameter                      | Pitch |                                        | Full Diameter                    | Pitch  |
| 25  | 0.25                               | 0.070 | 362.8                                  | 0.010                            | 0.0028 |
| 24  | 0.29                               | 0.080 | 317.5                                  | 0.011                            | 0.0031 |
| 23  | 0.33                               | 0.09  | 282.2                                  | 0.013                            | 0.0035 |
| 22  | 0.37                               | 0.10  | 254                                    | 0.015                            | 0.0039 |
| 21  | 0.42                               | 0.11  | 230.9                                  | 0.017                            | 0.0043 |
| 20  | 0.48                               | 0.12  | 211.6                                  | 0.019                            | 0.0047 |
| 19  | 0.54                               | 0.14  | 181.4                                  | 0.021                            | 0.0053 |
| 18  | 0.62                               | 0.15  | 169.3                                  | 0.024                            | 0.0059 |
| 17  | 0.70                               | 0.17  | 149.4                                  | 0.028                            | 0.0067 |
| 16  | 0.79                               | 0.19  | 133.7                                  | 0.031                            | 0.0075 |
| 15  | 0.90                               | 0.21  | 121.0                                  | 0.035                            | 0.0083 |
| 14  | 1.0                                | 0.23  | 110.4                                  | 0.039                            | 0.0091 |
| 13  | 1.2                                | 0.25  | 101.6                                  | 0.047                            | 0.0098 |
| 12  | 1.3                                | 0.28  | 90.7                                   | 0.051                            | 0.0110 |
| 11  | 1.5                                | 0.31  | 81.9                                   | 0.059                            | 0.0122 |
| 10  | 1.7                                | 0.35  | 72.6                                   | 0.067                            | 0.0138 |
| 9   | 1.9                                | 0.39  | 65.1                                   | 0.075                            | 0.0154 |
| 8   | 2.2                                | 0.43  | 59.1                                   | 0.087                            | 0.0169 |
| 7   | 2.5                                | 0.48  | 52.9                                   | 0.098                            | 0.0189 |
| 6   | 2.8                                | 0.53  | 47.9                                   | 0.110                            | 0.0209 |
| 5   | 3.2                                | 0.59  | 43.0                                   | 0.126                            | 0.0232 |
| 4   | 3.6                                | 0.66  | 38.5                                   | 0.142                            | 0.0260 |
| 3   | 4.1                                | 0.73  | 34.8                                   | 0.161                            | 0.0287 |
| 2   | 4.7                                | 0.81  | 31.4                                   | 0.185                            | 0.0319 |
| 1   | 5.3                                | 0.90  | 28.2                                   | 0.209                            | 0.0354 |
| 0   | 6.0                                | 1.00  | 25.4                                   | 0.236                            | 0.0394 |

# Electrical Benchwork

## Hand Screw-threading with Taps and Dies

IN nearly all screwed electrical fittings the British Association standard screw thread is the one adopted. A table of the various proportions of this thread is given on this page, but there is really no need for the reader to bother with the pitch, etc. The useful information is that which gives the size of the hole which must be drilled to receive a tap of a given size, and the column giving the diameters enables the reader to select a rod to suit a given die.

### Requirements

There is no need to purchase a full set of B.A. stocks and dies, as the smaller sizes are only used in fine instrument work. I find that any set which consists of taps and dies from 2 B.A. to 6 B.A. covers the full range of stuff I want to screw, and all wireless fittings are made within this range. It is only occasionally that they come into use, as screwed stuff may be bought so cheaply that it hardly pays to go to the trouble of screwing stuff oneself.

With regard to the taps, in this fine thread only one of each size is necessary. It will be found that these have a taper or pilot point which gives the required lead. The wrench (which embodies a collect socket) may conveniently be of the type shown in Fig. 1. The dies are all of the solid variety (see Fig. 2) and held in a socketed holder. Slight variations in cutting size are effected by means of a

grub screw which rides in a split (see Fig. 2).

In using taps great care is necessary to see that they enter the work squarely, and

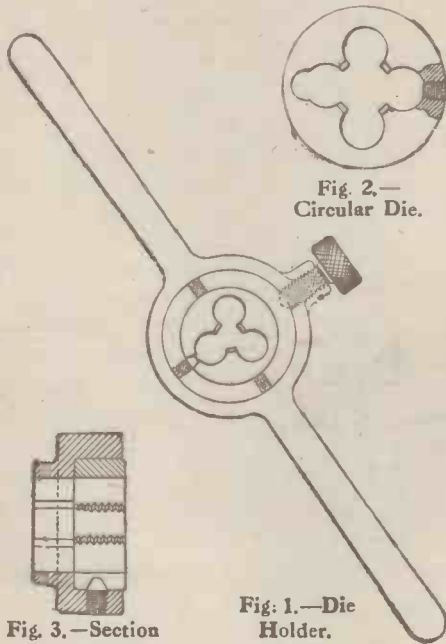

Fig. 2.—Circular Die.

Fig. 3.—Section through Die and Collet.

Fig. 1.—Die Holder.

you should sight along to ensure this after the first two or three threads have been cut, as it is difficult to correct the error if the tapping is taken too far. The cor-

ring round the hole, which prevents any bedding down on the surface, it is wise lightly to countersink each hole.

These fine taps break very easily, and to prevent this they should be moved backwards and forwards in the hole during cutting; you will "feel" when the tap is cutting up to the limit.

### Using Dies

Care is necessary in starting a die to prevent the thread from being atwist or "drunken," and it is safer slightly to taper the end with a file before beginning so that a "lead" is given to the die, enabling the threads to start fairly. An even pressure should be applied on each side of the stock so that the thread starts squarely, and, as with tapping, it is desirable after starting the first two or three threads to see how the diestock lies in relation to the rod. It should be square to the axis of the rod, and any adjustment effected by pressing harder on one side than the other. A small quantity of oil should be applied to the die and the stock should be turned forwards and backwards.

A lot of trouble is saved in fairly starting a die on a rod if, when purchasing the die stock, one is obtained with a guide portion to pilot the rod truly on the die (see Fig. 3).

Swarf should frequently be blown away from the die, otherwise it is likely to become jammed in it and strip the thread.

There is no need in the general run of wireless work to cut the threads so that the nut requires a spanner to seat it home. A fit enabling the nut or terminal to be spun on (but which also enables a pressure to be placed upon it when "home") should be aimed at.

INGOT.

TO do for the eye what the telephone has done for the ear has long been a favourite problem with inventors, a large amount of time, money and ingenuity having been bestowed upon the many attempts made to solve it. This particular branch of electrical science is known as "television," and has for its object the invention of some means whereby the actual presentment of a person or object placed at the transmitter can be produced instantaneously and automatically at a distance.

Although during the last fifty years numerous suggestions have been made and many experiments carried out with a view to solving this alluring and fascinating problem, up to the present all attempts have been more or less failures. The word failure is used advisedly. Results of quite a promising nature have from time to time been obtained by various investigators, but they have been mostly laboratory experiments, the apparatus used being in no way intended or suitable for practical use. The reason is not so much the fact that it is not known how it might be done (for as a matter of fact the broad principles underlying television have been known for a considerable number of years) as it is the immense practical difficulties that will have to be overcome before any system of television can be of commercial utility. Television is quite possible experimentally, but from a commercial point of view is entirely impracticable.

**Applications**

The practical applications are many and

varied. Television apparatus, used in conjunction with the ordinary telephone arrangements, would certainly possess many advantages and greatly increase the range of usefulness of the latter instrument. It would render that common phrase, "Hullo, are you there?" unnecessary, as each person would be able to see with whom they were conversing.

Imagine how wonderful it would be if we were able to enter a public hall, or even a private room, and by the aid of television to see on a screen, at the actual time of occurrence, say, a boxing match in London, the Derby run at Epsom, a cricket match at Lord's, and a thousand and one of the other interesting events that are constantly taking place!

**Experiments**

Although, as already stated, there have been several demonstration sets built for illustrating various methods of television, which, to a certain extent, have proved workable, both the apparatus used and the results obtained have been very elementary. So far, owing to the enor-

# TELEVISION

## SHALL WE EVER SEE

The First of a New

mous expense and the great difficulties which would have to be overcome, no really practical test has ever taken place.

In each of these experimental attempts a metallic circuit between the transmitter and receiver has been necessary, but quite recently, in view of the great practical difficulties that exist in attempting to work any television apparatus over a metallic circuit, wireless has been suggested as a possible solution.

Whether wireless television is possible or not experiment alone can prove, and the time may not be far distant when it will be possible to show, instantaneously and in natural colours, a topical event at the actual moment of occurrence on the screen at any number of theatres, the pictures in fact being broadcast in much the same manner as wireless concerts are now broadcast. Results obtained up to the present, however, in no way justify such an extravagant prophecy.

The whole problem of television, being in a purely experimental stage, offers enormous possibilities for original research work and is well worth the careful con-

## THE LATEST DEVELOPMENTS

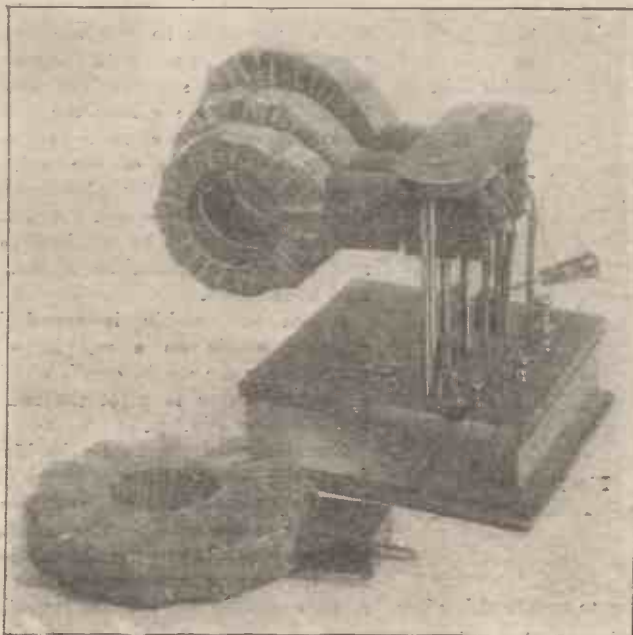

These photographs illustrate the great amount of ingenuity that is displayed in the construction of coil holders. The one on the left is by the City Accumulator Co., Ltd., and is lever-operated from the rear. The coils on the holder shown in the centre are capable of two



# VISION SEE BY WIRELESS?

Level Series of Articles

consideration of anyone who is interested and who requires a fresh field for the exercise of his inventive ability.

## Principles

It will perhaps be as well, before attempting to deal with the wireless aspect of the subject, to give a brief description of the principles involved, the difficulties to be overcome in practice, and the various attempts that have been made from time to time in an endeavour to find a successful solution to the problem.

Previous to the discovery of selenium (a non-metallic element possessing a high degree of electrical resistance variable with the amount of light to which it is exposed), all attempts to solve the problem of television failed. Several spasmodic efforts were made, however, to transmit writing and even sketches by electrical means, but the experiments were soon abandoned, there being at that time no great incentive for development. Quite recently, owing to the great and ever-increasing public demand for illustrated newspapers, "photo-telegraphy," as this

branch of electrical science is termed, has received a considerable amount of attention, some excellent results having been obtained over fairly long distances.

Although in some respects television and photo-telegraphy are closely allied, the difficulties to be overcome in the latter problem are much less than those to be overcome in the case of the former, for whereas with television the whole of the object to be transmitted must be reproduced practically instantaneously a number of times every second, in photo-telegraphy the received picture—which is a permanent record and not a transient impression—is built up gradually, as the subject can be retained for purposes of transmission as long as desired.

With the discovery of the wonderful properties of selenium (investigated by May in 1861) the possibility of its application to the solution of the problem of television was at once seen and numerous suggestions were put forward for this purpose.

As was only to be expected, the earliest workers endeavoured to construct their

apparatus to work upon a principle somewhat similar in character to that of the human eye, but in this case, as indeed in many others, the mechanical imitation of nature proved to be an exceedingly difficult problem.

The desire on the part of experimenters to apply the principle of the human eye as a working basis for their television apparatus was no doubt encouraged by the success which had attended the invention of the telephone receiver, its inventors having been greatly assisted in their work by studying the principles of the human ear.

The two cases, however, are not parallel. In telephony the vibrations consist of a number of impulses which impinge in very rapid succession on practically one spot on the telephone diaphragm; and while in television we also require a large number of impulses, the whole of these impulses must be delivered simultaneously or in such rapid succession as to appear simultaneous, and be distributed in proper sequence over the whole area of the televisionary screen.

## The Human Eye

The construction of the human eye is somewhat similar to the camera obscura, in which a lens throws an image of what is within its range upon a focusing screen. In the eye the image is similarly thrown by means of a lens upon what is virtually a screen, and known as the retina. Broadly speaking, the retina is composed of a large number of tiny nerve cells forming a mosaic of sensational elements. The optic nerve, which is an outgrowth

## INDUCTANCE-COIL HOLDERS



movements, pivotal and swinging. The third picture shows an ingenious adaptation of the screw principle. The makers of the two last mentioned pieces of apparatus are the Igranite Electric Co., Ltd., and Leslie McMichael, Ltd., respectively.

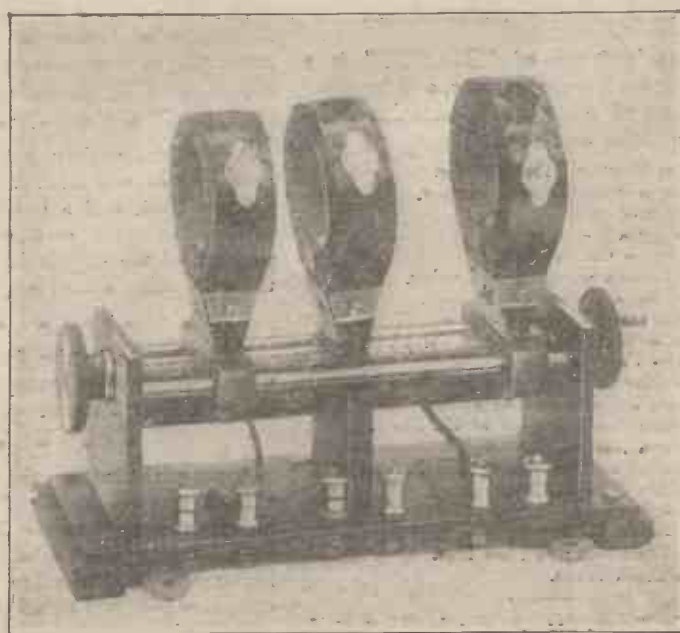

from the brain, is made up of very fine nerve fibres, each fibre being connected to one nerve cell of the retina. It has been estimated that the retina contains about 500,000 nerve cells and fibres.

These nerve cells are very sensitive to the electro-magnetic waves which we call light, so that when an image is focused upon the retina the various nerve cells are more or less stimulated, and the optic nerve conveys the impressions received to the brain.

There is one curious defect in human vision of which advantage has been taken by some workers in their attempts to produce a workable television model. This defect, known as the persistence of vision, has many valuable compensations. When light from some object is thrown upon the retina it makes an impression which lasts for some time (about one-tenth of a second) after the light has ceased. Were it not for this power of retention we could only see one letter of a word at a time when reading, and the cinematograph would be impossible.

We can say, therefore, that there are two methods by which we can reproduce a picture on our television screen in order to make it immediately and constantly visible. Either the whole of the picture must be produced instantaneously and repeated sufficiently often to allow movement being appreciated, or the picture can be built up gradually, the whole operation being required to take place in less than one-tenth of a second.

We have already stated that, in human vision, the image thrown upon the retina of the eye is conveyed to the brain in the form of a mosaic. In a somewhat similar but simpler manner advantage has been taken of this mosaic principle in the

mechanical reproduction processes so extensively used in printing. In these processes the picture is formed by means of a number of black dots upon a white background. The dot-mosaic character of the picture can be easily seen by examining a portion of any ordinary book illustration through a small microscope. It will be obvious that the greater the number of dots employed, the more complete will be the resultant picture. Even if a picture composed of fairly coarse dots is viewed at a distance, it will be found that the dot formation cannot be detected by the eye.

In high-class reproduction work as many as 15,000 dots per square inch are employed, and with this number the keenest eye, even with the closest scrutiny, can detect no signs of the dot character of the picture, although some of the finer details of the picture are necessarily destroyed. Compare this number with the 500,000 elements of the human eye for practically the same area and its perfection as a receiver is at once evident.

M. J. M.

## Radiograms

IT is estimated that approximately 35,000 persons visited the All-British Wireless Exhibition in the Horticultural Hall, Westminster, which closed on October 7th. On some days during the week there was a queue of people outside.

The Radio Corporation of America has announced that a world wireless combine, with New York as the centre, will include a British station at Carnarvon, a French at Saint Eassis, a German at Nauen, an Argentine at Montegrande, the whole representing a total invested capitalisation of \$170,000,000 (£34,000,000).

A wireless society has been formed by members of the L.C.C. staff at the new County Hall, and a 150-ft. aerial has been put up at their own expense. A large number of the staff hold special qualifications in science and engineering.

Experiments in the flying of a pilotless wireless-controlled aeroplane will shortly take place in France.

Among the many thousands of people who listened-in to the Prince of Wales's broadcast speech to the Boy Scouts of the nation were the blind soldiers of St. Dunstan's. Captain Ian Fraser, the blind chairman of St. Dunstan's, has been an ardent wireless experimenter for two years past, and in the course of a short address following the transmission he stated that

wireless telephony was opening a new world for the blind. A blind man's hobbies were limited, but wireless was one of those which he could pursue just as well as anyone else. In listening-in he was at no disadvantage to those who could see.

A demonstration of wireless telephony was given on the 7th instant at the works of Messrs. W. and T. Avery, Ltd., the weighing-machine makers, at Soho, near Birmingham, to about a thousand employees. A Tingey three-valve receiving unit was used, with two stages of low-frequency amplification, each embodying three valves. Three Weston loud-speakers and a "Magnavox" were put in circuit, and with the aid of these the large audience were enabled to hear music and speech from local amateurs and from 2L O quite clearly.

The Education Committee of West Bromwich are among the first of local authorities to recognise that wireless telephony has come to stay. A series of evening lectures on the fundamental principles of wireless telegraphy and telephony are announced. The scheme has already attracted the interest of a large number of intending students, and it is probable that at the end of the session the class will form a nucleus for the formation of a wireless club for the town.

It is rumoured that some enterprising firm has brought out a clothes-line which has a stranded copper centre for use in cases where landlords object to aerials.

An epidemic of these "endless-chain" prayers and good-luck letters has hit amateur wireless in America, promising no burnt-out valves if the recipient will maintain the continuity of the "chain."

The Radio Association are negotiating for premises in the West End of London. It is proposed to institute a library and information bureau, and equip the premises with the latest type of apparatus.

Is the doom of the gramophone in sight? A firm is now advertising: "Why not have your gramophone converted into a high-grade wireless receiving set?"

A considerable amount of progress has been made in the adaptation of the wireless telephone for use in tanks.

A new apparatus employing the thermionic valve for purposes of minute measurements has been devised. So sensitive is the instrument that the bending of a 1/2-in. steel bar caused by the impact of a smoke vortex ring is demonstrable. The instrument has been termed the "Ultra-micrometer."

## "WORK"

This week's issue of "WORK" is a Special Home Repair Number, and together with a host of other items, contains illustrated articles on:

- Putting Electric Bells in Order.
- Making a Small Vacuum Cleaner.
- A Page of Small Repairs.
- Repairing a Kettle.
- A Kitchen Clothes-airer.
- Odd Repairs with Bits of Leather.
- Disguising a Commonplace Clock.
- Clumping and Heeling Boots and Shoes.
- When an Electric Lamp will not Light.
- How to Paper a Room.
- Remedying Warped Doors and Windows.
- Cleaning and Overhauling a Gas Cooker.
- Replacing Pump Leather of Oil Stove.
- American Notions Illustrated.
- Enamelling and Lacquering Old Bedsteads.
- Repairing Door Fittings.
- Three-ply Picture-frames.
- Easily-made Tea-trays.
- Wall Decoration: A New Idea.
- Some Brush Kinks.

Thirty-six Pages. : Profusely Illustrated.  
NOW ON SALE, price 3d.

## Recording the Prince's Scout Speech

IT will interest our readers to know that the Prince's speech broadcast to the Boy Scouts was recorded by Mr. R. Horrocks, of Thornton Heath, Surrey, on a cylindrical phonograph blank, and has since been played over several times with highly satisfactory results, every word being perfectly clear and distinct, the receiving set being that described on page 323 of No. 16 AMATEUR WIRELESS.

The method of recording it was as follows: Messrs. Thos. A. Edison, Ltd., very kindly lent one of their "Edifones" for the purpose, these machines being the standard type supplied for office use for dictation purposes. During the afternoon various tests were made for conveying the received speech from the loud speaker to the "Edi-

fone," and it was found that the best results were obtained by removing the speaking tube, which is ordinarily used for dictation, and replacing with an aluminium horn about 8 in. in diameter at the big end and about 3 ft. long. This was then moved up until the receiving end of the horn was inside the loud speaker. At 7.30 p.m. the "Edifone" was started with a blank cylinder, the set switched on, and the whole of the remarks from Marconi House and the Prince's speech recorded. Incidentally the whole of the concert transmitted at 8 o'clock was also recorded, the results being excellent considering that the machine used is not designed for this purpose, but only for the dictation of letters.

## Broadcast Receivers: P.M.G.'s Regulations

THE following are the conditions, etc., according to the British Broadcasting Company, which broadcast receivers should fulfil to obtain Post Office approval:

1. That all types of broadcast receivers may be constructed for the reception of signals of any wave-lengths.

2. That the apparatus shall be so constructed that it is difficult to change the arrangement of the circuits embodied in the design by means of external connections.

3. The following units, each of which must consist of apparatus assembled, connected and mounted in a single container, shall be approved:

(a) Combined tuner and rectifier.

(b) Combined tuner, high-frequency amplifier and rectifier.

(c) Audio-frequency amplifier (of valve or other type).

Any combination of two or three of the above separate units (a), (b) and (c) will be allowed.

4. No receiving apparatus for general broadcast purposes shall contain a valve or valves so connected as to be capable of causing the aerial to oscillate.

5. Where reaction is used on to the first

receiving circuit it must not be adjustable, but must be fixed and incapable of causing oscillation.

6. Where reaction is used between a second or subsequent valve on to the anode circuit of a valve connected to the aerial, and there is no specific coupling provided between the first receiving circuit and the first anode circuit the reaction may be adjustable.

7. Tests of sets will be made on two aerials, one 30 ft. long and the other 100 ft. long.

8. The sets will be tested for the production of oscillations in the aerial and for interference properties with a factor of safety, i.e. increasing the high-tension battery by about 30 per cent., changing valves, etc., but not by altering any soldered connections.

9. The Postmaster-General must be satisfied that sets containing reaction can be reasonably repeated with consistent conditions.

10. After approval the type will be given a Post Office registered number and makers must see that the sets fulfil the non-interfering conditions before they are sold. All sets sold under the broadcast licence shall

bear the registered trade mark of the Broadcasting Company and the Post Office registered number.

11. The unit or set approved as the pattern instrument of a type shall be retained without alteration by the maker. The Postmaster-General shall have the right at any time to select any set of an approved type for test to see that the set is reasonably similar to the approved pattern. In the case of sets of an approved type employing reaction being found to oscillate the aerial the Post Office may cancel the authorisation of the future sale of that type. No change in the design of any set or unit may be made after approval without the previous sanction of the Postmaster-General.

## The Wireless Society of London

FURTHER progress has been made in connection with the arrangements for transmitting messages across the Atlantic. The sending out of the signals will take place from two stations in London. The scheme is being worked in conjunction with the American Relay League, and it is understood that transmission will also take place simultaneously from other stations situated in France and Belgium. The society have had an offer from the Marconi Co. for the use of their Carnarvon station, and this offer they will accept. In the last test Carnarvon was used for transmitting reports and results across the Atlantic each day.

At the exhibition at the Horticultural Hall the society were in a position to distribute over 1,000 tickets to affiliated societies, and on the closing day of the exhibition several patrols of Boy Scouts were invited to attend to hear the reproduction of the Prince of Wales's speech. The transmission was successfully and clearly received, the whole of the audience being extremely pleased with the results obtained. Societies all over the country also allowed Boy Scouts to listen in, and excellent signals were received. A letter has been received from Sir R. Baden Powell, on behalf of the Boy Scouts, thanking the society for the privileges given to the Scouts.

With regard to the section of the Wireless Society of London which is to cater specially for the needs of the broadcast receiver, it has been decided that a new

## OUR INFORMATION BUREAU

Expert Replies to Readers' Questions. Hundreds of Replies are sent by Post.

TO ENSURE A PROMPT REPLY PLEASE OBSERVE THE FOLLOWING RULES

Write distinctly, give all necessary details and keep to the point. Ask one Question at a time—never more than two. Send a Stamped and Addressed Envelope. Send the Coupon cut from page 454.

section be formed and that those joining should be called Associates. There will be no entrance fee, and the subscription will be a nominal one of 5s. The Wireless Society of London want to feel that they have the whole of those who are in any way interested in the wireless matters in this country under their working. It is hoped that the 120 affiliated societies will also start a scheme on the same lines and form separate sections, for the broadcast receiver of to-day will be the experimenter of to-morrow.

It has been proposed that the society should change its name from the Wireless Society of London to that of "The Radio Society of Great Britain." The motion will be brought forward at the next general meeting, when members will have an opportunity of expressing their views, and possibly a ballot will be arranged.

**CORRESPONDENCE**

**Slate for Panels**

SIR,—I notice in the Oct. 7 issue of AMATEUR WIRELESS that mention is made of the insulating properties of slate, and as one who has had several years' experience in the use of slate I tender my opinion for what it may be worth. Slate no doubt has high insulating properties,

but its one drawback is its tendency to condense moisture on its surface, thereby causing creeping of an electric charge. This can be seen by placing the warm hand on a piece of slate, and even when standing on a slate pavement moisture will soon appear, even through the best soles. Before warm weather in the slate-quarrying districts the surface of slate slabs will have beads of moisture on them for several days due to the condensing of the moist air on the surface. This does not happen in the case of metallic surfaces, and I venture the suggestion that the latter conducts the heat away, whereas slate is practically a non-conductor of heat. We generally ascribe the continual rain we get in all North Wales quarrying districts to the same cause. Apart from this drawback, slate is a non-conductor. It will cleave in more than one direction, but the most favourable is that parallel to its surface. To obviate the surface creeping of an electric charge I suggest shellacking the surface. Shellac adheres well and gives it an ornamental appearance. I have treated the slate top of my high-tension battery in this manner with very satisfactory results. As to the method of working slate I suggest a hack-saw rather than a carpenter's saw. To plane the surface of a slate slab, a chisel 1½ in. wide with a fine edge should be made from an old file; the edge should be well hardened. The surface can be smoothed by rubbing it crosswise and lengthwise with

this chisel, holding it slantwise, using a straight-edge to test for accuracy. When filing the sides and ends a slight chamfer should be made with a file on the off-side to avoid fraying when drawing the file. Both surface, sides and ends can then be polished with fine emery or glasspaper and finally shellacked. No trouble should be experienced in obtaining a good smooth surface, but the operator will find it a messy business. If slate is split into thinner sheets, this should be done from either end and not from the sides. It can be bored very easily with a breast drill. In conclusion, I may say that hundreds of tons of small slabs, too small for any other useful purpose—slabs under 12 in. by 6 in.—are thrown as waste every month in this district. These if sawed and planed to panel dimensions would serve as a good substitute for more expensive insulators.—R. H. (Bethesda).

**A New Type of Condenser**

SIR,—We note in issue No. 19 of AMATEUR WIRELESS a description of a variable condenser under the heading "A New Type of Condenser." Please note that this type of condenser is covered under our provisional patent No. 23 479/22, and we shall be pleased if you will issue a notification of this in your paper.—Yours faithfully, VICTORIA ELECTRICAL (MANCHESTER), LTD.

ZY ZY ZY ZY ZY ZY ZY ZY ZY ZY ZY ZY ZY ZY ZY ZY

"ONE ZY" is the Broadcasting signal for

**"COZWHY" Filament Fuses,**

which are now being distributed broadcast to those users of valves who realise that while "it is better to be careful than sorry," it is better to be well insured than either.

"COZWHY" Fuses positively protect your valve filaments

**Our Special Messages :**

TO THOSE WHO HAVE JUST BURNT OUT A VALVE. Don't you wish it had been a fuse that time? What a difference it would have made to your pocket.

TO THOSE WHO HAVE NEVER BURNT OUT A VALVE. Don't risk spoiling a good record. Fit a COZWHY and be safe.

TO THOSE WHO MAY BURN-OUT A VALVE AT ANY TIME (and that is, of course, to all who have not yet fitted COZWHYS). COZWHY fitting will not spoil the appearance of your set. On the contrary, our goods are of first-class finish and appearance worthy of the most exclusive sets. They are very easily fixed and will make no difference to your signals. They will save you money and improve your pleasure, for while not all of us can afford to have spare valves ready to fit immediately one gives out, the cost of spare fuses is trifling and they are replaced in a moment.

TO THOSE WHO HAVE DONE WITH BURN-OUTS (need we say these are the many new users of COZWHYS). Because you are insured, do not become careless of the welfare of your valves. It may only involve the cost of a fuse, it's true, but there is no reason why you should blow fuses. We do not regard it as good business that you should. We want COZWHYS to effect the maximum of economy on your set.

REMEMBER.—COZWHYS should not glow in use; when glowing they are very near their fusing point, and either you are using too light a fuse or exceeding the right current for your valve. The ½-amp. size will carry 6 amp. continuously, and are suitable for normal use on valves rated up to 6½ amp. Above this the ¾-amp. size should be used, but they will not, of course, afford the same protection to the lower-rated valves. For valves rated between 6½ and 7½ amp. they will be found to afford adequate protection.

If you want other values write us. We are fuse specialists of several years' standing.

PRICES : ½ or ¾ amp. Fuses 10d. each, 8s. per doz. Polished Ebonite Fuse-holders, with plated Ph. Br. Springs, 2s. 6d. each, 11s. per set of five. Post free. Cash with order.

**"COZWHY" Filament Fuses**

(without them carelessness costs 17s. 6d. per moment)

will shortly be standardised on some important receiving sets.

SOLE MAKERS: **BESWINNING'S, 49, Cowley Road, Ilford.**

ZY ZY ZY ZY ZY ZY ZY ZY ZY ZY ZY ZY ZY ZY ZY ZY



**"PERRYPHONES"**  
HEAD SETS FOR WIRELESS TELEPHONY  
4,000 ohms.  
**21/-**  
EVERY SET GUARANTEED.  
Beautifully finished, highly sensitive, detachable receivers.  
**IMMEDIATE DELIVERY**  
**THE JEARY ELECTRICAL CO., LTD.,**  
8, LAMBETH HILL, and 97, QUEEN VICTORIA ST.,  
LONDON, E.C.4  
And at Glasgow, Birmingham, etc.

**FIRST ALL-BRITISH WIRELESS EXHIBITION 1922**

**OFFICIAL CATALOGUE**

POST **6d.** FREE.

LIMITED NUMBER ONLY.

144 interesting pages. A valuable up-to-date guide for amateur or professional to the apparatus offered by over 60 prominent wireless firms. Apply to the

**EXHIBITION ORGANISERS,**  
**BERTRAM DAY & CO., Ltd.,**  
(Wireless Publicity Specialists),  
Dept. A, 9/10, CHARING CROSS, S.W.1.

GERRARD 8062.





**ORDER NOW—OR YOU MAY BE TOO LATE.**  
 OUR STOCK OF  
**BROWN RADIO HEADPHONES**

(“A” Type, Reed Pattern, Aluminium Diaphragms)  
 IS RAPIDLY BECOMING DEPLETED.

Large numbers are being taken up daily by all the leading wireless factors and merchants. Our customers include the following:

**BRITISH THOMSON-HOUSTON CO., Ltd.,**

**ARMY & NAVY STORES, Ltd., A. W. GAMAGE, Ltd., SELFRIDGE & CO., Ltd.**

During the last three months we have sold nearly £20,000 worth of these Headphones in all parts of the world.

**THESE FIGURES SPEAK FOR THEMSELVES.**

120 ohms, **42/6** (maker's price 58/-)  
 BRAND NEW—NOT RECONDITIONED

8,000 ohms, **49/6** (maker's price, 66/-)  
 ALL ALUMINIUM DIAPHRAGMS.

SULLIVAN, 8,000 ohms, **36/6.**

CORDS FOR EITHER OF ABOVE, 2/9, 3/- AND 3/6 EACH.

Postage (Registered), 1/- extra.

**OUR GILT-EDGED GUARANTEE STILL HOLDS GOOD.**

Every order despatched within 4 hours of receipt.

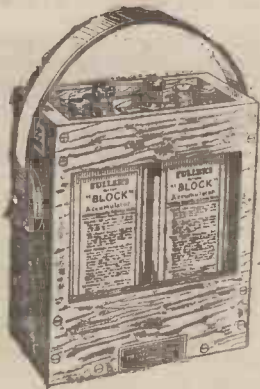

**FULLER  
 BLOCK TYPE  
 ACCUMULATORS,**

in all capacities up to 220 amp. hours, as supplied to

Metropolitan-Vickers Electrical Co., Ltd.  
 Callender's Cable and Construction Co., Ltd.  
 British Insulated and Helsby Cables, Ltd.  
 H. W. Sullivan.  
 and over 100 Public Electricity Undertakings.

Price List on Application.  
 200 always ready charged in stock.

**The “PARLPHONE”**

**LOUD SPEAKER** (Prov. Patent No. 21967)

Instantaneous success of our effort to provide a reliable loud speaker at a fair price.

**SOLID EBONITE. NO METAL. ENSURING  
 PERFECT CLARITY AND ABSOLUTELY  
 NO DISTORTION.** 25 inches high, 6½ inch base.

The interior is screwed and made to receive a Brown's Patent Standard Receiver. Order early if prompt delivery is required.

**32/6**

Carr. 1/3 extra



Marconi “R” Valves, 17/6 each. Mullard “Ora” Valves, 15/- each. “Dewar” Switches, 5/- each. Valve Holders, best quality, 1/9. Variable Condensers, .0005 mfd., 18/6; .001, 24/6. Murdoch's Filament Resistances, 6/9. Dubilier Condensers, 2/6 and 3/- each. Mullard Grid Leaks, 5/- each.

**WE STOCK ONLY THE FINEST QUALITY OF ACCESSORIES.  
 INFERIOR QUALITY ONLY LEADS TO DISAPPOINTMENT.**

Our Technical Experts always in attendance to give FREE ADVICE to Amateurs

**THE CITY ACCUMULATOR CO.**

**79, Mark Lane, London, E.C.3.**

Phone:  
 AVENUE 91

Agents: LONDON: A. W. GAMAGE, LTD., Holborn, E.C. SELFRIDGE & Co., LTD., Oxford Street, W. RICHFORD & Co., 153, Fleet St., E.C.4.  
 YORKS: BARNSELY BRITISH CO-OPERATIVE SOCIETY, LTD., Barnsley.  
 GLOS: BRISTOL WIRELESS Co., 52, Cotham Hill, Bristol.  
 S. WALES: SOUTH WALES WIRELESS INSTALLATION Co., LTD., 18, West Bute Street, Cardiff.  
 N. WALES, LANCs. Ches. & L.O.M.: THE “ALL-BRITISH” WIRELESS MANUFACTURES Co., LTD., 70, Central Bldgs., 41, N. John Street, Liverpool.

**OUR NEW SHOWROOMS—THE LARGEST AND MOST UP-TO-DATE IN THE CITY OF LONDON—ARE NOW OPEN, AND THE PUBLIC ARE CORDIALLY INVITED.**



# T.M.C. Wireless

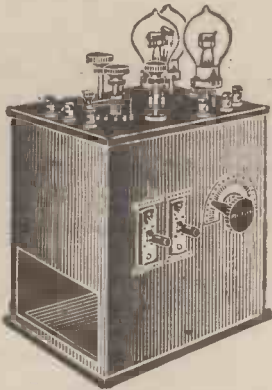

T.M.C. 3-VALVE BROADCASTING SET.

A REVELATION in Wireless Sets employing 1-valve detector, two valves for low frequency amplification. Apparatus mounted includes Variable Filament Resistance, three-Valve Sockets, Grid Leak and Condenser, two highly efficient Transformers, Grid Potential Blocking Condenser, Variable Condenser, Series Parallel Switch, Switch for using Loud Speaker or Headphones, Tuner and Reactance, complete with three Valves, Loud Speaker and Set of "De-Luxe" Headphones. Mounted in Polished Walnut. Size  $9\frac{1}{2} \times 7 \times 10\frac{1}{2}$  inches high.

THE MARVELLOUS 3-VALVE SET THAT WAS THE FEATURE OF THE EXHIBITION

The TELEPHONE MANUFACTURING Co., Ltd.,  
HOLLINGSWORTH WORKS, WEST DULWICH, S.E.21.

Telephone: SYDENHAM 2460

Telegrams: "BUBASTIS, DULCROX."

## EXHIBITION PUZZLE

If you did not see our Stand you probably have seen some of our components and accessories: Send 3d. in stamps for illustrated list (money refunded on first order of 2/6) and see if you can recognise our manufactures. We give best INSTRUMENT FINISH on all our goods.

FOR T(OP) V(ALUE) write to T(HAMES) V(ALLEY) WIRELESS & ELEC. SUPPLIES  
LATIMER ROAD WORKS, TEDDINGTON, MIDDX.  
Phone—Molesey 279—  
Wireless Dept.

## GET OUR LIST—IT'S FREE

ELECTRICAL SUPPLY STORES  
5, Albert Terrace, King Cross,  
HALIFAX.

EVERYTHING FOR WIRELESS IN STOCK

## SECONDS OUT OF THE RING AGAIN

Just a few more of our  
REDUCED PRICES



**ACCUMULATORS** (Oldham's Special Process). The finest Accumulators on the Market.  
4 volt 40 amp., 20/-, carriage and packing 2/- each  
4 volt 60 amp., 22/6, " " 2/4 "  
6 volt 40 amp., 27/6, " " 2/6 "  
6 volt 60 amp., 32/6, " " 3/- "

"Bell" Flash Lamp Batteries, for your High Tension ... per dozen 5/-  
Coil Mounting Plugs. Best Ebonite ... each 1/6  
Crystal Cups, with screws to fix crystal ... 3d.  
Contact Studs or Stops ... per dozen 1/-

**CONDENSERS (Fixed)**, .0001 to .0005 ... each 2/-  
" " .001 to .002 ... " 2/3  
" " .003 to .004 ... " 2/6  
**Filament Resistance**, for panel mounting ... " 3/6  
**Insulated Sleeving**, ... per yard 6d.  
**Inductance Sliders**, complete with spring and brasses ... each 6d.  
**Laminated Switch Arms**, the best ever offered ... 2/-  
**Valve Sockets** ... per set of 4 5d.  
**Valve Pins** ... " " 4 5d.  
**Valve Holders** ... " " each 1/-

We could go on giving rock bottom prices for hours, but you will find everything you want at the right price in our  
**CATALOGUES - 3d. Post Free**

We hold huge stocks of B.T.H., Mullard Ora, and Marconi Osram Valves

## J. L. CARTWRIGHT & CO.

Manufacturing Electrical Engineers  
Works:—BERRY STREET.

New Offices and Showrooms

24, London Road, - MANCHESTER

Wholesale Distributing Agents for Scotland:—  
J. Corston Sinclair & Co.  
47 Waterloo St. Glasgow  
to whom all trade inquiries in Scotland should be addressed.

'Phone: Central 4209  
'Grams: Pladuram, Manchester

140 ohm, 23/6. 4000 ohm, 25/-  
8000 ohm, 27/6. Postage 9d.  
Money back if not entirely satisfied

LIBERAL TERMS to the TRADE

# HULLO EVERYBODY!

COMPARE PRICES! COMPARE QUALITY!!

## COMPLETE SETS OF PARTS FOR MAKING VARIABLE CONDENSERS.

| Approx. Capacity in Micro-farads | No. of Plates | Price |
|----------------------------------|---------------|-------|
| •0015                            | 85            | 10/-  |
| •001                             | 57            | 7/6   |
| •00075                           | 43            | 6/9   |
| •0005                            | 29            | 5/6   |
| •0003                            | 19            | 3/6   |
| •0002                            | 13            | 2/6   |
| •0001                            | 7             | 2/3   |
| Vernier                          | 3             | 1/9   |

These Sets are complete ready for assembling and consist of the following parts: Necessary Aluminium Vanes (fixed and moving), all standard size, large and small Spacer Washers, Centre Square Spindle with Knob Bushed 2 BA, 3 round screwed Rods for sides, necessary Nuts and Washers, Brass Pointer, Engraved Scale, 2 Terminals, Lock Nuts, 3 Bushes and 2 Bronze Coil Spring Washers. Every part guaranteed best workmanship and quality. Generous quantity of all spares supplied.

Packing and Postage 1/3 per set extra.

EASY TO ASSEMBLE. Every part of the Highest Possible Quality. TRADE SUPPLIED with above Sets.

Aerial Wire, 7/22 Stranded Copper, 3/3 per 100 ft. Postage 1/-.

Knobs, tapped, 2 BA, 1½ in. diameter, 2/- doz. Special clearing line. Doz. lots only.

Condenser Parts, Fixed and Moving Vanes, 7d. doz.; 6 doz. 3/-.

Small Spacers, ¼ in., 3d. doz.; 6 doz. 1/4.

Large Spacers, ½ in., 4d. doz.; 6 doz. 1/9.

Ebonite Bases, circular (drilled), 10d. each.

Drilled Squares, 4 by 4, 1/8 pair.

Brass Washers, 4 BA, 3 doz. 2d.

2 BA, 1 doz. 1½d.; 6 doz. 6d.

Contact Studs, high-class quality, 6d. per doz., with nut.

Spring Coil Washers (Bronze), 4d. per doz.

Crystal Cups, large, 4 screws; 4d. each; 3/6 per doz.

Small, 2d. each; 1/3 per doz.

Crystal Detectors, parts, 1/6; complete 3/6.

Terminals, W.O. Pattern with Nut and Washer, 2d. each; 1/10 doz.

Telephone Terminals; complete with Nuts and Washers, 2d. each; 1/10 per doz.

Varieties of Terminals, 1/-, 1/3, 1/6 doz.

Brass Hexagon Nuts, 2 BA, 4 BA, 5 EA, 3d. per doz.; 6 doz. 1/3.

Switch Arms, with Laminated Blade, 1/-, 1/3. Extra quality, 1/6.

Inductance Coils, Wound No. 24 Enamel Wire, 3/3 (not sent by post).

Ebonite Condenser Dials, with Scale 0-180, splendid value, 1/2.

Condenser Bushes, 1d. each; 10d. per doz.

Stop Pins, Brass, 3d. per doz.

Ebonite Leading-in Tubes, 12 in. 1/6. Postage, 9d. Other sizes as cheap.

Valve Sockets with Shoulder, extra quality, complete with Nuts, 1/1 doz.

Valve Pins, 8d. per doz. (with Nuts, 10d.).

Valve Holders, 11d. and 1/2 each. Complete with Nuts.

Sets of Basket Coils, seven in set, 6/- set.

Porcelain Insulators, Reel Type, 1/- doz. (not sent by post).

Transformers, L.F. Open-Type Intervalve, 15/6 each. Postage 1/-.

Knobs, 1½ in. diameter, Tapped, 2 BA, 3d. each. Also with 2 BA Nut, 5d. each.

Crystal Receiving Sets, Fitted with Blocking Condenser, Terminals and Special Detector, £1 2s. 6d. complete.

Ivory Scales, best quality, 6d. each.

Pointers, Brass or Aluminium, 4 for 3d.; 8d. doz.

Filament Resistances, 2/6, 3/6; "Thor," 4/6.

Insulating Sleeving, 1½ mm. hole, 5d. per yard length; 4/6 doz.

Block Condensers, .001, .002, .0003, 1/6, 1/8; .004, 2/-.

S.P.D.T. and other Switches on Ebonite Base, 1/9, 1/10, 2/6 each.

Inductance Slider and Plunger, complete with 13 in. Brass Rod, 8d. (not sent by post).

Laminated Blades for Switch Arms, 3d. each; 2/6 doz.

Ebonite. To Callers only. Cut to sizes required (1½ in. only) at the rate of 4/- lb. Cutting 3d. per piece (not sent by post).

## HEADPHONES

21/- Best French Manufacture, with Universal Joint. Equal to any other or more expensive 'phone on the market. Resistance 4,000 ohms,

22/6 highest possible insulation, selected tungsten steel magnets, heavy insulated cords, polished aluminium case, oxidised copper headbands,

25/- Ebonite earcaps.

ALL ORDERS MUST BE accompanied by cash and sufficient enclosed to cover postage and packing—the prices quoted are too low to admit of being despatched except on above terms. TRADE SUPPLIED.

**M. RAYMOND,** 27, LISLE STREET, W.C.2.

RIGHT OPPOSITE  
DALY'S GALLERY DOOR:

Phone:  
Gerrard  
4637

To avoid mistakes, this address is close to  
Charing X Road and Leicester Square Tube.

Factories & Laboratories:  
King's Road, St. Pancras.

# ANODE

## Wireless & Scientific Instruments, Ltd.

All Communications to Registered Offices:

**265, STRAND, W.C.2**

|                                                                  |                        |
|------------------------------------------------------------------|------------------------|
| ANODE PATENT VARIABLE FOIL<br>CONDENSERS, Capacity '0005 mf. 9/6 | } Laboratory<br>Tested |
| ANODE PATENT VARIABLE FOIL<br>CONDENSERS, Capacity '001 mf. 10/6 |                        |

\*ANODE PATENT CRYSTAL SETS (Good  
Telephony up to 12 miles) . . . £3 9 6

\* " " SINGLE VALVE SETS  
(Patent Auto-transformer Circuit) 6 17 6

### \*UNIT SYSTEM

Unit 1. PATENT ANODE VARIOMETER  
TUNER (350-500 metres) . . . 4 17 6

" 2. HIGH FREQUENCY AMPLIFIER  
(One Valve) . . . . . 4 2 6

" 3. DETECTOR . . . . . 5 12 6

" 4a. LOW FREQUENCY AMPLIFIER  
(Two Valves) . . . . . 10 15 0

" 5. TELEPHONE TRANSFORMER  
(for Low Resistance 'Phones) . 2 15 0

Units 1 and 3 comprise a Receiving Set to which other  
Units can be added

\* All Valves, 'Phones and Batteries extra

## HAVE YOU A GRAMOPHONE?

THEN GET A

# GRAMAPHIX LOUD SPEAKER

THE GRAMAPHIX multiplies sound! THE GRAMAPHIX  
fits any gramophone! HAVE YOU HEARD THE GRAMAPHIX?

IT produces full volume of sound without distortion and makes your  
gramophone a RADIO LOUD SPEAKER.

The Gramaphix utilises the scientifically designed tone amplifier of the  
gramophone to secure mellowness and Beauty of Tone, therefore doing  
away with all that metallic sound, scratching and "ring" associated with  
other loud speakers. The Gramaphix is the talk of the wireless world.

Adjusted in a Minute by a child. LATEST and LOUDEST.

Why pay pounds when a better instrument can be secured for

APPLY FOR **10/6** IMMEDIATE  
TRADE TERMS DELIVERY  
Postage 9d.

HERE IT IS! SPECIFIC GUARANTEE  
TO RECEIVE TELEPHONY  
FROM A MINIMUM DISTANCE OF 25 MILES.

THE B.N.B. CRYSTAL SET £7 10 0  
(With 2 Sets of Double Earphones)

Operates on Wave Lengths up to 1,000 Metres

PHONES!!! Tested for clarity and purity of sound.  
2,000 Ohms. Post free and all new  
and no faults. Fully guaranteed. 24/-, 27/6

LACLAND ELECTRICAL MANUFACTURING AGENCY (Dept. A),  
68, GREAT QUEEN STREET, KINGSWAY (Holborn End), W.C.2 Gerrard 5341.

## Enormous Stocks of Ex-W.D. WIRELESS GEAR AT ABSURDLY LOW PRICES

Wheatstone Bridges, Marconi Type 16 Crystal Sets, Model L  
Receiving Sets, Shell Insulators, Wavemeters, etc., etc.

4 B.A. Terminals, Double..... Brass .....3/- per dozen  
..... Plated .....2/6 " "  
2 B.A. " Single ..... Brass .....9d. " "  
(Postage Extra)



### INTERVALVE TRANSFORMER

(New Goods)

Fitted with panel fixing  
plate and earthing wire  
for iron core.  
Fully tested; Ratio 5 : 1

PRICE **15/-**

Postage 9d. extra

Call and inspect our enormous  
stock or write for particulars and  
prices of your requirements.

**J. LIPOWSKY (DEPT.)**, ELECTRICAL AND  
WIRELESS ENGINEER,  
614, OLD FORD ROAD, BOW, LONDON, E.3.

Telephone: East 3345

Near Old Ford Station

Nos. 8 or 39 'Bus.

## ELECTRADIX RADIOS

### NOTICE.

9, Colonial Avenue, Minorities, E.1.

In order to remove any erroneous impression we state  
here, once and for all, that we have for years been Sole  
Agents for:—

1. TATE MOTORS AND DYNAMOS, in all sizes and  
voltages.
2. NORTHERN CABLES AND WIRES, from heavy  
cable to the finest silk-covered magnet wire.
3. FLETCHER'S "PENRHYN" SLATE, in all shapes  
for Electrical purpose
4. AS SUPPLIERS OF ENGINE SETS, Radio Units  
and Components, Electric Drills, Instruments, etc., new  
and ex-W.D., reconstructed in our own workshops.

That we have tons of Wireless and Electrical goods in stock  
at our City Depot, and when we say in stock we mean it. The  
goods are there ready for immediate delivery.

If you want 1,000 Dynamos, we are the only firm in London that can  
deliver at once. 10,000 Insulators, 20,000 Valve Legs, 20 Morse Inkers, 50  
Weston Relays, 5,000 Resistance Units, 2,000 Telephones, 100 Marconi Receiving  
Sets calibrated for Broadcast Wave-lengths, 200 Ammeters and Voltmeters, or a single  
Syphon Tape Recorder, Marconi Direction Finder, 50-watt Valve Transmitting Sets,  
etc. etc., we can supply from stock.

We have a large number of bargains not catalogued, and  
you are cordially invited to inspect these.

Colonial Avenue is the first on the left in the Minorities,  
nearly opposite Aldgate Station, Met. Railway.

For **LESLIE DIXON & Co.,**

H. LESLIE DIXON.  
M.I.E.E., A.M.I.M.E.

THE MARK OF RELIABILITY



1 to 12 volt.

1 to 35 amps.

# VOLT & AMMETER

Combined Dead Beat Pocket Type. New and not German. Splendid Instrument in Nickel plated Case. Ideal for Testing Cells & Filament Current

POST PAID 5/6 NUMBER LIMITED OTHER EXCEPTIONAL VALUES

- Aerial Wire. Enamelled Hard Drawn, 7/22's Copper, 5/- per 100'
- Aerial Wire. Bright Hard Drawn, 7/22's Copper, 3/6 per 100'
- Aerial Insulators. Shell type, 2" x 2 1/2". 9d. each.
- Aerial Insulators. Reel type, 2" diameter, brown 3d. each.
- Filament Resistances. For panel mounting, 2/6 each.
- H.F. Transformers, plug in type, 300 and 700 metres, 4/- each.
- H.F. Transformers, plug in type, 1,000 m. 4/6; 2,600 m. 5/6 each.
- H.F. Transformers. Formers only, with pins, 3/- each.
- Tangent H.F. Transformers. All ranges, 8/6 each.
- Switch Arms. Complete fitted with knob, 1/- and 2/6 each.
- Dewar Stitches. D.P. Change over, panel type, 2/- each.
- Lightning Arresters. Carbon block type, 1/6 each.
- Valve Holders. Flanged "A" type, 1/- Ebonite with 8 nuts, 1/3 each.
- Ebonite Panel, fitted with 3 Valve Holders, complete, 3/2.
- Ebonite Panel, fitted with 2 Valve Holders, complete, 2/3.
- Valve Sockets, per set of 4 with 8 nuts, 7d.
- Transformer Holder. With 4 terminals and wired, 3/6 each.
- High Note Buzzer (Army Type), worth treble, 3/- each.
- Telephone Transformers (Army Type), 9/- each.
- Wireless Jacks. Complete with plugs, 1/- the pair.
- Brown's Type "A" Headphones. Guaranteed new and unused. 8,000 ohms, 49/6; 120 ohms, 42/6. With cords, 51/6 and 44/6.
- Ever Ready Batteries (all sizes). 16 volt, 3/6 each.
- Mica. Clear Ruby, .002" thick, 3" x 2", 1/- doz. pieces.
- Inductance Slider Rod, 1" square, 13" long, drilled, 6d. each.
- Slider, complete with plunger for 1" rod, 6d. each.
- Contact Studs. Fitted with nut and washer, 1/3 doz.
- Condenser Vanes. Best Aluminium, 31", 1/6 doz. pairs.
- Condenser Spacing Washers. Small 3d., large 6d. doz.
- Condenser Screwed Rod. Brass 12" long, 1/8" dia. 3/16" dia.
- Condenser Centre Spindles. Large 7d., medium 6d., small 5d. - Square centres.
- Knobs. 1" diameter with bush same thread as spindles, 6d. each.
- Knobs. 1 1/4" diameter, 2B.A. thread, 4d. each.
- Crystal Cups. 4 screw type, 6d. each.
- Insulating Tubing. Assorted colours, 6d. per yard.
- Sheet Ebonite, 1" to 1 1/2" thick, 4/6 per lb.
- Terminals. Mark 3 N. Plated, 4B.A., 2/6 doz.
- Terminals. Small pattern, 9d. doz.
- Dubilier Condensers. All capacities at prices advertised.
- Grid Leaks. All resistances, 2/- and 5/- each.
- Vernier Condenser. 5 plate panel type, 4/- each.
- Condenser. 001, to stand or mount in panel, 16/6 each.
- Spring Coil Washers. 2d. each.
- Lipowsky Universal Tuners. 7/- each.
- All Technical Books at prices advertised.
- Black Insulating Tape, 1/6 per roll.
- Duros Accumulators. Supplied charged, 2-volt 45-amp. 10/- each.
- Fuller Block Accumulators. 18/3 per cell.
- Standard Coil Mounting Plugs, 1/6 each.
- Straining Bolts. Machine turned R.A.F. type, 1/3 each.
- Masconi-Osram "R" Valves. 17/6 each. Sent rex. post.
- Transmitters. Army type, 2/- each.

Write for "Complete Supplementary Price List of Exceptional Values," sent post free. All goods sent CARRIAGE PAID, but with orders under 5/6 add 6d. for postage.

**J. H. TAYLOR & CO.,**  
ELECTRICAL AND RADIO ENGINEERS.  
**Macaulay St., HUDDERSFIELD.**  
Telephone 34L. Telegrams: "Thorough," Huddersfield.

## HIGH CONDUCTIVITY SOFT COPPER INSTRUMENT WIRES. PRICES AT PER LB.

| S.W.G. | S.C.C. | D.C.C. | S.S.C. | D.S.C. | RNAM'D |
|--------|--------|--------|--------|--------|--------|
|        | s. d.  | s. d.  | s. d.  | s. d.  | s. d.  |
| 18     | 2 0    | 2 2    | 2 7    | 2 10   | 2 2    |
| 20     | 2 2    | 2 3    | 2 10   | 3 7    | 2 3    |
| 22     | 2 5    | 2 8    | 3 4    | 4 3    | 2 5    |
| 24     | 2 11   | 3 1    | 3 7    | 4 6    | 2 8    |
| 26     | 3 4    | 3 8    | 4 5    | 5 6    | 3 0    |
| 28     | 3 10   | 4 2    | 5 0    | 6 6    | 3 3    |
| 30     | 4 6    | 5 0    | 6 3    | 7 0    | 3 6    |
| 32     | —      | —      | 7 3    | 8 0    | 3 11   |
| 34     | —      | —      | 8 3    | 9 6    | 4 2    |
| 36     | —      | —      | 9 9    | 11 9   | 4 6    |
| 38     | —      | —      | 13 0   | 15 6   | 5 0    |
| 40     | —      | —      | 15 6   | 19 0   | 6 6    |
| 42     | —      | —      | 20 0   | 25 6   | 8 0    |
| 44     | —      | —      | 40 0   | 57 6   | 18 0   |
| 46     | —      | —      | 85 0   | 132 6  | 24 6   |
| 47     | —      | —      | 115 0  | 160 0  | 40 0   |

H.D. COPPER AERIALS  
PLAIN 7/22 4/- 5/- per 100 ft. coil.  
ENAM'D, 5/- 6/6 " " " "  
ENAMELLED AND D.C.C. BELL WIRE.  
203 SINGLE 1d. per yd.  
203 TWIN 2d. " " "

Terms: Cash with Order. Postage Extra.  
Special Prices to Trade for Quantities.

**HORROCKS AND ASPIN,**  
12, SCHWABE ST., RHODES, MANCHESTER.

## GREATEST BARGAIN EVER OFFERED

HEADPHONES 7/6 PER PAIR 150 ohms each.

HEADPHONES 7/6 PER PAIR 150 ohms each.

Finest quality Miac Condensers, 5 in. by 3 1/2 in., each containing about 200 sheets of best quality mica, 3/6 each. Transmitters, 7/6 each. Potentiometers, 7/6 each.

Special quotation for customers taking quantities.  
S. HYAMS, 25-26, King Street, Camden Town.  
Established 80 years. Phone 2832 North.

SCIENTIFIC APPLIANCES (Dale & Hollins). Electrical, Magneto, Optical and ALL RADIO WIRELESS PARTS and Materials at Lowest Prices. Call and see our immense stock or write for Information and Prices. In Centre of London, Top of Kingsway.

SCIENTIFIC APPLIANCES,  
11 and 29, Sicilian Avenue, London, W.C.1.

**PORTLAND'S PARTS BY POST**  
All parts fit and match. Ebonite, by return, 4/- lb., any size.  
Generous trade discount. List free.  
PORTLAND, 39, Sinclair Road, Olympia, W.14.

**EASY TERMS OR CASH**  
Mullard Phones, 4,000 ohms, 30s.; Ora Valves, 15s.; Variable Condensers, assembled .0005, 17s. 6d.; .001, 22s. 6d.; fixed capacity Condensers, .001 to .005, 8s. each; Grid Leak and Condenser, 4s. 6d.; Filament Resistances, 8s. and 6s.; Phone Transformers, 18s. 6d. and 17s. 6d.; L.F. ditto, 21s.; Intervalve ditto, 21s.; Accumulator, 4 volt, 15s.; H.T. Battery, 30 volt, 7s. 6d.; 3 Coilholder, 17s. 6d.; 2 ditto, 18s. 6d.; Coils at list prices, Aerial Wire, 100 ft., 7 1/2s. str. copper, 4s. 6d.; Valveholders, 1s. 6d.; Switch Arms, 2s. 6d.; Terminals, etc. Polished Cabinets with Ebonite Panel for 1, 2 or 3 valves, ready drilled, price on application. Single or complete sets of parts with full instructions and diagrams supplied on easy terms, stamped envelope.—G. BUSH, 119, Sutherland Avenue, London, W.9.

**ELECTRADIX RADIOS.**  
IMMEDIATE DELIVERY FROM OUR HUGE STOCKS  
Everything from a Recorder to an Earth Clip.  
The best equipped City depot.  
COME AND SEE US  
9, COLONIAL AVENUE is first opening on left in the Minories, nr. Aldgate Station, Metropolitan Railway.  
**LESLIE DIXON & CO.,** 9, COLONIAL AVENUE, MINORIES, E.1.

## PREPAID ADVERTISEMENTS.

B.A. Screws, Nuts, and Washers, assorted gross, 2s.; list, 2d.—J. H. Bennett, Station Road, Willesden Junction. 134 R

Wireless Dealers are advised to stock parts for making radio apparatus, as so many amateurs prefer to make their own instruments; there is also the additional profit in making your own sets from stock parts. Raw materials and partly machined parts can be had direct from the factory at the right price.—The "Newtonia" Wireless Factory, 13/15, Whitcomb Street, London, W.C.2. Regent 643 and 5469.

Sets Designed, concert coils and H.F. transformers wound to order, condensers and coils calibrated, faults righted, etc.—Walker, 23, Little Chester Street, S.W.1.

Cozwhy Filament Fuses will protect your valves from burn-outs. 1/2 or 1/4 amp., 10d. each, 8s. per doz. Polished ebonite fuse-holders, plated Ph.-Br. springs, 2s. 6d. each, 11s. set of five, post free. Cash with order.—Beswinning's, Cowley Road, Ilford, E. 14 R

Wireless Valve Sets, 57 10s. All accessories. Actual manufacturers. Demonstrations.—Wireless Installation, Ltd., 15, Aldersgate Street, E.C. 2 S

Amateurs.—1st wireless operator has three months' leave; practical help construction of sets; moderate remuneration and expenses.—Box 5, "Amateur Wireless." 1 S

Working Drawings of wireless sets supplied. Sound technical advice.—Puckle, Buckhurst Hill, Essex. 7 R

Two-valve Receiver, with tuner, 8 coils, 4 transformers, 3 valves, 2 pairs 2,000 phones, 90 v. H.T., 100 ft. aerial wire, insulators; 4/7 or offers. Owner going abroad.—Hinks, Hardington, Yeovil. 13 S

Accumulators, 750 only unspillable. Flash lamp, new, guaranteed, 2s., post free; usual price, 3s. 6d. 12 only, 4-volts 60 amps., 27s. 6d., free.—Scientific and Electrical Engineering Co., 37, Berners Street, London, W.1. 14 S

Build Your Own Sets. Teak boxes (brass bound), 12 1/2 in. by 10 in. by 4 1/2 in., adaptable for valve sets or battery boxes. Crossed postal order for 7s. 6d. to Major Elliot Bell, British Columbia House, 1/3, Regent Street, S.W.1.

Limited Number of 4,000-ohm Headphones, new and guaranteed, very sensitive, 20s.; postage 9d.—Collett, 51, Croydon Grove, Croydon. 15 S

Huge Purchase of ex-Government Wireless Stock. Write for list giving full details. 150-watt dynamos, 4; hedgehog coils, 3s. 6d.; loud speakers, 200 ohms, 7s. 6d.; 1-in. spark coils, 10s.; 1 1/2-in. spark coils, 12s. 6d.; Morse tapping keys, 3s., etc. etc. Three days' approval against cash, or please call. Write for detailed price list of all goods.—E. J. Galpin, 16, Loampit Hill, Lewisham, S.E.13, London. 15 S

Telephone Receivers Rewound up to 1,000 ohms, 5s.; 2,000 ohms, 7s. 6d.—Cash with order.—M. E. Hampshire, 139, Sydenham Road, S.E.26. 16 S

Fuller's Accumulators, 2 volt 40 amps., second-hand, in good condition; bargains; 6s. each.—White, 121, Adelaide Road, South Hampstead. 17 S

**WIRELESS MASTS**

45 ft., 39s. 6d. 25 ft., 29s. 6d.  
Complete with necessary Iron Fittings. Stay Lugs, etc., for IMMEDIATE ERECTION.  
Will save you endless trouble. Don't buy odd, unfinished or inferior thin steel poles.  
Bamboo Spreaders. Guy Wire. Strainers (Actual).  
List, particulars, post free 3d.  
Manufacturers: Trade Enquiries Invited.  
**THE AMATEUR WIRELESS SERVICE**  
Dept. 1, A.W., 33, Elms Road, Aldershot

**BUZZER SETS**  
(Government Surplus)  
COMPLETE WITH EAR-PIECE, TAPPING KEY, BUZZER, INDUCTION COIL, IN MAHOGANY CASE  
— LIMITED SUPPLY —  
8/6 CARRIAGE 1/3  
**CONDENSERS**  
VARIABLE, CIR: TYPE, CELL, CASE  
.001 .0005 .0003  
24/- 19/6 16/-  
VERNIER TYPE FOR PANEL MTG.  
.00005 .0003 .0005 .001  
6/6 9/6 12/6 15/-  
— WRITE FOR LIST —  
**GRIFFIN'S**  
80, NEWINGTON CAUSEWAY  
LONDON, S.E.1.



# Exide BATTERIES

**THE LARGEST SHIP IN THE WORLD**  
—the White Star Liner "Majestic"—uses Exide batteries for her wireless installation.

No finer testimony to the general reliability of Exides, and their particular suitability for wireless work, could be given.

**THE Chloride ELECTRICAL STORAGE COMPANY LIMITED.**

CLIFTON JUNCTION, N<sup>r</sup> MANCHESTER. | 219/229, SHAFTESBURY AVENUE, W.C.2.  
PRICES AND PARTICULARS ON APPLICATION.

**HIGHEST QUALITY. COMPETITIVE PRICES.**



**SPECIAL DESIGN FILAMENT RHEOSTAT**

Strong Phosphor Bronze Contact Arm which will not work loose. Easy to fix to Panel. Excellent construction.  
**PRICE 4/-.**

|                                       |         |                                                                      |         |
|---------------------------------------|---------|----------------------------------------------------------------------|---------|
| Aerial Wire, Stranded, 7/25, per 100' | ... 3/6 | Grid Leaks (Tubular) 2 Meg. (enclosed)                               | ... 2/- |
| " Pulleys, Aluminium with Cord        | ... 2/- | Grid Condensers                                                      | ... 1/6 |
| " Insulators, Green Egg Type          | ... 6d. | Valve Holders, Screwed Legs                                          | ... 1/- |
| " Reel, best quality                  | ... 3d. | Perikon Detectors                                                    | ... 4/- |
| " Ebonite Lead In Insulators          | ... 1/6 | Essex 15 v. H.T. Batteries                                           | ... 3/- |
| Inductance Tubes, 12" x 3"            | ... 6d. | Crystals (special selected), Bornite, Zincite, Galena, Silicon, etc. | ... 6d. |
| " " 12" x 4"                          | ... 8d. | Crystal Cups with Screw                                              | ... 4d. |
| " " 12" x 5"                          | ... 1/- |                                                                      |         |
| " " 12" x 6"                          | ... 1/3 |                                                                      |         |
| Sliders and Plungers                  | ... 6d. |                                                                      |         |
| Sq. Brass Rod, 12" x 1/2" x 1/2"      | ... 4d. |                                                                      |         |
| Enamelled Wire, 23 gauge, lb.         | ... 2/- |                                                                      |         |
| Knobs with 2 BA Brass Bush            | ... 4d. |                                                                      |         |

TRANSFORMERS, NOTE MAGNIFIERS, Etc. POSTAGE EXTRA.  
**THE ESSEX WIRELESS CO.** Office & Showrooms: 499, GROVE GREEN RD., LEYTONSTONE, E.11. (1 min. from Station, G.E.R.)  
Telephone—WANSTEAD 749.

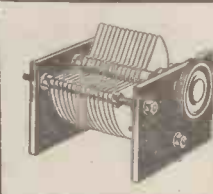

**CONDENSERS AT MANUFACTURERS' PRICES**

**0005 12/6**  
29 PLATES POST FREE

**S. J. H. WILKES**  
STATION RD., STECHFORD, BIRMINGHAM

**FOR TOOL BARGAINS**

CALL or WRITE TO-DAY to:  
Before buying elsewhere compare our prices. Remember, we have the Largest Stock of Tools to select from in London. We guarantee you satisfaction, so you can safely shop by post. Bargain List sent post free.

**GEORGE ADAMS,** DEPT. A/W, 255-6, HIGH HOLBORN, LONDON, W.C.1.

**GENTS' MAKE FITMENTS**

Send for our Sundries Pamphlet  
Make use of our Stocks  
May we quote for your Wholesale Requirements



**GENT & Co., Ltd., FARADAY WORKS, LEICESTER**  
London: 25, Victoria St., S.W.1. Newcastle-on-Tyne: "Tangent House," Blackett St.

**Guaranteed Radio Supplies**

Since we are the actual manufacturers of Radio apparatus we are in a favourable position to judge other supplies sold, but not manufactured by us. Already there is a quantity of inferior apparatus on the market which is certain to give unsatisfactory results, but no article finds a place in our Showrooms until we, by actual test, have proved its efficiency and reliability.

|                                                                                                                       |                 |                                                                                             |                      |
|-----------------------------------------------------------------------------------------------------------------------|-----------------|---------------------------------------------------------------------------------------------|----------------------|
| <b>AERIAL WIRE</b><br>150 ft. coils, enamelled copper, 3/6; Silicon Bronze, 4/6; 7/25 stranded, 4/6; 7/22 ditto, 6/6. | from <b>3/6</b> | <b>INSULATORS</b><br>Best quality, reel, 2d.; small shell, 5d.; small egg, 6d.; barrel, 1/- | from <b>2d.</b> each |
| <b>LEAD-IN TUBES</b><br>8 ft. long, with wingnuts                                                                     | <b>2/9</b>      | <b>RADIAL SWITCHES</b><br>Superior, 4-leaf laminated.                                       | <b>2/6</b>           |
| <b>FILAMENT RHEOSTATS</b><br>Velvet contact, fitted with "off" position, no switch required                           | <b>3/9</b>      | <b>GRID LEAKS</b><br>Own manufacture, each one "Megger tested" for dead accuracy.           | <b>2/6</b>           |

New Illustrated Booklet shows you how to build your own set with Peto Scott Standardised Radio parts  
Send 6d., to-day for a py.

These are six typical values from our big Catalogue. Send penny stamp for it to-day — you need it.

Offices and Showrooms:  
**64, HIGH HOLBORN, W.C.**



**RELIABLE APPARATUS AT POPULAR PRICES**

CRYSTAL SETS, VALVE SETS, etc. EVERY NECESSITY & LUXURY FOR THE WIRELESS EXPERIMENTER.  
Fully Illustrated List of Wireless Goods, post free, 4d.

**H. D. BUTLER & CO., LTD.**  
Office: BANK BUILDINGS, 222, GT. DOVER ST., S.E.1 (Opposite Boro Tube Station).  
Works: CANONBURY, LONDON, N.1  
Telephone: Hop 3029. Teleg: "Ingenuity," Phone London."

# "LISTEN-IN" ON THE STERLING No. 1 CRYSTAL W/T RECEIVING SET



The Sterling No. 1 Crystal Receiver has been specially designed for use in connection with the Wireless Telephony Broadcasting Scheme and is suitable for a range of about 25 miles.

**Immediate Delivery**

The set comprises:

**1. TUNER.**—This consists of an inductance which can be varied by means of tappings taken to stud switches. Two of these are fitted, one for coarse and the other for fine adjustment. A separate coil is provided which can be plugged into a fitting at the back of the instrument (as illustrated) for reception of time signals, etc., from Eiffel Tower.

**2. DETECTOR.**—This is of the crystal type, requiring no battery, and is designed to give universal adjustment over all parts of the crystal.

The apparatus is mounted on ebonite panel and fitted in polished walnut case.

The equipment includes one pair of No. R1258 DOUBLE HEAD TELEPHONES wound to a total resistance of 2,000 ohms the pair.

To be obtained from all dealers or direct from—

**Sterling Telephone and Electric Co., Ltd.,**

TELEPHONE HOUSE, Co., Ltd.,

210/212, Tottenham Court Road, London, W.1.

Telephone No.: 4144 Museum (7 lines). Telegrams: 'Cucumis, Wesdo, London.

Works: DAGENHAM, ESSEX.

BRANCHES: NEWCASTLE-ON-TYNE: 9, Clavering Place. CARDIFF: 8, Park Place.

**PRICE - £7 12 6**

## WIRELESS SERVICE STATION

ALL ORDERS ARE S.O.S. TO US AND WE TRANSMIT IMMEDIATELY

- MARCONIPHONES ... £5 15, £9 10, £25, Etc.
- METROPOLITAN VICKERS SETS £4 10, £23 10, Etc.
- BRITISH THOMSON-HOUSTON SETS £7 7, £14, Etc.
- G.E.C.O. PHONE SETS £5 10, £9 15, £25, Etc.
- STERLING SETS ... £7 12 6, Etc.
- Brown Loud Speakers ... £3 to £8 7s.
- Magnavox Loud Speaker, "Junior" type ... 210/-
- Magnavox Loud Speaker, "Senior" type ... £20
- 2-Valve Power Amplifier complete with valves, but less batteries (for Magnavox) ... £22 10
- 3-Valve Power Amplifier complete with valves, but less batteries (for Magnavox) ... £35
- Fixed Condensers, 1/8 each.
- Condenser Vanes, 3d. per doz.
- Condensers Spacer Washers, large, 5d. per doz.; small, 3d. per doz.



Condensers (Dubilier), 0.001, 0.002 and 5.003, 3/- each.  
Ditto ditto fitted with grid leaks, 7/6 each.

- Aerial, Earth and Phone Labels, each, 3d.
- Aerial Wire, 100 ft. 7/22, with 2 insulators, each set, 4/6.
- Aerial Silicon Bronze Wire, 18 gauge, per 100 ft., 2/6.
- Wireless Masts, in 4 sections, totalling 11 ft., 4/9.
- Valve Holders, 4 legs, with nuts and washers, 1/9.
- Ebonite Valve Holders, complete, best quality, 1/9.
- Slider and Plunger, 6d.



- Insulators, porcelain, small egg shape, 3d.
- Insulators, porcelain, 2-in. reel, 2d.
- Insulators, large shell type, 8d.
- Ivoryine Scales, 6d.
- Crystal Cups (small and large), each 2d. and 6d.
- Crystal Detectors, 3s., 4s. 6d.
- Lightning Arresters, 2/-.
- High-Frequency Transformer Former (3 divisions), 4/6.
- Leading-in Tube, 6 in. long, 2/-.
- Copper Foli, 4 x .002, per lb. 2/8.
- 2-Coil Holder, with extended arm, complete for panel mounting, 12/6.
- 3-Coil Holder, with extended arm, complete for panel mounting, 17/6.



Switch Knobs, 1 1/2 in. in dia., knurled edges, tapped 2BA, 3d.  
Contact Studs, with nut and washer, per doz., 8d.  
Valve Legs, with nut and washer, each set, 2d.

- Terminals, complete, small and medium, per doz. 1/8
- Terminals, complete, large, per doz. 2/0
- Square Brass Centre Rods for condensers 6d.
- 2 BA Brass Screwed Rods, 12 in. lengths 5d.
- Brass Nuts, 2BA, 4BA and 5BA, per doz. 4d.
- Tuning Bar, square, Brass rods in 13 in. lengths 5d.
- Ebonite Sheets, various thicknesses (cut to any size), 4/8 per lb.
- Switch Arms, complete, 1/0 and 2/6.
- Postage Extra.

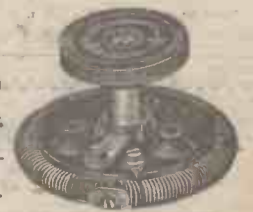

CASH REFUNDED IF NOT SATISFIED

GREAT REDUCTION IN PRICE OF "PALMERPHONES" FROM 29/6 TO 25/-

**GEORGE PALMER** (IMMEDIATELY BEHIND SHAFTESBURY THEATRE, SHAFTESBURY AVENUE),  
47, Gerrard Street, London, W.1.

WHOLESALE TRADE SUPPLIED



# Amateur Wireless And Electrics

FREE  
POST  
REPLIES

No. 21

SATURDAY, OCTOBER 28, 1922

Price 3d

## CONTENTS

Noisy Amplifiers

■ ■ ■

How to Make a  
Test Buzzer

■ ■ ■

Hints on Receiv-  
ing Telephony

■ ■ ■

A Transformer  
for Low-resist-  
ance Phones



A FREAK RECEIVING SET BUILT IN A COCONUT, WHICH WAS ON VIEW AT THE RECENT EXHIBITION

Rheostats

■ ■ ■

Television

■ ■ ■

The Valve

■ ■ ■

A Glass-tube  
Crystal Detector

■ ■ ■

A Novel Means of  
Increasing Con-  
denser Capacity

■ ■ ■

Radiograms : Correspondence : Information Bureau : Club Doings, etc.

# ECONOMIC ELECTRIC LTD.

WHOLESALE, RETAILERS and the PUBLIC, are requested to TAKE NOTICE that this advertisement is to introduce the

PRICE **15/-** **EXTRA** **XC** **15/-** PRICE  
 PATENTS PENDING

## THERMIONIC TRIODE

the latest and best development of the three electrode valve.

**RECTIFIES, OSCILLATES, AMPLIFIES**

**Unique Construction and High Amplification Characteristic.**

Filament current 5 amps at 4 volts. Anode potential 50 volts.

Obtainable from the patentees, ECONOMIC ELECTRIC LTD., and all dealers in Wireless apparatus. Wholesale enquiries should be sent to the patentees or to Mr. H. S. TYLER, 23b, Balham Hill, London, S.W.11.

Head Office: 10, FITZROY SQUARE, LONDON, W.1

INFRINGES NO PATENTS! Illustration Full Size

New Showrooms: 303, EUSTON ROAD, N.W.1.

Telephone: MUSEUM 1055

Branch Showrooms: TWICKENHAM



# MITCHELFONES

Are not a spasmodic production to meet a sudden demand, but have been on the market for over three months, and during this period 27,000 have been distributed to the trade, and consequently we have not been able to offer them direct to the retail buyer.

1,000 per week are now available, and we announce

## DELIVERY FROM STOCK

You post your order, or call at our premises and get them at once. Think what this means to you—you, perhaps, who have been waiting and are still waiting.

Standard resistance 4,000 ohms, double headgear with double headstraps, comfortable, highly efficient, and foolproof

**25/-** per pair.

Special Terms to Traders and deliveries that will surprise you.

## MITCHELLS Electrical & Wireless Ltd.,

Postal Address: McDermott Road, Peckham, S.E.15.  
 Retail Address: 188, Rye Lane, Peckham, S.E.15.

Phones: New Cross 1540/1544

GREAT BRITAIN'S GREATEST WIRELESS STORE

## TWO EXHIBITION SUCCESSES!

**Mast & Aerial Construction for Amateurs**  
**Crystal Receivers for Broadcast Reception**

BY F. J. AINSLEY, A.M.I.C.E.

Crown 8vo. 88 Pages  
 70 Diagrams and Illustrations

PRICE **1/6** NETT  
 (Postage 2d.)

This book is one which the amateur will read with gratitude to the author who has rendered a great service in removing the difficulties of mast and aerial construction. With the use of a few ordinary tools and by following the instructions given in the book this will be found a simple matter.

BY PERCY W. HARRIS

Crown 8vo. 80 Pages  
 Over 70 Photographs & Diagrams

PRICE **1/6** NETT  
 (Postage 2d.)

An explanation in popular language of the principles upon which the numerous Crystal Receiving Sets now on the market are designed, the reasons for the differences between them, and how all of them can be adjusted for the greatest efficiency.

Full directions for building a Simple Crystal Receiver for Wireless Telephone Broadcasting are also given.

All Real Amateurs Read  
**THE WIRELESS WORLD & RADIO REVIEW**

Price **6d.** Weekly

**The Wireless Press Ltd. (Dept. A.W.)**  
 THE PIONEER HOUSE FOR WIRELESS PUBLICATIONS  
 12-13, Henrietta Street, Strand, London, W.C.2

## Go to Hall's!

ACTUAL MANUFACTURERS  
 ESTABLISHED 1908.

# "HALL'S"

For the Cheapest and Best Obtainable

**HIGHLY EFFICIENT "BRUNET" HEADPHONES**  
 Guaranteed 4,000 ohms.

**VERY LIGHT 25/=** Beautifully Finished

**VALUE WITH QUALITY**

**VARIABLE CONDENSERS**  
 Vanes guaranteed thick 22 gauge.

| Capacity | No. of Vanes | Complete Parts |
|----------|--------------|----------------|
| .001     | 57           | 7/-            |
| .0075    | 43           | 6/-            |
| .0005    | 29           | 5/3            |
| .0003    | 19           | 3/3            |
| .0002    | 13           | 2/3            |
| .0001    | 7            | 2/-            |

Single valve panels, £1, complete in polished cabinet.  
 Amplifying panels, 30/- complete in polished cabinet.  
 Intervalve trans. formers, 16/6.

- Crystal Sets 15/-, 30/-, 43 0s.
- Single Valve Sets 23 10s. 0d., in Mahogany Case.
- Alum. Vanes 22 gauge, 1d. each, fixed and moving 2d. doz., 7/- gross.
- Spacers 4d. per doz., 8/6 gross.
- Spacers (small) 2d. doz., 2/- gross.
- Ebonite Knobs, for centre spindle, 4d. each.
- Aerial Wire 100 ft. length 7/22 copper 3/8.
- Valve Legs 4 for 5d., 1/- doz.
- Engraved Ivorine Scales 0.180, 6d.
- Filament Resistances, splendid value, 3/-.

- Switch Arms, complete with knob, collar, nuts, etc., 1/-, 1/8.
- Valve Holders 9d. each.
- Crystal Cups, plain 1d., 8 screw 2d.
- Terminals, all types, extraordinary value, 2 & 4 BA, 2d. each.
- Contact Studs 1/2 x 1/8 doz.
- Insulators, 1d. reel, 8d. egg type.
- Brass Nuts, 2 BA, 4 BA & 6 BA, 4d. doz.
- Ebonite Sheet, cut to any size, 4/3 lb.
- Fixed Condensers, any capacity, 2/-.
- Gridleak Condensers, 3/6.
- Ebonite Slider Plunger, 6d.

POSTAGE EXTRA. BALANCE REFUNDED IF EXCESS SENT.

SEND FOR FREE CATALOGUE **"HALL'S"** TRADE SUPPLIED Dispatch by Return

Telephone: Regent 1232.

**71, BEAK ST., REGENT ST., LONDON, W.1.**  
 Between Piccadilly Circus and Oxford Circus Bus Nos. 8, 6, 12, 18, 82, 51, 53, 59, 68 pass Beak St.

# Amateur Wireless

## and Electrics

No. 21

October 28, 1922

## NOISY AMPLIFIERS

An Article Describing a Simple Method of Improving the Note-magnifier

THOSE readers who have acquired a low-frequency amplifier having two or more stages of amplification, and are unable to get full magnification and at the same time freedom from howling or self-oscillation, will find in this article a simple method of overcoming their difficulties. Low-frequency amplifiers, or note-magnifiers as they are sometimes called, have an unfortunate habit of setting up a loud howl at the least provocation, and usually the only way to stop this howl is to reduce the high tension current and increase the filament current of the valves until they glow too brilliantly for the peace of mind of the operator, who is usually correct in assuming that some new valves will be his next expense. He reduces his filament current a little and immediately the howl returns.

Fig. 1 is a diagram of a typical three-valve low-frequency amplifier having separate high- and low-tension batteries. Where separate low-tension batteries are used for receiver and amplifier, the low-tension negative terminal of the amplifier should be con-



Operating the Marconi Portable Receiver.

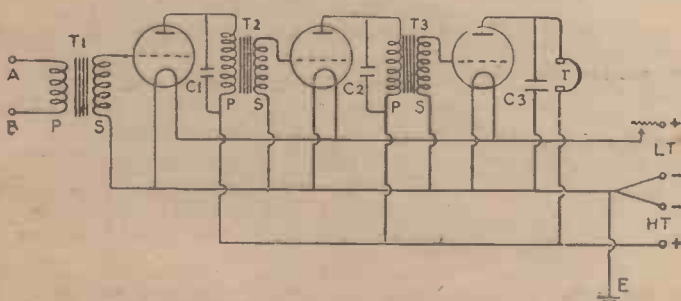

Fig. 1.—Circuit Diagram of Typical Three-valve Low frequency Amplifier.

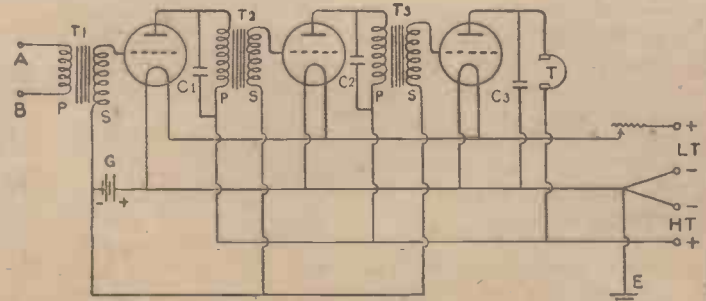

Fig. 2.—Diagram of Modified Circuit for Preventing Howling.

ected to earth as shown. This connection should be omitted in cases where the receiver and amplifier valves are supplied from the same accumulator. In Fig. 1,

T<sub>1</sub>, T<sub>2</sub> and T<sub>3</sub> are iron-cored transformers of the step-up variety—that is, the secondary has more turns than the primary. A and B are the input terminals for connection to the telephone terminals of the receiver. The fixed condensers C<sub>1</sub> and C<sub>2</sub> across the primaries of the second and third transformers should be about .002 microfarads, and C<sub>3</sub>, which shunts the telephones and high-tension battery, should be much larger; .01 microfarads would be suitable. This type of amplifier is fairly well standard, and in very many cases it will be found impossible to prevent howling unless the valve filaments are forced beyond their normal brilliancy.

The amplifier can be made to function correctly by means of a slight modification of the existing circuit, which stops any tendency to howl, permits of putting a lower voltage on the valve filaments, and at the same time increases magnification to a surprising extent. The secret is to keep the grids at a steady negative potential. Fig. 2 shows how this is done.

Instead of connecting the secondary windings of the transformers to the negative of the low-tension battery as before, they are now taken to the negative end of a battery of two small dry cells G. The positive end of this battery is connected to the negative of the filament battery, and it is as well to bring out the dry battery connections to a pair of terminals on the face of the panel in order that they may be short-circuited if it is desired to test the amplifier without the dry cells in circuit.

The writer uses two Leclanché cells, giving three volts in all, but tests should be made using one, two and three cells in order to discover what voltage is best suited to the valves in use.

It may be thought that in Fig. 1 the grids are already sufficiently negative, being connected to the negative of the filament battery. This is not so, for the reason that the grid voltage is practically nil, the grids being at earth potential.

P. T. B.

should a breakage occur the joining must be neatly soldered and dipped in hot wax.

When the whole of the wire has been wound, the last 6 in. should be carefully threaded through the other needle hole and carefully tucked away. The winding should now be tested for breakages with a battery and telephone. In this case a battery and bulb would be of no use.

**Secondary Winding**

If the winding appears to be continuous it should be neatly covered with two layers of waxed paper, and it is then ready to receive the secondary windings.

This is a much simpler matter. About 120 yd. of No. 36 s.c.c. copper wire should be wound on in exactly the same way as the thin wire, a few inches being left at the beginning and end of the wire for taking to terminals later. This wire must not be joined in any way to the thin wire.

**Testing**

When finished, another test should be made to ensure that no break has occurred, the test being made with a small 4-volt battery and bulb. In this case the bulb should light. If no break has occurred the wire should be covered with a few layers of waxed paper and the whole instrument fixed to a small mahogany

# A Transformer Suitable for Low-resistance Phones

THE use of a telephone transformer in valve sets is always to be recommended, as not only does it protect the delicate windings of head-sets and prevent demagnetisation, but also it helps to cut out many extraneous noises. It is not

generally known, however, that by using a telephone transformer in a crystal circuit the ordinary commercial watch-case telephones can be used with great success and so render unnecessary the purchase of expensive high-resistance telephones.

**Primary Winding**

The bobbin thus made has to be wound with 2½ oz. of No. 44 gauge s.c.c. copper wire. This is a tedious job, but must be done carefully as the efficiency of the instrument will depend upon this winding. Anyone with a little ingenuity can soon put together a small winding machine which will save much time and trouble.

Before commencing the winding a small hole should be bored with a needle through each of the wooden blocks, in one block as near to the core as possible, and in the other about ¼ in. up from the core. The winding can now be commenced, leaving about 6 in. at the beginning for connections later. This should be threaded through the small needle hole nearest the core and tucked away somewhere outside for the time being.

The winding should commence at the

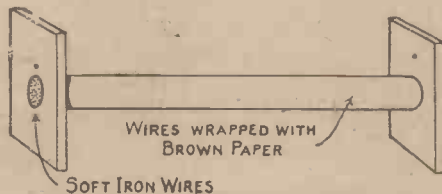

Fig. 1.—Former with Core.

**Materials**

The materials required to make this instrument are:

- 120 yd. of No. 36 d.c.c. copper wire.
- 2½ oz. of No. 44 s.s.c. copper wire.
- A few feet of No. 22 soft iron wire cut up into lengths of 4½ in.
- About four terminals.

**Core**

The core of the transformer should be made first. This consists of a bundle of short lengths of No. 22 gauge soft-iron wire, each wire being 4½ in. long, sufficient lengths being used to make a bundle about ½ in. in diameter. A strip of strong brown paper about 10 in. long and 4½ in. wide should be tightly bound round the wires, making them into a neat round bundle, the end of the paper being securely fastened with glue. When finished the whole should be dipped in hot paraffin wax.

Two pieces of good dry wood (preferably mahogany) are now required to fit securely on each end of the core to form a bobbin. These should be about 2½ in.

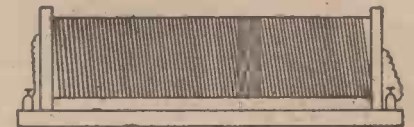

Fig. 2.—Completed Transformer.

baseboard. Four terminals should be fitted on the latter, preferably two at each end, and the loose wires which were left over at the beginning and ending of each winding taken to them. It is very important that the terminals should be carefully labelled, the two with the thin (44 gauge) wires attached being marked "P" (primary) and the other two with the thicker wires marked "S" (secondary).

The instrument is now complete and ready for use and will be found to well repay the time and trouble spent on it. It may, if desired, be given a coat of shellac varnish.

**Connections**

The sketch (Fig. 2) shows what the completed instrument should look like, and the diagram (Fig. 3) shows how the transformer should be used with low-resistance receivers.

In use, the two wires of the receiving set which would normally have been connected to the telephones should be connected to the terminals marked P and the telephones connected to the terminals S. The two ear-pieces should be wired up in series.

W. D.

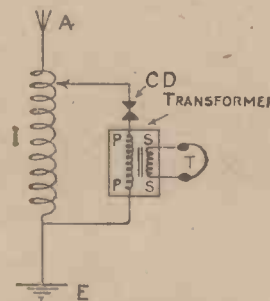

Fig. 3.—Circuit Diagram showing Use of Transformer.

end of the bobbin where the spare 6 in. was threaded through the hole, and should be wound as evenly and closely as possible to the other end of the core, and then wound back again, continuing in this way until the whole 2½ oz. has been wound on. Great care should be taken not to break the wire, which is very thin, but

# How to Make a Test Buzzer

Constructive Details of a Simply-made Yet Highly-efficient Instrument

THE buzzer here described will be found to be very useful for testing the sensitivity of crystal receiving sets. It is simple in construction, and the high

Make the core of the coil (Fig. 8) of soft iron. The lower end is drilled and tapped 2 B.A. for the purpose of affixing the coil to the magnet frame. Before being assembled it should be well annealed in order that any hardness caused by working the metal may be removed. This having been done, the cheeks are affixed with shellac varnish (thick) so that the ends of the core project for a distance of  $\frac{1}{8}$  in. That portion of the core between the cheeks is covered with a layer of waxed paper, and for extra insulation may also be given a coating of shellac varnish. When the varnish has set and the cheeks are secure in their positions, drill a small hole in the lower cheek close to the core and another close to the outer edge of the same cheek. The coil is now ready for winding.

The wire used is No. 30 silk-covered. Obtain a long 2 B.A. screw and cut off the head. Screw the shank into the hole in the base of the core. By this means the coil may be wound in the lathe or on a wheel-brace held in a vice. Insert the end of the wire through the inside hole in the lower cheek and wrap about 6 in. of it round the winding spindle. Now proceed to wind the coil in even layers to within about  $\frac{1}{16}$  in. of the edge, taking the finishing end through the other hole in the cheek. Cover the winding with a strip of oiled silk and put aside.

The contact screw is 4 B.A., and is fitted at one end with a platinum contact and at the other with a small knurled ebonite knob.

Fasten the coil to the magnet frame with a  $\frac{5}{8}$ -in. 2 B.A. screw, and then screw the armature spring into place with two  $\frac{3}{8}$ -in. 4 B.A. screws. Fit the contact screw and wing-nut to the standard and then screw these portions of the instrument on to the base in the positions shown. The connections are shown in Fig. 2. One end of the winding is taken to A, the other end is neatly soldered on to the base of the contact-screw standard, the magnet frame is connected to B and

D, and C is connected to the contact-screw standard. Although the wiring is shown on the upper surface of the base for clearness, it is much neater to run the con-

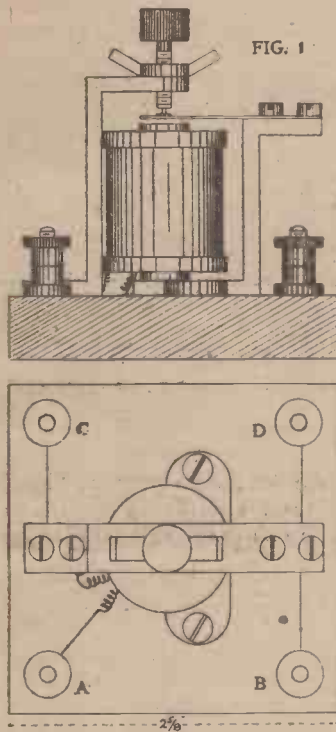

Figs. 1 and 2.—Elevation and Plan of Buzzer.

note is more pleasant to the ear than the drone of the oscillations given forth by the mechanism of an electric bell.

Figs. 1 and 2 are the elevation and plan of the instrument. The contact-screw standard (Fig. 3) is made from  $\frac{3}{8}$ -in. sheet brass, and the magnet frame (Fig. 4) is made of  $\frac{3}{8}$ -in. soft sheet iron. The wing-nut (Fig. 5) is of  $\frac{3}{8}$ -in. sheet brass. When cut to the shape and dimensions of Fig. 5 bend up the wings as shown in Fig. 1.

Thin clock-spring is used for the armature (Fig. 6). The fixing-screw holes are 4 B.A. clearance, and should be drilled to correspond with their associating holes in the magnet frame. A small hole is drilled at *a*, and a small piece of platinum wire (slightly longer than the thickness of the spring) is driven into it. The projecting portion of the wire is then hammered to the form of a small flat disc as shown in Fig. 1.

Ebonite  $\frac{3}{8}$  in. thick is preferable for the coil-cheeks (Fig. 7), but hard wood may be substituted if, when finished, the cheeks are given a coat of shellac varnish.

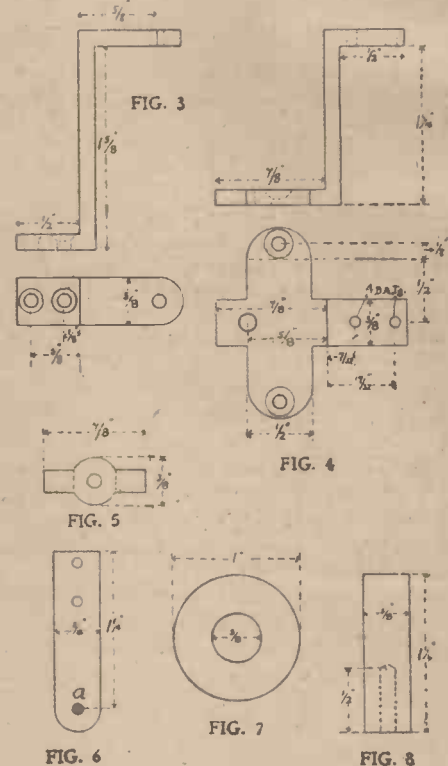

Figs. 3 to 8.—Details of Parts.

necting wires along shallow grooves cut into the bottom of the base.

A and B are connected to a battery of two dry cells with a tapping key in circuit with which to signal when testing. C is connected to an aerial rod. This is only a piece of  $\frac{3}{8}$ -in. brass rod about 18 in. long, supported vertically on an insulating base. D is connected to earth.

The buzzer is adjusted by loosening the wing-nut and advancing or withdrawing the contact screw until the best note is obtained, and then clamping up. J.MCG.

## A Novel Means of Increasing Condenser Capacity

IT was the writer's misfortune on one occasion to be held up for a large-capacity variable condenser. The capacity of the variable condenser on hand had a maximum of .001 microfarads, and one of .002 microfarads was required. The following method was used to produce the desired capacity. A small glass jar or container was obtained of such a size as to be capable of holding the vanes. This

was partly filled with insulating oil, so that when the vanes of the condenser were fitted into the container they were completely submerged in the oil, when the desired capacity was obtained. The reason, of course, is that as the specific inductive capacity of air is denoted by 1, and insulating oil has a specific inductive capacity of 2.2, the capacity of an air condenser in oil is almost doubled. L.C.

# All About the Valve.—III

The Third of a Series of Articles Explaining the Principles and Action of the Thermionic Valve

IN the first place, the "characteristic curve" of a two-electrode valve is merely a graphical method of illustrating the effect upon the thermionic flow (or plate

current) of a progressive variation in the voltage applied to the plate, say from zero to any given higher or lower value.

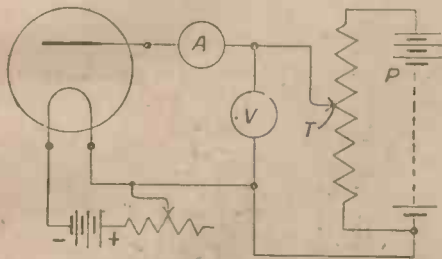

Fig. 6.—Circuit Arrangement for Investigating Effects of Plate Voltage.

plate, there would flow through the plate circuit a corresponding steady current amounting approximately to 0.75 milliamps.

Now consider the effect of applying a signal impulse giving a variation to the steady potential of, say, 2 volts on each side of the normal. The negative half-wave of the signal will reduce the total applied voltage to 8 volts and the point Z will be reached, corresponding to a normal plate current of 0.5 milliamps.

On the other hand, the ensuing positive half-wave of the signal will raise the total applied voltage to the point Y (12 volts), at which the corresponding plate current has a value of 1.5 milliamps.

The resultant increase of current (namely, 1.5 - 0.75 or 0.75 milliamps) is obviously greater than the resultant decrease (namely, 0.75 - 0.5 or 0.25 milliamps) for each high-frequency cycle. The net result on the plate current of the incidence of a damped train of waves is seen in Fig. 8. Each positive half of the high-frequency train creates a comparatively

large "hump" or increase above the dotted line representing the normal plate current, whilst each negative half of the wave train

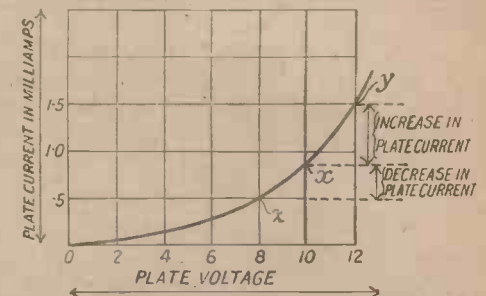

Fig. 7.—Curve showing Voltage and Current Effects.

gives rise to a practically negligible fall below the normal.

The successive pulses of non-directional current are amalgamated into the elongated hump shown in the lowest part of the figure in the manner previously explained, and each hump corresponds, as before, to one click. D. ALCASE.

A circuit arrangement for investigating this effect is shown in Fig. 6. The plate of the valve is connected by a sliding point T to the rheostat of a potentiometer giving a range of, say, 30 volts. As it is not necessary to throw the plate negative, relatively to the filament, the latter is connected to the negative end of the potentiometer. A milliammeter A is inserted in series with the plate, and a voltmeter V is in shunt between the plate and filament.

Starting with the tapping T at the lowest end of the potentiometer, it is gradually moved upwards, and readings are taken of the current in milliamps shown in A for every upward step of, say, 2 volts registered by V.

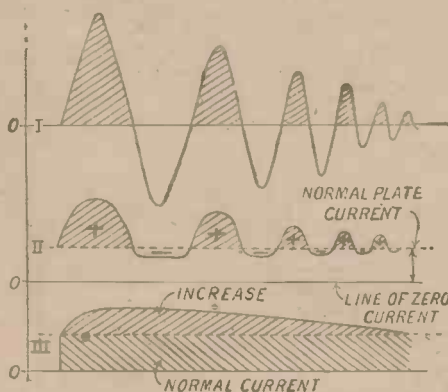

Fig. 8.—Effect of Incidence of Damped Train of Waves on Plate Current.

The resultant curve will be of the order shown in Fig. 7.

From a survey of this curve it is clear then that if we adjusted the tapping T to, say, a point X corresponding to a steady positive potential of 10 volts on the

## Hints on Receiving Telephony

IN view of the fact that a great many people are taking up wireless with the sole object of receiving speeches and music from the broadcasting stations, and in many cases have announced their intention of not even troubling to listen to commercial messages in Morse, it is considered that a few devices gathered in the course of several years amateur wireless work and that are not usually known to the beginner may be of interest.

### Beginners' Apparatus

In the first place it is probably correct to assume that most beginners will start with a crystal set, but I venture to suggest that before long most, if not all, of them will need something a little more sensitive and will naturally turn to valves. Some may perhaps be in the fortunate position of being able to purchase expensive multi-valve sets, but to the majority the question of cost will be of considerable importance, and it is for these individuals that the following remarks are primarily intended.

A great many experimenters are prone to despise a single-valve set, and airily give as their opinion that nothing under, say, three valves is of any use, but a

single-valve set handled by an expert is capable of yielding astounding results, and will give all the amplification necessary when one is prepared to wear head telephones. The reason why many amateurs fail to obtain good results from a single-valve set is almost invariably due to inefficient control over reaction. Added to this a great many do not yet seem to have realised that in order to receive telephony properly the valve must not be allowed to oscillate. The reaction coil should only be used for increasing signal strength and not for setting up a heterodyne, as when receiving continuous wave signals. An amateur who oscillates on telephony to all intents and purposes converts his receiving set into a transmitter, and every other amateur within a considerable radius has his reception spoiled by the continuous howl which results. While searching for weak telephony it is necessary to oscillate, but immediately the carrier wave is found tune down to the "silent" point and then slowly loosen the coupling of the reaction coil until the set stops oscillating, meanwhile keeping in the "silent" point by means of the aerial tuning condenser. If

(Continued on page 469)



For receiving vocal and instrumental items you must have

## MULLARD "ORA" VALVES

to get the best results.

**O**scillates **R**ectifies **A**mplifies  
Specially recommended where good amplification is required

The "Ora" Valve requires about 3.8 volts on the filament and 30 volts or over between the anode and filament for efficient results

**15/-** each

### IMPORTANT NOTICE

The great demand for Mullard "ORA" Valves and other accessories has compelled us to open much larger works. A greatly increased output is now available.

The Mullard "R" Valve is now reduced in price from 22/6 to 17/6



# Mullard Radio Valve Co. Ltd.

45, Nightingale Lane, Balham, S.W.12.

Contractors to H.M. Admiralty,

Signal School, Portsmouth.

War Office, Royal Air Force & Post Office.

Telephone: Codes: Telegrams:  
Battersea ABC (5 Ed) 'Radiovalve, Hammer'  
1068 Bentley's London.



| Name and Address                                                           | Quantity | Description              | Price        | Total |
|----------------------------------------------------------------------------|----------|--------------------------|--------------|-------|
| To the MULLARD RADIO VALVE CO. LTD., 45, Nightingale Lane, Balham, S.W.12. |          | Telephone Head Sets      | 30/- per set |       |
|                                                                            |          | "ORA" Valves             | 15/- each    |       |
|                                                                            |          | Grid A Resistances       | 5/- "        |       |
|                                                                            |          | Anode A or B Resistances | 2/6 "        |       |
|                                                                            |          | BA Condensers, 0.005 mfd |              |       |
|                                                                            |          | Combined Resistance and  |              |       |
|                                                                            |          | Valve Bases with         | 7/6 "        |       |
|                                                                            |          | Valve Sockets            | 5/- "        |       |
|                                                                            |          | Terminal Clips           | 1/3 "        |       |
|                                                                            |          |                          | 9d. per pair |       |

Please send me post free

I enclose (Cheque, Money Order, P.O.) value

to cover the cost.

Name of usual Wireless Dealer

**SEND THIS TO-DAY**

# A FREE GIFT FOR EVERY AMATEUR

In order to advertise our various lines of Wireless Accessories, we are offering, for a limited period only,  
**A COMPLETE SET OF FOUR CONCERT WAVE-LENGTH  
 BURNDIPT COILS** (Value 25/-)  
**FREE OF CHARGE**

to every purchaser of Accessories to the value of £5 or over, providing the order is received not later than November 4th, 1922. Apart from obtaining this very acceptable gift, every customer is assured of receiving the finest quality of accessory by purchasing from us. We stock one quality only, viz., the best it is possible to obtain. Inferior qualities lead only to disappointment.

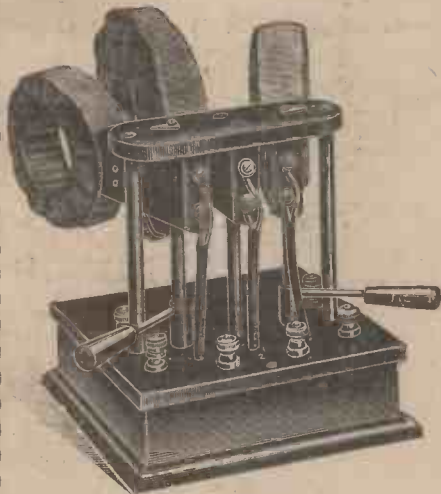

**Coil Holder 25/-**

A first class instrument, undoubtedly the finest on the market.

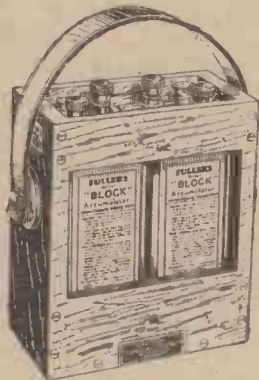

**Fuller Block Accumulator**

4 volt 40 amp. £1 12s. 6d.  
 Case 7/6 extra.

**FULLER BLOCK TYPE ACCUMULATORS** Carriage

|                       | £ | s. | d. | s. | d. |
|-----------------------|---|----|----|----|----|
| 4 volt 40 amp. ... .. | 1 | 12 | 6  | 1  | 3  |
| 6 volt 40 amp. ... .. | 2 | 8  | 9  | 1  | 6  |
| 4 volt 80 amp. ... .. | 2 | 8  | 0  | 2  | 0  |
| 6 volt 80 amp. ... .. | 3 | 12 | 0  | 2  | 6  |

Prices of several other capacities on application.

**FULLER STANDARD PLATE TYPE ACCUMULATORS**

|                       |   |   |   |   |   |
|-----------------------|---|---|---|---|---|
| 4 volt 30 amp. ... .. |   |   |   |   |   |
| 6 volt 30 amp. ... .. |   |   |   |   |   |
| 4 volt 80 amp. ... .. |   |   |   |   |   |
| 6 volt 80 amp. ... .. | 2 | 2 | 0 | 2 | 6 |

**BROWN "A" TYPE HEADPHONES**

|                   |   |   |   |   |   |
|-------------------|---|---|---|---|---|
| 120 ohms ... ..   | 2 | 2 | 6 | 1 | 0 |
| 8,000 ohms ... .. | 2 | 9 | 6 | 1 | 0 |

**SULLIVAN HEADPHONES**

|                   |   |    |   |   |   |
|-------------------|---|----|---|---|---|
| 8,000 ohms ... .. | 1 | 16 | 6 | 1 | 0 |
|-------------------|---|----|---|---|---|

**COIL HOLDER, as illustrated**

|  |   |   |   |   |   |
|--|---|---|---|---|---|
|  | 1 | 5 | 0 | 1 | 0 |
|--|---|---|---|---|---|

**BURNDIPT COILS, short wave, set of 4**

|  |   |   |   |  |   |
|--|---|---|---|--|---|
|  | 1 | 5 | 0 |  | 9 |
|--|---|---|---|--|---|

**INTERVALVE TRANSFORMERS**

|  |   |   |   |   |   |
|--|---|---|---|---|---|
|  | 1 | 5 | 0 | 1 | 0 |
|--|---|---|---|---|---|

**TELEPHONE TRANSFORMERS**

|  |   |   |   |   |   |
|--|---|---|---|---|---|
|  | 1 | 5 | 0 | 1 | 0 |
|--|---|---|---|---|---|

**"PARLIPHONE" LOUD SPEAKER**

|  |   |    |   |   |   |
|--|---|----|---|---|---|
|  | 1 | 12 | 6 | 1 | 3 |
|--|---|----|---|---|---|

**"ORA" VALVES**

|  |    |   |  |  |           |
|--|----|---|--|--|-----------|
|  | 15 | 0 |  |  | post free |
|--|----|---|--|--|-----------|

**MARCONI "R" TYPE VALVES**

|  |    |   |  |  |     |
|--|----|---|--|--|-----|
|  | 17 | 6 |  |  | " " |
|--|----|---|--|--|-----|

**VARIABLE CONDENSERS**

|                   |    |   |  |  |     |
|-------------------|----|---|--|--|-----|
| '0005 mfd. ... .. | 18 | 6 |  |  | " " |
|-------------------|----|---|--|--|-----|

|                                      |   |   |   |  |     |
|--------------------------------------|---|---|---|--|-----|
| (for panel mounting) 001 mfd. ... .. | 1 | 4 | 6 |  | " " |
|--------------------------------------|---|---|---|--|-----|

|                                      |   |   |   |  |     |
|--------------------------------------|---|---|---|--|-----|
| ditto in Ebonite case 0005 ,, ... .. | 1 | 0 | 6 |  | " " |
|--------------------------------------|---|---|---|--|-----|

|                  |   |   |   |  |     |
|------------------|---|---|---|--|-----|
| '001 mfd. ... .. | 1 | 6 | 6 |  | " " |
|------------------|---|---|---|--|-----|

**MULLARD CONDENSERS**

|                             |   |   |  |  |     |
|-----------------------------|---|---|--|--|-----|
| '0002 and '0003 mfd. ... .. | 2 | 6 |  |  | " " |
|-----------------------------|---|---|--|--|-----|

|                  |   |   |  |  |     |
|------------------|---|---|--|--|-----|
| '001 mfd. ... .. | 3 | 0 |  |  | " " |
|------------------|---|---|--|--|-----|

**MULLARD GRID LEAKS**

|  |   |   |  |  |     |
|--|---|---|--|--|-----|
|  | 5 | 0 |  |  | " " |
|--|---|---|--|--|-----|

**FILAMENT RESISTANCES**

|  |   |   |  |  |     |
|--|---|---|--|--|-----|
|  | 4 | 0 |  |  | " " |
|--|---|---|--|--|-----|

**TELEPHONE CORDS, best quality**

|  |   |   |  |  |     |
|--|---|---|--|--|-----|
|  | 3 | 6 |  |  | " " |
|--|---|---|--|--|-----|

**EBONITE SHEET, cut to size**

|                |   |   |  |  |     |
|----------------|---|---|--|--|-----|
| per lb. ... .. | 4 | 6 |  |  | " " |
|----------------|---|---|--|--|-----|

**TERMINALS, 4 BA. per doz.**

|  |   |   |  |  |     |
|--|---|---|--|--|-----|
|  | 3 | 0 |  |  | " " |
|--|---|---|--|--|-----|



**Brown "A" Type Headphones**

120 ohms £2 2s. 6d.  
 8,000 ,, £2 9s. 6d.

Over £20,000 worth sold since July last.

**The "Parli-  
 phone" Loud  
 Speaker**

The only Loud Speaker on the market that does not distort music and speech.

Capt. Ian Fraser,  
 President of  
 St. Dunstan's,  
 writes: "I have  
 had sp'endid  
 Telephony with  
 the Parli-  
 phone."

Only 32/6 each.



**WE SUPPLY THE TRADE—INQUIRIES SOLICITED.**

## THE CITY ACCUMULATOR CO.

79, Mark Lane, London, E.C.3.

Please note our new Telephone No.—AVENUE 1316.

Agents: LONDON: A. W. GAMAGE, LTD., Holborn, E.C. SELFTRIDGE & Co., LTD., Oxford Street, W. RICHFORD & Co., 153, Fleet St., E.C.4.  
 YORKS: BARNSELY BRITISH CO-OPERATIVE SOCIETY, LTD., Barnsley.  
 GLOS: BRISTOL WIRELESS Co., 52, Cotham Hill, Bristol.  
 S. WALES: SOUTH WALES WIRELESS INSTALLATION Co., LTD., 18, West Bute Street, Cardiff.  
 N. WALES, LANCs. CHES. & I.O.M.: THE "ALL-BRITISH" WIRELESS MANUFACTURES Co., LTD., 70, Central Bldgs., 41, N. John



**HINTS ON RECEIVING TELEPHONY** (continued from page 466)

you are in doubt as to whether you are still oscillating touch the aerial terminal with the finger, and if you do a loud click in the telephones will result. Further loosening of the reaction coil is then necessary until no click is heard on the same test being applied. The next



"Portland" Single-valve Receiver.

step is to bring the reaction coil or its equivalent back again as close as possible to the point where oscillation commences without actually oscillating. By the equivalent of the reaction coil is meant one or more of the devices given below, while all achieve the same result but in a much more delicate manner.

**Modifications**

Fig. 1 shows a standard single-valve circuit which gives good results, but I would like to draw attention to one or two possible modifications which are well worth trying, and which in some circumstances may materially improve matters. In the diagram it will be observed that the telephones are between the H.T. battery

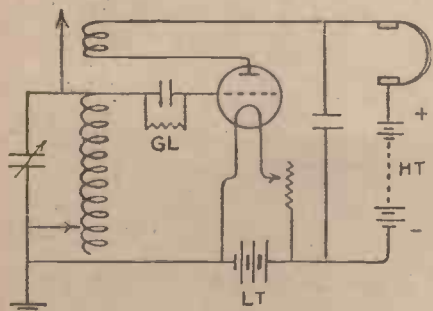

Fig. 1 - Standard Single-valve Circuit.

and the reaction coil instead of being, as usual, on the negative side of the latter, this generally giving the better results. Both methods should, however, be tried, for many small factors come into play to determine their relative efficiency on any particular set. The operation is quite simple—merely make the phones and H.T. change places, keeping the positive of the H.T. towards the reaction coil.

**The Grid Leak**

The value of the grid leak (G.L.) is a source of bother to many people, and writers almost invariably give as the best value 2 or 3 megohms. After considerable experiment the writer found that for short waves the best value is about half a megohm, provided the condenser across it is quite small—somewhere about .002 mfd. Some valves will even give better results when the grid leak is taken completely away.

One other change which should be tried is to move the connection between the earth and the filament battery from the negative side (where it is in the diagram) to the positive. This will have the effect of putting a positive potential on the grid of the valve, and is usually regarded as a cause of parasitic noises, but this is one of the cases where theory does not always agree with practice.

**Overlap**

Attention should then be concentrated on the elimination of what is known as "overlap," the comparatively unknown cause of many troubles. To ascertain if "overlap" is present the following experiment should be tried: Steadily increase the coupling of the reaction coil and note the exact adjustment at which oscillation commences. Then, without interfering with any other part of the set, loosen the coupling and note the adjustment at which oscillation stops. If these two adjustments do not exactly coincide "overlap" is present. This is almost invariably caused by incorrect values of H.T. and filament brilliancy, and suitable correction of these will usually remedy the evil.

Probably the best method of control is to have a variable condenser across the telephones and H.T. in place of the fixed one shown in the diagram—usually known as the "high-frequency by-pass condenser." A variation of this condenser will replace an alteration of the coupling of the reaction coil, in such a manner that a considerable movement of the condenser is necessary to equal so slight a movement of the reaction coil (the hand could not make it, thus affording a much finer adjustment. The great objection to this method is the cost, for this condenser must of necessity be large—quite .001 mfd.—and the cost of a variable condenser of this size is considerable. Of course the difficulty can be overcome to a certain extent by having a much smaller variable condenser in parallel with the existing fixed one, but this is not altogether satisfactory.

**Other Suggestions**

Another method of attaining the same object—and one much favoured by amateurs on account of its comparative cheapness—is to put a very small variable condenser across the reaction coil. The operation of this condenser is the same as before, the only thing to remember being that the condenser must be quite small, certainly not more than .0001 mfd.

Somewhat the same result is obtained if a variable condenser of about .0003 mfd. is substituted for that in parallel with the grid leak, usually known as the grid condenser; but this method is not always to be recommended, since the grid leak needs a certain value of condenser to function properly, and an alteration of this value will sometimes upset matters.

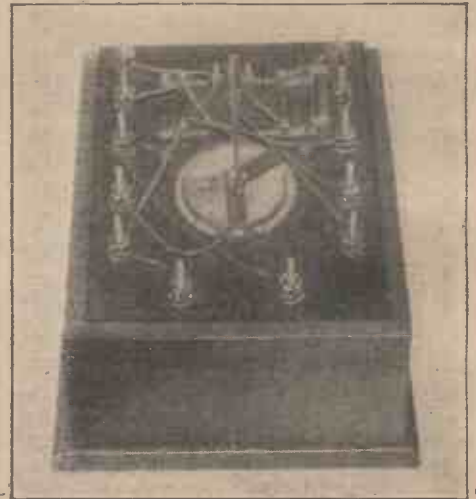

Rear View of Panel of "Portland" Receiver.

A method which usually gives excellent results but sometimes entails additional complications is what is known as potentiometer control of the grid. In this, the connection shown in Fig. 1 between the earth and the filament is removed from the negative of the L.T. battery and joined to the slider or middle terminal of the potentiometer of about 250 ohms resistance. The two ends of the potentiometer coil are joined one to each side of the L.T., and the effect of moving the slide towards the negative side is to increase reaction, while a movement towards the positive side has the opposite effect. The trouble with this

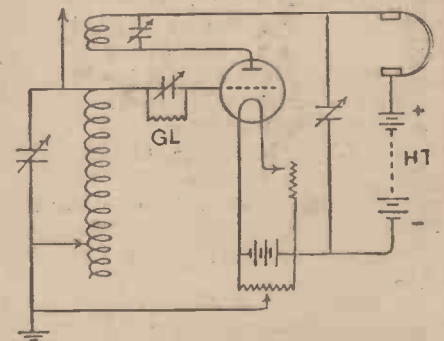

Fig. 2. Modified Single-valve Circuit.

method is that it frequently happens that on certain wave-lengths better results are obtained without a grid leak and condenser, while on others these units are necessary, thus involving some form of switch gear, which is to be deprecated.

Fig. 2 is a diagram similar to Fig. 1, but with all these devices incorporated. It is, of course, understood that usually only one of these is necessary. A. E. G.

# TELEVISION.—II

# THE ELECTRIC EYE: SOME EARLY APPARATUS

WILLOUGHBY SMITH, a well-known English telegraph engineer, requiring a very high resistance for testing submarine cables at the shore ends, was led, on account of its seeming suitability, to employ a stick of selenium. The results, however, were most unsatisfactory, the readings obtained varying in a most



Fig. 1.—Diagram of Simple Form of Selenium Cell.

unaccountable manner, hardly two being similar. Upon investigation, it was found by Mr. May—Willoughby Smith's assistant—that the variation in resistance was caused by the action of light upon the selenium, the resistance being much less when exposed to bright daylight than when placed in the dark.

## Selenium

This peculiar property of selenium has been very thoroughly investigated by a number of scientists, and the result of their work has enabled many useful scientific wonders to be performed. Among the many purposes in which selenium plays a leading part may be mentioned, the automatic control of electric street lamps; the optophone, an instrument for enabling the blind to read ordinary printed matter; photo-telegraphy, and television.

In its normal state selenium is practically a non-conductor of electricity, but when it has been prepared—that is, reduced to a crystalline condition by being heated at a certain temperature for some time and then slowly cooled—it will be found to have become a high-resistance conductor, its resistance being  $40 \times 10^9$  (forty thousand million) times greater than copper; as already stated, the resistance of prepared selenium varies under the action of light.

## Selenium Cells

For convenience, selenium is made up into what is known as a "cell," which in its simplest form consists merely of some prepared selenium sandwiched between two conductors. Cells of any resistance can be made, it being possible to obtain them with a resistance as low as 40 ohms or as high as 1,000,000 ohms. The resistance of a cell to a great extent depends upon the distance apart of the two conductors or, in other words, the thickness of the selenium section between

them, so that the closer together the two conductors are the less is the resistance of the cell, and *vice versa*. By connecting a number of these simple elements in parallel a large light-active surface of the same resistance as one element can be obtained.

A modern cell consists of a small square or rectangular piece of porcelain upon which a double coil of fine platinum wire is wound. The prepared selenium is placed in the spaces between the wires and forms a high-resistance conductor between them. A diagram of a cell is given in Fig. 1. The resistance of a cell is reduced about one-half when brought from the dark and exposed to bright sunlight, intermediate reductions being obtained by exposing the cell to varying degrees of light.

## Early Television Apparatus

The arrangement and action of the earliest apparatus devised for television was somewhat as follows: At the transmitting end there was a screen which was divided into a number of small square compartments, each compartment containing a selenium cell. At the receiving station there was a similarly divided screen, each compartment in this case containing a small electric globe. One wire from each cell was connected to a common battery terminal, the other battery terminal being connected to earth. At the receiver one wire from each globe was also earthed. The remaining terminals on each selenium cell and globe were separately connected by a wire in such a manner that each cell at the transmitter was connected to the globe that occupied a similar position on the receiver.

Now imagine this selenium-cell mosaic at the transmitter to be influenced by a simple black-and-white image projected upon it. Those cells which come under the illuminated portion of the image will have their resistance reduced sufficiently to allow current to flow through the various line wires and light the lamps to which they are connected at the receiver. The cells, however, which remain unexposed do not permit of current passing to the receiver globes.

In this manner a fairly good representation of a simple black-and-white image can be obtained, but the limitations of the method are obvious. Not only is it restricted to working over extremely short distances, but to transmit any complicated subject with reasonable accuracy would necessitate the use of a very large number of selenium cells and globes, with a correspondingly large number of connecting wires.

Apparatus working on similar lines to

the above has actually been constructed by Rhümer, of Berlin, but owing to its elementary construction the apparatus only lends itself to the reproduction of simple patterns such as squares arranged in different combinations. The transmitter and receiver in this case only contained twenty-five elements, and they cost £250. Later it was proposed to build a complete apparatus of 10,000 elements at a cost of £250,000.

## A Glass-tube Crystal Detector

THE advantages of the special detector illustrated will be readily seen. Its chief object is to prevent the tiresome and constant adjustment of the ordinary "cats whisker" type in finding and maintaining a sensitive spot in the crystal.

In the figure A is a rubber plug through which is driven a B.A. screw with a thin brass washer at the bottom to which the crystal is soldered. At the top is a nut and washer for connecting the rubber wire of the circuit. B is a similar rubber plug into which a number of gramophone needles are driven. The needles have a few turns of thin wire soldered to them previous to

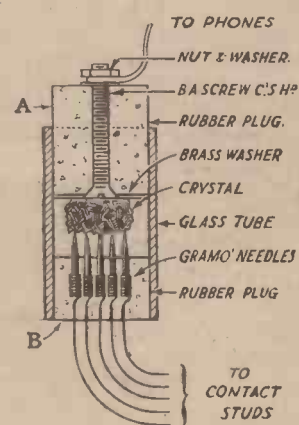

Glass-tube Crystal Detector.

being driven in. Wires from the needles are then taken to small contacts and operated by a suitable switch.

Both plugs are pushed, cork fashion, into a glass tube making fairly firm contact one with the other.

The switch provides a ready and definite means of finding a fresh sensitive point, should the one being used suddenly go "dis."

W. A. D.

# Broadcasting - - The Situation

## The British Broadcasting Company's Policy and Arrangements

A MEETING of the British Broadcasting Company was held on October 18th, when the policy and arrangements of the company were, for the first time, made public. A very comprehensive report of the meeting was published in the *Times* the following day, and this we print below almost in its entirety. Our own views upon the situation are given in another column.

Sir William Noble, formerly Engineer-in-Chief to the Post Office and now a director of the General Electric Company, presided over the meeting, which was attended by over two hundred representatives. Associated with him were representatives of the six companies who have guaranteed the capital of the new company (£100,000), and who will be immediately responsible for £60,000. These companies are the British Thomson-Houston Company, General Electric Company, Marconi's Wireless Telegraph Company, Metropolitan-Vickers Electrical Company, Radio Communication Company, and the Western Electric Company.

### The Company

The chairman said a complete agreement had been reached with the Postmaster-General. The British Broadcasting Company would be a public utility service for the broadcasting of news, information, concerts, lectures, educational matters, speeches, weather reports, and theatrical entertainments. The capital would be £100,000 in £1 shares, and any *bona-fide* British manufacturer could join the company by taking one or more shares. The directorate would consist of eight directors and a chairman. One director would be appointed by each of the six guarantor companies and two by the other members of the company. The chairman would be Lord Gainford, a former Postmaster-General.

### Conditions

Each member was required to pay £50. The money so received would not be used by the company, but would be put to a separate account and returned to the member when he left the company. Every member undertook that the apparatus he sold, except batteries, accumulators, and aerial equipment, was made in this country. The apparatus he sold must be engraved or otherwise marked so that its origin was known. Members would pay to the Broadcasting Company, to meet the expenses of broadcasting, a royalty on each apparatus as follows:

### Royalties

Crystal set, 7s. 6d.; microphonic ampli-

fier, without using valves, 7s. 6d.; crystal set and one valve, £1 7s. 6d.; crystal set and two valves, £2 2s. 6d.; one-valve set, £1; two-valve set, £1 15s.; three-valve set, £2 5s.; four-valve set, £2 15s.; on each other set a royalty *pro rata* to the above; each telephone ear-piece, 3d.; each loud-speaker with or without trumpets, 3s.; each valve, 2d.

Members also undertook not to make broadcast apparatus for any person who was not a member of the company. Only members of the company could have sets approved by the Postmaster-General, and each set would have to be stamped with the approval mark, "Type approved by P.M.G. B.B.C." For transmission purposes every member who had inventions must give the use of them to the company, that was to say, all patents would be pooled, so that the Broadcasting Company would be free of all royalties. By the licence which the Postmaster-General would grant to the Broadcasting Company the Postmaster-General guaranteed that no foreign-made sets would be allowed to be sold for broadcasting purposes.

### Protection

The Postmaster-General could not see his way to protect the company against foreign importations for a longer period than two years, and therefore the committee had decided that they could not guarantee a broadcasting service for longer than two years, because at the end of two years they did not know what would happen. It had been agreed, however, that before the two years expired the position would be reviewed by the Postmaster-General and the company. The licence to be issued by the Postmaster-General to the public would cost 10s., half of which would go to the Post Office and half to the British Broadcasting Company. The broadcasting licence had printed on it a note to the effect that the licence applied only to apparatus with the approved mark of the Postmaster-General.

### Wave-lengths

Since the negotiations began an important concession had been obtained as regards wave-length. It was first decided to limit the wave-length for broadcasting sets to 550 metres, but this was later raised to 700 metres, and now there was no limit. This meant that anyone with a broadcasting set would not only be able to receive the broadcasting programmes efficiently, but would be able to "tune-in" for any outside station. It was confidently hoped that this would mean a considerable addition to the numbers applying for broad-

casting licences, so that the income of the company would enable it to provide really high-grade programmes. The committee were fully alive to the necessity of having good programmes, and recognised that it was only by doing so that the success of the scheme would be assured. At the present time they were negotiating with the Postmaster-General to get authority to raise the power of the broadcasting stations from one and a half kilowatts to three kilowatts. In conclusion, the chairman said that, as soon as the company was registered and the directors appointed, consideration would be given to the question of commencing broadcasting. It was provided that the Broadcasting Company could not declare a dividend of more than 7½ per cent.

### Foreign-made Sets

A general discussion followed, and there seemed to be considerable misapprehension as to the position of foreign-made sets and sets which might be manufactured in this country, but by others than members of the company. Sir William Noble stated that the Postmaster-General had undertaken on behalf of the Government that foreign apparatus would not be imported for the purpose of broadcasting, and it was for the Postmaster-General and Parliament to decide what steps should be taken to give effect to that pledge. Mr. Kellaway had undertaken that no sets which arrived in this country subsequent to July 18th would be allowed to be sold for broadcasting purposes. With regard to those imported prior to that date, evidence had to be given that they were purchased before July 18th, that their number was reasonable, that they satisfied the conditions laid down by the Post Office, and that, if approved, the seller would have to pay upon them to the Broadcasting Company the same royalty as was paid on other sets.

### The Amateur

The position of amateur experimentalists was also raised, and it was stated by a representative of the Post Office that it had not been altered.

It was unanimously agreed to proceed with the registration of the company.

## An Editorial Comment

### The Amateur's Point of View

WE may attempt to explain one or two points in the agreement, the meaning of which may not be apparent to every reader. The greater part of Sir William Noble's statement is perfectly understand-

(Continued on page 475)

IN the first place, it is assumed that a rough idea has been formed of the supply on which the rheostat is to be used. The first point on which to decide definitely is the maximum voltage drop which the rheostat is required to give. The next factor to settle is the minimum current which will be required. This may have to be modified afterwards, as a very small minimum current compared with the voltage is apt to give rise to absurdly large dimensions. The total resistance of the rheostat winding is given by Ohm's Law:

$$R = \frac{E}{C}$$

when C is the minimum current in amperes, E is the maximum voltage drop, and R the total resistance in ohms.

**Considerations of Design**

The next, and most important, point to decide is the maximum current which will be allowed to pass through the instrument, for this governs the question of wire used (as these remarks apply to wire rheostats only) and also the insulating material to be used. This maximum current should always be plainly marked on the finished instrument, thus lessening the danger of someone "burning it out."

Up to this point rule-of-thumb working is all that is required, but from now onwards there is more demand for common sense, as the actual numerical data in hand are not sufficient to determine all that is required, thus necessitating several assumptions. In order to limit the number of possible solutions, and to simplify the working as far as possible, the writer has divided wire rheostats into three broad

An example of a high-class resistance unit. The wire is closely wound upon a tube of vitrified enamelware, a thin coat of superficial oxide upon the wire being sufficient to insulate successive turns. The makers are Isenthal & Co., Ltd., London, N.W.

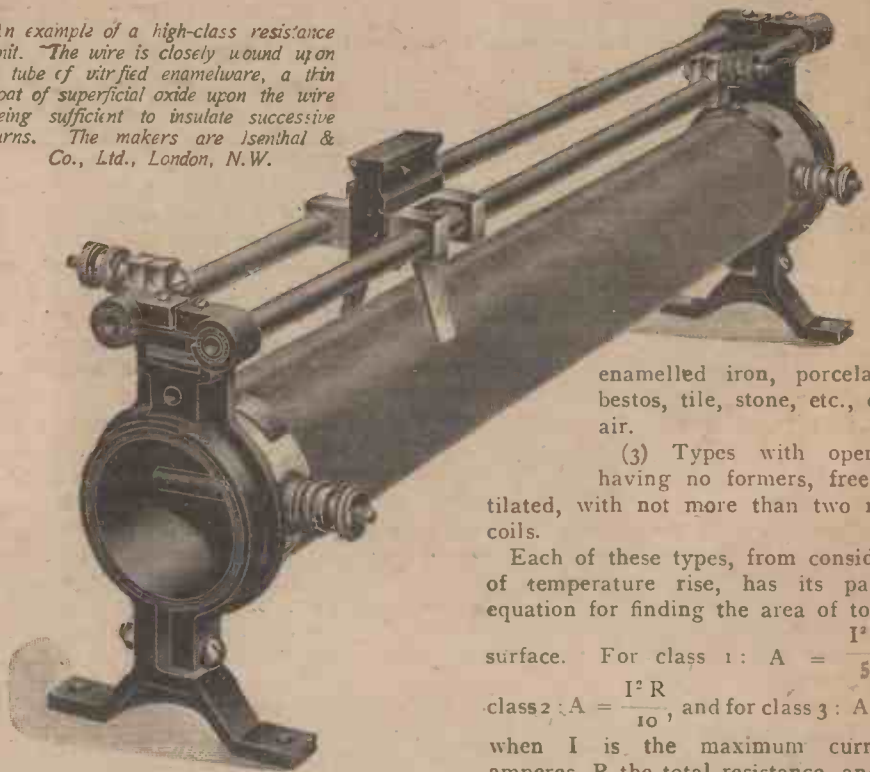

enamelled iron, porcelain, asbestos, tile, stone, etc., open to air.

(3) Types with open coils having no formers, freely ventilated, with not more than two rows of coils.

Each of these types, from consideration of temperature rise, has its particular equation for finding the area of total coil surface. For class 1:  $A = \frac{I^2 R}{5}$ , for class 2:  $A = \frac{I^2 R}{10}$ , and for class 3:  $A = \frac{I^2 R}{15}$ ,

when I is the maximum current in amperes, R the total resistance, and A the total area of coil surface in square inches. This value of the area, however, assumes that the wire is close-wound, and for rheostats which are wound with bare wire on formers a space equal to about half the diameter of the wire is left between the turns, thus making the total coil-area 1.5 A. If the rheostat is of the open-wound type, with no formers, a space equal to about one and a half times the diameter of the wire is left between the turns, giving the total area of coil surface to be 2.5 A.

The procedure is as follows: Try the formula for class 1 and find the area. Correct this area for spacing; if necessary, and judge whether or not it will be convenient to make an instrument of this area. If not, try class 2, and so on. This is the point at which to decide upon the arrangement of coils to be adopted, as described later in the notes on construction. If a single coil is to be used a reasonable length is assumed, and this is divided into the area (that is, A, 1.5 A or 2.5 A, as the case may be); the result is the girth or perimeter of the coil. Various lengths are tried until the one which gives the most reasonable proportions is found.

The same method is applied to rheostats with more than one coil, the length in this case being the total length to which the coils would stretch if they were placed end to end. Dividing this length into the surface area (either A, 1.5 A or 2.5 A, according to the design) gives the perimeter of one coil.

**Wire**

The next step is to decide what kind

classes, with reference to the insulating material used, as follows:

**Types**

- (1) Types wound on formers of wood, ebonite, moulded composition, fibre, ivory, and all combustible substances. Also all rheostats whose windings are totally enclosed, allowing for no ventilation.
- (2) Types wound on formers of slate,

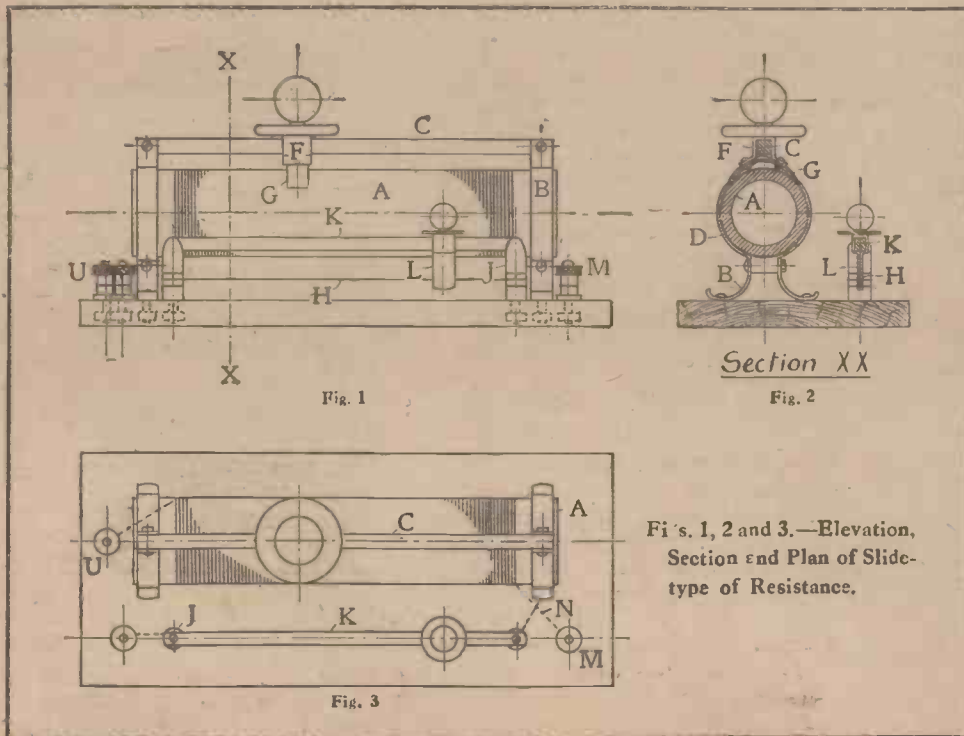

Figs. 1, 2 and 3.—Elevation, Section and Plan of Slide-type of Resistance.

# RHEOSTATS

## The Principles Involved—Types—Resistance Elements—Construction

of wire is to be used. For rheostats it is not usually necessary to have wire which is specially alloyed to give constant resistance at all temperatures (or has a very low temperature coefficient). The price of the wire obtained from a current catalogue will be the best guide. A list of the more important materials, with their values of  $\rho$  (specific resistance) is given below:

| Substance      | $\rho$                | Substance    | $\rho$                |
|----------------|-----------------------|--------------|-----------------------|
| Advance        | $19.2 \times 10^{-6}$ | Krupp Metal  | $33.4 \times 10^{-6}$ |
| Argentan       | 11.2 " "              | Lead         | 7.8 " "               |
| Calido         | 59.3 " "              | Manganin     | 16.5 " "              |
| Climax         | 34.7 " "              | Vonol Metal  | 16.1 " "              |
| Constantan     | 19.3 " "              | Nichrome I   | 38.8 " "              |
| Copper         | 0.63 " "              | Nichrome II  | 42.6 " "              |
| Eureka         | 18.5 " "              | Nickel       | 3.9 " "               |
| Excello        | 36.0 " "              | Platino'd    | 18.4 " "              |
| Ferro-Nickel   | 11.1 " "              | Resista      | 29.9 " "              |
| German Silver  | 13.0 " "              | Rheostan     | 17.5 " "              |
| Ideal          | 19.3 " "              | Rheostine    | 29.9 " "              |
| La Ia          | 18.9 " "              | Rose's Metal | 25.4 " "              |
| Pure Iron      | 3.48 " "              | Superior     | 34.3 " "              |
| Soft Steel     | 4.6 " "               | Therlo       | 18.4 " "              |
| Hard Steel     | 17.9 " "              | Wood's Metal | 22.2 " "              |
| Soft Cast iron | 29.3 " "              | Zinc         | 2.1 " "               |
| Hard " "       | 38.9 " "              |              |                       |

these kinds of rheostats (except the multi-coiled open type) are not very suitable for alternating current unless non-inductively wound (zigzag and not spiral), although they are often used for induction motors. If, however, they are intended for alternating current, they will be quite safe from the power point of view, as the maximum power which an alternating current can possess is equal to that of a continuous current with the same voltage and amperage.

### Well-known Patterns

The design of the rheostat having thus been dealt with, some general types of well-known patterns will be described. The sliding type is shown in Figs. 1, 2 and 3. There are modifications of this type, as, for example, those with two cylindrical coils and those with one rectangular coil. This particular type has one cylindrical coil and is well suited to amateur construction, having no cast parts. The former (A) in this type is usually either solid slate, hollow porcelain, or enamelled iron tube, but any material with sufficient

mechanical strength can be used, this having been determined in the design. The only material which has serious mechanical objections is wood, as it shrinks when the wire gets warm and the latter then comes loose.

When bare wire, or in fact any wire larger than about No. 20 S.W.G., is used, as mentioned before, a space must be left of about half its diameter, and in this case the former must be threaded. This, in the case of a round former, is done in a screw-cutting lathe, or, failing this, with the special tool shown in Fig. 4, which can easily be made. Two wooden uprights, one fixed and one made to slide up and down, are fitted to the base; these uprights have circular holes cut in them to take, in one case, the former (a stiff working fit) and in the other case a bolt, the thread of which is forced in the hole and screwed into the former. As close to the fixed upright as possible a small wooden block is fixed, against which the tool, which is ground as for screw-cutting, is clamped. The pitch of the thread is chosen as nearly as possible the same as that desired for the former. The end of the bolt is screwed into the former, so that when the head is turned the tool cuts a thread on it. Quite a shallow cut is all that is required to keep the wire in position, the depth being best obtained by trial. The former should be rubbed with soap as it passes through the hole.

### Winding the Wire

When the former is made the wire is wound on and fixed at each end by being passed through a hole and soldered. A sufficient length is left blank at each end

The diameter of the wire in inches is given by  $d = \sqrt[3]{\frac{\rho A}{.785 R}}$ , when  $\rho$  is the specific resistance in ohms per inch-cubed (from table). A is the area obtained from the formula (not corrected for spacing) and R is the total resistance, as before. The diameter of the wire having thus been calculated, the nearest S.W.G. size is found from a table, and the length to be obtained is given by  $L = \frac{A}{d}$  (this is independent of the spacing).

This completes the design from the electrical standpoint, everything required now being known. There are many other lines of attack possible, but the above method is perhaps the easiest to follow. It may seem a long process, but need not cause discouragement, as in reality it is quite straightforward, all that is required being the application of a few formulæ.

### Self-induction

It may have been noticed that the above working assumes that continuous current is being dealt with. As a matter of fact,

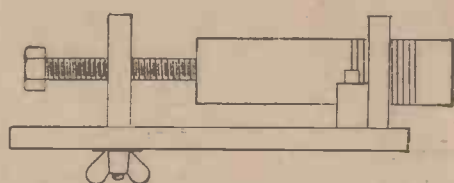

Fig. 4.—Simple Device for Threading Former.

### SOME DETAILS OF THE RHEOSTAT

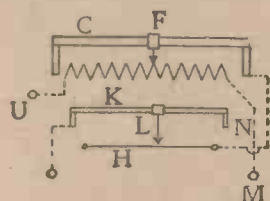

Fig. 5.—Diagrams of Connections for Sliding-type Resistance.

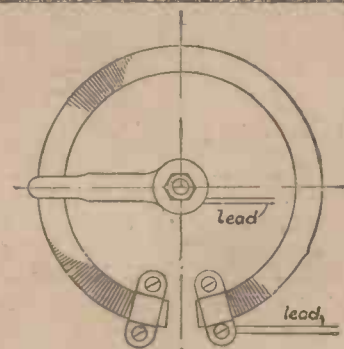

Fig. 6

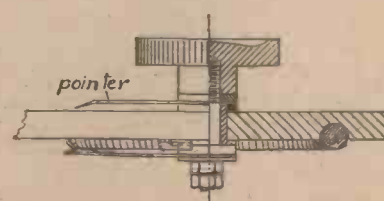

Fig. 7

Figs. 6 and 7.—Underneath Plan and Part Section of Rotary Resistance.

to accommodate the standards B, the former projecting slightly at each end. The standards are made in two halves, bent to shape from steel strips of a sufficient thickness to give the legs the necessary rigidity. The halves are clamped together round the former with bolts and nuts as shown. The guide C is clamped in the top, a spacing block D in the bottom. If the former is fragile, such as a porcelain tube, a strip of leather or fibre D must be placed under the clamping ring.

The guide C is of square brass rod, and carries the slider, which is surmounted by an insulating disc and a knob. The bridge, or saddle, F fits on the guide, and has five or six layers of thin phosphor-bronze or hard brass strip G screwed to it. These form the contacts, and are bent

both the coarse and fine adjustment sliders are moved in the same direction to avoid confusion in use.

A third terminal U is provided, which is connected to the other end of the main coil so that the instrument may be used as a potentiometer. In this case the supply is connected across the main coil and a tapping of any desired fraction of the supply E.M.F. taken from one end of the coil and the slider. If it is desired to dispense with the fine-adjustment wire no wooden base is needed, two of the terminals in this case being fixed to brass bands clamped round the former at each end, and the third to any part of either standard, or one end of the guide. This is the more usual arrangement. The brass parts should be lacquered.

One more type of wire rheostat is to be dealt with, namely, the old-fashioned open-coil type shown in Figs. 8 to 10. This is suitable for heavier loads than the preceding types owing to the fact that its wires can be raised to a higher temperature and can dissipate heat more quickly. In practice it is invariably made from iron castings, but it is thought that a design carried out in wood would be more acceptable.

In this case the great point to be observed is that all the coils must be kept at least 1½ in. from any wood part. Beech is the best wood to use, but any fairly hard wood will do. The frame M is dovetailed and pinned together as shown. Two rows of coils are sprung between the screw-eyes N, which are fastened into the back bar of the frame, and the slate panel O, which is pierced with holes corresponding to the screw-eyes. Two coils are made together, with a straight piece P between them, which is passed through two adjacent screw-eyes. The two other ends

are fastened, each with its neighbour from the next coil, through the holes in the slate, to the two brass studs corresponding to the eyes. Thus there is one stud for every two coils. It is as well to line the under side of the stud panel W with asbestos sheeting. The arm Q is pivoted to the centre of the back bar, and is kept down to its

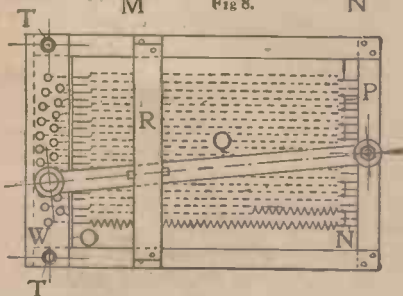

Figs. 8, 9 and 10.—Side and End Elevations and Plan of Open-coil Rheostat.

Photograph of Wheel-type Rheostat.

round in the manner shown, so as to spring stiffly on to the surface of the coil. The top strip is bent up slightly in the centre, so as to act as a spring, bearing against the under side of the guide as shown in the section.

**Fine Adjustment**

As the instrument is shown, it has an improvement in the form of a slide wire H for fine adjustment. This is unusual in this type of instrument, but is a great asset. As is shown in the figure, it is fixed at each end to the brass pillars J which are fixed to the base by nuts from underneath, and which also carry the guide K. The wire is insulated from the pillars by small fibre bands, as shown. The slider in this case carries a clip L of brass or phosphor-bronze, which makes firm contact with the wire, the length of which should be at least a turn and a quarter of the coil. The connections of the instrument are as follows: The current enters at the terminal M, goes to the coil via the thick copper wire N, up through the slider to the guide C, back to the standard B, down a thick copper wire to the slide wire, up the slider to the guide, and to the other terminal via the pillar J. The connections (shown in diagram form in Fig. 5) are so arranged that to increase the resistance

**Rotary Rheostats**

The small rotary type of rheostat (Figs. 6 and 7) is of interest as being that most usually employed for the valve-filament current regulator in wireless receiving sets. The construction is fairly well explained by the figure. The only point which might not be quite lucid is the coil. The former is made from a circular section or ebonite or erinoid rod, which is screw-cut. The coil is first wound in the lathe on a mandrel slightly smaller than the former, and is then screwed on to the former, which has afterwards to be bent round into a circle by the application of boiling water. The coil, when made, is pressed into a groove turned or cut in the face of the ebonite panel, the ends being secured with small brass straps as shown. The latter is bushed with brass to take the spindle, which carries a brass or phosphor-bronze contact arm, springing stiffly on to the coil. The part which makes contact is bent up at each side so as to move smoothly over the turns of wire.

Nowadays, especially in the cheaper patterns, it is often the practice to omit the bent former altogether, using instead a disc with a groove round the edge into which the coil is sprung. This type is simpler, but the coil is liable to get pulled out, causing endless annoyance.

work by the bridge R. A piece of thick copper wire conveys the current from the brass spring contact S, which bears on to the studs, through the arm to the spring contact V, which in its turn bears up against copper strip fitted along the bridge R.

The terminals T are screwed into the frame as shown, one being connected by thick copper wire to the end stud on the left-hand side and the other to the copper strip under the bridge R.

The best method of winding the coils is to mount a mandrel of the right size in a lathe, first close-wind the coils and then pull them out to the required pitch afterwards. They should be stretched fairly tightly when mounted in the frame.

This pattern of rheostat is intended for use in a vertical position, as when screwed to a wall, for this gives freer circulation of air. The same applies to the sliding type, but both may be used quite satisfactorily in a horizontal position.

M. SAXON SNELL.

**A Novel Crystal Cup**

THE centre terminal piece fixed to the top of the carbon rod of a dry cell, if broken off and the carbon cleaned out makes an excellent crystal cup, and has the merit of costing nothing. R. B

**BROADCASTING—THE SITUATION** (continued from page 471)

able, and readers will have a keen interest in finding out what is their position under the new arrangements.

**Licences**

Anybody can have a broadcast "listener's-in" licence by paying 10s. at the post office for it. What does this licence entitle him to? It gives him the right to use a receiver of a type approved by the P.M.G. and bearing the official mark of approval.

How can that mark of approval be obtained? By a member of the British Broadcasting Company only, and by that member submitting a type to the P.M.G. Apparatus made by a firm outside the British Broadcasting Company will not get the mark of approval, and therefore the amateur will not be entitled, by the terms of his licence, to use it. That seems to be perfectly clear.

Briefly put, the broadcast licensee can use only a wireless set bought complete from the trade, and it is up to him to see that it bears the mark of the P.M.G.'s approval.

**The Amateur Experimenter**

What is the position of the true amateur—the experimenter? Note, towards the end of the report, the sentence which we have put in italics. Surely the statement was made by the representative of the Post Office with his tongue in his cheek? So the position of the amateur experimentalist has not been altered! How very interesting! But what is the position? Does it not come to this: that the only person who can obtain an experimenter's licence is the one with sufficient knowledge of the subject to satisfy the rather exacting demands formulated by the questions on the application form? We want to know what is going to happen to the thousands and thousands of people who, in possession of only elementary knowledge, have been able to make highly successful receivers. Have these experi-

menters to drop their home-made gear into the dustbin, or use it secretly and in fear of a vague law? We should like to have seen a statement that the P.M.G. will deal generously—really generously—with everybody possessing the necessary patience, skill and enthusiasm to make his own set. For the good of the country, people who make their own sets should be encouraged. The more of them the better. Our fear is, though, that a very great number of these people will find it very difficult indeed to satisfy the Post Office officials as to their knowledge of the science and technique of wireless, and consequently there is every risk of a grave injustice being done.

**Some Advice**

Our advice to all readers who have made, or are making, their own sets is to apply for an experimenter's licence and not for the "listener's-in" licence. We feel certain that, sooner or later, the P.M.G. will agree that the man who has taken the trouble to ground himself in the subject sufficiently to allow of his making a set has a right to be called an experimenter.

As we have said repeatedly, we quite agree that no "listener-in" or experimenter, unless specially licensed, should be allowed to use any apparatus, whether bought or home-made, which re-radiates signals into the ether. It should be an offence to have in one's possession, without special permission, apparatus which, used carelessly or ignorantly, can cause considerable inconvenience to other "listeners-in." We quite agree that anybody seeking a licence to transmit should have special qualifications. But beyond that we do not wish to go. By all means let the mere "listener-in" who wants the music and the fun of broadcasting buy his set and help to pay, in that way, his share of the broadcasting expense. But let the other man—the enthusiast, the electrical experimenter, however humble his attainments may be—let him be free to use any set he likes as long as that set cannot cause interference.

public's needs, which was strikingly evidenced in the many interesting receiving sets exhibited, easily and quickly (almost automatically) adjustable to any of the English broadcasting wave-lengths, it being necessary with some of the sets simply to throw over a switch to the "on" position and rotate a disc until reception is clear. When finished, the switch has only to be thrown back to the "off" position, thus disconnecting the valves and earthing the aerial and protecting the instruments from lightning or static discharges.

Then one noticed several good adapters to plug into electric light sockets. It is claimed these are perfectly safe to use and have an efficiency of about 75 per cent. of a regulation outside aerial, which, of course, they replace.

**5-electrode Valves**

One also saw, *en passant*, the 5-electrode valve, consisting of filament and two plates and two grids, which is claimed to be thrice as powerful as the triode. A distinct improvement seems to have been effected in one of the triode valves shown with a metal hood over the filament, thus utilising the total emission from the filament and eliminating charges on the glass bulb.

**Crystal Reception**

It is rather disappointing that so little progress seems to have been achieved towards the greater perfection of crystal reception, and it is to be hoped that our serious experimenters will have something of real interest to show us at the next convention regarding this excellent mode of rectification.

**Telephones and Loud-speakers**

Telephones also might be further improved to meet the conditions imposed by wireless reception, and the loud speaker, although recently somewhat better in quality, is still a "loud speaker." Do let us have a "clear speaker." Then, too, there is the other side of the question to be considered—the persons speaking or singing for reproduction by the loud speaker. Are they selected especially for the timbre and pitch of their voice; are they trained singers or elocutionists, or both; and have they been instructed in regard to speaking or singing, to produce, enunciate, etc., in a manner most calculated to reduce to a minimum the mechanical defects of the telephone? Here seems to be a useful field for research for our students of the telephone and acoustics.

**Conclusion**

One thing that impressed itself on one's attention was that from point of attendance this exhibition has been an unqualified success, and if the public interest continues to increase in its present ratio, we shall require an Olympia to house the exhibition next year, and in time it will bid fair to approach the popularity of the Motor Show. W. P. A.

**PROGRESS**

Some Remarks Inspired by a Visit to the Recent Exhibition

THE outstanding impression borne in upon one at the recent exhibition was that wireless telephony had become tremendously popular within the past few months, due probably to the imminent settlement of the much-vexed broadcasting question, and in no little degree to the efforts of wireless clubs.

What impressed the visitor first of all was the obsolescence of the old loading-coil solenoid type tuner and its supersession by the more compact coil tuner, employing "pancake" or duo-lateral coils giving a range of anything from 180 to 25,000 metre wave-lengths, capable of the very finest

tuning and adjustment, and free from "dead-end" effects.

Especially is this the case with those coil-holders where the coils are held in position by a gimbal mounting, thus allowing the most exact tuning, dispensing with variable condensers, and giving an extensive range with the minimum number of coils and, in addition, getting the variocoupler effect. This certainly marks a decided advance in tuning.

**Semi-automatic Instruments**

Another step in the right direction is the manufacturers' keen appreciation of the

# Radiograms

A NOVELTY to be presented at the Empire Theatre, Stratford, next week is a wireless vocal doll. The automaton is entirely self-contained, and has no connections or contacts of any kind. To hear a doll on the stage reproduce a song sung by a singer (Miss Nella Allen) in her dressing-room in some remote part of the building is a distinct novelty. The entire apparatus is covered by patents.

An insurance company announces that for an annual premium of 7s. 6d. it will cover loss of or damage to the wireless apparatus, including aerial, third party damage up to £500 (any one accident), including damage to property belonging to or under the control of the insured. The company referred to is the Liverpool Marine and General Insurance Company, Limited, 7, Angel Court, London, E.C.

It is thought likely that the condition as to unrestricted wave-lengths of receiving apparatus will be modified after practical experience has been had of a broadcast service.

A tank capable of being directed from a wireless station many miles distant is undergoing trials.

Canadian wireless experts will shortly visit this country in order to discuss with the Post Office authorities a proposal to build a great wireless station in the Dominion.

Scottish experimenters are now finding it possible to hear more telephony than was formerly the case. Generally, Marconi House is coming in better in the western part of the country, and on a recent evening Writtle was heard excellently on four and five valves in Glasgow. Quite a number of inhabitants of lonely districts in the Highlands are taking steps to secure sets which will keep them in touch with the pleasures of civilisation.

Wireless news services are used by all the five daily papers of Washington, U.S.A.

Broadcasting at a big Housing and Health Exhibition in Glasgow is proving a great success, and is easily one of the most attractive items in the show. The opening ceremony was performed by Lady Weir, who, speaking into a wireless microphone, had her voice carried to all parts of the exhibition. The broadcasting is being

carried through by a local firm of piano and music sellers in conjunction with the Marconi Company.

It is officially stated that officers and other ranks of the Regular Army, Militia, Territorial Army, or Officers Training Corps who wish to instal private wireless sets for sending or receiving messages, are subject in all respects to the Postmaster-General's regulations governing the installation and working of such sets.

Arrangements have been made whereby at the Glasgow and District Radio Club's exhibition on Saturday, November 4, a special message will be sent to the show from the Northolt station. The transmission will take place at 7 p.m. on a wave-length of approximately 7,000 metres.

Wireless clubs are springing into existence in various parts of Scotland with remarkable rapidity. In quite a few of the smaller towns, such as Falkirk and Hamilton, enthusiastic bands of amateurs are forming themselves into energetic organisations. So far these clubs are for the most part isolated bodies, being quite independent in action. It is suggested that some sort of Scottish affiliation should be formed, to the advantage of all concerned.

A Czecho-Slovakian wireless company with a capital of 100,000 crowns, has been formed. The concern is named "Radio-slavia," and is intended for the construction and maintenance of wireless stations and the transmission of Press traffic.

In the action brought by the Marconi Wireless Telegraph Company, Limited, against the Mullard Radio Valve Company, Limited, for infringement of valve patents owned by the plaintiff company, Mr. Justice P. O. Lawrence decided on October 19th that the Mullard valve did not constitute an infringement of either of those letters patent. The defendants had alleged that the letters patent were, and had been, at all material times invalid, but his lordship held that this attack made by the defendant company on the validity of the plaintiff company's letters patent failed.

A very curious incident occurred at the reception of the Prince's broadcast speech. One of the Alexandra Palace attendants, who has been deaf for some years, heard every word of the speech in the grounds some 200 feet away from the nearest Magnavox.

## FORTHCOMING EVENTS TELEPHONY TRANSMISSIONS

- Eiffel Tower (F L), 2,600 metres. Each afternoon (Saturdays excepted).
- The Hague, Holland (P C G G), 1,085 metres, G.M.T. Oct. 30, 3-5 p.m.
- Writtle (2 M T), 400 metres. Oct. 31, 8 p.m.

## CORRESPONDENCE

### The Intervale Transformer

SIR,—In the interesting article on the above by Mr. W. J. Joughin in No. 15 of AMATEUR WIRELESS a table is given of readings based on measurements of a receiver in use, and a suggestion is made that some relationship exists between the quantities. As a matter of interest, the writer plotted the given values as per accompanying graph, from which it is evident that the voltage-current points lie on straight lines, having the following equations:

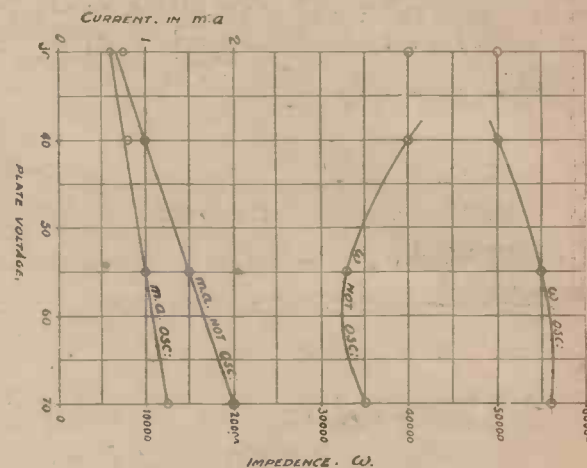

Graph of Transformer Values.

Not osc. : m.a. = 0.0333 V - 0.333  
 osc. : m.a. = 0.01625 V + 0.13

From the right-hand curves it will be noticed that minimum impedance when the valve is not oscillating occurs when the plate voltage is about 60, while the maximum value of impedance is reached with the valve oscillating and plate voltage about 65. Readers who are in a position to take measurements from their apparatus would derive valuable information from the plotting of co-ordinate values of various kinds, inasmuch as they could speculate with some degree of certainty as to the direction in which their experiments is leading them.—J. C. (Belfast).

A CHANGE OF ADDRESS.—Will readers note that Radio Supplies, 236, High Holborn, London, W.C.1, have moved to an address exactly two doors away, namely, 234, High Holborn, London, W.C.1.

Transmitting licences are being granted to American newspapers at the rate of about £10 each week.



**HELLO SOMEBODY!**  
WHO IS LOOKING FOR REAL VALUE

**Two-slide INDUCTANCE COIL**

Complete, 12 in. x 4 in. coil, mounted between wood ends with two brass rods, sliders and plungers, with small brass feet for fastening down to board or panel. Postage paid.

**10/6**

**HEADPHONES**

Best Quality, French, 4,000 ohms. Double Receiver. Postage paid.

**20/-**

**INDUCTANCE COILS**

Wound with 24 S.W.G. Enamelled Wire, 12" x 4", 12" x 3 1/2", 12" x 3 Postage paid.

**3/9**

**LEADING-IN TUBES.** Only 1/2 in. dia overall. No large holes in window frame or wall required. Made with best quality vulcanised fibre tube and terminals each end. 6 in. 1/8, 9 in. 1/10, 12 in. 2/-, all post paid.

*New Price Sheets sent free.*

**JACKSON,** 7, BLAKE ROAD, FULHAM, LONDON S.W.6.

**THE HOLBORN RADIO CO.**

8, High Holborn, London, W.C.1,

**OFFER THE FOLLOWING SPECIAL LINES:**

|                                                                                 |      |
|---------------------------------------------------------------------------------|------|
| Headphones, 4,000 ohm double headpieces                                         | 24/6 |
| Headphones, 8,000 ohm double headpieces                                         | 26/6 |
| Valve Detector Panel, complete in Mahogany Case, best finish                    | 28/6 |
| Set of Parts with drilled panel and instructions for assembling above           |      |
| Detector Panel                                                                  | 14/9 |
| Cabinet to Fit                                                                  | 3/6  |
| Amplifying Panel, complete in Mahogany Case                                     | 42/- |
| Condenser, '0005, in Mahogany Case                                              | 20/- |
| for panel mounting                                                              | 14/6 |
| ready to assemble                                                               | 8/9  |
| Crystal Set complete with Headphones, Aerial Wire, Insulators, Earth Wire, etc. | 65/- |

Postage Extra. **PRICE LIST POST FREE.**

If you are in trouble with your set, call and see our technical adviser. Expert advice gratis. All orders dispatched same day as received.

**THE HOLBORN RADIO CO., 8, High Holborn, W.C.1.**

'Phone Chancery 7278. 45 Doors from Gray's Inn Road

**HAVE YOU A GRAMOPHONE?**

THEN GET A

**GRAMAPHIX LOUD SPEAKER**

THE GRAMAPHIX multiplies sound! THE GRAMAPHIX fits any gramophone! HAVE YOU HEARD THE GRAMAPHIX?

It produces full volume of sound without distortion and makes your gramophone a **RADIO LOUD SPEAKER.**

The Gramaphix utilises the scientifically designed tone amplifier of the gramophone to secure mellowness and **Beauty of Tone**, therefore doing away with all that metallic sound, scratching and "ring" associated with other loud speakers. The Gramaphix is the talk of the wireless world.

Adjusted in a Minute by a child. **LATEST and LOUDEST.**

Why pay pounds when a better instrument can be secured for

APPLY FOR **10/6** IMMEDIATE TRADE TERMS DELIVERY

Postage 9d.

**HERE IT IS!** SPECIFIC GUARANTEE TO RECEIVE TELEPHONY FROM A MINIMUM DISTANCE OF 25 MILES.

**THE B.N.B. CRYSTAL SET £7 17 6**

(With 2 Sets of Double Earphones)

Operates on Wave Lengths up to 1,000 Metres

Outstanding merits: simplicity, sensitiveness, efficiency and reliable audibility. Fitted with terminals for the adaption of honey-comb coils, thereby making it possible for performances broadcasted on longer wave-lengths to be received. Each set is guaranteed to operate under normal conditions and is sold with this guarantee. These sets have all been recently improved upon, consequently buyers will get the latest and most up-to-date instruments.

**LACLAND ELECTRICAL MANUFACTURING AGENCY (Dept. A),**

98, GREAT QUEEN STREET, KINGSWAY (Holborn End), W.C.2 Gerrard 5341.

**RELIABLE APPARATUS**  
AT POPULAR PRICES

CRYSTAL SETS, VALVE SETS, etc. EVERY NECESSITY & LUXURY FOR THE WIRELESS EXPERIMENTER.

Fully Illustrated List of Wireless Goods, post free, 4d.

**H. D. BUTLER & CO., LTD.**

Office: BANK BUILDINGS, 222, GT. DOVER ST., S.E.1 (Opposite Boro Tube Station).

Works: CANONBURY, LONDON, N.1

Telephone: Hob 3029. Teleg.: "Ingenuity, Phone London."

**The RADIO PATHFINDER**

By **RICHARD H. RANGER**

Profusely Illustrated. Cr. 8vo. 6s.

Written in simple non-technical language, this book is scientifically accurate (its accuracy has been attested by experts). It imparts to the amateur a sound knowledge of the basic principles of radio telegraphy and telephony.

**HEINEMANN**

**WIRELESS ADVERTISING**  
1912 - 1922

Our claim to specialised knowledge in Wireless Advertising is based on Ten Years practical experience. This, together with our Complete Wireless Advertising Organisation, is at the disposal of every bona-fide Advertiser entirely free of charge. No business is too small or too large to command our prompt attention and courtesy.

Whatever your Advertising problem or difficulty it will pay you to get in touch with us. Why buy your experience when expert advice is yours for the asking?

**BERTRAM DAY'S**

(Bertram Day & Co., Ltd.)

Organisers of the First All-British Wireless Exhibition, 1922

Wireless Publicity Specialists  
Contractors, Printers & Publishers,

9 & 10, CHARING CROSS, S.W.1.

Gerrard 8063-8064

BRANCHES AT MANCHESTER AND GLASGOW.

# OUR INFORMATION BUREAU

Expert Replies to Readers' Questions: Hundreds of Replies are sent by Post.

TO ENSURE A PROMPT REPLY PLEASE OBSERVE THE FOLLOWING RULES

Write distinctly, give all necessary details and keep to the point. Ask one Question at a time—never more than two. Send a Stamped and Addressed Envelope. Send the Coupon cut from this page.

## Condenser Capacity

Q.—Please state the capacity of a tubular condenser, whose plates are 3 in. long and form two halves of a tube  $2\frac{1}{2}$  in. in diameter, these moving plates to rotate. How should two such condensers be connected to obtain maximum total capacity?—H. G. S. (4043).

A.—This type of condenser is known as the parallel-plate condenser and may be calculated by the following:—

$$S = \frac{A K N}{5,000 \times 900 \times d}$$

Where S = capacity in microfarads.

A = area of one plate in square inches.

K = the specific inductive capacity of the dielectric (Glass = 8.45 approximately).

N = the number of dielectrics under strain.

d = the thickness of the dielectric in inches.

Considering the above particulars,

$$S = \frac{3.92 \times 8.45 \times 1 \times 16}{5,000 \times 900 \times 1} = \frac{106}{900,000} = .00011 \text{ microfarads approximately.}$$

To obtain maximum value for two or more condensers always connect them in parallel with each other.—L. C.

Society held their bi-monthly meeting on Oct. 9th, when S. Skeet, Esq., delivered a lecture on "Set Construction." This he did very successfully, illustrating his remarks by many beautiful examples of his own work.

## The Wakefield and District Wireless Society

Hon. Sec.—ED. SWALE, II, Thornes Road, Thornes, Wakefield.

A MEETING was held on Oct. 6th in the Y.M.C.A. when Mr. R. Leedal, A.M.I.E.E., read a paper on "Accumulators." Many useful hints on the use and care of accumulators were given by Mr. Leedal. On Oct. 13th another meeting was held in the Y.M.C.A., when Mr. Bateman gave a very interesting lecture on his own receiving station. Mr. Bateman had on show a good deal of his apparatus, and very ably described it, drawing diagrams on the blackboard and showing how one, two or three valves could be used at will.

## Tottenham Wireless Society

Hon. Sec.—R. A. BARKER, 22, Broadwater Road, Bruce Grove, N.17.

THE third meeting was held on Oct. 5th, and was opened with half-an-hour's buzzer practice. The chairman then gave a lecture on "Retrospective Amplification," which was of great interest to everybody present. It was decided that the future place of meeting should be the Bruce Grove Schools, Sperling Road, and that the evening should be changed to the Wednesday of every week.

## The Fulham and Putney Radio Society

Hon. Sec.—J. WRIGHT DEWHURST, 52, North End Road, West Kensington, London, W.14.

AT a meeting held on October 13th after the preliminary business was disposed of, Mr. Houstoun opened discussion on the various forms of amplification and the screening of transformers, and Mr. Houstoun promised to have a set at the next meeting with a new type of screening arrangement. Another discussion was started on accumulators, and Mr. Calver gave a short explanation of the various ways the plates are now made. Mr. V. Craster mentioned a method they have in America of exchanging a fully charged element for a discharged one to obviate the waiting for accumulators to be recharged.

## Sunderland Wireless and Scientific Association

Hon. Sec.—H. G. MAC COLL, North Elms, Sunderland.

THE last general meeting of the session was held at the Technical College on Sept. 23rd. Nominations having been received for the officers and committee for the ensuing year, Mr. R. Sutherland Allan opened a discussion on the programme for the next session. He informed the meeting that a suite of rooms had been obtained for the association at Westfield House, consisting of a reading room, experimental and lecture room, secretary's office, and cloak room. These rooms are to be open daily for the use of members.

He then explained that the committee had arranged to run a number of courses of lec-

tures jointly with the Sunderland Y.M.C.A. Radio Society. The following courses had been arranged:—

- (1) Course of 24 wireless lectures.
- (2) Course of 12 lectures on elementary magnetism and electricity (before Christmas) followed by 12 elementary wireless lectures.
- (3) Course of elementary wireless lectures for beginners.
- (4) Lectures on other scientific subjects, lecturettes, debates, etc.
- (5) Four public popular lectures.
- (6) Courses of senior and junior buzzer practices.

The association held a wireless and scientific exhibition in connection with the Sunderland Housing and Health Exhibition, at the Whitehall Rink from October 3rd to 14th.

## The Liverpool Wireless Society

Hon. Sec.—MR. C. L. LYONS, 76, Old Hall Street, Liverpool.

A MEETING of the above society was held on October 12th, when Professor E. W. Marchant, D.Sc., delivered an address on the subject "Wireless Broadcasting." Briefly tracing the early history of wireless telegraphy point by point right up to the latest developments of the science, he entered upon the main features of his address, which were the advantages and disadvantages of wireless broadcasting as we might expect to develop into in the course of a very short space of time.

## Belfast Radio Association

Hon. Sec.—MR. S. DICKSON, 11, Eglantine Avenue, Belfast.

THE inaugural meeting of the above association was held on Oct. 6th. Applications for membership are invited.

## ANNOUNCEMENTS

"Amateur Wireless and Electric." Edited by Bernard E. Jones. Price Threepence. Published on Thursdays and bearing the date of Saturday immediately following. It will be sent post free to any part of the world—3 months, 4s. 6d.; 6 months, 8s. 9d.; 12 months, 17s. 6d. Postal Orders, Post Office Orders, or Cheques should be made payable to the Proprietors, Cassell & Co. Ltd.

General Correspondence is to be brief and written on one side of the paper only. All sketches and drawings to be on separate sheets.

Contributions are always welcome, will be promptly considered, and if used will be paid for.

Communications should be addressed, according to their nature, to The Editor, The Advertisement Manager or The Publisher, "Amateur Wireless," La Belle Sauvage, London, E.C.4.

## CLUB DOINGS

### Barnsley and District Amateur Wireless Association

Hon. Sec.—G. W. WIGGLESWORTH, 13, King Edward Gardens, Barnsley.

AT the official opening night of the above association, held on October 11th, the address was followed by a lecture divided into two parts—the first part on "Heterodyning," and the second part on "Directional Wireless."

In his remarks upon heterodyning, that is of beat reception without an oscillating aerial, the president emphasised the necessity for eliminating interference with other people's reception. To this end the president stated his intention of presenting to the association a "Heterodyne" wave-meter. The president's lecture on directional wireless was clearly elucidated by means of a large map, and appliances for tracing both land and air transmitting stations.

### Wolverhampton and District Wireless Society

Hon. Sec.—J. A. H. DEVEY, 232, Gt. Brickkiln Street, Wolverhampton.

AT a meeting of the above society held on Oct. 11th a very interesting lecture was given by Mr. D. P. Baker on "Time—Sundials to Wireless."

The lecturer in his discourse took the meeting back to the old methods of recording time, leading up step by step to the most modern methods of recording time by wireless.

### The Leicestershire Radio and Scientific Society

Hon. Sec.—J. R. CRAWLEY, 269, Mere Road, Leicester.

THE Leicestershire Radio and Scientific

Amateur  
Wireless  
(And Electric)

Querist's Coupon Available until  
Saturday, Nov. 4, 1922

# T.M.C. Wireless

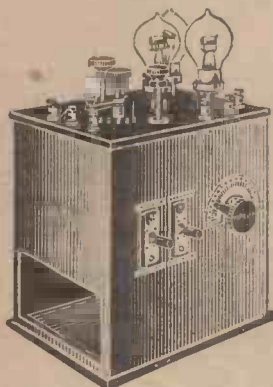

T.M.C. 3-VALVE BROADCASTING SET.

A REVELATION in Wireless Sets employing 1-valve detector, two valves for low frequency amplification. Apparatus mounted includes Variable Filament Resistance, three-Valve Sockets, Grid Leak and Condenser, two highly efficient Transformers, Grid Potential Blocking Condenser, Variable Condenser, Series Parallel Switch, Switch for using Loud Speaker or Headphones, Tuner and Reactance, complete with three Valves, Loud Speaker and Set of "De-Luxe" Headphones. Mounted in Polished Walnut. Size  $9\frac{1}{2} \times 7 \times 10\frac{1}{2}$  inches high.

**THE MARVELLOUS 3-VALVE SET THAT WAS THE FEATURE OF THE EXHIBITION**

**The TELEPHONE MANUFACTURING Co., Ltd.,**  
**HOLLINGSWORTH WORKS, WEST DULWICH, S.E.21.**

Telephone: SYDENHAM 2460

Telegrams: "BUBASTIS. DULCROX."

## THE "SENSIFONE"



4000 OHMS IN SERIES

EVERY SET TESTED AND GUARANTEED

27/6

Complete with Flexible Cords

SPECIAL TERMS TO THE TRADE

These Headphones are so named because they are so highly sensitive to even the weakest signals. "Sensifones" are all that modern skill can make them. You may get a more expensive set, but you will not get a better. They are made right.

Sole Makers:

**TOWNSHEND'S Ltd.**

(Established 1881)

49, ERNEST STREET, BIRMINGHAM

Agents and Showrooms:

LONDON: COWARD & CO., 81, Charlotte Street, W.1  
 MANCHESTER: COULSTON & CO., 5, Cross Street  
 NEWCASTLE: R. F. SUNDERLAND, Milburn House  
 G. ASGOW: CLARKSON HOOD & CO., 45, Hoje Street



## Splendid Valve Sets

Whether you can spend little or much, you will learn far more by building up your own Set. Our standardised Unit System permits you to add further Valves just as you wish. Well-designed instruments, finished ready for use, or in sets of parts with full instructions, can be built up in a few hours on the kitchen table without previous experience.

### SETS OF PARTS

No. 4 Detector Unit - 17/6  
 No. 5 Low Freq. Unit 33/6  
 No. 3 High Freq. Unit 13/6  
 Mahogany Cabinets to fit - each 3/6  
 Postage: 9d. per panel extra, but all orders over £2 sent post free.

Get Peto Scott Standardised Units and start right. Our new Booklet (6d. post free, returnable with first order) tells you all about this new system.

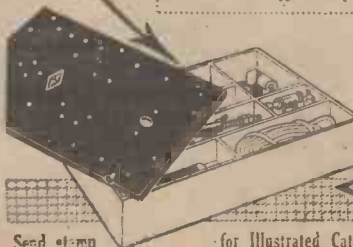

Offices and Showrooms:  
**FEATHERSTONE HOUSE,**  
 64, HIGH HOLBORN, W.C.1.



Send stamp

for Illustrated Catalogue,

M.A.S.

# HULLO EVERYBODY!

COMPARE PRICES! COMPARE QUALITY!!

## COMPLETE SETS OF PARTS FOR MAKING VARIABLE CONDENSERS.

| Approx. Capacity in Microfarads | No. of Plates | Price |
|---------------------------------|---------------|-------|
| ·0015                           | 85            | 10/-  |
| ·001                            | 57            | 7/6   |
| ·00075                          | 43            | 6/9   |
| ·0005                           | 29            | 5/6   |
| ·0003                           | 19            | 3/6   |
| ·0002                           | 13            | 2/3   |
| ·0001                           | 7             | 2/-   |
| Vernier                         | 3             | 1/9   |

These Sets are complete ready for assembling and consist of the following parts: Necessary Aluminium Vanes (fixed and moving), all standard size, large and small Spacer Washers, Centre Square Spindle with Knob Screwed 2 BA, 3 round screwed Rods for sides, necessary Nuts and Washers, Brass Pointer, Engraved Scale, 2 Terminals, Lock Nuts, 3 Bushes and 2 Bronze Coil Spring Washers. Every part guaranteed best workmanship and quality. Generous quantity of all spares supplied.

2 EBONITE (Drilled) ENDS supplied free of charge with the following Sets:

·0015, ·001, ·00075, ·0005  
Postage 1/3 per set extra. TRADE DISCOUNT

Aerial Wire, 7/22 Bare Copper, Stranded, best quality, 100 ft. 3/-; 150 ft. 4/6. Postage 1/2.  
Condenser Vanes, guaranteed accurate, 1 doz. 7d.; 6 doz. 3/-.  
Large Spacer Washers, 4d. doz.; 6 doz. 1/9.  
Small Spacer Washers, 3d. doz.; 6 doz. 1/-.  
Ebonite Discs, round, 4 in., 10d. each (drilled).  
Ebonite for top and bottom (square), 1/6 pair.  
Ebonite, 4/- lb. 3/4 in. and 1/2 in.  
Brass Washers, 2 BA, 1 1/4 d. doz.; 6 doz. 6d.  
Brass Washers, 4 and 5 BA, 3 doz. 2d.  
Contact Studs, turned and polished, complete with nut, 5 BA, per doz. 6d.  
Switch Arms, complete with knob, laminated blade, bushes, nuts, etc., 10 1/2 d., 1/5, 1/6, 1/8.  
Crystal Cups, 2 screws, 1 1/2 d.; 1/3 doz.  
Large Cups, 4 screws, 4d.; 3/6 doz.  
500 Crystal Detectors at 2/6.  
Pericon Crystal Detectors, 4/-.

Crystal Detectors, 2 cups enclosed with glass cover, dust proof, 4/6.  
Valve Sockets, turned and polished, shouldered base, with nut and washer, 4 for 5d.  
Terminals, 4 BA, complete with nut and washer, 1/- doz.  
Terminals, W.O. pattern, complete with nut and washer, 1/6 doz.  
Terminals, W.O. large, complete with nut and washer, 1/8 doz.  
Terminals, 2 BA large, complete with nut and washer, 2/3 doz.  
Terminals, telephone, complete with nut and washer, 1/3 doz.  
Terminals, telephone, complete with nut and washer, 1/3 doz.; small size.  
Knobs, 1 1/2 in. diameter, tapped 2 BA, 2d. each.  
Knobs, 1 1/2 in. diameter, tapped 2 BA, 3d. and 4d. each.  
Knobs, 1 1/2 in. diameter, 2 BA nut, 4 1/2 d. and 5d. each.

Reel Insulators, 2 in., 1/- doz. (not sent by post).  
Inductance Coils, 12 by 4, wound 24 enamel wire, 3/3 (not sent by post).  
Fixed Condensers, ebonite, with terminals, 1/6, 1/8, 2/-. From .0003 to .004.  
Insulating Sieving, all colours, yard lengths, 5d.; 3 for 1/2; 4/3 doz.  
Filament Resistances, for panel mounting, very fine values, 2/6, 3/6 each.  
Laminated Blades, for switch arms, 3d. each; 2/6 doz.  
Condenser Bushes, 1d. each; 10d. doz.  
Ivory Scales, 0-180, 4d., 5d., 6d. each.  
Switch on Ebonite Base, D.P.D.T., 2/-.  
Switches, S.P.S.T., S.P.D.T., 1/6 and 1/9.  
Brass Hexagon Nuts, 2 BA, 3 BA, 4 BA, 5 BA, 6 BA, 3d. doz.; 6 doz. 1/3.  
Crystals, Hertzite now in stock, 1/6, 2/- piece.  
Oojah Basket Coils, 7 in set, 5/-.

## HEADPHONES

Best French Manufacture, with Universal Joint. Equal to any other or more expensive phone on the market. Resistance 4,000 ohms, highest possible insulation, selected tungsten steel magnets, heavy insulated cords, polished aluminium case, oxidised copper headbands, Ebonite earcaps.

25/-  
and  
30/-

Excellent Phones, 4,000 ohms, at 21/- and 22/6. Headphones, 8,000 ohms, at 25/-  
Single, 4,000 ohms, 12/-; 2,000 ohms, 10/-. Trade Supplied.

Please enclose sufficient to cover postage and packing, as above prices are too low to permit of being sent otherwise.

**M. RAYMOND,** 27, LISLE STREET, W.C.2.

RIGHT OPPOSITE  
DALY'S GALLERY DOOR.

Phone:  
Gerrard  
4637

To avoid mistakes, this address is close to  
Charing X Road and Leicester Square Tube.

**CQ, CQ, CQ, de 5DB, 5DB, 5DB**

See What YOU SAVE

**4,000 OHMS PHONES**

**22/6**

PER PAIR. POSTAGE, 1s. EXTRA.

**GUARANTEED, TESTED.**

- Contact Studs, 1/4 by 1/4, with nut, 9d. per dozen.
- Systoflex Sleeving, assorted colours, 5d. per yard.
- Ebonite Knobs, 1 1/2 in., tapped 2 B.A., 4d., 5d., and 6d.
- Grid Condensers, 0003, extra quality, 1s. 6d., 1s. 9d.
- Aerial Wire, 7/22, copper stranded, 3s. 6d. 100 ft. Post 1s. 3d.
- VALVE HOLDERS**, turned ebonite, polished, with 8 nuts and 4 washers, 11d. each.
- Switch Arms, complete with laminated blade, collar, nuts, pointer, etc., special value, 1s. 3d., 1s. 8d., 2s. each.
- Filament Resistances, with knob and pointer, 3s. & 3s. 6d. each
- Terminals, 4 B.A., 1s. 6d. per dozen; various others, 1s. 9d., 2s. per dozen.
- Terminals, Telephone, 1s. 10d., 2s. per dozen.
- Slider Knob and Plunger, best quality, 6d. each; with 13-in. brass rod, 10d. Post 3d. extra.

\*Please include sufficient for postage. The above prices are too low to admit goods being sent otherwise.

**C. H. P. NUTTER,** *Expert adv'ce given free.*  
 Radio Corner, 243a, Selhurst Road,  
 South Norwood, S.E.25.

**The Universal Electric Supply Co. Ltd.**  
 4 BROWN STREET ONE DOOR FROM MARKET ST. MANCHESTER  
 Telephone 3493 CITY Established 1892  
 G.P.O. Box No. 512



**BEST VALUE :: RELIABLE QUALITY**  
**CONSULT OUR LARGE ILLUSTRATED CATALOGUE FOR ALL WIRELESS SUPPLIES AND COMPLETE SETS**  
**POST FREE, 6d.**

|                                                                                                                                                                                                                                                                                                                                                                                                                                                                                                                                                                                                                                                                                                                    |                                                                                                                                                                                                                                                                                                                                                                                                                                                                                                                                                                                                                                                                                                                                                             |
|--------------------------------------------------------------------------------------------------------------------------------------------------------------------------------------------------------------------------------------------------------------------------------------------------------------------------------------------------------------------------------------------------------------------------------------------------------------------------------------------------------------------------------------------------------------------------------------------------------------------------------------------------------------------------------------------------------------------|-------------------------------------------------------------------------------------------------------------------------------------------------------------------------------------------------------------------------------------------------------------------------------------------------------------------------------------------------------------------------------------------------------------------------------------------------------------------------------------------------------------------------------------------------------------------------------------------------------------------------------------------------------------------------------------------------------------------------------------------------------------|
| <p><b>DOUBLE HEAD RECEIVERS.</b><br/>                 Complete with Cords<br/>                 4,000 ohms ... 22/6<br/>                 8,000 ... 27/6</p> <p>Wireless Cords for Double Head Receivers, 2/3</p> <p><b>U.S. LOUD SPEAKER</b><br/>                 Excellent results, 36/-</p> <p><b>LOW FREQUENCY AND TELEPHONE TRANSFORMERS, 21/-</b></p> <p><b>PLUG-IN TYPE TRANSFORMER.</b><br/>                 Unwound ... 3/-<br/>                 Wound for various wave length, from 6/-</p> <p><b>FIXED CONDENSER, with Clips.</b><br/>                 .001 to .0005 ... 3/-</p> <p><b>HIGH GRADE ACCUMULATORS.</b><br/>                 4 v. 40 a. ... 21/-<br/>                 6 v. 40 a. ... 30/-</p> | <p><b>CONDENSER PARTS.</b><br/>                 Fixed and Moving Vanes:<br/>                 3 1/2 in. dia. ... 1/8 doz.<br/>                 Centre Rod:<br/>                 4 1/2 in. high ... 4/6<br/>                 Laminated Switch Arm:<br/>                 3 1/2 in. radius ... 2/3</p> <p><b>FILAMENT RHEOSTAT</b> 5/-<br/>                 "MAROONI OSRAM" "R" TYPE VALVES, 17/6</p> <p><b>AERIAL WIRE.</b><br/>                 8/20 ... 4/- 7/22 ... 5/- per 100 ft.</p> <p><b>AERIAL INSULATOR.</b><br/>                 Reel, 2 1/2, 4 1/2, 3 1/2, 10 1/2, Egg, 1 1/2 x 1 1/2, 6d.</p> <p><b>THE "MIRONITE,"</b> the new Super Crystal<br/>                 Exceptional results obtained.<br/>                 3/- per selected piece.</p> |
|--------------------------------------------------------------------------------------------------------------------------------------------------------------------------------------------------------------------------------------------------------------------------------------------------------------------------------------------------------------------------------------------------------------------------------------------------------------------------------------------------------------------------------------------------------------------------------------------------------------------------------------------------------------------------------------------------------------------|-------------------------------------------------------------------------------------------------------------------------------------------------------------------------------------------------------------------------------------------------------------------------------------------------------------------------------------------------------------------------------------------------------------------------------------------------------------------------------------------------------------------------------------------------------------------------------------------------------------------------------------------------------------------------------------------------------------------------------------------------------------|

**Extremely Sensitive HIGH NOTE BUZZER.**  
 Skeleton Type, 2/- Mounted on base, 2/3

**STEVENS'S AUCTION ROOMS LTD.**

(Established 1760)

**AN IMPORTANT SALE OF EX-GOVERNMENT WIRELESS APPARATUS,**

*including*

- BROWN'S HEAD TELEPHONES,** Reed Type, 120 and 8,000 ohms, in new condition.
- C. MARK III 3-VALVE AMPLIFIERS** (low frequency), in new condition.
- NEW MARK III TUNERS, MARK III C.W. TRANSMITTERS and RECEIVERS.**
- B MARK II 2-VALVE DETECTOR AMPLIFIERS, 50-WATT SPARK TRENCH SETS** for Receiving and Transmitting, Valve Boxes, Teak Instrument Cases, a quantity of 13-ft. masts, and a large quantity of Miscellaneous **WIRELESS GEAR.**

**STEVENS'S AUCTION ROOMS LTD.**

will sell the above by auction at their Great Rooms,  
 38, King Street, Covent Garden, W.C.2.  
 Thursday, 2nd November, 1922, at 12.30 o'clock precisely.

On View Wednesday afternoon from 12.30 to 5.30, and on morning of sale from 9.30 till 12 o'clock.

**Catalogues free on application.**

Telephone 1824 Cerrarl.

Telegrams Auks, Rand, London.

**A RECEIVING SET WITHOUT 'PHONES IS LIKE A SHIP WITHOUT A RUDDER**

**The "Brown" Super-Sensitive Telephones**

These Telephones are unquestionably the clearest and most sensitive made, and, consequently, increase the distance over which wireless can be heard. BROWN'S are recognised as the most comfortable to wear, due to their extreme lightness in weight and adaptable adjustment. There is no wireless headphones in the world to compare with BROWN'S.



**"A" TYPE**

Low Resistance 58/-

High Resistance 62/- to 66/-

**"D" TYPE**

Low Resistance 48/-

High Resistance 52/-

(Above Prices include cords.)

Wireless Instruments and parts manufactured by and bearing the name "BROWN" can still be bought with absolute confidence in their quality, value, and efficiency, because throughout this period of increasing wireless activity S. G. BROWN, Ltd., have wisely refused to lower their high standard of quality.

**IMPORTANT NOTICE.**—When purchasing BROWN'S, you should see that the name BROWN is stamped on the back of each ear-piece.

**IN UNIVERSAL USE. AS SUPPLIED TO BRITISH, ALLIED AND FOREIGN GOVERNMENTS.**

**ILLUSTRATED CATALOGUES POST FREE**

Head Office & Works—  
 Victoria Rd., NORTH ACTON, LONDON, W.3.

London Showrooms—  
 19, MORTIMER STREET LONDON, W.1.





# BOWER'S

## HAVE GREATLY REDUCED THE PRICE OF THEIR WIRELESS PARTS

WORKMANSHIP ON EVERY ARTICLE IS STILL UP TO THE HIGHEST STANDARD

Write NOW for Comprehensive Money-saving Price List  
**POST FREE**

TRADE INQUIRIES RESPECTFULLY SOLICITED

|                                                                                                  |      |          |
|--------------------------------------------------------------------------------------------------|------|----------|
| Aerial Wire, 7/22 bare copper stranded in 100 ft. hanks ...                                      | 5/-  | per hank |
| Ring Pattern Insulators, 2 in. by 1 in., 1/2 in. hole ...                                        | 4d.  | each.    |
| 1/2 in. sq. Section Brass Rod for Sliders, cut in 13 n. lengths and drilled ready for fixing ... | 6d.  | each.    |
| Inductance Slider, complete with plunger ...                                                     | 9d.  | each.    |
| Cardboard Cylinders, 12 in. by 4 in. diameter ...                                                | 8d.  | each.    |
| No. 24 Enamelled Wire, H.C., true to gauge ...                                                   | 2/8  | per lb.  |
| Large or small Condenser Plates (Aluminium) ...                                                  | 1/-  | doz.     |
| Large Spacer Washers for condensers (cut true to size) ...                                       | 7d.  | doz.     |
| Small " " " " (1,000th of an inch) ...                                                           | 5d.  | doz.     |
| Ivory Scales " " " " ...                                                                         | 9d.  | each.    |
| Condenser Box, in Polished Oak or Mahogany, 3 1/2 in. by 3 1/2 in. by 2 in. ...                  | 4/6  | each.    |
| 0003 mf. Condensers, complete, assembled in Polished Mahogany or Oak Boxes ...                   | 15/- | each.    |
| All necessary parts for above Condensers, no drilling or fitting required, but unassembled ...   | 12/6 | each.    |
| Ditto, but without box ...                                                                       | 9/6  | each.    |
| Ditto, but without box and Ebonite top, suitable for panel mounting ...                          | 8/6  | each.    |
| Crystal Detector, mounted on Ebonite, complete with Crystal ...                                  | 4/6  | each.    |
| Large or Small Contact Studs ...                                                                 | 9d.  | doz.     |
| Valve Legs, complete with nuts and washers ...                                                   | 2d.  | each.    |
| Government Surplus Accumulators, 16 volt 15 amp. hrs., in case complete (f.o.r.) ...             | 20/- | each.    |
| Hart Accumulators, 4 volt 24 amp. hrs. ...                                                       | 14/9 | each.    |

Packing and postage for last item, 1/8 each.

## J. B. BOWER & CO., LTD.

WIRELESS APPARATUS MANUFACTURERS

15, Kingston Road, WIMBLEDON, S.W.19

Phone: WIMBLEDON 1030.

Works: MERTON

### HIGHEST QUALITY. COMPETITIVE PRICES.



#### SPECIAL DESIGN FILAMENT RHEOSTAT

Strong Phosphor Bronze Contact Arm which will not work loose: Easy to fix to Panel. Excellent construction.

PRICE 4/-

|                                       |     |     |
|---------------------------------------|-----|-----|
| Aerial Wire, Stranded, 7/25, per 100' | ... | 3/6 |
| " Pulleys, Aluminium with Cord        | ... | 2/- |
| " Insulators, Green Egg Type          | ... | 6d. |
| " Reel, best quality                  | ... | 3d. |
| " Ebonite Lead In Insulators          | ... | 16  |

|                                  |        |                                                                              |
|----------------------------------|--------|------------------------------------------------------------------------------|
| Inductance Tubes, 12" x 3"       | .. 6d. | Grid Leaks (Tubular) 2 Meg. (en-closed) ... .. 2/-                           |
| " " 12" x 4"                     | .. 9d. | Grid Condensers ... .. 1/6                                                   |
| " " 12" x 5"                     | .. 1-  | Valve Holders, Screwed Legs ... 1/-                                          |
| " " 12" x 6"                     | .. 13  | Perikon Detectors ... .. 4/-                                                 |
| Sliders and Plungers ...         | .. 6d. | Essex 15 v. H.T. Batteries ... 3/-                                           |
| Sq. Brass Rod, 12" x 1/2" x 1/2" | .. 4d. | Crystals (special selected), Bornite, Zincite, Galena, Silicon, etc. ... 6d. |
| Enamelled Wire, 23 gauge, lb.    | .. 2/- | Crystal Cups with Screw ... .. 4d                                            |
| Knobs with 2 BA Brass Bush       | .. 4d. |                                                                              |

TRANSFORMERS, NOTE MAGNIFIERS, Etc. POSTAGE EXTRA.

### THE ESSEX WIRELESS CO.

Office & Showrooms:  
499, GROVE GREEN RD.,  
LEYTONSTONE, E.11.  
(1 min. from Station, G.E.R.)

Telephone-WANSTEAD 749.

THROUGH ITS EFFICIENCY THIS L.F. TRANSFORMER has EARNED A REPUTATION FOR ITSELF, AND IS NOW IN LARGE DEMAND BY EVERY CLASS OF USER



Ask Your Dealer for

## GENTS' "TANGENT" H.F. TRANSFORMER

GENT & CO LTD Faraday Wks. LEICESTER

Newcastle-on-Tyne: "Tangent House," Blakett St.  
London: 25, Victoria St., S.W.1.

PRICE 22/6 EACH

## FOR TOOL BARGAINS

CALL or WRITE TO-DAY to:

Before buying elsewhere compare our prices. Remember, we have the Largest Stock of Tools to select from in London. We guarantee you satisfaction, so you can safely shop by post. Bargain List sent post Free.

GEORGE ADAMS, D.P.T. A/W, 255-R, HIGH HOLBORN, LONDON, W.C.1.

## 1922-23

Our new Season's list is now ready and will be sent to any address for Two Stamps

SEND TO-DAY FOR YOUR COPY

ELECTRICAL SUPPLY STORES,

Wireless Specialists,

5, Albert Terrace, King Cross, HALIFAX.

## HERE WE ARE AGAIN!

The hundreds of letters which we are receiving from our customers prove beyond doubt that they are the finest Phones on the market, irrespective of price. A full description of these Phones is given in our

CATALOGUES 4d. post free.

Will any Customer not entirely satisfied with his Phones kindly return same when we will refund his cash.

For the High Tension Supply, British made guaranteed FLASH LAMP BATTERIES, 5/- per doz. Huge Stocks of B.T.H. Mullard Ora and Marconi Osram Valves



This illustration does not give a true representation of the swivel—a remarkable feature of our phones.

**SPECIAL OFFER PRICES**

|              |      |
|--------------|------|
| 140 ohm ...  | 23/6 |
| 4000 ohm ... | 25/- |
| 8000 ohm ... | 27/6 |



104/17

**CRYSTAL CUP.**  
With screw to fix Crystal.  
3d. each.



104 16 **INDUCTANCE SLIDER.**  
Complete with Spring and Plunger. 6d. each.  
104/16A 1/2" square brass rod in 13" lengths.  
4d. each.

Please remit ample postage. Balance will be returned.

Wholesale Distributing Agents for Scotland: J. Corst'n Sinclair & Co. 47, Waterloo St. Glasgow.  
Retail Agents at BOLTON—McLeod Bros., 189, Blackburn Road. BURY—Bennett & Co., 12, Union Square.  
WARRINGTON—Economic Electric Co., 64 & 66, Sankey Street. BRADFORD—The Gramophone Stores, 150, Bowling Old Lane.

Telephone:  
No. 4209  
Central.  
Telegrams:  
"Pladuram"  
Manchester.  
Code ABC  
8000 ohm ...  
5th Edition.

## J. L. CARTWRIGHT & CO.

Manufacturing Electrical and Radio Engineers

Please note new address:

(Dept A) 24, London Road, Manchester



104/19

**TERMINALS.**  
To fit flash lamp battery contacts.  
2/- per doz.

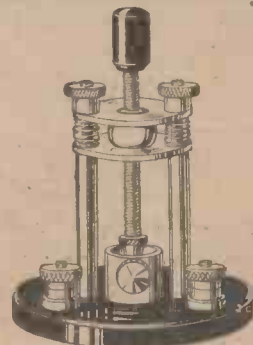

104/14

**CRYSTAL DETECTOR.**  
The neatest design and best finished Detector on the market. Both crystal and contact may be changed will. 5/- each.

Works:  
Berry Street,  
London Road,  
Manchester.

Radio brings it: **MAGNAVOX** tells it

# MAGNAVOX

## THE WORLD'S FINEST LOUD SPEAKER

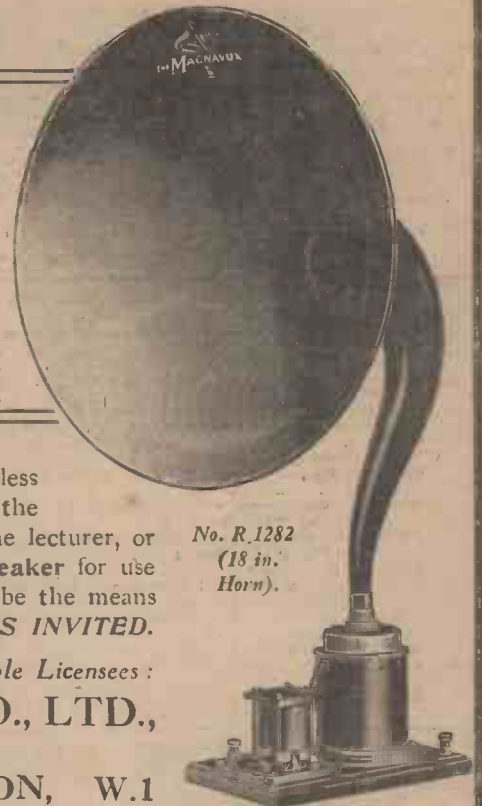

No. R.1282  
(18 in. Horn).

To enjoy and obtain the greatest possible satisfaction from your Wireless Receiving Set, equip it with a **Magnavox Loud Speaker**. Hear the voice of the singer faithfully reproduced, the perfect intonations of the lecturer, or the natural sound of music. The introduction of the **Magnavox Loud Speaker** for use with Radio Receiving Sets marks a most important development, and will be the means of making broadcasting extremely popular.

**INQUIRIES INVITED.**

To be obtained from all Dealers or direct from the Manufacturers and Sole Licensees:

**STERLING TELEPHONE & ELECTRIC CO., LTD.,**

Telephone House,

210/212, TOTTENHAM COURT ROAD, LONDON, W.1

Telephone: Museum 4144 (7 lines).

Telegrams: "Cucumis, Wesdo, London."

NEWCASTLE-ON-TYNE:

9, Clavering Place.

WORKS:

Dagenham, Essex.

CARDIFF:

8, Park Place.

**IMMEDIATE DELIVERY**

# MONEY SAVING

## STUDY THESE PRICES

**COMPLETE SINGLE HEADPHONE** (less head band) ... 2/9  
Low Resistance, postage 6d. extra.  
Very useful in making up. A very, very cheap and effective pair of Headphones, Loud Speaker, etc.

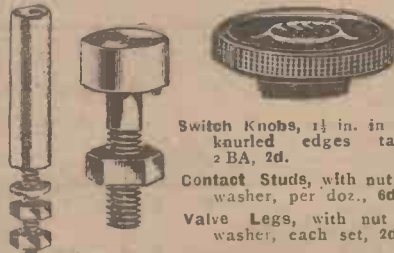

Switch Knobs, 1 1/2 in. in dia., knurled edges tapped 2 BA, 2d.

Contact Studs, with nut and washer, per doz., 6d.

Valve Legs, with nut and washer, each set, 2d.

Terminals, complete, small and medium, per doz. 1/6.

Terminals, War Office pattern, complete, large, per doz., 2/.

Square Brass Centre Rods for condensers, 6d.

2 BA Brass Screwed Rods, 12 in. lengths, 4d.

Brass Nuts, 2 BA, 4 BA, and 5 BA, per doz. 3d.

Tuning Bar, square, brass rods in 13 in. lengths, 5d.

Ebonite Sheets, various thicknesses (cut to any size), 3/6 per lb.

Switch Arms, complete, 11d. and 2/.

**POSTAGE EXTRA.**

Aerial, Earth and Phone Labels, each, 3d.  
Aerial Wire, 100 ft. 7/2d, with 2 insulators, each set, 3/6. (2/6)  
Aerial Silicon Bronze Wire, 18 gauge, per 100 ft., Wireless Masts, in 4 sections, totalling 11 ft., 4/9.  
Valve Holders, 4 legs, with nuts and washers, 1/-  
Ebonite Valve Holders, complete, best quality, 1/9.  
Slider and Plunger, 6d.



Insulators, porcelain, small egg shape, 3d.  
Insulators, porcelain, 2-in. reel, 2d.  
Insulators, large shell-type, 7d.  
Ivory Scales, 6d.  
Crystal Cups (small and large), each 2d. and 6d.  
Crystal Detectors, 3/- and 3/6.  
Lightning Arresters, 2/.  
High-Frequency Transformer Former (8 divisions), 4/6.  
Leading-in Tube, 6 in. long, 2/.  
Copper Foil, 4 x .002, per lb., 2/8.  
2-Coil Holder, with extended arm, complete for panel mounting, 12/9.  
3-Coil Holder, with extended arm, complete for panel mounting, 17/6.

**COMPLETE BUZZER SETS** (Government surplus), less Battery. With special Morse key, phone and head band and connecting cord, buzzer, platinum contacts, 2 heavy terminals, induction coil, mounted in strong teak case with canvas top and shoulder strap, each ... 7/6

Postage 1s. All in full working order. Must have originally cost over £3.

Fixed Condensers, 1/8 each.

Condenser Vanes, 7d. per doz.

Condensers Spacer Washers, large, 4d. per doz.; small, 3d. per doz.



Condensers (Dubilier), 0.001, 0.002 and 0.003, 2/6 each.

Ditto ditto fitted with grid leaks, 5/- each.

**CASH REFUNDED IF NOT SATISFIED**

**GREAT REDUCTION IN PRICE OF "PALMERPHONES" FROM 29/6 TO 25/-**

**GEORGE PALMER** (IMMEDIATELY BEHIND SHAFTESBURY THEATRE, SHAFTESBURY AVENUE),  
47, Gerrard Street, London, W.1.

**WHOLESALE TRADE SUPPLIED**