

Amateur

RADIO

For all two-way radio enthusiasts

On test: Icom IC900 FM
multiband mobile transceiver

A yagi and mast
for 20m



Modifying the Yaesu
FTV707 transverter

2m Propagation
— a 'green fingers' approach

**WIN A G4ZPY
PADDLE
KEY**

For Tomorrow's Radio Technology TODAY

BASE STATIONS

Good News for FT767 owners. Kenwood users take note!
IMPROVED YAESU FT767 RWC/MK2 HF-UHF BASE STATION

We are pleased to announce that we have now improved the synthesizer (two reviews) leading to better dynamic range by up to 10dB which now puts this transceiver in a class of its own! This modification is only available from RWC and is fitted FREE to all New units sent by us, or we will modify any existing unit for £59.50 inc. return carriage.

FT767 MK2/RWC COMPLETE TOP CLASS BASE STATION (EX VHF UHF) £1449.00
FT767 MK2/RWC COMPLETE TOP CLASS BASE STATION (EX VHF UHF) WITH 2M FITTED £1610.00
FT757 MK2 NEW IMPROVED HF TRANSCEIVER £885.00

FT726R MULTIMODE BASE STATION WITH 2MTRS. (SPECIAL PRICE) £799.00

ICOM IC735 SUPER MINI HF ALL BAND TRANSCEIVER £896.50
ICOM IC725E 2MTR 25W BASE STATION C/W 100W PSU £939.00
NEW ICOM IC575 6M 10W BASE STATION, 26-56 MHz RECEIVER TX10 AND 6M £949.00

Many more Makes and Models in stock. Please enquire.

FT767GX MK2/RWC

NEW



ICOM IC735



HANDHELDS

* = Extended RX coverage available, call for details

YAESU FT227R 2.5W (5W) DUAL BANDER C/W CHRG £385.00
YAESU FT23R/FNB10 2.5W (5W) 2MTRS C/W CHRG £249.00
YAESU FT73R/FNB10 2.5W (5W) 70CM CHRG £259.00
ICOM IC02E QUALITY 2.5W (5W) 8P3 C/W CHRG £225.00
ICOM MICRO 2E MINI 2.5W 2MTR C/W CHRG £195.00
CIE 1600 (VY SIM IC2E) 2.5W 2MTR C/W CHRG £165.00
KENPRO KT400EE 2.5W 70CM C/W CHRG £199.00
KENPRO KT200EE 2.5W (5W) 2MTR C/W CHRG £199.00
KENWOOD/TRO TH21E 2W 2MTRS. (WHILE STOCKS LAST) £139.00

PORTABLES

FT690R/MK2 2.5W MULTIMODE JOIN IN THE FUN! £399.00
FT690R/MK2 AS ABOVE C/W NICADS AND CHARGER £425.00
FT290R/MK2 2.5W MULTIMODE IMPROVED RECEIVER £385.00
FT290R/MK2 AS ABOVE C/W NICADS AND CHARGER £429.00
FT290R/MK1 2MTR MULTIMODE SPECIAL PRICE £329.00

MOBILES

YAESU FT211E 45W 2MTR NEW SUPER MOBILE FREE £299.00
SUN 58 MOBILE ANTENNA C/W SO239 G/MOUNT £359.00
ICOM IC26E 25W SUPER MINI MOBILE FREE SUN £359.00
S8 SO239 GUTTERMOUNT ASSY + EXT LOUDSPEAKER

NEW LICENCEES CALL FOR SPECIAL DEALS

INSURED P&P £10



NEW

SCANNERS

YAESU FRG9600/RWC

FRG 9600

We modify the Yaesu FRG 9600 modified receiver to Government departments and professional users. We offer more options and facilities than any other company. We transform the basic unit by improving sensitivity and adding extra bands. No other scanner has the many options and features available. Call now for much more information. Customised scanner required for the kit.

Modified Yaesu receiver, NOBODY can tune, unlike we can!
YAESU FRG9600 RWC MK1 60-30MHz IMPROVED RECEIVER £465.00
YAESU FRG9600 RWC MK2 60-30MHz N CONNector £495.00
YAESU FRG9600 RWC MK3 100kHz-950MHz MULTIMODE £595.00

NEW YAESU FRG9600 RWC/MK5 100KHZ-950MHZ ACTIVE F/END £625.00 NEW

YAESU FRG9600 MK3A/47000G5RV/PAAC AC PSU COMPLETE £699.00
100KHZ-950MHZ ALL BAND ALL MODE RECEIVING STATION ICOM IC7000 25-20GHZ ALL MODE SUPER RECEIVER £857.00
ICOM IC7000 47000 ABOVE WITH MATCHING DISCONE £945.00
UNIDEN BEARCAT UBC100XL SUPER HI-LEVEL C/W NICDS PSU £219.00
UNIDEN BEARCAT UBC175XL SUPER DESK TOP C/W PSU £199.00
REGENCY HX850 HANDHELD AM/FM MINI LB AIR/VHF/UHF £245.00
REGENCY MK7000 SAME COVERAGE SAME MAKE AS ABOVE £399.00
FDK AIR BAND HANDHELD THUMBWHEEL MINI C/W NICDS PSU £139.00
FDK AS ABOVE COVERAGE 140-173.0MHz FM BANDS £139.00
MANY MORE MAKES AND MODELS IN STOCK PLEASE CALL FOR DETAILS
INSURED P&P £10 ON SCANNERS

SHORT WAVE RECEIVERS

YAESU FRG800 SHORT WAVE ALL MODE 100KHZ-30MHZ £572.50
YAESU FRG800/FRV800 AS ABOVE WITH VHF CONVERTER £659.00
ICOM ICR71 100KHZ-30MHZ A TOP CLASS RECEIVER £738.00

NEW PRODUCTS

INTERNATIONAL MODEL 877R AIR-BAND RECEIVERS

This new tuneable receiver covers 50-174 MHz as well as CB in three bands and is a cost effective alternative to handheld scanners. The receiver is fitted with a helical antenna and has good performance for a radio with this coverage. It is ideal for monitoring Air Band, the two-metre and PMR/Marine bands as well as Band 2 FM Broadcast. A search control is also provided. Two versions are currently available.

Model 877R for use with Dry cells £39.50
Model 877R for Nicads and charger £49.50

DEALERS CALL FOR TRADE PRICES P&P £2.50

INTRODUCTORY OFFER



NEW

RAYCOM PRODUCTS

NEW ICOM TYPE COMPATIBLE NICAD PACKS, EMPTY CELL CASES AND DESK TOP CHARGER

A new range of professional Heavy Duty long life nicad packs, imported from the USA, available exclusively at RWC.

10AF 10V 800 MAH LONG LIFE, ICOM EQUIV BP5/8 £55.00
12AF 12V 600 MAH LONG LIFE, ICOM EQUIVALENT BP7 £52.50
(Both available for use in ICOM BC3060 OR RAYCOM NC580)
MT1 EMPTY Cell case for self assembly of up to 10x Nicads for a cost effective replacement for portable units BP3 etc. there is ample room for a D.C. pack size instructions. £9.50
AA NICADS (boxed) 1.2V 500mA Nicad cells for use in C160 NC580 Desk Top charger for all Icom type Nicads (above) 80mA, 200mAh charging platform 50mA & 80mA 14hr charge £39.50
Trade and Dealer enquiries welcome. Call for more details.
P&P £2.50 per order

Business radio users call now!



NEW

ANTENNAS & ACCESSORIES

ICOM AH7000 SUPER DISCONE 25-1300MHZ INC POST £79.00
NEW RAYCOM AIR BAND DISCONE 118-170 MHZ 6 ELEMENTS £12.50
RAYCOM DISCONE 60-800 MHZ 8 ELEMENTS SO239 SOCKET £27.50
SUN MOBILE 5/8 SO239 C/W SO239 MOUNTED LEAD/G/MOUNT £22.50
G5RV 1/2 SIZE HF MULTIBAND HF ANTENNA (INC POST) £15.00
G5RV FULL SIZE MULTIBAND HF ANTENNA (INC POST) £17.50
G5KW/W3DZZ 7.1MHZ TRAP DIPOLE ASSY, SO239 COAX FED £23.50
G5KW/W3DZZ 7.1MHZ MULTIBAND AS ABOVE, BALANCED FED £23.50
G5KW/W3DZZ 7.1MHZ 2X TRAPS, FOR SELF ASSY ANT £9.95

Hundreds of other types of base and mobile antennas in stock
JAYBEAM, TONNA, MET, SUN, HOXIN, POPULAR MODELS IN STOCK

NEW RWC are now appointed dealers for the West Midlands for Butternut, Cushcraft and MFJ products. Please ask for details of the range currently available.

MOD KITS

RWC MOD KITS, ANNOUNCEMENT

We apologise to customers waiting for various mod kits, supplies of crystals and components are increased and checked for kits varies, so there is occasionally a delay before we can send your kit of parts, please be patient! Rome was NOT built in a DAY! Kits still available
SANYO LC7137 SYNTHESIZER CB-10MTRS
LCL/DNT CB-10MTRS FT757GX MK1 FAST TUNING MOD STORNO COM713 FMR 2MTR KIT PVE A200 E-BAND 50MHZ KIT call for technical details, prices and delivery

WANTED DEAD OR ALIVE

Your used equipment. We also offer a very comprehensive range of guaranteed used equipment, e.g. Amateur band transceivers, SW receivers, scanning receivers, PMR and accessories. As far as we are aware we are the only company in the UK to offer a bi-weekly computerized used equipment list and special offers list.

Send a large SAE for copies.
ALL USED EQUIPMENT CARRIES 3 MONTH WARRANTY

RAY WITHERS COMMUNICATIONS LTD

Manufacturers, Importers and Suppliers of World Famous Communications Products

584 HAGLEY ROAD WEST, OLDBURY, WEST MIDLANDS B68 0BS

021-421 8201/2/3. VODAFONE 0836 504587. PRESTEL MBX 214218216 FAX 021 421 2468

Amateur Radio, Business Radio, Radio Telephones, Sales, Service Accessories and Antenna Systems.

Ordering Information: For fast delivery please order by Telephone, Telex or Fax, or send cash/cheques/drafts by post. All Credit/Charge cards accepted, £1000.00 Instant Credit available subject to status, we also offer our RWC Chargecard. Please call for further details and information. We do NOT advertise products that are not normal stock items. All prices correct at time of going to press. However, prices subject to change without prior notice. E&OE

Most other products advertised in this magazine are available at RWC.

★ WE WILL MATCH OR IMPROVE ANY GENUINE ADVERTISED PRICE ★



Amateur RADIO

**Editor:**

Anita Ley

Assistant Editor:

Lisbeth Stedman

Advertisement**Manager:**

Marian Vidler

Subscriptions:

01-760 0409

Accounts:

Clare Brinkman

Publisher:

Peter Williams

On sale: Last Thursday of the month preceding cover date

Next issue: Cover date January 1988 on sale 24 December 1987

Published by:

Amateur Radio Magazines, Sovereign House, Brentwood, Essex CM14 4SE, England (0277) 219876

Printed: In England

ISSN: 0264-2557

News Trade Sales by:

S M Distribution, 16-18 Trinity Gardens, London, SW9 8DX 01-274 8611

Front cover: ICOM

IC900E (p21). Photo by Jay Moss-Powell G6XIB

Whilst every care is taken when accepting advertisements we cannot accept responsibility for unsatisfactory transactions. We will, however, thoroughly investigate any complaints. The views expressed by contributors are not necessarily those of the publishers.

Every care is also taken to ensure that the contents of *Amateur Radio* are accurate, we assume no responsibility for any effect from errors or omissions.

© Copyright 1987
Amateur Radio Magazines

6 Christmas Gift Guide

A few ideas on products that may bring a smile to your face when you find them in your stocking on Christmas morning

10 Christmas Competition

Win a hand-crafted G4ZPY paddle key in our exciting Christmas quiz

11 Club News

Christmas booze-ups, more christmas booze-ups and....

12 DX Diary

Don Field G3XTT with this month's DX news

15 2m Propagation

Ian Poole explains how to go all the way on two metres

18 Modifying the Yaesu FTV707 transverter

Transform your FTV707 – you won't even need a magic wand!

21 Angus McKenzie Tests

This month G3OSS reviews the extraordinary Icom IC900E, with its state-of-the-art fibre optic cable connections

27 A 20m Yagi and Mast

Roy Quantick makes a 20m antenna for the pocket handkerchief sized plot – an article not to be sneezed at

34 SWL

Trevor Morgan GW4OXB with this month's news and a peek at the SPR52 Tone Processor

36 The Collins TCS Series

A H Cain takes a nostalgic look at one of the best vintage set-ups around

40 Bits to Build

The Rev Dobbs G3RJV builds a biometer – festive fun for everyone

43 Phone-Patch OK in VK

Tony Smith G4FAI – a pom ham reports on the latest wonder down under

44 50MHz

Ken Ellis reports on the latest opening to Botswana on the 6m band

46 Project Book

Martyn Williams looks into satellite dishes and sees the future

47 The RAIBC

Fiona McKenzie reports on the invaluable services of the RAIBC

48 On the Beam

Glen Ross G8MWR with all the latest news from VHF, UHF and microwaves

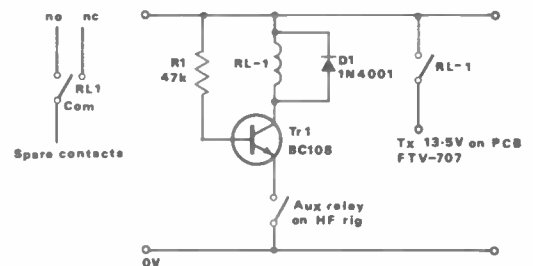
**49 Coming Next Month**

What's in store for you

50 Secondhand

Hugh Allison examines electrolytics and fixes a well-travelled FT290

53 Free Classified Ads

The market for buying and selling

SERVICES

45 Subscription order form

55 Free Classified Ad form

58 Back Issues order form

58 Advertiser's index

58 Advertising rates and information

VSA
PHONE
0474 60521

P.M. COMPONENTS LTD

SELECTION HOUSE, SPRINGHEAD ENTERPRISE PARK, SPRINGHEAD ROAD, GRAVESEND, KENT DA11 8HD

TELEX
966371
TOS PM

INTEGRATED CIRCUITS

AN103	2.50	LA4430	2.50	AL11270Q	1.10	TA7609P	3.95	TC4760	2.50	1DA4050	2.95	AA119	0.08	BYX36-150R	0.20
AN124	2.50	LA4461	3.95	SN7471	1.40	TA7611AP	2.95	TC8A00	2.50	1DA4600	2.90	BA115	0.13	BYX36-600R	0.60
AN214	2.50	LC7130	3.25	SN7421	0.95	TA7629	2.50	TC9A00	2.50	TD49503	3.18	BA148	0.17	BYX55-600	0.30
AN236	1.98	LC7131	5.80	SN76202N	3.95	TAA310A	3.50	TC8A30S	1.95	TEA1009	1.35	BA154	0.06	BYX71-600	1.78
AN239	2.50	LM7317	8.50	SN76110N	0.29	TAA350A	1.95	TC9A00	1.65	UFC41C	3.90	BA156	0.15		
AN240P	2.50	LM7322K	4.95	SN76115N	1.25	TAA350A	1.95	TC9A00	1.65	UFC566H	2.95	BA157	0.30		
AN247	2.50	LM7324N	0.48	SN76131N	1.30	TAA550B	1.95	TD4440	2.20			BA244	0.78		
AN260	2.50	LM7380N	1.50	SN76225D	2.95	TAA570	1.95	TD41001	2.95	UPC575C2		BA247	0.33		
AN262	1.98	LM7380N8	2.95	SN76227N	1.05	TAA6320S	2.95	TD41003A	3.95	UPC10001H	2.78	BA302	0.85		
AN264	2.50	LM7383T	2.95	SN76228N	2.95	TAA661B	1.95	TD41006A	2.50	UPC1020H	1.95	BA313	0.75		
AN271	3.50	LM7390N	3.50	SN76533N	1.85	TAA700	1.70	TD41010	2.15	UPC1024H	2.95	BA318	2.95		
AN301	2.95	LM1011	3.18	SN76650N	1.15	TAA930	3.95	TD41015	2.15	UPC1025H	1.50	BA328	2.95		
AN303	3.50	MS155L	2.95	SN76660N	0.90	TBA120AS/B	0.00	TD41020	1.95	UPC1025H	1.50	BA329	1.75		
AN313	2.95	MS1513L	2.30	STK011	2.95			TD41025	2.25	UPC1025H	1.50	BA331	0.30		
AN315	2.25	MS1521L	1.90	STK014	7.95	SA/SB/T/U		TD41030	2.50	UPC1025H	1.50	BA332	0.85		
AN316	3.95	MB3705	1.50	STK015	8.95	TBA231	1.30	TD41044	2.15	UPC1025H	1.50	BA333	0.75		
AN331	3.95	MB3712	2.00	STK018	7.95	TBA395	1.50	TD41170	1.95	UPC1026H	1.95	BA334	0.12		
AN342	2.50	MB3756	2.50	STK022	11.95	TBA396	0.75	TD41180	2.18	UPC1032H	1.95	BA335	0.10		
AN362L	2.50	MC1307P	1.00	STK032	7.95	TBA400N	2.55	TD41200	3.95	UPC1032H	1.95	BA336	0.10		
AN612	2.15	MC1310P	1.95	STK078	11.95	TBA480Q	1.25	TD41270Q				BA337	0.10		
AN632	3.50	MC1327	0.75	STK085	8.95	TBA510	2.50	TD41327	1.70	UPC1158H	1.95	BA338	0.15		
AN7140	3.95	MC1372Q	0.90	STK415	7.95	TBA510Q	2.50	TD42002	1.95	UPC1167C2	0.75	BA339	0.20		
AN7145	3.50	MC1399P	1.75	STK435	5.95	TBA520	1.10	TD42003	2.95	UPC1167C2	0.75	BA340	0.15		
AN7150	2.95	MC1350P	1.75	STK437	7.95	TBA520Q	1.10	TD42010	1.95	UPC1181H	1.25	BA341	0.48		
AN7151	2.50	MC1351P	1.75	STK439	7.95	TBA530	1.10	TD42020	2.95	UPC1182H	1.25	BA342	0.15		
BA521	3.38	MC1357	2.35	STK461	11.90	TBA540	1.25	TD42030	2.80	UPC1182H	1.25	BA343	0.15		
CA1352E	1.78	MC1495	3.00	STK463	11.90	TBA540Q	1.35	TD42150	2.50	UPC1185H	2.95	BA344	0.15		
CA3086	0.46	MC1496	1.75	STK0015	7.95	TBA550Q	1.95	TD42151	1.95	UPC1185H	2.95	BA345	0.15		
CA3123E	2.50	MC1723	0.50	STK0025	7.95	TBA560C	1.45	TD42160	2.50	UPC1191V	3.95	BA346	0.15		
CA3131E	1.95	MC337	2.75	TA7061AP	1.90	TBA570	1.00	TD42524	1.95	UPC1350C	3.95	BA347	0.15		
CA3140S	2.50	MC3401I	2.95	TA7072	2.85	TBA651R	2.50	TD42525	2.95	UPC1350C	3.95	BA348	0.15		
CA3140T	1.15	MC14518CP	1.90	TA7073	3.90	TBA673	1.95	TD42530	1.95	UPC1353C	2.95	BA349	0.15		
ETT6016	2.90	ML231B	7.80	TA7108P	1.50	TBA720A	2.45	TD42532	1.95	UPC1360	2.95	BA350	0.15		
HA1137W	1.95	ML232B	2.75	TA7120P	1.50	TBA750	1.95	TD42542	1.95	UPC1360	2.95	BA351	0.15		
HA1156W	1.50	MS239	2.95	TA7120P	1.50	TBA750Q	1.45	TD42541	1.15	UPC1365C	3.95	BA352	0.15		
HA1306	1.95	MS25807	6.78	TA7137P	1.50	TBA800	0.85	TD42541	1.15	UPC1365C	3.95	BA353	0.15		
HA1322	1.98	MS25807	6.78	TA7137P	1.50	TBA810AS	2.95	TD42542	1.95	UPC2002H	2.95	BA354	0.15		
HA1339A	2.95	SA4500A	3.50	TA7146P	1.50	TBA810P	1.65	TD42581	2.95	UPD2114LC	1.95	BA355	0.15		
HA1366W	2.78	SA4102S	7.25	TA7176AP	2.95	TBA820M	0.75	TD42582	1.95	UPD2114LC	1.95	BA356	0.15		
HA1377	3.50	SA41251	4.95	TA7193P	3.95	TBA820Q	1.45	TD42593	2.95	UPD2114LC	1.95	BA357	0.15		
HA1406	1.95	SA45010	5.35	TA7194P	2.95	TBA820Q	1.45	TD42593	2.95	UPD2114LC	1.95	BA358	0.15		
HA1551	2.95	SA45020	8.75	TA7204P	2.15	TBA890	2.50	TD42610	2.50	UPD2114LC	1.95	BA359	0.15		
LA1201	0.98	SAB5506	1.78	TA7205AP	1.18	TBA920	1.65	TD42610	2.50	UPD2114LC	1.95	BA360	0.15		
LA1230	1.95	SA55708	1.78	TA7222AP	1.80	TBA920X	1.95	TD42640	3.50	UPD2114LC	1.95	BA361	0.15		
LA1401	0.98	SA580	2.05	TA7227P	1.95	TBA990	1.49	TD42655	0.40	UPD2114LC	1.95	BA362	0.15		
LA1410	0.98	SA8590	2.75	TA7228P	1.95	TBA990	1.49	TD42680A	2.75	UPD2114LC	1.95	BA363	0.15		
LA4031P	1.95	SL1718	7.95	TA7310P	1.80	TCA270S	1.50	TD42690	4.45	UPD2114LC	1.95	BA364	0.15		
LA4400	3.50	SL1317	1.10	TA7313AP	2.95	TCA270S	1.50	TD42690	4.45	UPD2114LC	1.95	BA365	0.15		
LA4420	3.50	SL1320	1.10	TA7321P	2.95	TCA650	2.50	TD42710	3.50	UPD2114LC	1.95	BA366	0.15		
LA4422	2.50							TD42710	3.50	UPD2114LC	1.95	BA367	0.15		

DIODES

AA119	0.08	BYX36-150R	0.20
BA115	0.13	BYX36-600R	0.60
BA148	0.17	BYX55-600	0.30
BA154	0.06	BYX71-600	1.78
BA156	0.15		
BA157	0.30		
BA244	0.78		
BA247	0.33		
BA302	0.85		
BA313	0.75		
BA318	2.95		
BA328	2.95		
BA329	1.75		
BA331	0.30		
BA332	0.85		
BA333	0.12		
BA334	0.15		
BA335	0.15		
BA336	0.15		
BA337	0.15		
BA338	0.15		
BA339	0.15		
BA340	0.15		
BA341	0.15		
BA342	0.15		
BA343	0.15		
BA344	0.15		
BA345	0.15		
BA346	0.15		
BA347	0.15		
BA348	0.15		
BA349	0.15		
BA350	0.15		
BA351	0.15		
BA352	0.15		
BA353	0.15		
BA354	0.15		
BA355	0.15		
BA356	0.15		
BA357	0.15		
BA358	0.15		
BA359	0.15		
BA360	0.15		
BA361	0.15		
BA362	0.15		
BA363	0.15		
BA364	0.15		
BA365	0.15		
BA366	0.15		
BA367	0.15		
BA368	0.15		
BA369	0.15		
BA370	0.15		
BA371	0.15		
BA372	0.15		
BA373	0.15		
BA374	0.15		
BA375	0.15		
BA376	0.15		
BA377	0.15		
BA378	0.15		
BA379	0.15		
BA380	0.15		
BA381	0.15		
BA382	0.15		
BA383	0.15		
BA384	0.15		
BA385	0.15		
BA386	0.15		
BA387	0.15		
BA388	0.15		
BA389	0.15		
BA390	0.15		
BA391	0.15		
BA392	0.15		
BA393	0.15		
BA394	0.15		
BA395	0.15		
BA396	0.15		
BA397	0.15		
BA398	0.15		
BA399	0.15		
BA400	0.15		

PUSH BUTTON SWITCHES

Decca/ITT	6 way	7.98	C8 (late)	6 way	14.50
Decca	4 way	7.98	ITT	7 way	10.50
Hilachi	4 way	11.98	Mans	7 way	12.50
GEC213	6 way	10.30	Rank	4 way	10.50
GEC210	6 way	10.50	Luxor	6 way	10.50
GEC	6 way	10.50			

FUSES

2mm Q/B @ 0.06 each
100 MA, 200 MA, 250 MA, 500 MA, 1 AMP, 2 AMP, 3 AMP, 4 AMP, 5 AMP
Special offer: 100 per type 4.50
20mm A/B @ 0.15 each
100 MA, 150 MA, 160 MA, 250 MA, 500 MA, 800 MA, 1.25 AMP, 1.6 AMP, 2 AMP, 3 AMP, 3.15 AMP, 4 AMP
Special offer: 100 per type 11.50
1.25 inch Q/B @ 0.06 each
250 MA, 500 MA, 750 MA, 1 AMP, 1.5 AMP, 2 AMP, 3 AMP, 4 AMP, 5 AMP
Special offer: 100 per type 4.00

MS150	0.95	IN233	2.95
IN233	2.95	IN233E	4.95
IN233E	4.95	IN233W	4.95
IN233W	4.95	IN4001	0.04
IN4001	0.04	IN4002	0.06
IN4002	0.06	IN4003	0.06
IN4003	0.06	IN4004	0.06
IN4004	0.06	IN4005	0.06
IN4005	0.06	IN4006	0.06
IN4006	0.06	IN4007	0.06
IN4007	0.06	IN4008	0.06
IN4008	0.06	IN4009	0.06
IN4009	0.06	IN4010	0.06
IN4010	0.06	IN4011	0.06
IN4011	0.06	IN4012	0.06
IN4012	0.06	IN4013	0.06
IN4013	0.06	IN4014	0.06
IN4014	0.06	IN4015	0.06
IN4015	0.06	IN4016	0.06



P.M. COMPONENTS LTD

SELECTRON HOUSE

SPRINGHEAD ENTERPRISE PARK, SPRINGHEAD ROAD GRAVESEND, KENT DA11 8HD

TELEX
966371
TOS PM

PHONE
0474 60521
3 LINES

A SELECTION FROM OUR STOCK OF BRANDED VALVES (Contd)

DL63 1.00	ECL85 0.95	HBC90 1.95	OM5B 3.00	R19 2.50	VR105/30 2.50	4-250A 79.50	6CA7 3.50	7K7 7.50	30PL13 0.60	3087 4.50
DL70 2.50	ECL86 0.95	HBC91 1.95	OM6 1.75	R20 1.20	VR150/30 2.50	4-400A 87.50	6CB5 3.95	7L1 1.50	30PL14 1.78	3088 4.50
DL73 2.50	ECL805 0.95	HF93 1.95	ORP43 2.90	R1169 55.00	VU29 4.50	1000A 428.00	6CB6 1.95	7Q7 4.50	31J56C 5.00	5702 3.50
DL92 1.25	EF22 3.50	HF94 1.95	ORP50 3.50	R5559 9.50	VU39 1.50	4B32 35.00	6CD6A 4.50	7Y4 2.50	33A/158M	5704 3.50
DL93 1.10	EF37A 2.90	HK90 1.95	P61 2.50	RG1-125 4.95	W21 4.80	4B/551B	6CF6 1.95	8B8 2.50	35A3 19.50	5718 6.15
DL94 2.50	EF39 1.50	HL41 3.50	PAB080 0.75	RG1-240A 2.50	W61 1.50	4BQ7A 128.00	6CG7 3.50	8B10 2.50	35A5 4.95	5726 2.50
DL96 2.50	EF40 4.50	HL90 3.50	PC86 0.75	RG3-250A 8.50	W77 5.00	4BZ6 1.95	6CH6 6.95	8BQ5 1.05	35C5 4.50	5727 2.50
DL97 2.50	EF42 3.90	HL92 1.50	PC88 0.75	RG3-250A 8.50	W79 1.00	4C28 25.00	6CL6 3.25	8CWC5 1.50	35LEGT 2.00	5749 2.50
DL98 2.50	EF44 3.90	HL92 1.50	PC92 3.90	RG3-250A 8.50	W79 1.00	4C35 145.00	6CL8A 1.50	8EB8 1.50	35Z3 1.95	5750 1.85
DL99 2.50	EF46 3.90	HL92 1.50	PC97 1.10	RG3-250A 8.50	X24 4.50	4CX125C	6CM7 2.95	8FQ7 1.97	35ZGT 3.90	5751 1.95
DL100 2.50	EF48 3.90	HL92 1.50	PC97 1.10	RG3-250A 8.50	X41 4.50	4CX125C	6CS6 0.75	10CW5 1.50	35ZGT 3.90	5752 1.95
DL101 2.50	EF50 2.90	HL13DD 3.00	PC97 1.10	RG3-250A 8.50	X41 4.50	4CX125C	6CS7 0.95	10D2 1.25	38HE7 4.50	5762 550.00
DL102 2.50	EF52 2.90	HL13DD 3.00	PC97 1.10	RG3-250A 8.50	X41 4.50	4CX125C	6CS7 0.95	10D7 2.00	40KD6 5.00	5763 5.75
DL103 2.50	EF54 2.90	HL13DD 3.00	PC97 1.10	RG3-250A 8.50	X41 4.50	4CX125C	6CS7 0.95	10D7 2.00	42 6.95	5814 3.25
DL104 2.50	EF56 2.90	HL13DD 3.00	PC97 1.10	RG3-250A 8.50	X41 4.50	4CX125C	6CS7 0.95	10D7 2.00	42 6.95	5814 3.25
DL105 2.50	EF58 2.90	HL13DD 3.00	PC97 1.10	RG3-250A 8.50	X41 4.50	4CX125C	6CS7 0.95	10D7 2.00	42 6.95	5814 3.25
DL106 2.50	EF60 2.90	HL13DD 3.00	PC97 1.10	RG3-250A 8.50	X41 4.50	4CX125C	6CS7 0.95	10D7 2.00	42 6.95	5814 3.25
DL107 2.50	EF62 2.90	HL13DD 3.00	PC97 1.10	RG3-250A 8.50	X41 4.50	4CX125C	6CS7 0.95	10D7 2.00	42 6.95	5814 3.25
DL108 2.50	EF64 2.90	HL13DD 3.00	PC97 1.10	RG3-250A 8.50	X41 4.50	4CX125C	6CS7 0.95	10D7 2.00	42 6.95	5814 3.25
DL109 2.50	EF66 2.90	HL13DD 3.00	PC97 1.10	RG3-250A 8.50	X41 4.50	4CX125C	6CS7 0.95	10D7 2.00	42 6.95	5814 3.25
DL110 2.50	EF68 2.90	HL13DD 3.00	PC97 1.10	RG3-250A 8.50	X41 4.50	4CX125C	6CS7 0.95	10D7 2.00	42 6.95	5814 3.25
DL111 2.50	EF70 2.90	HL13DD 3.00	PC97 1.10	RG3-250A 8.50	X41 4.50	4CX125C	6CS7 0.95	10D7 2.00	42 6.95	5814 3.25
DL112 2.50	EF72 2.90	HL13DD 3.00	PC97 1.10	RG3-250A 8.50	X41 4.50	4CX125C	6CS7 0.95	10D7 2.00	42 6.95	5814 3.25
DL113 2.50	EF74 2.90	HL13DD 3.00	PC97 1.10	RG3-250A 8.50	X41 4.50	4CX125C	6CS7 0.95	10D7 2.00	42 6.95	5814 3.25
DL114 2.50	EF76 2.90	HL13DD 3.00	PC97 1.10	RG3-250A 8.50	X41 4.50	4CX125C	6CS7 0.95	10D7 2.00	42 6.95	5814 3.25
DL115 2.50	EF78 2.90	HL13DD 3.00	PC97 1.10	RG3-250A 8.50	X41 4.50	4CX125C	6CS7 0.95	10D7 2.00	42 6.95	5814 3.25
DL116 2.50	EF80 2.90	HL13DD 3.00	PC97 1.10	RG3-250A 8.50	X41 4.50	4CX125C	6CS7 0.95	10D7 2.00	42 6.95	5814 3.25
DL117 2.50	EF82 2.90	HL13DD 3.00	PC97 1.10	RG3-250A 8.50	X41 4.50	4CX125C	6CS7 0.95	10D7 2.00	42 6.95	5814 3.25
DL118 2.50	EF84 2.90	HL13DD 3.00	PC97 1.10	RG3-250A 8.50	X41 4.50	4CX125C	6CS7 0.95	10D7 2.00	42 6.95	5814 3.25
DL119 2.50	EF86 2.90	HL13DD 3.00	PC97 1.10	RG3-250A 8.50	X41 4.50	4CX125C	6CS7 0.95	10D7 2.00	42 6.95	5814 3.25
DL120 2.50	EF88 2.90	HL13DD 3.00	PC97 1.10	RG3-250A 8.50	X41 4.50	4CX125C	6CS7 0.95	10D7 2.00	42 6.95	5814 3.25
DL121 2.50	EF90 2.90	HL13DD 3.00	PC97 1.10	RG3-250A 8.50	X41 4.50	4CX125C	6CS7 0.95	10D7 2.00	42 6.95	5814 3.25
DL122 2.50	EF92 2.90	HL13DD 3.00	PC97 1.10	RG3-250A 8.50	X41 4.50	4CX125C	6CS7 0.95	10D7 2.00	42 6.95	5814 3.25
DL123 2.50	EF94 2.90	HL13DD 3.00	PC97 1.10	RG3-250A 8.50	X41 4.50	4CX125C	6CS7 0.95	10D7 2.00	42 6.95	5814 3.25
DL124 2.50	EF96 2.90	HL13DD 3.00	PC97 1.10	RG3-250A 8.50	X41 4.50	4CX125C	6CS7 0.95	10D7 2.00	42 6.95	5814 3.25
DL125 2.50	EF98 2.90	HL13DD 3.00	PC97 1.10	RG3-250A 8.50	X41 4.50	4CX125C	6CS7 0.95	10D7 2.00	42 6.95	5814 3.25
DL126 2.50	EF100 2.90	HL13DD 3.00	PC97 1.10	RG3-250A 8.50	X41 4.50	4CX125C	6CS7 0.95	10D7 2.00	42 6.95	5814 3.25
DL127 2.50	EF102 2.90	HL13DD 3.00	PC97 1.10	RG3-250A 8.50	X41 4.50	4CX125C	6CS7 0.95	10D7 2.00	42 6.95	5814 3.25
DL128 2.50	EF104 2.90	HL13DD 3.00	PC97 1.10	RG3-250A 8.50	X41 4.50	4CX125C	6CS7 0.95	10D7 2.00	42 6.95	5814 3.25
DL129 2.50	EF106 2.90	HL13DD 3.00	PC97 1.10	RG3-250A 8.50	X41 4.50	4CX125C	6CS7 0.95	10D7 2.00	42 6.95	5814 3.25
DL130 2.50	EF108 2.90	HL13DD 3.00	PC97 1.10	RG3-250A 8.50	X41 4.50	4CX125C	6CS7 0.95	10D7 2.00	42 6.95	5814 3.25
DL131 2.50	EF110 2.90	HL13DD 3.00	PC97 1.10	RG3-250A 8.50	X41 4.50	4CX125C	6CS7 0.95	10D7 2.00	42 6.95	5814 3.25
DL132 2.50	EF112 2.90	HL13DD 3.00	PC97 1.10	RG3-250A 8.50	X41 4.50	4CX125C	6CS7 0.95	10D7 2.00	42 6.95	5814 3.25
DL133 2.50	EF114 2.90	HL13DD 3.00	PC97 1.10	RG3-250A 8.50	X41 4.50	4CX125C	6CS7 0.95	10D7 2.00	42 6.95	5814 3.25
DL134 2.50	EF116 2.90	HL13DD 3.00	PC97 1.10	RG3-250A 8.50	X41 4.50	4CX125C	6CS7 0.95	10D7 2.00	42 6.95	5814 3.25
DL135 2.50	EF118 2.90	HL13DD 3.00	PC97 1.10	RG3-250A 8.50	X41 4.50	4CX125C	6CS7 0.95	10D7 2.00	42 6.95	5814 3.25
DL136 2.50	EF120 2.90	HL13DD 3.00	PC97 1.10	RG3-250A 8.50	X41 4.50	4CX125C	6CS7 0.95	10D7 2.00	42 6.95	5814 3.25
DL137 2.50	EF122 2.90	HL13DD 3.00	PC97 1.10	RG3-250A 8.50	X41 4.50	4CX125C	6CS7 0.95	10D7 2.00	42 6.95	5814 3.25
DL138 2.50	EF124 2.90	HL13DD 3.00	PC97 1.10	RG3-250A 8.50	X41 4.50	4CX125C	6CS7 0.95	10D7 2.00	42 6.95	5814 3.25
DL139 2.50	EF126 2.90	HL13DD 3.00	PC97 1.10	RG3-250A 8.50	X41 4.50	4CX125C	6CS7 0.95	10D7 2.00	42 6.95	5814 3.25
DL140 2.50	EF128 2.90	HL13DD 3.00	PC97 1.10	RG3-250A 8.50	X41 4.50	4CX125C	6CS7 0.95	10D7 2.00	42 6.95	5814 3.25
DL141 2.50	EF130 2.90	HL13DD 3.00	PC97 1.10	RG3-250A 8.50	X41 4.50	4CX125C	6CS7 0.95	10D7 2.00	42 6.95	5814 3.25
DL142 2.50	EF132 2.90	HL13DD 3.00	PC97 1.10	RG3-250A 8.50	X41 4.50	4CX125C	6CS7 0.95	10D7 2.00	42 6.95	5814 3.25
DL143 2.50	EF134 2.90	HL13DD 3.00	PC97 1.10	RG3-250A 8.50	X41 4.50	4CX125C	6CS7 0.95	10D7 2.00	42 6.95	5814 3.25
DL144 2.50	EF136 2.90	HL13DD 3.00	PC97 1.10	RG3-250A 8.50	X41 4.50	4CX125C	6CS7 0.95	10D7 2.00	42 6.95	5814 3.25
DL145 2.50	EF138 2.90	HL13DD 3.00	PC97 1.10	RG3-250A 8.50	X41 4.50	4CX125C	6CS7 0.95	10D7 2.00	42 6.95	5814 3.25
DL146 2.50	EF140 2.90	HL13DD 3.00	PC97 1.10	RG3-250A 8.50	X41 4.50	4CX125C	6CS7 0.95	10D7 2.00	42 6.95	5814 3.25
DL147 2.50	EF142 2.90	HL13DD 3.00	PC97 1.10	RG3-250A 8.50	X41 4.50	4CX125C	6CS7 0.95	10D7 2.00	42 6.95	5814 3.25
DL148 2.50	EF144 2.90	HL13DD 3.00	PC97 1.10	RG3-250A 8.50	X41 4.50	4CX125C	6CS7 0.95	10D7 2.00	42 6.95	5814 3.25
DL149 2.50	EF146 2.90	HL13DD 3.00	PC97 1.10	RG3-250A 8.50	X41 4.50	4CX125C	6CS7 0.95	10D7 2.00	42 6.95	5814 3.25
DL150 2.50	EF148 2.90	HL13DD 3.00	PC97 1.10	RG3-250A 8.50	X41 4.50	4CX125C	6CS7 0.95	10D7 2.00	42 6.95	5814 3.25
DL151 2.50	EF150 2.90	HL13DD 3.00	PC97 1.10	RG3-250A 8.50	X41 4.50	4CX125C	6CS7 0.95	10D7 2.00	42 6.95	5814 3.25
DL152 2.50	EF152 2.90	HL13DD 3.00	PC97 1.10	RG3-250A 8.50	X41 4.50	4CX125C	6CS7 0.95	10D7 2.00	42 6.95	5814 3.25
DL153 2.50	EF154 2.90	HL13DD 3.00	PC97 1.10	RG3-250A 8.50	X41 4.50	4CX125C	6CS7 0.95	10D7 2.00	42 6.95	5814 3.25
DL154 2.50	EF156 2.90	HL13DD 3.00	PC97 1.10	RG3-250A 8.50	X41 4.50	4CX125C	6CS7 0.95	10D7 2.00	42 6.95	5814 3.25
DL155 2.50	EF158 2.90	HL13DD 3.00	PC97 1.10	RG3-250A 8.50	X41 4.50	4CX125C	6CS7 0.95	10D7 2.00	42 6.95	5814 3.25
DL156 2.50	EF160 2.90	HL13DD 3.00	PC97 1.10	RG3-250A 8.50	X41 4.50	4CX125C	6CS7 0.95	10D7 2.00	42 6.95	5814 3.25
DL157 2.50	EF162 2.90	HL13DD 3.00	PC97 1.10	RG3-250A 8.50	X41 4.50	4CX125C	6CS7 0.95	10D7 2.00	42 6.95	5814 3.25
DL158 2.50	EF164 2.90	HL13DD 3.00	PC97 1.10	RG3-250A 8.50	X41 4.50	4CX125C	6CS7 0.95	10D7 2.00	42 6.95	5814 3.25
DL159 2.50	EF166 2.90	HL13DD 3.00	PC97 1.10	RG3-250A 8.50	X41 4.50	4CX125C	6CS7 0.95	10D7 2.00	42 6.95	5814 3.25
DL160 2.50	EF168 2.90	HL13DD 3.00	PC97 1.10	RG3-250A 8.50	X41 4.50	4CX125C	6CS7 0.95	10D7 2.00	42 6.95	5814 3.25
DL161 2.50	EF170 2.90	HL13DD 3.00	PC97 1.10	RG3-250A 8.50	X41 4.50	4CX125C	6CS7 0.95	10D7 2.00	42 6.95	5814 3.25
DL162										

Christmas Gift Guide

With Christmas only a few weeks away, many of us are posed with the inevitable problem of what to buy our loved ones that will light up their faces on the actual day. Generally, children and the fairer sex are easy to please, and will often point their spouses, etc in the direction of what they think they'd like. Unfortunately for them however, the male of the species is not so forthcoming and will often offer such useful advice as 'a surprise would be nice'! What makes it even worse, is that when they are presented with the purple and lime green tie that was chosen because it matches their eyes so beautifully, feelings are hurt when the expected smile is produced in the guise of an exasperated, and disdainful nod.

This year, however, we hope to prevent a few of those not so memorable moments on Christmas morning by

compiling a Gift Guide that can be left open on an appropriate page, where, hopefully, the right person will see it and be inspired by an idea for 'The Perfect Present' for their resident radio amateur.

Because generosity is always limited by funds, we have selected a number of different items that hopefully will include something that everyone can afford, and have categorised them by price. Of course, there is always someone who has decided that this is the time of the year that they should treat themselves and their shack to a real goodie, so we have also included some items that would really be beyond the reach of most Christmas present sized pockets, but probably be within the 'small self indulgence' bracket.

Under £10

In the amateur radio field, as in everything else these days, £10 doesn't buy a lot, but there are still some useful and attractive items that can make ideal gifts; a few of which are mentioned below.

Books are always a good idea for Christmas, as not only do they retail at prices that don't usually require a second mortgage, but they also give the recipient something to do while the rest of the family is watching *The Wizard of Oz* on television (again) on Christmas afternoon.

A new title on the market within a range of pocket books published in the Heinemann Newnes Technical Book range, is the *Radio Amateur and Listener's Pocket Book*. This hardback, informative publication covers telephony, telegraphy, RTTY, SSTV, satellite

communications and weather FAX, as well as a breakdown of the sort of equipment available on the market to receive all that the book covers. Available from William Heinemann Ltd, 10 Upper Grosvenor Street, London W1X 9PA, the book costs £8.95 plus P&P.

For those amateurs who are struggling to grasp the intricacies of the Morse code, *The Secret of Learning Morse Code* may be just the thing. Written from first-hand experience by M Francis, the book provides hope for class A aspirants who previously believed that Morse was beyond them. Numerous exercises and sample tests are provided and some of the myths surrounding the code are exploded. The author's tips on easy ways to learn really do help the uninitiated. Available from SPA Publishing Ltd, 18-20 Main Road, Hockley, Essex, the book costs £4.95 plus P&P.

Another relatively inexpensive idea for the amateur who's keen on home construction, is a new idea from The Electronic and Computer Workshop Ltd, Unit 1, Cromwell Centre, Stepfield, Witham, Essex CM8 3TH. The product is called Drillboy, and it enables even the constructor with a hangover to drill holes that are perfectly perpendicular and in-line. It attaches to almost any popular electric drill and ensures that the drill is kept at

90° to the work. It is a spring-loaded guide that grips firmly onto most surfaces – flat, curved and angled to give secure and accurate drilling. The all-in mail order price direct from ECW is £8.85.

Another small idea for the amateur who is tired of plugging and unplugging two different aerials to get the best reception, may also be interested in the TC2 – a 2 way antenna switch from Telecomms. The specifications are: power – 200W; frequency – 0-50MHz; impedance – 50 ohms; insertion loss – less than 0.3dB; and VSWR – less than 1.2:1. The high quality, double screened, low loss switch has holes provided for mounting purposes and costs £7.94 from Telecomms Ltd, 189 London Road, North End, Portsmouth, Hants PO2 9AE.

Under £25

With £25 at our disposal, a lot more avenues are open to us. If you're into using computers in the shack, G1FTU of Pearsons Computing produces a number of programs for the Spectrum that work without any special interfaces between the computer and the radio – which keeps the costs and clutter levels low. All the programs offer full Tx/Rx capabilities and feature a special 'receive only' mode for the listener.

G1FTU RTTY is the classic



RTTY program in regular use in over 30 countries. It can handle both amateur and commercial RTTY signals on HF and VHF, and an optional add-on filter is available as an extra for DX work. The program costs £10 on cassette and £12 on microdrive or Opus disk.

G1FTU CW is a full feature program for both the learner and advanced Morse code operator. There is even a built-in iambic keyer and the receive capability of up to 100 words per minute gives access to all those interesting stations on the bands. The program contains too many features to list here, but costs £10 on cassette or £12 on microdrive or Opus disk.

G1FTU SSTV is the latest slow scan television program available, and can be used to good effect on both HF and VHF. The multitude of receive and transmit capabilities of this program make it invaluable to every Spectrum user. The program comes complete with a free cassette containing 20 minutes of good quality SSTV recordings off-air, and costs £12 on cassette or £14 on microdrive or Opus disk.

Orders for any of the programs are processed by return of post, and the callsign of the recipient should be stated where applicable. The prices quoted above include postage and packing, and further information is available by telephoning (0246) 810652. Please send your orders to Pearsons Computing, 42 Chesterfield Road,

Barlborough, Chesterfield, Derbyshire S43 4TT.

A more sophisticated version of the same idea from Telecomms in the 'Under £20' bracket, is an antenna switch from Western Electronics. The ASW-1 uses a ceramic wafer switch and allows one single RF output from the transmitter to select any one of five antennas. The four antennas not in use are automatically earthed. The switch costs £20.70, and is available from Western Electronics, Fairfield Estate, Louth, Lincs LN11 0JH, and also from Amcomm Ltd in London and Jaycee Electronics Ltd in Fife, Scotland.

Other ideas in this price range all seem to collect in the aerial side of things, and include a KW Communications Balun (DBA1 1:1, £16.10) or a pair of KW Traps at the same price. Further information on their range, which is very extensive, can be obtained from KW Communications Ltd, Vanguard Works, Jenkins Dale, Chatham, Kent ME4 5RT. Tel: (0634) 815173.

Under £50

When you're spending this sort of money on a gift, it's as well to be sure that it is something that is really useful and won't end up in the one thing that every amateur has - a junk box. Something that will definitely appeal to anyone trying to get in on the 6m band, is the TC50DX, manufactured by Telecomms. The linear amplifier was designed with the owners of FT890s and the like in mind, and will boost the output of these radios by 8dB.

Because most linear amplifiers radiate high levels of 2nd and 3rd harmonics, which cause interference to other radio services, the TC50DX has a built-in harmonic filter which

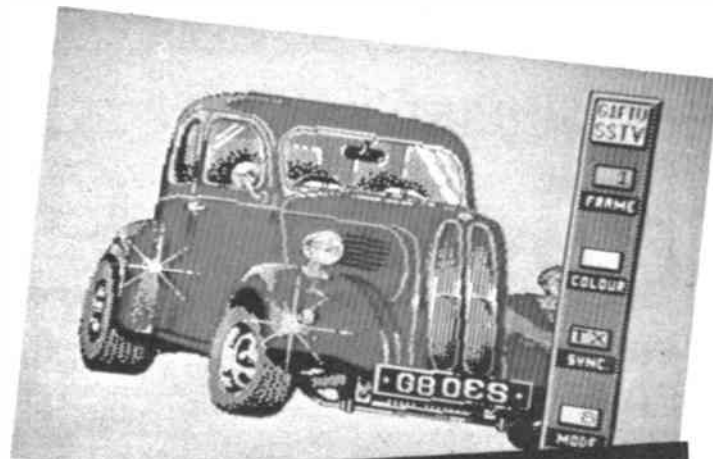

suppresses 2nd and 3rd harmonic radiation by up to 50dB. It has an integral on/off switch together with RF relay switching, but the unit may also be remotely dc switched. The technical specifications are: frequency range - 50-52MHz; power supply

rotation time - 50/60Hz 65 seconds; rotation torque - 220kg/cm minimum; mast size - 28-44mm diameter; vertical load - 45kg; and cable - 3 core. The antenna rotator costs £39.95 and a support bearing for heavy load applications is available at a cost of £13.95.

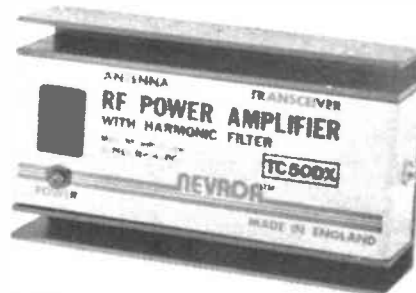
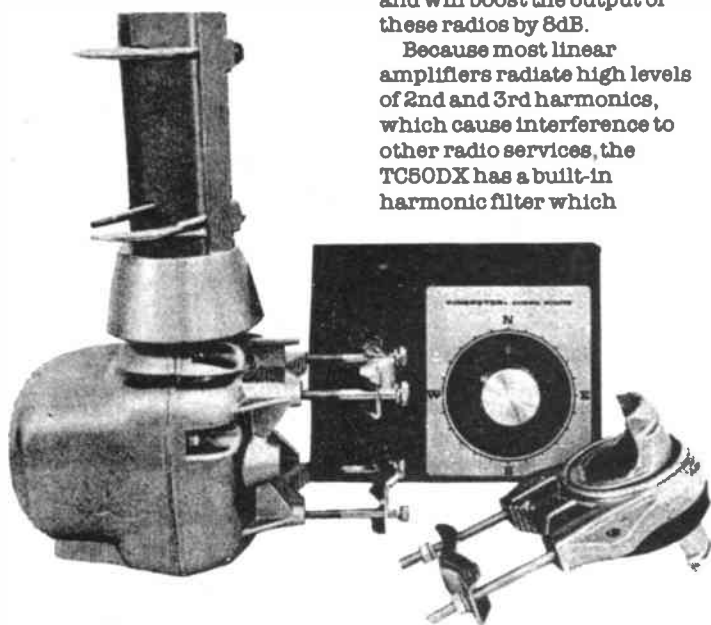

- 12-15Vdc; input power - 0-3W; output power - 15W; power gain - 8dB; and modes - 88B, FM and CW. The unit costs £29.95 and is available from Telecomms Ltd at the address previously listed.

Aerial Techniques can be reached at 11 Kent Road, Parkstone, Poole, Dorset BH12 2EH, or on (0202) 738232.

From Aerial Techniques you can purchase an automatic antenna rotator, which is ideal for anyone who is tired of rushing out into the garden in the pouring rain to turn the antenna into the path of that elusive DX. The technical specifications are: input voltage - 240Vac, 40VA maximum; rotation - 360° + 5° - 0° with mechanical stop;

Under £100

In the 'just above £50' bracket, but under £100 there is the Daiwa range of in-line power meters. Priced from £61.72, the meters read true in-line power regardless of their position in the feeder line. They all employ the Daiwa cross-needle movement, which is such a help in understanding the

Christmas Gift Guide

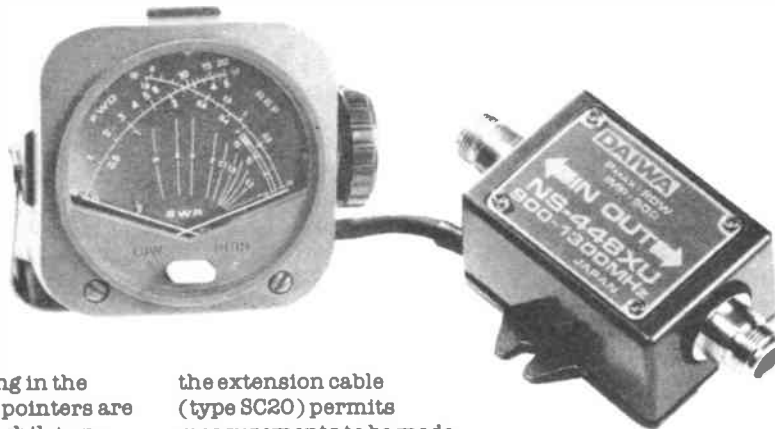

conditions existing in the feeder. The meter pointers are arranged so that whilst one pointer shows forward in the line, the other shows reflected power from the load. A series of scales on the meter face also shows the SWR on the line, indicated by the crossing point of the meters. Consequently, measurement of the three most important parameters of the transmission line system and the transmitter/aerial system can be measured simultaneously.

The CN410M and the CN460M meters are designed for mobile or base station use, and their specifications are respectively: frequency range – 3.5 to 150MHz/140 to 450MHz; forward power – 15/150W (both); and reflected power – 5/50W (both). The NS448 is a special version of the CN series, and covers the frequency range 900 to 1300MHz. It uses a remote power sensor head, with N type connectors, which with

the extension cable (type SC20) permits measurements to be made close to the aerial system whilst the meter is at ground level.

Priced at £61.72 for the CN410M, £65.40 for the CN460M, and £86.60 for the NS448, the meters are available from Lowe Electronics Ltd, Chesterfield Road, Matlock, Derbyshire DE4 5LE. Tel: (0629) 580800.

For the DX-TV enthusiast, or the amateur who's interested in monitoring sporadic E levels, Aerial Techniques retail the Yoko monitor-look portable 5in black and white TV. This small set covers Bands I, III and UHF signals, and B/G/I/L systems for use in the UK, France and Europe. The set works from the mains, 12Vdc or dry batteries and costs £95.00 plus £4.95 carriage and insurance, and is available from Aerial Techniques at the address



mentioned previously.

Western Electronics have another idea on the measurement theme, with their PM2000A SSB power

RMS and PEP, forward and reflected; power ranges – 200, 1000 and 2000W; impedance – 50 ohms; accuracy – 7%; and power requirement – 230Vac (for PEP measurement only). The meter costs £86.82 and is available from Western Electronics at the address previously mentioned.

Over £100

Now we're really talking. If you have a Yaesu FRG9600, R Withers Communications can improve its performance no end with their ingenious modifications. They have now introduced a further improvement to the model with a new high dynamic range active-mixer, which provides up to 6dB further gain than their previous Mk3



meter. The meter was designed to provide accurate indications of power between 3.5 and 30MHz, when using either AM or SSB. It is the latter application which will be of most interest to radio amateurs, which is achievable because the conventional through-line wattmeter configuration is supplemented by a peak reading voltmeter. When compared to a known accurate instrument at frequencies of 3.5 and 30MHz, and with CW power levels of 20W and 200W, the PM2000A indications were within 5% of the standard. Because of this result, when a sample meter was submitted to the Home Office some years ago, their view was that it was most suitable for amateur use.

The meter's technical specifications are: measurement modes – power-

modified version. Also featured in the new converter, is a multi-pole elliptical filter for better attenuation of unwanted signals, and also a new oscillator circuit for increased reliability and frequency accuracy.

Owners of unmodified FRG9600s can have the Mk5 HF 100kHz-80MHz modification and the Mk2 905-950MHz expansion fitted at a cost of £149.40, including return insured carriage – which will practically give you a new rig for the new year. Owners of rigs incorporating the Mk3 modification, can have the Mk5 unit fitted at a cost of £39.50, including return insured carriage. For further details of the modifications, contact R Withers Communications Ltd, 584 Hagley Road, West Oldbury, West Midlands B68 OBS. Tel: (021) 4218201.

Christmas Gift Guide



If your idea of a Christmas bonus is being able to listen to the Oscar satellites, then what you need is the ASTRID – a satellite monitoring service. ASTRID captures all the latest satellite news and data from Oscar 9 and Oscar 11 automatically, using its own dedicated, low noise receiver, aerial system and power supply. No longer do you have to compute 'pass' times and aerial azimuth/elevation settings to continuously 'track' each satellite pass, whilst simultaneously correcting for Doppler shift. Nor do you have to fiddle about with record and play back levels on tape recorders, or compensate for audio phase reversals, or generally disrupt the entire 2m station. No longer do you have to miss out on all the excitement because you can't be in the shack at all times of the day and night. ASTRID will overcome all these problems, enabling you

to become one of the few who can actually monitor both spacecraft continuously. And all for just £179 with no added extras.

For further details or more information, contact SRW Communications Ltd, ASTRID House, The Green, Swinton, Halton, North Yorkshire YO17 0SN. Tel: (0653) 697513.

Another idea for the 6m band enthusiast, is the 2m/6m linear transverter from R N Electronics. This highly professional piece of equipment, with 25W output, will operate with any popular 2m transceiver, bringing contacts in from the States during sporadic E conditions, and potentially Africa and Australia in the forthcoming sunspot activity. Be on this band for the first 1988 opening – and it will only cost you £172.00 plus £4.00 P&P. Contact R N Electronics, 37

Long Ridings Avenue,
Hutton,

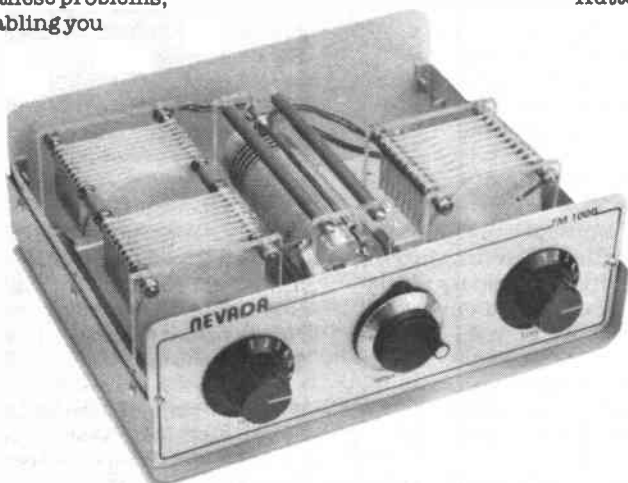

Brentwood, Essex CM13 1EE.
Tel: (0277) 214406.

A piece of equipment that would complement just about any shack, is the TM1000 high power ATU from Telecomms. The Nevada TM1000 is a broadband antenna tuning unit capable of handling up to 1000W of RF power. Using the ultimate transmatch design, it is possible to match a wide range of antenna impedances at a maximum efficiency on any frequency between 1.8 and 30MHz. The capacitors and roller coaster inductor have been constructed to the highest standards to ensure negligible stray reactance at high frequencies, and ensure years of trouble free use.

The technical specifications of the TM1000 are: frequency coverage – 1.8 to 30MHz, continuously variable; input impedance – 50 ohms; load impedance – 50-500 ohms, 50 ohm co-ax with VSWR of 10:1 or less; power handling – 500W average continuous duty, 1000W PEP; insertion loss – better than 0.5dB after tuning. Retailing at £139.00, the TM1000 is available from Telecomms at the address previously listed.

To make the listener's Christmas, you could always think about one of the Realistic receivers included in the Tandy Catalogue. The Realistic World Receiver retails at £149.95 and features FM stereo, full AM coverage from 150 to 2999kHz, including LW, MW and SW. It has auto and manual scanning modes, an LCD clock with timer and sleep modes, 24 hour time setting for SW listening convenience, power, stereo and signal strength LED indicators, and built-in speaker, telescopic aerial and selector switch sockets for adding stereo headphones and an external aerial.

The Realistic Pro-38 hand-held scanner retails at £129.95, and covers the 2m and 70cm bands in addition to the VHF and marine frequencies. This microprocessor controlled scanner has direct keyboard frequency entry and it is compact enough to go everywhere with you. For further information on both of the scanners, contact Selectronic, 203 High Street,

Canvey Island, Essex SS8 7RN.
Tel: (0268) 691481.

Another scanner which could light up someone's face on Christmas morning, is the Uniden Bearcat 100XL. This hand-held scanner has sixteen channels covering nine bands, including the aircraft band. Your priority frequency is checked automatically every 2 seconds, and the keyboard can be locked to prevent accidental programming. The LCD display is also lighted for better night viewing. Automatic search, automatic squelch and scan delay all help to make this small unit (1 3/8 x 7 1/2 x 2 7/8 in) a pleasure to use. Priced at £199.99, the 100XL is available from Telecomms at the address aforementioned.



Christmas Gift Guide

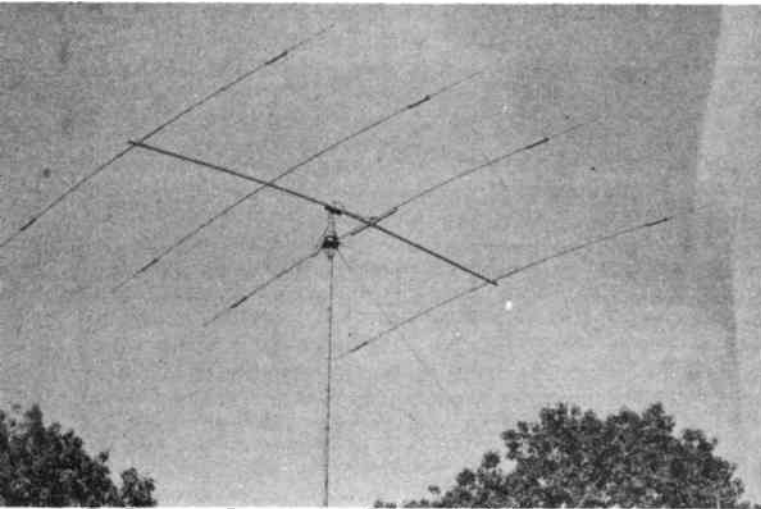

The Penetrator DX-34 in situ in Bahrain at A9BXD

Finally, if you really feel like splashing out on a quality antenna, Western Electronics' DX Penetrator range of

antennas will probably include something to tempt you. The range has been recently extended with the

addition of the DX-40K 40m dipole conversion kit, which can be attached to the driven element of all Western's DX-31 to DX-34 range of HF beams for 10, 15 and 20m, and the DX-51 which is a rotary dipole covering the 28, 24, 21, 18 and 14MHz bands. The power rating of all Western antennas is 2kW, and they have never had a trap failure. In fact owners of their antennas who suffered the recent storms in the Southeast were pleased to see their antennas standing fast, while others were miserably watching their aerial systems fall to the ground.

Anyone requiring further information on Western's range, which retails between £103.50 and £366.50, should write to Western Electronics, Fairfield Estate, Louth, Lincs

LN11 OJH, enclosing two first class stamps, and they will send you the latest details of their range and a current price list.

Get into the spirit . . .

Whatever you receive for Christmas, or decide to indulge in, even if it's the purple and lime green tie, we hope that you'll enter into the spirit of things and try to manage a little more than the perfunctory nod when you receive your gifts - after all, someone cared enough to make the effort to buy it for you. However, if you want to be sure of getting the very thing that will make your station the envy of the district, make the appropriate noises and you never know, you might get listened to - this time! Have a lovely Christmas.

Christmas Competition

Christmas Competition

Last month we reviewed some Morse keys that had been brought onto the market by Gordon Crowhurst G4ZPY. The range includes a single paddle key, a twin paddle key and a straight key which retail at £40, £45 and £25 respectively.

The keys are beautifully fashioned in highly polished brass, with Lakeland slate bases and are a tribute to that fine

tradition of British precision engineering.

The fact that G4ZPY originally manufactured them for his own use and for a few close friends only, but was forced into commercial production because of the demand speaks for itself. In fact, any amateur would be proud to be able to place one of them in his shack.

Consequently, we are more than pleased to be able to offer the top of the range key, the twin paddle version, as a prize in our Christmas Bonus Competition.

All you have to do is answer the four questions below on the history of Morse, and tell us in not more than 10 words why you would like to see a G4ZPY key in your

CHRISTMAS BONUS COMPETITION

1. What does the 'FB' in Samuel FB Morse stand for ?
.....
2. What was Samuel Morse's actual profession ?
.....
3. In what year was the International Code established ?
.....
4. Which special event station in America annually commemorates Morse's achievements ?
.....

I would like to see a G4ZPY key in my Xmas stocking because (not more than 10 words)
.....
.....

Send your entry to Christmas Bonus Competition, Amateur Radio Magazine, Sovereign House, Brentwood, Essex CM14 4SE (To reach us by the 31st December 1987). The Editor's decision is final and no correspondence will be entered into after the publication of the result.

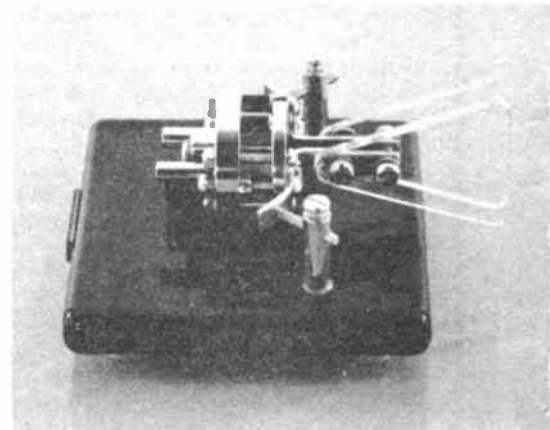

christmas stocking, and the prize could be yours. Don't delay, send your entry in before 31st December and keep your fingers crossed (not while you're keying of course!). The lucky winner will be able to click the new year off in style!

For those of you who don't like to leave things to chance, orders can be made for any of the G4ZPY keys by writing to Gordon Crowhurst, 41 Mill Dann Lane, Burscough, Ormskirk, Lancs L40 7TG or telephoning on (0704) 894299.

CLUB NEWS

Gone with the wind

Chelmsford Amateur Radio Society nearly missed their chance to broadcast the club events for the month – the recent hurricane force winds not only deprived the club president and his wife (Roy G3PMX and Ela G6WKM) of their mast and various antennas, but also cut them off from their electricity for six whole days.

Nevertheless, power restored, they finished the club newsletter in record time, and in time to tell us about the talk on Packet Radio which is scheduled for December 1st.

The club's Christmas social is due to be held on December 5th, and members will probably still be celebrating the bargains they picked up in last month's junk sale – even your intrepid reporter left clutching a modest memento of the occasion.

The club meets on the first Tuesday of the month at the Marconi College in Arbour Lane, Chelmsford, and anyone wanting to find out more should contact Roy or Ela on (0245) 360545.

DTI in the 21st . . .

The DTI Radiocommunications Division have just produced their second annual report, covering the year's happenings across the spectrum, not forgetting to mention amateurs – specifically, the new prize for youth achievement in amateur radio.

The coming year is also mentioned – a major piece of work planned is the revision of the amateur licence – the DTI say they are looking for a licence to take the hobby into the 21st century . . . look out, Buck Rogers!

Where is MARS?

The Midlands Amateur Radio Society are holding their Christmas party on December 8th, by which time, hopefully, it will have a new HQ. There is something slightly sinister about the way in which successive HQs have been demolished – the club

strenuously denies any blame . . . not even for the over-enthusiastic thumping of Morse keys.

Since the HQ may well be rubble by the time we publish this, we are at a loss to know where prospective members should go to make contact. Doubtless MARS will let us know its new address when it has one.

However, anyone who wishes to find out more for themselves is invited to contact Tony Rich G1XOK, of 9 Hartford Close, B17 8AU.

Morse and mince pies

The Stourbridge Amateur Radio Society are holding a night on the air on December 7th. This coincides with the date of the Christmas Dinner at the Cottage Inn, Kingswinford. Perhaps they will be practising Morse with mince pies?

The club's main meeting is on December 21st, though it's obviously secret as they gave no further information. Incidentally, we filled out the form for the Christmas dinner – although turkey probably doesn't travel well through the post.

STARS meet at G4CVK's shack, unless otherwise indicated in the club's newsletter, and those wanting to find out where this is should contact Eileen G4YBT on Brierley Hill 70097.

Southgate AGM

Southgate Amateur Radio Club must be comprised of hardy souls, as it is holding its AGM on December 10th – an interesting break from the fast and furious pace of the run-up to Christmas!

The second meeting in the month would fall on Christmas Eve, so it has been cancelled.

The club normally meets at 7.45pm at Holy Trinity Church Hall (upper), Green Lanes, Winchmore Hill, London N21. For more information please contact D C Elson G4YLL, the club's publicity officer, on (0992) 30051.

Junk sale

If you are looking for a late Christmas present for a friend in the hobby, then perhaps Edgware and District Radio Society's junk sale on December 10th could provide the answer. Who knows what hidden treasures might appear for sale?

The club meets on the

second and fourth Thursdays of each month at 8pm in the Watling Community Centre, 145 Orange Hill Road, Burnt Oak, Edgware. The club net is at 8pm on 1978MHz every Monday.

For further information please contact the hon secretary Ian G4IUZ on Hatfield 65707.

BARS talks

Banbury Amateur Radio Society have two meetings this month – the first being a talk on December 2nd by Neill Taylor G4HLX, the regional representative of Region 6. The talk will be in two parts, the first being on satellite communication and the second, a half hour of questions and answers on the RSGB at the present time.

Another talk is scheduled for December 16th, by Roger Gregory G4OCO on Packet Radio. There will be no meeting on December 30th.

The society now meets at two week intervals at 'The Mill', Spice Ball Park, Banbury, on Wednesday from 7.30pm onwards. All amateurs and SWLs are welcome, and further information can be obtained from Bryan G1IIO QTHR or on Banbury 51774.

Verulam rally

Verulam ARC are changing their habits for December – they are meeting on the second and third Tuesdays of the month instead of the second and fourth.

On December 8th the club is holding an activity evening, and on December 15th the AGM will be held at 7.30pm; visitors are welcome at all club meetings.

The club's third annual Christmas Rally will be held in the City Hall, St Albans on Sunday 6th, from 11am to 5.30pm, the admission price will be £1. Routes to the City Hall will be signposted, and there will be a talk-in on 70cm and 2m. Attractions will include trade stands, club stands, 'bring and buy', catering and a licensed bar.

For further information please contact Hilary G4JKS on St Albans 59318.

Film fun

Mid Lanark Amateur Radio Society will be holding its regular Christmas Film Show on December 18th, by courtesy of Gordon Hunter. No, we don't know what the film is: Snow White and the Seven

Receivers, possibly, or Alad-DX?

To find out more, contact the club secretary, David GM1SSA on Holytown 732403. The club normally meets at Wrangholm Hall Community Centre, Jerviston Street, New Stevenson, Motherwell ML1 4UQ.

Hic!

Felixstowe and District Amateur Radio Society are having Christmas drinks at the Grosvenor Hotel, Felixstowe on December 14th, but will be closed on December 28th.

All club lectures and social evenings take place at 8pm in the Scout Hut, Bath Road, Felixstowe, unless otherwise specified. Further details can be obtained from Paul Whiting G4YQC on (0473) 642595, daytime.

Food for thought

There is food for thought in Rugby Amateur Transmitting Society's programme of events for December. In fact, the annual Christmas Dinner takes place on December 15th and on the 22nd there is a Mince Pie evening. It sounds as if December is going to be a very satisfying month in Rugby.

The society meets every Tuesday at 7.30pm at the Cricket Pavilion outside Rugby Radio Station, and visitors and new members are always welcome. For more information, (or a menu?) please contact the hon secretary, Kevin G8TWH on (0788) 77986.

Calvados Nouveau

Beaujolais is not the only thing nouveau from France – we have received a letter with details of the Calvados award . . .

To qualify for this, applicants must have worked or heard ten stations located in the Calvados district on any band or mode. Special endorsements for VHF, HF, SHF, CW and RTTY etc, are available on request. Up to two missing stations may be substituted with one contact with the club station FF6KCZ (HF) or FF1KCZ (VHF).

Log details, certified by two other licensed amateurs, should be sent to the Award Manager, Pierre Roger FC1CNT, 8 Rue des Petites Haies, F 14440 Douvres la Delivrande, France. The cost, including p and p is ten IRCs.



DX DIARY

News for HF operators compiled by Don Field G3XTT

For HF DXers in the South-east, last October will linger in the memory for many years to come. I know of many DXers who suffered severe damage to, or complete loss of, their antenna systems in the hurricane force winds. I hope the readers of this column didn't suffer too badly. As it was, the long-awaited S0RASD operation from the Western Sahara appeared on the bands just a couple of days later, so it was essential to be able to put out at least some sort of signal on the bands.

More about S0RASD in a moment. In addition to that operation there was quite a lot else of interest on the bands during October. At the end of the month Walter DJ6QT appeared as S79WS from the Seychelles, and made his usual effort on the lower bands. He was due to be there until after the November CQWW CW Contest. Peter OH1RY showed up on the low bands from various Pacific stops as promised, despite some forced changes to his itinerary due to the political upheavals in Fiji.

The second operation of the year from the Andaman Islands, using the callsign VU4GDG, also took place during October and was a great success; UK stations worked them on at least five bands. Ten metres was probably the star band during October, and produced a lot of Asian and North American DX before and during the CQWW SSB Contest. Surely this gives yet more support to the view that the new sunspot cycle is on the way?

SORASD

The operation by EA2JG, OH2BH and EA2ANC is reported to have netted about 12,000 contacts in total, and some UK stations were able to work them on all six main HF bands. This was achieved with a TS440 running bare-foot. Operation was not continuous as the group had training commitments, sporadic power, and a sandstorm to contend with on the final Saturday. Congratulations are due to the Lynx DX Group on a fine effort under difficult circumstances. Readers will be interested to know that, thanks to a generous donation by the Kenwood Corporation, the group were able to leave behind three sets of HF gear in Western Sahara, and a local operator, Naama, was hoping to be active as S01A. Naama is, in fact, the Director of Communications for Western Sahara.

Of course, it still remains to be seen whether the ARRL will accept Western Sahara as a new DXCC country. Three options appear to be open. One is to create a new country, another is to resurrect Rio de Oro, which was deleted from the DXCC list in 1976, and the third is to do nothing; in which case the S0 operation will probably not count for anywhere at all.

There is some case for taking the second option. Apparently Spain agreed to cede Western Sahara to Morocco provided the inhabitants voted in favour of such a move. In practice no such vote ever took place. If you worked S0RASD and want a direct QSL, the address to

write to is Arseli Echeguren Bardeci EA2JG, Las Vegas 69, Luyando, Alava, Spain.

Finally on this one, you may have been intrigued by the S0 prefix being used by the DXpedition. This prefix is unallocated by the ITU and has previously been used from Sealand, one of the old fortifications in the North Sea outside UK territorial waters. According to normal ITU rules, the expedition from Western Sahara should, rather than selecting an unused prefix at random, have operated with their own callsigns /A, announcing the actual location from time to time. This is the normal practice, for example, from Abu Ail which has no official ITU prefix allocation.

Telecom 87

My one and only contact with the S0 took place just a couple of minutes before I had to leave home to head for Geneva and Telecom 87, the quadrennial (once every four years!) telecommunications extravaganza organised by the ITU. Although I was there on business, I did have the opportunity to meet a number of amateurs and to visit the Geneva club station, HB9G. I was particularly interested to see an HF amateur station, HB9/UK3F, being operated from the Russian stand. The equipment, although not very elegant to look at, was obviously of modern design with LCD frequency readout and with the inclusion of the 10MHz band.

I also had a second chance at Geneva to hear LA1EE's lecture about the Peter 1st

Island operation. Einar told me that they are currently putting an English commentary on to the Peter 1st videotape, so if you missed his lecture in England earlier this year, there may yet be the opportunity to see the video.

Thanks to Claude-HB9RX, I also have details of the Geneva Diploma. This attractive award is available for working (in the case of UK stations) six stations located in the Canton of Geneva. This includes the ITU station 4U1ITU. Special prefixes do not count, so HB7G and HB9G, for example, would count only once. Applications should consist of log extract and 7 IRCs, and should go to HB9RX, Claude Duret, Gros-Chene 46, 1213 ONEX, Geneva, Switzerland.

DX news

Plenty of odds and ends, though no major DXpeditions are scheduled for December. A61AB is reported to have a 5 element monobander for 20 metres at 75ft, so he should be a pretty potent signal from the Emirates. K8MN should also be active with a big antenna system from sometime in December, in his case from Guineau-Bissau with a J5 callsign. PY7ZZ was due to be operational as PY7ZZ/0 from Fernando de Noronha until last December, so if you were prompt in getting your copy of this mag there may still be time to catch him.

Leif SM0AJU was due to return to Tanzania to operate yet again as 5H3BH during the CQWW CW contest and through until 7th December. Apparently he will be pleased

to make skeds for the LF bands, though not during the contest itself. PA0CRA is due to operate from various spots in the Caribbean from about mid-December. PA3AXU/SU has been particularly active on all bands and will take skeds for the LF and WARC bands at 1500GMT on Saturdays around 14100kHz. He is in Egypt until August 1988. 9Q5DA told me recently that he hopes to be operational on 80 and 160m during the winter period.

WA2HZR should be signing 9M6ZR from Sabah until 8th December, CW only. Check the low bands at our dusk (1555GMT) and his dawn (2210GMT).

As I mentioned last month, Don GM4DGS is now resident in Sabah and runs an FT757 to a vertical. He looks for the UK on 14165kHz from 1500GMT on weekdays. His address is PO Box 14277, Kota Kinabalu, Sabah, East Malaysia, so it might be worth dropping him a line if you would like a sked.

7P8CB is reported active most days from about 1600GMT. He has been worked around 21220kHz, but I have noted many stations from 7P, 3D6, A2, etc moving up to ten metres recently with the improved conditions, so don't forget to check the higher band.

VK9ZG on Willis Island has been worked around 14230kHz during the afternoon, and is there until about next March. JA3FKP was due to arrive in Vanuatu (YJ) in November for a 2 or 3 year tour of duty. This operator has been active previously from various African countries, though I seem to remember that he spends much of his operating time working back into Japan.

Cocos-Keeling Island (VK9Y) seems to be getting as busy as Picadilly Circus these days (well, almost!). Ron ZL1AMO showed up from there as VK9AB back in October, and was particularly active and easy to work on 10 metres CW.

As reported last month, G3AAG and F6GVD were due to operate from the island from November 25th to December 7th. Now comes news that VE3XO will be there from 8th until 15th December, paying special attention to CW on 40 and 80m.

At the time of writing there

is some controversy over QSL cards for the recent operation by Greek amateurs from Mt Athos. Apparently SV2TX has been saying over the air that QSLs will only be sent out on receipt of \$5. This is in flagrant breach of both common courtesy and, indeed, DXCC rules. Let's hope it gets sorted out quickly. This attitude contrasts dramatically with recent reports that stations QSLing direct to T5GG have received a very fast reply and have also had their IRCs returned!

Prefixes

The Belgian authorities are now issuing ON9 callsigns to visiting amateurs. Some special prefixes will be on from Syria during December to celebrate 40 years of amateur radio by Rasheed YK1AA, who was first licensed in 1946 and has done much to promote amateur radio in Syria over the years. From December 25th to 31st, Rasheed himself will operate as 6C40TIR, Omar (YK1AO, who replaces Rasheed as President of the Technical Institute of Radio) will operate as 6C40O, Michel (YK1AN) as 6C40M, and Hikmat (YK1AM) as 6C40RJ. The new TIR HQ and QSL address will be PO Box 245, Damascus, Syria.

Bordering on insanity

SI8MI is the callsign which has been issued for use from the Swedish half of Market Reef. At one time the border ran as a straight line through the middle of the island, until someone spotted that the lighthouse, which belonged to Finland, had actually been built on the Swedish half of the island! As a result, in 1985 the border was changed to a zig-zag line which brings the lighthouse back into Finland.

Arguably, any earlier amateur activities from Market Reef were actually made from Swedish Territory and should not have counted for DXCC. The only reason the Finnish half of Market Reef counts separately from Finland is that, between it and Finland, lies a further DXCC country, the Aland Islands which, somewhat like the Channel Islands, have their own legislature. Whether SI8MI will get much of an airing remains to be seen. What is now the Swedish half of Market Reef consists of nothing but bare rock.

Contests

December is fairly quiet, and I mentioned the main contests last month. One addition is the ARRL 160 metre CW Contest from 4-6th December. Work only US and Canadian stations in this one, which can be frustrating when you hear rare DX and you are not allowed to work it!

Let me also give you advance warning of the CQWW 160 metre Contests in January and February. As with all *CQ Magazine* contests, these take place over the last full weekend of the month, so that the CW leg is on 29-31st January and the SSB leg on 26-28th February. Both contests run from 2200GMT on the Friday until 1600GMT on the Sunday, and the contest exchange is RS(T) plus country, state or province as appropriate.

I have to say I don't enjoy these contests as much as I used to, because there has been a massive increase in Top Band activity, and hence QRM, in recent years. This is particularly so as many European countries now allow high power levels in the exclusive part of Top Band (1830-1850kHz). In addition, split-frequency operation for DX working used to be the norm, with 1825-1830kHz reserved for European operators, and the DX stations operating at the bottom end of the band. This made it much easier to hear the DX, but is a method of operation which has largely fallen out of favour, perhaps out of ignorance on the part of the newcomers to the band.

Zones 23 and 24

CQ Magazine has recently more fully defined the boundaries of zones 23 and 24, taking account of the upsurge in amateur radio activity from China. This should avoid any confusion about which CQ zone a Chinese station is in, both for award purposes and in the various CQ Worldwide Contests. The two zones now comprise the following:

Zone 23 (central zone of Asia): Mongolia (JT), Tanna Tuva (UA0Y), Tibet, Inner Mongolia (BY3G-L), Ningxia (BY9A-F), Tsinghai (BY9G-L), Kansu (BY9T-Z), and the whole of BY0.

Zone 24 (eastern zone of Asia): BV, XX9, VS6, BY1, BY2, Tientsin (BY3A-F), Hopeh (BY3M-S), Shanxi (BY3T-Z),

BY4, BY5, BY6, BY7, BY8, and Shanxi (BY9M-S).

No doubt the above definitions will be reflected in the *DXNS Prefix/Country/Zone List* published by Geoff Watts (62 Belmore Rd, Norwich NR7 0PU) for £1. This is still one of the most useful reference documents for the aspiring DXer.

Looking ahead

Now news of one to note for the future. Bill K4LTA and his wife Ruby will once again lead a DXpedition to the Caribbean in the early spring. This time they are headed for Grenada (J3) and will be there from February 17th to March 8th, which includes both legs of the ARRL Contest. Bill always makes a big effort on the low bands (mainly CW) on these trips. W5PWG will be with them and will concentrate on the WARC bands.

Talking about the WARC bands, Tom GW3AHN recently worked his 100th country on 24MHz, having previously managed this on both 10 and 18MHz. This means that Tom has now worked 8 band DXCC, as well as being high on the DXCC Honor Roll. I happen to know that Tom is relatively limited for antenna space, so his achievement owes much to sheer persistence and a high standard of operating. Congratulations Tom.

That's the lot for another month. Why not, during December, set some DXing targets for yourself for 1988? Make them realistic but not easy, and this way you will have the incentive needed to keep your interest in DX during the year. Perhaps you could aim to finish that 5 band DXCC, or maybe achieve DXCC on QRP CW.

And, finally, do remember to drop the right hints for Christmas presents. A subscription to the RSGB's *DX News Sheet* (and *Amateur Radio Magazine*, of course!) or a nice shiny new triband beam to hang the decorations from! A very Happy Christmas to you all.

More from
Don Field in
the New
Year

L F HANNEY

77 Lower Bristol Road, Bath, Avon
TEL: 0225 24811

Your electronic component
specialist for Avon,
Wilts & Somerset

Closed Thursdays

STATE OF THE ART SPECTRUM SOFTWARE

G1FTU SSTV TX/RX

8, 16, 24, 32, 48 and 96 second SSTV. Colour text and graphics transmit. Brightness and contrast controls. Frame stores for saving and printing. 9 text memories. Good RX performance on HF and VHF. £12 on cassette, £14 on microdrive or Opus disc.

G1FTU RTTY TX/RX

The classic RTTY program, still going strong. Split screen, type ahead operation 45-110 baud amateur and commercial reception. Reverse tones, unshift-on-space, tuning indicator, etc, etc ...

£10 on cassette, £12 on microdrive or Opus disc.

G1FTU CW TX/RX

The ultimate morse transceiver program. Split screen, type ahead, software filters, QSO review, print, re-send. Variable speed and tone. INCLUDES A BUILT-IN LAMBIC KEYS. This program has it all. £10 on cassette, £12 on microdrive or Opus disc.

STOP PRESS! Dedicated Spectrum PACKET RADIO SYSTEM coming soon! Spectrum AX25 TNC with built-in software at half normal price.

Write or phone for full details. Return of post despatch on all orders. (Please include your callsign with the order).

PEARSONS COMPUTING
42 Chesterfield Road, Barlborough
Chesterfield, Derbyshire S43 4TT
Tel: 0246 810652

BILLINGTON VALVES

VALVES, TRANSISTORS, ICs, RARITIES OUR SPECIALITY
Usually the lowest prices!

Don't miss our new valve catalogue! Send SAE today for your copy, or phone for quotation. Wholesale/export inquiries welcomed. French and German spoken by arrangement.

Amazing Bargain Packs. 20lbs (9kg) of resistors, capacitors, transistors, switches etc etc. £10 +VAT delivered!

We wish to purchase audio valves PX4, PX25, DA100, KT66, KT88 etc. Complete valve collection, shop clearance etc considered. Ideally send listing mentioning price required.

Billington Valves, 39 Highlands Rd, Horsham, W Sussex RH13 5LS
Phone 0403 864086. Telex 87271 PROD SSG

Please phone to check that office is attended before calling in person.

ELECTRONICS & COMPUTING

INDIVIDUALS You don't have to continue working on things you don't believe in, with people who'd want you locked up if they knew what you really thought ...

Promoting Equality of Opportunity. For businesses and people who want a say in how their technology is used.
EIP Ltd., 28 Milsom St., BATH BA1 1DP (0225) 69671

EXCHANGE RESOURCES

**RECRUITMENT AGENCY
& BUSINESS CONSULTANCY**

BUSINESSES How would you like to try an agency that rewards you for ethical decisions? And deal with businesses which respect your views?

BATH 0225 69671

RADIO AMATEURS EXAMINATION TO ALL RAE STUDENTS

- 1) Are you finding home study difficult?
- 2) Would you like some C&G style practice questions?
- 3) Do you need some extra questions to supplement your college or correspondence course?
- 4) Would you like a Q&A manual designed to progress with an RAE course?
- 5) Are you having difficulty recognising circuits?
- 6) Could you do with some worked through examples on the scientific calculator?

**IF THE ANSWERS TO ANY ONE OF THE ABOVE
QUESTIONS IS YES, THEN YOU MUST OBTAIN THE
NEWLY PUBLISHED THIRD EDITION
RADIO AMATEURS'
QUESTION & ANSWER
REFERENCE MANUAL THIRD EDITION
BY REG PETRI. T ENG MI.ELEC I.E. G8CCJ**

WITH ADDITIONAL SECTIONS ON CIRCUIT RECOGNITION AND USING THE SCIENTIFIC CALCULATOR CONTAINING OVER 340 PAGES, 23 SECTIONS, 20 OF WHICH CONTAIN APPROXIMATELY 1100 PROGRESSIVE MULTIPLE CHOICE QUESTIONS AND ANSWERS. THE OTHER SECTIONS INCLUDE COMPUTER PROGRAMS FOR RAE FORMULA, CIRCUIT RECOGNITION, WORKED THROUGH, EXAMPLE, ON THE SCIENTIFIC CALCULATOR AND THE C&G SYLLABUS.
ISBN 0 9509335 2 x size A5 (210 x 148mm)

Available By Return Post From:

WP PUBLICATIONS
11 WAYVILLE ROAD
DARTFORD, KENT DA1 1RL
price £6.95 & £1 p&p UK

ALSO AVAILABLE a suite of computer programmes for the Commodore 64/128 only. Contains formula for the RAE and morse tutor.
Tape £5.95 inc p&p Disc £6.95 inc p&p

RADIO AMATEUR LICENCE

Start training now - No previous knowledge required. Study for 3-6 months. Post Coupon now for free brochure - without obligation:

**Radio & Telecommunications Correspondence
School, 12 Moor View Drive, Teignmouth, Devon.**
Tel: 06267 - 79398.

(AR.12)

NAME

ADDRESS

..... POST CODE

A 'Green Fingers' approach to 2m propagation

by Ian Poole G3YWX

Have you ever wondered why some people always appear to be on the air when conditions on the band are good? Is it because they are always listening, or is it because they know something you don't?

Usually two metres is not open to DX, with stations only audible over comparatively short distances and the range achieved being very dependent on the aerial and location. At other times the band will be positively alive with stations from much further afield putting in very good signals.

Unfortunately, this only happens for very short periods of time. Nevertheless, some people seem to be much luckier than others – they seem to have a sixth sense about the conditions on two metres.

Fortunately, with a little understanding about the ways in which signals are propagated on two metres, it is possible to pick times when there are more likely to be openings. Then all that necessary is to make sure that a monitor receiver is always nearby when conditions are right for DX operation.

There are several modes of propagation on two metres. Each has its own distinctive trade marks; each is likely to occur under its own set of given conditions. In view of this, each type of propagation will be looked at in turn. With this information to hand, it may well be possible to cultivate the two metre man's equivalent to 'green fingers' for working DX.

The atmosphere

Reflection and refraction of radio signals takes place in different parts of the atmosphere depending upon the type of propagation. However, there are two main active areas – the ionosphere and the troposphere.

The ionosphere is probably the area which springs to mind first of all. It contains the familiar E and F layers which are responsible for propagation of signals over long distances in the HF bands. In the VHF bands, there are several means by which signals are propagated; amongst them are sporadic E, aurora, and meteor scatter. All of them tend to occur at about the same altitude

as the E layer and give contacts over similar distances to those obtained by single hop propagation on HF.

It is interesting to note that propagation due to effects in the ionosphere is usually very dependent on influences outside the atmosphere. For example, meteor scatter is obviously very dependent upon when the earth passes through concentrations of meteors, and aurora is dependent upon solar activity.

The other area responsible for propagation is the troposphere. This region extends from ground level up to about 10km. As one might expect, signals which are propagated by reflection and refraction in this region tend not to give contact over distances as large as those obtained from ionospheric propagation. In spite of this, contacts with countries like Italy and Spain are quite possible. As the weather is governed by conditions in the troposphere there are many links between the weather and radio conditions. Because of this it is possible to keep a good eye on the weather map to see if there is any likelihood of a lift.

Line of sight

This mode of propagation is the one which is available when the band conditions are flat. Even so, stations can be heard at distances of up to thirty or forty miles with quite modest equipment, and those with better aerials and locations can regularly make contacts over much greater distances. All of this may seem to be a little strange, because these distances are definitely not just line of sight. In fact, if the distances which were achievable were really only line of sight, then most of us would be struggling to gain distances of five or ten miles.

The reason for this added bonus is the changing refractive index in the lower atmosphere. It is found that the air density changes with altitude, and it is obvious that the nearer it is to the earth, the more dense the air is and, higher up, it is less dense. This has a direct effect on its refractive index and in turn, this has an effect on the radio waves. As they are like light waves, they can be refracted and reflected in the same way. In fact, they are found to bend towards the area of highest refractive index. This is very

Fig 1 The Earth's atmosphere with its layers of ionisation

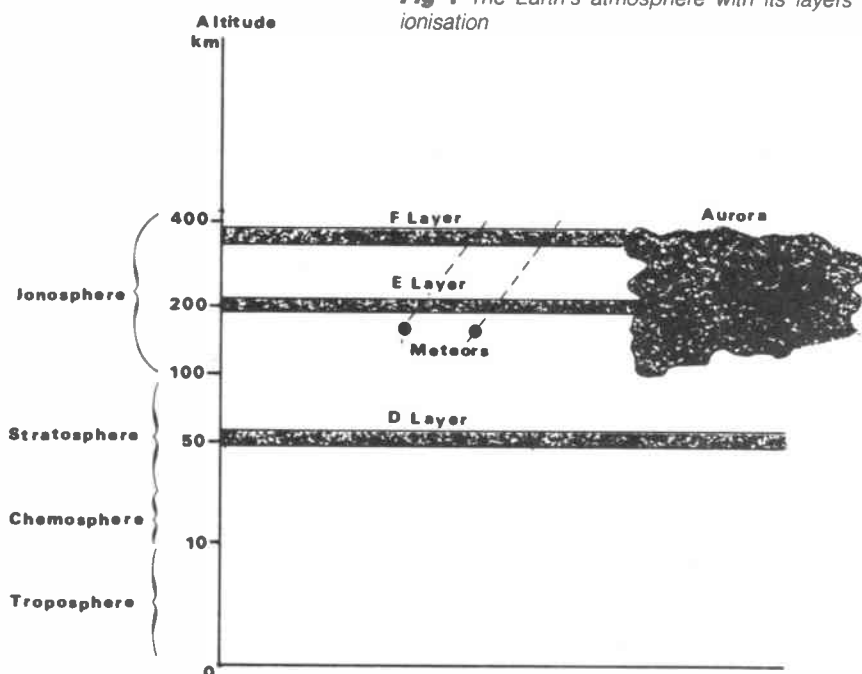

2m propagation

convenient because the waves tend to curve round the earth, slightly extending the range over which the signals travel.

Tropo

Sometimes the band is full of stations from all over the UK as well as some from the continent. On top of this, people are talking about 'Tropo' or the fact that there is a 'lift'.

This type of effect can be caused in several ways. However, the most common occurrence is during periods when a high pressure area is covering the country. So it is well worth keeping a good eye on the weather chart – in fact, the higher the pressure, the more likely it is that there will be a lift.

Similar conditions may also arise when a mass of warm air meets a mass of cold air in a cold front. The warm air tends to rise over the cold air, again giving a sharp boundary. This mechanism does not usually last for as long as the high pressure lifts, which may last for a few days. However, it will normally last long enough to make a good number of contacts.

Frosty mornings

Lifts caused by areas of high pressure tend to be most common in the summer time, although they can happen at most times of the year. However, it is still possible to make contacts over considerable distances during the winter – this happens on crisp frosty mornings.

On mornings like this, the lower layer of air is cooled by the ground, leaving the air higher up warmer, or rather, less cold. This gives a rapid change in the refractive index quite close to the ground, which makes a duct capable of propagating the signals over considerable distances.

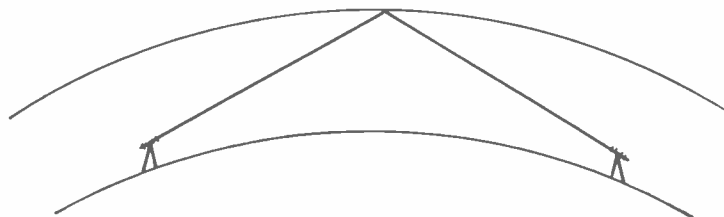

Fig 2 Propagation by forward scatter or reflection

Sporadic E

This is the type of opening that everyone waits for. When it occurs, the whole band comes alive and stations from distances up to 2000km are heard at incredible strengths.

When this happens, people try to work as many DX stations as possible and contest-style operation becomes the order of the day.

The effect is caused by the formation of highly ionised clouds in the E-layer. The level of ionisation can become so intense that sometimes frequencies up to 144MHz and even a little higher can

become affected, creating conditions more usually found on the HF bands. However, these clouds are comparatively small in terms of ionospheric effects. They are often as small as 100km across and, although they are sometimes stationary, they often move.

This will mean that the band will be open to a particular area and, during the course of the opening, this area may change. In addition to this, sporadic E openings on two metres are usually short lived, lasting from as little as a few minutes to an hour or so.

Rare and short

As these openings are so rare and short, it is useful to have a few points to help predict when they are likely to occur. The best month is undoubtedly June. The first major openings usually occur around the beginning of the month, although there are often some before this. This type of opening can also happen in July as well.

In fact, looking at the dates of the openings over the last few years, the first few days of June always produce a good crop of openings, as do the days around June 20th. Whether this is just coincidence or not is open to speculation, but it seems to have been true over the last few years. Having said this, there will also be other openings during the rest of the month, although possibly not as many.

Apart from being able to choose the most likely dates for the occurrence of an opening, it is also possible to get an indication of when one is actually brewing. Usually it is found that the lower frequency bands, such as 28MHz and then 50MHz, are affected first. The frequencies on which sporadic E effects are occurring will rise, until it is possible

that 2 metres may be affected. In fact, a good indication can be gained by listening to an ordinary VHF FM broadcast receiver. When it is possible to hear foreign broadcast stations from areas which cannot normally be heard, it is then time to sprint into the shack and fire up the two metre station.

Aurora

The Northern Lights or Aurora Borealis are not only a spectacular sight, but they can also be an indication of the presence of a form of propagation known as Aurora. During periods of high solar activity, the sun emits streams of charged particles which travel outwards and can enter the earth's atmosphere. When this happens, the distinctive Northern Lights can be seen and, in addition to this, magnetic storms will occur. These storms are a result of these particles causing changes in the earth's magnetic field. Associated with all of this, there is a large increase in the level of ionisation in the auroral zones around the poles, and this can give rise to the reflection of radio waves – including those in the two metre band.

The ionisation during an auroral event is very uneven, and it changes all the time. This has two effects: the first is that any signals which are reflected will have different path lengths, and this will give what is called multipath distortion. In addition to this, the changes which occur cause the signal to be doppler shifted in such a way that the combination of the two effects gives the signal a very distinctive auroral sound. Because of this, narrow band signals have to be used. Sideband can be used if signal strengths are good, but CW is by far the best mode to use.

The distances which can be obtained using aurora will vary widely. Nevertheless, it will be fairly easy to contact stations several hundred kilometres away, and probably the maximum distances which can be achieved will be just over 2000 kilometres.

In just the same way that other forms of propagation have seasons when they are most likely to occur, so does aurora. It has been found that it is most common in March and September, and then during the early evening around sunset.

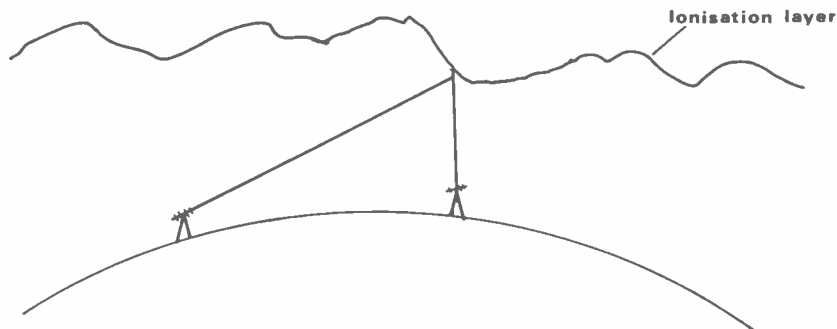

Fig 3 Propagation by backscatter

Another factor which affects the occurrence of aurora is the position of the station. This is because the further north the station is located, the more aurora events it will be able to use and the longer the occurrence will last. In fact, a station in the north of Scotland will be far better placed than a station in England.

One of the side effects of an aurora is that HF communications can be blacked out. This is because the HF signals can be almost totally absorbed by the ionosphere during magnetic storms. This may be of great annoyance to the HF operator, but to anyone interested in VHF it is very useful. Usually the best way to utilise this phenomenon is to monitor signals on 80 metres. When they start to become weak and watery, it is time to look around on 2 metres for an aurora.

Meteor scatter

Meteor scatter is used by only a few operators. Nevertheless, it is interesting to include it here and for those who do use it, the results can be very good.

Essentially, meteor scatter happens because the earth's atmosphere is continually being bombarded by meteors of various sizes. Even though it is only the few large ones which leave visible tracks in the sky at night, there are many smaller ones as well. All of these

will leave a trail of ionisation whose size is dependent on the mass of the meteor. The larger ones leave a trail which can last up to two minutes, whereas for the smaller ones, it may only be a second or so. This ionisation is very intense and will reflect radio signals, with two metres being about the top limit.

Ionisation trails

As these ionisation trails are generally within the E-layer, ie at an altitude of around 100 kilometres, the distances which can be obtained are similar to those of a sporadic E opening. However, it is not only possible to use the normal forward scatter mode as shown in Figure 2, as it is also possible to reflect the signal back from the ionisation trail and contact stations which are closer to home.

This form of propagation is quite specialised as the ionisation trails only last for a very short period. On top of this, the area which is affected is only small and thus only a small amount of the signal can be reflected. This means that stations using meteor scatter have to use high powers and very directive high gain aerials. Another obvious requirement is that the receiver should also be very sensitive. CW is generally the best mode, but in view of the short duration of the ionisation trails it has to be very high

speed CW. Finally, contacts are usually pre-arranged so that both stations can be listening on exactly the right frequency, at the right time, and with the correct beam heading.

Meteor scatter is not subject to quite the same changes in propagation as Tropo or sporadic E, but there are still seasonal variations. These are easy to predict, because there are certain concentrations of meteors at particular points around the sun. As the earth will pass through each one once a year it is possible to predict the exact time when they occur. Certain of these showers are given names, such as the Geminids, Aquarids or Perseids and when they are imminent, meteor scatter might be the mode for you.

Conclusion

Although the HF bands are traditionally thought of as being the bands for DX contacts, with VHF being left for local transmissions, this is obviously not true. With the right kind of equipment, a good eye on the conditions and a little operating skill, it is possible to contact a large number of countries and locator squares. A study of the propagation, as well as the reward of the DX contacts, all adds to the fascination of VHF operation, and of 2 metres in particular.

WIRRAL BASED COMMUNICATIONS

YAESU

CIRKIT

AERIALS

CMHOWES

ALINCO

ICOM

WOOD & DOUGLAS

MICROWAVE
MODULES

MGR SERVICES

BUSINESS
RADIO

NEW &
SECONDHAND

MARINE
RADIO

SPECTRUM COMMS

HEATHERLITE

CELLPHONES

MET ANTENNAS

PART EXCHANGE

BEST
PRICES



48 SHREWSBURY ROAD, BIRKENHEAD, WIRRAL, MERSEYSIDE
TEL: 051-653 3437



— Callers by appointment only —

The Yaesu FTV707 transverter is intended for use with the FT707 HF transceiver and at its new or secondhand price represents very good value for money. The main advantage of the frame is that either 50MHz, 144MHz or 430MHz may be installed giving complete coverage of the 6m, 2m or 70cm amateur bands. Each module offers the necessary repeater split for the band in use and this is selected via a front panel switch. The receive side of the transverter seems to be very good and produces excellent results when it is coupled up to an HF rig; on transmit the PA will produce about 12 watts out on FM/SSB and about 4 watts on AM. The transverter is housed in a 235 x 235 x 55mm metal case.

I purchased one of these units secondhand fitted with the 2m module. Being intended for use with the FT707 it came with all the various leads and connectors for direct coupling to that rig. I had very little information on how the Rx/Tx changeover was achieved and I was also

If your HF rig has a transverter socket then this should carry all the necessary input, output and control lines needed for transverter operation. Either way, wiring the FTV707 and the HF rig for receive is a very simple operation. The first job we must do is remove a trailing power lead intended for connection to the FT707 and wire our supply voltage to the unit.

On the back panel of the transverter there is a standard Yaesu power plug marked 'dc 13.5V', plus a dc power cable which supplies power and PA disable to the FT707. As this power lead is no longer needed I opened up the unit and removed it, it was then a simple matter of connecting 13.5 volts to the power socket.

The positive supply is connected to pin 3 and negative to pin 4, and you can use *Figure 4* to help you identify the correct pins. The socket marked 'Output' on the back of the transverter carries the 28MHz IF output and was taken to the

transverter. As already mentioned, some HF rigs have a special transverter socket on the back which carries all the inputs/outputs needed for transverter operation. Most solid-state rigs also have a pin to disable the PA and divert the low level RF from the PA board to the transverter socket. On rigs like the TS430 and TS930/940, this pin must be activated or no RF drive will appear on the transverter socket. To get a signal out on the 2m band it is necessary to apply enough RF drive to the transverter, and to get the unit to go into transmit mode at the same time as the PTT is operated on the HF rig.

Unlike most transverters, which only need a pin shorting to earth to put them onto transmit, the FTV707 needs a voltage taken to a point on the main control board. If you apply 13.5 volts to the point marked 'Tx 13.5V' on the main control board, the transverter will switch from receive to transmit and will stop like that until this voltage is removed. The

MODIFYING THE YAESU FTV707 TRANSVERTER

by Steven Goodier G4KUB and John Goodier G4KUC

told that the 'Tune' control and the repeater shift did not work. I felt the first thing to do was to get the transverter coupled to the HF rig and make sure that the receive side of the system was working. The HF rig at that time was a Yaesu FT102, and although this rig has no transverter socket it does have an auxiliary receive input, low RF drive output and a control relay.

auxiliary receive socket on the Yaesu FT102 transceiver. It was then a simple matter to connect a 2m antenna to the FTV707 and tune around the two metre band on the FT201. All seemed to work well on receive.

Wiring for transmit

Wiring for transmit depends on the type of HF rig to be used with the

problem we have is finding a way of supplying this voltage when the PTT on the HF rig is closed and also supplying a PA disable (if needed) at the same time. The best way of doing this is to make use of the auxiliary relay contacts provided on most HF rigs to control external equipment, such as linear amplifiers.

Figure 1 shows the circuit diagram of a simple transistor switch which is controlled via the auxiliary relay contacts on the HF rig. The circuit is based around a BC108 or BC109 transistor, which is permanently biased on via R1. When the emitter of Tr1 is grounded via the auxiliary contacts on the rig, RL1 is energised and the relay contacts close, routing 13.5 volts to the control board and putting the FTV707 on air.

Construction and fitting

There are two different layouts for this circuit, the first making use of a double pole changeover relay and the second using a single pole type. In either case both will supply the transverter with the 13.5 volts needed for transmit. If your HF transceiver needs a PA disable or you wish to control external equipment, such as a linear amplifier, then use the layout shown in *Figure 2*. The FT102 needs no PA disable, so I used a single pole DIL reed relay. This type of relay has the advantage of having a very fast changeover time of about 0.25ms.

You can see both layouts in *Figure 2* and *Figure 3* along with the PCB pattern. Construction is very simple and the

Voltagcs expected on the edge connector for both transmit and receive

Pin	Rx	Tx	Function
1 (A)			Earth
2 (B)			Crystal voltage switching
3 (C)			Crystal voltage switching
4 (D)			Crystal voltage switching
5 (E)			Crystal voltage switching
6 (F)			Crystal voltage switching
7 (H)			Crystal voltage switching
8 (J)			Earth
9 (K)			Tx in from ALC amp unit
10 (L)			Earth
11 (M)	13.5V	13.5V	Main supply line
12 (N)	0V	13.5V	Tx 13.5 volts from control unit
13 (P)			Variable tune voltage
14 (R)			Earth
15 (S)			RF gain voltage
16 (T)	0V	8V	Tx 8V from control unit
17 (U)			Power out to meter
18 (V)			ALC to ALC amp unit
19 (W)	13.5V	0V	Rx 13.5V from control unit
20 (X)			Earth
21 (Y)			Rx out
22 (Z)			Earth

layout is not critical and if wished can be built on a piece of Veroboard. Once built the board can be tested before fitting and to do this you will need to supply the circuit with about 13.5 volts. First connect the positive and negative supply as shown. Connect a voltmeter to the point marked 'Xverter 13.5V Tx' on the board and check there is no voltage. As soon as the pins marked 'Aux relay' are shorted together, this should cause the relay to operate and 13.5 volts should appear on the meter. If all is well the board can now be fitted inside the transverter.

Figure 4 shows the wiring of the board to the transverter, which can be seen to be very simple as there are only three wires to connect. The auxiliary changeover cables have to be brought out of the back to the HF rig, the best place to do this being through the 'dc out' hole on the back panel. There is only one connection to the FTV707 control board and this is to the point marked 'Tx 13.5V in'. The spare relay contacts shown can also be brought out of the back panel along with the auxiliary changeover cables. When you have completed the wiring the board can be held in place with a piece of heavy duty double sided tape. I fixed the board to the top of RL02 and this seemed to hold it in place. If you are going to use this method of fixing the board, then I would advise you to spray the track side with printed circuit board lacquer which will give it an insulating and protective layer.

It is now possible to test the transverter on transmit with full changeover controlled from the HF rig. The RF drive

from the rig is connected to the 'RF in' on the back of the transverter. Wire up the changeover cables and, before putting everything on air, make sure that the RF drive control on the HF rig is at zero. First check all is still working on receive and then if possible replace the antenna with a dummy load and watt meter. Key the rig and if all is well you should get an indication of output power on both the output meter on the transverter and the watt meter connected to the dummy load. It should be possible to vary the output power with the drive control on the rig and the maximum output power should be about 10-12 watts.

If you fail to get an output, then the drive level may be too low for the FTV707. If this is the case, then it may be possible to adjust VR01 on the ALC amp unit. The ALC amp unit is located in a silver screening box and is just to the right of

the control board. VR01 is accessible from beneath the transverter. If your system is still not transmitting then there could be a more serious reason which we will now look at.

Transmit problems

The main control board of the FTV707 has a rather complex switching system including relays, front panel switches and three IC switches. Various conditions must be met on the edge connector before the module will transmit, and in Table 1 is a list of voltages expected on the edge connector for both transmit and receive. Just a quick note about voltages: apart from the 8 volt line the supply voltage can vary from about 12 to 14 volts and some of the shown voltages will depend on your power supply unit. RL01 is the changeover relay and this supplies 13.5 volts to pin 12 (N) and 8 volts

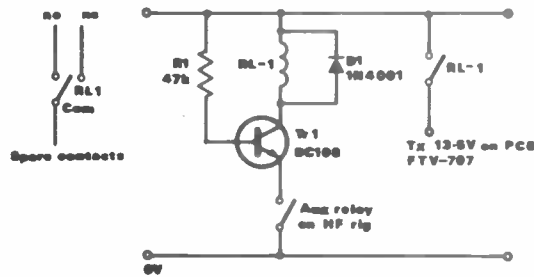

Fig 1 Circuit diagram of simple transistor switch

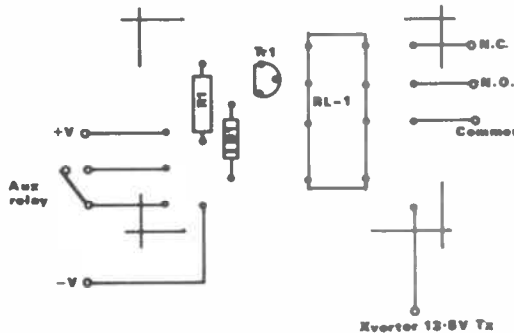

Fig 2 Showing board and layout of the double pole changeover version

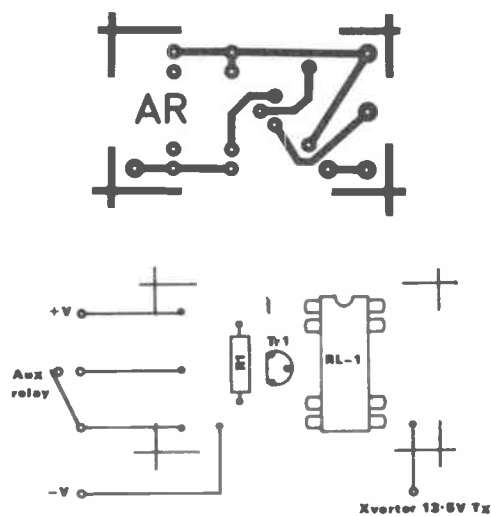

Fig 3 Layout of the single pole changeover version

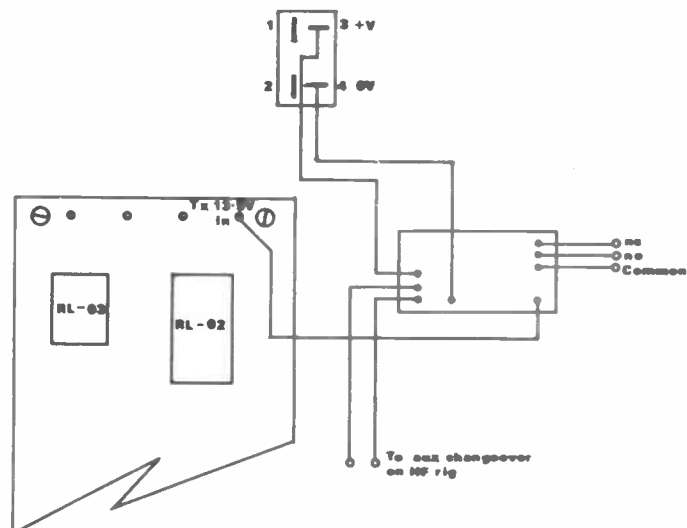

Fig 4 Showing the wiring of the board to the transverter

FTV707 MOD

to pin 16 (T) of the connector when on transmit. **NOTE:** the circuit diagram in the handbook shows the connector labelled 1 to 22, whilst the actual edge connector is labelled A to Z with G, I, O, and Q missing, making 22 pins in all.

The first thing to check is that when the PTT is operated, 13.5 volts appear at the point marked 'Tx 13.5V in' and RL01 pulls in. I had many problems locating both the voltages on pins 12 (N) (Tx 13.5V) and 16 (T) (Tx 8V) and this was tracked down to a faulty relay (RL01). Even though the relay was pulling in, the relay contacts were in fact burnt out and not making connection; once this had been changed however, all worked well. It is also worth checking Q03 which is an 8V voltage regulator IC providing the Tx 8 volts. Most of the outputs to the edge connector are taken via JO1, so check this for bad connections.

If all seems to be OK with the edge connector voltages, and you are still not getting any transmit, then it is worth taking a look inside the ALC amp unit. If the transverter has been purchased secondhand, then it may have been possible that too much RF had been applied to the input. If a lot of power has been applied to the ALC amp then this would result in a few burnt out resistors and a blown ALC FET Q01. These should therefore be changed and L01 and L02 should be checked to ensure that they

have not been burnt out resulting in an open circuit. The few problems I have had with the FTV707 have all been on the control board, but if your unit is still not working then it must be down to the module. If this is the case then I suggest you refer to the manual which contains block and circuit diagrams, circuit description and full alignment details.

I mentioned at the beginning of the article that the repeater shift and tune control were not working. After much studying of the circuit diagram I came to the conclusion that one or all of the switching ICs had gone down. Q05, Q06 and Q07 are 4066 quad analogue switches and each IC contains four sets of single pole switches. These control a great deal of the voltage switching inside the transverter and amongst other things are responsible for the repeater shift and tune control. I found it almost impossible to find out which IC had gone down, so I decided to change all three. I also fitted three IC sockets and the total cost of replacement was only £1.20. After these ICs were changed, the repeater shift and tune control seemed to function correctly.

Conclusion

Now that the minor faults have been rectified and the auxiliary changeover board has been fitted, the FTV707 transverter functions extremely well.

There is no doubt that this transverter frame is very versatile, and with the added benefit of plug-in modules for each band and repeater shift fitted as standard, the whole unit is very attractive. Since the unit was first modified to work with my FT102 I have in fact changed my HF rig and now own a TS440. Again interfacing it to this rig was no great problem (see *Amateur Radio* May 1987), proving the versatility of both the FTV707 and the modification. If you are looking for a transverter for average VHF/UHF operation, then I can thoroughly recommend the FTV707.

COMPONENTS LIST

Resistors

R1 - 47k

Semiconductors

Tr1 - BC108 or BC109

D1 - 1N4001

Miscellaneous

DIL reed relay single pole

Maplin FX89W

or

Ultra miniature relay double pole

Maplin YX95D

Printed circuit board, solder pins, wire etc



Fresh stocks again secured at this SPECIAL PRICE

NEW

£39.95

NEW AUTOMATIC ANTENNA ROTATOR - Aerial Techniques introduce their new automatic, economical rotator system for improvement of radio and television reception. Ideal for DXing and domestic use (pull in alternative out of area (TV regions), the full mount rotator accommodates ALL types of TV & FM aerial, large or small, having 192 lbs/in of motor torque. The system consists of two major components, the automatic control box and the rotor head unit, the vertical carrying capability of the latter is 45kg. The additional Support Bearing may be used for heavier load applications (up to three aerial arrays may be employed, depending on size). The attractively styled Control Console features continuous indication of beam/aerial heading, telling you the aerials position at all times. Bracket for Rotator support mast up to 52mm (2" approx) in diameter, stub/rotation mast is up to 40mm (1½" approx) in diameter.

KINGRC Automatic Antenna Rotator and Control Console (uses 3 core cable) **£39.95**

SUPPORT BEARING for heavier load applications **£13.95**

YOKO Multisystem VHF/UHF 5" screen Television. System B/G (5.5MHz sound) AND System L FRENCH standard (6.5MHz sound). Ideal for TV-DXing and Sporadic-E monitoring, covers Band 1, 3 & UHF; 3-way power, 12v DC (lead supplied), Dry batteries & Mains operation. (SAE leaflet) **£89.95**

(Carriage & Insurance on above TV £4.95)

'A TV-DXers Handbook' completely new and revised edition by Roger Bunney, a must for ALL DX enthusiasts **£5.95**

We are the specialist aerial company for all installations - domestic, fringe, distribution and DX. Try our comprehensive and illustrated Catalogue at 75p full of all the latest equipment, please include SAE with any other enquiries.

All prices inclusive of VAT & Carriage. Delivery normally 7-10 days. ACCESS & VISA Mail and Telephone orders welcome.



AERIAL TECHNIQUES (AR)

11, Kent Road, Parkstone,

Poole, Dorset, BH12 2EH. Tel: 0202 738232.



SHURE 450 MICROPHONES



For CB, PA and Ham Radio
The **BEST** for only

£39.95

PLUS £2.00 p+p
outside UK extra
Normally sold for £69.95

Also available hi-band VHF
mobile antenna's only

£9.95

PLUS £1.50 p+p
outside UK extra
Normally sold for £18.00

Cheques please allow 7 days for clearing
Postal orders same day dispatch

STEFAN'S RADIO LTD

78, MARKET ST CHURCH

ACCRINGTON BB5 0DN. LANCs

ANGUS MCKENZIE

TESTS



ICOM IC900E modular multiband FM mobile transceiver

The IC900E is definitely one of the most unusual mobile rigs that I have ever reviewed. It actually comes in several chunks and is designed in such a way that the extremely small main control panel section can be put almost anywhere that is convenient. The control panel is connected by a thinnish cable to the interface A unit. This unit includes the microphone input lead, which has a socket at its end into which an Icom hand mic can be plugged, and has two 3.5mm jack sockets for connecting two separate loudspeakers, although only one is normally supplied. A 13V dc flying lead also has a special Icom dc connector, and its extension is extremely long (7 metres) so as to reach a more distant than usual 13V line.

The control unit includes micro-processor operating buttons, the main microprocessors being within interfaces A and B, but these units are separated by some 5 metres of twin optical fibre cable. All the data control signals and audio on Tx and Rx pass between the interface A and B units via the optical fibre cable. The interface B unit also has to have a 13V dc input connection and is again fitted with a long extension lead from the flying Icom dc socket. On the back of the unit are six dc sockets which can supply dc to a maximum of six different band modules. These modules are also daisy chained together with a multiwire data plug and socket line for controlling all the functions via interface B. The user is expected to stack all the band modules in a group, and the entire stack can be placed well out of the way in the car, eg in the boot, with interface A being under the dashboard somewhere, or even under one of the front seats. Each of the band modules has its own flying coaxial output lead for RF. HF and VHF bands employ a line SO239 socket, whilst UHF and 23cm have an N type line socket. Interface A measures 177mm (W) × 25mm (H) × 177mm (D) and weighs 500g, and

interface B measures 179mm (W) × 27mm (H) × 202mm (D) and weighs 900g.

One of the many ideas of this remarkable Icom concept is that all the different parts of the system can be hidden away, leaving just the control unit, which measures only 153mm(W) × 50mm(H) × 38mm(D) and weighs 200g. One can immediately withdraw the control unit by unplugging the miniature plug and cable from it, and you could either take the unit with you in your pocket, or hide it under the seat etc. If you also remove your mobile whips, no-one need know that you have a rig in your car at all.

UX29H, which is a 45W model costing £249. The UK versions of the 2m modules have both 12.5 or 25kHz channelling. For the 70cm band, the module number is UX49, which delivers 25W and costs £269. There is also a 23cm module which has been announced to give 10W, type UX129, but no price has yet been fixed. For the US market there is also a module for the 220MHz band. The modules measure 179mm (W) × 27mm (H) × 191mm (D) and weigh 1.2kg.

The price of the control panel, interfaces A and B and all dc cables for the interfaces, as well as the microphone



One of the other strong points for this rig, or should I say, series of rigs, is that there should be no hassle with the most important part taking up so little room. It would be an ideal set-up for the smallest car, and complete control of all the modules is via the fibre optic cable. You will have to be very careful, however, not to kink this cable, but you will not have to worry about any form of interference getting into such a link, as it is of course completely impervious to electromagnetic breakthrough.

The different modules

Although all the modules look virtually identical, each one covers a completely different band. The UX19 delivers 10W of FM on the 10m band, but was not available at the time of writing, and has also not yet been costed. The UX59 gives 10W on the 6m band and costs £239, whilst the UX29E provides 25W on the 2m band and costs £229. Also for the 2m band is the

type HM15, fibre optic cable and one loudspeaker is £469. This price also includes various mounting kits. A second loudspeaker is optional, the type SP8, costing £23.

The system's viability

A very much longer fibre optic cable is available to special order so that you could mount interface B and the actual band modules with power supply in an attic, for example, to gain shorter cable runs, with just interface A and the control box in the shack. You could even consider putting the modules etc in the caravan that you might be towing, and have just the control unit and interface A in your car, allowing the fibre optic cable to feed between the vehicles. However, you have to consider the price, and the fact that for mobile operation, you will not be allowed to use 50MHz. This restricts you to just four bands with this system, including 23cm, which is hardly



UX49E, UX29H and UX59A remote units

used at all as yet, although it is likely to become much more popular in the future.

If you are a class B operator, then you would in all probability, be buying the rig for only 2m and 70cm, and unless you want the gimmicks of the fibre optic cable and the amazingly compact control panel, you might do better to look at Icom's IC3200E, Yaesu's FT2700 or the Kenwood TW4100E. If you are a class A operator, the Icom 900E set-up becomes more attractive, because it can include a 10m module; but alas, only with 10W, which is not much more power than you can get out of an extremely cheap, but effective, converted CB rig.

Icom's choice of philosophy

If we accept Icom's concept, and thus requirement of having two interface modules, with the capability of anywhere between, say, 5 and 20 metres separation, and with the idea that as much as possible of the rig should be hidden away, there are two basic approaches to the problem of interfacing the two sections of the complete system. Icom chose the latest modern high tec approach by choosing fibre optic.

Audio signals amplified up from the microphone connected to interface A

Rear panels of the remote modules above

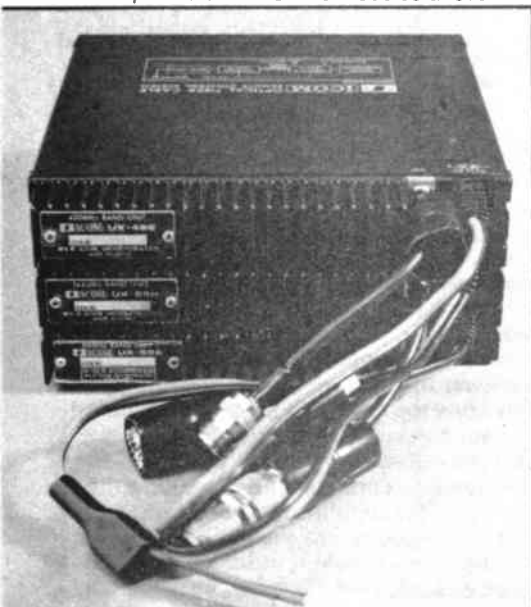

are first digitised with a 9.6kHz sampling rate, and then the digital signals are pulse width encoded onto infrared. These signals pass along the fibre optic cable, and are then demodulated at the other end. A digital to analogue converter allows reconstruction of the analogue signals, which pass through the low pass filtering to the normal transmitter FM modulation circuitry. Conversely, the output from the receiver's discriminator is again sampled at 9.6kHz and is transmitted after pulse width modulation at infrared down the second fibre optic cable from interface B to interface A, where it is then turned into audio, amplified and fed to the loudspeaker drivers.

High tec approach

Icom's high tec approach is very expensive to implement, which is why the whole IC900E, even with only two bands, costs around £1000. They could have used a perfectly normal multi-wire cable with very good screening, and individual screens internally for Tx and

allows the sub band audio to be switched on and off independent of the main audio level. In conjunction with the two separate jack sockets on interface A, the user can either have the main band and/or the sub band live with either or both bands coming from the main band speaker. The main and sub band audio signals can come out of separate speakers as if in stereo!

This is a super idea, which at first I thought rather gimmicky, but later, after I had become used to it, I found extremely useful. On the right hand side cheek of the panel there are two switches selecting matrix pad lock on/off, and illumination dimmer on/off. The matrix pad includes an on/off button which cuts all units when switched off, but powers up whichever units and modules have been selected for the main transceiver and independent receive selections.

The CPU in the control panel allows virtually anything in the system to be controlled, including the selection of low or high power on the chosen Tx module. The buttons operate VFO/memory selec-

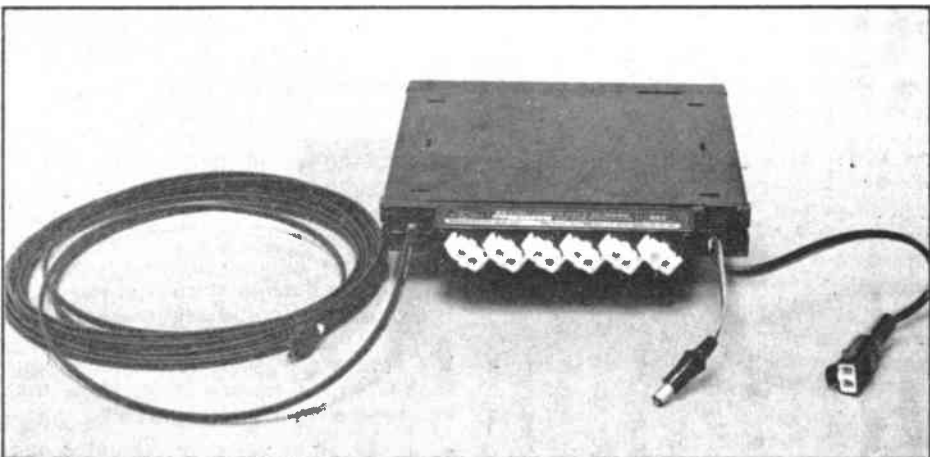

Rear panel of the Interface B unit and a coil of fibre optic cable

Rx audio, and various wires for data connections. No digitising circuits would then have been required, nor expensive fibre optic couplers etc. The coupling multi-way cable would have had to be a lot thicker than the fibre optic one, as otherwise the wires inside the cable could be easily broken. However, there could be appreciable earth currents at RF between interface A and B if they were analogue connected, and so there could easily be EMC problems. As it stands, the virtual complete isolation between the interfaces is very fascinating and clearly is easiest to cope with in virtually any installation, but at such a high cost.

The control panel

This very small unit includes a 3 x 5 matrix of push buttons, and a click step rotary for tuning. Above and below the tuning knob are fairly long rocker type microswitches for varying the squelch and volume levels. To the left of the matrix pad is the frequency and status display, enabling the user to see clearly both the main transceiver module that has been selected and a sub band which can be selected simultaneously on Rx only. A tiny button near the tuning knob

tion, ten memories being available on each band module. These memories cope with frequency and repeater info, and they can be recalled and rewritten very simply. After the main and sub bands have been selected using a 'set' facility, a button allows the main transceiver and sub bands to be interchanged. If you have been transceiving on 2m but monitoring 70cm as well, you could reverse operations on these two bands with one button push. Another button causes the squelch and volume controls and the tuning knob to act on either the main or sub band systems. Volume can be varied independently on the two chosen bands, even if they feed into just one speaker.

Direct access to a calling channel is available on the pad, and another button selects the required channelling (eg 10 or 20kHz for 6m, or 12.5/25kHz for 2m and 70cm). Incidentally, on 50MHz the FM calling frequency is actually 51.510MHz, channelling being every 20kHz. This coincides with US practice, and necessarily requires a 10kHz offset. This can be put in on the Icom, but vanishes if you go over the edge of the band with the tuning knob, thus requiring you to reset the offset. You have to do this by changing to

10kHz steps, then going up one, followed by returning to 20kHz.

The 'Dup' button cycles between repeater shift and simplex, and one function of the 'set' button and the tuning knob allows you to pre-select any required repeater shift and band frequency limits for the scanning modes. Facilities are provided for use with optional tone squelch, but these would not normally be used in the UK. The listen on input facility will be useful, and you can also tune up and down in 1MHz steps, which of course is useful on 70 and 23cm.

Icom supplied the SM15 hand mic with the rig, which includes a 1750Hz tone button on the back, together with the normal PTT lever and up/down buttons. These buttons allow scanning in the normal way.

Both the main and sub bands have their own digital frequency readouts, the main one being somewhat larger. There are two separate S meters usefully detecting the presence of a signal of intermediate strength, but of no more use than this (see comments in Laboratory Tests).

more rugged fitting.

The instruction book does give clear instructions, with diagrams, of how the brackets are to be assembled, but I regard it as very unfortunate indeed that Icom completely omit any proper description of the circuitry and how it all operates. I do not like this sign of the times, for it reminds me yet again that the Japanese seem to be treating us as black box purchasers, and quite frankly most of us can still do a good soldering job and are very interested in circuitry etc. Many experts on fibre optics and digital techniques would have been so interested to see how Icom have done everything. Furthermore, the equipment specifications have become extremely crude, and it is hopelessly inadequate just to specify input sensitivity and power output and a few other points, including selectivity and current consumption.

Subjective tests

After I had overcome my frustration with the daisy chain connectors, all three

Rocker up/down volume and squelch

I have a very strong personal prejudice against volume and certain other types of control that are operated by microprocessor control up and down buttons. I like to feel the angle of a knob, and when I was sighted I liked to see this angle, for in a flash I knew where I was. It is well known by psychologists that both the eye and the fingers are by nature necessarily extremely adept at estimating an angle, more so than they are for estimating the position of an up/down fader, let alone a number on a digital readout.

Let us make no bones about it, with today's high tech, up and down buttons are both much cheaper to manufacture and are more reliable than even a good quality rotary pot, and it is much more difficult for a rotary volume control to fit in with a digital control panel if there are no analogue voltage signals present. I would very much have preferred rotaries for squelch and volume, in just the same way that I prefer tuning knobs to up and down frequency stepping buttons, as are found on many handie talkies, although they are better than the dreaded thumb wheels.

I am also just a little concerned that the very thin umbilical cord between the control panel and the interface A unit could get damaged by repeated plugging and unplugging, or by the movement of the control panel end. If you are careful it will probably be all right, but I just don't feel confident about it. The instruction book gives a specific warning about the fact that great care is needed to avoid kinking or damaging the fibre optic cable.

I am also very concerned that the modules get extremely hot if they are on Tx for a very long time. I am not thinking so much of the interminable long overs that I hear sometimes on 2m FM, as the long and fun duplex QSOs that many of us love to have on two bands with another station, identifying at least once in 15 minutes etc!

The very philosophy of the rig encourages duplex, but you will most certainly have to buy the optional accessory fan if you are ever likely to use real duplex, as opposed to repeater working because of the heat problem.

Laboratory tests - Rx sections

All three modules tested had good sensitivities, the best actually being the 50MHz unit. They were all very consistent across their bands of operation and I did not detect any particular problems. Although the RFIM performance of the 144MHz module measured well, the 50MHz unit was some 11dB worse, which is surprising.

I don't think this would matter now, but if and when the DTI allocate frequencies below or above the 6m band for high power PMR etc, one might eventually get a surprise! Many amateurs have experienced problems from strong police transmissions between 146 and 148MHz when they are using the usual FM channels on the 2m band. There was slight evidence that the reciprocal mixing performance of the 433MHz module was not particularly

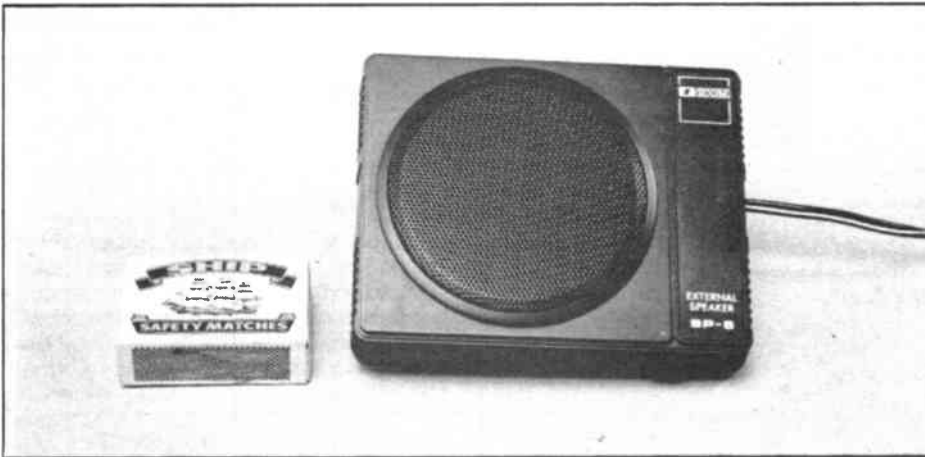

Size comparison of the SP8 external speaker

Installation

The instructions for installation were reasonably simple and at first everything fitted together perfectly, but when we switched on only the supplementary band was working. I am the sort of bloke that impatiently tries to get the rig working first, and when all else fails I ask Fiona to read the complete destruction book to me in detail. After going through the book a couple of times, and a whisky or two later, almost three hours had elapsed, by which time I was cursing the entire contraption not inconsiderably!

The problem was not finger trouble, but turned out to be a minor misfit problem with one of the tiny data daisy chain plugs. These are quite long and very flexible plugs, with extremely delicate wiring attached. Fiona did not wish to push too hard on the length of the plug, and one of them was incorrectly seated and required a very firm push to put it right. Once in, by the way, they are absolute hell to get out again if you want to avoid the risk of breaking the wires.

I strongly criticise Icom for using these very awkward data connectors. The daisy chains are also very close to a light tube on the front, and would have been much better situated on the back panel with a

units worked extremely well. The 50MHz unit was interconnected with a horizontal beam, whereas the 2m and 70cm ones were plugged through to omnidirectional vertical monopoles.

RF sensitivity of all three modules seemed very good, but not exceptional, and I couldn't detect any front end intermodulation problems. Audio quality was good, and I did not notice any effect on the received quality that I could attribute to the digitisation on normal transmissions.

I found that I was able to get a feel for all the matrix pad operations very quickly, and everything was more obvious than on much older Icom rigs of two or three years ago, although I quite like the IC28 etc. It was an excellent idea to provide the separate sub band receive capability, especially with the addition of a second speaker, and this is more useful than you might think.

Transmitted quality was thought to be good, although stations that received me very strongly did hear slight digital noise, and a slight mushy sound in the background at a very low level. There were comments that the peak deviation seemed a little high, and this applied also to the toneburst.

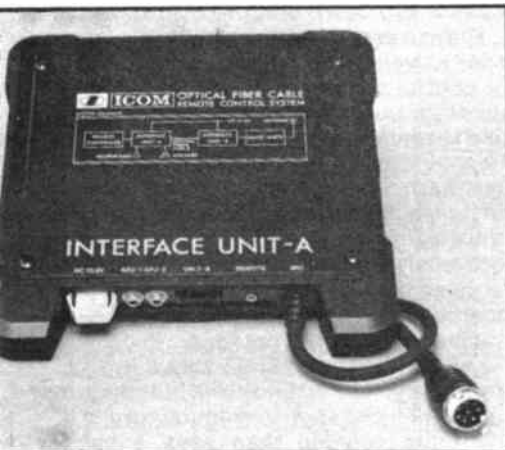

Rear panel of the Interface A unit

good, and RFIM was also poorer on this unit; the input intercept point being around 13.5dB worse than on the 144MHz module. Even so, it should be adequate until the population density of amateurs on the band becomes much greater.

Selectivity

The selectivity skirts on the 144MHz module were about as symmetrical as I have ever measured, and whilst the 12.5kHz channelling performance was inadequate, 25kHz selectivity was superb. Once again I have to deplore the inclusion of an 'E' filter in a rig provided with 12.5kHz channelling capability. In the 50MHz unit the 20kHz selectivity was very good indeed in the context of an amateur specification, whilst 40kHz selectivity was superb. The 433MHz module's selectivity measured well for 25kHz channelling.

I just could not believe the figures after we had measured the S meter calibration, and so we did them all over again, with the same results. An S meter which requires only a 5dB increase from S1 to S9 is well nigh useless, as for most of the time it will be either at the bottom or at the top, or yo-yoing like the clapper. I was also amused to note that it only took a 3dB increase above S9 to hit the top of the shop!

The audio distortion on the 144 and 433MHz modules was very much the average of modern rigs, but the 50MHz module was a little worse for some reason. The maximum output power into both 8 and 4 ohms was rather more than

Inside the Interface A unit

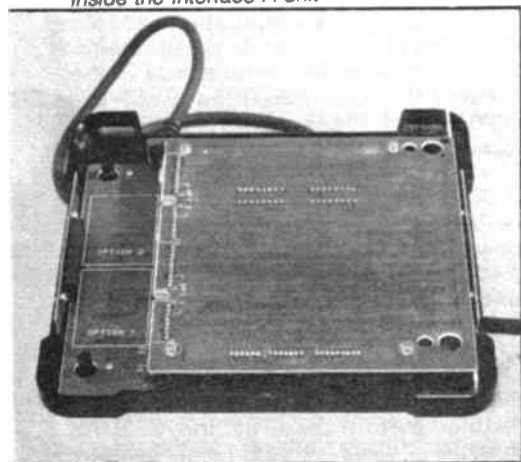

usual, which is a good point.

On checking the received audio frequency responses, I was immediately struck by the extraordinarily high bass roll-off frequency, which was just above 500Hz. Furthermore, the roll-off was quite steep; the response being 20dB down by 180Hz ref 1kHz. The HF end was quite flat up to 3kHz, but by 4kHz it was steeply attenuated. Frequencies above 3.5kHz or so produced very audible beats due to digital to analogue etc aliasing, frequencies of 4.5 and 5.1kHz for example both producing loud 300Hz beats. This effect will probably not be of any consequence, but it is worth my pointing it out in case you get any strange effects with data transmissions through the equipment.

Good discrimination

The capture ratio of 4.5dB shows that the rig discriminates quite well between stronger and weaker stations on the same frequency. Note that the first IF is somewhat unusual on all modules; the 144MHz one being 17.2MHz, the 50MHz modules being 13.99MHz and the 433MHz one being 23.15MHz, although the

set, I noted quite a lot of LF rumble and some digital noise zizzing away continuously. The transmitted signal to noise ratio did not measure all that well compared to other rigs, although most users would find it adequate. The transmitted frequency response fell quite rapidly above 2.6kHz, being very well down at 4kHz. Despite the rig being primarily intended for mobile use, the LF response was not attenuated anywhere near as much as it was on Rx, the turnover being at around 300Hz with a more gradual roll-off below it. The Tx response is thus almost ideal, although the HF end could have been just a little wider with an even steeper roll-off so as to avoid aliasing in the analogue to digital conversion etc.

All the Tx power measurements showed that the specified power was equalled or exceeded throughout each band, with the sole exception of the top end of 70cm, where it was only 1W low at 24W. The low power outputs were always very close to 10dB down on full power.

The transmitted frequency accuracies were excellent on the 144 and 433MHz modules, but transmissions were around

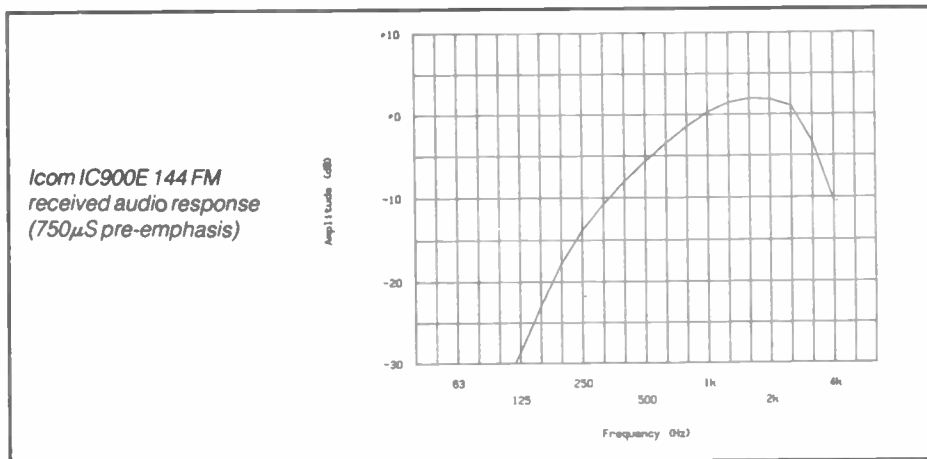

second IFs are conventional at 455kHz.

It seems to me that the use of unconventional IFs could also be contributing to the high price of this system. The frequency accuracy of all the modules was excellent, no improvement being gained to the overall sensitivity by offsetting the signal generator. The extremely symmetrical IF responses also point to excellent discriminator alignment. The squelch opened at well below the 12dB sinad level, and its threshold was variable over quite a good range.

The transmitter sections

When checking the deviation of the 1750Hz toneburst (this frequency was very precise), we noted that on all bands the maximum was surprisingly high. Peak speech deviation was at around 400 to 500Hz (vowel sounds), and the rig was clearly able to deviate at much too high a level if you made the appropriate noises into the mic. I noticed this consistently on all bands, although when accessing various repeaters, I only actually received one 'raspberry'. When listening to the transmission on a wide range audio amplifier connected to the output of my Marconi 2305 auto modulation test

900Hz low on 50MHz, which I thought a little surprising, although not a serious problem. The 433MHz unit was left on a soak test for 20 minutes or so, and despite being hot enough to burn the fingers after the end of the test, the frequency accuracy was still good. Repeater shifts were also very accurate throughout.

No harmonic problems

No harmonic problems were noted on any of the bands. We looked very closely indeed for second harmonic of 50MHz, and I found that any harmonic present was below -77dB - probably well below -80dB. This is a truly excellent performance, showing some very well designed filtering. You should note that we are only allowed at the moment a maximum of 25W ERP, and running the 50MHz module at its full output of 10W may well cause excessive ERP, so you may have to back the power down a bit by adjusting an internal pre-set. The total current taken by the set-up will be approximately 10A on Tx if you are using the 2m high power module, reducing to around 8A for 70cm on Tx, and 4A if you switch to low power. The typical Rx current drain is

250mA, which seems quite high, but of course there is a lot of active circuitry involved with all the digital and control circuitry.

You will thus need quite a good PSU if you are going to put the actual modules up near the roof etc.

Conclusions

Since mobile operation on 50MHz is not permitted as yet, I cannot see much point in buying the 50MHz module.

In any case, there is as yet very little FM activity on the 50MHz band, although it is certainly being introduced, for even the

Internal view of the 70cm unit

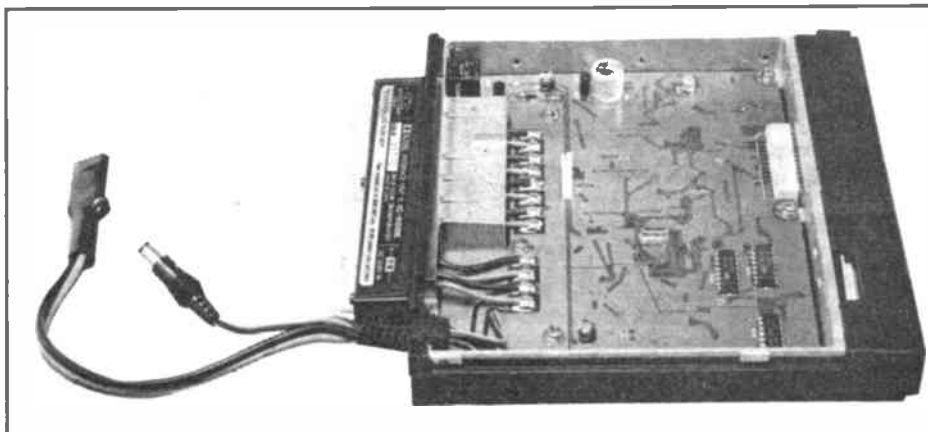
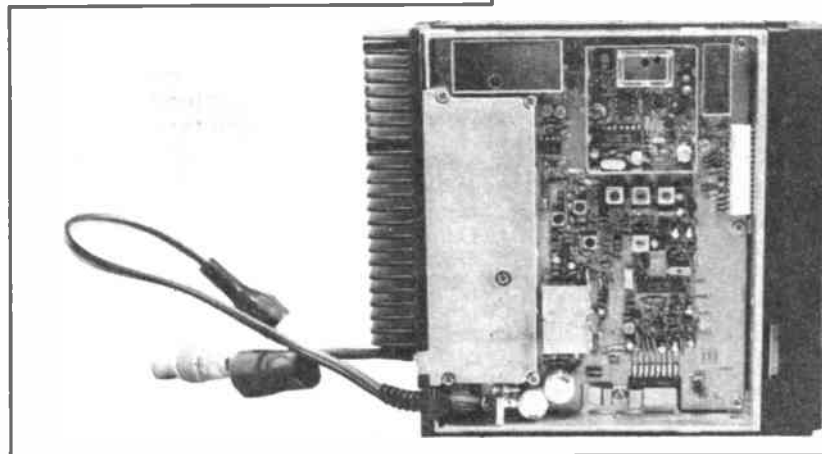

Internal view of the Interface B unit

my reaction would have been rather different. I just wonder how much the system will cost in the States, and I suspect that Icom in Japan have applied a very heavy loading to the price for the European versions.

I would like to thank Icom UK very much indeed for making the whole system available to me for quite a few weeks, and also thanks to Fiona for not only helping with all the measurements, but for helping me so much with overcoming the initial aggro, which required so much reading of the instruction book to ensure that it was not my finger trouble!

channellisation standard has now been agreed by the RSGB's VHF Committee. Packet radio frequencies are being allocated around 50.8MHz, but you would only be able to use these from a home base station in practice, unless you are very keen on working Packet portable!

It will be up to you to decide whether the 10m FM module is viable instead of using a modified CB rig, so looking at the system as it now stands for 2m and 70cm I cannot see very many people buying it, although it is obviously a rig that shows some most innovative design points.

Strange as it may seem, possibly the most viable use would be as a solution for the high block of flats problem when the amateur lives a long way down, but can get at a mains power point on the roof. Icom UK can supply longer lengths of fibre optic cable to special order, and the use of an Icom discone for several of the bands, and a 10m ground plane, could allow a lot of flexibility where none was previously available because of problems with coaxial cables that were too visible.

If and when you buy the 23cm module, don't forget that horizontal polarisation is the standard at the moment, and that the RSGB is discouraging the use of vertically polarised transmissions. You would thus need an Alford slot type antenna, or a little mini halo on the car for working 23cm repeaters etc.

If you can justify the expense of the complete system, then I think you will find it a fun purchase, for I am sure you will enjoy using it. I cannot class it as other than rather poor value for money though, and I don't think there is going to be a massive rush for this new model. If the price had been held somewhat lower,

Icom IC900E Laboratory Measurements

Parameter	6m (UX59)	2m (UX29E)	70cm (UX49)
Receiver section			
RF sens for 12dB sinad	-124.5dBm (0.13µV)	-123.5dBm aveg (0.15µV)	-123dBm (0.16µV)
RF input intercept point	-19dBm	-7.5dBm	-21dBm
Selectivity for stated spacing	20/40kHz 54/81.5dB aveg	12.5/25kHz 10/70dB	25kHz 64.5dB
S meter (dBm)	S1 -108 S5 -105 S9 -102 S9++ -99	S1 -109 S5 -106 S9 -105 S9++ -105	S1 -102 S5 -99 S9 -97 S9++ -92
Discriminator distortion			
3kHz deviation	2.6%	1.8%	1.6%
5kHz deviation	5%	3.8%	3.7%
Max power output for 10% distortion, 8/4 ohms		2.9/4.5W	
RF limiting threshold	-129dBm	-128dBm	-128.5dBm
Capture ratio	4.7dB	4.5dB	5dB
Transmitter performance			
Power output, high	11 to 11.5W	48 to 48.5W	24 to 26W
low	1.05 to 1.1W	5W	4.6 to 5W
Peak speech deviation	6.3kHz	7kHz	7kHz
Toneburst deviation	4.8kHz	5kHz	4.9kHz
Frequency accuracy	-900Hz	-200Hz	+290Hz

R N ELECTRONICS

Professionally designed equipment for Amateurs

6 METRE Linear TRANSVERTER

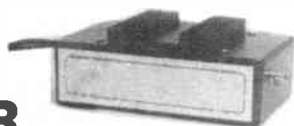

Allows any popular 2 Metre Transceiver (up to 3W) to be used on 6 Metres any mode (ssb, FM, CW, Packet etc.)

- *Low harmonic output*
- *DC or RF switching*
- *Low noise BF981 front end*

Boxed versions supplied with either PL259 or BNC plug to 2 metre transceiver

- 25W pep o/p complete boxed transverter **£172**
+4.00 p&p
- 2W pep o/p complete boxed transverter **£135**
+4.00 p&p
- 2W pep o/p assembled and tested P.C.B. **£105**
+2.00 p&p
- 25W pep o/p add on P.C.B. **£47**
+2.00 p&p
- Now Available :- 10W input alternator **£22**
+ £2 P&P

25W PA for use with FT690 etc. with 2-3W drive including switching and low pass filter **£82**
+4.00 p&p

ALL PRICES INCLUDE VAT

37 Long Ridings Ave Hutton Brentwood
Essex CM13 1EE. Tel: 0277 214406



TX - 3 RTTY/CW/ASCII TRANSCEIVE

The high performance, low cost system

Sillit-screen, type-ahead operation, receive screen unwrap, 24 large memories, clock, review store, call sign capture, RTTY auto CR/LF, CW software filtering and much more. Uses interface or TU. **BBC-B/Master** and **CBM654** tape £20, disc £22. **SPECTRUM** tape £35 inc adapter board. For **VIC20** we have our RTTY/CW transceive program. Tape £20

RX - 4 RTTY/CW/SSTW/AMTOR RECEIVE

This is still a best-selling program and it's easy to see why. Superb performance on 4 modes, switch modes at a keypress to catch all the action. Text and picture store with dump to screen, printer or tape/disc. An essential piece of software for trawling the bands. Uses interface. **BBC-B/Master**, **CBM64** tape £25, disc £27. **VIC20** tape £25. **SPECTRUM** tape £40 inc adapter board. The **SPECTRUM** software-only version (input to EAR socket) is still available £25. **TIFI INTERFACE** Perfect for TX3 and RX4, it has 2-stage RTTY and CW filters and computer noise reduction for excellent reception. Transmit outputs for MIC, PTT and KEY. Kit £15 (assembled PCB + cables, connectors) or ready-made £25, boxed with all connections. Extra MIC leads for extra rigs £3 each. State rig(s). **WORLD AND UK/EUROPE MAP LOCATOR** Maps, great circles, distances, bearings, contest scores. Lat/long, locators, NGR, hundreds of placenames. **BBC-B/Master**, **ELECTRON ONLY**. Tape £10. **MORSE TUTOR** £6, **LOGBOOK** £8, **RAE MATHS** £9 for BBC, **SPECTRUM**, **ELECTRON**, **CBM64**, **VIC20**. All **BBC** and **CBM64** programs are available on **DISC** at £2 extra. Prices include VAT and p&p, 1st Class inland, airmail overseas, normally by return. Eire, CI, BFPO deduct 13%.

technical software (AR)

Fron, Upper Llandwrog, Caernarfon
LL54 7RF. Tel: 0286 881886



ECW for KITS

- | | |
|---------------------------------------------------------------------------------------------------------------------------------------------------------------------------------------------------------------------------------------------------------------------------------------------------------------------------------------------------------------------------------------------------------------------------------------------------------------------------------------------------------------------------------------------------------------------------------------------------------------------------------------------------------------------------------------------------------------------------------------------------------------------------------------------------------------------------------------------------------------------------------------------------------------------------------------------------------------------------------------------------------------------------------------------------------------------------------------------------------------------------------------------------------------------------------------------------------------------------------------------------------------------------------|----------------------------------------------------------------------------------------------------------------------------------------------------------------------------------------------------------------------------------------------------------------------------------------------------------------------------------------------------------------------------------------------------------------------------------------------------------------------------------------------------------------------------------------------------------------------------------------------------------------------------------------------------------------------------------------------------------------------------------------------------------------------------------------------------------------------------------------------------------------------------------------------------------------------------------------------------------------------------------------------------------------------------------------------------------------------------------------------------------------------------------------------------------------------------------------------------------------------------------------------------------------------------------------------------------------------------------------------------------------------------------------------------------------------------------------|
| <p>▷ K2622 - AM/FM Antenna Amp. 22dB gain from 10MHz to 150MHz from this kit. Complete with metal case. 12-15V d.c. supply voltage direct or via coaxial input. 50-75ohm impedance lines. £12.13 per kit</p> <p>▷ K2554 - Quality FM Tuner. Varicap tuning from 85-108MHz. 1.2uV sensitivity, 70dB S/N ratio. AFC, AGC and output for digital frequency display. £32.02 per kit</p> <p>▷ K2553 - Stereo Decoder. Works with K2554 tuner kit, includes stereo indicator signal, stereo on/off and 19kHz filter. Excellent stereo radio reproduction. £17.99 per kit</p> <p>▷ K1771 - Short Range Transmitter. Miniature FM transmitter for short distance communications. Inputs from all mics., pre-amps, etc. 1Megohm input impedance, 5mV sensitivity. 100-108MHz adjustable output frequency. 9-12V d.c. supply. £9.20 per kit</p> <p>▷ K610 - LED VU Meter. VU level display using a 12-LED bar-graph. Adjustable input sensitivity for all types of signals. £15.47 per kit</p> <p>▷ K1798 - 16 LED Stereo VU Meter. Stereo VU display, twin 16-LED high resolution bar-graph output. Internal adjustable pre-amp to give sensitivity from 100mV to 10V full scale. £26.75 per kit</p> | <p>▷ K2032 - 3 digit DPM. Three digit digital panel meter module, +999 to -99mV full scale, zero adjust, overload indication. 1mV resolution and 0.1% linearity. 20uV/°C temperature stability. Compact unit easily built-in to other equipment. £28.54 per kit</p> <p>▷ K1803 - Universal Preamplifier. For signal matching, low-level input boosting, etc. 40dB gain, adjustable output. 20Hz-20kHz bandwidth. 40mV full scale input. £6.84 per kit</p> <p>▷ K2576 - 40W Power Audio Amplifier. No adjustments necessary and non-critical power supply from 2x6 to 2x18V unstabilised. 250mV input sensitivity. 10Hz-50kHz bandwidth. (+/-3dB). Protected against short circuit and thermal overload. £18.83 per kit</p> <p>▷ K2623 - Lab. Quality 24V/3A Power Supply. Short circuit protected bench power supply, adjustable output from 0 to 24V in three current ranges - 0.5, 1.5 and 3.0A. 0.05% line and 1% load regulation. - Indispensable! £40.14 per kit</p> <p>▷ Look at these other examples from our extensive range:</p> <p>K2574 - Up-down counter - four digit £67.22
K2579 - Universal start/stop timer £12.65
K1682 - Microprocessor Universal timer £77.58
Toroidal transformers from £14.15
Membrane keypads - 12 or 16 keys £13.20
Prototype cards, various patterns 160x100mm £5.79</p> |
|---------------------------------------------------------------------------------------------------------------------------------------------------------------------------------------------------------------------------------------------------------------------------------------------------------------------------------------------------------------------------------------------------------------------------------------------------------------------------------------------------------------------------------------------------------------------------------------------------------------------------------------------------------------------------------------------------------------------------------------------------------------------------------------------------------------------------------------------------------------------------------------------------------------------------------------------------------------------------------------------------------------------------------------------------------------------------------------------------------------------------------------------------------------------------------------------------------------------------------------------------------------------------------|----------------------------------------------------------------------------------------------------------------------------------------------------------------------------------------------------------------------------------------------------------------------------------------------------------------------------------------------------------------------------------------------------------------------------------------------------------------------------------------------------------------------------------------------------------------------------------------------------------------------------------------------------------------------------------------------------------------------------------------------------------------------------------------------------------------------------------------------------------------------------------------------------------------------------------------------------------------------------------------------------------------------------------------------------------------------------------------------------------------------------------------------------------------------------------------------------------------------------------------------------------------------------------------------------------------------------------------------------------------------------------------------------------------------------------------|

ECW

Prices include VAT & Postage. For your order, please make cheques payable to
ELECTRONIC & COMPUTER WORKSHOP LTD
Unit 1, Cromwell Centre, Stepfield, Witham, Essex CM8 3TH. Tel: (0376) 517413



A 20M YAGI AND MAST FOR THE 20M BAND

ROY QUANTICK G3UGL DESPAIRED OF MAST AND ANTENNA DESIGNS THAT WERE CLEARLY NOT FOR 'SMALL PLOTS' – SO HE DESIGNED HIS OWN, AND TELLS US HOW HE DID IT.

What is your idea of a small plot? Looking through some of the classic books about antennas and mast design suitable for small plots, they more often produce something that is still far too big to fall within this definition.

My garden plot is 48ft long (14.5m) by 25ft 6in (nearly 8m). There is a lump missing in this plot, where a garage is positioned in the corner near the house, and the property is semi-detached. I believe that this configuration is similar to that of many radio amateurs.

My particular interest in amateur radio is in working the HF bands, and this means having relatively large aerials. I must mention that I actually have planning permission to put up a 40ft (12m) tower, with thanks to the local planning authority for their foresight. However, due to a chronic shortage of the readies, this project has been shelved for the duration.

Some years ago, when the smoothed sunspot number was in the order of 145 and the 10.7cm solar flux went over 200 on occasions, the 10 and 15m bands were doing fine business. I then built a 15m two element yagi antenna which fitted my 'small plot' with room to spare.

From the log, I see my signals were getting into ZS2, 7P3, 5N9 and others were often 5 by 6 to 7, occasionally 5 by 9; a very respectable performance for a two element antenna which was just level with the eaves of this semi-detached QTH, and which had no linear amplifier.

However, in view of the decline in the sunspot number, it was decided to investigate the possibility of becoming active on the 20 metre band. First of all, I set myself two important criteria.

1. The antenna must fit inside my plot and not 'trespass' over the neighbours' plots.
2. The whole system must be manageable by one person ie, me. That is to say, I must be able to raise and lower the whole system by myself.

The height of the 15m antenna built previously was dictated more for convenience, with a system that was not too heavy and could be handled by one person. The results from my signals were most encouraging and while things were working well, I left it well alone. However, using a computer program to evaluate the angle of the main lobe at this height and frequency (22ft and 21.225MHz) (*Reference 2*), it showed a single main lobe at about 31.7 degrees without any further significant lobes.

I already knew that I would have to

increase the elevation of the 20m version of this system and it would be an interesting objective to achieve a similar launch angle if possible. My first consideration was – what would the maximum height I could handle in this small plot be?

Doing some scale drawings, it was established that a 30ft (9m plus) mast was just about the optimum, considering the spread of guy-lines and the rest position when being assembled and tuned. I also took into consideration the one guy-line that had to pass over the oil storage tank. It would be no good to find out later that there was a permanent 'bend' in a guy-line because of an obstruction. This is a real problem with a small plot, so scale drawings are invaluable.

Now, looking at the stock of hardware, I already had a 20ft aluminium scaffold pole and, more by luck than planning, I had another length of 11ft with a sleeve. I thus had a 31ft mast (9.5m). Using this figure for the mast and 14.300MHz for the frequency, I used the computer program (*Reference 2*) to see what the geometry indicated. This produced a launch angle of 33.7 degrees. So, most things being considered, one could assume a similar performance to the 21MHz antenna, and at least I was not going to be 'oo low for this frequency. It now seemed a

feasible project.

Interestingly, using the same computer program for this frequency, but for a hypothetical tower at 65ft (19.8m), produced two lobes, one at 16 degrees, and the other at 53 degrees. I have heard the argument used that such an arrangement could cater for short and long skip. The comparative signal strengths of split lobe patterns is beyond this article, but I feel that I am concentrating virtually all the available energy into one lobe, and I would have to go up to about 38 feet before I could see the angle coming down to somewhere near 28 degrees. Above 40ft, the lobe splits into two. All this data can be evaluated experimentally on a computer, and, I am particularly grateful to G3GIQ for his assistance in this area, particularly in the evaluation of changing ground reflectivity.

Launch angles from antennas is a vast subject, but those of us with small plots are going to get angles close to 33 degrees (at 14.300MHz) for a 30ft mast. Another 5ft only brings this angle down 3 degrees and we are already experiencing the law of diminishing returns, ie, at 40ft the lobe does come down to 23 degrees, but it's already splitting off with a lobe going 'straight up'. It seems that you either have to crank a tower up to 60ft or more, (18.3m) or stay down to below 35ft (10.6m).

At this stage, I had some idea of the maximum height possible for a rigid and guyed mast. Increasing the height of a mast also increases the weight, not to mention the increased size and weight of the 20m yagi antenna. It was obvious at this stage that I should consider some form of mechanical aid to lift the whole system. A number of schemes were studied, including gin poles and various pulley arrangements.

As I was considering a mast of 30ft, it was decided to use two sets of guy lines, one to the top of the mast and the other set to the halfway position.

On the basis of keeping the weight as low as possible, I decided not to use a rotator, at least, not for the initial installation. This presented the problem of how to turn the antenna into the desired direction. There are a number of ways to do this, but my method was to use

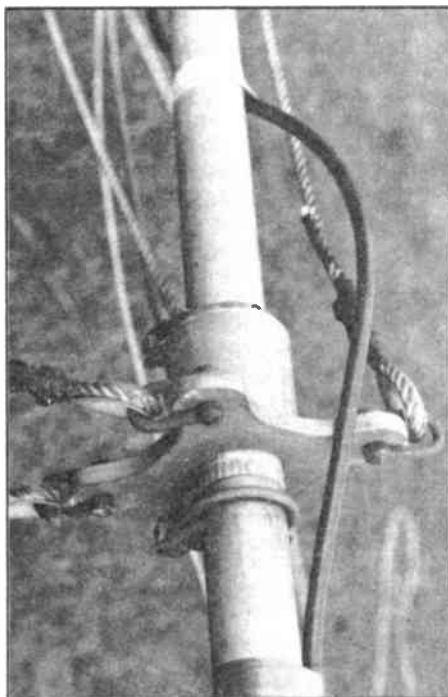

Photograph 1 Guy-line attachments showing the slip-ring, allowing the mast to rotate

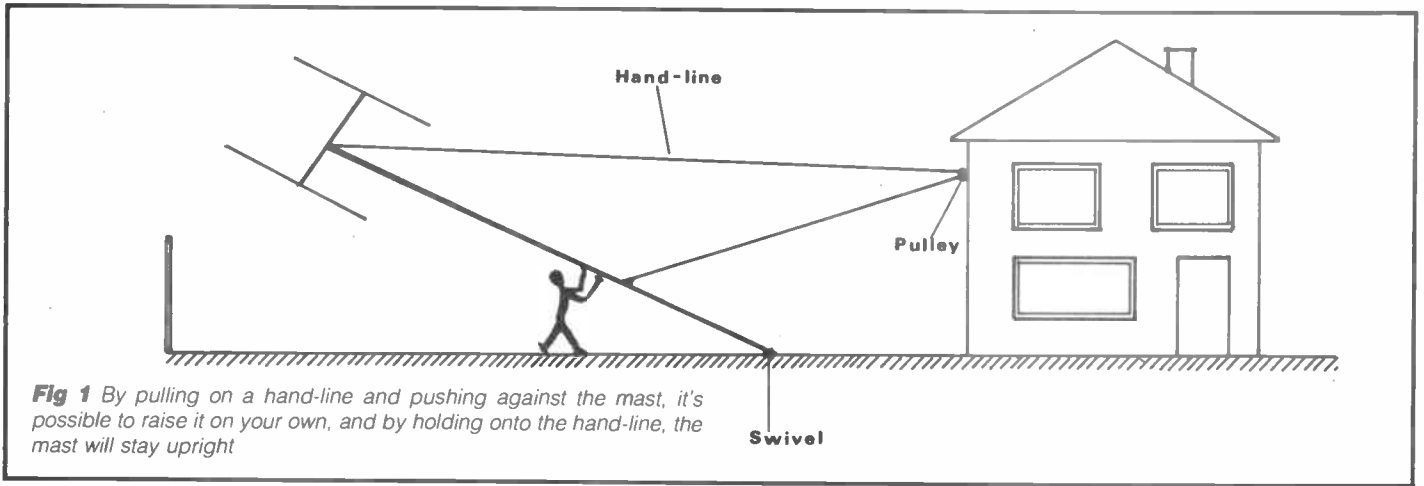
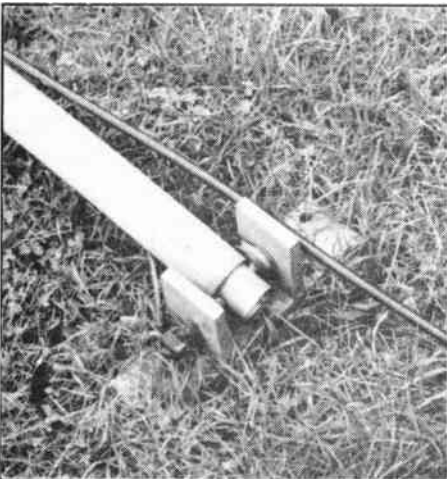

Fig 1 By pulling on a hand-line and pushing against the mast, it's possible to raise it on your own, and by holding onto the hand-line, the mast will stay upright

'slip' rings to attach the guy lines, which will allow the mast to turn and not disturb them (see *Photograph 1*). These slip rings are simply flat 7mm thick aluminium plates cut out to fit loosely over the scaffold pole and four lugs, spaced at 90 degrees, which are drilled to take D shackles. For the top fixing, one of the lugs has two holes, one for the guy line and one for the pulley, which is going to be part of the erecting system. Scaffold poles are standard 1 $\frac{1}{16}$ in in diameter (49mm), so a slightly oversize 2in hole (51mm) gives a good clearance. A 'sleeve' is necessary to support the ring. I made two out of aluminium bar, machined to give a wall thickness of about $\frac{1}{2}$ in (13mm), the internal diameter being the same as the ring. The sleeve was about 10cm long.

To position the rings and sleeve, use 2in (51mm) car exhaust clamps, and sit the sleeve and ring on top of that. A further clamp can be positioned above the ring to stop it sliding when the mast is on the ground. Cut a section out of a washing up liquid bottle and use it as spacer between the mast and the rings. This will stop any scoring. It is also possible to use a flat piece of the same plastic bottle and cut out a flat ring to act as a permanent lubricant between the two surfaces.

The mast, of course, must also be capable of turning on its base and be able to swivel when it's pulled up and lowered. The method I used was the ground stake/pivot system adopted with the smaller mast I made for the 15m



Photograph 2 The mast pivots on a 13mm coach bolt. It is located by inserting a thick walled aluminium tube about 50cm long through which passes the bolt. This allows the mast to pivot and rotate. The base plate has a $\frac{3}{4}$ in length of 10cm channel welded to it as a ground stake

Photograph 3 Showing the mast locked in the desired direction with scaffold clamps

version, except that this time I used a 1m length of aluminium tubing, drilled to take the coach bolt through the end, with sufficient clearance to rotate through horizontal to vertical. The diameter of this tubing was such that it fitted reasonably closely inside the scaffold pole. The wall thickness should be as deep as possible. I used 10 gauge (3.2mm).

All that's now necessary is to push the scaffold pole over this tube, and to use a few metal spacers to keep the mast away from the metal uprights. Admittedly, it is turning with metal to metal contact, but an occasional application of grease is all that is necessary, (see *Photograph 2*).

The next problem is how to lock the mast in a selected position, in fact, how to turn it at all. With tension in all guy lines, all the static forces are against you. What is needed is a bit of simple leverage. Using a further short length of iron scaffold pole, tap it into the ground about 1 $\frac{1}{2}$ metres away from the mast so that there is at least a metre left above ground - these dimensions are not critical, though it must be firm. A further length of tubing can be attached horizontal to the mast and to this a short post with scaffold clamps. It will now be locked solid (see *Photograph 3*). If a swivel clamp is used at the mast, it is possible to lift it over the short post and, used as a lever, this can turn the mast either way.

Using the original fixing on the rear wall of the house, which was used to attach a single sheave pulley for a 'hand line' it was, of course, very easy to pull up a 31ft mast without any antenna perched on top. However, an engineering friend of mine did a few swift calculations and concluded that there was a possibility of



pulling a block of about 4 bricks from the rear wall in this case.

The greatest pull would be at the point where the mast is resting on its ladder/trestle. In order to reduce this force, the rest position must be as high as possible. After all, with an antenna perched on top, it must be at least half a boom length high, plus the element droop above the ground. It should not be too high though, as it is necessary to be able to work on the matching system.

Another consideration is that it would be much easier to pull from as high as possible. More by luck than efficient planning, there happened to be some heavy duty stand-off brackets (24 inch, 61cm) on the rear wall, high up near the eaves. I considered using these to attach the pulley. They were certainly higher up, although not quite in line. Further consideration and discussion resulted in obtaining yet more lengths of (steel) scaffold pole. Using a sleeve, I had a total length of about 23 feet (7m). The pulley was attached to the top, and the line fed through it.

It was now possible to pull on the mast from a more advantageous angle. The forces were being distributed as a bending moment along the length of the steel pole, the weight being allowed to rest on the ground. It was obvious that a lot less effort was necessary, so I

considered that I was now all set to go ahead and make the antenna.

The antenna was assembled for the first time lengthwise in the garden. Two things became immediately obvious: it looked very big, and it felt quite heavy. It weighed in on the bathroom scales at 36lb (17kg), about the same as a popular 3 element tribander. I decided to try and pull up the equivalent weight and test out the erecting procedure. Using an old leather tool bag with a couple of pieces of iron and a brick, I had 39lb (18kg). I also had some help at this stage from G8FAK, who has had considerable experience with home brewed towers.

The tool bag was attached to the top of the mast, and our first attempt at raising it commenced. The exercise was a valuable one in assessing relative stresses and strains, both mechanical and mental. The greatest force required was the initial effort to get the whole thing to start to move upwards. The scaffold pole did bend slightly, but was deemed to be well within its bending limits. Of course, the pull on the mast was not directly in line with the ground pivot position.

With this test weight attached, a new phenomenon became apparent. It did not want to move upwards without first swinging towards the neighbours' fence and in fact, on one lift, the top of the mast went over the fence. It was as a result of the greater moment and in fact, the direction of pull not being exactly in line, which contributed to this. Lowering it back onto the step-ladder, it was time to re-assess the whole thing.

The mast was raised and secured at this point, as this was the best place to leave it. A further bit of construction was envisioned (it seems that I still had some confidence), which entailed making a support for the mast when it was lowered which would not sink into the soft earth. A substantial cross-tree and brace was constructed out of 4 by 2 timber, which would support anything I was able to construct (Photograph 4).

How could I stop the mast swinging? Various paper exercises were tried. Additional guy or restraint lines were not favoured as the whole thing would begin to look like the bowsprit on Nelson's flagship, and, of course, I still wanted to meet my original specification of being able to pull it up and lower it on my own.

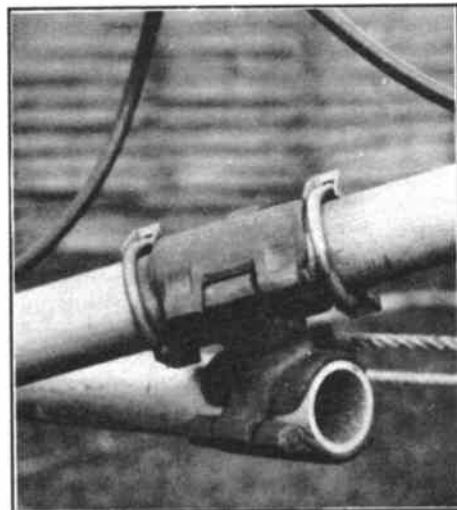

Photograph 4 The cross-tree support for the mast and antenna when lowered. The driven element can be reached from ground level, so all adjustments to the T match can be done quickly

One idea was to use a bracing pole, ie to brace the mast so that there would be no lateral movement, only through horizontal to vertical.

This meant that it was necessary to think out a scheme to attach the bracing pole to the main mast and still allow it to turn, and also to discover how to attach a universal joint at the ground point. Attachment to the mast was easy, just a scaffold swivel clamp, but the clamp to the mast must use spacers, so that when it is tightened, it does not clamp the mast (see Photograph 5).

At ground level there was a different problem, as the joint must work in two planes. It occurred to me (eventually) that using two swivelling scaffold clamps must produce a universal joint somehow. It is necessary to use a short length of tubing as a stand-off for this, which must be attached with a swivel clamp to a post driven into the ground. The second swivel clamp is then attached to this stand-off, which in turn is fastened to the bracing pole.

It is then possible to have the bracing pole go up at whatever angle you choose, and it will rotate when the mast is lowered.

Getting the geometry right is important, of course, because if the siting is wrong it will not rise vertically. The plan was laid out as in Figure 2. Approximately 4ft (just over 1m) of galvanised pole was tapped into the ground and attached to this was the first swivel clamp holding the short stand-off of about 1ft (30cm) of 50mm pipe. Attached to the stand-off was the second clamp, which in turn was attached to the bracing pole. I got a bit worried after knocking in the ground support, as re-arranging the side to which the clamps were attached could change the geometry.

However, I did have the right arrangement with the test pieces, and a bit of experimenting reproduced the correct arrangement. Lowering the mast onto the new trestle support was no problem and, after fixing the universal joint, it was only necessary to move the bracing pole to the mast, and find the point at which to fix it with my final clamp. As a test procedure I elected to use the full 20ft of this nice, shiny new scaffold pole and to reduce this length after a satisfactory performance (see Photograph 6).

Then came the moment of truth.

Fig 2 Showing the layout of the geometry of the mast

Position of 'universal joint'

Photograph 5 The bracing pole is attached to the mast with a swivel scaffold clamp. Spacers are used so that it can be tightened and still allow the mast to turn

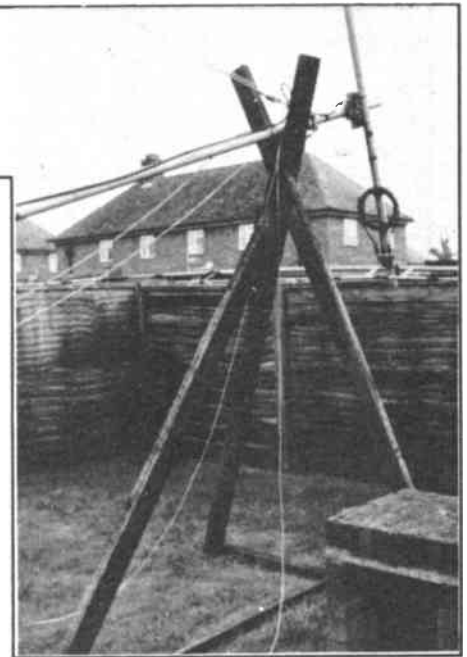

Raising it was easy and it came up with absolutely no lateral movement. It worked although, of course, I had added some weight to the structure which all had to be raised.

Although I had elected to go 'arm-strong' for rotation, this system lent itself to remote rotation (funds permitting) by positioning the rotator near the bottom of the mast. After all, the slip rings allow rotation of the complete mast, so there is no reason why this cannot be effected with the popular type of rotators.

It would be necessary, in this case, to substitute a short stub at the base, which must be drilled to allow the hinge pin (coach bolt) to be inserted. This can now hinge in the normal way.

The stub should be short, say about 18in, anything longer putting a bending moment on the rotator - particularly its top section - when the mast is being raised and lowered. Once upright, most rotators can take quite a heavy load in compression.

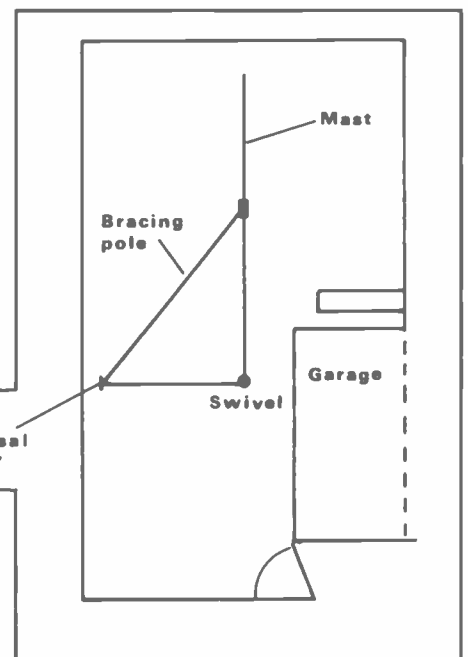



Photograph 6 The stand-off tube is attached to a further tube in the ground, with a swivel clamp forming a universal joint. This is shown after the mast had been lowered

With a small plot, going monoband on 14MHz seemed ambitious, after all, my 21MHz monobander nearly filled the available space.

Looking at the two element, 15m yagi antenna for a moment, the preferred frequency of 21.225MHz produced a driven element of 22ft 5in (nearly 7m) and a director of about 5% less, which just fitted into my plot of 25ft 6in across with a little room to spare. A full sized 20m driven element for 14.250MHz is 33ft 4in, that is to say, a theoretical overhang of nearly 4ft over each side of my plot.

The original line of thinking was to make a dual band antenna for 21 and 14MHz, something on the lines of G3NXN -WG Borland's concept (Reference 4). The reasoning behind this was to produce a reduced sized antenna for the 14MHz band. However, after drawing this out to scale, there was only some 1½ft of available antenna left to accommodate the traps and the tuning tips. Further consideration was given to constructing a triband antenna, introducing a 10MHz section to reduce the span of the 21MHz and the 14MHz section. However, considering the number of coils to wind and tune, together with having experience of home brewing these assemblies, this approach was rejected.

To design an inductive loaded two element yagi antenna from the drawing board is a complex exercise. A good start in this area is Les Moxon G6XN's excellent book (Reference 5). In chapter 12, p166 it states: 'Full sized elements can be reduced in length by about 33% with almost no change in any aspect of performance'. A very encouraging

observation. Using the empirical equation for calculating the length of the driven element (DE) (Reference 3, p88), a full size reduction to about the width of my plot (25ft, 7.62m) represented a reduction of 25%, still well within the maximum of 33% as postulated by G6XN, so a virtual full size performance could be expected.

It was also interesting to note, from G6XN's book (p9), that the current distribution in a driven element decreases to zero at the tips. It would be seen that, for a sine wave, the average current is 64% of the maximum, or alternatively, we can regard the maximum current as flowing through 64% of the length. Furthermore, 71% of the field is produced by the middle half and only 29% by the end portions. G6XN makes the point, that to make a shorter antenna it is better to sacrifice the ends rather than the middle. My proposed approach to the construction fits this observation completely.

Looking again at G3NXM's design, the coil winding was interesting and I considered this approach to be suitable for inductive windings, but of what size and how long and what position? The only reference I could find about inductive coil sizes was in the *ARRL Antenna Book* (Reference 6, p10-19) This design was, in fact, two antennas interlaced on the same boom, one of them being for 20m. The inductance coils were wound with Teflon-insulated audio co-axial cable with the shield-braid and inner conductor shorted together. It was also suggested that No 14 enamelled copper wire could be used. (American wire gauge). G3NXM used 16swg enamelled wire, and also 75 ohm twin lead but, of course, his design was for traps using bifilar connections. I tried a number of different coils, including enamelled copper wire, but by far the easiest to wind was 75 ohm twin lead.

At this stage, decisions had to be made regarding the element diameters. I think that the optimum gauge for aluminium tubing, considering the strength, flexing and general handling is 18 gauge (wall thickness of 0.048in, 1.22mm). Then,

going up or down in increments of ¼in means that it is possible to telescope into or over the subsequent diameters.

In my 21MHz antenna I used 1½in OD for the centre section, then the next diameter down was 1in; then down to ¾in. For the bigger antenna, I decided to use 1¼in gauge for the centre sections. These were supplied in 10 foot lengths.

To lock the tubes together, it is advisable to cut a compression slot into the larger tube. There are a number of ways to do this, but I think using a power drill with a circular saw attachment, complete with a guide rail and a workmate produces the most consistent results. Holding the tube in the jaws of the workmate, you can use the circular saw with the guide rail adjusted to cut exactly along the centre line of the tube. The cut will be dead straight, moreover, it will be about ¼in wide using the popular 5in cutting wheels. Use a cutting wheel for non ferrous metal only.

It is only necessary to make one saw cut, about 4in long, as a standard for all tubes. To clamp the tubes together, use appropriate sized Jubilee hose clips. Before inserting a tube, apply some 'Penetrox' (Mosley Electronics Ltd), or a squirt of WD40, then when the tube is correctly adjusted, tighten the hose clip.

The insertion position of a non conductive element into the tubes is at the 1in OD position (insert diameter ¾in). This point was as much one of convenience as one of appearance, and from the little literature available, seemed a good compromise. Now came the choice of the material to use. In the *ARRL Handbook* (Reference 6) the author uses Plexiglas (acrylic) rod, but I considered the alternative of PVC solid rod (PolyVinyl Chloride). Finding a diameter that would fit into 1in OD, 18 gauge tube, posed a problem as PVC is listed in metric sizes. However, the nearest to ¾in is 22mm, and I obtained about 4m.

At this stage of the proceedings, it was necessary to make up some test pieces using the PVC rod, and some lengths of 1in OD tubing, and to experiment with winding and clamping the 75 ohm twin feeder. The ends of the separate conductors were soldered together.

A point to make at this stage, is that when tightening the coil it is easier to first clamp one end tightly under a hose clip on the side opposite to the screw; keep it away from the compression slot. Insert the other end under the other clamp, but do not tighten it too much.

Fig 3 Test set-up for resonance: when set, centre section situated with an unbroken length of tubing 1¼in OD 18 gauge 10ft long

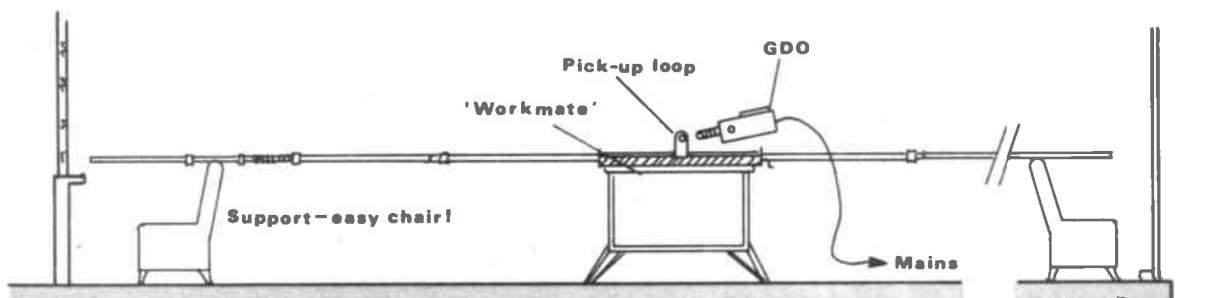

Holding the elements either side of the coil, it is now possible to twist the loose section, tightening up the coil. Now complete the tightening of the second clamp.

How long should the coil wire be? (I have already established the diameter, 22mm). Returning to the *ARRL Handbook* (Reference 6), the author used 30.5 turns of 1/4in across a gap of 6in. This works out to a wire length of nearly 9ft for each coil. The driven element span was 17ft (this is a 50% reduction from a full sized antenna!). Interestingly, the total length of the aluminium, plus the wire in the coils, comes out at nearly 34ft. This is the resonant length of a driven element for 14.050MHz, which is what the author said it does!

Of course, inductance would be a function of the coil diameter, the number of turns, the radius and the length and type of wire. This is all very well if you can figure this little lot out, but the *ARRL* reference at least gave me a starting point. It seems that a coil length somewhere around the loss of span could be somewhere in the ball park, provided the coil parameters are not changed too much.

My antenna span was to be 24ft. The reduction in size from a full sized antenna for a resonant frequency of 14.3MHz is 33.2 - 24ft = 9.2ft, which gives 4.6ft per coil.

The inductance formula (Reference 7, p22) shows a greater sensitivity to coil diameter than to the number of turns. Rearranging this formula, I used a computer to obtain an empirical relationship between the coil diameter and length from the *ARRL* design, and found a percentage increase in coil length for my smaller diameter of 22mm. This increase was 38% which, applied to my first calculation of 4.6ft, gave me a total coil length of 7.41ft (2.25m). This produced a coil of 27 turns across a gap of 5.5in (13.97mm).

With all design data and concepts established, it was now time to put this lot together and see how close I was to the truth.

The coil parameters were already set. The length of PVC rod used for the coil, with 1ft to insert either side, made a total length of about 30in. The elements were arranged as in Figure 3. For resonance tests, I used scrap aluminium for the centre section with a 2in (5.08cm) gap in the centre. A pick-up loop crossed this gap for the GDO. After setting up the elements and temporary centre section, the first test of resonance was a shock - it resonated at 14.3MHz!

The next step, after deciding that the resonance was correct, was to check the coils for security and then to wrap them in self amalgamating tape. Removing the temporary centre section and substituting the 1/4in OD 10ft continuous section, I had my driven element complete. Before dismantling it, it was necessary to mark it up. One way to do this is to use coloured plastic insulation tape. Use different colours for the adjacent sections, and also remember to identify which side the sections fit.

The director was designed to be 6%

smaller in size and 5% higher in frequency. The same test procedure was made, and again I was very close to the correct coil parameters: this time resonance was at 15.052MHz. I was very careful to mark these sections differently to those of the driven element; this may only be a two element antenna, but there are a total of 18 separate sections! However, it is not necessary, of course, to dismantle down to the last single item, but simply to a stage where they can be stored.

Element spacing

I used a 2in OD 14 gauge tube for the boom with a wall thickness of 0.08in. How long should it be? From Reference 3, p88, the empirical formula for element spacing is $120/F(\text{MHz})$. For 14.3MHz this would give 8.39ft, which is equivalent to 0.122 wavelength spacing. From G6XN's book, p70, this is the point where the mutual reactance between parallel half wave dipoles is zero, so I set the element spacing at this figure.

Looking at the *ARRL* reference p6-15, the choice of making the parasitic element a director rather than a reflector has certain advantages. In the first instance, it makes a smaller antenna and larger front-to-back ratios can be obtained with a parasitic element tuned as a director. Maximum theoretical gain is 5.5dB at a shade over 0.1 wavelength spacing, radiation resistance is in the order of 18 ohms. However, the tuning conditions that provide maximum gain do not provide a maximum front-to-back relationship.

In order to improve the front-to-back ratio, it is necessary to tune the parasitic element carefully. This is more critical than tuning for maximum gain, but a good front to back ratio can be obtained, theoretically at about 17dB, however, in the real world it will be more like 12 to 15dB at the expense of about 1dB or less of forward gain. (Reference 3, p70).

The formulae used for a two element full sized antenna are, $DE = 475/F(\text{MHz})$ and for the DIR, $448/F(\text{MHz})$. What I was particularly interested to find was the percentage relationship between the two constants, and this happens to be 6%. I already had the maximum size for the driven element set at 24ft, so a 6% reduction would make the director 22.56ft (6.87m).

Now what about resonant frequency? From the published data on antenna dimensions and frequencies from the above references, the size relationship between DE and DIR we already know is 6%, but the resonant frequency is 5%, so I set the resonant frequency at 5% higher for the DIR ie, 15.052MHz. As I stated earlier, this was the actual resonant frequency, because I found it possible to make it range from 14.9MHz to 15.2MHz in my experiments for the same physical span. Parasitic elements must, of course, not be self-resonant within the desired operating range of the antenna, otherwise there are going to be real problems.

References

- 1 Allaway, E J et al (1977) *Radio Communication Handbook*, RSGB, Vol 2:12-91 and 18.10.
- 2 Stonehocker, G (1986) *DX Forecaster*. (Horant Computer Program) *Ham Radio Magazine* (USA): 10-92
- 3 Orr, W I et al, (1983) *Beam Antenna Handbook*, Radio Publications Inc, USA, 5th Edition.
- 4 Borland, W G (1982) *A New Concept in Antenna Traps for Three-Band Beams*, *Radio Communication*, RSGB, Vol 58 July, 584-585.
- 5 Moxon, L A (1982) *HF Antennas for all Locations*, RSGB.
- 6 Anon, (1982) *The ARRL Antenna Book* USA, 14th Edition.
- 7 Jessop, G R et al, *Radio Data Reference Book*, 5th Edition. RSGB.
- 8 Timestep Electronics Ltd, Wickhambrook, Newmarket, Suffolk.



Next month . . .

Roy Quantick completes his article with a description of how to match the feeder to the antenna and construct the halfwave balun. Assembly and tuning are also covered, which only leaves the effort required on your part to have a go.

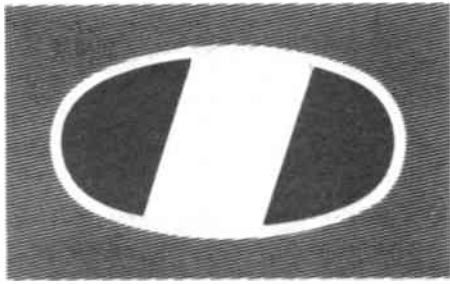

ICOM

Communications



VHF/UHF FM Handportables

If you want a handheld with exceptional features quality built to last and a wide variety of interchangeable accessories, take a look at the ICOM range of FM transceivers. All ICOM handportables come with a nicad battery pack AC wall charger flexible antenna and wrist strap

Micro 2E/4E

These new micro-sized 2 metre and 70 centimetre handportables give the performance and reliability you've come to expect from ICOM. Measuring only 148 x 50 x 30 the Micro fits in your pocket as easily as a cassette tape. The Micro 2E/4E features an up/down tuning system for quick frequency adjustments, 10 programmable memories, a top panel LCD readout up to 2.5 watts of output (optional).

IC-2E 2 metre Thumbwheel Handportable

This popular handheld from ICOM is still available. For those amateurs who require a straightforward and effective FM transceiver the IC-2E takes some beating. Frequency selection is by means of thumbwheel switches (with 5Khz up switch) simplex or duplex facility. Power output is 1.5 watts or low 150 milliwatts (2.5 watts possible with BP5A battery pack).

IC-02E/04E 2 metre and 70cm Keypad Handportable

These direct entry CPU controlled handhelds utilise a 16 button keypad allowing easy access to frequencies, memories and scan functions. Ten memories store frequency and offset, these handhelds have an LCD readout and power output is 2.5 watts or low 0.5 watt. 5 watts is possible with the IC-BP7 battery pack or external 13.8v DC.

IC-12E 23cm Handportable

Similar in design and style to the 02E/04E this 1296Mhz handheld utilises ICOM's experience in CHZ technology gained by the excellent IC-1271E base station. Power output is 1 watt from the standard BP3 nicad pack. external 13.8v DC powering is available to the top panel jack. With the growing number of repeaters on 23cm the IC-12E makes it an ideal band for rag chew contacts.

ALSO AVAILABLE FOR ICOM HANDPORTABLES ARE A LARGE RANGE OF OPTIONAL EXTRAS INCLUDING A VARIETY OF RECHARGEABLE NICAD POWER PACKS, DRY CELL BATTERY PACKS, DESK CHARGERS, HEADSET AND BOOM MIC, LEATHERETTE CASES AND MOBILE MOUNTING BRACKETS.

You can get what you want just by picking up the telephone. Our mail order department offers you free same day despatch whenever possible. instant credit interest free H.P. Barclaycard and Access facility. 24 hour answerphone service.



Datapost

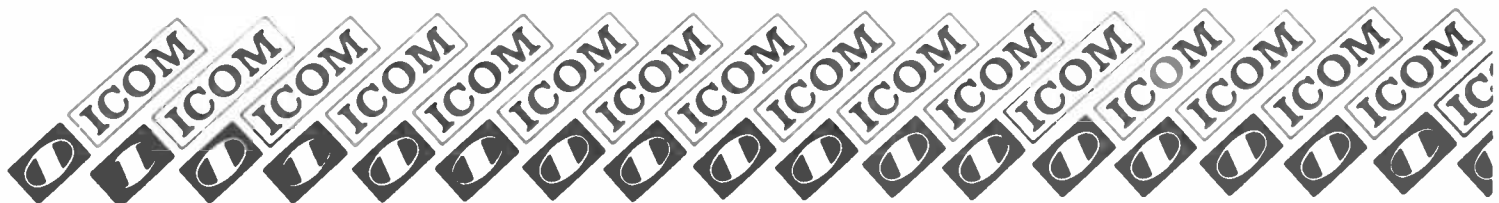

IC-28E, 2m FM Mini-mobile.

This 2 metre band transceiver is just 140mm (W) x 50mm (H) x 133mm (D) and will fit nearly anywhere in your vehicle or shack. Power output is 25 watts or 5 watts low power and is supplied complete with an internal loudspeaker.

The large front panel LCD readout is designed for wide angle viewing with an automatic dimmer circuit to control the back lighting of the display for day or night operation.

The front layout is very simple, all the controls are easy to select making mobile operation safe. The IC-28E contains 21 memory channels with duplex and memory skip functions. All memories and frequencies can be scanned by using the HM-15 microphone provided. Also available is the IC-28H with the same features but with a 45 watt output power.

Options include IC-PS45 13.8v 8A power supply, SP8 and SP10 external speakers, HS15 flexible mobile microphone and PTT switchbox.



IC-3200E, Dual-band transceiver.



If you are a newly licensed or just undecided about which band to first operate, then the ICOM IC-3200E is just the answer. This is a dual-band (144-146/430-440MHz) F.M. transceiver ideally suited for the mobile operator. The IC-3200E has a built in duplexer and can operate on one antenna for both VHF and UHF, and with 25 watts of

output power on both bands (the low power can be adjusted from 1 to 10 watts) you can never be far from a contact whether simplex or 2m/70cm repeater.

The IC-3200E employs a function key for low priority operations to simplify the front panel and a new LCD display which is easy to read in bright sunlight, 10 memory channels will show operating frequencies simplex or duplex, and four scanning systems memory, band, program and priority scan.

IC-48E, 70cm. FM Mini-mobile.

This 70cm. band transceiver is so small that it will fit almost anywhere in your vehicle or shack. Power output is 25 watts or 5 watts low, the IC-48E is supplied complete with an internal loud-speaker. The large front panel LCD readout is designed for wide-angle viewing with an automatic dimmer circuit to control the back lighting of the display for day or night operating. The front panel of the IC-48E is straightforward to make mobile operation safe and easy. The IC-48E contains 21 memory channels with duplex and memory skip functions. All memories and frequencies can be scanned by using the HM15 hand mic provided.

IC-48E options include the PS45 13.8V. 8 amp power supply, SP8 and SP10 external loudspeakers, HS15/SB mobile flexible microphone and PTT switchbox.

Why not try 70 cms as a serious alternative to the 2 metre band, you might be amazed at what can be achieved. For more information contact us or your local ICOM dealer.



Telephone us free-of-charge on:

HELPLINE 0800-521145.

— Mon-Fri 09 00-13 00 and 1400-17 30 —

This is strictly a helpline for obtaining information about or ordering ICOM equipment. We regret this service cannot be used by dealers or for repair enquiries and parts orders. Thank you

ICOM (UK) LIMITED
Dept AR, Sea Street,
Herne Bay, Kent CT6 8LD.
Tel: 0227 363859.

SHORT WAVE LISTENER

TREVOR MORGAN GW40XB

Well, in a month that has seen the sudden demise of what was laughingly called our summer, the bands have been something of a mixed bag. Ten and fifteen metres have come alive at times and even the new bands have shown promise – when they have opened up. As always, there was plenty to be heard if you happened to be around at the time when things were happening.

Big fish

One of those who did catch the 'big fish' when they surfaced was Joan Slater ILA185 of Matlock, who reported FY5YE, 8P6BC, VK2AVE, NL7JZ, YB6MF, KU4JC, KC7RD/5N, VP2MDY and KL7LF/P/KH3 on twenty metres while forty yielded PY5EG, PT7WX, ZD7DJ, ZD8RP and PT7CE. A nice one amongst the usual Europeans on fifteen was ZY4OY, but Joan couldn't find anything else worthy of note.

However, as she is still learning to drive her new Lowe HF125 and only has a temporary aerial at the moment, reception leaves a lot to be desired, but she is still delighted with the results thus far. Unfortunately, her disc drive started playing silly beggars and she can't get to her logs, so the old index cards are having to be used as a temporary measure.

Fast and furious

Since getting his Gold Prefix Award, Barrie Musselwhite ILA068, has been logging furiously out there in Warminster. Featuring amongst some very interesting stuff were ZS6ABM, S2OK, HS0B, 9K2DZ, VU2VAV, ZD8RP (QSL via Box 1, Ascension Island or to F H Bliss, Coppalex, North Road, The Reddings, Cheltenham), 9Y2SAL, VC8RCS, HP1AMD, 9Y2SLF, ZP4SOA (QSL via Box 520, Asuncion, Paraguay) and VF1YX (QSL via VE1YX).

Bill Cusack ILA168 from Letchworth relates that he sent a report to 9K2KW for a twenty metre logging made in

June, enclosing a couple of IRCs for good measure. Much to his surprise, he recently received not only a QSL card in return, but a very nice letter and his IRCs back! Now that's courtesy for you!

Elmer Liddicoat ILA003, of St Austell, is still chasing the prefixes for our Premier Award for 2000 different prefixes but says that as he's been getting the RAE and Morse test out of the way, he's been a bit short of time... a likely story! (only got one credit, too!). All joking apart, Elmer, now G0IGD, pays compliments to the staff at the Liskeard Centre where he took his Morse test. They made him feel right at home and stopped his hand shaking... take a bow, lads!

Noises off

It seems that Reg Keeley-Osgood G0GIA, of Gosport, didn't have it quite as easy when taking the test at a local rally. Nothing against the examiners, but the conditions and extraneous noises were diabolical. Quite different to the test centre at Winchester where things are done to perfection. But, as Reg puts it, how do you reckon on coping with crowded bands if you can't take a bit of noise in the test?

To be fair, the test should be held under as near perfect conditions as possible, but many test stations at rallies suffer from the same problems with noisy backgrounds and some terrible keys. It's bad enough, after having practised for months using a good quality key, being handed a right old clunker from the year dot, without having to put up with tannoys and other noises. As far as getting into the busy bands is concerned, we've always said that there's *no* substitute for good listening experience, as many of our readers have found.

Just to back up the point, this month's long Prefix Award claimant is Jon Sales ILA006, of Lancaster, who really went for it while getting

ready for his test and kept up the effort after becoming G0AZS (well done, Jon) and now claims the Gold Award for 1000 prefixes on Morse *only!* And a real cracker of a list it is too! This list also entitles Jon to the Premier Award as his previous Gold claim was for phone only, so a double 'congrats' is due. As a result of his improved Morse, Jon has claimed the RNARS 15wpm certificate as well.

Great reception

Having recently moved to a new QTH, Jon has put up a single element 140ft loop which has done wonders for reception. So to the list, which includes 3G87, 5A0, 5L2, 8P6, 9Y4, A71, AA7, AB9, BV2, CN32, CX5, FY2, HC2, HH9, HK7, HP2, IP8, J66, KT3/PJ3, KZ4, LU8, PP8, PW8, SN9, T77, VP9, YV5, ZP5, V47 and lots of other choice catches.

I had a couple of letters this month from readers enquiring about reference books for frequencies they could scan with their scanning receivers. There are quite a lot around at the moment and, with some new models coming shortly, there is obviously a big call for scanning literature.

Waters and Stanton do some good frequency guides at reasonable prices. The *Complete VHF/UHF Frequency Guide* covers 26-2250MHz including all types of users and costs £4.95. The *UK Listeners Confidential Frequency List* covers 1.6-30MHz at £5.95. The *VHF/UHF Airband Frequency Guide* is also £5.95. These prices are plus 80p postage.

Strictly illegal

This company does a range of books for the scanner user and the regular listener so drop them a line for full details at 18/20 Main Road, Hockley, Essex SS5 4QS. A quick reminder of the law concerning listeners, that it is illegal to relay *any* information you may receive to *anyone* other than the recognised authorities! Strictly speaking, it's illegal to even

listen to some transmissions, so be warned.

Also in the mail this month was a letter from Jim May, Hon Secretary of the ISWL, which has received a number of QSL cards destined originally for listeners with such numbers as G0I-1836523, G2S-2046746 and other such configurations. If you can identify these numbers, please let Jim know so that he can pass them on... otherwise their destination might not be as intended!

This raises the point that, with many organisations having their own QSL managers, there are a lot of cards going astray. If a foreign bureau doesn't know where to send a batch of cards it will bundle them off to the RSGB or ISWL or other recognised bureau.

Misdirected cards

If you do use a different bureau to those two, perhaps you would let me know what the prefixes of the members are (RSGB uses BRS and ISWL uses amateur prefixes such as G, GW etc) so that if any bureaux do mention misdirected cards, I can put them right.

While mentioning Jim May, he sent me a copy of the current ISWL magazine, *Monitor*, which made very interesting reading. Plenty of information and some nice articles by contributors. Details of the League can be gleaned from Jim, QTHR.

RAC award

The Cornish RAC issues an award for logging stations in that area, whether resident or visiting. The scoring is one point per station with thirty points required for 1.8-146MHz (one mode or mixed), nine points for 432MHz and over, and 20 points for RTTY on all bands.

The awards cost 50p and claims should include the usual date, time, frequency, mode of information. Send your claims to J Bowden G2AYQ QTHR.

And now to contesting, and that annual listeners' special.

The White Rose ARS 8th Annual Low Frequency contest is being held from 1200hrs on January 16th to 1200hrs on January 17th 1988. This is the 'phone' section. The Morse section is on January 30th and 31st at the same times.

Loggings for the 1.8, 3.5 and 7MHz bands will be valid. It's nice to know that the old ploy of 'locking on' to a bit of choice DX is frowned upon in this contest (great for prefix hunting...not for contests, lads) so log entries must not include the same callsign in the 'station worked' column more than ten times on any band and that station can only be claimed *once* for scoring... *duplicates must be shown!*

The object is to log a maximum of five stations per country in as many countries as possible. Countries outside your own continent score *five* points, all others score *one* point each. The total points on each band are to be multiplied by the number of countries heard on that band, eg 240 points x 10 countries = 2400 points. The final total is the three band scores added together. CQ calls are *not* valid nor are /AM or /MM.

The usual date/time/band/station heard/station worked and report at SWL. Only claims for stations actually heard will qualify and *full* callsigns *must* be given. Entries to John Hart G3ZGA, White Rose ARS, 146 Street Lane, Leeds LS8 2AD before February 23rd. Good luck lads!

Heath Robinsons

It was a heck of a long time ago that Vernon GW0DST and I experimented with data and RTTY for the first time and we came up with some right Heath Robinsons to interface our Speccies. The final outcome was a unit that has done sterling service for a few years now. However, while we were at Bristol t'other month, we saw a very nice filter on demonstration that looked like it might suit our requirements. So, throwing caution to the wind (and my wallet), I brought one home. How is it I always risk my loot on the test bed?

The SPR52 Tone Processor is presented as a ready assembled printed circuit board, which only needs a few off board components and a

box to complete the working unit. As is usual, I used one of my 'stock' boxes, the Maplin LF11M, which measures 5 1/4in x 4in x 1 1/2in, which was just the right size. This was drilled to take three 3.5mm jack sockets, two sub-miniature toggles (SPDT), a mounted LED and a hole for the PTT/mic line.

The circuit board is ready fitted with solder pins to attach the wire leads to, except for the LED (?), and soldering these leads was simple following the guide supplied. A 9V battery clip and leads were soldered to the power input terminals, but it is possible to power the unit from the station 13.8V supply. I found it best to solder all the parts before putting the completed unit into the box, as some of the pins are very close to the edge of the board.

Testing time

The unit was then tested briefly and the board mounted into the box. I used double stick pads and earthed the board to the box, but holes are supplied for fixing screws. Finishing the project is a matter of taste, but my favourite method is to give the box a coat of Holts undercoat, followed by metallic grey. Lettering can then be added using rub on letters and the finished box given a coat of clear polyurethane, which seals the letters and gives a hard surface.

For the Spectrum

The finished filter fits between the receiver (or transceiver) and the computer. It is designed with the Spectrum in mind, but I dare

say some will try it on other machines. An extra recorder connecting lead is not necessary, as once the program is loaded, the lead can be disconnected from the recorder and plugged into the filter. A lead terminated to fit the receiver audio output is necessary, and licensed amateurs can connect PTT/mic lines as required.

Improved reception

The unit was designed to improve the quality of RTTY reception, especially on the busy HF bands where close proximity signals or fading, even if slight, can cause displays of a mass of garbage or lines of single letters... very annoying when you want a printout! It consists of a receive buffer amplifier, a double filter section and an audio amplifier. To aid transmission, an active bandpass filter is included in the transmit line to ensure correct sine waves are presented to the transmitter. A filter bypass switch is included in the circuit and the output to the computer is controlled at 5V p/p for 500mV audio input.

Superb results

Loading the G1FTU RTTY program, I found that tuning was, as expected, much more critical, but once the signal was resolved the results were, quite honestly, superb. As I live in an awkward location between two hills, RTTY reception has never been marvellous and I have never managed to get a signal strong enough from the USA to resolve it. So it was much to my surprise that on my third attempt I resolved WA2JBM! This was followed by C31SD, a

crop of Europeans and YV0KAJ. Without the filter, the Europeans were still there but, although I could hear them, the others were no-go.

Better Morse

I swapped programs to the RX4 with the same results, with much less hash than without the filter and cleaner signal resolutions. Just to be nasty, I tried receiving SSTV through the filter, but without much success as the signals were clipped by the narrow filtering and, as the RTTY was so good, I was reluctant to adjust anything at this time. However, with the filter off, it was possible to both transmit and receive SSTV so there was no need to remove the unit when changing modes. Incidentally, I also found Morse signals better with the filter in.

It has proven to be a very effective filter and at £22.50 I can recommend it to those who don't want to homebrew. The filter is available from B&J Telecommunications, 9 Queens Walk, Thornbury, Bristol BS12 1SR. Please add 50p for postage.

Closing time

Well, it's closing time again. As the Christmas season is upon us yet again, I wish you all the very best for Christmas and the New Year! I hope your listening gives you great pleasure in 1988 and, for those taking RAE courses, that your experience stands you in good stead when exam time comes. Thank you all for your letters, favourable and otherwise, and please keep them coming! Regards es 73, Trevor.

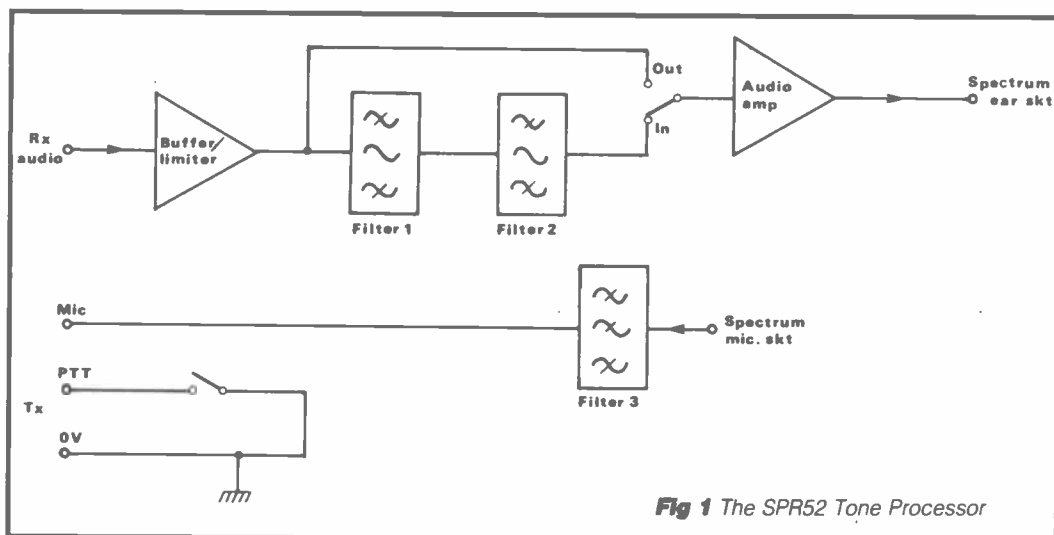

Fig 1 The SPR52 Tone Processor

Made by the Collins Radio Company for the United States Navy, the TCS had a number of variants, eg TCS7, TCS9, TCS10, TCS11, TCS12 and TCS13. These radios were basically the same and the transmitter/receiver to be described is the TCS12, as noted on the identification plates. The name Collins will be familiar to many readers and is a byword for rugged, well built equipment. The TCS12, although WWII vintage, falls into this category and no skimping in metalwork or components can be found.

In common with many radios manufactured during WWII both in the USA and UK, the mother factory was unable to meet the demand of the services and they were then built, to the same specification, by other manufacturers. In the case of the Collins TCS series, the plate could well indicate that Collins, Stewart-Warner, Magnavox, Sheridan or Meissner were the actual manufacturers. There is no significant difference between the different makes and I think it can be assumed that the components were in fact from the same source, with the assembly being done at the various factories mentioned.

Various uses

Although, as previously mentioned, the equipment was made for the US Navy, it could of course be used – and was used – in vehicles and as a low power, land based fixed installation. It found its way into both the RAF and the Royal Navy and the author has had many interesting discussions with radio operators of both services, who were unflinching in their praise of its performance both as a mobile unit and as a shore (land) base station. Flexibility was guaranteed by the availability of a wide range of power units, by far the widest in my own experience, which included 12 volts dc, 24 volts dc, 32 volts dc, 115 volts dc, 230 volts dc and 115/230 volts ac at 50/60Hz! Separate dynamotors, separate motors driving generators, single but dual voltage dynamotors and two 'look alike' ac mains power units just about covered every eventuality.

The radio proper consisted of the transmitter and the separate receiver, both of identical size. These were linked into the selected power unit by two 10ft multi-cored, armoured cables. Although capable of being operated in this mode (local control), a remote control unit was

THE COLLINS TCS SI

Among the many remaining examples of WWII equipment must rank very high. Certainly from an operational point of view it is more well known T1154/R1155 installation and most of th

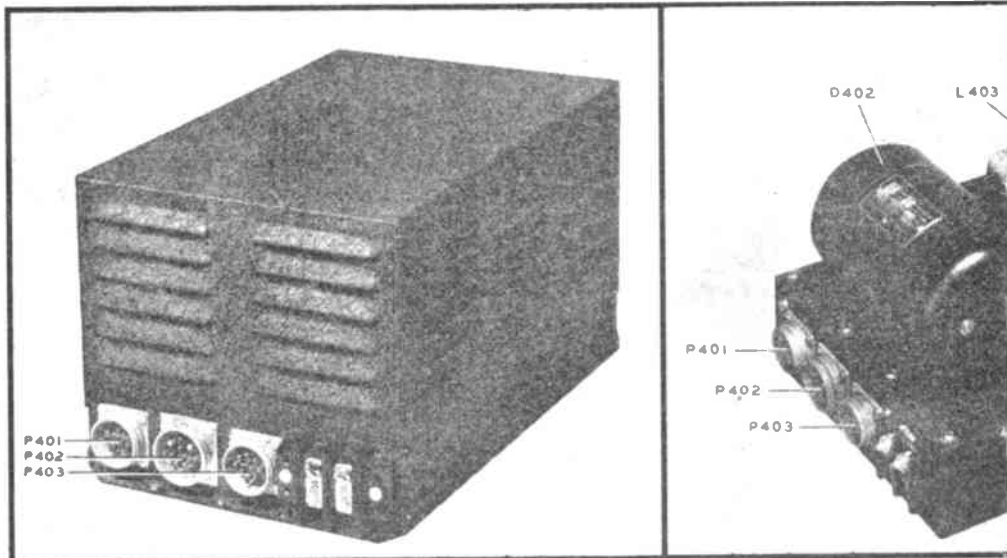

also available, which contained a speaker and matching transformer, key and mic input, volume control and toggle switches to energise the installation. A loading coil with taps was also available, which was useful when very short aerials were in use and operation was required on the lower frequencies – say 1.5 to 3MHz.

The TCS12 was capable of operating either in the CW mode or AM phone over the band of frequencies from 1.5MHz to 12MHz.

The transmitter

Massively built and weighing about 49 pounds in a 1ft cube, it included a very well designed ATU with roller coaster coil, variable coupling between tank circuit and ATU with a facility to insert a series or parallel capacitor in the circuitry. This ATU would in general match the PA into a vertical 20ft whip aerial (beloved of all naval installations). The valve lineup used the 12 volt heater, types 12A6 and 1625 in the PA and modulator. On CW two 1625s were used

in the PA and the heaters of the 1625 modulators were disconnected. In the AM mode one of the 1625 PA valve heaters was disconnected and the two modulator valves energised. With a fixed amount of current available from the PSU this was a very neat way round the problem.

Naturally the dc power input to the PA was much greater on CW than phone, nevertheless the anode and screen modulation of the PA produced a very potent signal, far superior to the various screen or grid modulation systems adopted by other rigs in use at the time.

Facilities were available to operate on four crystal controlled frequencies, in addition to the MO (VFO). The MO is beautifully geared down and no problem has ever been noted concerning backlash. The dial readout is well engraved, but being general coverage is by amateur standards cramped and small; nevertheless, given reasonable lighting, there are no great difficulties in operating on the bands covered. A useful MO test position allows the VFO to be

Fig 1 Block diagram of the transmitter

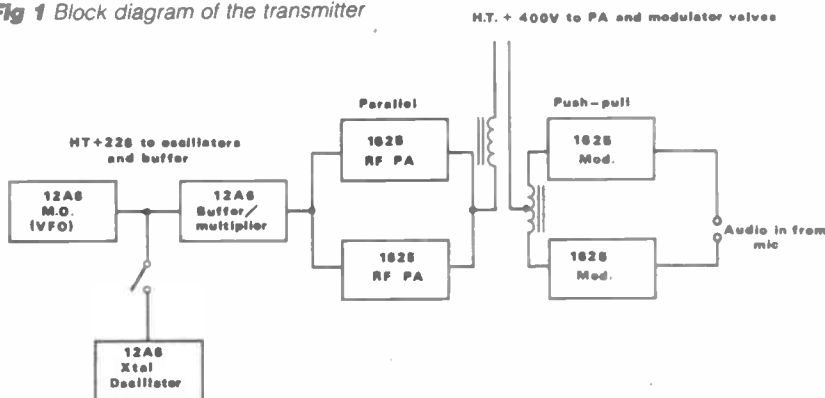
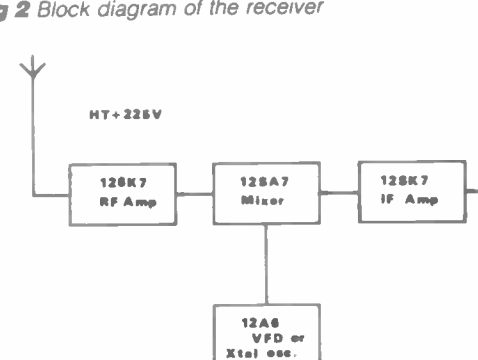
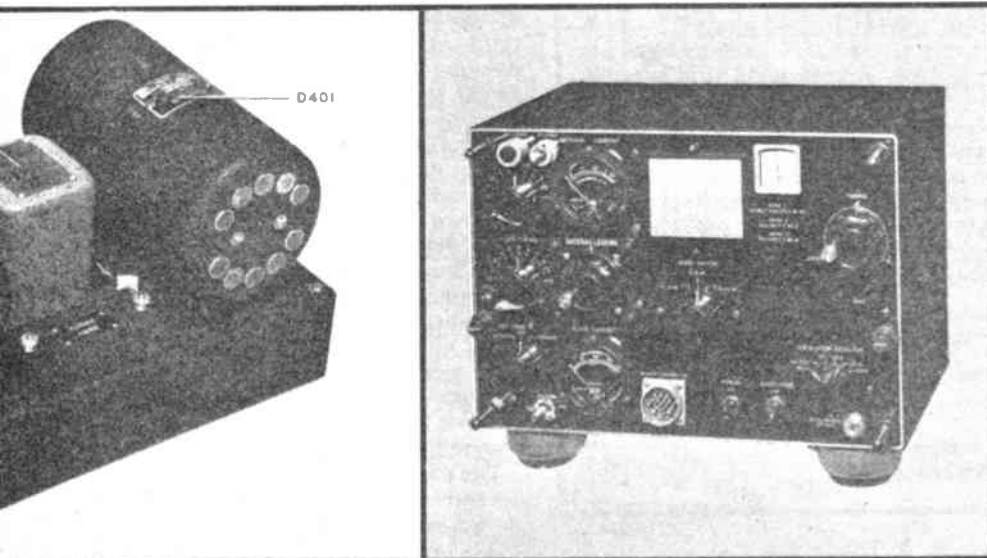

Fig 2 Block diagram of the receiver



RIES REMEMBERED

which are collectable and still usable, the TCS series of ... point of view it has a performance far in excess of the army radios of the same era, A H Cain reports.



'spotted' on the receiver. In this position the MO and buffer stage is running, but not the PA while the receiver is not de-energised.

Keying is rather a noisy affair, with two large relays breaking the HT supplies and the aerial connections. This could have been another minus factor at one time, as key click filtering would need a great deal of attention. A carbon mic is used for 'phone and although some modulation circuits using carbon mics can be a bit scratchy, this is basically a 'carbon quality' fault and a good carbon insert can in fact produce very acceptable audio.

A T17 mic is used with this installation, with a new carbon button and is satisfactory. There is no pre-amp with the modulator, the carbon mic driving the grids of the modulator valves via a step up transformer. The energizing voltage for the carbon mic is obtained from the cathode volts of the 1625 modulators, dropped and smoothed by a resistor and capacitor. A block diagram of the transmitter is shown in *Figure 1*.

The receiver

Marginally lighter at 40 pounds, the receiver is built to the same high standard as the transmitter. 12 volt heater valves are used throughout, with the following line up: RF stage, mixer with separate oscillator, either crystal control or MO (VFO), two IF stages at 455kHz, a detector and first audio stage in one valve, with a final audio amplifier valve. The output transformer is designed to operate into a 500 ohm load, so a matching transformer is required if a low impedance speaker is to be used (the correct matching transformer and speaker are contained in the remote unit; however it is not too difficult to find a 'near' match transformer). Phone output is from the same winding, but is via a dropping resistor to avoid excessive audio being applied to the headset.

There are two major peculiarities with the receiver, one being the oscillator circuit which has an output type valve (12A6). This would in theory give far too much oscillator drive voltage to the mixer. On a monitor receiver, the RF

output from the 12A6 is very powerful indeed. A 12J5 can be substituted without any circuit changes except slight recalibration, but although this performs satisfactorily and reduces current demand, there is a fall off in performance on the higher frequencies. The frequency range and number of bands is exactly the same as the transmitter.

The other peculiarity is the BFO, which utilizes the same valve, at the same time, as the first audio amplifier. These reflex circuits are not unknown when trying to get a quart out of a pint pot, but are not really the type of circuitry expected in a receiver where, in every other respect, money does not appear to have been considered! However, it works, although an official modification required the insertion of a small RF choke in the BFO circuitry. This was to prevent parasitic oscillation on the higher frequencies when an above average gain valve was fitted. With the type of valve fitted as RF and IF amplifiers (12SK7s) performance is adequate rather than outstanding. The use of very high 'Q' RF coils and IF transformers, ceramic valve holders and switches does, however, make up quite considerably for any losses suffered by the use of rather low gain valves.

Selectivity is, by modern standards, only fair and there is no filtering of any kind fitted to sharpen up the selectivity characteristics. The receiver will operate with either a separate aerial, or the transmit aerial from the aerial changeover relay in the transmitter. A block diagram of the receiver is shown in *Figure 2*.

Servicing

Although built on an early modular type system, neither the transmitter nor the receiver are particularly easy to get at for testing. The IF stage valve holders, for example, are inaccessible for voltage testing and the loomed wiring, lacking colour coding, can be difficult. In many cases, the best way to get at components is to remove the back or side plates of the units. At first sight this appears to be pretty drastic but as these plates, which also carry components, are bolted up with hefty crossheads, a good crosshead screwdriver can quickly dismantle whichever plate needs to come off. With care, this can be pulled back on the end of various leads from main and sub looms. A quick nick across some of the

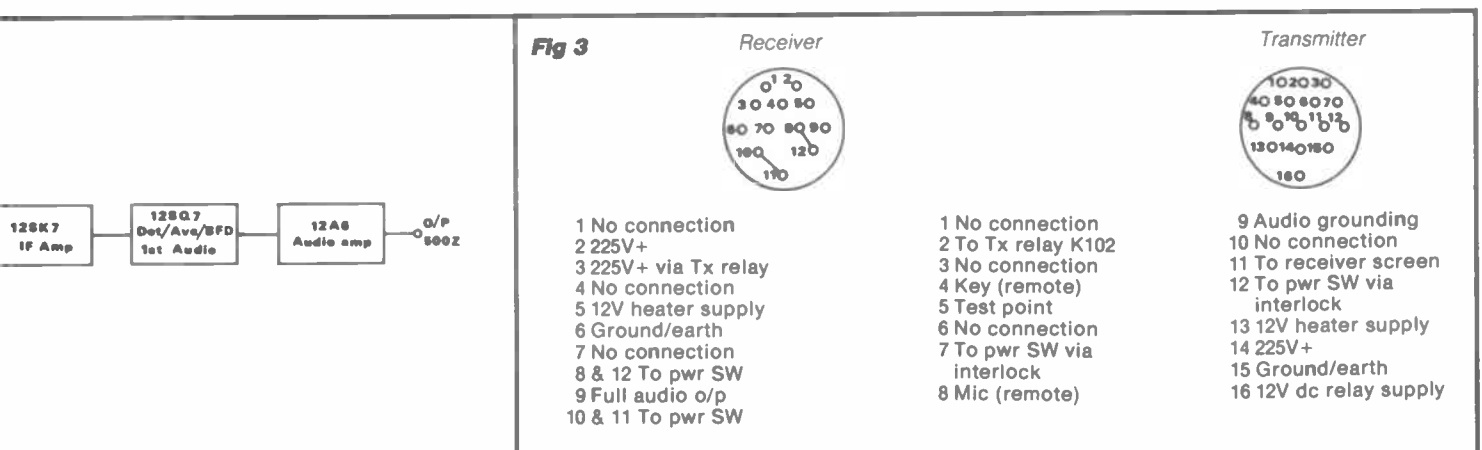

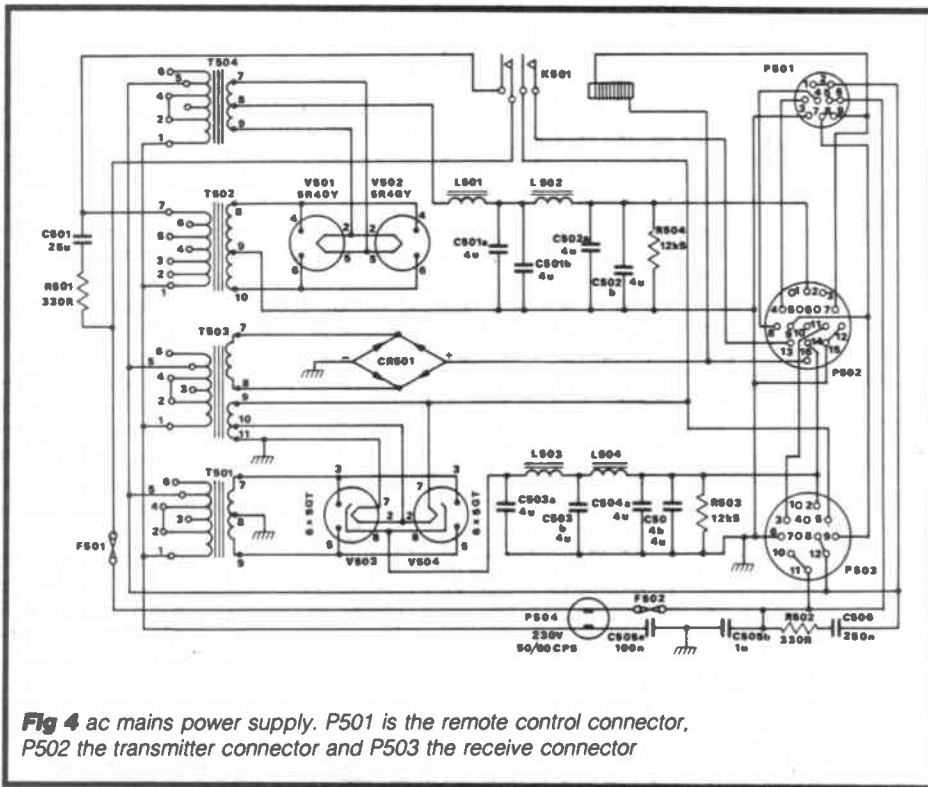

Fig 4 ac mains power supply. P501 is the remote control connector, P502 the transmitter connector and P503 the receive connector

loom lacing can work wonders in getting another half inch of clearance!

If leads or components have to be removed, it is much better to cut the wiring before replacing a component. The mechanical/soldered joints are extremely difficult to unsolder, so a fair amount of unnecessary burning can take place.

A re-made joint or component needs to be good but, as the unit is not going back into active service, the original type of soldered joint is not necessary. The construction and materials used in the original were of such a standard that faults were uncommon and much of the servicing consisted of valve replacement. Components were in general rated at least 100% above normal requirements and the author has yet to find a unit with a faulty capacitor in the HT line. More about resistors and RF carrying capacitors later.

Putting a station together

Although it is probably possible to find a complete TCS installation, most of us appear to find a transmitter... or receiver and then hunt for the other pieces. It is for these people that this part is written. The original units were fitted with multipin military style sockets and plugs for interlinking units. If these are still fitted, then it might be well worth taking some time to look for the associated plugs. Generally speaking, they will be difficult to find, but pin numbering and connections are shown in *Figure 3*.

Although the transmitter power input socket is a 16 pin device, and the receiver a 12 pin, not all the pins are used. If the remote facility is not required it is possible to substitute octal type plug/sockets. A six way cable is required for the receiver and an eight way for the transmitter, if the power on/off is

bypassed. These are minimum requirements, so naturally if other plug sockets with more pins are available, so much the better. Seven way caravan or trailer cable is satisfactory for the receiver, the eight way for the transmitter might need to be made up from singles and then sleeved.

It is useful to terminate both ends of the cables with plug/sockets, ideally a female plug at the transmitter and receiver ends and male at the power supply ends. This avoids the hazard of HT (400 and 250V) on exposed pins.

As with all refurbishing of equipment, it is well worth while obtaining at least a circuit diagram. With these, life is much easier!

Power source

Although a dc PSU could be made up, it seems reasonable to assume that it would be more convenient to operate from an ac mains source, and this could well be a faithful copy of the original as shown in *Figure 4*. Silicon rectifier diodes could replace the 5R4g and 6x5 valves, but bear in mind that peak HT volts will be applied to the circuits before the valves in the equipment have started to draw current. If at all possible use the valves shown. The basic requirements are: 12 volts ac or dc for valve heaters, 12V dc for relay operation, 400V for the transmitter PA and modulator and 225V for the receiver.

This 225 volts is also used to operate the oscillator and buffer stages of the transmitter. Although these HT voltages are the standard requirement, the PA and modulator will operate happily on anything down to 300V, whilst the 225V can be as low as 180V without causing any great deterioration in performance. A number of different mains transformers can be used, or alternatively one transformer which will supply all, or most of

the required voltage. One of the benefits of using solid-state rectifiers is the reduction in current and the usually separate winding required.

Operation

Using 350V HT for the PA and 200V for the receiver, the equipment worked well into a dummy load, and with a short length of wire on to the receiver, all the usual amateur and commercial traffic appeared in the right place and at the right volume. As the equipment is designed to work into a 20 foot vertical aerial, such an aerial was made up using aluminium tubing (from the local DIY shop). On 40 and 80 metres CW, reception was quite good but transmission reports were a bit feeble.

A few moments thought on 20 foot verticals at LF would indicate that, fitted to a Sherman tank or similar vehicle, a fair amount of metal is available as a counterpoise or artificial earth. On a steel hulled frigate, the earthing available must be superb and even on small wooden-hulled craft it is normal practice to have an earth plate on the outside of the hull, submerged.

The earth lead in the shack was worked on and some marginal improvement was noted, but it is extremely difficult to get a really good earth for quarter wave verticals at these comparatively low frequencies. Eventually the 20 foot vertical was abandoned and a 30 foot 'L' aerial substituted. This is common or garden hookup wire, 30 feet high at one end (on a mast), sloping to about 12 feet and continuing into the shack and the transmitter. This improved signal reports considerably, and 180 metres could be loaded up, although it is difficult to keep within the power limits for the band.

In view of this, no attempt has been made to work on 180 metres. Nothing very exotic has been worked, or even attempted, but 579 is pretty well standard for the run of the mill stations on 80 and 40. In view of this, no further aerial 'farming' has been attempted, although no doubt the efficiency of the present system could well be improved.

As mentioned earlier, the keying relays clatter quite a bit, but the main drawback was the lack of side tone. Some consideration was given to fitting an audio oscillator inside the transmitter, but this was discarded in favour of an RF 'sniffer' which in turn operated an audio oscillator, to drive a small speaker. Built up on a small chassis, with a 6in wire probe, this little unit sits next to the transmitter and provides a suitable means of monitoring the keying. The relays are certainly capable of following up to 25wpm, but no special attempt has been made to see what their limits are.

It is a remarkably easy transmitter to tune and doesn't get nasty when shown a length of wire which is not 50 ohms! The combination of roller coaster and capacitor loading will cope with most odd lengths of wire and as far as can be ascertained, neither key clicks or TVI are a problem. A search with an absorption wavemeter was made for harmonics, which are all too evident on many of the radio sets of the period. Nothing at all

was capable of lifting the wavemeter needle on any frequency other than the one selected.

Debugging

It must be remembered that the TCS series has been around since 1941/42 and was used until the early '50s. In that time it may have been operated in severe conditions of temperature, humidity and mechanical shock. Subsequent storage before eventual release as surplus to Government requirement, followed by possibly several owners, means that we have an elderly, well used... or mis-used... piece of equipment.

That many of these units show little sign of their history, must be a tribute to their original construction. There are however, one or two points which could usefully be noted. Ceramic end plates on the main tuning capacitor and the roller coaster, have been found in several instances to be either cracked or broken. Repair of this material is quite difficult and although a working repair can be made with various glues, no real 100% bond has been made to date.

Less frequently the ceramic wafers of the band switch break at the mounting studs. These switches are very heavy duty and require considerable force to move them, so a repair in this area needs to be good. A squirt with contact cleaner or lubricant will usually take some of the pressure off and at the same time clean up the large area studs of the switch itself. Oxidisation of these studs, if the unit has not been used for some time will be clearly visible as a black deposit. If this is so, then a little pressure rub with a fine emery board should clear the trouble. The same oxidisation can also be noted on the relay contacts.

Although the capacitors in the HT + line have never needed renewing, the moulded mica components in the RF circuits have. Their problems range from being open circuit to being short circuited and can cause some very weird symptoms. A certain amount of expertise is required to deal with some of the faults in this area. Although the resistors are generous in their power ratings, many of them will have changed their value. In some voltage dropping circuits this is not important unless the change is excessive, in others it can be quite critical.

A case in point is that after several QSOs on 80 and 40 metres it was decided to have a try on 10MHz, only to find that the transmitter did not function at all, with the PA current meter going off scale. Retuning to 7MHz everything appeared normal. A quick check with a monitor receiver indicated that somewhere between 8 and 9MHz the transmitter oscillator simply ceased to function.

The grid leak resistor of the 12A6 MO is a 1 megohm of at least 2 watts rating, but a check with an ohmmeter indicated that this resistor was in fact reading 5 megohms. Replacing the resistor, (which is a fairly long winded procedure, involving getting the bottom plate off the VFO compartment) cured the problem in this case. The most likely reason for this change in resistor values is not over-work, but a gradual chemical decomposi-

tion of the carbon/cement mixture.

The same is probably true of capacitors with paper or other materials chemically decomposing due to original contamination, however slight, or minor sealing faults allowing the ingress of moisture over a period of years.

Perhaps the most peculiar fault of all was noted in at least 2 transmitters, where the rivets holding the ceramic bases to the 1625 valve pin sockets had almost corroded away. This wasn't spotted until a 1625 was plugged into the holder and the whole of the metal pin section was pushed away from the chassis and into the transmitter! At least half the pins have this fault. It was at first thought to be a major disaster, requiring new 1625 valve holders, but if the corroded rivet is cleared from the ceramic, a small bolt with a nut can replace it. There was no evident corrosion on the valve holder pins, it was simply the rivets which had disintegrated.

240V ac for TCS12 Tx/Rx

To utilize existing components from the junk box the PSU shown has been built from commonly available components and operates satisfactorily using these. Note that 7 cores are required for the receiver cabling to the PSU and 8 cores are required for the transmitter cabling to the PSU. If 7 core 'caravan' type cable is used, then the number 8 core for the transmitter can be acquired by slipping a length of coaxial cable outer braiding over the 7 core and whipping the ends tightly before applying solder. This can be used as the

chassis/earth and permits all the switching to be utilized.

Referring to Figure 5: S1 applies ac at 240V to the primaries of T1 and T2. 12 volts dc is applied to the relay circuits in the Tx. 11.3 or 12.6V ac is applied to all heaters. (The common transformer has a 6.3 and 5V winding. These are in series to provide 11.3V which has proved adequate. If 2 by 6.3V windings are available, so much the better). HT is applied to the receiver by grounding the centre tap of T1 via the power on switch on the Rx. In this circuit there is also a low resistance relay (Relay A), whose contacts close when current flows. The Rx is now fully working. Putting the Tx power on switch to the 'on' position applies 350V to the transmitter changeover relay, which is energised only when the key or mic is operated.

Without this relay linkage (Relay A) it would be possible to apply HT to the Tx PA stages without any supply to the oscillator and multipliers. The PA current without any drive would be excessive.

The smoothing chokes in the PSU are approximately 10H at 100mA. A valve rectifier eg 5U4 could be used in place of the BY127s if space is available.

The Tx input is, of course, slightly down using only 350V HT but the Tx operates satisfactorily with HT supplies between 250V and 450V. There is no reason why a separate transformer could not be used for either relay supplies or heaters, it all depends on what is available.

Note that the audio line and the 225V HT are interconnected between Tx and Rx.

Fig 5 PSU Circuit diagram

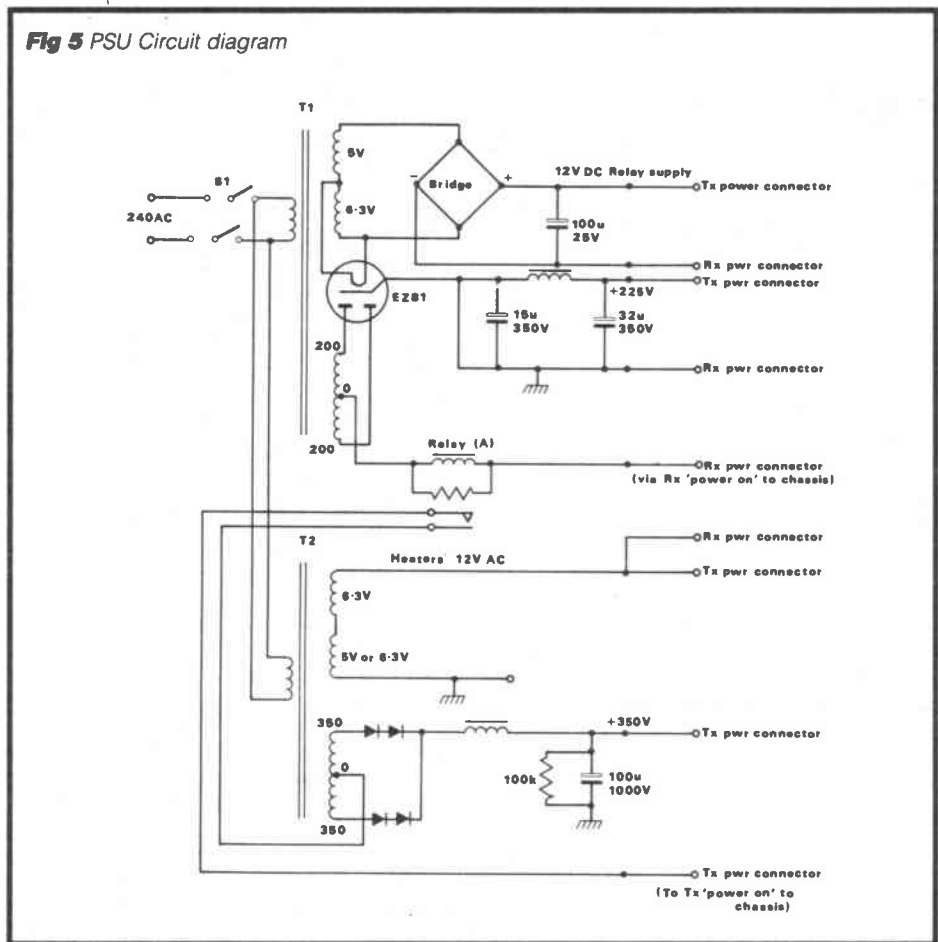

BITS TO BUILD

The Biometer – A fun project for Christmas – by Rev Dobbs G3RJV

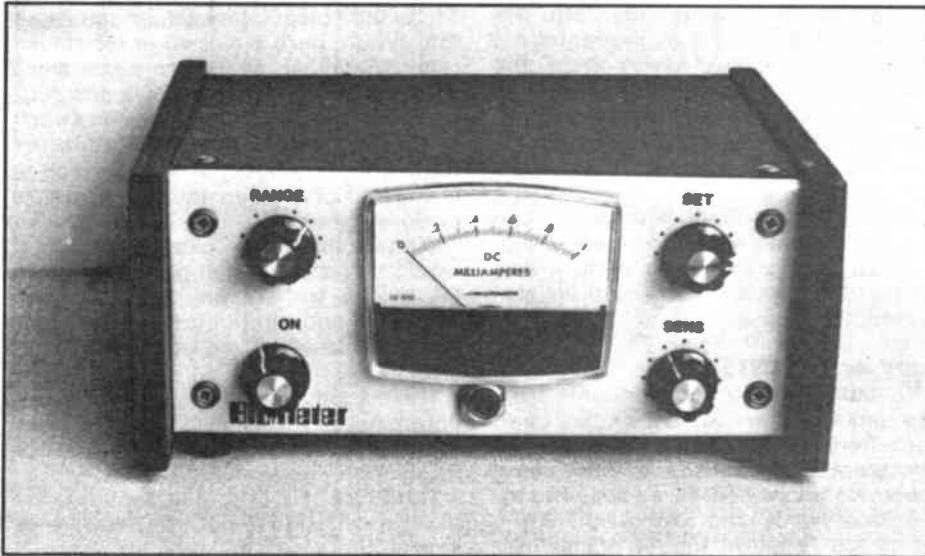

This little project has nothing to do with amateur radio, but it will provide the facilities of:

- A Lie detector
- A Relaxation monitor
- A Bio-feedback meter
- A Kissometer

A lot of interest and amusement, for a few components and an evening's soldering. So, show the family that amateur radio is not the anti-social pursuit they suspect and gather their interest, amusement... and perhaps wrath by building this novel little project.

This project began life several years ago. At that time a friend of mine was running a yoga relaxation class and he showed me some bio-feedback meters in a catalogue, sold as an aid to relaxation. They were based upon galvanic skin resistance and were expensive. I

assured him that it should be possible to make such a meter at a fraction of the cost. After he asked me to have a go... I really was on the spot, because I knew little of what they were about. A little reading and experimenting soon produced the Biometer, which he used to good effect for several years.

What is it?

The principle is really quite simple. Everyone who has owned a multimeter with a high resistance scale will know that it is possible to measure the resistance across the human body. This may be done by holding the meter probes in either hand and taking a reading on a high resistance scale. The reading will be in the order of several tens of thousands of ohms. The resistance has been measured by contact with the skin,

and this is sometimes called galvanic skin resistance.

The resistance varies from person to person and with variation in dryness and hardness of the skin. It also varies within an individual, not only with pressure and wetness of the skin and other physical factors, but apparently also with physiological factors. The resistance will also vary according to the emotional state of the subject. Galvanic skin resistance meters (GSR meters) were used as early forms of lie detector and in some forms of medical research.

The resistance changes are quite small and the total resistance is high. So what is required for such a meter is a device to measure small changes in a high total resistance.

Mr Wheatstone's Bridge

Every school child seems to know at least one circuit, here it is in *Figure 1*: the Wheatstone Bridge. Since its first use in 1943, Charles Wheatstone's little circuit for measuring changes in resistance must have been grudgingly sketched in thousands of school exercise books. Here are your revision notes on Mr Wheatstone's Bridge.

Figure 1 shows the traditional circuit. When the potential difference of one half of the bridge ($R1/R2$) equals the potential difference of the other half ($R2/R3$), the bridge is *balanced* and no current flows in the meter. An imbalance of any of the four resistors will cause a current to flow through the meter. In the usual application of the bridge, two of the resistors (say $R1$ and $R4$) are fixed and of the same value. One of the remaining resistors (say $R2$) is of unknown value and the remaining resistor ($R3$) is a variable resistance. When $R3$ is adjusted in value

Fig 1 Wheatstone bridge circuit

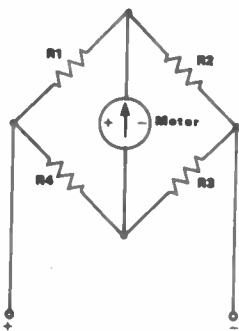
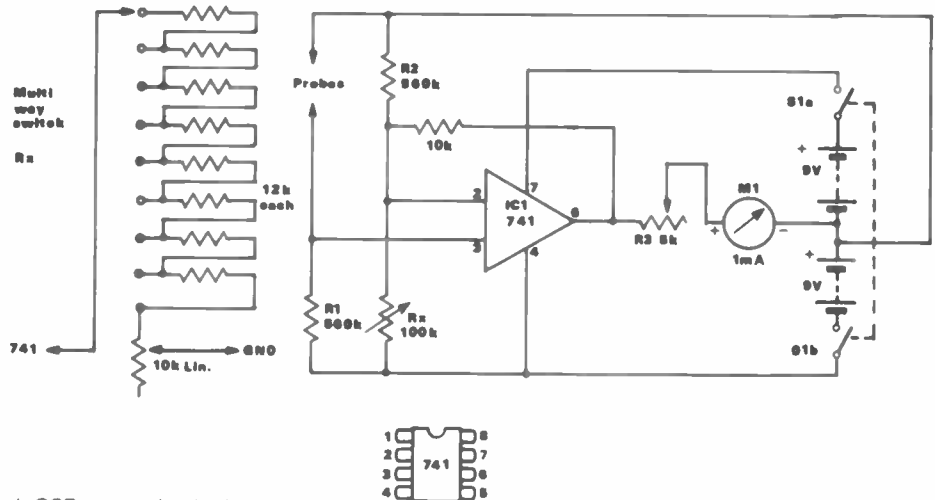

Fig 2 Biofeedback GSR meter circuit diagram



until the bridge is balanced and no current flows in the meter, R_3 is equal to R_2 .

The basic Wheatstone Bridge is quite sensitive, provided that the meter can show small enough current changes, and it can be used to show small changes in a high total resistance. So, this circuit lends itself to our applications, if we can find... or afford... a sensitive meter. A simpler and cheaper solution is to amplify the current flowing in the unbalanced bridge and use a cheaper meter.

The bridge amplifier

The circuit in Figure 2 shows the Wheatstone Bridge with an amplified metering circuit. The four legs of the Wheatstone Bridge are formed by 'The Probes' and 'RX', with R_1 and R_2 forming the fixed resistors. The probes will be used to measure the skin resistance and R_X is a variable resistance to bring the meter towards a low current reading.

The two halves of the bridge are fed into the input of an operational amplifier integrated circuit. The LM741 is perhaps the best known linear IC of all, and is certainly the cheapest. These things cost pence each. R_3 is the feedback resistor which controls the gain of the amplifier. Increasing the value of R_3 will increase the sensitivity of the circuit. The circuit has a balanced output and requires two batteries for a dual supply. The meter (M1) is an inexpensive 1mA full scale instrument.

A sensitivity control (R_4) is included. This reduces the sensitivity of the metering circuit. This may seem odd, when a sensitive circuit is required, but its inclusion is explained later.

R_X deserves some explanation. It is at the opposite end of the bridge from the probes which are measuring the skin resistance. This is the control which balances the bridge to produce a reading on the meter. R_X is a dual control made up of two sections: a 10k linear potentiometer and a bank of switched resistors. This is because a considerable range of resistance is required to balance the bridge. We humans are such that there is a wide variation in skin resistance detected by the probes.

The switched resistors, twelve of them, form a range switch to select the area of resistance required by the individual subject connected to the probes. The potentiometer is the set control for fine adjustment of the meter reading. When the meter is being set up to suit an individual subject, it will be a long way off balance until the usable range is found. This could damage the meter, so the sensitivity control is backed off until the balance of the bridge is such that the meter is recording a reasonable reading within its range.

Construction

The Biometer circuit is built on Veroboard, the layout being shown in Figure 3. The main components are mounted on the board as shown. The Veroboard is used with the copper tracks laid out horizontally as the board is shown in Figure 3. The only cut required

Fig 3 Veroboard layout

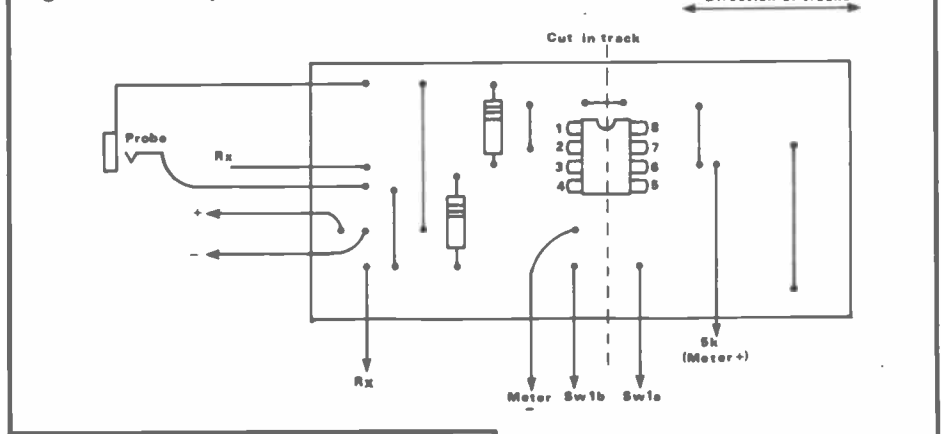

on the underside of the board is to divide the two sides of the LM741.

When the components have been soldered into place, a hacksaw blade (a junior hacksaw is best) is drawn across the tracks between the rows of pins on the LM741 to form a break right across the board.

After this cut has been made, check the edge of the cut carefully to ensure that the adjacent tracks have not been bridged by stray bits of copper. The tracks can be cleaned out with the sharp point of a penknife. Careful soldering is also required when using Veroboard to avoid bridging the gaps between tracks.

With the exception of the batteries, the other components are mounted on the front panel of the Biometer. The photograph shows the layout which I used in the prototype, it also shows that I used a rather expensive and fine looking meter... I was building to order at someone else's expense! Any old meter with a full scale deflection of around 1mA could be used however. The case for the Biometer is also rather splendid and again bought to order. Again any case of a suitable size, aluminium, plastic or even wood, could be used. One of the inexpensive aluminium cases sold by Minford Engineering would probably be suitable. It all depends upon how the constructor wishes to present the final instrument.

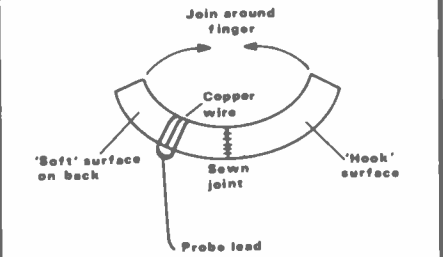
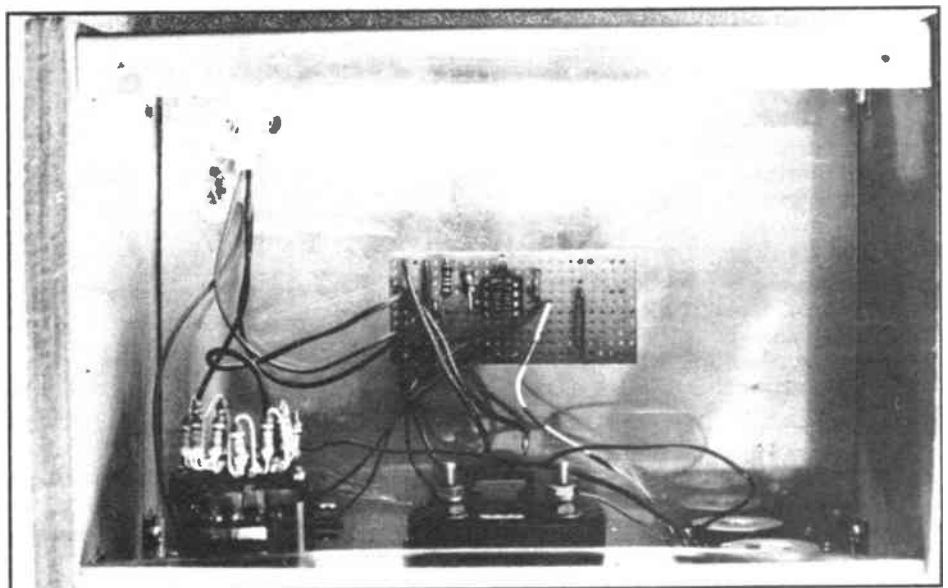

Fig 4 Velcro probe

The probes are open to experimentation. Originally I attempted to use hand-held strips of copper as probes, but these were useless because the readings varied according to how tightly they were gripped. A method of providing a consistent contact is required. I had a fair degree of success from using converted hairpins (the sort with a sprung hinge), but the best probes seemed to be the arrangement shown in Figure 4.

This makes use of Velcro, that all purpose soft fastening system. A piece of Velcro is cut to form a strip that will fasten around the average sized finger. This will have to be made by reversing two small pieces of velcro, sewing them in line, so that the free ends will join using the hook/felt combination. Don't know what I mean? Ask a needle-woman... opphs - person.



BITS TO BUILD

The actual electrical contacts are made from bare copper wire, which is bent and shaped around the Velcro as shown in *Figure 4*. About three turns of wire around the velcro strip, flattened to fit the shape of the velcro, seem ample for contact to the skin. The two ends of the wire are joined to a single insulated wire which forms one side of the probe. Each probe wire is connected to either side of a jackplug for connection to the Biometer.

Using the Biometer

The simple explanation is to connect up and have fun. A more measured explanation goes something like this. . .

Connect the probes to a subject, one probe to a finger on each hand. . . clean hands are helpful! Turn the *sensitivity* control back. Put the set control at its midpoint. Switch on the Biometer and quickly rotate the *range* switch until the meter needle appears on the scale. Advance the *sensitivity* control when the meter is recording. The meter reading can be finely adjusted by using the set control. The meter is now almost balanced and the skin resistance is producing a reading on the meter.

The purpose of the Biometer is to record small changes in the skin resistance of the subject, so the starting point is to set the meter needle at half scale. One simple test is to ask the subject to

begin deep rapid breathing. In most people this causes a deflection of the meter indicating a change in skin resistance. What you now do with the meter depends upon what you wish to try. . . or what the subject will allow!

For relaxation, assume a relaxed posture (you had better read books on this one!) and attempt to relax and make the reading on the meter go down, once it gets to nothing change the range switch. This technique, once mastered, is said to aid self-induced relaxation because the subject is receiving Biofeedback; that is they can see the effect of their relaxation. A feedback cycle is set up between the subject and the meter, as the reading goes down the subject is pleased and relaxes further, the meter goes down further and so on. . . Try it and see.

The Lie Detector usage is the opposite effect. Wire up the subject and throw in the difficult questions and see what happens. If the meter reading rises as the subject stammers out embarrassed answers. . . well! But be careful, the instrument could lose friends, please treat it as a light hearted piece of fun.

It is possible to join a probe onto a hand of two subjects and invite them (if the invitation is required) to kiss. It is said that the reading should indicate the passion of the exercise. I cannot claim to have conducted much research on this

osculatory application, but if anyone knows of fully funded research fellowships available in the subject, please let me know.

It might not be amateur radio, but this little project can provide a lot of interest and fun for anyone who can solder up a simple circuit.

BIOMETER TABLE OF VALUES

R1	560k
R2	560k
R3	10k
R4	5k linear potentiometer
RX	Made up from: single pole 12 way wafer switch 12 off 12k resistors 10k linear potentiometer
M	1mA meter (see text)
ICI	LM741
S1 A/B	Double pole on/off switch
9V	2 off PP3 9 volt batteries
Battery connectors	
Case	(see text)
Probes	(see text)

C.M.HOWES COMMUNICATIONS

Eydon, Daventry,
Northants NN11 6PT.
(mail order only)

Phone: 0327 60178

PLEASE NOTE: DUE TO EXPANSION, WE HAVE MOVED!

Our range of good quality radio kits enable you to build yourself many interesting projects. We have receivers, transmitters, transverters, filters, ATUs, mics, speech processors, oscillators, and more, sitting on the shelf at our new mail order premises. If you haven't got a copy of our summer catalogue, why not send an SAE for one? Alternatively, why not call on one of our stockists and see the kits for yourself? One or other of our stockists will be at most rallies this year, and we will be attending some in person too.

UK Dealers include:—

Bonex Ltd, Acton, London 01-992 7748
J. Birkett, Lincoln 0522 20767
MGR Services, Birkenhead 051-653 3437
Southdown Radio, Eastbourne 0323 639351
Ward Electronics, Birmingham 021-328 6070

Watch out for our new 2 to 6m transverters!

73 from Dave G4KQH, Technical Manager.



EASY TO BUILD KITS BY MAIL ORDER

PHONE-PATCH OK IN VK

Tony Smith G4FAI reports

When the Australian Department of Communications approved amateur radio third party working in 1980, it was assumed that phone-patching would automatically be allowed. However, in the following year, Telecom Australia announced a policy that expressly excluded phone-patch from use with amateur radio and CB equipment. It was allowed only for business communications, and then only in certain areas, as Telecom saw the interconnection of radio and telephone as being in direct competition with its own mobile telephone service.

The Wireless Institute of Australia entered into negotiations with Telecom. They dispelled some of the apprehension Telecom felt about amateur radio phone-patching, and a prototype amateur phone-patch unit was built by a commercial company serving business two-way radio users.

In September 1981, Australia's first authorised amateur phone-patch was made—a limited operation for demonstration purposes. VK3PC contacted VK9ZG on Willis Island, and members of the Weather Bureau Expedition on Willis were patched to their relatives in Melbourne, via a 15m radio link.

A major setback then occurred when Telecom decided to put the question of phone-patching to the Federal Government's inquiry into telecommunication services, lumping in consideration of amateur requirements with those of commercial users.

Finally agreed

Many protests and enquiries were addressed to Telecom, and the Minister for Communications became the recipient of a letter-writing campaign on the subject. Finally, in 1983, Telecom agreed that amateurs, among others, could use phone-patch. When the new

regulations were published, however, it was found that third party messages were banned(!), and there was to be a \$2 (Australian) charge per month for access charges and socket connection costs. After more protests, Telecom revised the rules in June 1985 to exclude the amateur service from the prohibition on third party traffic.

The WIA continued discussions with Telecom, and they jointly agreed to work towards developing suitable circuitry and construction details for a home-built phone-patch interconnection unit to be Telecom authorised.

In the meantime and quite independently, Sam Voron VK2BVS, who had been campaigning to obtain phone-patch in Australia for a number of years, was also trying to obtain a suitable inexpensive unit.

Approved interface

Geoff Donnelly VK2EGD, who works for Telecom's design laboratories in Sydney, contacted VK2BVS and, with Telecom approval, designed and built a Line Isolation Unit (LIU), intended to interface between the telephone system and amateur equipment. This design has now been approved by Telecom Australia for amateur construction and use, subject to the completed units being inspected and approved by a Telecom inspection officer—who initially is VK2EGD, the designer of the unit!

Full construction details have been published in the WIA journal, *Amateur Radio* (September 1987), and the units must be constructed precisely as described. The LIU is not a full phone-patch unit, but an interface between the telephone system and currently available unapproved units such as the Kenwood phone-patch PC-1. It is hoped to obtain approval for a full amateur home-brew patch unit at a later date.

Originally, Telecom insisted that the LIU required a special socket, but following representations by VK2BVS they have agreed that amateurs may use the normal telephone socket.

Restrictions

The present arrangements allow only single-ended patching—that is, only one end of a radio link can interface with the public telephone system. In certain emergency operations or exercises, double-ended patching (ie, telephone-radio-telephone) is permitted, and this facility can extend to appropriate community service activities and public displays of amateur radio. This dispensation will be reviewed by Telecom and the WIA in 18 months time.

Use of phone-patch must be in accordance with the current regulations concerning third party traffic. The phone party must be briefed on what is acceptable or otherwise while speaking over the radio link, and the amateur controlling the patch must not hesitate to interrupt if any breach of the regulations occurs.

Not permitted here

The circuit of the LIU is not reproduced in this article because third party communication and phone-patching is not permitted in the UK under the present regulations.

Should the position change at any time—for instance if phone-patching should be allowed for emergency communications (a logical extension of the current situation whereby members of user organisations can operate an amateur station under supervision)—then undoubtedly British Telecom would have its own requirements for an interface unit. Whether they would be as accommodating as Telecom Australia seems to have finally become, is another matter!

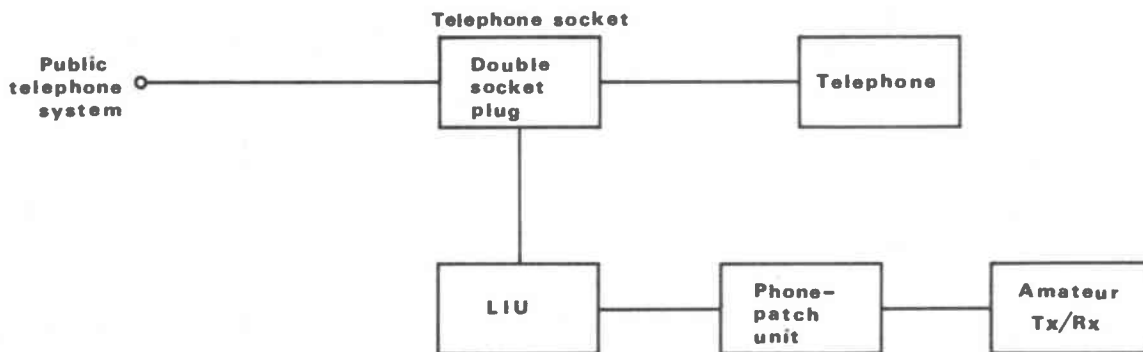

Interface Block diagram

50MHz

In last month's column I referred to the probability of transequatorial propagation (TEP) on 50MHz to South Africa, and the tests organised by the RSGB 50MHz Reporting Club during the current period. During the first half of October there had been considerable E propagation on 28MHz to the Mediterranean area, and although the British Isles are outside the main TEP zone to South Africa the possibility of TEP assisted by other modes of propagation was a probability.

From Hal Lund ZS6WB I received a news flash that the first QSO of the six metre TEP tests was made on Friday 2nd October between Dave A22KZ in Maun (KG19) and Costas SZ2DH (KM17). Dave reported hearing the 9H1SIX beacon from 1527-1900UTC. He heard the Beacon again on 4th October between 1715-1840UTC. Nothing was heard from Europe on ten metres at that time, and calls on 50.110 and 28.885 were unanswered. For the UK October 22nd was certain by a date to be remembered by the fortunate few who were favoured by a historic opening.

UK to Botswana - South Africa

During the early afternoon of the 22nd, Eric Parvin G2ADR (who has been operational on five and six metres since the early days) had a two-way crossband QSO with Dave A22ADR on 28/50MHz, and what is claimed an 'all time first' between Botswana - England on 50MHz at 1537Z. At 1646Z Bill Stirling GM4DGT of Alloa had the first 'all time 50MHz two-way QSO' with Dave in Botswana. Other stations who were successful included G4HBA, G4GAI and G3CCH. Apart from the GM QSO, the only Sporadic area affected in England was around the Yorkshire/Lancs and Humberside areas. No reports of reception have so far been reported from the South.

For the record the first two-way UK - South African 50MHz QSO took place on 5th November 1947 between G5BY and ZS1T, as reported on p48 of QST, June 1948. Hilton had only received his 50MHz permit a few hours earlier!

I have received a very detailed and interesting 'diary of events' for the month of October leading up to his historic opening from Ted Collins G4UPS, who spends many hours monitoring 28 and 50MHz.

The full log will be useful to the RSGB 50MHz Reporting Club. Ted reports:

- 3/10/87 QSO on ten ZS4TX/ZS6LN. Aurora on ten at 1955.
- 5/10/87 Heavy Solar disturbance 1601 - 1607. Ten open to Middle East, S Africa and S America.
- 7/10/87 Cyprus and S African beacons in on Ten. EA4CGN reports he is hearing FY7THF beacon on Six at 1904Z. Ted also hears FY7THF beacon briefly.

- 8/10/87 1750Z G4UPS/9H1BT 2 way QSO on Six.
- 12/10/87 Six open to Portugal, Ten open to W and VE during evening.
- 13/10/87 Ten open to Africa and N
- 15/10/87 America - Nil on Six.
- 16/10/87 High solar noise on Six at 1014. ZS and 5B4 beacons in on Ten. 1230 complete fade-out. 1400 beacons in again until 1700. 1743 9H1CG heard calling CQ on 50.110.
- 18/10/87 0915 2 way QSOs EA1MO/CT4KO on Six.
- 21/10/87 0925 5B4CY beacon in, 1154 QSO on Six LA6IT. VE1BNN reports big sporadic opening to W/VE.
- 24/10/87 1022 CT0WW beacon in on Six. 1139 CT1WW 2 way QSO on Six 59/59. ZS6ADH keyer heard by CT1WW. 1319 2 way QSO on Six with CT4KQ.

Details on A22KZ

A22KZ has a sked on Sundays and Wednesdays with G3TKN on 21.160kHz at 1600Z. His address is c/o Maun Secondary School, Maun, Botswana. He runs an Icom 551B (75 watts) to a 5 el beam at 35 feet. He leaves Botswana in December.

From David Butler G4ASR I heard that G4MAB, who is operating as ZD8MB from the Assension Isles has permission to operate on 50-54MHz. He has permission from the licensing authority to operate a beacon under the call ZD8VHF, but needs suitable equipment. This would be a valuable asset for propagation studies, as we know from the good work and results that Ted Collins achieved from there operating as ZD8TC. David is Editor of the *RSGB VHF/UHF Newsletter*, a monthly specialist publication issued on a subscription basis to both members and non-members of the society. G4ASR is QTHR.

The International 6 metre Digest

I have received a complimentary copy of the first issue of the above from Harry Schools KA3B, with permission to reproduce extracts from it for the benefit of our readers. He hopes to produce further issues every three months or so, but subscription rates and other details have not yet been decided.

DX Briefs: KH2F will be active on Midway Island from October 22nd using an Icom 551 and a 50 watt amplifier. WY5/KH3 on Johnston Island is QRV on 6m with a TS600 and 5 element beam at 70 feet. VS6DO in Hong Kong is getting on 6m with a TS600. PZ1AP in Surinam is active on 6m with 50 watts - weekend operation only. A61XL in the Arab Emirates will be running a beacon on 50.110 from 0100 - 1500Z, using a Yaesu FT767, 50 watt amplifier, and 6 el yagi provided by JF1FST.

Beacon Briefs: VP2MO in Montserrat now has a 24hr beacon operational on

50.086MHz with ten watts to a 6 el yagi at 50 feet. 4S7EA in Sri Lanka has a beacon on 50.110 or 50.000. When it's on 50.110 it calls CQ on 50.000, it is unattended.

WWV Geoclerf Broadcasts

The National Bureau of Standards (NBS) transmits information regarding solar activity via WWV on 2.5, 5.0, 10, 15 and 20.0MHz at 18 minutes past each hour. These messages are changed every 6 hours at 1800, 0000, 0600 and 1300UTC. The first bit of information is solar flux. Solar flux is measured at 2800MHz in Ottawa, Canada. It is a measure of the solar electromagnetic radiation - hence it is related to sunspot and flare activity.

Given next is the A index, which is a measure of geomagnetic activity for 24 hours, ranging from 0 (very quiet) to 400 (very disturbed). It is measured at Fredricksburg, Virginia (USA).

Following this is the K index, which is a logarithmic index of geomagnetic activity ranging from 0 to 9 units. The K index is determined by measurements every 3 hours at Boulder Colorado (USA). These measurements are then averaged to determine the A index for the 24 hour period.

The last piece of information transmitted by WWV is a forecast of solar-terrestrial conditions for the next 24 hours, as they correspond with solar activity such as flares and the geomagnetic field.

By monitoring WWV on a regular basis, and by paying special attention to the A and K indexes given, it is often possible to predict auroral conditions. Since the K index is measured every 3 hours, I

RELATIONSHIP OF THE K & A INDICES

K index	A index	Geomagnetic Activity
0	0	Quiet
1	3	Quiet
2	7	Quiet
* 3	15	Unsettled
* 4	27	Unsettled
* 5	48	Unsettled to minor storm level
** 6	80	Major storm level
*** 7	140	Major storm level
*** 8	240	Major storm level
*** 9	400	Major storm level

- (*) Aurora on 6m possible
- (**) Aurora on 6m very likely
- (***) Aurora on 6m

Note :- Geographic location has a direct bearing as to whether or not aurora is workable. Stations further north will obviously experience more openings

by Ken Ellis G5KW

generally use this as a possible indicator of aurora. However, it is important to note that sometimes the A and K numbers differ somewhat. Since one is measured in Colorado and the other in Virginia, variations may occur due to a variation in radiation levels at different places on the Earth. As a general rule, at 40 degrees N latitude, auroral conditions are usually present on six metres with a K index of 4 or 5 and above (see the *Table*).

Record breaking aurora

Probably one of the greatest geomagnetic storms of all time occurred on February 8-9th 1986; a storm caused by intense solar flare activity which began 5 days earlier on the 3rd. By 1800UTC on the 6th, the K index began to climb, reaching a level of 7 by 2000UTC on the 7th. A K value of 9 is very rare, but it was reached during two 3 hour periods on the 8th. Also on the 8th, the A index peaked

just above the 200 mark. With such impressive numbers the VHF bands were in a frenzy, especially six metres.

As we predicted, the last four weeks have provided some interesting TEP results and the solar flux numbers during the last few days are very encouraging for the immediate future. Please let me have your news reports. Thanks in advance. Ken Ellis G5KW, 18 Joyes Road, Folkestone CT19 6NX. Tel: (0303) 53276.

LOOK WHAT YOU GET EVERY MONTH IN

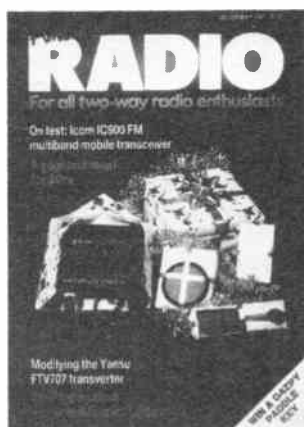

Amateur RADIO

- ★ **DX DIARY** Don Field G3XTT with all the news of rare DX, contests and DXpeditions
- ★ **ON THE BEAM** Glen Ross G8MWR with all the news and comment from bands above 50MHz
- ★ **G3OSS TESTS** Angus McKenzie – the fairest, most comprehensive reviews available anywhere

**MORE NEWS, MORE FEATURES, MORE FUN, MORE STYLE
THAN ANY MAGAZINE AVAILABLE ON THE MARKET TODAY**

Make sure of your copy by placing a regular order at your newsagents or by taking out a post free, inflation proof subscription, with early delivery to your door each month

Voucher removed

PROJECT

BOOK

by Martyn Williams

Following our recent Amrad 10GHz transceiver project, there has been a considerable amount of correspondence with reference to the mysteries of dish aerials and the use of them at varying frequencies.

The theory

A common problem seems to be that the dish is itself thought of as the aerial and this is not, in fact, true. The dish is simply a reflector that catches the radiation from an aerial, which is placed at the focal point of the dish. It then focusses this energy into a tight beam and sends it in the desired direction. Thinking of the whole system in terms of light will make things much more obvious.

If we have a light bulb without any form of reflector, then the light will travel in all directions and we have the classic isotropic radiator, which is loved by all aerial theoreticians.

If we now fit the lamp into a reflector, the light will be focussed and we have a stage spotlight. This, compared to the bare lamp obviously has considerable 'gain' in the required direction, but a lot of light from the lamp misses the reflector and is lost.

What we really need is a light which will just illuminate the reflector, to get the best results. In the stage spotlight, this overspill of light is focussed by a lens and this can be arranged in an aerial system – although it is rarely done, it being easier to arrange the feed to just fill the dish. If you now re-read this paragraph, substituting feed and RF as required you will have got the right ideas about dish operation.

How big?

It should, I hope, be fairly obvious that the larger the dish you use, the greater is the gain that you can obtain. What we are really talking about is the electrical, rather than mechanical size of the dish and it is convenient to think of this in terms of wavelength.

The apparent size of a given dish will be doubled if the wavelength is halved (frequency doubled) and so more gain will be achieved. A dish will work down to very low frequencies, but there is a limit to the size of dish that can be accommodated in the average back garden and eventually a point is reached where the achievable gain is lower than can be obtained by simpler means; perhaps a yagi array. This point is usually reached at around 1GHz.

The gain

The information in *Table 1* shows the gains to be expected on various amateur bands, with varying sizes of dishes. Because it is nearly impossible to evenly 'illuminate' the total area of the dish, the gains are calculated for an efficiency of

Table 2

Gain in dB	3dB beam degrees
15	30
20	17
25	9
30	5
35	3
40	1.5
45	0.9
50	0.5

50%. It will be seen that with gains of up to 50dB, a power gain of 100,000 times, can be readily achieved. These gains mean a narrow beamwidth, and *Table 2* shows the 3dB points for various gains, irrespective of frequency; all the figures have been rounded out slightly.

A thing that must also be kept in mind is that, with most dishes, the vertical 3dB width is the same as the horizontal so that it is important to check the horizontal and vertical positioning accuracy when setting up on a given bearing. There is little point in beaming the right way if the power is being sent vertically the wrong way.

Dish types

Ideally, the dish contour should be strictly parabolic, but in the real world ingenuity comes into play. Such things as pressed aluminium lampshades, dustbin lids and even searchlight reflectors have been put into use. It must be obvious that none of these are true paraboloids and therefore, some loss of gain must be expected, but keep in mind that it is better to use a dish which produces, say, 26dB gain rather than the theoretical 30dB, than not to have a dish at all.

Lumps and bumps

A frequently asked question is on the lines of 'My dish has some holes in it, does this matter?' The answer is, that such things as bumps, rivet and bolt heads can be safely ignored, if the total area involved is a small proportion of the total area of the dish surface. A continuous ripple on the dish surface can be more of a problem, but it does depend on the height of the deformation and the frequency on which the dish is to be used.

To put some figures on it – if the dish is covered in bumps which are about $\frac{1}{15}$ wavelength high, then there will only be a loss of 1dB compared to a perfect surface. For the gain to drop by 6dB, the surface irregularity over the total dish area would have to be $\frac{1}{6}$ wavelength. At 10GHz this means having irregularities 3mm high and on 1296 they would need to be around 25mm high, looking like corrugated iron! If your dish has not been belted with a lump hammer it should be usable.

Bits missing

Holes in the surface will also reduce the gain, but it depends on the size of the holes and the area they cover. Even if the whole dish is covered with holes, as is the case with a unit made from wire netting, the loss will be very small provided the diameter of the holes is no

Voucher removed

THE RADIO AMATEUR INVALID AND BLIND CLUB . . . THE WAY FORWARD

I think it is safe to say that never in its 33 year history has the RAIBC sustained such wide ranging and exciting changes as have been taking place in the last three months. The early history of the club is probably not generally known, but it evolved from the World Friendship Society of Radio Amateurs, which formed a Bedfast Section, operating for two years before the parent organisation wound up in 1953.

In February 1954 several ex-World Friendship Society members founded the Radio Amateur Invalid and Bedfast Club, although the word 'Bedfast' was changed to 'Blind' at the first proper AGM held at Alexandra Palace in 1979, as a result of a proposition to the floor by Angus G3OSS.

The aims of the club have always been to promote the enjoyment of amateur radio for disabled and blind amateurs, and to encourage disabled short wave listeners to take up the hobby. Over the years there have been many enthusiastic helpers, and the club's activities have expanded in a number of directions as needs were perceived.

In the summer of 1987 it was realised that a greatly expanded Committee was required to put many projects into practice. Angus had been appointed Chairman at the AGM held at Romsey, Hants in July 1987, and he gathered together new committee members, many of whom are themselves disabled. Each is responsible for a particular facet of the club's organisation, but closely co-operating with each other to provide what it is hoped will be a network of services to aid the blind and disabled to get the most out of the hobby.

Amateur radio is a hobby which is particularly wonderful for disabled people, providing challenge and interest, and far reaching friendships. It is often only in amateur radio that someone can forget their disability, and more to the point, other people will also forget it, or even not know about it. That chap who is always on CW – he may be a stroke victim with impaired speech. Someone else may be in a wheelchair, but on the radio they never have the impression that all conversation takes place two feet above their heads! And so the new committee have undertaken to consolidate and expand existing and new services.

The club's newsletter, *Radial*, is published eight times a year. This contains news of members, sales and wants, helpful hints, articles etc. It is also produced in cassette form for blind members, but it has always been necessary to charge extra if anyone wants both cassette and printed *Radial*. One of our present aims is to allow blind members who wish to do so to have both the cassette version, which has to be

returned so that the tape can be reused, and a printed copy for future reference, without any extra charge. The *Radial Fund* has been set up primarily for this purpose.

Other cassettes are produced by the club, covering such topics as the RAE manual, Morse tuition etc. These can be obtained either on a loan basis, or the material can be recorded onto members' own cassettes. Angus McKenzie's book *The Buyers Guide to Amateur Radio* has been read by a volunteer, G3ADV, onto tape, and is available on eight C90s, either on loan, or for sale to blind members for only £5.

On the education side too, the club has a number of Datong Morse tutors, which members can borrow for up to two years to help them through the test. The club can also supply information on various types of audio aids for tuning up rigs, mostly for the blind members, and has a limited supply of audio gimmicks – which the members affectionately call their 'growley boxes'. Another project is to facilitate research into further developments of such gimmicks.

One of the newest services is the appointment of a committee member to give personal advice to members on the ever present problem of EMC. Here we are lucky enough to have Les Hawkyard G5HD, who has been Chairman of the RSGB's EMC Committee. He has a supply of filters, which a manufacturer has kindly supplied at an advantageous price to the club, and these can be loaned to members, who can buy them at cost if they are found to be suitable.

Over the past two or three years, it has become very apparent that it is vital for members to have access to a club official, and now our Secretary, Margery Hey, has been able to organise a 'help' line which is answered most of the time. The number is (0953) 454920 (Norfolk).

Some manufacturers give price reductions on equipment and accessories, specifically for full RAIBC members only. Unfortunately, equipment is still a stumbling block for a member perhaps on a disability pension, unable to work, or struggling to support a family, so the loan equipment side of RAIBC is one that is very important. Over the years, much equipment has been loaned to members, and at present the loan equipment manager, Johnny Clinch G3MJK, and the audio aids manager, Phil Stanley G3BSN, are co-operating to contact all these members to make sure that the equipment is in good order and still being used.

On the loan equipment side, too, exciting events have been taking place, for the club is being given more and more excellent rigs and accessories, which are checked through, and then loaned to one of the members on the waiting list.

Of course, every care is taken to ensure that the equipment is suitable for the recipient, taking into account the constraints of the disability. If accessories are necessary, such as a power supply, we like to be able to find funds to buy that too. Many members have been overjoyed with equipment that the generosity and thoughtfulness of others has enabled us to provide, and how wonderful it is to hear more and more members appearing on the regular countrywide RAIBC nets, which operate at various times of the day and evening. The overall Net Controller is G4EUU, Dr John Moseley.

It is hoped to expand and consolidate a network of Local Representatives. These are experienced amateurs who will look after a few RAIBC members local to them, visit them, be on the end of a phone for advice etc, and be able to cope with some of the problems that inevitably crop up. We are desperately short of reps who have a knowledge of LF and HF antennas and rigs, in some areas, especially West and East Lancashire, and the Chairman G3OSS would be very grateful to hear from anyone who would like to hear more about what is involved.

All these services take time, money and equipment. No sooner do we get one project under way, than we realise that there is even more that we could do to enable even more disabled and blind people to get on the air, stay on the air, and get the last ounce of enjoyment from the hobby. We can make use of that rig you never use, which lies around taking up space, or if you would mention RAIBC in your will, you can know that your donation will be put to good use. Several well known amateurs who have sadly become silent keys in the last few months had so kindly remembered RAIBC either in their will, or by having told their XYs that their rigs should one day go to RAIBC.

If you know, or meet up with, any blind or disabled amateur who has not heard of the RAIBC, perhaps you will tell them of some of our activities, and invite them to contact us.

I see that I have been saying 'we', though I am not licensed, or disabled, or on the Committee! However, I have become involved in RAIBC in a number of ways, and am so convinced of the value of the organisation, and the good that it does and the pleasure that it gives, that perhaps I can be forgiven for the 'we'.

The Club Committee and friends also try to attend as many rallies and conventions as possible. The aim is to meet members, give information, and have some chairs around so that members and friends can sit down for a few minutes for a chat. So if you see the RAIBC banner, you will know who we are, and what it is all about.

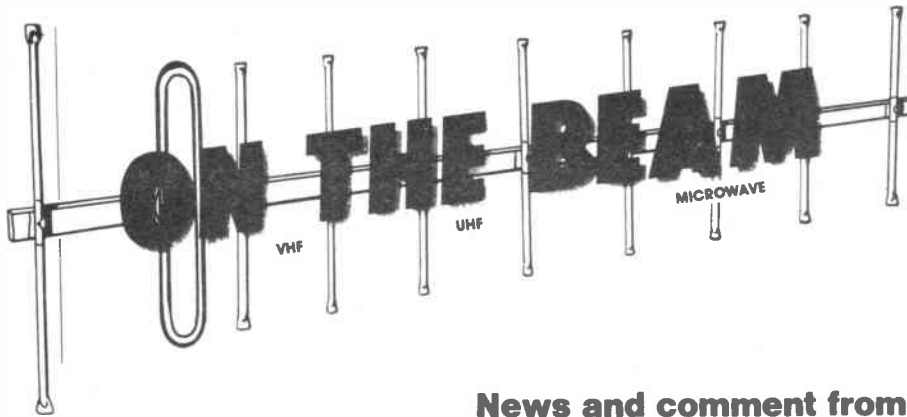

News and comment from Glen Ross G8MWR

You may remember that last month I mentioned the recent report that asks the government to try to get the amateur frequency allocations, particularly at VHF and above, reduced at forthcoming International conferences, and the lack of RSGB response to this. They did come back to it in the editorial of the October issue of *Radcom*, but the odd thing is that they have only mentioned the financial arguments put forward in the original report for selling frequency space. There was not a single thing about the possible reduction in amateur frequency space to allow this to happen. Perhaps they have not read that far yet?

A real threat

Remember that this threat of a reduction in the space that is made available to us is not just some bright sparks idea of what should happen. It is a recommendation produced by a heavyweight inquiry that was submitted to a government that is renowned for its fiscal policies and cost cutting activities at every possible opportunity. As such, it is going to get very serious official consideration. 'How about selling off the amateur radio section of the DTI to licensed amateurs, Prime Minister? Let them buy a share in the future of the hobby; who knows, we might even make a few quid out of it'.

Six opens

This band continues to pull surprises on us, and another one came on 22nd October with an opening into Botswana. The band opened at around 1530GMT and the opening continued until 1700GMT. There had been reception reports of the Botswana station, A22KZ, several days earlier, but no contacts had resulted at the time. It is thought the best contact to come out of the opening was with GM4DGT in Alloa; a distance of around 9000km. It is also known that G2ADR and G4GAI, both in Lancashire, also completed contacts. The contacts made during the opening represent the first G and GM contacts into South Africa. During the same opening several

stations worked 9H1BT on Malta, and this tends to confirm the theory that the long distance contacts were due to Trans Equatorial Propagation (TEP), extended at the European end of the path by the E layer. There are also reports that CT4KQ in Portugal and 9H1BT have both contacted ZS3E in Namibia.

Noviciates

There is growing concern that there is little interest shown in amateur radio by young people. It is a fact that the average age of people involved in the hobby is going up at the rate of one year per year, which indicates virtually no young intake. Why is this happening? At one time the newcomer to the hobby was probably someone who had accidentally discovered the amateur bands while tuning around on the short wave bands of the domestic receiver. This no longer happens.

For one thing, few domestic receivers now have a short wave band, and on those that do the amateur transmissions are just monkey chatter because there is no BFO to resolve them. When they do, perhaps, come into contact with a special event station it does not have the magic that it would have done a few years ago simply because most people have at least had some experience with Citizens Band. There is no longer an air of special mysticism about our hobby.

What next?

The usual answer to the problem is that we need a novice licence to get people into the hobby. This overlooks the fact that you still need an initial desire from someone before they will even take up the novice option. It is all rather like a supermarket moaning about lack of sales when in fact the goods are not on display to tempt the punter; you cannot sell something, no matter how good the product, if no one knows you have it. There is, however, some movement on this front. The RSGB are now worried about the lack of youth and are talking about a Student licence (it seems they

will call it anything except a Novice licence). Way back in 1968 parliament said we could have one, but nothing came of it.

Support

Now the DTI, at a public discussion on the matter, have said that they see it as the next priority to be tackled once the present review of the licence is completed. Amongst others supporting the idea are the Scouts and the Sea, Army and Air Cadets. They all see it as a valuable part of a training program and the offspin to that must be an increase of new young people entering the hobby. The Amateur Radio Novice Licence Campaign, under the able guidance of Ian Abel G3ZHI (QTHR), have come up with a set of proposals that have been distilled from input from many people and groups with an interest in promoting such a licence. They are interested to hear your proposals and ideas and would welcome a line from you; please enclose a SAE when you write as Ian dreads a large post bill!

Bits and bobs

Remember the proposal to put part of a digipeater network on 50MHz? How does that square up with the DTI ruling that there shall be no repeaters on the band? It seems that perhaps it doesn't, and that a slap on the wrist may be handed out. There is already talk of a rethink and that eventually the whole thing may go on the 70cm band.

The present series of G1 calls is nearing an end, and the DTI have announced that the next series to be issued will be the G7s. What will they do when the whole G series of calls are exhausted? The most likely would seem to be calls with an M prefix; it is either that or start out on 'transistor' call signs like 1A1AA; heaven protect us!

On the beacon front it is nice to hear the Cornish units back on the air on both two metres and four metres. The seventy centimetre one will not come back on until a new transmitter is installed on site.

Russian satellites

A nice report received from G8ATE at Leicester gives details of some of the results he has achieved using the new Russian satellites, RS10 and RS11. The results are particularly interesting because of the modest equipment in use. On the two metre side Bob uses an FT290 with a twenty watt linear, the aerials being a choice of a turnstile or a five element quad. On the receiving side he uses a Trio JR500S with a 40673 pre-amp, and a choice of vertical or horizontal dipole as the aerial.

He gives a list of 110 QSOs over a period of four days, which is too long to reproduce in full. Some of the more notable contacts included KA1LMX, W8UZC, K2QWD and WB2E in the States, plus VE2QO in Canada. Other nice call areas in the list included OZ6, SM7, DL4, OE1, HB9, I2, RB5, Y23, UA1 and TA1D. Bob also comments that he has had several QSOs running just 2 watts to the turnstile. So if you have not got a

ON THE BEAM

megastation there is still hope for you to get some good DX. I am always pleased to get reports of your DX, and interesting ones will certainly get a mention; how about putting pen to paper?

HF net

Yes, you did read that correctly. There are uses for the HF bands by dedicated VHF operators, and if you have a receiver that covers the twenty metre band it is well worth having a look at the section around 14.32 to 14.35MHz. This is where all the VHF men tend to gather to give news of openings and to arrange skeds for Moonbounce and meteor scatter operation.

This can be great fun to get in on; simply note the times of the various skeds that have been made and then see if you can hear anything of the DX station. Whatever you do you *must not* transmit during the course of the sked, it is hard enough to make these contacts at the best of times and having some idiot on the frequency calling 'break, break' is just not on.

That noise again

As more newcomers discover the delights of 23cm, the letters start to arrive asking what the funny rasping noise is that is sometimes heard on the band. It takes the form of a very rough sounding CW note and repeats every few

seconds. It is, in fact, caused by radar systems, and the regular pulsing is due to the rotation of the aerial system at the transmitting site. If this is something that you do not get normally, then its sudden appearance is a sure indication that the band is opening up and that a good search of the DX end is called for.

Four metres

The recent release of this band to class B operators has certainly increased the activity considerably, and the RSGB has recently announced a lowering of the requirements for its Four Metre Award. In the past this has required proof of contact with ten countries and 35 squares, and it must be admitted that this took a bit of getting. The fact that it could be done is confirmed by the issue of these certificates to G3OHC and G4BPY.

At first sight ten countries seems an awful lot, but remember that there is occasional activity from 5B4, C31, TF, OY and even ON.

Phase 3

The next generation of Amsat satellites are due to go up around 1990, and already some idea of what the parameters will be are starting to emerge. They will probably carry two main transponders, one (Mode J) having uplink on 144 and downlink on 435MHz. The other one (Mode L) will have uplink

on 1296 and downlink on 435MHz. The bandwidth is expected to be 500kHz and the output power a very healthy 250 watts PEP, with an expected life time of around eight years. It will be similar to Oscar 10 with an apogee at 35000km and perigee at 1500km, and a period of twelve hours. It is intended to fit two aerials, the higher gain one (15dB) being used when the satellite is close to apogee and the lower gain (and hence broader beamwidth) unit being switched in as the satellite comes closer to us.

Stateside microwave

Interesting news from the States, with the first claimed moonbounce contacts on 3.5GHz between KD5RO and W7CNK taking place on the 6 April. Twelve days later the first 5.6GHz contacts were made between W7CNK and WA5TNY. As if all this was not enough, W7CNK also reports hearing his own 10GHz signals coming back from the moon while running only 4 watts to a five metre dish.

The big switch

Time to pull it yet again. What a variety of news to report in one issue; I could not do it if you did not keep the information coming in. Send it direct to 81 Ringwood Highway, Coventry CV2 2GT, or on Prestel using 203616941. As a final thought for this year... Happy Xmas to you all.



**NEXT
MONTH**

Amateur
RADIO

all the regulars. . .

DX Diary
On the Beam
Secondhand
SWL
Straight and Level
Your letters and
features covering
the whole of
Amateur Radio

■ ANGUS MCKENZIE TESTS

G3OSS reviews the new Kenwood TR851E 70cm mobile multimode transceiver and Yaesu FT211 2m FM mobile

■ HF ANTENNAS FOR SMALL GARDENS

Don Field G3XTT continues his series by examining how far the size of an antenna can be reduced before you lose performance.

■ FT209 BASE STATION ADAPTOR

G4KUB and G4KUC build an adaptor for the ever popular FT209 to enable its use as a base station

DON'T MISS THE JANUARY ISSUE
On sale 24 DECEMBER

SECONDHAND EQUIPMENT GUIDE

by Hugh Allison G3XSE

I've received several letters from readers who have repaired electronic equipment recently, which have turned out to have a dried out electrolytic as the root cause of all the trouble. Quite a lot of these are the old blue plastic wrapped Mullard types, used extensively in professional equipment such as 'scopes, mobile radios, medical equipment etc, about ten to fifteen years ago. I've no idea what the design life of these capacitors is, but my experience of them is that they will soldier on forever unless used in a hot area. A good example of this is that I recently purchased two very old but all solid-state black and white TV cameras. These had spent the last twelve years in a small engineering works, one in the foundry and the other in a corridor. In the one from the foundry, every single electrolytic was low capacitance, or no capacitance at all, whilst the camera from the corridor was OK.

Saving grace

The great saving joy about electrolytics is that, ninety-nine times out of a hundred, you can simply put a known good one in parallel with the suspected duff one and see if the circuit springs to life. Remember to take care not to get a shock though if working on equipment with high voltages. It's also downright anti-social to leave electrolytics charged up on the workbench. I've been quite startled to pick up an electrolytic that's been lying unused on the bench for days and getting a belt out of it. A 1k Ω resistor is a handy thing to have to hand to discharge them, though that isn't without its dangers either. Electrolytics can hold enough energy to really heat up a 1k Ω resistor, thus instead of a shock you can end up with, literally, burnt fingers! I'm not a big fan of the admittedly spectacular method of shorting them out with a screwdriver, I'm sure it does the electrolytic harm.

I'm afraid a 'scope is a really useful tool when checking electrolytics. If the suspected capacitor is merely removing the dc yet coupling ac into the next stage, then a 'scope on ac coupling will soon tell you if the electrolytic has turned its toes up or not. If there is a signal on the driving end but not the receiving end, then the electrolytic is obviously a gonner.

The other great use of electrolytics is in decoupling. Wop a 'scope across it and if you have a signal on the hot end, then the capacitor is probably NBG. Both of these failures can be easily checked by putting a known good capacitor in parallel.

The area to beware of putting a known good one in parallel, is in start up circuits. Quite a lot of mains/battery TVs, for instance, use two electrolytics in series to generate a small start up voltage when the set is used on ac. Increasing the value of the bottom capacitor will decrease the start up 'pulse' and stop the set starting.

Piling on the heat

Your average soldering iron of the 40 to 60 watt variety is fine for general PCB work. The hassle is a joint on a large area of copper, especially if near a heatsink. A classic example of this is the emitter connection of the output transistor of an FT290.

It's impossible to unsolder with your normal iron and, just to be really annoying, there isn't the room to get in with a 200 watter. Solution? You need a friend (or the wife!) and another iron. There is just room to get two irons in, and you need the friend to either hold the other iron or haul the transistor out while you hold both.

Newbury car boot sale

This year was the first time that the Newbury Club had organised a radio 'do', and a very slick operation it turned out to be. Although they only attracted about half the sellers they had obviously planned for (about 50, not bad for a first attempt), I was exceptionally pleased with the stuff I bought. A whole Cortina full of genuine down-to-earth rubbish for £75 seemed a good day out, the stuff kept me occupied for weeks. Something tells me this could be an excellent event in years to come.

FT290

One of the bargains I bought at Newbury was a very sad looking FT290. The seller told me that it had fallen off his bike a few times, then been stolen and recovered. All of this had turned the set into a heap. The side panels were bent and featured more scratches than paint. The front panel had no markings left (they had rubbed off over the years) and was cracked. Also missing were some of the control buttons and lots of the screws. I bought that mess, plus a linear, for £20. Now the good news. The Yaesu main dealers I went to seemed to stock everything, and I mean everything, right down to the screws, and most of it seemed mega reasonably priced. For example, the front panel was £4.85 plus VAT and the buttons were 48p each (the switches to go with them were only 53p). It's also worth noting that the spares lady

seemed to know what she was doing with a manual.

Although new side panels were similarly quite cheap, I chose to have the old ones stripped and re-sprayed locally, and that cost me a pound a panel. The only slightly expensive bit required was a new PA transistor (a bit special since it's TO5, but not collector to case), which cost a naughty £6.11 plus VAT. All in all it took about £18 to transform a wreck into a pristine looking rig that worked well. OK the restoration took me a week or so of the odd few minutes here and there, but I thoroughly enjoyed it and have ended up with a rig probably worth about £175.

It's interesting to note that the only electrical fault was the PA, and that was due to some wally twiddling. Always check the VBE before fitting seven quid's worth of new transistor; the diode in the PA biasing in my one was open circuit and would probably have taken out the new replacement. When you consider the severe physical abuse the set must have suffered to get into the state I bought it in, it speaks volumes for the ruggedness of the design that there were no other electrical faults at all. It's also interesting to note the cheapness of a new front panel, by the way, since if you have fitted a mod that required hacking up the front, then tired of your mod, a fiver will turn it back into a 'new' set.

Points to note

Note two things about replacing FT290 front panels: The moulding around the control buttons (the bit that carries the legends telling you what the buttons do) is a separate moulding, ie the new front panel comes with a gaping hole in it; and secondly that replacing the front panel is not for the faint-hearted, those of a nervous disposition or those suffering from bad hangovers and/or the shakes. There are literally hundreds of very fine wires, plus plugs and sockets all over the place. *Do not force anything*, if it doesn't go back together easily then you have either trapped a wire or not aligned something properly. It still takes me an hour to do the job and I've done a few, the first one took all morning!

Allinco linears

Some of these two metre linears are a bit unusual in their construction. The top and bottom of the case are of the same extrusion, and the whole thing is held together by the two screws each end that hold on the end panels. One end carries the two SO259 sockets and RF in and out. The symptom of the common fault on these is that the linear stays in the

Christmas Gift Guide

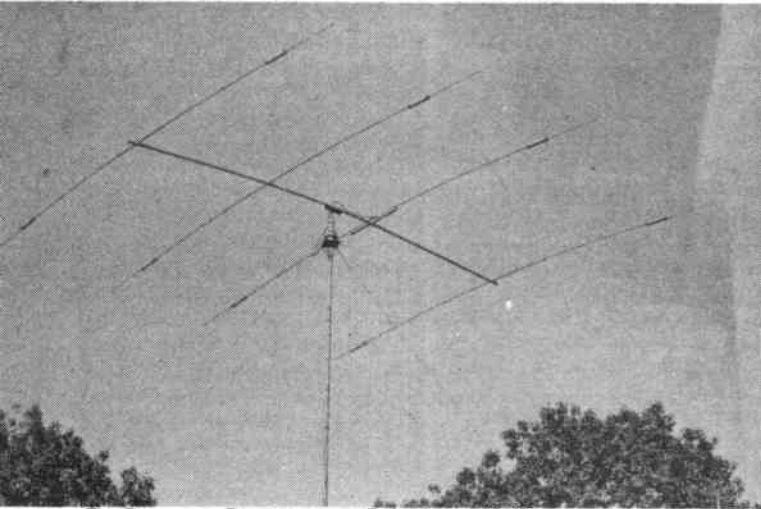

The Penetrator DX-34 in situ in Bahrain at A9BXD

Finally, if you really feel like splashing out on a quality antenna, Western Electronics' DX Penetrator range of

antennas will probably include something to tempt you. The range has been recently extended with the

addition of the DX-40K 40m dipole conversion kit, which can be attached to the driven element of all Western's DX-31 to DX-34 range of HF beams for 10, 15 and 20m, and the DX-51 which is a rotary dipole covering the 28, 24, 21, 18 and 14MHz bands. The power rating of all Western antennas is 2kW, and they have never had a trap failure. In fact owners of their antennas who suffered the recent storms in the Southeast were pleased to see their antennas standing fast, while others were miserably watching their aerial systems fall to the ground.

Anyone requiring further information on Western's range, which retails between £103.50 and £356.50, should write to Western Electronics, Fairfield Estate, Louth, Lincs

LN11 OJH, enclosing two first class stamps, and they will send you the latest details of their range and a current price list.

Get into the spirit . . .

Whatever you receive for Christmas, or decide to indulge in, even if it's the purple and lime green tie, we hope that you'll enter into the spirit of things and try to manage a little more than the perfunctory nod when you receive your gifts - after all, someone cared enough to make the effort to buy it for you. However, if you want to be sure of getting the very thing that will make your station the envy of the district, make the appropriate noises and you never know, you might get listened to - this time! Have a lovely Christmas.

Christmas Competition

Christmas Competition

Last month we reviewed some Morse keys that had been brought onto the market by Gordon Crowhurst G4ZPY. The range includes a single paddle key, a twin paddle key and a straight key which retail at £40, £45 and £25 respectively.

The keys are beautifully fashioned in highly polished brass, with Lakeland slate bases and are a tribute to that fine

tradition of British precision engineering.

The fact that G4ZPY originally manufactured them for his own use and for a few close friends only, but was forced into commercial production because of the demand speaks for itself. In fact, any amateur would be proud to be able to place one of them in his shack.

Consequently, we are more than pleased to be able to offer the top of the range key, the twin paddle version, as a prize in our Christmas Bonus Competition.

All you have to do is answer the four questions below on the history of Morse, and tell us in not more than 10 words why you would like to see a G4ZPY key in your

CHRISTMAS BONUS COMPETITION

1. What does the 'FB' in Samuel FB Morse stand for ?

.....

2. What was Samuel Morse's actual profession ?

.....

3. In what year was the International Code established ?

.....

4. Which special event station in America annually commemorates Morse's achievements ?

.....

I would like to see a G4ZPY key in my Xmas stocking because (not more than 10 words)

.....

.....

Send your entry to Christmas Bonus Competition, Amateur Radio Magazine, Sovereign House, Brentwood, Essex CM14 4SE (To reach us by the 31st December 1987). The Editor's decision is final and no correspondence will be entered into after the publication of the result.

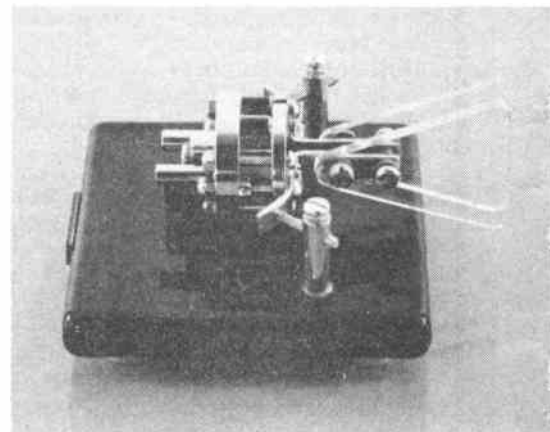

christmas stocking, and the prize could be yours. Don't delay, send your entry in before 31st December and keep your fingers crossed (not while you're keying of course!). The lucky winner will be able to click the new year off in style!

For those of you who don't like to leave things to chance, orders can be made for any of the G4ZPY keys by writing to Gordon Crowhurst, 41 Mill Dann Lane, Burscough, Ormskirk, Lancs L40 7TG or telephoning on (0704) 894299.

K W TEN-TEC LTD

TRANCEIVERS

CORSAIR II
ARGOSY II
CENTURY 22

H F MOBILE WHIPS

Helium-filled

LINEAR AMP

TRITON

AIRBAND TALKIES

CAA Approved

WALKIE-

ANTENNA TUNER

MODEL 229A

DUMMY LOAD,
MICROPHONES,
FILTERS, REMOTE VFO
etc

K W TRAPS, K W TRAP DIPOLES, BALUNS, ANTENNA SWITCH,
PRECISION MORSE KEYS

LATEST NEWS FROM K W

FRITZEL BALUNS, H.F. BEAMS & VERTICALS NOW IN STOCK.
(EXCELLENT GERMAN ENGINEERING)

A NEW TRANSCIEVER - IN ADDITION TO THE CORSAIR II,
ARGOSY II, & CENTURY 22, THE "PARAGON" IS EXPECTED
SHORTLY, THIS IS A 200 WATT INPUT TRANSCIEVER WITH
GENERAL COVERAGE RX CW/SSB/FSK/AM/FM (OPTIONAL)
AND MANY ADDITIONAL FEATURES.

Write or 'phone for Price Lists and/or brochures —

K W TEN-TEC LTD

Vanguard Works

Jenkins Dale, Chatham, Kent ME4 5RT

Tel: (Medway) 0634-815173; Telex: 965834

NEW! from Cirkkit

SUMMER 1987 ELECTRONIC CONSTRUCTORS CATALOGUE



6
MULTIMETERS
TO BE WON

PRICE ONLY
£1.20

- Many new lines
- Extended range of test equipment

- £11 worth of discount vouchers
- 6 Multimeters to be won in easy to enter competition.
- Available at your local newsagent or direct from address below.

Cirkkit

Access VISA

(0992) 444111

Cirkkit Distribution Ltd Park Lane, Broxbourne, Herts EN10 7NQ
Telephone: (0992) 444111 Telex: 22478



CAP CO ELECTRONICS LTD

63 Hallcroft, Birch Green
Skelmersdale, Lancs
WN8 6QB

Tel: 0695 27948

Stay Tuned Forever with a CAP.Co ATU-
Once Bought - Never Replaced

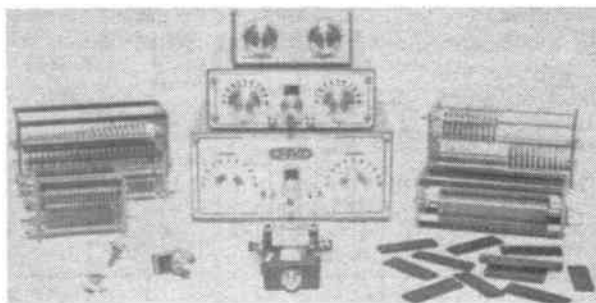

ANTENNA TUNING UNITS

SPC-300D 1Kw pep.....	£225.00
SPC-300D 3Kw pep.....	£225.00
NEW PRODUCT - VHF ATU	
SPC-100 1Kw pep.....	£59.95 + £3 p&p

CAPACITORS

CAP-25S S GANG 250 pfd.....	£15.50
CAP-25T T GANG 250 pfd.....	£15.50
CAP-10S S GANG 500 pfd.....	£21.00
CAP-25D DIFF 500 pfd.....	£18.95

8kv 2.5mm plate spacing + £2.00 p&p

CAP-31S S GANG 250 pfd.....	£17.95
CAP-31T T GANG 250 pfd.....	£22.95
CAP-12S S GANG 1200 pfd.....	£25.00

12kv 4.5mm plate spacing + £2.50 p&p

ROLLER COASTER + £2.00 p&p.....	£22.95
28 micro henries BULAUNS 4:1, 1:1 + £2.00 p&p.....	£16.50
Fully encapsulated.....	£16.50
AERIAL KIT + £1.00 p&p.....	£5.30
Clip-on Spreaders.....	
TURNS COUNTER + £1.00 p&p.....	£22.50
Digital.....	

CAP.CO are proud to announce THE GENUINE MAGNETIC LOOP ANTENNA - A RARE TECHNOLOGICAL BREAKTHROUGH

The Magnetic Loop Aerial is totally different from any other aerial. It relies solely on the magnetic portion of the electromagnetic wave to operate. It filters out all unwanted noise via 180° phase shift between the magnetic and electrical wave, exactly what is required from 1 to 14 Mhz where the electrical noise is virtually unbearable.

Manufactured
in Great Britain



TRANSCIEVING LOOP

Depending on the model used and within the bounds of the frequency designated for that model, the Control Box enables the user to operate the antenna from the lowest to the highest part of the frequency with no gaps.

There are various models of loops - typically 2 antennas and 1 Control Box is required to cover the whole HF frequency range from 1 to 30 mcs. A reduction of £100.00 is allowed for two aerials. Prices range from £59.95 for the receiving Loop to £456.00. Power ratings for these versions are from 100-200 watts.

The Commercial versions, power rating 500 and 1000 watts come complete with Automatic Controller which selects frequency required.

PLEASE WRITE INCLUDING SAE FOR FURTHER DETAILED INFORMATION

- It has a very high Q
- A radiation resistance of 0.003 of an ohm, never more than 800 milli ohms
- Has a bandwidth from 3Khz to 50Khz
- IT has an SWR of 1.4 to 1 at the very least, 1.1 to 1 on most bands
- Will operate at virtually ground level
- The loop has a vertically polarised radiation pattern containing both very high and very low angle radiation (ideal as a DX antenna)
- Does not require an Antenna Tuning Unit
- Depending on the model used, it only occupies from 80cm to 4mt of space
- It is ultra compact, light and waterproof
- Planning permission is not necessary

RECEIVING ONLY LOOP
IDEAL FOR SWL

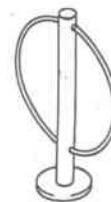

Our equipment is guaranteed, unique and as such protected by registered designs and copyright. Our policy is one of continual research and improvement therefore current specifications are subject to change without notice. Manufactured in Great Britain.

FREE CLASSIFIED ADS

FREE CLASSIFIED ADS CAN WORK FOR YOU

We are pleased to be able to offer you the opportunity to sell your unwanted equipment or advertise your 'wants'.

Simply complete the order form at the end of these ads. Feel free to use an extra sheet of paper if there is not enough space. We will accept ads not on our order form.

Send to: **Amateur Radio Classified Ads**, Sovereign House, Brentwood, Essex CM14 4SE.

DEADLINE AND CONDITIONS

Advertisements will be published in the first available issue on a first come first served basis. We reserve the right to edit or exclude any ad. Trade advertisements are not accepted.

FOR SALE

■ Realistic Pro32, 200 channel scanner, £100. Ensign Selfix camera, Ross lens, swap for 1987 WRTH, or sell, £18. Tel: Newton Abbot 67993

■ Collectors: ZC1 Mk 2 transceiver, believe New Zealand version of Army 22 set, quite good condition and appearance, offers? Tel: (08677) 2300

■ Trio TS780 top quality 2m/70cm multimode base station, exc cond, brand new with orig packing etc, lovely piece of equipment, only reason for sale: engaged! £700 ono. David A Dodds G4WLL. Tel: (091) 514 4122, office hours

■ R1155, no P/S, gc, £20. Old Radio Baby valve portable, circa 1930, £5. 1975 RadCom golden jubilee ed, £1. Buyer to collect. Wanted: JR310 Rx or WHY? Peter. Tel: (0642) 456327, days

■ Brand new Yaesu FT690R Mk II, still in box, swap for FT77, FT707, WHY HF? Yaesu FTV700 transverter, 2m module fitted, boxed, offers or swap/px Belcom LS102, Cobra 148 GTL, Superstar 360, Yaesu FT7B WHY? Lightweight rotator and control, 9 ele X-Y tonna for 2m, offers. Bob. Tel: Luton (0582) 401881 any time

■ Regency HX200 programmable hand-held scanner, 20 channels, AM/FM, microprocessor controlled, little used, search function, scan delay, scan hold, priority channel, LC display, ac/dc, rechargeable, including charger, earpiece, belt clip, case and Magbase aerial, £250 ono. Longridge, Bredfield, Woodbridge, Suffolk IP13 6AX. Tel: (03943) 4208

■ ATU, Amtec 300, offers. SX2000 scanner, 8 months old, £130. Tel: (0283) 221870

■ Icom R7000 VHF/UHF scanner, mint condition, boxed etc, bargain for quick sale, £650. Alan. Tel: (0232) 681962

■ Exchange 2m/70cm Jaybeam dual band crossed yagi, for HF mini-beam to cover 20m etc. Would consider sale of Jaybeam VIC 20 computer, £30 ono. Altai lightweight rotator, £20. Adonis MM202S mobile mic, £25. Nevada 934MHz mobile mag mount collinear P7M-E, 7dB, £38. Postage paid on small items or buyer collects. Tel: (0704) 892088, ask for Mike

■ Uniden Bearcat 175XL scanner radio, brand new, plus CTE International discone, £100 or exchange for good CB radio. Tel: (0705) 663762

■ Yaesu FRG9600 scanner, 60-905MHz, as new, with original box, with PA4C ac adaptor, £375 ono. Tel: Ilfracombe 63455

■ Trio R2000 general coverage Rx, with fitted VC10 VHF converter and Trio AT130, £400. Wanted: MuTek TWF144E transverter, good price paid. Tony G1YIY. Tel: (0789) 296342

■ Yaesu FT757GX CAT system, Yaesu FP757HD power supply, Yaesu FC902 ATU, Yaesu YD148 mic, DL1000 dummy load, HK708 Morse key, £650. G1OBN. Tel: Mansfield 756187

■ Cirkit 50MHz pre-amp, £10. MuTek 23cm converter (not working), £10. Fortop 428MHz notch filter, £5. IQD touch-tone keypad mike (as new), £22. Andrew Emmerson. Tel: (0604) 844130

■ Trio TS130V HF Tx/Rx, TL120 linear, VFO120 remote VFO, SP120 speaker, PS30 dc power supply, MC50 microphone, very good cond, all boxed, £600 ovno. Daiwa CNA1001 auto ATU, vgc, boxed, £90. Coutant 0-30V 1 amp PSU, £15. Bird coaxial resistor, 50Ω 50 watt, £15. Akai GXC730D auto rev, rev recording stereo cassette deck with leads and manual, vgc, £40. Also MB100 mounting bracket for TS130V. T R Cooling, 17 Hawthorn Avenue, Cherry Willingham, Lincoln. Tel: Lincoln (0522) 595051

■ ST5MC RTTY terminal unit, switchable 45/50 baud and Creed 444 with fitted reader and perforator plus paper and spare ink spools, both vgc, £100. T R Cooling G4XMQ, 17 Hawthorn Avenue, Cherry Willingham, Lincoln. Tel: (0522) 595051

■ MM tvtr, 28/432, hardly used, 10W output, 28MHz IF with satellite facility switch, £130 or would prefer exchange for any VHF equipment, ie 144MHz or 50MHz equipment, like 100W linear for 2m or hand-held etc, or may even accept a mini-beam for HF. See what you have around the shack. Who knows, it may be just what I want. G1OYH Howard. Tel: (0235) 813160, Didcot, Oxford area

■ Trio 2500 with speaker microphone, leather case and base stand, excellent condition, £230. Rodney. Tel: (0689) 58825

■ Yaesu FT709R speaker mic, £159 ono. Quad 405 Mk 2 Hi-Fi amplifier (2 x 100 watts), Quad 44 control unit, £485 ono. Philips CD304 CD player, £209 ono. Olympus OM2N, 50mm/f 1.8, £139 ono. Vivitar (OM) 75-205mm zoom, £49 ono. G4WVX Bruce QTHR. Tel: (06286) 64415

■ BRL210 Bremi mains amplifier, AM/FM/SSB, 100 watt FM, 200 SSB, only 4 months old, £90 plus postage. CP163 mobile amp, 30W, 60W, 100W FM, 60W, 120W, 200W SSB pre-amp, £60 plus postage. Zetagi B300PS AM/FM/SSB, 200 FM, 400 SSB pre-amp, £80 plus postage. Brian. Tel: (0249) 816334

■ 30ft, 3 x 10ft tower, £75. 4-1 balun, £10. CapCo 3000 ATU, £175. All ono. Tel: Bedford 44506, evenings and weekends

■ Belcom LS102, frequency readout, AM, FM, USB, LSB, 26-28MHz, mint condition and original boxing, only second owner from new, asking price of £160. Tel: (0978) 757435, or write to Tony Corbett, Sunnyside, New Road, Coedpoeth, Wrexham, Clwyd, North Wales

■ Yaesu FT757GX, FP757GX, MD1B8, tech supplement, boxed and in mint condition, £775 ono. 10-20m cubical quad with rotator, mounted on 50ft two section wall-mounted tower, £350 ono. Can deliver within 200 miles of Suffolk. Mike G0DUS QTHR. Tel: (0284) 705123

■ Ranger AR3500 mobile 10 metre multimode, 26-30MHz digital readout, AM, FM, LSB, USB, CW, 8W FM, 25W SSB, lovely rig, hardly used, cash needed urgently, hence £385. Les. Tel: (08926) 65183, evenings (Crowborough)

■ Sony CRF320 in mint condition, as new, boxed, 32 band receiver, £375 or exchange for RF9000, or cash offered for RF9000, RF6300, Grundig 600, 650, 400 radios. Tel: (0462) 33690

■ Valves/tubes list to overseas buyers. List consists of rare and hard to get valves for sale. Also available valves for ex WD equipment. MR RJ Shaw, 86A High St, Poole, Dorset BH15 1DB. Tel: Poole (0202) 680500

■ Callsign log book for Spectrum and BBC tape disc or micro-drive, logs, freq, date, time, name, sundries. Tape £5.00, disc £6.50, micro drive £8.00. Matthew Goodwin. Tel: (0454) 414516

■ Engineers tools, mics, tapes, cutters etc, many items, swap for 2 metre multimode, PSU, 70cms multimode, or 2m, 70cm dual multimode, what have you? Stan Goodwin. Tel: (0454) 414516

■ FC700 ATU, mint condx, £80. Tel: (0920) 871639 G4ZWP, after 4pm

■ Wanted: Handbook for APR4 receiver, also tuning units etc WHY? Sell or swap Bolex STD8 cine equipt, all mint. Camera, lenses, MR8 projector. Hounslow, 46 Garrick Road, Northampton NN1 5ND. Tel: (0604) 24486 evenings

■ Steepletone radio, model MBR7, MW, LW, FM, MB, Air, two short wave bands, 49m to 13m ideal for beginner, cost £60, sell for £25 & post. Still eight months guarantee. Mr T Goodhall, 9 Gregg Hall Crescent, Lincoln LN6 8AQ. Tel: 41223

■ FT707 transceiver, FM board fitted, this mobile HF rig for only £395. Ask for Don Weymouth. Tel: (0305) 779028

■ Trio 9130 25W multimode, in good condition and complete with original packing, £375. Tel: (0905) 620041 anytime

■ Altron AT32 telescopic tower, head unit fitted with rotary bearing, dismantled but buyer will have

to remove ground post and transport from site, £100. G2AIH. Tel: Surrey (0737) 350995

■ Code master CWR610E, CW, RTTY, ASCII, as new, used once, for UHF TV monitor, £150 or exchange for hand-held scanner with aircraft band. Tel: (0695) 76160 (Lancashire)

■ R1155, no mods, vgc, £40. Mullard valve tester, perfect, with 900 test cards, £75. Rohde Schwartz Rx, 10kHz-30MHz super set, £60. D43 scope vgc, £50. TF1331 scope, not well, £12 inc manual. CT52 miniature scope with manual, vgc £25. TF144G sig gen, vgc accurate, £25. ADM patt test Rx, similar design to Eddystone 840, good set, £35. CR100, vgc, £35. Lots of scope tubes, all good, £7.50 each inc post. Tel: Burnham on Sea (0278) 784205

■ Trio TS430S, £700. AT230 ATU, £170. YK88CN, YK88SN filters, £30. 430 FM unit, £30. LF30A LP filter, £25. Daiwa DK210 keyer, with Hi-Mound key, £52. Yaesu FT708 hand-held, £175 complete. 70cm collinear, £30. FT727 2/70cm hand-held, inc many extras, £399. Trio TR2500 handie, complete, £160. All as new, complete and boxed. Bob G4RWH Tel: (021) 7478784 anytime

■ Marconi signal generators: TF144G, 85kHz to 25MHz. Old but still accurate, £25. TF144H, 10kHz to 72MHz in mint condition, £140.00. Both with copy manuals. Built to last forever, so buyers inspect and collect. Phone Mike O'Beirne after 8.00pm. Tel: (0372) 62268

■ Realistic PR2004, 300 memories, 25-520, 760-1300MHz scanner, £275. Daiwa AF606F all mode active filter, £35. Both boxed as new. G8ZWW. Tel: Swanley (0322) 63968

■ Scanner receivers. Realistic PRO2001, VHF/UHF, manual, £85. Realistic PRO2002, VHF/UHF, Airband, clock, 50 ch, £125. CD6000AR Airband scans, 110MHz - 140MHz, £50. Including 12V mains PSU. Tel: (0703) 473403

■ Jaybeam Q4/2 metre 4 element quad, 9.4dB gain, as new, £18 ono. MC50 dual imp 4 pin desk mike, 50kΩ/500Ω, £25. MML144/50S linear amp 10 watts in, 50W out, £65. BBC Metrowatt LCD digital multimeter M2011, £25. Terry G4OXD, tel: (0462) 35248 after 6pm

■ ICS/AEA CPI 'computer patch' RTTY terminal unit, with G3WHO driver, EPROM (BBC) mint, £125. VHF communications 2 metre polarisation switch unit, £25. NEC 12in green screen high res, composite monitor, £45. Perfect SSB 24cm LT24S 2m/24cms oscillator/mixer unit, £150. Paul G4XHF, tel: (0293) 515201

■ TS930S, original box and manual. Complete with internal ATU, £1000 cash, no offers. Buyer must collect. Tel: (0902) 789806 evenings only

■ Jaybeam dual band crossed yagi 6y/2m/12y/70cm. Almost new, with rotator. Vic 20 computer, complete, in working order. Will exchange for unrestored horizontal stationary engine. Must be complete, would consider exchange for HF minibeam or WHY? All replies will be answered, whether sale or exchange. M Marsden, 205 Moss Lane, Burscough, Ormskirk, Lancs L40 4AS

■ Yaesu FT209R FM hand-held. 144-147.995MHz, three months old, very little used, with flexible ant, soft case, charger boxed, £160 or offers. Tel: (0902) 20636

■ Eddystone communications receiver 730/4 with BFO and crystal phasing, covers 480kHz to 30MHz in five bands, in good working order, £120 ono. John, tel: 01-397 7931 evenings, or 01-543 0077 office hours

■ Samwell Hutton wobblur with handbook. TEK 545A scope with Telford scope camera, two and four channel plug ins, £120. Many more professional instruments, WHY? W B Mansell G2CPM, 10 Wyndham Road, Shaw, Newbury, Berks RG13 2NJ. Tel: (0635) 40464

■ For sale or swap. CBM64, 1541 disk drive, AMT 1 RTTY, AMTOR, CW, etc plus software, price £400

FREE CLASSIFIED ADS

ono. For TS9130 or WHY? Frank G4YLJ, tel: (061) 330 0161

■ Icom IC2E 2m h/h, complete with new leather case, speaker mike and mobile adaptor, £100, buyer to collect. Tel: (03943) 7530 and leave message (answer machine)

■ Realistic 302DX comms Rx. Digital readout. Mains/battery. Built-in Morse practice oscillator. Complete, boxed with manual, £130. Tel: 01-462 6740

■ Icom IC730 HF rig, 100W, £400, plus MuTek TVVF144a 2m Tx, 28MHz IF, superb, £165. Also 4CX250B h/brew linear PSU and 19e1e 10cm, Tonna yagi, new type unused, £15 p&p extra, will split. £585 the lot. Conrad G6ZTU QTHR. Tel: (0226) 791196

■ Pye SSB130 HF 2-15MHz Tx/Rx, unused condx, £120. HRO Mx, £45. Eddystone 740, good condx, £60. SP600 54/54M, cabinet, superb Rx, £140. 1940s domestic radios, Pye, GEC, Philips, all now fully working. Bendix Tx, £30. Bendix RA10DB Rx, £40. Several Bendix Tx control boxes, PSU for R1132, £10. M/Module 100W VHF linear amp, £65. Pre-amp, £8. Pye Ex PMR base station and mobiles, 41-band. Cain, 18 Oaky Balks, Alnwick, Northumberland NE66 2QE. Tel: (0665) 602487 evenings

■ Yaesu FT7 transceiver, with handbook, circuit diagram, good condition, £200 ono. Sony ICF2001. FM/AM/SSB, with power unit, £75. Would swap Sony for DG5 digital display unit or AT200. Geoff G6YKY, 41 Penn Grove, Norwich, Norfolk NR3 3JZ. Tel: (0603) 406331

■ Royal Teacher, dual gauge 8mm standard, plus super cine projector, cost £65 new, also Decimo pocket secretary (vest pocket cassette recorder), cost over £70 new, total value approx £100. Will exchange both of above for best multimode CB transceiver offered, Nato 2000/Cobra/Concorde/ or WHY? Will sell for £100. All offers will be replied to, please include small percentage towards post and packing. Mr Robert Guiney, 134 South Seton Park, Port Seton, East Lothian EH32 0BN, Scotland

■ Converted 10mtr multimode, covers 28.05 to 29.7MHz in five bands with Tx/Rx, fine tune inc mike, box and p&p, £110. Daiwa elect keyer DK210 uses int PP3 included or ext 13.8V, £55 inc P&P. G4XIV, tel: (0904) 792208 after 8pm please

■ Advance AF sig gen H1 with manual, £15. Bradley electronic multimeter dc-1500MHz with probes and manual, £18. S G Brown, prof, h/phones, £5. 2mtr mobile whip and pod, £3. Racal mobile hand-held PTT mic, £3. Mobile 12V PSU for scanner Rx's, Bearcat SX200N etc, £5. 4 off h/duty Tx ae insulators, £3. Approx 100ft of RG-14A Tx 0.5in co-ax, £5. Approx 50ft of 300 ohm ribbon cable, £3. BA/metric ratchet socket set, £4. 13A 6SKT distribution block, £5. Box of useful components, meters, PSU modules, clean PCBs, resistors, caps, etc, £5 the lot. G4FZF QTHR. Tel: (0242) 580329

■ Realistic PRO2003 programmable scanner, covering 68-87, 88-107, 108-138, 138-174, 410-512MHz with fifty memory channels. Excellent condition, £130 or swap for HW9 or Argonaut 515. GM0CNP. Tel: (0383) 822206 evenings

■ Racal RA17 receiver with superb front panel in good working condition, £175. Tel: (0254) 823305

■ Sony ICF7600 FM MW SW 7 bands receiver, £20. Grundig Satellit 1400SL all bands receiver, £80. Both first class condition or exchange for a FRG7 or Lowe SX30. Taylor, 1 Cadley Close, Blandford Forum, Dorset DT11 7RY. Tel: (02548) 53933

■ Yaesu FT902DM transceiver in absolutised mint condition. Comes complete with SP901 external speaker, dynamic microphone and a brand new set of 6146B final tubes, which are still in original packing. Tubes cost £25 alone. Will sell as one complete unit for £600. Maurice Hughes, 128 Ravenswood Rise, Dedrige, Livingston. Tel: Mid-caldor 880345

■ SEM 70cm to 2m convtr, inc sat band, £15. Chapman stereo valve amp (ultralinear) 15W PC control unit tuner in gwo, £30. Large box misc valves some prewar, £10. All plus carriage or exchange for 28-30MHz Rx or tunable IF strip SSB, VHF GDO or WHY? G8ATE QTHR. Tel: Leics 392842

■ ARA Dressler 500 active antenna 50MHz to 1300MHz gain 17dB-typical, £100 one plus postage, good condition. Zenith audio speech processor give away price, £15. Plessey type 72 switches, 3 band, 3 pole, 30-way, £15 for seven. All letters

answered, SP Martin, 24 Collingwood Close, Worle, Weston-Super-Mare, Avon BS22 9PQ include phone and I will contact you.

■ Yaesu FT757GX HF tcvr and FC757AT auto ATU both very little used, £850 the pair. Tel: 01-514 5998 anytime

■ Icom ICR7000 (25MHz-2GHz), £699. Brother BP30 colour graphic writer, £95 ono. Brother EP43 dot-matrix (24x18) personal thermal printer, £85 ono. All three items are boxed, in mint condition with their instruction and service manuals. May exchange, with necessary cash adjustment, for: Sony ICF2001D, AOR AR2002 and/or telereader CD670 RTTY, CW, etc decoder. Nick. Tel: (07356) 4111 Extensions 6176 or 5522 (08:00 - 16:15, Mon to Fri)

■ Scanner JIL SX200N, 26-88MHz, 108-180MHz, 380-514MHz coverage, AM/FM modes, 16 memories, two speed scan rate, scan delay (switchable), complete with telescopic antenna, manual, boxed, all in vgc. Tel: Soton (0703) 476609 anytime.

■ Realistic DX302 communications receiver. 10kHz-30MHz, digital readout. AM, USB, LSB, CW, mains/batt, S meter, excellent condition, manual, boxed, £185. Gillespie, Tel: Worthing 206977 (Sussex)

■ FDK750E 2m FM, SSB CW all mode 1 to 10W Transceiver. Boxed, vgc, £250, no offers. (Tel: Houghton Le Spring 5848400 any Saturday) call, 2 Elmwood Street, Fence Houses, Tyne and Wear

■ Yaesu FT757GX, Yaesu FP757HD PSU, Yaesu ATU, FC902, Yaesu YD 148 mic, HK708 Morse key, dummy load 1000, good condition, £650. GIOBN Mrs Dorothy Smith, 61 Derwent Drive, Kirkby in Ashfield, Notts NG17 9SE. Tel: Mansfield 756187

■ Valves, 500 octal 12V, 6V types. Also many rare continental side contact types. British TV valves. All unused, boxed; 50L6GT, 35L6, 2525, 2524. Many others, all low prices, half the lowest advertised prices. All are retirement stock, no dealer. SAE for list, all post free. Wanted fair priced Swan transceiver. Don't mind valved type. Mr A D Jeffrey, 42 Dennis Road, Padstow, Cornwall PL28 8DF

■ QV06-40 valve, £5; 2x QV03-20 valves and bases, £2; 4CX250B and UHF base, £20; 25 watt VHF Hi-Band PMR amp with manual, £25; 40 channel CB mint/boxed, 20; Antenna combiner/splitter, £2; BAC designed video callsign generator, built and tested, £15; Wood and Douglas FM TV demod module, 53MHz in, video out. TVRO? £30; Pye PF70, Xtalred on RB0 and SU8, includes 2 NiCads and charger, £65; Sunpak Autozoom 5000 Pro flash gun, amazing power, £50; 135mm lens in Pentax 42mm screw and K mount adaptor, £20; Pentax ME autowinder, £20; Flashgun bracket, £4; Flashgun extension lead, £1. Tel: (0604) 766913 anytime.

■ Yaesu FT7 10W HF mobile rig. gwo, very sensitive on Rx, £240 ono. Also Trio 35MHz dual beam scope with probes, £300 ono. Wanted any details on software solution to Packet Radio using Commodore 64? WHY? Glenn, Tel: (0884) 41208 after 6pm please

■ FTV107R transverter with 2 metre module, £150 ono. GM1SYW QTHR

■ Kenwood MC50 desk mic, dual imp 50Kohm/500ohm, £25. Metrowatt LCD digital multimeter, model M2011, £25. Microwave modules MML144/50S linear amp, £65. Terry G4OXD, tel: Hitchin 35248 after 6pm

■ 934 NPR with Les Wallen mobile collinear, £300. FRG7, excellent condition, £125. Tel: Castletford (0977) 510663

■ R1475 working, PSU, manual, £15. W1252 wavemeter 20-40MHz in copper lined box, £12. Several PW and PE for 60s and 70s. Wanted FC102 ATU. Tel: (0765) 6159

■ Yaesu FRG7700 general coverage receiver and FRA7700 active antenna, £200. Sanyo RP8880 world wide receiver LW, MW, FM, MB and five SW bands, BFO, double conversion 10kHz calibration with xtal marke RF stage for all bands, £50. These items no longer required. Manuals and accessories included. Buyer to inspect and collect. Mr King, Inverkeithing. Tel: (0383) 414977

■ Shack clearance, various pieces of valve equipment for sale, including AVO valve characteristic meter, HT power supplies, signal generators, PCR HF Rx, Solartron I/c meter, and loads of bits and pieces. Paul, tel: 01-733 0665

■ Taylor 65B signal generator, £20 with manual; ex WD single beam scope, £10; Eddystone 870 Rx, £25; multimeter Barnett USA, £10; Dictaloope head-phones, £4; Bush VHF only mains Rx, £5; Bush TR130 battery Rx, £5; Grundig TK 24 reel to reel, £10; wanted Racal RA1770 Rx. Prefer inspect and collect. Tel: (041) 649 2328 (Glasgow)

WANTED

■ Handbook or copy for FT207R hand-held. Europa 2 metre transverter, or Spectrum 2 metre transverter. Ian G1MQH, tel: (0388) 662630 (Durham)

■ Can anyone help? Required either timing board for G4IDE Wefax, or circuit of same. Have all freq crystals 200kHz to 108MHz, Vidicons etc. J Brown, 45 Marlborough Avenue, Falmouth, Cornwall TR11 4HS

■ Bakelite radio sets, Ekco, Murphy etc, pre 1950 AR88 and 1155 sets. Also Super Skyrider receiver by Hallicrafters, model SX28, working or not but must be clean. Also sought, receiver with coverage 25MHz to 500MHz, have few valve radio sets late 40s, early 50s to sell. WHY? Tel: Clacton on Sea, 429779

■ KW transmitter wanted, Viscount, Viceroy, Vanguard, Valiant or Vespa, must be in working order and no mods. Tel: (0327) 860225

■ Collins Rx S51J manual required, for ham friend in Cyprus. I will pay for photocopy. Help much appreciated. A L Burley, 8 Peakirk Rd, Glinton, Peterborough. Tel: (0733) 252865

■ 430/726 70cms, unit 50/726, 6m unit and sat 726 satellite unit for Yaesu FT726R base station, offered £130, £165 and £40 respectively, if in perfect condition. FT690, will pay £265 plus any accessories. R7000 scanner, will pay £565. Tandy DX 400, will pay £50, condition unimportant, but, must be working. Used compact discs, not classical, just music. Videos, VHS only. Pocket TV. Mike G1XGM, 51B Brownhill Road, Catford, London SE6. Tel: 01-461 5398

■ Urgently wanted by SWL National HRO 5T 28MHz band spread coil, in perfect working order. Please send price to Dennis Sheppard, 76 Coronation Road, Earl Shilton, Leics LE9 7HJ

■ DG5 digital display unit for TS520S. Also suitable ATU, will buy or swap for FT7 rig. Geoff G6YKY, 41 Penn Grove, Norwich, Norfolk NR33JZ. Tel: (0603) 406331

■ Wanted RTTY unit kit (or built) and software for Acorn Electron, anything considered, any information on RTTY for Acorn very welcome. Peter Webster, 1 Loudon Cottages, Pitfour, Mintlaw, Peterhead, Aberdeen AB4 8LE, Scotland

■ Split stator capacitor, 250pF each section, pref ceramic. Derek D Wilson, 3 The Terrace, Loddswell, Kingsbridge, Devon. Tel: Kingsbridge 550391

■ Information - I have a Heathkit MGP-1. Can anyone please give me any info about this item? I will refund any expenses for copies of instruction manual etc. Bill McGill G0DXB QTHR. Tel: Rotherham 814010

■ Eddystone 888/A Rx in good working order, reasonable price offered. Chorley, 7 Foxfield, Everton, Lymington, Hants. Tel: Lymington 45231

■ Keen collector needs several items to complete R1155/T1154 installation. Anything considered, however small. Main area of dire need is aerial system. Will purchase or swap as you require. Also collect almost anything, air ministry. I have to swap R107 receiver, WW2 1.2 MHz-17.5 MHz mains or 12V; R210 receiver 2MHz-16MHz runs on 24V and is an army landrover receiver. NAAF1 receiver, new and boxed, WW2 medium wave, runs from 6V supply. WS19 items available include leads, connectors, Morse key, remote control box type E (full remote operation of WS19) and control boxes (various types). Many other items available. Contact Tony Howard, tel: (0908) 73114 anytime up to 10pm

■ Yaesu FRG9600/RWC Mk3, HF-UHF series scanning Rx. Details to J House, 4 Elizabeth Way, Kenilworth, Warwicks CV8 1QP. Tel: (0926) 54556, 6-9pm

■ RT279/APX any literature, poss swap for SCR399A manuals. Any accessories Also. Andrew Stuart, 13 Brookfield Cres, Leeds LS6 3DD

■ TenTec Argosy 525, Argonaut 509/515 Rx 9R59. Tony G3MRB, tel: (0531) 85420, Glos

■ Trio/Kenwood R600 or R1000 Ron G1HAL QTHR.

Amateur RADIO SMALL ADS

IAN FISHER COMMUNICATIONS OF STANHOPE

CB Works, The Market Shop, Market
Place, Stanhope (0388) 528464

Main Distributors of 27MHz CB radios and
the NEW CEPT models including SATCOM
and DNT.

Large stocks of coaxial cable, plugs,
sockets and adaptors.
All available via mail order. Retail/
Wholesale

OPEN: MON-SAT 10.30am-6.00pm
SUN 2.30 - 4.30
RING FOR DETAILS
(0388) 528464

ETESON ELECTRONICS



15B Lower Green,
Poulton-le-Fylde, Blackpool
Tel: (0253) 885107

ZENITH SPEECH PROCESSOR P-202

★ ★ ★ ★ ★ ★ ★ ★ ★ ★

NOW AVAILABLE DIRECT
MAIL ORDER ONLY

PRICE £28.50 INC VAT & P&P

SEND P/O OR CHEQUE TO:
ZENITH ELECTRONICS
14 CORTLANDT BUSINESS CENTRE
HAILSHAM, EAST SUSSEX
BN27 1AE

TELEPHONE: 0323 847973
TELEX: 878334 CALLS G

AGRIMOTORS

MERTON CB AND RADIO CENTRE
MERTON GARAGE AND POST OFFICE, MERTON.
Nr OAKHAMPTON, DEVON EX20 3DZ

OPEN 6 DAYS 9-6 LUNCH 1-2pm THURSDAY 9-1
(SUNDAYS BY APPOINTMENT)
SPECIALIST IN 934 MHz
SUPPLIERS OF ALL 27MHz AND 934 MHz EQUIPMENT
AMATEUR EQUIPMENT CATERED FOR
08053 200

D.P. HOBBS (Norwich) Ltd

13 St Benedicts Street, Norwich Tel: 615786



Open Mon-Sat 9-5.30
Closed Thurs 1.00pm



Stockists of:

YAESU, FDK, ICOM, JAYBEAM
& Electronic Component Specialists

CIRCUIT DIAGRAMS

Any Make, Model, Type, Audio Music Systems, Television, Video
Recorders, Amateur Radio, Test Equipment, Vintage Wireless etc.

£3.00 plus LSAE. State Make/Model/Type with order
Full Workshop Manual prices on request with LSAE.

MAURITRON (AR), 8 CHERRY TREE ROAD,
CHINNOR, OXON OX9 4QY

QUARTZ CRYSTALS and FILTERS

Large numbers of standard frequencies in stock for
amateur, CB, professional and industrial applications.
Stock crystals £5.00 each (inc VAT and UK post). Any
frequency or type made to order from £6.50.
Phone or SAE for lists.

GOLLEDGE ELECTRONICS

Merriott, Somerset TA16 5NS.
Tel: (0460) 73718.

Voucher Used

FREE CLASSIFIED ADS

Tel: (021) 230 2671 (day), (021) 550 6050 (evenings)

Will pay reasonable price for secondhand Yaesu ATU FT7700 and will consider any other FRG7700 add on goodies. Davies, tel: Wheatley (Oxon) 4024 most evenings

Please can anyone who has a Hy-Gain VII home base radio and wishes to part with it ring me. I have been trying to obtain the above set for 4 years with no luck. It is the horseshoe shaped one. Good home waiting, but radio must be in good cond and fully working. Can anyone put me out of my misery, if so phone Andy GU1WDT. Tel: (0481) 49112 after 5.30pm

Wireless and electrical trader service sheets, pre 1946 on valve radios and service manuals on same, any period. Operating instructions and data on Lafayette radio tube and transistor tester, model TE21. (Someone must have one somewhere). Contact Tom Valentine, 38 Grampian View, Montrose, Angus DD10 9SX, Scotland. Tel: (0674) 76503

Model MR44 operators handbook or service sheet required, details and cost to Jim, 89 Hornbeam Rd, Belfast, NI, BT17 9BN or tel: (0232) 301349

Datong MK Morse keyboard must be vgc. Also Yaesu CPU 2500R 2m FM trans and Trio Kenwood VFO120, SP120. Tel: (0305) 813202

Ascom ROM from ICS Electronics would like Ascom on ROM or disc. Fair price paid. John Taylor PO Box 4, Twickenham TW1 4JL. Tel: 01-891 2820 eves

FC107 ATU. Paul G4ZWP. Tel: (0920) 871639 after 4pm

I will swap my 160m and 80m transcvr for any 2 Pmetre SSB transceiver. Any rig considered. Sorry no cash. Ring Andy anytime. Tel: (0604) 415650 Northampton

Do you have an old Pye, Grundig or Philips type 22VR20 semi-portable video recorder for sale? This is video 2000 gear which went off market about four years ago. The other half is the 21VR20 tuner/timer which I already have. Good price paid

for the 22VR20 if in good condx. Write or phone if you have one or source of one known. Nev Kirk G3JDK, 54 Allendale Rd, Rotherham S65 3BY. Tel: R'ham 541606

Admiralty B40 comm Rx, 0.5 to 30MHz, five bands, BFO, Xtal calibrator, three bandwidths. Would exchange for SSB adaptor, VLF converter or add on digital frequency meter for Racal RA117. Cash adjustment if required. Ask for Steve. Tel: (0268) 752907 after 6pm

Icom IC202 and Icom IC402, your price paid in cash, can collect or will pay postage. Martin G4IYA, QTHR. Tel: Sitingbourne (0795) 21207 anytime

Can anyone help? Disabled person needs main transformer for Marconi Dynatron Mimco model 2235. Ronnie Lowe, 49 Braithwaite Road, Middleton, Manchester M24 3LW. Tel: (061) 6531391

Wanted by collector: vintage wireless equipment, especially military. Good price paid or have lots of nice things to exchange. See for sale column. Tel: Burnham-on-Sea (0278) 784205

1985 Radio Amateur Callbook United States Listings and 1985 Radio Amateur Callbook Foreign Listings. Price P&P, local if possible. G8CQC. Mr R H Mills, 48 Lady Bank, Birch Hill, Bracknell, Berkshire RG12 4BH. Tel: Bracknell 412239 after 6pm

BC348 rough sets, spares, dynamotors, original BC348 JNQ command ARC5 installation. WS19 control box, 12 pin plug. T1083 coil, amplifier range C. Control type 182. Cover for PSU type 16. Tuning unit TU10B. Cash or exchanges. Have nice R1116A, flying headset, leather, oxymask, electrics. Control Box MN26, R11474, two J switch plugs, plus other gear, WHY airborne? DW Parsonage, 52 Bramble Lane, Mansfield, Notts.

Grundig 2000, 1400 or 3400 short wave receiver, or Sony CRF320, 330K ICF6800, Panasonic RF8000, RF9000. Good cash price paid and collection arranged by private buyer, non workers considered. Please phone evenings/weekends. Tel: Oakley (02302) 2438

Cobra 148GTL or Concord III, urgent. Your price paid. Tel: (0283) 221870

RTTY to TV converter, either Tascos CWR610E or Microwave Modules MM2001, for app £120. Alan. Tel: (0232) 681962

Sony CRF330K, or 320. Also Panasonic RF9000 Rx. Cash paid. Pan-Crusader X, 12 band, FM/AM/SSB/CW digital Rx for sale. Tel: (061) 7431570

FT75 manual, circuit diagram, photocopy acceptable, appropriate costs refunded. R F Cashmore, 65 Michaelston Road, Cardiff CF5 4SX. Tel: 593057

Exchange: CBM64, datasette, joystick, many business/games progs, comm-in 64 boards, IC2E, IC27E, SX200, ST5 TU, all vgc. Wanted: Gen cov Rx (base or portable), 70cm module for FTV9V1, 2 metres/70cm dual bander, H/D rotorator, HF beam or WHY? Consider sale. Letters only, GMMOA QTHR, 4 Low Street, Buckie, Banffshire, Scotland AB5 1UX

Many items of hi-fi, test gear, exchange for Spectrum 128K+2 and software. Open to suggestions for music centre, Philips laser vision, linear tracking record deck, Bearcat 220 scanner etc. All letters answered. Findley, 27 Keytes Lane, Barford, Warwick CV35 8EP

Exchange Daiwa Search 9 shipping band rcvr, 11 crystals, VFO, hardly used, good condition, for similar good working order SW Eddystone rcvr for young SW listener. Ring or write. I am also still in need of Yaesu SP102 loudspeaker, price etc to 41 Poets Corner, Margate, Kent CT9 1TR. Bob. Tel: (0843) 225445

Wanted in exchange for Harrier CBX 40 channel FM CB radio: Ham Int Multimode II or any other side band radio, must be in full working order. Person must live in Northern Ireland or they must deliver set, as transport is not available. G Coyle, 15 Stoneburn Place, Curryrieran, Londonderry, Northern Ireland BT47 3UZ. Tel: 46313, after 5pm

FTV107, cash waiting. Also FC107 ATU. For sale: FC700, £80. Tel: (0920) 871639

FREE CLASSIFIED ADS

EBF80 0.95	EL500 1.95	KT33C 3.50	PV83 0.70	1Y8-60W 365.00	1HS9J 2.50	6/30L2 0.70	6H26 3.50	12SJ7 1.50	812A 35.00	7059 2.50
EBF83 0.95	EL504 1.95	KT36 2.00	PY88 0.85	1Y8-60W 365.00	1P28 25.00	6A303K 2.00	6J4 2.18	12SN7GT 1.85	813 27.50	7059 2.50
EBFR9 0.70	EL506 2.95	KT44 4.00	PY500A 1.95	1Y8-60W 365.00	1R5 0.90	6A7 4.95	6JAWA 3.18	12SW7 3.50	813 Philips 35.00	7119 9.00
EC96 7.00	EL509 6.25	KT45 4.00	PY800 0.79	U18-20 2.78	1S5 1.50	6A8 1.50	6J5GT 2.80	12Y7 4.50	829B 14.50	7189 3.50
EBL1 2.50	EL519 6.95	KT61 5.00	PY801 0.79	U19 11.85	1T4 1.00	6A84 3.50	6J6 2.00	12X4 1.95	833A 95.00	7193 7.50
EBL21 2.00	EL802 3.85	KT83 2.00	QB3-300 72.00	U25 2.00	1U4 1.75	6AC7WA 2.00	6J7 4.18	13D3 3.20	843 7.50	7199 7.50
EC22 0.75	EL821 2.95	KT86 USA 9.95	QB3-1750 72.00	U29 0.90	1U5 1.50	6AG5 2.50	6J7G 4.18	13D7 3.20	866A 6.50	7247 4.95
EC70 1.75	EL822 2.95	KT86 USA 9.95	QB3-5-700 72.00	U26 0.90	1X2B 2.50	6AH6 3.50	6J8A 4.50	13D9 3.20	872A 20.00	7360 15.00
EC81 7.95	EL823 2.95	KT86 USA 9.95	OB3-1750 72.00	U35 3.50	2A515A 11.50	6AJ4 3.50	6J8C 6.50	13DE7 2.50	873 60.00	7475 5.00
EC86 1.95	EM34 22.50	KT86 GEC 17.50	OB3-1750 72.00	U37 9.00	2B7 2.50	6AJ7 2.00	6J8E 6.50	13E1 145.00	954 1.00	7486 188.00
EC89 1.50	EM83 1.85	KT86 Sp yellow spot 196.00	OB3-1750 72.00	U41 6.95	2B22 99.50	6AK5 1.95	6J8F 6.50	13E7 3.50	955 1.00	7527 85.00
EC91 5.50	EM85 3.95	KT86 Sp yellow spot 196.00	OB3-3500 99.50	U50 2.00	2C36 70.00	6AK6 1.95	6J8G 6.50	13E8 3.50	956A 1.00	7531 8.50
EC92 1.95	EM87 2.50	KT87 9.00	OE03-10 4.95	U52 3.00	2C39A 32.50	6AK7 3.50	6J8H 6.50	13E9 3.50	1296A 0.60	7558 9.95
EC93 1.95	EM87 2.50	KT87 9.00	OE03-10 4.95	U51 1.91	2C39B 39.50	6AK8 2.25	6J8J 6.50	13E9 3.50	1626 3.00	7581A 9.95
EC95 7.00	EN91 1.95	KT88 USA 10.95	OE08-200 148.00	U191 1.00	2C40 37.00	6AK9 6.00	6K6G 6.50	15E 3.50	1768 95.00	7586 15.00
EC97 1.10	EN92 4.50	KT88 Selectron 17.50	QOE02-5 19.50	U193 1.00	2C42 29.50	6AM6 1.95	6K6H 6.50	16A0Q3 1.95	1849 315.00	7587 19.50
EC98 12.00	EY1 0.80	KT88 Gold lion 18.95	QOE03-12 7.95	U251 2.50	2C43 60.00	6AN5 4.50	6K6I 6.50	16H 0.40	1927 25.00	7591A 5.95
EC010 3.50	EY70 7.50	KT88 Gold lion 18.95	QOE03-20 35.00	U801 3.50	2C51 2.50	6AN6A 4.50	6L6G 2.95	16L 0.40	2040 25.00	7609 47.00
EC033 3.50	EY81 2.35	KT88 Gold lion 18.95	QOE06-40 45.00	UAF42 1.00	2D21 1.95	6AQB 0.85	6L6GC (GE) 5.75	17A8 3.50	2050 5.95	7698 75.00
EC035 3.50	EY82 1.15	KT88 Gold lion 18.95	QOV02-6 19.50	UBF80 0.50	2D21W 3.15	6AR5 5.95	6L6G 5.75	17AX4GTA 1.95	2050W 6.95	7699 25.00
EC038 1.95	EY83 1.50	KT88 Gold lion 18.95	QOV02-10 5.50	UBC41 2.25	2E22 49.00	6AS5 2.50	6L6G 5.75	17B3 2.50	4004A 11.50	7788 25.00
EC039 1.95	EY84 5.95	KT88 Gold lion 18.95	QOV03-20 25.00	UBC81 1.28	2E26 7.95	6AS6 2.50	6L6G 5.75	17B3 2.50	4212E 250.70	7815 55.50
EC041 1.95	EY85 5.95	KT88 Gold lion 18.95	QOV03-20 25.00	UBC81 1.28	2E26 7.95	6AS7 2.50	6L6G 5.75	17B3 2.50	4212H 250.70	7868 7.50
EC042 0.68	EY86 87.00	KT88 Gold lion 18.95	QOV03-20 25.00	UBC81 1.28	2E26 7.95	6AS7 2.50	6L6G 5.75	17B3 2.50	4313C 4.00	7963 7.95
EC043 1.95	EY87 87.00	KT88 Gold lion 18.95	QOV03-20 25.00	UBC81 1.28	2E26 7.95	6AS7 2.50	6L6G 5.75	17B3 2.50	4328D 9.00	8009 95.00
EC044 1.95	EY88 0.55	KT88 Gold lion 18.95	QOV03-20 25.00	UBC81 1.28	2E26 7.95	6AS7 2.50	6L6G 5.75	17B3 2.50	4471 35.00	8020 45.00
EC045 1.95	EY89 1.95	KT88 Gold lion 18.95	QOV03-20 25.00	UBC81 1.28	2E26 7.95	6AS7 2.50	6L6G 5.75	17B3 2.50	4687A 9.50	8136 2.15
EC046 1.95	EY90 1.95	KT88 Gold lion 18.95	QOV03-20 25.00	UBC81 1.28	2E26 7.95	6AS7 2.50	6L6G 5.75	17B3 2.50	5544 79.50	8156 7.95
EC047 1.95	EY91 1.95	KT88 Gold lion 18.95	QOV03-20 25.00	UBC81 1.28	2E26 7.95	6AS7 2.50	6L6G 5.75	17B3 2.50	5636 8.50	8417 6.95
EC048 1.95	EY92 1.95	KT88 Gold lion 18.95	QOV03-20 25.00	UBC81 1.28	2E26 7.95	6AS7 2.50	6L6G 5.75	17B3 2.50	5642 9.50	8444 25.00
EC049 1.95	EY93 1.95	KT88 Gold lion 18.95	QOV03-20 25.00	UBC81 1.28	2E26 7.95	6AS7 2.50	6L6G 5.75	17B3 2.50	5651 2.50	8874 215.00
EC050 1.95	EY94 1.95	KT88 Gold lion 18.95	QOV03-20 25.00	UBC81 1.28	2E26 7.95	6AS7 2.50	6L6G 5.75	17B3 2.50	5654 1.95	8950 10.50
EC051 1.95	EY95 1.95	KT88 Gold lion 18.95	QOV03-20 25.00	UBC81 1.28	2E26 7.95	6AS7 2.50	6L6G 5.75	17B3 2.50	5670 3.25	9001 1.50
EC052 1.95	EY96 1.95	KT88 Gold lion 18.95	QOV03-20 25.00	UBC81 1.28	2E26 7.95	6AS7 2.50	6L6G 5.75	17B3 2.50	5672 4.50	18042 10.50
EC053 1.95	EY97 1.95	KT88 Gold lion 18.95	QOV03-20 25.00	UBC81 1.28	2E26 7.95	6AS7 2.50	6L6G 5.75	17B3 2.50	5675 28.00	18045 10.00
EC054 1.95	EY98 1.95	KT88 Gold lion 18.95	QOV03-20 25.00	UBC81 1.28	2E26 7.95	6AS7 2.50	6L6G 5.75	17B3 2.50	5678 7.50	18048 11.50
EC055 1.95	EY99 1.95	KT88 Gold lion 18.95	QOV03-20 25.00	UBC81 1.28	2E26 7.95	6AS7 2.50	6L6G 5.75	17B3 2.50	5679 7.50	18048 11.50
EC056 1.95	EY00 1.95	KT88 Gold lion 18.95	QOV03-20 25.00	UBC81 1.28	2E26 7.95	6AS7 2.50	6L6G 5.75	17B3 2.50	5680 7.50	18048 11.50
EC057 1.95	EY01 1.95	KT88 Gold lion 18.95	QOV03-20 25.00	UBC81 1.28	2E26 7.95	6AS7 2.50	6L6G 5.75	17B3 2.50	5681 7.50	18048 11.50
EC058 1.95	EY02 1.95	KT88 Gold lion 18.95	QOV03-20 25.00	UBC81 1.28	2E26 7.95	6AS7 2.50	6L6G 5.75	17B3 2.50	5682 7.50	18048 11.50
EC059 1.95	EY03 1.95	KT88 Gold lion 18.95	QOV03-20 25.00	UBC81 1.28	2E26 7.95	6AS7 2.50	6L6G 5.75	17B3 2.50	5683 7.50	18048 11.50
EC060 1.95	EY04 1.95	KT88 Gold lion 18.95	QOV03-20 25.00	UBC81 1.28	2E26 7.95	6AS7 2.50	6L6G 5.75	17B3 2.50	5684 7.50	18048 11.50
EC061 1.95	EY05 1.95	KT88 Gold lion 18.95	QOV03-20 25.00	UBC81 1.28	2E26 7.95	6AS7 2.50	6L6G 5.75	17B3 2.50	5685 7.50	18048 11.50
EC062 1.95	EY06 1.95	KT88 Gold lion 18.95	QOV03-20 25.00	UBC81 1.28	2E26 7.95	6AS7 2.50	6L6G 5.75	17B3 2.50	5686 7.50	18048 11.50
EC063 1.95	EY07 1.95	KT88 Gold lion 18.95	QOV03-20 25.00	UBC81 1.28	2E26 7.95	6AS7 2.50	6L6G 5.75	17B3 2.50	5687 7.50	18048 11.50
EC064 1.95	EY08 1.95	KT88 Gold lion 18.95	QOV03-20 25.00	UBC81 1.28	2E26 7.95	6AS7 2.50	6L6G 5.75	17B3 2.50	5688 7.50	18048 11.50
EC065 1.95	EY09 1.95	KT88 Gold lion 18.95	QOV03-20 25.00	UBC81 1.28	2E26 7.95	6AS7 2.50	6L6G 5.75	17B3 2.50	5689 7.50	18048 11.50
EC066 1.95	EY10 1.95	KT88 Gold lion 18.95	QOV03-20 25.00	UBC81 1.28	2E26 7.95	6AS7 2.50	6L6G 5.75	17B3 2.50	5690 7.50	18048 11.50
EC067 1.95	EY11 1.95	KT88 Gold lion 18.95	QOV03-20 25.00	UBC81 1.28	2E26 7.95	6AS7 2.50	6L6G 5.75	17B3 2.50	5691 7.50	18048 11.50
EC068 1.95	EY12 1.95	KT88 Gold lion 18.95	QOV03-20 25.00	UBC81 1.28	2E26 7.95	6AS7 2.50	6L6G 5.75	17B3 2.50	5692 7.50	18048 11.50
EC069 1.95	EY13 1.95	KT88 Gold lion 18.95	QOV03-20 25.00	UBC81 1.28	2E26 7.95	6AS7 2.50	6L6G 5.75	17B3 2.50	5693 7.50	18048 11.50
EC070 1.95	EY14 1.95	KT88 Gold lion 18.95	QOV03-20 25.00	UBC81 1.28	2E26 7.95	6AS7 2.50	6L6G 5.75	17B3 2.50	5694 7.50	18048 11.50
EC071 1.95	EY15 1.95	KT88 Gold lion 18.95	QOV03-20 25.00	UBC81 1.28	2E26 7.95	6AS7 2.50	6L6G 5.75	17B3 2.50	5695 7.50	18048 11.50
EC072 1.95	EY16 1.95	KT88 Gold lion 18.95	QOV03-							

**VALUABLE
SPACE FOR
SALE!**

**Telephone
the advertising
department on:
0277 219876
for details**

2 METRE COLLINEAR UVRAL X2⁵/₈over 5/8

An omni directional antenna giving low angle radiation. The ideal base station vertical. Ruggedly constructed for long life

Technical Specification

Gain	- 6 dB
Impedance	- 50 Ohms
Max Power	- 100 Watts
Length	- 3.14 metres
SWR 144 to 146Mhz	- Less than 1.5
Wind Loading	- 4.6 Kgf at 100mph
Weight	- 1.2 Kgs
Mounting Diameter	- 25mm
Termination	- Free 'N' Socket

N Plug extra, costs **£3.93**

Send cheque or postal order for **£29.95** plus **£2.60** postage to:

BUCKLEYS (UVRAL) LTD

Beta Works, Range Road
Hythe, Kent CT21 6HG
Tel: (0303) 60127/60128

Various Frequencies Available

HEATHERLITE PRODUCTS

MOBILE MICROPHONES

Complete with control box, mic gain control, PTT, LED on Tx.

TYPE A suits the majority of rigs with plug, with scan buttons **£25.00**

with plug, without scan buttons **£23.00**

TYPE B with second stage amp (for some Icom rigs) **£23.00**

FOR SINGLE EARPHONE ON ANY OF ABOVE.....add **£2.00**

TYPE SW for hand portables using jack plug connections, mic with switching box, earphone, jack plugs..... **£14.50**

MIC and COAX only - mic, coax, circuit **£7.00**

mic, coax, circuit, earphone **£9.50**

POST AND PACKING on above **£1.50**

AMPLIFIERS

HF Explorer amplifier - pair of 3-500Z valves

..... **£950.00**

2m Explorer amplifier - 144MHz - single 4CX250B..... **£485.00**

2m Explorer amplifier - 144MHz - single 4CX350A..... **£525.00**

Carriage extra at cost

**No.1 Beverley Business Centre,
1 St. Nicholas Road,
Beverley, North Humberside**

TEL: 0482 871762 ACCESS/VISA cards accepted

RF DEVICES AT ROCK BOTTOM PRICES!

Nobody beats us!

Over 30,000 RF devices at low prices

REPLACEMENT RF TRANSISTORS

MRF454 HF/SSB 80W	£20.00
MFR450 HF/SSB 50W	£11.60
MRF238 VHF/FM 25W	£12.80
MRF475 HF/SSB 20W	£2.99
2SC1969 HF/SSB 18W	£2.50
2SC2043/1307 HF 16W	£2.00
2SC1947 VHF 3.5W	£7.60
2SC1946A VHF 32W	£14.30
BLW 60R HF/VHF 50W (Special)	£7.50

REPLACEMENT RF POWER MODULES

M57704/SAU3 UHF 15W	£36.00
M57712/37 SAV7 VHF/FM 25W	£39.00
M57713/SAV8 VHF/SSB 15W	£39.00
M57716/SAU4 UHF/SSB 15W	£49.00
M57719 VHF/PMR 15W	£29.00
M57727 VHF/SSB 38W	£45.00
M57749/SAU11 934/FM 7W	£29.00

Send **£1.00** p&p or SAE for full list
All prices inc. VAT

Many Ic's and other types in stock

RAYCOM LTD

DEPT AR 584 HAGLEY RD WEST
QUINTON BIRMINGHAM
B68 OBS

021 421 8201-3

☎ (24hr answer phone) ☎

MRZ

COMMUNICATIONS LTD STOKE-ON-TRENT

**DESK DC SUPPLY AND BASE
FOR ICOM PORTABLES**

ICOM-AMATEUR/PM

YAESU - AMATEUR

UK AND EXPORT



D & D ELE

(Kenni)

*The sort of shop you
find in Lisle St. All sorts of suit
along and bring SAE for in*

3a Braganza Street
Tel: 01-793 0054 (1)

HEATHI

Spares and services
Cedar Electronics
Drive, Bredon
Glos. Tel.

BEAM

Throughout the home
Price £10.50 + P&P £

Electronic
62 Bridge Street
Lancaster
Tel: 070682

TECHNICAL INFO SERVICES (AR)

76 Church St - Larkhall - Lanarks

Coupon removed

**Please mention
Amateur Radio
when replying
to any
advertisements**

ADVERTISING RATES & INFORMATION

DISPLAY AD RATES		series rates for consecutive insertions			
depth mm x width mm	ad space	1 issue	3 issues	6 issues	12 issues
61 x 90	1/8 page	£96.00	£82.00	£59.00	£53.00
128 x 90 or 61 x 186	1/4 page	£115.00	£110.00	£105.00	£92.00
128 x 186 or 263 x 90	1/2 page	£225.00	£210.00	£200.00	£180.00
263 x 186	1 page	£430.00	£405.00	£385.00	£345.00
263 x 394	double page	£830.00	£780.00	£740.00	£660.00

COLOUR AD RATES		colour rates exclude cost of separations	series rates for consecutive insertions		
depth mm x width mm	ad space	1 issue	3 issues	6 issues	12 issues
128 x 186 or 263 x 90	1/2 page	£305.00	£290.00	£275.00	£245.00
263 x 186	1 page	£590.00	£550.00	£530.00	£470.00
263 x 394	double page	£1,130.00	£1,070.00	£1,010.00	£900.00

SPECIAL POSITIONS	Covers:	Outside back cover 20% extra, inside covers 10% extra
	Bleed:	10% extra [Bleed area = 307 x 220]
	Facing Matter:	15% extra

DEADLINES		*Dates affected by public holidays			
Issue	colour & mono proof ad	mono no proof & small ad	mono artwork	on sale thurs	
Jan 88	26 Nov 87	2 Dec 87	4 Dec 87	24 Dec 87	
Feb 88	24 Dec 87	6 Jan 88	6 Jan 88	26 Jan 88	
Mar 88	26 Jan 88	3 Feb 88	5 Feb 88	25 Feb 88	
Apr 88	3 Mar 88	9 Mar 88	11 Mar 88	31 Mar 88	

CONDITIONS & INFORMATION	
<p>SERIES RATES Series rates also apply when larger or additional space to that initially booked is taken. An ad of at least the minimum space must appear in consecutive issues to qualify for series rates. Previous copy will automatically be repeated if no further copy is received. A 'hold ad' is acceptable for maintaining your series rate contract. This will automatically be inserted if no further copy is received. Display Ad and Small Ad series rate contracts are not interchangeable.</p>	<p>If series rate contract is cancelled, the advertiser will be liable to pay the unearned series discount already taken. COPY Except for County Guides copy may be changed monthly. No additional charges for typesetting or illustrations (except for colour separations). For illustrations just send photograph or artwork. Colour Ad rates do not include the cost of separations. Printed - webb-offset.</p>
<p>PAYMENT Above rates exclude VAT. All single insertion ads are accepted on a pre-payment basis only, unless an account is held. Accounts will be opened for series rate advertisers subject to satisfactory credit references. Accounts are strictly net and must be settled by the publication date. Overseas payments by International Money Order or credit card. FOR FURTHER INFORMATION CONTACT Amateur Radio, Sovereign House, Brentwood, Essex CM14 4SE. (0277) 219878</p>	<p>Commission to approved advertising agencies is 10%. CONDITIONS 10% discount if advertising in both Amateur Radio and Radio & Electronics World. A voucher copy will be sent to Display and Colour advertisers only. Ads accepted subject to our standard conditions, available on request.</p>

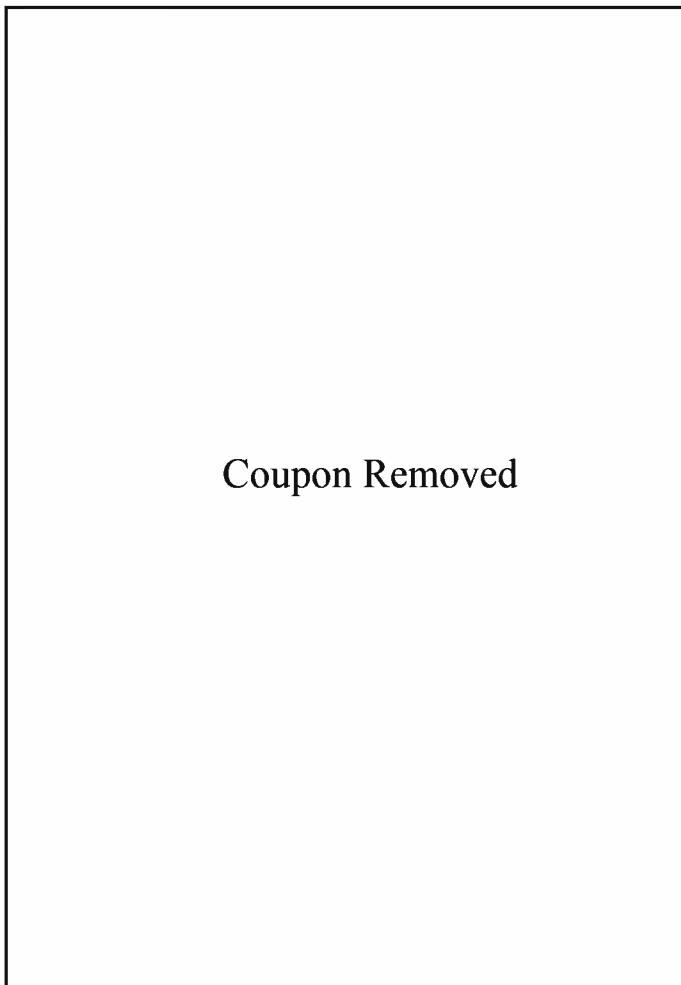

ADVERTISERS INDEX	
Aerial Techniques	20
Billington Valves	14
J Bull	59
Capco Electronics	52
Cirkit	52
P M Components	4,5
R N Electronics	26
Elect & Computer Workshop	26
Exchange Resources	14
L F Hanney	14
C M Howes	42
Icom	32,33
K W Communications	52
Pearsons Computing	14
W P Publications	14
Radio & Tele Com Sch	14
M G R Services	17
Stephans Radio	20
Technical Software	26
Waters & Stanton	60
R Withers	2



£1 BAKERS DOZEN PACKS

Price per pack is £1.00 * Order 12 you may choose another free item's market share are not new but guaranteed ok

- 1 - 5 13 amp ring main junction boxes
- 2 - 5 13 amp ring main spur boxes
- 5 - 3 flush electrical switches
- 7 - 4 in flex line switches with neons
- 8 - 2 80 watt brass cased elements
- 9 - 2 mains transformers with 6V 1A secondaries
- 10 - 2 mains transformers with 12V 1/2 A secondaries
- 11 - 1 extension speaker cabinet for 6 1/2" speaker
- 12 - 5 octal bases for relays or valves
- 13 - 12 glass reed switches
- 14 - 4 OCP 70 photo transistors
- 16 - 4 tape heads 2 record, 2 erase
- 17 - 1 ultrasonic transmitter and 1 ditto receiver
- 18 - 2 15000 mfd computer grade electrolytics
- 19 - 2 light dependent resistors
- 20 - 5 different micro switches
- 21 - 2 mains interference suppressors
- 22 - 2 25 watt crossover units 2 way
- 23 - 1 40 watt 3 way crossover unit
- 28 - 1 6 digit counter mains voltage
- 30 - 2 Nicad battery chargers
- 31 - 1 key switch with key
- 32 - 2 humidity switches
- 34 - 96 - 1 metre lengths colour coded connecting wires
- 36 - 2 air spaced 2 gang tuning condensers
- 37 - 2 solid dielectric 2 gang tuning condensers
- 38 - 10 compression trimmers
- 41 - 6 Rocker Switches 10 amp mains SPST
- 43 - 5 Rocker Switches 10 amp SPDT Centre Off
- 44 - 4 Rocker Switches 10 amp DPDT
- 45 - 1 24 hour time switch mains operated is h
- 46 - 1 6 hour clock timeswitch
- 48 - 2 6V operated reed switch relays
- 49 - 10 neon valves make good night lights
- 50 - 2 - 12V DC or 24V AC 4 CD relays
- 51 - 1 - 12V 2C D very sensitive relay
- 52 - 1 12V 4C relay
- 55 - 1 locking mechanism with 2 keys
- 56 - 1 Miniature Uniselector with circuit for electric jigsaw
- 57 - 5 Dolls House switches
- 60 - 5 ferrite rods 4 - 5 16 diameter aeriels
- 61 - 4 ferrite slab aeriels with L & M wave coils
- 62 - 4 200 ohm earpieces
- 63 - 1 Mullard thyristor trigger module
- 64 - 10 assorted knobs & spindles
- 65 - 5 different thermostats mainly bi metal
- 66 - 1 Magnetic brake stops rotation instantly
- 67 - 1 Low pressure 3 level switch
- 69 - 2 25 watt pots 8 ohm
- 70 - 2 25 watt pots 1000 ohm
- 71 - 4 wire wound pots 18 33 50 and 100 ohm
- 73 - 4 3 watt wire wound pots 50 ohm
- 77 - 1 time reminder adjustable 1 60 mins
- 78 - 5 5 amp stud rectifiers 400V
- 85 - 1 mains shaded pole motor 1/2 stack 1/2 shaft
- 86 - 25 aluminium fan blades fit 1/2 shaft
- 87 - 23 plastic fan blades fit 1/2 shaft
- 88 - 1 Mains motor suitable for above blades
- 89 - 1 mains motor with gearbox 1 rev per 24 hours
- 91 - 2 mains motors with gearbox 16 rpm
- 93 - 4 11 pin moulded bases for relays
- 94 - 5 BTG valve bases
- 95 - 4 skirted B9A valve bases
- 96 - 1 thermostat for fridge
- 98 - 1 motorised stud switch is h
- 101 - 1 12 hours delay switch
- 103 - 1 16V mains power supply unit
- 104 - 1 14V V mains power supply unit
- 105 - 1 15 pin flex plug and panel socket
- 107 - 1 15" speaker size radio cabinet with handle
- 109 - 10 x spindle type volume controls
- 110 - 10 slider type volume controls
- 112 - 1 heating pad 200 watts mains
- 114 - 1 11W amplifier Mullard 1172
- 115 - 1 Wall mounting thermostat 24V
- 118 - 1 Teak effect extension 5" speaker cabinet
- 120 - 2 p c b with 2 amp full wave and 17 other recs
- 122 - 10 mtrs twin screened flex white p v c outer
- 132 - 2 plastic boxes with windows ideal for interrupted beam switch etc
- 155 - 3 varicap push button tuners with knobs
- 188 - 1 plastic box sloping metal front 16 - 95mm average depth 45mm
- 241 - 1 car door speaker (very flat) 6 1/2" 15 ohm made for Radiomobile
- 243 - 2 speakers 6 - 4 15 ohm 5 watt made for Radiomobile
- 266 - 2 mains transformer 9V 1/2 A secondary split primary so OK also for 115V
- 267 - 1 mains transformers 15V 1A secondary p c b mounting
- 330 - 2 6V 0.6V mains transformer 3 p c b mounting
- 350 - 40 double pole leaf switches
- 365 - 1 7uf 660V 50hz metal cased condenser
- 453 - 2 2 1/2 in 60 ohm loudspeakers
- 454 - 2 2 1/2 in 8 ohm loudspeakers
- 463 - 1 mains operated relay with 2 sets c o contacts
- 464 - 2 packets resin filler sealer with cures
- 465 - 3 5A round 3 pin plugs will fit item 193
- 466 - 4 7 segment l e d displays
- 470 - 4 pc boards for stripping, lots of valuable parts
- 480 - 1 3A double pole magnetic trip saves repairing fuses
- 498 - 4 1000uf 25V axial electrolytic capacitors
- 504 - 1 Audax PM 8" speaker 15 ohm 5 watt rating
- 515 - 100 4BA 1 1/2" cheesehead plated screws and 100 4BA nuts
- 541 - 1 pair stereo tape head as in cassette recorder players
- 546 - 1 bridge rectifier 600V international rectifier ref 3S B100
- 548 - 2 battery operated relays (3-6v) each with 5A c o contacts 2 pairs
- 553 - 2 lithium 3V batteries (everlasting shelf life)

TELEPHONE BITS

- Master socket (has surge arrestor - ringing condenser etc) and takes B T plug £3.95
- Extension socket £2.95
- Dual adaptors (2 from one socket) £3.95
- Cord terminating with B T plug 3 metres £1
- Kit for converting old entry terminal box to new B T master socket complete with 4 core cable, cable clips and 2 B T extension sockets £11.50
- 100 mtrs 4 core telephone cable £8.50

COMPACT FLOPPY DISC DRIVE EME-101

The EME 101 drives a 3 1/2" disc of the new standard which despite its small size provides a capacity of 500k per disc which is equivalent to the 3 1/2" and 5 1/4" discs. We supply the Operators Manual and other information showing how to use this with popular computers. BBC Spectrum Amstrad etc. All at a special snip price of £27.50 including post and VAT. Data available separately £2, refundable if you purchase the drive

MULLARD UNILEX AMPLIFIERS

We are probably the only firm in the country with these now in stock. Although only four watts per channel, these give superb reproduction. We now offer the 4 Mullard modules i.e. Mains power unit (EP9002) Pre-amp module (EP9001) and two amplifier modules (EP9000) all for £6.00 plus £2 postage. For prices of modules bought separately see TWO POUNDERS

CAR STARTER/CHARGER KIT

For 6V battery. Dismounts via an adaptor kit to convert this into a normal 24hr time switch but with the added advantage of up to 12 on offs per 24hrs. This makes an ideal controller for the immersion heater. Price of adaptor kit is £2.30

THIS MONTH'S SNIP

is a 2 1/2 kW tangential heater metal box to contain it and 3 level switch to control it. Special price £7.50 post paid

VENNER TIME SWITCH

Mains operated with 20 amp switch one on and one off per 24 hrs. repeats daily automatically correcting for the lengthening or shortening day. An expensive time switch but you can have it for only £2.95 without case metal case £2.95 adaptor kit to convert this into a normal 24hr time switch but with the added advantage of up to 12 on offs per 24hrs. This makes an ideal controller for the immersion heater. Price of adaptor kit is £2.30



Ex Electricity Board Guaranteed 12 months

12 volt MOTORS BY SMITHS

Made for use in cars etc. these are very powerful and easily reversible. Size 3 1/2" long by 3 1/2" dia. They have a good length of spindle 1 10 hp £3.45 1 8 hp £5.75 1 6 hp £7.50



SOUND TO LIGHT UNIT

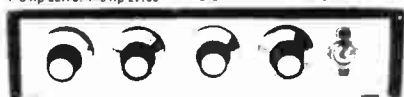

Complete kit of parts for a three channel sound to light unit controlling over 2000 watts of lighting. Use this at home if you wish but it is plenty rugged enough for disco work. The unit is housed in an attractive two tone metal case and has controls for each channel and a master on/off. The audio input and output are by 1/4" sockets and three panel mounting fuse holders provide thyristor protection. A four pin plug and socket facilitate ease of connecting lamps. Special price is £14.95 in kit form

9" MONITOR

Ideal to work with computer or video camera uses Philips black and white tube ref M24 306W. Which tube is implosion and X Ray radiation protected. VDU is brand new and has a time base and EHT circuit. Requires only a 16V dc supply to set it going. It is made up in a lacquered metal framework but has open sides so should be cased. The VDU comes complete with circuit diagram and has been line tested and has our six months guarantee. Offered at a lot less than some firms are asking for the tube alone only £16 plus £3 post

LIGHT BOX

This when completed measures approximately 15 x 14. The light source is the Philips fluorescent W tube. Above the light a sheet of fibreglass and through this should be sufficient light to enable you to follow the circuit on fibreglass PCBs. Price for the complete kit that is the box, choke, starter, tube and switch and fibreglass is £5 plus £2 post order ref 5P69

TANGENTIAL HEATERS

We again have very good stocks of these quiet running instant heat units. They require only a simple case or could easily be fitted into the bottom of a kitchen unit or book case etc. At present we have stocks of 1 2kw, 2kw, 2.5kw, and 3kw. Prices are £5 each for the first 3 and £6.95 for the 3k. Add post £1.50 per heater if not collecting

CONTROL SWITCH enabling full heat, half heat or cold blow with connection diagram, 50p for 2kw, 75p for 3kw

FANS & BLOWERS

5 £5 - £1.25 post 6 £6 - £1.50 post 4 - 4 Muffin equipment cooling fan 115V £2.00 4 - 4 Muffin equipment cooling fan 230 240V £5.00 9 Extractor or blower 115V supplied with 230 to 115V adaptor £9.50 + £2 post All above are ex computers but guaranteed 12 months 10 - 3 Tangential Blower New Very quiet supplied with 230 to 115V adaptor on use two in series to give long blow £2.00 - £1.50 post or £4.00 - £2.00 post for two

TELEPHONE LEAD

3 mtrs long terminating one end with new BT flat plug and the other end with 4 correctly coloured coded wires to fit to phone or appliance. Replaces the lead on old phone making it suitable for new BT socket. Price £1 ref B552 or 3 for £2 ref 2P164

POWERFUL IONISER

Generates approx. 10 times more IONS than the ETI and similar circuits. Will refresh your home, office, shop, work room etc. Makes you feel better and work harder. A complete mains operated kit, case included £9.50 + £2 P&P.

J & N BULL ELECTRICAL

Dept. A.R., 250 PORTLAND ROAD, HOVE, BRIGHTON, SUSSEX BN3 5QT MAIL ORDER TERMS: Cash, P.O. or cheque with order. Orders under £20 add £1 service charge. Monthly account orders accepted from schools and public companies. Access & B card orders accepted. Brighton (0273) 734648 or 203500

NEW ITEMS

Some of the many described in our current list which you will receive with your parcel

£2 POUNDERS*

- 2P122 1 30a rotary switch surface mounting with pointer knob
- 2P123 1 25a rotary switch surface mounting (circuit engraved) high medium low and off
- 2P124 1 28kv 0.01 mfd block condenser
- 2P132 1 heating heat stat for fire warning or protection
- 2P133 1 Circuit breaker 20a Crabtree ref C50
- 2P134 1 9V 500ma pssu plugs into 13a socket
- 2P135 1 10m 10mfd long life capacitor
- 2P138 1 Mains transformer 20V 0.20V 1 upright mounting
- 2P141 1 rechargeable battery D size 4 AH solder tag welded
- 2P142 1 10m 4 pin intercom cable White PVC outer
- 2P144 1 mains operated relay with 4 - 8 a.c. contacts
- 2P148 1 Technical information on 3 FDD refundable 1 vdu buy fdd
- 2P149 5 0uff battery operated model motors
- 2P150 1 PSU chassis with all components for 24V 2A d.c. unregulated
- 2P151 1 Metal box 12 x 14 x 4 with lid add £2.00 post
- 2P152 1 Motor start capacitor 80uf 250V
- 2P153 1 Two station intercom unused but line expires
- 2P154a 1 Nicad charger plug into 13a socket 5V 70A output
- 2P154b 1 Nicad charger plug into 13a socket 6V 9VA output
- 2P155 1 Mains transformer giving 16 17 18 & 20V 60W
- 2P158 1 Oven thermostat with temp calibrated knob
- 2P159 1 9V 500ma cased with mains lead and output lead
- 2P160 1 13a plug adaptor fused takes 3 - 3a plugs
- 2P161 1 6 diagonal side cutters
- 2P162 1 Stereo Matrix PCB mounting deemphasis RJS
- 2P163 1 AC Working capacitor 12uf 660V AC or 1500V d.c.
- 2P164 3 Phone leads 3 mtrs long (ags) one end B.T. plug other end

£3 POUNDERS*

- 3P7 1 DC voltage doubler or halver for 12V to 24V 12 to 6V 24 to 12V
- 3P8 1 24hr time switch (Sangamo) new condition Guaranteed 1 year
- 3P9 1 12V 500ma pssu plugs into 13a socket regulated
- 3P10 1 Mains transformer giving 16 17 18 & 20V 60W upright mounting fully shrouded plus £1 post
- 3P13 1 Noise filter to fit in mains lead of appliance up to 25r
- 3P15 1 waterproof case will take 150 watt transformer
- 3P16 1 signal box 3 lamps on face plate of metal box size 5 x 3
- 3P17 1 hose and starter to work 8 fluorescent tube at 125W
- 3P20 1 10 amp meter 3 a.c. d.c. equipment
- 3P21 1 power factor correction condenser 35uf 350v
- 3P22 1 200va auto transformer 230 to 115V toroidal encapsulated £1.50 post
- 3P24 1 3 Hoppy dist. for Amstrad etc
- 3P25 17 Electric fans, blers

£4 POUNDERS*

- 4P12 1 50m low loss coax 75ohm 1 ft post
- 4P13 1 Hirstmann time and set with new 15amp
- 4P14 1 150w mains transformer with 0th 43V 3.5A secondary
- 4P15 1 powerful motor 2" stack fitted with gearbox final speed 60rpm mains operated could operate door opener etc
- 4P17 1 Uniselector 3 pole 25W 50V coil standard size
- 4P18 1 Volt meter with digital display DIGIVISOR
- 4P19 1 12V dc motor will fit to gearbox 4P20
- 4P20 1 Gear train giving speed reduction

£5 POUNDERS*

- 5P86 1 Transformer upright mounting 230 240V primary 2 - 100 1a secondary
- 5P88 1 Transformer in waterproof metal box 24V 5A add £2 post
- 5P89 1 4 bank heating element each 2kw ideal connector heater
- 5P90 1 18" long tangential blower with motor at one end
- 5P91 1 14" blower motor in middle
- 5P92 10m Audio Co. a double screened 75ohm super low loss for TV
- 5P93 1 6 Alarm bell 24V dc or ac
- 5P94 1 Current transformer 14V out with 1a dc input
- 5P95 1 Vintage photo cell
- 5P99 1 Mains operated blower centrifugal output size app 5 - 1
- 5P100 1 Mains splitter 45a switch 3 - 15a fused circuits
- 5P101 1 Model motor 1 rpm from 6V reversible

£7 POUNDERS*

- 7P1 1 Instant heat solder gun mains with renewable tip and job light

£8 POUNDERS*

- 8P1 1 Charger transformer 10a upright mounting 230 240 primary 16v 10a secondary
- 8P2 1 6 underdome alarm bell suitable for a fire alarm or burglar alarm mains operated
- 8P3 1 heat sink big powerful solder ideal for power transmitter
- 8P5 1 1/2 hp motor 900 rpm capacitor run
- 8P6 1 24hr time switch 2 on offs 16a c o contacts 3 - 3 - 1
- 8P7 1 Silent sentinel invisible ray kit
- 8P8 1 Paps fan 3 1/2" x 3 1/2" 115V 230V metal bodied

£10 POUNDERS*

- 10P14 1 100a time switch 1 on off per 24hr extra triggers £1 per pair
- 10P15 1 Max demand meter 230 ac mains
- 10P16 1 powerful air mover 2 small type blowers with motor in middle
- 10P18 1 mains operated klaxon
- 10P19 1 12V alarm bell really loud mains operated in iron case - £5 post
- 10P22 1 sensitive volt meter relay
- 10P24 1 big panel meter face size 4 1/2" x 2 1/2" 200A movement scaled 1 10
- 10P26 1 Secretary phone auto dialer complete untested sold as such
- 10P30 1 Instrument psu on pcb has 4 outputs 12V 5V 6A 12V 5A 5V 5A
- 10P31 1 7 day time switch 16a c o contacts sep switches for each day
- 10P32 1 68 rpm 1 6th hp motor reversible

£15 POUNDERS*

- 15P1 1 kit for 115V hi fi amp
- 15P2 1 kit for psu to supply one or two 15P1 amps
- 15P3 1 time switch battery or mains operated 16a c o contacts 7 day programmable has 36hr reserve

COMPUTER

The Acorn Electron as used in many schools works into colour or b/w TV. Proper price £199, our price, tested and working and guaranteed, £45 + £3 post. Tested but slightly faulty £36 + £3 post. Tested but not working, but complete £20 + £3 post.

- ★ 2m/70cm
- ★ 25 Watts output
- ★ Full duplex operation
- ★ 21 Memories
- ★ 2 Call channels
- ★ Priority channel
- ★ Dual VFO's
- ★ 12.5 & 25kHz steps
- ★ Memory Scan
- ★ Programme Scan
- ★ Memory Skip

£449 inc vat

ALD-24E

ALINCO DUAL BANDER



This transceiver could transform your operating habits! It contains completely separate 2m and 70cms transceivers, permitting full duplex operation. To the un-initiated, this means you can transmit on 2m whilst receiving on 70cms, or vice versa. The built-in duplexer means a single antenna socket with a full 25 watts output on both bands. Measuring only 5.5"x2"x6.5" it is the ideal mobile rig. Its comprehensive memory and scanning facilities provide rapid access to both

simplex and repeater channels on 2m & 70cms. Using the dual VFO's you can instantly switch between 2m & 70cm and the single knob tuning provides simple and quick frequency selection. The large LCD readout incorporates an S-meter and is back lighted. If you are looking for a completely self contained 2m & 70cm station, then look no further. At this price it has to be a bargain. For further details of this amazing transceiver, send today for the full colour brochure.

OUR FAMOUS FREQUENCY MANUALS!

UK LISTENERS CONFIDENTIAL FREQUENCY LIST LATEST EDITION

This publication has now sold well over 3500 copies since it was advertised only a few months ago. Now the recent updated version is selling even better. No self respecting listener should be without a copy. If you enjoy exploring the short wave bands then this publication will add to your enjoyment. It covers the hf spectrum from 2 to 30 MHz and gives details of transmissions outside the amateur bands. Specially designed for the UK and European listener it sets out in a very easy way a comprehensive list of hundreds of interesting transmissions that will keep you occupied for days on end! Only a fraction of the cost of other similar publications it contains details of Marine, Air, Military, Embassy, Press and News agencies. Many listings have time schedules included together with comprehensive RTTY details. It tells you the frequencies used by civil and military aircraft whilst flying the Atlantic, when and where to pick up the press bulletins, long distance marine traffic etc and much more. Send today for your copy of this worthwhile publication.

£5.95 p&p 90p

NEW 4th EDITION VHF-UHF AIRBAND FREQUENCY LIST

This frequency manual is without doubt the most comprehensive list of VHF/UHF aircraft listings available in the UK. Of vital importance to the airband enthusiast or indeed any keen VHF/UHF listener it sets out in a very easy to follow manner full details of a whole host of stations. Every known UK airfield frequencies, etc. Included are Civil, RAF, USAF, MOD, Naval fields on both VHF and UHF bands. There are also air to air frequencies, the Red Arrows frequency, and much more. Send today for your copy and find out just how much you have been missing!

£5.95 p&p 90p

THE COMPLETE UHF-VHF FREQUENCY GUIDE 26-2000 MHz

Many listeners have asked for a guide to the wide VHF/UHF spectrum and to meet this request we have recently published this frequency manual. It covers the range 26 to 2000 MHz and has been specially prepared for the UK listener. Anybody who has used a scanning receiver will know that the wide frequency range involved means that it is difficult to know exactly where to listen. This guide takes all the guessing out of monitoring. It lists all the services throughout the spectrum together with both simplex and duplex frequency splits. If you've spent your hard earned money on a scanning receiver or are considering buying one you'll find that this publication contains a wealth of information that has previously remained un-published!

£4.95 p&p 75p

HF OCEANIC AIRBAND COMMUNICATIONS 1988 EDITION.

Prepared in response to many requests for more information about the air traffic on the hf bands this little guide sets out to explain to the beginner how the hf band works in relation to air traffic. It contains full details of the world aircraft frequency bands in the range 2 to 23 MHz together with control frequencies and those commonly used for Oceanic control. Also included are many VOLMET frequencies, the Search and Rescue frequencies used by RAF helicopters and Nimrods, the Hf RT network, London Company frequencies, European control centres etc. An ideal companion for the hf airband listener. Send today for your copy.

£3.50 p&p 70p

**WATERS
& STANTON
ELECTRONICS**

18-20 MAIN ROAD, HOCKLEY, ESSEX - 12 NORTH STREET, HORNCHURCH, ESSEX.
MAIL ORDER TO: 18-20 MAIN ROAD, HOCKLEY, ESSEX TEL: (0702) 206835

