

Amateur

RADIO

For all two-way radio enthusiasts

10m mobile operation

Multi-band grounded aerials

Justice/injustice: you & 'the boys in blue'



On test: Icom IC471H 70cm base station

**BACK TO BASICS:
PASS THE
RAE**

POST A PART ELECTRONICS

6 CHAPMAN COURT, CHARFLEETS ROAD
(AR) CANVEY ISLAND, ESSEX SS8 0PQ
Telephone 0268 690868
Telex 99305 ROSSER G



TRADE COUNTER NOW OPEN

ORDERS DESPATCHED SAME DAY
ADD 60p P&P, THEN 15% VAT.

ADD POSTAGE FOR OVERSEAS ORDERS.
ORDERS WITH AEROSOLS, PLEASE ADD 25p PER CAN.

Thorn 10G 20W (3500) R751 Safety Resistor	75p
Pye 713 Speaker 5" x 3" 70U	1.00
Pye 713 Complete Tube Base Panel with Focus Slider & Leads	2.75
Pye 713 Control Knobs	4 for 45p
Tube Base Socket IIT CVC32	50p
Tube Base Socket Thorn 3000/8000 etc	50p
IC Insertor 16 Pin	50p
Large IC Extractor	50p
Crystal 4.43MHz	65p
EHT Lead & Cap for Split Diode Opt	47p
Anode Cap	47p
Sanyo Anode Cap Assy + Lead. 12TCD-CT-1G	65p
Deгаuse Thermistors. PT37P. IIT/GEC	35p
Deгаuse VDR E299D/HP230 300V/8000	25p
Castors Set of 4	1.90
Double Fuse Holder on Small Pax Board 20mm type	10p
Single Fuse Holder on Small Pax Board 20mm type	5p
Direct Panel Mounting 20mm Fuse Clips	(pair) 15p
Single Fuse Holder on Small Pax Board. As pair early 3000 mains input	25p
EHT Cable	Metre 6p
13A Plugs	12 for 4.80
BF259 with Heatsink	14p
TI110 with Heatsink	40p
LI29/130/131 Coil	20p
6MHz Ceramic Filter	15p
DL700 (Philips) Chroma Delay Line	1.00
DL50 Chroma Delay Line	1.00
T9006A Lum. Delay Line	1.00
BK5/9K Lum. Delay Line	65p
Plastic Cover for 3K5 SP3825	1.50
TX9 Back Ground Control 10K	15p
TX9 Gain Control 100R	15p
1500 Metal Chassis Supports Pair	4.00
Thorn 9K5 Focus Pot	2.40
Thorn 4000 Focus Pot	2.75
Thorn 18U 9W (3K5) R752	30p

SERVICE AIDS

Ambersil MSA Silicone Grease	12oz 2.15
Ambersil Freezer	12oz 1.99
Ambersil Amberlube	6oz 1.89
Ambersil Ambertron	16oz 1.95
Ambersil Anti-Static Screen Cleaner	7oz 1.95
Ambersil 40+ Protective Lubricant	14.1oz 2.15
Ambersil Ambersilens Foaming Cleaner	13oz 1.26
Ambersil Circuit Lacquer	14oz 2.15

THICK FILM RESISTOR UNITS

3500 Thorn (5 Pin Connection) video	1.70
4000 Thorn (4 Pin Connection)	1.90
725/731 Pye (6 Pin Connection)	2.20
713 Pye (6 Pin Connection)	2.20

FUSES

20mm		1 1/2"	
50MA	10 for 70p	250MA	10 for 65p
315MA A/S	10 for 50p	750MA	10 for 65p
500MA	10 for 50p	7A	10 for 50p
1A	10 for 50p	10A	10 for 50p
2.5A	10 for 1.00	20A	10 for 50p
3.15A	10 for 1.00	50A	10 for 50p

Thorn Mains TX 3000/3500	7.50
Thorn Mains TX 8000/8500	10.00
Thorn S.D.P.T. 8000/8500	3.50
Thorn Scan TX 3000/3500	6.00
Thorn EHT TX 3000/3500	6.00
Thorn LDPT 9800	12.00
Thorn LDPT 1615	7.25
Thorn LDPT 1590/91	7.25
Thorn LDPT 1690/91	7.25
Thorn LDPT 8000	9.80
Thorn LDPT 8500	9.80
Thorn LDPT TX9	9.85
Pye LDPT 713	10.00
Pye LDPT 725	9.85
Pye LDPT 731	10.18
Philips LDPT G9	8.80
Philips LDPT G11	13.75
GEC LDPT 3113	7.40
Diode Split LDPT AT2076/35	14.75
Sanyo LDPT AM-WM-21	6.75
Sanyo LDPT AM-WM-4	7.30
Philips LDPT G8	7.80
Sanyo LDPT (CW21) 4-2751-44700	9.00
IIT LDPT CVC5-9	5.60
IIT LDPT CVC30	6.00
IIT LDPT CVC45	9.75
Baird 8570	10.25
Baird 8752	10.25
Korting AZ9100	10.25
Korting B92-170	10.25
Korting AZ2101	10.25
Korting AZ2103	10.25
Korting ZTR1001	10.25
Siemens V1155	11.75
Siemens V1823	11.75
Zanussi B5222	10.25
Zanussi B5223	10.25
Salora FRO257	10.25
Salora FRO259	10.25

300 Mixed Resistors	1.50
300 Mixed Capacitors	1.50
150 Mixed Electrolytics	2.00
100 W/W Resistors	1.00
20 Mixed Conv Pots	1.00
40 Mixed Pots	1.50
20 Mixed Sliders	1.00
40 Mixed Presets	60p
20 Mixed VDR & Thermistors	1.00
20 Mixed Ferrite Cores	50p
100 Mixed Ceramic Discs	1.00
20 Mixed Valve Bases	1.00

10 Spark Gaps	1.00
10-16 pin Quil IC Socket	90p
20 Assorted TV Knobs	1.00
10-16 pin Quil to Dil IC Socket	90p
100 Mixed Diodes	1.00
50 Mixed Mica Washers	65p
300 Mixed Resistors & Capacitors	1.50
10-16 pin Dil to Dil IC Socket	1.00
50 Electrolytics & 50 Capacitors	1.00
50 Mixed Poly Capacitors	1.00
30 Mixed Neons & Bulbs	1.00

Pye 78+161	50p	EHT TRAYS	
Pye 147+260	50p		Thorn 3000
Thorn 56+1K+47+12	1.24	Thorn 8000	3.50
Thorn 50+40+1K5	60p	Thorn 8500	6.00
Thorn 128+16+1K7+	50p	Thorn 9000	7.90
116+462+126	50p	Thorn 9600	6.00
Thorn 120+72+300	50p	Thorn 900/950	1.50
RBM 250+14+58	63p		
(TV161)	63p	Pye 713 5 lead	5.97
Pye 385+15+45 (713)	90p	Pye 725	6.35
Philips 282+682	90p	Decca Bradford	5.00
Philips 47R	52p	Baird 8750	7.10
Thorn 350+20+148+	1.40	Korting AZ9100	7.10
1K5+317	92p	Philips G8 (520)	6.50
Thorn 6+1+100	1.45	Philips G8 (550)	6.50
Thorn 8/8500 Plastic	1.45	Universal	5.00

AC128	39 BC172	9 BC559	8 BF173
AC131	40 BC174B	23 BC585	8 BF179
AC138	40 BC177	24 BCX33	8 BF180
AC141K	39 BC182LB	12 BCX34	11 BF184
AC142K	38 BC183L	12 BD1115	49 BF185
AC153	39 BC184L	13 BD131	30 BF194
AC176	33 BC187	24 BD132	46 BF195
AC176K/	BC204	15 BD133	59 BF196
AC128K	93 BC208	9 BD139	36 BF197
AC188	38 BC212L	9 BD140	38 BF198
AD142	1.18 BC213L	12 BD144	1.70 BF199
AD143	1.08 BC237	12 BD150	50 BF223
AD149	98 BC238B	8 BD163	98 BF224
AD181	32 BC238L	8 BD201	74 BF228
AD182	32 BC250A	15 BD203	78 BF240
AD263	1.05 BC251	8 BD204	98 BF241
AF127	45 BC252A	20 BD222	48 BF256
AF139	38 BC294	37 BD225	52 BF256S
AF239	41 BC301	32 BD232	50 BF257
BC107	15 BC303	31 BD233	60 BF259
BC108	15 BC307	10 BD234	60 BF271
BC109	15 BC308	8 BD237	65 BF274
BC115	16 BC309	14 BD238	85 BF307
BC117	21 BC327	10 BD241	59 BF308
BC125	26 BC328	18 BD244	85 BF355
BC126	23 BC337	17 BD278A	81 BF362
BC139	27 BC338	17 BD386	68 BF391
BC141	34 BC347	8 BD433	71 BF394
BC142	30 BC394	8 BD437	83 BF422
BC143	31 BC454	8 BD592	1.20 BF423
BC147	12 BC455	8 BD589	1.20 BF450
BC148	12 BC456	10 BD677G	1.35 BF453
BC149	12 BC460	40 BD707	95 BF458
BC153	16 BC463	22 BD708	95 BF459
BC154DR	16 BC464	8 BDX10	33 BF461
BC154YL	16 BC467	12 BDY20	1.09 BF566B
BC157	12 BC548	12 BDY82	99 BF566
BC158	12 BC549	8 BF137	20 BF694
BC159	15 BC557	10 BF153	20 BF757
BC171	9 BC558	10 BF154	25 BF852

24 BFR62	28 NKT276	20
29 BFR81	29 NKT453	1.85
32 BFR87	25 DT112	1.92
30 BFR90	174 DT121	2.08
30 BFR91	2.08 R1038	80
30 BF742	30 R1039	80
30 BF743	30 R2008B	1.40
16 BFX38	40 R2010B	1.10
16 BFY50	30 R2030	70
16 BFY51	34 R2265	1.30
15 BFY52	34 R2305	80
19 BRC116	1.50 R2322	50
15 BRC1693	1.43 R2443	25
18 BU105	1.00 RCA16446	30
19 BU125	1.10 RCA16589	1.25
20 BU207	1.05 RCA16600	1.40
9 BU208	1.15 RCA16799	1.13
21 BU208A	1.15 RCA16800	1.42
10 BU326A	1.30 RCA16802	1.30
20 BU407	1.70 SI299	2.25
20 BU408	2.76 S28000	1.25
20 BU500	2.30 S6080A/B	3.50
25 BU526	2.46 T6050V	1.30
11 BU807	2.94 T6052V	1.30
29 C1129	9 T903V	1.25
34 C1172B	9 T901V	1.45
40 E5365	54 T903V	1.30
50 E9003	28 T9054V	1.00
21 E9005	25 T9039V	1.10
16 ME0404	10 TIC45X	50
47 ME0412	10 TIC46	48
53 ME6002	10 TIC106C	40
43 MJ2501	2.36 TIP29	42
53 MJ3001	2.21 TIP30	42
37 MJ182	47 TIP31	35
40 MJ2340	50 TIP22	43
59 MJ3520	50 TIP33	61
35 MJ2955	1.40 TIP41	45
15 MJ3055	1.50 TIP42	45
16 NKT241W	8 TIP110	61
62 NKT241G	8 TIS91	25
31 NKT241Y	8 ZTX550	30

MULTISECTION CAPACITORS

100+150+150	350V 50p	200+200+100	350V 55p
220+47	350V 65p	200+200+75+25	350V 60p
200+150+50 350V 60p		50+50+8	300V 55p
200+200+100		100+50+100 350V 55p	
		100+150+50 350V 55p	
32+32+16	325V 54p	200+47	250V 60p
200+200+100+32	350V 70p	150+150+100	300V 1.80
		175+100+100 350V/	1.00
100+50+150 350V 58p		400 400V Thorn 9K2.50	
400+400	200V 72p	470 250V Philips G11	1.50
32+32+16	350V 52p		
200+32+300+100	350V 50p		
225+25	350V 70p		
200+200+100	350V 70p		
200+100+100+50	350V 60p		

CAN TYPES

0.2MF 250V	50p	1250MF 40V	50p
2MF 250V	50p	1250MF 50V	50p
22MF 275V	50p	1500MF 70V Thorn 3K	1.00
50MF 275V	50p	1500MF 100V	1.05
100MF 150V	65p	2000MF 30V	50p
100MF 250V	70p	2200MF 40V Thorn 4K	40p
100MF 450V	75p	2200MF 63V Philips G9	95p
220MF 400V Thorn 8K	1.30	2200MF 63V Philips G9	1.25
220MF 450V Thorn 4K	1.30	2500MF 35V	65p
400MF 350V Thorn 8K	1.30	2500MF 40V	65p
	1.00	3000MF 30V	65p
		3000MF 25V	60p
800MF 250V Print	80p	4700MF 16V	72p
Type	70p	4700MF 40V	75p

Thorn/Decca/GEC On/Off Switch. Push to make	75p
Philips G11 On/Off Switch. Push to make	75p
IIT CVC8 On/Off Switch	65p
IIT CVC9 On/Off Switch + Relay	70p
Philips G8 On/Off Switch	95p
Thorn 3/3500 A1 Switch	50p
Thorn 4000 A1 Switch	50p
Korting Shift Pot 50K	65p
2.5A Switch to make on/off switch	15p

DIODES

AA112	8p	IN4003	4p
AA119	8p	IN4004	5p
AA143	8p	IN4005	5p
AA149	8p	IN4006	5p
BA115	8p	IN4007	6p
BA154	8p	IN4008	5p
BB103	8p	IN4148	2p
BB105B	3p	IN4149	8p
BR103	52p	IN4742A	8p
BR303	46p	IN5234B	8p
BT106	1.50	IN5348	14p
BT116	1.00	IN5400	12p
BT119	2.56	IN5401	12p
BT120	2.82	IN5402	14p
BT151 650	1.00	IN5404	12p
BY127	12p	IN5406	16p
BY188	16p	IN5408	16p
BY204	26p	IS025	8p
BY206	16p	IS131	8p
BY207	16p	IS1658	8p
BY208/800	36p	MR854	35p
BY225	95p	SK1102	20p
BY227	1.20	MCR106/1	1.00
BY298	22p	MCR406	35p
BYX22/400	30p	ZN4444	1.50
BYX55/600	30p	Y869	75p
BYX71/350	80p	ZX150	12p
BZV15 C12R	1.16	DA91	5p
BZV15 C24R	1.16	MCR106/7	1.50
IN80	8p	MCR106/8	1.50
IN2070	8p	TD3500H	2.80
IN4001	4p	TD3500R	3.00
IN4002	4p	BY255	30p

INTEGRATED CIRCUITS

BRC1330	1.40	SN76013ND	1.80	TBA530	1.26	TDA2002	2.80
BRC3064	1.00	SN76023N	1.80	TBA540	1.00	TDA2030	2.10
BRC/M/200	1.00	SN76033N	2.00	TBA550Q	1.82	TDA2522	2.10
BRC/M/300	1.00	SN76115	2.00	TBA560C	1.50	TDA2530	2.61
CA3060	1.50	SN76131N	1.58	TBA611			

Amateur RADIO

**Editor:**

Jim Chalmers

Editorial Assistant:

Anita Ley

Advertisement**Manager:**

Anne Haden

Advertisement**Executive:**

Stewart Lansdale

Subscriptions:

01-684 3157

Accounts:

Clare Brinkman

Publisher:

Peter Williams

General Manager:

Alan Golbourn

On sale: Fourth

Thursday of the month

preceding cover date

Next issue: Cover date

March 1985 on sale

28 February 1985

Published by: Amateur

Radio Magazines,

Sovereign House,

Brentwood, Essex CM14

4SE, England

(0277) 219876

Printed: In England

ISSN: 0264-2557

News Trade Sales by:

Argus Press Sales &

Distribution Ltd, 12-18

Paul Street, London

EC2A 4JS.

01-247 8233

Front cover: Icom IC471H

70cm multimode reviewed

this month (p13). Photo by

Jay Moss-Powell G6XIB

Whilst every care is taken

when accepting

advertisements we cannot

accept responsibility for

unsatisfactory transactions.

We will, however, thoroughly

investigate any complaints.

The views expressed by

contributors are not

necessarily those of the

publishers.

Every care is also taken to

ensure that the contents of

Amateur Radio are accurate,

we assume no responsibility

for any effect from errors or

omissions.

Audit Bureau of Circulations
membership applied for
© Copyright 1985
Amateur Radio Magazines

6 Letters

Your opinions on topics of interest

8 Straight and Level

All the latest news, comment and developments on the amateur radio scene

10 DX Diary

Don Field G3XTT with this month's DX news

13 Angus McKenzie tests

This month G3OSS reviews the Icom IC471H 70cm multimode and the Icom IC04E 70cm FM handheld

22 Justice/injustice – the sequel

One man's tale of the relationship between amateurs and the police

24 Going 10 metre mobile

All you need to know about getting started in this mode

28 CW contesting in the Channel Islands

Nigel Cawthorne G3TXF relives the problems encountered in entering this contest from GU and GJ

32 On the Beam

Glen Ross G8MWR with all the latest news from VHF, UHF and Microwaves

34 QSL card art

Glean some ideas for the design of your QSL card

36 A multi-band grounded antenna

John Heys G3BDQ decorates his garden with a half-delta loop

40 SWL

Trevor Morgan GW4OXB examines the closed shop situation in amateur radio

44 CB conversions

This month a look at the PLL02 chip and modifications to the Colt 295 rig for 10m use

48 Aerials and propagation

Bill Sparks G8FBX explains impedance matching and looks at aerial forms

50 Coming next month

What's in store for you

51 Back to basics

Bill Mantovani G4ZVB gets down to the nitty-gritty on radio receivers

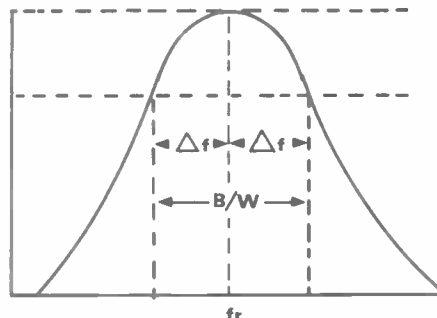
**56 Questions and answers**

Multiple choice questions to test you on your knowledge of the RAE with an analysis of the answers

61 Secondhand

Hugh Allison G3XSE describes an embarrassing equipment fault...

SERVICES**30** Newsagents order form**62** Subscription order form**65** Radio and Electronics World
subscription order form**66** Advertisers Index**66** Advertising rates and information

LOWE SHOPS TRIO TS830S

Whenever you enter a **LOWE ELECTRONICS' shop**, be it Glasgow, Darlington, Cambridge, Cardiff, London or here at Matlock, then you can be certain that, along with a courteous welcome, you will receive straightforward advice. Advice given, not with the intention of 'making' a sale, but the sort which is given freely by one radio amateur to another. Of course, if you decide to purchase then you have the knowledge that **LOWE ELECTRONICS** are the company that set the standard for amateur radio shops and after-sales service. The shops are open Tuesday to Friday from 9.00 to 5.30 pm, Saturday from 9.00 to 5.00 pm except Glasgow, which on Tuesdays opens at 10.00 am. For lunchtime closing arrangements, please check with the individual shop.

In Glasgow the LOWE ELECTRONICS' shop (the telephone number is 041 945 2626) is managed by Sim GM3SAN. Its address is 4/5 Queen Margaret's Road, off Queen Margaret's Drive. That's the right turn off Great Western Road at the Botanical Gardens' traffic lights. Street parking is available outside the shop and afterwards the Botanical Gardens are well worth a visit.

In the North East the LOWE ELECTRONICS' shop is found in the delightful market town of Darlington (the telephone number is 0325 486121) and is managed by Don G3GEA. The shop's address is 56 North Road, Darlington. That is on the A167 Durham road out of town. A huge free car park across the road, a large supermarket and bistro restaurant combine to make a visit to Darlington a pleasure for the whole family.

Cambridge, not only a University town but the location of a LOWE ELECTRONICS' shop managed by Tony G4NBS. The address is 162 High Street, Chesterton, Cambridge (the telephone number is 0223 311230). From the A45 just to the north of Cambridge turn off into the town on the A1309, past the science park and turn left at the first roundabout, signposted Chesterton. After passing a children's playground on your left turn left again (between the shops) into Green End Road. Very quickly, and without you noticing it, Green End Road becomes High Street. Easy and free street parking is available outside the shop.

For South Wales, the LOWE ELECTRONICS' shop is located in Cardiff. Managed by Richard GW4NAD, who hails from Penarth, the shop (the telephone number is 0222 464154) is within the premises (on the first floor) of South Wales Carpets, Clifton Street, Cardiff. Clifton Street is easily found, being a left turn off Newport Road just before the Infirmary. Once in Clifton Street, South Wales Carpets is the modern red brick building at the end of the street on the right hand side. Enter the shop, follow the arrows past the carpets, up the stairs and the 'Emporium' awaits you. Free street parking is available outside the shop.

LOWE ELECTRONICS' London shop is located at 223/225 Field End Road, Eastcote, Middlesex (the telephone number is 01 429 3256). The shop, managed by Andy G4DHQ is easily found, being part of Eastcote tube station buildings and as such being on the Metropolitan and Piccadilly lines (approximately 30 minutes from Baker Street main junction). For the motorist, we are only about 10 minutes' driving time from the M40, A40, North Circular Road (at Hanger Lane) and the new M25 junction at Denham. Immediately behind the shop is a large car park where you can currently park for the day for 20p. There is also free street parking outside the shop.

Although not a shop there is on the South Coast a source of good advice and equipment - John G3JYG. His address is 16 Harvard Road, Ringmer, Lewes, Sussex (telephone 0273 812071). An evening or weekend telephone call will put you in touch with John.

Finally, here in Matlock, David G4KFN is in charge. Located in an area of scenic beauty a visit to the shop can combine amateur radio with an outing for the whole family. May I suggest a meal in one of the town's inexpensive restaurants or a picnic on the hill tops followed by a spell of portable operation.



hf transceiver

The TRIO TS830S is for the operator who wants a dedicated amateur bands only transceiver, who is used to and wants a pair of rugged 6146B valves in the PA stage and who wants a compact rig which has its own in-built power supply. The TS830S is for the radio amateur who requires a rig capable of rising above today's crowded band conditions, a rig that has, as standard, the necessary features that will produce consistently good contacts where other lesser equipment would fail. The TRIO TS830S, a proven rig with an impeccable pedigree.

The TS830S covers on USB, LSB and CW the full amateur bands from 160 through to 10 metres.

Convenient to use, the transceiver has its own in-built power supply.

VBT (variable bandwidth tuning) enables the operator to, at will, vary the IF filter passband width and establish optimum IF bandwidth relative to the interference being experienced.

The IF shift control allows the IF passband to be moved up or down in frequency without having to retune the receiver. Hence, an unwanted signal, present in the IF passband, may be attenuated significantly by moving the passband in the appropriate direction.

As the IF shift and VBT are independently adjustable they can, to advantage, be used together.

The tunable notch filter in the TS830S is a high-Q active circuit in the 455KHz second IF. Sharp, deep notch characteristics will eliminate a strong interfering carrier within the passband of the receiver section.

The RF speech processor in the TS830S provides added audio punch and increases the average SSB output power whilst suppressing sideband splatter. Compression levels can be monitored and controlled from the front panel.

To cope with pulse type (such as ignition) noise, the transceiver has an in-built noise blanker.

For perfect listening, a tone control adjusts receiver audio frequency response to suit operating conditions.

Both RIT and XIT, transmitter as well as receiver incremental tuning are included to aid operating, XIT being a distinct advantage when calling a station that is listening 'off frequency'.

It is possible to monitor the transmitted audio in order to assess the effects of the speech processor: a most useful feature ensuring perfect signal reports.

TS830S amateur band transceiver.....£793.10 inc VAT, carr £7.00

LOWE ELECTRONICS

Chesterfield Road, Matlock, Derbyshire. DE4 5LE.
Telephone 0629 2817, 2430, 4057, 4995. Telex 377482.



the TELEREADER range

Those of you who have seen TELEREADER products will know that outstanding performance allied with ease of operation are the hallmarks of this particular company. The four models in our range are the CWR685E combined transmitter and receiver, the CWR675E having receive only and built in monitor, the CWR670E being a CWR675E without monitor and the CODE MASTER CWR610E which not only receives CW and RTTY (Baudot and ASCII) but doubles as a morse tutor. TELEREADER also have an AMTOR unit, the AMTOR10A, details for this are available on request.



The CWR685E has many outstanding features...
 CW, Baudot and ASCII receive and transmit: CW at 3-40wpm, RTTY at 45.45-300 bauds (six speeds).
 Built-in 5in green phosphor screen giving a clarity and brightness that I have not seen before.
 An external QWERTY keyboard housed in a substantial metal case and supplied with 3 feet of connecting cable. Not a 'rubber key or plastic faced touchpad' but a true keyboard.
 6 Memory channels (63 character capacity each). In addition the 4 standard test transmissions (RY, QBF, Baudot all characters, ASCII all characters) are permanently stored in memory and can be recalled and transmitted in a variety of formats. 480 characters of transmitting buffer memory are also included.
 Automatic and manual transmit/receive switching.
 Printer output: Centronics compatible parallel interface for hard copy.

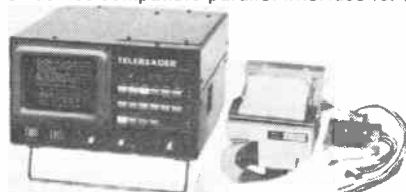

The TELEREADER CWR675E has a similar specification to the CWR685E having the built-in 5in green monitor but not including the transmit facility. The CWR675E provides for both the enthusiastic radio amateur and short wave listener access to both the amateur and commercial world of RTTY as well as providing a visual display of received morse code. The CWR670E is as the CWR675E but does not have the monitor.



The TELEREADER CWR610E Code Master is a compact CW/RTTY converter which also doubles as an audio-visual morse tutor. Features of the CWR610E Code Master are...
 CW, RTTY (Baudot and ASCII reception).
 CW: 3-40wpm, Baudot/ASCII: 45-600 bauds (seven speeds).
 CW morse practice at 2-30wpm.
 Display characters: 612 characters x 2 pages.
 Centronics compatible parallel interface for printer output.
 UHF/VIDEO display output.

CWR685E full receive/transmit	£771.64 carr	£7.00
CWR675E receive only with monitor	£449.17 carr	£7.00
CWR670E as above but without monitor	£392.80 carr	£7.00
CWR610E codemaster	£195.00 carr	£3.00
PK675 printer for CWR675E	£189.00 carr	£7.00
AMTOR10A amtor unit	£253.20 carr	£3.00

all prices include VAT.

TS430S



The TS430S combines the facilities of a solid state HF transceiver with those of a general coverage receiver. It's the ideal rig for the radio amateur who not only wants to communicate with his fellows but also enjoys listening to the world. As an amateur band transceiver the rig covers top band to ten metres, as a short wave receiver coverage is from 150KHz to 30MHz. Operating on AM, FM, USB, LSB and CW the TS430S is extremely compact and, as such, is the perfect transceiver for mobile, portable or base station operation.
 TS430S HF transceiver with general coverage receiver £733.55 inc VAT.

TW4000A



Taking into account the amount of activity on the 2 metre FM channels it is not surprising that many people have turned their attention to the wide open spaces of 70 centimetres. With the TW4000A, TRIO have produced a dual band FM transceiver that gives its owner the best of both worlds. Facilities include 10 memories, two VFO's, priority channel, full repeater operation, band scan and memory scan. In memory scan mode the rig can be instructed to look for either 2 metre or 70 centimetre signals. The transceiver produces 25 watt RF output on both bands and comes complete with mobile mount and microphone. For greater safety whilst mobile the optional VS1 board will announce frequency, memory channel and whether or not the rig is set on repeater shift.
 TW4000A dual band FM mobile £510.97 inc VAT.

R600



For those who are banned from the house and have to operate from the shed at the bottom of the garden, why not consider an R600 to monitor the bands from the comfort of the fireside. No wife would forbid such an attractive looking receiver in the lounge, after all it could also be used to listen to *Women's Hour*. The R600 is a basic receiver covering from 150KHz to 30MHz and having switched upper and lower sidebands, wide and narrow am and cw. It has a 20dB attenuator and a noise blanker fitted as standard. Operation is simple, select the mode of operation, turn the MHz dial to the correct band and, by using the VFO knob, tune to the desired frequency. The clear digital readout makes station selection simple. The TRIO R600, your passport to comfortable listening.
 R600 general coverage receiver £285.26 inc VAT.

LOWE ELECTRONICS

Chesterfield Road, Matlock, Derbyshire. DE4 5LE.
 Telephone 0629 2817, 2430, 4057, 4995. Telex 377482.



L·E·T·T·E·R·S

SPECULATION

I read GW4OXB's comments in the December issue on the 'Dipole of Delight' and his speculation as to what was in the sealed centre unit.

Whilst I am not certain that I can answer this, it is possible to speculate with some degree of confidence. Early issues of the *ARRL Antenna Book* highlighted the point that the centre of a resonant dipole was at voltage zero and could therefore be earthed. Feeding could then be via balanced line and delta match or coax and gamma match, with a reference to the fact that the ground wave screen gave improved rotary radiation/pick-up properties.

However, a gamma match might result in a rather wide centre unit and it may be that Mr Hateley is using a pair of capacitors at the centre, with the central connection earthed and their value chosen to give an impedance match to the coax.

Just thoughts – I've no idea how near to the truth.

LW Barker G3WAL

NO REPLY

There was a time, not so long ago, when a letter to a radio dealer – any radio dealer – brought forth results within a few days. Sadly, this is no longer the case.

During the past seven weeks I have written to eleven radio dealers – in each case enclosing a stamped envelope. Results to date? Nil!

I wouldn't have minded if they'd been 'nasty' letters, but they were simply asking for information on goods available, or quotations – or in the case of three of them, trying to get some action from one dealer who had welched over a £60 CCTV camera deal! In all, they cost me £3.74 in stamps, and nothing to show for it. It has certainly brought home to me that the amateur radio scene has attracted the attention of a lot of dubious characters who are out to make a 'fast buck', with no strings attached. It would appear that they also collect unused 17p stamps!

My advice to would-be buyers is to deal only with

established companies who advertise regularly in the radio magazines and are known to provide a good after sales service. If you *have* to buy from a 'junk' source, make sure it's within reasonable 'car range' before parting with your hard earned cash. This limitation certainly puts a question mark on 'rally buying' – but there again, every enthusiastic 'rallyer' knows the stalls he can trust.

If you *must* deal with an unknown 'junkman' then don't spend a fortune, don't bother to ask his address – examine your purchase carefully, and count your change! It's a bit restrictive I know, but from my experience you'll be in pocket in the long run, in more ways than one!

NeV Kirk G3JDK, Rotherham

'X' OPERATORS

I was most interested to read the article entitled 'Pirates Ahoy', in the September issue of *Amateur Radio*. Although my own ham experiences do not go back to the 1920/30s, I did start SWLing in 1945/46.

You may be aware that towards the end of 1945 the first amateur bands to be re-released to Gs were 10m and 160m and a little later 5m.

Operation on 20, 40 and 80 metres was not permitted until June 1946 and I can well remember listening on many occasions to stations, particularly on 40 metres, during the period say November 1945 to June 1946 signing X2DY, X2DX, X3JL etc. These are some of the calls that I can remember but there were many more. I can only assume that they were genuine pre-war calls and the operators were very impatient with the authorities for not releasing the aforementioned bands.

I was not a member of the RSGB at the time so I did not have access to the *Bulletin*, but I do know that reference to these operators did appear from time to time in *Short Wave Magazine* around this period. As far as I am aware nothing has ever been mentioned about this spate of illegal operation since then in any of the magazines and I

still don't know if in fact, for example, X2DY was G2DY. I should imagine that in any case none of the operators would ever have admitted to being an 'X' operator.

I should explain that the operators to whom I refer were obviously British and I only heard them on AM phone, because at the time I could not read CW although there may have been operation on CW of course.

I would be interested to learn if any other amateurs of that period can recall this particular spate of illegal operation. I would be very surprised if any of these 'X' stations ever issued QSL cards!

MC Pavely G3GWD, Kent

SOLDERING 'TIP'

I read your review on the Oryx soldering tools with interest – but with iron coated tips being the price they are, I feel I must stick my neck out and make one important observation.

I've been out of the electronics game for two years now, but prior to that ran a laboratory in which we had twenty soldering stations (Weller) with irons fitted with iron coated bits.

However, bit life was very short, until it was pointed out that we were using the wrong type (not make) of cored solder. We had been using Ersin 'Savbit' which apparently, due to its chemical composition, really chewed up iron coated bits.

On the recommendation of our suppliers, we switched to Ersin's standard 60/40 lead tin alloy solder, and our bit wastage ceased.

The remaining stocks of Ersin Savbit were used with standard copper coated bits with no ill effects.

HN Kirk, Yorks

GOOD LUCK TO CB

I do not often write letters to magazines, but I feel I should like to respond to the letter from David Harding printed in the December issue of *Amateur Radio*.

As to the ham fraternity washing their hands of CB, this is just not so. I have several amateur friends who

use CB for what it was intended – a means of short range communication.

I agree with Mr Harding that it is very useful for mobile operation and is used extensively as such.

I'm sure that most amateurs do not think that CB is 'negative and defeatist'; they just don't give it a thought. This is not to say however that most amateurs are against CB, most are prepared to 'live and let live' providing they are not blamed for the interference caused by some CBers.

I feel that the reason the authorities tend to ignore CB is the way it was thrust upon them. I also think that the RSGB is not against CB, they probably think as I do in that it is not pure amateur radio, that most CBers do not think as radio amateurs do, and that if a CBER wishes to take up amateur radio as a hobby he will get help from the RSGB and the amateur radio hobby in general.

I have been told by ex-CBers that it was the wallies who drove them away from the hobby. This may be so but I'm sure that any CB operator who tackles the technical side of radio will get a lot more satisfaction than can be obtained from pressing the 'mike' switch and talking.

This is not meant to be a criticism of CB and I hope it will not be taken as such.

Good luck to the CB operators who follow the terms of their licences. We amateurs have nothing against them.

RM Dotchin G3WEP, Bedford

ADVICE NEEDED

I am a home brew enthusiast who wishes to venture into the one side of the hobby that appears not to have been put into print – metal finishing or silver plating components.

Having scoured the technical bookshelves of our local library on the subject and drawn a blank, I wondered whether any of your readers may have any information on metal plating.

Any advice on plating would be much appreciated.

H Cheetham G1DCM, Nottingham

WOOD & DOUGLAS



Why not start 1985 on a new band?
We can now offer the following packages
for 24cms FMTV.

1. Receive Package (VIDIF Kit - 125ODC50 Boxed)£105.00
(VIDIF Ass - 125ODC50 Boxed)....£120.00
2. Receive Package (VIDIF Kit - TVMOD1 Kit - 125ODC50
Boxed).....£110.00
(VIDIF Ass - TVMOD1 Ass - 125ODC50
Boxed).....£126.00
3. Transmit Package Kit (UFMO1 - 70LIN3/LT - 70FM10 -
WDV400/1200 Boxed).....£130.00
Ass (As above)£155.00

The above prices are inclusive of VAT but exclusive of £1.50 postage. Please allow maximum of 28 days delivery for boxed items. No additional discount available for the purchase of more than one package. Please contact our sales staff for further information.



The demand for boxes connectors etc to make a professional finish on our pre-amp/linear combinations has encouraged our release of the following hardware packs:-

Typical Contents: Diecast Box, Heatsink, Switches, LED's, Cable etc

1. 2M LINEAR/PRE-AMP 25W (BNC Connectors).....£14.95
2M LINEAR/PRE-AMP 25W (SO239 Connectors).....£14.25
2. 2M LINEAR/PRE-AMP 10W (BNC Connectors).....£13.95
2M LINEAR/PRE-AMP 10W (SO239 Connectors).....£13.25
3. 144LIN25B KIT (BNC Connectors).....£13.75
144LIN25B KIT (SO239 Connectors).....£12.80
4. 70LIN10 KIT (BNC Connectors)£13.75
70LIN10 KIT (SO239 Connectors)£12.80

For further details on these Hardware packages please contact our sales staff on the telephone number below. Prices are inclusive of VAT but exclusive of £1.50 carriage.

While every endeavour is being made to hold prices on our products, due to the fluctuating dollar/pound exchange rate we cannot guarantee to hold some component prices. In particular RF Power components such as 'SD' part numbers will be affected. Please check current prices with our sales staff before ordering replacement parts.

Further details on our product range will gladly be forwarded on receipt of large size SAE Technical help is available by 'phone during normal office hours. Kits are usually available by return of post but please allow 28 days for unforeseen delays. Please add 75 pence to your total order for postage and handling. Credit card orders are gladly accepted, please give us a call.

ANYONE CAN SELL A KIT . . . REPUTATION SELLS OURS

**UNIT 13, YOUNGS INDUSTRIAL ESTATE
ALDERMASTON, READING RG7 4PQ**



Tel: 07356 71444. Tx: 848702



RSGB BOOKS

How to Pass the Radio Amateurs Examination

Edited by G L Benbow G3HB

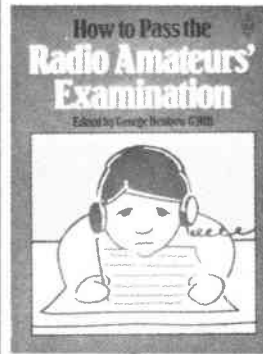

This recently published book is a guide to would-be amateurs intending to sit the Radio Amateur Examination. It is intended to compliment the Radio Amateurs' Examination Manual, giving facts about the examination and how to cope with multiple-choice type questions. There is a comprehensive series of test papers, included in the book. All the questions have been devised by members of the Education Committee of the RSGB and are set in a similar style to those encountered in the RAE. Chapter titles: What is a multiple-choice examination?; Tackling the multiple-choice RAE; Mathematics for the RAE; Preparing for the RAE; Sample multiple-choice examination papers.
91 pages, paperback 246 by 184mm price **£3.42**

Locator Map of Europe

The new international (Maidenhead) locator system came into use on January 1 1985. This new map published by the RSGB shows locator squares for Europe at a glance, with an inset world-wide locator map showing the main locator squares for the rest of the world. The instructions for its use are printed in 17 European languages including English. Size 625 by 900mm Price **£1.96**

There is also a desk version of the map printed on card

Price **70p**

Other RSGB Publications

A Guide to Amateur Radio (19th edn)	£3.91
Amateur Radio Awards (2nd edn)	£3.98
Amateur Radio Call Book (1984 edn)	£7.14
HF Antennas for All Locations	£7.35
Microwave Newsletter Technical Collection	£6.83
Morse Code for Radio Amateurs	£1.64
Radio Amateurs' Examination Manual	£3.84
Radio Communication Handbook (paperback)	£11.79
Teletypewriter Handbook (2nd edn)	£12.72
Television Interference Manual	£2.31
World at their Fingertips	£7.75
VHF/UHF Manual (4th edn)	£10.88
Meteor Scatter Data	£3.51
Logbooks	
Amateur Radio Logbook	£2.77
Mobile Logbook	£1.23
Receiving Station Logbook	£2.87
Maps	
Great Circle DX Map	£2.43
World Prefix Map in full colour (wall)	£2.53
Other Publications	
Active Filter Cookbook (Sams)	£12.71
All About Cubical Quad Antennas (RPI)	£5.83
Amateur Single Sideband (Ham Radio)	£5.46
Antenna Anthology (ARRL)	£5.00
ARRL Antenna Book (Hardback for p/b price while stocks last)	£5.78
ARRL Electronics Data Book	£4.47
Beam Antenna Handbook (RPI)	£6.83
Better Short Wave Reception (RPI)	£6.83
Care and Feeding of Power Grid Tubes (Varian)	£6.99
CMOS Cookbook (Sams)	£13.07
Complete Shortwave Listener's Handbook (Tab)	£12.21
FM and Repeaters for the Radio Amateur (ARRL)	£4.30
G-QRP Club Circuit Handbook	£4.52
Guide to Oscar Operating (AMSAT-UK)	£1.78
Hints and Kinks for the Radio Amateur (ARRL)	£4.47
How to Troubleshoot and Repair Radio Amateur Equipment	£10.47
IC Op-amp Cookbook (Sams)	£11.75
International VHF FM Guide	£2.45
Newcomer's Guide to Simplex and Repeaters on 2M	£1.24
Radio Frequency Interference (ARRL)	£4.18
Satellite Experimenters Handbook (ARRL)	£10.11
Satellite Tracking Software for the Radio Amateur (AMAST-UK)	£4.47
Secrets of Ham Radio DXing (Tab)	£7.92
Semiconductor Data Book (Newnes)	£7.97
Shortwave Propagation Handbook (Cowan)	£7.79
Simple Low Cost Wire Antennas (RPI)	£5.53
Solid State Design for the Radio Amateur (ARRL)	£7.87
Television for Amateurs (BATIC)	£2.23
The Radio Amateur's Handbook 1984 (ARRL)	£6.66
The Radio Amateur's Handbook 1985 (ARRL)	£14.80
Understanding Amateur Radio (ARRL)	£4.73
VHF Propagation Handbook (Nampa)	£3.75
Weekend Projects for the Radio Amateur (ARRL)	£4.95
World Atlas (RAC)	£3.35

Membership of the Radio Society of Great Britain is open to all Radio Amateur and Listeners. For details of subscription and the benefits of membership, please contact the Membership Services Department. All items in this advertisement include post and packing. Members of the Society are entitled to discounts on these prices. Personal callers may obtain goods minus postage and packing charges.



RSGB Publications

Lambola House, Cranborne Road,
Potters Bar, Herts EN6 3JW
Telephone: (0707) 59015

STRAIGHT & LEVEL

All the latest news, comment and developments on the amateur radio scene

SSTV GROWTH

More and more Ws are appearing on 20m SSTV using the new Robot colour system, which have been worked 2 way using either 12, 24, 36 or 72 second single frame colour.

Two of the latest users are WA2FF and N2WA, neighbours in Patterson, NJ, both using Robot's 1200C with Tandy TRS-80 computers for control and graphic generation. They will be able to work both G2BAR and G4UFV who are also equipped with 1200C systems.

Recent short skip on 20m enabled G3WW and GW3WIL to swap Robot 450C colour pictures, while on 2m G2BAR and G3WW have replayed one another's replays in colour.

Volker Wrasse's (DL2RZ) various SC model scan converters around Europe con-

tinue to give their owners 2 way SSTV QSOs with G3WW in 8, 16 and 32 second frame black and white and 24 and 48 second single frame colour. However, 8 second frame black and white and 3x3 or 2x2 RGB remain the standard types of SSTV transmissions.

There is a possibility that SSTV may be transmitted from the April 51-H space shuttle flight of Tony England W0ORE. In the USA considerable concern has been expressed over the picture mode formats to be used! Perhaps here however the RSGB can reserve the UK 2m SSTVers at least a QRM-free frequency?

STEP-BY-STEP

Computer users require a more than powerful memory and a fast printer to get

maximum production from their machines. They also need to be proficient at typing, getting information and instructions into the computer quickly and efficiently. Barron's new self-instruction book, *Step-by-Step Keyboarding on the Personal Computer*, teaches the user to increase typing output and thereby increase computer output.

All typing skills and special computer operations are taught one step at a time, then immediately strengthened through practice exercises and drills.

Topics include word processing techniques, preparation of all types of business correspondence, editing and proof reading a text, and other essential skills. Numerous business applications are included, making the book

particularly useful for upgrading office production. A special 'Word Processing Workbook' section contains 25 lessons with abundant instruction, practice and drill material. In addition, the book includes an introduction to the important words and symbols of BASIC.

For further information tel: (01) 734 7282.

MULTI-P6+

ARM are about to launch the Multi-P6+ mobile antenna which promises to be as versatile as a boy scout's pocket knife. This all stainless steel British made aerial should satisfy all the needs of the discerning mobile operator.

Designed primarily for 2m multi-mode working, the P6 is many aerials in one. It will

PANAVISE RANGE

The versatile Panavise range of bench-top tools and equipment has been enhanced by several recent additions, and Greenwood Electronics, the sole UK distributor, claims that it now caters for virtually any application.

The original 301 Panavise assembly comprises the 300 base which can be attached by screws to a bench-top and the 303 vice head which slots into a universal-type joint on the base and can be twisted and tilted to any desired position and then locked in that position by hand tightening a knob. An alternative vacuum base version (model 380) can be secured to any smooth non-porous surface. At least four types of base can be used on the original 301 'Vise'.

New developments include the model 324 Electronic Work Centre, which has a model 371 solder and solder-

ing iron holder mounted on the base. An adjustable PCB rack (315) completes this unit.

Other items that can be used on all base units are: the model 337 fixture head for production fixturing or the 336 up/down converter base to give additional dimensions of height and tilt. The model 376 with very wide-opening jaws and the model 366 with general purpose jaws fit all base units and offer greater versatility in clamping the work piece.

A novel vice for the electronics workshop, the Oryx 1B has a base which can be clamped to the side of a bench and a lockable ball joint which allows the vice head to be rotated 360° in the horizontal plane and through 90° in the vertical plane. By this means, the vice head can be adjusted easily through a complete hemisphere of positions relative to the base and its jaws can grip objects in any orientation from hori-

zontal to vertical.

Ideally suited for drilling and soldering work, the rubber faced jaws have a 90mm maximum opening and are designed to hold a PCB securely but gently. Moreover, the vice head can easily be detached and

replaced by a sponge-backed PCB holder accessory making the Oryx 1B an exceptionally versatile tool for any electronics workshop.

Greenwood Electronics Ltd, Portman Road, Reading, Berks RG3 1NE. Tel: (0734) 595844.

Oryx 1B vice

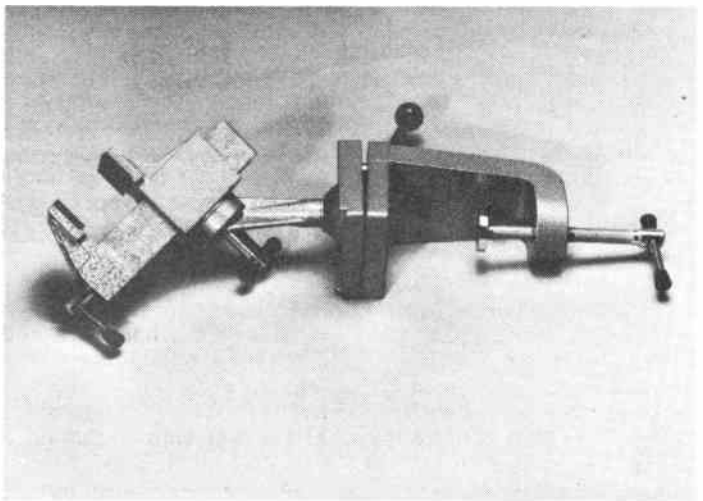

operate vertical or horizontal, directional or omni-directional. It can be used as a DF loop or, by attaching the extra element, easily converted to a directional horizontal col-linear, ideal for hill top DX working. In addition to all this its free space design allows these facilities to be used off the car, indoors or outside.

The tuning stub is continuously adjustable for higher frequencies, including 70cms. Performance in the vertical plane is equal to the popular 5/8 but as you don't have to rely on the vehicle as a ground plane a better all round radiation pattern is claimed.

For further information contact R Whithers Communications, 584 Hagley Road West, Oldbury, Warley, West Midlands. Tel: (021) 421 8201/2.

AMTOR/RTTY FOR THE BLIND

Over the past few weeks three radio amateurs, G4VWW - Steve, G6YYZ - Terry and G6TLI - Phillip decided to pursue a project in which a whole new world could be opened up for blind operators in the use of RTTY/Amtor.

The reason for this idea was mainly due to a friend Steve (G4VWW - IK3CSU) who visits them regularly once or twice a year from Italy.

During his most recent stay he took tremendous interest in the use of RTTY/Amtor, but there was only one problem: he could not operate the system unless there was someone in attendance.

At long last they have managed to overcome this, and decided to let other operators in the same position as Steve know that it can now be done.

The idea was to look at speech synthesis, which basically works on the same lines as a printer (but without the paper!) and also is compatible with most computers, ie RS-232C or Centronics parallel interface.

There were one or two problems to be overcome because the speech synthesiser they used which came from Braid systems had only an RS-232C serial port, and although their particular computer had provision for both, it only sent data to a printer via the Centronics port. So consequently it would not allow them to run

Amtor at the same time because the Amtor modem only had RS-232C as well.

Rather than wait for the optional Centronics port to be fitted they decided to overcome this problem by connecting both the Amtor unit and the Braid Synthesiser together.

This was done by using the RS-232C input to the computer from the Amtor unit and in parallel from the data output of the Amtor to the synthesiser.

All control codes to the Amtor unit and the synthesiser are sent by the computer from the RS-232C data out port. This meant putting the Amtor unit into transmit mode and then sending the various control codes to give the functions available (pitch, words or letters), and the data was then confirmed via echo back to the synthesiser.

It must be added that it depends on the particular computer that is in use, the computer that was used in this case being the Tono 9000E communications terminal.

Some computers have different provisions, such as the Apple 2 which can use TTL levels to drive the Amtor unit and RS-232C to send the data to the Braid synthesiser. The same also applies for the Commodore 64.

For further information contact Phillip Stanley G6TLI, 67 Clapham Road, London SW9 0HY.

BARTG NEWS

At the RSGB VHF Convention at Sandown Park on 23 March 1985, Ian Wade G3NRW, of the British Amateur Radio Teleprinter Group (BARTG), is presenting a talk entitled *How Packet Radio Works*.

Aimed at beginners to data communications, Ian first takes a brief look at the problems of RTTY and Amtor which initially prompted the development of packet radio, then moves on to the basic features of the AX25 packet radio protocol. Many practical uses of packet will be described, together with details of the hardware and software needed to run it. The talk is illustrated throughout with slides, tape recordings and visual aids, including a very special piece of string...

The winter 1984 edition of

the BARTG magazine *Datacom* is another bumper issue, with 116 pages of technical articles, reviews and news items covering all aspects of data communications, including RTTY, Amtor, packet radio and FAX.

Special features include full circuit and constructional details of the ST5MC terminal unit (TU), suitable both for conventional teleprinters and for home computers. The TU is based on the classic ST5 design, well proven over many years, and especially suited to handling weak RTTY and Amtor signals on HF and VHF. For this design BARTG supplies printed circuit boards and kits for home assembly, plus ready-built and tested units.

Datacom is sent free to BARTG members every quarter. Membership of BARTG has more than doubled during 1984 to just under 2700, and the group has now set a 1985 target of 5000 members.

For full details of membership, contact Mrs Pat Beedie GW6MOJ, 'Fynnonlas', Salem, Llandeilo, Dyfed, Wales. Tel: (0558) 822286.

CORRECTION

In the December issue an article entitled *Building Loaded Vertical Whips using CAD* incorporated a program which has caused some confusion. Below are listed a few points which may help to explain:

All instances where "I" appears in the copy of the program, it is figure 1 and not the capital letter. All instances where "O" appears it is figure 0 (zero) and not the capital letter.

Some people have had difficulty with LINE 220 due to the misinterpretation of the letters "LN". This is not a variable as possibly thought, but a function for logarithms, as an LN function appears on the ZX81 keyboard. The expression - (LN N/LN 10) in LINE 220 is calculating the natural log of variable N to log with base 10. This has to be done due to the computer dealing with natural logarithms.

The letters "PI" are also a function for π (3.142 etc) and not a variable.

Some queries were made regarding the two assignments of variable L, which appear in LINE 98 and LINE

750. No problems actually occur in practice as the two values do not interact.

The method of utilising a kind of shorthand for powers of numbers may confuse some people. On the ZX81, for instance, at LINE 350 "1E12" and "1E6" are used. 1E12 in fact is the same as using 10 to the power of 12, and 1E6 is the same as 10 to the power of 6. The use of this saves space in display and memory.

VERY MUCH ALIVE

We must apologise to Mr Rex Toby G2CDN who was referred to as the late G2CDN in the article entitled *'The pursuit of excellence: G3WW'* in the December issue.

As his callsign had not appeared in the 1983 and 1984 callbooks the author of the article assumed he was a 'silent key'. We are pleased to be able to reprint the following letter from Mr Toby himself, which verifies that he is still very much alive.

'I have just been informed by one of your readers, my good friend Steve Blayer G4UKR, that he was shocked to read in your magazine that I had passed away.

Apparently it was mentioned in an article written by John Heys G3BDQ, another friend of mine, covering the activities of G3WW (also known to me personally for 30 years!).

I happen to be 72 years old, and have just returned from South Africa where I have lived for the past 4 years, having the callsigns ZS2RJ and ZS6XC.

Perhaps you will be kind enough to let my many friends know that at this moment in time, the published information is erroneous! Many thanks in advance!

RACAL USER GROUP

In the November issue we mentioned the Racal User Group in these pages. Those who wished to obtain further information were advised to contact Mr Peter Barker G8BBZ.

Mr Barker has recently advised us of his change of address, and any enquiries should now be forwarded to him at 15 Epping Green, Woodhall Farm, Hemel Hempstead, Herts HP2 7JP.

All mail sent to his old address is being passed-on.

DX DIARY

News for HF operators compiled by Don Field G3XTT

A look at the future of the HF bands

With the New Year well and truly under way it may perhaps be a good opportunity to reflect on where HF amateur radio is taking us. When amateurs first started to explore the HF bands they found themselves doing valuable pioneering work and laying trails for the professionals to follow. Those days are past, although amateurs have continued to demonstrate innovation. One of the most striking examples was their adoption of SSB on the HF bands during the 1950s and 1960s, again a path which the professionals have followed at a later date.

Having said all this, there are those in our midst who believe that the only pioneering work now being done by radio amateurs is in the microwave part of the spectrum. Certainly it is true that the professionals are now extremely sophisticated in their use of HF, while on the whole we seek to preserve the status quo which existed as early as 20 years ago. Our contests are based on SSB and CW operations, our techniques are no more efficient in their use of the spectrum than they were then, our ability to raise a specific station other than by pre-arranged schedule is still largely a matter of chance.

Which way forward?

None of this need be so. Our VHF colleagues are starting to experiment with selective calling and packet radio, techniques which enable a

message to be sent in an efficient manner to a pre-determined station even when the distant operator is absent or otherwise engaged.

Potentially our HF bands could be used as the 'trunk' element of a worldwide packet-switched data network of which the VHF bands formed the 'local' end, permitting reliable messaging to radio amateurs throughout the world. This would be aided by improved propagation forecasting through the use of computers, just as the weathermen have been able to improve their forecasting as more powerful computers have become available.

Other possibilities

A host of other possibilities present themselves, and most are feasible now. All they require is the will and an element of co-operation in

agreeing standards, etc. Maybe this is not what you want out of HF, just as I am sure there were those who resented the passing of AM when the new-fangled SSB took over. Certainly I am sure that simple CW must continue to have a place.

We do not want, with our increasing sophistication, to disenfranchise up-and-coming amateurs in third world countries, or indeed here at home, who for whatever reason cannot afford the latest all-singing all-dancing microprocessor controlled creation. CW will continue to offer a cheap and simple way into the hobby, while at the same time going a very long way to overcoming the barrier of language (will the next generation of rigs include a language translation capability? Us English speaking amateurs tend to forget that

amateurs elsewhere have to learn a foreign language when they take up the hobby).

I would be interested to know what sort of scenario for HF amateur radio our readers envisage for the year 2000. Will it be as now, though perhaps with more RTTY given the increasing use of micros by amateurs? Will things have developed along some of the lines I have been discussing? Or will HF be dead in favour of a worldwide VHF network based on geostationary satellites acting as telephone exchanges in the sky? Why not put pen to paper and let me know what you think?

Operation Raleigh

In the meantime, and at a more down-to-earth level, *DX News Sheet* reports that there may be opportunities for radio amateurs to become involved with Operation Raleigh. Operation Raleigh, for those who don't know, is a round-the-world expedition for young people taking place over a four year period and modelled on a similar exercise, Operation Drake, which took place several years ago. Young people will join the expedition ship for three months at a time to take part in scientific and other activities. If all goes well it will be possible for radio amateurs to be involved when the expedition visits South Georgia in late 1985. The cost of the trip is likely to be around £2,500 per person, though there is no objection to this being raised

Drew GM3YOR, Steve G4JVG and XYL. Photo G37AY



through sponsorship.

Licensed British amateurs holding Class A licences, preferably under 25 years of age with proven HF operating skills, are invited to apply. Applications should ideally be in by the end of January, but in any case contact G3KMA at his callbook address if you require further information.

Vatican City

Three amateur stations show up from time to time from this small DXCC country. These are HV1CN, HV2VO, and HV3SJ. HV2VO is located outside Rome at the Vatican Observatory (but still on Vatican soil) and the licensee is Father Benedetti who is operational only on SSB. During December, however, some visiting Italian amateurs activated his station on CW on all bands much to the delight of many. A particular feature of the operation was the inclusion of 160 metres (which, I'm delighted to say, gave me my 101st country on the band).

There had been a previous attempt to operate 160 metres from the Vatican from HV3SJ's station at the Vatican proper in the centre of Rome, but this had proved to be impossible due to severe interference from the medium wave transmissions of Vatican Radio. If you worked HV2VO on the weekend of 7-9 December then QSL to I2BBJ.

Pacific News

VK0GC is now back on Macquarie Island and, from experience of his previous spell on the island, I would recommend looking for him in the mornings on 40 metres. Denise VK0YL is also reported to be operational from the island. VK3NM was due to be operational from Norfolk Island from 19-26 January and then from Lord Howe Island from 26 January to 3 February. VK9ZR should by now have replaced VK9ZA on Willis Island. VK9XZ, a new operator on Christmas Island, has been reported working into the USA on 80 and 40 metres and may by now have discovered the higher bands and be working into Europe. VK6IR and others are rumoured to be considering a DXpedition to both Christmas Island and Cocos Keeling Island, but are having prob-



Father Moran (GN1MM) with Roger G3KMA at a recent get-together of the Chiltern DX group. Photo G3ZAY

lems in finding accommodation.

Cocos Keeling

The above news item about Cocos Keeling Island is interesting in the light of an item by VK3YJ which appeared in the August 1984 issue of the American 73 magazine. VK3YJ reported that VK9NYG, a novice operator limited to 30 watts PEP and active almost exclusively on 10 metres, made the outstanding total of 22,000 contacts during a 2 year spell of duty on the island group which is located several hundred miles north-west of the Australian continent. VK9YA was also very active during his various visits to the island. Another call which will be familiar to many is VK9YC, a member of the Clunies-Ross family which was granted all rights to the island by Queen Victoria in 1886.

With these and other occasional operations most active amateurs have worked the islands and demand for an expedition might be expected to be low. However, Australia has been seeking to oust the Clunies-Ross family from the islands and is presently building a six million dollar high-security quarantine station there so casual visits by amateurs may become fewer and we may see VK9Y creeping back up the 'wanted' lists.

Africa

ET3PG and ET3PS have both been worked recently in the UK after many years of very low amateur activity from Ethiopia. One wonders if there is any connection with the current Western interest in Ethiopia due to the famine.

Also from Africa comes news that ZS2MI may soon be active again. This call is allocated to the weather station on Marion Island which counts as a separate DXCC country. The prospective operator is ZR6AOJ, a VHF-only licence holder who has special permission to operate on HF when on an island assignment (shades of Class B UK licence holders being allowed to operate HF from ZD8, VP8, etc). Finally, FT8XB is expected to show in the near future from Kerguelen Island, a remote French outpost in the Southern Indian Ocean. The QSL route for this station will be PO Box 83, 95101 Argenteuil Cedex, France.

Other news

A recent oddity to have appeared on the bands is UA9OO/YA, claiming to be in a town just inside Afghanistan. We must wait and see whether this turns out to be genuine. YA used to be a common prefix on the bands even though no official licensing procedure existed in Afghanistan. In the early 1970s, however, the authorities clamped down on amateur radio and confiscated equipment. Since then there has been no operation and, since the Russian invasion, very little prospect of return to any kind of normality.

JW0EQ is operational from Svalbard until September, mostly on CW, and has been reported on 160 metres as well as the higher bands. His QSL manager is LA5NM.

With regard to the new (WARC) bands, it is reported that Swedish amateurs have been allowed to conduct test

transmissions on all three of these bands since 1 December.

Contests

G3TXF has been doing a good job elsewhere in this magazine of keeping you abreast of forthcoming contests. Can I, however, draw your attention especially to the following contests which take place during February. The RSGB's 160 metre contest takes place from 2100 GMT on 9 February to 0100 GMT on February 10. The ARRL CW contest takes place over the full weekend of 16-17 February.

The last weekend of February (23-24) sees no less than three major contests: the CQ WW 160 SSB (there is no requirement for the serial number to be given in either this or the CW event at the end of January, please correct the rules given by Nigel last month), the French SSB Contest and the RSGB's 7MHz CW event. Flavour all this with numerous American 'QSO parties' on different weekends of the month and there should be a contest flavour to suit all tastes. Well, after all, what else is there to do before spring arrives?

Operating ethics

Finally, I note that ZS6BUX and ZS6DM seem to have incurred the wrath of the Botswana authorities during a recent DXpedition from there. It is not clear from the letter reproduced in *DX News Sheet* just what it was that they did wrong, but there is a salutary lesson to be learned. Not everyone is either sympathetic to or understanding of amateur radio - it behoves us, when guests in another country, to behave impeccably at all times. Bear this in mind if you are contemplating any operation overseas, either in a small way during a European holiday, or as part of a major DXpedition.

Amateur radio can be a marvellous way of building international harmony and goodwill, but can also, if misused, have entirely the opposite effect. Remember always to be ambassadors for this great hobby of ours.

When writing, please remember my new address; 105 Shiplake Bottom, Peppard Common, Henley on Thames, Oxon RG9 5HJ. 73s and good DXing.

COMPUTER WAREHOUSE

1000's OF BARGAINS FOR CALLERS

THE 'ALADDIN'S' CAVE OF COMPUTER AND ELECTRONIC EQUIPMENT

HARD DISK DRIVES

Fully refurbished DIABLO/DRE series 30 2.5 Mb disk drives DEC RK05, RK07A, TEXAS compatible
Front load, Free stand or rack mount £550.00
Exchangeable type (via lid removal) £295.00
me3025 PSU unit for 2 drives £125.00
DIABLO/DRE 44-4000A/B 5+5 ex stock from 1000's of spares for S30, 4000, 3200, HAWK ex stock Plus in house repair, refurbishing service Call for details or quotation **£995.00**

EX STOCK INTEGRATED CIRCUITS OVER 100,000 ITEMS INCLUDING:

Intel D8085AH-2 £25.00 D8271 £65.00
D8202 D8257-5 8255 D3002
2732 EPROM SPECIAL fully guaranteed
450ns £3.75, 350ns £4.00, 300ns £4.50

HOT LINE DATA BASE

DISTEL ©

THE ORIGINAL FREE OF CHARGE dial up data base 1000's of stock items and one off bargains
ON LINE NOW - 300 baud, full duplex CCITT tones, 8 bit word, no parity
01-679 1888

COMPUTER 'CAB'

All in one quality computer cabinet with integral switched mode PSU, Mains filtering, and twin fan cooling
Originally made for the famous DEC PDP8 computer system costing thousands of pounds. Made to run 24 hours per day the PSU is fully screened and will deliver a massive +5v DC at 17 amps, +15v DC at 1 amp and -15v DC at 5 amps. The complete unit is fully enclosed with removable top lid, filtering, trip switch, 'Power' and 'Run' LEDs mounted on Ali front panel, rear cable entries, etc etc Units are in good but used condition - supplied for 240v operation complete with full circuit and 1 tech man
Give your system that professional finish for only £49.95 + Carr Dim 19" wide 16" deep 10.5" high
Useable area 16" w 10.5" h 11.5" d
Also available LESS PSU, with FANS etc. internal dim. 19" w 16" d 10.5" h. £119.95 Carriage & insurance £9.50.

COOLING FANS

Keep your hot parts COOL and RELIABLE with our range of BRAND NEW professional cooling fans.
ETRI 60XU01 Dim. 92 x 92 x 25 mm. Miniature 240 v equipment fan complete with finger guard. £9.95.
GOLD JB-3AR Dim. 3" x 3" x 2.5" compact very quiet running 240 v operation. NEW £6.95
BUHLER 69.11.22, 8-16 v DC micro miniature reversible fan. Uses a brushless servo motor for extremely high air flow, almost silent running and guaranteed 10,000 hr life. Measures only 62 x 62 x 22 mm Current cost £32.00. OUR PRICE ONLY £12.95 complete with data.
MUFFIN-CENTAUR standard 4" x 4" x 1.25" fan supplied tested EX EQUIPMENT 240 v at £6.25 or 110 v at £4.95 or BRAND NEW 240 v at £10.50. 1000's of other fans Ex Stock. Call for Details. Post & Packing on all fans £1.60

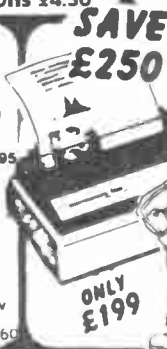

SAVE £250 SUPER PRINTER SCOOP

BRAND NEW CENTRONICS 739-2

The "Do Everything Printer" at a price that will NEVER be repeated. Standard CENTRONICS parallel interface for direct connection to BBC, ORIC, DRAGON etc. Superb print quality with full on addressable graphics and 4 type fonts plus HIGH DEFINITION internal PROPORTIONAL SPACED MODE for WORD PROCESSOR applications. 80-132 columns, single sheet, sprocket or roll paper handling plus much more. Available ONLY from DISPLAY ELECTRONICS at the ridiculous price of ONLY £199.00 + VAT Complete with full manual etc. Limited quantity - Hurry while stocks last.
Options: Interface cable (specify) for BBC, ORIC, DRAGON or CENTRONICS 36 way pig £12.50. Spare ribbon £3.50 each BBC graphics screen dump utility program £8.60 Carriage and Ins. £10.00 + VAT

ONLY £199

BUDGET RANGE VIDEO MONITORS

At a price YOU can afford, our range of EX EQUIPMENT video monitors defy competition!! All are for 240v working with standard composite video input. Units are pre tested and set for up to 80 col use on BBC micro. Even where MINOR screen burns MAY exist - normal data displays are unaffected

1000's SOLD TO DATE

- 9" HITACHI very compact fully cased, dim. 21cm H x 21cm W x 22cm D. Black and white screen **£44.95**
- 12" KGM 320-321, high bandwidth input, will display up to 132 columns x 25 lines. Housed in attractive fully enclosed brushed alloy case, B/W only **£32.95** GREEN screen **£39.95**
- 24" KGM large screen black & white monitor fully enclosed in light alloy case. Ideal schools, shops, clubs etc. **ONLY £55.00**
- 14" BRAND NEW Novex COLOUR type NC1414-CL. Many exciting features such as RGB TTL and composite video input, GREEN TEXT key, internal speaker and audio amp. Even finished in BBC micro matching colours. Fully guaranteed. **ONLY £199.00**

Carriage and ins on ALL videos £10.00

DUAL 8" DISK DRIVES

Current, quality, professional product of a major computer company, comprising 2 x 40 track MPI or Shugart FULLY BBC COMPATIBLE single sided drives in a compact, attractively styled, grey ABS structured case with internal switched mode PSU. The PSU was intended to drive both drives and an intelligent Z80 controller with over 70 ic's. The controller has been removed leaving ample space and current on the +, -5, +12 and -12 supply for all your future expansion requirements. Supplied tested with 90 day guarantee in BRAND NEW condition with cable for BBC micro. Ex Stock at only **£259.00** + £10.00 carr. Limited Quantity Only

SPECIAL 300 BAUD MODEM OFFER

Another GIGANTIC purchase of these EX BRITISH TELECOM, BRAND NEW or little used 2B data modems allows US to make the FINAL REDUCTION, and for YOU to join the exciting world of data communications at an UNHEARD OF PRICE OF ONLY £29.95. Made to the highest POST OFFICE APPROVED spec at a cost of hundreds of pounds each, the 2B has all the standard requirements for data base, business or hobby communications. All this and more!!

- 300 baud full duplex
- Full remote control
- CCITT tone standards
- Supplied with full data
- Modular construction
- Direct isolated connection
- CALL, ANSWER and AUTO modes
- Standard RS232 serial interface
- Built in test switching
- 240v Mains operation
- 1 year full guarantee
- Just 2 wires to comms line

NOW ONLY £29.95

Order now - while stocks last. Carriage and Ins. £10.00

GE TERMIPRINTER

A massive purchase of these desk top printer terminals enables us to offer you these quality 30 cps printers at a SUPER LOW PRICE against their original cost of over £1000. Unit comprises of full QWERTY, electronic keyboard and printer mech with pmt face similar to correspondence quality typewriter. Variable forms tractor unit enables full width - up to 13.5" 120 column paper, upper - lower case, standard RS232 serial interface, internal vertical and horizontal tab settings, standard ribbon adjustable baud rates, quiet operation plus many other features. Supplied complete with manual. Guaranteed working **£130.00** or untested **£85.00**, optional floor stand **£12.50** Carr & Ins £10.00

8" 19MB WINCHESTER DISK DRIVE

Made in the UK by a subsidiary of the World's largest disk drive manufacturer This BRAND NEW "end of line" unit offers an outstanding opportunity to add a MASSIVE 19 mb of storage to your computer system. Superbly constructed on a heavy die cast chassis the DRE 3100 utilises 3 x 8" platters in a dust free cavity. All drive functions are controlled by microprocessor electronics using an INTEL 8035 cpu and TTL support logic. Data to the outside world is via two comprehensive 8 bit TTL level bi directional data busses with full status reporting for ease of interfacing. Many features such as Av. seek time 35 ms, 512 bytes per sector, +24, -24 and +5 v DC supply, plug in card system, and compact size of approx. 19cm H x 21cm W and 42cm D etc, etc, make this item a real snip.

Units are BRAND NEW and BOXED and sold at a FRACTION of original cost - hence unguaranteed. Complete with 150 page manual, circuits and applications guide.

ONLY £225.00 Carriage £10.00
Suitable power supply unit - sold ONLY with drive £39.95.

PROFESSIONAL KEYBOARD OFFER

An advantageous purchase of brand new surplus allows a great QWERTY, full travel, chassis keyboard offer at fractions of their original costs.
ALPHAMERIC 7204/60 full ASCII 60 key, upper, lower + control key, parallel TTL output plus strobe. Dim 12" x 8" +5 v -12 DC **£39.50**
DEC LA34 Un-coded keyboard with 87 quality, GOLD, normally open switches on standard X, Y matrix. Complete with 3 LED indicators & i/o cable - ideal micro conversions etc pcb DIM 15" x 4.5" **£24.95** Carriage on keyboards £3.00

DATA MODEMS

Join the communications revolution with our range of EX TELECOM data modems. Made to most stringent spec and designed to operate for 24 hrs per day. Units are made to the CCITT tone spec. With RS232 i/o levels via a 25 way D skt. Units are sold in a tested and working condition with data. Permission may be required for connection to PO lines.
MODEM 20-1 Compact unit for use with MICRONET, PRESTEL or TELECOM GOLD etc. 2 wire direct connect 75 baud transmit 1200 baud receive. Data i/o via RS232 D socket. Guaranteed working with data **£49.95**
MODEM 20-2 same as 20-1 but 75 baud receive 1200 baud transmit **£130.00**
TRANSDATA 307A 300 baud acoustic coupler RS232 i/o **£95.00** brand new C£4.50
NEW DSL123 Multi Standard modem selectable V21 300-300 bps, V23 75-1200, V23 1200-75 full duplex, or 1200-1200 half duplex modes. Full auto answer via modem or CPU. LED status indicators. CALL or ANS modes Switchable CCITT or BELL 103 & 202. Housed in ABS case size only 2.5" x 8.5" x 9" **£286.00** + VAT
For further data or details on other EX STOCK modems contact sales office.

Carriage on all modems £10.00 + VAT.

66% DISCOUNT

ELECTRONIC COMPONENTS EQUIPMENT
Due to our massive bulk purchasing programme which enables us to bring you the best possible bargains we have thousands of IC's, Transistors, Relays Caps PCB's Sub-assemblies Switches, etc etc surplus to our requirements. Because we don't have sufficient stocks of any one item to include in our ads, we are packing all these items into the BARGAIN PARCEL OF A LIFETIME. Thousands of components at giveaway prices! Guaranteed to be worth at least 3 times what you pay! Unbeatable value!! Sold by weight
2.5kls **£4.25** + pp **£1.25** 5kls **£5.90** + **£1.80**
10kls **£10.25** + pp **£2.25** 20 kls **£17.50** + **£4.75**

ALL PRICES PLUS VAT

All prices quoted are for U.K. Mainland, paid cash with order in Pounds Sterling PLUS VAT Minimum order value **£2.00**. Minimum Credit Card order **£10.00**. Minimum BONA FIDE account orders from Government depts, Schools, Universities and established companies **£20.00** Where post and packing not indicated please ADD £1.00. + VAT Warehouse open Mon-Fri 9.30 - 5.30, Sat. 10.15 - 5.30. We reserve the right to change prices and specifications without notice. Trade, Bulk and Export enquiries welcome

32 Biggin Way, Upper Norwood, London SE19 3XF
Telephone 01-679 4414 Telex 27924

DISPLAY ELECTRONICS

ANGUS McKENZIE TESTS:

Fairly hard on the heels of the Icom IC271H high power 2m multimode is the 471H, having virtually identical facilities but on the 70cm band. The coverage is from 430 to 439.999MHz and modes included are FM, USB, LSB and CW. The rig is similarly styled to other Icom transceivers and is virtually identical to the 271H. The nominal maximum power output on all modes is 75W. Built-in up and down repeater shifts are incorporated, the actual transmit shift being set by the user, which then holds until it is changed on some future date. Two VFOs are included with the usual split mode, A = B, sweeping and scanning facilities.

32 memories

Thirty-two memories are incorporated which hold frequency mode and repeater offset. It is simplicity itself to put a frequency etc into memory and you can select VFO immediately from any memory, which is very useful. Memories 1 and 2 are used for program scan which allows you to scan all channels, or only channels of the chosen mode.

Receiver incremental tuning (RIT) allows the Rx to be offset up to ± 9.9 KHz, the frequency offset being indicated on the digital readout which also indicates main tuned frequency to the nearest 100Hz. RIT can be switched in or out on one button and can be returned to no offset with another, a multi-turn pot providing adjustment of RIT.

Other buttons switch MHz up and down, select normal or split operation, allow the memory channel to be pre-selected in readiness and select tuning steps which are 1KHz on all modes with the button in, or 10Hz/5KHz steps on SSB and CW/FM respectively with the button out. When the dial is rapidly rotated on SSB or CW the 100Hz step mode is engaged to give a higher QSY speed which is quite useful. A row of push buttons on the left of the tuning knob select VOX on/off on both SSB and CW, noise blanker on/off, AGC fast/slow, meter (selects discriminator centre O or S-meter on FM reception), masthead pre-amp on/off (13V dc positive on co-ax inner to antenna in Rx mode when switched on, compatible with SSB Products, Dressler and Icom masthead pre-amps) and finally, mode selective scan switch which works in conjunction with memory scan. The four mode switches are in a vertical line on the front panel to the left.

An eight pin socket on the front panel is for microphone interconnection, the mic supplied (HM12) including the usual PTT and up and down buttons, the latter switching memories where appropriate as well as shifting frequency in VFO mode. Concentric split rotaries are provided for RF and AF gain, Rx tone control and squelch (operating on all modes) and output power from 10W to full output combined with mic gain.

To the bottom left of the tuning knob is a push button entitled 'lock'. This not



THE ICOM IC471H 70cm MULTIMODE

only locks frequency but also activates the speech synthesiser (optional accessory) if fitted, when pushed in. This synthesiser, type ICX310, costs an additional £39 but does not have quite as many functions as its Trio equivalent.

The remaining front controls include mains on/off (this works on either 13V dc input or mains input), Tx/Rx MOX switch and six more miniature buttons selecting offset write (for selecting various repeater shifts which the rig can put into non-volatile memory), check button, which allows you to read the Tx frequency when on Rx for setting offsets (allowing one to listen on repeater input), repeater plus shift or minus shift, tone burst button and tone select button (selective calling, not normally used in the UK).

The fluorescent display indicates frequency, repeater shift status, mode, memory channel pre-selected, RIT, if in use, VFO and various other status

functions. The S-meter is to the left of this display and is illuminated. This reads output power on transmit. The quarter-inch headphone jack on the front panel can be used for mono or stereo headphones. On the top panel is a removable bug hutch cover revealing five preset finger turn POTs for adjusting CW delay, VOX delay, VOX gain, anti VOX level and CW side tone monitor level. The loudspeaker faces downwards, half-way back towards the left. There is a bale stand under the front which when brought up allows audio to be reflected forward by the bench.

On the back is a massive heat-sink with fan for the high power PA, the fan speed automatically switching to very fast for heavy duty cycles. The RF output socket is N-type which is excellent, although its position is a little cramped. The review sample operated just on 13V dc, but an additional accessory is a plug-in mains PSU, PS35, costing around £165 extra, the rig itself with mic costing £995 at the time of writing. 3.5mm jacks are fitted for Morse key and external speaker interconnections, the latter being very awkwardly positioned extremely close to the RF out socket. Below this incidentally, is a clamp-type earth connector.

A 24 hole accessory socket provides the following functions: pin 1 - output from squelch control stage (+8V when squelch is operating), pin 2 - 13.8V dc when the rig is switched on, pin 3 - external PTT input, pin 4 - audio output at fixed level before gain control, pin 5 - output from mic pre-amp/input to Tx gain



G3OSS TESTS

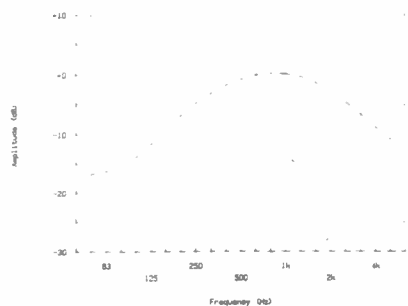

FM received audio response before mod, tone 1/2 way up

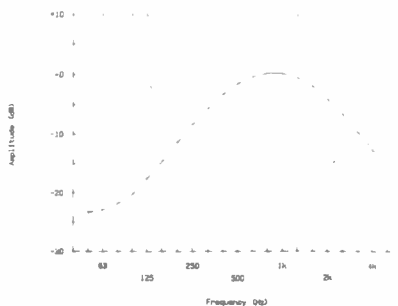

FM received audio response before mod, tone at max

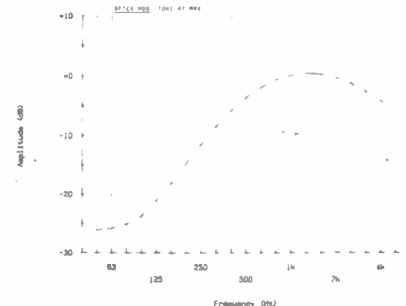

FM received audio response after mod, tone at max

pot, pin 6 – 8V dc present on Tx only, max 5mA, pin 7 – external ALC input, pin 8 – ground, pin 10 – voltage across internal meter, pin 12 – input control voltage for noise blanker, pin 13 – input voltage for operating FM squelch, pin 14 – input voltage to operate SSB/CW squelch.

The remainder of the pins have no connections. When using an electronic key, note that the key down voltage must be less than 0.4V to operate with the Icom correctly.

Ergonomics

The tuning knob can rotate very freely indeed which is rather nice, but if you prefer some stiffness an adjustment is provided behind it through a hole in the bottom cover. Most of the ergonomics are well thought out, although I have to admit that both the 271 and 471 rigs take quite a long time to get used to.

I am very surprised indeed that once again Icom omit a basic 'short to ground on Tx' socket for operating external linears. It would also be an advantage for Icom to provide a means by which you could limit the power output under all circumstances to save 5W PEP, again for operation with the linear by switching out the mains PA. However, there is a blank panel on the back behind which you can fit a digital interface unit, type ICEX309, for driving everything off a computer.

The high power PA incorporates two 2SC3102 in push/pull. The high power aerial changeover relay is a CX120P which Icom claims has a very low through loss. The output is extremely well filtered, the filters also acting on the Rx input.

The first Rx RF stage is a dual gate MosFET type 3SK48 followed by a 2SK125 which drives into a dual gate MosFET mixer type 3SK102, the first IF being at 70.15MHz. The second IF is 10.7MHz, whilst a third is at 455kHz and is used only for FM.

The audio Rx board is identical to that used in the 271H and therefore has the same evils. The audio gain control is a variable resistor which is varied by dc control and the top 35% of travel has almost no effect, almost all the effective control being right down at the bottom, which is inconvenient. The received audio responses seemed very muffled, especially on FM, and this was confirmed in the laboratory tests. A very significant improvement can be made to the received response by making two component changes: R208, 120K, change to 22K, and C165, 0.047μF, change to 0.0047μF. This will allow the tone control to have a wider range and thus gives a flatter response which improves intelligibility.

I used the rig with my SSB Products' GaAsFET masthead pre-amp and the pre-amp switch worked extremely well with my masthead. Despite my only having around 2dB loss in the aerial coax there was an astonishing improvement to the system noise figure when the masthead was switched in, the barefoot rig being a little disappointing, although around average for a Japanese black box.

The reciprocal mixing performance was acceptable but very strong signals seemed to spread quite a bit, most of this being breakthrough at an ever increasing audio pitch as one tuned away. The

apparent selectivity is very good however on normal signals, whilst on FM it is excellent. The audio quality, apart from response, was quite good, although power output was a little limited into 8 ohms.

I noted that with RF gain at maximum the onset of AGC was at a surprisingly low level, the S-meter seeming reasonably sensitive. As seems usual with Icom there are offsets of 3kHz when you go from USB to LSB, and 800Hz on CW, and this is infuriating if you want to change from SSB to CW in the middle of a QSO. The AGC characteristics were well controlled and about right (see pen charts). It was slightly annoying that one could not operate the VFO in 25kHz steps on FM and perhaps Icom need to have a think about this.

Transmit quality

Most amateurs quite liked the transmit quality, especially on FM, and distortion was at quite a low level. We noticed one very odd thing when we interconnected an external speaker – a whistle at around 16kHz was audible but at a fairly low level all the time on Rx, irrespective of gain control setting or squelch (it actually measured 16mV). This turned out to be breakthrough from the mini switched mode inverter which supplies juice to the frequency display, and surely Icom could add an appropriate capacitor somewhere. I have to admit that I couldn't hear this whistle myself, but my younger colleagues certainly could and found it a little annoying.

There is no doubt that the mic amplifier circuitry is far more appropriate than on older samples of the 271E, so it seems

AGC response FAST (paper speed 10mm/sec, pen speed 500mm/sec)

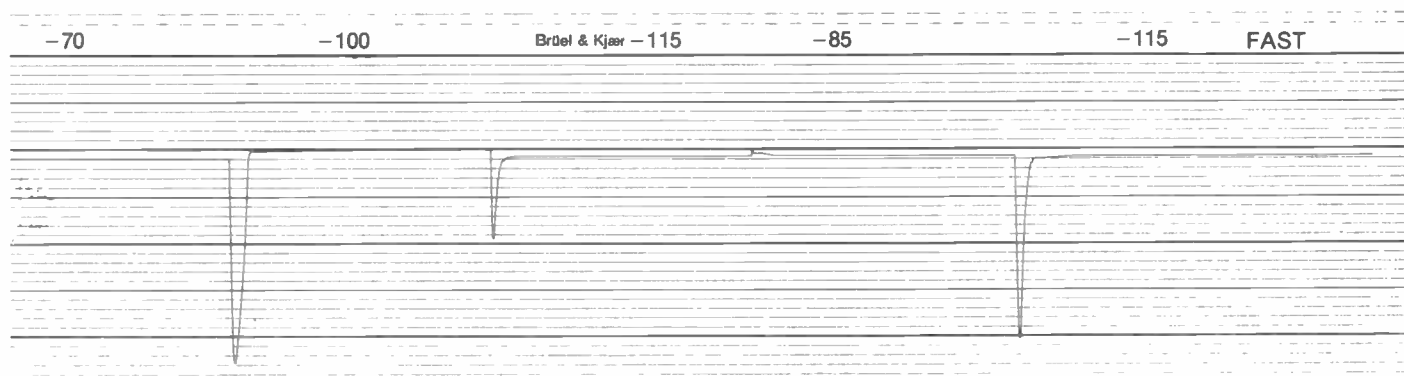

G3OSS TESTS

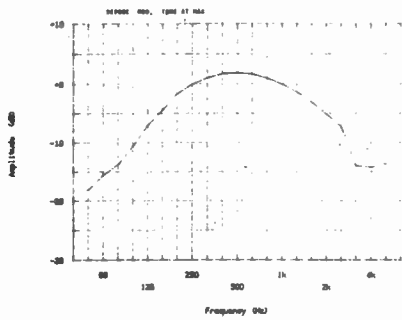

SSB received audio response before mod, tone at max

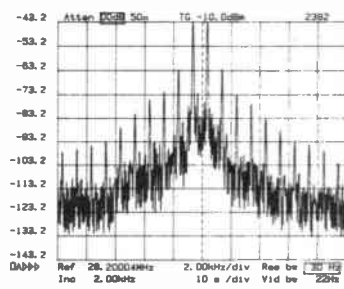

Intermodulation distortion products full power (86W)

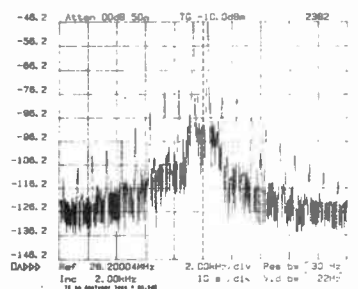

Intermodulation distortion products half power (43W)

that Icom do take note of some criticisms. The transmitter side was a pleasure to work and no problems were noted in operation. Power as factory set is controllable from around 10W to 80-odd watts output by the power control, but there are useful internal presets for adjusting both minimum and maximum powers and you could of course use this to obtain the required minimum power for operating a very high power linear. If this is the case you might prefer to consider the lower power version which is identical in every way but has a maximum power output of 25W (IC471E).

The instruction book is reasonably well presented, but there was one baffling point—the labelling of the Rx input board coupled with some other circuitry as 'RF.YGR'. After considerable thought as to what YGR stood for Thanet Electronics revealed the true answer – the letters stand for 'younger', the Japanese interpretation of 'earlier stages'!

Laboratory tests

The Tx section gave well above the rated power at the bottom and middle of the band, but power fell back to only 70W at the extreme HF end. Power control was very smooth. Carrier rejection was excellent as was sideband rejection. The output frequency accuracy on FM was reasonably good, although CW had a 650Hz offset. The repeater shift accuracy was excellent. Maximum deviation on FM was very well controlled and certainly not excessive, with tone burst deviation set just about right. Tone burst frequency, incidentally, was exceptionally accurate. RF harmonics were well below -65dB ref carrier which is

superb, especially considering the high power PA.

The transmitted audio frequency response on FM from the mic input socket to the output carrier, when checked with 750µs de-emphasis, was within 3dB from 500Hz to 2.5KHz and outside this band attenuation was gradual at the LF end, whilst very rapid above 3.5KHz. The response thus seems about ideal (see pen chart). We also checked the response with the rig around 20dB into limiting and it can be seen that over deviation is avoided. The maximum current drawn on Tx from 13.8V dc is 19 amps, so you will need a fairly elephantine power supply, even Rx drawing 1.6 amps.

The receiver input noise figure was calculated to be around 5.5dB, not bad but it could be a lot better. Thus, the rig was a little insensitive on all modes, thereby explaining why the apparent sensitivity improved so much when the masthead pre-amp was switched on. The RF intercept point did not measure particularly well, but I suppose it is not bad in the context of 70cm average working. With the masthead pre-amp on though it deteriorates considerably of course, and since this is necessary for DX operation, it shows that Icom's circuitry is not really good enough here.

We did not note any particular reciprocal mixing problems and IF selectivity on FM was very good, but we were dismayed to find a serious problem on SSB/CW. The IF board is the same as that on the 271H and, once again, there seemed to be bad breakthrough around the filter to the product detector circuit. This resulted in good selectivity measure-

ments down to -40dB, but -60dB was appalling, getting rapidly worse even at -63dB, selectivity at -70dB being as wide as 25KHz.

We were able to tune up and down across a strong carrier and note higher and higher pitch audio breakthrough to confirm this problem. A 1mV input signal for example was audible from ±20KHz or so, around the limits of Jonathan's hearing! Icom will have to do something about this.

FM limiting

FM limiting was reached at an extremely low RF input level which is good, and distortion on low level signals was quite reasonable. The S-meter gave the usual ridiculous small range on FM which seems common with almost all rigs, but had a very useful range of 33dB on SSB/CW between S1 and S9, although it was a little cramped at the top end.

Distortion was reasonably low on FM at normal levels, whilst product detector distortion on SSB was quite acceptable, although we have seen better. The maximum audio output power was, indeed, a little limited and below specification into 8 ohms and only gave another watt output into 4 ohms, which shows the limitation is clearly in the chip itself.

The capture ratio on FM was very good indeed thus showing excellent discrimination between stronger and weaker stations on the same frequency. I must particularly commend Icom for the excellent attainable best signal-to-noise ratio, both unweighted and weighted on the output if one filters out the switched mode breakthrough. Good quality FM

Transmitted FM response (750µs de-emphasis)

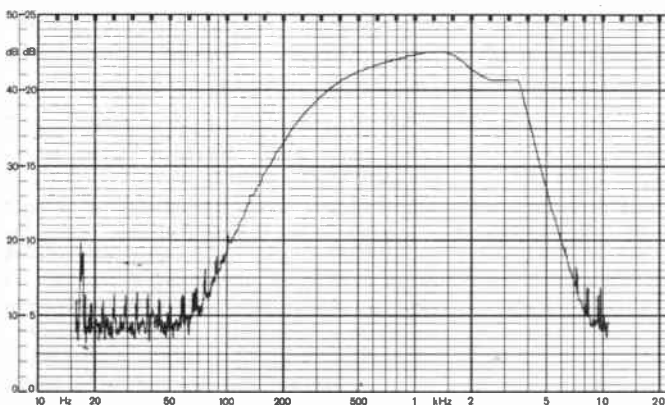

Transmitted FM response, 20dB into limiting (750µs de-emphasis)

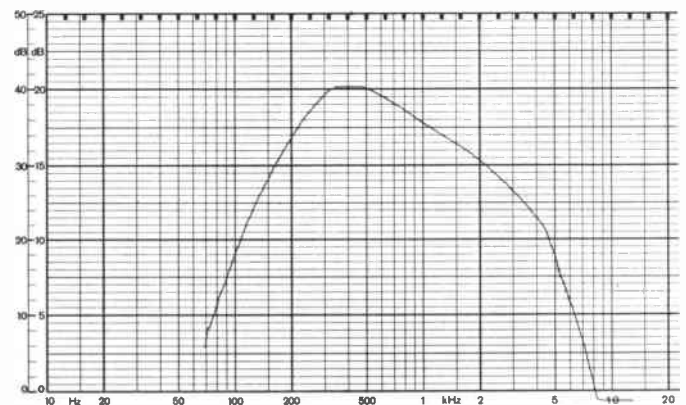

G3OSS TESTS

transmissions were a delight to listen to on a good quality external speaker once my colleague had modified the de-emphasis circuits.

We charted six different Rx responses, four on FM and two on SSB. Before modification there was far too much HF cut on all modes, resulting in a clothly reproduction even with tone control flat

out. We discovered to our amazement that the tone control seemed to boost mid when turned above halfway, making the sound even squawkier, although this was improved after modification. The bass end is reasonable enough but slightly more bass is cut out with the mod. However, you will see that the HF end vastly improves with the mod.

On SSB, the normal response is virtually an inverted 'U' shape, the flat part being very narrow, only around 1KHz of bandwidth, thus contributing to the very middy sound quality. Matters did not improve much with the mod and I cannot see why we cannot have a flat audio bandwidth after the detector from 300Hz to 3KHz, allowing the IF filter to give effective bandwidth control in the normal way.

Received frequency accuracy seemed to be around 1KHz offset on FM for best performance, and we noted a 250Hz error on SSB.

The new Marconi 2382 spectrum analyser arrived just a few hours before this review was delivered to the editor, and we were thus able to take some two tone plots showing the intermodulation distortion present in the RF output of the rig (see illustrations). At full PEP output the third order products were at -20dB, whilst at a total bandwidth of 20KHz, ie at ± 10 KHz, the IPs had reduced to an average of -57dB.

At half power, ie around 44W PEP output, the ± 10 KHz bandwidth gave IPs at -66dB, whilst the third order product averaged at -30dB. A two tone test represents the worst possible case for producing intermodulation, and so I regard the full power performance as adequate whilst half power performance is excellent. We mixed down the attenuated Tx output to a level of around -30dBm into an MCL mixer with IF output at 28.2MHz into the analyser, as the 471H output frequency is just slightly higher than the 400MHz limit of the analyser.

Conclusions

I cannot help but feel that this rig is overpriced for its facilities and performance, and this is particularly unfortunate since competition is very stiff for Icom. If you want a rig which will give a surprisingly high output power and you are prepared to accept the problems outlined above then you will probably be quite happy with it, especially if you also splash out on a masthead pre-amp to go with it.

The speech frequency read-out option will obviously be a boon for white stick operators, but I feel that we should all wait to see how the Trio TS811 fares for it may be a better buy. The rig is very well built, and of course the back up service from Thanet is excellent. I cannot see this rig being a top seller, but even so it has some good points, and perhaps Icom will introduce some improvements.

In the meantime, I will have to recommend the combination of a suitable secondhand HF transceiver with a Microwave Modules 70cm transverter and linear - a much better buy.

I would like to thank my colleague Jonathan Honeyball for the vast amount of work that he undertook in helping me take all the measurements, and Thanet Electronics for kindly loaning the review sample and for their time and patience discussing many of the points raised.

ICOM IC471H LABORATORY MEASUREMENTS

Transmitter Measurements

Maximum RF output power (max/min)

	FM	SSB	CW
432.025MHz	86/10W	86/10W	84/11W
433.4MHz	84/11W	84/11W	84/11W
439.975MHz	70/9W	69/9W	70/9W

Tx frequency accuracy

	FM	SSB	CW
			+370Hz
			+650Hz
			none
			within 10Hz

FM carrier drift: full power for 1 minute

Repeater shift accuracy 3.7KHz

Toneburst deviation 1750Hz within 1Hz

Toneburst frequency 4.8KHz

Maximum normal deviation 5.2KHz

Maximum provoked deviation less than -85dB ref carrier

Tx harmonic distortion -52dB

Carrier rejection better than -70dB

Sideband rejection at 1KHz modulation frequency

Receiver Measurements

Sensitivity (FM 12dB Sinad)

432.025MHz	-121.3dBm
433.4MHz	-121.6dBm
435.975MHz	-122.0dBm
439.975MHz	-122.4dBm

Sensitivity (SSB 12dB Sinad)

432.25MHz	-125.4dBm
-----------	-----------

Selectivity

FM, blank carriers off channel to degrade Sinad by 3dB	
+/- 25KHz spacing	67/66 dB
+/- 50KHz spacing	69/69 dB

Selectivity

SSB	
3dB Bandwidth	2.3KHz
6dB Bandwidth	2.4KHz
40dB Bandwidth	3.5KHz
60dB Bandwidth	11KHz
63dB Bandwidth	19KHz
70dB Bandwidth	25KHz

RFIM Performance (FM)

Carrier off channel for 12dB Sinad product (ref 12dB Sinad)	
50/100KHz spacing	67dB
100/200KHz spacing	66.8dB

Calculated Intercept Point

	-20.5dBm
--	----------

S-meter

RF Levels required to give the following meter readings

	FM	SSB
S1	-109dBm	-116dBm
S3	-103dBm	-112dBm
S5	-100dBm	-107dBm
S7	-97dBm	-95dBm
S9	-95dBm	-83dBm
S9+20	-92.5dBm	-70dBm
S9+40	-90dBm	-61dBm
S9+60	-79dBm	-51dBm

Capture ratio (FM)

	3.7dB
--	-------

Audio quieting (FM, at 12dB Sinad)

	15.5dB
--	--------

RFIM performance (SSB)

(ref 12dB Sinad)	
+20/+40KHz spacing	70.4dB
+100/+200KHz spacing	69.4dB

Calculated intercept point (SSB)

	-20.5dBm
--	----------

FM 3dB limiting point

	-125dBm
--	---------

Maximum audio output power (10% THD, FM, 1KHz tone, 5KHz deviation)

into 8 ohms	1.8W
into 4 ohms	2.7W

FM Audio distortion (125mW into 8 ohms)

1KHz deviation	3.5%	(Maximum attainable distortion, volume fully up, at 3KHz deviation was 6.6%)
3KHz deviation	1.4%	

SSB product detector distortion (at -80dBm)

	2.4%
--	------

FM best obtainable signal-to-noise ratio

Unweighted;	61dB
CCIR/ARM weighted;	60dB

Current drawn at 13.8Vdc, FM

Rx;	1.6 amps unswitched
Tx;	8 - 19 amps

Size; 125mm (H) x 300mm (W) x 324mm (D) inc projections

Weight; 7.1Kg

ICOM IC04E

70cm HANDHELD

In the May 1984 issue I reviewed the IC02E, the 2m version of the model surveyed here. The facilities and layout of those of the IC04E are virtually identical to those of the 02E.

The rig is supplied with a miniature 70cm rubber duck which is very thin, the length being around 16cm from the back of its BNC plug to the tip. On the top of the front panel is an LCD display indicating frequency, repeater shift information, sub-audible tone on/off, low battery state, T for Tx etc. Beneath this display is a matrix of 4 x 4 push buttons for selecting frequencies from 430MHz to 439.975MHz, the rig being channelled to the nearest 25KHz frequency.

Ten memories are incorporated together with a priority channel, scanning, memory to VFO and various other facilities described in the 02E review. The buttons are actually labelled 1 to 9, 0, asterisk, hash, A, B, C and D. A is either clear or scan stop, B is memory read or write, C is memory scan or programme scan, whilst D is call or lock.

If you wish to transfer from memory to VFO you have to press the A button for clear. The numbered buttons are multifunction as usual. Underneath this push pad is a small loudspeaker below which is the rechargeable battery pack, the review sample version being 8.4V nominal.

On the left side cheek there are three buttons; the main PTT with repeater tone burst button at its top, whilst above this the function shift button which enables all the second functions of the main push pad. On the top of the rig is the BNC socket for the antenna, below which are illuminated on/off and high/low power buttons. To the right are the on/off and volume controls, complemented by the normal squelch control; these are all very easy to use and well positioned.

Three miniature sockets on the top panel are provided for external input dc volts, external mic and speaker interconnections. On the back is a very strong spring loaded belt clip.

Internal mic

The internal microphone is built into the loudspeaker on the front panel. On the back of the battery is another dc input socket labelled 'dc 13.8V'. This, at first, was rather baffling until we resorted to reading the 'destruction book' which, incidentally, does not give information which you may need to have in a hurry, although circuit diagrams, which are reasonably easy to see, are included.



The batteries' 13.8V input is actually intended for a charging connection, and there is a resistor between this and the battery to limit charging current. The positive feed from the battery is taken directly up to the top deck and through to a relay which is also connected to the top dc input connection. Under normal use with internal batteries juice is taken straight through to the rig's on/off control, but when external dc volts are plugged into the top the relay becomes energised and applies the external voltage directly to the rig, whilst disconnecting the battery feed. There is, therefore, a standing current of 23mA when the rig is used on external voltage, even when it is switched off.

A battery charger is supplied with the rig which takes around 14 hours to fully charge the battery, but of course charging can be accomplished without removing the battery, although it is unwise to use the rig when it is being charged. There is a totally ludicrous situation here in the choice of polarity of the little dc input sockets, for Icom choose to use the complete opposite to Yaesu, thus giving total incompatibility with external dc leads and chargers. The Icom centre pin is positive whilst the outer is negative, and although a few other manufacturers use this crazy convention, by far the majority go the other way around, which is standard. Most sockets allow the positive feed to be back-connected when no plug is inserted, and break the connection appropriately when the plug is put in. It strikes me that this is a far better way of disconnecting the battery than Icom's expensive way of using a relay!

I am afraid I have to have a moan again about Icom's crazy software logic. As with the 02E I spent over an hour trying to sort out the logic of the keypad and, whilst memory 1 is the priority channel, many amateurs would want it to be a simplex one for emergency or Raynet use. Insertion of a simplex frequency in memory 1 precludes repeater shift being stored in memories 2 to 6, although if you attempt this, there is an indication on the LCD that it has stored shift. It is therefore a surprise when for the first time you assume that you are shifting up on Tx from memory 3, for example, and find that your output frequency is still repeater output! For some inexplicable reason, memories 7, 8, 9 and 0 are independent from memories 1 to 6, and do not have this problem. This is obviously a software writing mistake and since Icom have probably ordered 10,000 or more chips they obviously would not wish to redesign them and have to throw the faulty ones away!

Logic?

One other piece of logic that seems crazy to me is that if you have entered a repeater shift on a particular frequency you lose the shift immediately you go up or down one channel, thus making it impossible to hunt repeaters when you are in an unfamiliar location. I freely admit that under normal circumstances most users would only require perhaps four repeaters, but in many areas I find that I regularly use at least six from the same location.

You may think it is easy enough to enter a repeater shift, but unlike the Yaesu operation of only two buttons, the

G3OSS TESTS

Icom requires you to hold in the function button, then press shift followed by + and then 160, the latter representing 1.6MHz. After entering this you then release the function button. The necessity for pushing six buttons seems ridiculous and I feel Icom will need to rethink this.

For entering a repeater shift in memory you first select frequency, then repeater shift and continue to hold the function button down whilst pressing button B, followed by the required memory channel, after which your tired thumb can be released. For entering normal frequency you have to put in MHz followed by two figures, the rig then going to the nearest 25KHz channel.

Subjective tests

I tried this little rig a number of times, having mastered the dreadful ergonomics, and found it reasonably sensitive and giving quite good quality on receive. As is the case with so many walkie-talkies, the available volume from the speaker was not really high enough and for mobile use most definitely inadequate unless you use some form of audio power booster, eg the new Heil one. There was a tendency to boominess on the internal speaker, although the sound was always clear and certainly not coloured.

Many stations reported that the transmit audio quality was good, with excellent limiting. The higher than usual power on Tx was also a help, but power consumption is fairly high. Sometimes I found it slightly irritating that when changing channel the rig took a fraction of a second to activate the command, but I must admit that I am an impatient soul. I liked the general feel of the rig, but having reviewed the Trio TH21 I wonder whether even the reasonable weight of the 04E isn't a little more than it need be in terms of the latest high tech.

The input sensitivity did not seem quite so good as that of the old IC4E, but selectivity seemed adequate for all requirements. No technical problems arose.

Laboratory tests

You will see from the test figures shown that the 12dB sinad sensitivity averaged around 2.5dB worse than that of the old 4E. I find this a little disappointing and cannot see why this should be so. Selectivity however measured extremely well. The RF intercept point, as with its predecessor the 4E, is poor and you will find that you may get problems trying to receive a DX repeater on, say, RU6 if RU2 and RU4 are very strong. What you may hear is two repeater QSOs at once taking place on top of the distant repeater that you wish to hear, and you might well imagine that it is a form of jamming rather than a rig design fault. On looking back at my old results for the 4E, I note that the 04E is just 2dB better here, whilst the old FT708 Yaesu is very many dBs better.

The S-meter is in the form of a row of

LCD dots at the bottom of the display, the most sensitive indication being for an input signal of 1µV, whilst they all light up with a signal only 11dB stronger. Limiting was excellent, the limiting point being well below that of the sinad sensitivity. Distortion was at quite a low level for 125mW output.

The quieting ratio at the 12dB sinad point was virtually identical to it, showing extremely low distortion of low level signals, which is excellent. Available

output power is, of course, rather limited but I suggest that the built-in speaker is more inefficient than usual. Capture ratio is extremely good showing that a slightly stronger signal will capture reception quite effectively over a weaker one.

The overall frequency response from a 750µS pre-emphasised transmission was stunningly flat from around 400Hz to 3.8KHz. This perhaps is a bit too wide especially as 200Hz is only 7.7dB down,

ICOM IC04E – LABORATORY RESULTS

Receiver Measurements

Sensitivity (for 12dB sinad)	
432.025MHz	-121.2dBm
433.400MHz	-121.3dBm
435.975MHz	-120.3dBm
439.975MHz	-119.3dBm

Selectivity

(blank carriers off channel to degrade sinad by 3dB)	
+/- 25KHz spacing	65.6/65.5dB
+/- 50KHz spacing	71.8/71.8dB

RFIM Performance

Carriers off channel for 12dB sinad product (ref 12dB sinad)	
50/100KHz spacing	76.8dB
100/200KHz spacing	74.4dB

Calculated Intercept Point	-35.5dBm
----------------------------	----------

S Meter Readings

RF levels required to illuminate the following LCD bar pairs	
1st pair Always on	9th pair -100dBm
2nd pair -107dBm	10th pair -99dBm
3rd pair -105dBm	11th pair -98.5dBm
4th pair -104dBm	12th pair -98dBm
5th pair -103dBm	13th pair -97.5dBm
6th pair -102dBm	14th pair -97dBm
7th pair -101dBm	15th pair -96dBm
8th pair -100.5dBm	

Capture ratio	4.0dB
---------------	-------

Audio quieting (at 12dB sinad point)	12dB
--------------------------------------	------

3dB Limiting Point	-125.9dBm
--------------------	-----------

Maximum Audio Output (10% THD into 8 ohms) 0.4W

Audio distortion (125mW into 8 ohms)

1KHz deviation	2%
3KHz deviation	1.4%

Transmitter Measurements

Maximum RF output power	Battery (high/low)	Ext 13.8V (high/low)
430MHz	3.2/0.5W	5.5/0.51W
433MHz	3.1/0.5W	5.2/0.5W
434.6MHz	3.0/0.5W	5.2/0.5W
439.5MHz	2.9/0.5W	5.2/0.5W

Carrier frequency accuracy

433MHz	Maximum +60Hz
439.5MHz	Maximum +20Hz

Repeater shift accuracy	30Hz low (see review for memory comments)
-------------------------	---

Peak deviation (loud shout)	5.6KHz
-----------------------------	--------

Tone burst deviation	3.6KHz
----------------------	--------

Tone burst frequency	1750Hz within 0.5Hz
----------------------	---------------------

Tx harmonic distortion	Both 2nd & 3rd below -60dB ref carrier
------------------------	--

Current consumption

Tx 1.5/0.59A High/Low	Scquelched; 79mA
Rx external power	Half volume; 90mA

Rx on battery	Scquelched; 52mA
	Half volume; 68mA

Icom IC04E
FM received
audio response
(750µs pre-emphasis)

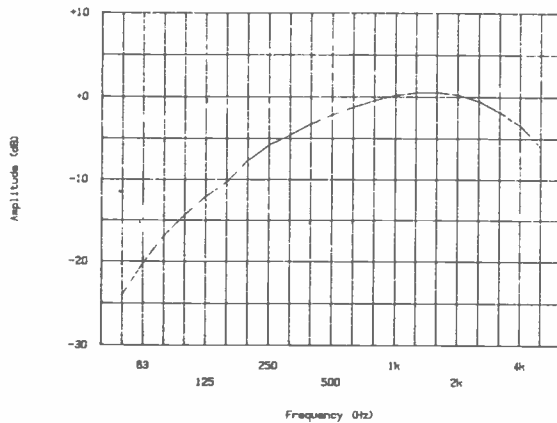

clearly resulting in the LF boominess noted subjectively. I would have preferred a steeper bass roll-off in the context of a walkie-talkie.

Both the receiver and the transmitter sections were extremely accurately aligned on frequency, the transmitted error being 60Hz at worst, but averaging only 20Hz for the entire duration of the tests! Repeater shift was also very accurate, within 20Hz. The average maximum deviation was around 5KHz, peaking at no more than 5.6KHz, the tone burst deviation being very well set at 3.6KHz. The tone burst frequency was only 0.5Hz in error, which is again excellent. The transmitted signal-to-noise ratio was excellent showing no synthesiser breakthrough problems.

Harmonics were right down at the noise floor of the analyser below -60dB ref the carrier level. We checked the power outputs both from the internal battery in a half charged state and from an external 13.8V dc supply. On the latter some 5.5W was noted at the low end of the band, reducing only marginally at the

top end. On low power the output was approximately 10dB lower which is ideal. When tested on its internal battery maximum power was around 3.2W, reducing to 0.5W average on low power, showing that the source impedance of the battery and the lower voltage are the main reasons for the reduction of high power output, whilst not affecting low power.

The current consumption from external dc is surprisingly high, reaching 1.5 amps on high power Tx, whilst on low power it was still nearly 0.6 amps. On receive, when squelched, the current drain from the battery is a little high at 52mA, rising to an average of around 70mA when receiving a transmission.

Conclusions

From a technical viewpoint this is quite a nice little rig, although you should note the reservations mentioned on Rx sensitivity and intercept point. I have to sum up everything at once though, and for me the serious snag is the very poor ergonomics which is such a pity.

It is difficult to review a rig in isolation and although manufacturers do not like comparisons, readers usually do. I feel that the forthcoming FT709R may well show up the IC04E, when it comes along, as it should have the same excellent ergonomics as the FT209 reviewed in the November issue. Another alternative will be the Trio TH41E which should also be available by the time you read this review, and I hope to review both these rigs eventually.

I can, therefore, only recommend the rig with strong reservations although it will probably become fairly popular, and I must admit that ergonomics are more important to me than to some of my friends. I suggest that you try to compare it with competition prior to purchase and that the FT708 is still the best buy at the time of writing. Needless to say, the rig is beautifully presented and is available in various versions for PMR on various commercial bands, and it is perhaps largely with these applications that the rig has been designed and so perhaps it is the amateurs who have to suffer the consequences.

Size

The rig measures 170x65x40mm (6¾ x2½x1½in) including protrusions but excluding the whip and the belt clip. It weighs 533 grams including battery, belt clip and whip and costs £269 including VAT with rechargeable BP3 battery pack, mains charger, rubber duck and carrying strap included. Optional extras including various battery packs, speaker/mic and headset were listed in the IC02E review. I would like to thank my colleagues Jonathan Honeyball and Nigel Bickell, both of whom have recently taken the RAE and who are hoping for the best, and Thanet Electronics for the loan of the review sample.

G3OSS UPDATES

Yaesu FT209R November 1984

Since writing my recent review of this product in this magazine, I have heard from retailers that one or two purchasers have had a minor problem with the rig when using it with a large outside aerial as a base station set-up. My advice was requested and I felt that the situation was sufficiently important to write this brief note.

The Rx front end is rather broadly tuned and so if strong signals are present well outside the 2m band, severe interference can be caused to the reception of 2m signals resulting from front end blocking. I created the problem for myself by putting the full output from my 8/8 vertically mounted J beam through a bomb proof pre-amplifier into the rig, and found that even some repeaters became almost inaudible.

I then put a Trio 2m band pass filter immediately in front of the rig and the problem completely vanished. I believe that this filter is no longer available and so tried the latest Mutek 2m bandpass

filter which also virtually cleared the problem. This is supplied with BNC sockets and seems most effective having minimal loss.

It serves as a warning though that using walkie-talkies for base station use can be driving them further than is fair, but at least this time there is a cure.

Tau SPC 3000 ATU December 1984

When I reviewed the Tau ATU recently I passed a comment that they should be improving the accuracy of the SWR measurements. They recently informed me that they had done this and also, at my suggestion, Tau have now incorporated 6:1 reduction drives on the two capacitor controls. Each knob now has a transparent flange behind it, and behind this is a pointer which moves slowly across the 1:10 scale as the main knob is rotated at the faster speed. The result is a beautifully smooth tuning action.

I decided to purchase one of these, which arrived just before sending copy to the publisher, but alas my own

purchased unit, when delivered, did not work at all. On opening it up we found that the problem was due to a dry joint which was soon repaired. Then we discovered that the power meter did not work either and, on further investigation, and upon repairing another dry joint, everything sprang to life!

The SWR readings are now a little bit more accurate than before but nowhere near accurate enough, so we dug inside and attempted recalibration by adjusting presets. This slightly improved matters. Tau will have to do something about this and have promised to do so yet again. I am rather worried about dry joints and the fact that we had to take the ATU completely to bits in order to put it right; thank goodness we did not have any spare bits left over on reassembly!

Tau are in the course of preparing new meter labelling with more detail as I have suggested. Finally, it was rather exasperating to find that one of the bolts was of an incorrect type and did not fit properly, so I had to replace it by one more or less identical to all the others.



South Midlands

* FREE FINANCE • 2 YEAR GUARANTEE

BRANCHES AT: SOUTHAMPTON, LEEDS, CHESTERFIELD

'YAESU' FOR H.F. EQUIPMENT – 'SMC' AT YOUR SERVICE



FRG8800

General Coverage

Continuous coverage from 150KHz to 30MHz. Two speed spin tuned VFO plus keyboard plus computer interface control.

All mode

The FRG8800 demodulates SSB (USB & LSB) CW, AM (Wide and Narrow) and FM narrow as standard. This, complemented by an all mode squelch, produces the most practical receiver available. The FM narrow is useful for 10M, CB and for VHF with the optional VHF convertor.

Memory

The FRG8800 comes fully equipped with twelve memories programmed and scanned at the touch of a single button. Any of the memory channels will accept a frequency within the whole range of the receiver, including the VHF range (with the optional VHF unit). The mode is also stored in the memory eliminating the need for inconvenient manual mode change, when hopping from one memory to the next.

Selectivity & Sensitivity

Four filters are fitted as standard (SSB/CW, AM, AM-NAR and FM-NAR) with bandwidths chosen for optimum performance, these combined with switchable AGC and variable tone control provides maximum enjoyment despite today's crowded bands.

High input sensitivities are obtained by the latest in RF stages, making the most of inefficient aerials and difficult locations, and a continuously variable RF attenuator control overcomes problems encountered with very powerful stations.

LCD Display

The back-lit green LCD display incorporates easy to read 'any angle' 10mm digits.

A twelve function display indicates the transceiver's status at a glance. It includes memory channel number, mode, and frequency to a resolution of 100Hz. Also included is a two dimensional LCD, graphical SIMPO and 'S' meter, which is conventionally calibrated at 1.5 and 0.9, +20dB, +40dB, +60dB respectively.

Keyboard

A 12 button keyboard is fitted as standard allowing quick accurate changes of frequency and band (MHz and KHz programmed individually). The keyboard also has nine control buttons to allow rapid changes from memory to VFO, memory to memory and VFO to memory. Memory channels can also be recalled at the turn of a knob, ideal for storing calling/working channels or broadcast reception.

The keyboard is complemented by an opto-coupled, two speed, VFO drive: fast for rapid tuning of a band or slow for accurately tuning in a signal. In addition a fine tune control compensates for drift in the received signal. The dial can be electronically locked preventing accidental change in frequency.

Clock/timer

Dual accurate 12 hour clocks, with AM/PM indicators are ideal for log keeping (GMT/Local). The clock uses the main digital display and features full back-up facilities in the event of a mains failure or disconnection. The timer can activate the receiver or tape recorder via the relay contacts provided. A snooze facility allows up to 59 minutes of listening.

VHF Converter (optional)

The FRV8800 extends coverage to include 118-174MHz all within the main frame, thereby allowing monitoring of; PMR, marine and air bands, as well as 2M.

The FRG8800 is operated as before via the keyboard or VFO, and the memory still holds any frequency and mode. The actual VHF frequency is displayed on the main LCD to a resolution of 100Hz.

Worldwide

At 6.1Kg (excluding convertor) the FRG8800 is ideal for taking on any trip. The power supply is easily adjustable from 240-220 VAC to 110-120V, 50/60Hz mains and 12VDC operation is available as an option.

SPECIFICATION

FREQUENCY COVERAGE:

150KHz – 29.999MHz
118MHz – 173.999MHz*

FREQUENCY RESOLUTION:

100Hz (Digital Readout)

FREQUENCY STABILITY:

<± 300Hz in 30 mins after 1 min on
< 50Hz in 30 mins after warm up

MODES OF RECEPTION:

AM, CW, FM NB, SSB (LSB/USB)
A3E, A1A, G3E, J3E

SELECTIVITY:

SSB/CW (J3E/A1A):
2.7KHz @ -6dB, 8.0KHz @ -50dB

FM (G3E) narrow:

12.5KHz @ -6dB, 30KHz @ -40dB

AM (A3E/A3E) (standard/narrow):

6.0KHz @ -6dB, 15KHz @ -50dB
2.7KHz @ -6dB, 8KHz @ -50dB

SENSITIVITY:

SSB/CW (J3E/A1A) @ 10dB S + N/N:
<0.4uV into 50 ohm, 1.50-30MHz
<3.0uV into 500 ohms, 0.15-1.6MHz
<1.0uV into 50 ohms, 118-174MHz*

FM (G3E) @ 20dB S + N/N:

<1.0uV into 50 ohms, 1.60-30MHz
<2.0uV into 50 ohms, 118-174MHz*

AM (A3E) @ 10dB S + N/N:

<4.0uV into 50 ohms 1.60-30MHz
<3.0uV into 500 ohms, 0.15-1.6MHz
<10uV into 50 ohms 118-174MHz*

SQUELCH SENSITIVITY:

SSB/CW (J3E/A1A):
<2uV, 1.60-30.0MHz
<4uV, 118-174MHz*

FM (G3E):

<0.5uV, 1.6-30.0MHz
<1.0uV, 118-174MHz*

AM (A3E):

<2uV, 1.60-30.0MHz
<4uV, 118-174MHz*

AUDIO OUTPUT:

1.4W in 8 ohms internal @ 10% T.H.D.
4-16 ohms external speaker/phones
Constant level line output (recorder)

POWER REQUIREMENTS:

100/120 220/24V @ 50/60Hz
35VA Rx, 5VA standby
12VDC (nominal)*
1A Rx, 0.020A standby

DIMENSIONS (Ex/Inc projections):

335/350 W, 120/130 H, 235/270 D, mm
Weight 6.1/6.3Kg (w/o, c/w VHF unit)

* OPTIONAL UNIT

SMC SERVICE

Free Securicor delivery on major equipment
Access/Barclaycard over the phone
Biggest branch agent and dealer network
Securicor B Service contract at £5.00
Biggest stockist of amateur equipment
Same day despatch whenever possible

FREE FINANCE

*On many regular priced items SMC offers
Free Finance (on invoice balances over £120)
20% down and the balance over 6 months or
50% down and the balance over a year
You pay no more than the cash price!
Further details on eligible items on request

GUARANTEE

Importer warranty on Yaesu Musen products
Able staffed and equipped Service Department
Daily contact with the Yaesu Musen factory
Tens of thousands of spares and test equipment
Twenty-five years of professional experience
● 7 years warranty on regular priced Yaesu products

STOCK CARRYING AGENT WITH DEMONSTRATION FACILITIES

John Doyle Transworld, Comms Neath (0639) 52374 Day, (0639) 2942 Eve

Communications Ltd.

MAIN DISTRIBUTOR FACTORY BACKED

BUCKLEY, STOKE, GRIMSBY, JERSEY, EDINBURGH, N. IRELAND.



YAESU FOR VHF EQUIPMENT — 'SMC' YOUR SUPPLIER

NEW

FT209/FT709R HANDHELDS

KEYBOARD ENTRY — SCANNING COMPREHENSIVE LCD DISPLAY

Two 4 bit CPU's 10 memories (independent Tx & Rx) reverse simplex (either) by single key touch scanning manual-auto band (full or partial) — memory clear-busy skip-select programmable power save system (10 selectable dwell times) Large LCD 1/4 Digits - 10 special functions any angle Meter S/battery condition VOX 65 x 34 x 169mm



INCREDIBLE		
FT209R (1.8W)	c/w FBA5 YHA14A, CSC10 etc	£209.00
FT209R (2.7W)	c/w FNB3 YHA14, CSC10 etc	£239.00
FT209R (3.7W)	c/w FNB4 YHA14, CSC11 etc	£249.00
FT209RH (2.3W)	c/w FBA5 YHA14, CSC10 etc	£229.00
FT209RH (3.7W)	c/w FNB3 YHA14, CSC10 etc	£259.00
FT209RH (5.0W)	c/w FNB4 YHA14, CSC11 etc	£269.00
CSC10	Soft case (FBA5 FNB3 fitting)	£6.90
CSC11	Soft case (FNB4 fitting)	£7.65

For general accessories see FT203R list
FNB3 FNB4 FNB4 YH2 MH12A2b SMC8 9AA NC15 MMB2

NEW

FT203R & FT703R HANDHELDS "THUMBWHEEL" TINY HANDHELD

Ultra compact 65W x 34D x 153Hmm synthesised handheld Computer aided design and component insertion with chip capacitors and resistors has produced this modern marvel 2.5W RF (10.8v) 3.5W RF (12V) It has VOX (for use with YH-2 lightweight headset and built in S/P O meter Supplied with tone burst helical and appropriate case



FT203R	c/w FBA5 CSC6 etc	£155.00
FT203R	c/w FNB3 CSC6 etc	£185.00
FT203R	c/w FNB4 CSC7 etc	£190.00
FBA5	7.2/9V Cell case only (6 x AA)	£8.50
FNB3	10.8V NiCad Pack (425mAh)	£35.00
FNB4	12.0V NiCad Pack (500mAh)	£40.00
CSC6	Soft case (FBA5 or FNB3 fitting)	£5.75
CSC7	Soft case (FNB4 fitting)	£6.90
YH2	Headphone/Microphone option	£29.90
MH-12A 2b	Speaker/Microphone option	£14.55
MMB21	Mobile mounting bracket	£7.65
SMC8 9AA	Charger (slow 13A style)	£6.45
NC15	Charger (quick) and Power Unit	£57.50

FT2700RH — TWO-IN-ONE

The ultimate 2M and 70cms FM radio based on Yaesu's new die-cast aluminium chassis, allowing 25W output on both bands Two 4-bit CPU's allow simple operation of the dual VFO's 10 channel memory with back up. Dual receiver front ends local synthesisers, IFs and transmitter RF stages gives full duplex capability. Comprehensive scanning facilities allow continuous or skip scanning between memory channels in the same band combined with a MHz switch for changing from one band to another. Large green LCD gives aesthetically pleasing and easy to read display of transceiver operating status incl memory and reverse repeater at a glance. The PO/S meter is a distinctive two colour graphical LCD incorporated into the main display



FT2700RH	Tx/Rx, 2M/70cms, 25W/25W Full Duplex	£320.00
FT2SYNTH	Voice Synthesiser Module	TBA
OMT2700RH	Owners Manual	£2.65

FT270R/RH — LARGE ON OUTPUT

FT270R/RH is a 2M FM Transceiver based on a unique diecast aluminium heatsink with ducting which allows a continuous 45W output (RH model) The R model is rated at 25W output The LCD display uses large 5mm digits allowing easy reading of all transceiver functions Dual 4-bit microprocessors allows quick operation of dual VFO's, ten memories and scanning Upper and lower band scanning limits can be set as well as monitoring priority memory channel Optional voice synthesiser is available to give an audible indication of frequency at the touch of a button

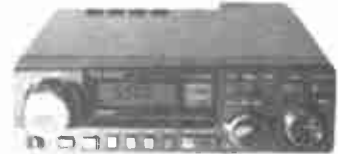

FT270R	Transceiver 2M, FM, 25W synthesised	£325.00
FT270RH	Transceiver 2M, FM, 45W synthesised	£380.00
FT2SYNTH	Voice Synthesiser Module	TBA
OMT270R	Owners Manual	£2.65

FT757GX THE BIGGEST SELLER

Every item normally sold as an extra is provided as standard including AM and FM modes a 600Hz narrow CW filter jambic keyer with dot-dash memory 25KHz marker generator IF shift and width filters effective noise blanker and AF speech processor all at no extra charge



FT757GX	Transceiver General Coverage Rx	£759.00
FC757AT	Automatic antenna tuner	£249.00
FP757GX	Switch mode PSU (50pc duty)	£140.00
FP757HD	Heavy duty PSU (100pc duty)	£179.00
FIF80	Computer interface for PC8001 NEC	£106.20
FIF65	Computer interface for Apple II	£54.80
FIF232C	Computer interface RS232C	£56.65

FT77 THE IDEAL MOBILE

Employing all the latest engineering and manufacturing techniques the FT77 is intended to offer the essential modern operating features in the most economical reliable and compact HF transceiver available



FT77	8 Band Rx/Tx 100W output	£479.00
FT77S	8 Band Rx/Tx 10W output	£449.00
FP700	Matching AC PSU	£145.00
FC700	Matching antenna tuner	£105.00
FV700DM	Digital VFO unit	£209.00
MKT77	Marker unit	£10.75
FMU77	FM unit	£28.35
AMU77	AM unit	£23.75

LEEDS SMC (Leeds) 287 Otley Road Leeds LS15, Yorkshire Leeds (0532) 782326 9-5.30 Mon-Sat	CHESTERFIELD SMC (Jack Tweedy) Ltd 102 High Street New Whittington, Chesterfield Chesterfield (0246) 453340 9.5 Tues-Sat	BUCKLEY SMC (TMSP) Unit 27, Pinfold Lane Buckley, Cheryd Buckley (0244) 549563 10-8.00 Tues-Fri 10-4 Sat	STOKE SMC (Stoke) 76 High Street Tulse Pits, Stoke Kidsgrove (07816) 72644 9-5.30 Mon-Sat	GRIMSBY SMC (Grimsby) 247A Freeman Street Grimsby, Linca Grimsby (0472) 59388 9.30-5.30 Mon-Sat	JERSEY SMC (Jersey) 1 Belmont Gardens St Helier, Jersey Jersey (0534) 77067 9-8.30 Mon-Sat Closed Wed	EDINBURGH SMC Scotecomm 23 Morton Street Edinburgh EH18 2HW Tel: 031-657 2430 10-8 Tues-Fri, 9-4 Sat	BANGOR SMC (N Ireland) 10 Ward Avenue Bangor, Co Down Bangor (0247) 464875
---	--	---	---	---	--	--	---

HEAD OFFICE S.M. HOUSE, RUMBRIDGE STREET, TOTTON, SOUTHAMPTON SO4 4DP, ENGLAND, & MAILORDER TEL: (0703) 867333, Telex: 477351 SMCMM G, Telegram: "Aerial" Southampton

JUSTICE/INJUSTICE

THE SEQUEL

Hugh Allison
G3XSE

One man's
tale of the
relationship between
amateurs and the police

A recent article in this learned magazine, entitled 'Justice/Injustice', had me spitting blood. I was so incensed with the article that I wrote a letter to this magazine. My letter produced literally hundreds of replies, many even offering me financial support, and asking so many questions that the editor asked me to write up exactly what happened. Here it all is, in chronological order.

24/1/80

At 8.30am I was driving in Harlow on my way to pick up my girlfriend (now the wife). I was enjoying a pleasant chat with Brian G4CTS, on 70cm via a local repeater. A police car pulled in front of me and flashed his 'stop' sign. PC Fincham, PC962, politely explained that the police radio system was being troubled with spurious 'Mayday' calls and he had reason to believe that I was originating them. He would not indicate his grounds for suspecting me. He wished to examine the equipment in my vehicle, which incidentally comprised two crystal controlled rigs, an IC32 on seventy and an IC22A on two. I explained that the conditions of my licence stated that the equipment could only be examined by a duly authorised person acting on behalf of the Secretary of State, and that he, as an unlicensed person, was not permitted to have access to the station.

PC Fincham politely ignored my request and proceeded to examine the equipment, which included his transmitting into GB3SV and causing it to 'come up'. After a fifteen minute examination PC Fincham declared that he was unhappy about the installation, despite being shown the licence. I explained that I was now late for work, as would be my girlfriend, to which PC Fincham replied he could and would keep me as long as he wished while he examined my equipment.

22/2/80

At 2pm I was working on my car, which was parked on a hardstanding. Alongside was my van, unlocked since I was taking and removing tools from it. PC1469 Crosby and PC592 Andrews arrived and started examining the radios in the van, without asking permission. I again attempted to explain the situation and was told to shut up. I was interrogated for forty-five minutes (again being made late for work). In the end the officers told me that since it was not a 'Summerkamp' type transceiver it was not on their list and I could 'consider myself let off this time'.

22/2/80-27/2/80

I was stopped a further three times by the police. In desperation I phoned the

local police station and an appointment was made to see the collator on 29/2/80. This appointment was made because I was annoyed at the harassment I was being given by the police (in particular, being made late for work). I was also extremely annoyed by the pure garbage being spoken by the police officers during my interrogations. The officers claimed to be fully trained on all radio matters (it later transpired that this comprised reading one side of an A4 sized sheet of paper!). The most memorable informed comment from a 'thoroughly trained police officer' was and I quote: 'Any transceiver containing more than sixteen channels is an illegal set'.

I was extremely annoyed with being in the impossible position of having to argue with police officers who had been given totally erroneous information; you simply cannot reason with a person who is totally ignorant of the subject under discussion. I also wished to complain about being detained whilst the vehicle was examined for illegal radio installations (a power that the police did not have) and to complain about police officers breaking the law by illegally operating my station, despite my teaching the police the law on the subject.

29/2/80

The day of the meeting with the police at Harlow police station. At 8am I drove my vehicle down the lane to the M11 junction. A police car pulled out from a layby there and 'tailed' me some twelve miles into Harlow. It then pulled in front of me and up came the 'stop' sign. PC1393 Norris refused to show me his warrant card. He insisted that the equipment was CB, despite being shown my licence (I was under no obligation to do this). He also informed me that the licence was out of date (it only shows the first year of issue). Despite being told that an 11am appointment with the collator at Harlow police station had been made, and despite being shown the log book, he charged me with the offence of 'suspicion of using CB equipment'. He wished

to examine the equipment, and as I ran through the licence conditions he leaned through the car window, took my vehicle keys and operated the equipment after opening the passenger door.

I was then forced to follow the police car to the Harlow police station, being told that I would be arrested for failing to co-operate with the police if I did not comply. It was unfortunate that PC Norris did not know where the police station was, since I followed him down several dead ends and had to keep backing up out of his way.

At the police station I was told by PC Norris to securely lock the vehicle so that nobody could touch anything, and that I was being taken to see the collator. With amateur licence in hand I was shown into a room and told to stand behind a rail. I was informed that I was being detained on a charge of 'suspected possession of citizens band equipment'. When I protested that the charge had been changed and was still a non-existent offence, I was told to 'shut up, we put what we want'. My possessions were demanded and itemised whilst several other officers in the room made comments, such as 'three dirty snot rags', and my licence was listed as 'assorted papers'. I was asked to sign the list, and when I protested that the licence was not listed I was told by the arresting officer, 'sign it or I'll do it for you'.

I was then told to remove my shoes and was locked up in a police cell. Since the police had removed my watch I had no idea of the time, but would guess at 9am. Whilst being held in police detention I was told that if I would only sign a statement admitting my 'guilt' I would be released. At the time this was a very, very, tempting offer. Police cells are not very pleasant places. I did not sign anything.

At 12 noon I was told by my jailer 'out, you'. I was allowed to put on my shoes and my possessions were returned. I was told that my vehicle had been inspected by three officers of the Radio Regulatory Division of the Home Office whilst I had been held in police detention, but my equipment was indeed genuine amateur

equipment and I was free to go. The log book had not been signed, as the inspecting officers are required to do by terms of the licence.

Although somewhat disorientated, I then went ahead with my meeting with the collator. He admitted that his officers did not know what they were doing and, quote: 'It's all an act really'. He gave me a piece of paper to produce to police officers in the future, which he said would stop my harassment. When I attempted to drive off I noticed that the door lock on the vehicle no longer worked, so I presume the door had been forced open by the police.

29/2/80

Evening, approximately 9pm. My girlfriend was driving myself and a few friends out for a drink in my car. In Dunmow a police car pulled in front of us as we were parking. PC1723 Bird started questioning us. I informed him that I had spent three hours that morning in a police cell and was thoroughly fed up with this constant harassment by the police. PC Bird then made a rude and offensive remark to me, in front of my friends.

Note that there was no radio equipment in the vehicle.

3/3/80

At 8.15am I was chatting happily to Brian G4CTS again, and as I joined the M11 I was boxed in by two police cars, one in front and one to the rear. PC1238 demanded to know what my callsign was, straight off. Four police officers then kept shouting at me all at once and acting annoyed when I didn't reply to one of them. I am afraid I cannot answer four people at one time. When I asked why he wanted to know the callsign PC1238 threatened to arrest me for 'failing to supply a police officer with a callsign'. I then showed him the paper supplied by the collator at Harlow police station. PC1238 (who refused to give his name) informed me that the paper was not worth having, since I could have installed illegal equipment since 29/2/80. It is interesting to note that during my four officer interrogation none of them asked me for my name or address. After fifteen minutes of interrogation about my radio equipment (despite my protests that they were not authorised to detain me for this purpose, or to examine my station), and being thoroughly frightened about being detained in police cells again, I was 'released' and then followed down the M11 by a police car.

Again late for work. I made a formal complaint to my MP about my harassment, and later to the police.

27/11/80

The Home Office wrote to me confirming that section 159 of the Road Traffic Act 1972 'does not, however, empower the police to detain a vehicle once it has been stopped solely in order to establish whether or not it contains unauthorised radio equipment'.

10/12/80

The Home Office confirmed that: 'A police officer is not an 'authorised person' for the purposes of the amateur radio licence'.

14/1/81

I received, after nearly a year, a reply from the police complaints board. Highlights of this letter are as follows: 'police officers in the Harlow area had been given information about police powers in connection with CB radio, part of which was misleading... He (the Deputy Chief Constable) accepts, however, that these frequent stops, and your arrest on one of those occasions, reflect a lack of knowledge of this area of the law at the time... The Deputy Chief Constable regrets the inconvenience caused to you... it turned out the officers were acting misguidedly...'

Re PC Bird: 'The Deputy Chief Constable apologises, however, for the objectionable remark apparently made by the officer. He intends to have the officer strongly advised about his future conduct... The Board can appreciate that you were justifiably annoyed at the frequency with which you were stopped, and particularly inconvenienced by your arrest.'

28/1/81

I received a letter from the Deputy Chief Constable, in which he describes my comments as contentious.

9/2/81

In another letter the police complaints board admitted to 'the lack of police knowledge of this subject at the time...' and said that 'neither the Board nor the Deputy Chief Constable were suggesting that there is any obligation to carry your licence with you'. The letter also stated that: 'Police do not have the authority to detain vehicles for inspection of radio equipment'.

Easter 1981

A friend was helping out at a Boys Brigade meeting. PC Bedford made careless and unwarranted remarks to members of the public about me.

28/5/81

The Deputy Chief Constable agreed that PC Bedford committed the above disciplinary offence.

7/8/81

In a further letter from the Deputy Chief Constable he said: 'I propose to enter into no further direct correspondence with you on this issue'.

I apologise for taking only bits out of letters, rather than print out every letter in full. This is obviously impossible, since my file on the above fills a large folder. I have tried not to take any sentence out of its context.

I note with interest that if you are up in court lack of knowledge of the law is no defence, but the police have used their ignorance of the law as their defence. My

biggest objection, however, is the lack of police apology for harassment. They just will not write it down, and use vague words like 'inconvenience', 'justifiably annoyed' etc.

Another facet of the above that gets right up my nose is that I have to waste hours and hours in a police cell or on the roads answering ignorant questions from the police who have no right to detain me, but the police will not agree to meet me or write an apology that will satisfy me.

Just think what would have happened if I had illegally detained a police officer on a non-existent offence for three hours, and while detaining him I had forced my way into his police car, made objectionable remarks to him and operated a radio system that I held no licence for.

Can't understand

Readers may be interested to note that during 1982 I was stopped by a police officer who was on foot. He had just received information that he was urgently required on the other side of town (he had no radio with him) and required me to transport him to the incident. He showed no interest at all when I wished to discuss with him the last time I tried to help out the police, and ended up locked in a cell. He couldn't understand my attitude to the police at that time. Can you?

Incidentally, I now operate mobile only very rarely. I couldn't take all the hassle again. Was it merely 'inconvenience' or was it police harassment? I know what I think it was, what do you think? It's amazing how everything stopped when I complained to my MP about it all.

And the RSGB...

As a finale, the RSGB requested all information on the matter and it was forwarded to them 'as it happened'. They promised to raise questions in the Home Office and get a complete apology. They did completely and utterly nothing. When asked why nothing had been done Mr Evans at the RSGB said, 'The police have such wide ranging powers under the prevention of terrorism acts that nothing can be done in this case'. The police never mentioned terrorism. Words fail me.

Opinionated?

Let us know your views,
problems, doubts,
prejudices, experiences
or whatever.

Amateur Radio
is the open forum for all
matters which affect you!
So come on – get angry!
Write to us today!

The choice of which band to operate mobile on is dependent on a number of different factors, not least the economical ones. With the price of both HF and VHF gear being well into three figures, and the risk of rigs being stolen, many amateurs today are looking towards a cheap and effective way of radiating a mobile signal.

The low cost of FM CB rigs either modified or unmodified, coupled with the abundant supply of cheap aerials, makes the 10m band an ideal proposition. In this article I will attempt to outline the benefits as well as the snags and pitfalls of 10m mobileing.

Getting on the air

Having obtained a working rig, it is worth pausing to examine its performance before installing it in the car. Most people on 10FM are using low deviation and receivers with 8KHz IF filters, so a check to make sure that the transceiver is spot on the correct channel is well worthwhile. If the rig is off channel, considerable distortion will be apparent on both received and transmitted signals with interference to and from the adjacent frequencies.

Next it is worth checking the deviation — if it is high, then the modulation will spread too far either side of the channel causing QRM to other operators. Speech peaks will also close the squelch on the receiver at the other end. The correct method of setting the deviation is with the appropriate deviation meter, but for the impoverished try shouting the word 'four' into the mic and see if you close your contact's squelch. If the squelch closes then the peak deviation is too high and should be backed off.

Some rigs have a separate mic gain and deviation control — in this case best results will be obtained with full mic gain, which should give a good punchy modulated signal. On rigs where the mic gain control alters the deviation, it is worth putting a small Vogad compressor circuit in the rig to maintain a constant audio level without over-deviating.

One of the biggest failings on 10FM is poor audio. The average CB rig and its microphone deliver a very strangled restricted signal, usually under-deviated. This results in a very severe limitation of usable range. The LCL and DNT rigs seem to suffer particularly from this problem. A variety of different modifications have appeared from time to time, but I would recommend the use of the old Pye Ranger or Cambridge mic insert, which gives a high output with a very punchy crisp response.

In fact, I have used this type of mic insert on SSB, AM and FM rigs with extremely good results. The name of the game is to communicate, so it is no use whatsoever having a BBC quality signal when you are going to be working under noisy and unsatisfactory conditions.

Worth checking

It is certainly worth checking the sensitivity of the receiver, and upgrading the RF amp and mixer on rigs where the performance is inadequate. A sensitivity of about 0.2 microvolts for

GOING 10 METRE MOBILE

All you need to know about getting started in this mode

*by John Petters
G3YPZ*

20dB of quieting should be the aim. If the rig will not produce this then there is a good chance that you will have stations calling that will be inaudible.

It is better to upgrade the front end of the rig rather than use an external pre-amp, unless you are using a multi-band rig, all of which are deaf on 10m. The use of a pre-amp in this case saves having to delve into a highly expensive piece of gear and avoiding possible invalidation of the manufacturers' guarantee. The transmitter should be checked to ensure that the required power and frequency are appearing at the output.

Installing the rig

There are several different ways of mounting a mobile radio into a vehicle. The position with respect to safety and ease of operation should be of paramount importance. The radio should be within easy grasp of the driver so as to avoid having to lean across the passenger seat to gain access to the controls. The use of a good boom mic is also advisable from a safety point of view, but choose one with the correct response.

If the rig is to be a permanent fixture (thieves and vandals permitting) it should be mounted so that the case has a good solid earth return. This is sometimes difficult with today's tendencies toward plastic interiors. A good earth is important from the point of keeping ignition interference out. If the rig is to be removable, then one of the CB type slide mounts will do a good job, but again in the interests of noise and indeed, VSWR, it is advisable to connect the antenna directly into the back of the rig avoiding the copper contacts on the

slide mount itself.

An extension speaker is a good idea as most rigs have the in-built speaker in the bottom of the case, which fires the sound downwards, making readability difficult under noisy conditions.

Electrical interference

Frequencies around 30MHz seem very prone to picking up all manner of man-made noises — far more than the VHF bands. The most irksome interference is that which is caused by the electrical system of the vehicle. This manifests itself from a variety of different sources, the most common being the HT ignition system, the generating system or one of the motors used to drive the windscreen wipers or heater fan, etc.

On an FM receiver the noise is not apparent until the squelch is opened by a carrier. Noise pulses can be seen as an S-meter reading. Depending on the amplitude of the carrier and the noise, and the effectiveness of the limiter, this interfering signal can modulate the incoming carrier, making it appear to be weak and scratchy. Ignition or generator noise will vary in intensity and speed with the engine revs.

Assuming that no other electrical apparatus is switched on, a simple test may be carried out to find which of the two noise sources is present. The engine should be revved and the S-meter reading observed. Switch off the ignition, thus removing the supply to the coil, and see if the S-meter reading diminishes. If it does, then the noise is being generated by the HT ignition system. If the reading persists then the generator/alternator is the culprit.

Curing Ignition Interference

Defeating the vehicular QRM is an art in itself, with a wide range of techniques and approaches. Much trouble can be avoided by proper installation in the first instance, rather than a quick 'bodge the rig into the cigar lighter' technique.

First and foremost, ensure that the rig is fed with a hefty coaxial supply lead (UR67 or similar) directly onto the battery (via a fuse, of course). This will prevent RF energy from the HT leads being induced into the supply line of the radio. The antenna base and feeder braid must be dc earthed to car body; this can be a particular problem with gutter-mount bases, and can wreak havoc with VSWR measurements.

Suppressed HT leads should be used. This should drastically reduce the problem. For really stubborn vehicles it is sometimes necessary to screen the HT leads with UR67 braiding, earthing both ends to the engine block. Metal shields should be placed over the plug ends and the distributor cap and the ignition coil should be encased in a tin can. The screening cans should then be earthed to the engine block.

A metal shield should also be fitted around the body of the distributor; this can be made from thin copper foil and formed to fit the contours of the distributor. This should then be grounded. The LT leads from the coil should be taken from the screen via feedthrough capacitors.

The car bonnet should be bonded to the body in several places by thick coaxial braid. The engine and exhaust pipe should be treated the same way. In some cases the exhaust pipe needs to be bonded at frequent intervals throughout its length, as this is usually a nice resonant antenna on 10m. By this time, if you are lucky, you will have banished the curse of the noisy ignition.

If not, then further bonding of the chassis and body of the vehicle, the doors, boot, windows etc, may be needed (see *Table 1*). On a Renault 4, the gearstick needs earthing to the engine as this can radiate quite effectively. Some dealers can also supply VHF suppressed plugs which may be of some considerable help.

Table 1 shows the areas of the vehicle that require bonding to the chassis with thick coaxial braid.

Generator/alternator noise

Interference from an alternator can be in the form of a whine which is audible in the receiver and is radiated on the transmitted signal, or, in the case of a generator, excessive sparks from the

brushes/armature which will sound similar to ignition interference. A feedthrough capacitor in the order of 0.01 microfarads should be fitted on the generator casing and used to feed the armature connection. Disc ceramic capacitors soldered directly onto the brush connections are also effective in by-passing this type of interference. In really stubborn cases, a parallel tuned L/C trap for 29MHz could be placed in series with the armature lead, hence rejecting RF noise at the receiver operating frequency.

Voltage regulators can also cause problems. Feedthrough capacitors can again be mounted on the battery and armature terminals, but the field winding should have a capacitor and resistor connected in series to earth. The resistor is used to prevent damage to the generator in the event of the by-pass capacitor going short circuit. If noise still persists, then the field lead from the generator should also be screened, with the braid being grounded. Finally, ensure that the generator/alternator is properly bonded to the engine block.

Instrument noise

Interference from wiper-motors and heater-fans can usually be cured by decoupling the supply leads with disc ceramic capacitors. Again, in stubborn cases, decoupling may have to be applied at the brush holders inside the motor, or the tuned series trap method may need to be incorporated. Interference from the fuel or heater gauges can usually be cured by decoupling at the sender elements.

10m mobile aerials

The range of antennae for 10m is considerable, and some caution is required before making the final choice. There are a variety of different mounting systems available, from gutter mounts to magnetic mounts as well as the proper 'drill a hole through the body' type. The latter is by far the best from an electrical point of view, as there is a permanent and definite chassis connection; however, not everybody likes the idea of hacking a great hole in a nice shiny new car!

A mag mount is the least desirable choice as there is no dc ground on this system. Mag mount antennae also have the distinct possibility of parting company with the vehicle at high speeds.

The quality of gutter mount construction varies from excellent to abysmal, and care should be exercised in examining the mechanical construction before parting with the cash. After mounting the base, check the dc resistance to chassis

to ensure that the base is effectively earthed.

The position of the aerial on the car body can seriously affect the efficiency of the system. The ideal is in the middle of the roof, thus giving a reasonably uniform groundplane. In practice, it is often only practical to gutter mount on the side of the car. This will give a distorted radiation pattern, with the effect of gain in the direction of the largest groundplane area. Mounting the aerial on the front wing or the boot of the car will have a very directive effect.

Best results

Of the many different types of antenna available, the helically loaded $\frac{5}{8}$ wave has proven to give the best results. The Rebel 500 in its 5ft version was used by G3YPZ for many years until a local vandal removed it last month!!! The DX27 $\frac{5}{8}$ wave, the Fire Stick and numerous others of that type of construction, should give good performance.

A full size $\frac{1}{4}$ wave whip is the easiest antenna to match, but its physical size is a bit prohibitive, and the results are not up to the standard of a good helical $\frac{5}{8}$ wave, with its lower angle of radiation. Such loaded $\frac{1}{4}$ waves as the DV27, the Oscar etc will perform adequately, but if a loaded antenna is to be used then it is better to use a centre loaded or top loaded type in preference to a base loaded whip. Again the mechanical construction should be a prime consideration.

As in the case of base station aerials the use of multi-band aerials for 10m mobile use will result in a very poor compromise. The aim is to radiate a good low angle signal with maximum efficiency.

All 27MHz aerials will need pruning to resonance for 10m operation. First steps first, check the feeder run into a dummy load to ensure that 1:1 SWR is present. Next, connect the feeder to the antenna and measure the SWR at the lowest operating frequency. The antenna should then be cut at not more than $\frac{1}{2}$ inch at a time, noting the SWR reading each time. If the aerial is for use on the FM portion of the band only, then it should be cut so that the minimum SWR is centred on 29.600MHz.

If full band coverage is required, then a resonant frequency of around 28.800MHz should give adequate performance throughout the band. Special care should be taken when trimming helically wound aerials as there can be many turns of wire in each $\frac{1}{2}$ inch of antenna. It is better with this type of aerial to unwind the helix a few turns at a time, checking the SWR after each alteration.

Working the band

For the amateur used to working on 2m, the transition to LF should not cause too many problems. FM activity on 10m is channelised with a 10kHz spacing. The calling channel is 29.600MHz which at peak operating times should be vacated as soon as a contact is established. The

Areas to be bonded

Engine block to frame	Bonnet to chassis
Air filter assembly to engine block	Front and rear bumpers to chassis
Exhaust manifold and pipe to engine block and chassis	Boot lid to chassis
Battery ground terminal to chassis	Doors to chassis
Steering column to chassis	Sun roof to chassis

10m MOBILE

favoured QSY channels are between 29.550 and 29.690MHz. Frequencies between 29.350 and 29.550 should be kept clear as these are allocated to the satellite service.

Some degree of patience may be required as activity, although firmly on the increase, is by no means as high as 2m. Don't get disillusioned if you do not get a reply to every call: just keep trying, because if everybody gave up and went back to 2m and the repeaters, there would never be any activity on any other band.

Range and power

The range of a mobile station is dependent on a number of factors - transmitter power, receiver sensitivity, aerial, background noise as well as terrain. Assuming a transmitter power of 4 watts into 5/8 wave helical whip in town, the range should be in the region of about 15 miles. Increasing the power to 25 watts will give a correspondingly greater coverage. If 100 watts are used then distances of up to 40 miles should be possible.

Unlike 2m, the 29MHz band does not suffer from excessive mobile flutter, the fading is much slower and similar to that experienced with Top Band mobile operating. The effects of buildings and hilly terrain on 10m signals is noticeably less drastic than on 2m. In many cases

the simplex mobile to mobile range on 10m can be as great as the 2m range via a repeater.

The DX aspect

So far I have only discussed the flat space wave or direct wave range. 10m also offers the benefits of tropo, sporadic-E and, of course, F2 ionospheric propagation. This opens up the possibilities of working not only considerable distances in the UK, but inter-Europe via E and worldwide via F2.

Table 2 shows a list of country prefixes worked by G3YPZ/M since 1979. The equipment used was a Unicom UX502 10FM transceiver with power varying

from 1 watt output to 100 watts. The antennae used were 1/4 wave full size whip, 4ft centre loaded gutter mount whip and the Rebel 500 helical 5/8 wave. In addition to the many simplex DX contacts, it is often possible to work through the American and European repeaters when conditions are good. I will however point out that the chances of working F2 DX for the next few years are slight, due to the declining sunspot conditions. Sporadic-E will be a regular occurrence even in the minimum years, but mainly during the summer months.

How much will it cost?

On current prices 10m FM is by far the cheapest band to get on. Rigs are available - fully modified - from around £40 with an aerial costing as little as a few quid. Most CB dealers carry a range of power amplifiers ranging from 25-100 watts with prices starting around £15. Gutter mounts for aerials can be obtained for around a fiver, but the best thing is to shop around for the best deal.

Clearly, though, it should be possible to get on the band for a total outlay of around £50, which in this day and age is next to nothing. A comparable 2m system would be approaching £200.

In the following article I will demonstrate the differences between 10m, 4m and 2m mobile operation under controlled conditions.

Country prefixes worked by G3YPZ/M

CN8, CT1, 2, 3	OE, OH, OZ
DJ, DL, DF, DA,	PY, PP
EA, EA8	RA, RQ, RL
EL8	SM, SV
F, FY7	UA, UB
G, GM	VE1, 2, 3, 6
HA, HG, HB9, HH7	VK6, VK4
I, IT	W1-0
JA, JH, JE	YU, YZ
KA, KG4, K1-0	ZS
LA, LU	4X, 4Z
N	

WPO COMMUNICATIONS

20 FARNHAM AVENUE, HASSOCKS G3WPO
WEST SUSSEX BN6 8NS MAIL ORDER ONLY

24hr ANSAPHONE 07918 6149



DSB/CW DSB80 2w+

Our most popular kit ever. Simple 80m (also 160m version) Tx/Rx with superbly sensitive receiver. VFO. Basic pcb kit (only needs psu/mic/key & speaker) ONLY £37.45. Case (punched but plain finish)/ hardware £24.45 and digital display option @ £24.10. All above for £79.00 inc. 12v operation.



only
£37.45
Basic Kit

ALPHA — SINGLE BAND SSB/CW 50W TRANSCIVER KIT

160M
or
20M



Our latest Transceiver for mobile or base station use. Full kit with painted custom case/bracket/digital display £199.50. Basic pcb kit with all components £149.50 (no display). 90dB+ dynamic range, excellent sensitivity, RF blanker, IF Gain.

BUILD AS PORTABLE OR BASE STATION 2m TRANSCIVER

Get on 2m FM! 6 channel max. 1W+ Tx and ideal for beginners. These are popular kits with Rx @ £39.50 & Tx £32.90. Both kits for £68. Verocase (undrilled) to make portable rig £7.50.

2M FM TRANSCIVER

£68!



UNIVERSAL MORSE MEMORY

Our unique design which works with Hand keys! 10-120 sec message length at any input/output speed. Memory back-up, sidetone, battery or external supply. SPECIAL MS VERSION now available with 1-15 sec message length.

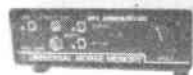

£40.50
READY
BUILT

See previous ads for more details

WE SPECIALISE in kits for the home constructor. Why not try something from us soon? Many kits are suitable for beginners and come with comprehensive instructions, drilled lined pcb and pots, wire etc. Our products are used worldwide and can help **YOU** get on the air to work the world or the locals. Many other products under development - watch this space for details. Most kits have pcbs and instructions only available. Our full catalogue is available for 50p in stamps (no cheques etc) or short form for S.A.E. Kits are sent in 7-10 days, but allow up to 28 days for delivery of popular items if not ex-stock. Export-Europe use UK prices Rest of World-UK +5%. All prices include post & VAT. Leave your credit card orders on our ansaphone

VFO KITS

MINISYNTH As used in DSB2. 1 band PLL VFO, versions for 9 & 10.7MHz i.f.s and for 160-10m (28-28.6). Full kit with tuning cap and crystal £29.70. Very stable - will drive an SBL1. **VHF MINISYNTH** our 2 metre version with continuous coverage of 144-146MHz. Direct output on 2m and options for up to 3 other bands ie 135 - 137 for Rx + 2 repeater shifts. Full kit with air tuning cap £38.50. Again, very stable - drives SBL1. **OMEGA** 9 band version - all amateur bands with 1MHz coverage. Very stable and clean output PLL VFO. For 10.7MHz i.f.s, the full kit with all crystals is £108. Drives SBL1 or similar.

NEW micron



OUR LATEST TRANSCIVER KIT, sets new standards in QRP performance - LOOK AT THESE FEATURES - a 6 band CW only 8/10W output rig covering the 80, 40, 30, 20, 15 & 10m bands (bottom 200KHz of each). 0.25uV sensitivity receiver, featuring AGC, with S Meter. Stable 2 speed VFO with IRT (Spot facility), 1W AF output to speaker, and 3 position LC filter + switchable attenuator. Silent solid state Rx/Tx switching with fast semi break-in and shaped keying. Sidetone facility. Fully variable RF power output from OW to full power metering. Needs +12v/14v supply.

PLUS CUSTOM punched & painted aluminium case/hard-ware and speaker with unique facility for optional INTERNAL ATU (Transmatch type) & SWR metering. **DIGITAL READOUT** option. The MICRON uses a compact single pcb design with easy step-by-step assembly instructions and drawings designed for the relative newcomer - minimal test equipment needed! Mostly prewound coils and transformers.

PRICES: Basic pcb kit inc VFO capacitor/drive/ enclosure, for 2 bands (state which) £99.45 - extra bands £11.75 each. Full pcb kit for 6 bands Tx/Rx £145. Case £46.20. **COMPLETE KIT WITH CASE/6 BANDS** £182.50. Optional extras - Digital readout (LCD) kit £33.56, and ATU Kit (for internal mounting) with SWR/Power metering at £37.00. **COMPLETE KIT/CASE WITH DISPLAY AND ATU** - £241.00.

Please phone or write for full brochure on the MICRON or place your order now!

C. M. HOWES Communications

FUN TO BUILD KITS BY MAIL ORDER

Make a useful addition to your station, and at the same time enjoy the satisfaction of building your own equipment, with a kit from C M Howes Communications. Our kits use good quality parts, a glass-fibre printed circuit board, and come with good, clear instructions and all board mounted components. The instructions are written with the first time builder in mind. You do not have to be an 'old hand' at construction to build a worthwhile, interesting project. Enhance your station for a modest outlay!

AP3 AUTOMATIC SPEECH PROCESSOR

The AP3 can add a really useful boost to your transmitted signal. The extra 'punch' added to your modulation by the AP3 helps to cut through the noise and QRM, so enabling you to make contacts that are not possible without it. The AP3 was described in an article in the September 83 edition of 'Ham Radio Today' by Dave G4KQH, and since then we have sold over a thousand units. The AP3 works from a 9 to 14V DC supply and automatically turns itself on and off from your microphones' normal PTT switch output. You simply select the amount of clipping you require (4 steps of approx 6dB), and speak into the mic. The AP3 automatically compensates for changes in speech levels, so you can still work the DX even if you whisper! Ideal for multi-operator contests! The unit can be used with high or low impedance mics, and can even work with the ICOM rigs having a mic preamp - if you make a couple of minor component changes - we can supply details, and the bits, when you order. Simple to build, and only one adjustment to make to set the output level, the AP3 has been a first time build for many operators. Could your station make a bigger impact on the bands?

AP3 kit £16.90. Assembled PCB module £21.40

CTX80 LOW POWER CW TRANSMITTER FOR 80M

The CTX80 has a variable output power level, up to about 5W RF from a nominal 13.5V DC supply. It has built in key-click suppression and a 5 element low-pass output filter, so you can put out a 'clean' signal. The CTX80 is crystal controlled (one crystal is provided), but provision is made for an external VFO as well as two additional crystals on the PCB. The VFO kit should be available by the time this ad appears in print. Send an SAE for details. The CTX80 is proving to be a very popular kit. It is easy to build, and the output transistor will survive if you forget to plug the antenna in! Build yourself a QRP station for home, portable or holiday use, how about using it with our DcRx Receiver?

CTX80 kit £12.95. Assembled PCB module £18.95

CM2 QUALITY DESK/MOBILE MICROPHONE

The CM2 is good quality microphone kit that consists of an electret condenser microphone capsule and a small electronics module that incorporates a Plessey 'VOGAD' chip to give automatic control of modulation levels. The unit produces a nice clear audio signal for your transmitter, no matter whether you talk loudly or quietly, near or further away from the mic, the modulation level is maintained correctly for you. Ideal for a desk microphone or for use in the car as a 'hands free' unit. The CM2 can be remotely keyed by a foot or gear-stick switch if required. The unit will work on an 8 to 14V DC supply, drawing only about 30mA from a 9V battery, and then only in transmit mode. The electronics turn off automatically when switching back to receive, no separate on/off switch is required.

CM2 kit £10.25. Assembled PCB module + mic capsule £13.75

**139 HIGHVIEW
VIGO, MEOPHAM
KENT DA13 0UT
FAIRSEAT (0732) 823129**

DcRx DIRECT CONVERSION COMMUNICATIONS RECEIVER.

The HOWES DcRx is a low cost, easy to build, amateur band receiver. It has been designed with the newcomer to the hobby in mind. Single band versions are available to cover 160, 80 or 20/30 meter bands. The receiver runs off a nominal 12V DC supply and will deliver up to a watt into a 'speaker or headphones. The kit comes complete with ready-wound coils and requires very little alignment. Read the review of this kit by G3RJV in the May 84 issue of 'Shortwave Magazine'. The DcRx is used by many QRP (low power) operators as well as Short Wave Listeners. Don't be put off by the low price, this receiver works well and is capable of world-wide reception. Modes SSB and CW. A case and two tuning capacitors are the only major parts to add to finish your receiver. We have suitable tuning capacitors for all but the 160M version, at £1.50 each while stocks last.

DcRx kit £14.80. Assembled PCB module £19.90. PLEASE STATE WHICH BAND YOU REQUIRE.

ST2 CW SIDE-TONE/PRACTICE OSCILLATOR

The ST2 provides a nice sounding sinewave note of approx 800Hz at up to 1W. It can work from your key, or by RF sensing. In use by many Morse classes, and suitable for the CTX80. Read about it in the recent edition of 'Amateur Radio'.

ST2 kit £7.30. Assembled PCB module £10.80

XM1 CRYSTAL FREQUENCY MARKER

A really useful piece of test equipment to have in the shack, besides helping to keep you 'legal'. EIGHT marker outputs useable from LF to UHF. On-board voltage regulator for 8 to 24V DC use. This is the mk2 version which has a 10MHz crystal and 'ident' facility. Read about the mk1 version in the June 84 edition of 'Amateur Radio' under the heading 'Build the XM1'. An accurate, stable signal source is a must for any station.

XM1 kit £16.80. Assembled PCB module £21.30.

EM1 ELECTRET MICROPHONE CAPSULE

Not really a kit as such, the EM1 is the microphone capsule included in the CM2 kit. We sell it separately so that you can use it with our AP3 to build a sophisticated, speech processed desk mic. Useful for many other projects too. EM1 capsule and instructions for use with AP3 £1.90.

LIGHT-WEIGHT HEADPHONES

We stock these for use with our DcRx and ST2 kits, but they can be used with almost any receiver. These 'phones are similar to the ones sold with personal stereo players, but our version comes wired with a 3.5mm mono jack plug to suit most CB or Amateur Radio equipment. We can also supply with 1/4 inch mono jack, or a stereo one to special order. These 'phones give good audio and are 16 Ohm nominal impedance (mono).

Price £3.30.

If you would like further information on any of our products, simply drop us a line, enclosing an SAE, we have an information sheet on each kit. **Please add 60p p&p** to your total order value.

73 from Dave G4KQH Technical Manager

G3/G4

RCQ SAY AUCTION IT?



SELLING YOUR RIG CAN BE FAST, EASY AND PAINLESS WHEN YOU USE THE SERVICES OF G3RCQ ELECTRONICS. WE ADVERTISE BIG IN ALL THE MAGAZINES, OUR TURNOVER OF EQUIPMENT IS FAST, THIS MEANS WE CAN OFFER THE **BEST PART EXCHANGE DEAL** AND THE **BEST CASH DEAL**. OUR ADVERTISING IS THERE TO HELP YOU SELL YOUR USED EQUIPMENT WITHOUT DELAY. **REMEMBER** IF YOU ARE SELLING **USED EQUIPMENT** - CONTACT G3RCQ TEL: (040-24) 55733

AUCTION

AUCTION YOUR SURPLUS EQUIPMENT FROM THE COMFORT OF YOUR OWN HOME! **HOW?** LETS SAY YOU HAVE AN 'XYZ' RIG FOR DISPOSAL AND YOU VALUE IT AT £150 YOU SEND ME 10% (£15) FOR INCLUSION INTO THE AUCTION, PLUS FREE ENTRY INTO **LIST-A-RIG** YOUR ESTIMATED PRICE OF £150 WILL NOT BE QUOTED SO YOU MAY EVEN RECEIVE BIDS OVER AND ABOVE WHAT YOU EXPECT. THERE ARE NO FURTHER CHARGES. IF YOUR RIG DOES NOT SELL WITHIN 2 MONTHS (THATS TWO AUCTIONS) YOUR 10% FEE WILL BE RETURNED IN FULL.

NATIONAL ADVERTISING FREE

I WILL ADVERTISE NATIONALLY IN ALL MONTHLY MAGAZINES ON A ROTATION BASIS LISTS OF ITEMS TO BE AUCTIONED. POTENTIAL PURCHASERS WILL BE INVITED TO SUBMIT THEIR BIDS BY POST TO ME BEFORE A SPECIFIED DATE (AUCTIONS ARE MONTHLY). ALL BIDS WILL BE FORWARDED TO YOU THE SELLER. IT IS THEN UP TO YOU TO CONTACT THE BIDDER OF YOUR CHOICE AND CONDUCT THE SALE.

LIST-A-RIG

IMAGINE A DATA BASE WHICH IS CONSTANTLY BEING UPDATED AND CONTAINS ITEMS FOR SALE OR WANTED. THE LIST ENCOMPASSES DEALERS AND READERS ADVERTS. LIST-A-RIG IS SENT **FREE** UPON RECEIPT OF A S.A.E. TO INCLUDE YOUR OWN ADVERT THE FEE IS £2 FOR **TWO MONTHS ADVERTISING**

A FAIR DEAL IS MY POLICY

WHEN YOU DEAL WITH G3RCQ YOU GET A STRAIGHT DEAL. A FULL NO QUIBBLE GUARANTEE, COUPLED WITH FREE ADVICE COVERING 25 YEARS OF AMATEUR RADIO.

BUY & TRY

IF YOU BUY A RIG FROM ME YOU HAVE ONE MONTH TO CHANGE YOUR MIND! IF DURING THE FIRST MONTH OF PURCHASE YOU DECIDE THAT YOU HAVE MADE A MISTAKE OR YOU SIMPLY CANNOT GET ON WITH THE RIG I WILL ALLOW YOU 90% IN PART EXCHANGE FOR ANOTHER RIG OF EQUAL OR GREATER VALUE. IF YOU WANT CASH BACK WITHOUT ANOTHER RIG I WILL GIVE YOU 80% OF YOUR PURCHASE PRICE.

FEBRUARY AUCTION: (Equipment may be sold by private treaty).

ICOM 271
LAR ANTENNA SWITCH
ICOM IC 740 HF TRANSCEIVER
YAESU FP700 20AMP PSU
TV CAMERA & MONITOR
TECH TE200 SIGNAL GENERATOR
YAESU FRDX400 RECEIVER
MM ATV CONVERTER

KW103 SWR/POWER
HF TRAP DIPOLE WITH FEEDER
SX200 N SCANNER
BEARCAT SCANNING RECEIVER
ADVANCE VALVE VOLTMETER
70CMS BEAM 2'14 ELEMENT
DATONG PC-1 GEN/COV 2M CONV
TANDY TRS80, MONITOR, CASSETTE

CUSHCRAFT JR. BOOMER
STANDARD C146 2M HANDIE
ICOM BASE MIC. IC SM6
QM70 2M LINEAR AMPLIFIER
ALENCO 2M LINEAR
YAESU FT707 TRANSCEIVER
MIZUHO SB-2M 2M SSB PORTABLE
YAESU FRT7700 ATU

DATONG RF SPEECH PROCESSOR
ICOM ICR71 HF RECEIVER
EDDYSTONE 940 GEN/COV RECEIVER
YAESU FT720RU 70CMS FM
KW204 TRANSMITTER
TRIO TS770 MULTIMODE 114/432
MM RECEIVE CON 28/144
TRIO SIG GENERATOR SG-402

IF YOU ARE INTERESTED IN PURCHASING ANY OF THE ABOVE PLEASE SEND YOUR BIDS TO THE ADDRESS BELOW.

**NEW GEAR
LET G3RCQ
QUOTE, WE
SUPPLY ANY
MAKE OF NEW
EQUIPMENT**

**SEND S.A.E. TODAY FOR CURRENT LIST AND FULL INFORMATION
USED EQUIPMENT CENTRE, G3RCQ ELECTRONICS
65 CECIL AVENUE, HORNCHURCH, ESSEX
TELEPHONE HORNCHURCH (040-24) 55733
PLEASE LEAVE A MESSAGE ON THE ANSWER PHONE 73'S DE DAVE & CORAL G3RCQ & G4RCQ**

**MAIL ORDER
NO PROBLEM
OUR W/O DEPT
SEND RIGS ALL
OVER THE
COUNTRY**

CW CONTESTING IN THE CHANNEL ISLANDS

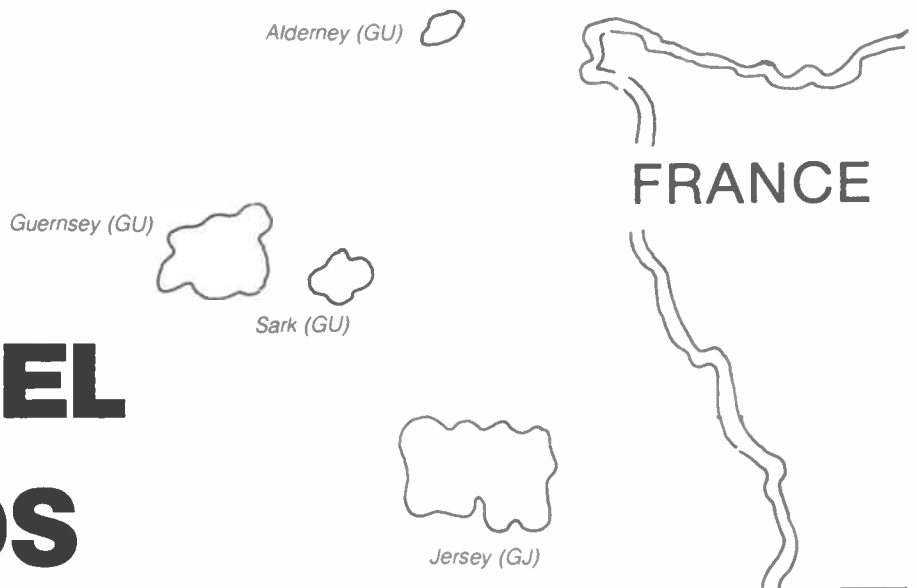

NIGEL CAWTHORNE G3TXF

There's no doubt about it! The weather does go in cycles. Four years running a group of CW contest enthusiasts have operated the CQ Worldwide CW Contest from the Channel Islands and every year there have been gales and storms.

With the CQ WW CW Contest being on the last weekend in November, there is a greater likelihood of storms than at many other times of the year. But nevertheless the fact that this CW contest suffered severe storms for four years running over the same weekend seems more than just coincidence!

The rules and background to the CQ Worldwide Contests were described in the October '84 edition of *Amateur Radio*, and as explained, the scoring in the contest depends not only on the numbers of stations worked but also the number of CQ zone and country multipliers worked. Being in a rare country, even with a relatively low signal, can be a lot of operating fun during the CQ WW Contests.

Alderney '81 and '82

In 1981, Roger G3SXW and the writer operated from Alderney, the northernmost part of the Channel Islands, using the call GU3SXW. With there being no winter boat service to Alderney we had to fly in with all the gear. For this first trip we took two complete HF stations as well as a simple tri-band HF dipole and separate dipoles for 40, 80 and 160m.

Alderney is one of the smaller Channel Islands, being about 3 miles long and 1 mile wide. Any QTH on the island is never far from the sea. The Belle Vue Hotel made an ideal QTH. It not only had wide views of the sea and an excellent HF take-off, but also had a large flat roof.

The Belle Vue Hotel was our CQ WW CW Contest QTH for two years running. In 1982, the same team, but now joined by Ian G3WVG, returned to the same

Alderney location. For the 1982 GU3TXF entry we used a tri-band beam on the roof of the hotel, which was a great improvement over the tri-band dipole. The beam helped improve our performance over the previous year's, but there were still problems with the LF antennae.

Although an ideal QTH for the HF bands, for the LF bands this location had one major drawback and that was the lack of space for long antennae. Also there were major interaction problems between antennae for different bands, which made spotting multipliers impossible on some bands.

Another disadvantage with Alderney was the need to take everything by air. The excess baggage charge became a major cost of the trip. In 1982, the three

operators checked in at Southampton airport with 250Kg of luggage!

So, after two years of operating from Alderney, for the 1983 CQ WW Contest it was decided to try a different approach. The Channel Islands contain two DXCC multipliers: Jersey (GJ) and Guernsey and Dependencies (GU). For 1983 we would go for a change of prefix and country – we planned on operating from Jersey.

Jersey '83

Planning for the first Jersey visit started several months ahead. Operating from a totally unknown site/hotel always has its risks (will the hotel manager let us put up antennae? Will there be TVI problems?). On Alderney we had been

Ian G3WVG prepares one of the masts in Jersey



able to clamber over the hotel roof as much as we needed and there had been no TVI problems.

Fortuitously, during the autumn prior to the 1983 Contest, Roger G3SXW was visiting Guernsey and was able to make a hop over to Jersey for a reconnaissance of likely sites. On this preliminary visit Roger was met and greatly assisted by Bert GJ2LU, who already had a site in mind for us: Corbière on the South-West tip of Jersey. It was an excellent choice. The take-off was even better than Alderney and there was plenty of open space for antennae next to the hotel. The first operation from Jersey was to be as GJ3SXW during the 1983 CQ WW CW Contest.

Planning

Having found a good site on Jersey, we immediately planned on much better antennae than we had used in previous years from Alderney. As we would be travelling by car and ferry rather than by plane, the weight restriction problems that we had had in previous years did not apply. We could take everything that we could get into the van! For Jersey, we were planning bigger things, and especially bigger antennae!

For the 1983 operation, the team was joined by Dennis G3MXJ. Dennis had had plenty of experience putting up masts in all sorts of locations and was a veteran of the record breaking contest expeditions to Guernsey made some years earlier as GC4DAA and GU4DAA.

With the extra ground space available, we planned on two HF beams on 40ft masts. Two beams would give the flexibility required to be able to run QSOs on one band while searching for multipliers on others. Planning meetings were held months before the contest and detailed lists of all the items we would need to take were drawn up. Scaffold poles were ordered from the local hire

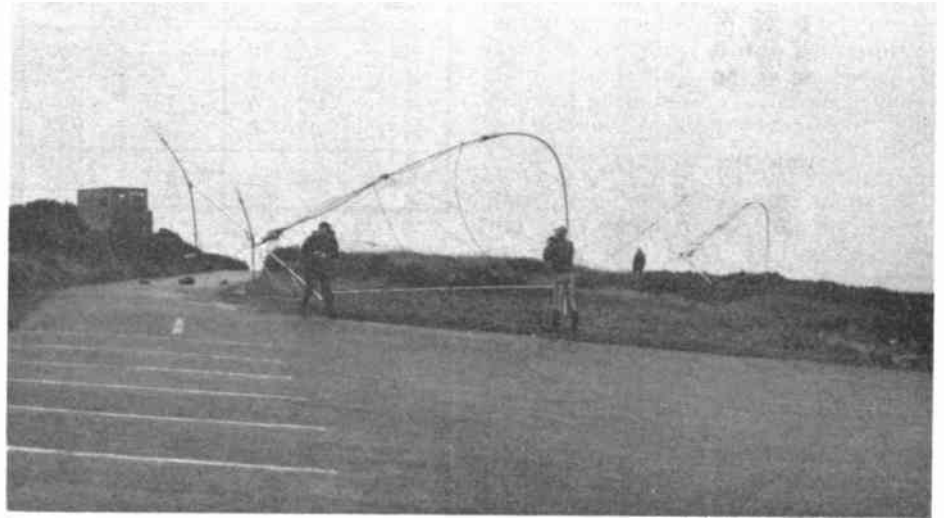

Disaster strikes in the 1983 contest

company for delivery at the hotel on the morning of our arrival.

The weather during the week before the 1983 contest weekend was excellent: bright sunshine and clear blue skies. What could be better for putting up antennae at a cliff top QTH! We had allowed three full days before the contest for antenna work. Heavy stakes had to be hammered into the rocky ground. We were expecting that it would be windy at some time during the contest, so care was taken to make sure that the mast stakes were firmly in the ground. Getting the stakes into the ground was a major problem because just below the top-soil there was solid rock. Dennis G3MXJ spent several hours bashing with a mallet to find secure locations for the sets of stakes that were needed to hold up the 40ft masts.

By Thursday evening both beams were up and working and the LF antennae had been installed. The stations were set up in one room in the hotel and by early Friday everything was ready for the contest, which would start at midnight. The afternoon was spent away from the station in St Helier and in the evening we met Bert GJ2LU for a relaxing evening before the contest.

CQ Worldwide Contests start at 0000z on the Saturday morning and run for 48 hours to midnight on the Sunday. Just before the contest a few final preparations were made to the checklogs and other essential operating records. At 0000z the first contest CQ went out on 40m, and GJ3SXW was off to a flying start.

During Friday the wind off the sea had begun to get up, but the masts with their three levels of guying looked solid and secure in the wind. There was just some movement in the beam at the top, as it exercised the play in the rotator.

Saturday morning brought the first openings on the HF bands and showed that our planning for two HF beams had been worth it. One station ran pile-ups of stations after the GJ multiplier, while the spotting station trawled the other bands picking up valuable multiplier contacts.

During Saturday we tracked QSO and multiplier progress on an hourly basis against the previous year's performance (GU3TXF) and found that we were well ahead. Things were going well.

Declining sunspot numbers meant that the HF bands did not produce the same openings to the US as we had had in previous years. Nevertheless QSO rates of up to 160 an hour were being run with the USA on 15m. In previous years 10m had been the main US pile up band, but we will have to wait until the next sunspot cycle before such 10m pile ups return.

Storms

By 1900z the HF bands were getting quiet. The main station was now on 40m,

Ian G3WVG operating the main station



CW CONTESTING

with the spotting stations hunting for multipliers on 20m and the LF bands.

Outside, the wind had been getting stronger throughout Saturday and windows were rattling. Being perched right on top of the cliff, the hotel received the full force of the winds straight off the sea. By early evening the weather had turned really nasty. It was now blowing a strong gale. The masts still looked solid in the wind. The guys had all been checked and the stakes were still firmly in the ground.

At about 1930z the pile up stopped coming on 40m. Several more CQs, but no replies. The band still sounded hopping but GJ3SXW was not getting through! SWR was showing 5:1. Something must be wrong!

Once outside we could see what had happened. There had been a powerful gust which had blown down both masts in the same moment. No wonder we weren't getting out on 40m: the antenna was on the ground! All the antennae were down! The two beams had taken nose-dives into the rocky ground and the LF wire antennae were a floppy tangled mess! Despair and GJ3SXW goes QRT for 15 hours!

Early Sunday morning we untangled the wires and disconnected the buckled beams. They were not as badly damaged as we had first thought. One beam was reassembled and put onto a post only 6ft high pointing out to sea towards the US. It still worked like a bomb!

The LF wire antennae were tied to any convenient point and GJ3SXW was back on the air again on all bands, but with a somewhat reduced signal and operating capability.

We had learnt what damage the weather can do to antennae! A single hurricane force 12 gust had done it all. The masts withstood the gales, but that single hurricane gust was the final blow to the fine pair of HF beams at GJ3SXW! Despite the loss of so much operating time, we still clocked up some 2,000 QSOs.

Corbière lighthouse: backdrop to the 1983 & 1984 contests

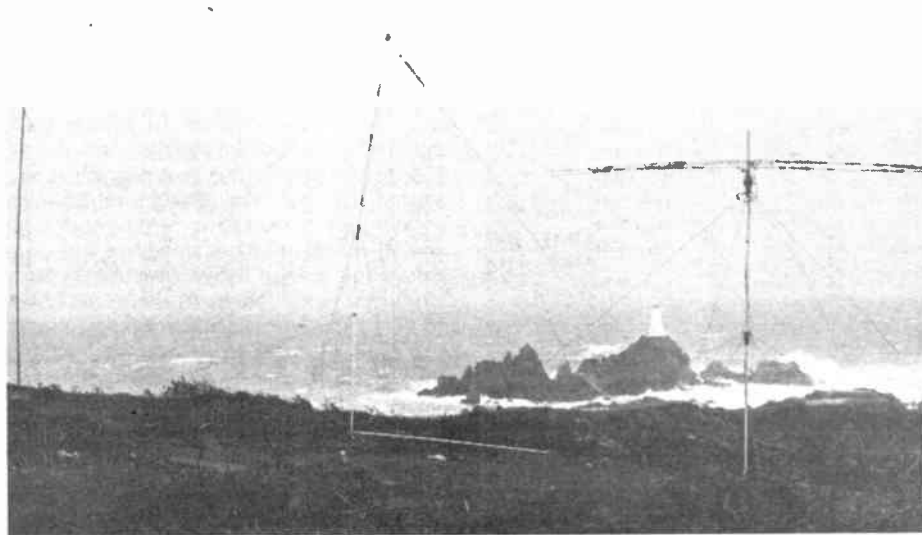

CQ WORLDWIDE CW CONTESTING FROM THE CHANNEL ISLANDS SUMMARY OF QSO TOTALS MADE PER BAND

Year	Call	160m	80m	40m	20m	15m	10m	Total
1981	GU3SXW	-	482	521	486	772	870	3,131
1982	GU3TXF	69	507	513	523	762	951	3,325
1983	GJ3SXW	127	400	511	602	638	138	2,416
1984	GJ0AAA	220	713	843	758	522	5	3,061
Totals		416	2,102	2,388	2,369	2,694	1,964	11,933

Jersey '84

For 1984 the philosophy was to be different. It was 'get on the air and stay on the air for the whole contest' whatever the weather. Antennae were planned accordingly. For this year it was to be a single beam at 20ft, and two masts for the LF antennae. Guyed masts carrying simple wire antennae present much less resistance to the wind than a guyed mast with triband beam and rotator on top!

After the 1983 disaster, we thought that we had seen the worst possible weather on Jersey. In 1984 we were to be proved wrong!

This year the storm started on the Friday just before the contest. We had all three masts up by then. Two 40ft masts for LF wire antennae and a tiny 20ft mast for the beam. At around 1900z on the Friday evening, the wind again got up to hurricane gusts as it had done the year before. But this year it was not just one gust, but several. The 20ft mast with the beam stood solid, even though the beam elements were being blown bow-shaped.

One of the 40ft masts partially collapsed before the contest started. The first hour of the CQ WW CW Contest this year was spent not with all operators quietly relaxed in the shack but with G3WVG and G3TXF out in the storm on the cliff top rebuilding the 160m and 40m antennae, leaving G3SXW in the shack to work the pile-up on 80m!

The weather this year was worse, but

its timing was better! The worst of the storm was before the contest, so that as the contest progressed things got better rather than worse.

Bert GJ2LU and Frank GJ4HSW had driven out from St Helier on the Friday evening before the contest to take a look at the station, only to find that the storm had breached the sea-wall in St Helier, many of the streets were flooded and that many roads on the island were closed. As they reached the hotel, there were police announcements on the TV advising Jersey people to stay indoors as roads were being blocked by falling trees in the storm.

Described in the local paper as 'the worst storm on the island since 1967', it just had to be the weekend of the 1984 CQ WW CW Contest!

New call - new prefix

Previous CQ WW CW Contest operations from the Channel Islands had been with individual callsigns (eg GJ3SXW and GU3TXF). The imminent arrival of the new G0 series of callsigns was seen as an opportunity to book a suitable club call for contest use. In 1983 a request was sent to reserve the callsign G0AAA for the '3 As Contest Group'.

During the year the rate of issue of new calls was followed with keen interest, in the hope that the club call would be issued in time for the Jersey trip. Just two weeks prior to leaving for Jersey, the '3 As Contest Group' was issued with their call, G0AAA.

The first CQ by GJ0AAA at the beginning of the 1984 CQ WW CW Contest was the very first with the new UK prefix GJ0. The new prefix added interest to the contest operation. The callsign is long on CW, but was distinctive because of the new prefix. To some operators it was also confusing. Some tried to turn it into DJ0AAA or even G10AAA, probably thinking these look less strange than GJ0AAA!

As planned, and despite all that the Channel Islands weather could throw at us, GJ0AAA did stay on the air continuously during the 48 hours of contest and netted 3060 QSOs. QSL via G3TXF.

If you plan to visit the Channel Islands do not forget to drop a line to the local telecommunications board to advise them of your operating dates before you go and also to make contact with the local club. You'll receive a warm welcome even though it might be blowing a gale outside!

MARCO TRADING

VISA

RESISTOR - CARBON FILMS 5%

1/4W 1R0 to 10M (E12 Range) **2p each** 15p/10.75p/100
 1/2W 2R2 to 10M (E24 Range) **2p each** 15p/10.75p/100
 1W 10R to 2M2 (E12 Range) **7p each** 65p/10.60p/100
 2W 10R to 2M2 (E6 Range) **7p each** 70p/10.60p/100

RESISTOR KITS
 each value individually packed

1/4W pack 10 each value E12-10R to 1M 610 pieces **4.80**
 1/2W pack 5 each value E12-10R to 1M 305 pieces **2.78**
 1W pack 10 each value E12-2R2 to 2M2 730 pieces **5.25**
 2W pack 5 each value E12-2R2 to 2M2 365 pieces **3.00**
 1W pack 5 each value E12-2R2 to 1M 353 pieces **15.00**
 2W pack 10 each value E6-10R to 2M2 317 pieces **18.00**

TERMINAL BLOCKS

5amp 12 way **1.11**
 5amp 12 way **0.20**
 10amp 12 way **0.40**
 15amp 12 way **0.46**
 32amp 12 way **0.90**

MULTIMETER SPECIAL
 Russian type U4324 (20,000 Ω/V)

DC Volts: 0.6, 1, 2, 3, 12, 30, 60, 600, 1200, AC Volts: 3, 6, 15, 60, 150, 300, 600, 3000
 DC Curr. mA/0.06, 0.6, 6, 60, 600, 3000
 AC Curr. mA/0.3, 3, 30, 300, 3000
 DC Resistance: 0.2, 5, 50, 500, 5000
 level dB -10 to +12
 Requires 3 AA Batteries (batteries not included)
Price £12.00 incl. of p/p & VAT

FUSHERS
 20mm Panel Mounting **0.35**
 20mm Chassis Mounting **0.08**
 1/4in Panel Mounting **0.35**
 1/4in Chassis Mounting **0.12**
 Carline 1/4in holder **0.10**

BUZZERS
 SOLID STATE

6v and 12v - 80p each
 AA to 95 10 - £8.00
 HP 11 £2.30
 4 - £3.80
 C - £2.35
 4 - £2.75
 PP3 £4.45
 4 - £18

FUSES Prices per 10

1/4" Quick Blow 100, 150, 250mA £1.30
 1, 1.25, 1.5, 2, 2.5, 3, 10, 15A 50p, 1/4" Time Delay 100mA £3.50
 150mA £2.25, 250, 300, 500, 600, 750, 850mA £1.84, 1.25, 1.9, 1.6, 2A, £1.34, 2.6A 0.15, G 6A £2.82, 20mm Quick Blow 100, 125, 160, 200, 250, 315, 400, 500, 630, 800mA, 1, 1.25, 1.6, 2, 2.5, 3, 15, 4, 5, 6, 3A, 40p, 20mm Time Delay 100, 125, 160, 200mA £1.80, 250, 315, 400, 500, 630, 800mA £1.00, 1, 1.25, 1.6, 2, 2.5, 3, 15, 4, 5, 6, 3A 85p, 1" mains, 2, 3, 5, 7, 10, 13A 85p

BRIDGES

1/2A 50V **0.27**
 100V **0.28**
 200V **0.32**
 400V **0.40**
 600V **0.67**
 800V **0.88**
 2A 100V **0.52**
 400V **0.58**
 600V **0.61**
 800V **0.67**
 5A 100V **0.78**
 200V **2.40**
 600V **3.50**
 25A 50V **2.05**
 100V **2.25**
 200V **2.40**
 600V **3.95**

GENERAL DIODES

400mW Plastic 3V-75V 8p each 10/5p
 1.5W Flange 4-7-17V £1.26 each
 2.5W Plastic 7.5-75V 87p each
 20W Stud 7.5-75V £1.31 each

INTEGRATED CIRCUITS (IC) EACH

AN240P **3.42** SN76503P **1.40**
 AN214QQ **3.88** SN76533N **1.80**
 AN7150 **2.98** SN76650N **1.05**
 CA3065 **1.75** SN76220N **1.80**
 CA4031P **2.88** SN76666N **0.80**
 CA4102 **3.30** STK015 **6.50**
 CA4250 **3.80** TA7108P **3.20**
 CA4407 **3.07** TA7120P **3.80**
 CA4422 **3.07** TA7129AP **3.65**
 LC7120 **5.33** TA7130P **1.85**
 LC7130 **8.26** TA7172P **1.80**
 LC7137 **1.18** TA7175P **1.80**
 LM380N **0.80** TA7172P **1.80**
 LM1303N **2.82** TA7176 **4.50**
 HA1151P **3.12** TA7202P **4.18**
 MC1307P **1.88** TA7204P **3.80**
 MC1310P **1.85** TA7205AP **1.80**
 MC1312P **2.25** TA7208P **3.27**
 MC1327P **1.25** TA7210P **6.80**
 MC1330P **0.83** TA7221P **3.90**
 MC1349P **1.85** TA7223P **3.68**
 MC1350P **1.20** TA7227P **1.80**
 MC1351P **2.50** TA7310A **6.80**
 MC1352P **1.80** TA7609P **4.28**
 MC1357P **2.88** TA7611AP **2.88**
 MC1358P **1.30** TAA263 **2.48**
 MC1496P **1.18** TAA310A **2.65**
 ML215 **2.80** TAA550 **2.80**
 ML232B **2.10** TAA570 **1.95**
 ML237B **2.30** TAA611A12 **3.50**
 M555 **0.28** TAA611B12 **2.65**
 C-mos 555 **0.88** TAA630S **1.80**
 NE555 **0.80** TAA661B **1.70**
 SAA1024 **0.85** TAA700 **2.80**
 SAA1025 **1.80** TAA840 **3.35**
 SAA550 **2.80** AD100 **2.80**
 SAS560S **1.85** FM FILTER **1.20**
 SAS970S **1.85** TBA120A **1.00**
 SAS980 **2.85** AS, S, SA, SB **1.20**
 SA5590 **2.82** Q T U U Q **1.32**
 SO9503P **1.10** TBA120B **1.30**
 SL432A **4.00** TBA231 **1.45**
 SL901B **8.20** TBA281 **2.65**
 SL917B **6.25** TBA395 **1.80**
 "V" **1.10** TBA480Q **1.50**
 SN7603N **2.44** TBA400 **2.30**
 SN76013 **1.90** TBA510 **2.80**
 SN76032ND **2.90** TBA510C **2.60**
 SN76033N **2.46** TBA520/Q **1.60**
 SN76110N **1.12** TBA530/Q **1.30**
 SN76115N **2.00** TBA540/Q **1.40**
 SN76131N **1.86** TBA550/Q **1.82**
 SN76226ND **1.80** TBA560C **1.70**
 SN76227N **1.10** TBA560CQ **1.40**

BRITISH TELECOM
 A-PROV

PLUGS & SOCKETS

BT Plug and 4 core lead **£1.28**
 BT Plug only **65p**
 BT/PC Insertion tool **90p**

BT Master Socket **£3.25**
 BT Secondary Socket **£2.28**
 BT 4 Core Cable 112/100M Drum **£12.10**
 BT Plugs 4-Way 58p each 10/55

SOLDERING SECTION

Antex 15W iron **5.00**
 Antex 18W iron **5.00**
 Antex 25W iron **5.20**
 Antex elements **2.00**
 Antex bits **0.95**
 Antex stands **1.90**
 Soldersucker **4.50**
 Spare nozzles for Soldersucker **0.45**
 Antex Soldering station complete with 1 iron-30W or 4DW **49.95**
 25W kit - iron with 13A plug and stand **6.40**
 15W KIT - iron with 13A plug and stand **6.20**

SERVICE MIX

All Servical Products
 Switch Cleaner **1.00**
 Circuit Freezer **0.96**
 Foam Cleaner **0.84**
 Aero Klean **0.78**
 Silicone Grease (Aerosol) **1.00**
 Antistatic Spray **0.88**
 Plastic Seal **0.82**
 Excel Polish **0.82**
 Fire Extinguisher 600g **2.80**
 Video Head Cleaner **0.88**
 Solder Mop (Std) **0.72**
 Solder Mop (L/Gauge) **0.72**
 Additional p/p on above 30p

POWER LEADS 4 Way Spider Plugs 65p

1985 CATALOGUE

Send now for our latest catalogue - 123 pages - packed with complete range of components - fully illustrated price 65p per copy. Includes 30p credit note, special offer sheets, order form and pre-paid envelope.

NI-CAD Ni-Cad charger, PP3 AA CD Prices

Universal **£6.00**
 Ni-Cad charger **£4.48**
 PP3 AA CD Price **£16.00**

CHART RECORDERS

Brand new 5 channel pen recorders complete with charts spares kit. Full spec upon request. Once only bargain 65p + £10.95 plus 15% VAT

TRANSFORMERS - All 240V primary

4.5 0-4.5v 400 mA 50p
 50p 45p 35p 30p
 58p 50p 43p 40p
 0-6v 500 mA 65p
 60p 48p 45p
 Carriage-45p per transformer, £1.60 per 10, £4.50 per 100, £30 per 1000

EUROPEAN ADAPTORS

These very high quality British made two pin European adaptors are ideal for driving British cassette recorders, TV games, calculators etc. The adaptors fit in the UK shaver socket.

DC Voltage Current 1-10-100-

EO8 4.5V 200mA/1 50p 45p 32p
 EM3 200mA/1 £1.80 80p 55p
 EO9 6V 400mA/1 £1.50 £1.25 85p

C-MOS

25C1969 **2.88**
 25C2028 **0.73**
 25C2029 **1.00**
 25C2078 **1.05**
 25C2081 **0.73**
 25C2098 **2.90**
 25C2122A **2.20**
 25C2156 **1.20**
 25C2314 **0.80**
 25C2335 **1.50**
 25C2749 **2.70**
 25C2752 **2.80**
 25D234 **0.54**
 25D348 **3.30**
 25D986 **0.82**
 25K134 **0.28**
 25K135 **1.90**
 3N126 **1.90**
 3N211 **2.52**
 3K415 **0.78**

ROTARY POTS

0.5W CARBON
 LOC 4K - 2M2
 IN 1K - 2M2
 32p ea 10 for £3
 Any 100 for £27.50

VEROBOARD

3/4 x 3/4 **0.81**
 2/4 x 5 **1.00**
 2/4 x 17 **3.25**
 3/4 x 17 **1.05**
 1/4 x 11 **1.18**
 3/4 x 17 **4.10**
 4/4 x 17/4 **4.95**
 Pkt of 100 pins **0.90**
 Spot face cutter **1.48**

IC SOCKETS

D11 to D11
 8pin **0.70/10**
 14pin **0.10**
 16pin **0.11**
 18pin **0.14**
 22pin **0.21**
 24pin **0.28**
 28pin **0.36**
 40pin **0.34**
 BNC 50R Plug
 PL259 - Male Plug

Pin insertion tool **1.80**
 Vero wiring pen **1.50**
 Dip board **3.85**
 Vero Strip **1.28**

IC SOCKETS

D11 to D11
 8pin **0.70/10**
 14pin **0.10**
 16pin **0.11**
 18pin **0.14**
 22pin **0.21**
 24pin **0.28**
 28pin **0.36**
 40pin **0.34**
 BNC 50R Plug
 PL259 - Male Plug

REGULATORS

9 15 25 78L05 **30p**
 MALE way way way 78L12 **30p**
 Solder lugs 0.80 1.05 1.60 78L15 **30p**
 Angle pins 1.50 2.10 2.50 7805 **55p**
 FEMALE 7812 7815 **55p**
 Solder lugs 1.05 1.60 2.00 7815 **55p**
 Angle pins 1.65 2.10 2.90 LM317K **3.80**
 COVERS 0.85 0.80 0.80 LM317T **90p**
 LM340KC £1

MULTIBLOCK

Multiblock 4-Way Extension Socket
 PVC body with internal cable grip fitted with 13A fuse and neon indicator. Market load 13A 250V, length 10 1/2" Width 2 1/2"
 Price £3.90 each (p/p) 25p in addition to 35p normal charge
 13A Mains Plugs 40p 10p/£3.80

PLUGS & SOCKETS

Metal Co-ax Plug **0.18** 10/1.50
 Plastic Co-ax Plug **0.10** 10/1.20
 Single Junction Socket **0.80** 10/8.00
 Plastic Phone FM Plugs **0.20** 10/1.75
 1PL259 **0.38** 10/3.50
 Reducer **0.15** 10/1.25
 1/4in Plastic-Mono Plug **0.30** 10/2.30
 2.5mm Plug Metal **0.15** 10/1.40
 3.5mm Plug Metal **0.16** 10/80p
 2.5mm Chassis Socket **0.10** 10/1.20
 2pin 1/4in Mono Chassis Socket **0.14** 10/1.78
 4pin 1/4in Mono Chassis Socket **0.20** 10/2.70
 6pin 1/4in Mono Chassis Socket **0.30** 10/1.25
 4mm Banana Plug - R or B **0.15** 10/1.20
 4mm Banana Socket - R or B **0.15** 10/80p
 PP3 Battery Connectors **0.08** 10/1.25
 PP3 Battery Connectors **0.15** 10/1.25

TRANSISTORS

BC108 **0.10**
 BC109 **0.10**
 BC113 **0.14**
 BC114 **0.12**
 BC115 **0.12**
 BC116 **0.15**
 BC117 **0.22**
 BC119 **0.30**
 BC125 **0.15**
 BC140 **0.28**
 BC142 **0.42**
 BC151 **0.10**
 BC152 **0.08**
 BC154 **0.12**
 BC159 **0.10**
 BC160 **0.30**
 BC161 **0.30**
 BC168B **0.12**
 BC170 **0.18**
 BC170B **0.14**
 BC171 **0.10**
 BC172 **0.10**
 BC173 **0.08**
 BC174 **0.09**
 BC175 **0.09**
 BC182L **0.14**
 BC183 **0.09**
 BC183L **0.08**
 BC184 **0.10**
 BC184L **0.10**
 BC188 **0.12**
 BC207 **0.15**
 BC208 **0.16**
 BC212 **0.09**
 BC212L **0.08**
 BC213 **0.10**
 BC213L **0.10**
 BC214 **0.10**
 BC215 **0.12**
 BC216 **1.25**
 BC219 **3.82**
 BC220 **3.60**
 BC221 **1.80**
 BC223 **0.80**
 BC225 **0.86**
 BC232 **0.45**
 BC233 **0.80**
 BC234 **0.82**
 BC235 **0.83**
 BC236 **0.83**
 BC239C **0.14**
 BC251 **0.12**
 BC254 **0.14**
 BC301 **0.30**

TOGGLE SWITCH

SPST-2 TAG **65p**
 SPDT-3 TAG **85p**
 DPDT-6 TAG **85p**
 (C-off)

ROTARY SWITCHES

1p12W **40p**
 2p6W **40p**
 3p4W **40p**
 4p3W **40p**

TRANSISTORS

BC108 **0.10**
 BC109 **0.10**
 BC113 **0.14**
 BC114 **0.12**
 BC115 **0.12**
 BC116 **0.15**
 BC117 **0.22**
 BC119 **0.30**
 BC125 **0.15**
 BC140 **0.28**
 BC142 **0.42**
 BC151 **0.10**
 BC152 **0.08**
 BC154 **0.12**
 BC159 **0.10**
 BC160 **0.30**
 BC161 **0.30**
 BC168B **0.12**
 BC170 **0.18**
 BC170B **0.14**
 BC171 **0.10**
 BC172 **0.10**
 BC173 **0.08**
 BC174 **0.09**
 BC175 **0.09**
 BC182L **0.14**
 BC183 **0.09**
 BC183L **0.08**
 BC184 **0.10**
 BC184L **0.10**
 BC188 **0.12**
 BC207 **0.15**
 BC208 **0.16**
 BC212 **0.09**
 BC212L **0.08**
 BC213 **0.10**
 BC213L **0.10**
 BC214 **0.10**
 BC215 **0.12**
 BC216 **1.25**
 BC219 **3.82**
 BC220 **3.60**
 BC221 **1.80**
 BC223 **0.80**
 BC225 **0.86**
 BC232 **0.45**
 BC233 **0.80**
 BC234 **0.82**
 BC235 **0.83**
 BC236 **0.83**
 BC239C **0.14**
 BC251 **0.12**
 BC254 **0.14**
 BC301 **0.30**

TRANSISTORS

BC108 **0.10**
 BC109 **0.10**
 BC113 **0.14**
 BC114 **0.12**
 BC115 **0.12**
 BC116 **0.15**
 BC117 **0.22**
 BC119 **0.30**
 BC125 **0.15**
 BC140 **0.28**
 BC142 **0.42**
 BC151 **0.10**
 BC152 **0.08**
 BC154 **0.12**
 BC159 **0.10**
 BC160 **0.30**
 BC161 **0.30**
 BC168B **0.12**
 BC170 **0.18**
 BC170B **0.14**
 BC171 **0.10**
 BC172 **0.10**
 BC173 **0.08**
 BC174 **0.09**
 BC175 **0.09**
 BC182L **0.14**
 BC183 **0.09**
 BC183L **0.08**
 BC184 **0.10**
 BC184L **0.10**
 BC188 **0.12**
 BC207 **0.15**
 BC208 **0.16**
 BC212 **0.09**
 BC212L **0.08**
 BC213 **0.10**
 BC213L **0.10**
 BC214 **0.10**
 BC215 **0.12**
 BC216 **1.25**
 BC219 **3.82**
 BC220 **3.60**
 BC221 **1.80**
 BC223 **0.80**
 BC225 **0.86**
 BC232 **0.45**
 BC233 **0.80**
 BC234 **0.82**
 BC235 **0.83**
 BC236 **0.83**
 BC239C **0.14**
 BC251 **0.12**
 BC254 **0.14**
 BC301 **0.30**

TRANSISTORS

BC108 **0.10**
 BC109 **0.10**
 BC113 **0.14**
 BC114 **0.12**
 BC115 **0.12**
 BC116 **0.15**
 BC117 **0.22**
 BC119 **0.30**
 BC125 **0.15**
 BC140 **0.28**
 BC142 **0.42**
 BC151 **0.10**
 BC152 **0.08**
 BC154 **0.12**
 BC159 **0.10**
 BC160 **0.30**
 BC161 **0.30**
 BC168B **0.12**
 BC170 **0.18**
 BC170B **0.14**
 BC171 **0.10**
 BC172 **0.10**
 BC173 **0.08**
 BC174 **0.09**
 BC175 **0.09**
 BC182L **0.14**
 BC183 **0.09**
 BC183L **0.08**
 BC184 **0.10**
 BC184L **0.10**
 BC188 **0.12**
 BC207 **0.15**
 BC208 **0.16**
 BC212 **0.09**
 BC212L **0.08**
 BC213 **0.10**
 BC213L **0.10**
 BC214 **0.10**
 BC215 **0.12**
 BC216 **1.25**
 BC219 **3.82**

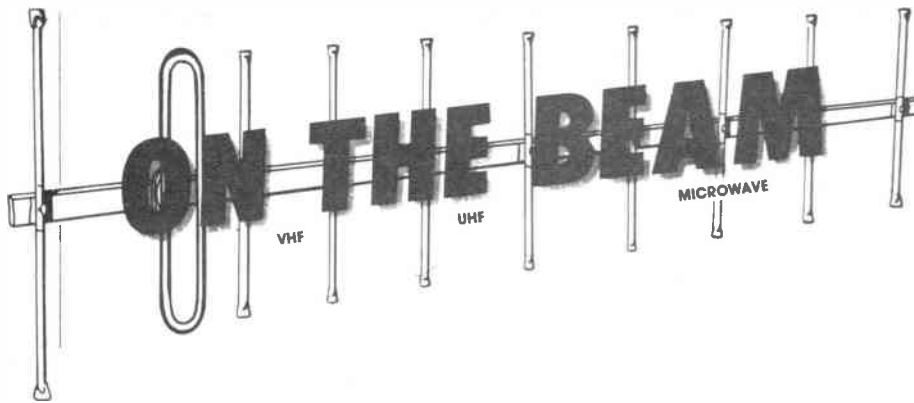

News and comment from Glen Ross G8MWR

Class 'B' Morse

In the looking ahead spot in the January edition we remarked that class B Morse might be here a lot sooner than you expected. We were right! It was, in fact, announced just a couple of days too late to get the news into the January issue but, from the leaked information going the rounds, it was obvious that it could not be far away.

The news was finally released at the AGM of the RSGB and was received with cheers of delight. This is something that the RSGB has been working towards for a long time and anyone who has had to negotiate with government departments will realise that the only way is to tread very slowly; any hint of pressure and they close up like a clam.

They are also not to happy about any publicity concerning what is going on and in fact the 50MHz experiment was held up for a long time due to just that. Taking all things into account the RSGB must be congratulated on the outcome of the negotiations.

All amateurs

We have received a lot of correspondence about this matter. The two main points are as to how you go about getting authority and, because the letters are coming from the RSGB, is it for RSGB members only? The answer to the second one is that it is available to everyone on request. The method of obtaining the 'letter of variation' is to write to the RSGB, 'Lambda House', Cranborne Rd, Potters Bar, EN6 3JW, including two stamps to cover the cost of correspondence, and simply ask for the letter.

It will help them if you mark the envelope 'Class B Morse'. The letter does not come into effect until the 1st April but it is advisable to apply as soon as possible. A lot of people, when first hearing the news, refused to believe it simply because of the starting date.

Many people have asked why it is required to apply to the RSGB and why a notice was not published in the *London Gazette* to modify the existing licences. This is due to the fact that one of the main

reasons for reluctance on the part of the authorities was the amount of paperwork that would be involved in issuing the letters. The RSGB neatly pulled the rug from under them by saying that they would look after that side of things.

As to why the letters are required in the first place, it is due to the fact that the powers that be have authorised the 'experiment' for a period of one year only and they wish to be able to judge the amount of interest that exists. This would obviously have been impossible if a general notice had been issued.

What now?

Whether we get this facility on a permanent basis depends on the amount of interest which class B operators produce. It is therefore *absolutely essential* even if you are not going to use Morse yourself that you apply for the permit to do so. Only if there is a deluge of applications can we be reasonably sure that class B Morse will be written into the licence in a year's time. It really is up to you.

At the moment there is no firm news of any restrictions on the use of Morse apart from the obvious one that you cannot go on the HF bands, and it seems likely that you will, in effect, have a class A licence restricted to frequencies above 144MHz.

It seems probable that, because there is going to be some lousy Morse flying around, you will have to send your callsign vocally at the start and finish of each period of sending, but this is a very small price to pay for the advantages which we are getting. As to any power or frequency restrictions which may be written in, we will let you know as soon as we get the news.

What next?

We got it right about the class B Morse, will we also be right with our forecast that crossband (HF to VHF) will soon be here? It is so obviously something that ought to be in the licence and it is very difficult to see how it could produce any problems. Perhaps next year?

Incidentally, while we are on this

subject, let us restate the fact that it is just as illegal for a class A operator to work from, say, 28MHz to 50MHz as it is for a class B operator to work crossband from 144MHz. In both cases the operator is working to a band that he is not licensed to use. It is rather distressing to see some of the amateur radio press, including the RSGB's *Radio Communication*, not only condoning this practice but actually publishing the results obtained. I am not trying to be a killjoy, but if it is OK for one section to bend the rules then it should be a case of *all for one and one for all*; perhaps class B operators are more law abiding?

Microwave moves

As from January 1st the section of the 10GHz band recommended for wide band FM use has moved from 10.37 to 10.4GHz. In fact the vast majority of stations moved up immediately after the end of last year's contest season. The Microwave Society tuned up about fifty systems at the Leicester show and a similar number were returned at the RSGB's Sheffield microwave workshop event.

It seems as though some people in the southeast of the country are staying on 10.1GHz due to the fact that they get a lot of contacts into the continent and the feeling is that the continentals will stay put. In fact the current information seems to be that a lot of them are either going to move up or will have the facility to tune the whole band. It looks as though there may be a split of interest for a while and the best advice we can give to newcomers is to check what your local operators are doing. North of Watford you should have no trouble; 10.4GHz rules.

Talkback will be the same as last year, centred around 144.175MHz, which works well except for the odd occasion when there is a two metre contest on and then the 10GHz man gets the impression that he is trying to operate in two contests at once! The exact dates for this year's cumulatives are not yet known but they will be held each month from May to September.

The Microwave Society will be running contests to coincide with the European SHF/Microwave events and all dates will be announced as soon as they are available. There is a strong feeling that the present contest activity is no longer appropriate and that it would be much better to have regular activity days; for example, on the first Sunday of each month. Five events are no longer enough in view of the tremendous increase in activity on this band: in fact it is now very difficult to find a weekend when there is not some activity, to the extent that there were several stations operating portable in the Midlands on Boxing Day!

Certificates

Another item in last month's edition was the announcement of the new certificates and these have already brought in a lot of interest.

One comment that has been made by several people is that they like the idea of having to achieve several aims to get

ON THE BEAM

the wallpaper rather than just chase squares or whatever. This really is the whole point of the exercise, if you are just after new squares then the tendency is to keep listening until you hear a new one and then grab it. What this means in practice is that you tend to spend a lot of time listening instead of talking and you become one of the vast army of *licensed listeners* with which we are now blessed.

Once you have amassed a reasonable score your only real chance of adding more is to wait for the next big lift and so it goes on. We think that if you have to achieve certain standards in different areas to get the award then this is going to mean spending a lot of time on the air, after all some counties are not very radioactive and you may catch someone on in conditions that are far from 'lift'.

Another point that has received favourable comment is the fact that we all started on the 1st January this year. This seemed to us such an obvious idea that we had not realised how much comment we would get on this point. It means that it will be some time before anyone gets the award but at least we all start from scratch.

QSL cards must be available to confirm each contact but the same card could be used in more than one group. A card, from GM9ZZZ for example, could be used to confirm a square, county, country and even the distance category. When

you claim your award you will need to send in a list of the QSLs you hold to confirm each section but *not* the cards. We will then make a random selection of a few cards that we want you to send to back up your claim and, assuming everything is in order, your cards and the certificate will be on the way to you.

No records will be kept so if you want to update to a higher grade it will be treated as a new claim. The awards are also available to VHF listeners, of course.

Getting the cards

The best way of getting the cards is to use the RSGB QSL bureau system. Many people are not aware that you can use the system without being a member of the RSGB. The only snag is that a non member can only use it on an inward basis, not to send cards out. This is because sending cards out costs postage and you can't really expect to get something for nothing.

You will need to send some stamped SAEs to the person who handles your incoming cards, with your callsign clearly marked in the top left hand corner. (The address of the person who handles your cards can be obtained from the RSGB at the address given earlier in the article). Do not expect to get cards back in a week, the manager will wait until your envelope is reasonably full before sending it on to you. Do not give

up hope of receiving that QSL card you are still waiting for: I recently received a card from an LA station confirming a contact made seven years ago!

Things to do

Listed in the table are some dates for your diary of the contests and rallies that we have been informed of so far. These and our new certificates should be enough to keep you going for some time. If you have details of rallies, contests or other activities please send them to me at 81 Ringwood Highway, Coventry, from where you can also get details of the certificates and get your Maidenhead locator computed for you if you send details of your latitude and longitude. Please enclose an SAE, or at least a stamp, with your enquiry.

CONTESTS AND RALLIES

Feb	10th	70MHz cumulative contest
	17th	432MHz fixed contest
	24th	70MHz cumulative contest
March	2/3rd	144/432MHz contest
	10th	70MHz cumulative Northern Rally at Belle Vue Pontefract Rally
	24th	70MHz cumulative White Rose Rally at Leeds
	31st	432MHz CW contest
April	21st	70MHz contest Lough Erne Rally at Enniskillen

50ft aluminium masts. Kit contains 10x5ft interlocking poles 2in dia complete with guys, base & stakes. As new £65 p/paid (callers £50)

12ft aluminium mast 3x4ft screw in sections (2in dia), 1x50ft coax cable. 4 guy ropes complete in canvas bag £16 p/paid (callers £12)

Ex-govt 27ft telescopic aerial close to 5ft good condition, complete with base & fittings £45 p/paid (callers £25)

Fibreclass aerial sections 3ft x 1½ dia push-in type. £2.50 per section, min 5 p/paid

Steel 2in dia interlocking mast section 4ft length, £4 each section p/paid

4ft collapsible whip aerial ex-govt £1 each p/paid

Bases for whip aerials tank type £2.50 each, p/paid

For callers only - 24ft steel whip aerial 6ft sections (as new) £12 each

(Few only) Tank whip aerial 3x4ft sections (12ft) £5 p/paid

Opening times: Monday-Friday 8.30-5.00pm, Saturday 8.30am-12am
Please allow 14 days for delivery. Mainland only

A.H. THACKER & SONS LTD
HIGH STREET, CHESLYN HAY NEAR WALSALL, STAFFS

AMATEUR ELECTRONICS UK

G6XBH **R.A.S. (Nottingham)** G8UUS
Radio Amateur Supplies
Tel: 0602 280267

Visit your Local Emporium
Large Selection of New/Used Equipment on Show

AGENTS FOR:
F.D.K
AZDEN
ICOM
YAESU
PORTOP ATV

ACCESSORIES:
Wetz Range
Microwave Modules
Adonia Mics
Mutek Pre-Amps
Barenco Mast Supports
DRAE PSU and
Wave Meters

AERIAL: Tonna, Halber, New Diamond Range of Mobile Whips
PLUS OWN
'Special' Q.R.P. GW5 HF5 Band Beams
JUST GIVE US A RING
Monday: CLOSED Tuesday - Saturday: 10.00am to 5.00pm

**3 Farndon Green, Wollaton Park, Nottingham, Off Ring Road
Between A52 (Derby Road) & A609 (Ilkeston Road)**

HATELY ANTENNA TECHNOLOGY (GM3HAT)
1 Kenfield Place, Aberdeen AB1 7UW
Scotland, UK
DIPOLE OF DELIGHT

NEAT & TIDY - preserves visual amenity of small city gardens Works in attic. EFFECTIVE & BROADBAND - simple NO-TUNE with modern semiconductor PA's COAX-FED + CAPACITIVE BALUN - no antenna can claim better 'ANTI-TV' behaviour

NEW YEAR NEW PRODUCT. DUAL BANDER for 80 and 40 metres bands DD 3 65/7 Smart and Lightweight 1kw pep. Low VSWR. Quiet background

MULTIBANDERS	DD 3.65/7 length 42m (138ft)	£48.50	Unified Price structure
	DD Europe 7/21 21m (69ft)	£28.00	
	DD USA 7/21 21m (69ft)	£28.00	
	DD 10/18/24 15m (50ft)	£38.00	
	DD 14/21/28L 10.7m (36ft)	£48.50	
MONOBANDERS	DD 7/14/21/28L 21m (69ft)	£38.00	UK inc VAT First C1 Post OX exempt VAT Airmail Parcel Post
	DDM 10 length 15m (50ft)	£23.00	
	DDM 14 10.7m (36ft)	£15.50	
	DDM 21 7m (24ft)	£11.50	
	DDM 28 5.8m (19ft)	£11.50	Cheques ANY CURRENCY where allowed

Price includes waterproofing sleeve for connector and inconspicuous insulators. Does not include coax or PL259 required. For UK purchasers of antenna, recommended 5mm 50ohm coax at 30p per metre & PL259 inc reducer at £1 parcel post paid. SAE for full technical details (2 IRC's for DX Airmail). 1 month money back guarantee.

Prepared by: Maurice C Hately, B Sc (Eng), M Sc, MIEE Chartered Electrical Engineer

RTTY AND CW TRANSCEIVE WITH NO TERMINAL UNIT

This fantastic program interfaces direct with your rig, slashing the cost of previous systems. Split screen, type ahead, all the usual features and more. Tape and kit for the very simple interface, including PCB and User Port connector, for only £20.00. Ready-made interfaces available. For CBM64, BBC-B, and VIC20 (+ at least 8k). CW-only version for SPECTRUM £10

And four superb programs for CBM64, VIC20, BBC-B, SPECTRUM

LOCATOR QTR or Maidenhead locator or lat/long. Distance, headings, contest points, converts between locator and lat/long. Tape £8.

LOGBOOK Date, band, mode, call and remarks. Superfast callsign search. Easy, fast updating of files. Screen/printer output. VIC20 needs at least 8k expansion. Tape £8.

MORSE TUTOR Britain's best. Learn fast in easy stages from absolute beginner to over 40 wpm. Join the hundreds who have succeeded with this program. Tape and full learning guide £5. For ZX81-10k also.

RAE MATHS All the practice and testing you need. Tape and comprehensive reference sheet detailing all you need to know. VIC20 needs expansion (any). For ZX81-10k also. Don't let maths make you fail. PASS with this program.

All programs are very easy to use and come with full instructions. Prices include p&p 1st Class by return. Add £1 per tape if outside UK or Ireland.

technical software (AR)
FRON, UPPER LLANDWROG, CAERNARFON,
GWYNEDD LL54 7RF. Tel. 0286 881886

QSL CA

Terry Weatherley

QSL cards come in all shapes and sizes and vary from the very simple to the very ornate. All, of course, give the basic details of the time and date of the contact together with the details of the owner's station and usually a cheery message. In this article I will illustrate from my collection the various types of card in circulation. Indeed a collection of 'types' can be as interesting a collection for DXCC.

Many cards are rather like the author's own - G3WDI - functional. They feature a large callsign and space for the contact and station details. Neat and tidy but hardly artistic. Let's look at some of the alternatives to this, the 'bread and butter' card.

The view cards of VE1TG and 9H4H are two examples which have the call and location printed over a view of the home state, town or village. Sometimes there is a line drawing and/or a map to help locate the town and give something of its flavour. DB2BP's card shows this type clearly.

The 9J2DT card shows a variation of this style. An animal indigenous to the country is used. The card is supplied by the Zambia National Tourist Board and carries the message 'Greetings from Zambia' on the back. The QSL is seen by Zambia, at least, as a means of spreading goodwill for the country of origin.

When I was newly licensed, ten metres was 'wide open' and with 50 watts of AM you could work the world. Contacts with the USSR were very easily made and the UAs always QSL. Many of the Russian cards showed the latest Russian space probe. On UTSME's card Yuri Gagarin (licensed as UA1LO but that's another story) is shown after his first spaceflight, on April 12th 1961. UK5QAO's card shows the Lunik of 1966, while UB5FWJ shows the dogs Weterok and Ugolyok, who flew in Cosmos-110 and landed on March 16th of that year. Also from 1966, we have the

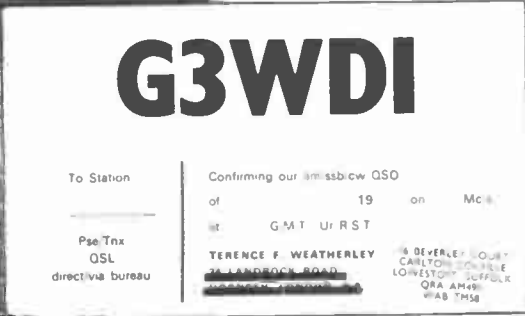

9J2DT



©1966 American & British...
The logo Weterok and Ugolyok...
JONAS... and...
1966

RD ART

erley G3WDI

LUNA 10 orbiting the moon. RA6HCF shows the Venura probe of 1967. RA1WAP shows Soyuz 4 and 5 linking together with a cosmonaut space-walking between the two in 1969. K2UTC's card is the only one to show the Americans on the moon.

Other Russian cards show 'heroic scenes' but some show folk heroes. I am curious to know the origin of the character on one card sent by a Russian short wave listener (UB5064247), as he looks most un-Russian, almost like an English squire.

Some cards show the operator either in a photograph, like DJ9NY, or as a cartoon showing the operator and his location (SM6CVX). One such cartoon shows the operator DK4VK and his fab 'gear'.

Other cards too, raise a smile. DB5YH's card shows a TV set suffering TVI together with the irate viewer. A 'thinks balloon' shows the expected football match. The card from OH2WQ which says 'your effort has not been in vain. You have now worked a Finnish station' is also amusing.

Blatant advertising is rare, although some commercial organisations will supply QSL cards for licensed employees. ZS6ZE's card bears a discrete Mullard symbol. The only card I have that is a pure ad is the listener card G13863, carrying a reproduction of a famous Guinness ad (Guinness is... well Guinness).

While looking through my collection I came across the card showing two skaters. 'Ah', I thought, 'Torvill and Dean have received the final accolade', but no - it was from RA6LWA for a contact on ten metres in 1970!

A display showing the different styles and types would certainly brighten the shack and prove an interesting talking point for amateur and non-amateur alike. QSLing is an 'art' in more ways than one.



A MULTI-BAND GROUNDING ANTENNA

by John Heys G3BDQ

In January 1984 I had an article published in *Amateur Radio* which was entitled 'Grounded Half Delta Loops'. This was one of the very few antennae I have discussed which was not actually based upon personal experience. Instead, I relied upon the wisdom of the originators of the idea, Messrs Belrose (VE2CV) and DeMaw (W1FB) together with some limited operating experience of the antenna by a few friends.

Impossible

It was impossible for me to emulate such an antenna for Top Band and harmonic operation for I did not have the very necessary 80 to 100 foot tower! My garden and lawns are filled with the counterpoise and radial wires which are a must for LF DX work and I am sure my XYL would really leave home if a lofty lattice tower went up to further spoil the view. She already hints that the name of our house should be changed to 'Wiresend' or 'The Spider's Web'! This means I must make do with a 36 foot mast

at the bottom of the garden and a pole on the chimney stack rising to about 45 feet from the ground.

DX season

Towards the end of July my thoughts turned towards the coming 160 metre DX season and some possible improvements to the existing sky-wire situation. The antenna then was an inverted 'L' about 190 feet long, which sloped down towards the east. Its current maxima (the bit which does the work) on 1.8MHz was about 126 feet in from the far end and was most certainly not at the highest point in the system. The wire was dropped to the ground and 30 feet of wire was snipped off. This action brought the maximum current area on Top Band a quarter wave from the wire end which was at the high point 45 feet up. The rest of the wire sloped down above the roof slope to the upstairs shack window.

Tests over a few weeks showed that the change was for the better and it had enhanced the DX capability on 160

metres. Contacts with HZ1AB, UA9 and UL7 stations and many USA stations were made; W2BHM being worked in full daylight on August 12th. Amateurs are never fully satisfied however, and after further arrangements thoughts were again directed toward antenna improvements. Nowhere, apart from a couple of feet in the downlead, was there any good run of vertical wire along the antenna's length so it was decided that something new must be tried.

The *half-delta loop*, as described by its inventors, had a grounded vertical section (normally the tower) from which a 206 foot wire sloped down to ground level where it was fed with low impedance coax. My maximum height at the far end of my antenna arrangements was only 36 feet but I decided to have an earthed vertical wire of that length to come down from the end of my antenna. The most convenient place to locate this was above a small rectangular asparagus bed some halfway down the garden. This meant that the top wire had to be cut yet

Side elevation (not to scale) showing the antenna described by G3BDQ. The earthing and counterpoise system is far more elaborate than shown here

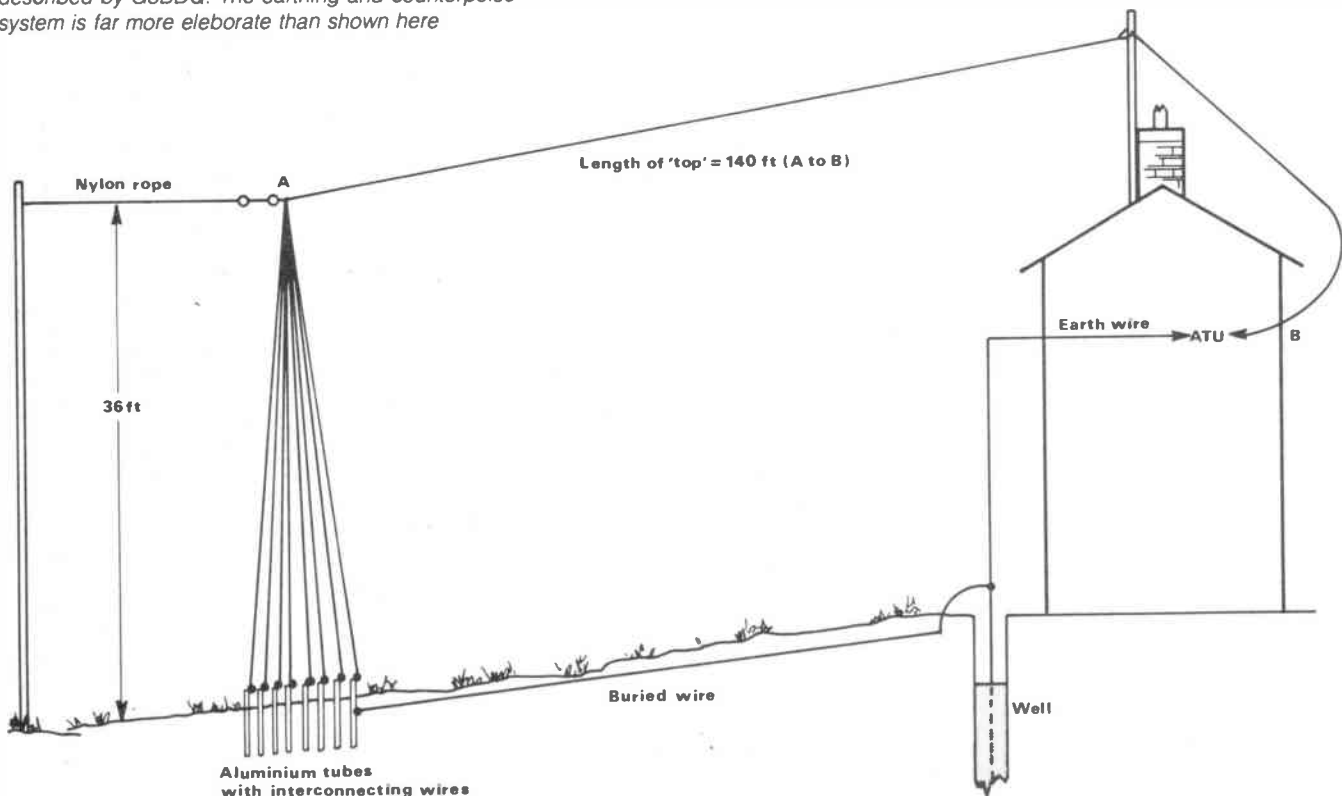

again, this time to 140 feet. I now had a 176 foot antenna, the last 36 feet of which came down vertically to the ground.

Good earthing

Articles about half delta loops stress the importance of good earthing at the foot of the vertical section, so I drove down about five feet of stout 1¼ inch diameter aluminium tubing to which the end of the wire connected. I also linked this earth tube with my main station/garden earth system which centres on an old well. The antenna was in no way resonant on any amateur band but the premise that any length of wire can be matched proved to be correct and the station ATU with an addition (see later paragraph) allowed an SWR of unity: the magic 1:1 on Top Band.

Tuning was in no way critical and frequency changes of plus or minus 40KHz could be made before the SWR rose to 1.5:1. This is very good for Top Band, many loaded verticals etc being most frequency conscious. Its 'flatness' or wide bandwidth is a characteristic of loop systems, which all exhibit an inherent low 'Q'. I always distrust any antenna which may be matched with a sharply tuned 1:1 SWR reading but which then needs a re-tune when only small frequency excursions are made to either side of resonance. This is a feature of short loaded antennae such as mobile whips using traps or loading coils.

The antenna as described was then given a good 'workout' on 1.8MHz and it was also surprisingly excellent on all the other bands up to 28MHz. Its performance on 7MHz was particularly good, for the vertical section worked as a vertical quarter wave radiator and many QSOs with real DX were made. Although during the winter particularly the writer's chief interest is the 160 metre band, many excursions are made to the other bands too and almost everything desirable that is heard is also worked, the writer often being 'first in the queue'.

Idle thoughts

Whilst away on holiday in September idle thoughts were turned as usual towards antennae, and seeing a VHF Discone atop a chimney stack in deepest Dorset triggered a fresh line of thought. On the first dry day following my return home the antenna was lowered and three additional 36 foot vertical wires were soldered to the end of the horizontal section. These additional three wires were thinner and lighter than the original down-wire and they were fanned out with each going to its individual aluminium rod at the corners of the asparagus plot, which measures approximately 6ft x 4ft. As the total antenna current in the vertical section is divided between the four wires a much thinner wire may be used. This reduction of current in each wire also means that the earth connection will be at a higher impedance and earth losses will be reduced. The thinner wire also reduces the possible strain upon the antenna supports.



A useful daytime check of antenna efficiency on Top Band is to take signal strength readings of a commercial CW station on about 1831KHz and also the constant carrier that seems to haunt 1825KHz. The 'S' readings do fluctuate from hour to hour and from day to day, but at my QTH they are both better than 20dB over S9 and represent useful signals for antenna tests. The new multi-wired vertical section seemed to have increased the strength of the marker signals by some 2 to 3dB so things started to look promising! With four wires the whole antenna also became even less frequency conscious and more broad-banded.

DX results

In late September and through most of October much Top Band DX was worked. My signals now had a greater proportion of vertical polarisation and the antenna seemed to reduce incoming and my outgoing signals after dark to middle distances; that is over the UK and into the nearer parts of Europe. No longer were PA0HIP or EA3VY blocking my receiver! At distances beyond 2,000 miles the improvement was dramatic for I received many S7 and S8 reports from the USA and was hearing things that were formerly down in the noise.

The antenna worked as well as ever on the other bands and 'plums' such as D68WB, 3B8FK, J28EG and A61AA were easily worked on 21 or 14MHz. The members of my local Top Band 'natter net' also noticed a big increase in my signal put out from the 2 watt AM rig. The strength of ground wave went up spectacularly; a station about 18 miles away who formerly never gave me better than S6-7 reported my signals at a new and consistent S9.

Similar system

One of the British Top Band stalwarts is Dave G4AKY who spent an hour or so at the G3BDQ homestead when visiting in the area. We discussed various Top Band

topics and antennae in particular. Dave surprisingly had adopted a similar antenna system at his new QTH where he faces a restriction in antenna length. He uses five vertical wires down from his horizontal top, and these are soldered to tin cans buried in the ground. His locals reported a 3dB increase in ground-wave signal when he went up from one vertical wire to five!

More down wires

Following his visit my antenna came down again and now it sports eight vertical down wires, each going to its own aluminium earthing rod. All these rods are inter-connected with heavy wires and go to the common earthing system. In the shack an ohm-meter between the free end of the antenna and the earth wires at the ATU shows no measurable resistance: certainly under 0.1ohm. This has the added bonus of being some protection against lightning, for the vertical section acts as a lightning conductor and the antenna cannot build up static charges.

All closed loop antennae have lower noise levels than open-ended systems such as long wires or dipoles. The QRN levels are reduced and it is often possible to work on through quite noisy conditions. On Top Band the antenna can be regarded as either a grounded loop or as a top loaded quarter wave. You pay your money and takes your choice!

On 160 metres the antenna shows some directivity along the line of the top wire, but it is not significant. It does in my case, however, reduce the strength of certain strong SM and EA stations which is a blessing when DX hunting. One SM by the way has six full sized vertical quarter waves which can be phased to work as a switched beam every 60 degrees round the compass. He also uses some 26Km of ground wire, but that is another story! On the other bands stations are workable from all over the globe with no noticeable nulls or gaps in the radiation pattern, and low angle radiation seems to be inherent.

Awkward impedance

Most, if not all, commercially made ATUs, even the very highly priced ones, cannot cope with very high or very low impedances. It is inevitable that on some bands the grounded loop will present the ATU with an awkward impedance which seems quite unmatchable, so the use of an 'outboard' 'L' section ATU is needed. I use one on Top Band and also on 7MHz, for here the shack ATU could not get the SWR below 1.7:1. The other bands can be tuned normally.

The very high or very low impedance of the antenna which normal ATUs cannot cope with (most only manage antenna impedances between 500 and 10 ohms) may be brought to a sensible value with the 'outboard' unit. This unit is a large coil with lots of tapping points and a variable capacitor (one end grounded) which may be connected by 'croc' clips to either end of the coil. This means that

both 'high-in low-out' and the converse can be handled. The output from the additional 'L' section then goes through the usual station ATU. The additional tuned circuit also reduces the chances of out of band signals going out or coming in!

'Batteries'

After he had seen my aluminium ground stakes and other bits of aluminium earthing arrangements G4AKY resolved to do something about his tin cans! In an earlier article dealing with earthing systems I stressed the advantages of aluminium over other metals for amateur earthing. Dissimilar metals should *never* be used, even when located some metres apart. Such use will create 'batteries', so increasing the chances of corrosion and certainly raising noise levels.

Soldering

One problem of course when using aluminium is that it is not easily soldered. Soldering to a hefty metal tube when it has been sunk into the ground for most of its length is far from easy even when the tube is made of copper, so the writer makes good mechanical connections with aluminium 'greenhouse' nuts and bolts, then liberally coats everything with a thick application of silicon

rubber sealant. This has proved to be very effective and the silicone rubber protects the connections through any weathering and also seems distasteful to the many creepy crawlies which inhabit my garden. My ants eat anything! The vertical down-wires may be arranged around a square, a rectangle, a circle or 'what-have-you' so long as they are equally spaced.

Improvement

The improvement gained in going up from four to eight down-wires has been marginal, so the use of four or five wires is adequate. Increasing the number of wires becomes an exercise of diminishing returns; at first the improvement is dramatic, and then it falls off. This is understandable, for when more than about eight or ten wires are used there is little to be gained. Such a number at HF (including Top Band) so close together in terms of wavelength resembles a solid cone of metal. This effect is also noticed when putting out radials for a ground plane antenna. To go from four to eight wires only seems to increase signals by half one dB. A better earthing and or counterpoise system will pay far greater dividends.

Should the reader only be able to have a vertical section no longer than 20 feet all is not lost. Such a length will still

provide useful advantages over a horizontal low wire. Although a full quarter wavelength on Top Band is around 126 feet, most of the radiated power will be from the lower half of this. The lucky types with 60 or 70 foot verticals for the band do very well indeed, for such a length will contain most of the high current section of the antenna.

My 176 foot wire plus an earth downlead of about 30 feet and then the 'L' section of the additional ATU brings the whole system to about a half wavelength on 1.8MHz. The ground 'image' below the antenna represents another half-wave loop so the whole thing is rather like a full wave quad loop. The designers of the half delta antenna wanted a low impedance feed so they had to make their systems resonant on the band. By using a matching device and bringing the end into the shack the antenna length is no longer critical.

Go vertical!

Using this kind of antenna do not expect tremendous signal reports from the UK or near Europeans outside your ground wave range (about 30 miles). If you want a big signal over the UK a 'low' dipole up at from 40 to 50 feet is needed; but such a beast will be almost useless for the real DX with its high angles of radiation. For the DX 'go vertical'.

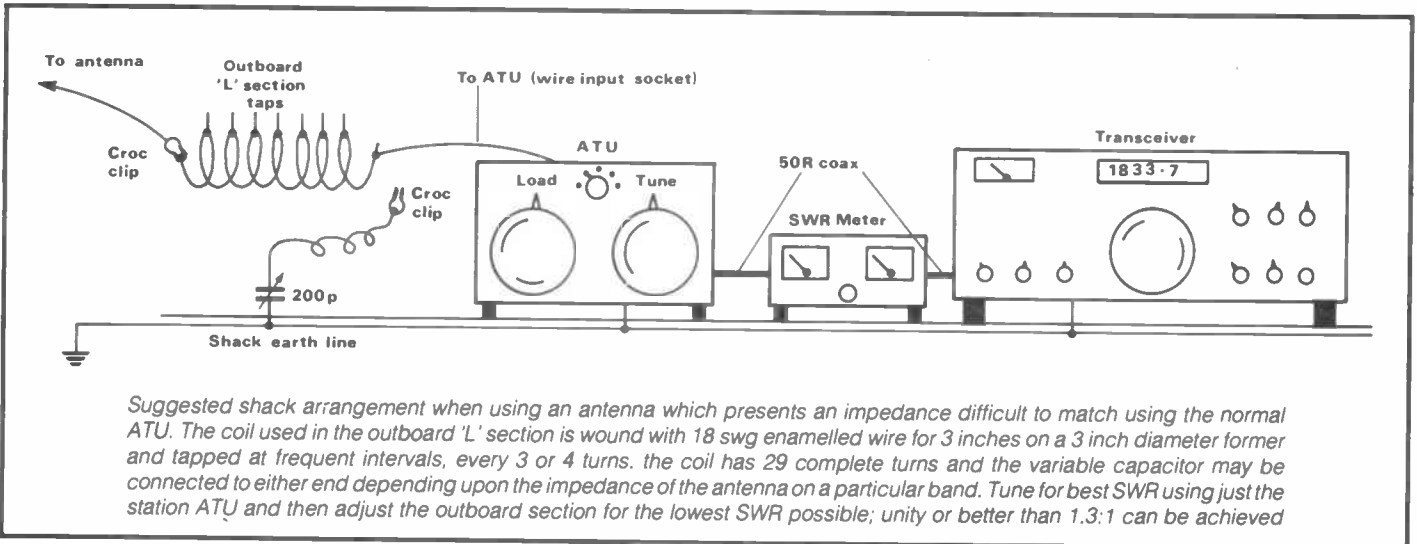

NEWSAGENT ORDER FORM

Amateur
RADIO
For all two-way radio enthusiasts

To (name of newsagent)

Please order a copy of *Amateur Radio* for me every month

NAME

ADDRESS

Newtrade distributors: Argus Press Sales & Distribution Ltd, 12-18 Paul Street, London EC2A 4JS. (Tel: 01-247-8233)

TAU

TAU SYSTEMS LTD
81 GREENEY PLACE
EAST DILLIBRANDS
SKELMERSDALE WNS 8SA
ENGLAND Phone: 0865 24662

INTRODUCING the REAL ATU
FULL COVERAGE, TUNES 1-5 CONTINUOUS TO 29-350 Mcs

NEW model SPC 3000

Special Features

- 1 Renowned "SPC" transmatch circuit
- 2 TAU innovative composite design*
- 3 Large speed Capacitors rated 5kV, leased to 7kV
- 4 Roller Coaster inductor infinitely variable
- 5 Balun built in, 1Kw, 4 to 1 impedance ratio
- 6 Transmitter switch, thro ATU or direct to antenna
- 7 Five position antenna switch to 5 input/outputs
- 8 Twin Meter automatic readout of SWR & Power
- 9 unsurpassable transmission strength and clarity
- 10 Solid, traditional precision radio engineering
- 11 Heavyweight, long-life construction
- 12 Superb ultra-compact cabinet design with tilt feet
- 13 Superlative finish and looks — compatible with all rigs
- 14 Will tune any Transmitter/Aerial combination to optimum
- 15 Lifetime investment — will never need replacing

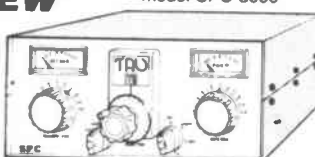

£349.95

including UK VAT
ex works, carriage extra

UNDOUBTEDLY THE FINEST ATU AVAILABLE — NOBODY MATCHES UPTO US! TAU SYSTEMS LTD

SHORT WAVE LISTENER

TREVOR MORGAN GW40XB

It's funny how people without an insight into a given hobby tend to be a bit offhand about those who are absorbed by their pastime. I suppose I am as bad as anyone else on this score as my television 'off' button is fully operational on Saturday afternoons while literally millions of soccer fans are glued to the box.

However, when you are involved in the same hobby, such as amateur radio, it is surprising how antagonistic or disinterested members of one branch of the hobby can be towards another.

It wasn't so long ago when it was a natural progression to start in the listening field and proceed to the HF operating part of the hobby via two metres. However, times change and now, in the days of so called 'black boxes', it is quite normal to have a newly licensed amateur on HF who has come straight from the tech onto the bands, having never used a receiver or even a two metre rig.

Now, there's nothing basically wrong with that, and in fact there are some very good operators on the bands today who have never used a receiver in their lives. But, these operators have missed not only the grounding that short wave listening gave the old timer (if you'll pardon the expression), but an intrinsic part of the overall hobby of amateur radio.

Many facets

This hobby contains many facets, among which short wave listening is just one. Yet, within the world of the listener there are as many branches as there are in the hobby as a whole. Further, within the listening fraternity there are those who have widely differing reasons for interest in amateur radio and methods of getting pleasure from the hobby.

Some time ago, a well respected ham mused that there are many separate and unique hobbies within the hobby and a distinct lack of affinity between the pro-

tagonists of each of the branches.

Closed shop

Hobbyists in general are well known to be somewhat *closed shop* within their own sphere, and whereas we would tend to regard a person who spent hours collecting bits of coloured rock as a bit odd we think nothing of personally spending hours separated from one's family in a sideroom or garden shed twiddling the knobs on a radio set. The hobbies are entirely different but the interest and devotion are the same.

So, with this in mind, why do so many amateurs regard the short wave listener as a lesser being? The same devotion to the hobby is there; the same keenness to learn all there is to learn about equipment and its use is evident on both sides.

As far as the manufacturing industry goes, the keen short wave listener will spend almost as much on receivers, antennae and various accessories as the average licensed amateur. Publishers could probably sell nearly as many magazines to listeners as they do to licensed

amateurs. The same goes for books and other items of interest to the short wave listener. The problem is that the listener is no longer taken seriously enough to make him a commercially viable proposition.

As a result of this less and less space is given over to listeners in magazines (which is where *Amateur Radio* scores with, on average, more listener orientated pages than any other magazine), less new equipment is available with some companies practically disappearing from the market, preventing new people from becoming interested in listening... the ever decreasing spiral.

So, having stirred up this month's hornets' nest, we will plod on with the main topic of the month.

Contests

Any weekend you can tune in to the amateur bands and hear calls of 'CQ CQ Contest'. To some they are the bread and butter of the game while to others they are, to put it very politely, a thorn in the backside! To the short wave listener they can be the means of hearing more pre-

fixes than at any other time or a waste of valuable space on already crowded bands. Whatever your feelings, they are part and parcel of this hobby of ours and can be cursed, ignored or worked... the decision is yours.

Many of the contests have a short wave listeners section and awards are given to those with the highest scores at the end of the contest, exactly as for the licensed operators for whom the contest was probably intended in the first place (there are special contests for listeners... more anon).

The idea

Basically, the idea behind the contest is to use your equipment and your knowledge to best advantage to make as many contacts as possible within a given period. Now this sounds simple in itself, but don't be fooled! Some people spend weeks ahead planning strategy, testing equipment, trying out wrinkles and checking propagation forecasts ready for the big day when, at the given time for the start of the contest, all hell will break loose on the frequencies in use!

CRAY VALLEY RADIO SOCIETY 14th SWL CONTEST 1984

Name and callsign	No of QSOs	Country multipliers	Total
CW SECTION SINGLE OPERATOR			
Donald Piccirillo BRS 52868	530	158	83740 ★
John Goodrick BRS 44395	517	143	73931
Dick Stanbridge RS 31879	291	108	31428
PHONE SECTION SINGLE OPERATOR			
Frans Van Oostenbrugge NL 4483	353	139	49067 ★
Raymond Binet ONL 6866	342	135	46170 ★
Jean-Jacques Yerganian ONL 383	287	154	44198
Norman Henbrey BRS 28198	250	150	37500 ★
Brenda Hunt BRS 46999	253	101	25553
Marc Domen ONL 6945	192	109	20928
Graeme Casselton RS 44984	143	83	11869 ★
Tony Aspinwall G SWL	155	72	11160
Mike Dawson BRS 44083	69	35	2415
Ewald Bartunek OE1 0140	44	28	1100 ★
Jan Wiollavz SP 0604 BB	33	27	981 ★
PHONE MULTI-OPERATOR			
David Whitaker & Arthur Miller	435	171	74385 ★
Marcus & Dominic Walden	233	109	25397

★ Certificate winners

Anyone who runs away with the idea that a short wave listener has any easier a time just doesn't know the name of the game.

The annual 'Contest Calendar' is printed and frequently updated in *Radio Communication*, the monthly organ of the RSGB. The calendar gives brief details of forthcoming contests and these are enlarged upon and necessary rules given in later editions.

So what is required to enter one of the many contests?

The details of the contest must be thoroughly studied well in advance. The organisers will have based their rules on definite guidelines and breaches of the rules can incur penalties. These can be simply a loss of points from your overall score but can also involve the disqualification of your valued entry!

Firstly, write to the organiser for a copy of the rules – unless they have been published. Secondly, check whether special log sheets are needed, if so these can be obtained from the organisers or the RSGB. Organisers seem to bear a close relationship to the chap who wrote your house insurance policy and it is advisable to read and re-read the rules to make yourself fully aware of them before the day.

Points

Points are usually awarded per contact with a mysterious thing called a multiplier which can either multiply the points scored at the time of contacting him or the total points scored overall or ... well, read it again!

Contests can take place on one band, or part of a band, or over the entire amateur spectrum so check carefully. Out of declared zone working also causes penalties.

Check which countries are taking part. This is important for two reasons. The first is obvious as trying to explain a contest operation to a non-participating party can be time-wasting and downright frustrating. Secondly, the old matter of propagation comes in to the act here as never before in your innocent listening life.

The short wave listener is on a par with the solo amateur in a contest as he usually has to do his own log keeping and checking as well as keeping

accurate scores, rolling his own fags and screaming at the kids to keep quiet!

Good terms

It is prudent, as the great day approaches, to be on good terms with the neighbours, who will undoubtedly suffer a sudden onset of the dreaded TVIs and the wife who, although knowing you're not down the pub with the lads, will be expected to keep you supplied with char and wads (tea and sarnies) for the period of the contest.

As far as equipment is concerned, you should already be aware of your receiver's ability, or lack of it, for DXing and should choose your contest accordingly. That aerial you've been using 'successfully' for ages could be a liability in some contests, all depending on the area to be covered and the bands to be used. The use of an ATU is of more importance in a contest than during that casual flip through the bands, and you may find the humble G5RV or endfed wire far better for contesting than that DXers dream of a beam because you will be listening for calls from all stations of the compass and the directionality of the beam would be a definite disadvantage here.

Audio filtering is a good bet and can make the difference between a contact and a 'got-away' with the bands crammed with stations all begging for points.

Headphones are a must for any serious contender. The super-duper hi-fi headphones so beloved during 'Bizet's Carmen' can be a positive drag on short wave. Those tweeters and woofers will pull in the QRM like magnets. Good communications headphones have the response 'tailored' round the range of the human voice so that a lot of the unwanted rubbish is excluded or at least reduced.

If you can't afford them, a pair of the cheaper lightweight phones could be used. Remember, you may be wearing them for hours at a time and your ears are going to be pretty hot under them. I prefer to wear headphones just a little forward of the ears so that any sudden plops or shrieks don't result in perforated eardrums!

There's not much point in sending reports to contest

GB2MAR

MARCONI
RADIO & ELECTRONICS
CLUB

THE AIRPORT
PORTSMOUTH
HANTS

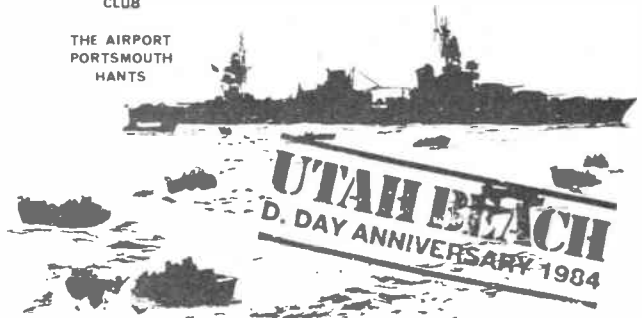

G4WQZ/FØIMY

stations as they are well aware from their contacts where their signals are going.

In most contests it is necessary for listeners to have logged both sides of the QSO and provide exchanged reports as well as their own and also any contest serial numbers given. These numbers are given on each contact and may be area codes, zone numbers or the position in the log. Alternatively, counties may be given (or the local equivalent) and these must be entered on the sheet. Once again, close examination of the rules is of the utmost importance.

Nervous

If you've never entered a contest before and are a bit nervous, next time you hear one in progress try logging the stations you hear. You may find yourself hooked!

For those of you who had a go at the Cray Valley Radio Society SWL Contest, we print the results herewith and congratulations to the winners of the respective sections!

If your club has a listeners' contest coming up or a contest with a listeners section, please let me know so that we can publicise it. *Two months notice please.*

Local activity

With the sunspot activity getting down to the 30s and even less at times, activity on the bands has been fairly local with the occasional opening for long distance contacts at varying times of the day. During a week in November, even operating a special event was sadly lacking in DX, with only the odd catch.

Talking of special events, this is one of the specialised

interests that can be undertaken by a listener with the most limited of equipment.

An event station can be licensed by the DTI to any full licence holder for a special occasion. In this country, special event call signs have the prefixes GB2, GB4 or GB0 allocated with the suffix usually referring to the event in question. For instance, a traction engine rally might attract the call GB2TER. The suffix is chosen by the applicant or the sponsor such as the local council, club association, etc.

In other countries, the special call sign can bear no relationship to the country's normal range of prefixes. For instance, 4N4SA was the call sign of the Sarajevo Winter Olympic station in Yugoslavia (normally YU series). However, the Geoff Watts DX list comes in handy again as most of the currently issued call signs are listed for easy reference.

Most of the special stations make an effort to present a specially designed QSL card, which is one reason why the hunting of these stations is so popular amongst both the licensed and listening fraternities.

As there are so many of these stations on the air in the GB area, an extensive collection of cards can be made, even using modest equipment, but please make your report worth the effort!

Next month

Next month we'll have the result of the QSL card competition. Don't forget, this is the listeners' section so let's have some news of your activities or if you have something you'd like to see in the section, let me know. Good listening.

PHONE
0474 813225
3 LINES



P.M. COMPONENTS LTD

DEPT REW SELECTRON HOUSE, WROTHAM ROAD
MEOPHAM GREEN, MEOPHAM, KENT DA13 0QY

TELEX
966371
PM COMP

INTEGRATED CIRCUITS

AN124	2.50	MC1330P	1.10	STK437	7.94
AN2140	2.80	MC1330P	1.20	STK439	7.95
AN239	2.80	MC1350P	0.85	STK461	11.50
AN240P	2.80	MC1351P	1.50	TA7061AP	1.50
AN264	2.50	MC1357	2.35	TA7108P	1.50
AN612	2.15	MC1358	1.50	TA7120P	1.50
AN962L	2.80	MC1495	3.00	TA7129P	2.50
AN7140	3.50	MC1496	1.25	TA7130P	1.50
AN7145	3.50	MC145106P		TA7137P	1.00
AN7145M	3.50			TA7146	3.95
AN7150	2.95	MC1723	0.50	TA7176AP	2.98
BA521	3.00	MC3357	2.75	TA7193P	3.98
CA1352E	1.75	MC3011L	2.50	TA7203	2.95
CA3086	0.45	ML221B	1.75	TA7204P	2.18
CA3123E	1.95	ML232B	2.50	TA7205AP	1.18
CA3140T	1.15	MMS5807	8.76	TA7222AP	4.80
ETT610	2.50	PLL02A	8.76	TA7227P	4.25
HA1339A	2.95	SAA500A	3.50	TA7310P	1.80
HA1366M	2.75	SAA1025	7.28	TA7314P	2.95
HA1373	2.50	SA9201D	6.35	TA7314P	2.95
HA1566	2.95	SAS5560S	1.75	TA7137P	1.00
LA1230	2.15	SAS5570S	1.75	TA7314P	2.95
LA4102	1.85	SA5580	2.85	TA7321P	2.28
LA4140	2.95	SL901B	4.85	TA7321P	2.28
LA4031P	1.95	SL917B	6.65	TA7321P	2.28
LA4140	2.95	SL1310	1.80	TA7321P	2.28
LA4250	3.05	SL1327	1.10	TA7321P	2.28
LA4420	1.95	SL1327G	1.10	TA7321P	2.28
LA4430	2.50	SN76501N	1.00	TA7321P	2.28
LA4400	4.15	SN76503N	0.95	TA7321P	2.28
LA4422	2.80	SN76503N	2.75	TA7321P	2.28
LA4461	3.95	SN76503N	1.95	TA7321P	2.28
LC7120	3.25	SN76110N	0.95	TA7321P	2.28
LC7130	3.50	SN76115N	1.28	TA7321P	2.28
LLC7131	3.50	SN76115N	1.30	TA7321P	2.28
LC7137	3.50	SN76226D	1.10	TA7321P	2.28
LM1011	1.15			TA7321P	2.28
LM324N	0.45	SN76227N	1.05	TA7321P	2.28
LM380N	0.95	SN76533N	1.65	TA7321P	2.28
LM3837	2.95	SN76544N	2.68	TA7321P	2.28
MS1513L	2.50	SN76544N	2.68	TA7321P	2.28
MS155L	2.95	SN76550N	1.15	TA7321P	2.28
MS1521L	1.50	SN76660N	0.95	TA7321P	2.28
MB3712	2.00	STK014	7.95	TA7321P	2.28
MB3756	2.50	STK015	8.50	TA7321P	2.28
MC1307P	1.00	STK043	9.95	TA7321P	2.28
MC1310P	1.95	STK435	5.95	TA7321P	2.28
MC1327	0.95	STK435	5.95	TA7321P	2.28
MC1327G	0.95	STK435	5.95	TA7321P	2.28

NEW BRANDED CATHODE RAY TUBES

TBA720A	2.45	TDA2571	2.95
TBA7500	2.85	TDA2581	2.28
TBA7500A	1.85	TDA2582	2.95
TBA810P	1.65	TDA2593	2.95
TBA820M	0.78	TDA2600	6.50
TBA820Q	1.45	TDA2610	2.50
TBA890	2.80	TDA2611A	1.95
TBA920	1.85	TDA2640	3.50
TBA950/2X		TDA2650	2.45
TBA970	2.95	TDA2650A	2.75
TBA990	1.40	TDA2650B	2.95
TBA990C	1.40	TDA2650C	2.95
TC2A70	1.10	TDA2650D	2.95
TC2A70S		TDA2650E	2.95
TC6850	2.90	UPC575C2	
TC8A00	2.95	UPC1025H	
TC8A30S	1.95	UPC1028H	
TC8A90	2.90	UPC1029H	
TDA440	2.20	UPC1032H	
TDA1001	1.95	UPC1035H	
TDA1002A	1.95	UPC1036H	
TDA1003A	3.95	UPC1037H	
TDA1004A	3.25	UPC1038H	
TDA1005A	2.90	UPC1039H	
TDA1010	2.15	UPC1040H	
TDA1035	2.50	UPC1041H	
TDA1037	1.95	UPC1042H	
TDA1044	2.15	UPC1043H	
TDA1170	1.95	UPC1044H	
TDA1190	2.15	UPC1045H	
TDA1270	3.95	UPC1046H	
TDA1327	1.70	UPC1047H	
TDA2002	1.95	UPC1048H	
TDA2003	2.95	UPC1049H	
TDA2010	2.95	UPC1050H	
TDA2512	2.95	UPC1051H	
TDA2522	1.95	UPC1052H	
TDA2523	2.95	UPC1053H	
TDA2524	1.95	UPC1054H	
TDA2530	1.95	UPC1055H	
TDA2532	1.95	UPC1056H	
TDA2540	1.95	UPC1057H	
TDA2541	2.18	UPC1058H	
TDA2560	2.18	UPC1059H	

DIODES

A1865/20	65.00	D14-210GH	78.00
AW3611	26.00	D14-210GH/50	78.00
CME822W	110.00	D14-340GH/KM	45.00
CME822GH	28.00	D14-340KA	45.00
CME1428GH	45.00	D16-100GH	65.00
CME1523GA	39.00	D16-100GH/65	65.00
CME1523GH	39.00	D16-100GH/75	65.00
CME1431GH	39.00	D16-100GH/9A	78.00
CME202GH	45.00	D16-100GH97	65.00
CME2024W	45.00	D18-130GH/7	65.00
CME2325W	45.00	D18-160GH	65.00
CME3126GH	45.00	D21-10GH	65.00
CME3128GH	45.00	D21-10GJ	65.00
CME3128W	45.00	D21-10LD	65.00
CME3132GH	45.00	D21-10LH	65.00
CME3135W	45.00	D21-10LH	65.00
CRE1400	28.00	D21-10LH	65.00
CV429	35.00	D21-10LH	65.00
CV1526	15.00	D21-10LH	65.00
CV2185	15.00	D21-10LH	65.00
D13-471GH/25	45.00	D21-10LH	65.00
CV2193	15.00	D21-10LH	65.00
CV2328	15.00	D21-10LH	65.00
CV5119	85.00	D21-10LH	65.00
CV5320	85.00	D21-10LH	65.00
CVX385	85.00	D21-10LH	65.00
D9-120	45.00	D21-10LH	65.00
D10-210GH	45.00	D21-10LH	65.00
D10-210GH/68B	45.00	D21-10LH	65.00
D10-210GH/72	45.00	D21-10LH	65.00
D10-230GH	45.00	D21-10LH	65.00
D10-230GH/25	45.00	D21-10LH	65.00
D10-293GH/90	45.00	D21-10LH	65.00
D13-27GH	49.50	D21-10LH	65.00
D13-30GH	49.50	D21-10LH	65.00
D13-33GH	49.50	D21-10LH	65.00
D13-47GH/24	55.00	D21-10LH	65.00
D13-47GH	55.00	D21-10LH	65.00
D13-51GH/26	55.00	D21-10LH	65.00
D13-450GH/01	55.00	D21-10LH	65.00
D13-471GH/25	55.00	D21-10LH	65.00
D13-550GH	55.00	D21-10LH	65.00
D13-600GH	55.00	D21-10LH	65.00
D13-610GH	55.00	D21-10LH	65.00
D13-610GH	55.00	D21-10LH	65.00
D13-611GH	55.00	D21-10LH	65.00
D13-630GH	55.00	D21-10LH	65.00
D13-630GH	55.00	D21-10LH	65.00
D14-120GH/08	65.00	D21-10LH	65.00
D14-150GH	75.00	D21-10LH	65.00
D14-150GH	75.00	D21-10LH	65.00
D14-172GH/84	65.00	D21-10LH	65.00
D14-172GH	65.00	D21-10LH	65.00
D14-173GH	65.00	D21-10LH	65.00
D14-173GH	65.00	D21-10LH	65.00
D14-173GH	65.00	D21-10LH	65.00
D14-173GH/82	65.00	D21-10LH	65.00
D14-181GH/96	65.00	D21-10LH	65.00
D14-181GH	65.00	D21-10LH	65.00
D14-181GH/50	65.00	D21-10LH	65.00
D14-181GH	65.00	D21-10LH	65.00
D14-182GH/98	65.00	D21-10LH	65.00
D14-200GH/50	65.00	D21-10LH	65.00
D14-200GH/50	65.00	D21-10LH	65.00

SEMICONDUCTORS

AA119	0.08	BY210-800	0.33	1N23B	5.00		
BA115	0.13	BY223	0.20	1N23C	5.00		
BA145	0.18	BY298-400	0.22	1N23FER	5.00		
BA154	0.06	BYX10	0.20	1N23WFE	5.00		
BA156	0.18	BYX36-150R	1N4003	0.04	BA5K	0.70	
BA157	0.30		1N4004	0.05	B9H	0.70	
BA1X13	0.04	BYX36-600R	1N4005	0.03	BSAKSOT	0.40	
BA1X6	0.16		1N4006	0.05	B9C	0.70	
BA1X8	0.30	BYX55-600	1N4007	0.06	B13B	5.00	
BT151	0.78	BYX55-600	1N4008	0.10	B14A	3.00	
BY126	0.10	BZK61	0.18	1N5401	0.12	12 Pin CR	2.95
BY133	0.18	BZV95C30	0.35	1N5402	0.14	Nuvistor	2.95
BY174	0.48	C54E	4.00	1N5403	0.12	Dctal	0.35
BY176	1.20	CS10B	8.45	1N5407	0.13	SK610	35.00
BY179	0.83	OA47	0.09	1N5408	0.14	UX5	1.75
BY182	0.55	OA90	0.05	1T44	0.04	Valve Can	3.00
BY184	0.35	DA91	0.06	1T723	0.15	8 Pin Dil	0.14
BY199	0.40	DA95	0.06	1T2002	0.18	14 Pin Dil	0.18
BY206	0.14	DA202	0.14			16 Pin Dil	0.17
BY206-800	0.33	1N21DR	5.00			18 Pin Dil	0.18

WIREWOUND RESISTORS

4 Watt SR-10K	0.20
7 Watt R47-22K	0.20
11 Watt IR5-15K	0.25
17 Watt IR-15K	0.30

ZENER DIODES

BZX61 0.15	VA1040	0.23
6V2 7V5 8V2 9V1 10V	VA1056S	0.23
11V 12V 13V 15V 16V	VA1104	0.40
18V 20V 22V 24V 27V	VA18650	0.76
30V 33V 36V 39V 47V	VA1097	0.28
51V 56V 68V 75V		

THERMISTORS

7V Power Mike	25.00
batteries	25.00
TR175 E25 ea	19.00
other prices on request	

BATTERIES

2V7 3V 3V3 3V6 3V9	8.65
4V3 4V7 5V1 5V6 6V	8.65
6V8 7V5 6V2 9V1 10V	8.65
11V 12V 13V 15V 18V	8.65
20V 24V 27V 30V	8.65

ELECTRO-OPTICAL

95025	25.00
9558B	25.00
9677A	22.00
P4218BAM	19.00
XP1002	28.00
XP117M	24.00
XP2040	35.00

DIODES

AA119	0.08	BY210-800	0.33	1N23B	5.00		
BA115	0.13	BY223	0.20	1N23C	5.00		
BA145	0.18	BY298-400	0.22	1N23FER	5.00		
BA154	0.06	BYX10	0.20	1N23WFE	5.00		
BA156	0.18	BYX36-150R	1N4003	0.04	BA5K	0.70	
BA157	0.30		1N4004	0.05	B9H	0.70	
BA1X13	0.04	BYX36-600R	1N4005	0.03	BSAKSOT	0.40	
BA1X6	0.16		1N4006	0.05	B9C	0.70	
BA1X8	0.30	BYX55-600	1N4007	0.06	B13B	5.00	
BT151	0.78	BYX55-600	1N4008	0.10	B14A	3.00	
BY126	0.10	BZK61	0.18	1N5401	0.12	12 Pin CR	2.95
BY133	0.18	BZV95C30	0.35	1N5402	0.14	Nuvistor	2.95
BY174	0.48	C54E	4.00	1N5403	0.12	Dctal	0.35
BY176	1.20	CS10B	8.45	1N5407	0.13	SK610	35.00

A SELECTION FROM OUR STOCK OF BRANDED VALVES

A1714 18.60	EAJ901 3.50	EL85 4.50	M8079 6.00	Q0E03-27 00	U16-20 0.75	1T4 0.70	6AG5 1.50	6F33 17.00	12CA5 1.95	572B 49.50
A1998 11.50	EB34 1.50	EL86 0.85	M8082 7.50	QQV02-6 19.50	U19 11.95	1U5 1.00	6AG7 1.50	6F35 1.95	12CX6 1.20	5847 10.95
A2067 11.50	EB41 3.95	EL90 1.50	M8083 3.20	QQV03-10 Multi-lard 9.50	U24 2.00	1X2B 1.40	6AH6 2.95	6F8B 12.50	12D08B 3.50	5879 8.50
A2134 14.95	EB91 0.52	EL91 0.70	M8091 7.90	QQV03-20 28.00	U25 0.90	1Z2 0.85	6AJ4 2.00	6GG6 5.50	12DW4A 3.50	5886 13.95
A2293 6.50	EB93 2.50	EL95 0.70	M8096 3.00	QQV03-20B 32.00	U26 0.90	2B22 69.50	6AJ7 2.00	6GHA 0.80	12D7 2.50	6058 2.80
A2426 29.50	EB94 1.05	EL153 12.15	M8098 5.50	QQV06-40A 27.50	U37 9.00	2C21 1.00	6AK5 1.50	6K65 1.50	12E1 17.95	6064 2.95
A2599 37.50	EB98 1.50	EL183E 3.50		QQV07-50 63.50	U40 6.95	2C39A 23.50	6AK6 2.50	6K66 1.95	12E14 28.00	6087 9.50
A2792 27.50	EB99 0.90	EL183P 3.50		QQV07-50 63.50	U41 2.00	2C39BA 39.80	6AL5 0.60	6GS7 2.15	12GN7 4.90	6158 3.20
A2900 11.50	EB99 0.90	EL360 6.75	M8099 6.00	QQV06-40A 27.50	U42 3.00	2C40 37.00	6AM4 3.25	6GW6 2.50	12H57A 4.90	6205 3.00
A3042 24.00	EB99 0.90	EL504 1.40	M8100 5.50	QQV07-50 63.50	U45 1.00	2C51 0.75	6AM6 1.50	6GW8 0.80	12K5 1.00	6550A 9.00
A3383 24.00	EB99 0.90	EL509 5.25	M8106 7.50	QQV06-40A 27.50	U46 6.95	2C52 32.00	6AN5 2.65	6H1 9.50	12K7GT 0.60	6687 9.50
AC/THI 4.00	EBF83 0.65	EL519 6.25	M8136 7.00	QQV07-50 63.50	U47 1.00	2C55 1.80	6AN8A 2.65	6H3N 1.10	12K8 1.10	6733 5.95
ACT22 59.75	EBF85 0.95	EL519 6.25	M8137 5.50	QQV06-40A 27.50	U48 0.75	2C55 1.80	6AN8A 2.65	6H3N 1.10	12K8 1.10	6733 5.95
AC/S2PEN 8.50	EBF89 0.70	EL802 3.65	M8161 6.50	Q0E03-27 00	U49 1.00	2C55 1.80	6AN8A 2.65	6H3N 1.10	12K8 1.10	6733 5.95
AH221 39.00	EBF93 0.95	EL821 8.50	M8162 5.50	Q0E03-27 00	U50 2.00	2C55 1.80	6AN8A 2.65	6H3N 1.10	12K8 1.10	6733 5.95
AH238 39.00	EBL1 2.50	EL822 12.95	M8163 5.50	Q0E03-27 00	U51 1.00	2C55 1.80	6AN8A 2.65	6H3N 1.10	12K8 1.10	6733 5.95
AL60 6.00	EC52 0.75	EM4 9.00	M8195 6.50	Q0E03-27 00	U52 1.00	2C55 1.80	6AN8A 2.65	6H3N 1.10	12K8 1.10	6733 5.95
AN1 14.00	EC70 1.75	EM80 0.70	M8196 5.50	Q0E03-27 00	U53 1.00	2C55 1.80	6AN8A 2.65	6H3N 1.10	12K8 1.10	6733 5.95
ARP12 0.70	EC80 9.50	EM81 0.70	M8204 5.50	Q0E03-27 00	U54 1.00	2C55 1.80	6AN8A 2.65	6H3N 1.10	12K8 1.10	6733 5.95
ARP34 2.00	EC81 7.95	EM84 1.65	M8223 4.50	Q0E03-27 00	U55 1.00	2C55 1.80	6AN8A 2.65	6H3N 1.10	12K8 1.10	6733 5.95
ARP35 1.26	EC86 1.00	EM87 3.95	M8224 2.50	Q0E03-27 00	U56 1.00	2C55 1.80	6AN8A 2.65	6H3N 1.10	12K8 1.10	6733 5.95
ATP4 3.50	EC90 1.00	EM87 3.95	M8225 4.50	Q0E03-27 00	U57 1.00	2C55 1.80	6AN8A 2.65	6H3N 1.10	12K8 1.10	6733 5.95
AX50 5.50	EC90 1.10	EN10 8.00	ME1401 29.50	Q0E03-27 00	U58 1.00	2C55 1.80	6AN8A 2.65	6H3N 1.10	12K8 1.10	6733 5.95
AZ11 4.50	EC91 5.50	EN32 13.50	ME1402 29.50	Q0E03-27 00	U59 1.00	2C55 1.80	6AN8A 2.65	6H3N 1.10	12K8 1.10	6733 5.95
AZ31 2.50	EC92 1.75	EN91 1.10	ME1501 14.50	Q0E03-27 00	U60 1.00	2C55 1.80	6AN8A 2.65	6H3N 1.10	12K8 1.10	6733 5.95
BL63 3.00	EC93 1.50	EN92 1.50	MM4 3.00	Q0E03-27 00	U61 1.00	2C55 1.80	6AN8A 2.65	6H3N 1.10	12K8 1.10	6733 5.95
BS450 67.00	EC97 7.00	ESL150 14.95	MLD6 4.50	Q0E03-27 00	U62 1.00	2C55 1.80	6AN8A 2.65	6H3N 1.10	12K8 1.10	6733 5.95
BS810 55.00	EC97 7.10	ESL872 25.00	ML4 4.50	Q0E03-27 00	U63 1.00	2C55 1.80	6AN8A 2.65	6H3N 1.10	12K8 1.10	6733 5.95
BS14 55.00	EC80 12.00	EY51 0.80	MS4B 5.50	Q0E03-27 00	U64 1.00	2C55 1.80	6AN8A 2.65	6H3N 1.10	12K8 1.10	6733 5.95
CIK 19.00	EC33 3.50	EY81 2.35	MU14 1.50	Q0E03-27 00	U65 1.00	2C55 1.80	6AN8A 2.65	6H3N 1.10	12K8 1.10	6733 5.95
C3JA 21.00	EC33 3.50	EY83 1.50	N37 12.50	Q0E03-27 00	U66 1.00	2C55 1.80	6AN8A 2.65	6H3N 1.10	12K8 1.10	6733 5.95
C6A 9.00	EC33 3.50	EY84 5.95	N78 9.85	Q0E03-27 00	U67 1.00	2C55 1.80	6AN8A 2.65	6H3N 1.10	12K8 1.10	6733 5.95
C112G 70.00	EC81 1.15	EY86/87 0.50	OA2 0.85	Q0E03-27 00	U68 1.00	2C55 1.80	6AN8A 2.65	6H3N 1.10	12K8 1.10	6733 5.95
C1108 54.95	EC81 1.00	EY88 0.55	OB2WA 1.50	Q0E03-27 00	U69 1.00	2C55 1.80	6AN8A 2.65	6H3N 1.10	12K8 1.10	6733 5.95
C1134 32.00	quality 1.95	EY91 5.50	OA3 2.50	Q0E03-27 00	U70 1.00	2C55 1.80	6AN8A 2.65	6H3N 1.10	12K8 1.10	6733 5.95
C1148A 115.00	ECC82 0.55	EY500A 1.50	OB2 0.85	Q0E03-27 00	U71 1.00	2C55 1.80	6AN8A 2.65	6H3N 1.10	12K8 1.10	6733 5.95
C1149 130.00	ECC82 Multi-lard 1.50	EY802 0.70	OB2WA 1.25	Q0E03-27 00	U72 1.00	2C55 1.80	6AN8A 2.65	6H3N 1.10	12K8 1.10	6733 5.95
C1150 136.00	ECC82 Philips 1.95	EZ40 2.75	OC3 1.50	Q0E03-27 00	U73 1.00	2C55 1.80	6AN8A 2.65	6H3N 1.10	12K8 1.10	6733 5.95
C1534 32.00	ECC83 0.65	EZ41 2.15	OC4 1.70	Q0E03-27 00	U74 1.00	2C55 1.80	6AN8A 2.65	6H3N 1.10	12K8 1.10	6733 5.95
CCA 2.60	ECC83 Br-mar 1.35	EZ81 0.75	OM5B 3.00	Q0E03-27 00	U75 1.00	2C55 1.80	6AN8A 2.65	6H3N 1.10	12K8 1.10	6733 5.95
CC3L 3.00	ECC83 Philips 1.95	EZ90 1.50	OM6 1.75	Q0E03-27 00	U76 1.00	2C55 1.80	6AN8A 2.65	6H3N 1.10	12K8 1.10	6733 5.95
CV Nos Prices on request	ECC84 0.50	G55/1K 9.00	ORP43 12.00	Q0E03-27 00	U77 1.00	2C55 1.80	6AN8A 2.65	6H3N 1.10	12K8 1.10	6733 5.95
D63 1.20	ECC85 0.60	G180/2M 9.00	P61 2.50	Q0E03-27 00	U78 1.00	2C55 1.80	6AN8A 2.65	6H3N 1.10	12K8 1.10	6733 5.95
DA41 22.50	ECC86 2.75	G322 Mullard P41 2.50	PABCO 0.50	Q0E03-27 00	U79 1.00	2C55 1.80	6AN8A 2.65	6H3N 1.10	12K8 1.10	6733 5.95
DA42 17.50	ECC88 0.85	G240/2D 8.00	PC86 0.75	Q0E03-27 00	U80 1.00	2C55 1.80	6AN8A 2.65	6H3N 1.10	12K8 1.10	6733 5.95
DA90 4.50	ECC91 2.00	G400/1K 14.95	PC88 0.75	Q0E03-27 00	U81 1.00	2C55 1.80	6AN8A 2.65	6H3N 1.10	12K8 1.10	6733 5.95
DA100 125.00	ECC90 0.72	GC10B 17.50	PC96 1.50	Q0E03-27 00	U82 1.00	2C55 1.80	6AN8A 2.65	6H3N 1.10	12K8 1.10	6733 5.95
DAF91 0.45	ECC189 0.78	GC10D 17.50	PC97 1.50	Q0E03-27 00	U83 1.00	2C55 1.80	6AN8A 2.65	6H3N 1.10	12K8 1.10	6733 5.95
DAF91 0.70	ECC801S 3.50	GC10E 17.50	PC800 1.10	Q0E03-27 00	U84 1.00	2C55 1.80	6AN8A 2.65	6H3N 1.10	12K8 1.10	6733 5.95
DAF96 1.00	ECC804 0.60	GC10/4E 17.50	PC900 1.25	Q0E03-27 00	U85 1.00	2C55 1.80	6AN8A 2.65	6H3N 1.10	12K8 1.10	6733 5.95
DC70 1.75	ECC200 12.00	GD87B 17.50	PC84A 0.40	Q0E03-27 00	U86 1.00	2C55 1.80	6AN8A 2.65	6H3N 1.10	12K8 1.10	6733 5.95
DC80 1.20	ECC200 12.00	GD86W 8.00	PC85 1.10	Q0E03-27 00	U87 1.00	2C55 1.80	6AN8A 2.65	6H3N 1.10	12K8 1.10	6733 5.95
DCX4-1000 12.00	ECCF82 1.15	GT1210M 5.00	PC88 0.70	Q0E03-27 00	U88 1.00	2C55 1.80	6AN8A 2.65	6H3N 1.10	12K8 1.10	6733 5.95
DCX4-5000 25.00	ECCF86 2.25	GA4 9.00	PC89 0.70	Q0E03-27 00	U89 1.00	2C55 1.80	6AN8A 2.65	6H3N 1.10	12K8 1.10	6733 5.95
DET16 28.50	ECCF200 1.85	GN10 15.00	PC805 0.80	Q0E03-27 00	U90 1.00	2C55 1.80	6AN8A 2.65	6H3N 1.10	12K8 1.10	6733 5.95
DET18 28.50	ECCF201 1.85	GN15 15.00	PC806 0.70	Q0E03-27 00	U91 1.00	2C55 1.80	6AN8A 2.65	6H3N 1.10	12K8 1.10	6733 5.95
DET2 35.00	ECCF202 1.85	GS10C 16.50	PC807 0.80	Q0E03-27 00	U92 1.00	2C55 1.80	6AN8A 2.65	6H3N 1.10	12K8 1.10	6733 5.95
DET24 39.00	ECCF203 1.85	GS10H 12.00	PC808 0.65	Q0E03-27 00	U93 1.00	2C55 1.80	6AN8A 2.65	6H3N 1.10	12K8 1.10	6733 5.95
DET25 22.00	ECCF806 10.25	GS12D 12.00	PCF82 0.60	Q0E03-27 00	U94 1.00	2C55 1.80	6AN8A 2.65	6H3N 1.10	12K8 1.10	6733 5.95
DF91 0.70	ECH3 2.50	GT1C 14.00	PCF84 0.85	Q0E03-27 00	U95 1.00	2C55 1.80	6AN8A 2.65	6H3N 1.10	12K8 1.10	6733 5.95
DF92 0.80	ECH4 3.00	GT1C S/S 13.00	PCF86 1.20	Q0E03-27 00	U96 1.00	2C55 1.80	6AN8A 2.65	6H3N 1.10	12K8 1.10	6733 5.95
DF96 0.65	ECH5 2.15	GTE175M 8.00	PCF87 0.40	Q0E03-27 00	U97 1.00	2C55 1.80	6AN8A 2.65	6H3N 1.10	12K8 1.10	6733 5.95
DF97 1.00	ECH2 0.40	GTR150W 1.00	PCF201 1.80	Q0E03-27 00	U98 1.00	2C55 1.80	6AN8A 2.65	6H3N 1.10	12K8 1.10	6733 5.95
DH63 1.20	ECH81 0.85	GU20 35.00	PCF80 0.40	Q0E03-27 00	U99 1.00	2C55 1.80	6AN8A 2.65	6H3N 1.10	12K8 1.10	6733 5.95
DH77 0.90	ECH83 0.78	GUX1 13.50	PCF801 1.35	Q0E03-27 00	U100 1.00	2C55 1.80	6AN8A 2.65	6H3N 1.10	12K8 1.10	6733 5.95
DH79 0.56	ECH84 0.69	GUX3 24.00	PCF802 0.60	Q0E03-27 00	U101 1.00	2C55 1.80	6AN8A 2.65	6H3N 1.10	12K8 1.10	6733 5.95
DH149 2.00	ECH2000 1.50	GUX5 14.50	PCF803 1.25	Q0E03-27 00	U102 1.00	2C55 1.80	6AN8A 2.65	6H3N 1.10	12K8 1.10	6733 5.95
DK31 0.90	ECL80 0.90	GY501 1.20	PCF808 1.25	Q0E03-27 00	U103 1.00	2C55 1.80	6AN8A 2.65	6H3N 1.10	12K8 1.10	6733 5.95
DK92 1.20	ECL82 0.65	GY802 1.00	PCF200 1.50	Q0E03-27 00	U104 1.00	2C55 1.80	6AN8A 2.65	6H3N 1.10	12K8 1.10	6733 5.95
DK96 2.50	ECL83 2.50	GY802 1.00	PCF200 1.50	Q0E03-27 00	U105 1.00	2C55 1.80	6AN8A 2.65	6H3N 1.10	12K8 1.10	6733 5.95
DL35 2.50	ECL84 0.74	GZ30 1.00	PCL82 0.85	Q0E03-27 00	U106 1.					

THE 11m CB TO 10m AMATEUR BAND CONVERSION GUIDE

PART THREE

A look at the PLL02 chip and modifications to the Colt 295 rig for ten metre amateur use

ROGER ALBAN GW3SPA

BSc. C ENG, MIEE

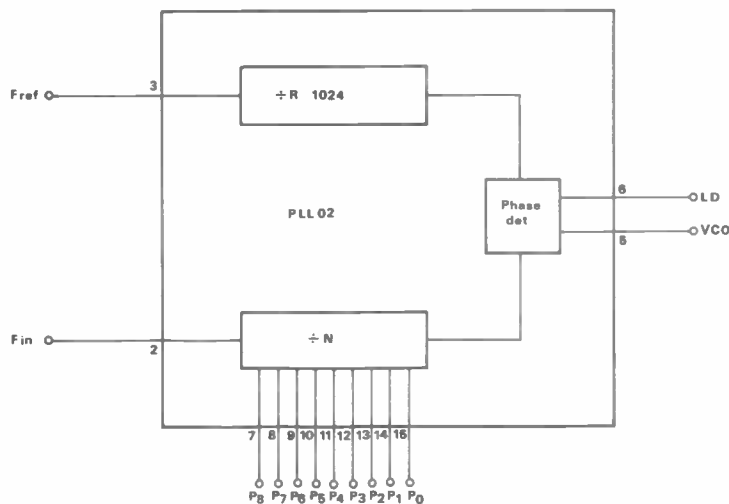

Fig 1 PLL02 phase lock loop chip

Another PLL used in the early days of American CB and adopted by the stable of Ham International and Colt is the PLL02 (Figure 1) which has a fixed reference divide of 1024 and a maximum divide-by-N of 511, similar to the Motorola PLL chip the MC145106. It is believed that the maximum 'Fin' frequency is around 4.5MHz but if any reader has further information concerning this PLL chip the author would be pleased to receive it. The lock detector appears at Pin 6. The truth table is the same as given in December's article for a device with 9 program lines.

This PLL chip is used in the Colt 295 which uses three mixers and three crystal oscillators to obtain the correct VCO offset in frequency for both transmit and receive. The block diagram is shown in Figure 2. The frequency injected into the receiver first mixer is the sum of the VCO plus the loop crystal oscillator which ensures that the mixer injected frequency is above the receiver frequency, thus satisfying the normal

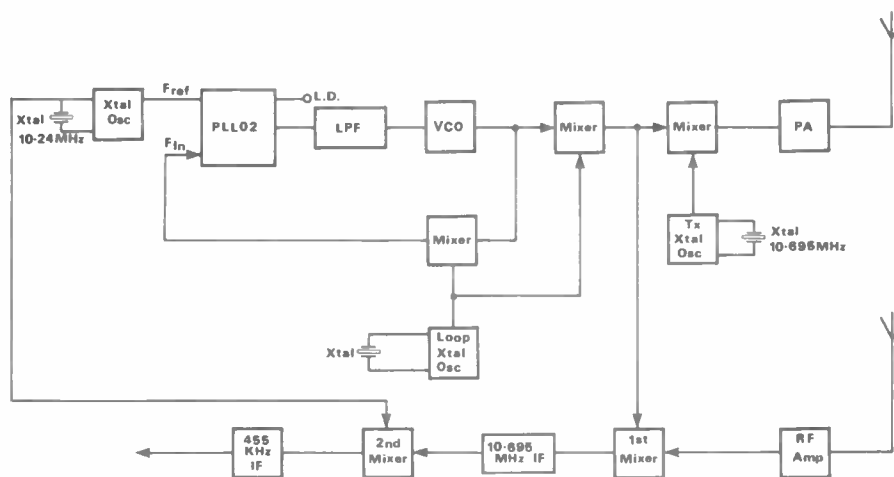

Fig 2 Block diagram of Colt 295 American AM CB rig

CONVERSIONS

Function	P ₆	P ₇	P ₈	P ₉	P ₄	P ₃	P ₂	P ₁	P ₀		
Pin No	7	8	9	10	11	12	13	14	15		
2 ⁿ	256	128	64	32	16	8	4	2	1		
Channel										- N	Frequency MHz
1	1	0	1	0	0	1	0	1	0	330	26.965
2	1	0	1	0	0	1	0	0	1	329	26.975
3	1	0	1	0	0	1	0	0	0	328	26.985
4	1	0	1	0	0	0	1	1	0	326	27.005
5	1	0	1	0	0	0	1	0	1	325	27.015
6	1	0	1	0	0	0	1	0	0	324	27.025
7	1	0	1	0	0	0	0	1	1	323	27.035
8	1	0	1	0	0	0	0	0	1	321	27.055
9	1	0	1	0	0	0	0	0	0	320	27.065
10	1	0	0	1	1	1	1	1	1	319	27.075
11	1	0	0	1	1	1	1	1	0	318	27.085
12	1	0	0	1	1	1	1	0	0	316	27.105
13	1	0	0	1	1	1	0	1	1	315	27.115
14	1	0	0	1	1	1	0	1	0	314	27.125
15	1	0	0	1	1	1	0	0	1	313	27.135
16	1	0	0	1	1	0	1	1	1	312	27.155
17	1	0	0	1	1	0	1	1	0	310	27.165
18	1	0	0	1	1	0	1	0	1	309	27.175
19	1	0	0	1	1	0	1	0	0	308	27.185
20	1	0	0	1	1	0	0	1	0	306	27.205
21	1	0	0	1	1	0	0	0	1	305	27.215
22	1	0	0	1	1	0	0	0	0	304	27.225
23	1	0	0	1	0	1	1	0	1	301	27.255
24	1	0	0	1	0	1	1	1	1	303	27.235
25	1	0	0	1	0	1	1	1	0	302	27.245
26	1	0	0	1	0	1	1	0	0	300	27.265
27	1	0	0	1	0	1	0	1	1	299	27.275
28	1	0	0	1	0	1	0	1	0	298	27.285
29	1	0	0	1	0	1	0	0	1	297	27.295
30	1	0	0	1	0	1	0	0	0	296	27.305
31	1	0	0	1	0	0	1	1	1	295	27.315
32	1	0	0	1	0	0	1	1	0	294	27.325
33	1	0	0	1	0	0	1	0	1	293	27.335
34	1	0	0	1	0	0	1	0	0	292	27.345
35	1	0	0	1	0	0	0	1	1	291	27.355
36	1	0	0	1	0	0	0	1	0	290	27.365
37	1	0	0	1	0	0	0	0	1	289	27.375
38	1	0	0	1	0	0	0	0	0	288	27.385
39	1	0	0	0	1	1	1	1	1	287	27.395
40	1	0	0	0	1	1	1	1	0	286	27.405

Fig 4 Truth table for PLL02 phase lock loop chip used in American CB

Fig 5 Truth table for PLL02 phase lock loop chip used in modified 10m FM rig

FUNCTION	P ₆	P ₇	P ₈	P ₉	P ₄	P ₃	P ₂	P ₁	P ₀		
PIN NO	7	8	9	10	11	12	13	14	15		
2 ⁿ	256	128	64	32	16	8	4	2	1		
CHANNEL										-N	FREQUENCY MHz
1	1	0	1	0	0	0	1	0	1	325	29.31
2	1	0	1	0	0	0	1	0	0	324	29.32
3	1	0	1	0	0	0	0	1	1	323	29.33
4	1	0	1	0	0	0	0	1	0	322	29.34
5	1	0	1	0	0	0	0	0	1	321	29.35
6	1	0	1	0	0	0	0	0	0	320	29.36
7	1	0	0	1	1	1	1	1	1	319	29.37
8	1	0	0	1	1	1	1	1	0	318	29.38
9	1	0	0	1	1	1	1	0	1	317	29.39
10	1	0	0	1	1	1	1	0	0	316	29.40
11	1	0	0	1	1	1	0	1	1	315	29.41
12	1	0	0	1	1	1	0	1	0	314	29.42
13	1	0	0	1	1	1	0	0	1	313	29.43
14	1	0	0	1	1	1	0	0	0	312	29.44
15	1	0	0	1	1	0	1	1	1	311	29.45
16	1	0	0	1	1	0	1	1	0	310	29.46
17	1	0	0	1	1	0	1	0	1	309	29.47
18	1	0	0	1	1	0	1	0	0	308	29.48
19	1	0	0	1	1	0	0	1	1	307	29.49
20	1	0	0	1	1	0	0	1	0	306	29.50
21	1	0	0	1	1	0	0	0	1	305	29.51
22	1	0	0	1	1	0	0	0	0	304	29.52
23	1	0	0	1	0	1	1	1	1	303	29.53
24	1	0	0	1	0	1	1	1	0	302	29.54
25	1	0	0	1	0	1	1	0	1	301	29.55
26	1	0	0	1	0	1	1	0	0	300	29.56
27	1	0	0	1	0	1	0	1	1	299	29.57
28	1	0	0	1	0	1	0	1	0	298	29.58
29	1	0	0	1	0	1	0	0	1	297	29.59
30	1	0	0	1	0	1	0	0	0	296	29.60
31	1	0	0	1	0	0	1	1	1	295	29.61
32	1	0	0	1	0	0	1	1	0	294	29.62
33	1	0	0	1	0	0	1	0	1	293	29.63
34	1	0	0	1	0	0	1	0	0	292	29.64
35	1	0	0	1	0	0	0	1	1	291	29.65
36	1	0	0	1	0	0	0	1	0	290	29.66
37	1	0	0	1	0	0	0	0	1	289	29.67
38	1	0	0	1	0	0	0	0	0	288	29.68
39	1	0	0	0	1	1	1	1	1	287	29.69
40	1	0	0	0	1	1	1	1	0	286	29.70

convention. The first IF frequency is 10.695MHz and the 10.24MHz obtained from the reference crystal oscillator is injected into the receiver 2nd mixer to arrive at a second IF frequency of 455KHz.

On transmit, the frequency injected into the receiver 1st mixer is injected into a transmit mixer where it is subtracted from the frequency of a crystal oscillator operating at the same frequency of the receiver first IF, to arrive at the transmit frequency. During receive the transmit oscillator is inhibited. The VCO is also fed to a down mixer connected to the loop crystal oscillator to ensure that 'Fin' always remains below 4.5MHz, the maximum operating frequency of the PLL02 chip. Should the loop become unlocked the LD output from the PLL02 chip inhibits the transmitter; this is a common practice on the majority of CB sets.

Colt 295

The Colt 295 is designed as an 80 channel set in two groups of 40 channels and was designed to operate on the American forty channels of CB. Each group is selected by altering the frequency of the loop mixer crystal oscillator. The band switch on the front panel selects the two groups of channels, the low position selecting the American 40 AM channels, and the high position selecting the group of 40 channels higher. On the low channels the loop crystal oscillator is operating at a frequency of 20.48MHz, which in this set is derived from doubling the 10.24MHz reference oscillator frequency. On the higher channels the loop mixer crystal oscillator is operative at a frequency of 20.705MHz.

If you own one of these sets and require to convert it for 10 metre operation, the crystal in the loop mixer crystal oscillator will need to be exchanged for a 21.6275MHz crystal to ensure that channel 30 corresponds with the calling frequency of 29.6MHz.

The frequency table for the Colt rig is shown in Figure 3. It should be noted that Channel 1 10m FM corresponds to an operating frequency of 29.26MHz and not 29.31MHz as obtained from previous examples. The reason for this is that the American CB channels do not all correspond to a change of frequency in 10KHz steps. Certain frequencies are missed, and thus from Figure 4 - right hand column - changing from Channel 3 to Channel 4 corresponds to a jump in frequency of 20KHz. Also note that in changing from Channel 23 to Channel 24 the frequency jumps back by 20KHz. In the Colt 295 this unconventional change in frequency can be amended.

Diode switching

The odd changes in the coding of the programming levels is obtained by diode switching after the channel switch, and these diodes can be re-arranged to give the required coding. Figure 4 also shows the truth table for the logic that appears

CONVERSIONS

on the program pins of the PLL chip. By adding the 2ⁿ for any given channel, one arrives at the divide-by-N number.

Figure 5 gives the required truth table, such that the operating frequency is incremented in 10KHz steps when the channel switch is incremented. A close examination of the two truth tables will reveal that the programme lines P₀ through to P₆ are altered by the channel change switch and that the other program lines remain unchanged. It is also usual to find P₈ permanently strapped to the positive supply voltage and P₇ earthed. Again by manipulating P₈ and P₇ it is possible to extend the operating range of the set, provided the loop remains locked.

Before replacing the loop oscillator crystal it is advisable to take the measurement of the phase detector voltage output from the PLL chip, Pin 5, with the set on Channel 19. Replace the crystal and retune the VCO inductive core until you obtain the same voltage reading on Pin 5, remembering to have the channel switch set on the High position. At this stage the loop should be locked.

All that remains to be done is to tweak up the transmitter coils and receiver RF amplifier. The Colt 295 is a handy rig because it contains an FM band which makes modifying this set relatively easy. For those of you who have obtained a set which does not contain an FM modulator/demodulator board, examples of providing this modification will be given later.

For repeater working the 100KHz offset can be obtained by changing the transmit oscillator crystal for a 10.795MHz crystal. The two crystals may be changed using a small relay operated from a switch on the front panel.

Binatone Route 66 rig

During the later half of 1981 a few manufacturers opted for a multi-purpose PLL chip designed rig to meet UK specifications for CB sets. One such set is the Binatone Route 66, which uses the PLL02 PLL chip. The Colt 295 used two mixers to ensure the VCO frequency operated at around 18MHz, whereas the Binatone Route 66 rig uses only one mixer in the loop circuit (Figure 6). If Channel 20 is selected this corresponds to a UK CB frequency of 27.79125MHz, which corresponds to a VCO frequency of 38.48625MHz. One will note that the VCO frequencies in this rig are approximately double that of the Colt 295.

Fig 3 Frequency table for the Colt 295 rig

Mode of operation	Operating Frequency MHz	Frequency at first mixer MHz	Xtal Osc MHz	VCO MHz	'Fin' MHz	-N
AM CB chan 1	26.965	37.66	20.48	17.18	3.3	330
AM CB chan 30	27.305	38.00	20.48	17.52	2.96	296
AM CB chan 40	27.405	38.10	20.48	17.62	2.86	286
10m FM chan 1	29.26	39.955	21.6275	18.3275	3.3	330
10m FM chan 30	29.60	40.295	21.6275	18.6675	2.96	296
10m FM chan 40	29.70	40.395	21.6275	18.7675	2.86	286

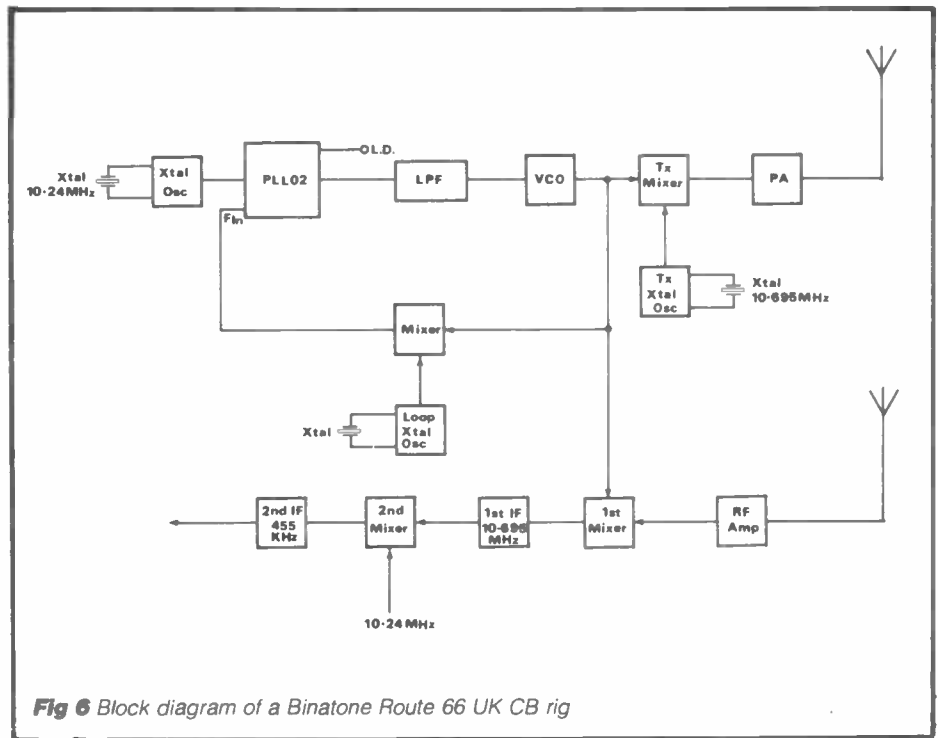

Fig 6 Block diagram of a Binatone Route 66 UK CB rig

CHAN	÷ N Ratio	CHAN	÷ N Ratio	CHAN	÷ N Ratio	CHAN	÷ N Ratio
1	168	11	178	21	188	31	198
2	169	12	179	22	189	32	199
3	170	13	180	23	190	33	200
4	171	14	181	24	191	34	201
5	172	15	182	25	192	35	202
6	173	16	183	26	193	36	203
7	174	17	184	27	194	37	204
8	175	18	185	28	195	38	205
9	176	19	186	29	196	39	206
10	177	20	187	30	197	40	207

Fig 7 Divide-by-N ratios used in the Binatone Route 66 UK CB rig

The mixer crystal oscillator operates at a frequency of 36.61625MHz corresponding to a 'Fin' of 1.87MHz. With a reference frequency crystal of 10.24MHz and a divide-by-R ratio of 1024 the corresponding divide-by-N number for Channel 20 is 187. This again is different from the divide-by-N ratios used in the Colt 295 rig. Figure 7 shows the various divide-by-N ratios used in the Binatone.

To convert this rig for use in the 10m

band such that Channel 30 corresponds with the calling frequency of 29.6MHz, the loop crystal oscillator will need to be replaced and the rig re-tuned. From Figure 7 the divide-by-N ratio for Channel 30 is 197, corresponding to a 'Fin' of 1.97MHz.

For a transmit frequency of 29.6MHz the VCO will be required to operate at 40.295MHz, and therefore the mixer oscillator frequency required is 40.295MHz - 1.97MHz or 38.325MHz. For repeater working the 100KHz transmit frequency shift can be obtained by changing the Tx mixer crystal oscillator as previously described.

Next month

Next month I will be looking at the dedicated PLL chips used in American CB rigs to prevent the equipment from being modified to operate on frequencies other than the American CB channels, and how to get around this obstacle.

Bored with a humdrum existence? Tired with a tedious life?

Fancy straying from the straight and narrow or even crossing to the wrong side of the tracks? Yes, we thought as much . . .

So what's the solution? Where's the sparkling new package to break the dreary mould? Why it's here! . . .
4x4 Magazine!

4x4 has all that's best in off-road and four-wheel-drive action. Lacking only a mushroom cloud in terms of spectacle, it's guaranteed to excite and entertain, but beware! . . . This magazine contains explicit material which some readers, especially those of a frail disposition, may find disturbing. You have been warned!

Contents

Greenroading: an introduction ● Long-term test: Lada Niva ● All-terrain trikes ● 4x4 Favourites: Haflinger ● The French connection: off-road in the EEC ● Axle-deep: a beginner's guide to 4x4 ● Pull-out colour centrespread ● News, views, hardware and a lot more besides

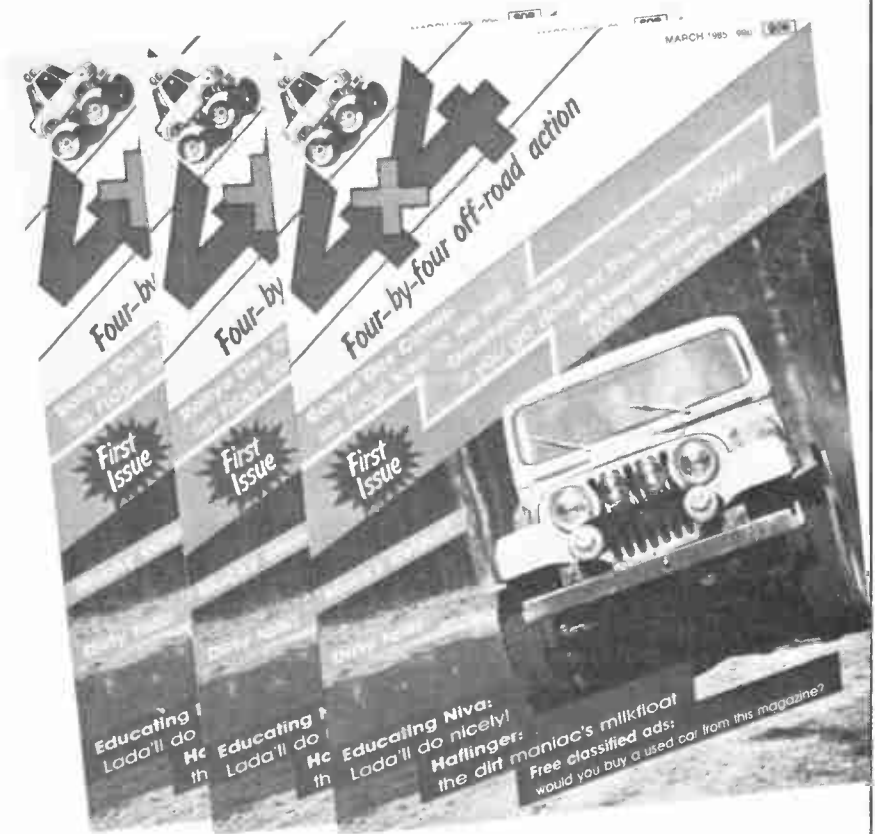

Place a regular order with your newsagent or take out a subscription

Send £1.25 for a sample copy

ON SALE AT YOUR NEWSAGENTS 14 FEBRUARY

4x4 SUBSCRIPTION ORDER FORM

TO: Subscription Department · 4x4 · Sovereign House · Brentwood
Essex · CM14 4SE

PLEASE SUPPLY: (tick box) for 12 issues, all rates include P & P

Inland £15.20
World-Surface £16.45
Europe-Air £22.55
World-Air £29.30

Cheques should be made payable to 4x4 Magazines. Overseas payment by International Money Order or credit card.

PAYMENT ENCLOSED: £ —

CREDIT CARD PAYMENT Signature

NAME ADDRESS

Postcode AR0285

AERIALS AND PROPAGATION

BILL SPARKS G8FBX

PART 5

Impedance matching explained and a look at aerial forms

A further point of discussion is the contentious one of standing wave ratios. SWR is one of the most misunderstood and misquoted expressions used in amateur radio. It is basically an indication of the degree of mismatch appearing between a source of RF energy and the load to which it is applied.

In March 1956, a classic article appeared in *QST* and the subject is as relevant today as it was then. The heading was 'My Feedline Tunes My Antenna' and the article went on to

discuss the effects of mismatch on an aerial installation.

A favourite question in the RAE requires the student to differentiate between the resistive loading of quarter or half wave sections of a coax line. Unless a line is perfectly matched resistance-wise to its characteristic impedance, variations in the impedance will appear along the line.

Figure 1 shows this effect in greater detail, the important fact being that at quarter wave intervals a purely resistive load will appear with the spacing between these loadings varying either as a capacitive or inductive reactance. The relative order in which the two values appear is determined by the relationship between the optimum load and the applied load. If the impedance of the applied load is higher than the characteristic impedance of the line will be capacitive whereas the reverse applies if the load is lower than Z_0 .

Figure 2 is the classic diagram which appeared in *QST* when the article was reprinted in April 1977. Theoretically, the characteristic impedance of a transmission line is that value of resistance which when used to terminate the line makes the input impedance independent of the electrical length of the line.

This is not strictly true, since the losses shown in any one line are a function of length and will show a gradual variation in input impedance as a cumulative effect of series resistance (and, to a limited degree, the effect of impedance variation due to the different R and X relationship along the line).

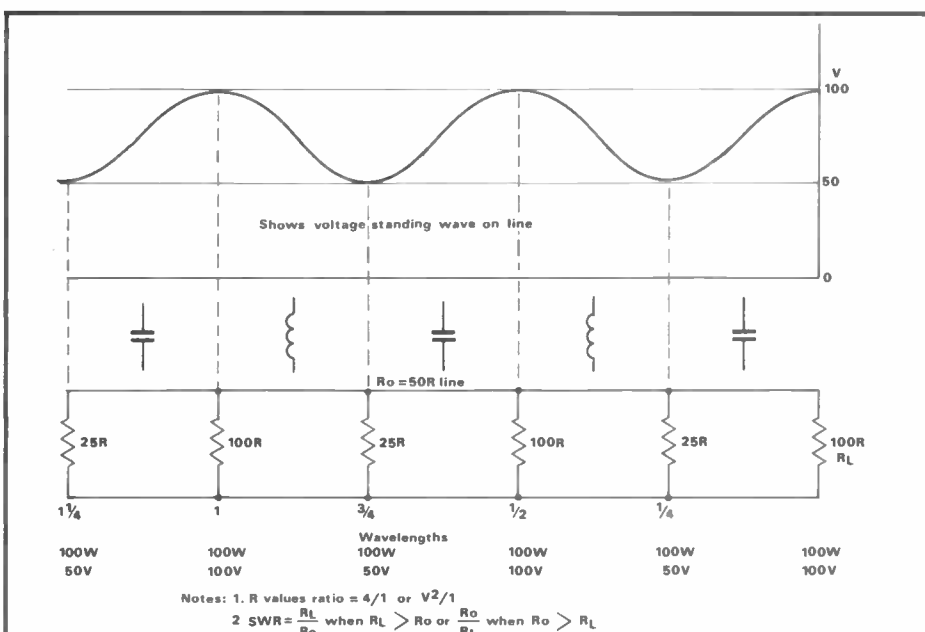

Fig 1 Showing effect of mismatched load on line

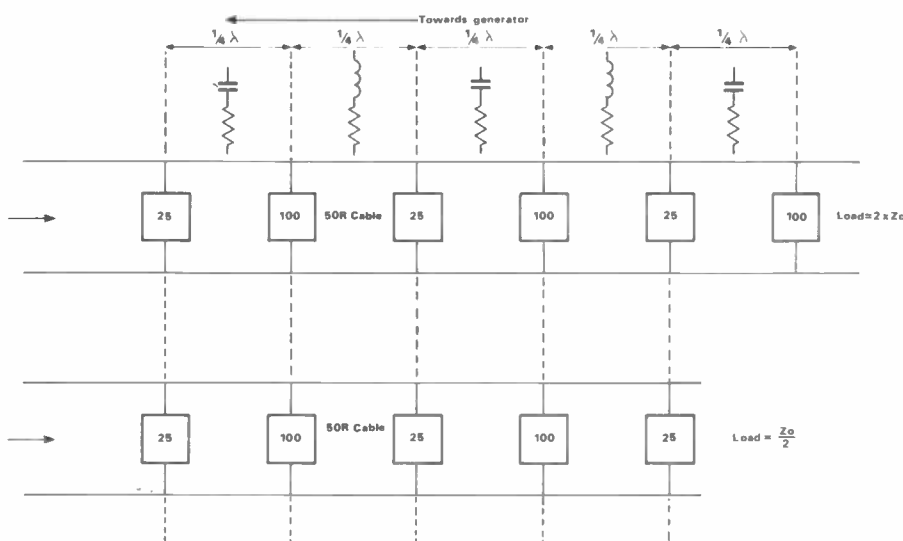

Fig 2 The original diagram which appeared in *QST* April 1977

First principles

From first principles, in order to achieve a perfect match the voltage or current must be constant in value along the line. As can be seen in Figure 2, this is not possible in a mismatched line since as the resistance and reactance vary along the line, so must the voltage and current.

By taking examples from the original article and referring to the upper of the two examples shown, let us assume we are putting 100 watts into the 100ohm load.

The current at that point will be one ampere and the voltage 100V. At a quarter wave back along the line the resistance is 25ohms and from I^2R we find that the current is now 2 amps and the voltage 50V. At the half wave point we are back to our starting point.

This variation in current and voltage along the line gives us our variations in standing wave values, and the ratio between the current maximum and

AERIALS & PROPAGATION

minimum or voltage maximum or minimum is the SWR. In this case the ratio is 2 to 1 so we say the SWR is 2:1.

One rather important feature is that this is also the square root of the ratio of the two resistive values. The maximum SWR is the ratio of the two voltage values measured at successive quarter wave intervals, but can be measured at other points with reduced values for specific frequencies. Obviously the calculations can be further complicated by the presence of reactance in the circuit.

The 'experts' who adjust the length of the line to get resistive points and lower SWR values are only making things easier to couple into, they are *not* affecting the load value. The only method of varying the SWR satisfactorily is to adjust the load to an optimum value. All other techniques are basically compromises.

One important feature to remember is that all power that enters a line can only leave via the aerial. A high SWR at the aerial, consistent with a low value at the Tx, is an indication of losses in the line and can be simply demonstrated by estimating the SWR at the Tx end, and introducing the loss factor of the line.

For example, a length of RG 58/U of 65ft, feeding an aerial on 21MHz, would have a matched loss of 2dB per 100ft, or 1.6dB per 65ft. If we measured the SWR at the transmitter it would not represent a true reading as we should really take the reading at the point of connection to the

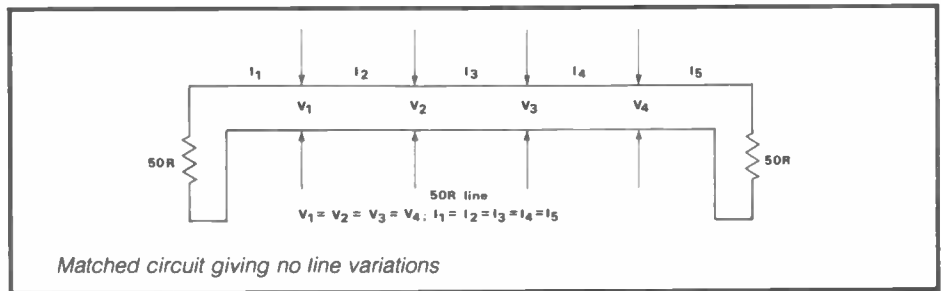

aerial.

Because of line loss, we tend to see more forward power at the Tx than at the aerial, and also less reflected power at the transmitter than at the aerial. These two factors in combination give a totally false impression of the true state of affairs at the aerial, and the greater the line loss the worse the effect of this variation.

Figure 3 shows the true values of aerial SWR for measured values at the Tx for various line losses. Taking our 21MHz example, we find that a 2.0 value at the Tx is almost 3 at the aerial. Some of the fraternity will immediately go into a state of panic at an SWR value of 3:1, but what does it mean in actual power loss?

From Figure 3 we can set our line loss against our SWR and find the additional loss, which amounts to some 0.6dB. By adding all the losses we arrive at about 1.9dB. If we replace the cable with RG8 we gain about 0.8dB, hardly worth it at 21MHz. The same calculation carried out

at 145MHz or 432MHz is very illuminating. The appendix to this series published next month will show the relationship between power and expanding wave ratios.

Matching

Most transistorised output stages are designed to work with SWR values of 2:1 or less. Higher SWR values can create high values of current and voltage in the output networks, and in some cases can cause damage to output devices, or voltage breakdown of capacitors, or even overheating of coils.

It is advisable to use some form of impedance matching network in the form of a matching device sufficient to enable the Tx to operate within safe limits, but this does not mean that an inefficient aerial will now be made efficient, only that more power is transferred into it.

The secret is to match the aerial itself to become a perfect substitute for the purely resistive load equal to the

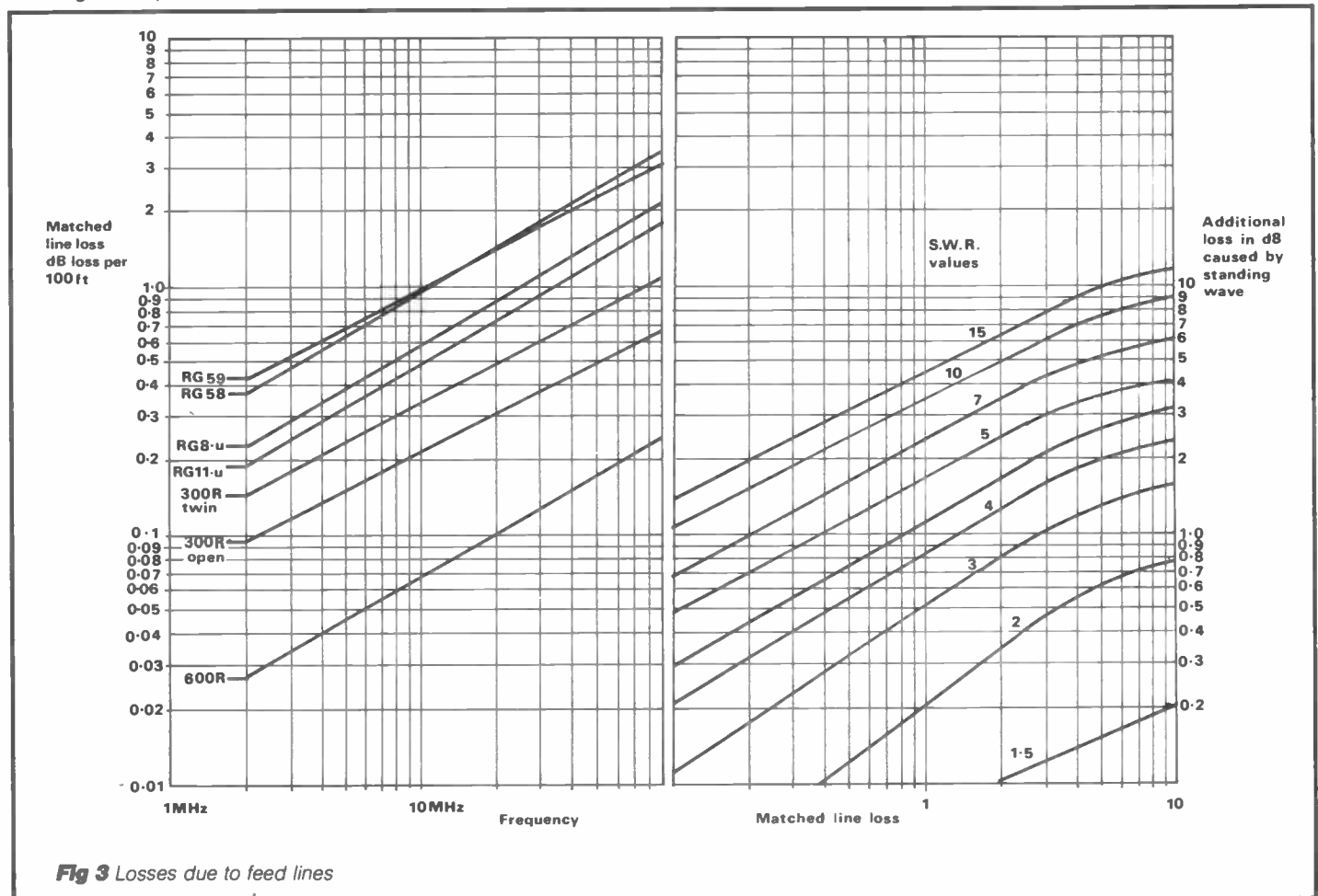

AERIALS & PROPAGATION

characteristic impedance of the feeder, thus ensuring maximum transfer of power to the radiator. This can preferably be done at the aerial end of the feeder, thus eliminating feeder losses.

Aerial forms

It is outside the scope of this presentation to discuss aerial forms in detail. The radiation patterns of simple wire aerials are shown in the appendix, in a later article, and attention is drawn to the basic principle of the co-linear aerial. By effectively using three half wave sections in series and folding the centre one back into itself the phase of the resultant output fields is additive, and becomes more concentrated, consequently giving gain in a reduced vertical dimension.

This aerial used in a vertical configuration gives less radiation in a skyward direction and more into a horizontal plane, and so is very popular on VHF FM. The effect of a similar arrangement using horizontal dipoles, fed out of phase at selected parallel spacing, can also give gain in a selected direction.

By feeding one aerial only and varying the electrical length of a similar aerial a small fraction of a wave length away, a suitable phase distribution, which can be additive or subtractive, can be achieved. Thus a forward gain, in which one element acts as a reflector and the other as a director without direct power being

fed into them, is created. Such elements are called parasitic elements. This is the Yagi UDA aerial, known generally as the Yagi.

The so called $\frac{5}{8}$ aerial is basically a shortened $\frac{3}{4}$ wave in which the $\frac{1}{8}$ wave is absorbed in an inductive reactive circuit to compensate for the capacitive reactance present in the shortened aerial. The two reactances cancel and effectively present an 80ohm resistive load to the feeder of the $\frac{5}{8}$ physical length.

From the points discussed it should be obvious that an aerial which is end fed and is one half wave long will be fed at a voltage or high impedance point. Simply, this can be fed from the top of a parallel tuned circuit (high dynamic resistance). An aerial that is only a quarter wave length will be current fed, and will need to be fed from a low impedance source on the top of a series resonant circuit (maximum current, low impedance). These are also shown in the appendix, next month.

The voltage fed aerial is shown as a Hertzian aerial, and the current fed as a Marconi. The effect of the height of an aerial above ground is significant since a radiated wave travelling from the aerial to the ground and reflecting back through the aerial will induce currents back into the radiator.

If the aerial is one half wave above ground or a whole number of half waves

high, then the reflected wave will travel a whole number of full waves before it returns to the aerial (aerial - ground - aerial), thus it will be in phase with aerial currents and have no effect on current distribution. Any other height will have a varying effect on the phase relationship in the aerial and will have a marked control over the radiation resistance, and consequently the matching impedance.

The objective of this series of articles has been to present a relatively simple explanation of the performance of aerials and propagation for RAE students and others. The presentation has far exceeded the exam requirements in many sections, but this has been purposely carried out to enable a proper understanding of the subject to be created and to clarify many conflicting arguments heard over the air. Obviously, such a wide subject can only be glossed over and it is hoped that sufficient meat has been left attached to the bare bones to create a satisfying meal.

Appendix

Next month's appendix gives a more theoretically applied slant to certain comments without being too advanced. Probably the most conclusive studies of aerials suitable for the beginner are those by Bill Orr W6SAI, obtainable at most rallies from the RSGB bookstall.

COMING NEXT MONTH

Amateur RADIO

ANGUS MCKENZIE G3OSS
reviewing the new Microwave Modules MMT144/28R
2m transverter

RECEIVER SPECIAL
a survey of recent reviews and how to align older receivers

CONTEST CALENDER
Nigel Cawthorne G3TXF with a look at contests in 1985

THE DREADED DECIBEL
J Glanville G3TZG with the theory behind the unit

Plus DX Diary, On the Beam, SWL, Back to Basics, Straight and Level, your letters and features covering the whole of amateur radio

DON'T MISS the March issue - on sale 28 February
To be sure of your copy of *Amateur Radio* complete the newsagents order form in this issue or take out a post-free subscription

COMING NEXT MONTH

BACK TO BASICS

Bill Mantovani G4ZVB continues his common-sense approach to passing the RAE. This month: RADIO RECEIVERS

This month it's time to get down to the nitty-gritty on radio receivers. For those of you who have done their homework since the January issue of *Amateur Radio*, understanding Chapter 4 of the *Radio Amateurs' Examination Manual* should prove fairly straightforward, so let's begin by looking at certain terms used in connection with radio receivers (see table).

The *sensitivity* of a particular receiver is a measure of its ability to receive weak signals, sometimes so weak that they barely stand out from the background noise on a particular band. As explained, a receiver's sensitivity is usually quoted as being that level of signal at the antenna input which will produce a standard ratio of signal-to-background noise. Therefore, if a receiver's sensitivity is said to be $1\mu\text{V}$ for 10dB signal-to-noise ratio, this means that the level of the signal ($1\mu\text{V}$) will be about three times the level of the noise present with the antenna removed and the input correctly terminated.

Winkle out weak DX

Communications receivers, as amateur receivers are often called, should ideally have very good sensitivity to allow the operator the best possible chance of winking out that weak DX signal but at the same time, a receiver must also be able to cope with extremely strong signals from stations much closer to home. The sensitivity of a communications receiver can thus usually be varied by the operator by means of an RF gain control, or the facility can be built into the receiver circuitry as *automatic gain control* (agc). Amateur receivers will normally employ both methods.

Agc allows the sensitivity of a receiver to be controlled automatically according to the strength of the signal being received. If the signal is strong, then the sensitivity of the receiver will be reduced automatically (as high sensitivity is unnecessary), but if the wanted signal is extremely weak then the agc circuit will increase the receiver's sensitivity to a high level. Agc is also useful if the signal suffers from fading (QSB, as it is referred to in the Q-code). The agc circuitry tries to vary the sensitivity in accordance with the incoming signal to produce an almost constant, fade-free signal for passing on to the detector stage. A receiver that is able to cope equally well with very strong signals and very weak ones is said to have a good *dynamic range*.

Crowded

On today's crowded amateur bands, stations often have to operate on frequencies that are very close to each other, thus making it difficult for an amateur to work a particular station without experiencing considerable interference from other signals. A

receiver should therefore have good *selectivity*, that is, its selectivity must be high enough to allow the reception of the desired signal, whilst at the same time disregarding signals on adjacent frequencies and so minimising the amount of adjacent channel interference.

Bandwidth

The *bandwidth* of a receiver is closely linked with selectivity. If a receiver has a high selectivity it is said to have a narrow bandwidth but at the same time there are constraints which do not allow the bandwidth to be too narrow, and which thus place a limit on a receiver's usable selectivity. This limit is governed by the bandwidth of the type of signal which is being received. In practice, for communications-quality speech in a double sideband (DSB) system a bandwidth of about 6KHz is required, whilst for single sideband (SSB) speech a bandwidth of half this figure is adequate. A bandwidth narrower than this would result in a loss of some of the speech component of the transmitted signal, so that the received signal begins to sound unintelligible.

For CW, at manual keying speeds, the bandwidth can be reduced even further at the transmitter end to between 100 – 300Hz. However, the *frequency stability* of the oscillator stage in the receiver (and transmitter) could cause the receiver tuning to drift if the receiver bandwidth were any less than the above figures, possibly losing the station being worked altogether. Ideally, the receiver should be able to receive just the right bandwidth for any mode, so provision is made in modern communications receiver designs to switch the bandwidth

to the correct level for each particular mode of reception by means of filters.

Tuned radio frequency receiver

For the RAE we are interested in two basic types of receivers, the tuned radio frequency or TRF receiver and the superheterodyne or superhet receiver. In the early days of radio, TRF receivers were widely used by amateurs and consisted, briefly, of a regenerative detector followed by one or more stages of AF amplification. At the front end, a tuned RF amplification stage would be added to improve the sensitivity of the 'straight' receiver, hence the name TRF. This basic design of receiver has limited characteristics so today its appeal is restricted more to the beginner, for whom it can be a particularly good constructional project and also a useful basis for the study of far more complex circuits. A block diagram of a simple three-stage TRF receiver is shown in *Figure 1*. Let us now look at the three stages a little more closely.

RF amplifier

The purpose of the RF amplifier is to increase the sensitivity and selectivity of the receiver. It also isolates the antenna from the following detector stage and stops it from affecting the correct operation of the detector. The incoming RF signal is amplified before being passed to the detector stage but further improvements in sensitivity may be achieved by the use of additional RF amplifier stages. The amount of RF amplification should not, however, be so high as to cause instability in the receiver.

Sensitivity – indicates the ability of a receiver to receive weak stations.
Selectivity – is the ability of a receiver to receive one particular signal whilst ignoring others on adjacent frequencies which may often be much stronger.
Dynamic range – a wide dynamic range allows the receiver to cope with both strong and weak stations that may appear together on similar frequencies.
Bandwidth – if a receiver has high selectivity it is said to have a narrow bandwidth.
Automatic gain control – (agc) is where the strength of the incoming signal is used to automatically control the sensitivity of a superhet receiver, giving a fairly constant audio output.
Frequency stability – is the ability of a receiver to remain tuned to the desired signal without drifting off-frequency.

The detector stage

The function of the detector stage in a TRF receiver is two-fold: to convert the radio frequency signal to an audio signal and to generate a degree of feedback for the reception of CW.

The AF amplifier

The AF stage simply amplifies the audio frequency output from the detector and drives headphones or a loudspeaker, the amount of AF amplification being varied by means of a gain control. The complete circuit of a three stage TRF receiver is shown in the RAE manual together with a description of how it works. Tr1 is the RF amplifier, Tr2 operates as a detector (with the feedback for CW reception being adjusted by means of the 300pF variable capacitor connected to the drain), and Tr3 is the AF amplifier. FETs are used for Tr1 and Tr2, whilst the transistor Tr3 is connected in a simple common-emitter amplifier circuit. You should understand the basic operation of this fairly simple receiver circuit before moving on to the more advanced superhet receiver.

A note first about the term *bandspread*. Tuning of the TRF receiver shown is by means of two sets of ganged variable capacitors. The high value capacitors are used to tune the RF stage and the detector stage, whilst the smaller value variable capacitors connected across these main tuning capacitors serve to allow a small portion of the tuning range of the main capacitors to be spread over the whole range of these smaller bandspread capacitors, thus making tuning on the crowded bands somewhat easier.

Superhet receivers

The block diagram of a simple superhet receiver (Figure 2) shows that the superheterodyne principle utilises somewhat more stages than the TRF receiver. A superhet receiver offers considerable improvement in selectivity and an increase in gain over the straight TRF receiver, and operates as follows.

The frequency of the received signals is first converted to a single, fixed frequency called the *intermediate frequency*, which is usually fairly low. It is at this IF that all of the receiver's selectivity can be obtained together with most of the gain, because the IF amplifier (or

Fig 1 A three stage TRF receiver block diagram

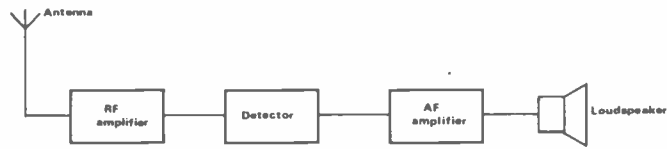

amplifiers) only need to be tuned to one set frequency, and once correctly adjusted can be left alone. Hence, the circuits can be designed to achieve a high amplification factor whilst retaining good stability.

The majority of Chapter 4 now discusses in greater detail the purpose and function of each separate stage of the superhet receiver, but this article will concentrate on the points most relevant to the RAE syllabus. Do make sure that you read the chapter carefully and understand the basic design principle of the superhet receiver, because there will certainly be a number of questions on this topic in the exam. Remember, also, that it is the *principle* of the superheterodyne receiver that you are required to understand: you will not be asked to explain the workings of each stage in minute detail as some candidates have thought!

The superhet principle

This is the basic superheterodyne principle of reception, which you should become familiar with. The frequency of the incoming signals is converted to a fixed intermediate frequency by a frequency mixing process performed by the aptly named *mixer* stage. Here, the incoming signal frequency is mixed with the output of the *local oscillator*, whose frequency is varied by the receiver's tuning control. The process produces two frequencies at the mixer output (see Figure 3a), one being the sum and the other the difference of the local oscillator and signal frequencies.

Only one of these frequencies will be accepted by the following IF stage (that to which the IF amplifier is tuned), whilst the other is rejected. This intermediate frequency is then amplified and fed to the detector stage, which converts it to an audio frequency for amplifying in the AF stage (just as it does in the TRF receiver).

In order to compensate for variations in the level of the received signals, the gain of the receiver is varied as necessary by the *automatic gain control* (agc). The agc stage is connected to the output of the IF amplifier, from which it produces a voltage whose amplification is proportional to the amplitude of the incoming signal. This voltage is then used to control the gain of the IF stage.

BFO

For the reception of *continuous-wave* telegraphy (CW) signals a *beat frequency oscillator* (BFO) is used to provide a signal which will beat with the IF and so produce an audible beat note. The BFO is very loosely coupled to the detector, operates at the intermediate frequency and is variable either side of this frequency by a few KHz to give an audible note that is acceptable to the listener.

Let us now look at one or two problems that are associated with the design of superhet circuits.

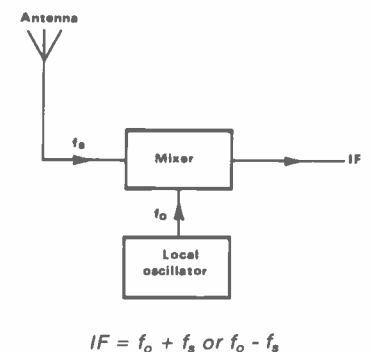

Fig 3a The mixer process

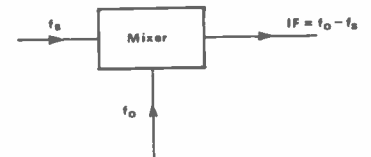

Fig 3b How the wanted signal produces the correct IF

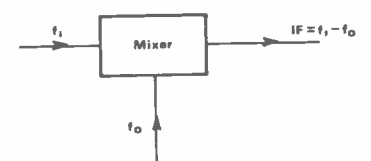

Fig 3c How the image frequency also produces the correct IF

Fig 2 Block diagram of a simple, single-conversion superhet receiver

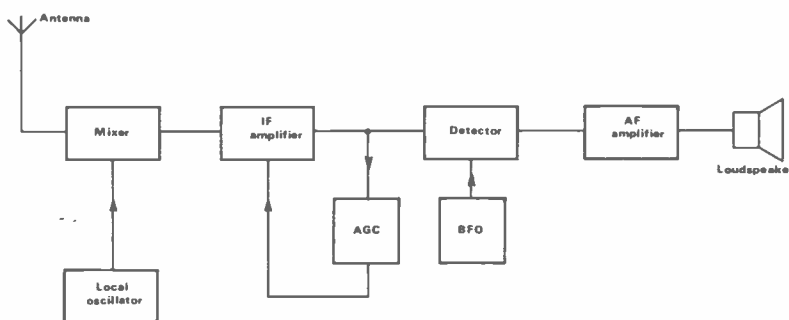

Fig 4a Basic diode detector circuit

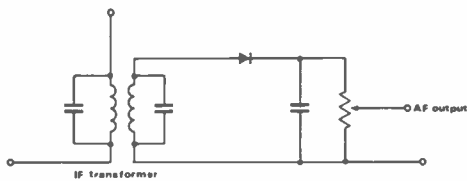
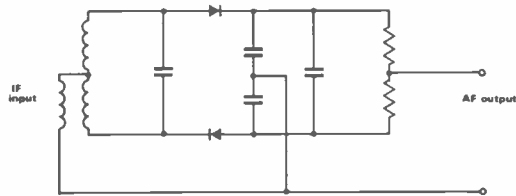

Fig 4b Basic ratio detector circuit



As previously mentioned, two frequencies appear at the output of the mixer stage but only that which matches the intermediate frequency will be accepted by the IF amplifier; the other is rejected. However, it is not just the wanted signal frequency which can mix with the local oscillator frequency to produce a signal at the required IF. As the example on page 38 of the *RAE Manual* shows, it is quite possible for there to be a very strong signal present on a frequency other than that to which the receiver is tuned which can also mix with the local oscillator frequency to also produce the correct IF. This is shown more readily in *Figures 3b and 3c*.

The unwanted signal which has also produced the correct IF is called the *image* or *second-channel* frequency and makes it sound at the audio output as if the receiver were picking up two signals simultaneously on the same frequency. The interference caused, only occurs when the second channel signal is strong enough to operate the mixer. This can happen if there is no RF stage present to isolate the antenna from the mixer, or when the mixer stage is inadequately screened. Remember that the image or second-channel is numerically twice the intermediate frequency away from the wanted signal, so that if the IF were increased then the incidence of image interference would be reduced. We shall look at how this is done in practice in a moment.

The local oscillator (LO) needs to have good frequency stability otherwise the receiver will appear to drift. Usually, the frequency of the local oscillator will be on the high side of the signal frequency. The LO tuned circuit must maintain a frequency separation equal to the intermediate frequency over the mixer tuned circuit throughout the receiver tuning range. This is known as *tracking*.

The RF amplifier

As with the TRF receiver, an RF amplifier stage can be employed in a superhet circuit to improve the sensitivity, and hence the signal-to-noise ratio, of the receiver. The RF amplifier also serves to reduce the chance of second-channel interference, and its tuning is ganged to the mixer/local oscillator control.

The IF amplifier

Typically, a superhet receiver can have one, two or even three stages of IF amplification. The IF amplifier circuit is based around a tuned circuit which responds to one frequency only and the selectivity of an IF amplifier is solely determined by the design of the coupled tuned circuits of the *IF transformer*. Study *Figure 4.8* in the *RAE manual* to familiarise yourself with selectivity curves and the terms *nose width*, *skirt width* and *shape factor*.

Typical IF values in use today are between 455-470KHz for receivers that operate up to 30MHz. Remembering what was said at the beginning of this article about optimum bandwidth for a particular reception mode, it is possible to reduce the bandwidth by reducing the value of the IF. This will increase the chances of second-channel interference, but good selectivity and second-channel performance can be achieved by the use of two different IF frequencies. This is called the *double superhet* and it gives very good performance indeed. A high first IF is used to ensure minimal second-channel interference, whilst a low second IF makes for good selectivity and a narrow bandwidth.

Another way to achieve better IF selectivity is to use a *bandpass filter* of which two typical types are the crystal filter and the mechanical filter. The former is useful when receiving CW due to the narrow nose bandwidth, whilst the latter is normally used for suppressing the unwanted sideband in a single sideband transmitter.

The detector

This demodulates the output of the IF amplifier to recover the modulation that was superimposed on the carrier at the transmitter. The AF output from the detector is fed to a conventional audio amplifier and converted into sound by headphones or a loudspeaker. The use of a BFO to resolve CW signals has already been covered.

The most common form of detector is simply a diode acting as a half-wave rectifier, the output being developed across the diode load resistor as shown in *Figure 4a*. The above is called the *diode* or *envelope detector* and is used for the reception of amplitude-mod-

ulated (AM) and CW signals. For the detection of frequency modulated (FM) signals, the ratio detector circuit of *Figure 4b* is often used. Make a note of the circuits in *Figures 4a* and *4b* as a typical RAE question could be to state the use of a particular detector circuit, or to simply state which is a detector circuit from the choice given. There are such questions in the sample papers at the back of the *RAE Manual*.

In order to be able to resolve SSB signals it is necessary to insert a signal into the detector to replace the carrier wave which was suppressed in the transmitter. A *carrier insertion oscillator* is used for this purpose, but the function can also be performed by the BFO to some degree. The preferred circuit for the resolution of an SSB signal is the product detector, which can also be used for the resolving of CW. That is about it on receivers, save to mention some other features often found in receiver designs.

The crystal-controlled *calibration oscillator* provides a calibration marker every 100KHz (typically) throughout the tuning range of the receiver, so that the scale can be accurately adjusted. A *noise limiter* is often included to try to reduce any electrical noise which may be causing interference. Certain other noises, such as the infamous "woodpecker", also cause havoc with reception, but by employing a circuit which limits signals which exceed a particular modulation level it is sometimes possible to reduce this interference.

Most, if not all, communications receivers now come equipped with a *signal-strength* or S-meter to give an indication of the strength of the incoming signal. The meter is calibrated in S-units but as there is no agreed definition of an S-unit, the readings are only really of use with reference to other signals being received.

We have now discussed the basic principle of the superhet receiver; to convert incoming signals to a fixed IF followed by demodulation and audio amplification. It is possible to convert the received signal directly to AF, a principle known as *synchrodyne* or *direct conversion*, but problems with oscillator stability tend to confine this type of receiver to lower-frequency amateur bands.

The principles we have discussed also apply to receivers which cover the VHF and higher frequency ranges, although the IF will usually be much higher and its bandwidth greater. Next month: transmitters.

Acknowledgements and references

Radio Amateurs' Examination Manual – GL Benbow, G3HB (RSGB)
A Guide to Amateur Radio – Pat Hawker, G3VA (RSGB)
 City and Guilds of London Institute.
Radio Communication Handbook (fifth edition) – RSGB
How to pass the Radio Amateurs' Examination – George Benbow, G3HB (RSGB)

* 4,000 WORLD-WIDE USERS

Isn't it about time
you switched
to Icom?

IC-751

The IC-751 could be called the flagship of the ICOM range as it features 32 memory channels, full HF receive capability, digital speech synthesizer, computer control and power-supply options. The 751 is fully compatible with ICOM auto units such as the AT-500 and IC-2KL. The IC-751 now has a remote push-button frequency selector pad.

Standard features include: a speech processor, switchable choice of J-FET pre-amp or 20dB pin diode attenuator and two VFO's, marker, 4 variable tuning rates, pass band tuning, notch, variable noise blanker, monitor switch, direct feed mixer in the front end, full break-in on CW and AMTOR compatibility.

The first IF is 70.045 MHz. Any XIT and RIT adjustment is shown on the display. The transmitter features high reliability 2SC2904 transistors in a low IMD (-32dB @ 100W) full 100% duty cycle. For more detailed information on this excellent set, please get in touch with us.



IC-290D/290E



290D is the state of the art 2 meter mobile, it has 5 memories and VFO's to store your favourite repeaters and a priority channel to check your most important frequency automatically. Programmable offsets are included for odd repeater splits, tuning is 5KHz or 1KHz.

The squelch on SSB silently scans for signals, while 2 VFO's with equalising capability mark your signal frequency with the touch of a button. Other features include: RIT, 1 KHz or 100Hz tuning/CW sidetone, AGC slow or fast in SSB and CW, Noise blanker to suppress pulse type noises on SSB/CW.

You can scan the whole band between VFO's/scan memories and VFO's. Adjustable scan rate 144 to 146 MHz, remote tuning with IC-HM10 and HM11 microphones. Digital frequency display, Hi/Low power switch. Optional Nicad battery system allows retention of memory.

Special Offers for 1985: 25 watt IC-290D reduced to £469 and the 10 watt IC-290E reduced to £399. The 70cm version IC-290E is reduced to £529. Take advantage of this money-saving offer.

* AT THE LAST COUNT

Thanet ICOM Thanet ICOM Thanet ICOM Thanet ICOM Thanet ICOM Thanet ICOM Thanet ICOM Thanet ICOM

DOORS CAN'T BE WRONG

IC-271 & 471

ICOM can introduce you to a whole new world via the world-communications satellite OSCAR. Did you know that you can Tx to OSCAR on the 430-440 MHz IC-471 and Rx on the 2m IC-271.

By making simple modifications, you can track the VFO's of the Rx and Tx either normally or reverse. This is unique to these ICOM rigs and therefore very useful for OSCAR 10 communications. Digital A.F.C. can also be provided for UOSAT etc. This will give automatic tracking of the receiver with digital readout of the doppler shift. The easy modifications needed to give you this unique communications opportunity are published in the December '84 issue of OSCAR NEWS. Back issues of OSCAR NEWS can be obtained from AMSAT (UK), LONDON E12 5EQ.

This range includes the IC-271E-25W, 271H-100W and the 70cm versions IC-471E-25W and 471H-75W r.f. output. The 271E has an optional switchable front-end pre-amp. The 271H has a mast-head pre-amp AG-25, and the 471E and 471H use the AG35 mast-head pre-amp. Other options include internal switch-mode PSU's: the 271E and 471E use the PS25 and the 271H and 471H use the PS35.

Also available are the SM6 desk microphone and a speech synthesizer that announces the displayed frequency, what more could you ask for?

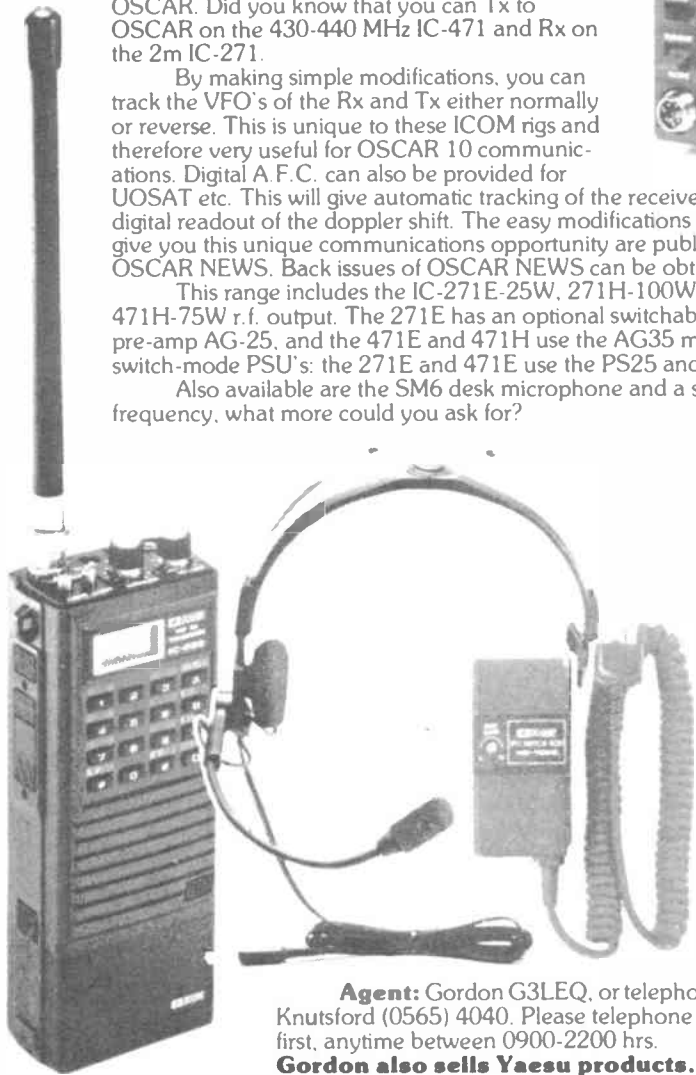

Agent: Gordon G3LEQ, or telephone Knutsford (0565) 4040. Please telephone first, anytime between 0900-2200 hrs.
Gordon also sells Yaesu products.

IC-02E, IC-04E

The direct entry microprocessor controlled IC-02E is a 2 meter handheld features include: scanning, 10 memories, duplex offset storage in memory and odd offsets also stored in memory. Internal Lithium battery backup and repeater tone are included. Keyboard entry is made through the 16 button pad allowing easy access to frequencies, duplex, memories, memory scan and priority.

The IC-02E has an LCD readout indicating frequency, memory channel, signal strength, transmitter output and scanning functions. New HS-10 Headset, with earphone and boom microphone, which operates with either of the following:- HS 10-SB Switch box with pre-amplifier giving biased toggle on, off and continuous transmit. HS 10-SA Voice operated switch box, with pre-amplifier, mic gain, vox gain and delay. The IC-2E and 4E continue to be available.

You can get what you want just by picking up the telephone. Our mail-order dept. offers you: free, same-day despatch whenever possible, instant credit, interest-free H.P., telephone Barclaycard and Access facility and a 24 hour answering service.

Please note that we now have a new retail branch at 95, Mortimer Street, Herne Bay, Kent. Tel: 69464. Give it a visit, BCNU.

QUESTIONS & ANSWERS

RAE PRACTICE DEVISED BY R.E.G. PETRI G8CCJ

Fig 1

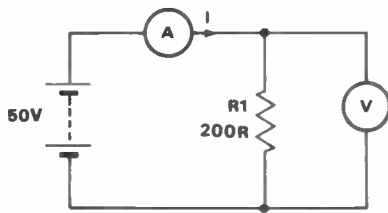

- Which one of the following formulae would you use to calculate the current 'I' flowing in the 200ohm resistor R1?
 - $I = V/R$
 - $I = V^2/R$
 - $I = R/V$
 - $I = V^2R$
- You are asked to calculate the power dissipated in the 200ohm resistor R1 (Figure 1). Which one of the following formulae would you use?
 - $W = VI$
 - $W = R^2/V$
 - $W = V/R^2$
 - $W = R/I$
- Referring to Figure 1, what is the current 'I' flowing, and the power dissipated in the 200ohm resistor R1?
 - 50A/200W
 - 0.25A/12.5W
 - 5A/20W
 - 2.5A/125W

Fig 2

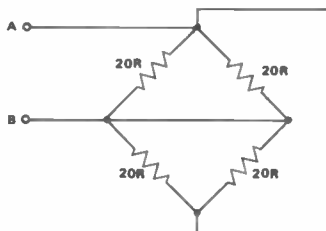

- You are presented with a jumble of resistors which appear to be connected as shown in Figure 2. Which one of the circuit arrangements shown below will put this jumble into a simple form for easy calculation?

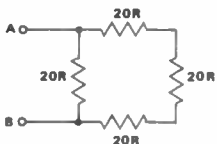

(a)

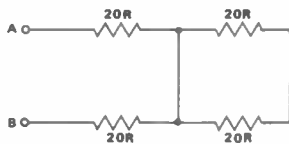

(b)

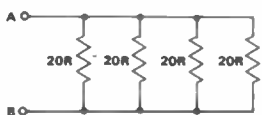

(c)

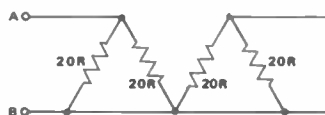

(d)

- What is the total resistance of the circuit shown in Figure 2, measured across terminals A & B?

- 15Ω
- 40Ω
- 5Ω
- 10Ω

Fig 3

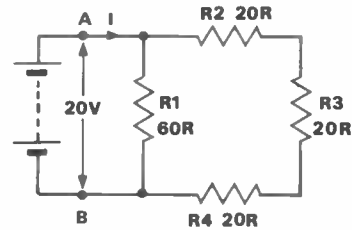

- Figure 3 shows a series/parallel resistor combination. What resistance does this circuit present to the battery at terminals A & B, and what is the total current 'I' flowing from the battery?

- 120Ω/20A
- 20Ω/1.20A
- 30Ω/6.66A
- 30Ω/0.66A

Fig 4

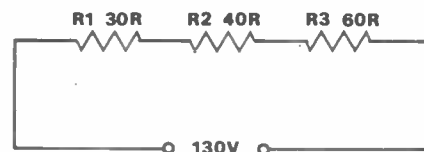

- A 130 volt supply is applied across the three series connected resistors shown in Figure 4. What potential difference would you measure across R1, R2 & R3 respectively, when using a high resistance voltmeter?

- 30V, 40V, 60V
- 60V, 40V, 30V
- 15V, 20V, 30V
- 30V, 20V, 15V

- The frequency, 'f' hertz, of an alternating current or voltage is determined by:

- the maximum amplitude of the waveform
- the minimum amplitude of the waveform
- the number of complete cycles of the waveform that occur in one second
- the number of 'zero crossings' in one hour

- An alternating current has a peak value of 325 volts. What are the peak-to-peak and rms values?

- 230V/115V
- 650V/230V
- 650V/325V
- 495V/230V

- Figure 5 shows a 10V rms alternating supply connected across a pure resistance of 100Ω. What is the rms current?

- 0.1A
- 1A
- 10A
- 100A

QUESTIONS & ANSWERS

Fig 5

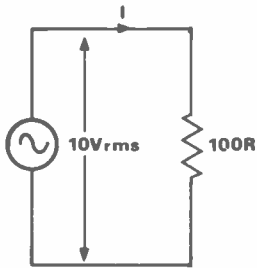

11. Referring to *Figure 5*, it may be said that:
- current does not flow in the resistor when the voltage is at maximum
 - the voltage is at minimum when the current flowing is at a maximum
 - the voltage and current are in phase
 - the voltage and current are in anti-phase
12. Reactance is the term given to the ability of an inductor or capacitor to:
- amplify an alternating current
 - magnify an alternating current
 - resist the flow of an alternating current
 - compensate for circuit losses

Fig 6

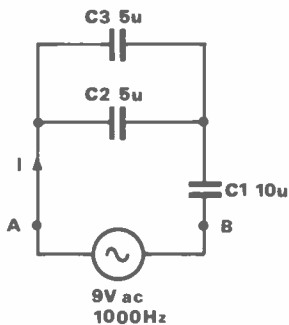

13. Referring to *Figure 6*, what is the total capacitance presented to the generator across terminals A & B?
- $20\mu\text{F}$
 - $15\mu\text{F}$
 - $10\mu\text{F}$
 - $5\mu\text{F}$
14. In *Figure 6*, what is the capacitive reactance ' X_C ' of the capacitor combination?
- 31.83Ω
 - 318.3Ω
 - 3183Ω
 - $31.83\text{K}\Omega$
15. In *Figure 6*, what is the current ' I ' flowing from the generator?
- $282.7\text{mA}/0.282\text{A}$
 - $28.7\text{mA}/0.028\text{A}$
 - $2.82\text{mA}/282\text{A}$
 - $0.283\text{mA}/28.3\text{A}$

16. When an alternating current flows in a circuit consisting of pure capacitance:
- it lags the voltage by 90°
 - it leads the voltage by 90°
 - it is in phase with the voltage
 - its frequency instantly halves

Fig 7

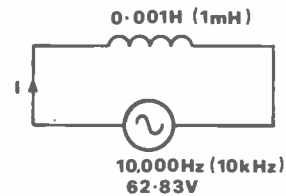

17. In *Figure 7*, what is the reactance of the inductor, and the current ' I ' flowing from the supply?
- $6.283\Omega/10\text{A}$
 - $62.83\Omega/1\text{A}$
 - $628.3\Omega/0.1\text{A}$
 - $1000\Omega/6.28\text{A}$
18. In a circuit consisting of pure inductance, the voltage:
- is in phase with the current
 - lags the current by 90°
 - leads the current by 180°
 - leads the current by 90°
19. Which one of the phasor (vector) diagrams below represents your answer to Q18?

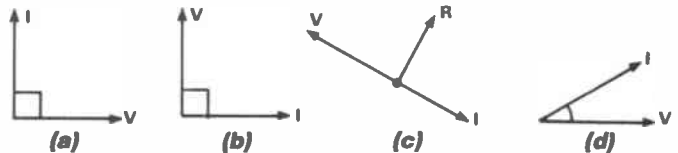

20. The series resonant circuit in *Figure 8* is said to be at resonance when:
- the values of inductance and capacitance are equal
 - the supply voltage leads the current by 120°
 - the inductive reactance ' X_L ' is equal to the capacitive reactance ' X_C '
 - the inductor has no copper losses

Fig 8

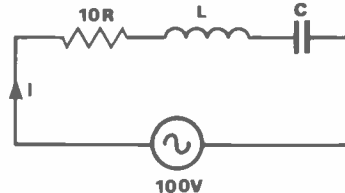

21. What is the resonant frequency of the series tuned circuit in *Figure 8*, given that $L = 100\text{mH}$ ($100 \times 10^{-3}\text{H}$) and $C = 1000\text{pF}$ ($1000 \times 10^{-12}\text{F}$)?
- 1.59KHz
 - 15.915KHz
 - 159.14KHz
 - 20KHz
22. In *Figure 8*, what current will flow in the circuit at the resonant frequency?
- 10mA
 - 100mA
 - 1000mA
 - 10A

23. Which one of the response curves shown below is typical of a parallel resonant circuit?

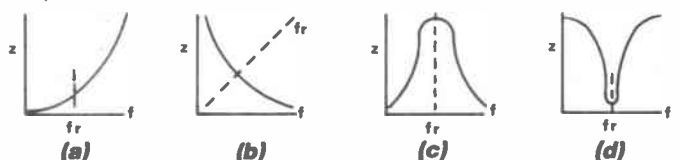

QUESTION & ANSWERS

Fig 9

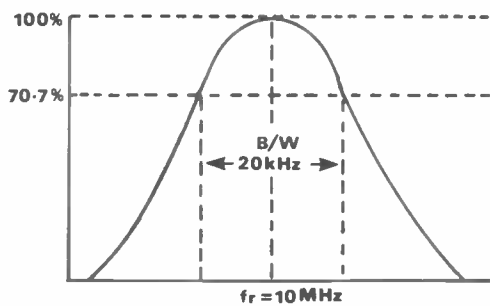

24. Figure 9 shows the response curve of a parallel tuned circuit. What is the 'Q' of the circuit?
- (a) 10
(b) 20
(c) 500
(d) 1000
25. Reducing the value of the capacitor in a series or parallel tuned circuit will:
- (a) increase the resonant frequency
(b) decrease the resonant frequency
(c) have no effect on the resonant frequency
(d) have no effect on the circuit 'Q'.

ANALYSIS

How did you get on with the questions? They were not really designed to catch you out, but rather to give you some practice in calculation and reasoning. I have attempted in the limited space available to make the questions as instructive as possible, which is why some of them are so closely related. Let's take a look at each of the questions in turn.

Q1. Did you remember the Ohms Law triangle? It's all in there.

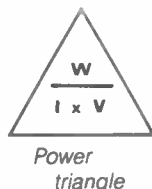
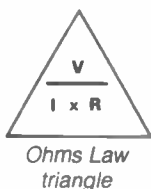

- Q2. As for the power dissipated in R1, you can't get that from the Ohms Law triangle, can you? However, you'll be pleased to know that there is a 'power triangle' which works in exactly the same way (simply cover the unknown quantity and the required formula is exposed).
- It is possible to combine the equations or formulae from the two triangles to produce other related equations, for instance:
- $W = V \times I$
but $I = V/R$
which by substitution gives:
 $W = V \times V/R = V^2/R$
also $V = I \times R$
which by substitution with $W = V \times I$ gives:
 $W = I \times R \times I = I^2R$
- We now have two new formulae for power.

Q3. First use the formula $I = V/R$, and substitute the known values ie: $I = 50/200 = 1/4 = 0.25A$. To find the power, $W = V \times I = 50 \times 0.25 = 12.5W$.

Q4. I bet you didn't like this one! In fact, it's the sort of everyday problem that a service engineer or amateur electronics enthusiast may encounter. Anyway, I hope you got it right or your next answer will almost certainly be wrong.

Q5. The jumble breaks down into four resistors in parallel. In December, Bill Mantovani gave you the general formula for parallel resistors, so write the formula down and just substitute the figures. Schoolboy maths really! Look:

$$\frac{1}{R_1} + \frac{1}{R_2} + \frac{1}{R_3} + \frac{1}{R_4} = \frac{1}{R_T} = \frac{1}{20} + \frac{1}{20} + \frac{1}{20} + \frac{1}{20} = \frac{1}{R_T}$$

$$= \frac{4}{20} \text{ therefore } R_T = \frac{20}{4} = 5\Omega$$

Why not try this one on your calculator? Using the table, I'll work it out with you, step by step. I'm using a Casio fx-2800P, and if your calculator is different you may find that your 'displayed' result is not quite the same, but you'll soon get used to it.

COMMENTS	KEY STROKE	DISPLAY	EXP
Clear	AC		0
first resistor	20	20	0
1/20	INV	2	0
	1/x	0.05	5
	+	0.05	5
second resistor	20	20	0
1/20	INV	2	0
	1/x	0.05	5
	+	0.1	1
third resistor	20	20	0
1/20	INV	2	0
	1/x	0.05	5
	+	0.15	15
fourth resistor	20	20	0
	INV	2	0
	1/x	0.05	5
	=	0.2	2
1/R _T		0.2	2
only necessary where 1/x is a 2nd function	INV	0.5	5
	1/x	2	Answer

Q6. To calculate the total resistance of this circuit, you must first calculate the resistance of the series branch R2, R3 and R4, which should be treated as a single resistor of equivalent value in parallel with R1. The total resistance of R2-R3-R4 = 20+20+20 = 60 ohms.

We can now re-draw the circuit (for the purpose of calculation) like this:

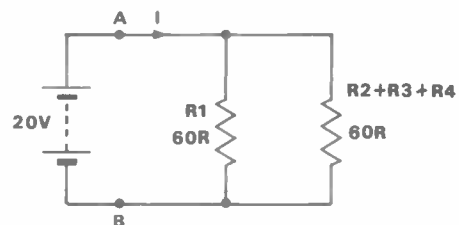

You can see that you now have a simple parallel circuit, which can either be calculated by the formula used in the previous question, or by means of the simplified formula:

$$R_T = \frac{R_1 \times R_2}{R_1 + R_2} = \frac{60 \times 60}{60 + 60} = \frac{3600}{120} = 30\Omega$$

Having found the total resistance of the circuit, the current flowing from the 20 volt supply is easy to calculate:

$$I = \frac{V}{R} = \frac{20}{30} = 0.66A$$

Q7. This question demonstrates the potential differences that exist in a series circuit. In this circuit, the sum of all the potential differences (PDs) add up to the supply voltage.

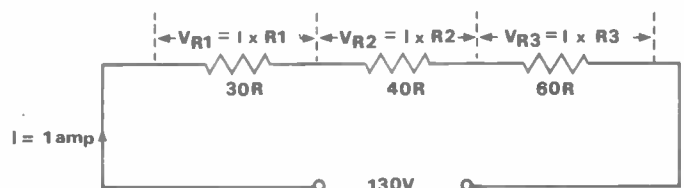

QUESTIONS & ANSWERS

Calculate the total current:

$$I = \frac{V}{R_1 + R_2 + R_3} = \frac{130}{130} = 1A$$

The individual PDs are:

$$V_{R1} = I \times R_1 = 1 \times 30 = 30V$$

$$V_{R2} = I \times R_2 = 1 \times 40 = 40V$$

$$V_{R3} = I \times R_3 = 1 \times 60 = 60V$$

The sum of the individual PDs is therefore:

$$30 + 40 + 60 = 130V.$$

Q8. Not much explanation required here – take our domestic ac mains supply, which has a frequency of 50 hertz. This means that there are fifty complete cycles of the voltage or current per second.

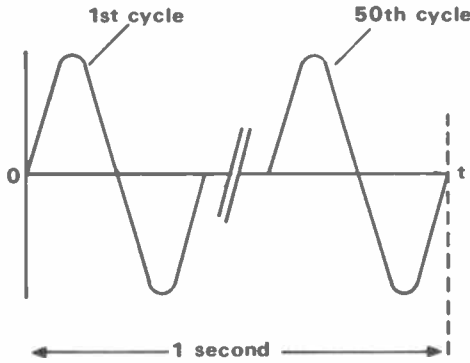

Q9. The peak value is always higher than the root mean square (rms) value. The formulae to remember are:

$$V_{rms} = V_{pk} \times \frac{1}{\sqrt{2}} = V_{pk} \times 0.707$$

$$V_{pk} = V_{rms} \times \sqrt{2} = V_{rms} \times 1.414$$

The peak-to-peak value is twice the peak value.

Q10. This is really just another Ohms Law calculation:

$$I_{rms} = \frac{V_{rms}}{R}$$

Q11. When the load is non-reactive, the current and voltage will be in phase.

A non-reactive load is one with negligible self-inductance and self-capacitance.

For most purposes a solid carbon resistor can be considered non-reactive. Wire-wound resistors usually possess some inductance and capacitance due to their construction.

Self-inductance and self-capacitance are not desirable features in a resistor, so resistor types must be carefully chosen to suit the proposed application.

Q13. This should have been fairly easy for you. The first step is to lump the two parallel capacitors C2 and C3 together, giving an equivalent capacitance of 10µF. Considering this as a single capacitor in series with C1, we find the total capacitance:

$$\frac{C_1 \times C_{2,3}}{C_1 + C_{2,3}} = \frac{10 \times 10}{10 + 10} = \frac{100}{20} = 5\mu F$$

Q14. The formula for capacitive reactance is:

$$X_c = \frac{1}{\omega C} = \frac{1}{2\pi f C}$$

where $\omega = 2\pi f$

Substituting all known values into the formula we get:

$$X_c = \frac{1}{2 \times \pi \times 1000 \times 5 \times 10^{-6}} = 31.83\Omega$$

Practice with the calculator again – following the table – it will make life easier for you.

Q15. Substitute the known values into the formula:

$$I = V/X_c$$

Remember that there are 1000mA in one amp.

REMARKS	KEY PAD OPERATION	DISPLAY	← EXP →
clear	AC	0	
	2	2	
	X	2 0	
	=	3 4 1 4	
	X	6 2 8	
You are calculating the bottom line of the formula ie $2 \times \pi \times f \times c$	1000	1 0 0 0	
	X	6 2 8 3 1	
	5	5	
	EE or EXP	5 0 0 6	
	6	5 0 0 6	
change sign	+/-	5 0 0 6	
Inverse or second function if required for 1/x	=	0 0 0 3	
Answer	INV	0 0 0 3	
	1/x	3 1 8 3	

(see Q14)

Q16. In a circuit consisting of pure capacitance the current leads the voltage by 90°. This can be demonstrated by allowing the rotating phasor (vector) to trace the graph (as below, for a 360° revolution).

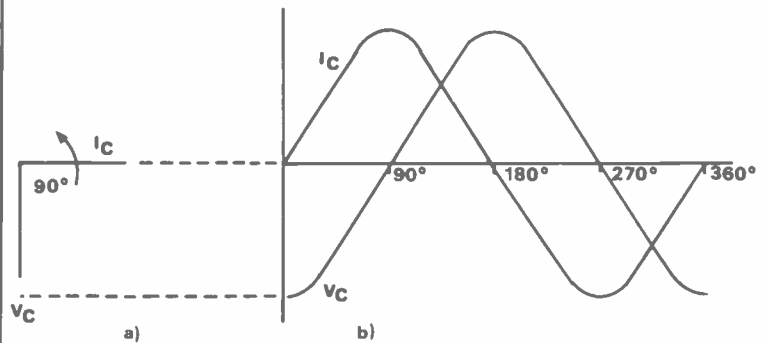

Q17. Another calculation – you should be getting used to them by now! Have you remembered the formula?

$$X_L = \omega L = 2\pi f L$$

That's it, but don't forget:

You shouldn't need the help of your calculator for this one, just substitute the known values:

$$X_L = 2 \times \pi \times 10,000 \times 0.001 = 2 \times 3.14 \times 10,000 \times 0.001 = 62.8\Omega$$

To calculate the current, substitute known values into:

$$I = \frac{V}{X_L}$$

Q18 & 19. In a circuit consisting of pure inductance the voltage leads the current by 90°. This is demonstrated below as for Q16.

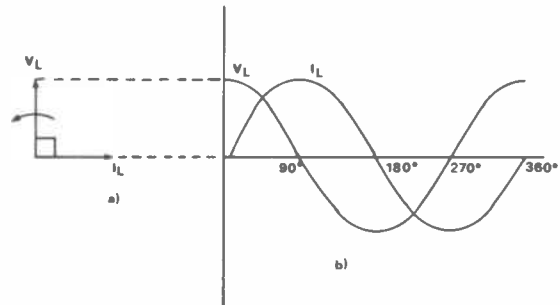

Q20. The circuit is said to be at resonance when the capacitive reactance and the inductive reactance are equal ($X_L = X_C$). We can expand this to find the formula for the resonant frequency 'fr':

$$\omega L = \frac{1}{\omega C} \quad \text{or} \quad \omega^2 = \frac{1}{LC}$$

$$\text{which means } (2\pi)^2 f^2 = \frac{1}{LC}$$

$$\text{which divided by } (2\pi)^2 \text{ gives } f^2 = \frac{1}{(2\pi)^2 LC}$$

which taking the square root of both sides gives

$$f_r = \frac{1}{2\pi \sqrt{LC}}$$

This formula holds good for both series and parallel circuits.

SECONDHAND EQUIPMENT GUIDE



It wouldn't be fair to name names, it would be too embarrassing for the man in question. We will call him Paul, and I'll not mention that this Paul just happens to be the editor of *Short Wave Magazine*. Paul gets invited to give a lecture to a club in Chesham. The club in question offers to talk Paul in on GB3VA, the local repeater. On the night of the lecture our hero hears the club calling him at S9+ on his 2300, but they cannot hear him. Paul has to ask for directions from passers by.

Next morning Paul gives his 2300 to your scribe, requesting the PA be repaired. The 2300 is connected up to the workbench and produces a healthy two watts.

'Funny', says the editor of *SWM*, 'that's exactly how I had it last night'.

'Exactly how you had it?' enquires your scribe.

'Yes', says the editor of *SWM*.

Your scribe then explains to the editor of *SWM* that on a 2300, as with most rigs, you dial up the output frequency of the repeater in question on the rig and, by switching in the repeater shift, automatically transmit 600KHz down. Who had dialled up the *input* frequency (thereby hearing the club calling him on the input) and selected the repeat mode? As I was saying last month, even I cannot repair working equipment. . .

Switching

Continuing my analysis of repair by percentage of faults over the years, the second major category of faults after power supply related ones (detailed last month) are switching faults.

In my book, switching faults cover three distinct 'types' of switch, the normal on/off or rotary switch (including micro-switches), relays and electronic switching.

With normal switches, failure is often fairly obvious. Sometimes the switch just

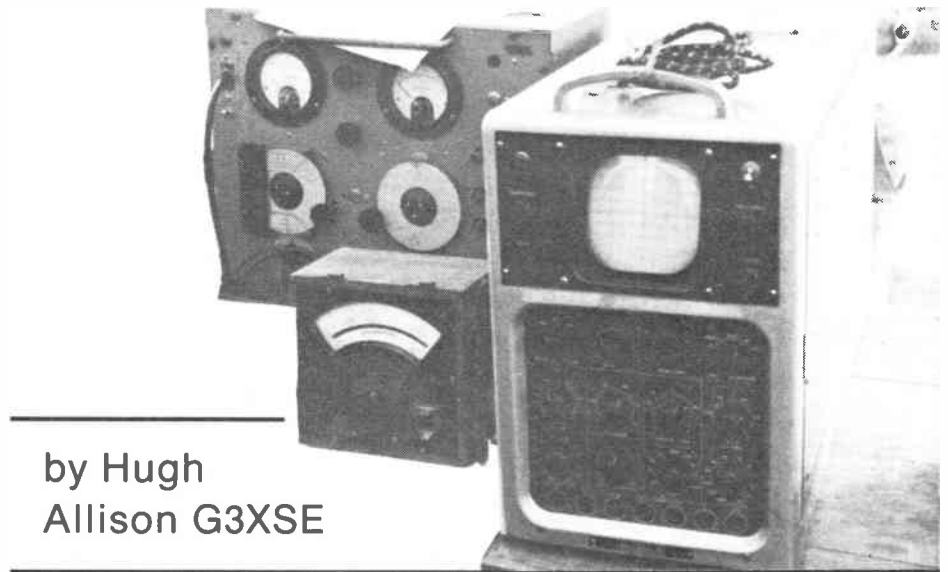

by Hugh
Allison G3XSE

doesn't feel right, or doesn't sound normal when operated. Other faults can often be located by analysing what isn't working and following the fault back from there - the screen grid switch on Trio equipment detailed a few months back is a classic example of this. A problem with normal switches increasingly seen on my workbench is the failure of a switch that controls only a microscopic current.

A good example of this is a +5KHz switch on a synthesised rig, where the switch only has pico amps of CMOS gate current flowing through it. The failure mechanism is, apparently, a build-up of oxide on the switching surfaces. If the switch is handling larger currents the make/break spark is often enough to blast off the oxide layers, but with pico amps there just isn't the energy. Obviously the correct repair is to change the switch, but if one isn't available contact-cleaners such as 'Electrolube' can often work wonders.

Suppose, however, that the switch is completely sealed. If it isn't possible to get the spray into the switching chamber, I have found a 'last ditch' bodge which works surprisingly well. *Disconnect the switch from the circuit* (it isn't necessary to remove it physically) and connect a current limitable power supply across the switching contacts. Set the current limit on the power supply to four fifth's of the switch's current rating, set the power supply voltage to, say, twelve volts, then keep operating the switch in question until you achieve a current flow. This method has been particularly successful with micro-switches. Several Sharp radio cassettes and dozens of Sony videos are proof that the method can give years of extended life.

Relays

Again, sound can be a clue. If, say, going from receive to transmit used to give a nice healthy 'clonk' and all you get now is a feeble 'tap', then the relay may well have a pair of welded-up contacts. Fortunately, most relays have transparent covers and it is often possible to watch the contacts move. Incidentally, most covers will come off on the clear plastic type. There are normally two small cut outs on the cover that are held in lugs. These are usually located at the wiring end of the relay, and the cover can be released by pushing the lugs back (or opening out the cover) with two jewellers' screwdrivers.

Welded up contacts can often be separated by putting a sharp blade *underneath* the contacts and pushing up (with due regard to personal safety). *Never* push down, you will bend the contacts apart in such a way that they will not make reliably in future. Old Pye

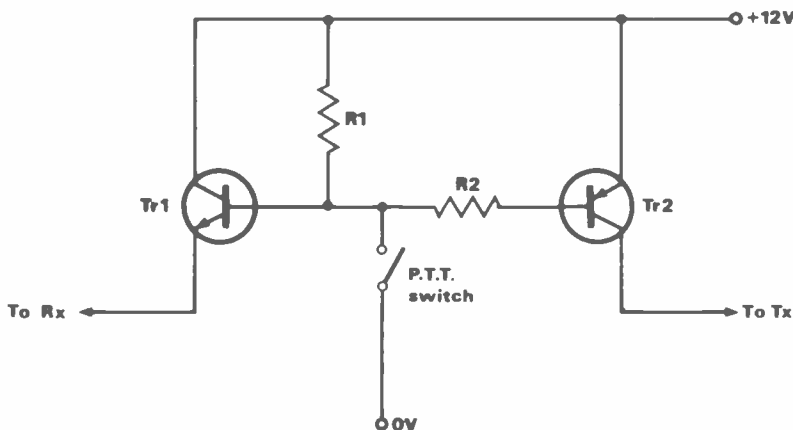

Fig 1 Typical electronic switching circuit

SECONDHAND

Cambridges are notorious for welding up their relay contacts for no good reason.

Electronic switching

Consider the circuit of *Figure 1*. The +12 volts is the normal, nominal rig voltage after the on/off switch. With the push-to-talk (PTT) switch open, R1 keeps Tr1 biased on and thus the supply is routed to the receiver. If the PTT switch closes, the base of Tr1 is taken to ground and it ceases to conduct. Tr2, being a PNP transistor, now conducts since R2 biases it on. Simple enough? The above circuit is extremely common (with minor variations) in most hand-portables and,

dare I say it, in CB rigs. Normally the PA transistors and the audio output stages are connected to the 12V rail at all times and only the lower power stages are switched, thus allowing low current transistors to be used.

A common fault is that the owner runs the rig into a short circuit. This blows the PA transistor (which, as above, is not connected to the switching circuit). The now duff PA stage causes the driver stage to take excess current, due to it running into a different load from normal. The driver stage is switched by the above circuit, and the excess current blows up Tr2. Often this is fairly

spectacular, and blows a hole in the transistor case or cracks it in half.

The Palm range of hand-portables (Palm II and Palm IV) are particularly prone to the above. The quick way of verifying that the above has happened is to look for volts on the collector of the driver transistor whilst holding down the transmit switch. No volts coming up equals a dead switching transistor.

Next month

Next month I'll be looking at common problems with the Dressler D200S 2m linear amplifier and integrated circuit audio amplifiers.

LOOK WHAT YOU GET EVERY MONTH IN

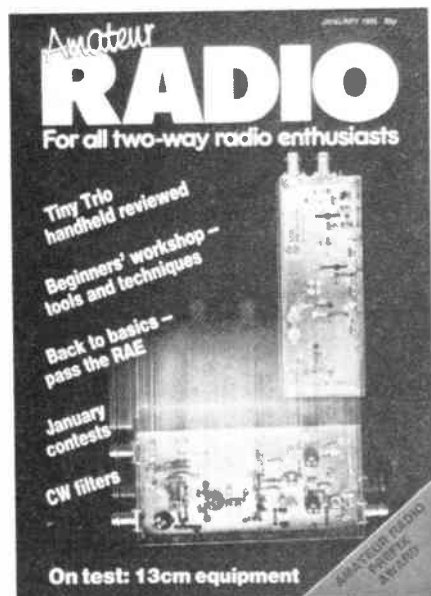

Amateur RADIO

- ★ **DX DIARY** Don Field G3XTT with all the news of rare DX, contests and DXpeditions
- ★ **ON THE BEAM** Glen Ross G8MWR with all the news and comment from bands above 50MHz
- ★ **G3OSS TESTS** Angus McKenzie - the fairest, most comprehensive reviews available anywhere

MORE NEWS, MORE FEATURES, MORE FUN, MORE STYLE THAN ANY MAGAZINE AVAILABLE ON THE MARKET TODAY

Make sure of your copy by placing a regular order at your newsagents or by taking out a post free, inflation proof subscription, with early delivery to your door each month

AMATEUR RADIO SUBSCRIPTION ORDER FORM

To: Subscription Department • Amateur Radio •
513 London Road • Thornton Heath •
Surrey • CR4 6AR Tel: 01-684 3157

NAME
ADDRESS
.....
.....
Postcode.....

PLEASE SUPPLY: (tick box) for 12 issues, all rates include P & P

Inland	World-Surface	Europe-Air	World-Air
£11.80..... <input type="checkbox"/>	£12.95..... <input type="checkbox"/>	£17.75..... <input type="checkbox"/>	£25.70..... <input type="checkbox"/>

PAYMENT ENCLOSED: £ -

Cheques should be made payable to Amateur Radio. Overseas payment by International Money Order, or credit card

CREDIT CARD PAYMENT



.....

Signature.....

R WITHERS COMMUNICATIONS

584 HAGLEY ROAD WEST, OLDBURY, WARLEY
B68 OBS (QUINTON, BIRMINGHAM)
Tel: 021-421 8201/2 (24 HR ANSWERPHONE)



NEWSFLASH



"THE FASTEST
GROWING AMATEUR
RADIO DEALERS IN
THE U.K."



Raycom Ltd have appointed R.W.C. their
sole distributors for these fantastic new
products

"AT LAST AN R.F. POWER AMPLIFIER TO SUIT YOUR NEEDS" ...

... THESE 'STATE OF THE ART' RAYCOM UNITS WILL MATCH ANY
PORTABLE OR HAND-HELD TRANSCEIVER ON THE MARKET. JUST
LOOK AT THESE FEATURES ...

- ★ For the first time ever a choice of linear or class 'C' (FM/CW) amps specially designed to match your hand-held or portable radio. (Suitable also for most Transceivers).
- ★ All units use Toshiba or Mitsubishi RF power modules - used in all new VHF/UHF transceivers.
- ★ Factory adjustable 200mw to 5W inputs. All amplifiers set for 1/3 watts, other drive levels set to order.
- ★ Full twelve months parts and labour warranty against faulty workmanship or component failure.
- ★ All units have RF relay changeover plus switchable SSB/FM hang time and status L.E.D.'s.

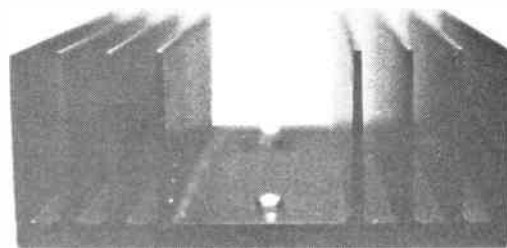

FROM
£39.50
+ P&P



THEY SAID ... "IT COULDN'T BE DONE!"

10 FM IS HERE TO STAY. RAYCOM LTD ANNOUNCE A 'REAL' AMATEURS PROJECT, (SUITABLE FOR BEGINNERS AND SWLs) THIS MODIFICATION COVERS OVER 90% OF LEGAL FM CB RADIOS, I.E. ANY SET WITH THE SANYO LC7136 or 7137 SYNTHESIZER CHIPS, AND CONVERTS TO 10MTRS FM INCLUDING REPEATER SHIFT FOR UNDER £25.

- ★ MEASURES ONLY 5 1/2" x 3/4". FITS EASILY INSIDE ALMOST ALL 27MHz RIGS
- ★ FITTED IN MINUTES - ALL YOU NEED IS SOLDERING IRON, SIGNAL SOURCE AND SIMPLE TEST EQUIPMENT (SHOWN ACTUAL SIZE). INSTRUCTIONS EXPLAIN COMPLETE OPERATION OF MOD BOARD



☆☆☆☆☆☆
★ **ONLY £22.50** ★
★ **Plus £1 p&p** ★
☆☆☆☆☆☆

- ★ COMPLETE WITH FULL INSTRUCTIONS - ONLY EIGHT WIRES TO SOLDER (INCL. RPT SHIFT)
- ★ EACH CIRCUIT BOARD FACTORY TESTED - SUCCESS GUARANTEED. FROM A PROVEN DESIGN BY BILL SPARKS G8 FBX & COLIN HERRABIN G3 SBI
- ★ COVERS 29.300 TO 29.690MHz IN 10KHz 40 CHANNEL STEPS
- ★ WILL COVER UP TO AND BEYOND 30MHz ON MOST CB's
- ★ WE CAN FIT THE MODIFICATION FOR £19.50 BUT ENCOURAGE YOU TO FIT IT YOURSELF. (PLUS COST OF MOD BOARD)



★ SUITABLE FOR AMSTRAD, BINATONE, MUSTANG, UNIDEN, HARRIER, MIDLAND, PLANET, COLT, COBRA, LCL, FIDELETY AND THOUSANDS MORE - CONTACT US FOR SET AVAILABILITY
Telephone orders accepted on ACCESS or VISA cards, postal orders allow 7/10 days delivery. Please add £2.50 on amplifier orders, and £1.00 post & ins on mod kits. Two or more items post free. Both products copyright FBX-RWC 1984. Patent applied for. Shop callers welcome. Late nights Thursday & Friday till 7pm. Please make cheques payable to R Withers Communications

UHF UNITS (430/440 MHz)

TYPE	ORDER CODE	PRICE
25 W FM/CW	U25F	£79.50
15W FM/CW/SSB/AM	U15L	£69.50
15W FM/CW	U15F	£59.50
VHF UNITS (144/149 MHz)		
45W FM/CW	V45F	£62.50
35W FM/CW/SSB/AM	V35L	£59.50
25W FM/CW	V25F	£48.50
15W FM/CW/SSB/AM	V15L	£49.50
15W FM/CW	V15F	£39.50

Amateur RADIO SMALL ADS

MORSE TUTOR

£4.00 on cassette. **£8.50** on microdrive for Sinclair Spectrum. 4 to 19 words per minute, variable spacing, variable groups of random letters, numbers or mixed; Random sentences, own message, single characters and variable pitch. Feedback on screen, printer, or speech (Currah Microspeech 48K only) and repeat facility, 16K and 48K versions on one cassette 48K only on microdrive.

WD SOFTWARE

Hilltop, St. Mary, Jersey, C.Islands
Telephone (0534) 81392

G W MORSE KEYS 4 Owen Close, Rhyl, Clwyd Wales LL18 2LQ

THE GW MORSE KEY

A joy to use and to look at, this key is made from solid brass polished and mounted on a slate base, here in GW land (not JA) Mounting the key on slate stops all movement of the key when in use. £34.50 pp £2.00 ea.

24 HR LCD CLOCK

Clear 1/2" high lcd readout repeat alarm clock, battery powered (2 AA pencils). No R/F problems known. Complete with batteries £9.50 pp £0.50 ea

GWHP PRODUCTS

The full range of Gwhips always in stock for quick and prompt delivery or collection.

NEW NEW BASE STATION ANTENNA FROM NEW
NEW GWHP PRODUCTS NEW
NEW AVAILABLE SOON NEW

For full information and price list please send SAE

BRASS CALL PLATE

Your call sign engraved on a brass plate for fixing to the GW morse key or any of your radio equipment. £1.00 only
NO POST & PACKING CHARGE FOR ORDERS OVER £50.00



Telephone
the advertising
department on:
0277 219876
for details

SPECTRUM RTTY/CW

The RADSOFT complete Receive System which includes ready made boxed miniature terminal unit & machine language program. Plug in and receive RTTY @ 45, 50, 56 & 75 BAUDS MORSE from 5-70 WPM. This well proven system ONLY £40.

Tel: (0783) 288598 Postage & VAT paid.
From: **UPDATE COMPUTER SYSTEMS,**
83 Nora St, Sunderland.

VINTAGE RADIOS repaired - restored.

Over 200 Radios stocked. 1922-1960. RADIO VINTAGE, 250 Seabrook Road, Seabrook, Hythe, Kent CT21 5RQ. Phone anytime (0303) 30693.

MORSE READING PROGS

Work on clean signals without hardware interface. ZX81 1K UNEXPANDED MEMORY. Translated code, with word and line spaces for easy reading. Automatic scroll action. **£7.00 incl.**

SPECTRUM 16-48K. Scroll action with 10 page scrolling memory. Instantly accessible page by page **£8.00** inc. All types variable speeds. Feed signal direct into EAR socket.
Pinehurst Data Studios, 69 Pinehurst Park, West Moors
Wimborne, Dorset BH22 0BP.

AMTOR for the DRAGON 32/64

Now you can run AMTOR directly on the DRAGON without expensive external hardware.

Program + Timer/interface module to add to your own TU..... **£55.25**
RECEIVE ONLY version..... **£36.25**
MF2 SWL Terminal unit. 170/425/850 Hz. Switched shift + Morse capability..... **£32.00**

For full details send 2 x 16p stamps
Visa accepted
Please add VAT at the current rate to all prices

PNP COMMUNICATIONS (AR)

62 Lawes Avenue, Newhaven
East Sussex BN9 9SB Tel: (0273) 514465

Amateur RADIO

This method of advertising is available in multiples of a single column centimetres — (minimum 2cms). Copy can be changed every month.

RATES

per single column centimetre:
1 insertion £7.00, 3 — £6.60, 6 — £6.30, 12 — £5.60.

SMALL ADS

Eastern Communications

31 Cattle Market Street

NORWICH

(0603) 667189

MAIL ORDER

ACCESS/BARCLAYCARD

MON-FRI 9.30-5.30
SAT 9.30-5.00

AMATEUR RADIO EQUIPMENT BOUGHT, SOLD & EXCHANGED

For the best deal - Personally Guaranteed. Ring **G4TNY ELECTRONICS** Dave, on 025 587 663 or 040 24 57722 anytime!

Or write:

132 Albany Road, Hornchurch, Essex RM12 4AQ
Is my North Essex Office NEARER you?

Send SAE for our latest list
MAIL ORDER - A SPECIALITY!

MISSING DX?

LONG WIRE ANTENNA? Outside or INDOOR, boost DX with a 0.1-30MHz Antenna Tuner, ideal for FRG7700 etc or LOW tx, fun-to-build kit £25.20 includes ALL parts, pre-wound coils, case, instructions, by-return postage etc, and list of other kits.

CAMBRIDGE KITS

45 (BP) Old School Lane Milton, Cambridge

AMATEUR RADIO SMALL AD ORDER FORM

TO: Amateur Radio · Sovereign House
Brentwood · Essex CM14 4SE · England · (0277) 219876

PLEASE RESERVE.....centimetres by.....columns

FOR A PERIOD OF 1 issue..... 3 issues..... 6 issues..... 12 issues.....

COPY enclosed..... to follow.....

PAYMENT ENCLOSED:.....

£ —

Cheques should be made payable to Amateur Radio. Overseas payments by International Money Order

CHARGE TO MY ACCOUNT.....

COMPANY

ADDRESS

SIGNATURE TELEPHONE.....

C P I

XXX ADULT VIDEO CLUB

For the genuine adult films. Available only from ourselves. Ring

0924-471811 (24hrs)

For the intimate details or write
ADULT VIDEO CLUB
P.O. Box 12, Batley, W. Yorks.

SOUTHDOWN RADIO SUPPLIES 40 TERMINUS RD EASTBOURNE (opp. Railway Stn.)
Tel: (0323) 639351
Open: Mon-Sat 10-6 (Closed Tues)
Amateur Radio Equipment Yaesu, Icom, Standard, Tonna, Drae, Kenpro, Halber, Wood & Douglas, Daiwa, Howes kits & MET antennas

DW ELECTRONICS G3 XCF
Amateur Radio Supplies
71 Victoria Rd, Widnes
Tel: 051-420 2559
Open Mon-Sat 9.30-6 (closed 1.00pm Thurs)
We supply Yaesu, ICOM, Tonna, Jaybeam, Microwave Modules, Datongs etc

QSL Cards
Printed on white or colour gloss cards, printed to your own design.
Please send SAE for sample to:
Caswell Press
21 Homethorpe Ave, Redhill, Surrey
Tel: (Redhill) 71023

★ **SERVICE MANUALS** ★
For ALL Amateur Radio, Vintage Wireless, Audio, Television, Video, Test Equipment etc. etc. Thousands stocked. LSAE enquiries and quote by return plus FREE catalogue.
★ **MAURITRON TECHNICAL SERVICES** ★
Dept AR, 8 Cherrytree Rd
Chinnor, Oxon OX9 4QY

MORSE CODE PREPARATION
Cassette A: 1-12 wpm for amateur.
Cassette B: 12-25 wpm for professional examination preparation.
Each cassette is type C90.
Price of each cassette (including booklets) £4.75.
Morse key with separate battery (PP3) — driven solid-state oscillator and sound transducer produces clear tone for sending practice. Price of key with electronic unit £7.75.
Price includes postage etc. Europe only
MH ELECTRONICS (Dept AR)
12 Longshore Way, Milton, Portsmouth PO4 8LS

ALPHA KEYS
Precision engineered keys for the connoisseur. Twin or single paddle keys individually made to be one of the smoothest and lightest movements ever. For the fast operator.

CAVITY WAVEMETER
One wavemeter to cover 144MHz to over 2500MHz. Can measure RF as low as 50 Milliwatts with suitable meter. Also now short version to cover 430MHz to over 2500MHz.

10GHz WAVEMETER KIT
A pre machined cavity to make a 10GHz wavemeter using your micrometer. Can be fixed direct to your wave guide.

COAXIAL RELAY KITS
The cavity block is pre machined to take your BNC or N type sockets.

Send large SAE for full information to:
PAUL SERGENT G40NF
6 GURNEY CLOSE
COSTESSEY
NORWICH NR5 CHB
Tel: (0603) 747782

AKD Armstrong Kirkwood Developments
10, Willow Green, Grahame Park Estate, London, NW9
Tel: 01-205 4704

VHF/UHF ABSORPTION WAVEMETER
Covers 120-450 MHz. Extremely sensitive. Low-profile. Requires PP3 battery. **£24.95**

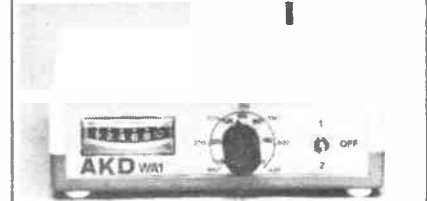

HIGH PERFORMANCE RF FILTERS
SLIMLINE, ATTRACTIVE APPEARANCE
Used by British Telecom, Thorn-EMI, ITT, Telefusion, Granada etc.

Standard range terminated in Belling Lee plug/socket (75ohms) — others to order
Model TNF2 Tuned Notch Filters (Braid & Inner) for 2, 10, 15, 20 Metres & CB (state which) **£7.50**
The TNF2 range have a very low insertion loss and very high rejection over the band for which they are supplied. They are the best possible answer for aerial borne interference from a single known frequency or frequency band
Model RBF1-70cms Notch Filter (inner only!) **£6.32**
Model BB1 Braid Breaker **£6.32**
Also available, 3 High Pass models and a "Radar Blip" filter for VCRs. Please send A4 or C4 stamped addressed envelope for filters data sheet and price list.
All items are manufactured by AKO in UK and carry a two year guarantee plus 14 day money back promise (no reason required).
Items usually despatched within two days from receipt of order. Prices include VAT, postage & packing.
(Prep.) J.W. ARMSTRONG
ALSO AVAILABLE FROM MOST LEADING AMATEUR RADIO DEALERS

THE PERFECT COMPLEMENT TO AMATEUR RADIO

Packed with construction projects and the latest technology plus pages of readers' classified ads



- Take out a **POST-FREE (UK)** sub while offer lasts
- Delivery to your door by publication date each month
 - Inflation proof — price guaranteed for 12 months

On sale NOW at your newsagent and at equipment dealers

RADIO & ELECTRONICS WORLD SUBSCRIPTION ORDER FORM

To: Subscription Department • Radio & Electronics World • 513 London Road • Thornton Heath • Surrey • CR4 6AR. Tel: 01-684 3157

PLEASE SUPPLY: (tick box) for 12 issues, all rates include P & P

Inland	World-Surface	Europe-Air	World-Air
£11.80 <input type="checkbox"/>	£13.10 <input type="checkbox"/>	£19.20 <input type="checkbox"/>	£25.90 <input type="checkbox"/>

Cheques should be made payable to Radio & Electronics World. Overseas payment by International Money Order, or credit card.

PAYMENT ENCLOSED: £

CREDIT CARD PAYMENT

NAME.....
ADDRESS.....
.....
.....Postcode.....

Signature.....

ADVERTISERS INDEX

Armstrong Kirkwood Developments.....	65	G W Morse Key.....	64
Cambridge Kits.....	64	Paul Sergent.....	65
Caswell Press.....	65	Pinehurst Data Studio.....	64
P M Components.....	42,43	Post a Part.....	Inside front cover
P N P Communications.....	64	Radio Vintage.....	64
W P O Communications.....	26	Radsoft Computers.....	64
Display Electronics.....	12	R A S (Nottingham).....	33
Eastern Communications.....	64	R S G B.....	7
D W Electronics.....	65	W D Software.....	64
G4TNY Electronics.....	64	Southdown Radio.....	65
M H Electronics.....	65	South Midlands Communications.....	20,21
Hatley Antennas.....	33	Tau Systems.....	38
Hightech Antennas.....	Inside Back cover	Technical Software.....	33
C M Howes.....	27	A H Thacker.....	33
Low Electronics.....	4,5	Thanet Electronics.....	54,21
Marco Trading.....	31	Used Equipment Centre.....	27
Mauritron Electronics.....	65	Vortex.....	65
Microwave Modules.....	Outside back cover	R Withers Communications.....	63
		Wood & Douglas.....	7

Amateur RADIO

ADVERTISING RATES & INFORMATION

ABC membership approved pending first audit Jan-Dec 1985

DISPLAY AD RATES

depth mm x width mm	ad space	series rates for consecutive insertions			
		1 issue	3 issues	6 issues	12 issues
61 x 90	1/8 page	£66.00	£62.00	£59.00	£53.00
126 x 90 or 61 x 186	1/4 page	£115.00	£110.00	£105.00	£92.00
126 x 186 or 263 x 90	1/2 page	£225.00	£210.00	£200.00	£180.00
263 x 186	1 page	£430.00	£405.00	£385.00	£345.00
263 x 394	double page	£830.00	£780.00	£740.00	£660.00

COLOUR AD RATES

depth mm x width mm	ad space	series rates for consecutive insertions			
		1 issue	3 issues	6 issues	12 issues
126 x 186 or 263 x 90	1/2 page	£305.00	£290.00	£275.00	£245.00
263 x 186	1 page	£590.00	£550.00	£530.00	£470.00
263 x 394	double page	£1,130.00	£1,070.00	£1,010.00	£900.00

SPECIAL POSITIONS

Covers: Outside back cover 20% extra, inside covers 10% extra
Bleed: 10% extra [Bleed area = 307 x 220]
Facing Matter: 15% extra

DEADLINES

*Dates affected by public holidays

issue	colour & mono proof ad	mono no proof & small ad	mono artwork	on sale thru
Mar 85	31 Jan 85	6 Feb 85	8 Feb 85	28 Feb 85
April 85	28 Feb 85	5 Mar 85	8 Mar 85	28 Mar 85
May 85	28 Mar 85	3 Apr 85	4 Apr 85*	25 Apr 85
Jun 85	25 Apr 85	1 May 85	3 May 85	23 May 85

CONDITIONS & INFORMATION

SERIES RATES
Series rates also apply when larger or additional space to that initially booked is taken.

An ad of at least the minimum space must appear in consecutive issues to qualify for series rates. Previous copy will automatically be repeated if no further copy is received.

A 'hold ad' is acceptable for maintaining your series rate contract. This will automatically be inserted if no further copy is received.

Display Ad and Small Ad series rate contracts are not interchangeable.

If series rate contract is cancelled, the advertiser will be liable to pay the unearned series discount already taken.

COPY
Except for County Guides copy may be changed monthly.

No additional charges for typesetting or illustrations (except for colour separations).

For illustrations just send photograph or artwork.

Colour Ad rates do not include the cost of separations.

Printed — web-offset

PAYMENT

All single insertion ads are accepted on a pre-payment basis only, unless an account is held. Accounts will be opened for series rate advertisers subject to satisfactory credit references.

Accounts are strictly net and must be settled by the publication date.

Overseas payments by International Money Order or credit card.

FOR FURTHER INFORMATION CONTACT

Amateur Radio, Sovereign House, Brentwood, Essex CM14 4SE
(0277) 219878

Commission to approved advertising agencies is 10%

CONDITIONS

10% discount if advertising in both Amateur Radio and Radio & Electronics World.

A voucher copy will be sent to Display and Colour advertisers only.

Ads accepted subject to our standard conditions, available on request.

A New Approach to HF Antennae Design

Compare these performance figures of Hightech Antennae's **MBFr80** with the best 3 element antennae available today.

	Typical Spec. for 3 element Tri Band Beam	Hightech Antennae's Spec for MBFr80
	No. of Elements — 3	2 Parasitic + 1 Absorber Element
Front to Back Ratio	25dBd	43dBd
Forward gain	6dBd min.	Better than 4.5dBd
VSWR at Resonance	1.5 : 1	1.1 : 1
Max. Power Input	1kW (100% duty cycle)	2kW (100% duty cycle) 5kW peak
Input Impedance	50 ohm	50 ohm
Boom Length	4.2m	4m
Max. Element Length	8.2m	4.6m
Max. Wind Survival	75mph	100mph
Net Weight	16.3kg	8kg
Wind Load	80mph = 47kg	100mph = 23kg

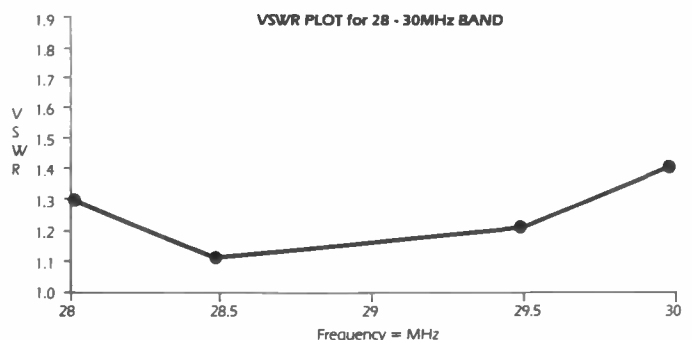
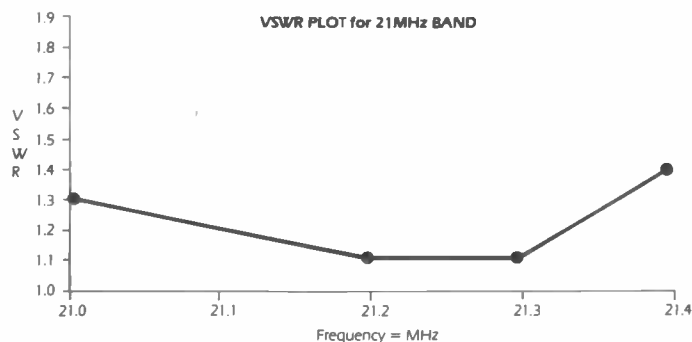
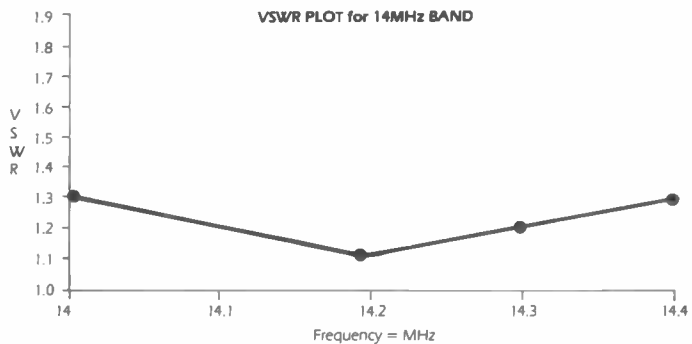

The front to back ratio advantage from Hightech Antennae's **MBFr80** is 18dBd better than other antennae available today. Remember this is a 3 S-unit noise reduction in unwanted directions over and above other antennae.

6dBd = 1 S-unit

Massive front to back ratio. This is more important than forward gain on today's crowded amateur bands.

Flat VSWR across all HF bands.

No need for the purchase of ATU's for those with solid state PA's.

No need for the purchase of baluns.

A complete break with the coil and capacitor trap arrangement with, of course, its associated losses, restricted bandwidth etc.

Expandability: Extra parasitic element (director)

Extra absorber element for even greater front to back ratio.

With the conversion kits available, a 3 element, 3 band beam with an enormous front to back ratio will become the standard for others to follow.

H I G H T E C H Antennae (Scotland) Ltd

To: HTA (Scotland) Ltd., 24 Gremista Ind. Est., Lerwick, Shetland Is. ZE2 0PX

Please Supply MBFr80 Antenna(e)

@ £189.95 incl. VAT & P & P

Name (please print)

Address (please print)

Postcode

I enclose a cheque/PO payable to HTA (Scotland) Ltd value £

or debit my Access Card No.

Cardholder Signature

Credit Card Hotline 0595 - 5949

Please allow 28 days for delivery Offer valid UK only

MICROWAVE MODULES LTD



2 METRE MULTIMODE TRANSVERTER MMT144/28-R

NEW RELEASE

FEATURES

- ★ 25 watts Tx output
- ★ GaAsFET RF stage
- ★ Transmit ALC circuit
- ★ 13.8V DC operated
- ★ Repeater shift (normal, simplex, reverse)
- ★ High level DBM mixer
- ★ LED Bargraph Power Meter
- ★ RF Vox – Adjustable delay & manual override

SPECIFICATION

General

Input freq range	: 28-30MHz
Output freq range	: 144-146MHz
Repeater shift	: Simplex, normal, reverse
DC requirements	: 13.8V DC & 6 Amps

Transmit Section

Output power	: 25 watts +/- 1dB
Input level range	: 1/4 to 300mW
ALC range	: 20dB
Modes of operation	: SSB, FM, CW, AM
Spurious outputs	: -65dB or better

Receive Section

Gain	: 20dB min
N.F.	: 2dB or better
3rd order intercept	: +19dBm (output)

DESCRIPTION

This new transverter has been designed to allow users of existing HF band transceivers to establish a first-class transceive facility on the 144MHz band. The MMT144/28-R incorporates many new and exciting features which combine to make this product simply superb.

Receive Section

An NEC GaAsFET is employed in a noise-matched configuration feeding a high level double balanced mixer via a bandpass filter. IF gain is achieved by a JFET post amplifier. This combination produces a good signal to noise ratio, excellent immunity to overload and cross modulation, resulting in a rugged receive system having a third order output intercept point of +19dBm.

Two separate low-noise oscillators, operating at 116.00 and 115.40MHz are included, running from a regulated 8.2 volt supply. Selection of the wanted oscillator is achieved by a quad op-amp circuit, controlled by the front panel mounted 'MODE' switch. This provides simplex, repeater and reverse repeater operation. The output of each oscillator feeds a JFET buffer amplifier via the quartz crystal which acts as a filtering element to reduce amplitude noise and reciprocal mixing products. The resultant high level injection is extremely pure and free from harmonics.

Transmit Section

The incoming 28MHz signal, in the range 1/4 to 300mW, is initially fed to the RF VOX circuit, ALC control circuit and the input level control. This signal is then fed into a pair of MOSFETs in a balanced mixer configuration, together with the local oscillator injection, to produce the wanted signal in the range 144-146MHz.

This signal is then amplified by several linear stages up to the specified output power of 25 watts. A visual indication of relative output power is provided by a front panel mounted LED bargraph display. A rear panel mounted level control allows the user to adjust the sensitivity of the transverter to suit the transceiver in use, and a front panel mounted RF VOX delay control allows adjustment to suit SSB/FM modes.

The ALC circuit has a 20dB dynamic range and has been incorporated to ensure that a totally clean signal is produced by the transverter. This is a particularly useful feature which will virtually eliminate compressed signals and the resultant problems caused to local stations.

PRICE : £215 inc VAT (p+p £3.50)

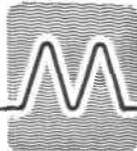

HOURS:
MONDAY – FRIDAY
9-12.30. 1-5.00
AR

MICROWAVE MODULES LTD
Brookfield Drive, Aintree, Liverpool L9 7AN,
England.
Telephone: 051-523 4011.
Telex: 628608 MICRO G.