

ELECTRONICS

AND

COMMUNICATIONS

NO. 7 1/2 PR. 1031
8 EASTGATE CREW
SCARBOROUGH ONT

EP
CR
OE
12



AN AGE PUBLICATION
TORONTO, CANADA

JULY 1958

INTRODUCING...

the first combined

G P C AND D D A

GENERAL PURPOSE DIGITAL COMPUTER AND DIGITAL DIFFERENTIAL ANALYZER



*ultimate versatility
in solving complex
technical
problems...*

The general purpose digital computer solves most scientific and engineering problems with speed and accuracy... yet easier programming makes the digital differential analyzer a superior choice for solving differential equations. Bendix now combines the advantages of both in the *new* G-15D Computer and its optional DDA accessory. Working together, and supported by a full complement of input-output equipment, these units provide the *best* means of solution. And the rental or purchase cost is far below that of most general purpose computers alone.

A new brochure tells the details of the G-15D's talent for conserving your scarce engineering manhours. Let us send you a copy.



COMPUTING DEVICES OF CANADA LIMITED
P.O. BOX 508 • OTTAWA • CANADA

WESTERN DIVISION — Commercial Building, Edmonton, Alberta

5702

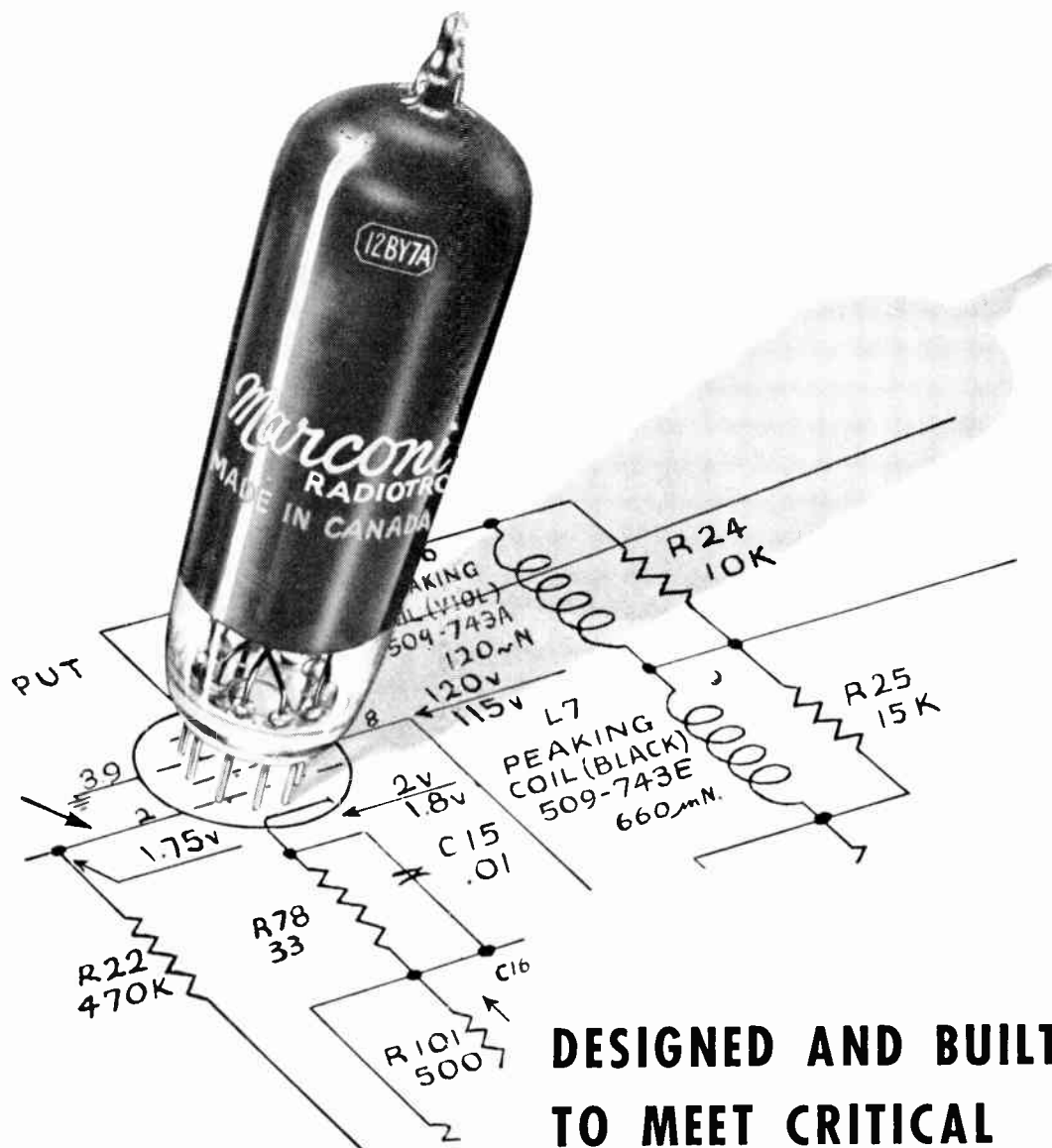

DESIGNED AND BUILT TO MEET CRITICAL OPERATING CONDITIONS

Rigid inspection at every step maintains the high quality engineered into Marconi tubes . . . assures complete satisfaction under the most critical operating conditions. Perfection in every unit is the traditional Marconi standard that means greater power, better tone and longer life to please your every customer.



MARCONI RADIOTRONS

ELECTRONIC TUBE AND COMPONENTS DIVISION

CANADIAN **Marconi** COMPANY

830 BAYVIEW AVENUE, TORONTO, ONTARIO

Branches: Vancouver • Winnipeg • Montreal • Halifax • St. John's, Nfld.

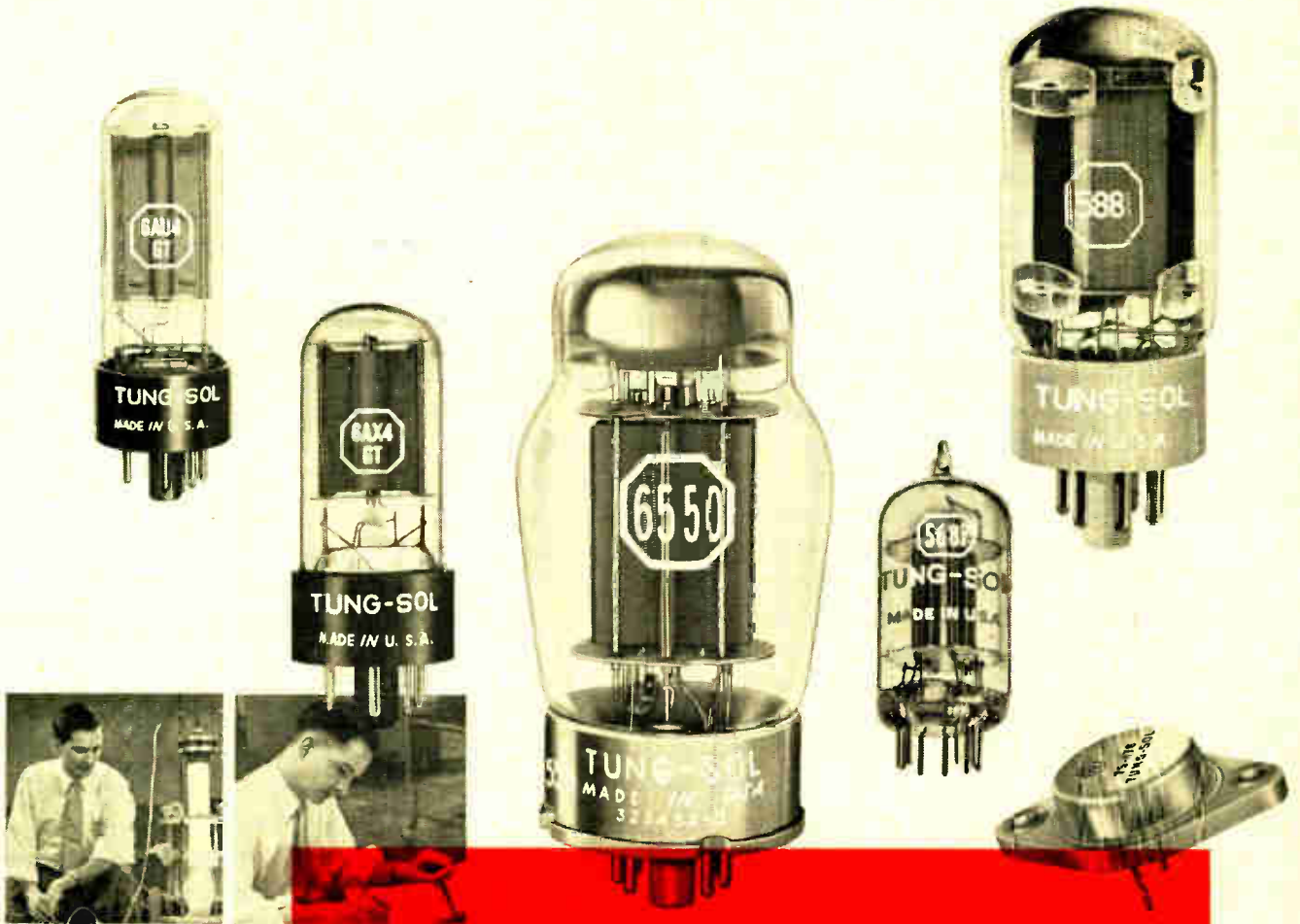

**RESEARCH, DESIGN, DEVELOPMENT
AND QUALITY PRODUCTION IN VOLUME**



TUNG-SOL®

ELECTRON TUBE DIVISION TUNG-SOL ELECTRIC INC., NEWARK 4, N. J.

IN CANADA: ALPHA ARACON RADIO CO., LTD., TORONTO, ONT.

For further data on advertised products use page 65.

Electronics And Communications

VOLUME 6

JULY 1958

NUMBER 7

FEATURES

Flight Test Data Reduction For The Avro Arrow	16
by A. Cohen	
Heat-Dissipating Electron Tube Shields (Part I)	21
by John C. McAdam	
Angular Acceleration and Rate Generator	26
The Canadian Astronautical Society Project Charm	27
by A. E. Maine	
Automation For Sintering Plant Operation	34
The B.B.C. Vision Electronic Recording Apparatus	39
Courtesy The Engineer, London, England	
Proportioning Control Minimizes Temperature Spread	41

DEPARTMENTS

EIAC Report	7
Editorial	11
New Products	42
News Report	47
IRE Convention News	48
Book Review	70

Editor, Thomas W. Lazenby; Editorial Assistant, D. K. Trowell; Consulting Technical Editor, Leslie Hill, Ph.D.Eng.; Art Editor, Wm. McReynolds; Photo Editor, Guido Milanesio; Advertising Manager, H. E. Dallyn; Assistant Advertising Manager, Arthur Dixon; President, Norman G. McHardy; Vice-President, Secretary-Treasurer, L. R. Kingsland; Business Manager, Clifford A. Sparks; Production Manager, Nevill A. Campling; Circulation Manager, Paul A. Irwin. United Kingdom and European Representative, Norman F. Keenan, 47 Manchester Street, London, W. 1, England. West Coast Representative, Dillenbeck-Galavan, Inc., 266 South Alexandria Ave., Los Angeles 4, Calif. Montreal Representative, Keith Edgar, 116 Rue de Flandre, Montreal 23 (Preville), Quebec, Telephone: OR. 1-2020.

All business and editorial correspondence should be addressed to the Toronto office.

PUBLISHED BY AGE PUBLICATIONS LIMITED

Founded in 1923 by Norton W. Kingsland

Publishers of Heating, Plumbing and Air Conditioning AGE • Restaurants and Institutions
Automatic Heating • Wine, Beer and Spirits • Industrial Aeronautics

450 Alliance Avenue, TORONTO 9, ONT., CANADA. Tel. ROger 2-7225.

SUBSCRIPTION RATES: Canada, U.S.A. and British Possessions - \$5.00 per year • Foreign - \$10.00 per year.

Contents copyright by Age Publications Limited. No part of this periodical may be reproduced without the consent of the publisher.

Authorized as second class mail. Post Office Department, Ottawa.



Member Canadian Circulations



Audit Board, Inc.

PRINTED IN CANADA

60

Simpson STANDARD PANEL INSTRUMENTS

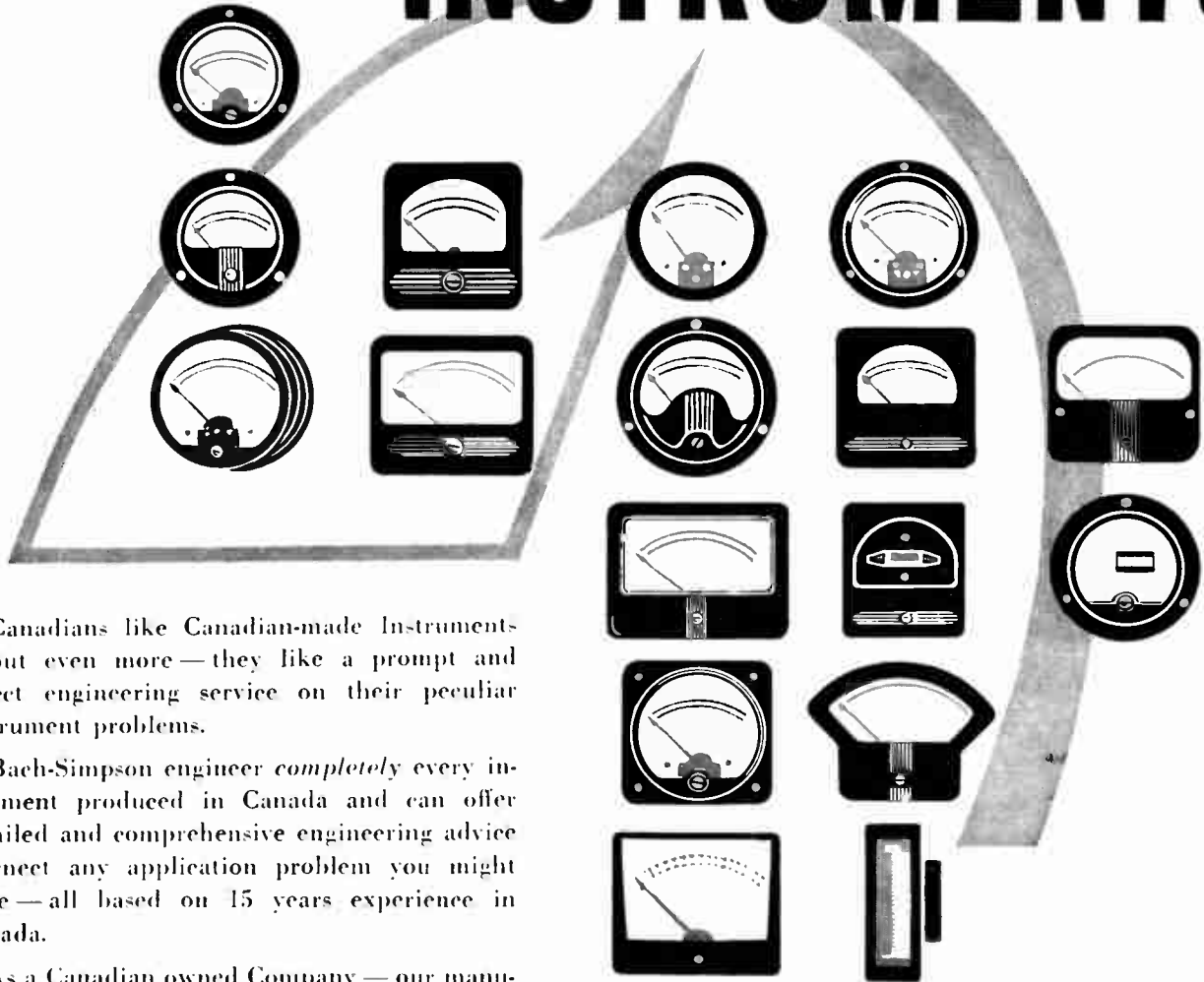

Canadians like Canadian-made Instruments — but even more — they like a prompt and direct engineering service on their peculiar instrument problems.

Bach-Simpson engineer *completely* every instrument produced in Canada and can offer detailed and comprehensive engineering advice to meet any application problem you might have — all based on 15 years experience in Canada.

As a Canadian owned Company — our manufacture is complete from movement design, tool and mold manufacture, through case styling, dial printing to packaging — all in either commercial or military types.

Apart from the complete coverage of all electrical types and ranges — over 50 different case styles alone are available from Canadian production and tooling — and if you find your application calls for a new design — our engineering department is at your disposal.

Bach-Simpson Limited also produce Laboratory Test Apparatus, Radio Service Equipment, Automotive Service Test Equipment, Electronic Control Apparatus for Industry and Instrument components and accessories.

Bach-Simpson
LIMITED

G6008

1255 BRYDGES ST.,

LONDON, CANADA

IN U.S.A.: SIMPSON ELECTRIC COMPANY, 5200 W. KINZIE ST., CHICAGO 44, ILL.

For further data on advertised products use page 65.

EIAC Report

By Basil Jackson, A.R.Ae.S., Tech. M.C.A.I.

At the recent 29th annual meeting of the Electronic Industries Association of Canada (formerly Radio-Electronics-Television Manufacturers Association of Canada) the Deputy Minister of Transport, J. R. Baldwin, gave an address entitled "The Role of Industry in the Field of Telecommunications and its Importance in the Economic Growth of our Country".

The following is a condensation of Mr. Baldwin's address.

Statistics show that the growth of telecommunications in Canada in recent years has exceeded that of most other industries. The designers and manufacturers of telecommunications equipment have reason to be proud of their part in this development and its aid to the growth of Canada.

Throughout this growth it has been necessary to relate the developments within our country with other countries of the world. International co-ordination of telecommunications is accomplished through the medium of the International Telecommunication Union, the United Nations specialized agency in the field of telecommunications. The International Telecommunication Union dates back to 1865 when it started as the Telegraph Union. Subsequently, its activities were broadened to cover the field of telephone communications and the field of radio.

Basically, the functions of the International Telecommunication Union are founded on the essential need for international co-operation in the field of telecommunications. Ninety-five countries including Canada are in the Union and the decisions adopted by these countries set the pattern for the use of telecommunications throughout the world, while recognizing the sovereign right of each country to regulate its own telecommunications.

Canada is also a member of the International Civil Aviation Organization and subscribes to the Safety of Life at Sea Convention, both of which involve radio usage.

The International Civil Aviation Organization, through a number of Committees, deals with many phases of international aeronautical telecommunications including equipment standards and requirements, operational procedures and radio aids to air navigation, with the goal of standardization of aeronautical telecommunications facilities throughout the world, both airborne and on land.

The Safety of Life at Sea Convention specifies what vessels are required to carry radio equipment for safety purposes and also indicates the type of radio apparatus to be carried by each class of vessel concerned.

I have outlined the international aspects of telecommunications to emphasize the fact that the Department, in addition to coping with our internal telecommunication problems, must also assist in solving world-wide telecommunication problems, yet must at the same time protect our national position with regard to use of radio frequencies.

We will have a heavy burden to carry in the international field during the next year or so. The International Telephone and Telegraph Consultative Committee Study Groups of the International Telecommunication Union will meet in Geneva early in September of this year followed by a Plenary Assembly. The International Radio Consultative Committee of the International Telecommunication Union is expected to meet in Los Angeles commencing in April of 1959.

Continued on page 8

EIAC Report

A Radio Conference of the International Telecommunication Union is scheduled to be held in Geneva commencing in August of 1959 to revise regulations and will last approximately four months. A Plenipotentiary Conference of the International Telecommunication Union is to be held in Geneva commencing in October of 1959 and will last approximately two months.

We already have the benefit of advice and co-operation from your member companies and of the Canadian Radio Technical Planning Board in dealing with our domestic radio and radio frequency problems and we need your support and assistance in preparing for these international meetings.

We have established a Committee with several sub-committees for the purpose of reviewing radio frequencies and associated radio problems, for the guidance of delegates to the forthcoming conferences.

It is not always possible for us to assess, in detail, the requirements of industry and so, when our Committee has completed its study, we propose to obtain the views of industry. To consult each interested company would be impossible. The most appropriate approach to this problem seems to be through the medium of the Canadian Radio Technical Planning Board and I would urge you to review your problems, think of the future of telecommunications in Canada - with particular emphasis on radio frequencies - and have your representatives present them to the Canadian Radio Technical Planning Board for discussion with the Department so that they may be taken into consideration by our delegates.

These are our immediate problems - but what does the future hold for telecommunications? What more do we need in the line of public communications?

We are bound to see the extension of telegraph and telephone service to remote areas as yet unserved, increased capacity on all communication systems to permit expansion of the private wire teletype and data processing services, and increased telephone cable capacity and intercity dialing on our telephone systems will, of course, necessitate extension and expansion of existing microwave systems.

These things present a challenge not only to the communications companies but also to the telecommunications manufacturers who, in the final analysis, provide the tools of accomplishment.

As for broadcasting, color television is, without question, the next forward step. Manufacturers have an important job in this field. Techniques must be evolved which will permit lowering color television equipment costs. Once this is done, a fertile field will undoubtedly be opened up.

Dealing with the "special services", one of the most outstanding needs of aviation and marine users is an "area coverage" position fixing system suitable for short and long range navigation. This, of course, should be related to some international standardization and difficulties are anticipated in this regard.

The Department is not alone in facing problems of the future involving telecommunications. You, as manufacturers of the essential equipment, must also have an eye to the future, both short-term and long-term. The future health of the telecommunications industry depends on research, not only in the true and conventional sense, but equally in direct operational research to determine what the operational needs will be a few years from now and what techniques can be available to meet these needs. The faster the development in the telecommunications field, the further ahead we must look - in short, I suggest you look not only at what you can build and sell today, but also at what you may be called upon to do a few years from now.

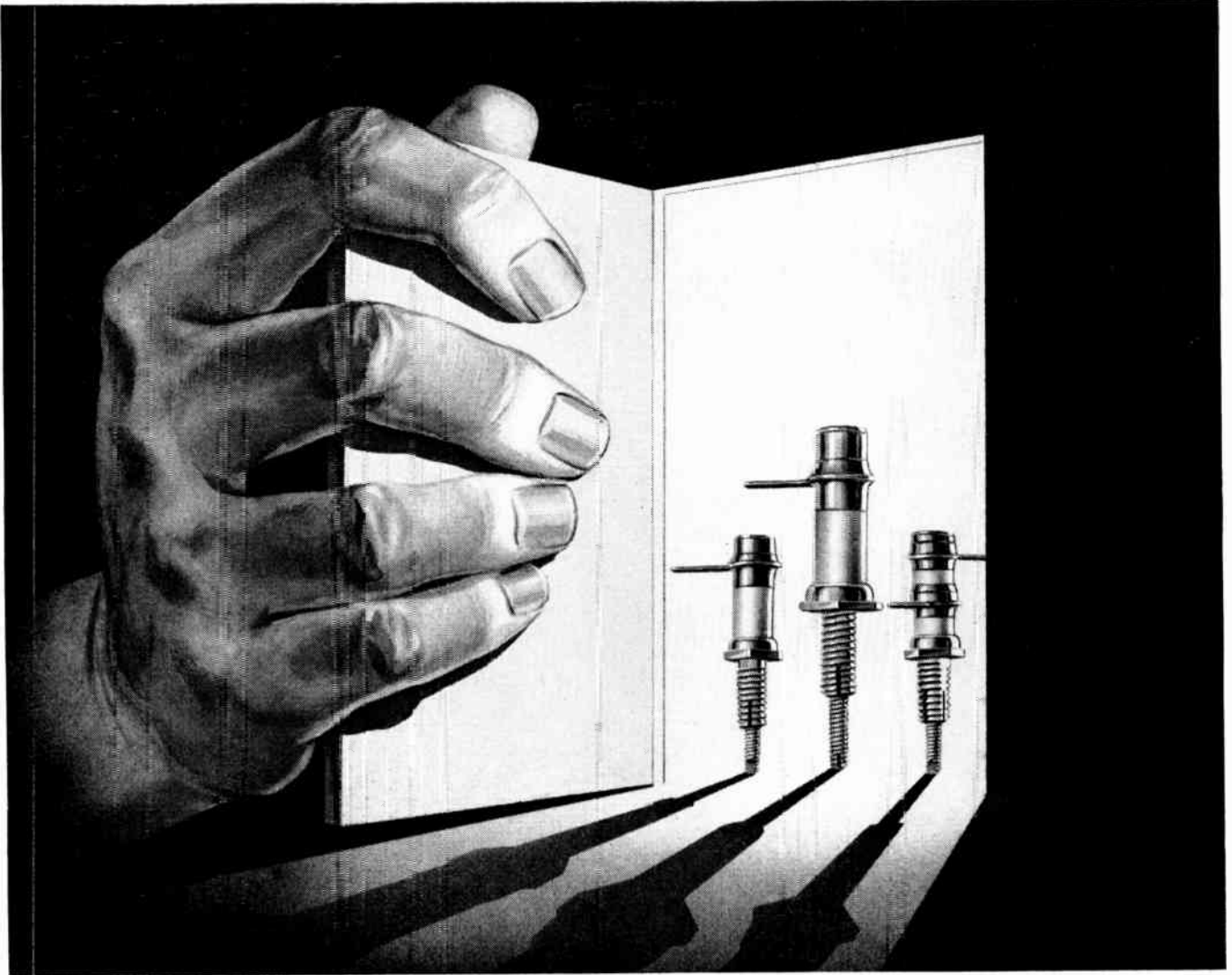

CTC Capacitor Data: Metallized ceramic forms CST-50, in range 1.5 to 12.5 MMFD's; CST-6, in range 0.5 to 4.5 MMFD's; CS6-6 in range 1 to 8 MMFD's; CS6-50, in range 3 to 25 MMFD's; CST-50D, with two ranges on one form: 1.5 to 10 MMFD's and 5 to 10 MMFD's. Variable capacitors available with split mounting studs and separate locknuts or with Pertua-Torq® Tensioning Devices and standard locknuts.

Family of midgets... every one dependable

This is the kind of family sure to make its way in distinguished fashion.

While they are all midgets, these capacitors all have an outstanding ability to do their jobs as well as capacitors many times their size.

Their tuning elements virtually eliminate losses in tuning range because of air dielectric resulting in wide range of minimum to maximum capacity. Tuning sleeves are at ground potential, locked internally by a permanent tensioning device which holds the setting under severe conditions of vibration or shock.

Most important, however, is that all benefit from Cambion responsibility of manufacture. Whether in standard or custom manufacture, Cambion electronic components invariably guarantee dependable performance. Each contributes at the highest level to the finished product of which it is a part.

Cambion research and experience stand ready to help you solve component problems. For specifications and

prices write Cambridge Thermionic of Canada Limited, 2425 Grand Boulevard, Montreal 28, P. Q., Canadian Representative; Samuel C. Hooker (Canada) Limited, 4126 Bathurst St., Downsview, Ontario.

New Series X2122 Stand-Off Capacitors with ceramic dielectric are exceptionally rugged. These are general-purpose RF by-pass capacitors for use in high quality electronic equipment. The encapsulating resin provides rigidity and durability under extreme conditions of shock, vibration, and humidity. Over-all height mounted is under $\frac{3}{16}$ ". Available in a wide range of values, color coded.



CAMBRIDGE THERMIONIC CORPORATION
GAMBION®



Makers of guaranteed electronic components, custom or standard

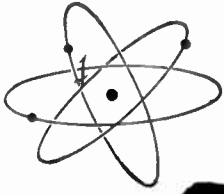

ACT NOW

for space at the

IRE CANADIAN CONVENTION AND EXPOSITION

ELECTRONICS and NUCLEONICS

*your finest opportunity to show your products
to the finest prospects—*

For three full days, you can display and demonstrate your products and services at low cost, to a concentrated audience which you cannot meet again for a year.

Your audience will be eager to see all it can, learn all it can, and above all, be receptive to your message.

During those three days you and your representatives will meet the key men who make or influence buying decisions about your products.

Act NOW! to reserve space. Write to-day for illustrated brochure.

**OCTOBER
8-9-10**

1958



AUTOMOTIVE BUILDING., C.N.E., TORONTO

Office—1819 YONGE STREET, HUDSON 8-7768

Sponsored by the Canadian Sections of the Institute of Radio Engineers

For further data on advertised products use page 65.

Electronics And Communications

Canada's Third IRE Exposition

It would be hard to find more concrete evidence of the growth of the Canadian electronics industry than the Canadian IRE Convention and Exhibition which this year will mark its third anniversary.

The initial and second years' success of this event has, quite obviously, been due in large part to the wholehearted response of manufacturers who, realizing the importance of exhibiting their products at a focal point of attraction for thousands of engineers and buyers, have reacted promptly to the opportunity with ready zeal and good business horse sense.

As progressively successful as this event has been over the past two years, there is every reason to expect that this year's Convention and Exhibition will prove to be an even greater success and it is interesting to note that the importance of the event in the field of electronics, not only in Canada but abroad too, has attracted the attention of overseas governments including those of the United Kingdom, the U.S.S.R., France and the United States.

At the time of writing it is understood that no formal submission for exhibition space has been submitted by these governments but their expressions of interest in the event have been made known.

While it would indeed be most flattering to have such august bodies as the above displaying at the Exhibition, it is more than satisfying to know that the Convention and Exhibition in itself has proved to be of a caliber capable of evoking interest from such sources. If, therefore, any measure of exhibition value may still be sought by prospective but undecided exhibitors, they could do no better than consider the fact that governmental agencies from abroad would not likely consider anything other than top quality events of this nature at which to parade their national scientific achievements.

This is the age of the atom, the age of automation and the age of space flight and it is undeniable that without the aid of electronics the accomplishments that have been made in these fields in recent months would still be in the realm of things to come.

Canadians have contributed largely to the store of scientific knowledge and manufacturing know-how that has placed the world well over the threshold of the atom and space age, and insofar as Canadian progress in the electronics science is concerned the forthcoming IRE Convention will provide engineers from coast to coast in Canada and from many overseas lands with the opportunity of acquainting themselves with the latest Canadian developments. This opportunity, of course, will be provided through the many technical papers to be presented at the engineering symposium.

As in the past, every effort is being made by IRE Exhibition officials to stage an event that will be of interest and benefit to management and engineering, not only in the electronics industry but in industry generally into which electronic equipment is being integrated at an ever increasing rate. It is evident, therefore, that if management in the electronics industry wishes to keep abreast of the latest developments they will plan on having their firms represented at the Convention by an adequate number of their engineering personnel. It is equally evident that if business management generally is desirous of being informed on the latest types of electronic instrumentation and equipment with which business may be conducted more efficiently and economically, then they too will assure themselves of appropriate company representation at the Canadian IRE Convention and Exhibition to be held October 8, 9 and 10 in the Automotive Building, Exhibition Park, Toronto.

RETMA's Change Of Name

It was inevitable, we believe, that the Radio-Electronics-Television Manufacturers Association of Canada would sooner or later get around to changing its name, if for no other reason than to save wear and tear on the jaw-bone joints of those many people who had to mouth the unwieldy phrase in business conversation. And so at the recent 29th Annual Meeting of RETMA, the name "Radio-Electronics-Television Manufacturers Association of Canada" was packaged neatly up in the ribbons of an official announcement and cast to the cool, clear winds of Muskoka. And what had started out to be the 29th Annual Meeting of the Radio-Electronics-Television Manufacturers Association of Canada ended up as the 29th Annual Meeting of the Electronic Industries Association of Canada, or could it be the first annual meeting of the Electronic Industries Association of Canada? This technicality, of course, may well be overlooked and if the EIAC ages thirty years in the first year of its existence, r.o. one will mind too much.

In more serious vein, however, the change of name is indicative of the expansion of the Canadian electronics industry which, since the end of World War II, apart from defense contracts, has been largely composed of television and radio manufacturing. Now, however, the need to

satisfy the ever-growing demand of Canadian industry for industrial and communications equipment has created a new and promising market.

Already many Canadian business firms have experienced the benefits to be gained from modernizing their plants with automated processes and data processing machines are now widely accepted in Canadian business. Improved communications facilities are now in the planning stage for Canada and the demand for nucleonic equipment with which to control this country's future atomic power installations, together with the endless variety of other applications required in business, has attracted the attention of management in the Canadian electronics industry and led them to accept the challenge of providing much of the equipment for this expanding industrial market.

The Canadian electronics industry is no longer one of television and radio manufacturing alone but an industry providing an endless variety of equipment. To better signify, therefore, the all-encompassing interest of RETMA in this expanding electronics industry, the officials of this organization have chosen well in the selection of their new name. May the new Electronic Industries Association of Canada continue to serve and prosper under its new name as it has done under the old.

INTREWW



NEW TYPE 6 SERVO MOTORS

Here's one of the smallest precision servo motor series currently available. The new Daystrom Transicoil Type 6 Motors are wound for 26-, 33-, and 52-volt operation. Control phase is center tapped for operation with transistor drive. These Motors develop .125 oz-in. min. stall torque and 6200 RPM free speed. Each unit weighs only .9 oz. and is less than 1¼" overall.



NEW TYPE 8 INDUCTIVE POTENTIOMETER

This Inductive Potentiometer is an infinite resolution a-c potentiometer whose output voltage is linear rather than sinusoidal with the angle. Output voltage phase is dependent upon the direction of shaft displacement from null. When operated into load resistors not less than those specified, output is linear within .25% through an angular rotation of +85° through null to -85°.



NEW TYPE 8 SYNCHROS

The new Daystrom Transicoil Type 8 Synchro Line consists of transmitters, control transformers, differentials and repeaters. Dimensions equal to BuOrd Size 8. Operation: 115V 400 cycles or 26V 400 cycles. Accuracy of ± 10 minutes is standard. Other accuracies are available upon request. Corrosion resistant construction throughout. Conforms to MIL-E-5272-A. Operating temperature range is -54C to +125C. Higher temperature units also available.

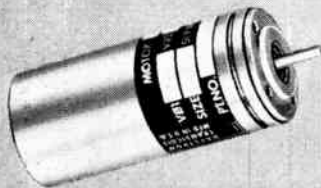

NEW TYPE 11 INERTIAL DAMPED MOTOR

Here's inertial damping with no reduction in no-load speed! This new Type 11 Motor (BuOrd size 11) provides acceleration or deceleration damping in high-speed and high-gain servo systems. In non-critical applications, this motor can be used as a low-cost substitute for damping motor generators.

DATA SHEETS AVAILABLE Write for complete specifications, mechanical data, dimensions and characteristics.

5830

DAYSTROM LIMITED

840 Caledonia Road, Toronto 19, Ontario; 5430 Ferrier Street, Montreal 9, Quebec. A subsidiary of Daystrom, Incorporated.

For further data on advertised products use page 65.

PULSE AMPLIFIER KLYSTRONS

Eimac First for Power Amplifier Klystrons

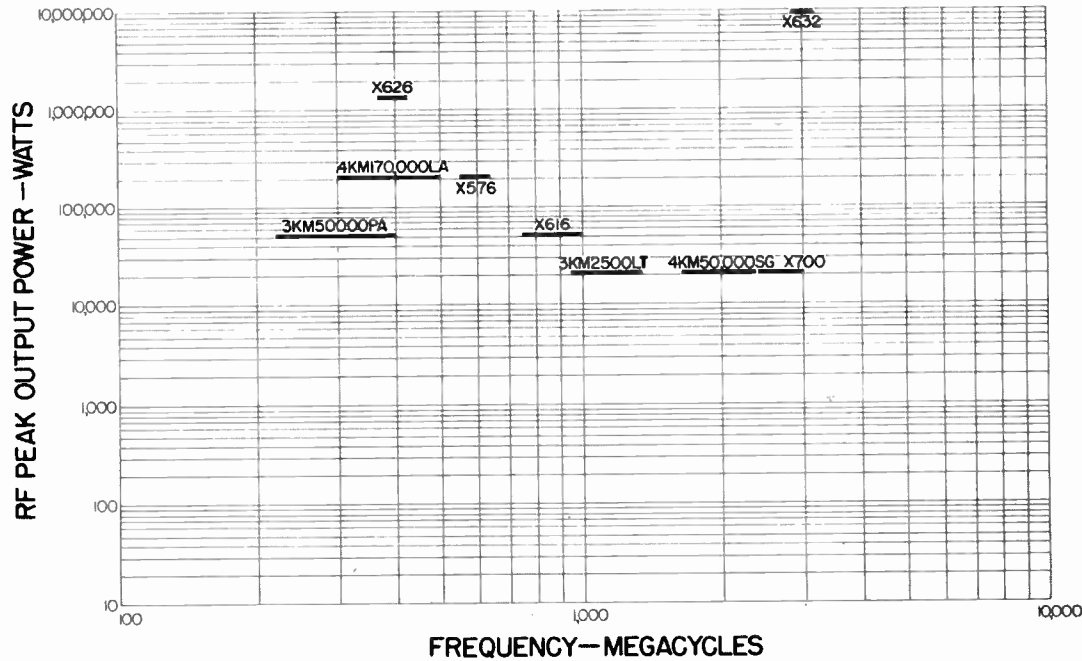

...Across the RF SPECTRUM

CW AMPLIFIER KLYSTRONS

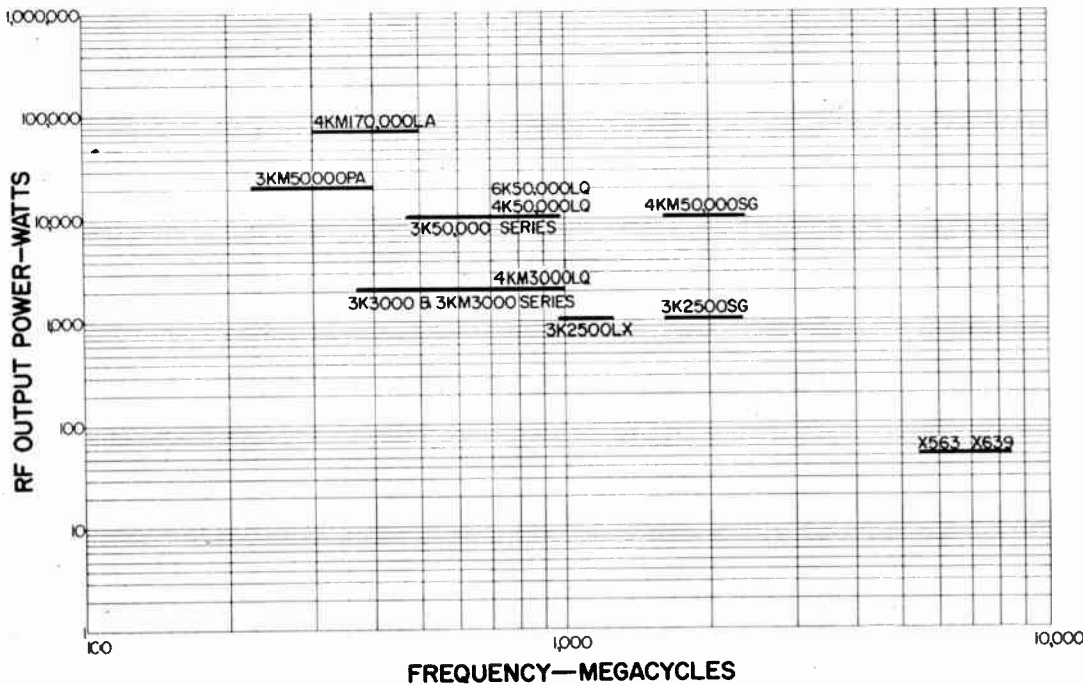

The exceptional ability of Eimac amplifier klystrons to conveniently and reliably generate high RF power at ultra-high and super-high frequencies makes them ideal for use in such important aeronautical applications as high-power ground-to-air communications, TACAN and other air navigational systems, super-power radar for missile tracking, tropo-scatter communications networks for early warning defense and other UHF microwave systems.

The broad frequency coverage and wide power range now offered by Eimac amplifier klystrons is shown in the accompanying charts. Frequency coverage extends into the SHF range, and multi-megawatt pulse output powers are available.

For more detailed information on Eimac's reliable, simplified approach to high power at high frequencies, write for a copy of Klystron Facts Case Five. The Eimac Application Engineering Department will gladly assist you in planning the use of Eimac power klystrons.

EITEL-McCULLOUGH, INC.
SAN BRUNO · CALIFORNIA
Eimac First for Power Amplifier Klystrons



EIMAC DESIGNED AND MANUFACTURED PRODUCTS

Negative Grid Tubes	Vacuum Tube Accessories
Reflex and Amplifier Klystrons	Vacuum Switches
Ceramic Receiving Tubes	Vacuum Pumps
Traveling Wave Tubes	

Eimac family includes more than 40 ceramic electron tube types

The World's Largest Manufacturer of Transmitting Tubes

Canadian Representative:

R. D. B. SHEPPARD
2036 Prince Charles Road, Ottawa 3, Canada

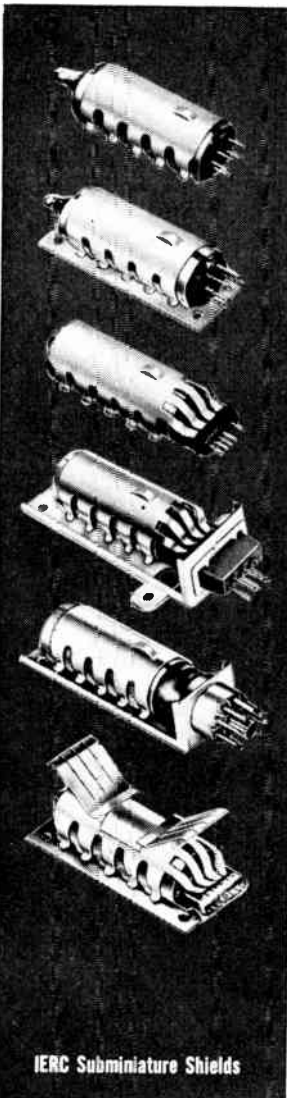

IERC Subminiature Shields



IERC Military "B" Type Miniature Shields
 Meets MIL-S-9372B (USAF) Meets MIL-S-242A (SHIPS)



IERC Miniature Hardmount Shields

AVAILABLE IN CANADA!*



IERC "TR" Shields
 Meets MIL-S-19786A (NAVY),
 MIL-S-9372B (USAF), SQ-6307/2 (SIG. CORPS.)

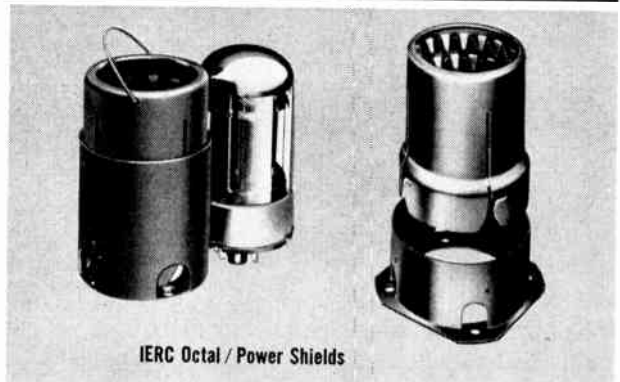

IERC Octal / Power Shields

IERC Heat-Dissipating Electron Tube Shields

give maximum cooling, retention, shock protection and longest tube life!

Make it a point to investigate IERC Heat-dissipating Tube Shields—immediately available in a wide selection to meet every electronic equipment requirement. IERC shields are the only commercially available shields which actually meet or exceed specifications for military applications by providing greatest reduction of electron tube bulb operating temperatures, maximum vibration and shock protection plus compatibility with all tube diameter tolerances. All IERC Heat-dissipating

Tube Shields are of an exclusive, patented, time-proven design and are the most widely preferred make for new electronic equipments as well as for extensive equipment retrofitting programs. Design, development and engineering facilities offered by IERC are the most experienced, complete group available.

MANUFACTURED BY
International Electronic Research Corporation
 145 West Magnolia Boulevard, Burbank, California

PATENTS 2897659, 2766020 OR PATENTS PENDING/CROSS-LICENSED WITH NORTH AMERICAN AVIATION, INC.



WRITE for FREE, Revised Edition of the famous IERC Tube Shield Guide. Over 1,200 electron tube and tube shield combinations added to last edition. The best guide to effective tube cooling—top reliability!

*** R-O-R**

R-O-R ASSOCIATES, LTD.
 1470 Don Mills Rd., Don Mills, Ontario

Manufactured in Europe by: Europalec, Les Clayes, Sous-Bois, Paris, France

For further data on advertised products use page 65.

Rogers 6155 is a Special Quality Transmitting Tetrode with a proven longer life performance over its equivalents. Extended life is assured through its powdered glass construction and the use of a rugged zirconium coated graphite anode which guarantees freedom from gas deterioration.

The 6155 is recommended for use in broadcasting, communication and television transmitters as a replacement for the 4-125A or 4D21. It requires less drive and has a plate dissipation of 125 watts. The 6155 Tetrode has maximum ratings to 120 Mc/s, and its typical output in class C telegraphy is 375 watts.

**Rogers Special Quality tubes are finding more and more applications in all types of professional equipment. The greater reliability and lower maintenance cost of the apparatus in which they are used more than compensates for the higher initial cost.*

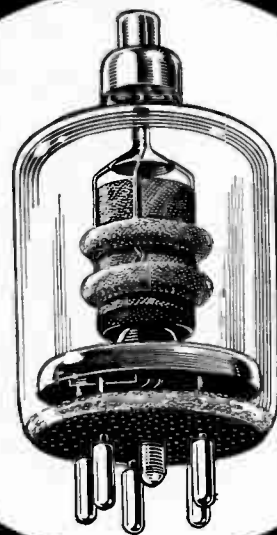

ROGERS

electronic tubes & components

A DIVISION OF PHILIPS ELECTRONICS INDUSTRIES LTD.
116 VANDERHOOF AVENUE, TORONTO, ONTARIO / BRANCHES: MONTREAL, WINNIPEG, VANCOUVER

★ Rogers Electronic Tubes are sold through Canada's Independent Electronic Parts Distributors

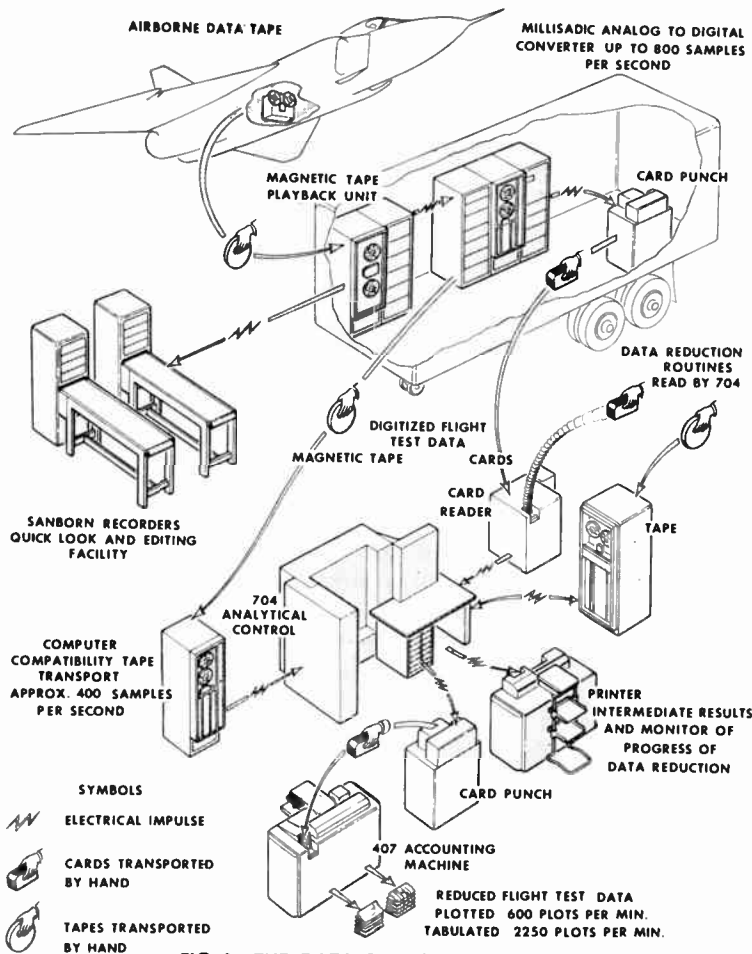

FIG. 1 THE DATA REDUCTION PROCESS

In the design and development of a modern aircraft, the digital computer is playing an ever increasing role. Not the least important function it has to play is to speed the processing of Flight Test Data. Avro Aircraft is currently developing a system for handling flight test data, and the purpose of this article is to give an account of the methods being used and the progress to date.

At the center of the system is an IBM 704 Computer — the first of its kind in Canada. The computer plays a dominant role in determining the stability characteristics and the performance of the aircraft.

The object of the exercise is, of course, the flight testing of the AVRO Arrow. Without the use of a high speed computer, and a rapid and efficient method of feeding large quantities of data to it, the flight testing of an aircraft as complex as the Arrow would be an impossible task.

Flight Test Data Reduction For The Avro Arrow

By A. Cohen*

DATA is acquired in flight by measurements of various physical quantities by means of sensors; the outputs of these sensors are recorded in analog form on C.E.C. Magnetic Data Tape. The data is played back after flight onto Sanborn Recorders for "Quick Look" records and editing. Selected portions of the flight are then digitized on a C.E.C. MilliSadic for input to the IBM 704. Output from the 704 is provided on punched cards for tabulating or plotting on an IBM 407 Accounting Machine.

The Computer

The IBM 704 Computer was installed at AVRO early in 1957. The installation is illustrated diagrammatically in Figure 2. It is a small 704, consisting of a Core Store of 4096 thirty-six bit words — access time 12 microseconds; four Type 727 Magnetic Tape Units, each tape capable of storing up to one million 704 words — reading and writing rate 2500 words per second; a Card Reader

which reads at 250 cards per minute — 6000 704 words per minute; a Card Punch which operates at 100 cards per minute — up to 7200 Hollerith characters per minute; and an attached Line Printer which can print at 150 lines per minute — 10,800 characters per minute. Also shown are the Central Processing Unit, a MilliSadic Compatibility Tape Unit, control and power units.

The 704 is capable of carrying out up to 40,000 operations per second and it can compute in fixed point and in floating point arithmetic.

Data Acquisition and Digitization

The aircraft is fully instrumented with sensors to measure all kinds of data, such as pressures, temperatures, control surface angles etc., required to determine

*Avro Aircraft Limited, Malton, Ontario. This article is based on a paper presented to the Canadian Conference for Computing and Data Processing.

the behavior of the aircraft during flight. According to the particular type of test being undertaken during the flight, certain of the sensors are recorded on Datatape. Three 24 track Datatapes are flown, making 72 tracks in all. 66 tracks record continuous information, and the other 6 record Pulse Width Modulated data, commutated at 900 samples-per-second. The commutators are 45 segment switches, rotating at 20 revolutions per second; 40 of the segments being used for recording data. Thus there are 240 commutated channels of information, each recorded at 20 samples-per-second.

After the flight, most of the parameters recorded are displayed on Sanborn Recorders. These give "Quick Look" records for first analysis of the flight and it is from these traces, coupled with the known program of manoeuvres performed during the flight, that portions of the flight are selected for more detailed analysis on the 704 computer.

Depending on which computing program is required to be used on an edited part of the flight, certain parameters will be required digitized. This is done on the MilliSadic. A few words about its operation will be useful.

The MilliSadic at AVRO accepts inputs in the form of analog voltages or pulse width information, and converts these to digital counts in the range 0-999. The digital counts are written onto a digital magnetic tape which can be used as a buffer tape between the high speed digitizing process — upwards of 40 samples per second — and the slow speed card punching — 20 samples per second; or it can be used for direct input to the IBM 704, which has been modified to accept it.

The MilliSadic operates in two modes. To digitize analog voltages — continuous data — it can operate in a commutated, multi-channel input, mode in which up to 100 continuous channels of information can be sampled in sequence, by a commutator in the MilliSadic, at a total of 400 samples per second. Thus 100 channels could be sampled, each at 4 samples per second; or 50 channels

could be sampled at 8 samples per second; the total is always 400 per second and the number of channels is 100 or a sub-multiple of 100. Only one tape reader is available for reading the Datatape so that there is a maximum of 24 continuous channels available for input to the MilliSadic.

The channels are commutated and digitized, and digital counts are written onto the digital tape.

The MilliSadic can also be operated in a single channel mode. In this case the MilliSadic commutator is not used and up to 1200 samples per second can be digitized from the channel. Such a high sampling rate from a single channel is only required, at present, when digitizing a commutated track of pulse-width information, when the sampling rate is locked to the sampling rate of that particular commutator — about 900 samples per second.

Certain features of the sampling and digitizing processes may be noted.

1. The airborne commutators are all independent. There is therefore, no synchronization between any two commutators.
2. The MilliSadic commutator is independent of the airborne commutators so that there is no synchronization between it and any of the airborne commutators.
3. In the case of a commutated channel, 45, and in the case of continuous channels, 20, are the practical limits on the number of parameters which can be digitized in one run through the MilliSadic, since only one Datatape can be used at a time and the MilliSadic can digitize either one commutated channel or selected continuous channels from that tape.
4. For practical purposes, in normal operation, the AVRO MilliSadic cannot digitize at less than 20 samples-per-second on either commutated or continuous data. Although on continuous channels it can digitize at 4/second on each channel, the total number of samples is still 400 per second so that if only 20 inputs are provided, the other 80 inputs are wasted. This difficulty can be partially overcome if card input

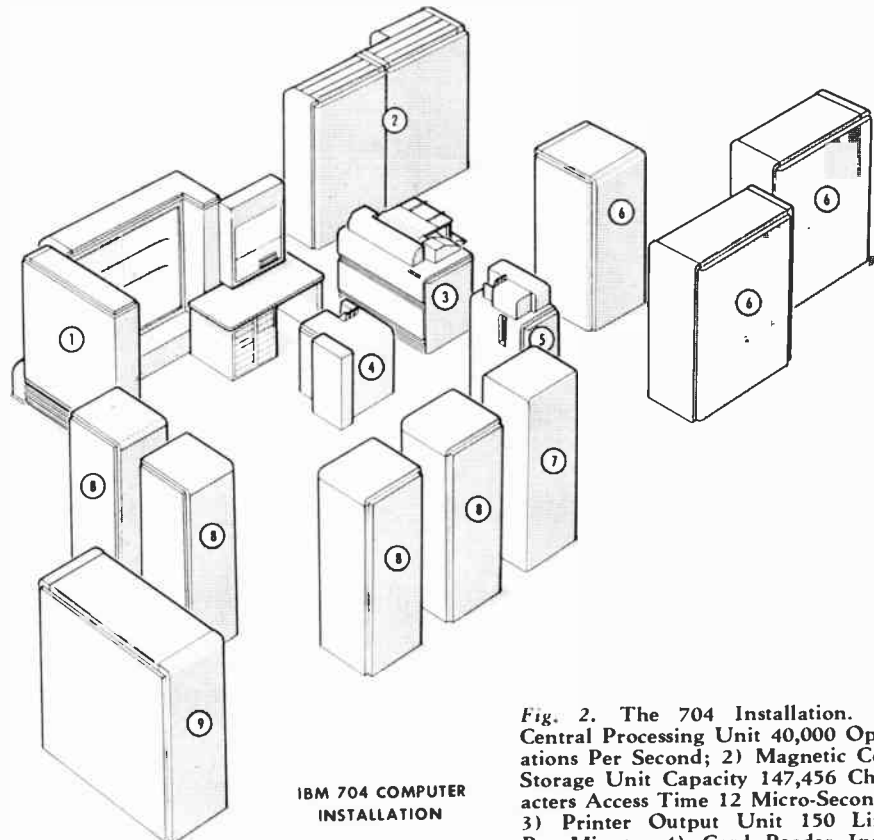

Fig. 2. The 704 Installation. 1) Central Processing Unit 40,000 Operations Per Second; 2) Magnetic Core Storage Unit Capacity 147,456 Characters Access Time 12 Micro-Seconds; 3) Printer Output Unit 150 Lines Per Minute; 4) Card Reader Input Unit 250 Cards Per Minute; 5) Card Punch Output Unit, 100 Cards Per Minute; 6) Power Units; 7) MilliSadic Compatibility Tape Unit Input For Flight Test Data; 8) Tape Unit Auxiliary Memory And Input-Output Unit, Transfer Rate 90,000 Characters Per Second, Storage Capacity approx. 32 Million Characters; 9) Tape Control Unit.

8-4 PUNCH WITH

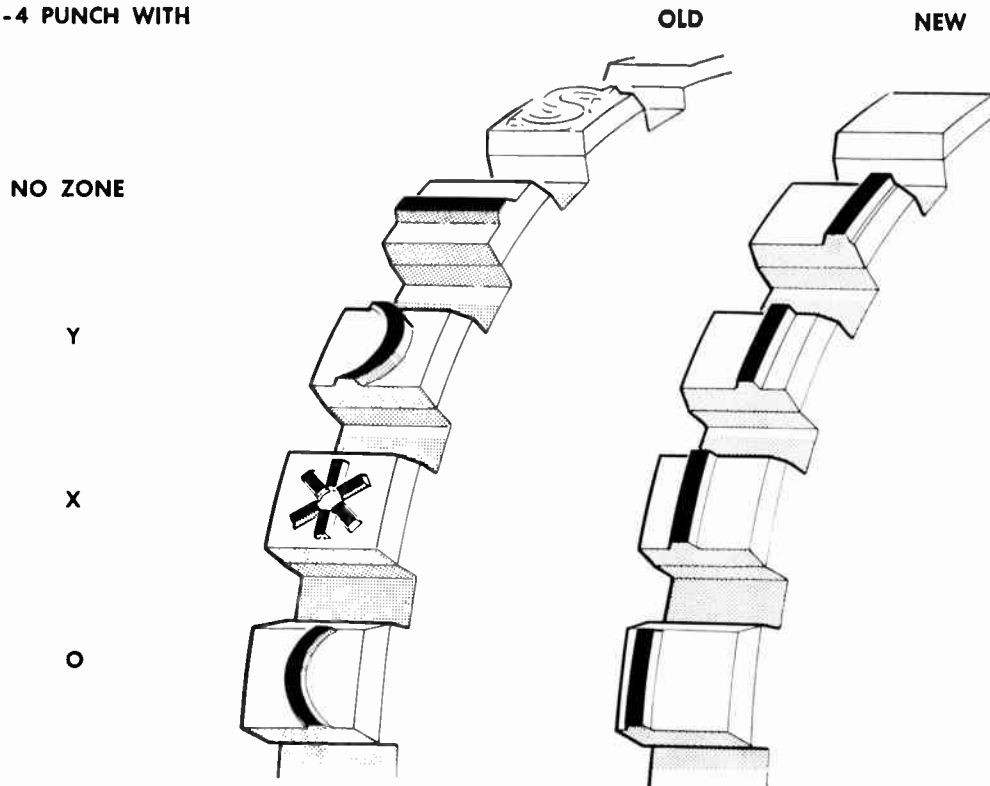

Fig. 3. Split Type Wheel Characters.

to the computer is being used, since five cards are punched for 100 samples and the 20 inputs could all be contained on the first card. The other four cards can be sorted out. In some cases, however, this sampling rate is far greater than is required, and in order to minimize input to the computer, an "Intervalometer" is used which causes the MilliSadic to digitise only at certain intervals — from 1/10th second to 10 seconds — on either commutated or continuous channels.

The Computing Scheme

As far as possible, three principles have been borne in mind in devising the Computing Scheme.

1. Simplicity of Programming — it should be as simple as possible to fit programs into the scheme.
2. Simplicity of Operation — this refers to the setting up of a series of computations for handling by the machine.
3. Flexibility of Operation — the scheme must be capable of handling a variety of different kinds of computing problems.

The job is well suited to an Interpretive Scheme, and a special Interpretive Program has been written. With simplicity of operation in mind, pseudo-instructions are written in octal form — one pseudo-instruction to one 704 word. The pseudo-program then needs no complicated assembly or decoding, and it can be read in with a standard loader. Primarily the pseudo-instruction gives the number of a sub-program, to be executed next, to the Interpretive Routine. Three octal digits give the sub-program number, three digits give a Data File Number, and up to three magnetic tapes may be specified by one octal digit each. A sub-program may use one, two or three tapes.

Programs are stored in one file on a tape, the Interpretive Routine at the head. This routine is written in a self-loading form so that pressing the "Load Tape" button causes it to load into core storage and enter itself. The Interpretive Routine first loads the pseudo-program and then interprets it. Each pseudo-instruction may be followed by a calling sequence of up to seven words, which

is mainly useful for selecting results, either for output, or for input to another program.

Progress of the data reduction is monitored on the Attached Printer. The Interpretive Program includes a Comment sub-routine which is used to identify, on the printer, the sub-program which has been used and the data file which has been operated on. Certain information on tape reading errors is also printed. The Comment sub-routine may also be used by any of the sub-programs to print comments on any aspect of the proceedings, such as overflows, errors etc.

A useful debugging facility is provided by the Interpretive Program, with a Breakpoint Print sub-routine. Any computing sub-program can, under Sense Switch control, call for the print out of selected intermediate results by the Breakpoint Print routine. This is stored on the program tape in the form of a sub-program and it is called down by the Interpretive Program when required. Before returning control to the computing program, the cores and machine condition are restored.

A set of Input and Output routines are used, with the appropriate computing program, to process edited portions of the flight. In the Input Stage, component files of data are read in, synchronized if necessary, merged, sorted packed three data samples to one 704 word, and written onto IBM 727 tape in a standard format for input to the computing program.

In the Execution Stage, a computing program accepts the data file in standard format, processes it, and writes a file of results, in another standard format, onto another 727 tape. A feature of the system is that a file of results can be used as the input to another computing program. Thus the MilliSadic data is written, by the input routines, onto tape as a file of First Stage Data. The computing program which processes it, a First Stage Program, writes a file of First Stage Results. This, in turn, can be used as Second Stage Data to be processed by a Second Stage Program into Second Stage Results; and so on. All files of results are written in the same standard format; and so it is possible to proceed to any stage of computation.

In the Output Stage, results files are punched out in suitable form for recording on an IBM 407 Accounting

FIG. 4 X. Y. PLOTS

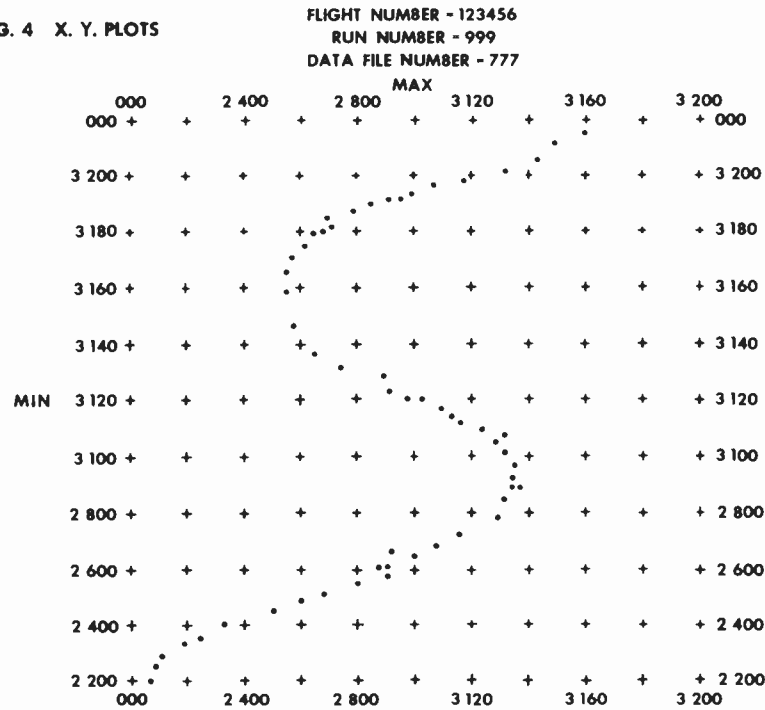

Fig. 4. X.Y. Plots.

Machine. Provision is made for several forms of printed and plotted results. By maintaining the same format for results files at all stages of computation, a set of standard output programs can be used to punch all results.

Use of Magnetic Tapes

Four 727 tape units are required for complete operation of the computing scheme. The program file is written onto Tape 1, which may be used with Load Tape button. Tape 2 is used for First Stage Data Files, two other tapes being used by the input programs to assemble the data file. During computation, first stage data is read from Tape 2, and results are written in alternate stages on Tapes 3 and 4.

No results are written onto Tape 2 and, normally, no data is written onto Tape 1. However, since the AVRO 704 configuration has four 727 tape units only, some alternative procedure is required when one tape unit is on maintenance. In this case a limited program of data reduction will be executed by making use of Tape 1 for temporary storage of data or results files. Such a file will be written after the program file, and it must be for immediate use, as it will not be retained.

Data and Results Files

Much of the work of data reduction for the Arrow is analysis of time history data from the flight. Some of the most important programs, however, are concerned with the computation of Stability Derivatives, which are, of course, not time dependent. The form of a file of results must therefore be able to accommodate both a time history and a table of constants.

All files start with Initial Data Records. The number of these records is fixed so that they do not require identification. Information in the first record is used to control the handling of the rest of the file. The first word of each of the data records identifies the type of record. Time history data or results records come first. A file of results may then include an arbitrary number of optional records, one of which can be a table of constants. The last record of all files is a Record Count of the number of records in the file. This is used for backspacing over the file.

Input Procedures

A set of five basic input programs prepares a file of

data in the standard format required for input to the computing program. Some programs require as many as seventy or eighty inputs. It is not possible to digitize as many as this in one pass through the MilliSadic so that two or more files of data must be read in to the computer to form the complete data file. It is usually necessary to take at least two commutated channels in addition to continuous channels, and this inevitably means using asynchronous data. If only one commutated channel were required, in addition to continuous channels from the same Datatape, it would be possible to synchronize the sampling of the continuous channels to the commutation pulses from the appropriate commutated track. This, however, would not normally be adequate, so that no attempt is made to achieve any synchronization in the digitization stage. Instead a synchronizing program is used to interpolate the input data, to fixed time intervals, in the computer. Finally, to accept the data inputs in any sequence, a sorting program is used and this program will also pack the data, three samples to one 704 word.

The five input programs are therefore:

- (1) Card — 727 Tape Read
- (2) MilliSadic Tape — 727 Tape Read
- (3) Synchronize
- (4) Merge
- (5) Sort and Pack

These programs represent the most straight-forward system for data input. However, simplicity has been achieved at the expense of efficiency. The MilliSadic tape can be read in to the computer at the rate of between 500 and 1000 samples per second. Due to the necessity for using the above programs for synchronizing, merging and sorting, and the associated tape handling required, the average rate of preparation of data files, in the required format, is between 150 and 200 samples per second. This represents the true rate of input of data to the computer.

It is planned to improve the efficiency of the input programs by developing routines which combine some of the facilities at present incorporated into separate programs. Thus a MilliSadic tape read program could synchronize the data before writing to 727 tape. Another MilliSadic tape read program could synchronize and merge with another file. The use of such programs would considerably improve the input and it is estimated that an input rate of about 400 samples per second can be achieved.

Output Routines

A set of four Output Programs punches results in the appropriate form for recording on the IBM 407 Accounting Machine. Punched Card output is preferred to tabulating or plotting on the attached Line Printer. There is an advantage in speed of output, although this is not always very great, but the main reason is that the punched card output can be stored and reproduced as required, without any further call for 704 time. Two programs punch cards for tabulating, one giving scaled results, and the other giving results in floating decimal form. Two plotting programs punch cards for X, Y plotting and for Time History plotting. This set of four programs appears to meet all the requirements of the data reduction system. Further programs will be added as required.

Checking Procedures

A computing scheme such as this clearly should include some checking procedures. There is, however, a certain difficulty in checking data, and the reading of data from magnetic tape. This is that if an error is discovered in data read from a tape it may not always be possible to do anything about it. Checking all data written on magnetic tape for accuracy would be very wasteful of time, and anyway, it is not always very important to detect an error. In the calculation of time histories, one incorrect bit of data may affect the calculation of one point, but its effect on that point may be negligible, and there may be no effect on other points, whatever the magnitude of the error caused. The attitude to such errors then, is that if it is negligible it is not worth detecting, and if it is large it will usually be obvious, and so may be unimportant.

The checking procedures adopted are, therefore, directed at discovering those errors which can be crucial. A logical check sum is computed for each record and is written onto the tape at the end of the record. Certain of the data in the Initial Data Records is used to control the handling of the whole file of data. It could be disastrous if this control data were incorrect. The writing of all Initial Data Records is checked, therefore, and if it is found to be impossible to write a record correctly the data reduction is stopped and the machine turned over to the service engineers. On reading back Initial Data Records, if an error is found, up to four attempts will be made to read back the record correctly. If this is not successful, the failure is noted for a comment later on the attached printer. The error may not be serious however — there is no way of telling — so the processing of the file will continue. It is considered worth while to attempt this and perhaps get a file of useless results — the comment on the printer will give the warning however — rather than leave the processing of that file for the sake of a possibly trifling error.

No attempt is made to check the writing of data, as distinct from initial data, on magnetic tape. There is no check on the reading of the MilliSadic tape, but a logical checksum is written at the end of each data record on 727 tape. On reading the data record, the checksum is tested. Checksum failures are counted and the number of failures is stored for comment later on the printer. There is no attempt, however, to read a data record again in the event of a failure.

The Interpretive Program will print out, in addition to the program number and the data file number, a note on which initial data records contained errors, and the total number of checksum failures found in reading data records. Frequent tape reading errors are then apparent, and appropriate action can be taken.

Display of Results

Most of the data reduction results are required plotted, this being the easiest way to digest lengthy time histories. Efforts have therefore been concentrated on developing an efficient method of output and display of these time histories.

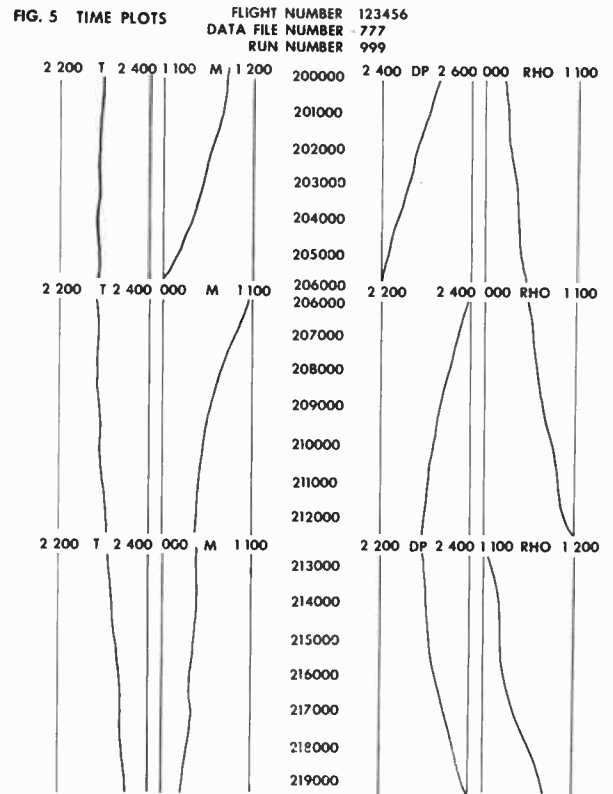

Fig. 5. Time Plots.

The IBM 407 Accounting Machine may be used very effectively as a fast plotter. For this purpose our 407 has had a number of modifications incorporated. Here are a few details of these changes:

1. The selector capacity has been greatly increased. Co-Selectors have been increased from 16 to 32; Pilot Selectors have been increased from 15 to 20; Digit Selectors from 2 to 6; four 3 position, 10 level, Field Selectors, of which there are normally none, have been added; and there are 10 extra filters, making 20 in all. This is all standard optional equipment.
2. Non-standard modifications include a carriage with line spacings of 6 per inch and 10 per inch, instead of 6 per inch and 8 per inch; and four special plotting characters, on the type wheels, in place of four little used symbols. These are illustrated in Figure 3. Effectively they sub-divide character spacing into four.

Both X, Y and Time History plotting can be achieved on the 407. For X, Y plotting, suitable scales are determined by the computer to accommodate the plot within a 10 inch by 10 inch graph. Plot codes are computed and, together with headings and scales, they are punched out on cards. The cards are sorted on the Y code, which controls the paper feed. Plotting is carried out at 150 points per minute, plus time for printing scales and headings. The special plotting symbols may be used or not, as required. Without their use, a plotting accuracy of $\pm \frac{1}{2}\%$ of full scale is obtained; using them the accuracy is $\pm \frac{1}{8}\%$ of full scale. An example is shown in Figure 4; effectively the use of the special plotting symbols.

For Time Histories, which constitute the bulk of the plotting requirements, a different approach is made. In this case the special plotting symbols are used, and four graphs are plotted side by side. Scale factors are fixed and the scale ranges are adjusted to accommodate the variables. Whenever necessary, the scale ranges are changed, and a scale card is punched out. The effect is shown in Figure 5. Plotting accuracy is $\pm \frac{1}{2}\%$ of full scale for each of the plots. Plotting proceeds at the full line feed rate of the 407 — 150 lines per minute, up to 600 plotted points per minute.

Heat-dissipating electron tube shields and their relation to tube life and equipment reliability is a subject of paramount importance to manufacturers of electronic equipment. Recent researches into this problem are dealt with in detail in the following article.

Heat-Dissipating Electron Tube Shields

Part 1

By John C. McAdam*

THE failure of electron tubes — and the resulting failure of equipment — is a problem that has been long with us. So long, in fact, that many of us appear to be conditioned to a state of mental resignation regarding it. High failure rates have been accepted as a “fact of life”, a condition which we find costly and hazardous, but with which we must live in the electronic age.

Strangely — for so general a condition — our studies have shown a lack of understanding of the nature of the problem. For example, while tube failure rates are known to be high, the relationship between tube failures and equipment failures is not so well known. Neither do we find broad understanding of the reasons for tube failures.

Through this presentation we hope to show some significant facts:

1. That 3 equipment failures out of 4 are caused by failure of tubes;

2. That the main cause of tube failure is high operating temperature;
3. That an immediate solution to a major part of the problem can be obtained through use of heat-dissipating tube shields.

Toward the end of World War II and in the years since then, numerous surveys have been made by the U.S. Military, either directly or through contracts with research organizations, to determine the causes of electronic equipment unreliability. These studies have shown that resistors cause about 3 per cent of all equipment failures, another 3 per cent to 4 per cent of failures can be traced to capacitors, but the big cause of equipment failure — and this is the unquestioned summary conclusion of all the

*Vice President Engineering
International Electronic Research Corporation.

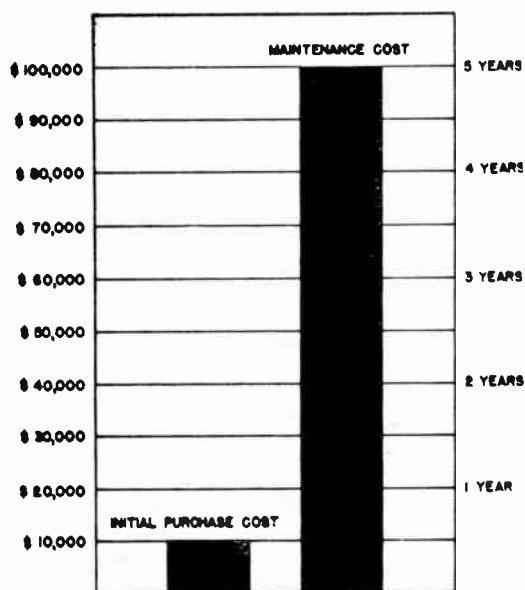

MAINTENANCE COST OF MILITARY EQUIPMENT

Figure 1.

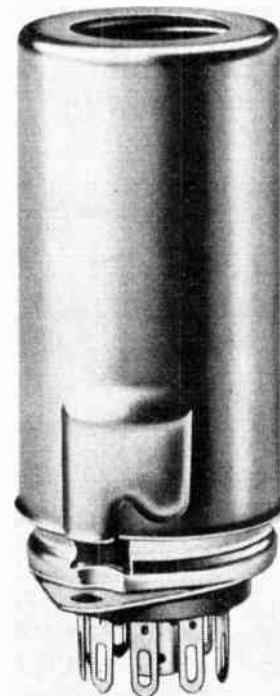
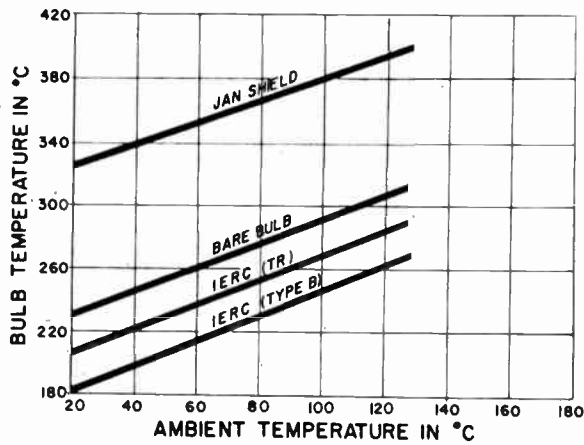

Figure 2.



6005/6A05 OPERATING AT MAXIMUM PLATE DISSIPATION . . .

Figure 3.

studies — is failure of tubes. The reports show that not less than 75 per cent of all equipment failures are caused by tube failures.ⁱⁱ And further investigations have shown that the main cause of tube failure is high operating temperature.ⁱⁱⁱ

During the past five years, many additional tests have been conducted by commercial and military laboratories. These tests have shown that the “normal” operating temperatures of many tubes are well above safe limits.^c In a thumbnail analysis of these many surveys, the pointed conclusion is reached that if a mere two-to-one increase in tube life could be achieved, it would eliminate more than one-third of all equipment failures. Put another way, this much improvement in tube life would accomplish more toward raising equipment reliability than if all other causes of failure were completely eliminated.

Notable, also, is the effect that tube life improvement would have in reducing equipment maintenance costs. During an average five-year use period, the cost of maintaining electronic equipments, as calculated by U.S. Military services, represents a minimum expenditure equal to 10 times the original cost of equipment purchase.^d (Figure 1) That is, if an equipment is purchased for \$10,000, the maintenance cost for a five-year period amounts to \$100,000. And — obviously — a saving of only 10 per cent in the maintenance cost will save the entire original purchase price.

A U.S. Navy engineer reports^e that his branch of the military service spends \$45 million annually for the purchase of replacement electron tubes. He also indicates that it costs ten times this much to get the replacement tubes through the channels of supply and into the equipment — a total cost of \$495 million every year. The

ii — See Ref. 1 through 6 and 31

iii — See Ref. 7 through 12

c — See Ref. 7, 8 and 10

d — See Ref. 13, 14 and 30

e — See Ref. 15

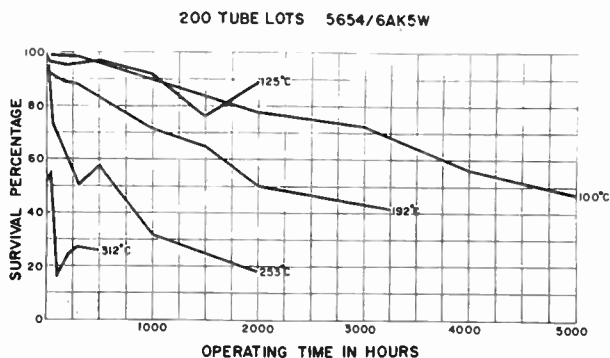

Figure 5.

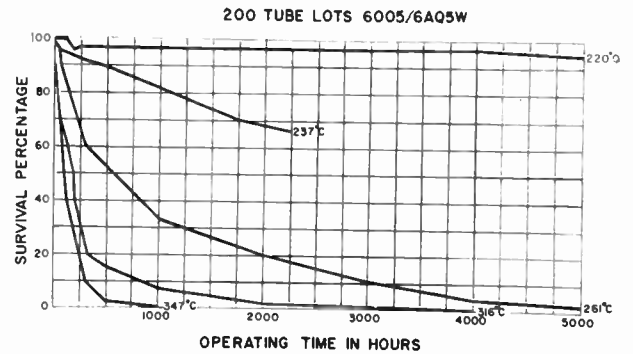

Figure 4.

report calculates that if tube life could be prolonged by a factor of only 2, some \$247 million could be saved — and if prolonged by a factor of 4, then the yearly saving would amount to \$371 million.

An illustration in terms of a single piece of equipment is reflected in a study made by Aeronautical Radio, Inc.^f This was a two year field test on equipments using six type 6005 tubes. Under conditions of original application, the tubes had an average life of 1000 hours. By doing nothing more than applying heat — dissipating tube shields to these tubes, average life was increased to 12,000 hours. With six tubes on each piece of equipment, this means that no less than 66 tube failures were eliminated for every one and one-half years (12,000 hours) of operation. At an average cost of \$5.50, the purchase saving on the tubes during such a one and one-half year period would amount to \$363 — and this saving is accomplished by an expenditure of approximately \$9 for the six “Life Saving” tube shields.

The term “life saving” should be excused. While applying it to tube life in this instance, all of us are aware of the human-life-saving aspects of electronic reliability — whether it is from the certain functioning of a warning system, the accurate firing of a defensive weapon, or the correct radar intelligence that may save the life of a single aircraft pilot. A better appreciation of what is involved may come from deeper penetration into:

The Scope Of The Problem

Our present predicament with electronic equipments, and with the tubes they use, has grown with our technological development of complex electronic systems. Before World War II, a typical destroyer carried equipment using about 60 tubes; a modern destroyer requires 4,000 tubes for the operation of essential equipment. As requirements for equipment have gone up, space available for individual equipments has almost disappeared. Equipment has been miniaturized and then subminiaturized.

f — See Ref. 16

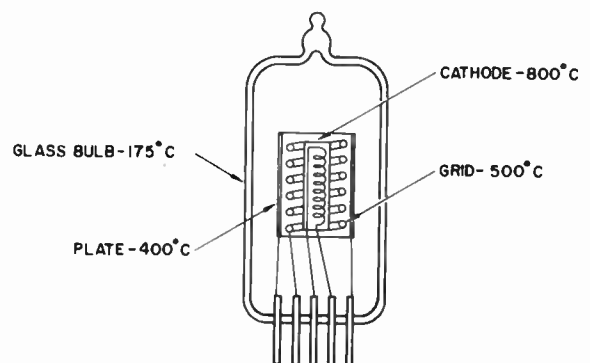

TYPICAL MINIATURE TUBE TEMPERATURES

Figure 6.

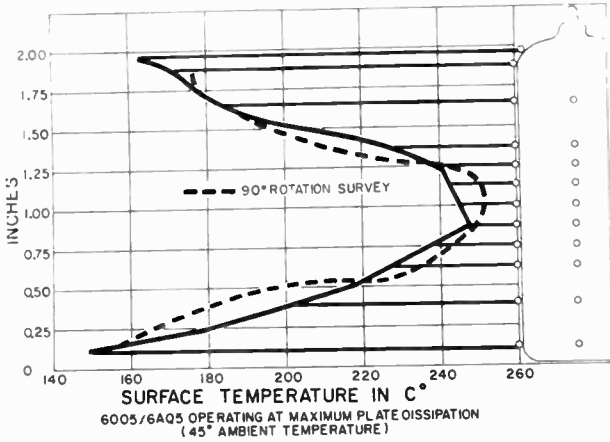

Figure 7.

And the smaller equipment is asked to perform more functions than the old.

Each change has meant more heat generated with less space in which it could be dissipated. The smaller tubes often generate as much heat, individually, as their older counterparts; yet they are crowded into ever smaller spaces, bundled together, causing an ever increasing environmental temperature in which they must operate.

The degree of temperature increases referred to are reflected in tests conducted by the U.S. Navy Electronics Laboratory. These tests show that the internal temperature rise in such conventional equipment as radar, communication and navigation, etc., amounts to 30 to 40°C. This must be added to the required external environment of 50 to 85°C for military equipment and means that internal environmental temperatures run at about 100°C for many of these equipments.† Curves, to be illustrated later, show that some tubes exceed their maximum bulb temperature ratings when operated in an ambient temperature of only 25°C.

These discrepancies in ratings versus actual operating conditions bring to light a serious aspect of the total problem — the lack of adequate temperature-life information on tubes. This data should be available to design engineers. Yet, neither specifications, nor manufacturers' data sheets, list pertinent temperature data on tubes.

For some tubes, a maximum allowable bulb temperature is listed by the manufacturer. But this, frankly, is a poor guide when reliability is at stake. Usually it represents a maximum temperature at which the tube will pass certain specification tests. But if this same temperature is prolonged — as in actual operation — it may well induce rapid failure. It will be shown later that the temperatures listed in many specifications are not

† — See Ref. 19

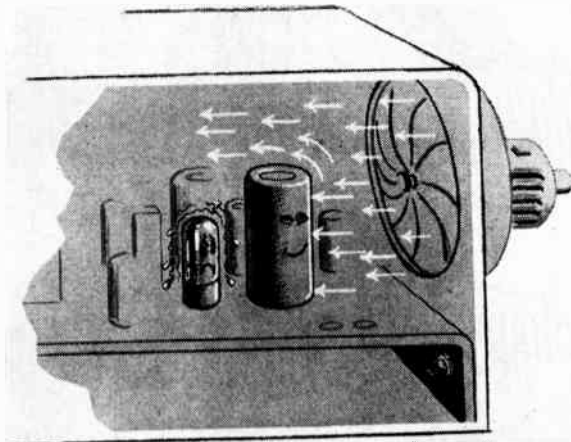
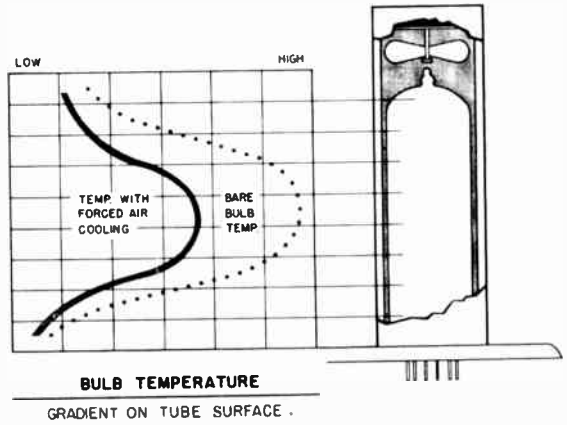

Fig. 9. Inefficient Forced Air Cooling.



TUBE SURFACE TEMPERATURE GRADIENT WITH FORCED AIR COOLING

Figure 8.

only vague and misleading, but actually promote the misapplication of many tubes.

Another negative factor that has evolved with increased use of electronic equipment is the widespread use of what is referred to in the United States as a JAN-type shield. (Figure 2) This shield, developed a number of years ago to afford electrostatic shielding and retention for miniature tubes, is probably responsible for more tube failures than any other single cause.

Figure 3 shows that bulb temperatures, when the JAN shield is applied, range more than 100°C higher than bare bulb temperatures operating in the same environment. The solid wall of the JAN shield, the captive air between tube and shield and the shiny, heat-reflective finish, mean that JAN shields increase the temperature of all tubes with which they are used — without exception.

To summarize the scope of our problem, we are dealing with more heat than ever before, in smaller spaces, in vastly increased numbers of equipment, and in infinitely more critical applications. Compounding these factors,



Figure 10.

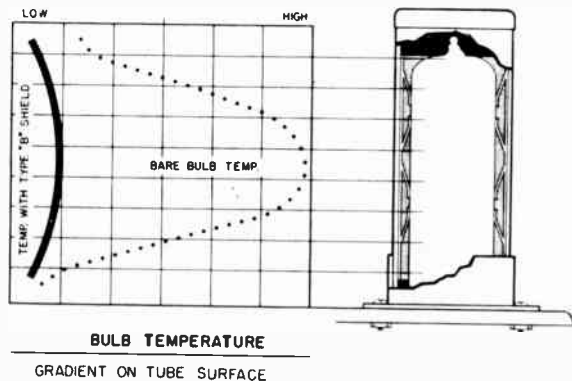

Fig. 11. Tube Surface Temperature Gradient With Heat-Dissipating Shield Cooling.

we have a lack of temperature-versus-life data on specific tubes and a general usage of a type of electrostatic shield which raises tube bulb temperatures from 20 to 35 per cent above normal.

Studies Leading Toward Solution

There has been general agreement for some years that high operating temperatures cause tube failure. It is more recent that high temperature has been identified as the main cause. And, unfortunately, there has been very little precise test data to indicate the relationship of tube life to bulb temperature.

In 1954, the U.S. Army Signal Corps Laboratory gave a contract to the General Electric Company at Owensboro, Kentucky for a life data on electron tubes.^h One factor tested was the influence of bulb temperatures. Five types of miniature tubes were selected and lots of 200 tubes of each type were tested. The lots consisted of tubes from several different manufacturers. Each lot of tubes was operated at a selected bulb temperature for a period of 5000 hours. The per cent surviving at various time intervals within this period was plotted in relation to the operating temperatures.

Figure 4 shows the failure rates of Type 6005 tubes at five pre-selected constant operating temperatures. Note that while 97 per cent of the tubes tested at 220°C were still operating at the end of the 5000 hour period, an increase of just 17°C — to 237°C — produces a failure rate of 32 per cent in the first 2000 hours. Also note that on the lot operated at 316°C, 98 per cent failed in the first 2000 hours. Yet 316°C is lower than the temperature at which the same tube operates in a JAN shield at room ambient.

Figure 5 shows similar data on the 6AK5 tube. Here again the pattern is the same — failure rates always increase as bulb temperatures rise. Other curves from the General Electric Report show the same pattern, although space does not permit showing them.

One of the other tubes covered by the report was a Type 5670 which operates at a low dissipation of less than one watt. This tube showed a definite failure increase after 3000 hours even when operated at the low temperature of 115°C. Specification and tube data sheets list 165°C as the maximum allowable bulb temperature for this tube. This fact casts light on a related problem of misapplication in equipments which contain many tubes. When the tubes are of different types, although some may withstand reasonably high temperatures, others operating nearby may suffer sharply curtailed life. It will be shown later that the most practical approach to the solution of this problem is the use of the most efficient heat-reducing device on all the tubes, regardless of their individual temperature limitations.

Further studies have been under way in recent years to determine the effect of temperature on the materials and characteristics of electron tubes. Cornell University Engineering Laboratoriesⁱ, Sylvania Electric Company^j,

^h — See Ref. 9

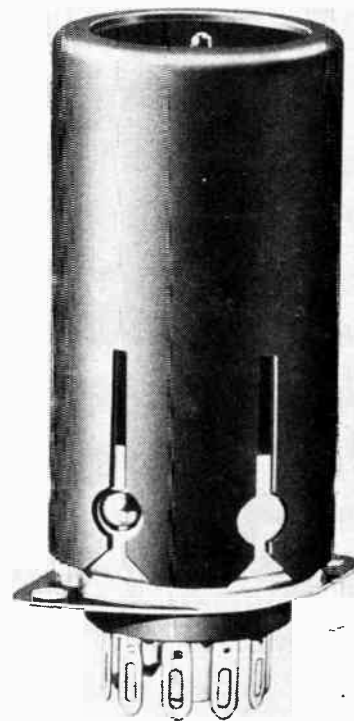

Figure 12.

and Aeronautical Radio, Inc.^k, all under military contract, were prominent in these investigations. A summary of their findings follows:

Deterioration of tube performance characteristics as the result of elevated temperatures is principally caused by evolution of gas within the tube. Other deterioration causes induced by high temperature, in order of importance, are: getter migration, grid emission, glass failure, inter-electrode leakage, contamination, grid loading, and loss of emission.

The gas evolution is from the inner surface of the glass and the surfaces of the plate and other tube elements. Its occurrence varies directly with temperature increase. The gas "poisons" the tube and causes a gradual lowering of its transconductance — to the point of ultimate failure.

High temperatures are necessary on the filament and cathode elements of the tube as shown in Figure 6. There is no necessity for heat to be present on the other elements. In many tubes the filament dissipation is only a small part of the total dissipation of the tube. A 6AQ5 tube, for example, has a plate dissipation of about 12 watts, but only 3 watts of filament dissipation. It is the combination of the heat generated on the plate of the tube — and the ambient temperature — which causes the tube glass and other elements in the tube to operate at excessive temperatures. The type of glass used in most miniature tubes is such that it absorbs most of the heat radiated by the plate. A high percentage of the tube heat is concentrated on a very small area of the glass, as shown in Figure 7.

This "hot spot" appears opposite the center of the plate.^l As the ambient temperature increases, bulb and plate temperatures are increased in turn, as well as the temperatures of other tube elements. This great difference in temperature between the relatively cool ends of the tube and the hot spot at its center is the main cause of glass failure.

ⁱ — See Ref. 10 and 20

^j — See Ref. 21

^k — See Ref. 8

^l — See Ref. 18

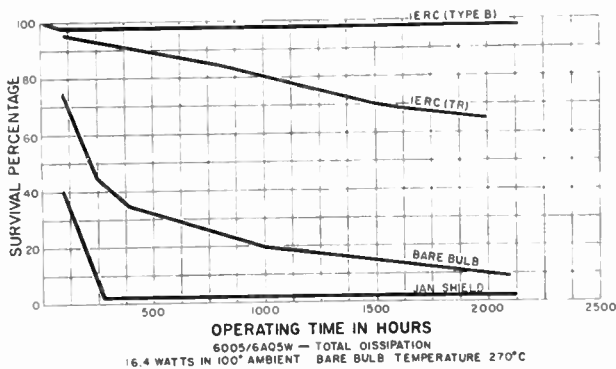

Figure 13.

Most past attempts to cure the heat problem have involved forced air convection. As shown in Figure 8, forced air cooling lowers the ambient environment of the tube — providing a partial solution — but does little to relieve the temperature gradient present on the tube surface. Also, because of mechanical difficulties in directing air flows, tubes are often found in air pockets (Figure 9) so they receive little cooling effect.

What About Transistors?

Some, who have given up any hope of solving the tube heat failure problem are patiently waiting for a day when transistors and magnetic amplifiers may replace all tubes. There is little doubt that eventual development and production of such components will solve many of our present problems. But transistors have heat problems of their own; they appear to need many additional years of development and production experience before they can hope to replace tubes in their hundreds of millions of present applications. Since we must live with tubes for years to come, then we must live with the problem of dissipating the heat. An effective solution to the heat problem has actually been available for the past five years — though it has not been widely known.

Solution: The Heat-Dissipating Tube Shield

About five years ago, International Electronic Research Corporation (IERC) developed an effective heat-dissipating tube shield. (Figure 10)

This tube shield dissipates the heat by radiation, convection and conduction. It grasps the hot tube bulb and distributes the heat from the hot spot over a large surface area. This way, it not only reduces the general temperatures present on the tube glass, but also greatly reduces the temperature gradient along the surface of the tube. (Figure 11)

As shown in Figure 3, the temperature reduction when using an IERC Type B shield on a typical 6005 tube amounts to from 40 to 50°C below the bare bulb operating temperatures and from 125 to 150°C below corresponding operating temperatures encountered with the use of the old JAN shield.

It should be remembered that the JAN shield came into wide use before the heat failure problem of electron tubes was generally recognized. But it must be observed that if one were purposely to design a poor thermal device for a tube shield — a literal "killer shield" — he could do no better than the JAN shield as it was originally designed and is still used. As earlier mentioned, the JAN shield assures a captive air space between tube and shield; its shiny surface reflects heat back into the tube. In addition, there is almost no thermal contact from the shield to base, or from the base to the chassis.

Design of the IERC heat-dissipating shields began from the base up — in recognition of all the deficiencies in the JAN type shields. In the Military Type B shield (Figure 10), for example, the base has a wide flange for effective thermal contact with the chassis. The shield, in turn, has a tight thermal fit to the base. The tube is grasped firmly along its entire surface with the beryllium copper spring

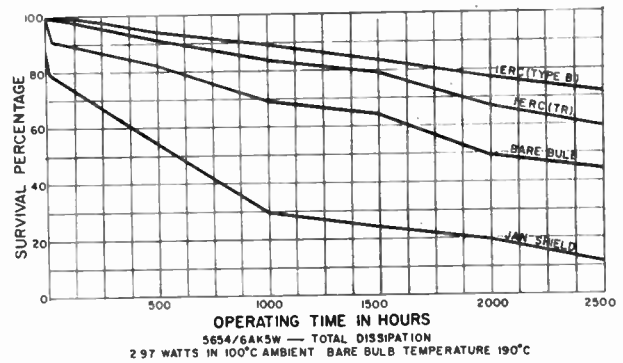

Figure 14.

fingers. To date, this type of shield has proved to be the most effective vertical mount type shield — both in its heat dissipation characteristics and its retention of the tube in extreme shock and vibration environments."

About three years ago, need arose for a method of applying heat dissipating shields in equipments which had the old JAN bases mounted to their chassis. It did not appear practical to remove sockets from these thousands of equipments in order to apply the Military Type B base and shield.

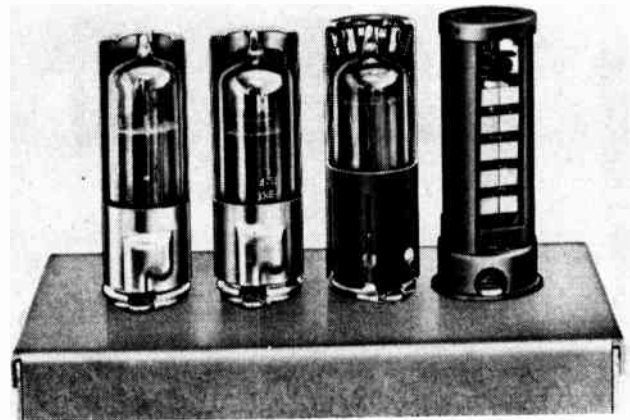

Figure 15.

Figure 12 shows the retrofit type shield which was developed by IERC to meet this problem. This shield, with its beryllium copper spring finger liner and its blackened shell, snaps onto the old JAN type base. Although it is a little less effective than the Type B shield — primarily because of lack of thermal contact between the JAN base and the chassis — its performance characteristics as shown in Figure 3 indicate that it does reduce temperature of the tube bulb well below bare bulb temperature — and more than 100°C below JAN shield temperatures.

While it has been shown that high temperature shortens tube life hazardously — and that the heat dissipating tube shields as described effectively lower tube temperatures — correlation of these facts is needed to prove that heat dissipating tube shields prolong tube life and increase equipment reliability to a high degree.

Figure 13 compares the failure rates of 6005 type tubes when different types of shields are used. This information is derived from the data shown in Figure 3 (Tube temperatures vs. tube shields) and the information contained in the curves in Figure 4 (Tube life vs. tube temperatures).

Figure 14 shows this same correlation for a 6AK5W type tube. The extended life and resulting increase in reliability is clearly indicated.

There have been other attempts to solve the problem of heat dissipation.

" — See Ref. 22 and 23

Figure 15 permits some comparisons. At the left is a cut-away of a JAN shield. Next to it is a JAN Shield cut-away showing a corrugated brass insert liner. This corrugated liner represents a different attempt to relieve the tube temperature problems caused by the JAN shield — the liner being intended to conduct heat from the glass to the shield. Although some laboratory tests indicated this liner was an effective device, quantity use in field service showed it to be of doubtful value. Variations in diameter of the glass bulb in tubes of like identification caused the trouble. Diameters of seven pin miniature tubes were found to vary from .700" to .730" and variations were from .800" to .840" in nine pin tubes. For the liner to be effective it must contact the tube bulb

o — See Ref. 18

surface — and hence must conform to the diameter variations. But the brass corrugated type liner — because of its configuration — cannot act as a spring.

Two deficiencies have resulted: when placed over tubes of larger diameter, either the tube breaks or the liner is permanently deformed; when a deformed liner is placed over a tube of smaller diameter — a frequent occurrence in field use when tubes are replaced and shields are re-used — the heat conductance from tube to shield is no longer effective. Of interest is the fact that the U.S. Navy Department, which originally promoted use of this brass corrugated liner, no longer recommends its use. It has become obvious that tube shields for heat dissipation must have liners with spring properties.

Part II of this article will appear in the August issue of ELECTRONICS AND COMMUNICATIONS.

— REFERENCES —

- Given F. J. "Reliability in Electronic Equipment", Guided Missile Committee of AIA, White Sands Proving Ground, April 20, 1954.
- "Progress Report on Reliability of Electronic Equipment" Volume 1 & 2, Research and Development Board, Department of Defense, EL/217, February 1952.
- "Parts Failure Analysis", Vitro Corporation of America, Silver Springs, Md., Report No. 25, November 1, 1951.
- Carbart R. R. "Survey of Current Status of Electronic Reliability Program", Report No. RM-1131, The Rand Corporation, Santa Monica, California, August 14, 1953.
- NEL Reliability Design Handbook, Section 1.1, "Reliability Surveys", May 1, 1955, U.S. Navy Electronics Laboratory, San Diego, California.
- "Reliability Factors for Ground Electronic Equipment" McGraw-Hill Book Co., for Rome Air Development Center, Griffiss Air Force Base, New York.
- NEL Reliability Design Handbook, Section 1, Page 11, "Electronic Equipment Failure During Evaluation Test", R. J. Steelman, August 1, 1955.
- Aeronautical Radio, Inc., General Report No. 1, "Investigation of Electron Tube Reliability in Military Applications" Washington, D.C., January 4, 1954.
- Bowie W. S. "Study of Electron Tube Life", General Electric Co., Owensboro, Kentucky. Contract DA-36-039-SC-42524.
- Cornell University, "Signal Corps Tube Analysis Program" Technical Report No. 22, Cornell School of Electrical Engineering, Ithaca, New York, May 1, 1955.
- Acheson, Marcus A. and Eleanor M. McElwee, "Concerning the Reliability of Electron Tubes", Proceedings of the IRE, Volume 40, No. 10, October 1952.
- "Electron Tube Temperature Problem in Relation to Design for Reliability", Vitro Corporation of America, Silver Springs, Md., Report No. 51, November 30, 1953 (Contract DA-36-034-ORD-k426).
- The Background of "Reliability", T. A. Smith, IRE Transactions on Reliability and Quality Control, September 1956.
- NEL Reliability Design Handbook, "Introduction" by R. J. Steelman, March 4, 1954.
- "Heat Dissipation in Electron Tubes", W. D. Campbell, Proceedings of the RETMA Symposium on Applied Reliability, University of Southern California, December 19-20, 1956.
- Aeronautical Radio, Inc., Report No. DCA 56-1161 "The Cooling Effects of a Special Tube Shield", Field Engineering Report, Army Radio Station "WAR", October 25, 1956.
- "Techniques for Reliability Measurements and Predictions, based on Field Failure Data", Vitro Laboratories, Silver Springs, Md., Report No. 80, October 10, 1955. (Contract NOBSR 63389).
- D. R. Walin, "Vacuum Tube Envelope Temperature Measurements" NEL Report No. 594, March 30, 1955, U.S. Navy Electronics Laboratory, San Diego, California.
- NEL Reliability Design Handbook, Section 201.1, "Electron Tube Engineering Data Sheets", W. B. Wells, and Section 505.1.
- "Design Manual of Natural Methods of Cooling Electronic Equipment", James P. Welsh, Cornell Aeronautical Laboratory, Buffalo, N.Y., Report No. HF-845-D-8, November 1, 1956. (Contract NOBSR-63043).
- "High Temperature and Altitude Life Evaluation and Pulse Ratings of Subminiature Vacuum Tubes", Final Engineering Report, Contract AF33(038)9853, Sylvania Electric Products Inc., Emporium, Pa.
- Qualification Tests of Heat Dissipating Electron Tube Shields, Test Report No. 131, January 1956, United ElectroDynamics, Division of United Geophysical Corp., Pasadena, California.
- "Evaluation Tests of Heat Dissipating Electron Tube Shields of Various Designs" Test Report No. E-472, March 1957, United ElectroDynamics, Division of United Geophysical Corporation, Pasadena, California.
- Military Specifications, Electron Tubes, MIL-E-1.
- "Evaluation Testing of TR Tube Shield and JAN Bright Tube Shield" Test Report No. E-154, May 1956, United ElectroDynamics Division of United Geophysical Corp., Pasadena, California.
- Specification "Heat Dissipating Electron Tube Shields" MIL-S-9372(USAF).
- "Development and Application of a Thermal Diode Thermatron for use in Studying Methods of Cooling Electron Tubes", James P. Welsh, Report No. HF-1053-D-3, May 1957, Cornell Aeronautical Laboratory, Buffalo, New York. (Contract NOBSR 72531).
- "Evaluation of Shields for Cooling Miniature Electron Tube Types", Max Bialer, W.A.D.C. Technical Report 53-174, Wright Air Development Center, Wright-Patterson Air Force Base, Ohio.
- Interim test report on Evaluation Tests of Electron Tube Shields, May 10, 1956, United ElectroDynamics Division of United Geophysical Corp., Pasadena, California.
- EIA Conference on Electronic Equipment Maintainability, University of Southern California, December 18, 19, 1957. Paper delivered by Mr. C. I. Cummings of Jet Propulsion Laboratory, California Institute of Technology.
- R. D. Mills W. W. Wright "The Rating of Thermionic Valves for use under Abnormal Ambient Conditions" British Journal of Electronics, November 1955.
- "Qualification Tests of Heat Dissipating Tube Shields" Report No. E-169, November 1956, United ElectroDynamics Division of United Geophysical Corporation, Pasadena, California.

Angular Acceleration And Rate Generator

A FLOOR model angular acceleration and rate generator for running tests on accelerometers and rate gyros is of particular interest to aircraft and missile engineers. Frequency and acceleration characteristics of the rate generator are infinitely adjustable within the range of the unit by sliding weights inward or outward on a suspension arm, by using heavier or lighter weights, or by varying the winding of the torsion bar that powers the generator. To achieve widely different ranges, the torsion bar itself may be changed. This is a simple operation, since the torsion bar is held at each end by a Jacobs chuck. As a result of these adjustability features, a range from 0.5 to 200 radians per second² is obtained.

Motion of the accelerometer or rate gyro on test is transmitted to a built-in 358° potentiometer of 9000 ohms

resistance. The sine wave output of the potentiometer may be fed to a recording instrument. An adjustable protractor right under the mounting table aids in winding the torsion bar the right amount and in checking the rotation in each direction.

After the torsion bar is wound, a solenoid latch holds the mounting table motionless until the operator is ready to begin the test by flipping a switch. The angular acceleration and rate generator has a solid steel tubular frame and a ball-bearing mounted spindle. Four leveling screws are provided in the base. Several torsion bars and assorted weights are provided with the equipment.

Aircraft and missile engineers will find this equipment invaluable for testing angular accelerometers and for evaluating rate gyros.

The Canadian Astronautical Society Project Charm

By A. E. Maine*

The name "CHARM" derives from the initial letters of the words "Canadian High Altitude Research Missile" and designates a project sponsored and undertaken entirely by The Canadian Astronautical Society. The keynotes of the project are economy and improvisation since the whole program is operated on a limited budget. These restrictions however in no way interfere with the safety and performance aspects of the rocket system as outlined in this article.

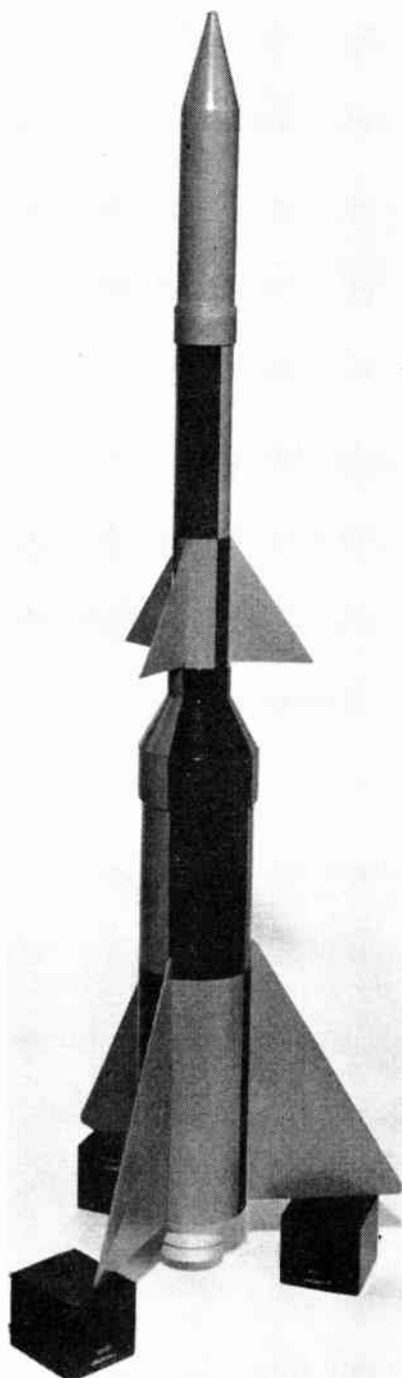

Fig. 1. Model of High Altitude 2-Stage Rocket.

In the latter part of 1957 it was decided by the newly formed Canadian Astronautical Society to embark on experimental as well as purely theoretical research programs. After much discussion concerning costs and effort it was considered that the design and construction of a small instrumented high altitude research rocket would be within the capability of the Society and at the same time provide challenging problems for practically any member who cared to participate in the work. Commencement of the work was, however, conditional upon being able to obtain raw materials and certain used, but still functional electronic components. In this connection the De Havilland Aircraft of Canada, Limited, generously made available, wherever it could, the required items at small cost. Other companies made available such services as welding and cutting during "after-work" hours. These facilities, together with the considerable effort produced by members on a voluntary basis, have resulted so far in the design and manufacture of a substantial part of the apparatus required. Even though the pay-load is only 1½ lb. it is quite out of the question, for safety and legal reasons, to fire the rocket from other than a properly set up military range, so realization of the final goal hinges upon such a facility being provided by the authorities.

The scientific value of the actual measurements it is proposed to make is relatively negligible, but the practical value to those participating in the project in terms of learning, tackling and overcoming problems and gaining

*Guided Missile Division, The De Havilland Aircraft of Canada, Downsview, Ontario. Secretary, The Canadian Astronautical Society.

direct experience in the remote fringes of the approaching space age is considered to be extremely high. It is generally unwise to speculate too much upon future events, but in a broad way it is expected that successors to the first minimal rocket built by the Society will be relatively more sophisticated and will be capable of yielding scientific data of small, but nonetheless real, value.

The final goals are fairly straightforward; it is intended to telemeter final stage acceleration continuously until burn-out and thereafter atmospheric temperature and pressure, and acceleration until impact. Rocket roll rate will also be estimated from shortly after launch until the trajectory peak is reached. The pay-load is expected to reach an altitude of 120,000 ft. and attempts will be made to recover it.

As with any project of this magnitude the first few months were spent in carrying out a general feasibility study during the course of which various fuels were considered and discarded and the rocket vehicle took on various sizes and forms. Towards the end of the study phase, the type of solid fuel was chosen and the vehicle design solidified, with the exception of the fin calculations which are still proceeding. Initially, drag-free performance and trajectories were computed, but the drag integrations have since been carried out using a simplified method and the required performance appears to be met by the proposed rocket design. Organization of the project has been facilitated because various aspects have been worked on simultaneously by the Society's Specialist Sections which include Analysis, Propulsion, Electronic, Mechanical and Recovery Groups.

The Rocket

Fig. 1 is a photograph of a solid wooden model of the two stage rocket and in the following paragraphs notes are given concerning its general design basis.

A single stage rocket design to achieve the required altitude would be of much greater weight, size and cost than a multi-stage configuration. Increased complexity, however, together with the high altitude fuze type stage ignition, limits the economical number of stages in this application to two. Also, firing convenience dictates an "all weather" rocket that will not be too finicky if a stiff breeze is blowing during launch. This means that it is advisable to have a very high thrust-weight ratio initially in order to minimize the effect of horizontal components of the weight vector, and windage. This feature is also very necessary from the aspects of adequate fin stabilization during the initial part of the flight. However, it is undesirable for the speed to approach too high a value at the lower altitudes due to the severe fin and body loads

that would result. For these reasons it was decided to use a high thrust, short burning time first stage in combination with a long burning time second stage.

In the interests of economy, energy and availability, it was decided to utilize a perchlorate-hydrocarbon type of fuel, which has a reasonably competitive specific impulse of 180 secs. The same fuel is for both stages, the first employing a radially-outward burning charge, and the second, an axially, or "cigarette burning" type. It follows that the first stage case may be considered as working "cold", the fuel having almost completely burned away by the time the flame reaches the walls; while the second stage may be thought of as being "hot" in operation. The case design is therefore quite different for each, the first stage case being made from synthetic resin bonded fiberglass and the second stage, from thin SAE 4130 steel.

At the front end of the second stage is the payload and recovery package which will coast after burn-out with the second stage to maximum altitude. Separation of the pay-load from the second stage is arranged to occur during the descent when "spoilers" are extended. As the impact point is approached, a parachute is opened, thus further slowing the falling payload.

Some basic design factors of the rocket are set out below:

All-up Weight	70 lb.
1st Stage Diameter	6.3"
2nd Stage Diameter	3.125"
Length of 1st Stage	34"
Length of 2nd Stage	23"
Length of Payload	15"
Total Assembled Length	71"
1st Stage Thrust	3,600 lb.
2nd Stage Thrust	110 lb.
1st Stage Burning Time	2.2 secs.
2nd Stage Burning Time	22.0 secs.

The Rocket Pay-Load

The outer skin of the pay-load is made from synthetic resin bonded fiberglass and the dry batteries and antenna are carried in the pointed nose section. Near the other end are the transmitter and the encoder-modulator units. The central space is used for the signal transducers, and the recovery apparatus is carried in the last 3" length of the cylindrical section. Immediately below the battery compartment an etched circuit jack socket of special design is located and this enables the internal electronic circuits to be supplied with power from an outside source during test and setting up operations.

The Transmitter

The transmitter is designed for operation in the region of 220 Mc/s but is capable of being tuned 30 Mc/s above and below this value. Two different circuit arrangements were made up experimentally; the first was of the tuned line type employing a single 3A5 miniature triode and the second a T.P.T.G. push-pull oscillator using a type 6112 subminiature double triode. With both circuits, frequency stability which is vitally important in telemeter-

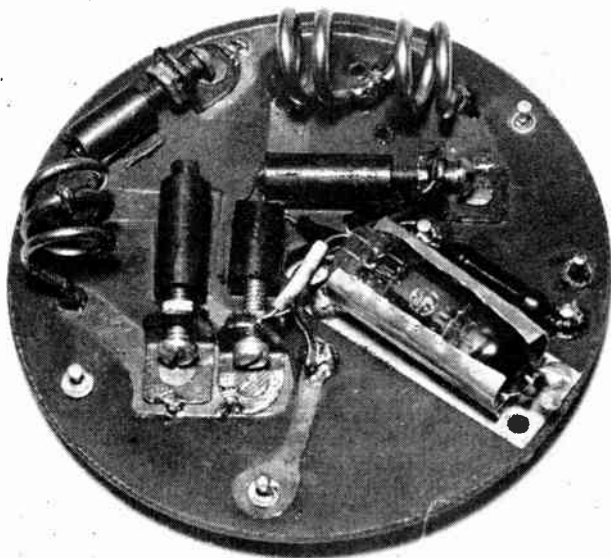

Fig. 2 (a). Photograph of Rocket Transmitter.

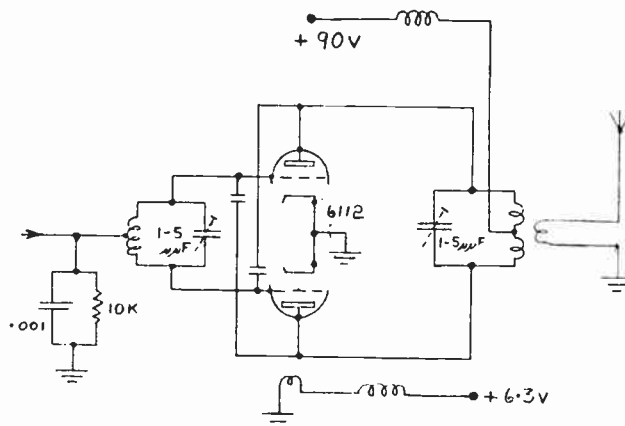

Fig. 2 (b). Diagram of Transmitter.

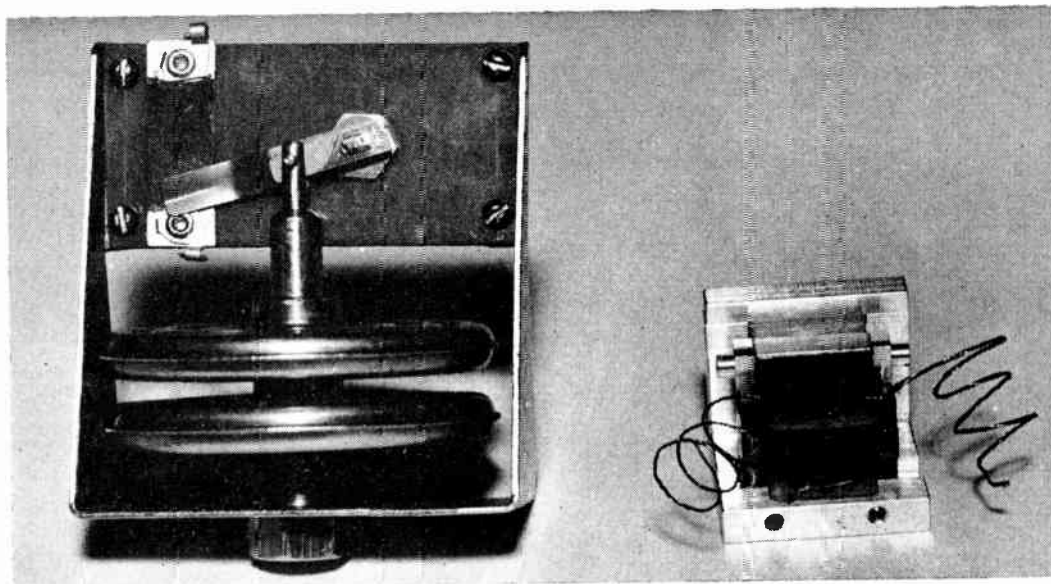

Fig. 3. Accelerometer and Pressure Transducer.

ing work, is largely the result of the mechanical stability of the frequency determining elements, and these were made from thick copper bars or tubes and firmly mounted on plastic boards. An assessment showed the second type of oscillator to be the best choice in that it could be engineered into a smaller space, the electrical performance of the two being otherwise quite similar. Fig. 2a is a photograph of the T.P.T.G. oscillator and Fig. 2b shows the circuit arrangement, which, of course, is perfectly standard. The complete transmitter is only 2 $\frac{3}{4}$ " diameter and weighs less than 2 ounces. The circuit connections were made using copper clad bakelite and these were etched out by means of a commercial "printed wiring" kit. The coupling and tuning capacitors were fabricated using short copper tubes with internal insulating sleeves into which short steel rods could be screwed. The scheme provides very fine adjustment and the tuning elements are easily clamped by means of lock-nuts. The antenna is loosely coupled to the plate coils and an R.F. output

power approaching $\frac{1}{4}$ watt is obtainable into a dummy load.

The choice of the type of modulator to be used is determined firstly by the rigid requirements of frequency stability and secondly by the physical size and power consumption of the modulating means. Experiments with transistors showed that pulse grid modulation was satisfactory in that there was negligible F.M. present and the modulator size is minimized.

The antenna takes the form of a partly folded capacity loaded dipole made from two thin copper strips which follow the internal contours of the nose section. Polar diagram plotting of the antenna pattern is about to be started and modifications to the design described may be expected.

The Signal Transducers

(a) **Pressure Transducer:** The basic arrangement of the pressure transducer is shown by the photograph, Fig. 3, and takes the form of a pair of aneroid bellows sealed with

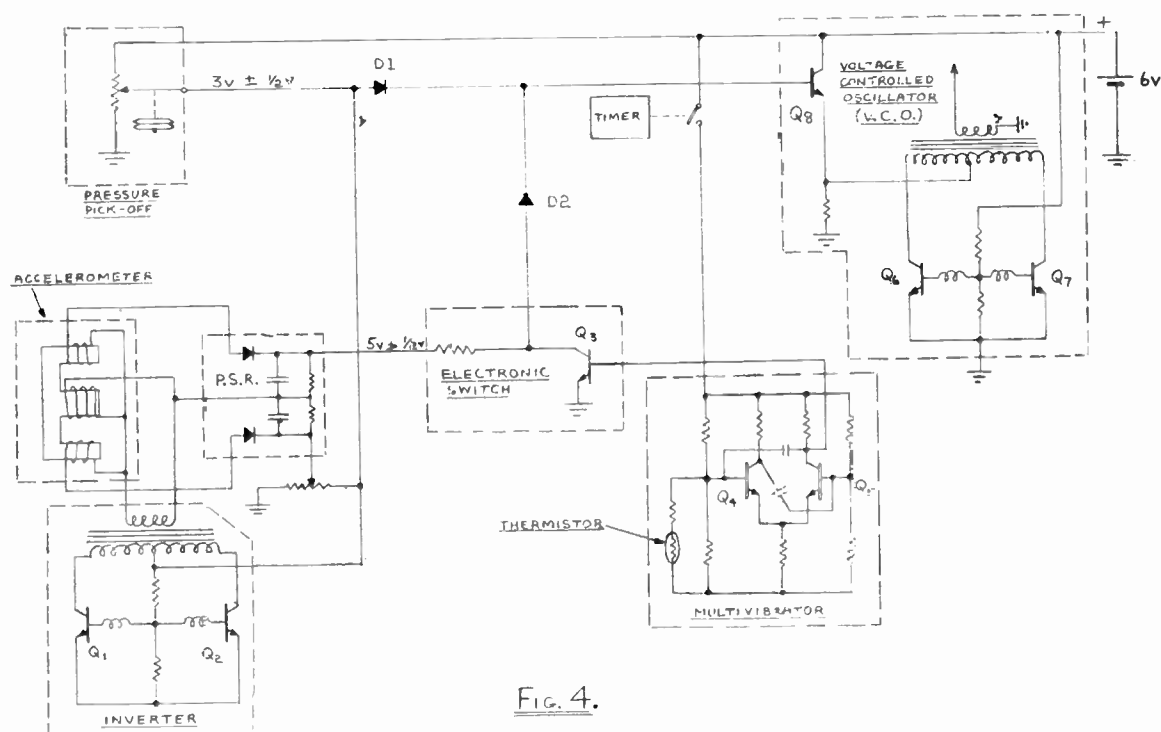

FIG. 4.

Fig. 4. Circuit Diagram of Signal Encoder.

a reference pressure. One end of the bellows assembly is secured to the mounting frame and the other end operates the slider of a potentiometer through a simple linkage. The action is quite straightforward, the bellows contracting or expanding axially according to whether the ambient pressure is above or below the reference pressure. Accuracy of the transducer will be poor at high vehicle velocities for aerodynamic reasons; near the zenith, however, reasonable results should be obtained. The transducer is mounted with its line of action at right-angles to the thrust line and is provided with an additional mechanism for pay-load recovery purposes as described under "Recovery Section".

(b) **Temperature Transducer:** The temperature transducer takes the form of a thermistor bead mounted on a small copper disc and embedded into the fiberglass nose cone, flush with the surface. Thermal time constants are kept to the minimum in order that rapid changes of air temperature with altitude may be recorded. Errors are likely during second stage boost due to local skin friction effects, but in the free coast to maximum altitude such errors should not be serious.

(c) **Accelerometer:** The accelerometer is capable of recording accelerations of plus minus 100g and is an AC operated type of transducer. It takes the form of a small "I" bar of soft iron mounted on compliant supports and closing the magnetic circuit of a laminated iron yoke of "E" planform. A small air gap exists between the two parts. A coil is wound upon each leg of the "E" core and the two outer coils are joined in series and routed to a phase sensitive rectifier (PSR). The central leg is excited from an AC source, and in the absence of any force on the I-bar, the PSR delivers zero output. When the I-bar is moved by "g" forces, the areas of pole coverage at each outer leg become unbalanced in a differential manner and a signal is passed on to the PSR which yields a DC output voltage proportional to the magnitude of I-bar movement and of a polarity determined by the direction of the applied force. Since rapid changes of acceleration may be expected during and after the boost ignition phases it is necessary to achieve a high natural frequency in the basic design of accelerometer so that any transients may be faithfully recorded. This has been achieved by using short stiff springs for the I-bar mounts and reducing the mass of the latter to the minimum. Control of the damping factor to about 0.5 is secured by enclosing the entire unit in a case and filling this with oil. The unit presently being constructed, and illustrated in Fig. 3, part built, is slightly over one inch long and weighs 2 ounces.

The Signal Encoder

The type of telemetering employed is the time multiplexed F.M.A.M. system and this was chosen largely on account of its good S/N ratio and relative simplicity. Fig. 4 shows the circuit used, and basically this consists of an electronic switch controlled by a multivibrator which connects the pressure transducer and accelerometer signals in turn, repetitively to a voltage controlled oscillator (VCO). This circuit delivers a train of square waves at a frequency strictly proportional to the applied control voltage, and this is passed on to the transmitter through a buffer or modulator stage. The temperature intelligence is superimposed upon the other two signals by means of connecting the thermistor into one base circuit of the multivibrator. Changes of thermistor resistance unbalance the multivibrator "on" and "off" times resulting in a form of P.W.M. At the receiving station and after demodulation, the frequency during an "on" period gives the magnitude of the first signal, the frequency in an "off" period represents the second signal, and the ratio of the time durations of the two signals yields the third signal.

Turning to the circuit diagram, a conventional magnetic multivibrator is used to supply excitation to the accelerometer primary coil, and a half wave P.S.R. with short time constant smoothing networks passes the DC signal through a resistance to the collector of the switching transistor. When the transistor is turned on, the

accelerometer signal is grounded and the pressure signal is applied to the V.C.O. through an isolating rectifier D1. When the electronic switch is off the P.S.R. bias voltage blocks D1 and the signal passes on through diode D2 to the V.C.O. During the greater part of the vehicle ascent only the acceleration signal is of interest, consequently the electronic switch is held off by means of a clock-work time delay which mutes the multivibrator. The V.C.O. comprises a second magnetic multivibrator whose DC feed voltage is determined by a control transistor (Q8) and hence the frequency is made to follow the control signal applied to this stage. Experimental work has shown the encoder to be effective and stable and economic in components; entirely transistorized it is presently being engineered into its final form.

Recovery Section

An attachment to the pressure transducer takes the form of a pivoted bar which is operated by the aneroid bellows. At a pressure equivalent to about 20,000 ft. altitude, the bar rides over a ratchet and thereafter moves freely. When the atmospheric pressure rises, as the pay-load returns to earth, the bar contacts the ratchet from the opposite direction and forces it back a short distance to close a switch. This action completes a circuit to a small explosive charge which separates the pay-load from the second stage and releases spoilers. A second small charge ignited from a delay fuze later throws out a small nylon parachute or ribbon drogue arrester. A part of the experimental recovery system is shown in Fig. 5 attached to a dummy pay-load. The parachute is dyed "distress orange" for easy observation and the separation charge is interlocked through a 50g acceleration sensitive switch provided with a dash-pot action.

The Launcher

The launcher which also serves as a transporter for the rocket is erected such that the lower end of the launcher rails extends well below the level of the trailer and several feet of rail length are accommodated below ground level in a suitably dug hole. This provides an



Fig. 5. Dummy Payload with Parachute.

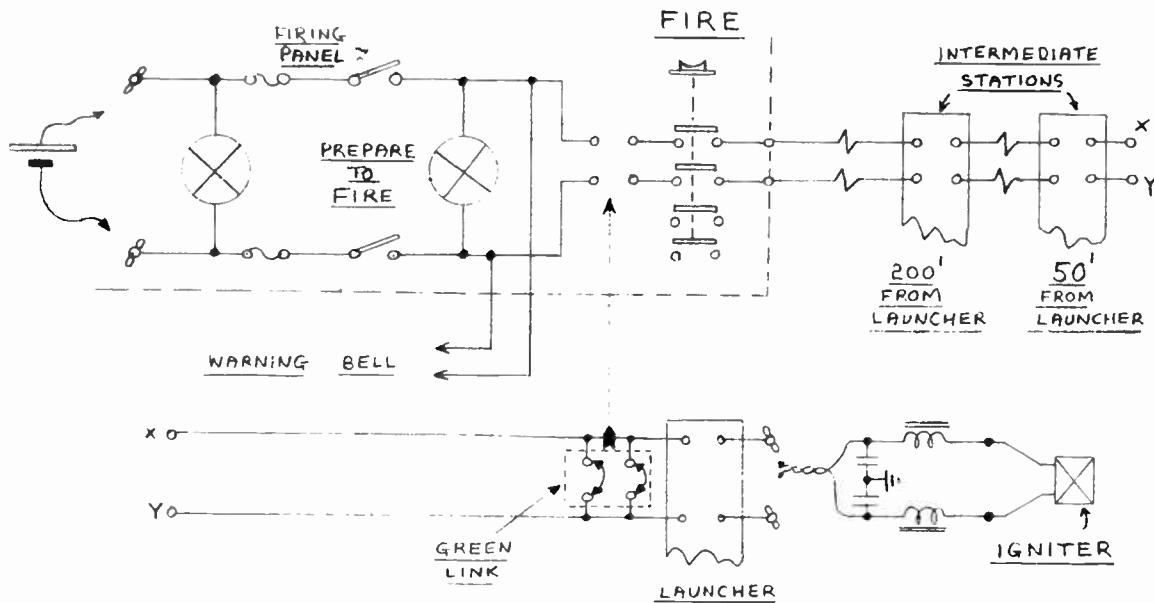

Fig. 6. Main Firing Circuits.

additional safety measure in view of the energetic nature of the first stage. The framework is made almost entirely out of light alloy angle and "U" section strips and the four rail sections can be readily handled and assembled by a few men. Jacks and stakes picket the launcher firmly to the ground before use.

Main Firing Circuits

The design of the main firing circuits is dominated by the insistent demands of absolute safety and with this factor prominently in mind the circuit arrangement given in Fig. 6 was devised. In order to describe its operation it is useful to consider the main firing sequence leading to the final count down.

With the launching crew working on the rocket at the launcher, all safety links are removed except for the shorting link "A" which is colored bright green for easy observation. The links are carried on the person of the Range Officer, and the sockets at the launcher and intermediate stations are designed such that accidental bridging of the contacts is virtually impossible. At this time the firing battery is disconnected from the Firing Panel and the igniter leads of the rockets are shorted together and taped up. An L.C. filter is connected in each lead to the igniter such that induced voltages due to the adjacent radar and high power communications apparatus cannot circulate a firing current.

In preparing to fire, the Range Officer clears the launcher of all personnel and performs the deliberate action of untaping the boost leads and joining them with

wing nut terminals to the launcher connections box. He then removes the shorting plug "A" and inserts the link "B". After this he proceeds to the two intermediate stations en route to the Command Post and inserts links "C" and "D". Upon arriving at the Command Post range warning flags are raised and range scouts posted. The battery is next connected to the Firing Panel using wing nuts, and a monitor lamp lights. Main fuses are next inserted and the "Prepare to Fire" switch closed. This gives a second visual indication and arms the firing bell warning circuit. Assuming that all conditions are favorable for firing, the Range Officer inserts the green shorting plug (which he removed from the launcher) into the Firing Panel where it acts as a series link. He then presses the firing button thus completing the battery circuit to the rocket igniter.

To further increase overall safety only the four links exist, there being NO spares, all links are different sizes and brightly colored. Also the Firing Panel is a completely self-contained and enclosed unit and is not connected to any other electrical power source.

The complete system described, using the Firing Panel shown in Fig. 7 has been used successfully at the Society's first static rocket motor firing conducted some months ago.

Internal - External Supplies

The various electrical supplies required inside the rocket are provided by dry batteries, and in the interests of minimum weight, these are chosen such that they have a working life of only a little in excess of the expected launch to impact time. Prior to launch, telemetering setting up and calibration may run into several hours, consequently it is necessary to have an external power unit in use during this time.

This requirement is met by the External Electrical Power Supply Unit, the circuit diagram of which is shown in Figure 8. Essentially, this unit consists of a wooden box containing high capacity dry batteries, monitoring meters and switching facilities. The operation is intimately bound up with the special socket mounted in the pay-load, and this takes the form of a series of pairs of stiff spring contacts, which in the absence of a plug are electrically joined. The plug itself is a wafer of bakelite carrying etched copper conductive bars on the upper and lower surfaces, and the facilities provided by the external unit are determined by how these two sets of contacts are selected and used. For the purposes of explanation the different modes of operation are suggested by the diagrams

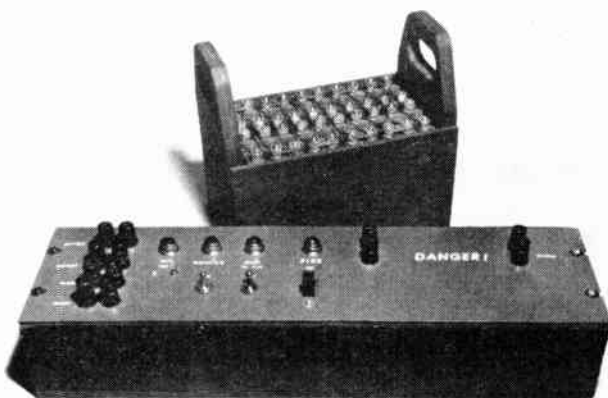

Fig. 7. Photograph of Firing Panel.

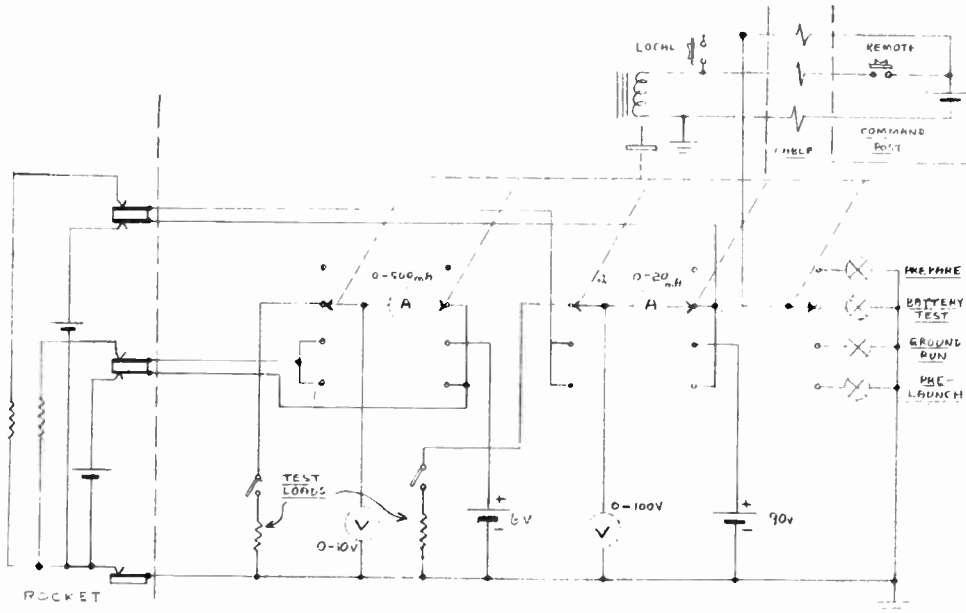

Fig. 8. Circuit of External Electrical Power Supply Unit.

of Figure 9 (a)-(d). In the first illustration, (a) the plug is effectively a wafer of bakelite, with no conductive bars at all and when inserted, isolates the rocket loads from the internal batteries, thus behaving like a switch. In (b), the conductive bars on the lower face of the plug are used, and this enables the rocket circuits to be energized from external supplies complete with voltage and current monitoring. When the upper plug bars only are used, the rocket batteries may be checked, on and off load, by external means as shown in (c). Figure 9(d) shows the use of both sets of conductive bars at once, and this connection allows the rocket batteries to supply the internal load with the voltages monitored externally. Finally the diagram (e) shows the flight condition, with no plug in position, and the rocket circuits thereby supplied from the internal batteries. Construction of the external unit is quite straightforward and is designed for handling over rough terrain. The function switching is accomplished by a magnetically operated rotary switch (Ledex) and this can be carried out by means of a control on the external unit itself, or remotely from the Command Post. The meters are mounted together at the top of the unit to permit easy viewing from a remote position by telescope.

Umbilical Plug Extraction

Mounted on the launcher near the payload station there is a small geared d.c. motor operating a windlass. The cord of this is attached to the rear of the double sided power supply plug. The outgoing leads are supported by means of two brackets, one fixed and the other capable of slight movement and coupled to a micro-switch. Just before launch, the motor is switched on by remote means and the umbilical plug is snatched out of engagement. The reeling in of the cord continues until a projection behind the plug engages the second bracket; the micro-switch then operates and turns off the windlass drive, thus preventing over running and consequent damage.

The Telemetry Receiving Station

In keeping with other aspects of the program, the telemetering station is kept as simple as possible and use is made of readily obtainable items wherever this can be done.

The Receiver

The receiver consists of a slightly modified TV tuner whose I.F. signal at 40 Mc/s is fed either to a high performance communications receiver or to a second

frequency changer followed by five stages of narrow-band I.F.'s tuned in the region of 1 Mc/s. In this application, extremely efficient A.G.C. circuits are required to prevent serious fading due to the rocket motion and changes in altitude, and loss of track from the ground station steerable

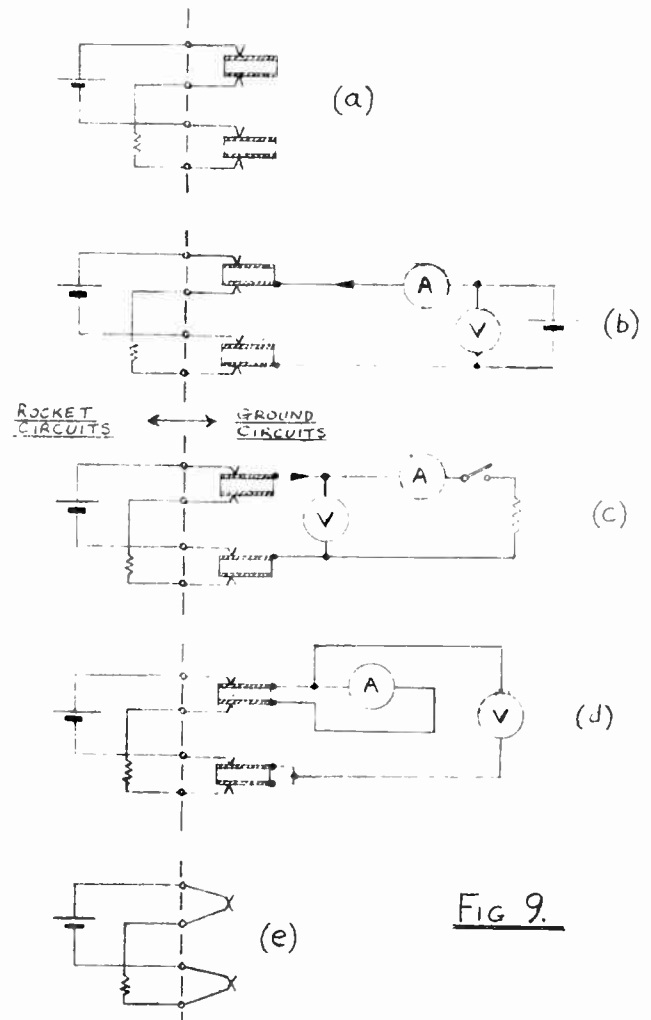

Fig 9.

Fig. 9. Circuit uses of Special Plug and Socket.

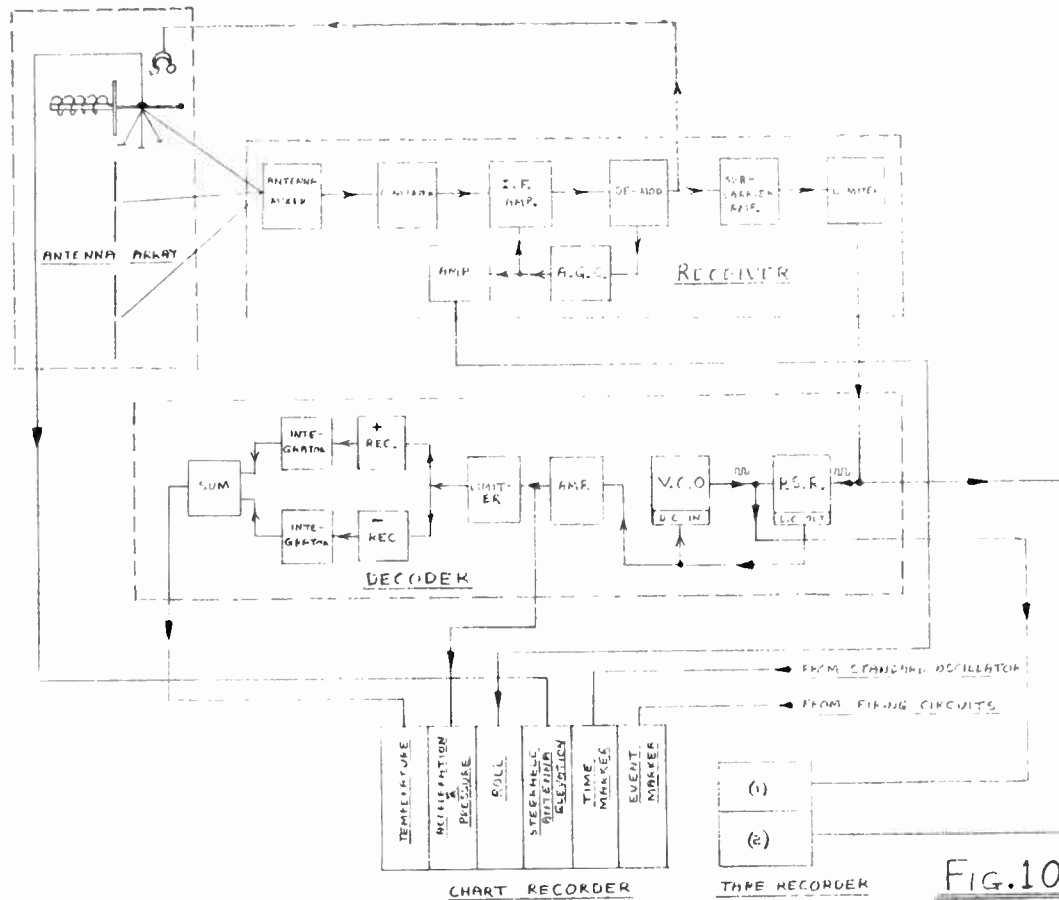

Fig. 10. Telemetering Receiving Station.

antenna. One component of fading will quite certainly be due to rotation of the rocket about its roll axis, and it is proposed to make use of this effect to estimate roll rate. This is done quite simply by taking the A.G.C. control signal through a buffer amplifier and thence to the recording means, as indicated in Figure 10.

The Antenna

The main telemetering antenna, which is illustrated in Figure 11 is a highly directional, non-polarized type giving a gain of about 12 dB. In use it is mounted on a tripod with an extended steering handle enabling it to be moved readily in azimuth and elevation. The rocket is manually tracked in flight by the antenna operator who follows visually using open sights, until the rocket is lost from view, and thereafter he is guided by headphone signals delivered from the telemetering receiver. The motion of the antenna will be largely confined to elevation movement since azimuthal drift, even with appreciable winds, is expected to be negligible. The telemetering ground station will be located at least half a mile from the launcher and one or more omnidirectional antennas will be located on a ½ mile base line and diversified such that signals should still be received even if track is lost completely by the helical antenna.

The Decoder

After demodulation the FM signal is applied to a 2-stage amplifier and limiter and then passed to a tape recorder, thus enabling data reduction to be carried out after the firing if so required. The limited signal is also routed to an FM frequency discriminator, which is essentially an inverted form of the encoder. Turning to Figure 10, the limited signal is applied to the input terminals of a phase sensitive rectifier and a reference square-wave signal is applied to the P.S.R. from a V.C.O. of the type used in the rocket. The output of the P.S.R. is

smoothed by means of short-time constant CR networks and the resultant direct voltage is used for controlling the frequency of the V.C.O. The system constitutes a phase-locked, tracking oscillator. The bias on the V.C.O. is adjusted such that with zero d.c. voltage from the P.S.R. the V.C.O. frequency lies midway between the center frequencies of the two signal transducer bands. In operation, the control voltage to the V.C.O. becomes a copy of that existing in the missile, apart from system noise, and is fed to the recorder.

As mentioned earlier, the F.M. detected square-wave is assymmetric in form because the temperature signal is superimposed upon it. This intelligence is extracted by amplifying the local V.C.O. signal, separately rectifying the positive and negative parts, integrating each signal and then summing in a resistive "T" network. With a perfectly symmetrical 50-50 square-wave, corresponding to -20°C . the final summed signal is zero. Temperatures 50°C . above and below this reference point give 30-70, and 70-30 ratios and the signal is driven negative and positive in correspondence, intermediate temperatures giving, of course, intermediate amplitudes. The decoded temperature signal is fed to a second channel on the chart recorder.

Recorders

For the magnetic recordings, good quality commercial tape recorders are available and satisfactory. The decoded signals however, demand a high performance multi-channel oscillographic recorder in order to extract the maximum signal intelligence, and this requirement represents one area where improvisation is unrewarding. A minimum of six channels are required in order to record simultaneously, (1) combined acceleration and pressure, (2) temperature, (3) A.G.C. voltage (roll), (4) telemetering antenna elevation, (5) time markers, (6) event markers. The event markers are pulses obtained from the firing button, the rocket

leaving the launcher rails, and other events set in by manual means.

Pay-Load Tracking

Without the use of auto-tracking radar, location of the descending pay-load and determination of its final impact point is not an easy matter. To avoid a substantial outlay of equipment it has been decided to build three or four so-called Triangulation Receivers. These will be located at points several miles from the launching site and the crews operating them will attempt to get fixes using directional, steerable antennas similar to the one used at the telemetering station. The receivers themselves have not been designed yet since, if possible, ordinary mobile communication equipment with additional R.F. converters will be used. If this scheme involves difficulties, modified TV receivers and video strips will be developed and engineered into small portable packages.

The final recovery operation will depend upon what communication methods can be made available, and it is expected that at least one light aircraft will be involved. Recovery of the pay-load is interesting from a technical point of view but also strongly desirable in that at least some of the parts recovered may be used again.

Development Status And Conclusions

At the inception of project "CHARM" it was estimated that some two years would be required to complete it. Work carried out to date is in broad agreement with the original schedule and there remains an appreciable amount of field work to be done in the future.

Fuel properties have been established experimentally and electrical igniters and the various associated igniter phases have been successfully developed. The greater part of the electrical and electronic equipment has been designed and is presently either in the "breadboard" stage or has been engineered and constructed. The rocket and launcher mechanical design has been largely completed and manufacture is commencing. Initial rocket motor static firings with complete instrumentation were carried out earlier in the year and several more such tests concerning the first and second stages are contemplated in the near future.

As remarked in the introduction, many interesting problems have arisen in the course of the work carried out

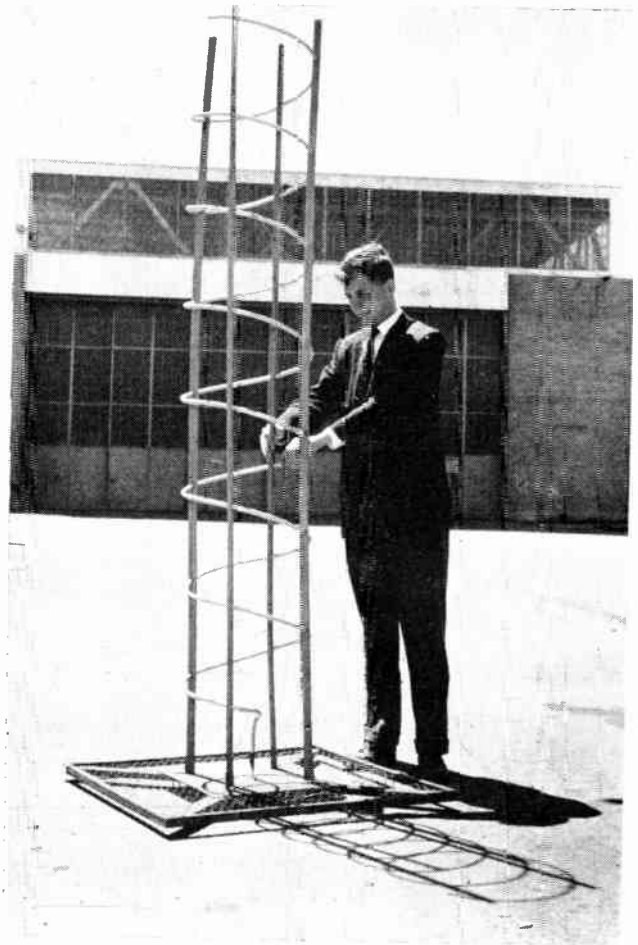

Fig. 11. Steerable Helical Antenna for Telemetering Receiver.

so far and acknowledgment is made to all members involved in the program who have given so much of their free time and effort to arriving at appropriate solutions. The thanks of the Society also go to the private companies involved who have been uniformly helpful and encouraging.

Automation For Sintering Plant Operation

AN electronic control panel, complete with TV screen which gives the operator a continuous picture of the end product, is the nerve center of the most fully automatic sinter plant ever built.

Designed by the Dwight-Lloyd Division of McDowell Company, Inc., Cleveland, for U.S. Steel Corporation's Youngstown District Works, the \$60,000 panel brings into one man's hands all process controls for the entire sintering plant. Centralized plant operation from this panel will reduce the required number of operators to a minimum even though the design capacity of the new plant exceeds any now in operation.

The control panel will be built into an air-conditioned pressurized room at the facility, now being completed by McDowell Company construction forces.

In addition to the TV screen, the console contains the intercommunication system and the trouble signals and controls. Rectangular panels corresponding to the various machinery lines light up in the event of process fault. By this means, the central operator can immediately pinpoint the exact trouble spot, and dispatch one of the floor operators to correct it.

The control console comprises two other main sections. At the left is an illuminated mimic panel, designed to

picture the flow of materials through the plant. Push-button starting controls for all machinery are also located in this section. The right-hand section consists of instruments which chart the performance of all the elements of the plant, recording raw materials flow, fuel consumption, product output, draft, temperatures and other data necessary to economical operation. Controls in this section are wired to automatically adjust the rate settings of each of the different pieces of machinery.

Over 1500 hours of electrical engineering time went into making drawings for the complex circuits in the console. The unit contains over $4\frac{1}{2}$ miles of wiring, and many thousands of dollars' worth of instruments.

Sintering is done to transform fine iron ores into clinker suitable for feeding the steel industry's blast furnaces. In the last five years, the industry has built or contracted for enough sinter plants to more than double its annual sintering capacity. By the end of this year, it will be able to produce as much as 60 million tons of sinter annually.

The continuous sintering process was invented by Messrs. Dwight and Lloyd in 1906. McDowell's Dwight-Lloyd Division traces its lineage back to the inventors, and has had a major role in the continuing improvements of the sintering process.

**with your carrier
and radio equipment—**

Lenkurt

**provides complete
instruction and
maintenance information**

The wise choice is made. Your Lenkurt equipment is installed. Now you have to get to know it.

To make this easy, Lenkurt provides complete, detailed information about the equipment. Questions about wiring, lining-up, operation, tests and maintenance are quickly answered. Detailed drawings and schematics leave nothing in doubt.

Here is a service that can *really* save time, money and worry. Your nearest branch of Automatic Electric will be delighted to show you such information.

AUTOMATIC  ELECTRIC

ORIGINATORS OF THE DIAL TELEPHONE



8753

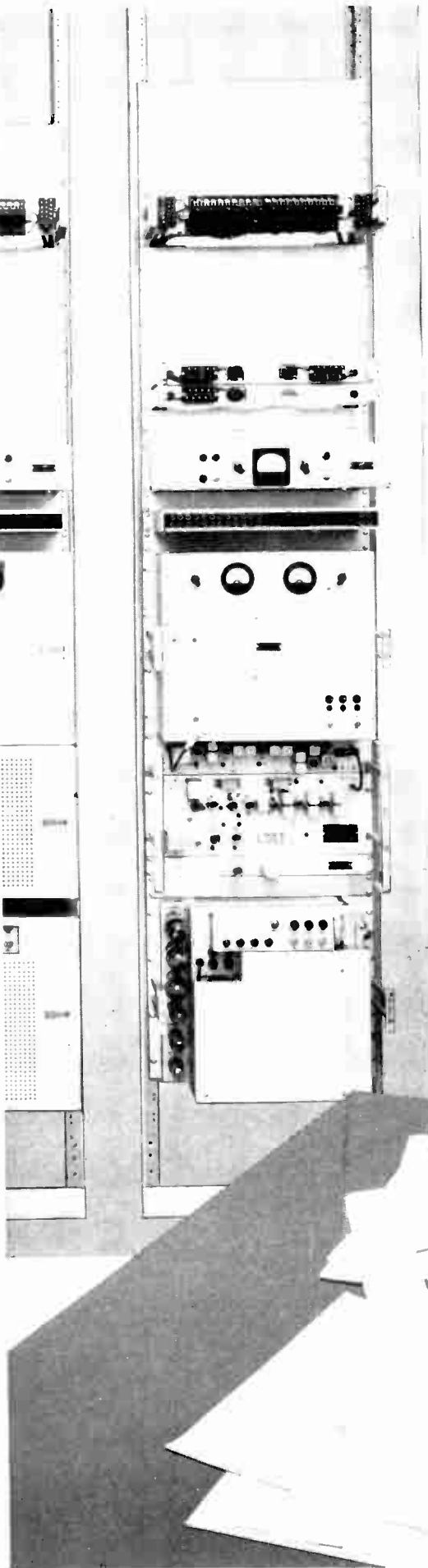



Gardenia White

Forget-Me-Not Blue



Camelia Pink



Turquoise



Sunlight Yellow

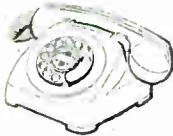

Dawn Grey



Sand Beige



Jade Green

Garnet Red



Classic Ivory

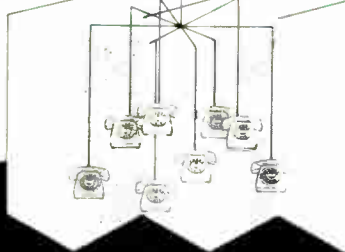

This display is one of many described in the Automatic Electric Do-it-yourself Display Idea Book. All are clearly described. All are easy and economical to build.

to sell **MORE** telephone service
sell **COLOUR!**

You can sell more telephone installations, more extensions . . . when you offer your subscribers 10 harmonizing telephone colours to choose from! In modern homes, stores and offices people use colour to create new dimensions in living. Telephones in decorator colours that blend or contrast with desks, counter tops, kitchens, dens, bedrooms, and living rooms are literally "causing a sensation".

SO TO SELL MORE TELEPHONE SERVICE, SELL COLOUR!

For further data on advertised products use page 65.

these valuable aids from **AUTOMATIC ELECTRIC** will help you sell the new type 80 Monophone in all ten colours!

TALK with COLOR



COUNTER OR WINDOW STAND-UP DISPLAY

Features the Type 80 Monophone, in full colours. Sells subscribers (when they pay their bills) and passers-by! Available free.

TELEPHONE COLOUR SELECTOR



Outline of Type 80 on clear plastic—with all ten Automatic Electric decorator colours attached. Easily carried in wallet. Price 25¢ each.



DIRECT MAIL LITERATURE

A 4-page brochure in full colour. Lets your subscribers see the complete range of Type 80 Monophones. Available free.



INVOICE STUFFERS

that double as easily-pocketed counter literature in full colour. Does a strong sales job. Available free.

MINIATURE TYPE 80 PHONES

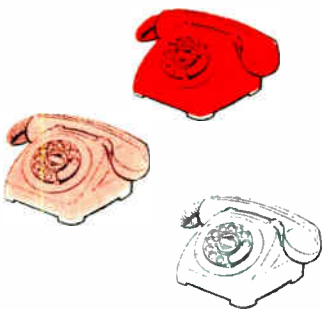

in all ten Automatic Electric Colours—Sand Beige, Garnet Red, Dawn Grey, Sunlight Yellow, Turquoise, Classic Ivory, Jade Green, Gardenia White, Camelia Pink and Forget-Me-Not Blue. Use these miniatures as counter or window display material—or as samples to subscribers who are seriously thinking about coloured units.



DO-IT-YOURSELF DISPLAY IDEA BOOK

Contains many practical ideas for eye-catching window displays you can build yourself. Available free.

5754-P

For full information about these useful sales aids or the new, coloured Type 80 Monophone, write our nearest branch office. Head Office: Automatic Electric Sales (Canada) Ltd., 185 Bartley Drive, Toronto 16. Branches in Montreal, Ottawa, Brockville, Hamilton, Winnipeg, Regina, Edmonton, Vancouver.

MADE IN CANADA BY



ORIGINATORS OF THE DIAL TELEPHONE





YOU CAN HELP SHUT-IN CHILDREN KEEP UP WITH THEIR CLASSMATES

—with Executone School-to-Home Telephone Systems

To a child, illness or accident can be an overwhelming experience. Being ill and confined to a sick room is only a part of it. He is also shut off from school life, from all normal contact with

children his own age. In various parts of Canada there are thousands of these shut-in children. Luckily, equipment is available that gives the sick child a feeling of belonging again.

The Executone School-to-Home Telephone System, now available in Canada exclusively through Automatic Electric, consists of a small amplifier and two simple, compact units. One is installed in the sick child's home. The other is portable and can be plugged-in in any classroom at the child's school. The two units are linked by ordinary telephone wires through the

nearest exchange, and the child can then take part in day-to-day classroom activities.

Executone School-to-Home Telephone Systems change the child's entire attitude to his handicap, and may easily speed him well on the road to recovery. Already the systems have been highly successful in well over 4,000 cases.

Many Telephone companies are performing an outstanding public service *and* earning additional revenue by making them available in their territory. For further details call or write any Automatic Electric office.



*The Executone Speaker-Microphone
for the classroom*

*Automatic Electric Sales (Canada) Limited, 185 Bartley Drive,
Toronto 16, Ontario. Branches in Montreal, Ottawa, Brockville,
Hamilton, Winnipeg, Regina, Edmonton, Vancouver.*

AUTOMATIC ELECTRIC

SALES (CANADA) LIMITED

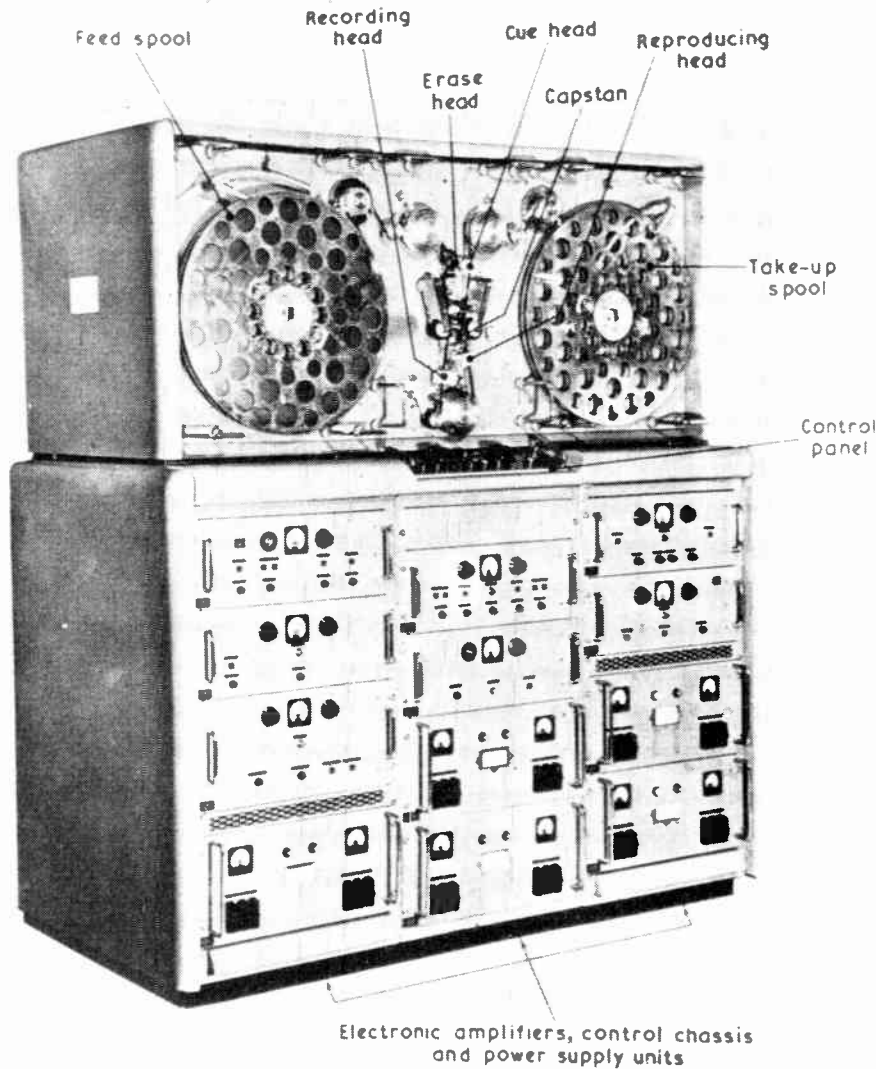

VERA — the B.B.C.'s latest apparatus for storing video and sound signals uses a three track system — operates at 200 inches per second and uses normal sound recording tape.

The B.B.C. Vision Electronic Recording Apparatus

Courtesy *The Engineer*, London, England

THE Vision Electronic Recording Apparatus known as "VERA" has been designed and developed in the research department of the B.B.C. to record the vision and sound signals of television programs for subsequent reproduction at any time after the recording has been made. The channels which are to be put into service will consist of two machines, similar to the one illustrated, which can be controlled from a central control desk. The machine uses $\frac{1}{2}$ -inch magnetic tape, and a reel (20 $\frac{1}{2}$ in. diameter) such as those shown will carry fifteen minutes of program. Continuous recording is possible by the use of two machines and the control desk. The tape speed employed in the present model is 200 in. per second and the magnetic tape used may be a normal thin-base sound recording tape of good quality.

"VERA" uses a three-track system of recording, two of

the tracks being devoted to the storing of the video signal and one to the storing of the sound signal. Separate recording and reproducing head-stacks are employed, each stack containing three identical heads separated from each other by copper screens and aligned to the accuracy required in the manufacturing process. Continuous monitoring of the recorded signal during the process of recording may be carried out.

In the tape transport system embodied in the machine most of the power required to drive the tape is supplied by the spooling motors, which are arranged to move the tape past the heads at a speed just below the chosen recording speed of 200 in per second and close to the constant tension required, even when the drive motor is not engaged. This result is obtained by varying the power fed to the spooling motors in accordance with (a) their torque/speed charac-

teristic, and (b) the amount of tape on the reels at any particular moment, the latter determining the speed of rotation required of the reels. When the drive is engaged the drive motor is, therefore, required to supply only a limited amount of power to bring the tape speed up to 200 in per second. The drive is engaged by lowering two rubber idlers on to a common capstan so that there is formed a loop of tape which is largely isolated from transient effects in the reels by the idlers and other mechanical filtering elements. Inside this loop lie the recording and reproducing head-stacks, the magnetic parts of which incorporate ferrite materials. Each head is stated to have an effective life of some 100 hours. The erasing head is placed at a convenient point which lies outside the loop and precedes the recording head. A "Velodyne" system of speed control and correction of the driving capstan is employed. During recording periods the servo driving motor is made synchronous with the mains frequency, whilst on reproduction the output of the machine is frame-synchronized to station synchronization signals. The machine is fitted with the usual facilities for braking and for spooling the tape backwards or forwards at a variable speed when the drive system is not engaged.

For storing the video signal the two video tracks are associated, on the recording side, with a band-splitting system in which the video signal is divided into two frequency bands of approximately 0 to 100 kc/s and 100 kc/s to 3 Mc/s. The 0 to 100 kc/s video band is made to frequency modulate a carrier and this frequency-modulated carrier is recorded on one track. The low-frequency content of the video signal is thereby transferred to a frequency band corresponding to shorter wavelengths so that both the low-frequency and the long-wavelength difficulties inherent in the conventional magnetic recording system are avoided. In addition, the amplitude-limiting facilities normally associated with the reception of frequency-modulated signals may be incorporated in the reproducing chain to eliminate undesired amplitude fluctuations and overcome almost all "drop-out" difficulties, even when employing thin-base sound recording tape not specifically manufactured for video or instrumentation purposes. The higher vision band, from 100 kc/s upwards, is recorded simultaneously on the second video track in a conventional manner.

On reproduction the output from the frequency-modulated video track is limited, demodulated, and added to the output from the higher frequency track to reform the composite television waveform. Before transmission to line the synchronization information, including line and frame synchronizing signals and suppression periods, is extracted, reconstituted and added back into the video signal. It is, of course, obvious that the higher frequency video band, which employs a conventional recording/reproducing system, will be subject to the same unwanted amplitude-modulation which is being eliminated by the frequency-modulation system of the lower frequency video band. It is, however, an important finding that in practice this does not appear of major importance, for as long as the synchronization signals and the main brightness

structure of the picture, represented by the 0 to 100 kc/s band of the video signal, are maintained intact, reasonable variations in the higher frequency band do not noticeably degrade the subjective result.

All the low-frequency and long-wavelength difficulties which, in the case of the lower video frequency, are overcome by the use of the carrier system, will also be manifest in the sound channel if a conventional recording of the sound signal is attempted under the higher tape speed conditions dictated by the video signal requirements. These difficulties are overcome by employing an identical technique to that used to store the lower video frequencies. Accordingly, the sound signal is, before recording, made to frequency-modulate another carrier which is recorded on the third track. On reproduction the carrier is limited and demodulated to provide a sound signal of high fidelity exactly synchronous in time with the video information reproduced from the other two tracks.

As in other forms of picture or sound recording a requirement will arise in the use of magnetic vision recorders for the editing of program previously recorded. Simple editing, in the form of replaying extracts from a previously recorded program, may be achieved by starting the machine at any predetermined point in the recording. This facility is available because the machine is equipped with the usual facilities for spooling the tape backwards and forwards to find a desired point in the recording. The method may be extended, as in magnetic sound-recording practice, by cutting and joining extracts from various recordings or different parts of the same recording. Individual frames cannot, however, be examined in a "gate," as in optical film editing, for the tape must be reproduced at the correct speed before a picture can be reproduced on a monitor. A cueing arrangement for the "marking" of editing points has, therefore, been provided. For this purpose there is provided an extra cueing head, lying outside the isolated tape loop, which is fed through a separate recording amplifier from a 30 kc/s oscillator. When the tape is being normally reproduced and the observer wishes to mark some particular point for subsequent cutting or starting he presses a "Cue" key on the control panel of the machine which causes a 30 kc/s burst of signal to be recorded on the sound track of the tape. At this frequency it will not appear in subsequent normal reproduction, since it lies well below the frequency-modulated carrier signals which carry the sound program, and any interference effects it might otherwise have will be removed by the limiting process which precedes detection of the television sound signal. When the tape is being slowly moved past the reproducing head, using the spooling speed control, at a fraction of the normal speed, the cue signal will produce an audible note in the loudspeaker or headphone system so that the point previously marked is found.

The cutting and joining of tapes is accurately and quickly carried out by the use of a splicing device provided and the resultant join provides no visible disturbance in the picture.

The 5th Annual Directory And Buyers Guide Electronics and Communications

Canada's established Buying Guide for the electronic and communications market.

Check lists have already been mailed to over 4,500 suppliers in Canada, the United States, Europe and the United Kingdom.

If you sell in Canada, make sure you receive one. When received, do not neglect to fill in and return promptly.

This valuable reference directory will be published in December 1958 to serve our readers and advertisers during the following twelve months.

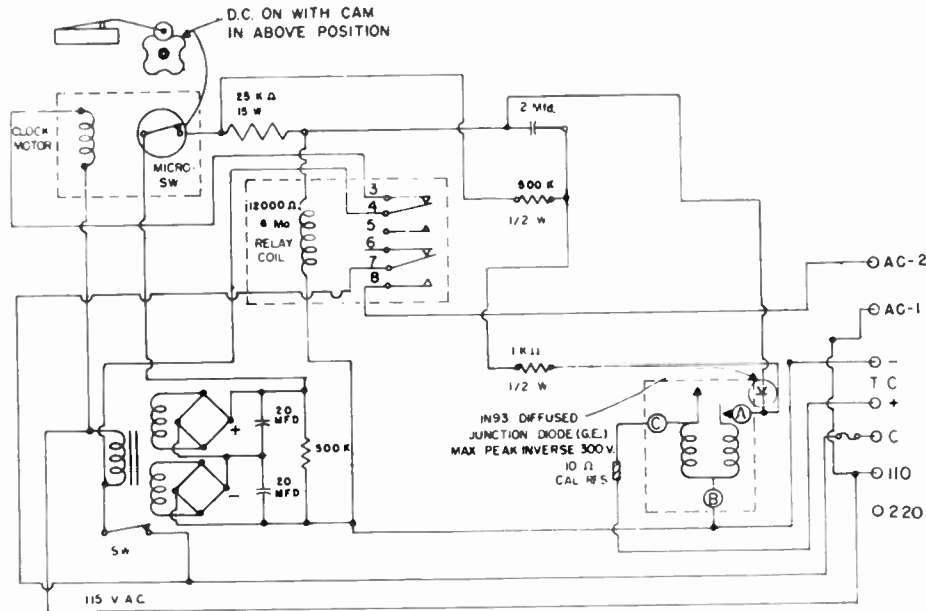

General Schematic Of The Proportioning Control.

Proportioning Control Minimizes Temperature Spread

TEMPERATURES can now be maintained within a total spread of as little as one degree Fahrenheit with a simplified proportioning control that takes advantage of the positive action provided by the locking contacts of a meter-relay, but which levels out the temperature to an extent never before possible with meter-relay "on-off" circuit.

This improved action has been achieved by adding a condenser, a resistor and a 300-volt diode to one of the circuits frequently used with the company's familiar Simplytrol controls. In addition, the power supply voltage was increased from the normal 125 to 300 volts.

Key to the accuracy of the new control is an ingenious use of electrostatic attraction across the contacts of the meter-relay. This attraction is used both to proportion the amount of time the heat is turned on and to cause an anticipated, or premature, closure of the contacts before the limit point is reached by the signal pointer. This anticipation keeps the cumulative effect of a heat build-up from raising the temperature past the limit.

The amount of electrostatic attraction varies inversely with the square of the distance between the moving contact and the control point. The attraction thus increases very sharply as the contacts approach each other and a small distance means a disproportionately large difference in attraction. Hence the meter-relay becomes even more sensitive than usual to small changes in load temperature.

While originally designed for the accurate control of temperatures anywhere from minus 200 to 3000 degrees Fahrenheit, the new circuit may be used to monitor many other variables with comparable precision. In general, any other functions that are measurable in current or voltage may be controlled within the limits of maker's

meter-relays — from about 10 microamperes to 50 amperes.

Temperature readings of the new control are "absolute" in the sense that they are transmitted directly from a thermocouple to the meter-relay, without the drift or distortion often caused by amplifiers. The signal is indicated continually and the limit point may be easily adjusted anywhere on the scale.

A variation of an "on-off" sampling circuit is used in the new control, with the load relay that turns on the heat being normally energized. The sampling period, when the heat is off, remains constant and is fixed by an automatic cam interrupter. The length of the heating period varies. It is determined by the electrostatic attraction, which in effect senses the amount of heat needed to maintain an even temperature.

Higher-than-normal open circuit voltage is applied across the meter-relay contacts to provide the electrostatic attraction at the moment the load relay pulls in and the heat goes on.

The farther the indicating pointer of the meter-relay falls away from the fixed contact, at the beginning of the cycle, the longer the heat is on and the greater the electrostatic attraction that builds up. Hence the contacts come together even more prematurely than normally, to prevent the cumulative heat from building up too far.

Closing of the contacts causes the load relay to drop out and stop the heat. After the sampling interval the load relay pulls in again and the proportioning cycle is repeated. The sampling interval that will give the most effective control can be determined easily by changing cams.

A feature of the circuit is "fail-safe" action. Since the load relay is normally energized, any failure in the circuit will drop out the relay and prevent further heating.

New Products

New Product specifications published in Electronics and Communications have been briefed for your convenience. If you require further information on any of the items published you may readily obtain such by using our Readers' Service, Page 65. Just mark the products you are interested in on the coupon on Page 65 and the information will be in your hands within a few days.

Compression Connectors

Item 1995

New single and double tap connectors that can also be used as dead ends and stirrups have been added to the complete line of compression type electrical connectors offered by Thomas and Betts Limited, Montreal, Que. These connectors are installed with a positive acting pocket size tool which can be operated with one hand. They are designed for use on all aluminum and aluminum-to-copper connections.

The "T & B" "Shure Splicing" line also includes right angle tap connectors and pin terminals for connecting aluminum and A.C.S.R. to copper equipment terminals. All connectors have king-size contact length for long, low resistance contact.

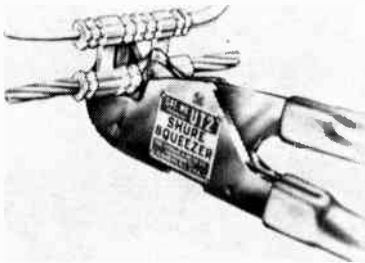

The PALTAP connector is for single taps and dead ending for easy installation overhead. Clearance required for the installing tool is no greater than that needed for line pliers.

The TWINTAP compression connector is designed to accept two tap conductors. The tap portion has a solid barrier between conductor bores to provide a positive cable stop and assure even application of compound. The TWINTAP saves considerable space on crowded poles where two or even four services are terminated. It is converted easily to a stirrup that accepts hot line clamps.

All connectors installed by the pocket size UT2 are coated with T&B Joint Compound and vacuum packaged on cards. Cards have wire sizes boldly printed on them to assure proper connector selection.

Thomas and Betts Limited, 759 Victoria Square, Montreal, Que.

Single Sideband Radiotelephone

Item 1996

Racal Engineering Limited of Bracknell, Berks., England, announces the new 60 watt Single Sideband Radiotelephone TRA.55.

The Racal Model TRA.55, which is a small, compact and inexpensive equipment, provides 60 watts of sideband power equivalent in communications effectiveness to a conventional AM transmitter having something in the order of 7 or 8 times as much power.

The TRA.55 is designed to be extremely simple to operate and it can easily be used by entirely unskilled personnel. Four pre-set channels are provided and a single switch selects the transmitter and receiver channels simultaneously. To operate the equipment it is only necessary to switch on and select the required channel. The set will then be receiving. To transmit, a switch in the handle of telephone handset is depressed.

A built-in loudspeaker is provided for use alternatively with the telephone ear-piece.

The frequency range is 3-12 Mc/s. Power supply — 100-125 and 200-250 V 40/60 c/s.

AC supply consumption — receive 95 watts, transmit 300 watts.

The dimensions of this set are — width, 20½ inches; height, 24½ inches; depth, 20½ inches.

Further details available from the Canadian representatives — Intronics Limited, P.O. Box 51, Stittsville, Ontario.

Vertical Radiators

Item 1997

Beatty Class "B" 20" Steel Tele-Mast, used for general mast work, has now found increased demand from broadcasting stations, where the government has granted an increase in power. More power requires more height to use it to advantage. This means new and higher masts.

This Beatty mast is built entirely according to C.S.A. specifications or better. It is capable of going to heights of 300 feet. It is furnished as a standard mast on a hinged base and also mounted on an insulated, hinged base for use as vertical radiator, with insulated guys. It is convenient to climb and has utility holes on all sides for attachment of lead-ins, lighting equipment, etc.

Beatty Bros. Limited, Fergus, Ontario.

Motor Controller

Item 1998

Servomex Controls Ltd. of Crowborough Hill, Sussex, England, has recently placed on the market a high precision motor controller type M.C. 43. Being expressly designed for rapid reversal, it can be switched from full speed forward to full speed reverse in as little as 1.4 seconds and is therefore eminently suitable for high speed production work.

It is suitable for operation with an input supply ranging from 200 to 250 volts, single phase, 50-60 cycles and provides a range of speeds from 0 to 6,000 r.p.m. which can be smoothly varied in either direction. An electrical tachometer on the control panel enables the operator to determine the motor speed with a guaranteed absolute accuracy of plus and minus 1.5% of full scale.

The torque produced is a minimum of 21 ounce-ins. at all speeds and does not diminish at the higher speeds. A feature of the instrument is that the application of full torque does not cause a speed change of more than 6 r.p.m. over the whole range of speeds.

The control unit is mounted on a standard 19 ins. rack panel of 14 ins. height. The depth is 15½ ins. and weight 88 lbs. A 12-way flexible cable 6 ft. in length connects

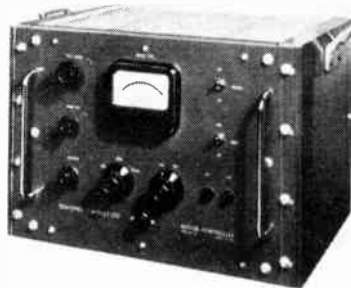

it to the motor which is suitable for foot or flange mounting and has a 1" x ¼" shaft at each end. The weight of the motor is 7¾ lbs. All metal work is stove enamelled or cadmium plated. Wooden covers are available for bench use.

Further details are available from the Canadian agents, Electrodesign, 738 Notre Oame Street West, Montreal, Que.

Capacitance Bridge

Item 1999

The General Radio Type P-582 Capacitance Bridge, designed to calibrate capacitive fuel-gage testers, meets the essential requirements of Specification MIL-T-4778 and bears the militarily assigned commercial standard designation TTU 24/E.

It is a self-contained bridge system which includes a 400-cycle oscillator and a sensitive null indicator. A "transformer bridge" is used, with inductively coupled "ratio arms," to make possible direct (three-terminal) capacitance measurements. Capacitance from the unknown terminals to ground has no effect unless it is very large. Designed originally to calibrate capacitive, aircraft, fuel-gage testers, the bridge is also well suited to general capacitance measurements at 400 cycles.

The capacitance range of the Type P-582 Bridge is 5 micromicrofarads to 0.011 microfarad with an accuracy of ±0.1% over most of the range. The dissipation factor range is 0 to 0.11 with an accuracy of ±2% of reading ±0.0002. The detector circuit employs RC feedback amplifiers to provide high selectivity and sensitivity. The null indicator has a compressed response and uses a ruggedized meter. Two panel lights indicate the direction of capacitive unbalance, thus reducing greatly the time required to balance the bridge.

The Type P-582 Capacitance Bridge is mounted in a metal cabinet supplied with

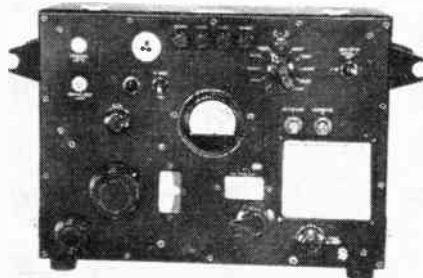

a detachable cover. The instrument is ready for operation after connection to the 115-volt power line.

For further details apply to General Radio Company, 99 Floral Parkway, Toronto 15, Ontario, Canada.

Brochure On Microwave Silicon Diodes

Item 2000

A 24-page brochure describing microwave silicon diodes has been issued by Microwave Associates, Inc. of Burlington, Massachusetts. This new catalog includes up-to-date technical data and receiver design information for low noise mixer and video diodes for applications in the 300 mc to 70,000 mc frequency range. A recently developed diode for test equipment applications is also described.

Performance curves, nomographs, outline drawings, and photographic illustrations are used to increase the usefulness of this brochure and provide a clearer picture of comparative diode performance. Minimum noise figure receiver design, balanced mixers, high level diode modulator techniques, reliability, high temperature operation, and diode measurement techniques are some of the many topics covered by articles in this catalog.

Copies are available upon request to E. G. Lomas, 227 Laurier Avenue West, Ottawa 4, Canada.

New Products

Transistorized Power Amplifier

Item 2001

A new 60-watt transistorized power amplifier, offering considerable savings in its overall compactness has been announced by Canadian Westinghouse.

The unit, only 8" wide, 4" high and 4" deep, was designed as a servo amplifier for closed loop servo systems, without utilizing an output transformer and will find many applications in electronic control circuits where servo techniques are employed. An interesting feature is that the unit includes its own heat sink which adds only 4" to the overall depth. This is removable when the amplifier is used on a large machine where a heat sink is unnecessary.

Power output is 60-watts continuous operation at 50°C, although higher outputs and temperatures are permitted when the duty cycle is reduced.

Untuned, the frequency range is approximately 150 cycles to 3 kilocycles, but the unit is normally tuned to 60 cycles with a bandwidth of ± 20 cycles. Standard input is 24 V. D.C. A 110 V. A.C. power supply is also available for use with the unit.

For further information please write the Information Department, Canadian Westinghouse Company Limited, Hamilton, Ontario.

Progressive Shorting Type Switch

Item 2002

The Daven Company, Livingston, N.J., announces the development of a new Progressive Shorting Type Switch which shorts out, absolutely, every other position on the switch but the one actually in use.

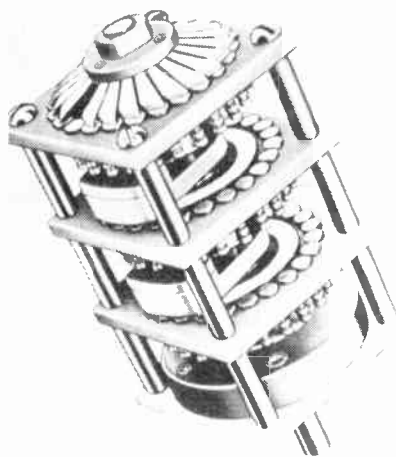

Particularly useful in the metering of a single position or for the gathering of pertinent information on it, the Daven Progressive Shorting Switch assures that only one — the desired position — is in operation at any one time. Also the switch's separate ring connection makes possible switching one meter between every position consecutively, continuous programming, and other special applications.

Among the other applications possible with the new Daven unit are capacitor decade switching, sequential power distribution, ammeter switching, voltmeter switching, control decks for rotary solenoid operation, and network sequencing applications.

Available as 20, 24, and 32 pole units, these switches can be ganged for multiple deck application. Solid silver alloy fingers, designed for self-wiping action, ensure extremely low and uniform contact resistance. Contact materials and slip rings are made of solid silver alloy.

For more information, write The Daven Company, Livingston, N.J., U.S.A.

Mobile Oscillograph Recorder

Item 2003

Designers and engineers making use of recording instrumentation will be interested in the Edin Mobile 2-Channel Recording Instrument recently developed by Edin Company, Inc. of Worcester, Mass. The recorder simultaneously depicts and records such phenomena as voltage, current, pressure, vibration, temperature, displacement, strains, acceleration or force.



Built to withstand rough treatment, the sensitive unit will reliably record, for example, strains as low as 10 micro-inches per inch and currents as low as 1 microvolt. Weighing 106 pounds and standing only 31 inches high, the compact instrument contains a 2-channel direct-writing recorder with a choice of any two standard amplifiers.

Rubber-tired, non-static and self-locking casters are employed which permit the unit to be quickly wheeled between recording locations. Record charts are page numbered and are accordion-folded to permit easy access for referral and to eliminate time-consuming paper rewinding. Long, pull-out power cord rewinds automatically.

Further information may be obtained from the Electronics Division of A. C. Wickman Limited, 1425 The Queensway, Toronto, Ontario, Canada.

Portable Electroplater

Item 2004

A compact unit measuring only 34" x 23" x 33" contains all the equipment and features for precision-plating of electrical or electronic parts, specification precious metals plating, or "pilot plant" set-ups, according to an announcement from Sel-Rex Corporation, Nutley, New Jersey. A completely re-designed version of this firm's Jet Plater, the new models are said to permit either barrel or rack plating with any cold alkaline solution, and most acid plating solutions, on a mass-production basis.

According to Sel-Rex, the new Jet Platers provide the ideal operation for precision-plating; i.e., a stainless steel, canned turbine pump, in conjunction with a vinyl jet orifice manifold at the bottom of the plating tank, causes the plating solution to swirl constantly around the work, assuring smooth, even deposits. In operation, the solution is continuously drawn off from the bottom of the tank, circulated through the pump and built-in filter, and returned to the tank under pressure.

It is reported that the units are completely automatic — all operations being controlled from convenient panel board which incorporates dual scale ammeter, powerstat control for rectifier, circuit breakers, and automatic timer which sounds alarm upon completion of plating cycle.

In addition to the space-saving convenience of a complete plating "plant" in a compact package, Sel-Rex states the Jet Plater permits increased production work without sacrifice of quality.

For further particulars apply to Sel-Rex Corporation, Nutley, New Jersey, U.S.A.

Time Delay Relays For Loads To 60 Amps

Item 2005

A new series of full power SPST, 2PST and 3PST Time Delay Relays rated at 20, 35 and 60 Amperes or up to 5 Hp. at 115 Volts, A.C. was recently announced by the Ebert Electronics Corp. of Queens Village 28, N.Y. These employ a cased, high reliability design thermal timer available in a wide choice of Ebert's MiniRelay, Standard or Heavy Duty Power Relays to meet job requirements. This low-priced Time Delay Relay line is the first to offer such high load capacities in the non-mechanical timer field and feature hermetically sealed, positive, mercury-to-mercury snap action.

Adjustable "make" delay periods are available factory pre-set in several ranges covering delays of from 3 to 120 seconds. The delay timer settings may be shifted at any time with a standard hex key applied to a readily accessible set screw. These reliable Time Delay Relays may be had compensated for ambient temperatures of from -65° to $+85^{\circ}$ C. or ambient adjusted to suit application requirements. The timer has a repeat accuracy of $\pm 5\%$.

Dimensionally these Ebert Relays require no more mounting space than do Ebert's Standard or Heavy Duty models of themselves, while the midget MiniRelay and timer are supplied on a Bakelite panel sized to meet specifications. Ebert Time Delay Relays are available for A.C. or D.C. service in most voltages and, reports the manufacturer, need not be de-rated. Specifically designed to provide accuracy, long-life, dependability and high load ratings at the lowest cost, Ebert Time Delay Relays are carefully made to Ebert's strict quality standards.

The above units have been pre-tested in and found completely satisfactory for the following typical applications: appliances, automation, air conditioning, refrigeration, computers, delay starting of high current drain devices or equipment, rectifier protection, sequence switching, general control, heating equipment, hold-over circuits, communications, overload protection and cathode protection.

For further particulars and prices, write the Canadian representative: Philips Industries Ltd., 116 Vanderhoof Ave., Leaside, Toronto, Canada. Attention Industrial Sales.

Low Capacitance Sub-Miniature Relay

Item 2006

A new relay for switching radio frequencies on applications such as antenna change-over on mobile radio is announced by Magnecraft Electric Company of Chicago, Illinois.

A special contact spring construction is designed to provide the lowest possible capacitance between springs. Low loss ceramic is used for contact spring insulation. Operating voltages, 6 to 110 VDC. SPST or SPDT contacts, rated 2 amperes at 24 VDC or 115 VAC non-inductive load.

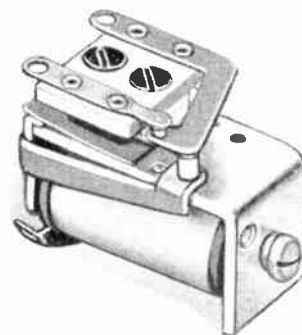

Overall dimensions; 1-1/2" long, 1" high, 1/2" wide. Descriptive literature on request to Magnecraft Electric Company, 3354R W. Grand Ave., Chicago 51, Illinois, U.S.A.

New Products

Quick Adjusting Leads Bender

Item 2007

No. 700 Universal Component Leads Bending Block is an improved fast setting gage for bending component lead wires so they will accurately register with the holes in printed circuit panel boards. Its purpose is to provide an inexpensive and fast means for avoiding plier damage to components and their leads, and to prevent wire lead distortion and out of line or twisted components on the assembled printed circuit panel.

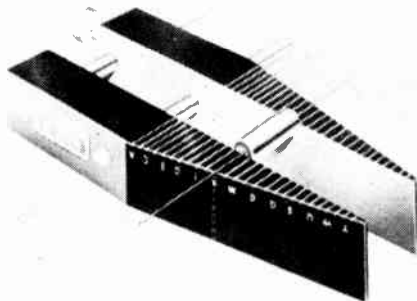

The manufacturer states that this new hand tool can be adjusted to the body length of any component measuring from 0 to 1 3/4" long, and that this is done in a small fraction of the time required by any other known device. The adjustable sliding jaw can be securely locked in position with a conveniently accessible knurled head thumb screw. After this jaw is set to the body size of the component, the wedge end of the tool is positioned between the two terminal holes on the printed circuit panel to determine the exact spacing for the bends. By placing the component on the tool with the leads resting in the grooves so noted, both leads can be quickly bent over the edges of the tool simultaneously by a simple downward swiping pressure of the fingers. All plier damage to components and their leads is thus avoided and much costly component replacement is eliminated. The leads may be bent to provide an inward or outward spring action against the sides of the panel holes by bending the leads downward and slightly toward the points or toward the body of the tool, as the case may be.

It is possible to bend both leads as close as .070 inch to the ends of the component. The bends can be made for panel holes as wide as 3 inches apart. It will accommodate leads of any diameter up to .045 inches and it can be used with practically any size or shape of two lead type component.

No. 700 Universal Component Leads Bending Block weighs 10 ounces and is produced by the **By-Buk Company**, 4314 W. Pico Blvd., Los Angeles 19, California, U.S.A.

Co-Axial Ferrite Isolators

Item 2008

Airtron Canada Limited announce the manufacture of a line of Co-Axial Ferrite Isolators for applications in both 3/8" and 7/8" ID Co-Axial Systems. The units furnish sufficient isolation between the signal source and reflected RF energy to afford suitable protection to the oscillator tube extending its life and insuring optimum power output and frequency stability. Consequently, system efficiency and overall system reliability is greatly improved.

The 3/8" Co-Axial Ferrite Isolator has been designed to operate over the frequency range of 2000 to 4000 mc/s providing minimum isolation characteristics. Other electrical characteristics of the 3/8" unit are 1 db maximum insertion loss, 1.30 maximum VSWR and 5 watt CW power handling capability with 2:1 load mis-match. Overall length of the unit is 10".

The 7/8" Co-Axial Ferrite Isolators have been designed to operate over a frequency range of 2350 to 3600 mc/s and 3500 to 5000

mc/s respectively, providing a minimum isolation of 10 db, an insertion loss of .8 db maximum, and input VSWR of 1.25 maximum and 300 watts CW average power capacity with a 2.5 load VSWR. Cooling fins are provided on the 7/8" Co-Axial Isolator as standard equipment for rapid dissipation of heat which allows operation at the power levels indicated. Overall length of these units is 14 1/4".

The standard 3/8" Co-Axial Isolator has type "N" female connectors on both the input and output, whereas the 7/8" unit is equipped with any combination of male and female type "LT" connectors. Both units can be supplied with combinations of these or other connectors as required.

For further information please write to **Airtron Canada Limited**, 300 Campbell Avenue, Toronto, Ontario for Catalog Sheet Nos. 3610 and 3620.

Variable Reluctance Hi-Fi Cartridge

Item 2009

A new high fidelity pick-up cartridge has been developed for the hi-fi "perfectionist" by the Goldring Mfg. Co. of Great Britain.

Fitted with the new Golden Mu-Metal shields, the new Goldring "600" is a variable reluctance type cartridge with two main air gaps in the magnetic circuit. A micro-cantilever armature in each gap carries a carefully mounted jewel tip — diamond for L.P. grooved records, and normally, sapphire for standard grooved records. By reducing dynamic mass, transient response has been markedly improved and record wear considerably reduced. This reduction in mass takes the high frequency resonance beyond 21,000 cps.

The vibrating systems of the "600" cartridge have a wide frequency range and exceptionally high compliance to ensure accurate tracing with negligible distortion. Hum voltages are virtually cancelled out by the push-pull arrangement of the cartridge coils.

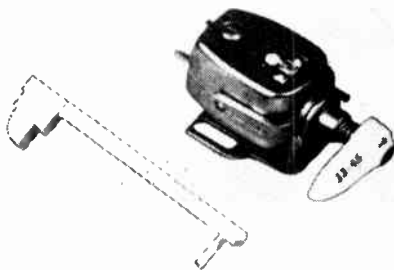

Designed to fit all standard arms and shells having 1/2" fixing centres for the cartridge bracket, each Goldring "600" comes individually packed with a stylus cleaning brush in an attractive plastic box. This facilitates handling and distribution by jobbers.

Detailed information and technical specifications may be obtained by writing to **Electronics Division, Musimart of Canada Limited**, 901 Bleury St., Montreal, sole Canadian agents for Goldring products.

Dynavolt Vibration Pickup

Item 2010

The Dynavolt Vibration Pickup, developed by Mandrel Industrial Instruments of Houston, Texas, is a low cost rugged moving-coil device, useful wherever conversion from motion to voltage is desired. Individual calibration is furnished with each pickup and precise all-metal construction insures long-term constancy of this calibration.

Standard units have coil resistances of either 215 ohms for feeding transistors or transformers, or 1000 ohms for feeding higher impedance circuits. Natural resonant frequencies other than standard may be obtained on special order.

All units use heat-treated beryllium copper spider springs to position the aluminum coil form in the cylindrical alnico magnet field. This spring suspension elimi-

nates doubtful readings for very low amplitude vibrations such as occur with mechanical pivot-type pickups. All units are unaffected by temperature and pressure variations in normal use.

The Dynavolt Vibration Pickup is intended for use in almost any motion-sensing application. Its output is sufficient for driving a-c voltmeters directly. Its light weight allows use where excessive mass of the motion transducer would upset normal characteristics of the device to be monitored.

Additional information upon request to the Canadian representative — **Radionics Limited**, 8230 Mayrand St., Montreal 9, Que.

Phototimer Scanner

Item 2011

The new Westinghouse Verithin phototimer scanner, an x-ray exposure monitor for spot film work, is now available from X-Ray and Radium Industries Limited, Toronto.

This unit consists of a plate of plexiglas with a central area treated to glow when exposed to x-rays. The whole assembly is encased in a light plastic housing.

Location of the Verithin phototimer keeps the spot-film device slim and uncluttered — no bulky photocell housings, no "pile-up" of mechanism. The phototimer is only 3/8 inches thick.

Other advantages include: (1) completely and permanently sealed against room light, dust, barium and other foreign material; (2) provides for both conventional and Fluorex spot films; (3) eliminates need for special phototiming cassettes; (4) scanning area, 12 1/2 square inches, assures constant density and eliminates danger of "barium block"; and (5) servicing is very simple, since Verithin is outside the spot device, there is nothing to take apart.

For further information, please write **X-Ray and Radium Industries Ltd.**, 261 Davenport Rd., Toronto.

Oscillographic Recording Chart Reviewer

Item 2012

A new oscillographic recording chart viewer developed by Sanborn Company provides variable chart drive speeds from 15 in/minute to 100 ft/minute, and accepts charts up to 16" wide and 200 feet long. The viewer is designed especially for use with Sanborn 1- to 8-channel regular or the new translucent Permapaper charts, and will accept other types of charts as well.

The Model 276 Chart Viewer has a direction-reversing switch combined with the speed control to allow rewinding at any time, and automatic braking to prevent supply roll overrun when speed is reduced. The chart table is finished in black to provide the best viewing of translucent Permapaper charts, and is equipped with a transparent plastic cursor to facilitate examination and correlation of multi-channel recordings. Cursor slides left to right and is pivoted at one end to allow rotation through a small angle.

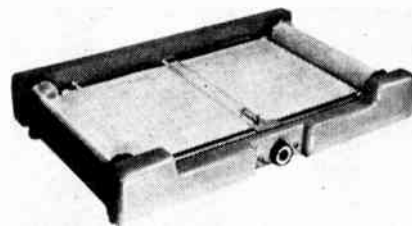

The Chart Viewer Cabinet has a smooth gray finish, with controls and other exposed hardware either chrome plated or buffed aluminum. Over-all dimensions are 36" x 22 1/2" x 7 1/4" high and total weight is approximately 25 pounds. Controls and equipment include main power switch, direction/speed selector control, pilot light and fuse. Further information is available on request from the **Industrial Division, Sanborn Company**, 175 Wyman Street, Waltham 54, Mass., U.S.A.

New Products

Battery-Operated Recorder

Item 2013

A self-contained, battery-operated recorder has been announced by the Stancil-Hoffman Corporation, one of the pioneers in this field. Weighing 13 pounds, the recorder is designated as the Minitape, and contains an automatic volume control preamplifier, a recording amplifier, and a separate playback amplifier. These transistor amplifiers are on printed circuit plug-in assemblies. Designed for a 50 ohm microphone input, full level recording is possible at distances of 10 feet or more, and the automatic volume control feature handles this extreme sensitivity as well as close talking.

The Minitape is available at any of the standard type speeds although $7\frac{1}{2}$ " per second is the most popular and at this speed it is flat to 10,000 cycles. The centrifugally governed motor, along with the amplifiers, is powered by a nickel cadmium battery, and the tape speed is held to within 1% of full charge to discharge.

Recognizing that a recorder of this type will be operated over extreme temperature ranges, the Minitape is designed to very tight tolerances and uses precision ball bearings for greatest efficiency. The unique speed control system coupled with this construction permits recording any type of music including piano. Furthermore, the signal to noise is comparable to the most expensive professional AC driven unit, and there is an absence of microphonics and other disturbances encountered in vacuum tube recorders. Erase is provided as well as high speed rewind.

The battery may be recharged an infinite number of times without deterioration and a single charge lasts over two hours of continuous recording. The Minitape may be remotely controlled at reasonable distances, and many accessories are available including the remote control unit, a miniature power amplifier and speaker system, an automatic voltage regulated battery charger, microphones, and a canvas carrying case.

For further details, write Caldwell A/V Equipment Co. Ltd., 447 Jarvis Street, Toronto 5, Ontario, Canada.

C To X Band Coaxial Directional Couplers

Item 2014

A new broad band series of coaxial couplers covering a $2\frac{1}{2}$ to 1 frequency range with flat coupling and high directivity from 4,000 to 10,000 mc has been introduced by the Narda Microwave Corporation, Mineola, New York.

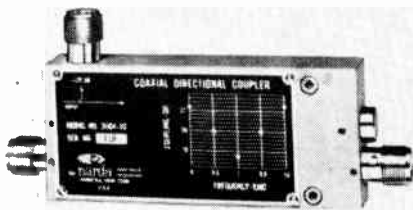

A unique feature incorporated into each new coupler is a name plate which includes a chart providing calibration to 0.2 db accuracy at five frequencies.

To insure the high directivity characteristics of these couplers, the secondary arm termination is completely built-in.

Models are available for 10, 20, and 30 db coupling, all with Series N, female connectors and a 1.2 primary line and 1.3 secondary line VSWR.

Exclusive Canadian sales representative for these Narda couplers is Mel Sales, a Division of Measurement Engineering Limited, Arnprior, Ontario.

Valve Voltmeter

Item 2015

Advance Components Limited of England announce Type 77 Valve Voltmeter, which is an extremely compact and portable instrument of high performance. Its dimensions are the smallest consistent with serviceability and good instrument design. It incorporates a four-stage amplifier with bridge rectification to the meter.

There are twelve ranges covering from 0.001 volt to 300 volts a.c. and measurements are possible down to $100\mu\text{V}$. A very low capacity screened lead (PL40) is provided for use on the more sensitive ranges. The scale is calibrated in r.m.s. volts and also dB referred to 0 dBm (1 milliwatt 600 ohms). Measurements may be made between 10 c/s and 5 Mc/s and, having a high input impedance (10 Megohms), it is useful for all amplifier measurements and voltage measurements generally.

Type 77 can also be used as an amplifier with a gain of 1000, adjustable in 10 dB steps, up to 5 Mc/s. It is very useful as an oscilloscope amplifier, and high impedance loads do not affect the voltmeter reading. A low-capacity lead which completely screens the input, and incorporating a screened test-prod, is supplied with the instrument.

The instrument has a $4\frac{1}{2}$ in. scale, fitted with an anti-parallax mirror, and is fused by a slow-blow device which permits temporary short circuits.

Type 77 can be used on mains voltages from 100-130 V and 200-250 V.

For additional information apply to the Canadian representative — Mr. J. B. Smyth, 380 Craig St. West, Montreal 1, Que.

Teaching Machine

Item 2016

A "Teaching Machine" for training operators in the use of typewriters, teleprinters, desk calculators, Morse transmission keys, and similar key punch machines has been developed by the Solartron Electronic Group Limited, represented in Canada by Computing Devices of Canada Limited.



With this machine, an organization which has to train punch-operators will be able to ascertain much more quickly — probably inside half an hour — whether any of their trainees are basically unsuited to keyboard operating. Those operators who are successful on the teaching machine will learn much more quickly than with a human teacher, in part because the impersonality of the machine will never incur personalized frustrations or antipathies.

The Solartron Teaching Machines have been especially designed to give each trainee progressive training as would in fact be given by a human teacher. In addition, the machine continuously gages each trainee's individual performance and assesses on a basis of "goodness factor" the assistance given with each exercise. Thus, if the trainee makes a consistently good effort in following the easier exercises which are displayed first, the Solartron Teaching Machine presents more difficult exercises — but if mistakes are then made the rate of presentation will ease off. In addition, the machine will eventually concentrate on only badly assimilated parts of the exercise. A guide panel which is illuminated as a "ready reference" guide to the group of exercises is also controlled, via the measuring of operator efficiency, so that when a fairly high level of proficiency is achieved the illumination fades and eventually disappears altogether.

The manufacturers claim that use of the Solartron Teaching Machine will significantly speed up the training of operators on all key punch machines.

Computing Devices of Canada Limited, P.O. Box 508, Ottawa, Ontario.

General Purpose Counter

Item 2017

General Purpose Counting Equipment Type 1339A has been developed by Airtec Limited of High Wycombe, Bucks., England, in conjunction with the United Kingdom Atomic Energy Research Establishment to provide comprehensive scaling facilities for Geiger and Scintillation Counters used for the accurate assay of Alpha, Beta and Gamma active samples.

Two main units form the basic equipment and these may be supplemented by suitable sub-units for Beta Gamma Counting to serve any of the alcohol quenched types of Counter and most types of halogen quenched counters, or for Alpha Counting with Scintillation Type Probes.

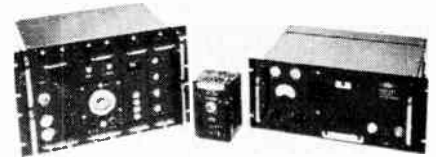

Of the two main units, the Power Unit provides all the power supplies, including stabilized E.H.T. for the basic equipment and all accessory equipment. The Scaling Unit, the second of the two units referred to, consists of a Slow Scaler Sub-Unit and a Paralysis/Timing Sub-Unit. It also has incorporated a Dummy Panel and Adaptor Panel which are replaced by the accessory units when required.

Write for further particulars to the Canadian representative — Radio Communication Equipment & Engineering Ltd., 850 Fifth Avenue, Lachine, Montreal 32, Que.

Post-Amplifier

Item 2018

The new Millivac VS-102A post-amplifier has a gain of 300, a frequency response of 20 cps - 10 MC and a maximum output of 28 V peak-to-peak. Its output impedance is adjustable between 35 and 130 ohms, to match various transmission lines. It is used to increase the output voltage and output power of continuous wave generators and sweep generators, to make possible alignment of amplifier output stages at their true high operating signal level. Capacitive loads as high as 100 MMF have practically no influence on the output voltage of this amplifier at its upper 10 MC frequency limit.

Millivac Instruments, a division of Cohu Electronics, Inc., 2315 Second Ave., Schenectady 3, N.Y., U.S.A.

Silicon Power Diodes

Item 2019

Miniaturized, hermetically sealed silicon power diodes, developed specifically for applications where savings in space and weight are prime considerations, are now available from International Rectifier Corporation, of El Segundo, California. The diodes provide d.c. forward currents up to 45 amperes with a maximum peak inverse voltage to 500 volts.

These units are designed for use at high temperatures and are capable of operation at a junction temperature of 200°C. Manufactured to meet rigid military requirements, the diodes utilize the latest advances in ceramic-to-metal hermetic sealing to provide added stability in environmental extremes of temperature, shock and vibration. To further increase reliability, no soft solders or fluxes are used in the sealing operation.

Bulletin SR-304, describing these units in detail, is now available from the Canadian factory representatives, Atlas Radio Corporation Ltd., 50 Wingold Ave., Toronto 19, Ontario.

New Products

Wide Range Audio Generator

Item 2020

Type 81 Wide Range Audio Generator, a product of Advance Components Limited of Hainault, Ilford, England, provides a maximum output of one watt into 600 ohms over a frequency range of 15 c/s to 200 kc/s and employs modern techniques in electrical design and construction, including printed circuits. Outstanding attenuation and source impedance facilities and the wide frequency range combine to make this model a very useful instrument with extensive applications.

This signal generator employs a resistance-capacitance Wien bridge oscillator which may be switched to any of four ranges. The oscillator frequency is controlled by a variable capacitor, the frequency reading being calibrated on a drum scale of length 8 ins. A logging dial increases the effective scale length to approximately 18 ins. The oscillator is stabilized against changes of output level and distortion.

The output level is controlled by units and decade attenuators. The units attenuator consists of a potential divider composed of close tolerance high stability resistors. The voltage applied to this attenuator is monitored by a rectifier meter calibrated from 2.8 volts and 5.25 volts r.m.s. into 600 ohms. The level is either continuously variable or adjustable in 1 dB steps. The total range of the output voltage is from 20 mV to 25 V r.m.s. into 600 ohms. The output from the units attenuator is fed to the amplifier and output stages, which in turn feed the decade attenuator via an unbalanced to balanced transformer.

Further details may be obtained from the Canadian sales agent and representative: Mr. J. B. Smyth, 380 Craig St. West, Montreal 1, Que.

Telemetry Counter

Item 2021

Greatly simplified telemetry measurements, which combine high resolution and short measurement time, are made with the new Model 2503 FM/FM Telemetry Counters manufactured by Dynac, Inc. in Palo Alto, California.

With the 2503, RDB channels are push-button selected and the visually displayed count is normalized to read deviation from midband directly in percent of the midband period. By using a period measurement technique, percent-deviation readings as well as count time and resolution are independent of channel. A resolution of one part in 10^5 is achieved with a one-second measurement period. The measurement period can be reduced by front-panel control to 0.1 second.

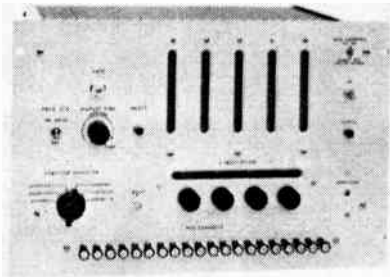

The 2503 has five decimal places and uses an internal crystal-controlled, 100-ke time base or an external time base. It also measures frequency and ratio either directly or normalized. Two models are available, one specifically for simplified measurements and field use, the other for greater flexibility in laboratory use. Field model available in either cabinet or rack mountings, Lab model in rack only.

For further information contact the Canadian representative: Atlas Instrument Corp., 50 Wingold Ave., Toronto 19, Ont.

Transistorized Voltage Regulated Power Supply

Item 2022

Kepeco Laboratories, Inc. announce the release of a new tubeless transistorized small package voltage regulated power supply featuring excellent regulation, low ripple content, fast recovery time, good stability, low output impedance, low temperature coefficient, short circuit protection, over-current control, remote programming, and remote error signal sensing.

The Model SC-36-0.5 delivers 0.36 volts, 0-0.5 ampere. Regulation for line or load is less than 0.1% or 0.003 volt, whichever is greater. Ripple is less than 1 millivolt RMS. Recovery time is less than 50 microseconds. Stability for 8 hours is less than 0.1% or 0.003 volt, whichever is greater. Operating ambient temperature is 50°C maximum. Temperature coefficient is less than 0.05% per °C. Output impedance is less than 0.04 ohm.

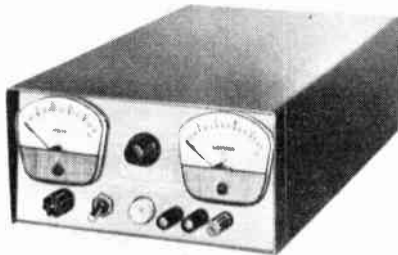

Additional features include the following: Overtemperature protection; continuously variable output voltage without switching; a design to operate continuously into a short circuit; either positive or negative can be grounded; units can be series connected; suitable for square wave pulsed loading; terminations on front and rear of unit; power requirements 105-125 volts, 50-65 cycles. 400 cycle units are available.

This compact unit is 8 $\frac{1}{2}$ " wide, 4 $\frac{1}{4}$ " high, and 13 $\frac{1}{2}$ " deep. A rack adapter is available. Kepeco Laboratories, Inc., 131-38 Sanford Avenue, Flushing 55, N.Y., U.S.A.

Microsecond Chronometer

Item 2023

This instrument is one from the new range of "Cintel" transistorized equipment for time and frequency measurement produced by Rank Cintel Limited of London, England.

Transistors are used throughout together with printed circuit techniques giving rise to an extremely light and portable instrument with very low power consumption. To give extra lightness combined with great strength, the case is manufactured from fibreglass.

Specification

Time Range: 1 μ sec to 1 sec in 1 μ sec steps.

Accuracy: The accuracy is determined by that of the crystal plus the inherent gating error which is constant at $\pm 1 \mu$ sec.

Crystal Accuracy: Without Oven $\pm 0.002\%$. With Oven: Long term stability better than ± 2 parts in 10^6 week. Greater accuracy, or a longer range of time measurement can be obtained by the use of an external frequency standard.

External Frequency: Frequency: 30c/s to 1.2Mc s.

Standard: Amplitude: 5V peak to peak. Input Impedance: 5k Ω 306 pF.

Gate: The gate is operated in response to +ve and -ve going pulses in any combination. Amplitude: 1 to 20V peak. Input Impedance: 500 Ω 30 pF. Rise Time: Not important as separate start and stop triggers provided.

Output Frequency: Sub multiples of the internal crystal frequency are provided at a level of 5V peak in 2000 Ω . The following frequencies having a 1 in 4 duty cycle are obtainable: 10, 10 2 , 10 3 , 10 4 and 10 6 c/s. Accuracy to that of crystal.

Reset: Resetting of the equipment to zero after the completion of a measurement is obtained by manual operation of the reset

button. Alternatively it can be accomplished by open circuiting the terminals provided.

Power Input: The instrument is designed for mains or battery operation and contains its own stabilized power supply. Mains Input: 110-120V, 200-250V a.c. in 10V steps. 40-100 c/s. Battery Input: 12V d.c.

Consumption: 130mA at 12V d.c. (without crystal oven). 505mA at 12V d.c. (with crystal oven).

Transistors: 40 Mullard OCC44, 10 Mullard OC45, 36 Mullard OC71.

Additional data about this equipment may be obtained by reference to **Dawe Instruments Ltd., Canadian Division, 1654 Bank Street, Ottawa, Ontario.**

Miniature Co-Axial Connectors

Item 2024

A new series of miniature coaxial connectors designed for use with coaxial cable and for mounting on printed circuit boards is announced by H. H. Buggie Inc., of Toledo, Ohio. Designated the ECC series, connectors are available in a 50 ohm constant impedance group, 50 ohm non-constant impedance group and 93 ohm non-constant impedance group. Connector bodies are brass with albaloy plating, insulation is machined Teflon. Rated voltage for the series is 500 d.c. Mounting pins are for standard $\frac{1}{16}$ -inch line spacing.

The series are in the 50 ohm constant impedance group and include a straight receptacle, right-angle receptacle, 360-degree swivel-type receptacle and an interchangeable mating plug. Height of the straight receptacle is $1\frac{1}{16}$ -inch and mated length with the $\frac{3}{4}$ -inch long plug is $1\frac{1}{16}$ -inch. The right-angle receptacle is $\frac{5}{16}$ -inch high, mated length is $1\frac{1}{16}$ -inch. Height of the swivel-type is $2\frac{3}{16}$ -inch, mated length $1\frac{1}{16}$ -inch.

For further information, write to H. H. Buggie Inc., Box 817, Toledo 1, Ohio, or their Canadian representatives, Chas. W. Pointon, Limited, 6 Alcina Avenue, Toronto 10, Ontario.

Multi-Purpose Counter In Package Form

Item 2025

Following closely on the announcement of their Model C, the first in its new series of transistorized electronic counting packages, Veeder-Root Inc. of Hartford, Conn., now announces the second in this series: The Model N-1 "Count-Pak".



This complete counting package utilizes a compact, glow-transfer, cold-cathode counting tube, and a high-speed magnetic counter, combined with a small, adaptable photo-head. Unit is designed to count accurately at speeds up to 30,000 counts per minute for more than one billion counts, and it will reset at rated speeds without losing counts.

As in all its "Count-Paks", Veeder-Root uses transistors and printed circuits (no tubes or relays) which mean low heat and simple wiring, both basic factors in long and uninterrupted operation. Model N-1 comes in a rugged, 2-tone case. And the photo-head can be assembled in configurations to meet the requirements of any application.

This multi-purpose counter can be used to measure accurate lengths, to count high-speed shaft revolutions, and to count objects like fruit, bearings, pencils, packages, cans, pills, etc. Prices and details may be obtained through Veeder-Root of Canada Ltd., 955 St. James St. W., Montreal, P.Q.

News Report

A monthly roundup of news and personnel changes in the Canadian electronics industry

Electronic Manufacturers Elect New President

The Association formerly known as the Radio-Electronic-Television Manufacturers Association of Canada held its 29th Annual Meeting on June 20th at the Bigwin Inn, Muskoka, Ontario. At that time the new name of the Association was adopted, and henceforth it will be styled the Electronic Industries Association of Canada.

On that occasion Ronald M. Robinson was elected as President of Electronic Industries Association of Canada for the ensuing year. As EIA chief, he heads a hundred-plus company group, representing an industry — including supporting services — producing \$500 million a year.



R. M. ROBINSON

Mr. Robinson is Vice-President and General Manager, Electronic Equipment and Tube Department, Canadian General Electric Company Limited, in Toronto. He joined the company in 1928, serving first as an apprentice. He then returned to complete his school education, attended the University of Toronto and graduated in 1935 with a B.A.Sc. Honors Degree in Electrical Engineering. In that same year Mr. Robinson returned to C.G.E. as an illuminating engineer. Promotions quickly followed, and in 1944 he became General Manager of the C.G.E. subsidiary, the Wheeler Reflector Company of Canada Limited. From then on he advanced rapidly to become general manager in turn of several divisions of the company, and in 1955 was appointed to his present position.

Baldwin Addresses EIAC 29th Convention

Excerpts From Address Of J. R. Baldwin, Deputy Minister, Department of Transport, To The 29th Annual Meeting Of RETMA, Bigwin Inn, Muskoka, Ontario — June 19th and 20th, 1958.

For report of address see EIAC Report, pages 7 and 8.

"In keeping with Canada's development, the government-owned Canadian Overseas Telecommunication Corporation has reduced our dependence on foreign-owned international communication systems."

"Recent departmental activity in the field of aeronautical telecommunications includes Airway VOR and radar-improved air traffic control displays and data processing systems, meteorological facsimile and high speed data transfer and computation. We must also work towards improved air/ground communications in Northern Canada and the longer overseas routes."

"We are bound to see, I believe, the extension of telegraph and telephone service to remote areas as yet unserved, increased capacity on all communication systems to permit expansion of the private wire teletype and data processing services, and increased telephone cable capacity and inter-city dialling on our telephone systems which will, of course, necessitate extension and expansion of existing microwave systems."



J. R. BALDWIN

"... the Department is continuing its improvement of marine radio services and is studying the possibility of expanding radio traffic control to include certain canals, locks and other confined waters. The matter of authorizing operation of radiotelephone equipment by ships officers for bridge-to-bridge communication is also under consideration."

"... color television is, without question, the next forward step. Manufacturers have an important job in this field. Techniques must be evolved which will permit lowering color television equipment costs. Once this is done, a fertile field will undoubtedly be opened up."

E.I.A.C. EXECUTIVE



Electronic Industries Association of Canada executive elected at recent 29th annual meeting are shown above. Back row (left to right): J. D. Houlding, Ralph A. Hackbusch. Front row (left to right): E. Leaver, W. H. Jeffrey, Past President, R. M. Robinson, President, S. D. Brownlee and J. Key.

IRE Convention News

Variety Keynotes Technical Papers Col. Kurt Swinton Banquet Speaker

The application to brain surgery of ultra-high frequency sound waves and the choice of White Lake, B.C. as a site for Canada's largest radio telescope will be among the 120 subjects covered by scientists meeting here October 8th, 9th and 10th for the Institute of Radio Engineers 1958 Convention and Exposition.

Details of the Technical Program and Exposition have been announced by Dr. George Sinclair, Chairman of the IRE Executive Committee responsible for planning the Convention, and by A. P. H. Barclay, Technical Program Chairman. Twenty-five sessions covering fields ranging from medical electronics and education to cosmic rays and microwave systems will comprise the three-day Technical Program. Over 300 exhibits featuring nucleonic and electronic projects, products and components will be on display in the Exposition.

According to Dr. Sinclair, 86 per cent of the space allotted commercial exhibitors is now booked. Other areas, he added, are being reserved for scientific agencies in Britain, the United States, Russia and France. It is hoped that these nations will accept invitations forwarded through diplomatic channels, and send to the Convention exhibits devoted to Sputniks, Zeta and other headline developments, Dr. Sinclair said.

In two previous years, the IRE Convention has been established as one of Canada's outstanding scientific events. For the first time this year the

full text of all technical papers presented will be reproduced with drawings and diagrams in a Convention Record. This costly project will be underwritten by the IRE.

The education of engineers and scientists will again be a major topic discussed at the Convention. Colonel Kurt Swinton, vice-president of the Encyclopaedia Britannica of Canada Ltd. and a leading authority on education, will be the Banquet Speaker on Thursday, October 9th. During the Technical Program a panel of distinguished Canadian, United States and, possibly, British and Russian scientists will discuss the balance between theory and practice in engineering education.

Medical electronics will be the subject of two of the 25 technical sessions. William J. Fry, a scientist at the University of Illinois will present the paper on the application of ultra-high frequency sound waves to brain surgery. He will explain how focussed beams of ultra-sound have been used to produce changes at any desired depth in the brain without disrupting intervening tissue. His report will be based on a neurosurgical program being carried out in collaboration with the Neurosurgery Division of the State University of Iowa.

Scientists from the National Research Council will describe the search for a suitable location for the Dominion Observatory's radio telescope and the reasons for the decision to locate at White Lake near Penticton,



COL. KURT SWINTON

B.C.

The spacious Automotive Building in the grounds of the Canadian National Exhibition will again be the scene of the IRE meeting. Technical sessions as well as the exposition will be staged there.

IRE members, professional engineers, technicians, business executives, educators and students will attend the Convention. Exhibits will also be viewed by the general public on the final evening and by senior high school students. Six science students from universities across Canada will attend the Convention as guests of the IRE.

IRE Technical Program Committee



Members of the Technical Program Committee for the Institute of Radio Engineers 1958 Convention and Exposition. From left to right: R. J. A. Turner, Philips Electronics Industries Ltd.; Frank A. Ford, Canadian General Electric Co. Ltd.; J. R. Bain, Engineered Sound Systems Ltd.; Chairman, A. T. H. Barclay, Philips Electronics Industries Ltd.; W. E. Hodges, Electro-Acoustical Consultant; W. Ornstein, Canadian Marconi Co. Ltd., Montreal. The three other members of the Committee not shown in the photo are: L. Kerridge, Ryerson Institute of Technology; Vice chairman. D. K. Ritchie, Ferranti Electric Ltd.; G. Sinclair, Sinclair Radio Laboratories Ltd.

INSTITUTE OF RADIO ENGINEERS 1958 CONVENTION AND EXPOSITION

TECHNICAL PROGRAM SCHEDULE OCTOBER 8, 9, 10

Date	Papers To Be Presented				
Wed. October 8 2:30-5:00 p.m.	Electronics for Guided Missiles	Industrial Electronics	Reliability Requirements & Achievements in Design and Production	Broadcast and Transmission	Propagation
Thur. October 9 10:00 a.m.-12:30	Aircraft Electronics	Industrial Electronics	Education	Medical Electronics	Antenna Design
Thur. October 9 2:30-5:00 p.m.	Stereophonic Disc recording and Audio	Semi-conductor Theory and Measurement	Communication Systems	Cosmic Radiation	Aircraft Theory
Fri. October 10 10:00 a.m.-12:30	Transistor Circuit Design	Astronautics	Engineering Writing and Speech	Medical Electronics	Microwave Theory Techniques
Fri. October 10 2:30-5:00 p.m.	Semi-conductor Applications	Computers	Vehicular Communications	Design Techniques	Microwave Systems

New Caldwell Appointment

Gordon Fraser has been recently appointed manager of the Caldwell Lab., according to an announcement by Sydney Banks, Production Vice-President of S. W. Caldwell Ltd.

Mr. Fraser has had some eighteen years' experience in the film industry. He has been associated with Rapid, Grip and Batten, the National Film Board, Dynamic Films in New York and more recently with Shelly Films as sales manager.

Mr. Fraser, in his new capacity, will be in charge of all laboratory functions.

11-Storey H.O. Building For Union Carbide Canada

A. A. Cumming, president, Union Carbide Canada Limited, recently announced that building operations on the company's new head office building at 123 Eglinton Avenue East, Toronto, will proceed at once on the superstructure, the two-level substructure of the eleven-storey building having already been completed.

The new premises will occupy an entire block on Eglinton Avenue East near the Yonge Street subway terminus, and will bring together the management personnel of Union Carbide and its present operating Divisions — Bakelite Company, Carbide Chemicals Company, Electro Metallurgical Company, Linde Air Products Company, National Carbon Company and Visking Company, as well as a new Division to be announced shortly.

Union Carbide Canada Ltd. which operates 29 plants across Canada has other major construction projects underway including an addition to the Carbide Chemicals plant at Montreal East and a Linde oxygen tonnage plant at Sault Ste. Marie, Ontario.

Couch Ordnance, Inc. Names Canadian Rep

Couch Ordnance, Inc. of 3 Arlington St., North Quincy 71, Massachusetts, has recently appointed a Canadian representative in Leonard Electric Limited, 346 Bering Avenue, Toronto 18. The telephone number of Leonard Electric Limited is BELmont 1-2731.

Couch Ordnance, Inc., which is a subsidiary of S. H. Couch Company, Inc., manufactures standard relays and switches.

Merger Announced Of Two Electric Firms

Consolidation of Ferranti Electric Ltd., Toronto, and Packard Electric Co. Ltd., of St. Catharines, has been announced. The new name of the two merged firms will be Ferranti-Packard Co.

Thomas Edmondson, formerly president and general manager of Packard Electric, will be the president and chief executive officer of the new company with Dr. J. M. Thomson, formerly president and general manager of Ferranti Electric, acting as chairman of board of Ferranti-Packard Co.

The new consolidation will manufacture products formerly produced by both companies. The plants of both companies will be utilized in the manufacture of the various types of products.

Servomechanisms (Canada) Appoints European Rep

Servomechanisms (Canada) Limited, Toronto 15, Ontario, has announced the appointment of *Materiels et Constructions* as its exclusive representative for sales engineering and technical liaison throughout Europe and the British Isles. The address of *Materiels et Constructions* is 15 Rue

de la Faisanderie, Paris XVIe, France.

All the products and services of Servomechanisms Inc., of Hawthorne, California, and Westbury, New York, as well as the products of the Canadian organization are available throughout the world through Servomechanisms (Canada) Limited.

Canadian Research Institute Celebrates Twentieth Birthday

On June 8, 1958, the Canadian Research Institute marked its twentieth anniversary and completed twenty years of progress in research and development.

R. Spencer Soanes, M.A.Tor., M.E.-I.C., the founder and president of the Institute, reflecting on the major revolution in thinking amongst Canadian firms in their attitude towards re-



R. Spencer Soanes

search, made the following observations: "In 1938, approximately 60 per cent of manufacturers who were interviewed stated dogmatically that they had no production problems whatsoever and believed themselves capable of either handling all developmental problems or of expecting all new products to come to them effortlessly through an affiliate or parent firm outside this country. Less than 5 per cent of executives talked to were willing to discuss their problems with an outside research firm. Now, twenty years later," continued Mr. Soanes, "while there is still the occasional diehard who insists he has no plant difficulties, most firms freely admit some shortcomings and are prepared to accept outside expert assistance."



TANTALEX[®]
SOLID ELECTROLYTE
CAPACITORS

Sprague's new solid-electrolyte tantalum capacitors combine true miniaturization with electrical stability previously unobtainable in an electrolytic capacitor of any type. They are ideal for transistorized circuits. Write for Bulletin 3520B.

**CANADIAN
MANUFACTURING
REPRESENTATIVE**

Micarta Fabricators
Limited
18 Toronto Street
Toronto, Ontario
Phone EMpire 8-4251

News Report

Hysol (Canada) Ltd. Has New Location

Hysol (Canada) Ltd., formerly at 184 Laird Drive, Toronto, has announced its recent change of address to 44 Beechwood Drive, Toronto. The mailing address, however, is: P.O. Box 53, Station "R", Toronto 17, Ont.

The telephone number at the new offices is HOward 1-0708.

Closed-Circuit TV Conveys Weather Forecasting Data

The first successful demonstration of closed-circuit television in Canada to convey meteorological forecasting data to commercial airline pilots was recently held at the Department of Transport facilities, Dorval Airport, Montreal, according to a recent announcement by P. T. Wilson, manager of sales and planning for Canadian General Electric Company's communications equipment.

ELECTRONIC ENGINEER

Nationally known firm of manufacturers' representatives has opening for engineer with background in modern dry type rectifiers, sales and application. Excellent opportunity for right man.

Box 1017

ELECTRONICS & COMMUNICATIONS
450 Alliance Ave. - Toronto 9, Ont.

While tests were still being conducted, Mr. Wilson said, complete details of the demonstration were not yet available, but he intimated that both the Department of Transport and Commercial Airlines had witnessed for the first time a close-up view, by means of closed-circuit TV, of a technique which could provide the solution to a communication problem which is becoming increasingly serious.

As municipal airports become larger and more complex, the need has become evident for an effective, economical way of making weather information available at the most convenient pilot briefing point. Mr. Wilson outlined the way recent developments in closed-circuit TV had provided a "relatively inexpensive answer" to this vital communication problem and yet achieved a feeling of "live" participation.

Northern Electric Announces Building Program

Northern Electric announced today that they are preparing plans and specifications for a manufacturing plant to be built on the land which they own on 401 Highway at Wellington Road, south of London, Ontario. The plant will ultimately have floor space in excess of three hundred thousand square feet and employ more than 1000 people in the manufacture of telephone apparatus.

Northern Electric's present program is to call for tenders at the beginning of 1959 for construction to commence in the early spring of the year with the plant to be available for partial occupancy by the year end.

These plans are contingent upon the existence of a high rate of activity in the telephone manufacturing industry. Such activity is dependent upon the demand for telephone apparatus by the operating telephone companies in the various Canadian Provinces and is controlled to a major extent by the level of the construction program of The Bell Telephone Company of Canada. That program will depend upon the outcome of the Telephone Company's recent application for a rate increase.

Northern Electric state, however, that in the event of the rate application being unsuccessful and the Bell construction program reduced, their plant building program will be reassessed and may be deferred.

Stanley M. Smith

Stanley M. Smith, well-known in electrical industry circles from coast-to-coast, died May 25th at his summer home at Shebandowan, Ontario.

Mr. Smith joined Canadian Westinghouse in 1913 as a salesman for the company's Halifax office. He served with distinction in World War One, receiving the Military Cross and retiring with the rank of Captain.



FOREMOST IN

SONAR

**UNDER WATER ACOUSTIC DETECTION
AND RANGING EQUIPMENT**

Edo

(CANADA) Ltd.

CORNWALL, ONTARIO

For further data on advertised products use page 65.

World's First Battery Operated Pocket Tape Recorder

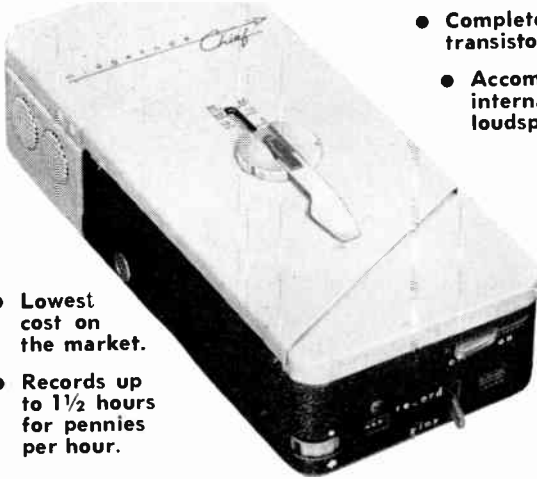

- Completely transistorized.
- Accommodates internal loudspeaker.

- Lowest cost on the market.
- Records up to 1½ hours for pennies per hour.

Midgetape is pocket size. It has a variety of devices for confidential recordings. Power converters for non-battery use in car, office or home. One battery with visual life indicator. Ideal for engineers, lawyers, insurance investigators, doctors, public relations and salesmen, as well as for inventory taking.

INSTANTANEOUS RECORDING SERVICE
40 - 42 LOMBARD STREET - TORONTO 1, ONTARIO
TELEPHONE EMPIRE 3-5767

Do You Require a High Temperature PRECISION RESISTOR?

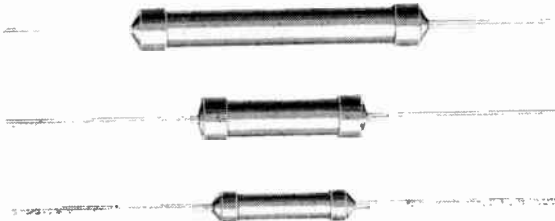

NEW



IRC Precision carbon alloy film resistors feature:

- 200° c operation.
- Lower temperature coefficient.
- High value performance.
- Available in ½-1-2 watt sizes at ± 1% tolerance.

(Types HTC, HTF, HTH)

Write Department 23 for further information.

INTERNATIONAL RESISTANCE CO. LTD.
349 CARLAW AVE. TORONTO 8, ONT.
SALES OFFICES:
Radiovision Sales Ltd. 492 Somerset St. West 1500 St. Catherine St. West
325 Tenth Ave. West Ottawa Montreal
Calgary, Alta. Ont. Que.



F. V. TOPPING • *Electronics Ltd.*

DESIGN - PRODUCTION - ELECTRONICS

- Radio Frequency Control Equipment
- Careful Custom Production
- Communications Accessories
- Transistorized Equipment: Power Converters Public Address Systems

A CANADIAN COMPANY WITH NEW IDEAS

94 Laird Drive HU. 7-1546 Toronto 17, Ont.

TYPE PCB FOR PRINTED WIRING

Electrolytic capacitor in wax impregnated cardboard tubes sealed with high temperature wax. Terminals are solder coated brass, well suited for dip soldering.

Wide range of capacities and voltages.

Canadian Sales Representative

WM. T. BARRON

939 Lakeshore Road — Toronto 14, Ont.

Daly Capacitors Limited

FORMERLY DALY-ARROW LIMITED
Manufacturers of Electrolytic Capacitors
140 KENDAL AVE., TORONTO 14, ONT.



the NEW High Brightness Neon Glow Lamp NE-51H

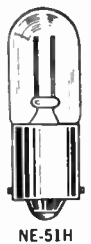

This lamp may be operated at about 3 times the level of current that may be applied to the standard lamp, and it will produce 8 times as much light — with long life !

For prompt delivery on this and other Neon Glow Lamps contact us.

Lake Engineering Co. Ltd.

767 WARDEN AVE SCARBOROUGH, ONT.
PLYMOUTH 7-3253

COMPUTER APPLICATION CONFERENCE



The above photograph shows a group of well-known Canadian and American Engineers planning for the coming AIEE Power Industry Computer Application Conference. The International Session is to be held at the King Edward Hotel, Toronto, September 15-17, 1958. An interesting program is being planned dealing with the application of computers to many varied engineering problems, and will be of value to all engineers.

Microwave Network Extends From Sea To Sea

July first, birthday of the Dominion of Canada, also marked the official opening of the world's longest single microwave network system. The \$50 million project was a major engineering and construction undertaking that involved pioneering in a real sense. Pushing the chain of microwave towers across Canada meant struggling through some of the roughest terrain and the severest weather this country can offer.

The continent-spanning microwave network, built and operated by the Trans-Canada Telephone System, is

now able to knit the people of Canada more closely together through the "picture-window" of television.

Seven of Canada's major telephone systems — three of them government-operated and the others privately-owned — pooled their efforts to construct the coast-to-coast backbone microwave network. The scores of long-haul telephone circuits the system now provides will play an important part in Canada's business progress and prosperity.

In the words of Thomas W. Eadie, Bell Telephone president and chairman of the Trans-Canada Telephone System, the microwave network "constitutes one of the most significant

advances in the history of Canadian communications; it will augment tremendously Canada's communications resources, so necessary for the continuing growth and expansion of a country with such vast dimensions."

Newfoundland will be linked to the microwave network next year when Canadian National Telegraphs completes the difficult 70-mile hop across the Cabot Strait.

Electrohome Appointment

Francis A. Banks, Manager of the Technical Products Division of Dominion Electrohome Industries Limited, has announced the appointment of James Court as Sales Manager for the Division. Mr.

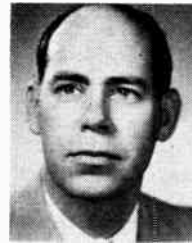

James Court

Court will be in charge of the sale of industrial electric and electronic equipment for use in the manufacturing and process industry in Canada. He has held positions, as project engineer and sales manager, with leading Canadian manufacturers. During the war, he served as a radar technician in the R.C.A.F. Upon his discharge, he attended the University of British Columbia from which he graduated in 1951 with the degree of Bachelor of Applied Science in Electrical Engineering.

ANOTHER PRODUCT OF CANADIAN INGENUITY:

A truly dependable source of 20 c/s ringing current.

- Independent of A.C. mains.
- No maintenance.
- Accurate frequency for signalling.
- 20 watt capacity.

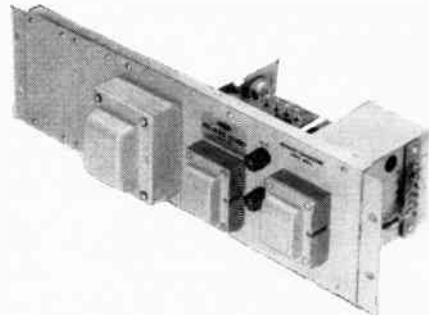

PYLON RINGING GENERATOR
TYPE RG-1

**LEADERS IN QUALITY,
AVAILABILITY**

For a complete line of
RECEIVING AND PICTURE TUBES

POWER AND TRANSMITTING TUBES

TRANSISTOR, DIODES AND RECTIFIERS



Electronic
TUBES

CANADIAN GENERAL ELECTRIC COMPANY LIMITED

Yes! for **DEPENDABILITY** **STRUTHERS DUNN CONTACTORS**

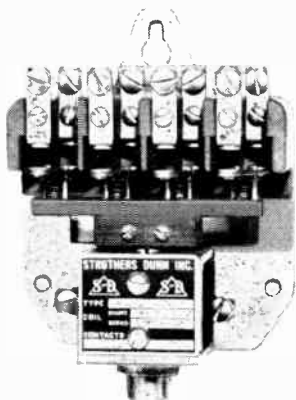

48KXX (3 pole)
48LXX (4 pole)

FEATURE

- Rugged construction for long, trouble-free operation.
- Compact design for easy insulation — even with heavy gauge wire.

Exceptionally well suited to built-in motor control applications.

Generous safety factor under high overload conditions.

Write to Department 20 for Bulletin 7048.

RELAY DIVISION J.R. LONGSTAFFE CO. LTD.
300 CAMPBELL AVE., TORONTO, ONTARIO

for an entirely new
range of time delays

delay intervals:

$\frac{1}{10}$ to 5 seconds

recovery rate:
extremely rapid

specify sturdy, thoroughly
field-tested

G-V HOT WIRE TIME DELAY RELAYS

Series H



Over two years of successful field service in electronic, aeronautical and industrial equipment prove these new G-V relays to be dependable, efficient and accurate.

- Adjustable Delay even though hermetically sealed
- DC or AC of any frequency for energization
- Small and Light. $\frac{3}{4}$ " diameter, $2\frac{3}{4}$ " length. Weight: 1 oz.
- Wide Ambient Range compensated from -70°C to 100°C or higher
- Continuous Energization without damage
- Available in 7-pin Plug-in and Flanged designs



Write for Pub. No. 35 — engineering data and drawings

G-V CONTROLS INC.

54 HOLLYWOOD PLAZA, EAST ORANGE, NEW JERSEY
Represented in Canada by:
LEONARD ELECTRIC, LTD., 346 Bering Ave., Toronto 18



CONTROL KEY SWITCHES for **LOW VOLTAGE MULTIPLE SWITCHING**

T.M.C. CONTROL KEY SWITCHES, precise in design and of robust construction, are today performing their vitally continuous work in varying apparatus all over the world.

Operators feeling the clean and positive "Make and break" action in any of the fifty standard spring combinations forget any fear of failure.

The contact springs made of nickel silver operated by hard plastic rollers on steel cams and silver contacts, ensure perfect performance. (Platinum or other metal can be supplied for special operating conditions.)

Telephone EM. 6-5314 or write for T.M.C. Control Key Catalogue giving full technical data to:

TELEPHONE MANUFACTURING CO. LTD.
SAXONY BUILDING • 26 DUNCAN STREET • TORONTO, ONT.

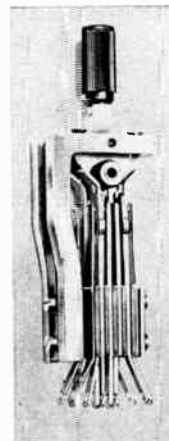

Lever type control
key switches (above)

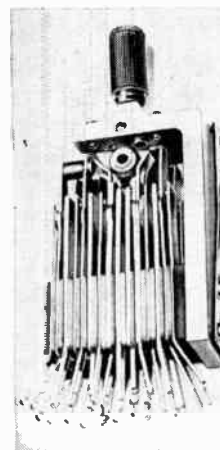

Plunger type
control key
switches →



1/8" Bit L. No. 70
Shield L. No. 68

ADCOLA
(Regd. Trade Mark)

3/16" Bit
L. No. 64

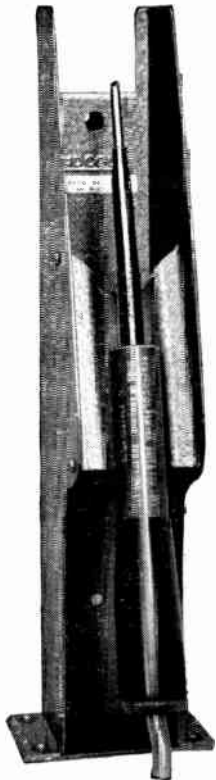

**C.S.A. APPROVED
SOLDERING
INSTRUMENTS**

Designed in Three Sizes
1/8" 3/16" & 1/4" Bits.

Manufactured for
All Supply Voltages
6/7 to 230/50 v.

Instruments maintain
soldering temperatures
and through jointing is
achieved in all the
fields of soldering, from
pin point to general
work in all sound equip-
ment.

Insulation standards are
approved in all leading
countries.

All Designs Cover the
Demands for Continual
Bench Production
Assembly.

Canadian, British and
Foreign Pats.
Reg. designs, etc.



Canadian
Representative:

L. J. LAMB
Box 103 - Weston, Ont.

**FOR PRECISION LABORATORY OR
PRODUCTION TESTING**

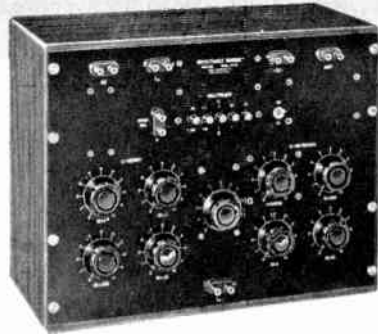

**FREED 1110-AB
INCREMENTAL INDUCTANCE BRIDGE
AND ACCESSORIES**

Accurate inductance measurement with or without su-
perimposed D.C., for all types of iron core components.

- INDUCTANCE — 1 Millihenry to 1000 Henry
- FREQUENCY — 20 to 10,000 Cycles
- ACCURACY — 1% to 1000 Cycle, 2% to 10KC
- CONDUCTANCE — 1 Micromho to 1 MHO
- "Q" — 0.5 to 100
- SUPERIMPOSED D.C. — Up to 1 Ampere
- DIRECT READING — For use by unskilled operators.

ACCESSORIES AVAILABLE:

1140-A Null Detector, 1210-A Null Detector — V.T.V.M.,
1170 D.C. Supply and 1180 A.C. Supply.

INSTRUMENT DIVISION

FREED TRANSFORMER CO., INC.

71 Weirfield St., Brooklyn (Ridgewood) 27, N.Y.

The BEST in PROJECTORS

**SUPERIOR PERFORMANCE
and RELIABILITY**

New JENSEN HYPEX
Projectors and Hypex
lifetime driver units.

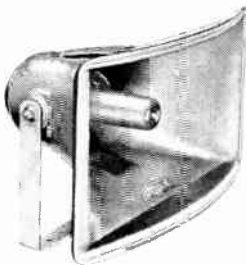

- Higher power ratings.
- Lifetime guarantee on driver units.
- Corrosion and weather resistant construction.
- A projector or driver unit for every requirement.
- 15 to 100 watts.
- Axial, radial, coaxial, rectangular types.
- 60 - 15,000 cycles.

Write to Department 22 for Catalog 1070.

SPEAKER DIVISION J.R. LONGSTAFFE CO. LTD.

300 CAMPBELL AVENUE

TORONTO, ONTARIO

Now!

**ARROW-HART
SWITCH
CONTROLS**

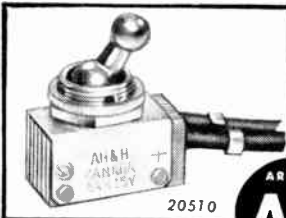

**FOR ALL YOUR
ELECTRICAL
APPLIANCES**

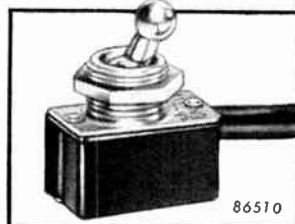
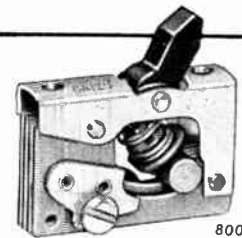

A complete range of one-hole
mounting, quick make and break
switches for vacuum sweepers,
fans, power tools, etc., and
radio and electronic equipment.

Send for your copy of the new illustrated Bulletin Z-2,
today. Ask us for any additional advice and information
you may need.

**ARROW-HART & HEGEMAN
(CANADA) LIMITED**

Industry Street, Toronto 15, Ontario, RO. 2-1101
7365 Mountain Sights, Montreal, Que.

Representatives:

Cochrane Stephenson (Western) Ltd., Winnipeg, Calgary,
Edmonton, Vancouver; George C. Robinson, Saint John, N.B.



5702

For further data on advertised products use page 65.

TRANS-CANADA SKYWAY

OPENED JULY 1st 1958

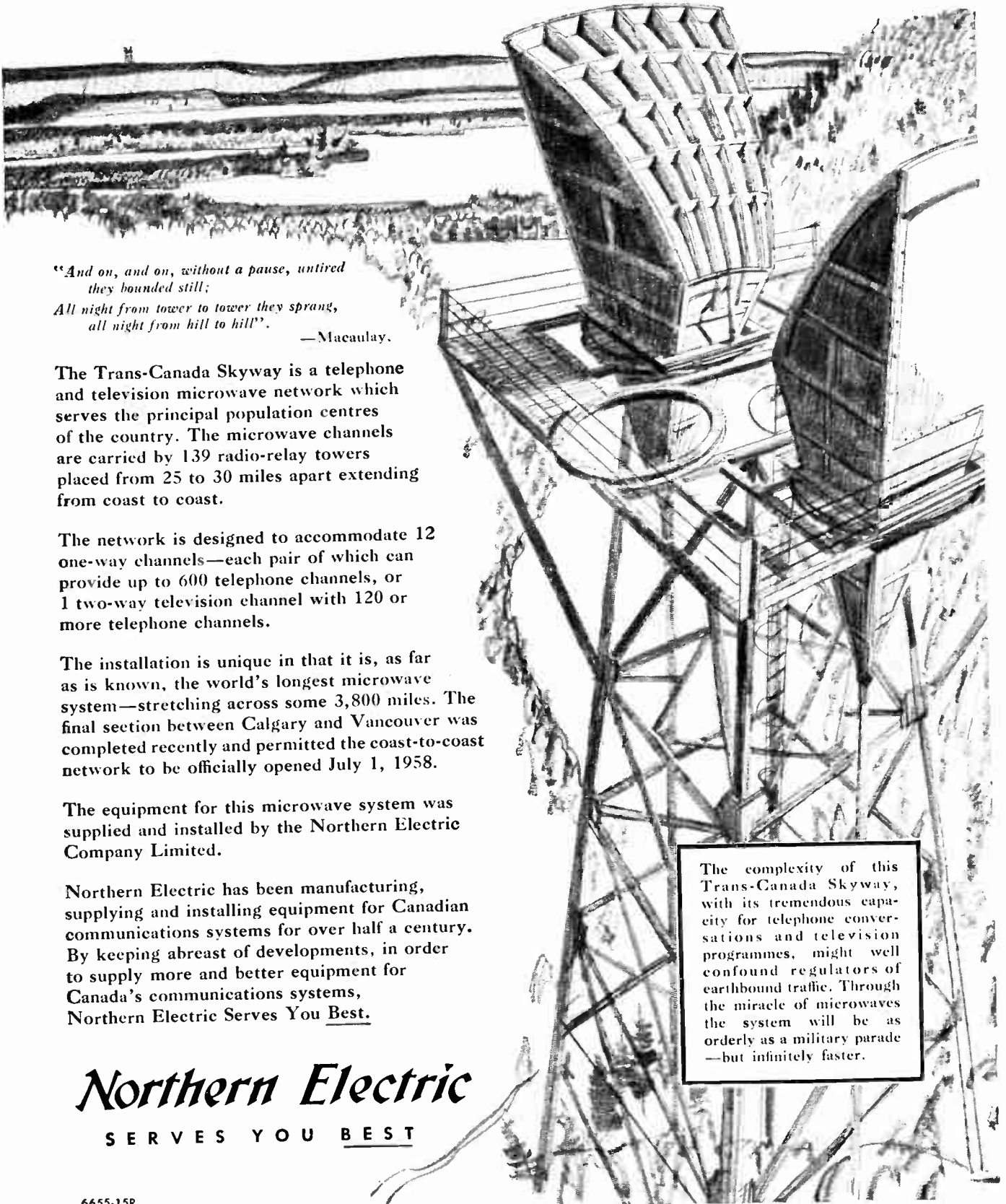

*"And on, and on, without a pause, untired
they bounded still;*

*All night from tower to tower they sprang,
all night from hill to hill".*

—Macaulay.

The Trans-Canada Skyway is a telephone and television microwave network which serves the principal population centres of the country. The microwave channels are carried by 139 radio-relay towers placed from 25 to 30 miles apart extending from coast to coast.

The network is designed to accommodate 12 one-way channels—each pair of which can provide up to 600 telephone channels, or 1 two-way television channel with 120 or more telephone channels.

The installation is unique in that it is, as far as is known, the world's longest microwave system—stretching across some 3,800 miles. The final section between Calgary and Vancouver was completed recently and permitted the coast-to-coast network to be officially opened July 1, 1958.

The equipment for this microwave system was supplied and installed by the Northern Electric Company Limited.

Northern Electric has been manufacturing, supplying and installing equipment for Canadian communications systems for over half a century. By keeping abreast of developments, in order to supply more and better equipment for Canada's communications systems, Northern Electric Serves You Best.

Northern Electric

S E R V E S Y O U B E S T

The complexity of this Trans-Canada Skyway, with its tremendous capacity for telephone conversations and television programmes, might well confound regulators of earthbound traffic. Through the miracle of microwaves the system will be as orderly as a military parade—but infinitely faster.

6655-15R

NEW COURSE FOR TECHNICIANS

Sponsored by Electronics Industry

The Service Committee of the Electronic Industries Association of Canada (formerly Radio-Electronics-Television Manufacturers Association) has completed plans to sponsor an advanced upgrading servicing course for practicing television service technicians. The course will commence at Ryerson Institute of Technology, Toronto, in October. The course will be conducted two nights a week for a period of sixteen weeks and will include theory and practice in the art of handling test equipment and servicing television receivers. To enable individual tuition to be given, the initial class will be limited to twenty students.

Before applications can be considered, a qualifying examination must be passed and those applying must have from 3 to 5 years' experience in the television servicing business. Those passing the examinations at the end of the course will be awarded an industry-sponsored certificate of proficiency.

Television technicians in the Metropolitan Toronto area who desire to apply for the course should complete and mail the coupon below, and should send it to the Electronic Industries Association, 200 St. Clair Avenue West, Toronto 7, Ontario. Technicians residing outside the Metropolitan Toronto area are invited to forward the coupon as an indication to the Electronic Industries Association of the interest in this upgrading course in other parts of Canada, as long-range plans include extending the course to other schools across Canada.

TO: Electronic Industries Association of Canada,
Room 410, 200 St. Clair Avenue West,
TORONTO 7, Ontario.

Please forward further information on how I can qualify for the EIA-sponsored upgrading course in television servicing.

Name _____

Address _____

Self-employed Dealer-Service Technician

Number of Years Employed _____

Education: Grade VIII Grade XI
 Grade IX Grade XII
 Grade X Grade XIII
 University

Other Education _____

multi-range multi-purpose

automatic cut-out

20,000 ohms / volt d.c.

a.c. & d.c. current ranges

accurate

Model 8 Universal AvoMeter

ELECTRONICS RADIO TELEVISION

The multi-range instrument with automatic cut-out protection for overload . . . just reset and carry on reading.

OTHER FEATURES:

- 4 Current Ranges: 100 mA. to 10 Amperes A.C.
- 7 Current Ranges: 50 μ A. to 10 Amperes D.C.
- 14 Voltage Ranges: 2.5 Volts to 2,500 Volts A.C. and D.C.
- 3 Resistance Ranges: 0.5 Ohms to 20 Megohms



Comprehensive AvoMeter Bulletin available on request.

Complete factory repair service with all spares in stock, available at our Toronto plant.

R.H. Nichols LIMITED

4544 DUFFERIN STREET • TORONTO
MAILING ADDRESS BOX 500 • DOWNSVIEW, ONT.

Reduce size but maintain H.P.

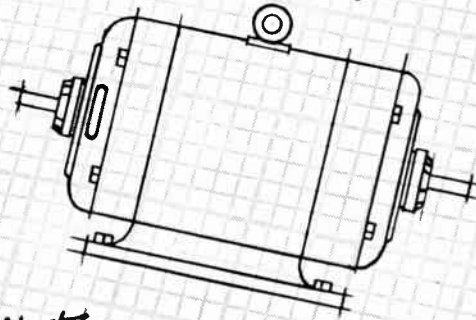

Specify Federal's Isonel Magnet Wire for the windings

USE FEDERAL ISONEL FOR MOTORS WITH HIGHER TEMPERATURE REQUIREMENTS

The outstanding thermal properties of Federal's Polyester (Isonel) Magnet wires permit the operation of motors at higher temperatures. This means the motor size can be reduced for a given horsepower, or greater horsepower can be obtained from a given size.

While having this advantage of higher

operating temperatures, Federal's Isonel possesses the excellent heat shock, chemical and abrasion resistant properties of vinyl-acetal magnet wire. It has improved resistance to flow at high temperatures; and it does not craze, giving higher voltage breakdown and better shelf-life.

Specify Federal . . . for the best in Magnet Wire.

5804

GUELPH, ONTARIO • St. John's Nfld. • Truro • Montreal • Toronto • Winnipeg • Regina • Saskatoon • Calgary • Edmonton • Vancouver

H. K. PORTER COMPANY (CANADA) LTD.
FEDERAL WIRE AND CABLE DIVISION

Divisions of H. K. Porter Company, Inc.: Connors Steel, Delta-Star Electric, Disston, Forge and Fittings, Leschen Wire Rope, Quaker Rubber, Refractories, Riverside-Alloy Metal, Vulcan-Kidd Steel. In Canada: H. K. Porter Company (Canada) Ltd., Disston, Federal Wire and Cable.



ELECTRONIC INSTRUMENTS

RADIATION MONITOR

consists of a RATE METER UNIT, 4 types of probe and sample holder

COUNTING RANGES:

0-5000 counts per sec over 4 ranges.

ACCURACY:

Measurement for a regular pulse input is better than $\pm 2.5\%$.

TEMPERATURE RANGE:

Equipments operates over a temperature range of 0° to 40° C.

The equipment is fully transistorized.

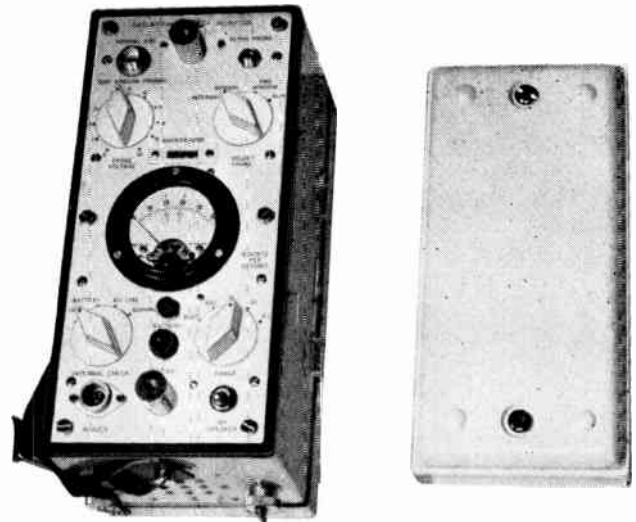

RADIATION MONITOR TYPE 255

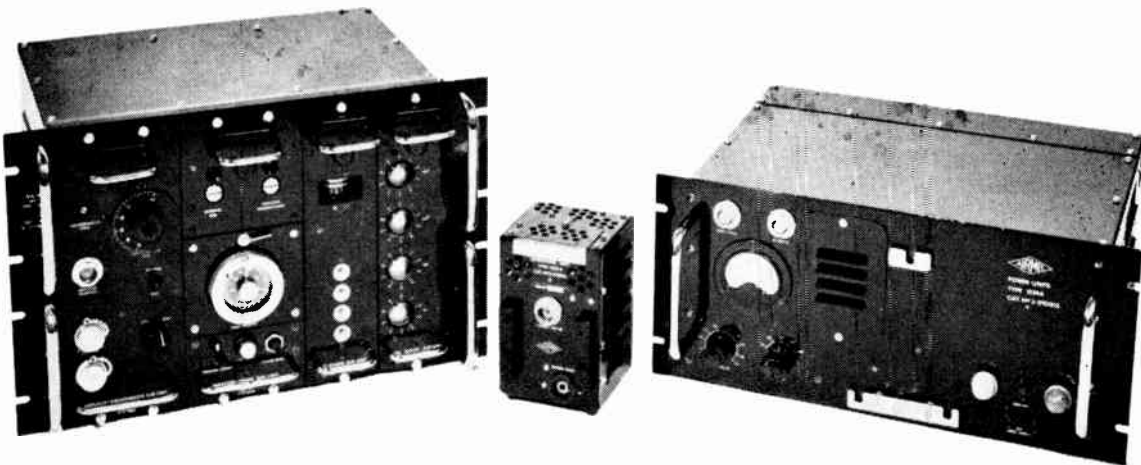

GENERAL PURPOSE COUNTER TYPE 1339A

General Purpose counting equipment Type 1339A has been designed and developed in conjunction with the United Kingdom Atomic Energy Research Establishment to provide comprehensive scaling facilities for Geiger and Scintillation Counters used for the accurate assay of Alpha, Beta and Gamma active samples.

AIRMEC ELECTRONIC EQUIPMENT INCLUDES:

Time & Frequency Meters
Frequency Standards
Ionisation Testers
Oscillators
Signal Generators

Electronic Batch Counters
Electronic Tachometers
Photocell Controls
Temperature & Level Controls
Radio & TV Servicing Equipment

Analogue Computers
Automatic Coordinate Setting Equipment
Tool Alarm Units
Limit Switches
Radiation Monitors

Klystron Power Units
Transistor Testers
VHF Wave Analysers
Counting Equipment
Smoke Alarms

Catalog and specifications sheets on request.



**RADIO COMMUNICATIONS
EQUIPMENT & ENGINEERING LTD.**
475 METROPOLITAN BLVD., MONTREAL 32

For further data on advertised products use page 65.



to overcome
a "space" problem . . .

AGE PUBLICATIONS LIMITED HAS A NEW, MODERN HOME

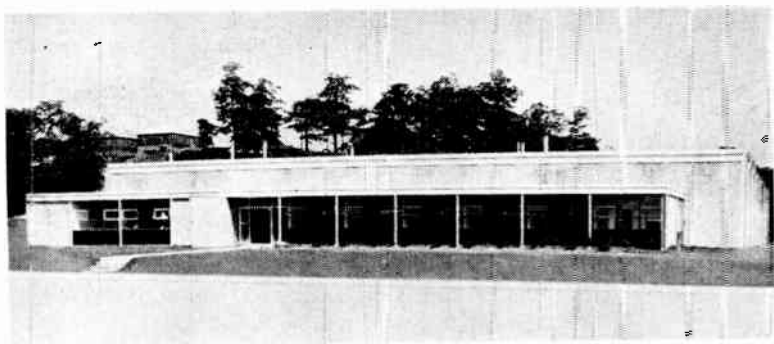

Age Publications' spacious new home at 450 Alliance Ave., near Eglinton and Jane.

We've had "space" problems at AGE, on and off for 35 years. First one building that got more and more cramps, then a second building next door.

But more publications, and more advertising in all of them, meant more staff and more equipment. Soon, even our two buildings began to bulge.

So now we've moved into a new, modern building that provides 31,000 square feet of floor space. New presses and plant equipment are laid out to streamline our operations and improve our services still further.

As of July 1, over 65,000 copies of the various Age publications will be written, edited, printed and published every month at our new premises. The address is 450 Alliance Ave., south of Eglinton and east of Jane.

We know you'll benefit from the new strength and freedom this move will give Electronics and Communications and others of Age's vigorous and successful business publications.

ELECTRONICS and COMMUNICATIONS

Head Office: TORONTO, ONT., CANADA

It pays to investigate the Age Group of successful, established business papers

- Restaurants and Institutions
- Wine, Beer and Spirits
- Electronics and Communications
- Automatic Heating
- Industrial Aeronautics
- Heating, Plumbing and Air Conditioning Age

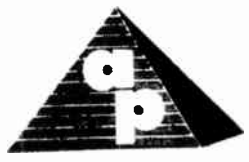

***EXPERIENCE
SINCE 1894**

Built into
American Beauty
ELECTRIC SOLDERING IRONS

***EXPERIENCE: "Knowledge,
Skill, Or Technique Resulting From Experience."**

Since 1894 we have been designing, manufacturing and constantly improving our electric soldering irons! Today, no matter what the requirements, there's an American Beauty in the right model, correct tip size and proper watt input to do any soldering job quickly, properly, efficiently.

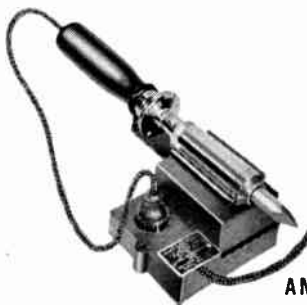

TEMPERATURE REGULATING STAND

An automatic device for controlling tip temperature while iron is at rest. Prevents overheating of iron and eliminates frequent retinning of tip, while at same time maintaining it at any temperature that may be desirable or necessary.

Write for 16-page illustrated catalog containing full information on our complete line of electric soldering irons—including their use and care.

AMERICAN ELECTRICAL HEATER COMPANY 
172-G DETROIT 2, MICHIGAN

RELIABLE, LIGHTWEIGHT, PORTABLE POWER

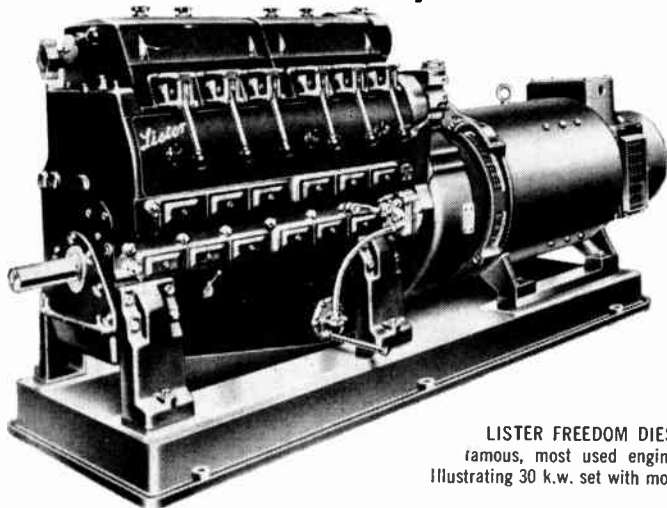

LISTER FREEDOM DIESELS—the most famous, most used engines in industry. Illustrating 30 k.w. set with model FR6 Engine.

Built in a tradition of reliability, Lister-Blackstone engines incorporate the very latest improvements in Diesel design. The full line includes engines from 3½ to 1300 h.p. and there are models for every purpose. Ease of maintenance and economical operation are assured when you specify Lister-Blackstone. Service and spare parts are available from coast to coast.

Write us for the name of your nearest Distributor.

CANADIAN LISTER-BLACKSTONE LIMITED

1921 EGLINTON AVE. E., TORONTO 13 • 3135 WEST BROADWAY, VANCOUVER
25 ST. JAMES ST., VILLE ST. PIERRE, MONTREAL

In the U.S. — Lister-Blackstone Inc., 42-32, 21st St., Long Island City 1, N.Y.

DISTRIBUTORS: B.C. Equipment Co. Ltd., 551 Howe Street, Vancouver; Bruce Robinson Electric (Edm.) Ltd., 10056-109th Street, Edmonton; Medland Machinery Limited, 576 Wall Street, Winnipeg; Russel-Hipwell Engines Ltd., Owen Sound; Consolidated Engines & Machinery Co. Ltd., 5645 Pare Street, Town of Mount Royal, P.Q.; Russel-Hipwell Engines Ltd., 1298 Barrington Street, Halifax; Clayton Construction Co., Ltd., P.O. Box 118, Muir Bldg., St. John's, Nfld.

News Report

Narda Ultrasonics Forms Chemical Process Division

Paul M. Platzman, vice-president in charge of sales of Narda Ultrasonics Corporation, Mineola, L.I., N.Y., recently announced the formation of a Chemical Process Division and the appointment of Dr. Bernard Schmidt as manager of the new division.

In making the announcement Mr. Platzman said: "We have now virtually completed our industrial distributor and engineering sales organization, both nationally and internationally, and the time has come for a searching study in the chemical process industries for those applications in which ultrasonics equipment can work with the dramatic results which it has shown in many fields of industrial cleaning."

Electrical Communications Inc. Appoints Eastern Canada Rep

Tele-Radio Systems Limited, 3534 Dundas St. W., Toronto, have been appointed exclusive representatives in Ontario, Quebec and the Maritimes for Electrical Communications, Inc., 555 Minnesota St., San Francisco, Calif.

Electrical Communications, Inc. are designers and manufacturers of the "Secode" selector which is used as the basic unit in a number of different selective calling devices with wide application in the fields of communications, supervisory control and telemetering.

Nelson Hogg Joins Hunting Associates Ltd.

The appointment of Nelson Hogg as a senior geologist with Hunting and Exploration Services Limited, of Toronto, was recently announced by W. H. Godfrey, Vice-President.

Mr. Hogg has had a broad experience in geological work extending



Nelson Hogg

over the past 20 years. He graduated as a mining engineer from the University of Toronto in 1938 and obtained his S.M. degree in geology from the Massachusetts Institute of Technology. Since 1952 he has been associated with Howe Sound Mining Company as Chief Geologist in the Snow Lake Division, and as Field Geologist in the Toronto Exploration Division. Prior to that Mr. Hogg spent many years mapping in Ontario for mining companies, and six years as Resident Geologist for the Ontario Department of Mines in the Porcupine Area.

FOR WIDER USEFULNESS . . . IMPROVED PERFORMANCE
 . . . GREATER RELIABILITY IN OSCILLOGRAPHIC RECORDING

THE
NEW SANBORN "350" SERIES
 6- AND 8-CHANNEL

DIRECT WRITING SYSTEMS

Here are the completely new, instantaneous direct writing 6- and 8-channel Sanborn "350" oscillographic recording systems designed to give you the most useful possible combination of *performance accuracy—flexibility—reliability—and operating convenience.*

Consider first some characteristic *performance* figures and features: essentially flat response to 100 cps at 10-div. peak-to-peak amplitude, down 3db at 120 cps; limiter circuit *ahead* of Amplifier assures damping at all times; current feedback Power Amplifier design to prevent thermal drift; true damping by velocity feedback; galvanometer natural frequency 55 cps; hysteresis level less than 0.2 div.; linearity 0.20 div. over entire 50 divisions; permanent, inkless, direct writing in true rectangular coordinates on plastic coated Permapaper.

Now notice the *packaging*: an entire 6- or 8-channel "350" system—Preamplifiers and their own Power Supplies, Recorder assembly with built-in Power Amplifiers and Power Supplies, and other components—is housed in one mobile cabinet. Preamplifier modules are separated from Recorder-Power Amplifier unit, so that either can be used separately. Self-contained Recorder package uses transistorized, plug-in Power Amplifiers, Power Supplies with solid state rectifiers, low impedance, low voltage enclosed galvanometers; when used as a separate unit, sensitivity is 0.1 volt, chart division.

Add to these "350" performance and packaging features the value and convenience of extremely easy chart loading from the front; nine electrically controlled chart speeds, selected by pushbuttons, with contacts for remote control; built-in paper take-up, paper footage indicator and timer-marker stylus; four presently available interchangeable Preamplifiers (Carrier, DC Coupling, Servo Monitor-demodulator, True Differential DC), with several more to follow.

These are highlights of the new "350's"—duplicated by no other equipment in existence today. *Ask your local Sanborn Engineering Representative for more information, or write Sanborn directly.*

(All data subject to change without notice)

INDUSTRIAL DIVISION

SANBORN COMPANY

175 Wyman Street, Waltham 54, Mass.

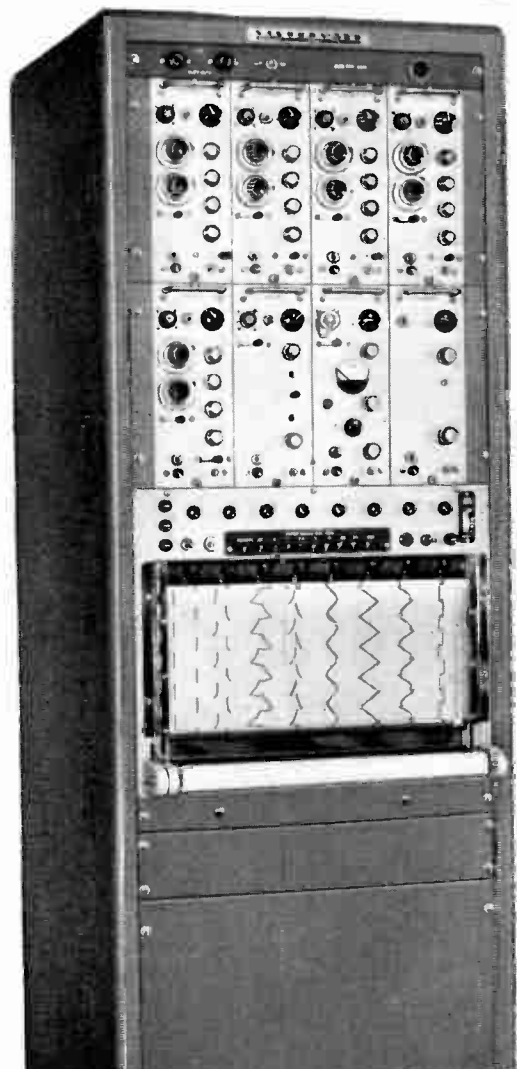

Any "350" Preamplifier installs easily in any channel. Electrical connections made by mating connectors on Preamp and Power Supply.



Quick, simple paper loading is done from front; hinged viewing window is removable. About 8" of record visible. All controls on front panel.

Any of nine chart speeds can be instantly selected by pushbutton. Remote control of all functions provided by connectors at rear.



Recorder back plate holds eight plug-in Power Amplifier modules (one shown unplugged), four on either side of Power Supply section. Entire back plate removable for servicing.



R-O-R ASSOCIATES, 1470 Don Mills Road, Don Mills, Ontario, Canada

NEW PLUG-IN UNIT

for Measuring Transistor High-Frequency Characteristics by the Pulse-Response Method

The Type 53/54R Unit can trigger the Oscilloscope sweep either on the start of the test pulse only, or on both the start and finish to display delay, rise, storage, and fall times simultaneously.

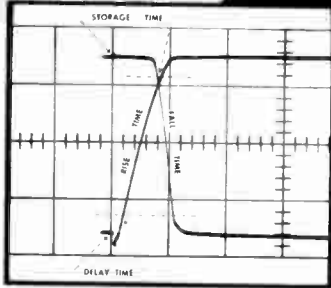

The Type 53/54R Unit and your Tektronix Oscilloscope with the Plug-In Feature equip you to measure transistor delay, rise, storage, and fall times. No other equipment is needed. Just plug in the Type 53/54R Unit and you're ready to go.

C H A R A C T E R I S T I C S

Collector Supply

1 to 15 v continuously variable, positive or negative. Current Capability, 400 ma.

Mercury-Switch Pulse Generator

Risetime less than 0.005 μ sec. Overall risetimes with the oscilloscopes are as follows:

- Types 541, 543, 545—0.012 μ sec
- Type 551—0.014 μ sec
- Type 533—0.023 sec
- Types 531, 535, 536—0.035 μ sec

Type 532—0.07 μ sec (The Type 532 and Type 536 have an additional limitation in the lack of signal delay in the main vertical amplifier).

Amplitude—0.02 v to 10 v, continuously adjustable, across 50 ohms. Eight calibrated steps—0.05, 0.1, 0.2, 0.5, 1, 2, 5, and 10 v.

Bias Supply

—0.5 v to +0.5 v and —5 v to +5 v, continuously variable. Current Capability—100 ma.

Calibrated Vertical Deflection

0.5, 1, 2, 5, 10, 20, 50, and 100 ma/cm collector current.

Price—\$300 f.o.b. factory

High-frequency characteristics of a transistor under five different conditions of drive. In each pair, the photograph at left shows delay time and rise time, the start of the driving pulse coinciding with the 2-cm graticule line. The second photograph of each pair shows storage time and fall time, the end of the pulse coinciding with the 2-cm line. The Type 53/54R Unit plugged into a Tektronix Type 543 Oscilloscope—3.5-v collector supply, 500-ohm collector load, 2-ma div vertical calibration, 0.5- μ sec div sweep rate. Driving conditions at left of each pair.

Low-frequency characteristics of the same transistor under driving conditions paralleling those of the first three pairs at left. Family of curves photographed on a Tektronix Type 575 Transistor-Curve Tracer—0.5-v div horizontal calibration, 1-ma div vertical calibration, 500-ohm load line. Driving conditions at right of each photograph.

Drive voltage: 10 v through 20 kilohms.

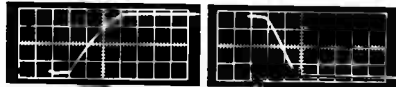

Drive voltage: 2 v through 1 kilohm.

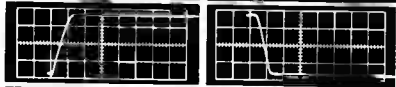

Drive voltage: 0.5 v through 50 ohms.

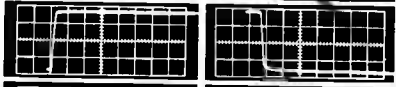

Class A drive: 0.05 v through 50 ohms.

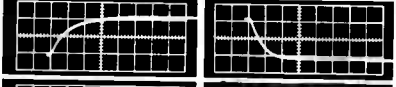

Class A drive: 0.1 v through 1 kilohm.



Drive voltage: 0.2 v step through 20 kilohms.

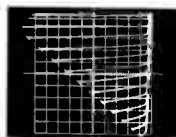

Drive voltage: 0.05 v step through 1 kilohm.



Drive voltage: 0.02 v step through 50 ohms.

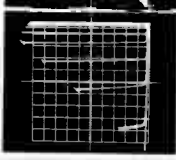

Tektronix, Inc.

P. O. Box 831 • Portland 7, Oregon

Phone CYpress 2-2611 • TWX-PD 311 • Cable: TEKTRONIX

TEKTRONIX FIELD OFFICES: Albertson, L.I., N.Y. • Albuquerque • Bronxville, N.Y. • Buffalo • Cleveland • Dallas • Dayton • Elmwood Park, Ill. • Endwell, N.Y. • Houston • Lathrup Village, Mich. • East Los Angeles • West Los Angeles • Minneapolis • Mission, Kansas • Newtonville, Mass. • Palo Alto, Calif. • Philadelphia • Phoenix • San Diego • Syracuse • Towson, Md. • Union, N.J. • Willowdale, Ont.

TEKTRONIX ENGINEERING REPRESENTATIVES: Arthur Lynch & Assoc., Ft. Myers, Fla.; Gainesville, Fla.; Bivins & Caldwell, Atlanta, Ga.; High Point, N.C.; Hawthorne Electronics, Portland, Ore.; Seattle, Wash.; Hytronic Measurements, Denver, Colo.

Tektronix is represented in 20 overseas countries by qualified engineering organizations.

Please call your Tektronix Field Engineer or Representative for complete specifications and, if desired, to arrange for a demonstration at your convenience.

ENGINEERS—interested in furthering the advancement of the oscilloscope? We have openings for men with creative design ability. Please write Richard Ropiequet, Vice President, Engineering.

For further data on advertised products use page 65.

News Report

National Research Council Installs Digital Computer

A recently acquired digital computer will ease the work load and improve efficiency for engineers in the Mechanical Engineering Division of the National Research Council.

The computer is a Bendix G-15D, supplied by Computing Devices of Canada Limited. The G-15D, is a small, high-speed, stored-program digital computer, especially designed for fast efficient work on engineering and scientific calculations.

Among major projects scheduled for the computer are the design of a new low speed wind tunnel, data reduction of test results from existing wind tunnels, flight test and other facilities, and studies on VTO aircraft wing design.

Simplified programming methods developed for the computer make it possible to train engineers in the use of it in about half of a day. Already about 30 N.R.C. engineers have gained sufficient proficiency to be able to use it for small problems which come up in their work.

Willmot Associates Formed For PR And Writing Services

The formation of Willmot Associates, a new public relations and writing service with headquarters at 25 Farmcote Road, Don Mills, Ontario, was recently announced by Ross Willmot, director of the group.

The service represents in Canada a number of business organizations abroad. Through Public Relations (Industrial) Ltd., of London, England, Willmot Associates offers PR services to Canadian companies throughout the Commonwealth. The service has working arrangements



Ross Willmot

with various communications people throughout Canada and abroad.

Mr. Willmot has been director of public relations for the Hunting companies in Canada for the last three years and also was in charge of public relations at A. V. Roe Canada for a similar period. He is a former information officer for the Canadian Department of External Affairs. Originator and secretary-general of the International Society of Aviation Writers, Mr. Willmot was recently made the first life member of the body which has 850 members in 43 countries.

The Complete Industrial Television System...



Completely matched from camera to monitor

The only Industrial Television system designed as a complete package... every piece of equipment designed to work perfectly with associated equipment... complete for either local or remote pickup. Designed and manufactured by Du Mont... from camera to monitor.

Complete planning, installation and servicing

The only Industrial Television system offering complete, local planning, installation and servicing by competent local contractors... your assurance that the system will be right... right from the start.

DU MONT[®]

Canadian Distributor

ELECTRONIC SERVICE SUPPLY COMPANY

210 - 9th Avenue East
Calgary, Alberta

Branches or Representatives in most
Canadian Cities

INDUSTRIAL
TELEVISION DEPARTMENT
ELECTRONIC SERVICE SUPPLY
COMPANY

210 - 9th Ave. East Calgary, Alberta

- I'm interested in a demonstration.
Please tell me more.
- Send me Industrial Television Handbook.

NAME _____

COMPANY _____

ADDRESS _____

Switchboard efficiency to meet your needs!

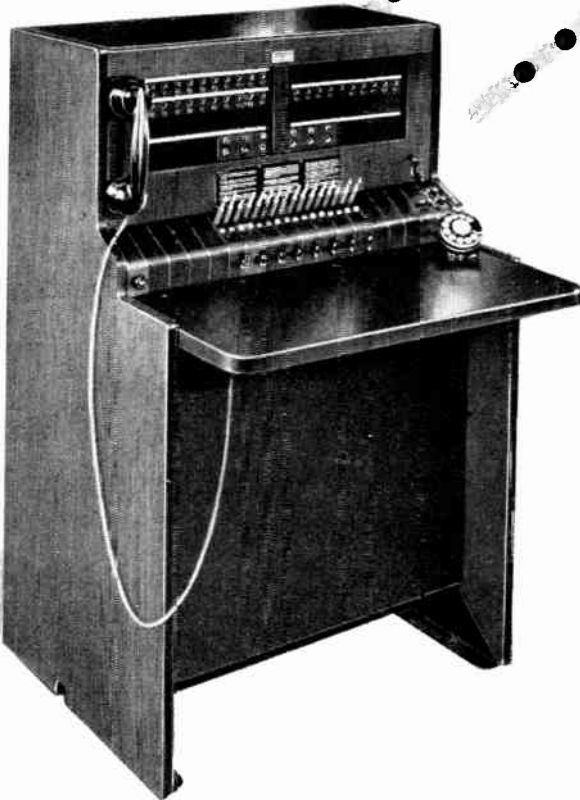

No. 555

PRIVATE BRANCH EXCHANGE

This is a modern switchboard with the new "plug-in" type units, permitting actual service requirements to be closely met.

Available in capacities of

- 60 and 120 Station Lines
- 14 Central Office Trunks
- 15 Cord Circuits

Two positions may be installed side-by-side to increase the maximum capacity to 240 lines.

The low design makes it convenient for attendant-receptionists to converse with employers' visitors or client over the top of the switchboard.

No. 507

PRIVATE BRANCH EXCHANGE

A small compact switchboard with a capacity of

- 12 Station Lines
- 5 Central Office Trunks
- 5 Connecting Circuits.

Requires about the same amount of space as the average typewriter.

Convenient and simple to operate by an attendant with other duties.



Northern Electric

COMPANY LIMITED

44 BRANCHES THROUGHOUT CANADA

INDEX TO ADVERTISERS

Page number is on the right.
Key number for use with
READER SERVICE CARDS is
on the left.

Key No.		Page No.
1.	Adcola Products Ltd.	54
2.	American Electrical Heater Co.	60
3.	Amphenol Canada Ltd.	67
4.	Arrow-Hart & Hegeman (Canada) Ltd.	54
5.	Automatic Electric Sales (Canada) Ltd.	35
6.	Automatic Electric Sales (Canada) Ltd.	36-37
7.	Automatic Electric Sales (Canada) Ltd.	38
8.	Bach-Simpson Ltd.	6
9.	Bendix Aviation Corp.	67
10.	Burdy Canada Ltd.	71
11.	Cambridge Thermionic Corp.	9
12.	Canadian General Electric Co. Ltd.	52
13.	Canadian I.R.E. Convention	10
14.	Canadian Lister-Blackstone Ltd.	60
15.	Canadian Marconi Co.	3
16.	Computing Devices of Canada Ltd.	2
17.	Daly Capacitors Ltd.	51
18.	Daystrom Ltd.	12
19.	Edo (Canada) Ltd.	50
20.	Eitel-McCulbough Inc.	13
21.	Electronic Service Supply Co. Ltd.	63
22.	Freed Transformer Co. Inc.	54
23.	G-V Controls, Inc.	53
24.	General Radio Co.	72
25.	Helipot Corp.	70
26.	Instantaneous Recording Service	51
27.	International Electronic Research Corp.	14
28.	International Resistance Co. Ltd.	51
29.	Lake Engineering Co. Ltd.	51
30.	J. R. Longstaffe Co. Ltd.	53
31.	J. R. Longstaffe Co. Ltd.	54
32.	Muirhead & Co. Ltd.	68
33.	National Fibre Co. of Canada Ltd.	69

(Continued overleaf)

Please ADD my name to the mailing list for **ELECTRONICS & COMMUNICATIONS** (no obligation).

My Name (Please Print)

Mail copies to my home, or business address as noted below.

Street

City Prov.

If you have recently **CHANGED** your address for receiving copies of E & C please note former address here:

Company Nature of Business

Signature Position

7-58 (For card to be valid it must be completed in full, including signature)

PLEASE SEND FURTHER INFORMATION ON THE FOLLOWING NEW PRODUCT ITEMS AS NUMBERED BELOW — USE PRODUCT ITEM NUMBERS

- | | | | | | | | | | |
|-------------------------------|-------------------------------|-------------------------------|-------------------------------|-------------------------------|-------------------------------|-------------------------------|-------------------------------|-------------------------------|-------------------------------|
| <input type="checkbox"/> 1995 | <input type="checkbox"/> 1996 | <input type="checkbox"/> 1997 | <input type="checkbox"/> 1998 | <input type="checkbox"/> 1999 | <input type="checkbox"/> 2000 | <input type="checkbox"/> 2001 | <input type="checkbox"/> 2002 | <input type="checkbox"/> 2003 | <input type="checkbox"/> 2004 |
| <input type="checkbox"/> 2005 | <input type="checkbox"/> 2006 | <input type="checkbox"/> 2007 | <input type="checkbox"/> 2008 | <input type="checkbox"/> 2009 | <input type="checkbox"/> 2010 | <input type="checkbox"/> 2011 | <input type="checkbox"/> 2012 | <input type="checkbox"/> 2013 | <input type="checkbox"/> 2014 |
| <input type="checkbox"/> 2015 | <input type="checkbox"/> 2016 | <input type="checkbox"/> 2017 | <input type="checkbox"/> 2018 | <input type="checkbox"/> 2019 | <input type="checkbox"/> 2020 | <input type="checkbox"/> 2021 | <input type="checkbox"/> 2022 | <input type="checkbox"/> 2023 | <input type="checkbox"/> 2024 |
| <input type="checkbox"/> 2025 | <input type="checkbox"/> 2026 | <input type="checkbox"/> 2027 | <input type="checkbox"/> 2028 | <input type="checkbox"/> 2029 | <input type="checkbox"/> 2030 | | | | |

PLEASE SEND FURTHER INFORMATION ON THE FOLLOWING ADVERTISEMENTS AS NUMBERED BELOW — USE KEY NUMBERS

- | | | | | | | | | | | | |
|-----------------------------|-----------------------------|-----------------------------|-----------------------------|-----------------------------|-----------------------------|-----------------------------|-----------------------------|-----------------------------|-----------------------------|-----------------------------|-----------------------------|
| <input type="checkbox"/> 1 | <input type="checkbox"/> 2 | <input type="checkbox"/> 3 | <input type="checkbox"/> 4 | <input type="checkbox"/> 5 | <input type="checkbox"/> 6 | <input type="checkbox"/> 7 | <input type="checkbox"/> 8 | <input type="checkbox"/> 9 | <input type="checkbox"/> 10 | <input type="checkbox"/> 11 | <input type="checkbox"/> 12 |
| <input type="checkbox"/> 13 | <input type="checkbox"/> 14 | <input type="checkbox"/> 15 | <input type="checkbox"/> 16 | <input type="checkbox"/> 17 | <input type="checkbox"/> 18 | <input type="checkbox"/> 19 | <input type="checkbox"/> 20 | <input type="checkbox"/> 21 | <input type="checkbox"/> 22 | <input type="checkbox"/> 23 | <input type="checkbox"/> 24 |
| <input type="checkbox"/> 25 | <input type="checkbox"/> 26 | <input type="checkbox"/> 27 | <input type="checkbox"/> 28 | <input type="checkbox"/> 29 | <input type="checkbox"/> 30 | <input type="checkbox"/> 31 | <input type="checkbox"/> 32 | <input type="checkbox"/> 33 | <input type="checkbox"/> 34 | <input type="checkbox"/> 35 | <input type="checkbox"/> 36 |
| <input type="checkbox"/> 37 | <input type="checkbox"/> 38 | <input type="checkbox"/> 39 | <input type="checkbox"/> 40 | <input type="checkbox"/> 41 | <input type="checkbox"/> 42 | <input type="checkbox"/> 43 | <input type="checkbox"/> 44 | <input type="checkbox"/> 45 | <input type="checkbox"/> 46 | <input type="checkbox"/> 47 | <input type="checkbox"/> 48 |
| <input type="checkbox"/> 49 | <input type="checkbox"/> 50 | <input type="checkbox"/> 51 | <input type="checkbox"/> 52 | <input type="checkbox"/> 53 | <input type="checkbox"/> 54 | <input type="checkbox"/> 55 | <input type="checkbox"/> 56 | <input type="checkbox"/> 57 | <input type="checkbox"/> 58 | <input type="checkbox"/> 59 | <input type="checkbox"/> 60 |

Name Position

Company Nature of Business

Street City Prov.
7-58

PLEASE SEND FURTHER INFORMATION ON THE FOLLOWING NEW PRODUCT ITEMS AS NUMBERED BELOW — USE PRODUCT ITEM NUMBERS

- | | | | | | | | | | |
|-------------------------------|-------------------------------|-------------------------------|-------------------------------|-------------------------------|-------------------------------|-------------------------------|-------------------------------|-------------------------------|-------------------------------|
| <input type="checkbox"/> 1995 | <input type="checkbox"/> 1996 | <input type="checkbox"/> 1997 | <input type="checkbox"/> 1998 | <input type="checkbox"/> 1999 | <input type="checkbox"/> 2000 | <input type="checkbox"/> 2001 | <input type="checkbox"/> 2002 | <input type="checkbox"/> 2003 | <input type="checkbox"/> 2004 |
| <input type="checkbox"/> 2005 | <input type="checkbox"/> 2006 | <input type="checkbox"/> 2007 | <input type="checkbox"/> 2008 | <input type="checkbox"/> 2009 | <input type="checkbox"/> 2010 | <input type="checkbox"/> 2011 | <input type="checkbox"/> 2012 | <input type="checkbox"/> 2013 | <input type="checkbox"/> 2014 |
| <input type="checkbox"/> 2015 | <input type="checkbox"/> 2016 | <input type="checkbox"/> 2017 | <input type="checkbox"/> 2018 | <input type="checkbox"/> 2019 | <input type="checkbox"/> 2020 | <input type="checkbox"/> 2021 | <input type="checkbox"/> 2022 | <input type="checkbox"/> 2023 | <input type="checkbox"/> 2024 |
| <input type="checkbox"/> 2025 | <input type="checkbox"/> 2026 | <input type="checkbox"/> 2027 | <input type="checkbox"/> 2028 | <input type="checkbox"/> 2029 | <input type="checkbox"/> 2030 | | | | |

PLEASE SEND FURTHER INFORMATION ON THE FOLLOWING ADVERTISEMENTS AS NUMBERED BELOW — USE KEY NUMBERS

- | | | | | | | | | | | | |
|-----------------------------|-----------------------------|-----------------------------|-----------------------------|-----------------------------|-----------------------------|-----------------------------|-----------------------------|-----------------------------|-----------------------------|-----------------------------|-----------------------------|
| <input type="checkbox"/> 1 | <input type="checkbox"/> 2 | <input type="checkbox"/> 3 | <input type="checkbox"/> 4 | <input type="checkbox"/> 5 | <input type="checkbox"/> 6 | <input type="checkbox"/> 7 | <input type="checkbox"/> 8 | <input type="checkbox"/> 9 | <input type="checkbox"/> 10 | <input type="checkbox"/> 11 | <input type="checkbox"/> 12 |
| <input type="checkbox"/> 13 | <input type="checkbox"/> 14 | <input type="checkbox"/> 15 | <input type="checkbox"/> 16 | <input type="checkbox"/> 17 | <input type="checkbox"/> 18 | <input type="checkbox"/> 19 | <input type="checkbox"/> 20 | <input type="checkbox"/> 21 | <input type="checkbox"/> 22 | <input type="checkbox"/> 23 | <input type="checkbox"/> 24 |
| <input type="checkbox"/> 25 | <input type="checkbox"/> 26 | <input type="checkbox"/> 27 | <input type="checkbox"/> 28 | <input type="checkbox"/> 29 | <input type="checkbox"/> 30 | <input type="checkbox"/> 31 | <input type="checkbox"/> 32 | <input type="checkbox"/> 33 | <input type="checkbox"/> 34 | <input type="checkbox"/> 35 | <input type="checkbox"/> 36 |
| <input type="checkbox"/> 37 | <input type="checkbox"/> 38 | <input type="checkbox"/> 39 | <input type="checkbox"/> 40 | <input type="checkbox"/> 41 | <input type="checkbox"/> 42 | <input type="checkbox"/> 43 | <input type="checkbox"/> 44 | <input type="checkbox"/> 45 | <input type="checkbox"/> 46 | <input type="checkbox"/> 47 | <input type="checkbox"/> 48 |
| <input type="checkbox"/> 49 | <input type="checkbox"/> 50 | <input type="checkbox"/> 51 | <input type="checkbox"/> 52 | <input type="checkbox"/> 53 | <input type="checkbox"/> 54 | <input type="checkbox"/> 55 | <input type="checkbox"/> 56 | <input type="checkbox"/> 57 | <input type="checkbox"/> 58 | <input type="checkbox"/> 59 | <input type="checkbox"/> 60 |

Name Position

Company Nature of Business

Street City Prov.
7-58

BUSINESS REPLY CARD
No Postage Stamp Necessary if Mailed in Canada

5c POSTAGE WILL BE PAID BY

ELECTRONICS AND COMMUNICATIONS

450 Alliance Avenue

Toronto 9, Ontario



BUSINESS REPLY CARD
No Postage Stamp Necessary if Mailed in Canada

5c POSTAGE WILL BE PAID BY

ELECTRONICS AND COMMUNICATIONS

450 Alliance Avenue

Toronto 9, Ontario



BUSINESS REPLY CARD
No Postage Stamp Necessary if Mailed in Canada

5c POSTAGE WILL BE PAID BY

ELECTRONICS AND COMMUNICATIONS

450 Alliance Avenue

Toronto 9, Ontario



INDEX TO ADVERTISERS

(Continued)

Key No.	Page No.
34. Nichols Ltd., R. H.	56
35. Northern Electric Co. Ltd.	55
36. Northern Electric Co. Ltd.	64
37. Porter Co. (Canada) Ltd., H. K.	57
38. Pylon Electronic Development Co. Ltd.	52
39. Pylon Electronic Development Co. Ltd.	67
40. Radio Communications Equipment & Engineering Ltd.	58
41. Rogers Electronic Tubes & Components (A Div. of Philips Electronics Industries Ltd.)	15
42. Sanborn Co.	61
43. Sprague Electric International Ltd.	50
44. Tektronix, Inc.	62
45. Telephone Mfg. Co. Ltd. ...	53
46. Topping Electronics Ltd., F. V.	51
47. Tung-Sol Electric Inc.	4

ACTIVE CIRCULATION

It costs us a lot of active dollars annually to keep our circulation lists up-to-date and it's important enough to us that we have them audited every year by CCAB (Canadian Circulations Audit Board Inc.)

Advertisers trust CCAB audited figures so we get more advertisers and YOU get the high standard of editorial you have always wanted to read.

ELECTRONICS and COMMUNICATIONS

is a



audited publication

AMPHENOL

CAPTIVATED CONTACTS now Available with Type BNC RF CONNECTORS



- Prevent contact recession which causes circuit discontinuity.
- Improved cable clamping
- Mates with all BNC connectors.
- Weatherproof.
- Interchangeable.
- Available from stock.

Captivated contacts also available from stock in types N & HN.

For further information write to Department 21 for Amform 3001.

CANADA LIMITED
300 CAMPBELL AVE.
TORONTO ONTARIO

TELEPHONE AMPLIFIER

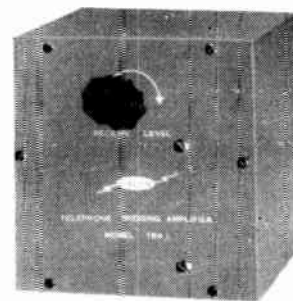

MODEL
TBA-1

- High impedance bridging type.
- No loading or mismatch effects.
- Fully transistorized, low drain.
- Ample transmit and receive gain.
- Ideal for dispatching lines.



PYLON ELECTRONIC DEVELOPMENT company, Ltd.

Communications Systems and Equipment
161 CLEMENT ST., VILLE LASALLE, MONTREAL 32, QUE.

BENDIX "SP" ELECTRICAL CONNECTOR— NEWEST MEMBER OF THE PYGMY FAMILY

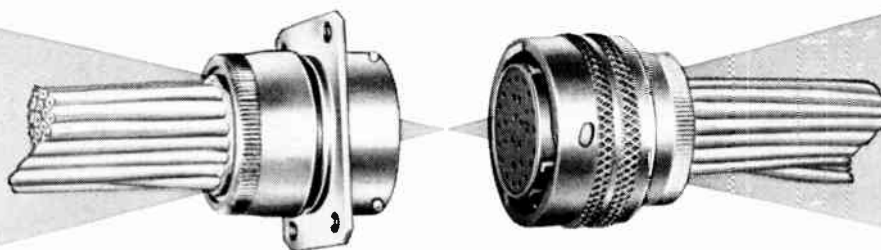

Flange Design Permits Back Panel Mounting

The new Bendix* "SP" connector uses an alumilite finish offering superior resistance to abrasion and corrosion. Flange size and location designed to permit back panel mounting with No. 6 screws. Other outstanding features of the new connector are similar to those of the well-known "PT" type.

- Safety wiring completely eliminated
- Mechanically assisted coupling and uncoupling through cam action
- Closed entry, probeproof socket contacts

- Visual and audible inspection of coupling—perfect for "blind" locations
- Three-point bayonet lock; perfect axial alignment of mating parts at all times
- Constant spring tension behind mated insert faces
- Five-key polarization—positive protection against mismatching or cross-plugging
- Resilient inserts, performance-proven in millions of Bendix connectors
- Heavy gold plating over silver on all contacts
- Both pin and socket contacts machined from high-grade copper alloy

- Machined bar stock or impact-extruded shell components
- Alumilite finished to resist abrasion and corrosion—no thread wear—easily withstands 500 hours of salt spray

With the introduction of "SP" Pygmy Electrical Connectors, Bendix again demonstrates its well-known policy of anticipating the needs of industry.

Export Sales and Service: Bendix International Division,
205 East 42nd St., New York 17, N. Y.
Canadian Affiliate: Aviation Electric, Ltd.,
200 Laurentien Blvd., Montreal 9, Quebec

*REG. TRADEMARK

Scintilla Division

SIDNEY, N. Y.



MUIRHEAD

LINEAR VARIOMETERS

SIZE II LINVAR IIM16AI

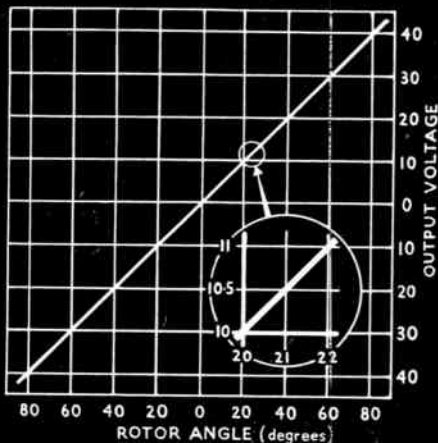

Patents in various countries.

This small size, low weight Linvar housed in a standard BuOrd size 11 synchro frame has a voltage output proportional to the rotor angle. The linear relationship extends for $\pm 85^\circ$ from the zero output position and is achieved by a special patented design of the rotor and stator laminations which gives a smooth variation of output voltage devoid of any fluctuations due to tooth ripple. If the rotor output is biased by a suitable voltage

of the same frequency and phase it is possible to obtain zero output in one extreme position and a linear relationship over a range of 170° from this point. The Linvar can be applied to satisfy the requirements of analogue computation remote control or indication, and may be operated by mechanical measuring devices, e.g. strain and deflection gauges, weighing machines, etc., where an A.C. output voltage varying linearly with deflection is required.

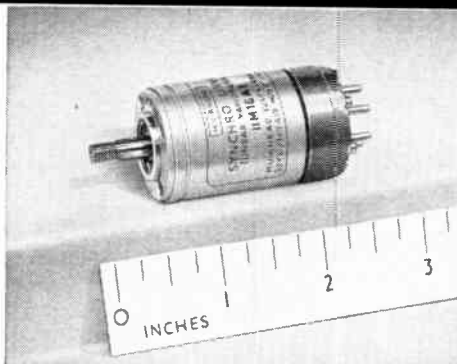

TECHNICAL DATA

POWER SUPPLY	115V
SUPPLY FREQUENCY	400c/s
POWER CONSUMPTION	0-40W
MAXIMUM OUTPUT VOLTAGE	42.5V
VOLTAGE GRADIENT	0.5V per degree
TIME PHASE OF OUTPUT VOLTAGE (relating to input voltage)	3 degrees lead
RANGE OF LINEARITY	$\pm 85^\circ$
ACCURACY	$\pm 1/4\%$ of maximum voltage
WEIGHT	4.5 oz.

Delivery, prices and a data sheet giving full information on the Size II Linvar are available on request.

MUIRHEAD

MUIRHEAD INSTRUMENTS LIMITED

STRATFORD · ONTARIO · CANADA Telephone: 3717 & 3718

336/3Ca

News Report

R. H. Nichols Limited Has New Quarters

R. H. Nichols Ltd. has acquired a new site at 4544 Dufferin St., Toronto, which provides for larger and better facilities in all departments — production and assembly, inspection, machine shop, instrument service and repair, engineering and drafting, as well as in administration — with ample room to extend the building should further expansion be necessary.

Mail should be addressed to Box 500, Downsview, Ontario. The telephone number is MELrose 3-8190.

Canadian Westinghouse Appoints Union Liaison Officer

The appointment of W. E. McBride as manager, union relations, for the Canadian Westinghouse Co., Hamilton, was announced recently by J. W. Henley, industrial relations manager.

Mr. McBride was formerly with Brazilian Traction Light and Power Company following an earlier industrial relations appointment with Canadian Industries Limited. He obtained his Bachelor of Commerce degree from the University of British Columbia and a M.Sc. degree in business administration from Columbia University.

CDC APPOINTMENT



WM. F. POTTS

William F. Potts has been appointed Aviation Sales Engineer by Computing Devices of Canada Limited, according to a recent announcement by CDC Marketing Director W. S. Kendall. Mr. Potts will be responsible for the sale of aviation radio and radar equipment in Canada. CDC represents the Radio Division of Bendix Aviation Corporation in Canada.

THE NATIONAL SCENE



KEEPING "ELECTRONIC BRAINS" FROM LOSS OF MEMORY. One of science's greater marvels is IBM's 705 Electronic Data Processing Machine—which makes intricate calculations and logical decisions in millionths of a second. Heart of this electronic "wizard" is its main magnetic core memory. Designed for use with the machine's high-speed printer is the IBM 760 Control and

Storage Unit containing its own core memory of 1,000 positions which allows central processing to continue in the 705 while other data are being printed. Helping the 760 remember what information is to be printed is a job for PHENOLITE® Laminated Plastic. PHENOLITE's unique combination of properties makes it ideal for this application.



MOST ADVANCED FORM OF ELECTRONIC STORAGE. The 1,000-position core memory for the IBM 760 Control and Storage Unit—a portion of which is shown here—consists of pinhead size cores strung on copper-wired frames of PHENOLITE. Electrical impulses, passing through wires, alter the magnetic state of cores so that a group of them stands for a word or figure. Reversing the process recalls information from storage. PHENOLITE frames safeguard the circuit and permit stacking of core planes as shown.

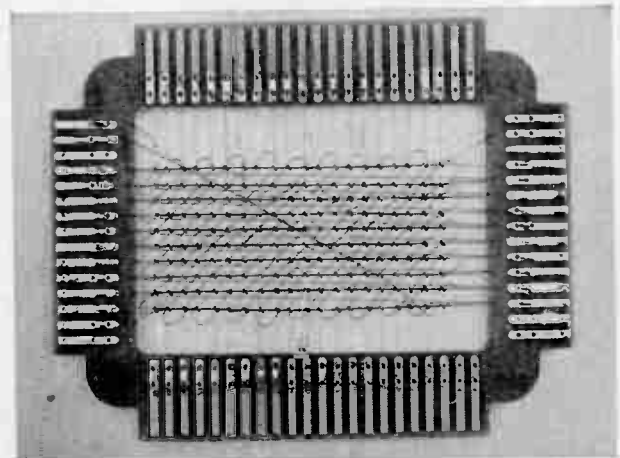

PHENOLITE MEETS CRITICAL STANDARDS. Core frames like the one shown are punched out of laminated PHENOLITE by IBM. Each frame has printed circuit type terminal strips and soldered connections. PHENOLITE proves an ideal material for this application because it is mechanically strong and stiff, punches cleanly, etches well, remains flat, has high dielectric properties and withstands the heat of dip soldering.

NATIONAL CAN HELP YOU reduce unit product cost or improve product performance at no added cost. Here's why . . . You can select the "one best material" from over 100 grades of PHENOLITE, Vulcanized Fibre and National Nylon—without compromise in properties or cost. You can simplify production and purchasing with the timed delivery of 100% usable parts—from a single reliable source. You gain competitively with National's new materials and grades—the direct result of programmed materials-research.

You benefit by calling National first. Check Telephone Directory Yellow Pages, or write Toronto—Dept. O-7.

ELECTRONICS & COMMUNICATIONS, JULY, 1958



NATIONAL

FIBRE COMPANY OF CANADA, LTD.

ATLANTIC & HANNA AVENUES, TORONTO

1411 CRESCENT STREET, MONTREAL

For further data on advertised products use page 65.

II ELIPOT's newest potentiometer... the single-turn, 1-1/16" A.I.A. diameter, all-metal series 5200... fends off 2,000 cps at 30G's, repels 10 cycles NAS 710, procedure III humidity, rides out 50G's shock and 100G's acceleration.

We're tough, too... on the 5200's mechanical tolerances. Register face, diameter and shaft runouts are all held to 0.001" max... spring-loaded shaft eliminates endplay.

All this with linearity to $\pm 0.15\%$... power rating of 3 watts at 100°C (derating to zero at 150°)... 250 to 100,000 ohms standard resistance range... *and certified test data to prove our every claim.*

What a pot for airborne applications... at a down-to-earth price! Write for data file E 72 for the proven facts.

Beckman®

Helipot

Helipot Corporation, Newport Beach, California
a division of Beckman Instruments, Inc.
Canadian Factory:

No. 3 Six Points Road, Toronto 18, Ontario
Sales Representative: R-O-R Associates, Ltd.
1470 Don Mills Road, Don Mills, Ontario

potentiometers... dials... delay lines...
expanded scale meters...
rotating components... breadboard parts

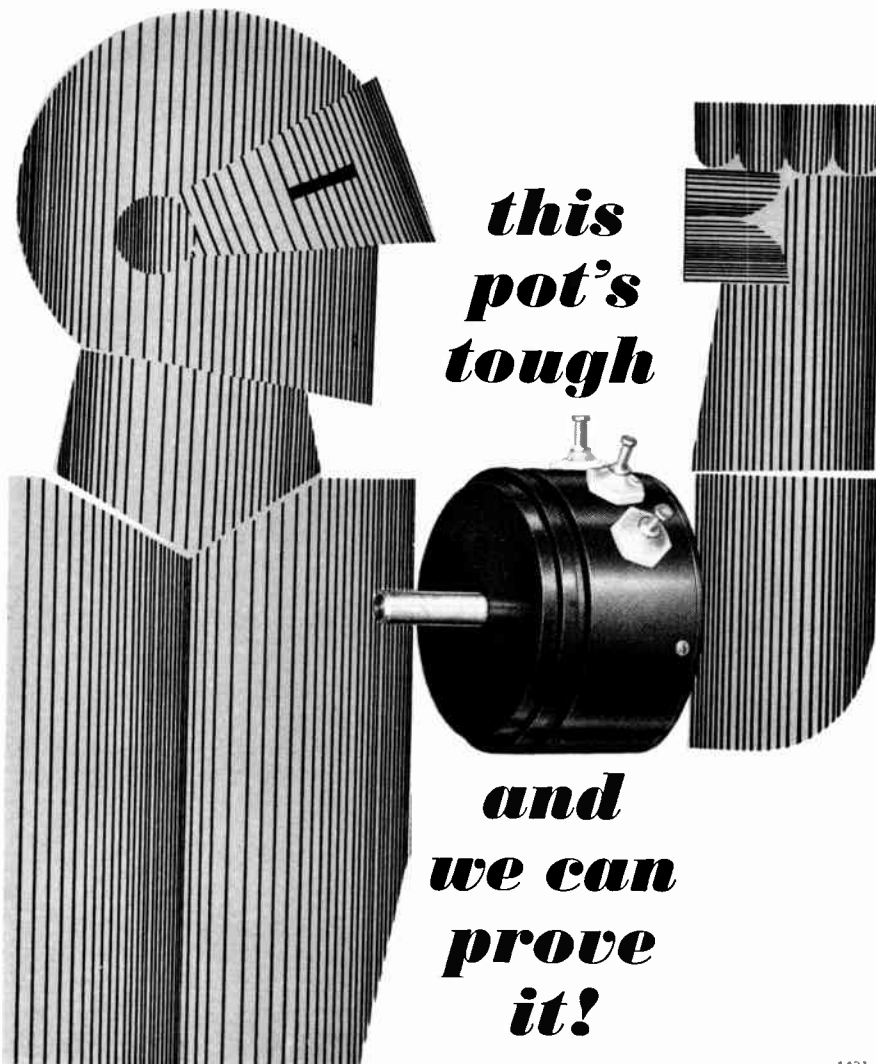

**this
pot's
tough**

**and
we can
prove
it!**

Book Review

An Introduction To The Theory Of Random Signals And Noise by Wilbur B. Davenport, Jr., and William L. Root.

As the first of a group of books, to be known as Lincoln Laboratory Publications, this book introduces the reader to the statistical theory underlying a study of signals and noises in communications systems.

The volume contains an introduction to probability theory and statistics, a discussion of the statistical properties of the Gaussian random process, a study of the results of passing random signals and noise through linear and non-linear systems, and an introduction to the statistical theory of the detection of signals in the presence of noise.

Parts of probability theory and the modern theory of random processes are developed in a way suitable for an engineer. The material is applied to give a coherent treatment of many basic communications engineering noise problems.

Advances of the last few years which are covered include: theory of filters for minimizing the mean-square error or maximizing the signal-to-noise ratio; transfer-transform method of analyzing signals and noise in non-linear devices such as limiters and detectors; and application of statistical methods to the design of a radio or radar receiver.

An Introduction To The Theory Of Random Signals And Noise is published by McGraw-Hill Company of Canada Limited, 253 Spadina Road, Toronto 4, Ontario, contains 393 pages, hard cover bound, price \$12.00.

Basic Television by Dr. Alexander Schure.

This is the most understandable presentation of the basic theory, operation and circuitry of black and white television ever published.

Everything from the transmitter to the picture on the screen is explained with utmost clarity in words as well as by illustrations that "visualize" each concept discussed.

The presentation is contained in 5 volumes, each complete in itself.

Volume 1 covers The Studio, Development and Transmission of Video and Sound Signals. Volume 2—The Overall View of the Receiver, Antennas and Transmission Lines. Volume 3 — Circuitry of Tuners, Conversion, I-F Amplification, Video Detectors and Amplifiers. Volume 4 — Circuitry in Synchronization, Vertical and Horizontal Sweep Systems, High-Voltage Power Supply. Volume 5 — Picture Tubes, Low-Voltage Power Supplies, Sound Section Circuits, Closed Circuit TV.

Basic Television is published by John F. Rider Publisher, Inc., 116 West 14th St., New York 11, N.Y. The whole 5 volumes contain 688 pages and over 700 illustrations. Individual volumes (paper bound) are \$2.25 each, or \$10.00 per set. Also available are the 5 volumes in single cloth binding at \$11.50.

Vacuum Tube Rectifiers by Dr. Alexander Schure.

This is volume 21 of the Electronic Technology Series. It meets the high standards of accuracy and readability found in the other books of this series.

Coverage includes physical characteristics of rectifiers, single-phase rectifiers, polyphase rectifiers, output filter circuits and rectifier and filter design data.

Theory and circuitry are given for such vital aspects of the topic as half-wave and full-wave rectifiers, voltage-multiplying circuits, polyphase rectification and filter circuits. The tables of tube characteristics provided supplement the design theory discussed in the text, making this a practical as well as a theory book.

Vacuum Tube Rectifiers is published by John F. Rider Publisher, Inc., 116 W. 14th St., New York, N.Y., and is obtainable through the Canadian representative — Charles W. Pointon Limited, 6 Alcina Avenue, Toronto 10, Ontario. It contains 69 pages, paper cover bound, price in Canada \$1.60.

1431

For further data on advertised products use page 65.

*meets MIL-STD-242 and
NAVORD OSTD
600-7-3.02.29(int.)*

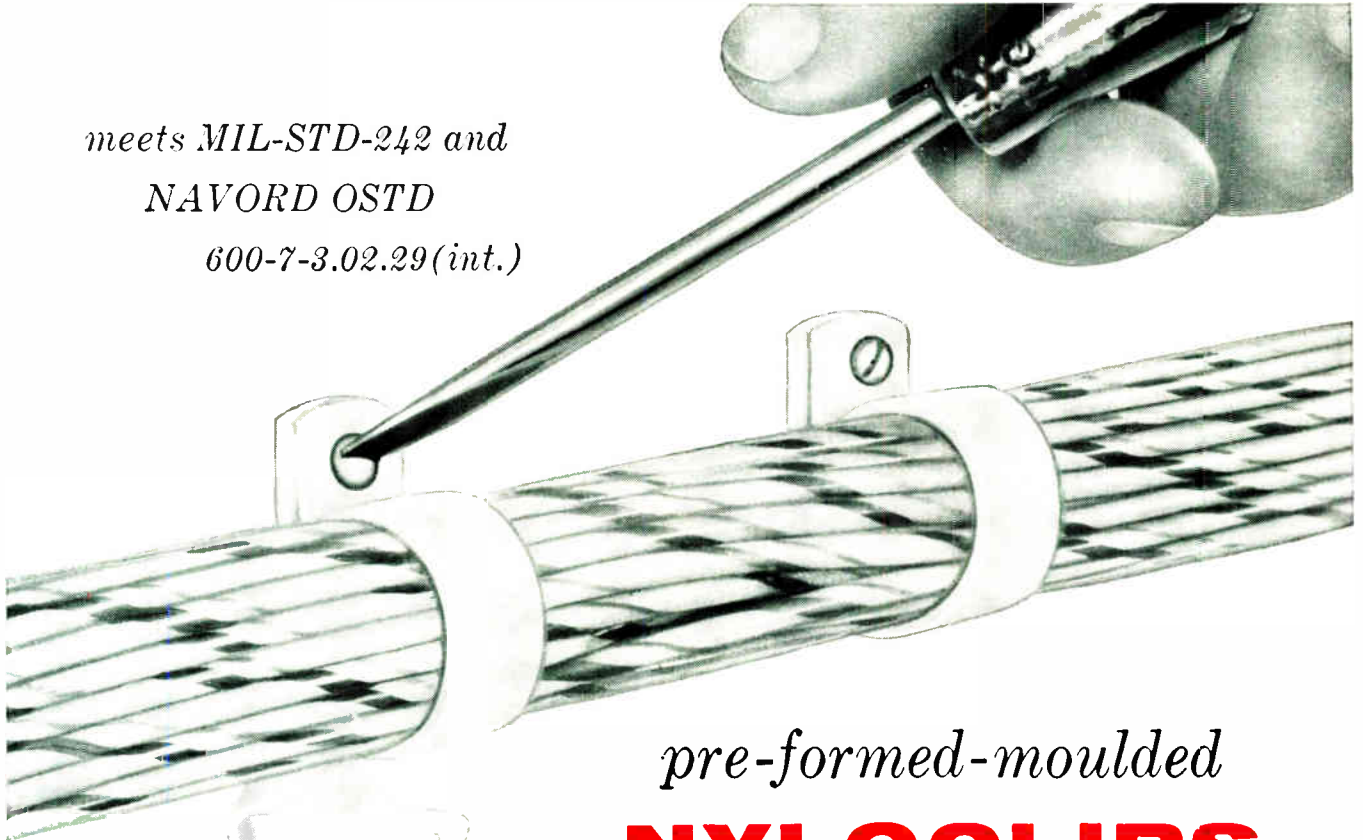

pre-formed-moulded

NYLOCLIPS

Nyloclips fill the bill completely on all applications requiring light, self-insulating cable clamps. Seventy per cent lighter in weight than comparable metal clamps. Smooth, non-abrasive surfaces; rounded edges will not chafe conductors or cause grounds or shorts. Insulating properties reduce failures caused by grounds and shorts. Insoluble in common solvents, alkalies, dilute mineral acids and most organic acids. Retains strength at temperatures up to 300° F, (150° C.), and is unaffected by petroleum oils and greases, lubricants, hydraulic fluids, lactic acid and photographic solutions. Good for -60° F. to 300° F.

SAMPLES of these Burndy Nyloclips will be sent you without cost upon your written request.

BURNDY CANADA LTD., 1530 Birchmount Road,
(Metropolitan Toronto), Scarborough, Ontario.
PLymouth 7-8761.

Offices in Montreal, Winnipeg, Calgary, Vancouver.



BURNDY

5602-R

**New Fully Militarized
GR Type P-582
Capacitance Bridge**

(Military Designation: Test Set, Capacitance Bridge, TTU-24/E, Precision, Three-Terminal, Depot)

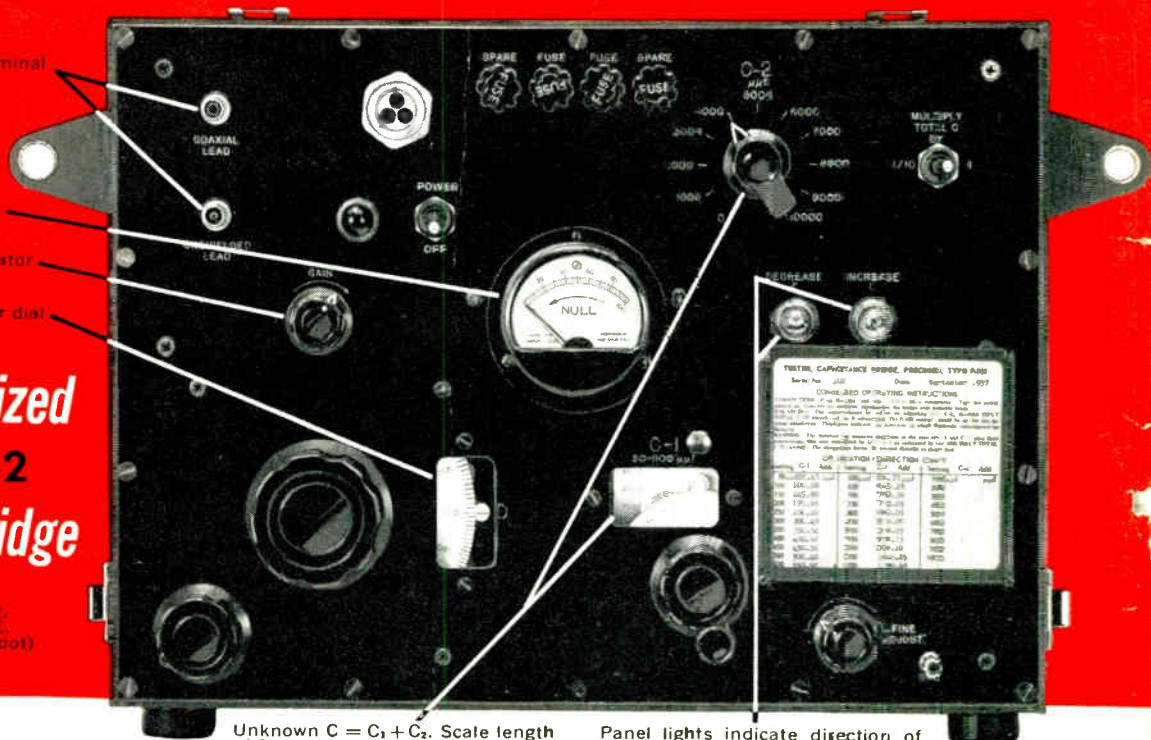

Unknown $C = C_1 + C_2$. Scale length of C_1 calibration is over 19 feet.

Panel lights indicate direction of bridge balance.

... for accurate measurement of 3-terminal capacitance and dissipation factor at 400 cycles. This bridge with its many unique features is useful for general-purpose capacitance measurements, and is ideal for testing precise capacitance fuel-gage testers.

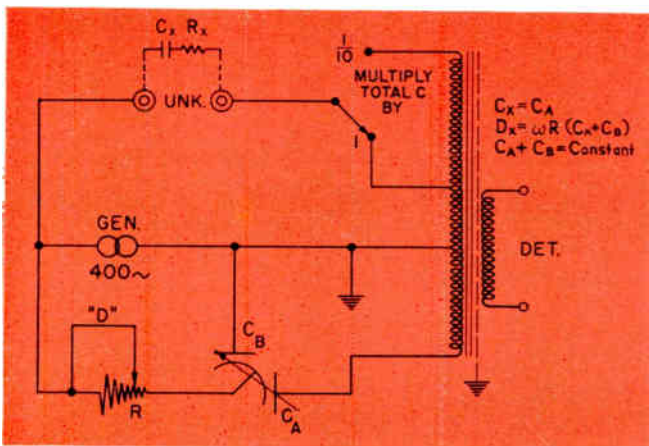

A transformer-type circuit is used to obtain precise 1:1 or 10:1 ratio arms with which to compare the unknown, C_x , against the internal standard capacitor. This standard is a special differential G-R Type 722 variable capacitor, plus a silvered-mica decade to extend the range to 11,000 μf . The sum ($C_A + C_B$) is held constant, so that the variable resistor R may be calibrated in D directly.

The 400-cycle oscillator uses a thermistor-stabilized R-C Wein Bridge network in a three-stage feedback circuit. Frequency is virtually independent of tube parameter changes. The detector uses two cascaded, twin-T feedback amplifiers for high selectivity. Stray impedances from the unshielded and coaxial leads to chassis ground (third terminal) shunt oscillator and bridge transformer respectively and, therefore, cause negligible bridge errors.

UNIQUE FEATURES:

- ★ Completely Self Contained . . . oscillator, bridge circuit, and null detector in one cabinet.
- ★ Reads D directly, no calculation necessary.
- ★ Null indicator has compressed response for easy balance.
- ★ When null indicator is upscale, one of two panel lights indicates the direction of capacitance adjustment necessary (increase or decrease value of standard). If neither light operates with up-scale reading, then dissipation-factor adjustment must be made.

SPECIFICATIONS

Ranges:
 Capacitance: 5 μf to 0.011 μf
 Dissipation Factor: 0 to 0.11
Accuracy:
 Capacitance: Depends on setting of variable and fixed capacitors.
 Variable Capacitor: on X1 Range, $\pm 0.4 \mu\text{f}$ or $\pm 0.1\%$, whichever is greater; on X1/10 Range, $\pm 0.04 \mu\text{f}$ or $\pm 0.1\%$, whichever is greater.
 Decade Capacitor: $\pm 0.1\%$ on both ranges.

Dissipation Factor: $\pm 2\%$ of reading ± 0.0002 .
Detector Sensitivity:
 X1 MULTIPLIER position — 10% deflection for 0.05 μf ΔC .
 X1/10 MULTIPLIER position — 10% deflection for 0.005 μf ΔC .
Tube Complement:
 Five-5751, 12AT7WA, 6X4WA.
Price \$2175.

GENERAL RADIO Company

Cambridge, Massachusetts, U.S.A.

Canadian Office: 99 Floral Parkway, Toronto 15, Ontario

Arthur Kingsnorth

Richard J. Provan

Telephone: CHerry 6-2171

Repair Service:
 Bayly Engineering, Ltd.,
 Ajax, Ontario



WE SELL DIRECT. Our District Sales Offices are staffed by engineers especially trained to help you in the selection of instruments and measuring systems best suited to your needs. We welcome your inquiries — will help solve your problems.