

ELECTRONICS AND COMMUNICATIONS

MR F W PRETIOSI
6 EASTGATE CRES
SCARBOROUGH ONT

EP
CR
OEL
121

A Study Of The Results
Of Relay Qualification Tests
By E. J. Parnell-Smith

Controlling The Rate And Magnitude
Of Change Of A Variable

Process Control Systems
As A Management Tool
By Thomas Roy Jones

A 500 m/W Satellite Radio Transmitter

JUNE 1958



AN AGE PUBLICATION
TORONTO, CANADA

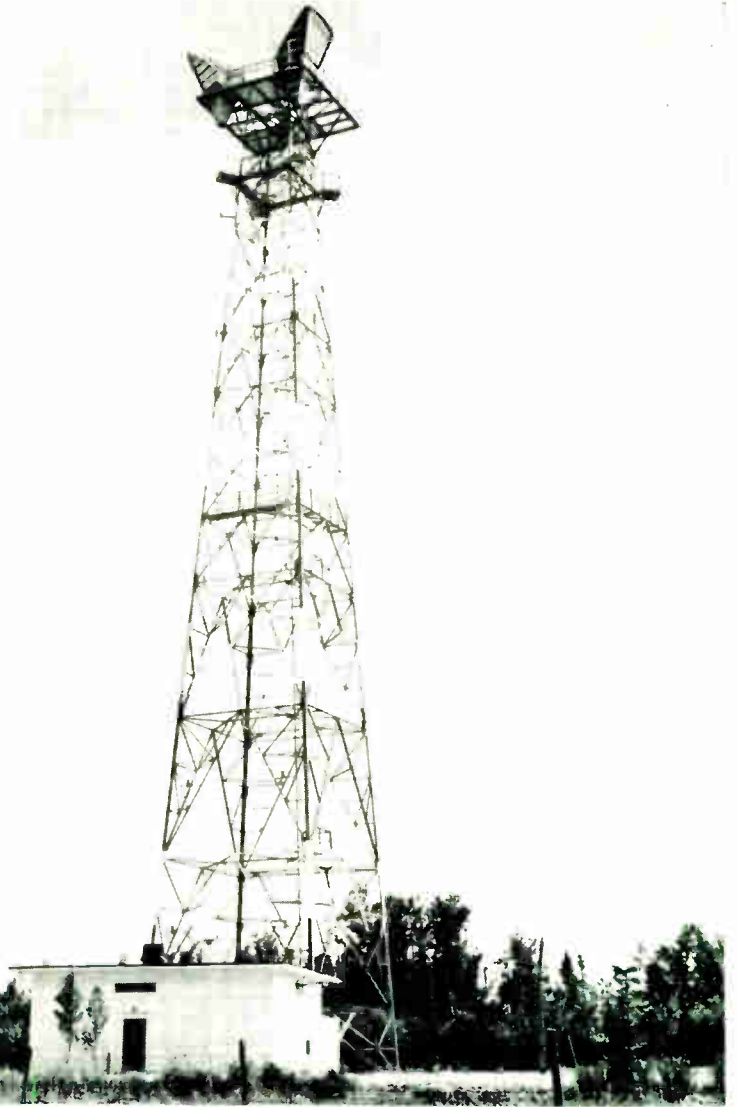

FASHIONS CHANGE IN **STEEL** TOO

For almost half a century transmission towers have cable-crossed city and pasture alike to feed us electric power. Now inventive genius has added the fashionable and highly practical television and micro-wave relay tower to our horizon.

Central has fabricated and erected many towers in Canada similar to this one of several built for Eastern Telephone and Telegraph. Have Central Bridge quote on your next structural steel job.

CENTRAL BRIDGE *Company Limited*
Fronton, Ontario

*For your structural steel requirements
call Central soon.*

MAGNETRONS

FROM CANADIAN MARCONI

Vital electronic components now produced in this country

A million dollar production plant, complete with micro-wave tube development laboratories, now assures Canada of a domestic supply of magnetrons for vital defence and navigation equipment.

These same laboratories are being staffed and equipped to deal with advanced work on magnetrons and other micro-wave devices. We would welcome the opportunity to help you with any of your micro-wave tube problems.

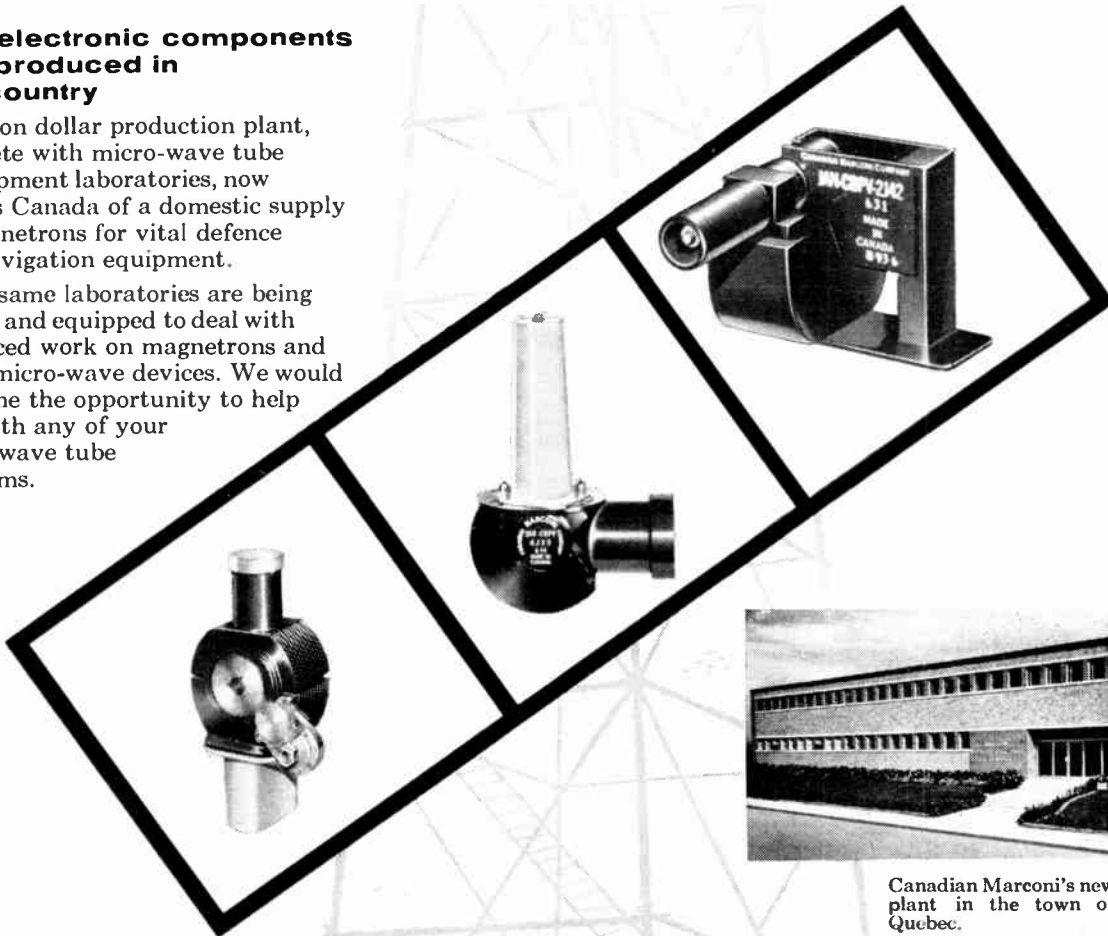

Canadian Marconi's new Electronic Tube plant in the town of Mount Royal, Quebec.

Electronic Tube and Components Division

CANADIAN Marconi COMPANY

830 Bayview Avenue, Toronto, Ontario

BRANCHES: Vancouver • Winnipeg • Montreal • Halifax • St John's, Nfld.

NEW OHMITE®

12 1/2 WATT MINIATURE RHEOSTAT

High power handling capability for small size

Newest addition to the Ohmite line of vitreous-enamelled rheostats is the new Model "E" miniature 12 1/2-watt rheostat. This new unit is smaller than many one- or two-watt potentiometers. It provides time-tested Ohmite all-ceramic and metal design features for uses where as much as 12 1/2-watt dissipation is required and space is extremely limited. Built to operate at a maximum hot spot temperature rise of 300° C at an ambient of 40° C, Model "E" is also useful for operation at high military ambients, derated linearly to zero at 340° C, attained. Rugged, lasting, power rheostat performance is thus available in such small size that new possibilities in miniaturization and dependability are afforded the apparatus designer.

Like the larger Ohmite rheostats, Model "E" has a ceramic base, and ring-shaped ceramic core. Vitreous enamel holds the turns of wire against shifting, and fastens the base and core together. Also, the Model "E" has a ceramic hub insulating the shaft; a metal-graphite contact; folded spring arm; independent compression spring; slip-ring; a stop directly connected to the shaft. The entire assembly is a miniaturized, dependable version of the time-proven Ohmite power rheostat design. Mounting is by a 1/4"-32 threaded bushing. The shaft is 1/8" in diameter. Resistance range: up to 5,000 ohms with 23 stock values; higher values available with OHMICONE inorganic coating. Resistance tolerance: ±10%. Torque: 0.1 to 0.2 pound-inch. A small finger-grip knob, in keeping with the rheostat dimensions, is available.

Special length shafts and bushings, screwdriver shafts, locking type bushing, tandem mountings, enclosures, etc., similar to the variations available on the larger rheostat, can be provided upon specific request.

ACTUAL SIZE
Model "E"
Only 3/8" Diameter
Weight: 0.52 Ounce

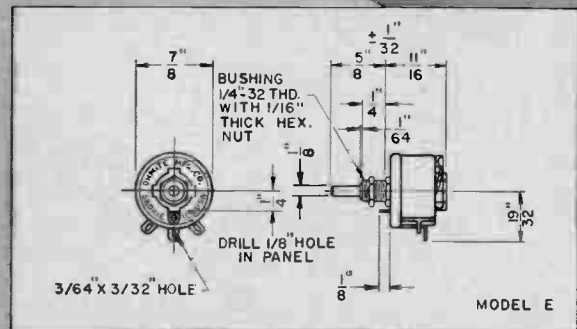
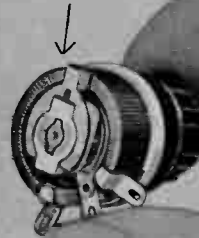

INDUSTRY'S MOST COMPLETE LINE OF RHEOSTATS

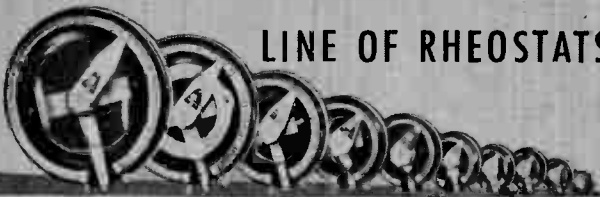

OHMITE®

QUALITY
Components

WRITE FOR BULLETIN 157

Now 11 Sizes! — 12 1/2 to 1000 Watts

All sizes available from stock in a wide range of resistance values, including the NEW Model "E." Ten sizes are available to meet MIL-R-22A requirements in each of the 26 type designations.

RHEOSTATS RESISTORS RELAYS
TAP SWITCHES TANTALUM CAPACITORS
R. F. CHOKES VARIABLE TRANSFORMERS

OHMITE MANUFACTURING COMPANY 3689 Howard St., Skokie, Ill.

A. C. Simmons & Sons, Ltd.
100 Merton St., Toronto 12.

C. M. Robinson & Co.
1550 Erin St., Winnipeg 3, Man.

Electronics And Communications

VOLUME 6 JUNE, 1958 NUMBER 6

FEATURES

A Study Of The Results Of Relay Qualification Tests 18
 By E. J. Parnell-Smith

Simple Automation Cuts Costs 60 to 1 25

Controlling The Rate And Magnitude Of Change Of A Variable 26

Process Control Systems As A Management Tool 28
 By Thomas Roy Jones

Automated Continuous Seam Welding 31

A 500 m/W Satellite Transmitter 32

DEPARTMENTS

Business Briefs And Trends 7

Editorial 11

New Products 38

CRTPB Newsletter 42

News Report 43

Book Review 66

President, Norman G. McHardy; Vice-President, Secretary-Treasurer, L. R. Kingsland; Editor, Thomas W. Lazenby; Consulting Technical Editor, Leslie Hill, Ph.D. Eng.; Editorial Assistant, D. K. Trowell; Advertising Manager, H. E. Dallyn; Assistant Advertising Manager, Arthur Dixon; Production Manager, Nevill A. Campling; Business Manager, Clifford A. Sparks; Circulation Manager, Paul A. Irwin; Art Editor, Wm. McReynolds; Photo Editor, Guido Milanese. United Kingdom and European Representative, Norman F. Keenan, 47 Manchester Street, London W. 1, England. West Coast Representative, Dillenbeck-Galavan, Inc., 266 South Alexandria Ave., Los Angeles 4, Calif. Montreal Representative, Keith Edgar, 116 Rue de Flandre, Montreal 23 (Preville), Quebec, Telephone: OR. 1-2020. All business and editorial correspondence should be addressed to the Toronto office.

PUBLISHED BY AGE PUBLICATIONS LIMITED

Founded in 1923 by Norton W. Kingsland

Publishers of Heating, Plumbing and Air Conditioning AGE • Restaurants and Institutions
 Automatic Heating • Wine, Beer and Spirits in Canada • Industrial Aeronautics

31 - 35 Willcocks Street, TORONTO, ONT., CANADA. Tel. WALnut 2-3115.

SUBSCRIPTION RATES: Canada, U.S.A. and British Possessions - \$5.00 per year • Foreign - \$10.00 per year.

Contents copyright by Age Publications Limited. No part of this periodical may be reproduced without the consent of the publisher.

Authorized as second class mail. Post Office Department, Ottawa.

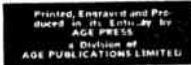

Member Canadian Circulations



Audit Board, Inc.

PRINTED IN CANADA 60

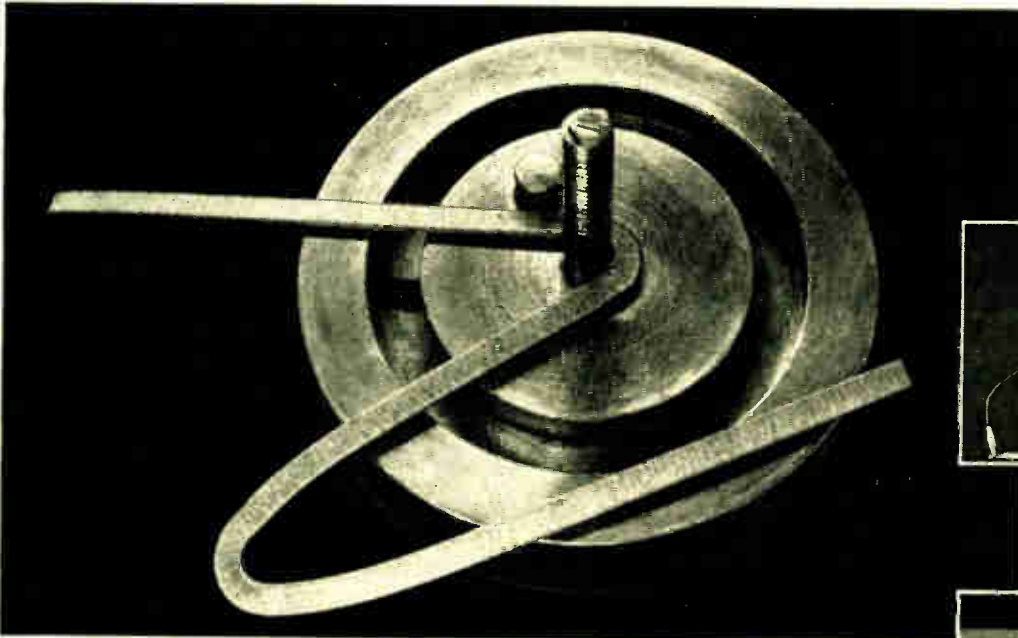

Standard lab test shows Phillips Daglas on the mandrel after the bend test. The ability of the insulation to withstand a strong edgewise bend is clearly shown.



Dielectric strength test for voltage breakdown shows insulation on wire standing up when subjected to severe voltage test.



Twist test shows insulation adhering firmly to the copper while wire is being subjected to extreme torsion.

◀ DAGLAS INSULATED MAGNET WIRE TAKES SEVERE EDGEWISE BEND

New Daglas Magnet Wire combines glass with polyester fibres fused together and bonded to the wire at high temperatures.

It has all the good characteristics of glass magnet wire plus the advantages of superior abrasion resistance, and a remarkable adhesion which permits reasonably severe edgewise bending without opening up the insulation.

Phillips DAGLAS

- ★ Accepted for Class B(130°C) windings with standard varnish.
- ★ Suitable for Class H(180°C) when used with Silicone varnish.
- ★ Tough hard surface has high abrasion resistance.
- ★ Remarkable adhesion—insulation won't scuff or unwind. Makes taping of ends unnecessary.
- ★ Hard finish is unaffected by conventional varnishes.
- ★ Withstands severe edgewise bend on rectangular wire without fraying or opening up. As a result, sleeving or taping of bends may be eliminated.

Now being used by the major Canadian Electrical Manufacturers.

- ★ Available in sizes suitable for winding any STANDARD MOTOR.
- ★ Now being used in the regular production of GENERATORS.
- ★ Can be used in any Class B or Class H dry type TRANSFORMER.
- ★ Withstands the severe pounding to which COMMERCIAL ELECTRO-MAGNETS are subjected.
- ★ Stands up to weather extremes and rough usage in TRACTION MOTORS as used on street cars and transportation.
- ★ Provides the best known answer to problems in Class B & H REVERSING MOTORS as used in pulp mills, refineries, mines, etc.



Phillips Electrical Company Limited.
Head Office—Brockville, Ontario.
The Canadian affiliate of the British Insulated Callender's Cables Group. 5820

MONTREAL • OTTAWA • TORONTO • HAMILTON WIRES CABLES WINNIPEG • REGINA • EDMONTON • VANCOUVER

For further data on advertised products use page 61.

business briefs and trends

★ The development of an anti-submarine "electronic warning line" is being planned by the Canadian Government in co-operation with the United States and Great Britain. General Charles Foulkes, chief of staff, has described this electronic fence, or ship-plus-aircraft barrier, as part of a new measure in warfare whose development should not be delayed in order to prepare, in the event of war, for prevention of attack by enemy submarines on single ships or convoys leaving Atlantic ports.

* * *

★ TV distributor sales to dealers for the month of March were up nearly 2 per cent over sales in March, 1957, according to a report from RETMA of Canada. Sales for March 1958 were 30,245 units against 29,716 for March of the previous year. This upward swing in March 1958 has brightened the outlook for sales during the whole of 1958.

* * *

★ Two devices, a Betameter and an Aquatel, have been combined ingeniously into a control system which operates with great success in the papermaking industry. The system has been devised and built by the Isotope Products Division of Canadian Curtiss-Wright Ltd. at Oakville, Ontario. By its means the basis weight of the paper and its moisture content can be automatically measured, gaged and controlled, while continuous automatic adjustments are made as process fluctuations are recorded.

* * *

★ A well-known physicist recently described a "new and very scarce type" of management official essential to scientific industry today — the composite scientist and administrator with profit consciousness. "The greatest returns to investors in electronics companies," said President R. T. Silberman of the Kin Tel Division of Cohu Electronics Inc., "will accrue from those situations where management has developed techniques to profitably convert technological developments to useful products and can exist in the highly competitive manufacturing and distribution climate that now is developing."

* * *

★ The Province of Saskatchewan has recently improved its facilities for efficient operation of the Maintenance Branch of the Department of Highways by installation of a two-way radio communication system to establish direct contact between head office and district offices. The three base stations are at Regina, Weyburn and Carlyle through which access is gained to highway districts in other parts of the province.

* * *

★ A Toronto daily newspaper is expanding its news coverage facilities by using closed-circuit television connected with a screen in its window. Philips Electronics Industries Ltd. supplied and installed the equipment which is a pioneering effort on the part of this newspaper to disseminate news stories and pictures.

* * *

★ The British Radio and Electronic Component Manufacturers Federation drew visitors from 29 nations at the annual exhibition held in London in April. A wide range of small components originally designed for guided missiles is now available for commercial applications and particularly for use in computers, and some of these were displayed for the first time at the "Component Show". British production of radio and electronic components had increased seven times in volume, it was reported, from 250 million components in 1946 to 1,750 million in 1957.

* * *

★ The B.C. section of the cross-country microwave system, scheduled to open June 1, 1958, presented the most problems in construction of the 3800-mile system due to the mountain ranges running north and south, at right angles to the route of the network. Most of the thirteen B.C. sites are erected on ridges approximately 30 miles apart.

business briefs and trends

★ It is claimed that Britain is sending more radioisotopes overseas than the rest of the world's exporters combined. W. G. Busbridge, Principal Scientific Officer of the United Kingdom Atomic Energy Authority's Isotope Division recently said that "the value of isotopes far outstrips their cost to research, medicine, industry and agriculture."

* * *

★ A new computing service has been prepared by a firm of consultant engineers in Toronto to aid engineering firms with their mathematical problems in large building projects, particularly bridge building. Where the engineering personnel of such firms are not equipped with the knowledge of programming their problems into computers, the service should prove most acceptable and extremely economical. This computing service has been developed by ENELCO, a subsidiary of A. M. Lount and Associates.

* * *

★ Transistor sales continue to rise. Figures issued by Electronic Industries Association reveal that dollar sales increased 87 per cent in 1957, while unit sales increased 123 per cent.

* * *

★ The Dominion Electrohome Industries, Ltd. of Kitchener, Ont., reported that it began the year 1958 with the largest dollar value of orders on hand in the company's history. Sales of television, radio, hi-fi units and other products made by this company increased by close to \$1 million in 1957.

* * *

★ An experimental electron tube that can detect and measure events that happen in less than one ten-millionth of a second is one of science's latest achievements. It is expected to be a powerful new tool in nuclear research, and is designed to help identify the mesons, anti-protons and other elementary particles that result from bombardment of atomic nuclei.

* * *

★ At a cost of \$3.5 million, an additional circuit in the 138,000 volt submarine power cable link between Vancouver Island and the mainland of British Columbia is being laid by British Insulated Callender's Cables for the British Columbia Electric Company. The design of the cable will be identical with the submarine power link completed by the same company two years ago.

* * *

★ An order worth \$1 million for powering a new microwave radio link between St. Johns, Newfoundland, and Sydney, Nova Scotia, has been awarded to a British firm, W. E. Dorman and Company Ltd., together with Mechron Engineering Products Ltd. of Ottawa.

* * *

★ A bright market outlook has been predicted for leak detector equipment by P. Ron Doyle, Specialist, Instrument Sales, Canadian General Electric Company Ltd., who has estimated that sales of these electronic devices during 1958 will be the highest in the company's history. Mr. Doyle based his forecast primarily upon three factors: the expanding nucleonics market, in which the electronic devices sniff out leakage in sealed systems designed to carry radioactive fluids; the growing use of leak detectors in the manufacture of consumer products; and the increasing application of leak detectors in the maintenance of plant equipment.

* * *

★ Stuart D. Brownlee, executive vice-president of Canadian Admiral Corporation of Port Credit, Ontario, recently revealed that his company has been first in both unit and dollar sales in seven out of the nine years TV sales statistics have been compiled by RETMA of Canada.

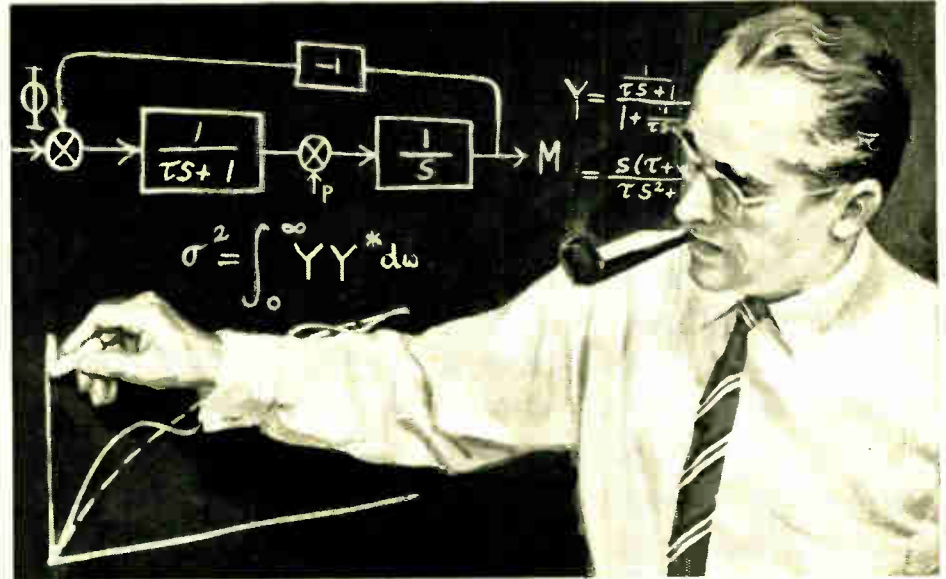
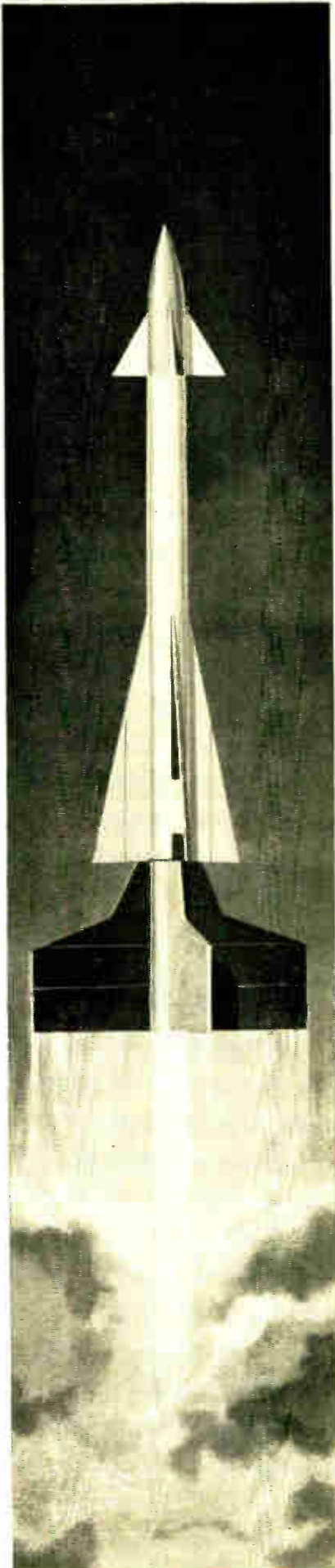

RCA VICTOR DEFENCE ELECTRONIC SYSTEMS at work...

RCA Victor is proud of the part it plays in Canada's defence planning by conducting research, development and production in all phases of Defence Electronic Systems technology.

The search for the talent necessary for this important work will never end. Perhaps you—or someone you know—is an engineer who would be interested in working with this creative group and meeting its challenges. If so, simply contact Dr. J. J. Brown, RCA Victor Company, Ltd., 1001 Lenoir Street, Montreal, Quebec.



DEFENCE ELECTRONIC SYSTEMS
RCA VICTOR COMPANY, LTD.
MONTREAL

What's *new* for you in **CANNON PLUGS**

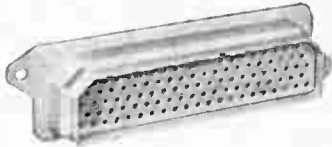

DPJ-33S



DPG-34P

- ▶ **Vibration**
 - ▶ **Moisture**
 - ▶ **Pressure**
- ▶ PROTECTION**

with new DPJ and DPG Connectors

New DPJ and DPG Connectors feature sealing by means of a rubber seal around the insert faces. Exceptionally good protection against vibration and undesirable pressure and moisture conditions is provided. The DPG currently is available in 5 different insert arrangements, the DPJ with 3 insert layouts. Write for Bulletin DP-101 TODAY!

new



"EX" SEALED CONNECTORS

- ▶ **No Potting Required**
- ▶ **Light weight**

New EX Connectors feature a monobloc silicone insert into which the contacts are inserted after wiring. When the endbell is tightened over the insert, the contacts are completely sealed . . . giving a sealed connector of minimum weight without potting.

EX plug assemblies are currently available in four shell configurations with socket contact inserts . . . EX05, EX06, EXG06 and EX08. They are basically identical with the exception of endbell variations in each case. EX plugs mate and seal with standard AN, AN-E, and GS type receptacles, and are available in practically all AN layouts using #12 or #16 contacts from sizes 8S to 28. Write for Bulletin PR-EX TODAY!

new



Available in square-flanged receptacle, Q02, and straight plug, Q06. Insert Diameters: 1/16", 1/8", and 1/4"

"Q" MINIATURE CONNECTORS

- ▶ **Self-Locking** ▶ **Sealed**
- ▶ **Vibration Resistant**

Designed for control and instrumentation circuits of all types where space, vibration, moisture, or pressure conditions are limiting factors. Resilient grommets seal behind inserts . . . rubber sealing ring seals around the insert faces. Locking engagement accomplished by a beryllium copper latch within a spring loaded sleeve. Three shell sizes, with 7, 13, 19, 37 silver-plated brass 10-amp. contacts for #18 AWG wire. Alternate positioning. Cymel 592 insulators. External parts are cadmium plated aluminum. Hermetically-sealed, round-flanged receptacle, QH25, also available. Write for Q Miniature Bulletin TODAY!

CANNON ELECTRIC (CANADA) LIMITED, 160 Bartley Drive, Toronto 16, Ontario
 Montreal Office: Montreal Airport, Dorval, P.Q.
 Ottawa Representative: M. J. Howard & Co., 1206 Bank Street
 Factories also in Los Angeles, Salem, London, Melbourne
 Licences in Paris, Tokyo.

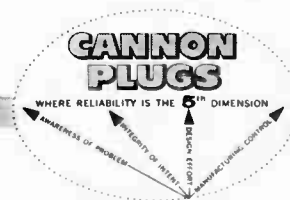

5805

For further data on advertised products use page 61.

Electronics And Communications

 Volume 6

JUNE, 1958

 Number 6

Pardon Our Preaching

IN THE past year or two the Canadian electronics industry has been the recipient of several business brush-offs that have resulted in the placing of sizable contracts for industrial electronic equipment with other than Canadian manufacturers. On the surface it would appear as if those firms ordering such equipment were displaying anything but confidence or loyalty in the Canadian electronics industry. Confidence and loyalty in the Canadian electronics industry, of course, are not sufficient reason why Canadian buyers or any other buyer should place business with it unless specifications can be met and price quotations can compete with outside bidders. Everything being equal, however, it is likely that some of the orders for electronic equipment that have been placed outside of the country could have remained in Canada to the mutual advantage of all concerned.

It is interesting to speculate, therefore, on some of the possible inequalities or weaknesses in the Canadian industry that have resulted in the enrichment of others at the expense of Canadian industry.

It is, we believe, true that the Canadian electronics industry, as we know it today, has had two main sources of support. First, there has been the radio and television market constituted of the general public and secondly, there has been the Government with its defense contracts, not all of which, however, the Canadian industry has been favored with.

Insofar as the radio and television market has been concerned, it has provided Canadian manufacturers with millions of dollars of revenue. Manufacturers, therefore, cannot be admonished for having concerned themselves with this segment of the industry. If there is a market for a product, then business management would surely be remiss if they did not take every last advantage of it, and it may be said that management in the Canadian electronics industry has taken every last advantage of the radio and television market. So much then for this particular main-brace of the Canadian industry.

In the matter of defense electronics, the Canadian industry has been fairly well nourished. Albeit there have been times when the placing of defense contracts outside of the country has, in the opinion of industry authorities, been uncalled for. Nevertheless in the years since the Korean war and during the ensuing years of the cold war the awarding of defense contracts and the anticipation of further such contracts may well be suspect of having created too keen a desire on the part of the industry to rely too heavily and concentrate too vigorously for the Government defense dollar. It is just conceivable, therefore, that one of the results of this pre-occupation with the desire to win Government contracts has had the unfortunate effect of distracting the attention of management from the dollar potential that has been inherent in the field of industrial electronic equipment as opposed to radio, television and defense work. It must, of course, be admitted that these fields have constituted the markets with the immediate dollar return over the past decade, but there is surely more to business management than planning on capturing a share of existing markets. It is not

only existing markets that business management must concern itself with, but those markets which may be forecast by obvious trends and we suggest that the trend to electronic computation and automation has been patently obvious for some years past.

Despite this trend and the obvious development of a Canadian market for industrial electronic equipment, few Canadian firms, it would now appear, took early enough or vigorous enough action to identify themselves as dealers in industrial electronic apparatus to land some of the substantial orders that have recently been placed by Canadian buyers.

Could this lack of early interest in the field of computers and automation have been due to a pre-occupation with television, radio and the defense market? The question is an interesting one and one that may not be fully answerable without some admission of guilt on the part of Canadian industry.

No doubt there will be future Canadian orders for industrial electronic equipment and if potential purchasers are to be made aware of the Canadian industry's capacity to provide this equipment, either through representation or manufacture, then the Canadian industry would be well advised to start talking loudly about its ability to do so.

In this respect it may be said that firms who have captured continent-wide respect as manufacturers of washing machines, radios, television sets, heavy electrical equipment or even light bulbs cannot rely on their reputation in these fields to sell themselves also as leaders in the field of electronics unless they are prepared to loudly proclaim their stake in this new industry. It is not likely that a potential customer for an electronic computer or a control system will be impressed with a firm's reputation for quality light bulbs or electric generators. What the potential customer for electronic systems will be interested in is electronic systems only, and the natural and direct way to attract the attention of such customers is to talk electronic computers and systems from every available and appropriate platform. It has been with such strategy, we believe, that other than Canadian firms have succeeded in getting Canadian buyers to sign on the dotted line for some of those recently placed million dollar contracts the equipment for which could well have been labelled "Made In Canada".

While it is most necessary that firms who have won continent-wide recognition as manufacturers of household consumer products or even heavy industrial equipment must continue to advertise themselves as competent and qualified in these fields of endeavor, it seems to us that if they are to achieve equal prominence in the field of electronics they must advertise themselves just as vigorously in this area of endeavor. It is not likely that the Canadian home-owner seeking to purchase a television set or a refrigerator would be influenced by the advertising of a remote foreign manufacturer to buy his product, but it is surprising how many customers for industrial electronic equipment are influenced by this means to buy the product of far-distant manufacturers. The answer, of course, is to let Canadians talk louder.

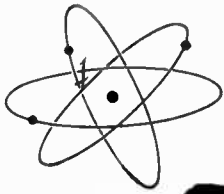

ACT NOW

for space at the

IRE CANADIAN CONVENTION AND EXPOSITION

ELECTRONICS and NUCLEONICS

***your finest opportunity to show your products
to the finest prospects—***

For three full days, you can display and demonstrate your products and services at low cost, to a concentrated audience which you cannot meet again for a year.

Your audience will be eager to see all it can, learn all it can, and above all, be receptive to your message.

During those three days you and your representatives will meet the key men who make or influence buying decisions about your products.

Act NOW! to reserve space. Write to-day for illustrated brochure.

**OCTOBER
8-9-10**

1958



AUTOMOTIVE BUILDING., C.N.E., TORONTO

Office—1819 YONGE STREET, HUDSON 8-7768

Sponsored by the Canadian Sections of the Institute of Radio Engineers

For further data on advertised products use page 61.

9 REASONS why your Advertising in Canada should be in



1. It pioneered in this field 5 years ago.
2. It is tailored to meet the distinctively different needs of the Canadian market.
3. It is edited by a staff with decades of experience in business paper publishing.
4. It tells management what your product can do and tells the engineers how it does it.
5. It is edited by men with engineering technical background and years of experience on sales engineering and market research in this market in Canada.
6. It has been an important factor in rapid development and progress of this field during the past 5 years.
7. It has the largest circulation in its field and whose circulation lists are the result of five years careful checking, eliminating and adding where needful to bring it up to the utmost in efficiency.
8. It is carrying more than twice as much technical advertising to more electronic engineers than any other publication in the field.
9. Its technical articles are being listed regularly in the monthly survey of the world's top electronic engineering articles.

ELECTRONICS and COMMUNICATIONS
450 Alliance Avenue Toronto 9, Ontario

THERMOMETAL®...
 for use in electrical appliances, thermal cutouts, heating controls... in any application involving the indication and accurate control of temperatures, electrical currents, voltages, etc. Supplied in strip form, rolled and slit to close tolerances and tempered to meet specifications. Also supplied as elements and sub-assemblies, with or without contacts attached, fabricated in accordance with specifications.

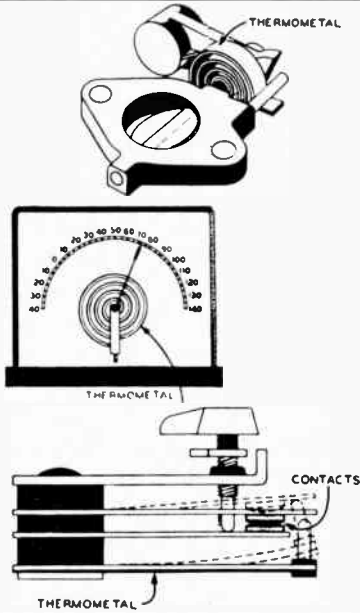

FINE WIRE...
 of ductile and non-ductile materials for every application requirement. BAKER research has developed processes for bare drawing wire as fine as .0004". Where smaller fine wire is required, the Wollaston process, for ductile metals, and the Taylor and Extrusion methods, for non-ductile materials, are employed.

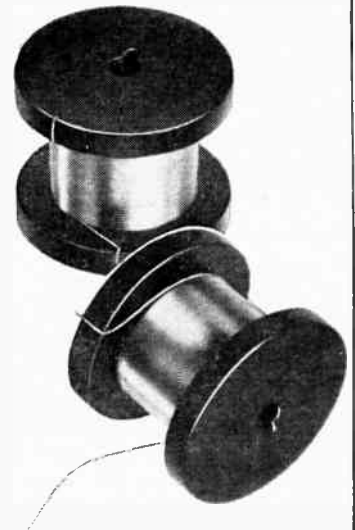

- ▶ for controlling temperature...
- ▶ for fine wire...
- ▶ for precious metal contacts...
- ▶ for corrosion-resistant surfaces...

PRECIOUS METAL CONTACTS
 for long operating life and unvarying performance. Available in pure or alloyed forms of Silver, Platinum, Palladium, and Gold. These contacts provide extremely high resistance to atmospheric corrosion, deformation, arc erosion, sticking and metal transfer. They are supplied as wire, rod, sheet, and as fabricated forms.



RHODIUM PLATING...
 an economical, hard, white, corrosion-resistant surface. Extremely well-suited for many electrical and electronic applications. Resistant to corrosive atmospheres, oxidation, arc erosion. Reduces wear on moving surfaces, assures low noise level for moving contacts, no oxide rectification, low and stable contact resistance. Ideal when a low-resistance, long wearing, oxide-free contact is required.

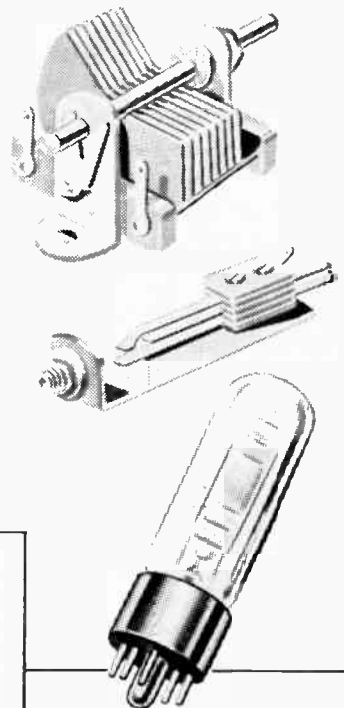

ENGELHARD INDUSTRIES
 OF CANADA, LTD.

512 KING STREET, EAST • TORONTO, ONTARIO, CANADA

✱

SALES OFFICE: ENGELHARD INDUSTRIES (QUEBEC), LIMITED

1255 UNIVERSITY STREET, MONTREAL, P.Q., CANADA

For further data on advertised products use page 61.

Doing Pulsed or "Fast" Circuit Work?

Square Wave Generator



1 cps to 1 MC; 0.02 μ sec rise time

-hp- 211A Square Wave Generator. Versatile, wide range instrument for testing oscilloscopes, networks, video and audio amplifier performance, modulating signal generators, measuring time constants. Offers simple control of electronic switchers; is also convenient for indicating phase shift, frequency response and transient effects.

Special features include two separate outputs — a 7 volt, 75 ohm circuit for television work and a 55 volt, 600 ohm output for high level work. Both outputs offer full amplitude variation. May be operated free-running or externally synchronized with positive going pulse or sine wave signal of 3 volts minimum amplitude. Compact, weighs only 25 lbs. Price \$265.00.



Pulse Generator

0.07 to 10 μ sec pulses, 0.02 μ sec rise time



-hp- 212A Pulse Generator. Time saving basic instrument for radar, television and other "fast" circuit work, including testing rf amplifiers, filters, band pass circuits; oscilloscopes and peak measuring equipment, pulse modulating uhf signal generators. Offers positive or negative pulses of 50 watts amplitude, delay and advance sync out circuits for synchronizing to other circuits, direct-reading pulse length control, high quality pulses with 0.02 rise and decay, flat top and minimum overshoot. Jitter less than 0.01 μ sec. Permits delivery of accurate pulses to end of long transmission lines; if line is correctly terminated, pulse shape is independent of line length, sync conditions, input voltage or output attenuator setting. Internal impedance 50 ohms or less, either polarity. Repetition rate, internal sync 50 to 5,000 pps, external sync 0 to 5,000 pps. Available for rack mount. Cabinet model \$565.00.

Call your -hp- representative for details or write direct. *Data subject to change without notice. Prices f.o.b. factory.*

Represented in Canada by

ATLAS INSTRUMENT CORPORATION, LTD.

50 Wingold Ave., Toronto 10, Ontario • 105-525 Seymour St., Vancouver, B.C. • 72 Princess St., Winnipeg, Manitoba



also offers new 120A Oscilloscope—dc to 200KC—\$435

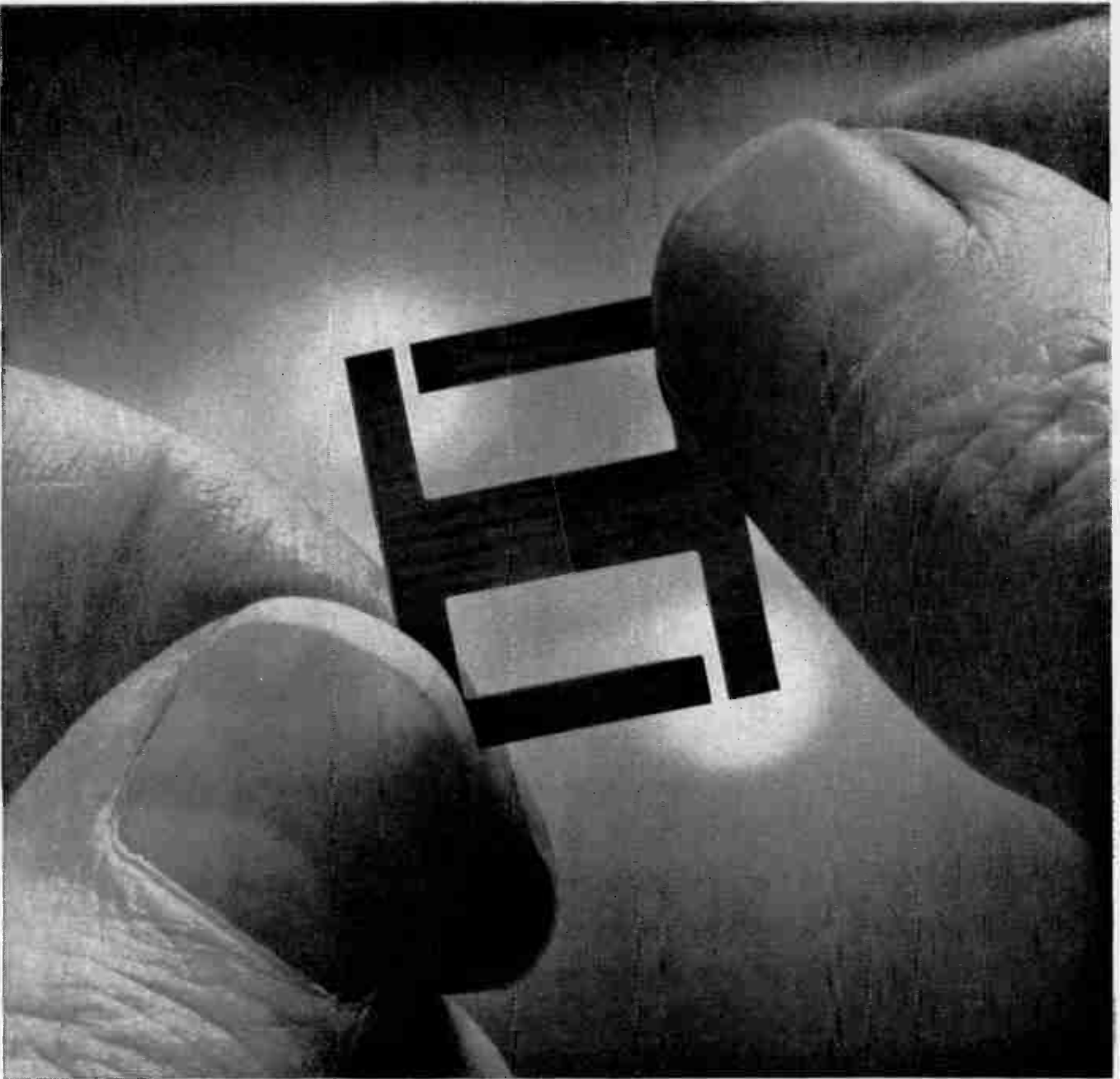

See the air-gap on this new lamination for miniaturization

Look at the air-gaps on this new performance-guaranteed lamination we have developed and are stocking. The F-187's fixed air-gap provides constant inductance or linear inductance, as needed, because it prevents d-c saturation of the stacked core.

The F-187 $\frac{3}{16}$ " wide center leg is designed for miniaturized filter circuits for communication applications. It is ideal for carrier equipment, and can be used most successfully for microwave, computer or other applications where frequency control is critical.

Being an "F" shape, the new standard stacks more easily than EI-187, and thus offers welcome savings on the production line. There can be advantages to you, too,

in being able to order any quantity, prototype or production, directly from stock.

There's more detailed information on this new member of Magnetics, Inc. family of "Performance-Guaranteed" laminations—and all of our other standard laminations. Just write—*Magnetics, Inc., Dept. EC-49, Butler, Pa.*

MAGNETICS inc.

For further data on advertised products use page 61.

FROM *Standard Telephones and Cables Limited*



another product for modern industry

the **MOSAIC** diagram system

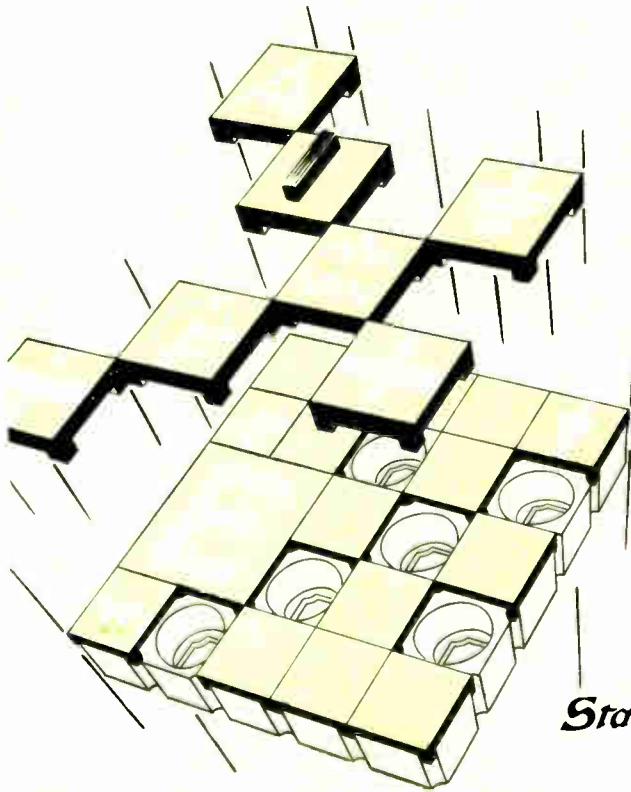

A comprehensive — yet simple — visual control system within the complex control-room, has become an integral need in all branches of our rapidly expanding industry, which to-day must be better equipped than ever before . . .

Aware of all current industrial needs, S.T.C. has designed and developed the Mosaic Diagram — a supervisory display which can be revised at any time to meet any expansion or change . . . thereby offering the only complete solution to all network problems . . . outstanding features of this system are:

- At-a-glance colour differentiated control.
- Simplicity, Adaptability and Flexibility.
- Finest mechanical and technical quality.

"Standard" Mosaic Diagrams are now being used in many industrial concerns throughout the world. These installations have already proven how greatly the scope of equipment control and supervision may be increased . . . and of how marked economical improvement can be realized through the adaptability of the Mosaic and the more efficient employment of personnel.

We invite you to consult us for analysis of your present operational problems, and an explanation of the S.T.C. Mosaic Diagram System.

Standard Telephones and Cables Limited

9600 ST. LAWRENCE BLVD.,
MONTREAL 12, P. Q.



PRODUCTS FOR INDUSTRY — THE WORLD OVER

The Canadian Military Electronics Standards Agency (CAMESA) is the Tri-Service Agency responsible jointly to the Canadian Navy, Army and Air Force, to co-ordinate the Standardization of Electronic Parts.

Testing the products of Canadian and Allied Industries to military requirements and the issuing of an approved product list of acceptable items, is one of the primary functions of the Agency. Reports were, and are, being received from all Branches of the Canadian Armed Services of serious failures in the field, and of the general unreliability of relays.

CAMESA, therefore, undertook a testing program on relays in order to try and establish approved sources of relays that would meet the Tri-Service requirements of MIL-R-5757.

There are many published articles and papers on reliability and based on the majority of these papers, Relays are next to tubes in the listing of the most unreliable components. It appears too that tubes will not necessarily head the list for much longer, due largely to the introduction of solid state devices. This will of course leave the field clear for relays to top the list.

A Study Of The Results Of Relay Qualification Tests

By E. J. Parnell-Smith

Department of National Defense (CAMESA)

IT is the intention of this article to outline the problems being met by the Canadian Armed Services with regard to the procurement of reliable relays. The article includes a summary of the test results and tabulates the types of failures encountered, in the order of the frequency that they occur, so that the basis of the tests will be known. Details of the method and the equipment used have also been tabulated.

One of the main problems encountered in the initial stages of the relay test program was the complete lack of any standard types in use by the Military. The specification adopted by the three Canadian services was MIL-R-5757B and the later version MIL-R-5757C is now applied. This in itself is a major step towards standardization, but few manufacturers were interested in any particular specification. Usually prime contractors for Military equipment would specify their own requirements and drawings, and it is the prime contractor generally, that the relay manufacturer has to satisfy.

Under these circumstances our testing program was undertaken. The selection of the relays for testing was based, in some cases, on relays that were in use in military equipment and in other cases on literature and advertisements issued by the manufacturers, indicating the type of performance required in military use.

In nearly every case where samples were submitted for test the manufacturer was informed of the intention of the Agency to perform qualification tests to MIL-R-5757.

All of the reports and tests were conducted by the Research Division Laboratories of the Hydro-Electric Power Commission located in Toronto. This laboratory performs tests on many electronic parts for and on behalf of CAMESA. The details of the equipment and the method used by the Hydro Laboratories have been included in this article.

Articles previously published have indicated, and we

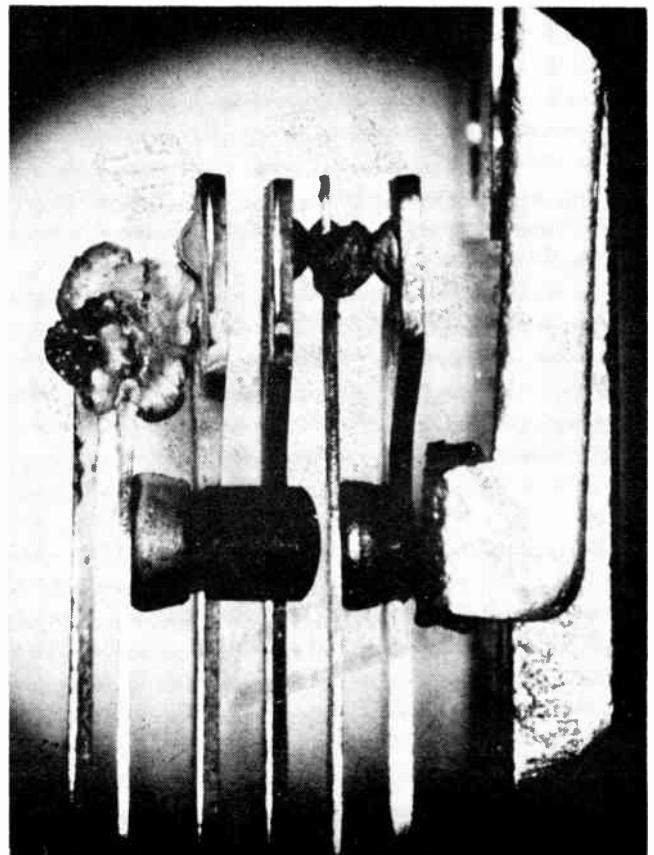

Fig. 1. Contacts burned and welded during life tests.

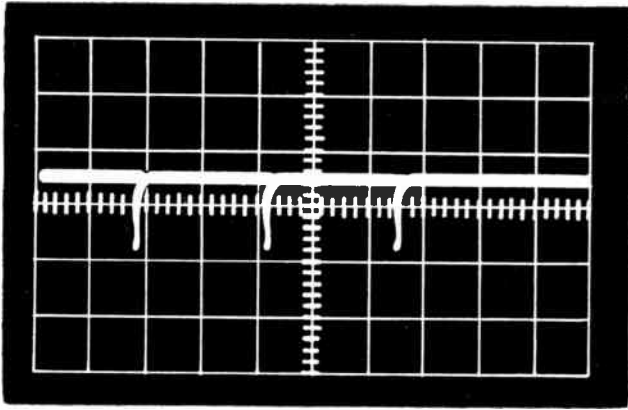

Fig. 2a. Vibration at 45 cps (Resonance). Sweep time — 10 MS/CM.

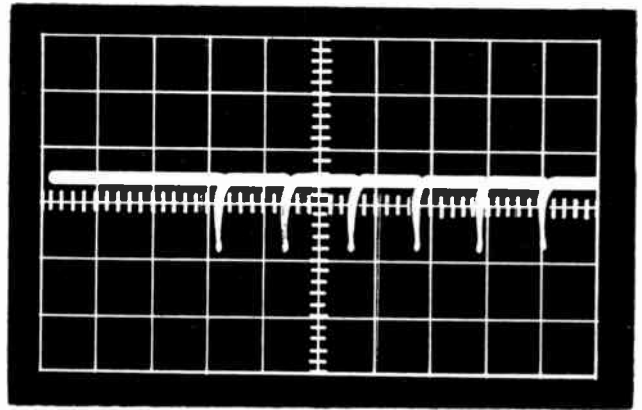

Fig. 2b. Vibration at 45 cps (Resonance). Sweep time — 20 MS/CM.

certainly agree, that correlation of the different methods is a very great problem; therefore, it will be known upon what our findings are based. It is also hoped that the detailed list might be of some assistance to the program established by Mr. T. Ross Welch in a paper entitled "Practical Approach to Standardization" given two years ago, to list the various different methods in use today.

To return to one of the prime objectives of the program, standardization: it was quite apparent that standardization could not be met simply by devising a list of relay drawings and preferred styles, and waiting for manufacturers to submit samples for testing to these standard types.

It would be a most cumbersome task to list all the available relay styles up to today, as thousands of types are in existence and though a considerable amount of data has been accumulated to date, no one design stands out as being especially superior to another.

MIL standard drawings are common in many specifications and standardization has been achieved to a large degree on such components as connectors, resistors, capacitors, plugs and sockets, etc., but this is not the case with relays.

Our first step, therefore, has been to try and establish a quality level. If a specification based upon Service electrical and environmental conditions is accepted by all three Service members, it has very little value to the services if they cannot then procure items to it. Before approved sources to MIL-R-5757 existed an obvious and logical remark that some manufacturer would make was: "Well, my relay doesn't meet the specification. Can you show me a list of approved types by other manufacturers that do?" Under circumstances like this there is little incentive to produce relays to meet the specification.

This position has now been overcome to a degree, since twelve relays are now listed in the Canadian Approved Products List. This is not to say that we have listed anything like a sufficient selection to meet the present need, but it is, at least, a start.

At the initiation of our testing program we encountered several problems in performing all the qualification tests outlined in Table IV of the specification. Testing cannot proceed without obtaining a supplementary document from the manufacturers outlining the electrical and physical characteristics of the relay. For this purpose a relay identification form was brought into use and sent for

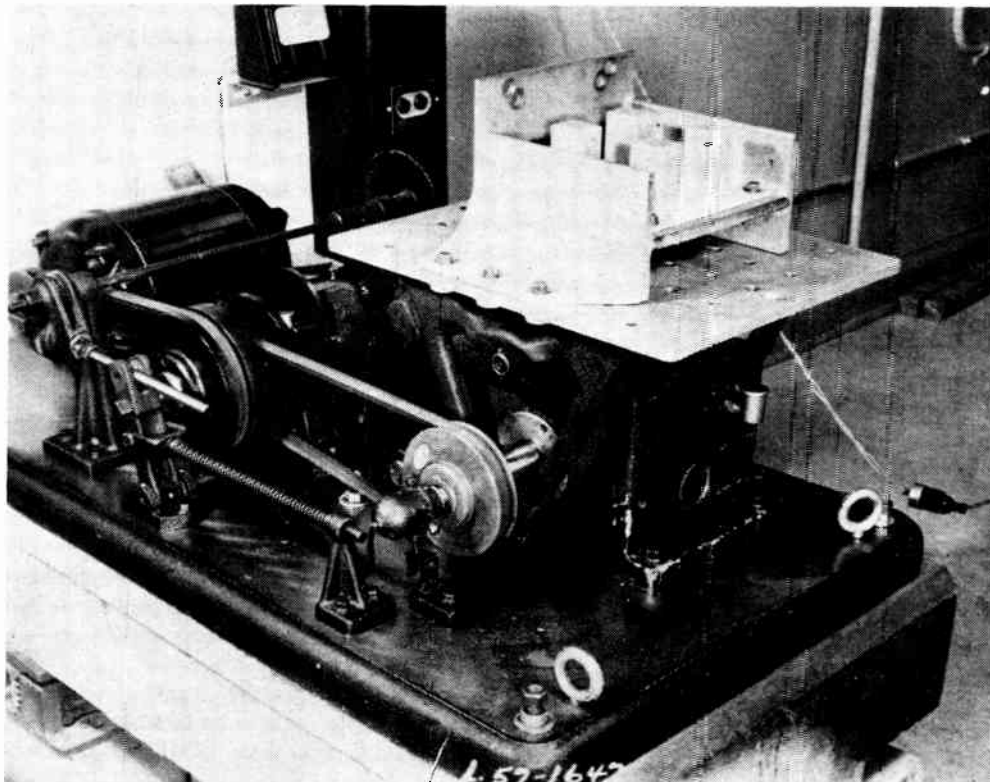

Fig. 3. All American Vibration Machine, Model 100 VA.

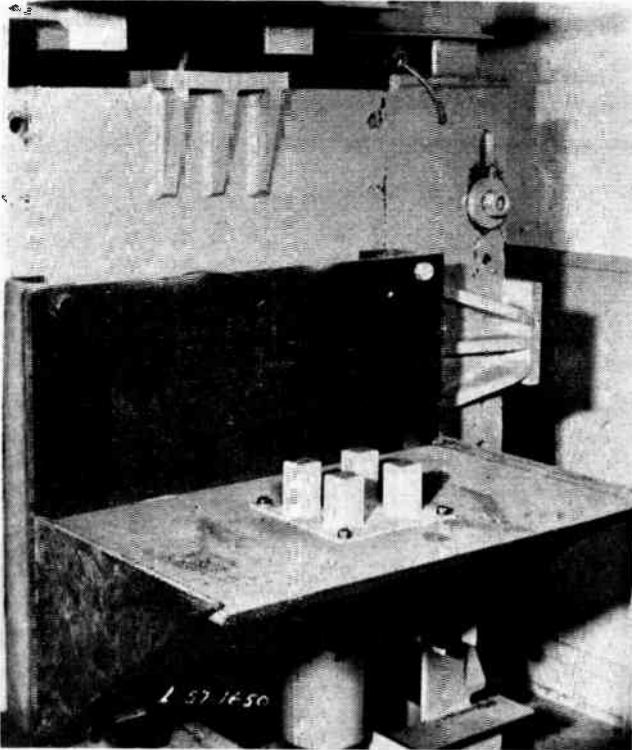

Fig. 4a. Type C Shock Testing Machine.

completion to the manufacturers. We were unable to obtain test data from any source where complete tests had been carried out to indicate the type of methods used, so all methods had to be devised between ourselves and the testing laboratory.

Such problems as how Bounce should be measured, should the full current be applied to the contacts during this test, and how the resulting data should be recorded. What current should be applied to the coil? During vibration tests — which last for a total of 6 hours — can you keep a man continually observing the contacts on a scope? During the initial Dielectric Strength test, it is necessary to ensure that no permanent damage is done if you wish to complete all the tests.

The list of test methods has been based on our own experience and interpretations, and is not necessarily the original methods adopted. Mistakes were made and learned by and quite often assistance in the form of criticisms and suggestions were offered by the Relay Manufacturers.

Test Results

The actual detailed results endeavor to show the main causes of failures and to detail the specific faults that were the prime factors in the failures. The summary covers 80 different reports covering tests to MIL-R-5757B and C. Only two reports are to the C version as the change over from B to C was relatively recent and the results have not yet filtered through.

The main failures in the order of highest occurrence were as follows:

| | |
|--|----|
| Contact Resistance (30 Milliohms on 100 Millivolt drop) | 43 |
| Life (100,000 operations at rated load) | 43 |
| Vibration (p0-55 cycle 0.6 inch max. excursion) | 39 |
| Resistive Overload (4 times rated resistive load) | 31 |
| Shock (30g min. Barry Sand drop Machine) | 29 |
| Moisture Resistance (2 weeks cycling) | 21 |
| Sealing (immersed in saline solution) | 5 |
| Bounce | 5 |
| Hi and Lo temp. | 5 |
| I.R. | 2 |

Any relay failing the tests has been failed on more than one test. The list can possibly lead to a misunder-

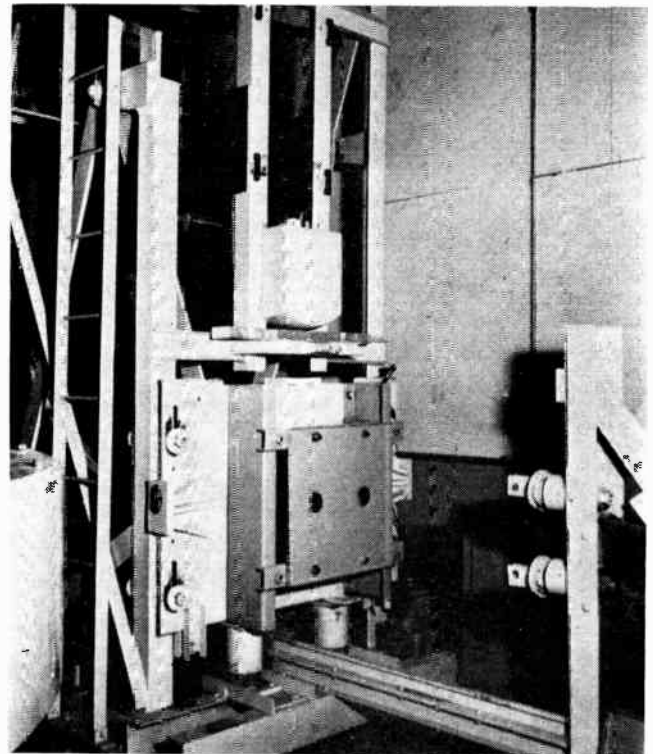

Fig. 4b. Type C Shock Testing Machine.

standing in some respects in that insulation resistance is listed at the bottom, whereas there were many failures due to poor I.R. not specifically headed as such but rather as one of the end tests after life or vibration, etc. The list of failures noted are headed according to the title of the particular test as laid down by the specification.

The list can be broken down to indicate what type of failures occurred. Considering the objective of establishing a quality level and for purposes of having complete information on hand to determine whether the specification should be modified, the tests were conducted according to the qualification Table IV tests and completed whether or not there were early failures in the Group I tests. From a purely yes or no basis two failures in either of the Group I categories would be specification grounds for failure. In a particular instance a submission of relays was tested and failures were encountered due to a faulty header. These failures were noted after shock followed by moisture resistance cycling in Group III tests with resulting poor I.R. and leakage failures. According to the specification the relays were not approved, but a report was despatched to explain the reason for not approving the items. In reply the manufacturer stated that the company had run into similar difficulties and had found that by modifying the headers in question the problem had been overcome. Resulting from a subsequent resubmission, approval was issued for this relay. This merely illustrates the advantage gained in following through the tests to completion regardless of possible early failures.

To return to the results the following list illustrates the details of the failures that were listed.

Contact Resistance: The requirement to MIL-R-5757C is 50 milliohms or 100 millivolts, to MIL-R-5757B 30 milliohms.

Since the majority of the tests were conducted to MIL-R-5757B the average figures that were obtained were 45 milliohms. According to the latest version of the specification the majority of these failures would now pass. No relay was however failed under contact resistance only.

Although many samples failed the initial contact resistance, this did not impede the measurement of contact resistance after environmental tests as these tests were made on a comparison basis depending on the initial values

obtained, i.e., if the initial contact was 45 milliohms something in the order of a ten milliohms increase after one of the environmental tests would not be considered as a failure.

Life

The main cause of failure during life was contact resistance. Upon examination of many of these failures there were signs of discoloration and carbon deposits on the contacts. These failures, it is felt, were caused by sparking and arcing of the contacts in the presence of gases given off inside the relay cans. Papers have previously been given at conferences dealing with this problem. Other failures were in the form of contacts welding, burning off, and failing to make contact; and general deterioration of the contacts causing malfunction before 100,000 operations could be completed, some even as low as 5,000 operations.

These latter type failures indicated that many of the ratings supplied had been well above the actual contact capacity. In view of this consistent type of failure considerations were given to automatically derating contact loading by 50 per cent. This would, however, have led to considerable confusion between the advertised ratings and the test ratings, so it was not pursued.

Vibration

As previously mentioned the highest proportion of the relays reported here were tested to MIL-R-5757B. Tests were performed at 10 to 55 cycles max. excursion of 0.6 inches.

A variety of failures were recorded during vibration: in approximate order of occurrence, sample failures were as follows: Contact Resistance, greater than 30 milliohms, Contact interruption of varying durations and frequencies in one or more of three mutually perpendicular planes, Contacts would not close or open in one or more planes, Relay structure loosening, leads breaking off.

Some of the contact resistance failures after the 6 hour test could be attributed to variation in spring tensions and contact mating surfaces being out of alignment.

Shock

Min. 30g 11 millisecs Barry Sand Drop. No interruption.

The failures recorded under this test were in the majority of cases simply in the form of interruption in one or more planes, and very little mechanical damage was recorded. Mounting studs pulled out or cracked in 5 cases, all of which were supplied from the same company.

Overload

(4 times rated Resistive Load)

The failures noted during this test were contact resistance and contacts burning and welding. No consistent connection can be made between this and similar failures noted during life.

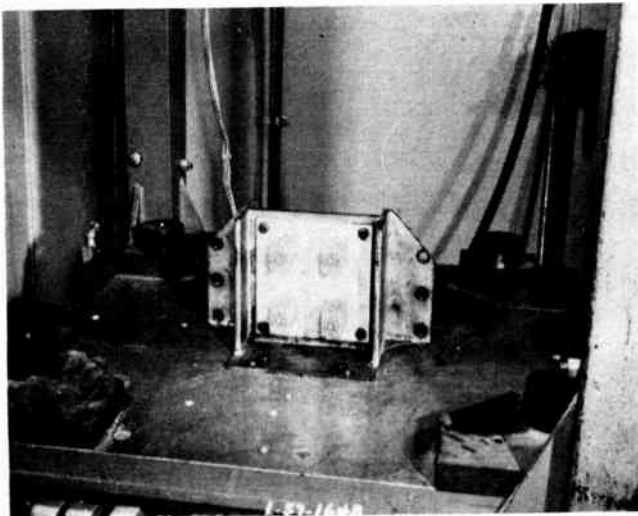

Fig. 5a. Close-up of unit under test on Medium Impact Shock Testing Machine.

Moisture Resistance

(2 weeks humidity cycling)

The failures in this test as far as sealed relays are concerned, can be attributed to the headers in most cases. As the failures consist of low I.R. (less than 50 megohms) and dielectric strength failures. During the tests a dc polarizing voltage is applied to the coil terminals: evidence of migration has been detected in some cases, which, depending on the extent, will decrease the I.R. Damage caused by shock is also shown up in this test in the form of I.R. and dielectric failures.

Sealing

(Immersion under pressure in an Aqueous solution)

Failures under this test are obvious, as a sample failing this test leaks, as evidenced by bubbles, or internal corrosion being apparent on opening the relay.

Bounce

(Contacts shall be examined for evidence of bounce, no set duration unless specified.)

Practically all relays bounce: The failures recorded were to the manufacturers own specified duration. Some samples failed at 600 microseconds when 500 was specified; others did not fail specification with 15 millisecond duration as no time was specified. This is rather an anomaly that could occur to MIL-R-5757B but not to the current Canadian issue of MIL-R-5757C. No relay was failed due to bounce only.

High and Low Temperature Operation

(Cycling at min. and max. temperatures)

The failures noted here were pick up and drop out values being outside the specified value. At the high temperature more current is required to pull in and at the low temperature the relay will not drop out within its specified limits. These failures were marginal and do not represent a major problem.

Insulation Resistance

(100 megohms min.)

Again these failures are not significant and the average figures obtained are greater than 1000 megohms.

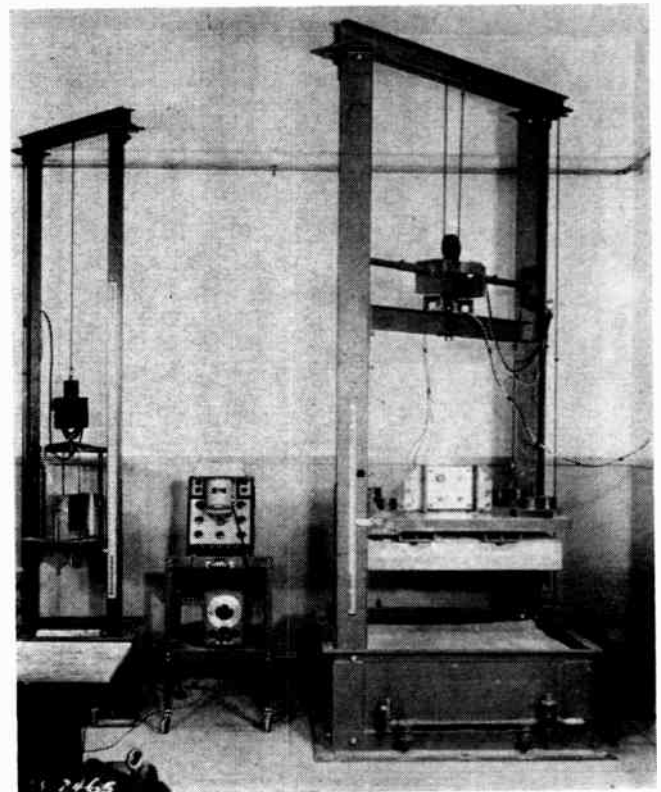

Fig. 5b. Overall view of Barry Corporation 150-400 VD Medium Impact Shock Testing Machine.

Some Considerations on the Results

Relay Characteristics

The coil voltages of the tested relays were divided amongst 270, 110, 60, 50 and 26.5 volts, with the highest proportion at 26.5 vdc.

The contacts were divided over a range of .25 amps to 6 amps with the voltages approximately the same as for the coils.

Bounce Versus Life

It was felt that from several known examples there would be some guideposts obtained from a study of this nature to indicate inherent weakness from one relay to another. For instance, one would think that a relay with long Bounce characteristics would show up badly during the life test, by virtue of the series of make and break actions for each cycle of operation. This was not borne out. The average of maximum total durations of the relays that failed during life were compared against the average duration of those that did not. Considering that these figures were taken from approximately 900 relays of 80 different types the data is fairly substantial.

The average figure obtained for the failures is 4.4 milliseconds and for those passing the life test was 4.75 milliseconds.

Armature Designs

The total of 80 types is made up of 69 clapper, 6 plunger, 4 rotary and 2 balance armature designs. Considering the predominance of the Clapper type armature no real comparisons can be made as to the superiority of one type over another. The 12 types approved are made up of 6 clapper, 1 balanced, 2 rotary and 3 plunger.

It should be remembered that the relays considered here will all be at least one year old, and it seems that more emphasis is being placed on the balanced, rotary and plunger designs in the past year than the clapper. But to all intents and purposes, a relay is considered as a Black-Box from the test standpoint.

MIL-R-5757C

The qualification approval requirements of MIL-R-5757C do not differ very greatly from the previous B version. However, based on our experience we prepared an amendment to this for Canadian use. In this amendment we have tried to clarify some of the definitions and have

included the requirements of MIL-R-2501B. The most significant change of both the C version and 2501B from B is that life tests are conducted at the maximum temperature of the class. From the few results available from the lab, it appears that this test is more stringent than testing at room ambient, but nothing conclusive is available at this time. Another significant change is that the contact resistance has been increased to 50 milliohms.

The amendment referenced is Canadian Specification Sheet No. 3 (CSS-3). The significant points of this amendment are as follows:

Moisture Resistance — Applicable to sealed relays only.

Contact Bounce — 1 millisecond total duration unless otherwise specified.

Vibration — 3 Grades have been included up to 2000 cycles.

Shock — 4 Grades have been included from 20g to 50. 20g was included chiefly for Sensitive Relays.

Life — The Lamp load has been deleted, owing to a laboratory report indicating that the consistency and repeatability of such tests are not reliable. Four different Inductive Loads have been set for various current ratings.

Outline of Test Equipment and Procedures To MIL-R-5757

Sealing

Equipment Used:

(1) Pressure chamber manufactured by Tenney Engineering Inc., Newark, N.J.

or

(2) Temperature-Altitude Test Cabinet, Serial No. 4793, Model FH-11-33 manufactured by Conrad Inc., Holland, Michigan.

Procedure: The samples are immersed in an aqueous saturated solution of sodium chloride in a glass container and subjected to an absolute pressure of 2.5 inches of mercury for four hours. The immersed relays are observed for evidence of leakage indicated by bubbles emanating from the case.

Note: A mass Spectrometer manufactured by VEECO may be used when applicable for sealing test II.

Dielectric Strength

Equipment Used: A variable, 60 cycle supply.

Procedure:

Atmospheric Pressure—The test potentials indicated by the manufacturer and as required by MIL-R-5757 are applied in the following manner.

- (a) Between the coil and case.
- * (b) Between the coil and each set of contacts.
- * (c) Between each set of contacts and the case.
- * (d) Between each set of contacts.

* Each set of contacts refers to a complete switching circuit, i.e. all three contacts of a Form C set are connected together as a single unit for this test.

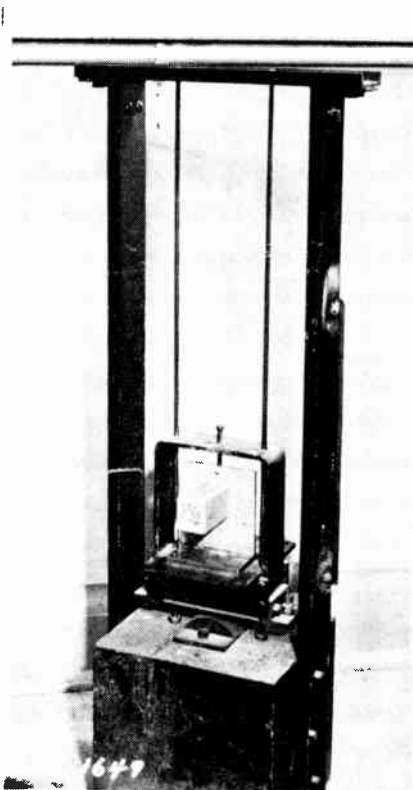

Fig. 6. JAN-S-44 Shock Testing Machine.

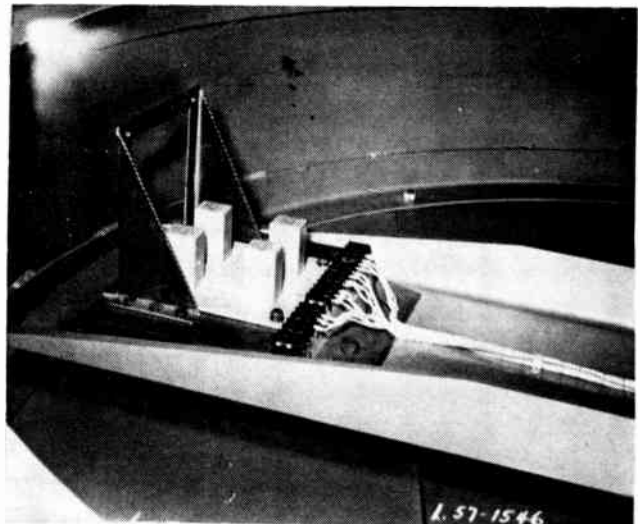

Fig. 7. Shaevitz Accelerator Type G-6-A.

(e) At the conclusion of all other tests the flashover voltages between mating contacts are determined. This procedure was initiated to prevent damage to contact surfaces which might have a bearing on succeeding tests and measurements.

The MIL-R-5757 test potentials are determined from the individual circuits, i.e. the test potential applied between the coil and the case depends on the nominal coil voltage. The test potentials for the remaining tests are determined in the same manner with the highest voltage rating being the guiding factor in each case.

The potentials are applied at a rate of 500 volts per minute and maintained at the maximum for one minute. In the case where the manufacturer's test potentials differ from the specifications, the relays are subjected to both potentials, the lowest first.

Reduced Pressure — During this test the samples shall be in a pressure chamber (see Sealing) maintained at a barometric pressure of 1.3 inches of mercury for sealed relays and 3.4 inches of mercury for unsealed relays. One hundred and fifty per cent of the specified rate voltage but not less than 350 volts are applied as described under atmospheric pressure.

Insulation Resistance

Equipment Used: Leeds and Northrup Guarded Insulation Test Set, Model 5602-A.

Procedure: Electrification Time — Two minutes. Test Voltage — 100 volts d-c.

Insulation Resistance determined between:

- (a) Coil and case.
- (b) Coil and each set of contacts.
- (c) Contacts and case.
- (d) Mutually insulated contacts.

If in any of the above cases where parallel resistance paths are present a low value of insulation occurs, tests are continued on an individual basis until the faulty insulation path is determined.

Pick-up Voltage

Equipment Used — A variable voltage supply.

- (1) D-C supply.
 - (a) Low ripple 2%
 - (b) Good regulation — no voltage drop during armature action.
- (2) A-C supply.
 - (a) Good waveform
 - (b) Good regulation
 Voltmeter as required.

Procedure: With the contacts being monitored the coil voltage is gradually increased from zero to a point where all contacts assume their energized position. The coil voltage at the point of final contact action is the pick-up voltage.

Drop-Out Voltage

Equipment Used: Same as for pick-up voltage.

Procedure: The nominal coil voltage is applied to the coil and then gradually reduced until all contacts return to their de-energized position. The coil voltage at the point of final contact action is the drop-out voltage.

Equipment Used: Rubicon High Precision Type "B" Potentiometer Cat. No. 2780 or Kay Lab Microvolt Ammeter & Amplifier.

Procedure: Rated contact current is passed through the contacts at 6 volts d-c. Either of the above instruments, depending on the precision required, is used to measure the voltage drop across the contacts.

Contact Bounce

Equipment Used: A Tektronix Oscilloscope, Type 535, combined with a Dumont Oscilloscope Record Camera, Type 302.

Procedure: With rated current passing through the contacts at rated contact voltage, the relays are operated several times. The input of the oscilloscope is connected across the contacts and the oscilloscope is adjusted to trigger on the voltage rise produced when the contacts first close. The camera shutter is held open during this operation, and because it is a type which incorporates a

self-developing feature, oscillograms of contact bounce are available within 60 seconds of the relay operation. Using the timing circuits of the scope in conjunction with a 10 cm graticule it is possible to read the contact bounce values directly from the oscillograms with minimum effort.

Coil Current

Equipment Used: Good quality Ammeters & Voltmeters.

Procedure: Apply rated voltage to the relay coil and measure the resultant current.

D-C Coil Resistance

Equipment Used: Wheatstone Bridge or Ohmmeter.

Procedure: Same as for any resistance.

Operating & Release Times

Equipment Used: A Hewlett Packard Electronic Counter, Model 523B or a Tektronix Oscilloscope, Type 535, combined with a Dumont Oscilloscope Record Camera, Type 302, whichever is most practical.

Procedure: The operating and release times are defined as:

- (a) operating time — the time from the instant power is supplied to the coil to the instant all switching action ceases.
- (b) release time — the time from the instant power is removed from the coil to the instant all switching action ceases.

Measurement using Hewlett Packard Electronic Counter

— The time interval measurement start is connected across the coil and the stop is connected across the contacts. As the time measured will not include contact bounce, the contact bounce measurements taken previously must be added to the time interval recorded by the counter. Care must be taken to select the proper slope of the initiating and stopping voltages or erroneous results will occur.

Measurements using the Tektronix Oscilloscope — The external triggering function of the scope is connected across the coil terminals while the scope input is connected across the contacts. The resulting oscillograms will indicate the operating or release time, including contact bounce, but takes longer than the previously described method, i.e. electronic counter.

Temperature Cycling

Equipment Used: An oven and a low temperature cabinet. The capacity of each must be such that the addition of the cold or hot component will not change the ambient temperature by an appreciable amount.

Procedure: Two temperature cabinets are used for this test, one maintained at the maximum temperature and one at the minimum temperature. Leads are run into both cabinets for pick-up and drop-out measurements. The samples are transferred back and forth from one cabinet to the other.

Vibration

Equipment Used: A vertical-motion vibration machine, Model 100VA. A horizontal-motion vibration machine, Model HL-A both manufactured by All American Manufacturing Co. A test jig of our own construction (Fig. 3).

Procedure: The test is conducted in accordance with Method 201 of MIL-STD-202 with the following additions and exceptions.

The samples are rigidly mounted as shown in the attached photographs and are vibrated in three mutually perpendicular planes, using the major axis as a reference. Continuous duty relays are energized for one hour and de-energized for the other hour in each plane. Intermittent duty relays are operated according to their duty cycle for one hour and de-energized for the other hour in each plane. During the test the contacts are monitored to observe contact interruption or closure and the relays operated according to a duty cycle are also observed for mal-function, i.e. pulse or stepping relays.

Overload

The test is conducted exactly as outlined in MIL-R-5757C, Paras. 4.6.10 to 4.6.10.3.

Each set of contacts is monitored continuously during the test so that in case of contact failure the exact operation at which it failed can be noted.

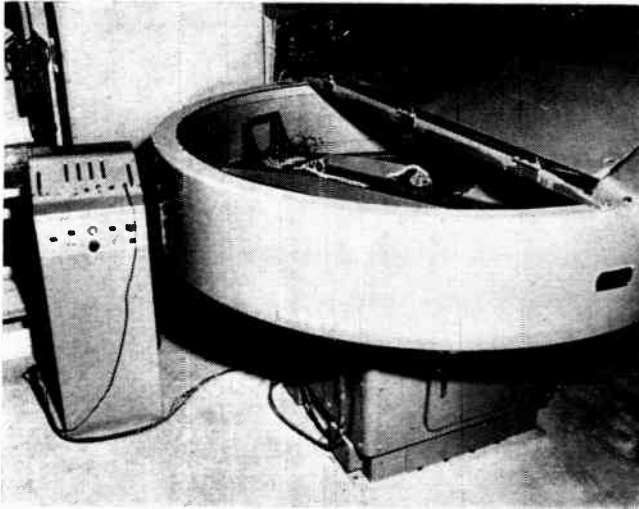

Fig. 8. Overall view of Shaevitz Accelerator Type G-6-A.

Corrosion

Equipment Used: Singleton Corrosion Test Cabinet, manufactured by G.S. Equipment Company.

Procedure: The relays are suspended by their mounting studs using waxed string and subjected to the test outlined in Method 101, MIL-STD-202, for 50 hours. At the completion of the test the relays are washed, shaken, air blasted, and then dried for 24 hours at 40C. They are then examined and failed only when the base material is corroded or the relay has become inoperative.

Shock

Equipment Used —

Shock Test I — A type C Shock Testing Machine constructed to Bureau of Ships DWG-10-T-2145-L by Halton Metal Products (Figs. 4a & 4b).

Shock Test II — A 150-400 VD Medium Impact Shock Testing Machine manufactured by Barry Corporation (Figs. 5a & 5b).

Shock Test III — A Shock Testing Machine for Electrical Indicating Instruments, constructed to JAN-S-44 by Ontario Hydro. Test jigs as shown on the attached drawings and photographs (Fig. 6).

Procedure —

General — The relays are rigidly mounted as shown in the accompanying photographs and drawings. They are subjected to shocks of various G in each of three mutually perpendicular planes with the relays both energized and de-energized (continuous duty relays) or operating at the rated duty cycle for pulsing or stepping relays. During these periods the controls are monitored for interruption or closure or mal-function.

Shock Test I — A total of 18 hammer blows are applied, 9 for each coil condition, 3 in each plane.

The hammer blows are delivered from 1 ft., 3 ft. and 5 ft. heights. The position of the anvil plate to which the mounting platform is attached is not changed during these tests. Tests in the first plane are effected by striking the shock pad located at the top of the plate and in the other two planes by striking the anvil at the back of the plate. One rotation through 90 degrees of the samples and the use of both hammers is necessary to perform the test in all three planes. This test equipment simulates shipboard conditions and is described in MIL-S-901B (Navy), Shock-proof Equipment, Class #1, (high—Impacts), Tests for Shipboard Application. The only relays tested by CAMESA on this machine were severely damaged; i.e. broken mounting studs, spilt cases, contacts jarred off their mountings, and coils open-circuited. These relays were of the conventional low power, military type, but did not seem to be designed for this type of environment.

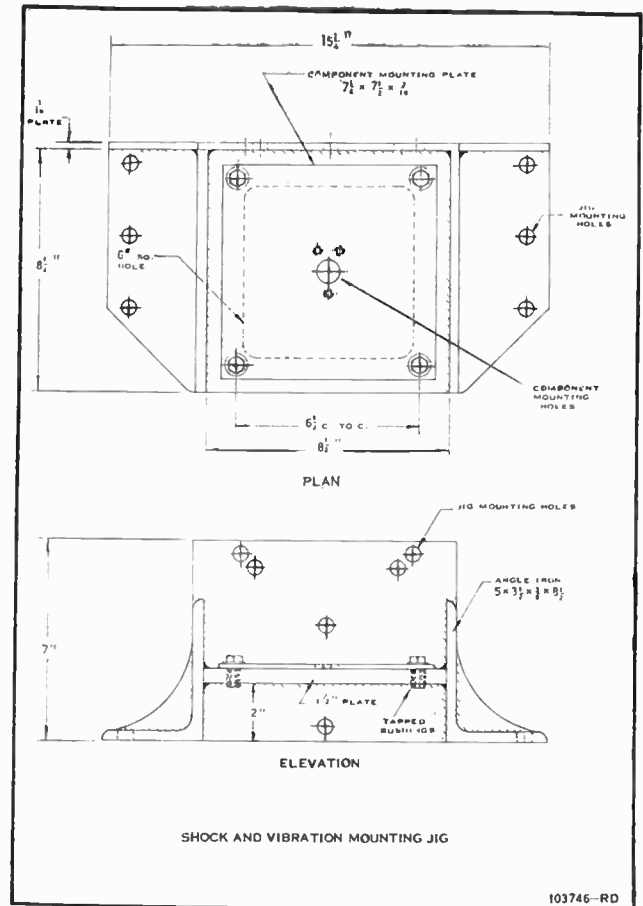

Shock Test II — The shock to which the relays are subjected is increased in 10G steps, from 20G to 50G, to determine the point at which contact interruption or closure occurs. Each shock pulse is 11 milliseconds in duration and is produced by arresting the motion of a freely falling elevator in a volume of sand.

Shock Test III — The relays are subjected to 10 blows of 75 gravity units each in each of the three positions. This shock machine is fully outlined in JAN-S-44.

Moisture Resistance

Equipment Used: Climate-Lab, a humidity and temperature cycling cabinet manufactured by American Instrument Co. and a Westinghouse Freezer.

Procedure: The relays are mounted on non-corrosive metal plates and placed in the cabinets with the terminals downward. The tests are programmed as outlined in MIL-STD-202, Method 106, with the total program, with the exception of Steps 7A and 7B, being conducted in the Climate-Lab Cabinets. A Westinghouse Freezer was used for Step 7A (Storage at -10C). Step 7B is the vibration section of the test.

During Steps 1 to 6 inclusive of each cycle a polarization voltage (100 v d-c) is applied between the coil (positive) and the mounting frame (negative) of one-half the samples.

Measurements (Initial) — The insulation resistance of each relay is measured after a 24 hour drying period at 40C. The measurements are taken in ambients of 25C and 50% R.H. after the samples have been in this ambient for two hours.

Measurements (Final) — Upon completion of Step 6 of the final cycle the insulation resistance of each relay is measured under ambient conditions of 25C and 90-95% R.H. (In Climate-Lab). After a 24 hour drying period at 25C and 50% R.H. the insulation resistance is measured, the pick-up and drop-out voltage, contact resistance, d-c coil resistance are measured and a dielectric test is performed.

High-and-Low Temperature Operation

Equipment Used: A Conrad Temperature - Pressure Cabinet.

Procedure: The relays are energized at the nominal coil voltage for 2 hours at the high ambient extreme, and conditioned for 15 hours at the low ambient extreme for the particular type of relay.

Measurements — The pick-up and drop-out voltage of each sample is measured at the end of the above test periods while the relays are still in the chamber at the appropriate ambient temperatures.

Life

Equipment Used: A temperature cabinet of the mechanical convection type.

Procedure: Each relay is operated at the rate of 10 cycles per minute for a total of 100,000 operations or until failure occurs. The relays are operated at the nominal coil voltage and at rated contact load. A separate load is supplied for each stationary contact, with the moving contact connected to the positive output of the power supply. Contact loads simulate as far as possible the actual circuit conditions. If none are supplied, a load is applied which will correspond to previous tests on similar relays. The tests are conducted at the maximum operating temperature of the particular relay type. Each set of contacts is checked twice each day (the tests usually are conducted only during working hours) to ascertain whether they are still operating properly.

Measurements—After the test, the insulation resistance and electrical characteristics are measured.

Terminal Strength

Procedure: A force, as specified (usually 5 pounds), is applied to each terminal at the point where the external lead is soldered to it. This force is applied parallel to, and at right angles to the longitudinal axis of the terminal and is maintained for 30 seconds for each arrangement.

Destructive Sealing

Equipment Used: See Sealing.

Procedure: The samples are immersed in an aqueous saturated solution of sodium chloride in a glass container and subjected to an absolute pressure of 2.5 inches of mercury for four hours. They are then returned to normal pressure for four hours after which the relays are opened and examined for leakage.

Conclusion

Based on present day advertisements and literature relays designed for military application are a vastly improved product to those produced a few years ago. This is due in no small way to technical conferences such as the National Conference On Electromagnetic Relays where interested parties concerned are afforded the opportunity of exchanging ideas. The relay industry in both Canada and the United States has aided the relay studies made by CAMESA by cooperation and assistance.

Acknowledgement

The author gratefully acknowledges the help and assistance of the Research Division of the Hydro-Electric Power Commission of Ontario in the preparation of this article.

Simple Automation Cuts Costs 60 To 1

A MAJOR production problem in the manufacture of IBM computer systems has always been the inspection required on the high-speed printing cams. Typical cams may be up to 12 inches long and 3 inches in diameter, and are cylindrical in shape.

So critical are the possible accelerations in follower systems caused by errors of the cam, that specifications require precise checking of the unit at 720 distinct points around the cam, and the repeating of this operation at three different locations or tracks along its length. Thus 2160 separate point inspections are required on each cam. At each measured point, the cam is required to be within one thousandth of an inch, of desired radius. The inspection process is further complicated by a requirement of ± 0.0001 inch on maximum error change between any two successive measured points, which requires 2160 additional calculations.

With all of this detail required for each and every cam, an inspection time of twelve hours per cam track was considered a serious problem.

To solve this production problem, IBM engineers reasoned that it should be possible to devise an automatic checking device to perform the inspection operation automatically, accurately, and rapidly.

The problem was presented to the gaging engineers of Airborne Instruments Laboratory, Mineola, N.Y. by the IBM Corp. of Endicott, N.Y. Working in close association, the two engineering groups of AIL and IBM have now developed a completely automatic machine which performs the complete inspection operation — in twelve minutes per track — a reduction of sixty to one on inspection costs. The great time and cost saving is, of course, realized at the same time as a significant improvement in reliability over the former tedious manual operation.

In operation, the cam to be measured is mounted, adjacent to the master part, on a slowly rotating arbor. A precision roller contacts the master and automatically positions three precision Microtrol Gage Heads, which in turn contact the part being measured. Thus three independent "tracks" are measured. The Microtrol Gage Heads provide electronic signals, corresponding to dimensional

errors, to the Microtrol Amplifier, Recorder Drive Unit, and Variation Indicator Unit. These units provide:

1. A permanently recorded chart of cam errors.
2. A warning signal if part tolerance is exceeded at any point.
3. A continuous arithmetic check of dimensional changes from point to point.



IBM engineers testing the AIL Automatic Cam Analyzer which has reduced their inspection costs by a factor of 60 to 1.

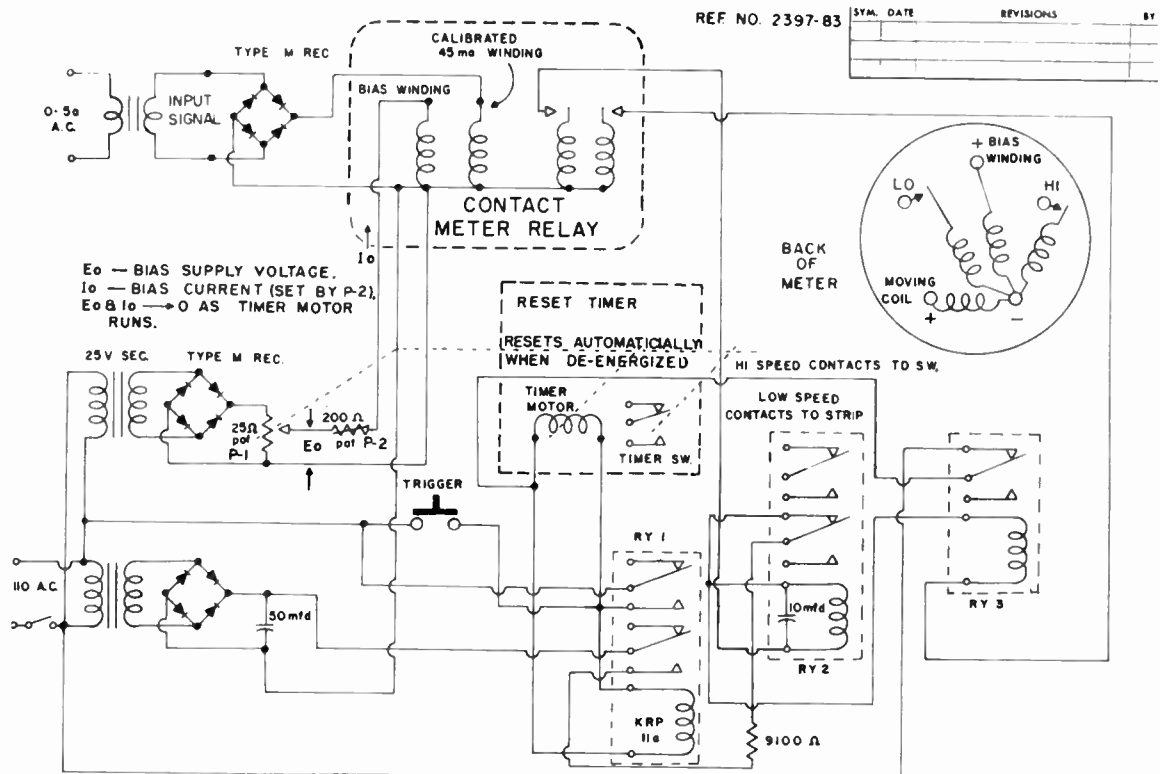

Programming circuit using differential meter-relay.

Signal comparison and initiation of control action, two factors required to be integrally controlled in programming sequences, can now be achieved with simple circuitry.

Controlling Rate And Magnitude Of Change Of A Variable

A SIMPLE, inexpensive method of controlling the rate and/or magnitude of change of a variable has been developed which involves a circuit built around a new kind of contact meter-relay action, and applies to any variable that can be measured electrically.

The circuit accomplishes the same programming effect as a closed loop pulse servomechanism, but much more easily. It is believed to be the first control circuit to apply a feed-back signal directly to a meter-relay as a means of guiding control action. Programming can be set up by means of cams, punched tape, or any other common method.

The circuit is considered to represent something of a "break-through" of a relatively uncomplicated electro-mechanical device into a field hitherto reserved for complex electronic hook-ups. It is expected to lead to widespread use of meter-relays in programmed operations, since the meter-relay performs the dual function of signal comparison and initiation of control action. These two factors, required in any programming set-up, can only frequently be accomplished without the use of intricate

electronic combinations.

The meter-relay signal is absolute and direct, moreover, without the distortion or drift that results from the amplification necessary in an electronic hook-up. At the same time the meter-relay retains its familiar advantages of indicating the signal and permitting easy adjustment of signal limits.

The circuit is sufficiently sensitive that a tiny fraction of the signal may represent a full scale movement of the pointer on the meter relay.

The nub of the circuit is a "differential" meter-relay with two moving (signal) coils, instead of the usual one. There is only one moving pointer, however. Depending on the polarity of the coils, the indicating pointer shows either the sum of, or the difference between, the signals reaching the two moving coils. The meter-relay also has two adjustable pointers, which are preset at high and low signal limits.

In the usual arrangement, the moving coils are connected so that the indicating pointer shows the sum of their signals, and the low adjustable pointer is set at the

strength of a false or bias signal. The bias signal is set at a point from which it will be completely dissipated in the time interval of the cycle.

The bias signal and the feed-back signal, from the device being controlled, add up to the total signal of the indicating pointer. The feed-back is a direct reflection of the control being exercised. If the bias signal is reduced, the indicating and low adjustable pointers meet and their contacts lock. As the bias signal decreases, the meter-relay attempts to "make up the difference" by increasing the signal to the other moving coil. Since this latter signal is the feed-back from the controlled device, it indicates that a change corresponding to the signal increase has occurred in the action of the device. The bias signal is dissipated at the end of the timing run. The signal then rises rapidly to the setting of the high adjustable pointer. The timer is then caused to reset and the cycle begins again. The circuit could be varied so that at this stage it would hold the signal for a specified length of time.

Sequential Description of Differential Circuit

In this circuit the rate of change of a variable is being controlled automatically. The variable is motor current, expressed in AC amperes.

Key to operation of the circuit is a new kind of contact meter-relay, called a "differential" type, which has two moving coils instead of the usual one. Polarity of the coils is such that the single indicating pointer shows the sum of the signals passing through the two coils. The sum remains constant, so that if one signal decreases, the other increases.

In this case a bias, or false voltage is being produced internally in the control. It in turn is impressed on the bias winding of the differential meter-relay. (The amount of this bias signal can be controlled at will. Here it is set at a point from which it will be completely dissipated in the time interval of the cycle.) The bias signal is impressed across a 25-ohm potentiometer which is linked mechanically to a timer motor and reset mechanism.

When the cycle begins with the momentary closing of the trigger contacts, No. 1 relay closes and is held in through the contacts of No. 3 relay. Closing of No. 1 relay impresses 115 volts AC on the timer motor, which begins to run and to reduce the bias signal to zero in its preset time interval.

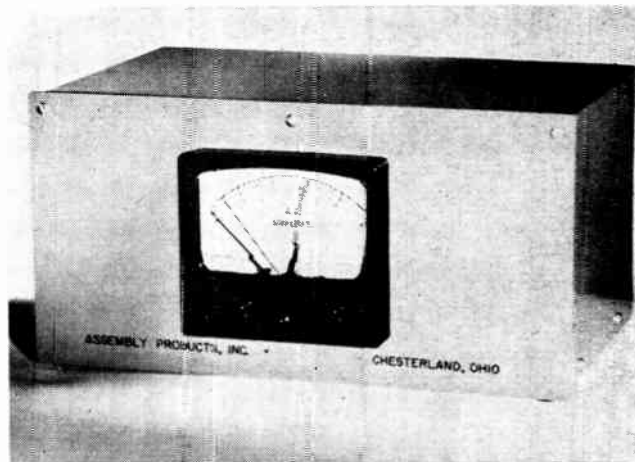

Programming control instrument rate and magnitude.

The low adjustable contact on the meter-relay has been preset to the original amount of the bias signal. Therefore the reduction of the bias signal by the timer motor results in meeting and locking of contacts on the indicating (signal) pointer and the low adjustable pointer. The low pointer contact is connected into a double-pole, double-throw relay, No. 2. When this relay is actuated it produces a pulsing signal. Time of pulsation depends on the size of the capacitor across the relay's coil. The pulsing signal from No. 2 relay is impressed on a universal fractional horsepower AC motor which is connected to a Variac. Output of the Variac controls the device, and a current from the device feeds back as the input signal.

Since the differential meter-relay maintains the sum of the signals in its two coils, the feed-back current is increased at the same rate as the bias signal is reduced. At the end of the preset timing run, the timer switch closes and the fractional horsepower motor is put into high speed. This high speed was preset by a resistor in series with the motor. Output of the Variac is then increased quite rapidly up to the high limit on the meter-relay. When the high contacts close, No. 3 relay operates, opening No. 1 relay and resetting the timer. The next cycle begins with momentary closure of the trigger contacts.

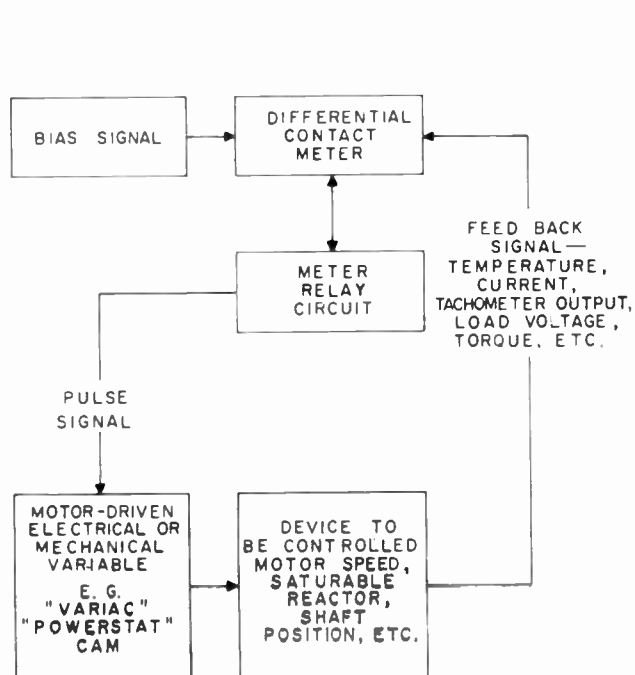

Block diagram of typical programming circuit.

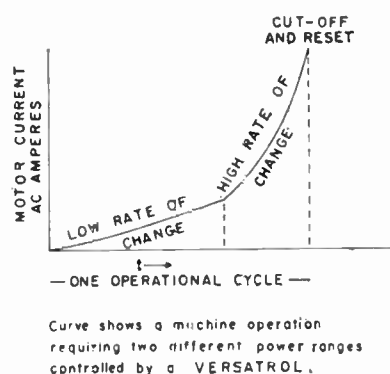

"In its constant battle for increasing quality and production while reducing costs industry will find that electronic control systems now stand ready to give valuable assistance in the maintenance of an economical balance between costs and profits"



THOMAS R. JONES

Process Control Systems As A Management Tool

By Thomas Roy Jones
President Daystrom Incorporated

WE OF THE United States and the peoples of the free world are between the horns of a dilemma. On the one, we meet the tremendously growing demand for manufactured products. On the other, the shortage and unrealistically increased costs of labor.

Despite the current recession, it is reliably estimated that by 1975 we shall be faced with a severe shortage of labor on all fronts. Both business economists and government statisticians agree on this point.

In September 1955, *Factory Management* put it this way: "If automation increases at its present rate, every available worker will have to be putting in 40 hours a week to keep raising our standard of living. But additional workers to permit a shorter work week, won't exist. The only alternative would be to slow our progress toward higher living standards."

It is unlikely that America will accept the alternative of slower progress.

In the March 21st issue of *Electronics*, George Haller, Chairman of the Technical Program Committee of the 1958 IRE Show, was quoted as saying: "It may seem like looking pretty far ahead but the electronics industry is like Alice-in-Wonderland — it has to keep running just to keep pace with some other fields."

Mr. Haller, in quoting from the great mathematician, Lewis Carroll, left out some very important words. The full quotation is even more apt and fitting to our situation. Here it is:

"This is a strange sort of country," said the Queen. "Now here you see, it takes all the running you can do to keep in the same place. If you want to get somewhere else, you must run at least twice as fast as that!"

In the electronic industry, we shall have to run very fast indeed!

Let us elaborate a bit on our thinking and progress on this matter of automation.

We see automation as a function of management. It is a partnership of control and operating mechanism — with control the dominant partner.

Once management establishes operating policy, day-to-day factors such as rate of production, its quality and its method of delivery are under system control. Such a system must be near-infallible, accurate, economically sound — and fast.

Back in the twenties, several schemes for automation were actually put into practice — but they were soon abandoned as uneconomic. Now how can something which was uneconomic thirty years ago be economic at this date?

We all know the answer — it lies in the fact that the components of the economic picture have changed. Techniques have made revolutionary advances. The size and speed of machines and the scope of chemical processes have increased. The contribution of capital investment to costs has become greater, so that idle time has become more onerous. Labor costs have skyrocketed. As a result, the gains to be realized from automation have become

larger in comparison to the cost of automating.

And so — in comparison with yesterday — we are able to offer methods of automation which are economically justified by virtue of increased and improved product output, lowered maintenance costs through near-infallibility, higher safety and a multitude of other factors — in addition to the more productive use of labor — which can result in greater profit.

Back in the days of World War II, the urgency of the situation caused engineers and scientists to attempt to accomplish specific functions by tying together two components — each excellent in itself. A good radar would be tied in with a good gun-sighting mechanism. This failed. There arose the need for a new approach which ultimately taught us that the only solution to the problem of control was "systems engineering." Entire systems were designed from the ground up. This yielded an extraordinary advance in the science and application of electronics.

From these beginnings there evolved the present day principles of automation.

Systems Engineering

Systems engineering, as developed by the military, implies the single over-all approach for the solving of any complex problem and thus assumes the responsibility for *all* engineering on the project.

Systems engineering is the *team* approach. It involves such a variety of methods that it is becoming almost impossible for one man to understand them all. It requires a new type of engineer — one who can think beyond the limitations of available hardware and utilize every resource of his team to do the job.

Systems engineering presupposes the ability of an engineer to evaluate a grouping of equipment, united by some well-defined interdependence of action, and so combined as to form an integral whole to function in

unison and in obedience to some form of control. This signified the broad concept and has the definite implication of a single responsibility for many discrete groups of instrumentation, each dedicated to the sensing, signalling and control of separate steps in a complex whole.

In other words, the whole problem is approached from the start as a unit and the entire solution is predicated on a total handling of the solution.

The state of the systems art is now such that it is possible to provide many "off the shelf" components for control systems. By this I mean basic unit systems which are designed to meet different needs — without major engineering. They require special adaptation to each specific case, but this is relatively simple. The method obviates the necessity for individual research with its attendant high cost.

The prime purpose of this "building block" technique, is to make automation through electronics economically feasible. The term is one which leads to a multiplicity of meanings. In some instances, a large investment can be economically sound because of the great quantities of product produced, or because of the product uniformity it gives, or because of the speed of production it affords.

In any event, we find that—in general—most automation investments *must* pay off within a given period. There must be an adequate return on the investment.

The electronic industry is now in a position to talk nuts, bolts and dollars.

There is no question but that closed loop process control is a reality — *provided* sufficient funds are made available. Our main effort now must be directed toward getting facts and figures from experience which will demonstrate the economy of closed-loop control — and to reduce costs to a point where closed loop-control will be economically available to ever-broadening segments of industry.

While the application of a systems concept may appear to be costly, the assurance of performance and the more

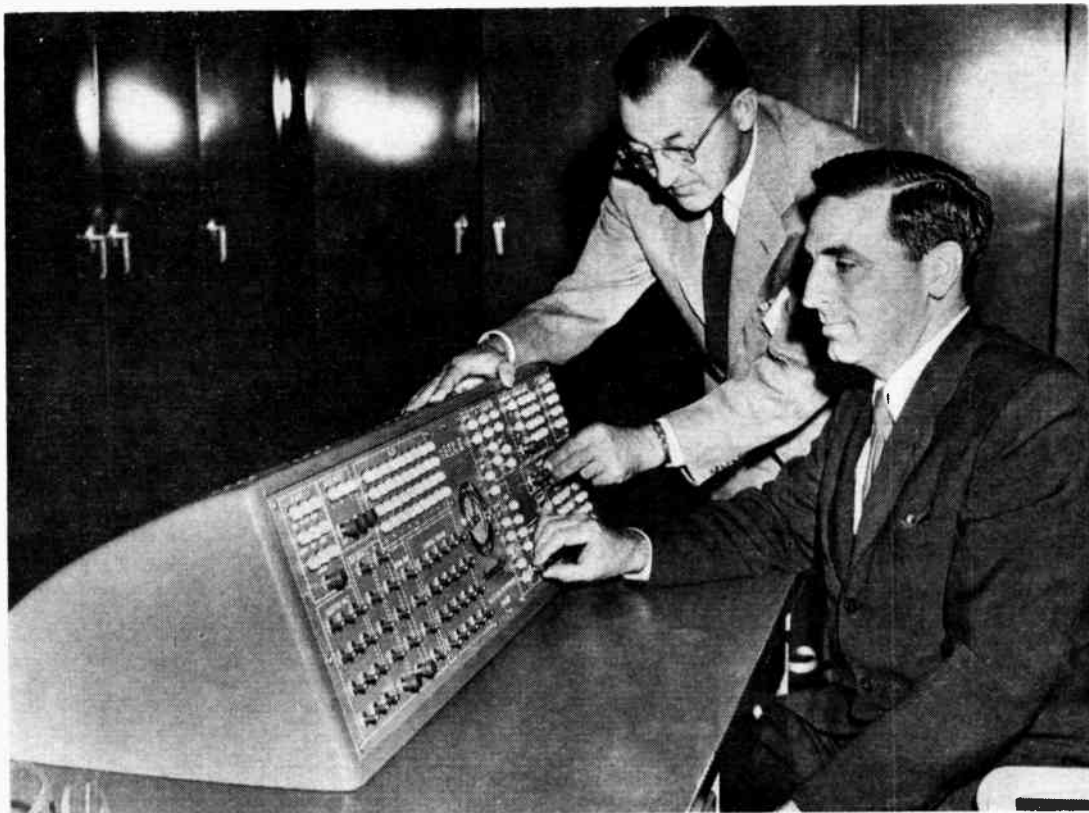

The significance with which management is accepting automation as a management tool is depicted in the above photograph which shows Perry C. Smith, (right) general manager of Electronic Instruments Division of the Burroughs Corporation, explaining the control panel of a UDEC II to Walter M. Phillips, (left) Philadelphia's city representative and director of commerce. The UDEC II is shown working on the first of many industrial problems that it will solve in the greater Philadelphia-Delaware Valley industrial area during the years ahead. UDEC II — a \$250,000 assembly of electronic equipment — with its staff of experts will be available to business, industry, government, science and education.

disciplined approach to a production problem can make such a system effectively economical.

Until recently, the conventional approach to data handling — especially in conjunction with automation projects — has been to employ “special purpose” types of computers. These were, for the most part, analog in operation. Such equipment lacked the internal programming flexibility and the memory storage which characterize the “general purpose” digital type of computer. But there has been a break-through.

Solid State Digital Computer

As an example of the most advanced techniques, one new Southern power plant will, in a few weeks, be utilizing a general purpose information system which is adaptable to process control. The system uses solid state components throughout and has been designed for “on line” continuous operation. It not only performs all the mathematical computations needed to process the vital operating data being alarm-scanned and recorded, but supplies the necessary signals to control all elements of the automatic data collection equipment.

Automatically, this installation — (1) Monitors 350 points involving temperatures, pressures and flow which are critical in the operation of the plant, scanning them in rapid sequence to determine if they are within pre-set operating limits; (2) prints, at regular time intervals, the value of each of a multiplicity of variables in the power station process systems; (3) linearizes, scale-factors, and integrates each input signal so that the printed values of the variables are digitally expressed in the pre-selected dimensional units; (4) actuates an alarm signal if the pre-set operating limits are exceeded; (5) identifies the “off-limit” signal, indicates its location within the plant; (6) prints the value of the “off-limit” signal together with its identifying number and the time of occurrence.

For the first time in the history of the industry, a completely solid-state digital computer — with no moving parts — has been delivered for industrial application. There are no pin-boards, plug boards, relays or rotating machinery such as stepping switches or magnetic drum memories.

The use of a completely transistorized computer as well as other advanced design factors, makes it possible to avoid the failures so often associated with conventional equipment. If industry has, in the past, been reluctant to accept electronic systems on the score of reliability, I point to this installation as the beginning of a new era in electronic control system dependability and predict that the future will see tremendous forward strides.

One important factor, of course, is that solid-state devices can be designed to possess an intrinsic reliability far greater than other electronic equipment. Here then, is the answer to one of the major reasons for industry's past reluctance to accept total automation by means of electronic control.

In its constant battle for increasing quality and production, while reducing costs, industry will find that electronic control systems now stand ready to give valuable assistance in the maintenance of an economical balance between costs and profits. By making better use of manpower, conserving materials, fully utilizing equipment and delivering product quantity, quality and uniformity heretofore unattainable by human control, automatic control systems will justify their cost in wider operating profit margins. Complete control systems will constitute a sound capital investment by the user.

Actually, in spite of the great strides made, we have yet to scratch the surface of the potential in electronic equipment applications for industry. In time, the adoption of systems by industry will make it possible to run entire plants at optimum conditions without human supervision. The most immediate prospects for this lie in the chemical, petrochemical, power and similar continuous process industries.

The objectives of electronic design are undergoing a revolutionary and basic change. No less an authority than Dr. Baker of General Electric states that “We are entering

a new era in the electronics industry where the largest amount of income will be from the industrial application rather than (that of) communications” We stand on the threshold of an entirely new world — a world in which automation will become the touchstone of economic progress — if not of national survival itself.

Industrial Evolution

Technological progress can — and probably will be at such a rate as to outstrip the number of qualified workers and technicians available. The new technologies created by automation will make new demands on labor as well as on the total economy.

This is not a new phenomenon by any means. It happened in England with the first textile mill, in America with the advent of the automobile and the automatic telephone exchange. What we face is not a threat to our economy or to employment but a necessity to adjust fast enough to realize the obtainable benefits of the changing techniques.

In the long run, automation, like every other technological improvement, will stimulate employment and upgrade workers. It will take over the menial tasks. Last year, for the first time in history, white collar workers exceeded the blue-collar — and, it is estimated that by 1975 professional personnel may account for one out of every eight workers.

Let us examine what happens when technological progress enters the scene.

1. The industries which supply automation and technological advances create new employment opportunities.
2. Entire new industries which employ thousands, are created by the new automation technologies.
3. The service industries provide new jobs.
4. A chain reaction takes place throughout the entire economic structure.

What we face then, is a new industrial evolution — though not a revolution.

Dr. Gordon S. Brown of MIT had this to say: “Automation will mushroom. We want it to mushroom. We couldn't stop it if we wanted to. It will bring change to all of us.”

There, I believe, is the key to the whole economic aspect. We are coming on a time of vast plenty *provided* we accept automatic operation fast enough.

Last year, speaking before the United States Congressional Subcommittee on Economic Stabilization, I answered the question “Should automation be encouraged?” with a categorical YES. I stated then that if this nation is, with our available manpower, to provide the standard of living to which we all aspire, we must have greater unit-productivity by the individual worker. Such increased productivity can be achieved only through a greater application of automation.

If we do not encourage automation, the public will foot the bill. Raw materials are becoming scarcer and more costly. Our increasing population will make unprecedented demands. Labor costs are increasing. These factors will bring us a sharp rise in the prices of familiar articles. But, as automation begins to fulfill its promise, the rewards will come. Ordinary standard items will gradually become relatively cheaper as factories learn to make them automatically.

There are three excellent examples of automation that have steadily held (or reduced) prices while everything else has skyrocketed. They are gasoline, electricity and the telephone.

Let's look at one of these examples — gasoline. Automatic control has reached a particularly advanced state in petroleum refining and the oil refinery is today's prototype for tomorrow's automatic factory. It is not much more than 30 years since automatic controls first appeared in our country's refineries. In the same period, vehicle fuel economy was improved 77 per cent. In 1926, gasoline burned at a constant speed of 40 miles per hour gave 26 ton-miles per gallon. In 1957, gasoline gave us 46 ton-miles per gallon.

Today, we wring more than twice as much gasoline

from a barrel of oil as we got with old refining methods—and the result is that today's gasoline (aside from taxes) costs us only a cent or two more per gallon than it did 30 years ago.

Recently Mr. Krushchev said to an American newspaper man: "We declare war upon you — excuse me for using such an expression — in the peaceful field of trade. The threat to the democratic countries of the world is not the ICBM but in the field of peaceful production. We declare a war we will win over these countries."

The Russians have issued warnings to us many times before. They have usually made good on what the warning predicted. Krushchev's latest statement means that we must be constantly alive to our future. The Russians have a great advantage over a nation of free people for their government can starve the population to bring about any end it may deem advisable for purposes of state. In a free

country, we have to depend upon individual drive and willingness to cooperate to produce the same results.

Unless we are constantly on the alert, taking advantage of every foothold — of every handhold — in the climb to pre-eminence, Mr. Krushchev's forecast may well come true.

The whole future and the very existence of free enterprise and the free world depends on the progress we make. If we are slow in accepting the vast strides of today in automation, we jeopardize the world in which we live and the battle for survival will become a grim one.

If, on the other hand, we continue to apply the broad and open-minded outlook for which we are noted, if we continue to move forward with ideas and plans and installations, there is no limit, no end, no visible horizon to the ultimate goals we will reach.

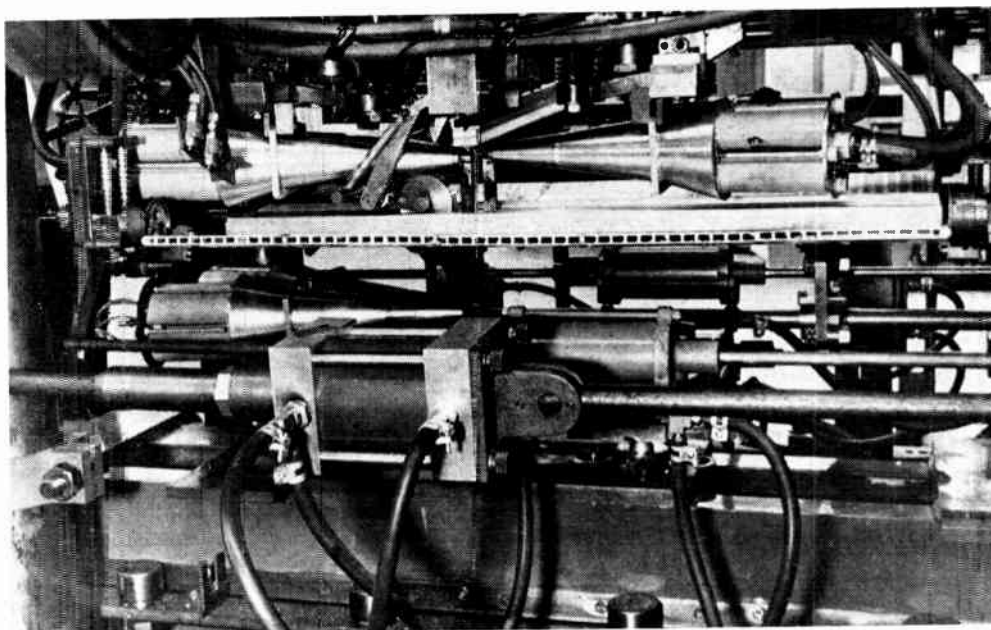

General view of the ultrasonic welder showing the cone-shaped welding heads used to amplify the sound waves.

Automated Continuous Seam Welding

WHAT IS believed to be the first automated, continuous seam, ultrasonic welder has been produced by Gulton Industries, Inc., Metuchen, N.J.

This revolutionary piece of equipment was developed as a result of a research contract and built to exact specifications to be used in a classified project.

The continuous seam, ultrasonic welder joins aluminum to aluminum, aluminum to stainless steel, or any two dissimilar or similar metals.

Through high frequency sound alone, two pieces of metal are joined as a result of a molecular transference or plastic flow at the interfaces of the two metals and below the melting point of either metal.

The continuous seam ultrasonic welder is similar in performance to standard electric seam welders. It achieves a rate of speed of 200 inches of welding per minute. However, it accomplishes this with aluminum which previously was impossible.

The prototype welder was designed to weld corrugated sheets to long curved aluminum extrusion. Its operation is completely automatic including feed.

Designed for the production of 30 inch seams, any length seam can be produced by incurring only the slightest redesign of the mechanical equipment. Although

the machine can be made to weld flat sheets, the particular one shown was specifically constructed for the welding of semi-circular sheets. It is capable of welding eleven different radii without any modifications.

Standing 13 feet high, 12 feet long and 10 feet wide, the ultrasonic welder weighs roughly three tons. It is powered by two, 2kw generators which operate alternately depending on the forward or backward motion of the welding heads, and which supply 500 watts of power to each welding head.

The machine was designed to accept pieces for welding of a thickness of .010 inches. Other pieces can be welded from .080 inches down to very fine foil. The pieces to which it is to be welded, under the present characteristics of the machine, can be five inches thick or more if necessary.

The continuous seam ultrasonic welder is a multiple-head welder with eight heads, four heads operating simultaneously. It is a self-monitoring instrument in that it is constantly checking itself against failure. Should failure occur, the machine automatically shuts down. A control board of panel lights is used to locate the defective part in the event of failure. However, once set or modified for a specific operation, an operator only has to stack the sheets or pieces to be welded, turn on the machine and finally remove the finished work.

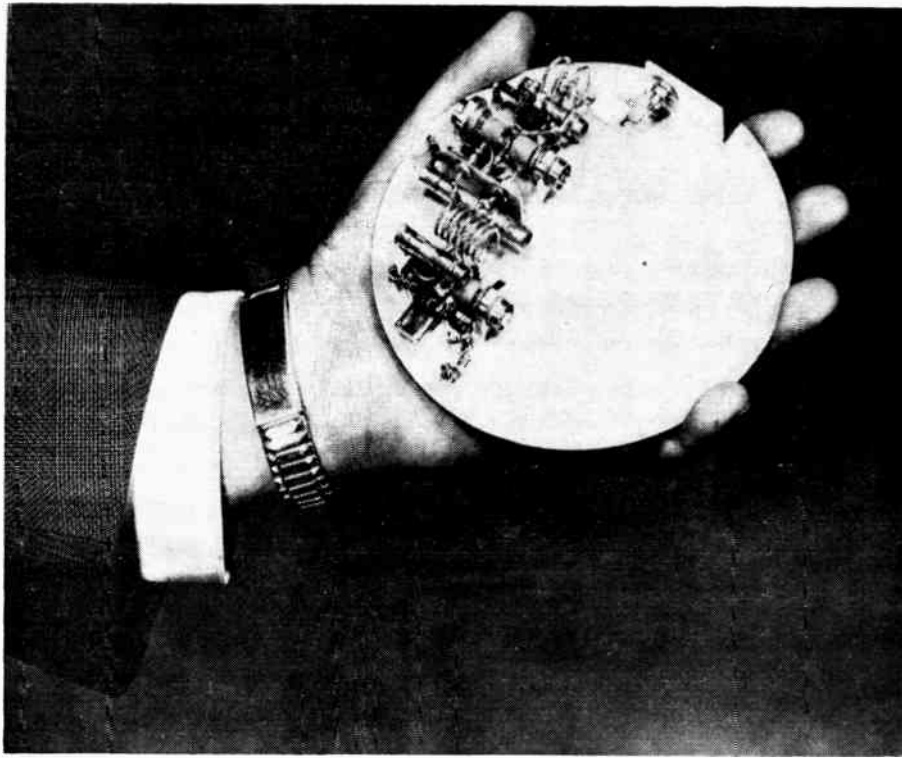

A 500 milliwatt satellite radio transmitter developed for Naval Research Laboratory weighs less than 3 oz., yet broadcasts 1½ to 4 times as long on same battery power as any previously known transmitter.

A new combination of known components integrated by research scientists to provide more power for space signals will double the efficiency of satellite communications.

A 500 m/W Satellite Transmitter

A NEW transmitter developed by the engineers of the DuKane Corporation will permit future satellites to continue broadcasting outer space data 1½ to 4 times longer than presently possible.

The transmitter was developed as a 500 milliwatt version of the Naval Research Laboratory's 100 milliwatt satellite transmitter. In designing the new transmitter, engineers achieved a better efficiency as well as the desired power level.

Engineers emphasized that although the circuit works and works well, months of extensive development and testing will be required before it can be programmed into an actual satellite.

The crystal controlled transmitter employs three recently developed Western Electric transistors capable of operating as oscillators or amplifiers at 108 megacycles. The special circuits employed give much greater over-all efficiency than is now possible with vacuum tubes.

A tube transmitter, developed for the same purpose by the DuKane engineers, requires five times the battery voltage and five times the battery power needed by the new transistor development.

The revolutionary nature of the new transmitter is as though someone re-arranged the parts in an automobile engine that normally gave 20 miles per gallon and came up with 40 to 80 miles per gallon of gasoline.

In satellite programs, this means a highly significant saving in weight, since fewer batteries can do the same amount of work. Or, using the same batteries, the satellite transmitter can broadcast for a much longer period of time.

This particular transmitter has been described as a new combination of known components, and was designed primarily for use in the satellite program. Its broadcast signals would be used in telemetering information on space conditions to monitor stations throughout the world, and

Turn to page 37.

**“Reliable”
ready-access
cable
terminal**

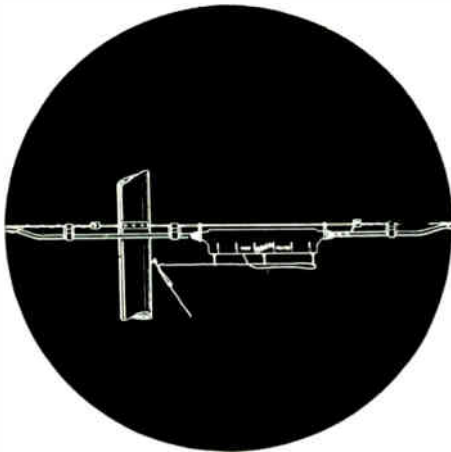

for plastic insulated and jacketed conductors in aerial cable.

- Easy to install—does not require the services of a cable splicer and helper.
- Compact—body is only 3 inches wide, 4 inches high, 16 inches long—overall length is 23 inches.
- May be used on any size of cable up to 1.2 inches overall diameter.
- Housing is weathertight but not hermetically sealed.
- Flexible split Neoprene can be folded back for maintenance and wiring changes.
- Available without terminal blocks or with one, two, three, or four 6-pair blocks.
- Installer—serviceman can readily add up to four 6-pair unprotected terminal blocks.
- Loading coils or other units may be installed in place of terminal blocks.

Each unit contains all parts ready for immediate installation. For complete information and literature on Ready-Access terminals, write or phone

Automatic Electric Sales (Canada) Limited, 185 Bartley Drive Toronto 16, Ontario. Branches in Montreal, Ottawa, Brockville, Hamilton, Winnipeg, Regina, Edmonton, Vancouver.

P.S.—Now available with the “new standard” colour-coded terminal blocks.

AUTOMATIC ELECTRIC

SALES (CANADA) LIMITED

5812

Convert to dial in easy, econ

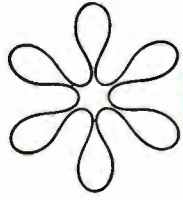

GO STROW

TO MEET REALLY HEAVY GROWTH, ADD A FRAME WITH AS MANY SHELVES OF SWITCHES AS YOU NEED.

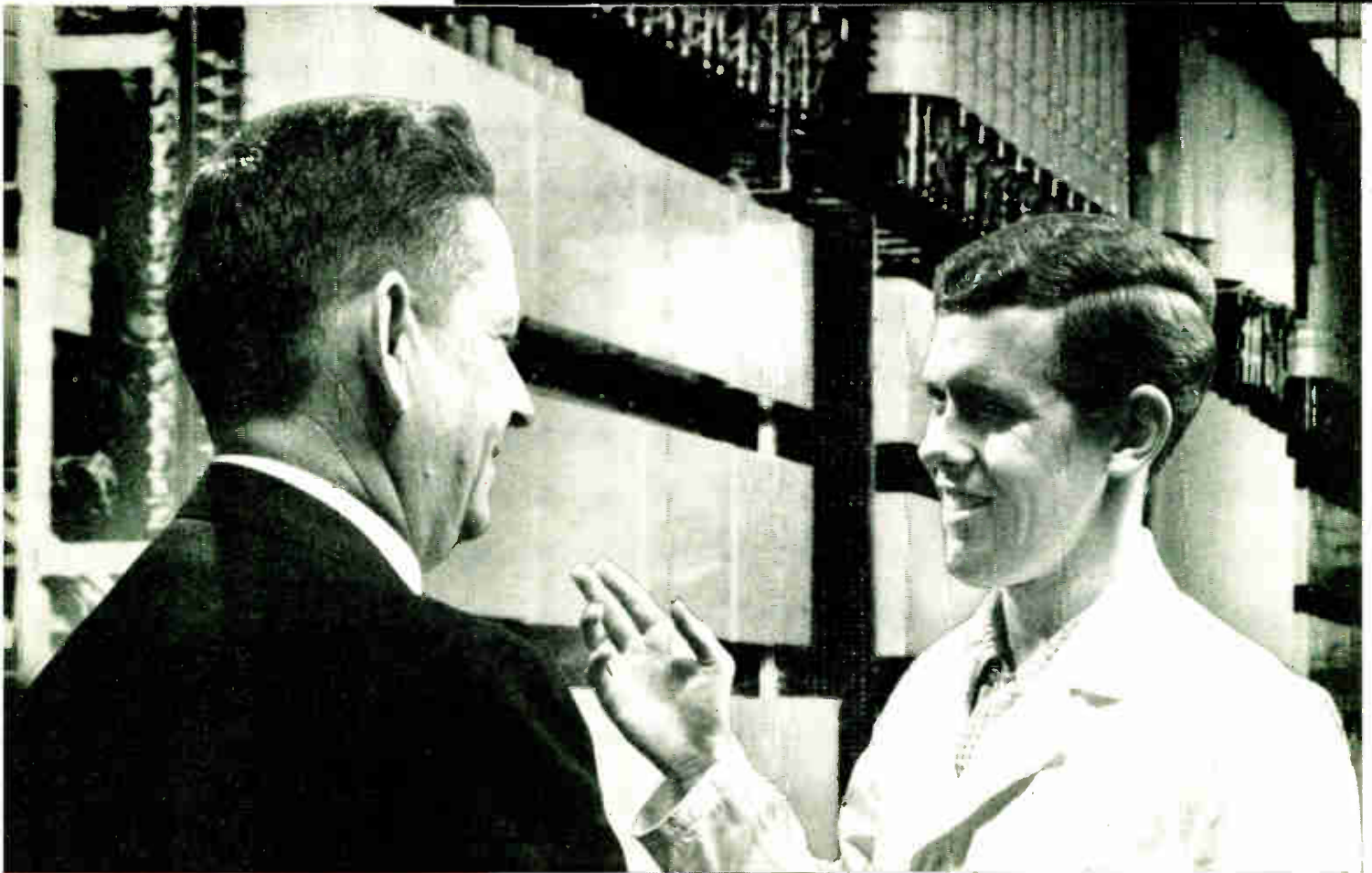

STROWGER PROVIDES FOR TODAY

- Economical expansion with simple jack-in equipment.
- Banks and wipers in plain view—easy to see and reach.
- Low maintenance, fast call tracing.
- Simplified checking—each switch and its control relays mounted as a unit.
- Trunk repeaters for carriers, microwave, physical or composite circuits.
- Automatic time announcing and weather reporting.
- Quick, easy testing of lines for leaks, grounds, etc., with the Automatic Line Insulation Routiner.

and for TOMORROW

- Intertoll dialing with the latest supervisory standards.
- Easy adaptation to Direct Distance Dialing.
- Easy adaptation to automatic toll ticketing.
- Ready expansion to director operation.
- "Four-wire" toll switching.

omical stages – WNGER NOW!

ADD A SWITCH TO TAKE CARE OF MODERATE GROWTH.

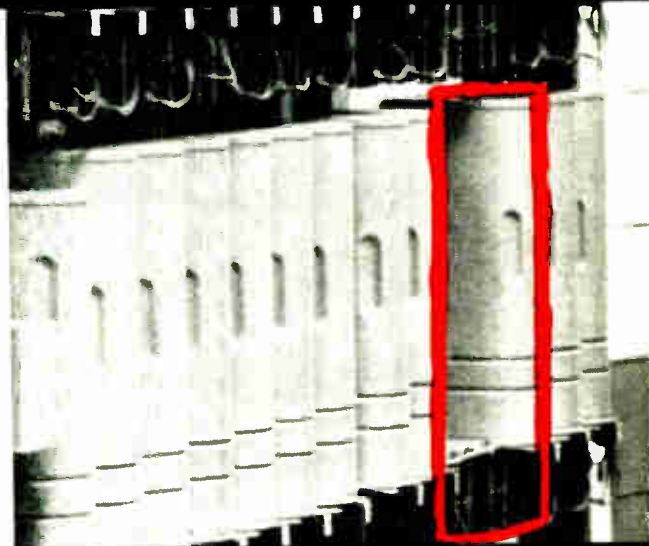

ADD A SHELF OF SWITCHES WHEN LARGER GROWTH OCCURS.

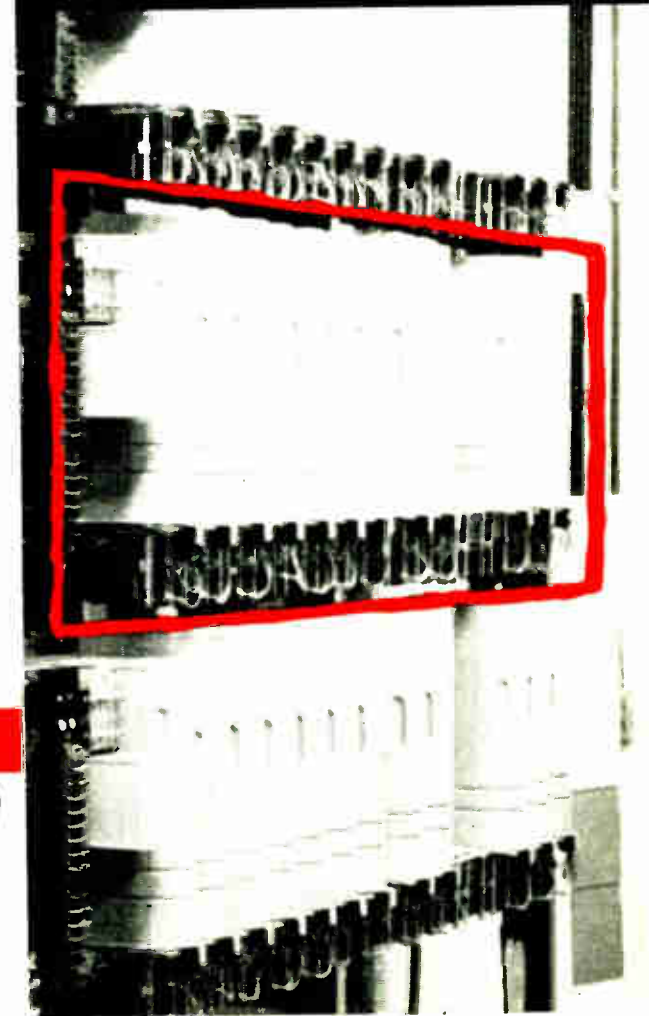

Converting to dial isn't as difficult or as costly as you might think—not if you do it the Strowger way. With Strowger the same basic units are used for small and large exchanges; you simply buy the equipment you need to get started and install extra equipment step-by-step, as your community grows. Extra switches or banks can be added quickly and easily. And if your community's growth becomes really spectacular, you can install pre-assembled frames containing any number of shelves you need.

Strowger has many important advantages—for rural areas, quiet towns or teeming cities. It incorporates all the latest advances in design and quality construction. Its reliability has been proven in almost every part of the world—in some exchanges, for instance, Strowger equipment installed 40 years ago is still in constant use. Every Strowger unit is designed for extreme ease of maintenance. The few parts that inevitably wear out with prolonged use, can be quickly replaced—at very low cost, and without service being interrupted.

Whatever the size of your community, when you install Strowger you invest in up-to-the-minute equipment that can be readily adapted to meet every changing need.

If you would like further information, call or write any Automatic Electric office, today.

Automatic Electric Sales (Canada) Limited, 185 Bartley Drive, Toronto 16, Ontario. Branches in Montreal, Ottawa, Brockville, Hamilton, Winnipeg, Regina, Edmonton, Vancouver.

5834

AUTOMATIC  **ELECTRIC**

ORIGINATORS OF THE DIAL TELEPHONE





A BIG TEAM OF TWO FOR YOU

In the field of radio and telephone communications equipment, Lenkurt and Automatic Electric need little introduction. Working together, this famous team serves you in the new and growing field of data transmission.

Many types of Lenkurt standard commercial equipment already in use meet the exacting requirements for data transmission, and Automatic Electric engineers are fully qualified to advise you on these applications. So call Automatic Electric—and let the “big team of two” supply you with the information, equipment and service necessary to make data transmission a valuable addition to your facilities.

Find out how Lenkurt and Automatic Electric, working together, can help solve *your* data transmission or other communication problems.



For complete information write or call your nearest Automatic Electric office. AUTOMATIC ELECTRIC SALES (CANADA) LIMITED, 185 Bartley Drive, Toronto 16, Ontario. Branches in Montreal, Ottawa, Brockville, Hamilton, Winnipeg, Regina, Edmonton, Vancouver.



1837-R

ORIGINATORS OF THE DIAL TELEPHONE



For further data on advertised products use page 61.

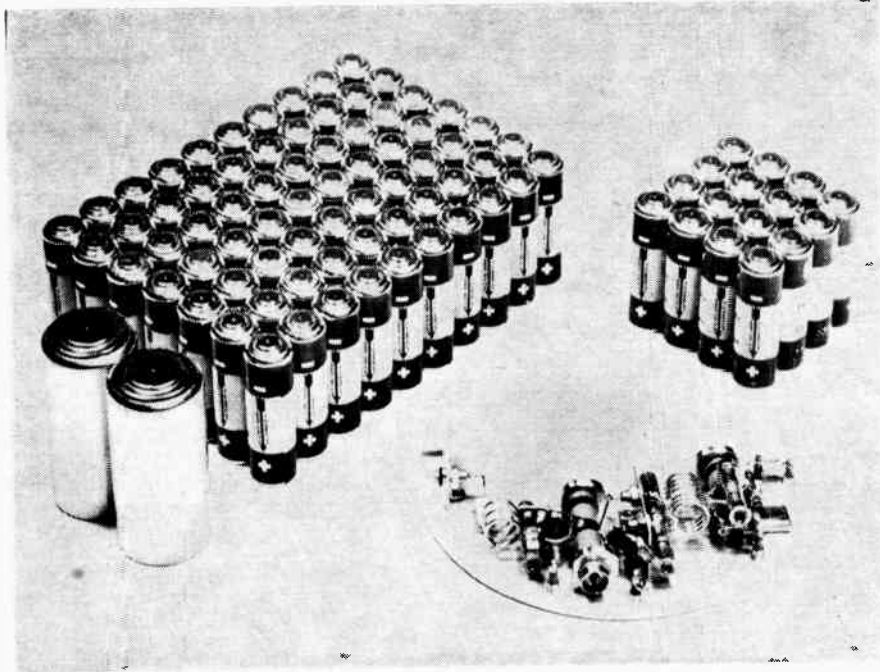

Comparison of number of mercury cells needed for a tube-type transmitter with number needed for same life and power output with the new transistor circuit is shown above, demonstrating great savings in weight possible with new transistor.

as an aid to tracking the satellite's path.

The tiny "broadcasting station" weighs less than three ounces, and occupies less than six cubic inches of space (a cigarette package occupies about seven cubic inches). For a power output of 500 milliwatts, it uses one-half to one-fourth the battery power needed by any other transmitter now known.

Civilian Uses

The combination of light weight and low battery drain suggest other uses, as well, in both military and civilian applications. Police, fire department, and civil defense applications have been suggested. The new circuits would make possible a radio transmitter small enough to fit into a shirt pocket, or be built into an infantryman's helmet.

The efficiency of the new transmitter could facilitate getting a rocket to the moon by substantially reducing the payload requirements.

Engineers say the transmitter can be operated on solar batteries, drawing its power from the sun and sending out its signals indefinitely, but with one-half to one-fourth of the rocket surface heretofore required for sun exposure.

Typically, the output stage of a conventional tube-type transmitter doing the same job would need 4620 milliwatts

power to produce 500 milliwatts output. By contrast, the output stage of the new transmitter needs only 930 milliwatts power to produce the same output. The corresponding efficiencies are 11 per cent and 54 per cent.

As an additional advantage, the DuKane circuit operates on a single 20 to 24 volt battery, whereas a tube-type transmitter requires two different types of batteries, a low-voltage filament and a high-voltage plate supply.

Tubes also generate heat, and the heat must be dissipated, a problem which crops up so often in miniaturization. The transistor circuit greatly reduces this problem. Simplified circuitry and reduced shielding problems because of low operating impedances also make it possible to squeeze an amazing amount of transmitting power into extremely small space.

Until now, transistors have not lent themselves very well to efficient VHF (very-high-frequency) operation, when high output power was needed. The electronic breakthrough making this possible is the result of more than eight months of intense research and development work by a DuKane research team.

A comparison of the operating efficiencies of the new circuit and a typical tube-type circuit is shown in the accompanying table.

COMPARISON OF THE NEW 108 MEGACYCLE SATELLITE TRANSMITTERS

Stage Characteristics at 500 Milliwatt Output

| | <i>Tube Type</i> | <i>New Transistor Type</i> |
|----------------------------------|------------------|----------------------------|
| Collector Voltage | _____ | 20 volts |
| Collector Current (pair) | _____ | 45 milliamps |
| Collector Circuit Input Power | _____ | 900 milliwatts |
| Collector Circuit Efficiency | _____ | 58% |
| Emitter Power Input | _____ | 30 milliwatts |
| Plate Circuit | 120 c. @ 32 ma. | _____ |
| Screen Circuit | 120 v. @ 5 ma. | _____ |
| Filaments | 2.25 v. @ 80 ma. | _____ |
| Total Input Power to Final Stage | 4620 milliwatts | 930 milliwatts |
| Over-all Final Efficiency | 10.8% | 53.8% |

New Products

New Product specifications published in *Electronics and Communications* have been briefed for your convenience. If you require further information on any of the items published you may readily obtain such by using our Readers' Service, Page 61. Just mark the products you are interested in on the coupon on Page 61 and the information will be in your hands within a few days.

Range Of Vibration Measuring Instruments

Item 1971

A complete range of instruments for the measurement and analysis of machinery vibration has been developed by Dawe Instruments Limited, of London, England, and is now available from the company's Canadian plant in Ottawa. The instruments range from a pocket size meter for field use to comprehensive analyzers and recorders for routine measurement in factories and plants.

All the instruments are equipped with pick-up units or transducers. These are attached to the vibrating machinery and convert vibrations into electrical signals. The signals are then passed through electrical networks, amplifiers and meters, to give direct readings of amplitude, velocity, acceleration, etc., as required.

A vibration generator, a modified valve voltmeter, various types of stroboscopes, a high speed level recorder, and portable balancing equipment for measuring unbalance in rotating machinery, are also included in the range.

For complete details of these and other Dawe instruments, copies of illustrated literature, etc., write to Dawe Instruments Limited, 1654 Bank Street, Ottawa, Ontario, Canada.

Signal Generator

Item 1972

Testing and aligning of the multitude of electronic apparatus employed by modern industry is a function of the radio-frequency test instrumentation distributed in Canada by Instronics, Ltd., Ottawa, for BJ Electronics, Borg-Warner Corp.

Typical of such instruments is the BJ Electronics Model 75A Signal Generator which combines precision, flexibility and stability to produce a single product which will fulfill all general laboratory needs in the 10 to 440 mc region.

The Model 75 Signal Generator has a range of 10 to 440 megacycles in a single band, continuously tunable. While tuning, an automatic level control feature maintains the carrier output within ± 1 db and will maintain a preset depth of modulation as the instrument is tuned across the band. Modulation capabilities include amplitude modulation at 400 or 1000 cycles from an internal source, or 80 to 5000 cycles from an external source, frequency modulation from 400 to 1000 cycles from the internal source and 80 to 5000 cycles from an external source, with up to ± 75 KC deviation.

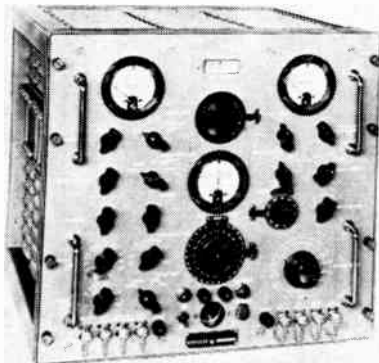

Sweep modulation from up to ± 7.5 megacycles is available. This sweep is continuously adjustable over ranges of 0 to ± 75 kilocycles, 0 to ± 750 kilocycles, or 0 to $\pm 7\frac{1}{2}$ megacycles. In addition, internal pulse

modulation from 50 to 5000 pulses per second is included, each pulse variable between 1 and 30 microseconds with a variable pulse delay of 1 to 100 microseconds.

Many of these features are made possible by the means of a unique system of signal generation. Two cavity oscillators are heterodyned to generate the basic carrier. One cavity is variable-tuned, the other is controlled by a reactance tube. This makes possible an automatic frequency control loop which reduces drift to less than 0.002% per hour and results in low incidental frequency modulation. To increase the flexibility of the instrument, the power supply has been designed to operate from 50 to 450 cycles AC at 115 volts and will tolerate a 10% change in line voltage without degrading performance. The instrument is built to USAF specifications to result in a highly ruggedized, reliable signal generator. It is to be noted that these features are unusual in a precision, stable device of this type.

Instronics, Ltd., 11 Spruce Street, Ottawa, Ontario.

Quick-Reset Revolution Counter

Item 1973

This interesting new Series 1522 counter, recently introduced by Veeder-Root Inc., Hartford 2, Connecticut, is available either with or without predetermining wheels. With the predetermining feature, the wheels can be pre-set to any number within

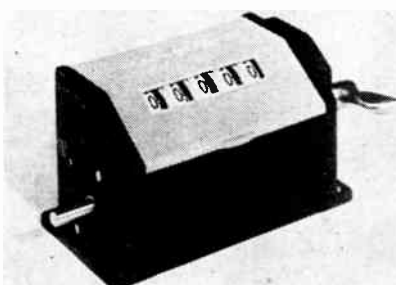

the counter's capacity of 100,000; and at that pre-set number the counter automatically knocks off. Instant resetting to zero is just a matter of depressing the reset lever through a full 60° arc. Also, if desired, the counter will subtract in opposite direction. It speeds up to 6000 rpm of the drive shaft and 8000 counts per minute are the maximum recommended. The knock-off switch connected to the counter is not recommended for more than 10 amps, at 125 or 250 volts AC; or 1/2 amp at 125 volts DC; or 1/4 amp at 250 volts DC. Standard ratio, 1 to 1.

As a plain high-speed quick-reset revolution counter . . . without the predetermining feature, the Series 1522A Counter is recommended for all counting jobs (either adding or subtracting) where high speed, long-lived accuracy and easy, instant resetting are required. This is the only counter of this type that resets instantly with one touch of the lever, while machine is running.

In either version, Series 1522 Counters come in a rugged, handsome 2-tone gray case that makes them visually acceptable for any application.

Prices and complete specifications available from the makers, Veeder-Root Inc., Hartford 2, Connecticut, U.S.A.

Insulated Standoff Terminal

Item 1974

The first insulated standoff electrical terminal to operate in the extremely high temperature region of 1000°C. and still maintain its electrical function has been announced by Litton Industries Components Division of Los Angeles for its USECO product line. Brand new, this insulated standoff terminal will also maintain its electrical function while in an environment in which electronic equipment will operate in conjunction with a nuclear power source.

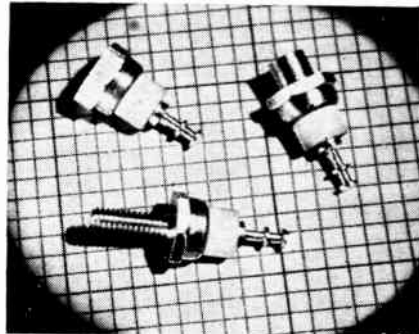

To meet the rigid physical and electrical properties required to operate in the 1000°C. region, each part of this new insulated standoff terminal was completely engineered to provide a satisfactory assembly. The more common insulated terminals in use today lose electrical properties or functions in the relatively low heat range of 90°C. to 150°C. with some few exceptions reaching around 250°C.

In addition to the high temperature requirement, materials used in the new terminal are capable of withstanding high impact, high resistivity at high temperatures, no water absorption and high resistance to nuclear radiation.

One of the significant advancements in the new USECO standoff terminal is the use of extremely high strength alumina as the insulator. Besides withstanding temperatures in excess of 1000°C., alumina will withstand 400,000 p.s.i. compression. Non-brittle, the alumina insulator used on the new USECO terminal will withstand greater than .05 foot-pound impact on IZOD type test.

Bases and lugs for the terminal are specifically designed to take advantage of the excellent mechanical properties of alumina as well as the heat properties.

For further product information, write to the Canadian representative: Lake Engineering Co. Ltd., 767 Warden Avenue, Scarborough, Ontario.

Telephone Pick-Up Coil

Item 1975

Microtran Co., Inc., of Valley Stream, N.Y., has introduced a new improved Telephone Pick-Up Coil. This Model HP-61 may be used for transcribing telephone conversations with recorder or for making messages audible with amplifier.

The new compact unit is 2" long, 5/8" in diameter and has improved sensitivity and superior shielding over its predecessor. The unit is also suitable for use as a probe for locating sources of hum.

The Pick-Up is still supplied with 6' shielded cable and standard telephone plug. Additional data on this product may be obtained by writing to Hudson Randall International, 123 Manville Road, Toronto 13, Ontario, Canada.

New Products

Electronic Sentry

Item 1976

A device that is expected to provide telephone companies with an important source of additional revenue, is now available to telephone companies from Automatic Electric (Canada) Limited. It is an electronic unit capable of reporting dangerous or abnormal conditions in plants, office buildings, warehouses, etc., to managers or any other selected persons, at any time of the day or night. It can also be set to dial the police in the event of a break-in, or to call the nearest fire department in the event of fire.



Known as the Electronic Sentry, the unit is activated by ordinary detection devices. Thermostats, tank level gages, intruder alarms, etc., react to changes in conditions, and the Electronic Sentry takes over from there — automatically. It connects itself to a telephone line, dials the prearranged number, reports what the trouble is and where it is located, and repeats the message until it is clearly understood. If the dangerous or abnormal condition is not corrected within a given time, the Sentry calls again and again until it is.

Automatic Electric state that the Sentry is a significant step forward in safety and security engineering. They expect it to be widely used in every type of commercial and industrial building, on a rental basis from telephone companies.

For further information, illustrated literature, etc., write to Automatic Electric Sales (Canada) Limited, 185 Bartley Drive, Toronto 16, Ontario.

Silicon Power Rectifier Applications

Item 1977

The unusual characteristics exhibited by Silicon Rectifiers produced by Taylor-Leslie Mining & Engineering Corporation Ltd. have led to their widespread use in many special applications. For example: the wide temperature range of operation (to 150°C.) without derating or detectable change in characteristics, makes it ideal for aircraft and missile applications. Compact design for relatively large power requirements has resulted in the use of these Silicon Rectifiers in computers, calculators and magnetic amplifiers.

Following are typical applications for Taylor-Leslie rectifiers: Battery Charges—railroad, telephone. DC Power Supplies for—railway signaling, relays, telegraph, telephone. Special Applications—electrolysis, spark quencher, voltage doublers, magnetic amplifiers, DC field power supplies, relay power supplies.

For additional data on these Silicon Power Rectifiers write to Taylor-Leslie Mining & Engineering Corporation Ltd., P.O. Box 312, Terminal "A", Toronto, Ontario, Canada.

Power Supplies

Item 1978

Of unusual design is a multiple output DC-DC power supply, built in semi-circular form into half of 6" diameter x 2 3/8" high cylinder for infantry missile support. The other half of the cylinder houses the 25.5 to 30.5 VDC source. This power supply, a product of Universal Transistor Products Corporation, is built to withstand up to 100g and to operate at 100% relative humidity. It produces 150 VDC at 60 MA $\pm 1\%$, and 180 VDC at 85 MA $\pm 1\%$ regulated line and load. It utilizes germanium transistors and tantalum capacitors, and is designed to operate from -55°C to +70°C. Ripple is less than 300 MV in each output. Weight of unit approximately 25 ounces.

Another product of Universal Transistor Products Corporation is a 6 1/2 ounce 1 1/8" diameter power supply, which occupies less than four cubic inches (not much larger than the battery that powers it) and produces 12,000 VDC at 1 x 10⁻⁷ amperes from a single 1 1/2 VDC "C" size battery. The high voltage is obtained from a transistor oscillator circuit which is powered by the 1 1/2-volt cell.

The unit powers an infra-red conversion tube. A second version occupies less than six cubic inches and produces 16,000 VDC from a 1 1/2 VDC "D" — size flashlight cell input. Other units that produce fixed outputs from 500 to 20,000 VDC are available.

Additional information about these power supplies may be obtained through the exclusive Canadian representative — Conway Electronic Enterprises Reg'd., 1514 Eglinton Avenue West, Toronto 10, Ontario.

Variable Laboratory Attenuators

Item 1979

Jerrold Electronics Corporation of Philadelphia, has announced introduction of two variable attenuators offering 0 to 62.5 db attenuation in 0.5 db steps from DC to 500 mc.



The units are designed for electronic laboratories in the communications, radar and telemetering industries. With the introduction of attenuators Model AV 50 and Model AV 75, Jerrold's Test Instrument Division — formed little more than a year ago — now offers an integrated line of precision test equipment for RF measurements of gain, loss and impedance characteristics by comparison techniques.

The attenuators, Model AV 50 and Model AV 75, utilize precision, carbon-deposited resistors for highest accuracy. They exhibit a maximum insertion loss of only 0.25 db from DC to 250 mc, and 0.5 db from 250 mc to 500 mc. Each attenuator incorporates a newly developed rotary, coaxial switch that features a floating rotor with dual wiping, self aligning contacts mounted in a "Tel-F" dielectric. The switches are housed in individual shielded sections.

A rugged, compact, cast-aluminum case measuring only 8 3/8" x 5 3/8" x 2 1/2" is used for the attenuators. The slim design of the case permits the attenuators to be inserted into the most complex test set-ups without consuming large areas of valuable bench space. Switch knobs are marked in a white line to show at a glance if any attenuator section is in or out of the circuit. Coaxial terminals are located on the same end of the case to simplify connection of the unit in test set-ups.

Model AV 50 has a characteristic im-

pedance of 50 ohms and utilizes improved type BNC connectors. Model AV 75 has a characteristic impedance of 75 ohms and utilizes Jerrold "F" Series, constant impedance connectors.

Additional data obtainable from Jerrold Electronics (Canada) Limited, 50 Wingold Ave, Toronto 10, Ontario.

Power Tetrode Transistor

Item 1980

Honeywell Controls Limited, Toronto 17, Ontario, has announced that full-scale production has begun of its recently-developed power tetrode transistor for high fidelity and other audio uses. The transistor is termed the first of its kind in the electronics industry.

Pilot production operations were carried out in the Boston Division of the Minneapolis-Honeywell Regulator Co., but C. G. Bell, sales manager of the Semi-Conductor Division of Honeywell in Toronto, stated that with the start of full production, activities would be transferred to Minneapolis, where Honeywell's main transistor production facilities are located.

Demand for the new transistor, described as having unusual high-frequency and low distortion characteristics for high fidelity use, has far exceeded initial output, Mr. Bell said. The transistor has a frequency response up to 20,000 cps with only 2 per cent distortion. It is expected that volume production of it will spur more widespread development of hi-fi equipment using transistors instead of vacuum tubes.

Further enquiries should be directed to Sales Promotion Department, Honeywell Controls Limited, Toronto 17, Ontario.

Transistor Meter "teletrans I"

Item 1981

From their very conception, transistors have adapted themselves to a wide variety of applications in almost all the sciences. This tremendous growth in the use of the transistor has brought with it a demand for an instrument which will read with high accuracy the various dynamic parameters characteristic of transistors.

The Transistor Meter "teletrans I" by Telefunken, represented by the Ahearn and Soper Co. Ltd., 384 Bank Street, Ottawa, fills the above requirements completely and adds the feature of portability. This multiple measuring instrument is for both pnp and npn transistors. This compact meter measuring 6 3/16" x 8 1/2" x 4 3/16" and weighing less than 6 lbs by means of press button switching measures a total of 13 transistor characteristic data.

Incorporated in this meter are the following units: A bridge section operating together with a 1000 cps oscillator, a zero indicator and mains section. The power consumption is very low due to full transistorization and thus the instrument has no self-heating worth mentioning.



Accessories are available which extend the range of RA to 100 Kohms and Rg to 10 Kohms. Special adaptors and sockets are also available which will make this very versatile instrument adaptable to the many new and highly specialized transistors presently being developed.

For further information write The Ahearn and Soper Company Limited, 384 Bank Street, Ottawa 4, Ontario, Canada.

New Products

Instrument Facilitates Transducer Recording

Item 1982

To enable direct recording of the output of differential transformer transducers, a new Exciter-Demodulator has been developed by Daytronic Corporation, Dayton, Ohio, and is being marketed in Canada by A. C. Wickman Limited, Electronics Division.

The new instrument supplies current regulated AC excitation to the transducer, demodulates and filters the resulting signal and supplies a linear DC output signal proportional to transducer input. Direct operation is provided with standard strip chart recorders, X-Y plotters, digitizing equipment, etc.

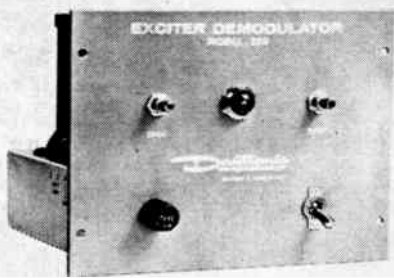

A magnetically regulated, tubeless circuit insures maximum reliability for critical applications plus freedom from drift. The instrument may be used with Daytronic, Schaevitz, or similar differential transformer transducers. The model 200 is designed for operation with instruments having input impedance of 3000 ohms or greater. The model 200L is designed to match the characteristics of instruments having input impedance values from 400 to 3000 ohms. Both models are designed for panel mounting but will operate on any level surface.

Complete descriptive information on the new instrument is provided in Daytronic Bulletin No. 200, available upon request from A. C. Wickman Limited, Electronics Division, 1425 The Queensway, Toronto, Ontario, Canada.

Twin Contact Plug-In Relays

Item 1983

Plug-In Twin Contact Relays are the latest development in high reliability relays plus the important feature of plug-in convenience. The new "picture-window" relay dust covers permit quick, visual inspection of relay operation—without exposing relays to trouble-making dust.

These relays provide greater reliability through twin contacts, improved insulation and greater high voltage breakdown resistance. They also provide quicker, easier service; just plug the relay in—no soldering, no wiring, and in most cases no power shut-off. Servicing may be done on the test bench.

Specifications:

Coil Voltage—up to 230 volts DC or AC (factory tested to withstand 1000 volts breakdown). **Contacts**: up to 12 springs per stack, with two to four welded Palladium contacts per spring (depending upon type). These contacts are rated to carry a 3 ampere or 150 watt maximum non-inductive load. **Twin-Contacts**—these self-wiping dual contacts are used on all relays for greater reliability. The contact springs are of special spring-temper, nickel-silver. 12-point Standard Plug Mounting—all similar type relays are wired the same way—to make replacement as simple as changing a radio tube.

For further details contact R. H. Nichols Limited, P.O. Box 500, Downsview, Ontario, Canada.

Digital Voltmeter

Item 1984

The new Electro Instruments' Digital Voltmeter, Model DVA-500, combines the E-I Universal Power Module and 5-digit E-I Switch Module to produce a 5-digit voltmeter which has an accuracy of 0.01%, plus or minus 1 digit.

The DVA-500 has a range of 0.0001 to 999.99 volts with an input of 1,000 megohms on the 10 volt scale, and 11 megohms on other scales. Automatic features include ranging, polarity and calibration. Stability is better than 0.01%.

Like other modules on the new Electro Instruments' design, the Model DVA-500 features important new specifications. These include new logic which speeds balance time and prevents the loss of significant digits on down ranging under all conditions, increased switch life, wider dynamic range and elimination of radio noise or line transients during operation.

Bulletins 175-1 and 175-2 which give complete information on the DVA-500 are available from the Canadian representative — Electromechanical Products, Markham Rd., Agincourt, Ontario.

Sitting-Standing Principle

Item 1985

The Sitting-Standing Principle, or the variation arrangement in seating, has not only been highly recommended in principle by doctors, but actually works out excellently in practice, according to R. Middleton, Divisional Sales Manager of the Royal Metal Manufacturing Company Limited of Galt, Ontario, who explains it in the following terms.

No matter how comfortable or correct the working position may be, it becomes irksome to the employee after a protracted period. While constant standing is fatiguing and often harmful to the health of the worker, constant sitting is perhaps just as disadvantageous. Varying the working position rests tired muscles and definitely diminishes fatigue. This in turn increases production and efficiency.

The Sitting-Standing idea works as follows: the work bench should be from 34 to 40 inches high and should have no obstruction below to interfere with the workers' legs. The chair or stool should have an adjustable range of from 24 to 32 inches, and be set at a height that will permit the worker's elbows to be the same distance from the floor, whether sitting or standing. It is essential that the elbows be at about the same level whether sitting or standing, which places them in the same relation to the work in either position. Otherwise the worker will remain too long in the more convenient position of the two, causing unnecessary fatigue. In computing the elbow height, it must be remembered that the bench or machine may not be the actual working level but the height of the object worked upon on the bench may represent the working surface.

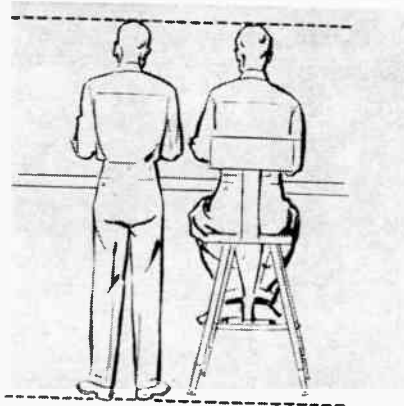

For further information on this method of increasing employee production efficiency through improved seating write R. Middleton, Divisional Sales Manager, Royal Metal Manufacturing Company Limited, Galt, Ontario.

Ferrite Isolators

Item 1986

Airtron Canada Limited announce the manufacture of a new Series of L-Band, WR-650 resonant absorption Ferrite Isolator, which provides constant uni-directional transmitter to load isolation for low, medium and high power Microwave applications in lower Microwave frequency ranges.

The WR 650 Ferrite Isolators furnish sufficient isolation between the transmitter and the RF energy reflected from line mismatches to ensure optimum frequency stability and power output, thus affording protection to transmitter tubes and eliminating the necessity for mechanical adjustments of phase shifters to correct "Long Line" effects.

All units are WR-650 waveguide size and operate over a frequency range from 1250 to 1350 mc/s with a high degree of performance.

While the low and medium power versions do not require cooling, the high power unit requires either forced air or a liquid cooling agent. Recommended liquid flow is one gallon per minute with the cooling liquid at a maximum temperature of 65°C.

For further information please write to: Airtron Canada Limited, 300 Campbell Avenue, Toronto 9, Ontario for catalog sheet No. 3550.

Panel Meters

Item 1987

Available for the first time in Canada is the world famous line of Gossen electrical measuring instruments. Illustrated is the popular Model Px series of panel meters, produced in 2", 3", 4", 5" and 7" sizes. This series, of a styling very acceptable in Canada, features sturdy plastic cases, rugged construction, high accuracy (1.5%) and moderate cost. They are available as A.C. and D.C. voltmeters, ammeters, wattmeters, and many special types. All have shock mounted jewels, and oversize movements, and despite the low price, are competitive with ruggedized types of Canadian and American manufacturers.

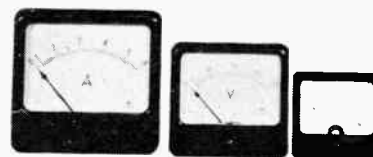

The Gossen Px series of panel meters is stocked, finished and serviced in Canada. All standard ranges and a fantastic variety of special calibrations are available on very short notice, often within 72 hours. Multi color scales, mirror anti parallax backs, expanded ranges, can be supplied.

A catalog sheet describing the range and showing Canadian prices is available for the asking from the Canadian representative — Criterion Instrument Division of Canadian Research Institute, 46 St. George St., Toronto 5, Ontario.

Strip Chart Recording Potentiometer

Item 1988

Westronics Incorporated announces production on a new 5" strip chart potentiometer recorder with plug-in range resistor features. The recorder is available with a variety of ranges for thermocouple, resistance bulb and linear milli-volt spans. The recorder also features a wide range of chart speeds from one inch per hour to two inches per second.

Total panel space required is 9½" wide by 8½" high and the recorder weighs approximately 25 pounds. Optional features include quick change chart drive, re-transmitting slidewire, event marking pens and limit switches.

Inquiries should be addressed to Westronics Incorporated, 3605 McCart St., Fort Worth, Texas, U.S.A.

New Products

Univistors

Item 1989

Universal Transistor Products Corporation announces its new range of Univistors, transistorized replacements to instantly replace Vibrator units. The Univistor is a transistorized plug-in device which has a life expectancy of very many thousands of hours of continuous operation.

Due to the transistorized nature of the unit, the hash level of a receiver is greatly reduced thereby considerably increasing its signal to noise ratio, and due to this, the efficiency factor in communications systems. There are no wiring or circuit changes required. Univistors are available with bases corresponding to commercially available vibrators. In addition, the Univistor can not be damaged by input polarity reversal.

For further information in the above regard, contact — Conway Electronic Enterprises Reg'd., 1514 Eglinton Ave. West, Toronto 10, Ontario, who are exclusive Canadian distributors for the Universal Transistor Products Corporation.

Selenium Contact Protectors

Item 1990

A new series of selenium contact protectors for a.c. voltages has been developed by International Rectifier Corporation to eliminate arcing and erosion across the contacts or relays, switches and other components. The new a.c. series will supplement the established line of d.c. arc suppressors.

Standard contact protector types are now available for a.c. working voltages ranging from 26 to 156 volts, with coil currents from 0.20 amps to 1.2 amps. Three basic configurations are available: (1) encapsulated diode types for limited space applications. Extremely small in size, protectors

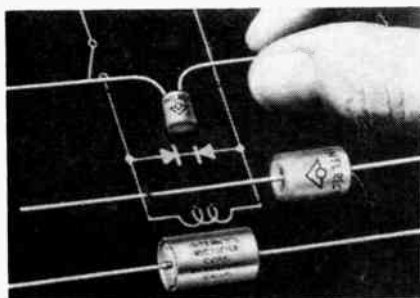

in this series measure only 0.01 cu. in. — slightly larger than a match head. (2) Fibre tube cartridge types, and (3) hermetically sealed cartridge types for application in environmental extremes.

The extremely low cost of these selenium suppressors — negligible by comparison to the maintenance cost of unprotected devices — along with their small size make them ideal for a wide variety of contact protection applications. When operated within design limits they can greatly increase the maintenance-free operating life of the equipment concerned. Pigtail-type construction of the suppressors assures ease of mounting in any position. Write for Bulletin SR-150A to the Canadian representative: Atlas Radio Corporation Ltd., 50 Wingold Avenue, Toronto 19, Ontario.

Remote Area Monitoring System

Item 1991

A new system for around-the-clock monitoring of radiation in remote areas, built to AEC specifications, is announced by The Victoreen Instrument Company.

The system is designed for continuous area monitoring around reactors, hot cells, plants, laboratories and radiation facilities. In addition, the unit gives automatic alarm when radiation reaches high or dangerous levels. The Victoreen Instrument Company RAM can be used to indicate radiation failure in reactors and hot systems, can indicate catalyst flow rates or level indica-

tion in process control, door interlock actuation, or Civil Defense fall out and disaster control.

The system is of unitized construction and is composed of three basic components. These basic units are: Control unit which incorporates the power supply; plug-in station; and sensing element.

The control unit is designed for relay rack mounting and can accommodate up to 20 channels. Plug-in stations have a knob adjustment for range control and screw-driver adjustment for track, span and filament. The sealed sensing elements include a hermetically sealed voltage-saturated ionization chamber containing the electrometer tube. Output of the sensing element is logarithmic with respect to radiation intensity. Elements for detecting beta as well as gamma radiation contain a solenoid operated beta discrimination shutter.

Ranges of Victoreen's remote area monitoring system can be tailored to the application. In general, standard units cover any three consecutive ranges of gamma radiation between .01 mr/hr and 1,000,000 r/hr. Six-decade range available. Beta-gamma radiation range is from 1 mr/hr to 1,000,000 r/hr. Gamma energy response is independent within $\pm 10\%$ from 80 key to 2 mev; accuracy exceeds $\pm 15\%$ of actual intensity over entire range. Response time is inversely proportional to incident radiation intensity and is approximately 10 seconds at 1.0 mr/hr.

Full details on the new Victoreen remote area monitoring system are available on request to the Canadian representative — Radionics Limited, 8230 Mayrand St., Montreal 9, Que.

Standardized Load Banks

Item 1992

A completely new line of Standardized Load Banks for obtaining artificial electrical loads has been announced by Ward Leonard of Canada Limited.

Ordinarily, load banks for specific jobs are specially designed and built to order, oftentimes at high cost with relatively long delivery. With Ward Leonard's new concept in load bank design, the purchasing engineer is offered a wide range of loading resistors and switch selection in combination with standard size enclosures and mountings.

Each load bank consists of a sturdy, metal framework; pre-wired resistance elements; terminals for external connection and load section switching components where needed. Elements are Ribflex® or Barohm® ribbon type resistors.

Recommended for use by testing labs, jet engine and motor manufacturers, communications equipment makers, etc., these load banks are available in capacities up to 70 kw per unit, 600 volts max.



Complete technical information on this new Standardized Load Bank is given in Bulletin 39 and the 4-page Data and Price Guide supplement, available on request from Ward Leonard of Canada Limited, 1070 Birchmount Road, Toronto 16, Canada.

Smallest Servo Motor

Item 1993

Small enough to pass through an engagement ring, this tiny low inertia servo motor has just been developed by the Eclipse-Pioneer Division of Bendix Aviation Corporation. Measuring only $\frac{1}{2}$ inch in diameter by $1\frac{1}{4}$ inches long, it is believed to be the smallest 400-cycle motor available for use in servo systems where instant response to input signals is mandatory.

The subminiature motor consists of a squirrel-cage rotor mounted on precision ball bearings, a two-phase stator and a stainless steel housing. While the motor illustrated incorporates a tapered shaft, similar units can be supplied with shafts designed for specific applications.

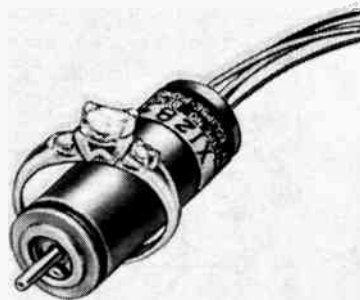

Characteristics of the motor include: size — number 5 frame; weight—0.94 oz.; fixed phase and control phase voltage—26 volts; frequency—400 cycles; fixed phase and control phase current—92 ma; fixed phase and control phase impedance— $283 = 192 + j210$ ohms at stall; power input—3.3 watts; stall torque—0.11 oz. in.; no load speed—9500 rpm; rotor moment of inertia—0.22 gm-cm²; torque-to-inertia ratio — 35,000 rad/sec²; operating temperature range — -55°C . to $+70^{\circ}\text{C}$.

Complete information is available from the Canadian affiliate of the Bendix Aviation Corporation: Aviation Electric Limited, 200 Laurentien Blvd., Montreal, Que.

Miniature Predesigned Mechanisms

Item 1994

Precision Mechanisms Corporation announces a novel line of miniature predesigned mechanisms and mechanical components for the servo and instrument industries.

The new apparatus eliminates the need to design, detail, and fabricate mechanisms for many applications. A typical unit, which may be assembled in minutes from stocked parts, consists of 6 rotating shaft components, is $2\frac{1}{8}$ inches in diameter, and is available in an almost unlimited choice of gearing and component configuration.

Standard stocked components include truly miniature clamp-on gears, antibacklash gears, pin couplings, and slip clutches. These, in conjunction with a predesigned ball bearing gear plate assembly and .125 inch diameter shafts of various standard lengths, provide a versatile precision gear box with as many as six shaft extensions on either side. A complete mechanism is formed by assembling standard pre-bored component mounting plates to the gear box. All sizes of servo components are accommodated by means of pilot adapter rings.

With this new apparatus the optimum in a new design can be readily attained by changing gear ratios, introducing antibacklash gearing, varying the components, and so forth. Once optimized, the unit may be shipped as deliverable equipment to fulfill contract commitments. It will meet the requirements of MIL-E-5400.

Enclosures for the predesigned mechanisms are available in hermetically sealed and dust tight designs with plug-in or AN connectors.

Precision Mechanisms Corp., 577 Newbridge Avenue, East Meadow, N.Y., U.S.A.

Newsletter

Canadian Radio Technical Planning Board

WHO'S WHO IN THE PLANNING BOARD

No. 5 — The Canadian Education Association

The Canadian Education Association is an inter-provincial association of education authorities supported by the departments of education of the ten provinces of Canada. Among its directors are the deputy ministers of education of all provinces, a number of superintendents of schools representative of large urban school systems, and representatives of teacher-training institutions. The ministers of education are honorary presidents of the Association. The CEA office, with a staff of eleven, is supported by grants in proportion to population from departments of education and by grants from more than forty urban school systems across Canada.

Affiliated with the CEA are other national educational associations — the Canadian Association for Adult Education, the Canadian Home and School and Parent-Teacher Federation, the Canadian School Trustees' Association, and the Canadian Citizenship Council. By formal agreement, the Canadian Teachers' Federation acts in co-operation with the CEA on matters of common interest. All these national associations have representation on the directorate of the CEA.

Mobile Radio Use To Double In Ten Years

An announcement made at the 10th annual meeting of the U.S. National Mobile Radio System in Detroit recently states that the use of mobile radio will double in the next ten years — that the number of U.S. licenses will exceed 600 and that \$14 million will be spent on mobile equipment.

The type of equipment in which expansion is anticipated includes message recorders, personal paging devices, direct dial systems, and small transistorized automatic units. It was noted that an increasing number of municipal, medical, and industrial customers was evident in the field of mobile radio.

U.S. Fleet Using More SSB Equipment

Rear Admiral H. C. Bruton, Director of Naval Communication of the U.S. Navy, said recently that the introduction of single sideband (SSB) radio equipment into the Fleet was being accelerated. He also stated that the use of meteor scatter for solving some of the problems connected with ship-to-shore communications was anticipated.

Single sideband systems are rapidly growing in importance and in application. As one example of what is taking place in the United States, it has been announced that \$3,500,000 has been allocated to the Air Materiel Command for the conversion of the radio equipment of 900 SAC aircraft to the new system.

Tests conducted during the past year have revealed the superiority of the SSB system. Among the advantages are reduction of adjacent channel interference, less atmospheric disturbance, and less tendency to weak signals and fading. Also, spectrum space is conserved, of paramount importance in view of the tremendous increase in the demands for spectrum

Results Of Ballot On Canadian Railroads Radio Frequency Plan

Results of the ballot conducted among CRTPB contributing sponsors on the Canadian Railroads Radio Frequency Assignment Plan for 30 KC Narrow Band Assignments have been received and communicated to the Department of Transport.

The plan, prepared by the CRTPB Railroad, Highway and Transit Utilities Committee and co-ordinated with the Radio Committee of the American Association of Railroads, was

circulated to all contributing sponsors early in April. Results of the ballot showed that, of twelve replies received, eight approved the plan (including one with comment) and four did not approve.

Detailed results of the ballot have now been sent to the Department of Transport after the replies had been considered at a meeting of the CRTPB Executive Committee on May 13. The Executive Committee passed a resolution authorizing the Secretary-Treasurer to advise the DOT that, from a technical standpoint, the CRTPB approved the plan submitted by the Railroad, Highway and Transit Utilities Committee. The opinion was expressed to the DOT that the comments received as a result of the ballot were largely policy matters which came under the jurisdiction of the DOT.

Recent CRTPB Meetings

The Executive Committee met on May 13. The Fixed Land and Maritime Mobile Committee met on May 23.

Radio Frequency Spectrum Management

A few copies are still available of the paper entitled "A Canadian Point of View on Radio Frequency Spectrum Management" by C. M. Brant, Chief of Technical Co-ordination, Department of Transport.

Applications for copies, which are free, should be addressed to the Canadian Radio Technical Planning Board, 200 St. Clair Avenue West, Toronto 7, Ontario.

New Contributing-Sponsor

As a result of the recent ballot, a new contributing-sponsor member of the CRTPB has been admitted into membership. The new member—Royal Canadian Mounted Police—Ottawa. Main representative is Major J. C. Gornall, Officer in Charge, Communications Branch RCMP; alternate representative Sergeant W. J. Huget, Assistant Officer in Charge, Communications Branch RCMP.

U.S. Business Radio Service Band For Mobile Equipment

It is apparent that the FCC will soon approve the proposed Business Radio Service in the United States. The forthcoming approval is attributed in part to the FCC's recent decision to convert the 25 to 50 mc and 152 to 163 mc portions of the spectrum to narrow-band. It is expected that the Business Radio Service band will be used by department stores, appliance dealers, local-delivery companies, building contractors, service organizations and large sales forces.

U.S. Aircraft Company Protests FCC Action

The Douglas Aircraft Company has protested, with other aeronautical interests, the FCC's recent action in taking the 8,800 mc band away from civilian use and giving it to the military services. The FCC proposes to move doppler radar operations to the 13,250 mc band, from the 8,800 mc band. Douglas Aircraft maintains that this will seriously delay implementation and use of this system.

Next Issue In September

The "CRTPB Newsletter" will not be published in July and August; the next issue will be in September. Readers of the Newsletter are advised that some of the best fishing spots for July and August are located in the 415-490 kc. band.

Canadian Radio Technical Planning Board
200 St. Clair Avenue West, Toronto 7, Ontario

F. H. R. POUNSETT, President; C. J. BRIDGLAND, Vice-President; R. A. HACKBUSCH, General Co-ordinator;
R. C. POULTER, Director of Public Relations; F. W. RADCLIFFE, Secretary-Treasurer

News Report

A monthly roundup of news and personnel changes in the Canadian electronics industry

CGE President Wins Signal Honor

An honorary doctorate in science was conferred recently on J. Herbert Smith, president of Canadian General Electric Company, by the University of New Brunswick at Fredericton, N.B.

Mr. Smith is a graduate in electrical engineering of the University of New Brunswick (B.Sc. '32, M.Sc. '42) and has maintained an active interest in University affairs during his business career.

Allan B. Du Mont Labs Appoints Canadian Reps

One of the most comprehensive and flexible ranges of industrial television equipment is now available to Canadian users with the appointment by Allen B. Du Mont Laboratories, Inc., of Clifton, New Jersey, of engineering representation in this country. The Du Mont line includes two basic cameras together with accessories such as tripods, weatherproof housings, remote control of all adjustments, monitors, switching equipment, lenses and cable suitable for every educational and industrial application.

Canadian distributor is Electronic Service Supply Company. Western Canada is covered by the company from their Head Office at Calgary, Alberta. Representatives for Eastern Canada are Tele-Radio Systems Ltd., 3534 Dundas St. West, Toronto 9, Ont.

Conway Electronic Enterprises Rep For Diamond Antenna

Julian C. Conway of Conway Electronic Enterprises Reg'd., 1514 Eglinton Ave. W., Toronto 10, announces the appointment of his firm as exclusive Canadian distributor and technical representative for the Diamond Antenna & Microwave Corporation of Wakefield, Massachusetts.

Diamond Antenna & Microwave Corporation manufacture a wide range of microwave instrumentation and are suppliers of wave guide components, attenuators, terminations, frequency meters, and antenna components.

"Robot" Representation In Canada

Canadian Applied Research Limited announced recently the completion of an agreement with Robot Berning & Co., of Dusseldorf, West Germany, whereby the Canadian company will handle the camera products of this firm for the industrial and scientific field in Canada.

Canadian Applied Research Limited, a member company of A. V. Roe Canada Limited, designs and manufactures instrumentation equipment for the fields of aviation, photogrammetry, photography, and general industry. Their MK7 Instrumentation camera and Automatic Tri-Film Processor are outstanding products in the

industrial photographic equipment field.

The word "Automation" is being used more frequently in Canada, and the "ROBOT" automatic cameras will complement this expanding industrial and research program.

Carleton University Launches Research Program

The department of physics of Carleton University, Ottawa, is helping to meet the challenge of the nuclear-space age with a research project concerned with the performance of electrical insulation materials at high temperatures.

The project, announced by President C. T. Bissell, will begin in the fall of 1958 when the university is re-located on Carleton's 130-acre Rideau River campus in new and modern buildings. It will be under the direction of Dr. John Hart who has been awarded a National Research Council grant of \$10,000 to launch the program.

The properties of electrical insulation will be investigated at temperatures as high as 1800 degrees Centigrade. This field is virtually unexplored, as very little research on the subject has been conducted at temperatures higher than 500 degrees Centigrade, according to Dr. Hart.

An estimated \$100,000 will be required during the next five years to finance the program. Research grants will be sought from industry, foundations and institutions established to encourage scientific research.

President Bissell has pointed out two significant aspects to the project: while the results from research such as Carleton University intends to conduct would have direct application to industrial processes, the opportunity for training students and future research workers will be of equal importance to the university and to industry.

CDC SALES APPOINTMENTS



R. C. PRITCHARD

R. WAINWRIGHT

N. C. WILSON

Appointment of Norman C. Wilson as Sales Manager of Computing Devices of Canada Limited was recently announced by CDC Marketing Director, W. S. Kendall. Mr. Wilson was formerly Sales Manager of the Technical Products Division of Dominion Electrohome Industries Ltd. He will have responsibility for the sale of a wide range of CDC and agency products.

Added to the CDC sales staff at the same time were Roger K. Wainwright and R. C. Pritchard. Mr. Wainwright is a sales engineer and will work on sales and applications in Eastern Canada, with headquarters in Ottawa. Before joining CDC, he was a technical officer at the Dominion Bureau of Statistics. Mr. Pritchard is to be responsible for the sales of CDC developed navigation systems, including the Position and Homing Indicator and Antac.

Haydon Switch Appoints Philips Electronics

Haydon Switch Inc., Waterbury, Connecticut, announced recently that their products will be marketed exclusively in Canada by Philips Electronics Industries Ltd., 116 Vanderhoof Avenue, Toronto 17, Ontario.

Haydon Switch Inc. are manufacturers of sub-miniature and standard single blade switches, available in hermetically sealed or molded plastic cases. The hermetically sealed switches are tested to environmental specifications and are suitable for use on high performance aircraft or missiles.

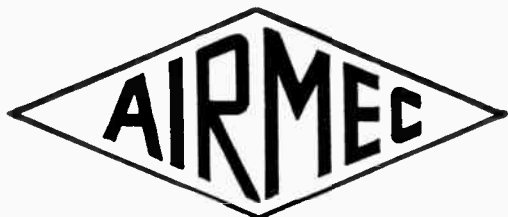

Electronic Instruments

Frequency Standard

- Master Oscillator frequency: 100 Kc/s, Crystal controlled.
- Outputs: 100 c/s, 1, 10, 100 and 1000 Kc/s. (These outputs available simultaneously in sinusoidal and pulse waveform.)
- High Stability.
- Beat detector with loud speaker built-in.



H.F. Signal Generator

- 7 Ranges from 30 Kc/s to 30 Mc/s.
- Dial Frequency Calibration accuracy: $\pm 1\%$.
- Internal or External AM may be employed on all ranges except on 30-100 Kc/s. Accuracy of percentage modulation ± 5 below 50% and ± 10 above 50%.
- Automatic Gain Control.
- Output 5 volt into not less than 300Ω .

Other Airmec products include:

Time & Frequency
Meters
Ionisation Testers
Oscillators
Temperature & Level
Controls

Electronic Batch
Counters
Electronic Tachometers
Photocell Controls
Radio & TV Servicing
Equipment

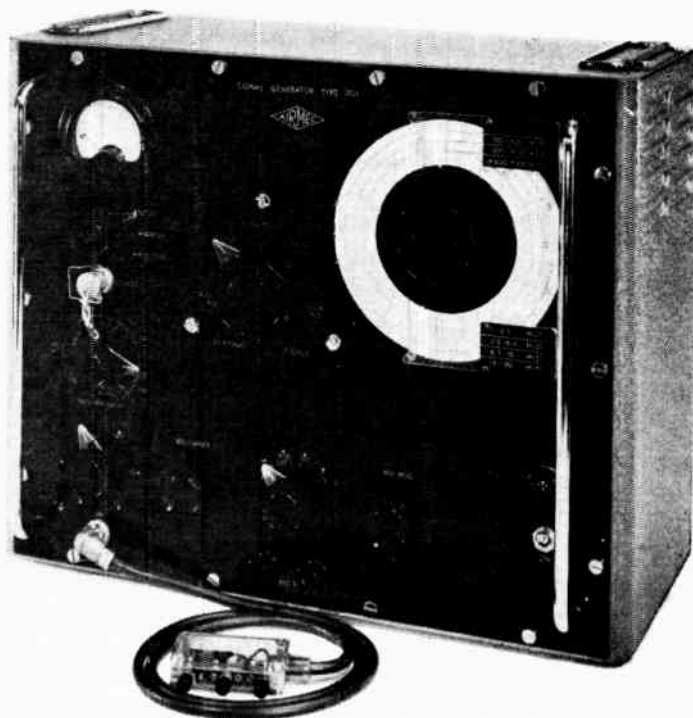

*Descriptive folders, catalog and
specification sheets on request from*



RADIO COMMUNICATIONS EQUIPMENT & ENGINEERING Ltd.

475 METROPOLITAN BLVD. • MONTREAL 32

For further data on advertised products use page 61.

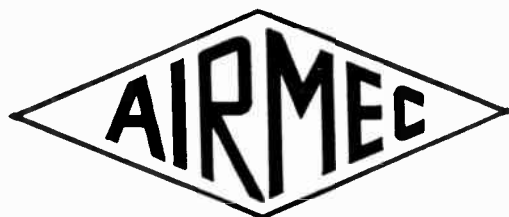

4-CHANNEL OSCILLOSCOPE

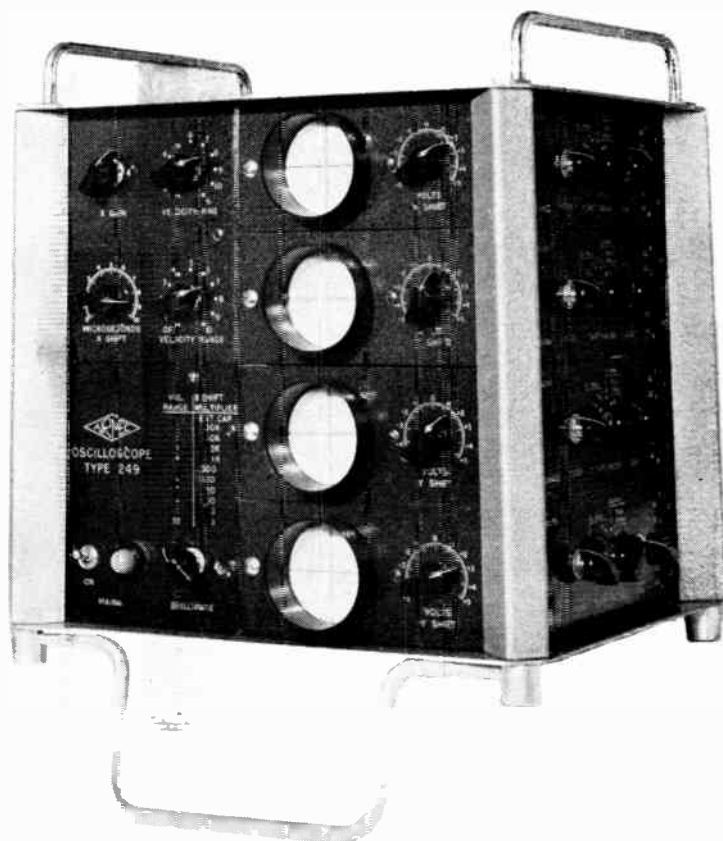

Dimensions:
15" x 13" x 12"

- Compare and measure four related waveforms simultaneously
- Extremely suitable for work on computers, multiphase control systems, pulse generators, time base generators, etc.
- Complete independence of controls
- 4 identical Y amplifiers
- 2" screens
- Unexpanded time base speeds from .3 micro seconds per cm. to 100 ms/cm.
- X shift calibrated in microseconds
- Input signal from 10mV to 500 V

Airmec Electronic Equipment Includes:

Time and Frequency Meters
Frequency Standards
Ionisation Testers
Oscillators
Signal Generators

Electronic Batch Counters
Electronic Tachometers
PhotoCell Controls
Temperature & Level Control Equipment
Radio and TV Servicing Equipment

Descriptive folders, catalog and specification sheets from

RADIO COMMUNICATIONS EQUIPMENT & ENGINEERING Ltd.

475 METROPOLITAN BLVD. • MONTREAL 32



News Report

Dr. George Sinclair Wins Guggenheim Fellowship

Dr. George Sinclair, professor of electrical engineering at the University of Toronto and Chairman of the Executive Committee handling arrangements for the 1958 Institute of Radio Engineers Canadian Convention, has been awarded a Guggenheim



Dr. Geo. Sinclair

Fellowship to continue his research on slot antennas. He is one of six Canadians named by the Simon Guggenheim Memorial Foundation of New York to receive 1958 Fellowships totalling more than \$21,000.

Dr. Sinclair will use the research facilities of the University of Illinois' Antennas Laboratory for his studies. He leaves for Urbana, Illinois, July 1, but will commute to Toronto every month for the regular meetings of the I.R.E.'s Executive Committee.

For his previous contributions to antennas theory, Dr. Sinclair was awarded the grade of Fellow by the I.R.E. in 1954.

Teleprompter Of Canada In Medical Telecast

At a medical telecast performed in Montreal, Teleprompter of Canada Ltd., a division of S. W. Caldwell Ltd. took part in the first transmission of X-Rays via microwave in Canada.

At the Jean Talon Hospital in Montreal, Teleprompter personnel, headed by Operations Manager, Bruce Emonson, set up two Dage Vidicon cameras: one showing the X-Ray table equipped with the Philips image intensifier and camera, the other showing the monitors and control panel. The output from these cameras was combined by a switcher arrangement with the output from the intensifier camera and fed to a microwave transmitter provided by the Bell Telephone Company of Canada, mounted on the hospital roof.

This transmitted signal was received at the Hotel Dieu Hospital auditorium some 12 miles away and displayed on a 9 x 12 foot screen by one of Teleprompter's television receiver-projectors to members of the Montreal Medical Society.

With the two-way radio audio arrangement, the program was conducted so that the viewing audience was able to see the patient on the X-Ray table, the operational setting up and the actual resulting X-Ray

pictures. Dr. Albert Jutras, Professor of Radiology at the University of Montreal, who developed the system of X-Ray television, was able to issue directions to the X-Ray operators at Jean Talon Hospital from the Hotel Dieu Hospital, and discuss with the Society members the condition of the patient as indicated by the X-Ray pictures.

CGE Appoints Johnson Electric Supply As Manufacturer's Rep

Johnson Electric Supply Limited of North Bay, Ontario has been made an authorized Canadian General Electric manufacturer's representative for Progress Line 2-Way Mobile Radio and G-E Industrial Television Equipment.

P. T. Wilson, sales manager of Canadian General Electric's Communications Equipment unit, Royce Works, Toronto, announced the appointment.

E. G. Johnson and A. G. Johnson of Johnson Electric Supply Limited will utilize their existing sales headquarters at 135 McIntyre Street East in North Bay in handling the General Electric Progress Line Mobile Radio and Industrial Television equipment. Their associates Bill Amendola in Timmins and George Cozac in Sault Ste. Marie, will conduct their sales activity from these district offices of Johnson Electric. These men have had extensive electronic experience and will maintain facilities where all types of mobile radio equipment may be serviced. Their sales area covers Northern Ontario and parts of North Western Quebec. An office in Sudbury will also handle enquiries for the G-E Mobile Radio and Industrial Television equipment.

Potter & Brumfield Plan Canadian Plant

Potter & Brumfield, Inc., of Princeton, Indiana, the relay manufacturing subsidiary of American Machine & Foundry Co., recently announced plans for a manufacturing facility in Canada. The new operation will be located in Guelph, Ontario (at 135 Oxford Street), and will start manufacturing around August 11, 1958.

The company will be known as Potter & Brumfield Canada Ltd., and will be a wholly owned subsidiary of the Princeton firm. Personnel appointments will be announced at a later date, according to R. M. Brumfield, president of the parent company.

Canadian sales are handled by Charles L. Thompson, Ltd., North Vancouver, B.C., and Winnipeg 2, Manitoba; A. T. R. Armstrong Ltd., Toronto 9, Ontario; and Aeromotive Engineering Products, Montreal, Que.

3M Toronto Sales Office Re-Locates

The re-location of their Toronto branch sales office has been announced by J. A. Gauthier, Manager, Sales Administration for Minnesota Mining and Manufacturing of Canada Ltd.

The new address of the "3M" Toronto branch sales office is Keele and Lawrence Plaza, P.O. Box 1201, Postal Station "T", Toronto 19, Ontario. The telephone numbers are CHerry 4-5607 and ROger 6-6166 for suburban customers.

The sales office for Thermo-Fax Copying Products will remain at its present location, 227 Eglinton Avenue West, Toronto.

AWARD FOR ATLAS RADIO SALESMEN



A top ranking sales award goes to Fred Harris (center) and Joe Bass (right) of Atlas Radio Corporation, 50 Wingold Avenue, Toronto. The plaque being presented by Nat Welch, Vice-President for Sales, ORRadio Industries, Inc. is the company's International Sales Award for Irish Tape Sales for the 1957-58 fiscal year. Atlas represents ORRadio in Canada. The award was presented at ORRadio's international sales meeting held recently in Chicago.

The Mullard EN33 Thyatron is an improved plug-in replacement for the 2050 thyatron. One of a line of Rogers Special Quality* tubes, the EN33 has greater electrical ratings than the 2050 and consequently, when operated under similar conditions, offers a longer-life performance. It is smaller in size and has a higher permissible average and peak cathode current. The EN33 has many applications in industrial control circuits, motor and lighting controls, and AC and DC switching.

**Rogers Special Quality tubes are finding more and more applications in all types of professional equipment. The greater reliability and lower maintenance cost of the apparatus in which they are used more than compensates for the higher initial cost.*

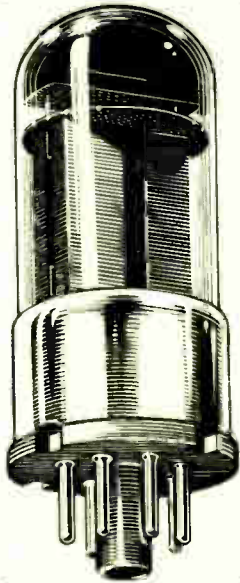

ROGERS

electronic tubes & components

A DIVISION OF PHILIPS ELECTRONICS INDUSTRIES LTD.
116 VANDERHOOF AVENUE, TORONTO, ONTARIO / BRANCHES: MONTREAL, WINNIPEG, VANCOUVER

★ Rogers Electronic Tubes are sold through Canada's Independent Electronic Parts Distributors

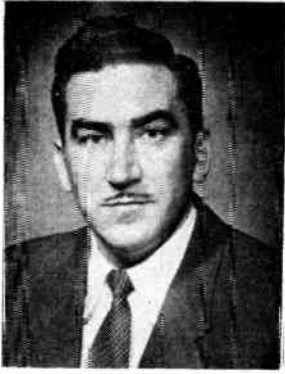

J. E. RAFTIS



G. F. C. WEEDON



T. W. PURDY

NEW DEPARTMENT

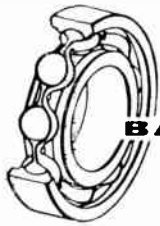

BALL BEARINGS

for

High capacity high speed applications

or miniature instrumentation

From high capacity, ultra precise N. D. bearings of special steels, finish and tolerances, to tiny instrument bearings of exquisite accuracy, your Canadian source of supply is R&M Bearings Canada Ltd. Experienced salesmen and engineers are available to discuss standard or specialized applications. Call your nearest R&M office for prompt service.

R&M BEARINGS CANADA LTD.

VANCOUVER WINNIPEG LONDON HAMILTON
TORONTO MONTREAL THREE RIVERS QUEBEC CITY

For catalogues write **R&M** at
1006 Mountain Street, Montreal, P.Q.
Catalogue ABC for high capacity bearings.
Catalogue PIB for miniature bearings.

R&M 6-

Canadian Motorola Electronics' Appointments

Mr. R. M. Brophy, President of Canadian Motorola Electronics Limited has announced the formation of a new department in the Company to handle microwave radio, carrier, and control products. Canadian Motorola has a long term sales and manufacturing agreement with Motorola Inc., Chicago, and is exclusive Canadian representative for radio carrier products available from Philips Telecommunication Division, the Netherlands.

Mr. John E. Raftis has been appointed Manager of the newly created Microwave and Industrial Products operation. Garth F. C. Weedon has been named Sales Engineer, and Thomas W. Purdy, Systems Engineer. These persons bring together a unique combination of skills resulting from many years' experience in complex communications systems work, comprising the telephone, telegraph, and power utility fields. They are supported by a staff of able project engineers together with bids and contracts administration.

Canadian Motorola Electronics is organized to undertake multi-channel radio projects including completely packaged microwave system installations.

Plant Expansion By Magnetics, Inc.

Magnetics, Inc., of Butler, Pa., producer of magnetic components and devices for industrial control systems, has completed a plant expansion and improvement program designed to meet expanding markets and anticipated increases in sales volume.

The new facilities, under construction since last year, were placed in operation June 1, 1958.

Expansion of the plant provides Magnetics, Inc. with greatly needed space for production of static devices by the company's reactor division, Control.

Convention Papers To Appear In Permanent Form

It has been announced by A. P. H. Barclay, Chairman of the Technical Program Committee of the IRE Canadian Convention, that it is planned to publish all Convention papers presented at the IRE Canadian Convention in Toronto, October 8-10, in a Convention Record.

Mr. Barclay points out that the success of this venture will depend largely on the speed and completeness with which the Convention Record is published. To this end it will be necessary that copies of all papers selected for presentation be made available by the author in suitable form for publication.

The Convention Record will be printed by photo-offset which should result in maximum economy and speed of publication.

For further data on advertised products use page 61.

The Green Cards on Page 61 are for You

Use the circulation card
whenever you need it because,
when properly completed
and returned by you,
it helps us keep
our mailing list clean
so that
your copies of

ELECTRONICS & COMMUNICATIONS

keep coming without fail

DO YOU WANT 100% POSITIVE CONTACT 100% of the TIME?



Amphenol Blue Ribbon Connectors offer you complete reliability at all times!

FEATURES:

- Perfect dimensional stability
- High insulation resistance
- High arc resistance
- High individual contact pressure
- Positive contact under extreme vibration
- Superior electrical characteristics
- High tensile strength
- Low insertion and withdrawal force
- Float mounted female inserts
- Positive polarization in a compact manner
- Available from Stock from your Local Distributor

For further information write to Dept. 14.



CANADA LIMITED
300 CAMPBELL AVE.
TORONTO ONTARIO

BIG NEWS ABOUT A LITTLE PRODUCT

(ACTUAL SIZE)

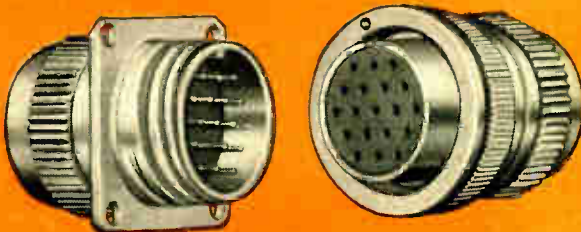

Bendix "PYGMY" Electrical Connectors

- | | |
|--|--|
| Gold Plated Contacts | Can be pressurized to current MIL-C-5015 specification |
| Closed Entry Sockets | High Strength Aluminum Shells |
| Resilient Scintflex Insert | Variety of Styles Available—General Duty, Environmental Resisting, Potting Types, Jam Nut Receptacles, Hermetically Sealed Receptacles |
| Alumilite or Cadmium Plate Finish | Wide Choice of Insert Patterns (1 to 55 contacts) |
| Two Quick Disconnect Couplings—Double Stub Quick Action Thread or Three-Point Bayonet Lock | Designed especially for miniaturized Electronic Equipment |
| Light Weight | |
| Small Envelope Size | |
| Maximum Serviceability | |

New "PYGMY" Connectors for Miniaturized Electronic Equipment Installations

Although the newly developed "Pygmy" line of miniature electrical connectors is approximately one third smaller in size and weight than the standard Bendix* AN connector, they provide the same outstanding qualities of serviceability, ruggedness, reliability and resistance to vibration, moisture and corrosion for which all Bendix connectors have become world famous.

If you have an application for miniaturized electronic equipment requiring lighter and smaller connectors than standard AN types, you'll find Bendix "Pygmy" connectors the best possible solution. Write for complete detailed information to:

The Canadian Affiliate of
THE BENDIX AVIATION CORPORATION
*REG. U.S. PAT. OFF.

AVIATION ELECTRIC
LIMITED

200 Laurentien Blvd., Montreal, P.Q.

Branch Plant:
Aviation Electric Pacific Limited, Vancouver Airport, Vancouver, B.C.

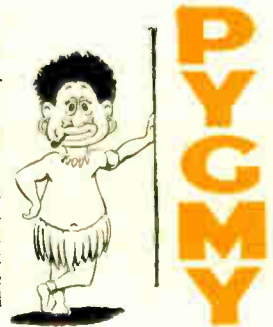

MEASUREMENTS' New VACUUM TUBE VOLTMETER



MODEL 162

This versatile instrument has been specially designed for voltage and resistance measurements in laboratories, on production lines and in service shops.

- Push-buttons provide **RANDOM ACCESS** to all functions and ranges—reducing operator error and fatigue
- Balanced degenerative amplifier provides stable zero and good overload protection
- Single zero control for all ranges
- Compartment for lead and probe storage

Laboratory Standards  **WRITE FOR BULLETIN**

MEASUREMENTS
A McGraw-Edison Division
BOONTON, NEW JERSEY

Canadian Representative:
H. Roy Gray Ltd., 46 Danforth Rd., Toronto

STOCK DELIVERY

- | | |
|---------------------------|--------------------|
| SYNCHROS | PRECISION |
| RELAYS | POTENTIOMETERS |
| TUBES | SERVO MOTORS |
| DIODES | SYNCHRONOUS MOTORS |
| METERS | PULSE TRANSFORMERS |
| | TRANSISTORS |
| LABORATORY TEST EQUIPMENT | |
| MICROWAVE EQUIPMENT | |

Listed Below Are Typical Values
From Our 16 Page Bargain Catalog
(Available Upon Request)

- WINSLOW model 5G-1000 MEGOHMMETER
— Insulation Resistance Test Set — hand cranked generator — Range 0-1000 megohms at 500 VDC \$129.50
- GENERAL RADIO Type 715AE DIRECT CURRENT AMPLIFIER in portable Esterline Angus case \$250.00
- SOLA \pm 30710 2KVA CONSTANT VOLTAGE TRANSFORMER — Pri — 95-125 190-250 V 50 or 60 cy. Sec—115 V \pm 1%, regulation 2000VA \$125.00
- BOSTON Cat. \pm UD-48 GEAR REDUCTORS — Ratio 48 to 1—0.25 HP at 1800 RPM \$ 32.50
- HELIPOT Mod. B PRECISION POTENTIOMETERS — 10K ohms, 15 turns, 10 watts, linearity 0.02% \$24.50
- VANDYKE PRECISION POTENTIOMETERS—50K ohms, 10 turns, linearity 0.5%, hermetically sealed \$ 8.50
- 115-Volt 60-cy Synchros
- | | |
|----------------------------------|---------|
| Type 1G Generators | \$37.50 |
| Type 1F Motors | 37.50 |
| Type 1CT Control Transformers | 37.50 |
| Type 1DG Differential Generators | 45.00 |
| Type 3HG Generators | 62.50 |
| Type 3F Motors | 62.50 |
| Type 3HCT Control Transformers | 62.50 |
| Type 3D Differential Motors | 62.50 |
| Type 3HDG Differential Generator | 62.50 |
- MANY OTHER STANDARD TYPES
IN STOCK

ELECTRONIC RESEARCH LABS
718 Arch Street Phila. 6, Pa.
Phone — MArket 7-6771

News Report

Electrolabs Appointed Canadian Rep

Chicago Industrial Instrument Company and their sales division, Barnett Instrument Company of Clarksville, Tennessee, have announced the appointment of Electrolabs, 7385 St. Lawrence Blvd., Montreal, as their exclusive Canadian representative.

"Chicago" make a line of high quality electrical and electronic test equipment including specialized instruments such as low-reading centi-ohm meters, moisture testers, photo-flash battery testers, appliance power-testing meters, etc.

C. S. Gregory Appointed Secretary COTC

The appointment of Cecil S. Gregory, Montreal, to the post of Secretary, Canadian Overseas Telecommunication Corporation is announced by D. F. Bowie, President of the Corporation. He was named Chief Accountant when the Crown Company was formed in 1950 and brings a wealth of telecommunication accounting knowledge to his new position.

Digital Computer For University Of Manitoba

The installation of a Bendix G15D general purpose digital computer at the University of Manitoba was recently made possible by a grant from Pioneer Electric Limited of Winnipeg.

The computer has been installed in the Engineering building on the Fort Garry campus of the University of Manitoba, where it will be used for training and research in the fields of mathematics, science and engineering.



Pioneer Electric Limited, a major Canadian manufacturer of transformers and switchgear, is using the computer to solve complex problems associated with the design of large power transformers and other company products.

Shown in the accompanying photograph are Pioneer Electric personnel with the computer.

WELWYN

*Hermetically Sealed
Deposited Carbon Resistors*

WELWYN
CANADA
S12 1%
WELWYN

High stability resistors sealed into glazed and vitrified ceramic shells for complete protection against ambient humidity changes. Silicone oil filled. Acts as efficient convective medium for improved heat dissipation. Also serves as infallible quality control for detecting seal leakage defects.

Each resistor is subjected to sustained pre-load test at 1½ times rated wattage. Insures against catastrophic failures under normal operating conditions.

Designed to meet military specifications.
MIL-R-10509 (current issue)

for complete data, write to:

WELWYN CANADA LTD.

1255 BRYDGES ST.

LONDON, ONT.

News Report

Paisley Products Represents Electro Tec

Paisley Products of Canada Ltd. has been appointed by Electro Tec Corporation, South Hackensack, N.J. as representative for its Canadian territory. The company maintains offices at Toronto 13, Ontario, address P.O. Box 159, Station "H".

Electro Tec Corporation manufactures a complete line of precision electro-deposited slip ring assemblies, contactor assemblies, miniature switches, high performance aircraft relays, commutators and other precision components for the instrumentation and electronic industries.

Caldwell Executive Appointment

Spence Caldwell, president of S. W. Caldwell Ltd., 447 Jarvis St., Toronto, announced recently the appointment of Sydney Banks as vice-president in charge of production.

Mr. Banks, well known in the Canadian film production industry and the advertising world joined Caldwell's in 1955 and was, prior to his new appointment, executive producer at the Queensway Film Studios.

In his new post, Mr. Banks will handle the supervision and administration of all film activities and complete printing and processing laboratory operations.

ASSISTANT MANAGER



F. M. HANNA

Fred M. Hanna has recently joined George Kelk Ltd. as Assistant Manager. He will assist in management and engineering aspects of the company's activities in industrial and airborne instrumentation. Mr. Hanna graduated in Engineering Physics, U of T in 1942. Before his new appointment he held engineering and executive positions with PSC Applied Research and the Photographic Survey Corp.



WE HAVE SYNCHROS AND SERVOMOTORS READY FOR IMMEDIATE DELIVERY

Call Muirheads for an answer to your synchro delivery problems. It's more than likely we have what you want in stock, or, if not, we can give a realistic answer.

The list of synchros in production is extensive and new types are being added all the time. Sizes include 08, 10, 11, 15, 18 and 23: types: Control Transmitters, Control Transformers, Control Differential Transmitters, Resolvers, Torque Receivers, Torque Transmitters, Torque Differential Transmitters and Receivers, Linear Variometers, Servomotors, Motor Tachometers and Tachometer Generators.

**It's your move next, let us quote for your needs
Data and prices on request**

MUIRHEAD

PRECISION ELECTRICAL INSTRUMENTS

MUIRHEAD INSTRUMENTS LIMITED

STRATFORD · ONTARIO · CANADA



3717 & 3718

318/3Ca

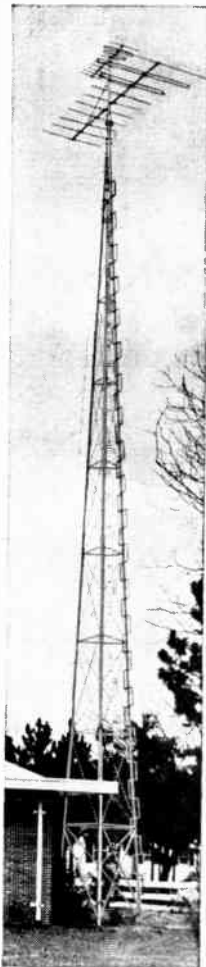

ANTENNA TOWERS

for TV — AMATEURS
— COMMUNICATIONS

Check these features — they're found in all Aermotor Steel Antenna Towers.

SELF-SUPPORTING — no cumbersome guy wires needed.

HEAVILY GALVANIZED AFTER FABRICATION — completely protected against rust.

EASILY ASSEMBLED

STRONG — towers safely sustain loads of 1500 lbs. — safe in winds to 85 MPH.

← **TYPE MI-98**

For TV Antenna up to 6 square feet of projected area. Heights to 100'.

TYPE MP-5 →

For Amateur Beams up to 20 square feet of projected area. Heights to 97'3".

TYPE MP-9 (Not illustrated)

Meets "RETMA" Standard TR-116 Specifications. Heights to 123'5".

TYPE MP-15 (Not illustrated)

In heights up to 149' for heavy duty radio and TV applications.

TYPE MP-29 (Not illustrated)

In heights of 40 - 80 and 100' for heavy duty Microwave Antenna applications.

Write today for complete information on Aermotor Steel Antenna Towers and an Aermotor Franchise in your territory.

AVIATION ELECTRIC
LIMITED

200 Laurentien Blvd., Montreal, P.Q.
Branch Plant: Aviation Electric Pacific Limited,
Vancouver Airport, Vancouver, B.C.

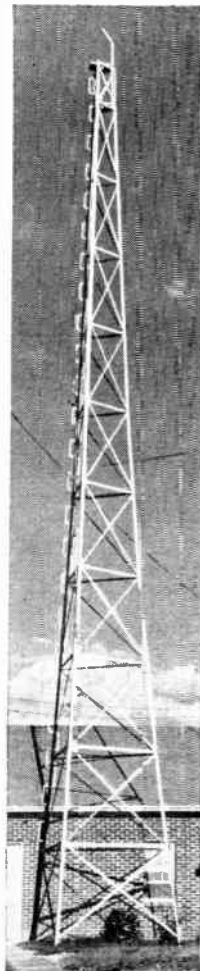

News Report

B.C. Professor Heads Professional Engineers

Professor W. O. Richmond, P. Eng., of Vancouver, has been elected President of the 30,000-member Canadian Council of Professional Engineers, during the Council's recent three-day annual meeting in Vancouver. He



Prof. W. Richmond

succeeds C. N. Murray, P. Eng., of Sydney, N.S.

Professor Richmond is head of the department of mechanical engineering at the University of British Columbia.

As president, he will head the national advisory body for Canada's 11 provincial and territorial professional engineering organizations.

Canadians Visit Electronic Parts Distributors' Show

The 1958 Electronic Parts Distributors' Show, held in the Conrad Hilton Hotel, Chicago, May 19-21, drew some 175 persons from every segment of the Canadian electronics industry, and from practically every province of the Dominion.

Canadian headquarters, under the direction of C. G. "Jerry" Pointon, chairman of Canadian Electronic Sales Representatives, was an active spot, as electronic jobbers, engineers, manufacturers and sales personnel met to renew past acquaintances and to make new ones who have entered the picture during the year.

The annual Canadian reception and luncheon on Tuesday, May 20, drew a capacity crowd to hear Carl Pollock, president of Dominion Electrohome Industries Limited, of Kitchener, Ontario, speak on the growth and development of the Canadian electronics industry during the past two or three decades, touching upon its ills and deficiencies, and suggesting progressive steps to meet today's need for good selling practices and the eliminating of price-cutting.

Ralph Hackbusch, general co-ordinator of the Radio Technical Planning Board of Canada and Director of Engineering and Past-President of RETMA, introduced the speaker. Leo Rosenberg, newly elected president of the Canadian Electronic Wholesalers' Association, proposed the vote of thanks.

Among the special guests at the luncheon were Joseph A. DeMambro, past-president of NEDA, and Charles W. Pointon, a pioneer in the Canadian telephone and radio industry, father of chairman "Jerry" Pointon.

RELIABLE, LIGHTWEIGHT, PORTABLE POWER

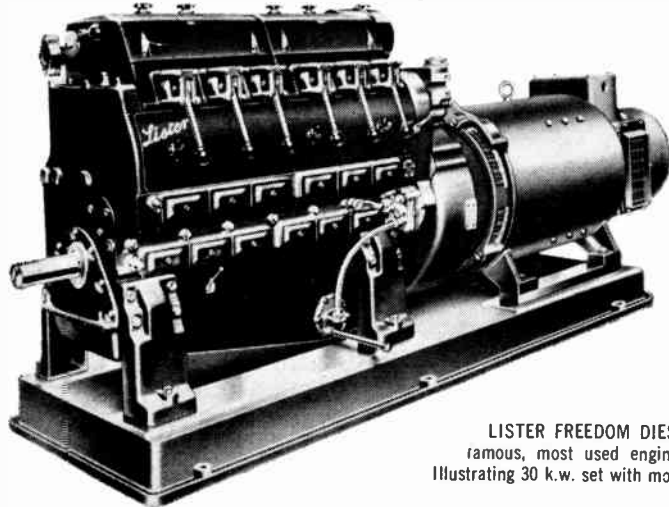

LISTER FREEDOM DIESELS—the most famous, most used engines in industry. Illustrating 30 k.w. set with model FR6 Engine.

Built in a tradition of reliability, Lister-Blackstone engines incorporate the very latest improvements in Diesel design. The full line includes engines from 3½ to 1300 h.p. and there are models for every purpose. Ease of maintenance and economical operation are assured when you specify Lister-Blackstone. Service and spare parts are available from coast to coast.

Write us for the name of your nearest Distributor.

CANADIAN LISTER-BLACKSTONE LIMITED

1921 EGLINTON AVE. E., TORONTO 13 • 3135 WEST BROADWAY, VANCOUVER
25 ST. JAMES ST., VILLE ST. PIERRE, MONTREAL

In the U.S. — Lister-Blackstone Inc., 42-32, 21st St., Long Island City 1, N.Y.

DISTRIBUTORS: B.C. Equipment Co. Ltd., 551 Howe Street, Vancouver; Bruce Robinson Electric (Edm.) Ltd., 10056-109th Street, Edmonton; Medland Machinery Limited, 576 Wall Street, Winnipeg; Russel-Hipwell Engines Ltd., Owen Sound; Consolidated Engines & Machinery Co. Ltd., 5645 Pare Street, Town of Mount Royal, P.Q.; Russel-Hipwell Engines Ltd., 1298 Barrington Street, Halifax; Clayton Construction Co., Ltd., P.O. Box 118, Muir Bldg., St. John's, Nfld.

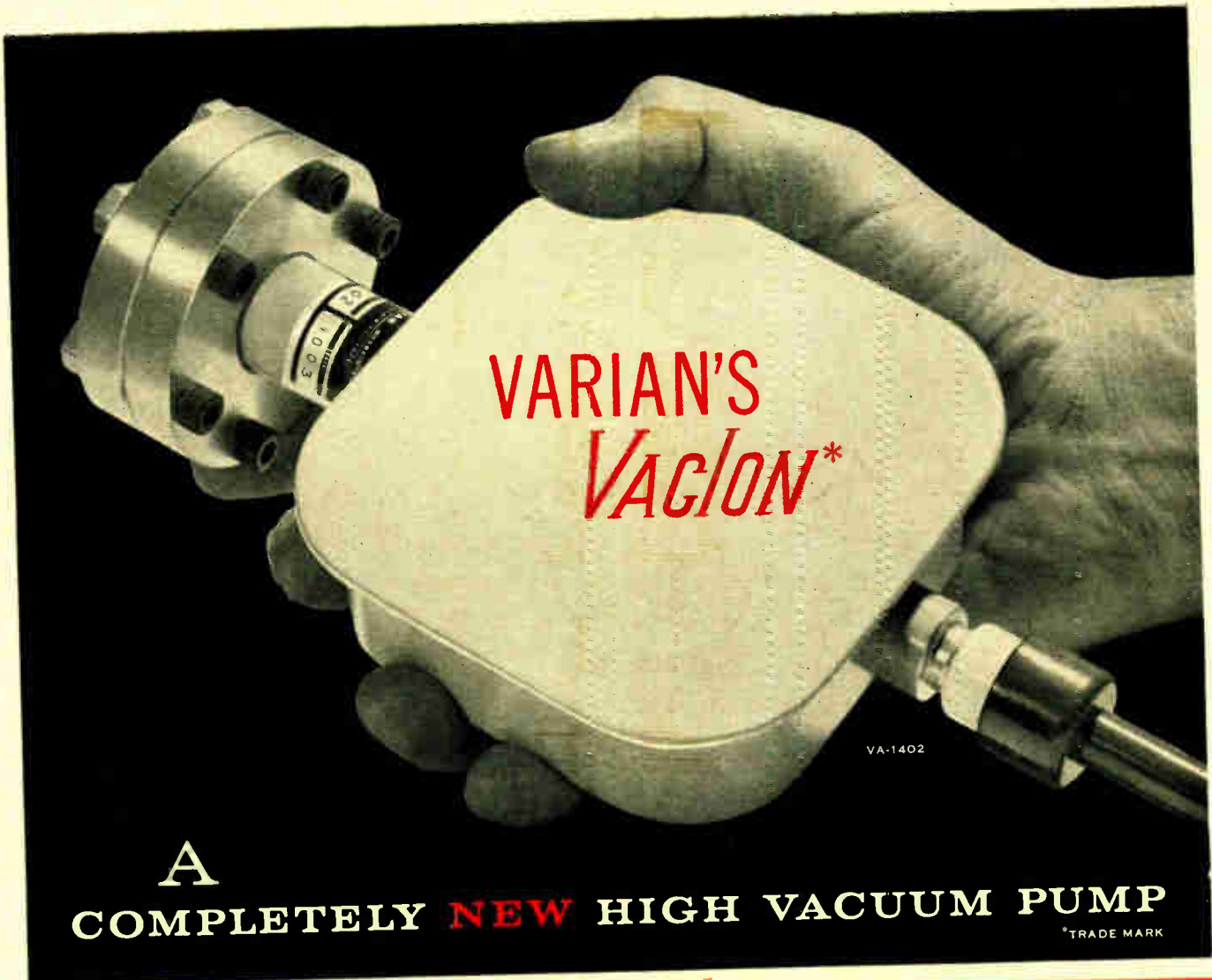

VARIAN'S
*VACLON**

VA-1402

A
COMPLETELY NEW HIGH VACUUM PUMP

*TRADE MARK



Used where clean high vacuums are required... processing vacuum tubes... evacuating accelerator sections and ionization chambers... laboratory and industrial applications.

SIMPLICITY ITSELF—

The Vaclon high vacuum pump operates entirely electronically — no moving parts.

NO OIL VAPORS—

Cold traps or vapor traps are not necessary.

ULTRA HIGH VACUUM—

Creates vacuum in excess of 1×10^{-6} mm of Hg; one trillionth of an atmosphere. This small compact unit has a pumping speed of 10 liters/second at 10^{-7} mm of Hg.

LOW POWER CONSUMPTION—

At 10^{-6} mm Hg power consumption is only 0.24 watts. No continuously running fore-pump is required.

MEASURES ITS OWN VACUUM—

The current indication on the power supply meter provides a practical measurement of pressure.

SIMPLE INSTALLATION—

Complete unit consists of the Vaclon Pump shown above, a permanent magnet, and a power supply.

ONLY FROM VARIAN—

The Vaclon high vacuum pump has no equal for simplicity, cleanliness, and compactness. Get the complete story in the Vaclon High Vacuum Pump Engineering Bulletin — write for your copy today.

THE
MARK OF
LEADERSHIP



VARIAN associates

OF CANADA, LTD. • GEORGETOWN, ONTARIO

KLYSTRONS, TRAVELLING WAVE TUBES, BACKWARD WAVE OSCILLATORS, LINEAR ACCELERATORS, MICROWAVE SYSTEM COMPONENTS, R. F. SPECTROMETERS, MAGNETS, MAGNETOMETERS, STALOS, POWER AMPLIFIERS, GRAPHIC RECORDERS, RESEARCH AND DEVELOPMENT SERVICES

CANADA'S COMPLETE QUALITY PACKAGE

DU MONT[®] 2-WAY RADIO



Now available at competitive prices, 30, 60 and 100 watt mobile equipment for full coverage and extended range. Dumont 30 mc/s and 150 mc/s equipment features "strip chassis" construction utilizing new electrical and mechanical designs to provide base station stability in a mobile unit. Vibrator, dynamotor, or transistorized power supplies now available for most models. All Dumont models fully certified for land-mobile service and comply with D.O.T. type approval requirements for split channel use.



Features

- Superior receiver sensitivity for crystal-clear reception
- Defies obsolescence
- Rugged mechanical design
- Base station stability in a mobile unit
- New "No Juggle" microphone
- Precision protection circuits
- Low power drain
- Long service life
- Simplified servicing
- Extremely low maintenance cost

ELECTRONIC SERVICE SUPPLY COMPANY

210 - 9th Avenue East Calgary, Alberta

Branches or Representatives in Most Canadian Cities

News Report

World Power Conference Meets In Canada

One of the largest international gatherings of its kind ever held will convene in Montreal, from September 7-11 inclusive, at the new Queen Elizabeth Hotel.

The occasion will be the technical session of the World Power Conference, meeting in Canada for the first time in its history and which it is expected will attract more than 1,000 scientists, engineers, economists and other experts from some fifty different countries.

In addition to participation in the technical session in Montreal, many of the delegates plan to accompany study tours which have been organized to visit important hydro, thermal and atomic energy plants.

Founded in Great Britain in 1924, the World Power Conference is an international non-governmental agency which forms a continuing link between the different branches of power and fuel technology, between experts of the nations of the world and between scientists and engineers on the one hand and economists and administrators on the other.

Under the "production" section of the Conference, delegates will examine trends in the production of hydraulic energy, of thermal energy, including coal, oil and nuclear, and of other forms of energy.

SNELGROVE APPOINTMENT



D. M. ZAND

C. R. Snelgrove, President of C. R. Snelgrove Co. Limited, announces the appointment of David M. Zand as Advertising and Sales Promotion Manager. The appointment is in keeping with the company's policy of increased activity in the development of new markets and accelerated communications with present customers. Mr. Zand brings to his new assignment a thorough advertising and marketing knowledge of the electronics industry.

For further data on advertised products use page 61.

While your product
is in the

Blueprint Stage

consult with **BUD**
about your

HOUSING REQUIREMENTS

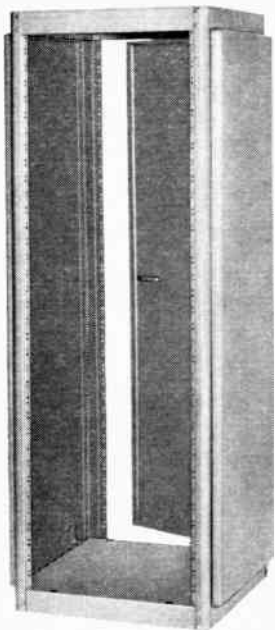

Prestige Relay Rack

● You will save time and money . . . add beauty and value to your instruments if you investigate the hundreds of sheet metal housings Bud has available from stock. And if your requirements are special, you can depend on our production to be economical and on schedule. We invite you to send your blueprints for estimate without obligation.

● Illustrated are two of the newest Bud housings embodying beauty, economy and versatility. They have exclusive features found in no other similar products regardless of price. See them at your local Bud Distributor or write to us for literature.

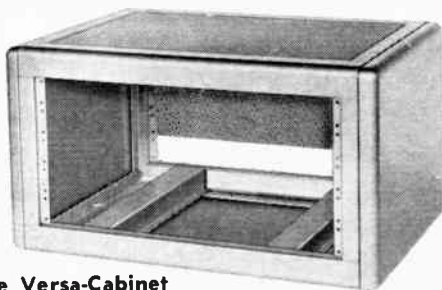

Prestige Versa-Cabinet

TENATRONICS, LTD.

Davis Drive, East

NEWMARKET, ONTARIO

Exclusive Canadian Representative for



BUD RADIO, INC.

Dept. EC, 2118 East 55th Street
Cleveland, Ohio

HAMMOND

presents a new line of
CONSOLES • TURRETS • EQUIPMENT TABLES

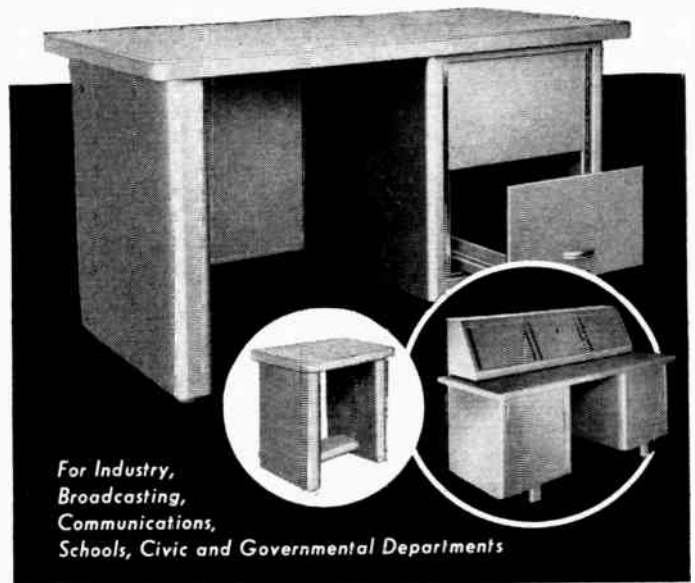

For Industry,
Broadcasting,
Communications,
Schools, Civic and Governmental Departments

SINGLE, DOUBLE AND TRIPLE CONSOLES: . . . of heavy gauge steel, beautifully finished in beige-brown or gray "Hammerlin". Tops are covered in colour keyed linoleum, and bright metal moulding conceals all mounting screws. Single and double models have one 10 1/2" x 19" panel and a sliding drawer of the same size. Triple Consoles have three panels and one drawer. All models have 21" removable, rear panels.

SINGLE, DOUBLE AND TRIPLE EQUIPMENT TABLES: . . . produced in the same materials and finish as the console models. The three standard sizes are suitable for carrying a variety of equipment.

TURRETS: . . . in matching finish and materials, for mounting on Consoles or Equipment Tables. Front panels set at 30° angle with screws covered by bright metal strip. Single-piece, removable, locking rear panels, well louvered, are designed for maximum accessibility. Rear knockouts are provided in each unit.

complete data bulletin 5060 sent on request

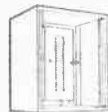

DESK TYPE CABINET RACK:
In 9 standard sizes with panel space from 8 3/4" to 54 1/4".



"HANDY" CASES
Better accessibility to components than conventional boxes.

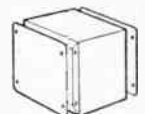

UTILITY CASES:
For portable equipment, and prototype development.



CABINET AND RACK PANELS:
Exclusive Hammond alloy, works, punches, drills cleanly; also in steel.



EQUIPMENT CABINETS:
Give "original" equipment a professional look.



STANDARD RELAY RACKS (floor type):
Mounting alignment is retained under extreme equipment loads.

Hammond also specializes in "original" equipment built to your own design. For further information contact —

HAMMOND MANUFACTURING COMPANY LIMITED

Guelph, Ontario, Canada

Since 1927 — Canada's Transformer Specialists

H,57/1



New Surface Wave Transmission Line

- * **Transportation Economy**
- * **Installation Economy**
- * **Maintenance Economy**

... with No Loss
in Performance Characteristics

The Prodelin G-Line assembly is a surface wave transmission line for use in commercial or military service up to 9000 mc. It replaces conventional waveguide or coaxial transmission lines and permits transportation, installation, and maintenance at lower costs than ever before possible.

The Prodelin G-Line is terminated at both ends by identical RF field transformer sections which provide an efficient transition from a conventional feed line to the surface wave wire and back again at the antenna input end.

- **Lowest wind loading of any line available**
- **No elbows, bends, or complicated plumbing to install**
- **No pressurization required**

Hundreds of Prodelin G-Line systems are already operating successfully. Learn how G-Line can lower your shipping, installation, and maintenance costs while delivering superior performance characteristics. Manufactured for antenna application under exclusive U.S. license.

WRITE TODAY!



Dept. EC-6, 307 Bergen Avenue, Kearny, N. J.



News Report

Teleprompter Announces New Appointments

R. C. "Bob" Wilson has been named manager of Teleprompter of Canada Ltd., a division of S. W. Caldwell Ltd., it was announced recently by the president, Spence Caldwell.

Mr. Wilson was formerly special assistant to Mr. Caldwell and prior to joining the firm was a sales representative for the Armstrong Cork Company in the United States.

Mr. Wilson's main objective in his new position will be to further the development of closed circuit television presentations in Canada and to introduce Teleprompter's new electronic equipment for public speaking and sales meetings.

A further appointment has been announced for Teleprompter of Canada Limited in the promotion of Bruce Emonson to technical and operations manager of the company.

As technical and operations manager, Mr. Emonson will supervise overall technical operations related to closed-circuit TV and Teleprompter services.

Stereo Records Now Produced In Canada

The first stereo record ever manufactured in Canada was pressed Thursday, May 15, at the Sparton plant in London, Ontario.

Mr. G. A. Holmes, President of Sparton of Canada Limited, personally operated the record press for this historic occasion.

Porter Of Canada Appoints General Sales Manager

The appointment of J. B. Clarke, M.E.I.C., as general sales manager of the Federal Wire and Cable Division of H. K. Porter Company (Canada) Limited, is announced by H. F. Nunn, vice-president and general manager of Porter, Canada.



J. B. Clarke

Mr. Clarke, an electrical engineering graduate of the University of Manitoba, joined Federal Wire and Cable in 1948 as sales representative in the Eastern Ontario and Montreal area, after two and one-half years as an engineer in the Rural Electrification Department of the Manitoba Power Commission.

In 1950, Mr. Clarke was assigned to the Lakehead, Manitoba, Saskatchewan and Alberta Territories as district sales manager. Mr. Clarke was appointed assistant general sales manager in October 1957.

For further data on advertised products use page 61.

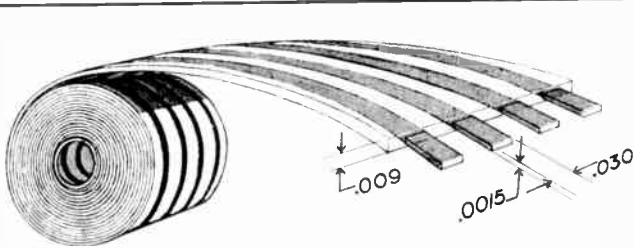

REDUCE COSTS WITH POLYSTRIP RIBBON CABLE

Polystrip cable is a thin multiple conductor, flexible cable consisting of a number of parallel flat copper wires sandwiched between two plastic sheets. Ideal for Computers-Airborne equipment, etc., where space and weight must be kept to a minimum. Amphenol, as well as other manufacturers supply connectors suitable for use with this cable.

FEATURES — Flexible • Light • Solderable • Reliable • Strong • High dielectric strength • Matches printed wiring — High insulation resistance Saves space — Resists chemicals & moisture — Withstands repeated flexing — No. of conductors available: 5 to 51. Maximum voltage between conductors 600 volts. Maximum continuous current per conductor, all carrying same current in free air at 25°C is 1 amp.

For engineering data and sample write to Dept. 13

INTERNATIONAL RESISTANCE CO. LTD.

349 CARLAW AVE.

TORONTO 8, ONT.

SALES OFFICES:

Radiovision Sales Ltd.
325 Tenth Ave. West
Calgary, Alta.

492 Somerset St. West
Ottawa
Ont.

1500 St. Catherine St. West
Montreal
Que.

MOLONEY

Specialists in transformers

NO CORE TOO SMALL

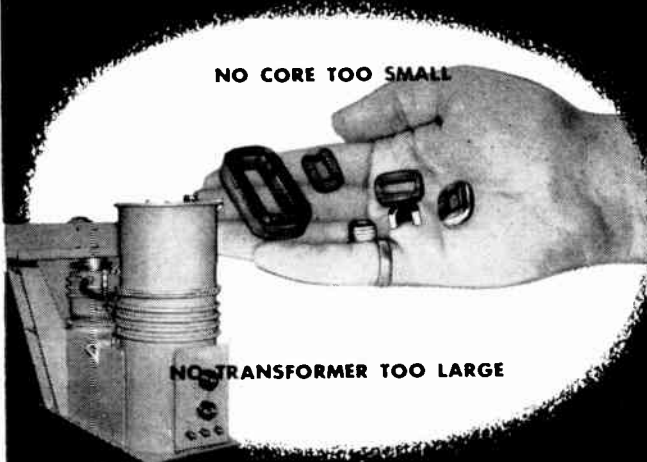

NO TRANSFORMER TOO LARGE

For larger and higher voltage electronic components, consult MOLONEY

MOLONEY

ELECTRIC COMPANY OF CANADA LIMITED

FACTORY & HEAD OFFICE: 213-219 STERLING RD., TORONTO

REGIONAL OFFICES: MONTREAL, CALGARY

Sales agents across Canada

5804

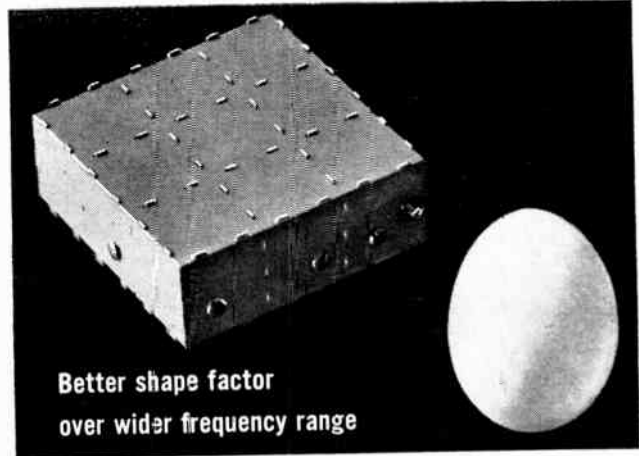

Better shape factor
over wider frequency range

DAVEN'S NEW "EGG CRATE" LC FILTERS

Center frequency: covers the range from 0.4 MC to 60.0 MC depending upon specific requirements. Center frequency stability: ± 1.0 KC per MC from -55°C to $+105^{\circ}\text{C}$. Shape factor: BW₆₀/BW₆ to 2.1. Shape factors can be modified for optimum time delay.

Daver's new LC filters are ideal for shaping the pass band of AM/FM or FM/FM data link receivers, double or single side band receivers and generators, direction finding receivers, communication and telemetering receivers, and spectrum analyzers.

Write today for complete, newly-published technical data.

THE **DAVEN** CO.



LIVINGSTON
NEW JERSEY

TODAY, MORE THAN EVER, THE DAVEN © STANDS FOR DEPENDABILITY
In Canada: ADAMS ENGINEERING LTD., Montreal and Toronto.

97% OF E & C READERS WRITE US WHEN THEY MOVE!

One sure way of finding out what readers think of a publication, is to see how much trouble they will take to make sure they continue receiving copies — regularly. Of every 100 readers of ELECTRONICS AND COMMUNICATIONS who change their addresses, 97 make a point of writing a special letter to say so!

Who are our readers? Almost everybody who is anybody in electronics or communications — anywhere in Canada. They're consulting engineers, development engineers, project superintendents, etc. They're divided roughly 3 to 1 between technical personnel and management. And because the two categories overlap and interweave, our editorial content is successfully aimed at both groups. Our Fifth Annual Directory and Buyers' Guide is now in preparation. It will go to over 10,000 prospective buyers of your products across Canada.

Be sure to be represented. Write for your product check list, advertising rates, etc.

Electronics and Communications

31-35 Willcocks Street — Toronto 5, Ontario

Teflon^{*}...

Your Best Source Is

JOHN CRANE

| Thickness Inches | Nominal Size |
|------------------|--------------|
| 1/16 | 12 x 12 |
| 3/32 | 18 x 18 |
| 1/8 | 24 x 24 |
| 3/16 | 36 x 36* |
| 1/4 | 48 x 48* |
| 3/8 | |
| 1/2 & Up | |

* Can be furnished in 1/2 sheets

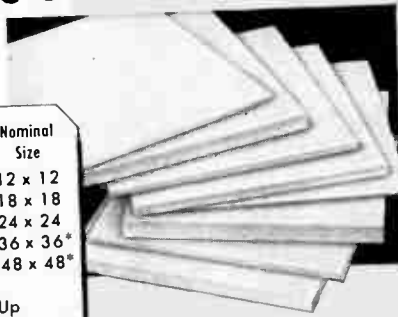

SHEET

HERE'S WHY: You can order in quantity and in a wide variety of sizes—and be certain of complete uniformity throughout. Our strict density control assures you thoroughly non-porous Teflon—free from any flaws which might possibly affect your end use or product. Dimensions are accurate to your most critical tolerances—no rejects, waste of material or loss of time. You get product purity—Teflon at its best in every one of its remarkable characteristics. Delivery is prompt—you get the quantity you want when you want it.

Since the availability of Teflon, "John Crane" engineers have worked with Industry to successfully solve innumerable problems and develop new applications. *You can benefit from their experience and know-how.*

| DIAMETER INCHES | |
|-----------------|--------|
| 1/4 | 1 |
| 3/16 | 1 1/16 |
| 3/8 | 1 1/8 |
| 7/16 | 1 1/4 |
| 1/2 | 1 3/8 |
| 5/8 | 1 1/2 |
| 3/4 | 1 3/4 |
| 7/8 | 2 |
| | 2 1/4 |
| | 2 1/2 |
| | 3 |

Other diameters on specification



ROD

| TYPICAL SIZES INCHES | |
|----------------------|-------|
| O. D. | I. D. |
| 3/8 | 1/4 |
| 1/2 | 3/8 |
| 3/4 | 1/2 |
| 1 | 3/4 |
| 1 1/2 | 1 |
| 2 1/2 | 1 1/2 |
| 3 | 1 3/4 |

TUBING

Characteristics of Teflon

- CHEMICAL**
Completely inert.
- ELECTRICAL**
Very high dielectric strength. Extremely low power factor.
- THERMAL**
Temperature range -300° to +500° F.
- MECHANICAL**
Strong, flexible, weather resistant.
- LOW COEFFICIENT OF FRICTION**
Absolutely non-stick.

* DuPont Trademark

Request full information and ask for our bulletin, The Best in Teflon. Crane Packing Company, Ltd., 627 Parkdale Ave. North, Hamilton, Ontario, Canada.



JOHN CRANE CRANE PACKING COMPANY 38 YEARS INDUSTRIAL PROGRESS

News Report

A. Deskin Sales Extends Representative Lines

A. Deskin Sales Co. of 6875 Fielding Avenue, Montreal, has recently been appointed as sole Canadian representative for several United States companies.

The list of principals includes: Nylon Molding Corp. of Garwood, N.J., manufacturers of the Nylon "Catterpillar" Grommet, "Presslok" compression fittings and wire supports for every aircraft and commercial application; Union Electronics and Machine Corp. of Wakefield, Mass., approved manufacturers of "R.F." connectors; Allard Instrument Corp. of Mineola, N.Y., makers of precision magnetic visual rotary indicators, synchronous motor brakes, miniature motors and relays; Precision Metal Products Of Malden of Stoneham, Mass., manufacturer of turret terminals, Teflon, ceramic and melamine insulated terminals and fabricated terminal boards to meet all requirements; Tech Laboratories, Inc. of Palisades Park, N.J., makers of high quality precision attenuators and rotary selector switches for every application.

Philips Electronics Represents Analogue Controls

Philips Electronics Industries Ltd., of 116 Vanderhoof Avenue, Toronto 17, Ontario, has recently been appointed to be the exclusive Canadian representative for Analogue Controls Inc., Mineola, N.Y. Analogue Controls are manufacturers of high precision potentiometers, both single and multiturn types.

F. J. Martin Appointed General Sales Manager

Conway Electronic Enterprises Reg'd. announces the appointment of Fred J. Martin, A.M.Inst.E.E., as general sales manager of its Instrumentation Division.

Mr. Martin has a wide background of experience in industrial electronic equipment, and in this regard was sales manager of Dawe Instruments Ltd. of England for a period of 5 years. Mr. Martin also possesses a wide knowledge of communications in all aspects due to a 17 year experience in the Radio Communications Branch of the Royal Navy.

Mr. Martin will represent the above company in all industrial, educational, and broadcast equipment phases.



F. J. Martin

where modern styling is required...

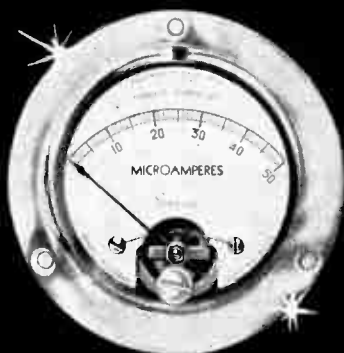

Simpson Model 1421
Transparent Case



Simpson Model 1502
Edgewise

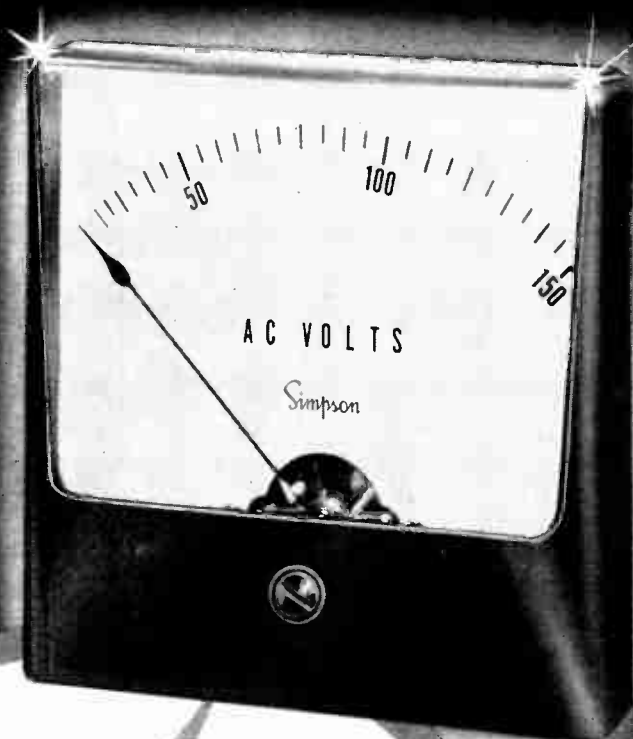

Simpson
Model 1327
Wide-Vue

NEW Simpson PANEL INSTRUMENTS

These NEW Simpson Panel Instruments are not only functional, but sleek and clean of line for ultramodern panel styling. Conservative, traditional case designs still have their place, but with Simpson instruments you have complete freedom of choice.

Circuits too can go modern and Bach-Simpson facilities are completely flexible in all phases of movement design to meet the most exacting or advanced requirements. Never discard any equipment design requiring unusual instrumentation without first consulting us.

Bach-Simpson
LIMITED

IN U.S.A.: SIMPSON ELECTRIC COMPANY,
5200 W. KINZIE STREET, CHICAGO 44, ILLINOIS

1255 Brydges St.

London, Ontario

H-6948

For further data on advertised products use page 61.

INDEX TO ADVERTISERS

Page number is on the right. Key number for use with READER SERVICE CARDS is on the left.

| Key No. | Page No. |
|---|----------|
| 1. Adcola Products Ltd. | 64 |
| 2. Amphenol Canada Ltd. | 49 |
| 3. Automatic Electric Sales (Canada) Ltd. | 33 |
| 4. Automatic Electric Sales (Canada) Ltd. | 34-35 |
| 5. Automatic Electric Sales (Canada) Ltd. | 36 |
| 6. Aviation Electric Ltd. | 49 |
| 7. Aviation Electric Ltd. | 52 |
| 8. Bach-Simpson Ltd. | 60 |
| 9. Bud Radio Inc. | 55 |
| 10. Canadian I.R.E. Convention | 12 |
| 11. Canadian Lister-Blackstone Ltd. | 52 |
| 12. Canadian Marconi Co. | 3 |
| 13. Cannon Electric (Canada) Ltd. | 10 |
| 14. Central Bridge Co. Ltd. | 2 |
| 15. Crane Packing Co. Ltd. | 58 |
| 16. Daven Co., The | 57 |
| 17. Dawe Instruments Ltd. | 65 |
| 18. Daystrom Ltd. | 59 |
| 19. Daystrom Ltd. (Weston Div.) | 13 |
| 20. Eitel-McCullough Inc. | 63 |
| 21. Electronic Service Supply Co. | 54 |
| 22. Engelhard Industries of Canada Ltd. | 14 |
| 23. General Radio Co. | 68 |
| 24. Hammond Manufacturing Co. Ltd. | 55 |
| 25. Helipot Corp. | 66 |
| 26. Helipot Corp. | 67 |
| 27. Hewlett-Packard Co. | 15 |
| 28. International Resistance Co. Ltd. | 57 |
| 29. International Resistance Co. Ltd. | 64 |
| 30. Instantaneous Recording Service | 64 |
| 31. Lectronic Research Laboratories | 50 |
| 32. Longstaffe Co. Ltd., J. R. | 65 |
| 33. Magnetics Inc. | 16 |
| 34. Measurements Corp. | 50 |
| 35. Moloney Electric Co. of Canada Ltd. | 57 |
| 36. Muirhead & Co. Ltd. | 51 |

(Continued overleaf)

ATTENTION CIRCULATION MANAGER

Please ADD my name to the mailing list for **ELECTRONICS & COMMUNICATIONS** (no obligation).

My Name

(Please print)

Mail copies to my home, or business address as noted below.

Street

City

Prov.

If you have recently **CHANGED** your address for receiving copies of E & C please note former address here:

Company

Nature of Business

Signature

Position

6-58

(For card to be valid it must be completed in full, including signature)

PLEASE SEND FURTHER INFORMATION ON THE FOLLOWING NEW PRODUCT ITEMS AS NUMBERED BELOW — USE PRODUCT ITEM NUMBERS

1971 1972 1973 1974 1975 1976 1977 1978 1979 1980
 1981 1982 1983 1984 1985 1986 1987 1988 1989 1990
 1991 1992 1993 1994 1995 1996 1997 1998 1999 2000

PLEASE SEND FURTHER INFORMATION ON THE FOLLOWING ADVERTISEMENTS AS NUMBERED BELOW — USE KEY NUMBER

1 2 3 4 5 6 7 8 9 10 11 12
 13 14 15 16 17 18 19 20 21 22 23 24
 25 26 27 28 29 30 31 32 33 34 35 36
 37 38 39 40 41 42 43 44 45 46 47 48
 49 50 51 52 53 54 55 56 57 58 59 60

Name

Position

Company

Nature of Business

Company Address

City

Prov.

6-58

PLEASE SEND FURTHER INFORMATION ON THE FOLLOWING NEW PRODUCT ITEMS AS NUMBERED BELOW — USE PRODUCT ITEM NUMBERS

1971 1972 1973 1974 1975 1976 1977 1978 1979 1980
 1981 1982 1983 1984 1985 1986 1987 1988 1989 1990
 1991 1992 1993 1994 1995 1996 1997 1998 1999 2000

PLEASE SEND FURTHER INFORMATION ON THE FOLLOWING ADVERTISEMENTS AS NUMBERED BELOW — USE KEY NUMBER

1 2 3 4 5 6 7 8 9 10 11 12
 13 14 15 16 17 18 19 20 21 22 23 24
 25 26 27 28 29 30 31 32 33 34 35 36
 37 38 39 40 41 42 43 44 45 46 47 48
 49 50 51 52 53 54 55 56 57 58 59 60

Name

Position

Company

Nature of Business

Street

City

Prov.

6-58

BUSINESS REPLY CARD
No Postage Stamp Necessary if Mailed in Canada

5c POSTAGE WILL BE PAID BY

ELECTRONICS AND COMMUNICATIONS

31 - 35 Willcocks Street

Toronto 5, Ontario



BUSINESS REPLY CARD
No Postage Stamp Necessary if Mailed in Canada

5c POSTAGE WILL BE PAID BY

ELECTRONICS AND COMMUNICATIONS

31 - 35 Willcocks Street

Toronto 5, Ontario



BUSINESS REPLY CARD
No Postage Stamp Necessary if Mailed in Canada

5c POSTAGE WILL BE PAID BY

ELECTRONICS AND COMMUNICATIONS

31 - 35 Willcocks Street

Toronto 5, Ontario



INDEX TO ADVERTISERS

(Continued)

| Key No. | | Page No. |
|---------|---|----------|
| 37. | Ohmite Manufacturing Co. | 4 |
| 38. | Phillips Electrical Co. Ltd. | 6 |
| 39. | Prodelin Inc. | 56 |
| 40. | R.C.A. Victor Co. Ltd. | 9 |
| 41. | R & M Bearings Canada Ltd. | 48 |
| 42. | Radio Communications Equipment & Engineering Ltd. | 44 |
| 43. | Radio Communications Equipment & Engineering Ltd. | 45 |
| 44. | Rider, Publisher, Inc., John F. | 66 |
| 45. | Rogers Electronic Tubes & Components (A Division of Phillips Electronics Industries Ltd.) | 47 |
| 47. | Standard Telephones & Cables Mfg. Co. (Canada) Ltd. | 17 |
| 48. | Stark Electronic Instruments Ltd. | 64 |
| 49. | Telephone Mfg. Co. Ltd. | 65 |
| 50. | Varian Associates of Canada Ltd. | 53 |
| 51. | Welwyn Canada Ltd. | 50 |

ACTIVE CIRCULATION

It costs us a lot of active dollars annually to keep our circulation lists up-to-date and it's important enough to us that we have them audited every year by CCAB Canadian Circulations Audit Board Inc.)

Advertisers trust CCAB audited figures so we get more advertisers and YOU get the high standard of editorial you have always wanted to read.

ELECTRONICS and COMMUNICATIONS

is a



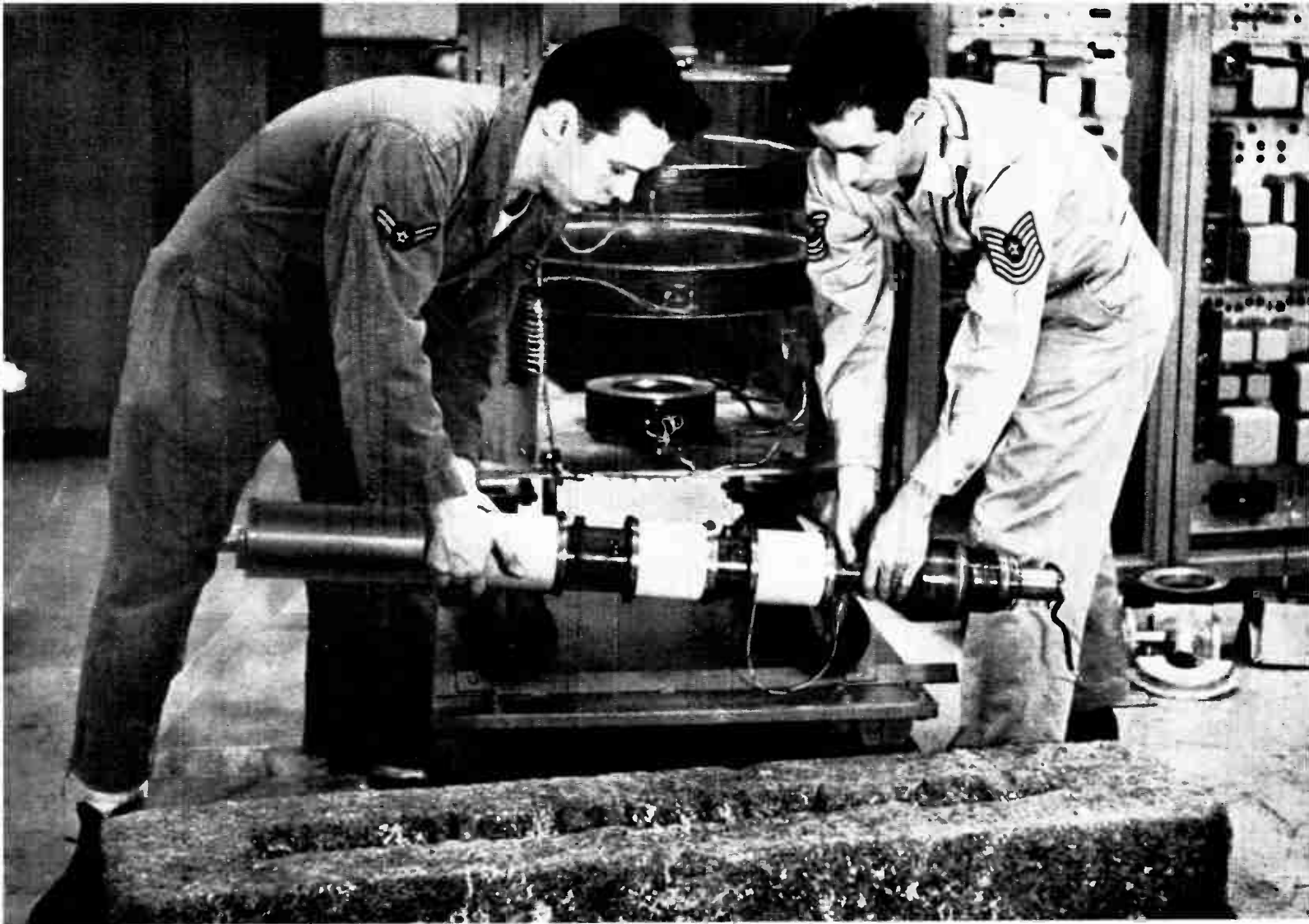

U. S. Air Force personnel remove 25,137 hour klystron from advanced Pole Vault base. Department of Defense Photograph.

Eimac Klystrons Going Strong after 25,000 Hours in Pole Vault Tropo-Scatter Service

After 25,137 hours on the air, and still in perfect operating condition, this Eimac 3K50,000LF UHF klystron has been acquired through the cooperation of the U.S. Air Force and Canadian Marconi, Ltd. This klystron was one of the original tubes installed in Project Pole Vault, the first tropo-scatter communications line ever established. The tube is just one of a number of Eimac klystrons that have exceeded 25,000 hours of reliable on-the-air time in this system. Eimac klystrons are used as final amplifiers in the Pole Vault 10 kilowatt transmitters that handle multiple-channel voice and teletype communications. Experience with this first system in our early warning defense network confirmed klystron-powered tropospheric scatter as an outstandingly dependable system of long distance communication.

The exceptional performance of these tubes under the difficult logistical and environmental conditions of the far north is indicative of the reliability and conservative rating of performance-proved Eimac external-cavity klystrons. Eimac amplifier klystrons are now being used extensively for tropo-scatter communications throughout the United States, Canada and other regions of the world. Eimac klystrons for communications and pulse applications are now available covering frequencies from VHF to SHF and to multi-megawatt output powers.

For further information, write for a copy of the 24-page booklet "Klystron Facts Case Five."

EITEL-McCULLOUGH, INC.

SAN BRUNO CALIFORNIA

The World's Largest Manufacturer of Transmitting Tubes

Canadian Representative:

R. D. B. SHEPPARD

2036 Prince Charles Road, Ottawa 3, Canada



5813

Products Designed and Manufactured by Eimac

Negative Grid Tubes

Reflex and Amplifier Klystrons

Ceramic Receiving Tubes

Vacuum Tube Accessories

Vacuum Switches

Vacuum Pumps

Includes the most extensive line of ceramic electron tubes

ADCOLA

(Regd. Trade Mark)

1/8" Bit L. No. 70
Shield L. No. 68

3/16" Bit
L. No. 64

C.S.A. APPROVED SOLDERING INSTRUMENTS

Designed in Three Sizes
1/8" 3/16" & 1/4" Bits.

Manufactured for
All Supply Voltages
6/7 to 230/50 v.

Instruments maintain
soldering temperatures
and through jointing is
achieved in all the
fields of soldering, from
pin point to general
work in all sound equip-
ment.

Insulation standards are
approved in all leading
countries.

All Designs Cover the
Demands for Continual
Bench Production
Assembly.

Canadian, British and
Foreign Pats.
Reg. designs, etc.

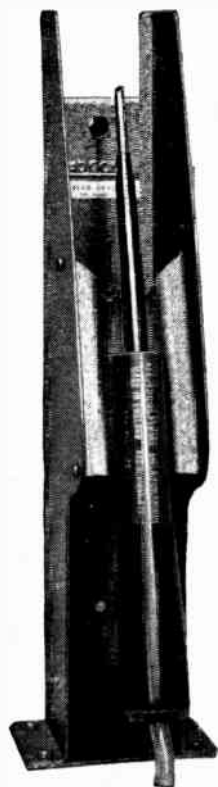

Canadian
Representative:

L. J. LAMB
Box 103 - Weston, Ont.

REVODEx DIAL FOR PRECISION POTENTIOMETERS

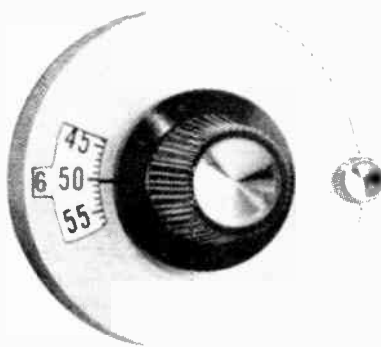

The knob and scale
that give accurate
settings and readings
by single scale read-
out.

- Non-shift locking device.
- Single scale, one dial read-out.
- Convenient construction.
- Easy mounting — attached directly to potentiometer.
- Matches all panels — available in black or clear anodized aluminum body.

Write to Dept. 19 for
Bulletin A 11.

Write for Bulletin A 5 for complete information on new
Type H Standard line of precision potentiometers:

Moisture Seal and High Temperature Hermetic Seal
Sub Miniature • Single Turn, Etc.

INTERNATIONAL RESISTANCE CO. LTD.

349 CARLAW AVE.

TORONTO 8, ONT.

Radiovision Sales Ltd.
325 Tenth Ave. West
Calgary, Alta.

SALES OFFICES:
492 Somerset St. West
Ottawa
Ont.

1500 St. Catherine St. West
Montreal
Que.



STARK Model 8-77
Portable — Only 16 lbs.

NEW —

*hi-speed, mutual conductance
tube tester*

Stark

- e Dynamic Mutual Conductance . . . the time-proven Stark-Hickok method of precise voltage calibration that assures you of professional, tube testing accuracy.
- x Snap-In Master Socket Panel . . . a unique feature, socket panel slips off easily exposing new type 11-pin socket and saves time in replacing worn out sockets.
- c High Speed Short Test . . . 12 times more sensitive!
- U Grid Current Test . . . gas content is accurately measured in terms of microamps.
- S Filament Continuity Test immediately determines if filament open or not. Reserve Cathode Capacity Test weeds out tubes which could cause trouble in the near future.
- i Filament Voltages: In 18 steps from 0.6 to 117 volts.
- e Scale Reading: Read directly on the 3-range mikro-mho scale (0 to 3,000, 6,000, 15,000).

Features

Write for full particulars.

STARK ELECTRONIC INSTRUMENTS LTD.

Factories and Sales Office: AJAX, ONT.
Foreign Division: 276 West 43rd Street, New York 36, N.Y.

World's First Battery Operated Pocket Tape Recorder

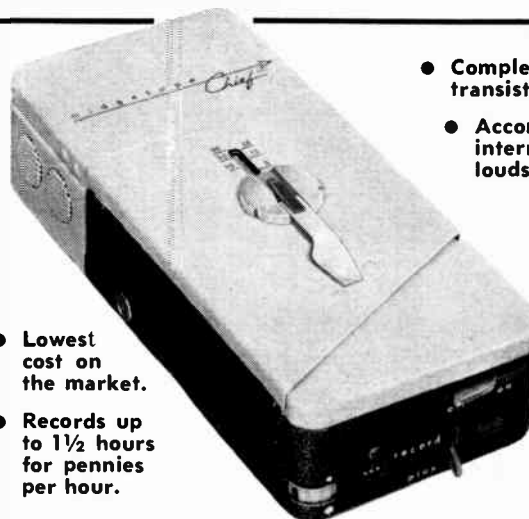

- Completely transistorized.
- Accommodates internal loudspeaker.

- Lowest cost on the market.
- Records up to 1 1/2 hours for pennies per hour.

Midgetape is pocket size. It has a variety of devices for confidential recordings. Power converters for non-battery use in car, office or home. One battery with visual life indicator.

Ideal for engineers, lawyers, insurance investigators, doctors, public relations and salesmen, as well as for inventory taking.

INSTANTANEOUS RECORDING SERVICE

40-42 LOMBARD STREET - TORONTO 1, ONTARIO
TELEPHONE EMPIRE 3-5767

Due to mailing list requirements of the Canadian Circulations Audit Board, we must reserve the right to restrict circulation when the prospective addressee is not engaged in the industry served by

ELECTRONICS & COMMUNICATIONS

NEW BRITISH ELECTRONIC INSTRUMENTS

- Automatic Frequency Monitors
 - Electronic Counters
 - Capacitance and Inductance Bridges
 - Square Wave and Pulse Generators
 - Adjustable Phase Correction Units
- made by Cinema-Television Ltd., and available in Canada throughout Dawe Instruments.

For an illustrated catalogue with full details of this equipment, write *today* to:

DAWE INSTRUMENTS LIMITED

CANADIAN DIVISION: 1654 Bank Street, Ottawa, Ontario
5802

NEED A SUB-MINIATURE SENSITIVE SWITCH???

Type E4-100 Series
QPL listed MS25085

ACTUAL SIZE

STD. MODEL E4-103 —
Weight064 oz.
Pretravel020 Max.
Overtravel007 Min.
Rel. Force...40 Grams Min.
Cont. Pressure... 60 Grams
Cont. Gap020 Max.

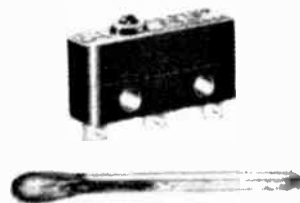

TEMPERATURE RATINGS

— 65°F. to + 350°F.
— 65°F. to + 250°F.

CONTACT MATERIAL

Fine Silver—Silver Cadmium
Gold Flash—Gold Alloy

OPERATING FORCE

150 to 300 grams
(Variations for Special Applications)

SWITCH LIFE

Available from 25,000 to 1,000,000 cycles

MOVEMENT DIFFERENTIAL

Normal of .003 max. can be varied for special application from .001 to .005. Low movement differential and accurate

repeatability give close control for bi-metal, sensitive diaphragm and similar applications.

ELECTRICAL RATING

150,000 ops 125/250 V a-c 2.5 amps.
100,000 ops @ 125/250 V a-c 5.0 amps.
50,000 ops @ 125/250 V d-c 2.5 amps Ind.
50,000 ops @ 30 V d-c 4.0 amps Res.
25,000 ops @ 30 V d-c 10 amps Res.
(Higher rated switches also available)

ACTUATORS

Short and Long St. Steel, Toggle, Push-Button, Roller, Wide Leaf, and others.

For further information write to Dept. 17.

J.R. LONGSTAFFE CO. LTD.

300 CAMPBELL AVENUE — TORONTO, ONTARIO



CONTROL KEY SWITCHES

for LOW VOLTAGE MULTIPLE SWITCHING

T.M.C. CONTROL KEY SWITCHES, precise in design and of robust construction, are today performing their vitally continuous work in varying apparatus all over the world.

Operators feeling the clean and positive "Make and break" action in any of the fifty standard spring combinations forget any fear of failure.

The contact springs made of nickel silver operated by hard plastic rollers on steel cams and silver contacts, ensure perfect performance. (Platinum or other metal can be supplied for special operating conditions.)

Telephone EM. 6-5314 or write for T.M.C. Control Key Catalogue giving full technical data to:

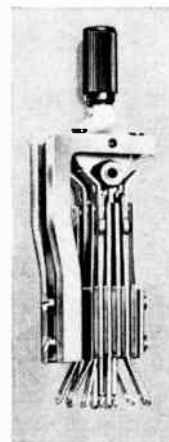

Lever type control key switches (above)

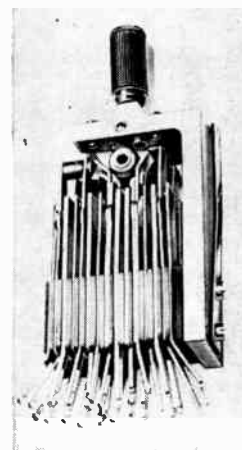

Plunger type control key switches →

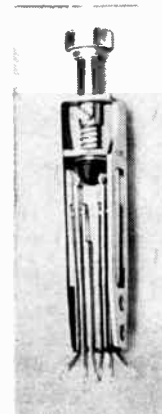

TELEPHONE MANUFACTURING CO. LTD.

SAXONY BUILDING • 26 DUNCAN STREET • TORONTO, ONT.

NEW RIDER BOOKS with modern concepts spark electronic progress

A 'tool' for all who design vacuum tube circuits.

CONDUCTANCE CURVE DESIGN MANUAL, by *Keats Pullen, Jr., Eng.D.* The author, a world-famous electronics authority, has devised an original technique for designing electronic circuits based on conductance curves. G_m , R_p and μ are replotted as necessary so as to enable design using small signal parameters to predict large signal performance. This technique greatly shortens design time and minimizes problems arising from approximation. A vitally important contribution to engineering progress.

Circuit reliability can be improved and distortion reduced at the same time by using the tables and curves in the manual. Engineers, engineering students, and laboratory technicians can now select the proper tubes and their associated components to suit the needs of almost any type of circuit with greater reliability than ever before. The manual contains conductance curves for more than 70 of the most representative vacuum tubes used in all services. #210, 8½" x 11", stiff cover, spiral binding, \$4.50

Physics, mathematics and their relationship to electrical communications made crystal clear in this brilliant work.

PHYSICS AND MATHEMATICS IN ELECTRICAL COMMUNICATIONS, by *James Owen Perrine, Ph.D.* This is a profound and probing explanation of what happens in electrical circuits that contain resistance, inductance and capacitance. While it is a penetrating analysis, it is presented in an unusually lucid manner. The author demonstrates a talent for selecting that avenue of approach in analysis which leads to utmost clarity. The text contains numerous explanatory diagrams, many conceived by the author, that point out and simplify concepts that normally are considered complicated. Each graph, complete with point-by-point identifying nomenclature, illuminates the text. On a foundation of associated mathematics made completely understandable and replete with numerical examples, the author brilliantly ties together physical concepts and electrical communication. An entirely new approach is used in analyzing hyperbolic functions, exponential equations and related functions. Of special significance is the content of the graphical demonstrations of electrical behavior. #211, 8½" x 11", cloth bound, \$7.90

First Omnibus of the Transistor Art

TRANSISTOR ENGINEERING REFERENCE HANDBOOK, by *H. E. Marrows*. Covering transistor performance characteristics, operating specifications, manufacturing processes, applications, testing, sources, etc. Related components—electrical characteristics, physical dimensions, sources, etc. The most complete handbook for use in engineering, scientific research and manufacturing of transistor devices. #193, cloth bound, 288 pp., \$10.45

CLOSED CIRCUIT TV SYSTEM PLANNING, by *M. A. Mayers & R. D. Chipp, P.E.* Closed circuit television is science and industry's newest means of visual communication. This book is devoted to the applications of equipment and the planning of closed circuit TV systems for use in factories, schools, hospitals, railroads, department stores, banks, advertising agencies, airports, transportation terminals and in numerous other areas. System layout, available equipment, composition of a complete system are covered. Fully illustrated. #203, cloth bound, 8½" x 11", \$10.50

FUNDAMENTALS OF TRANSISTORS, by *Leonard Krugman*. Written by one of the pioneers in transistor development, this book deals with basic operation, characteristics, performance, and application. Soft cover, 144 pp., illus. #160, Only \$2.85

Buy these Rider books at your electronic parts jobber or book store. If your favorite store does not sell these books order direct.

 **JOHN F. RIDER PUBLISHER, INC.**
116 West 14th Street, New York 11, N. Y.

In Canada:
Charles W. Pointon, Ltd.
6 Alcina Ave., Toronto, Ontario

Book Review

Physics And Mathematics In Electrical Communication by *James Owen Perrine, Ph.D.*

This is a profound and probing explanation of what happens in electrical circuits that contain resistance, inductance and capacitance. While it is a penetrating analysis, it is presented in an unusually lucid manner. The author demonstrates a talent for selecting that avenue of approach to analysis which leads to utmost clarity.

The text contains numerous explanatory diagrams, many conceived by the author, that point out and simplify concepts that normally are considered complicated. Each graph, complete with point-by-point identifying nomenclature, illuminates the text.

On a foundation of associated mathematics made completely understandable and replete with numerical examples, the author brilliantly ties together physical concepts and electrical communication.

An entirely new approach is used in analyzing hyperbolic functions, exponential equations and related functions.

Physics And Mathematics In Electrical Communication is published by *John F. Rider Publisher, Inc.*, 116 West 14th St., New York 11, N.Y., contains 261 pages, hard cover bound, price \$7.50.

Notes On Analog-Digital Conversion Techniques prepared by staff members of the **Servomechanisms Laboratory**, Department of Electrical Engineering, Massachusetts Institute of Technology, and edited by *Alfred K. Susskind*.

This book, which is an outgrowth of a special summer program on analog-digital conversion techniques held at M.I.T. late in 1957, offers a detailed exposition of both theory and design. The authors have stressed fundamental concepts and have expressed these concepts in quantitative terms where possible. Inherent engineering limitations are taken into consideration and relative merits of various approaches are weighed.

The subject matter is divided into three parts. The first pertains to systems aspects of digital information processing that influence the specifications for analog-to-digital and digital-to-analog conversion devices. In the second part, a detailed engineering analysis and evaluation of a variety of conversion devices is presented. The third part is devoted to a case study based on development work done at the Servomechanisms Laboratory of the M.I.T. Dept. of Electrical Engineering.

The presentation is suitable for readers who have been away from formal academic work for some time and who have little previous knowledge of the field.

Notes On Analog-Digital Conversion Techniques is published by *John Wiley & Sons, Inc.*, 440 Fourth Avenue, New York 16, N.Y., contains 420 pages, hard cover bound, price \$10.00.

Conductance Curve Design Manual by *Dr. Keats A. Pullen, Jr.*

The author of this book has devised an original technique for designing electronic circuits which will shorten design time and minimize the problems arising from the educated "guess".

This manual explains the use of conductance curves in circuit designing and provides more than seventy of the most representative vacuum tube conductance curves used in all services. With the aid of these graphs, design using small signal parameters can be used to predict large signal performance.

This is a vital contribution to engineering progress.

Conductance Curve Design Manual is published by *John F. Rider Publisher Inc.*, 116 West 14th St., New York 11, N.Y., contains 128 pages and 73 illustrations, spiral binding, price \$4.25.

Your Helipot Rep is the Man to See

For same-day delivery of stock models... for modified pots in 10 days or less at no extra cost... for any potentiometer requirement... get in touch with

Angus-Sloane Associates
13 East Main St., Moorestown, N. J.
BElmont 5-1900
Teletype MOORESTOWN NJ 1050

Bivins & Caldwell, Inc.
1923 No. Main St., High Point, N. C.
High Point 2-6873
Teletype HIGH POINT NC 454
3133 Maple Dr., N.E., Atlanta 5, Ga.
CEdar 3-7522, Teletype AT 987

Eltron Engineering Sales Co.
246 Walnut Street
Newtonville 60, Mass.
DEatur 2-6975
Teletype NEWTON MASS 211
2345 Whitney Ave., Hamden, Conn.
ATwater 8-9276

Harris-Hanson Company
2814 South Brentwood Blvd.
St. Louis 17, Missouri
Mlssion 7-4350, Teletype WEB 237
7916 Paseo Avenue
Kansas City 30, Mo.
Hiland 4-9494, Teletype KC 448

Arthur H. Lynch & Associates
35 West North Shore Ave.
Fort Myers, Fla., WYandott 5-2151
Teletype FT MYERS FLA 458
P. O. Box 2492, Gainesville, Fla.
FRanklin 2-8028

Roy J. Magnuson
3347 West Irving Park Road
Chicago 18, Illinois
KEystone 9-7555, Teletype CC 913
1359 West Maynard Drive
St. Paul, Minn., MIDway 6-7943

G. S. Marshall Company
2065 Huntington Drive
San Marino, California
RYan 1-6781, SYcamore 5-4304
Teletype PASA CAL 7797
2015 El Camino Real
Redwood City, Calif.
EMerson 6-8214
3915 East Broadway, Tucson, Ariz.
EAsT 7-1501
3525 Fifth Ave., San Diego, Calif.
CYpress 8-8234, 8-8235

Norvell Associates
3603 Lennox Ave., Dallas 19, Texas
LAKeside 6-7861, Teletype DL 1082

E. A. Ossmann Corp.
830 Linden Ave., Rochester 10, N. Y.
LUdlow 6-4940, Teletype RO 189
1204 South Ave., Syracuse 7, N. Y.
GRAnite 6-7073
147 Front Street, Vestal, N. Y.
ENdcott 5-0296

Sheridan Associates
Roselawn Center Bldg
Cincinnati 37, Ohio, MELrose 1-2460
5348 Pearl Rd., Cleveland 29, Ohio
TUxedo 4-8060

S. Sterling Company
15310 West McNichols Road
Detroit 35, Mich., BRoadway 3-2900

Samuel N. Stroum Co.
1612 Broadway, Seattle 22, Wash.
EAsT 3-6117, Teletype SE 403

B. B. Taylor
2270 Grand Ave., Baldwin, N. Y.
BALdwin 3-8000
Teletype FREEPORT 1676

Allen I. Williams Company
126 West 12th Ave., Denver 4, Colo.
MAIn 3-0343, Teletype DN 134-x

Canada: R-O-R Associates, Ltd.
1470 Don Mills Road
Don Mills, Ontario, Canada
Toronto HICKory 4-4429
6201 Cote St. Luc Road
Montreal, Quebec, DEXter 0845

THIS STOCK PAYS DIVIDENDS

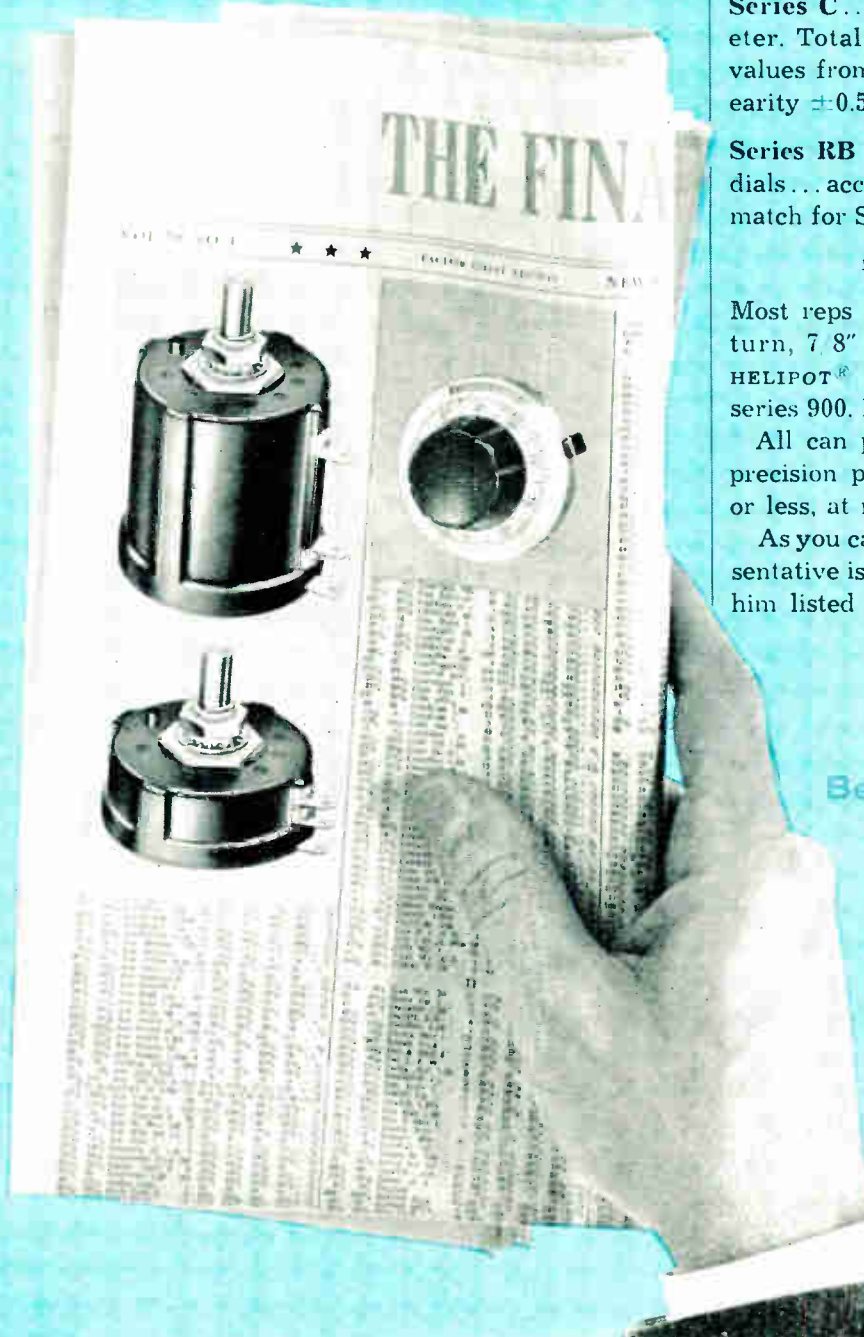

Helipot declares a 3-in-1 potentiometer dividend for you:

- Quality** blue chip!
Price best buys!
Delivery same day!
-

Every Helipot representative carries these market-leaders on his shelf for over-the-counter sales:

Series A ... 10 turns. 1-13/16" diameter. Total resistance: 15 standard values from 25 to 300,000 ohms. Linearity $\pm 0.5\%$ or $\pm 0.1\%$.

Series C ... 3 turns. 1-13/16" diameter. Total resistance: 10 standard values from 10 to 50,000 ohms. Linearity $\pm 0.5\%$.

Series RB Duodial[®] turns-counting dials ... accuracy 0.01 turn. A perfect match for Series A potentiometers.

Most reps also stock Series AJ, 10-turn, 7/8" diameter miniatures ... HELIPOT[®] single-turns ... Duodial series 900. R and SR.

All can provide modified HELIPOT precision potentiometers in 10 days or less, at no extra cost!

As you can see, your Helipot representative is a man to see ... you'll find him listed in the adjoining column.

Beckman / Helipot

*Helipot Corporation
Newport Beach, California
a division of
Beckman Instruments, Inc.
Engineering representatives
in 27 cities*



METHOD FOR DIELECTRIC MEASUREMENTS

from 200 to 5000 Mc.

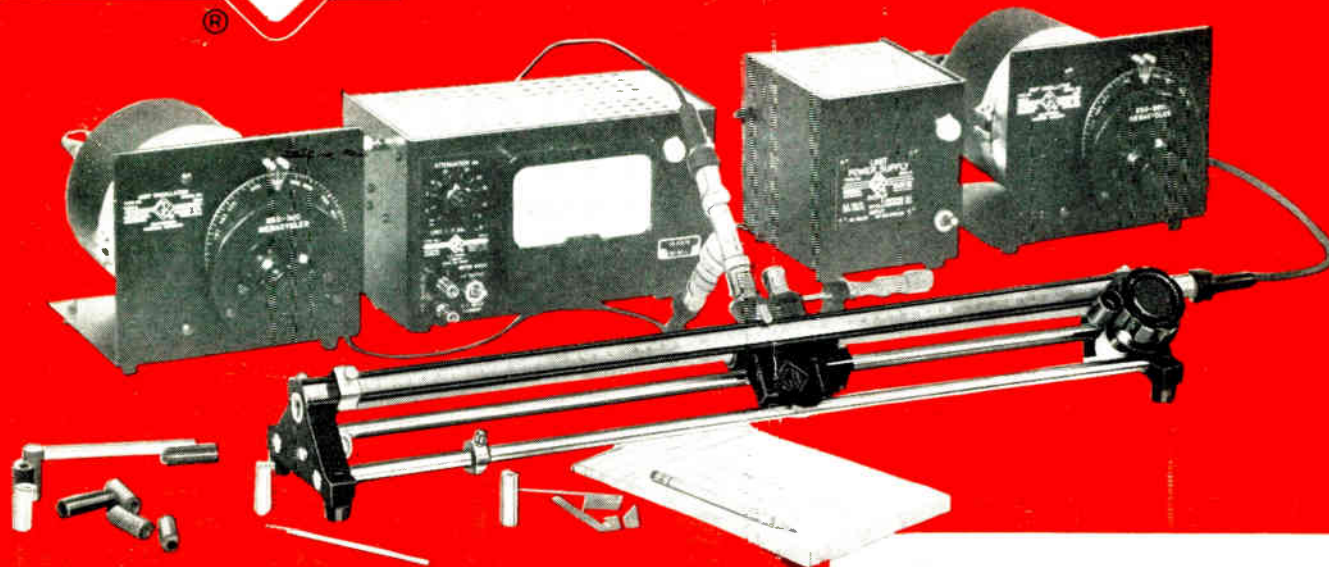

The new Type 874-LM Dielectric-Measuring Line now makes possible rapid and straightforward measurements of solid materials having dielectric constants between 1 and 10, and dissipation factors between 0.0001 and 0.05. Measurement accuracy is $\pm 2\%$ for dielectric constant, and $\pm(5\% + 0.0001)$ for dissipation factor.

The Dielectric-Measuring Line is an air-dielectric, coaxial transmission line whose field is sampled by an electrostatic pick-up probe mounted on a precision probe carriage. Basic construction of this new instrument is similar to that of the time-proven G-R Type 874-LBA Slotted Line with these exceptions: the line is open at one end to accept cylindrical dielectric specimens; and the inner and outer conductors of the coaxial line have silver overlays to minimize losses.

Operation is simple: A cylindrical specimen is fitted into the end of the air-dielectric line. The frequency of a signal source driving the line at the other end is adjusted until a voltage minimum is obtained close to the face of the sample (usually within about 1 cm). Dielectric constant (K) and dissipation factor (D) can then be calculated from these two simple expressions.

$$K = \left[\frac{N\lambda}{4(\ell + x)} \right]^2 \quad D = \left[\frac{\Delta_{10}}{3(\ell + x)} \right] - A$$

With this method there are no complex transcendental equations to solve. The use of the DNT Detector eliminates the need for modulation of source and consequent f-m difficulties and provides an accurate, linear response over a wide range of signal levels.

- λ = wavelength of supplied frequency.
- ℓ = physical length of sample (cm).
- N = odd integer representing number of quarter wavelengths in sample.
- x = distance from voltage minimum to front face of dielectric sample.
- Δ_{10} = width of voltage minimum between 10 db points (measured by micrometer on dielectric line).
- A = constant obtained from chart which corrects for resistive losses in the line.

Type 874-LM Dielectric Measuring Line... \$400

Frequency Range:

Minimum: $200 \frac{Mc}{\sqrt{K}}$
 Maximum: 5000 Mc or $\frac{9000}{\sqrt{K}}$ Mc, whichever is smaller

Sample Dimensions:



Length depends on dielectric constant and frequency. Long samples can be made up of a number of short sections.

K and D Ranges and Accuracy:

K (dielectric constant): $\pm 2\%$ between 1 and 10
 D (dissipation factor): $\pm(5\% + 0.0001)$ between 0 and 0.05

Scale:

Calibrated in centimeters, can be shifted to simplify calculations. Micrometer can be read to 0.0002 cm.

Dimensions: 26 x 4 1/2 x 3 1/2 inches. Net Weight: 8 1/2 pounds.

ACCESSORIES RECOMMENDED:



Any one of a wide variety of G-R Unit Oscillators that cover the v-h-f and u-h-f ranges with Type 1201-A Regulated Unit Power Supply.



G-R Type DNT Detector Assemblies made up of a Type 874-MR Mixer Rectifier, Type 1216-A Unit I-F Amplifier, and appropriate Unit Oscillator.

Four combinations available for following ranges: 40 to 530 Mc; 40 to 280 Mc; 220 to 950 Mc and 870 to 2030 Mc.

Type 874-F Low-Pass Filters. Four models cover ranges of interest below 500 Mc, 500-1000 Mc, 1000-2000 Mc, and 2000-4000 Mc.



Type 874-G6, 6-db Pad.

GENERAL RADIO Company

Cambridge, Massachusetts, U.S.A.

Canadian Office: 99 Floral Parkway, Toronto 15, Ontario

Arthur Kingsnorth

Richard J. Provan

Repair Service:
 Bayly Engineering, Ltd.,
 Ajax, Ontario

Telephone: CHerry 6-2171



WE SELL DIRECT. Our District Sales Offices are staffed by engineers especially trained to help you in the selection of instruments and measuring systems best suited to your needs. We welcome your inquiries — will help solve your problems