

MR F W PREZIOSI
8 EASTGATE CRES
SCARBOROUGH ONT

EPM
CRC
QEL
1211C

ELECTRONICS AND COMMUNICATIONS

INTERMEDIATE
COUNTER STAGES
B,C,D,E,F,G,

An X-Ray Image Intensifier

Philips Industries Limited and N. V. Philips Eindhoven
(Netherlands)

Electronic Computing For The Small Or Medium Sized Business

by L. E. Sandford

Materials-Standards Programming - A

Management Responsibility

by J. McKerrow

Electronic Applications In Industry

pages 32 - 47 inclusive

MARCH 1958



AN AGE PUBLICATION
TORONTO, CANADA

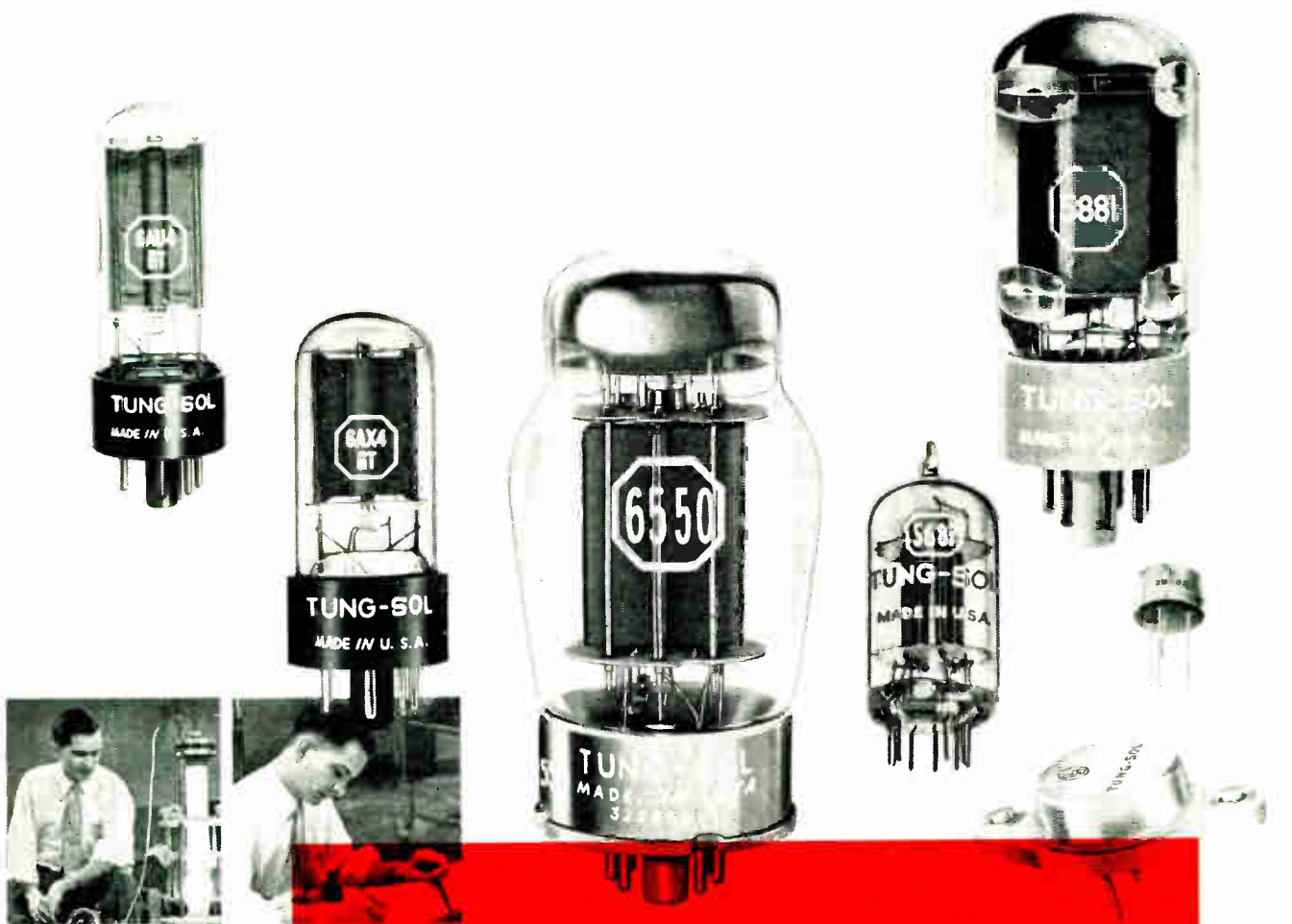

**RESEARCH, DESIGN, DEVELOPMENT
AND QUALITY PRODUCTION IN VOLUME**



TUNG-SOL®

ELECTRON TUBE DIVISION  TUNG-SOL ELECTRIC INC., NEWARK 4, N. J.

IN CANADA: ALPHA ARACON RADIO CO., LTD., TORONTO, ONT.

For further data on advertised products use page 69.

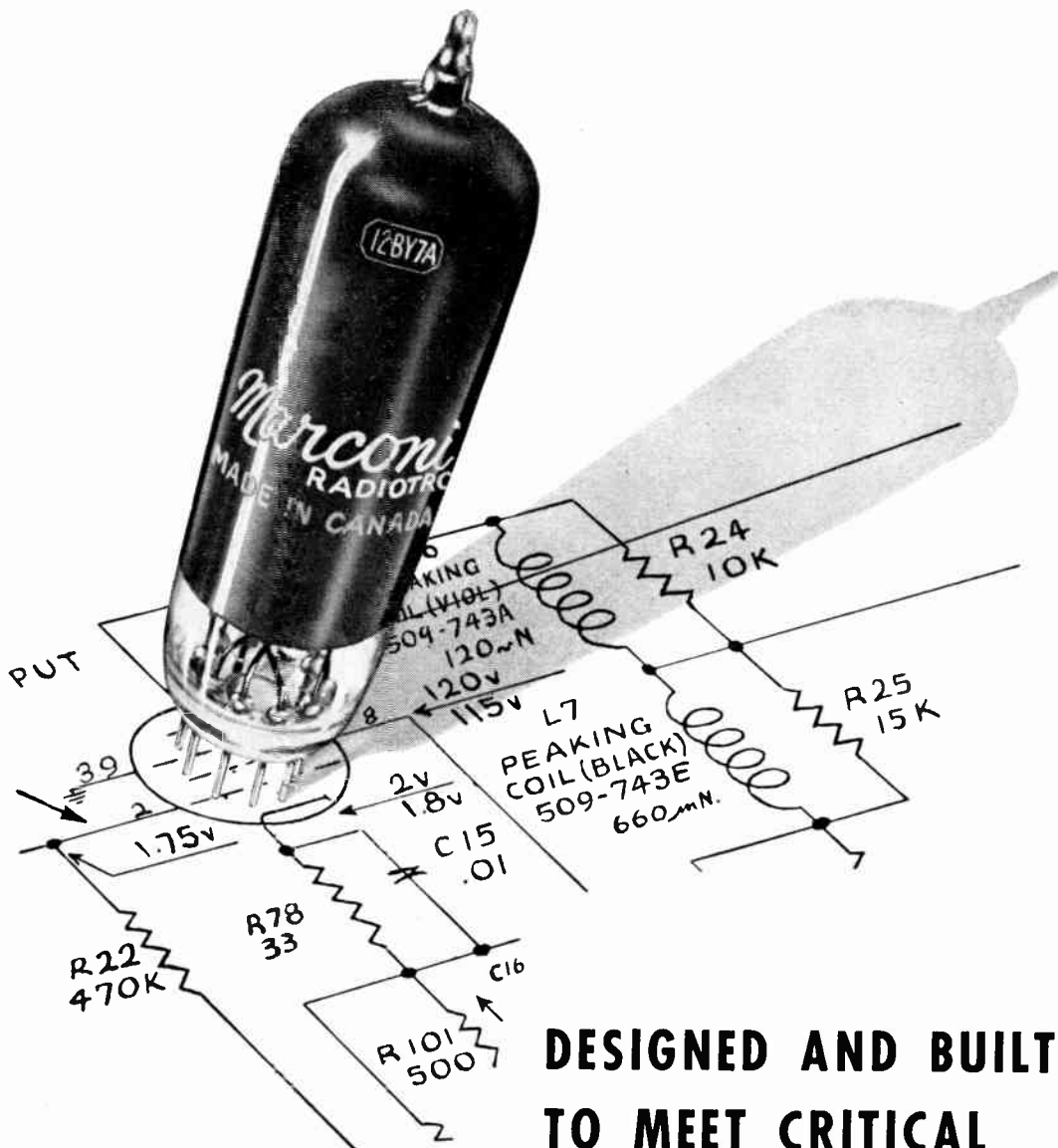

DESIGNED AND BUILT TO MEET CRITICAL OPERATING CONDITIONS

Rigid inspection at every step maintains the high quality engineered into Marconi tubes . . . assures complete satisfaction under the most critical operating conditions. Perfection in every unit is the traditional Marconi standard that means greater power, better tone and longer life to please your every customer.



MARCONI RADIOTRONS

ELECTRONIC TUBE AND COMPONENTS DIVISION

CANADIAN **Marconi** COMPANY

830 BAYVIEW AVENUE, TORONTO, ONTARIO

Branches: Vancouver • Winnipeg • Montreal • Halifax • St. John's, Nfld.



Target Transponder

PARAMI

Miss Distance Indicator

Field Tested*

Proven

Now in Production

Procurable
by Catalog Number

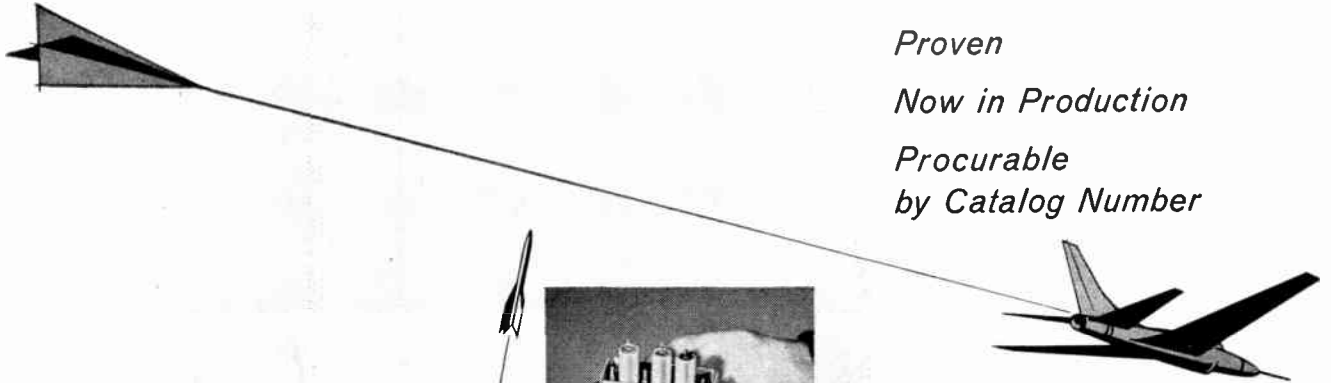

Missile Transponder

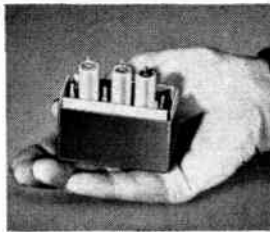

PARAMI

employs two airborne transponders and a single rack ground station, operates in any weather, at any location, or time. Production equipment for towed targets and drones available on assigned frequencies.

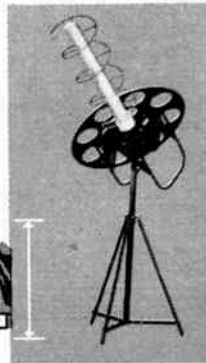

Receiving Antenna
(Tripod Height 4')



Ground Station
(68" High)

This precise electronic MDI features:

1. A real time printed record in tens of feet.
2. 195 data points per second (up to 390 available on order).
3. Intercept recorded to 100 miles line of sight.
4. Closing velocities to mach ten.
5. Mobile versions for uninstrumented ranges.
6. MDI ranges suitable to effective pattern of any warhead.

	Distance from Target	Accuracy
MISSILE TRANSPONDER	0-200'	± 10'
	0-500'	± 10'
	0-3000'	± 10'
PROXIMITY SCORERS (Adjustable)	0-100'	± 5'
	0-400'	± 10'

TARGET LOCATOR ACCESSORY	0-100 mile range	± 2%
	Azimuth	± 5%
	To 70,000' altitude	± 2%

*Test Results Available on Request



means quality instrumentation

THE RALPH M. PARSONS COMPANY

ELECTRONICS DIVISION

151 SO. DE LACEY AVENUE, PASADENA, CALIFORNIA

LOS ANGELES
NEW YORK
WASHINGTON

ANKARA
BAGHDAD
BEIRUT
JEDDAH
KARACHI
MADRID
NEW DELHI
PARIS
TORONTO

For further data on advertised products use page 69.

Electronics And Communications

VOLUME 6

MARCH, 1958

NUMBER 3

FEATURES

An X-Ray Image Intensifier	22
Philips Industries Limited, Toronto, and N. V. Philips Eindhoven (Netherlands)	
Electronic Computing For The Small Or Medium Sized Business	26
by L. E. Sandford	
Materials-Standards Programming — A Management Responsibility	29
by J. McKerrow	
A Presentation Of Short Features On Applications Of Electronic Equipment In Industry	32-47

DEPARTMENTS

Editorial	9
RETMA Report	11
CRTPB Newsletter	12
Editor's Page	15
New Products	50
News Report	57

President, Norman G. McHardy; Vice-President, Secretary-Treasurer, L. R. Kingsland; Editor, Thomas W. Lazenby; Consulting Technical Editor, Leslie Hill, Ph.D. Eng.; Editorial Assistant, D. K. Trowell; Advertising Manager, H. E. Dallyn; Assistant Advertising Manager, Arthur Dixon; Production Manager, Nevill A. Campling; Business Manager, Clifford A. Sparks; Circulation Manager, Paul A. Irwin; Art Editor, Wm. McReynolds; Photo Editor, Guido Milanese. United Kingdom and European Representative, Norman F. Keenan, 47 Manchester Street, London W. 1, England. West Coast Representative, Dillenbeck-Galavan, Inc., 266 South Alexandria Ave., Los Angeles 4, Calif.

PUBLISHED BY AGE PUBLICATIONS LIMITED

Founded in 1923 by Norton W. Kingsland

Publishers of Heating, Plumbing and Air Conditioning AGE • Restaurants and Institutions
Automatic Heating • Wine, Beer and Spirits in Canada • Industrial Aeronautics

TORONTO, ONT., CANADA: 31-35 Willcocks Street, Tel. WAInut 2-3115. MONTREAL, QUE., CANADA: Keith Edgar,
116 Rue de Flandre, Montreal 23 (Preville), Quebec, Telephone: OR. 1-2020.

SUBSCRIPTION RATES: Canada, U.S.A. and British Possessions - \$5.00 per year • Foreign - \$10.00 per year.

Contents copyright by Age Publications Limited. No part of this periodical may be reproduced without the consent of the publisher.

Authorized as second class mail. Post Office Department. Ottawa.



Member Canadian Circulations



Audit Board, Inc.

PRINTED IN CANADA



Simpson WIDE BAND LABORATORY OSCILLOSCOPE

Model 2610

Designed and produced in Canada for the Canadian market, the Model 2610 represents a new approach to precision oscilloscope engineering at a modest price.

Major improvements in long term stability, frequency response and ease of operation have been effected. Features 5% overall accuracy from D.C. to 6 Mc/sec. on the Y-Axis; or rolled off response providing 75 Millimicroseconds rise time on pulse waveforms with less than 3% overshoot. Free running time base from 3 c/sec. to 500 Kc/sec., or calibrated triggered sweeps as desired.

In either application synchronizing and triggering is remarkably effective at all usable signal amplitudes throughout the passband of the amplifier. Signal delay of 0.3 microseconds is provided switched in or out as desired. Flexibility as to internal or external blanking, triggering, etc., is provided by interlocking switches, while complete shielding prevents stray coupling and pulse distortion. Y Amplifier gain in excess of 2,000 x provides deflection sensitivity better than 3.3 Millivolts R.M.S./c.m. Employs twenty-five tubes, including flat faced 5" type C.R.T.

Price including cables and line cord — \$550.00. Sales Tax extra.



Bach-Simpson
LIMITED

1255 BRYDGES ST.

LONDON, ONT.

For further data on advertised products use page 69.



300 watt ceramic tube
vs. 250 watt glass tube
in high temperature furnace.

Second in a series describing the advantages of ceramics in electron tubes.

Surviving Heat Extremes is an Eimac Ceramic Tube extra

In a high temperature furnace the difference between a ceramic tube and a glass tube is physically evident. But, long before the glass tube reached the state of complete collapse shown above, it had lost its usefulness as an electron tube.

Before the temperature reached the softening point of glass, the glass envelope began giving off gaseous products that contaminated the tube's vacuum. The ceramic tube remained internally clean far above the softening point of glass. The materials used in Eimac ceramic tubes are stable to more than 600° C. — the temperature at which Eimac processes these tubes.

Not far above 400° C. the envelope of the glass tube

had softened enough to allow the anode to move slightly to one side, radically disturbing the electrode spacing. The electrodes of the ceramic tube were held rigidly in place by ceramic spacer rings and brazing alloys capable of withstanding far higher temperatures.

The 4CX300A used in this test is just one of a complete line of Eimac developed and produced ceramic tubes whose resistance to damage by heat, physical shock and vibration, plus small size with added power make it ideal for airborne and missile applications, or wherever ruggedness and compactness are a must.

Write our Application Engineering Department for a copy of the new explanatory booklet "Advantages of Ceramics in Electron Tubes."

EITEL-McCULLOUGH, INC.
SAN BRUNO • CALIFORNIA

"Eimac First with ceramic tubes that can take it"

Canadian Representative:

R.D.B. SHEPPARD, 2036 Prince Charles Road, Ottawa 3, Canada



Products Designed and Manufactured by Eimac

Negative Grid Tubes

Reflex and Amplifier Klystrons

Ceramic Receiving Tubes

Vacuum Tube Accessories

Vacuum Switches

Vacuum Pumps

Includes the most extensive line of ceramic electron tubes

INSTRUMENTATION CAMERA

The Perfect Answer

to Film Recording

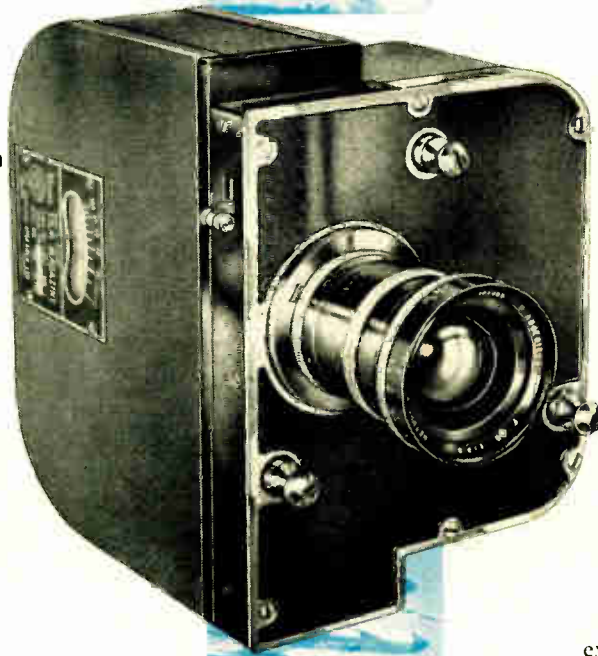

SPECIFICATIONS INSTRUMENTATION CAMERA TYPE T232 Mk7

Size: 7½" x 5½" x 6½"
 Weight: 13½ lbs.
 Power: 28 volts DC; constant demand, 4 amperes; intermittent up to 1.8 amperes. The Type T232 DC power supply, which operates from 110v 60 cps, is available to power the camera.
 Lens: 28mm Augenieux F3.5, or to customer specification.
 Magazine: 100 ft. 35mm standard sprocketed film, No. 10 daylight loading spool, 400 ft. magazine available on special order.
 Picture Formats: 18x25, 25x25 or 25x36 mm.
 Exposure: 1/100 second, or longer with intervalometer control.
 Interval Time: 3 cycles per second maximum.



HERE is the perfect answer to the problems of film recording. The Mark 7 Instrumentation Camera is completely flexible through the entire field of instrumentation and aerial survey positioning photography. The shutter is a focal plane type, the basic exposure speed of which is 1/100 second.

The camera may be cycled from 3 frames per second to any desired longer interval. Interchangeable apertures permit photographs of 18x25, 25x25 or 25x36 mm. A high degree of accuracy is achieved in respect to lens alignment, focusing and format positioning. Main components designed on the "module" system make conversion from one camera type to another relatively simple should customer requirements change. Write for literature and quotations.

Canadian Applied Research Limited

(formerly PSC Applied Research Limited)

1500 O'CONNOR DRIVE
 TORONTO 16, ONTARIO, CANADA



MEMBER: A. V. ROE CANADA LIMITED & HAWKER SIDDELEY GROUP

For further data on advertised products use page 69.

Electronics And Communications

Volume 6

March, 1958

Number 3

Technological Change In Industry

Hon. Michael Starr,
Minister of Labor



Hon. Michael Starr

TECHNOLOGICAL change in industry is now perhaps more widespread and more rapid than ever before. Readers of *Electronics and Communications* know this better than most of us, because there are few of these changes to which electronics has not contributed in some degree. In Canada, and in other industrialized countries, new materials, new processes, and more complex tools are being introduced and automatic controls are becoming more common, while automatic computing devices are finding a wider application in offices.

Such changes are inevitable. Technical progress is a continuing thing, and its results are bound to be applied wherever and whenever they are advantageous. And such new applications are desirable, in the main, because they make it possible to produce goods of better quality at lower cost, and thus help to raise the standard of living of the whole population.

However, the effects of these changes on employment and on the future manpower requirements of industry are naturally troubling many people. The immediate effects on employment appear alarming in many cases. The introduction of a more complex machine tool on a production line, for instance, may mean that the same output can be obtained with half the number of machine operators. This, however, is only one part of the total effect of this particular change.

Within the plant a greater number of men may be needed to maintain and set up the new machines and more may be needed for the designing of products, the planning of processes, and for supervision. Lower costs resulting from the new processes may allow an increase in sales, and thus actually increase total employment. Employment may also be created in the industries producing the new machines and in those selling materials or components.

The total effect is complex and we should not conclude hastily that a higher rate of technological advance will produce serious unemployment. If the country is prosperous, such advances will be reflected in increasing output and a rising standard of living, and any employees who might be temporarily thrown out of work will in most cases be able to find other jobs fairly quickly.

However, much depends on the employer. A firm expects to plan carefully for a major change in production methods. It should plan just as carefully to make the adjustment as easy as possible for its employees. Good communication between management and workers is particularly essential at this time. The coming change should be explained clearly to the employees beforehand, lay-offs should be kept to a minimum, and employees who have become redundant should, as far as possible, be employed elsewhere in the plant in jobs for which they are qualified or for which they can be trained.

A closely allied problem which the Department of Labor is now studying is the effect of technological change on the training requirements of Canadian industry. A technological change in a plant may alter somewhat the types of skill required in the employees, shifting emphasis from semi-skilled and unskilled labor to professional, technical and highly-skilled personnel.

The supply of highly-trained manpower is already causing concern in Canada. With an increasing proportion of jobs in the skilled category and an increasing number of young people entering the labor force each year, our educational facilities will be strained more than ever before. Expansion of school and college facilities will be necessary, but just as necessary will be an increase in in-plant training and apprenticeship plans by employers.

Unless the demand can be met, the supply of trained manpower might well become the limiting factor in the application of these technical developments which promise so much for Canada's future.



These shielded coil forms offer the utmost in reliability due to their unique design and construction. Dimensions when mounted, including terminals, are: LS-9, $\frac{1}{16}$ " diameter x $\frac{1}{2}$ " high; LS-10, $\frac{5}{8}$ " x $1\frac{1}{4}$ "; LS-11, $1\frac{1}{4}$ " x $1\frac{1}{2}$ ". Each form mounts by a single stud. Single layer or pie-type windings to

your specifications. LS-14 is double-ended for primary and secondary windings with separate tuning slugs for independent tuning of each section; its overall length excluding tuning slugs is $1\frac{1}{4}$ "; OD is $\frac{1}{2}$ ". See photograph below for new aluminum housing shielded coil forms.

Reliability – under any condition!

Cambion® miniaturized shielded coil forms are highly shock resistant. With mechanically enclosed, completely shielded coil winding, they bring all the ruggedness and dependable performance you require for your "tight spot" applications — IF strips, RF coils, oscillator coils, etc.

Cambridge Thermionic Corporation combines *quality control* with *quantity production* to supply exactly the components you need, in any amount. Our *quality control* includes material certification, checking each step of production, and finished product. And *Cambion quantity production* means we can fill your orders for any volume, from smallest to largest.

Any Cambion coil form may be wound to your specifications in any desired quantity. For samples, specifications and prices, write to Sales Engineering Dept., Cambridge Thermionic Corpo-

ration, 420 Concord Ave., Cambridge 39, Mass. On the West Coast contact E. V. Roberts and Associates, Inc., 5068 West Washington Blvd., Los Angeles 16 and 1560 Laurel St., San Carlos, Cal.

New aluminum housing shielded coil forms with anodized finish. Available in three sizes, as variable tamper-proof units with positive locking mechanism and more precise tuning, or as fixed shielded coil forms. Flange mounted by means of two number 2-56 screws. Mounted heights above chassis are $\frac{1}{8}$ ", $\frac{3}{8}$ ", and $\frac{1}{2}$ " (in variable units exclusive of tuning element).

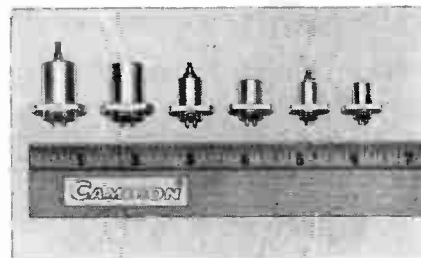

CAMBRIDGE THERMIONIC CORPORATION

CAMBION®



Makers of guaranteed electronic components, custom or standard

See Cambion Guaranteed Components on Display at Booth 2219, IRE Show, New York Coliseum, March 24-28

For further data on advertised products use page 69.

RETMA Report



By Basil Jackson, A.R.Ae.S., Tech. M.C.A.I.

Components Engineering Report on International Standardization

In his report at the recent Components Division meeting in Hamilton, the chairman of the Components Engineering Committee, J. W. Lucyk, impressed upon those present the importance of Canada taking more active participation in the field of international standardization. He reported on the 12th meeting of the Canadian National Committee of the International Electrotechnical Commission. In calling on manufacturers of electronic and electrical equipment and components, users, and the military services to recognize the importance of international standards, Mr. Lucyk said,

"The world is getting smaller as proven especially by recent events. There is a growing concern over the great activity by the Iron Curtain countries which in time might take over the international standardization program if other countries do not continue to take an active interest."

General Communications Engineering Committee

The recently-formed General Communications Engineering Committee, of the Electronics Division, at its inaugural meeting decided to prepare industry specifications on compatible single sideband equipment, single sideband equipment, and on AM double sideband equipment. Compatible single sideband equipment will be considered as a first step.

Industrial Relations Panel

At a recent meeting of the Components Division, the RETMA Industrial Relations Committee organized a panel dealing with industrial relations in small plants. Under the chairmanship of W. E. Curry, the Industrial Relations Committee chairman, the panel speakers were Miss Belle White, Personnel Manager, International Resistance Company Limited, and Fred Martin, Supervisor, Personnel Services, Canadian Westinghouse Company Limited. Both speakers stressed the importance of giving proper attention to the personnel/management relationship of a small business.

The meeting was reminded of the discussions on industrial relations matters which take place after the business portion of the regular monthly meetings of the RETMA Industrial Relations Committee.

Problems Of Spectrum Allocations

The RETMA Director of Engineering, Ralph A. Hackbusch, in his report to the Board of Directors, mentioned that the Department of Transport had brought to the attention of the Canadian Radio Technical Planning Board the fact that the International Telecommunications Union, operating under the aegis of the United Nations, would hold a conference in Geneva in 1959. At this conference the world tables of frequency allocations will be discussed and compiled. The Department of Transport would like the assistance of industry generally in handling the work connected with the Geneva Conference. Mr. Hackbusch mentioned that there was yet no place in the ITU allocation tables for Doppler radar or scatter systems, and the DOT in Canada thus had no basis, at this time, on which to license these systems. Also, the aeronautical interests required about four times as much spectrum space as that now allocated to them and it was pointed out that, in Canada, radio is used to a larger extent, per capita, than in any other country.

New Director Elected

At the recent Receiver Division meeting in Montreal Mr. L. M. Daley of Canadian Marconi Company was unanimously elected a director, representing the Receiver Division, to fill a vacancy on the Board. Mr. Daley will serve until the regular elections take place at the annual meeting in June.

Newsletter

Canadian Radio Technical Planning Board

Who's Who In The Planning Board No. 2 — RETMA

The Radio-Electronics-Television Manufacturers Association of Canada is a voluntary association of manufacturers representing the Canadian electronics industry. To it belong over a hundred manufacturers of end products and components who produce \$500 million worth of electronic goods, equipment, and services each year.

RETMA was established in 1929, as the Radio Manufacturers Association, and was renamed as the industry developed. There are three main divisions, the Receiver Division, for members manufacturing radio and television receivers, a Components Division, for members producing electronic components and accessories of all types, and an Electronics Division, whose members manufacture commercial, industrial, and military electronic equipment. The three divisions report to a Directorate consisting of directors elected by the divisions.

Engineering Committees

Each division has a number of committees dealing with specific activities. Among these are numerous engineering committees dealing with receivers, components, and equipment. The engineering committees whose work is most closely related to Planning Board activities are the Mobile Equipment Committee, Microwave, Radio Relay and Multiplexing Committee, Television Broadcast Committee and the Radio Broadcast Committee. Specifications dealing with these subjects are compiled and ultimately approved as RETMA Standards and passed to the Planning Board for consideration and eventual recommendation to the Department of Transport. The work of the engineering committees is co-ordinated by an Engineering Advisory Committee whose chairman is the Director of Engineering, who reports to the Board of Directors.

Statistical and Engineering Services

The Statistical Service of RETMA provides members with monthly figures on production, sales, inventories of electronic products and equipment. These statistics are of a precise and detailed nature to show industry developments in many fields.

The main functions of the Engineering Service, working through the engineering committees, is to formulate technical standards and specifications to avoid duplication of effort by individual members. Many engineering man-hours are saved by this means. The distribution of Standard Proposals and Engineering Standards is made to all members on a regular basis, and RETMA members have engineers, representing RETMA, on the various technical committees of the Canadian Standards Association and in other organizations.

Related Services

RETMA is in close touch with Government agencies and makes recommendations on tariffs and other legislation. Its Industrial Relations Committee is active in the field of advancing good labor-management relationships, and has sponsored many informative panels for this purpose.

Training lectures for radio and television technicians have been arranged for many years by RETMA, as well as promotional campaigns such as national radio and television weeks and the production of a film about the Canadian electronics industry.

FCC Activities

The Federal Communications Commission of the United States has finalized part of the split channel rule-making by reducing from 2.37 to 1.365 mc. space allowed to the Railroad Radio Service in the 152-162 mc. band. The spectrum space thus gained is scheduled for the Maritime Mobile, Motor Carrier, and the Auxiliary Broadcast services.

The FCC has asked for comments, by April 1, on the proposed ruling that the technical standards adopted in FCC Docket No. 11253 be mandatory in all new systems in the 25-50 mc. and the 152-162 mc. bands and that the spectrum space thus gained be made available to other applicants. The proposal will permit equipment now in use to remain in operation under certain specified conditions.

The FCC's proposal to form a Business Service to replace the Special Industrial Service has met opposition. However, the Special Industrial Service may not be abolished. A smaller spectrum band having more "split" channel space may be used for the Special Industrial Service.

DOT Training Course On Radar

The Department of Transport has begun a series of training courses for technicians to maintain the long-range surveillance radar equipment installed in Ottawa and Vancouver and which will ultimately be installed in Toronto, Montreal, Winnipeg, Saskatoon, North Bay, Quebec, Moncton, Regina, Kenora, Calgary, the Lakehead, Halifax and Edmonton, in that order.

The surveillance radar will improve the margin of safety with which aircraft can be handled. Air traffic control centers operated by DOT will be able to assign routes and altitudes to aircraft, for their safe separation, with greater ease than before. The new radar equipment will be able to plot aircraft from a range of between 1 to 150 miles distance, up to an altitude of 60,000 feet.

Stationary objects such as buildings and trees are eliminated from the screen — the screen shows only moving objects; unwanted reflections from rain will be eradicated. A map of the local area appears on the screen so that aircraft on it can be seen in their exact geographical positions.

Note: An engine caught fire on a United States military transport aircraft passing over Toronto recently. The pilot radioed Toronto's Malton Airport to say that he was preparing to abandon the aircraft. Malton's short-range surveillance radar however, guided him to a safe landing at Downsview airdrome, northwest of Toronto.

Committee Meetings

The Fixed Land and Maritime Mobile Committee met on March 20 in Montreal. Under discussion were the split channel standards for VHF mobile equipment.

Canadian Radio Technical Planning Board
200 St. Clair Avenue West, Toronto 7, Ontario

F. H. R. POUNSETT, President; C. J. BRIDGLAND, Vice-President; R. A. HACKBUSCH, General Co-ordinator; R. C. POULTER, Director of Public Relations; F. W. RADCLIFFE, Secretary-Treasurer

NEW LOW-COST COMPUTER WITH ADVANCED COMPUTING TECHNIQUES



*The only desk-side electronic computer with direct programming
and automatic positioning of decimal point*

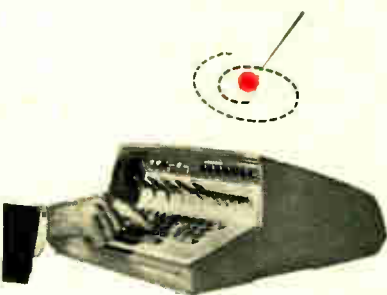

*A few applications
of the 610
Auto-Point Computer*
Analysis of
Mass Spectrometric Data
•
Formulae Evaluations
•
Calculation
of Aeroelasticity
•
Data Reduction

Two *exclusive* features of the new IBM 610 Auto-Point Computer help make your engineering time more completely creative. First, direct programming: computation takes place as the program *is being written*, eliminating the need for separate program test runs. Second, automatic positioning of decimal point: the engineer is relieved of the burden of planning movement of the decimal point, greatly reducing problem-solution time.

The new Auto-Point Computer also gives you, among other valuable features, single-instruction square root, simultaneous division and multiplication, and highly flexible tape units. The IBM 610 was designed with reliability as a prime consideration; built-in self-checking provides assurance of accuracy. In addition, this low-cost electronic desk-side computer does not require air conditioning.

Discover today how the mobile IBM 610 can solve a wide range of scientific and engineering problems for *your* business. For details, simply call the local IBM representative.

TIME EQUIPMENT • DATA PROCESSING • ELECTRIC TYPEWRITERS

IBM

**TIME
EQUIPMENT**

THE NATIONAL SCENE

TEN-TO-ONE THE Copper Clad Laminate YOU WANT IS HERE!

From these ten basic PHENOLITE® Grades, you can select the base material, resin, properties and price to fit your present printed circuit need.

If your problem is finding a suitable cold-punch material, try samples of XXXP-470-1. It's designed for use in automated production equipment. If you are looking for higher heat resistance, check Grades G-10 and G-11.

Out of National's research laboratories come new advances every day. See your National Representative about new products and applications. He can keep you posted on the full line of PHENOLITE Laminated Plastic, Vulcanized Fibre and National Nylon for electronic applications across-the-board. In the meantime, write for our new "PHENOLITE Copper Clad Data" folder. Address Dept. F-3.



NATIONAL

FIBRE COMPANY OF CANADA, LTD.

Atlantic & Hanna Aves., Toronto • 1411 Crescent St., Montreal

SEE THESE PRODUCTS ON DISPLAY AT
THE I.R.E. SHOW, BOOTH 4419-21.

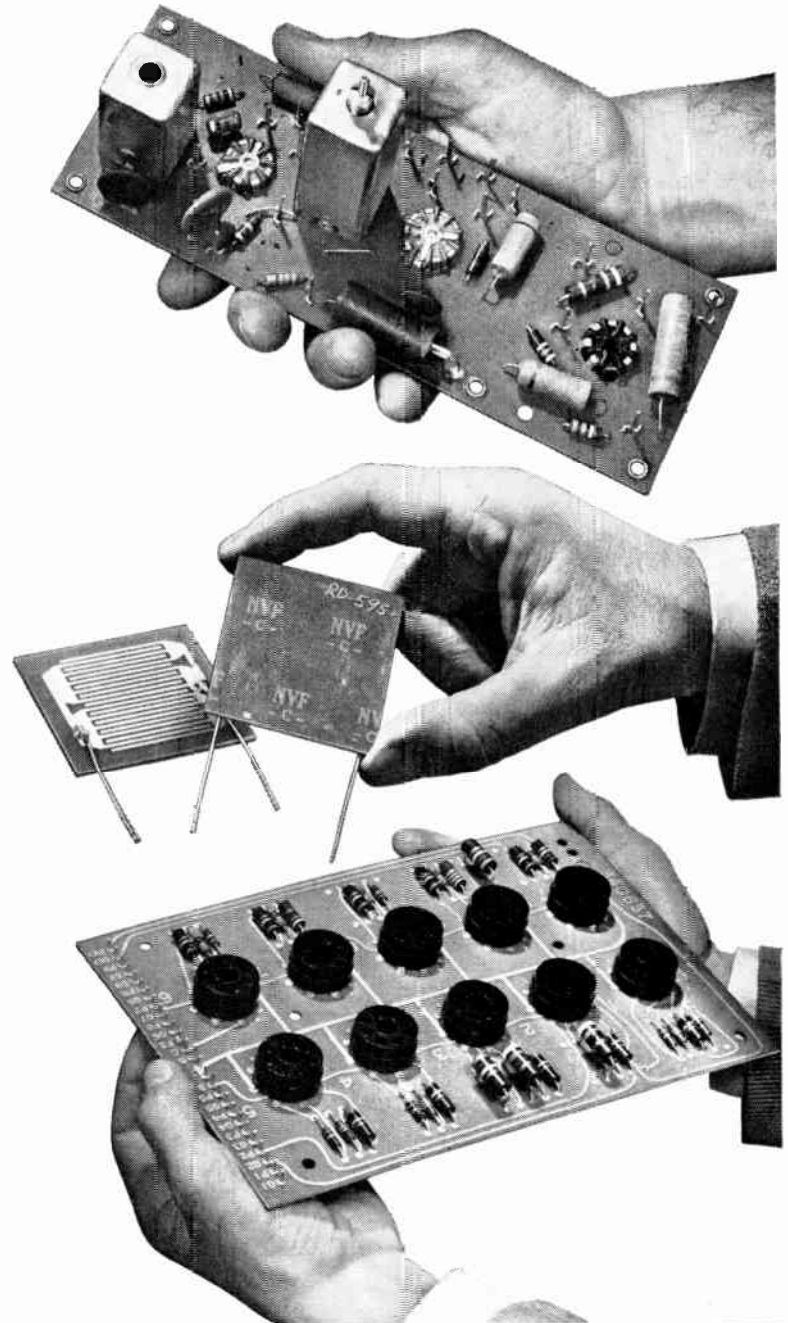

TYPICAL TEST VALUES ON COPPER CLAD PHENOLITE

GRADE	PROPERTIES OF BASE MATERIAL					COPPER CLAD PROPERTIES				RELATIVE COST
	Dielectric Constant	Dissipation Factor	Moisture Absorption	Flexural Strength	Maximum Operating Temperature	Copper Bond Strength		Hot Solder Resistance	Surface Resistance	Based on XXXP on Arbitrary Scale of 1
	10 ⁶ Cycles	10 ⁶ Cycles	¼", % 24 Hrs	Psi	Degree F	Pounds to Pull 1" Strip		Secs to Blister 1" Square > Greater Than	Megohms, Etched Retma Comb Pattern, 96 Hrs/35°C/90% RH	½" Thk. 1 Oz. Copper 1 Side
						1 Oz	2 Oz			
P-214-B-1	5.3	.040	2.20	18,000	250	8	11	> 10 @ 475°F	100,000	.81
XXP-209-G-1	4.6	.037	1.30	17,000	250	8	11	> 10 @ 475°F	200,000	.92
XXP-239-1 PHENOCLAD	4.2	.035	0.67	15,500	250	8	11	> 10 @ 475°F	200,000	.92
XXXP-219-C-1	4.5	.030	0.70	15,500	250	8	11	> 10 @ 475°F	500,000-1,000,000	1.00
XXXP-455-1	4.0	.026	0.55	23,500	250	8	11	> 10 @ 475°F	1,000,000-1,500,000	1.00
XXXP-470-1	3.7	.027	0.48	14,000	250	8	11	> 10 @ 475°F	300,000-500,000	1.00
N-1-852-1	3.3	.030	0.20	16,000	165	8	11	> 10 @ 450°F	2,000,000	2.69
G-5-813-1	6.8	.018	1.00	55,000	300	8	11	—	—	2.98
G-10-865-1	5.2	.012	0.13	60,000	250	10	15	> 30 @ 500°F	1,500,000-2,000,000	3.49
G-11-861-1	4.9	.015	0.17	60,000	300	10	15	> 30 @ 500°F	2,000,000	3.55

For further data on advertised products use page 69,

the editor's page

*A commentary on affairs
pertinent to the electronics
and communications industries.*

“Zeta’s Little Sister”

ONE of the most outstanding scientific developments of recent times, notwithstanding the launching of Russia’s Sputniks and the “placing in orbit” of the United States Explorer has been the creation by British scientists of what is commonly known as a “man made sun”. An interesting insight into this achievement and the men who have brought it about is reported by John Wingfield from London who says:

“During the hullabaloo over ZETA, the British machine which was the first in the world to control the tremendous forces of hydrogen power, very little has been said, or heard, of Sceptre — ‘Zeta’s little sister’.

And that is a pity. For it may be Sceptre’s successors — and not ZETA’S — which will eventually give the world abundant electric energy from fuel drawn from the sea.

Indeed, it is not generally appreciated that Britain has had two scientific teams working on the problems of controlled H-power — and that both have built their own reactors.

Bad planning? A waste of scientific brain-power? By no means. For these two teams have worked in the closest possible collaboration — their laboratories are only 20 miles apart — but have set out to solve the same basic problems by using slightly different methods. The one which worked under free-enterprise conditions has produced what appears to be the more economical machine.

The results of the two teams’ work is ZETA — a comparatively large machine which has achieved temperatures of five million degrees, but uses millions of times more power than it generates — and Sceptre, a smaller machine which has achieved nearly four million degrees in return for far less power.

The story of these two teams began ten years ago, when preliminary work on thermonuclear power was started at Imperial College, by a team under Sir George Thomson, and at the Clarendon Laboratory, Oxford, by another team under Dr. P. C. Thonemann.

By 1950 the independent work of the two teams was showing such promise that the Government decided to transfer them to places which could be more conveniently guarded.

Thus in 1951 the Oxford group was moved to Harwell and the Imperial College group to the Associated Electrical Industries laboratory at Aldermaston. The Harwell team, with full Government financial backing, designed ZETA. The Aldermaston team has only been partly financed by the Government. Much of the cost has been borne by AEI itself, which has invested great sums in the Sceptre project.

The problem facing both groups was to generate an ‘H-Bomb’ reaction — without, of course, an explosion — in a laboratory.

The H-bomb owes its tremendous power to a process known as ‘nuclear fusion’. Under extremely high temperatures, atoms of heavy hydrogen — found in unlimited quantities in the sea — fuse together and form atoms of helium. In the hydrogen bomb the colossal heat needed to set off this reaction is provided by an atom bomb. The A-bomb explodes first; the heat reacts upon

the heavy hydrogen contained around it and sparks off a ‘thermonuclear reaction’.

The scientists, therefore, had to generate heat equivalent to that produced by an A-bomb explosion in order to spark off their hydrogen reaction — and at the same time keep everything under safe and perfect control.

Both teams began tackling this problem in much the same way. The method they used is now fairly well known. They built a glass tube filled with heavy hydrogen and shaped like an ‘O’, and discharged high-energy current through it. In the late summer of last year, the group at Harwell — with their machine ZETA — succeeded in creating a controlled reaction, closely followed by the Aldermaston team working on Sceptre.

But what is not so widely known is the nature of the complex difficulties which even now have not been fully resolved.

Early attempts to produce high temperatures in the O-tube — technically called a ‘torus’ — failed because the discharge was highly unstable. Instead of remaining straight, and running around the center of the tube, it developed ‘kinks’ which grow at the fantastic rate of two million miles an hour, and touch the tube walls. This kinking, which the scientists call ‘wriggling’, not only causes severe heat losses but also vaporizes the tube — at five million degrees even the toughest material becomes white-hot gas.

It took four to five years of patient research to overcome this difficulty — and much more remains to be done.

Both ZETA and Sceptre have maintained their tremendous temperatures for the scientifically long time of thousandths of a second — thousands of times better than the Americans, who can maintain their reaction only for millionths of a second.

But before hydrogen power can be used to generate electricity for homes and industry, the temperatures inside the machines must be far greater — scientists are talking of creating temperatures of 100 million degrees — and must be maintained for far greater periods. Only then will these machines generate more power than they consume — ZETA, for example, uses up a billion times more power than it generates.

This is why Sceptre may yet prove to be the more valuable line of research. It is a good deal smaller than ZETA, and so far has not yielded such high temperatures, but the temperatures it has attained have been generated much more economically. It may well be that we will find that the smaller reactors are the more efficient in practical use.

Whatever the outcome, whether reactors of the future be giants or pygmies, whether the first thermonuclear power station is built by Britain, Russia or America, the whole world owes an incalculable debt to the men of Harwell and Aldermaston and to the great free-enterprise concern behind them.

Britons are proud that they were first. They may well have changed the future of the world, and laid the foundations of prosperity for generations to come.”

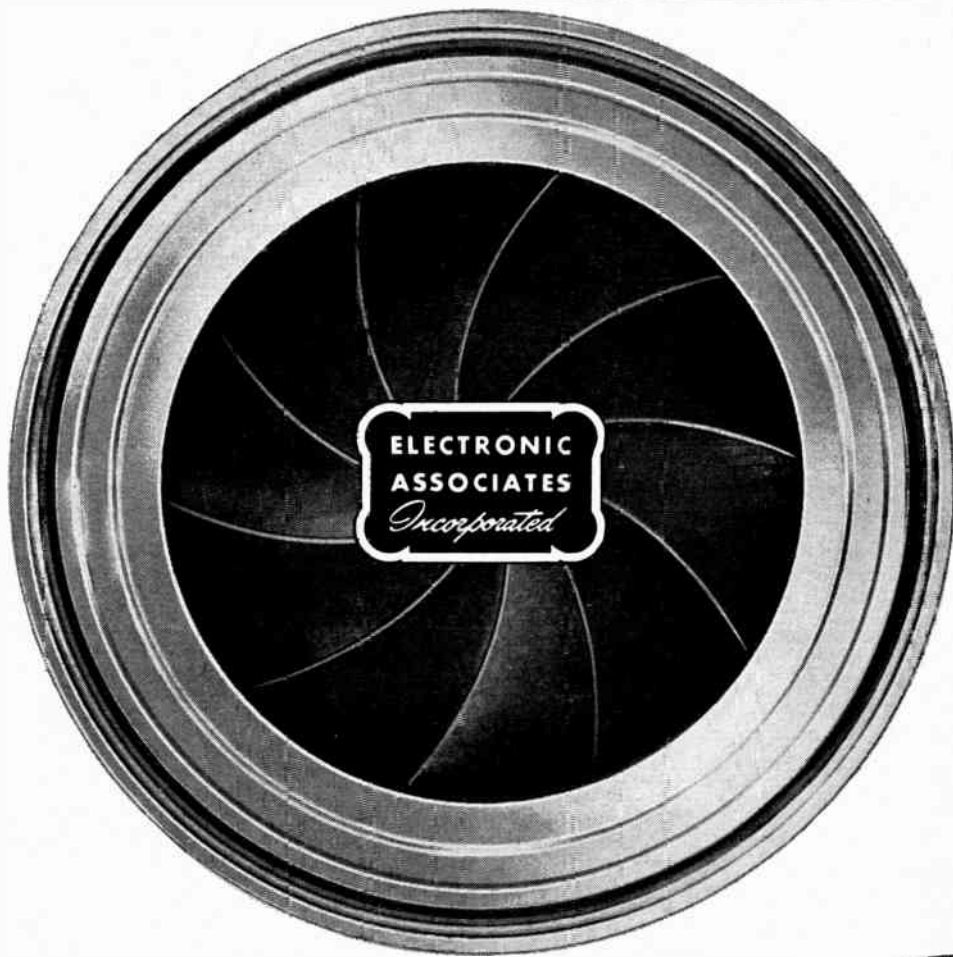

8 Channel Rectilinear Recorder

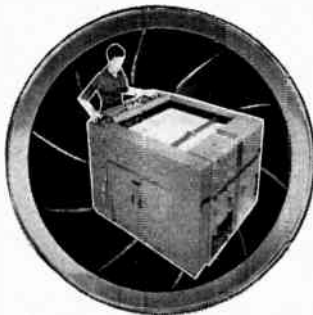

Daraplotter - Line plotter

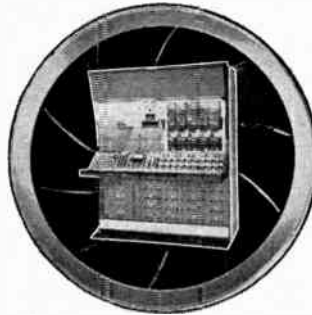

231 R Analog Computer

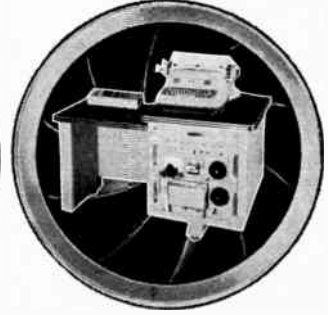

Analog Computer Automatic Digital Input-Output System

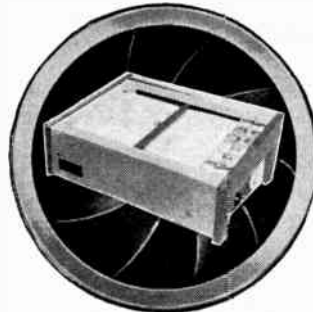

1100D or E Variplotter

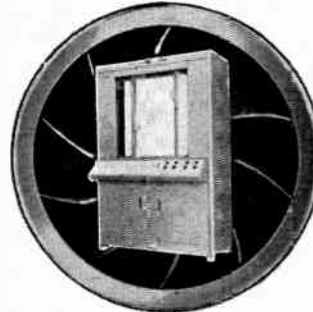

205N Variplotter

FOCAL POINT OF THE ANALOG COMPUTING AND PLOTTING INDUSTRIES

THE ONE SOURCE you naturally look to for the very latest advances in the arts of data reduction, analog computation, and plotting, recording, or digital read-out equipment. *Write Dept. EC-3.*

See Electronic Associates' equipment demonstrated at the IRE Show, March 24 to 27, the Coliseum, New York. Our booth numbers are 1202 thru 1208.



••••• MANUFACTURERS OF



LONG BRANCH, NEW JERSEY • TEL. CAPITOL 9-1100

For further data on advertised products use page 69.

FORWARD WITH CANADA

Blueprinting the Future...

Today, more than ever before,
Canada's future is being shaped
by the slide rule
and the drawing board.

In every construction project,
in communications, power development
and in public utilities,
innumerable items of electrical equipment
are required.
Ordering these units
calls for a high degree
of planning and co-ordination.

Purchasing from Northern Electric
gives you immediate access
to over 100,000 items
which are the dependable products
of more than 1,000 manufacturers.

With Northern Electric offices
and warehouses throughout Canada,
electrical supplies and equipment
are always available to you
at short notice.

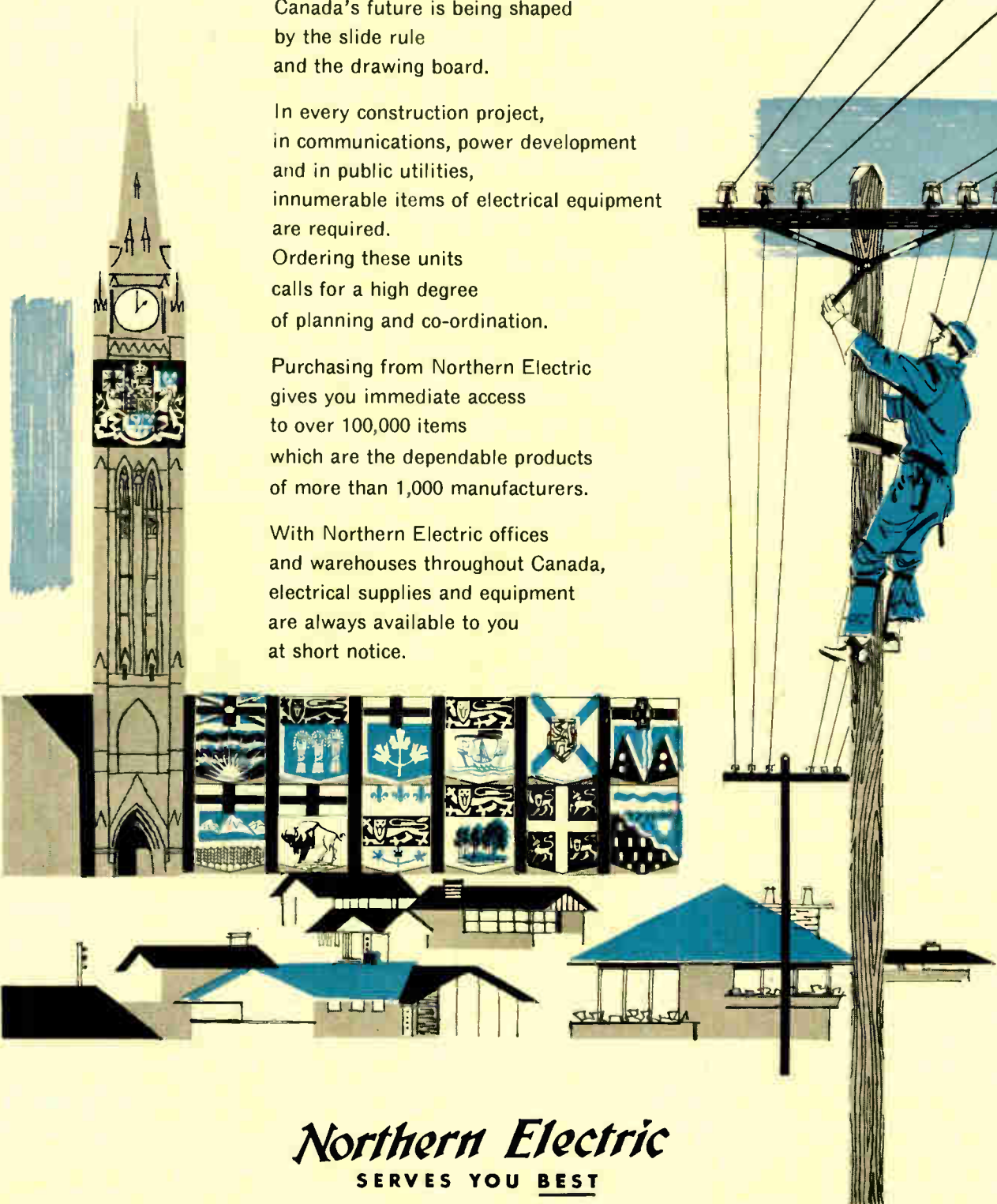

Northern Electric
SERVES YOU BEST

6658-2

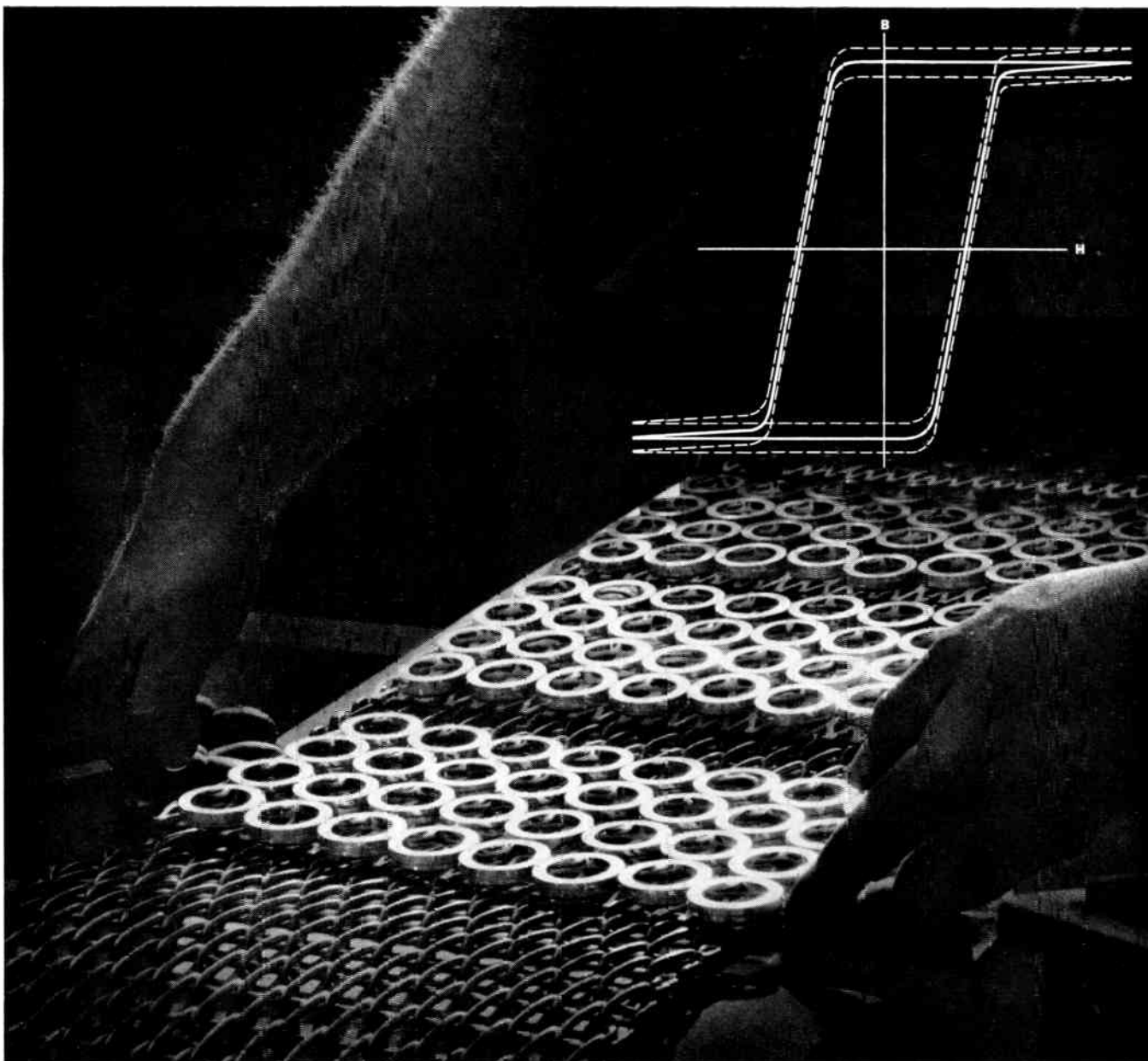

Now—guaranteed maximum and minimum performance limits for tape wound cores!

For the first time you can order tape wound cores with guaranteed performance to published limits.

All tape wound cores coming from the hydrogen atmosphere annealing furnaces at Magnetics, Inc. are tested by flux reset as proposed by the AIEE Working Group on Core Matching and Grading*. Thus, standard cores are given a standard test to give engineer-designers a standard component whose performance is guaranteed within fixed limits.

Magnetics, Inc. has established the limits to provide maximum, minimum and nominal B_m , B_r/B_m , H_i and gain performance data. It is published for one, two, four and six mil tape thickness for Orthonol® and Hy Mu 80.

Now it is possible for you to select and order cores specifically suited to your design (just as with any other standardized

component). You'll save many hours of experimenting, and because the reliability of the data is guaranteed, you'll be sure at every stage of design and production.

The published limits for Magnetics, Inc. tape wound core performance are ready now. Write for your copy:
Dept. EC-45, Magnetics, Inc., Butler, Pennsylvania.

MAGNETICS inc.

*Paper No. 58-71, Winter General Meeting, AIEE, February, 1958.
Flux Reset Test is one of two tests proposed for standardization.

For further data on advertised products use page 69.

The **Rogers 6360 twin tetrode**, is a Special Quality* miniature transmitting tube designed to give reliable, efficient and long life performance at V.H.F. up to 225 Mc s at maximum ratings.

Typical plate output power is 14.0 watts at 200 Mc s with a plate supply voltage of only 300 volts. As a tripler with an output of 175 Mc s, 5.5 watts is obtained with a plate supply voltage of 300 volts.

The 6360 is particularly suitable for push-pull operation in either fixed or mobile transmitters and may also be used as an amplifier, oscillator, multiplier, modulator or audio amplifier. In new equipment or for replacement purposes, this Special Quality tube provides high output at very low initial cost.

**Rogers Special Quality tubes are finding more and more applications in all types of professional equipment. The greater reliability and lower maintenance cost of the apparatus in which they are used more than compensates for the higher initial cost.*

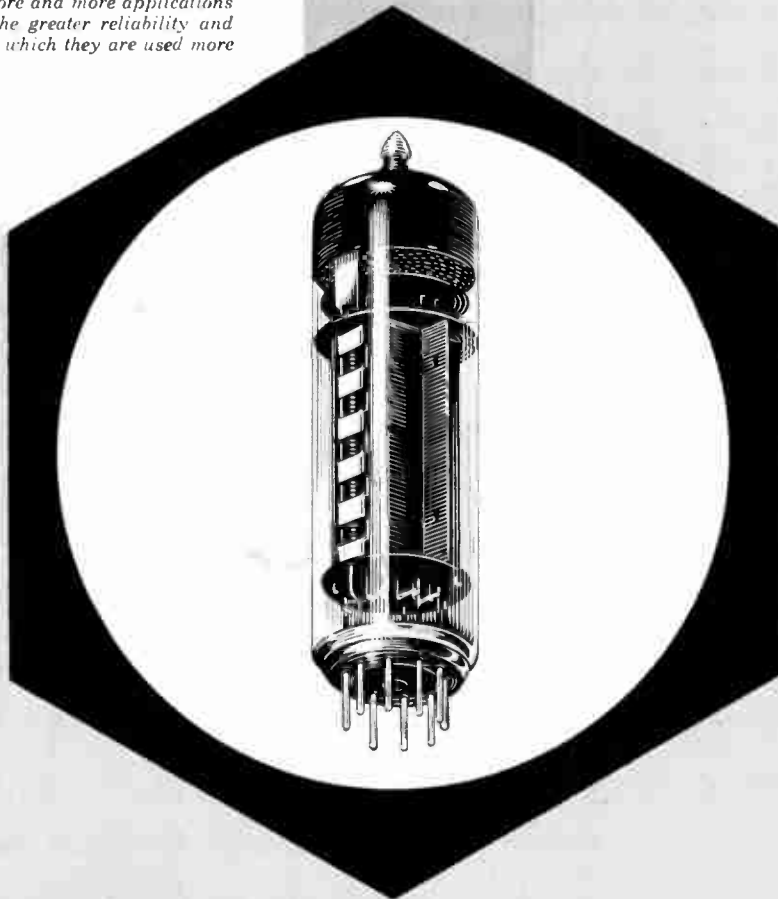

ROGERS

electronic tubes & components

A DIVISION OF PHILIPS ELECTRONICS INDUSTRIES LTD.

116 VANDERHOOF AVENUE, TORONTO, ONTARIO / BRANCHES: MONTREAL, WINNIPEG, VANCOUVER

★ Rogers Electronic Tubes are sold through Canada's Independent Electronic Parts Distributors

World Radio History

ARMATURE-FRAME — has semi "knife-edge" construction with good flux path; resists wear and guarantees fast, trouble-free operation.

CONTACT FINGERS — alloy leaf-spring type especially manufactured to Ward Leonard's own rigid specifications gives millions of trouble-free operations.

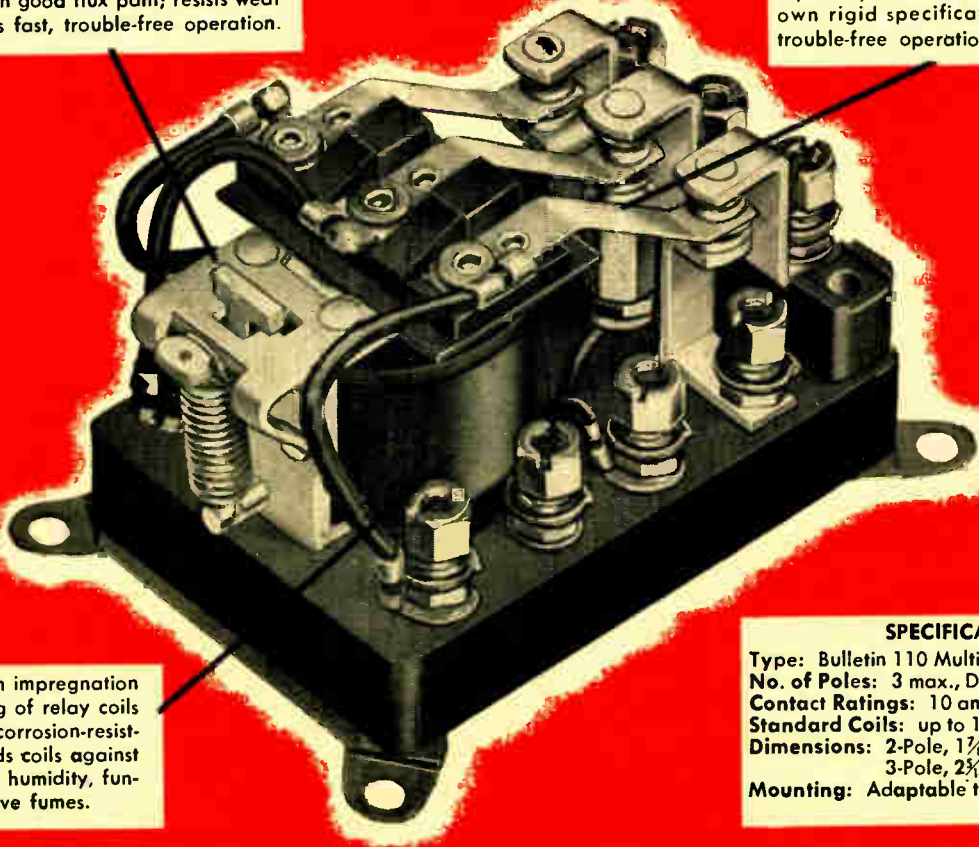

COIL — vacuum impregnation and end sealing of relay coils plus a special corrosion-resistant finish guards coils against salt spray, high humidity, fungus and corrosive fumes.

SPECIFICATIONS

Type: Bulletin 110 Multipole Midget
No. of Poles: 3 max., Double Throw
Contact Ratings: 10 amps., 115 volts, A.C. max.
Standard Coils: up to 115 volts, A.C. or D.C.
Dimensions: 2-Pole, 1 7/8" x 3" x 1 7/8" high
3-Pole, 2 3/8" x 3 3/8" x 1 7/8" high
Mounting: Adaptable to plug-in mounting

Here's why you get long life from Ward Leonard relays

• When applied properly and given normal care, Bulletin 110 relays, shown above, have a life expectancy of several million operations. Such exceptionally long life, typical of Ward Leonard's relay line, is made possible by: 1. Good mechanical design. 2. Quality-controlled manufacturing methods and materials. 3. Ample "safety-factor" electrically and mechanically.

Whether your product is a complex electronic instrument or a simple household gadget, our engineers will be glad to help you select the dependable electrical controls you need. Write Ward Leonard of Canada Ltd., 1070 Birchmount Rd., Toronto 16.

SHOWN AT RIGHT are typical Ward Leonard relays designed to meet your specific requirements in dimensions, methods of mounting, circuit connections, contact materials, coils and other features.

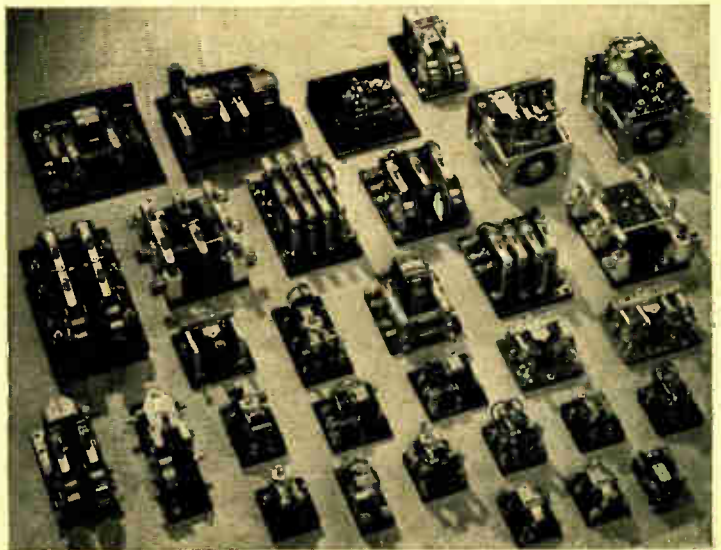

5801



**WARD LEONARD
OF CANADA LIMITED**

1070 BIRCHMOUNT ROAD TORONTO 16



CANADIAN FACTORY AND HEAD OFFICE

Resistors • Rheostats • Relays • Motor Controls • Dimmers • Switchboards • SAFT Batteries • Barkelew Switches • Kenco Pumps

World Radio History



MODEL 372 SLIDING COAXIAL TERMINATIONS

This equipment, available only from Narda, provides the most convenient means for evaluating the residual VSWR of coaxial slotted lines. VSWR of the element is 1.05 or less; covers range from 2000 to 12,400 mc.

N Connector, male or female \$110 C Connector, male or female \$116



MODEL 371 FIXED COAXIAL TERMINATION

This Narda coaxial termination is the first and only to cover the entire frequency range from S to X band. Same range and element VSWR as above.

N Connector, male or female \$55 C Connector, male or female \$58

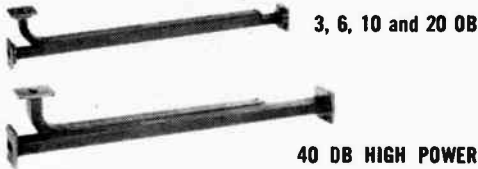

3, 6, 10 and 20 dB

40 DB HIGH POWER

HIGH DIRECTIVITY COUPLERS

The 40 db High Power Coupler is another exclusive Narda product. Similar to standard types, except that coupling irises are in the narrow wall, it may be used at full rated power of the waveguide size. Nominal coupling value is 40 db; directivity 40 db. Directivity for 3, 6, 10 and 20 db couplers is also 40 db. Standard cover flanges on primary line; low VSWR termination and standard cover flange on secondary. All bands covering frequencies from 2600 to 18,000 mc.



STANDARD REFLECTIONS

Narda offers five values of reflections for each of six different waveguide sizes... the most complete choice we know of! Provides calibrated reflections or VSWR's for use in standardizing reflectometers or calibrating slotted line impedance meters.

SPECIFICATIONS

Reflection Coefficient	0.00	0.05	0.10	0.15	0.20
Accuracy	0.002	0.0025	0.0035	0.0045	0.007
VSWR Equivalent	1.00	1.105	1.222	1.353	1.50

Models for 2.60 to 18.0 kmc, from \$125 to \$300

Microwave engineers—

Where can you use these exclusive features offered by narda?

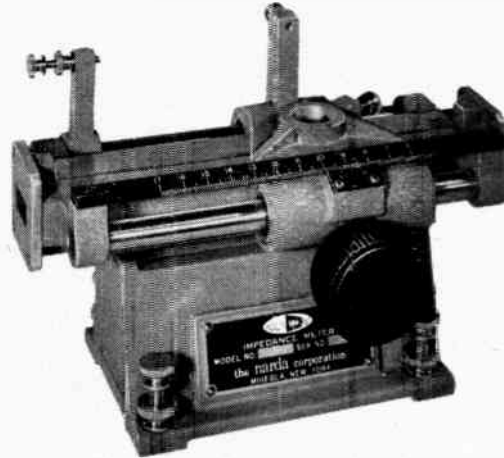

Waveguide and Coaxial IMPEDANCE METERS

Exclusively in Narda Waveguide and Coaxial Impedance Meters, the carriage mounting and drive mechanism are integral with the precisely machined transmission line casting. This insures permanent accuracy and freedom from slope errors—no more tedious adjustment or possibility of misalignment.

Other features include angle-mounted scale and vernier for optimum visibility; readily removable supporting pedestal; and smooth carriage travel action. Waveguide models, accurate for VSWR's of 1.01, are available for complete coverage from 2600 to 18,000 mc; N or C Connector coaxial models, from 1500 to 12,400 mc.

WAVEGUIDE IMPEDANCE METERS

Frequency (kmc)	Narda Model	Residual VSWR	Price
2.6 — 3.95	224	1.01	\$425
3.95 — 5.85	223		350
5.3 — 8.2	222		325
7.05—10.0	221		270
8.2 —12.4	220		250
12.4 —18.0	219		270

COAXIAL IMPEDANCE METERS

Frequency (kmc)	Connectors (One Male, One Female)	Narda Model	Price
1.5 to 12.4	Series N	231	\$360
1.5 to 12.4	Series C	232	390

Complete Coaxial and Waveguide Instrumentation for Microwaves and UHF—including:

- DIRECTIONAL COUPLERS
- TERMINATIONS
- FREQUENCY METERS
- HORNS
- TUNERS
- ECHO BOXES
- SLOTTED LINES
- BENDS
- ATTENUATORS
- STANDARD REFLECTIONS
- BOLOMETERS
- THERMISTORS

MAIL COUPON TODAY FOR FREE CATALOG AND NAME OF NEAREST REPRESENTATIVE

The Narda Microwave Corporation
160 Herricks Road
Mineola, N. Y.

Dept. EC-1

NAME

COMPANY

ADDRESS

CITY PROV.



the narda
microwave corporation

160 HERRICKS ROAD, MINEOLA, N. Y. • PIONEER 6-4650

● Figure 1 to the right shows the TV camera focussed on the X-Ray equipment and "image amplifier" at the recent demonstration of this equipment at the Jean-Talon Hospital, Montreal.

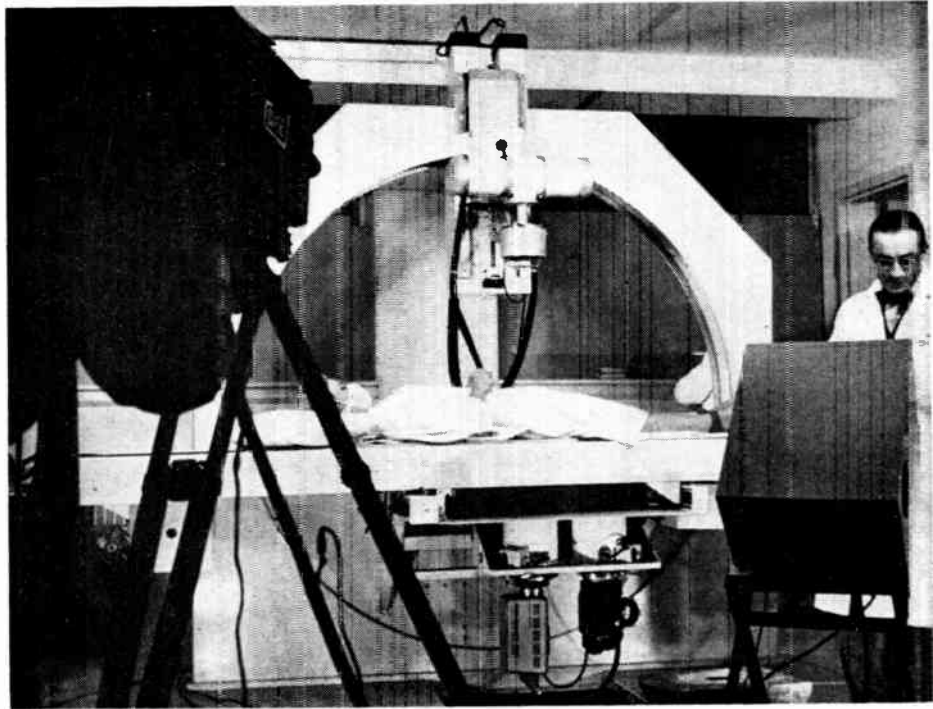

A medical telecast performed at the Hotel Dieu and Jean-Talon hospitals in Montreal recently demonstrated a greatly improved method of fluoroscopic diagnosis. A new device, developed by Philips Electronics Industries, amplified the dim fluoroscopic image so that, for the first time, it could be picked up and successfully transmitted by the TV camera. Seated in the Hotel Dieu auditorium, one hundred doctors saw flashed before them on a movie screen an actual fluoroscopic examination of a patient at Jean-Talon Hospital three miles away. Advanced electronic and other special equipment used in the demonstration included the Jean-Talon Hospital's large new X-ray installation and Philips closed-circuit television cameras and receivers, as well as the "image amplifier". The following article reported by Philips, Eindhoven, Netherlands, describes the

X-Ray Image Intensifier

Courtesy Philips Industries Limited, Toronto and N. V. Philips Eindhoven (Netherlands)

THE X-ray image intensifier described in this article offers the possibility of obtaining X-ray images of good contrast and sharpness without subjecting the patient to a dangerous X-ray dose. The image intensifier thus offers in fact the only practical solution for cinematography. Further important applications are industrial fluoroscopy and radiography and televising X-ray shadow pictures of moving objects.

Whereas the amplification of very small voltages and currents by means of electronics has become plain sailing ever since the electron tube was introduced, a new branch of electronics — the intensification of light — has emerged recently, partly owing to the stimulus of television. The original object of this development was the conversion of long-wave into short-wave light ("wavelength transformation"), which was investigated in Philips' laboratories as long ago as 1934. Now, however, the emphasis is on luminance intensification with special reference to the intensification of weak fluorescent images.

The research work in this field has led, amongst others,

to the development of the X-ray image intensifier), which offers the possibility of extracting as much information as possible from the fluorescent image of the particular object, for a given X-ray dose, or — and this is even more important — of minimising the X-ray dose to which the patient is subjected, for obtaining the required unification.

That the ordinary fluoroscopic image has only a very low luminance level is a fact of which every radiologist is aware. The consequences of this are very serious. Not only is the observation of such a dim image very fatiguing, but also the capacity of the eye for detail perception is very limited at these low levels. The luminance for instance of a normal image of the stomach is of the order of 0.003 cd/m² or about 0.01 asb. At this level, detail perception takes place with the peripheral rods which allow of only very limited discrimination. And even for this the

¹⁾ M. C. Teves and T. Tol, Electronic Intensification of Fluorescent Images, Philips techn. Rev. 14, p. 33, 1952 (No. 2). The Application of the X-ray Image Intensifier, Philips techn. Rev. 17, p. 69, 1955/56 (No. 3).

observer has to adapt his eyes very thoroughly, a procedure which takes 15-30 minutes. It is therefore not surprising that from the beginning of fluoroscopy the need for higher screen luminance has existed.

It can be shown that with ordinary fluoroscopy the information in the screen depends on the X-radiation absorbed by the screen. However, the observer cannot extract all this information, owing to the weakness of the optical link between the fluorescent screen and the human detecting organ (that is, the retina of the observer's eye). The same applies to fluorography (miniature radiography), which likewise involves an appreciable loss of light in an optical link, viz. that between the fluorescent screen and the film; the loss is so great that only about 1 per cent of the information latent in the screen is transmitted to the film.

Full-size radiography is very much better in this respect. The direct optical contact between fluorescent screen and film here prevents any loss of light, but it has the disadvantage of a relatively high dose being administered to the patient and of being expensive.

With regard to the first two methods referred to, an image intensifier considerably increases the amount of information obtainable with a given dose. Compared with full-size radiography it offers the advantage that it enables the dose to be reduced. A further advantage of the image intensifier is that cinematography can be employed.

Another very important field of application is industrial radiology. Nowadays this reliable, non-destructive method of inspecting workpieces is used on a large scale, but when these are made of metal and have appreciable thickness, the conventional methods become impracticable. Due to the high absorptive power of steel, for example, normal X-ray shadow pictures obtained by fluoroscopy are very faint, and the detail perception is poor, whilst radiography becomes very time-consuming and expensive. The considerable increase in luminance given by means of the image intensifier reduces or even eliminates these objections.

Finally, the combination of a television camera tube and the image intensifier offers very interesting possibilities that have not yet been completely investigated at present.

Hence the main purpose of the image intensifier is to make good the light loss in the optical link between the fluorescent screen and the light detector (retina of the eye, photographic film or plate, or, possibly, the photo-cathode of a television camera tube).

Description

The image intensifier is an evacuated glass envelope containing a fluorescent screen on a thin aluminum base (Fig. 3); in contact with the screen is a photo-cathode. X-radiation striking the screen makes it fluoresce, and the light then releases electrons from the photo-cathode. The number of electrons so released from each point on the cathode is proportional to the luminous intensity of the fluorescent screen at that point. By means of an electric field, the electron image thus formed is reproduced, reduced 9 times in size, on another fluorescent screen, the viewing screen. Part of the energy of the electrons striking this screen is reconverted into fluorescent light to form a 9 times smaller facsimile of the image on the first fluorescent screen. This facsimile can then be viewed through a simple eyepiece of roughly 9× magnification, so that the image is seen in its original size, that is, roughly 13 cm in diameter, and upright, but about 1000 times brighter than originally.

The luminance intensification arises from two factors (which, however, are not independent of each other).

Firstly, an increase in the overall luminous flux (or "lumen intensification") due to the fact that the electrons from the photo-cathode are accelerated by the electric field; there is an accelerating voltage of roughly 22 kilovolts between the photo-cathode and the viewing screen. The higher the energies of the electrons striking the viewing screen, the more intense the fluorescence produced. Although only about 1 in every 10 light quanta falling on the first fluorescent screen releases an electron, and only about one tenth of the electron energy is converted into light on the viewing screen, the energy imparted to the electrons nevertheless results in the latter screen producing between 12 and 20 times as much luminous flux as an ordinary fluorescent screen viewing the same subject.

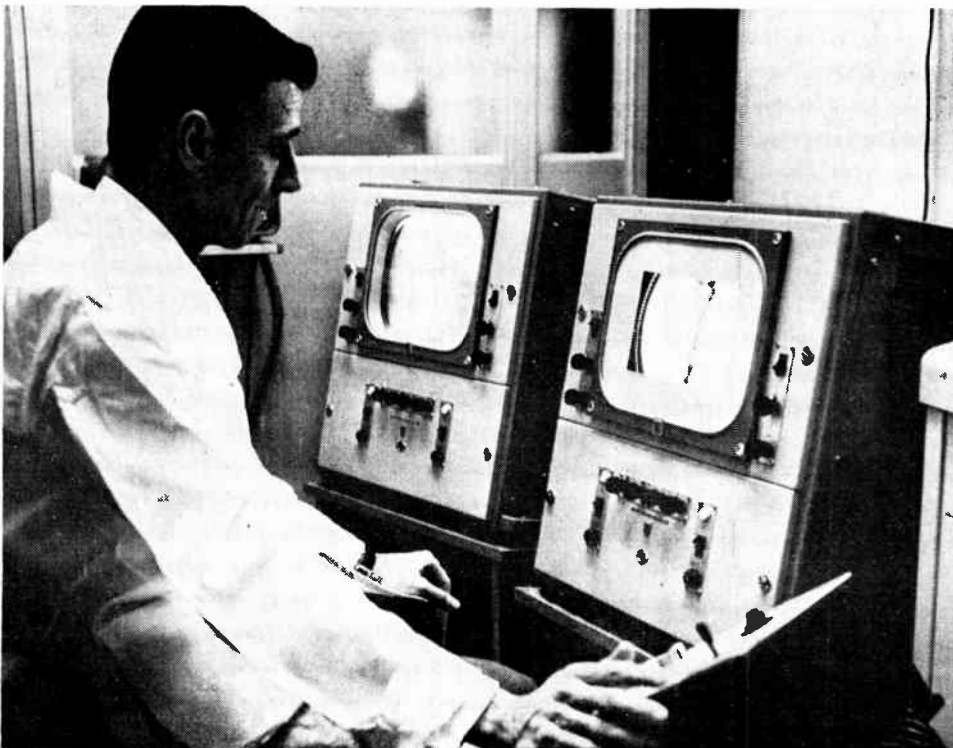

● Figure 2 above shows the TV receivers in the Hotel-Dieu Hospital demonstration with the screens carrying the visual information which was projected in the auditorium.

The second factor is the electron-optical reduction of the image size; it enables all the photo-electrons to contribute to the formation of the image, so that the amount of light generated does not depend upon the area over which these electrons are distributed. By employing a reduction of 9 times, the area within which the electron energy is concentrated is reduced by a factor of 9^2 ; hence the total luminous flux is emitted from an area about 80 times smaller than it would be with reproduction on a scale of 1:1. This, by definition, means an increase in luminance by a factor of 9^2 . The total luminance intensification is the product of the lumen intensification and the gain from the reduction of the image size; with the tube under consideration, it is between 10 and 20 times 9^2 , or from 1000 to 1600. Thus the luminance is so increased as to make good all the light loss involved in the forming of the image.

Fig. 4 shows the complete image intensifier with its HT generator, and the binocular viewing system fixed to the housing that contains the tube.

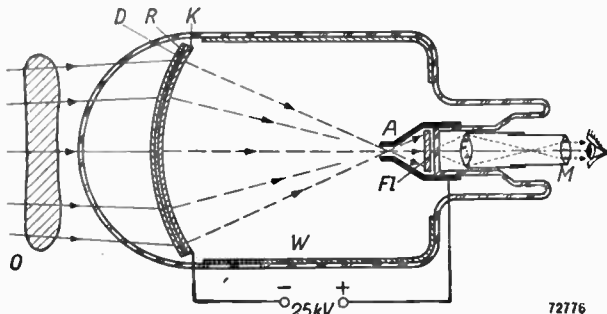

● Fig. 3. Schematic cross-section of the X-ray image intensifier tube. *R* fluorescent screen receiving the X-radiation after it has passed through the object *O* and the glass wall of the tube; *D* support carrying the fluorescent screen and the photo-cathode *K*. The fluorescence produced in *R* releases electrons from the photo-cathode. The "electron image" is reproduced, reduced in size, on the viewing screen *FI* by the electric field between *K* and the hollow anode *A*. It can then be observed through a simple microscope *M*. *W* is the conductive lining of the tube.

Possibilities and Limitations

The main factors that determine whether the outlines of an X-ray image will be seen are the *contrast* of its parts and their *sharpness*. When looking at the whole mechanism of the image formation, distinction should be made between two main parts: the formation of the latent X-ray image, and its intensification and transformation into visible light by the intensifier.

It is obvious that the better the latent image the better the visible image will be. Therefore it is advisable first to consider whether and how the latent image can be improved. It is a well-known fact that the contrast of an X-ray image is increased by lowering the X-ray tube voltage and reducing the scattered secondary radiation. Sharpness is in turn improved by the use of a small focal spot. Most precautions taken to improve the primary image have a tendency to lower the luminance of the fluoroscopic image and therefore their use is restricted. Now it will be clear that all those restrictions are more or less overcome by a device which gives a considerable increase of the luminance. It is quite often more profitable to use part of the gain in luminance to improve the primary image by decreasing the voltage of the X-ray tube, by the use of grids and the use of a fine focus whose lower loading capacity is offset by the better definition of its pictures.

The two main factors will be discussed separately.

Contrast

The process involved in the intensification and transformation of the primary X-ray image into a visible one by the image intensifier are all linear processes. In other words the "gradation" of the tube is unity ($\gamma = 1$),

which means that the contrast of the image as such is not improved. This does not mean, however, that the perception of the contrast cannot be improved. Three steps can be distinguished:

- The latent image has such a high initial contrast that a normal fluoroscopic screen shows it clearly. In these cases the advantage of the intensifier is not its better contrast perception but its possibilities of obtaining sharper images at lower dosage rates and with higher luminance, that is to say, requiring less adaption.
- The latent image has initial contrasts that would be visible to the cones of the fovea centralis but, on account of the low brightness level, are only observed by the peripheral rods which have only a reduced discriminative power. Here the primary advantage of the intensifier is obvious. Not only does it give the improvements mentioned sub (a), but it lifts the whole picture to a brightness level where the cones take over observation. These more sensitive organs can perceive contrasts where the rods fail; in other words a sub-liminal contrast becomes now supra-liminal and can be observed.
- The latent image has such low contrasts that, even after intensification and observation they remain sub-liminal. In these cases the image intensifier gives no improvement. Although the luminance of the image is increased, it does not give more information (cf. the so-called "empty" magnification of microscopic observations).

It will thus be clear that in all cases it is of advantage to increase the contrast of the primary image as far as possible.

Sharpness

With regard to sharpness or definition, the image intensifier is in a far better position for the following reason. The normal fluoroscopic screen is necessarily a compromise between grain size and light output. Modern screen techniques have been greatly improved, but exceedingly fine-grained screens would have such a low brightness as to make them impracticable for normal use.

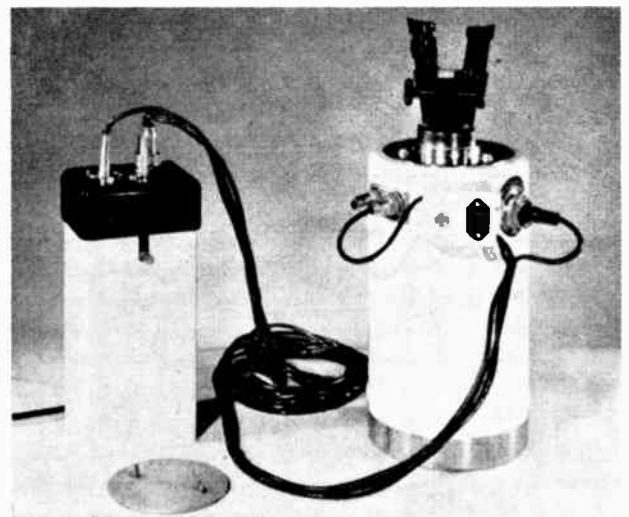

● Fig. 4. Complete image intensifier with HT generator and binocular viewing system.

The X-ray screen in the image intensifier is not meant to be observed and is not, therefore, subject to the above compromise. Consequently, utmost care could be paid to grain size, with the result that this has been reduced to a degree where it is no longer a factor in the determination of picture sharpness. The viewing screen is not excited by the relatively low X-ray intensities, but by accelerated electrons, and therefore, although a certain light-producing efficiency is naturally necessary in this case, it does not impose restrictions on the grain size.

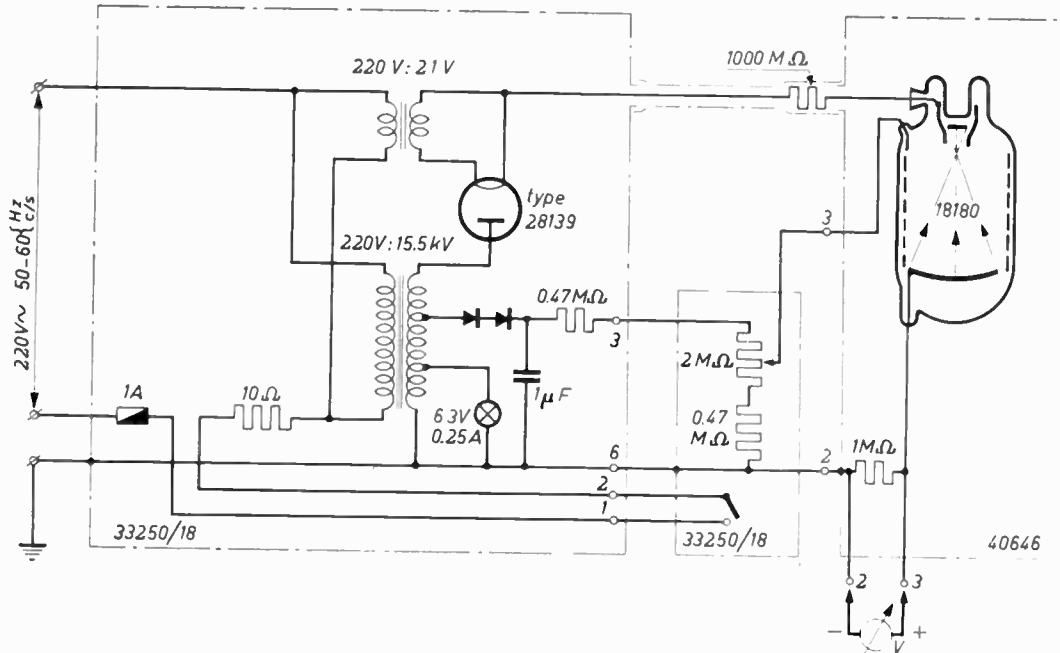

● Fig. 5. Circuit diagram of the HT generator 33250/18.

The result of this favorable combination is an overall definition that is much better than that of the normal fluoroscopic screen. The image of the intensifier has a definition of about thirty black and white lines per cm in the central part of the picture and of twenty lines per cm in the periphery. It is thus not surprising that photographs taken of this picture with a suitable optical system and on sufficiently fine-grained films show an improvement in sharpness over normal photofluorographic pictures.

Another phenomenon is caused by the mechanism of the image formation. The intensifier tube, like all electron tubes, is subject to the fact that free electrons are separate entities and that a beam of them is not continuous but is composed of discontinuous units. But also the latent image is formed, not by a continuous stream of energy but by a varying stream of discrete units: the X-ray quanta.

This mechanism shows the phenomenon of statistical variations, determined by the basic structure of all these processes and which cannot be influenced by technical counter-measures. These variations in the intensity of the radiation appear in the final image as tiny luminance variations changing place and giving an impression as if thousands of luminous ants were crawling over the picture area in all directions. From the nature of the phenomenon it follows that the effect becomes more noticeable as the initial radiation intensity is decreased. For this reason there is a lower limit to the useful decrease of the X-ray intensity.

Optical Aids

It is neither necessary nor customary to employ optical aids in the examination of an X-ray image on a conventional fluorescent screen. However, to resolve the detail of the image, the eye must be properly adapted to the low luminance level of the screen.

With the image intensifier, however, precisely the

reverse holds good. Although bright enough to be examined under ordinary room lighting, the visible image formed in the intensifier is so reduced by the electron-optical system that optical instruments are required to enable the details to be perceived.

The short survey below gives an impression of the various optical aids by means of which the image of the intensifier can be observed. These accessories can be interchanged at a moment's notice by permanently fixing the prefocused adaptor 36702/00 onto the housing of the intensifier.

- Binocular system 36714/02. This is based on the same principle as a binocular microscope and gives a magnification of roughly 9 diameters.
- Fluoroscopy reflector 36710/02. This is in fact a periscope by means of which a magnified image can be observed from various points.
- "Arriflex" camera 36704/02. By means of the image intensifier and this camera, cinematography is possible without risking overdose of the patient or overloading of the X-ray tube.
- Spherical correction plate with lens 36704/02. By means of this correction plate it is possible to use various types of camera the focus of which is permanently adjusted to infinity.

Circuit Diagram

Fig. 5 shows the circuit diagram of the HT generator 33250/18. The smoothing of the HT is ensured by the capacitance of the HT cable combined with the 1000 MΩ series resistor. The auxiliary direct voltage applied to the internal screen of the image intensifier can be adjusted by means of the potentiometer on the control unit so that optimum sharpness is obtained. The reading of a tube voltmeter connected to terminals 2 and 3 is an indication of the tube current and hence of the X-ray dose.

Electronics In Industry

A noiseless electronic air conditioning system has been developed by an American company, whose officials forecast that electronics may be helpful to the homeowner of the future in protecting him from extremes of heat and cold. The system comprises large wall panels which become cold under the influence of direct electric heat, and produce a heating effect when the current is reversed. The system is said to be capable of maintaining a room temperature 25 degrees cooler, or considerably more than 25 degrees warmer, than the outside temperature.

Though management of small and medium sized business concerns have followed with interest the development of computers and their business application potential little has been written to inform small business management of the preliminary investigation steps that will determine for them whether computers can be used to advantage in their business operations. The following article deals with this aspect of electronic computation and presents a pattern of investigation that will show the value of

Electronic Computing For The Small Or Medium Sized Business

By L. E. Sandford *

EVERY businessman has read of the large electronic computing and data processing systems being installed by some of the giant corporations in Canada. The Canadian Pacific Railway, for instance, has an IBM 705 system in its Montreal office; Avro is using an IBM 704 for scientific and engineering problems; Shell has ordered

one of the IBM 700 series computers. UNIVAC II's have been ordered by London Life, Sun Life and Ontario Hydro. UNIVAC II's rent at approximately \$25,000 monthly. IBM 704's and 705's cost more. The salary bill for staff for one of these computers may amount to anything between \$5,000 and \$20,000 a month.

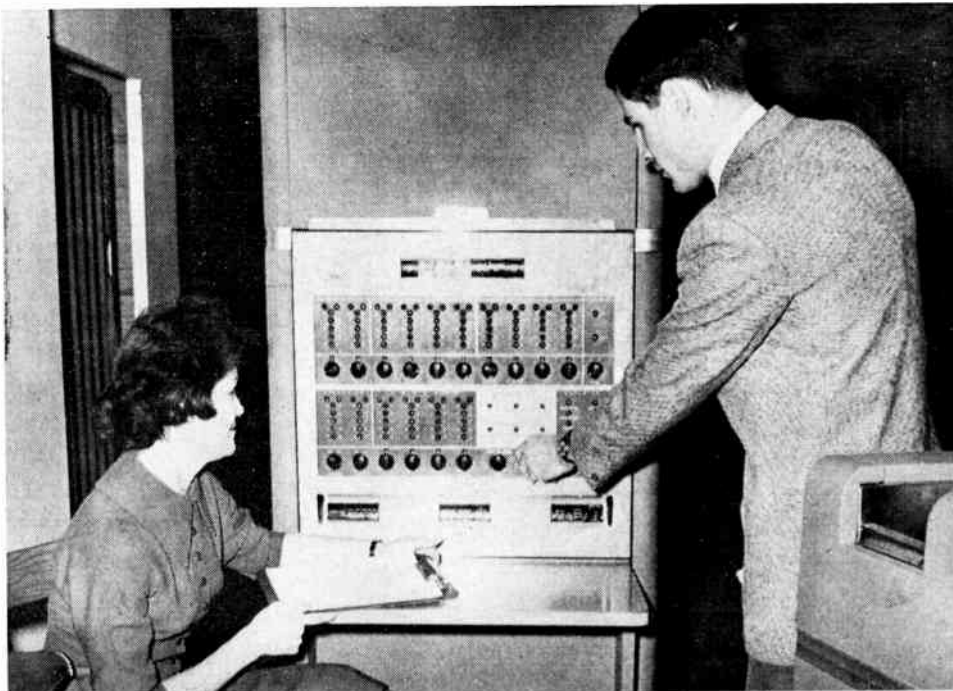

● The computer at work on an inventory control problem. Operators are shown manipulating the console to give a visible indication of the inventory data stored in the computer's magnetic drum.



● Members of the KCS staff check a computer's card output for a sales analysis problem in the above photograph.

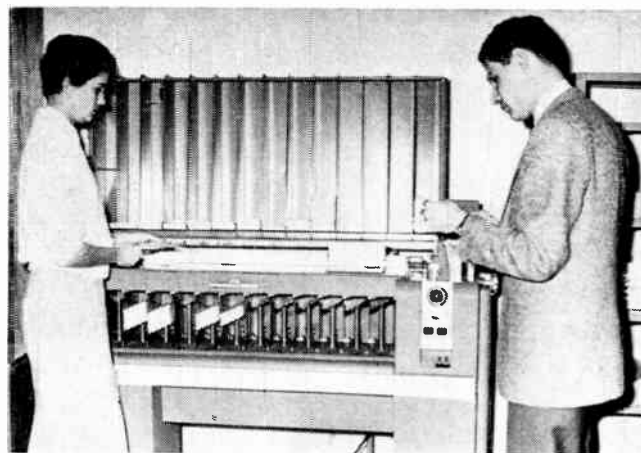

● Computer operators are shown in the above photograph operating an IBM sorter capable of sorting cards at a speed of 600 per minute.

Plainly all of these large computing systems are far beyond the pocket of the small or medium-sized company. But this does not mean that only the largest organizations can use computers. There are four possible ways in which the smaller businessman can get into the picture.

First he can consider the "baby" computers such as the Burroughs Electrodata I01 and 102, the McBee Librascope LGP 30, and the Bendix G 15. These rent from less than \$1,000 to under \$2,000 a month. In some circumstances a staff of only one or two persons would be sufficient to program and operate the equipment. Thus, smaller installations of this type, plus the necessary staff, can be thought of as involving an expenditure equivalent to the salaries of from five to a dozen clerks or stenographers.

Alternatively the small company need not acquire a computer at all, but can reap the advantages of electronic computation and data processing in one of three ways. Time can be rented on someone else's installation or work can be prepared and programmed for the computer, then handed over to a computing consultant or service bureau for processing. Also a consultant or service bureau can be called in to do the complete job, that is, to analyse the problem, program it, process the data on a computer and supply the required solutions, summaries, analyses and reports.

Costs

What will this cost? Naturally everything depends upon the complexity of the problem and the volume of data to be processed. To gain some idea, an IBM 650 Electronic Data Processing Machine normally rents at \$80.00 an hour. One hour does not sound very much but in that time the 650 can accept up to 960,000 digits on 12,000 80-column cards, make all the necessary calculations and produce answers up to 480,000 digits on 6,000 80-column cards. Programming time and program testing represent a further cost. A program is a detailed series of instructions telling the machine how to handle any given problem. Some programs for relatively simple jobs can be prepared in a matter of hours or days. For complex calculations, as for example those of the Operations Research type, several man-months or man-years of programming may be involved, but the small businessman will not be concerned with projects of this size. Computing consultants and service bureaux are accepting jobs which cost as little as \$500 to \$1,000 in all, that is, for analysis, programming and processing.

In short, if small or medium sized companies do in fact have problems or routines which lend themselves to electronic computing or data processing, the cost factor may not be an insuperable obstacle.

The businessman may well ask "What can a computer

do for me which cannot be done by other methods or can be done better than in any other way?"

Basically, a computer does no work which could not be carried out by a clerk with pencil and paper. It adds, subtracts, divides, multiplies, stores information, looks up tables, compares, and makes a few simple logical decisions. That is all. But, the computer has the edge on the clerk in a number of ways. Primarily it is speedier. Secondly, the computer is also far more accurate than the clerk. Try writing down twenty ten-digit numbers and adding them up. Add them up five times. How many different answers do you get? It has been said that if in the course of a year the entire population of New York dialled only one wrong number, that would be a fair representation of the degree of accuracy of an electronic computer.

Thirdly, the computer — unlike the clerk — does exactly what it is told to do. No more and no less. It has to be told only once and it does what it is told in a highly integrated fashion. A computer can be instructed by means of a program to take the number of hours an employee has worked, multiply by the rate per hour, adjust for overtime rates, deduct tax, Blue Cross, PSI, insurance contributions etc. at the correct rate, and calculate net pay. Once the computer has been programmed to do this, all that has to be fed into it for each pay period is the number of hours worked and adjustments, if any, in the rate of any of the deductions for each man. A computer can be given far more complicated problems than this — how much inventory should be carried — the best way of scheduling production — a forecast of sales — and the machine, provided it has been correctly programmed, will deal with the whole problem at once without the need for human intervention.

Lastly, depending upon circumstances, electronic computation or data processing may be the most economical method of carrying out a given task. In many cases it is not, and the advantages to be gained lie in other directions such as speedier decisions, better policies based on up to date and accurate information, improved customer service, and so on.

Are The Advantages Real?

All these advantages are no doubt very fine. They look good on paper. But, the businessman still has to determine whether he really wants to make use of them. He can get his information, reports, tabulations, etc. much faster, but does he need them faster? He can be sure of accuracy with the computer but do existing inaccuracies or suspected inaccuracies really bother him all that much? He can with the aid of a computer have certain operations carried out in a highly integrated way. Does this benefit him? He can speed up his decisions, make better decisions maybe, but are the improvements or hoped-for improvements really worth the trouble?

* Mr. L. E. Sandford is Business Applications Consultant, KCS Data Control Ltd., Toronto and Montreal.

There is no readymade answer to any of the questions. It is a case of finding out. Nor should the cost of finding out be disproportionate to the possible gains. An investigation costing \$5,000 one way and another, which results in the single discovery that advantages worth \$500 a year are likely to accrue from turning over a given operation to electronic computing, is an investigation that perhaps should never have been made.

How then can the small or medium-sized company get to know whether electronic computing or data processing is in the long run going to be of benefit?

Here is a suggestion. First, two, three or four senior executives — the Comptroller or Treasurer, the Chief Engineer, the Vice-President Marketing, the Vice-President Manufacturing, for example, should get together and decide that working independently of each other they will each make a quick survey and prepare a brief report. Each report will list the tasks for which the executive is responsible and which involve calculation or processing of numerical or alphabetical data in some way or other. Thus the Comptroller or Treasurer will list all the accounting tasks — payroll, inventory keeping, receivables, payables, budgeting, budgetary control, costing, cost control and so on which come within his purview. The Chief Engineer may be concerned with engineering or scientific or other calculations either as regular day-to-day tasks or from time to time. The Vice-President Marketing will no doubt be interested in sales forecasting, inventory, salesmen's commissions, marketing or consumer surveys etc. And the Vice-President Manufacturing will be concerned with production scheduling and a variety of related matters.

Each report should enumerate these tasks, state the volume of work involved, the staff employed on that work and any other relevant details, with dollar evaluations of costs wherever possible. The reports should also show — and this is very important — the information each executive would like to have if he could get it or could get it in time for it to be of any use. Thus, for example, if the Vice-President Marketing would like to have at 9 a.m. every morning on his desk a detailed summary of yesterday's orders and sales, he should say so in his report, even though he considers it is plainly impossible to get that information.

These reports should not be lengthy nor should too much time be spent on their computation. A lot will depend upon the size of the company, but often a one to five page report from each executive will be quite sufficient. Possibly the reports will have taken a day or so to compile.

The next step is a further meeting of the executives each of whom will have had the opportunity of reading all the other reports. This can be a brainstorming session at which each man asks any of the others "What about such-and-such?" "Don't you also do so-and-so?" "Would not this or that be of real practical use to you?"

One person, perhaps the Comptroller or Treasurer, will now assume the responsibility for combining the reports, eliminating duplication and producing possibly a ten or twelve page statement which is in effect a brief summary of everything done in the company which comes under the heading of calculation or processing of data plus everything the company would like to do if it were feasible.

Now things are on the move. The company does not pretend to know much or anything about electronic computing and data processing. But it has in a short space of time, with relatively little effort, reached the point where it can ask someone qualified to express an opinion "What do you think? Is electronic computing or data processing for us in any shape or form? Or should we forget all about it?"

Who should be asked? Logically the best person is one who has had a wide variety of practical experience in the application of electronic computing and data processing techniques to problems and routines in business and industry — and in particular to the small or medium-sized

concern. In short, just as a man goes to a doctor about his health, a dentist about his teeth, a cobbler about his shoe repairs, so he might well consider going to a computing and data processing consultant about his computing and data processing problems.

What will it cost? Probably nothing or next to nothing for a quick opinion if the company's report has been reasonably well prepared. A good computing consultant should be able to say after an hour or two's study whether there is any point in looking further into any particular areas, and he will quite likely be glad to do this without charge or at a very nominal fee. If the consultant feels that there is scope for a closer look, he will say so. He will indicate how long that closer look will take and what it will cost. It may for instance require one consultant's time for a week or two weeks or so. It should result in a report to the company which says item by item "Forget about this", or "This seems to be a worthwhile area for the following reasons", or "This is a possible, but leave it for now" or "You can do something about this but you don't need a computer — punched card methods should suffice". The report should also state whether or not, looking at things as a whole, the company might think along the lines of getting its own installation eventually, or alternatively, should have the work done by a Service Bureau or Computing Consultant.

Going Ahead

So, step by step, the company has made progress. Now it has something practical — albeit still very preliminary and tentative — to think about. It has not spent a lot of money, it has not wasted a lot of time. It is ready to make a decision to go ahead or not to go ahead. Ordinarily if it does go ahead, it will tread warily for some time. Even if there appear grounds for thinking that a computing installation on its own premises might be desirable eventually, it will be as well to get into the thing one step at a time. The consultant or service bureau can be asked to take over a given problem which seems to have distinct possibilities to analyze it, program it for the computer, process it and produce the desired summaries, reports, tabulations etc. The prudent course is probably to select one of the smaller problems or routines first and ask for a quotation. If the quotation is reasonable and if the problem is one which is already being solved by existing methods, it seems advisable to use those methods once or twice more even though the computer is also producing the answers. When — and not until — the company is satisfied that electronic methods have proven advantageous for Problem No. 1, it can consider going along with Problem No. 2. The important thing to note is that there are check points all along the road. The consultant's first quick opinion may be entirely negative. So the company stops right there. Or his preliminary report may be negative. Red light again. Or it may be encouraging up to a point but not sufficiently to arouse any great enthusiasm. Or the processing and solution of Problem No. 1 may not be a real success. The likelihood of failure materially diminishes as the company moves further along the line, but these check points are always valuable.

There are no doubt a number of other methods by which executives in the smaller companies can find out, with a minimum of expense, what, if anything, electronic computing and data processing can do for them.

Whatever the method the first hurdle will have been overcome when the vague generalities and the technical jargon so common in the computing field are pushed aside and a company gets down to asking itself, and answering, the basic questions — "What do we do or what would we like to do that a computer could do for us?" "If we use a computer, where and how is it likely to be of benefit to us?" The answers are important. They merit more than a few vague generalities and opinions based on a cursory reading of the subject. In these days of lower profit margins they could be vital to a company's whole future.

Repetition of effort and the consumption of valuable engineering time is the price paid by many companies in the investigation and selection of materials and components. The following article shows how a Materials and Standards Program can save up to 30 per cent of engineering time in the selection of appropriate materials.



● View of the component engineering sample files which are cross-referenced with supporting technical data.

Materials — Standards Program A Management Responsibility

By M. J. McKerrow *

FACED with increasing responsibilities in the electrical and electronic field, the designer-engineer must not only calculate the theoretical requirements of his circuit, but must take into account the general proportions of available parts and ensure that he is selecting and specifying the right items.

He must consider the performance requirements of his equipment; economic considerations for purchasing; availability and required quality level of the parts and materials used and other related factors which might affect his basic design. Consequently, the designer generally has to investigate, locate and approve every component, material and process for each project.

** M. J. McKerrow is presently Supervising Engineer, Materials and Standards Section, Electronics Division, Canadian Westinghouse Company Limited. He also serves as chairman of the Electronics Division standardization sub-committee, and as Secretary of the Drafting and Materials Control Committees. Mr. McKerrow was responsible for establishing the Hamilton/Toronto Section of the Standards Engineers Society, now comprising thirty-eight members. He is presently Chairman of the Section, and a member of the National Board of Directors of the Standards Engineers Society, Camden, N.J.*

One is, therefore, not surprised to find in an engineering department that each engineer must search for his information in specifications, manufacturer's catalogs, trade magazines, consult with supplier representatives and other sources. In effect the designer must compile his own "encyclopedia" of information for his purpose.

It is interesting to note that in many organizations anywhere from 10 to 30 per cent of the total design engineering time could be more accurately described as "Component and Materials Engineering". It is also realistic to consider that in many instances this time is duplicated on each major project, since no organized means are generally available for transposing the decisions and solutions of the one group to the other.

In this critical period, where the supply of engineers and technicians does not meet the demand, the following questions might be asked: Is this the proper method to conserve engineering effort so that it can be used principally for creative purposes in solving new problems? Is this the responsibility and fault of the engineer or of the management?

In considering the overall problems of making skilled and experienced technical personnel more productive, Westinghouse Electronics Division management decided at an early date that it was their responsibility to find a solution. The implementation of the solution resulted in the establishment of an effective Materials and Standards program.

The major services provided by this program can now be discussed under the separate headings of "Standardization" and "Technical Information".

Prior to reviewing standardization activities, and in order to appreciate the close association of standardization and management, it is necessary first to define the meaning of standardization and standards. Many definitions of these terms are available.

Standards And Standardization

For purposes of this discussion, standardization in the broad sense should be considered as the organized solution of common problems. Standards should, therefore, in turn be considered as the records of such solutions drawn up in order to avoid waste of creative effort in the consideration of the same problems.

Keeping this definition in mind, if we now briefly consider the following major management tasks it will be realized why an effective Materials and Standards operation should be of such vital interest to management and why its organization is basically a management responsibility.

Management in its simplest definition is essentially responsible for:

- (1) Planning for the future and continuing profitability of the Company. Any plan must be related to Standards of some kind.
- (2) Capital investment: Standards play a big role in capital investment of machine tools and materials inventories.
- (3) Organization: Standards of performance ratings, physiological testing standards are important aids in the placement of personnel.
- (4) Costs: Customers who pay bills are vitally affected by standards. At the same time their ideas are of great interest to management.
- (5) Research: Both on improvements of present products and the development of new products. All developments are all closely related and tied in with standards.
- (6) Manufacturing: More and more standardization is needed to lower costs and insure productivity by improved plant layouts, tooling and better cost control.

It will be realized, at this stage, that we are all dependent on standards and are benefitting from the many advantages established by standards without generally being aware that they exist. Few of us realize how closely standards are interwoven in our daily lives and how much simpler they have made our existence.

Standards, like habits are an indispensable aid to the life of man. From our consumer point of view they have

meant lower prices, better quality and more safety. Standards provide more convenience in use and greater availability of the products we purchase every day.

If you were moving from Toronto to the West Coast, for example, you would be assured that your appliances would fit the wall receptacles, your garden hose fit the water outlet and the spare parts for your car readily available from your neighborhood garage.

Item Investigation

In the Electronics Division at Westinghouse the standardization program is responsible for reducing to a practical level, the almost endless variety of parts, materials and processes, which in the absence of some such control would come into use in the design and manufacture of electronic equipment.

The many complicated details involved in the procedure for investigating if a particular item should be considered as a standard are conducted on a very practical level and not from a desk or isolated office. If after this thorough investigation and evaluation covering cost, applications, availability and performance, a new standard seems feasible, the relevant details of the item are drafted into a proposal and submitted for final approval to a Committee. This Committee, identified as the Electronics Division Standardization Sub-Committee, consists of responsible and experienced technical representatives of the individual Engineering and Manufacturing Departments of the Division. Approval of the proposed Standards by this Committee is by letter ballot. Meetings are only convened when and if necessary to agree on points of major differences.

Approximately 250 copies of the Electronics Division Standards Books have been distributed to engineers, engineering assistants and layout draftsmen. This distribution covers not only the Electronics Division but includes on a request basis other Divisions in the Company in addition to the Westinghouse Electric Corporation in the United States. From this book the initial choice of materials, parts and processes should be made. Notice it is not mandatory because it is felt that when Standards are available engineering common sense will dictate that a selection should be made from Standards rather than order specials.

A few of the advantages of this standardization program can be listed as follows:

- (1) Frees the designer from the time-consuming task of looking through endless specifications and catalogs for the item he requires in addition to having to approve each item for every project.
- (2) The ordering of a standard item is simple — generally all that is needed is the Electronics Division Standard number and the component's name itself, for example "Resistors ES-450-333".



● Manufacturers' files plus new product display board releases shown in the above photograph form an important part of a Materials Standards Program organization.



● This illustration shows part of the comprehensive manufacturers' catalog files available for loan to engineering and manufacturing departments.

Savings Effectuated

However, behind this brief description are a vast number of limitations, tolerances and specifications. If you had to sit down with the supplier and tell him exactly what material, dimensions and other limitations you required in a particular item and then have him tell you exactly what he could do to furnish the item, negotiations would stretch into a long series of discussions.

Standards enable you, your engineers, the Purchasing Department and the supplier to speak the same language. It eliminates the need for writing new specifications for each project undertaken.

Standardization provides for you, between one pair of covers, a catalog of technical data on components and materials listed in a standard form for maximum utility and reference.

One of the major benefits, however, that can be obtained by standardization is that as a particular item is used for an increasing number of applications, a point is eventually reached, where it becomes economically possible to maintain the item continuously in stock with the following advantages:

- (1) Reduction of paper work and costs in the Purchasing Department due to the elimination of frequent ordering of materials and parts in small quantities.
- (2) Reduction in costs due to availability of quantity discounts resulting from larger orders of materials and parts, and the avoidance of "minimum order" penalties.
- (3) Elimination of special purchase orders necessitated by "job end" shortages due to unforeseen shrinkages, breakages etc.
- (4) Availability of materials and parts at all times for experimental work and prototype models.

To provide some indications of the savings possible by applying an effective standardization program, it can be stated that recorded cost improvements during the last year or so, as a result of the Westinghouse Electronics Division Standardization activities, have enabled dockets to be approved for a total of over \$20,000. It is pointed out that the word 'recorded' has been used because in standardization there are many intangible savings difficult to evaluate in terms of dollars and cents.

Technical Information Service

In the first standards engineering activities, many daily technical questions were asked concerning market availability and recommendations of suitable parts and materials for particular engineering applications were sought after. As a result of this type of engineering service requirement which had unofficially grown to some considerable proportions, management approved the establishment of a recognized "Technical Information Service" as part of the Materials and Standards activities.

The responsibilities of the Technical Information Services can be enumerated as follows:

- (1) The maintaining of an effective liaison contact and the provision of technical assistance to the Purchasing Department during the following conditions of operations:

On an initial visit of a supplier's representative irrespective of whether this visit was requested. During repeat visits from an established supplier

concerning technical problems relating to outstanding or on completed orders. On a "Purchasing Department" request basis.

- (2) Maintaining up-to-date an efficient manufacturers' catalog file, supported by technical data obtained from supplier contacts, Environmental Laboratory Test Reports, engineering experience, etc.
- (3) Maintaining up-to-date an effective materials and components file of engineering samples suitably referenced so that all technical data pertaining to the samples is readily available.
- (4) Responsible for disseminating technical data on new components, equipment, processes, specifications, catalogs, etc., to members of Engineering and Manufacturing Departments via medium of "Product News", a monthly bulletin, or special mailing lists.
- (5) Responsible for providing the following services to the Engineering and Manufacturing Departments on a request basis:

Provision of technical data on new and established products of suppliers and their general applications. Providing information as to sources of supply for components and materials to meet specified requirements. Provision of an advisory service on component and materials substitutions for specified applications.

- (6) Responsible for establishing component and material evaluation programs for the Environmental and Appraisal Laboratory on items of current or potential general application in the Division.

Management Co-operation

On considering the organization of a Materials and Standards activity it would be an error not to mention the importance of having the backing of top management. If the vice-president of engineering, or the general manager, or division manager is not fully aware of the advantages of the program and is not particularly interested in the activity, it is not reasonable to expect lower levels of management and subordinate employees to be sympathetic or co-operative. Some support would undoubtedly exist, but it would depend upon the assigned authority or influence of enlightened individuals rather than upon Company policy and direction. In such an atmosphere the Materials and Standards group continually finds itself devoting excessive energy to justifying its existence and defeats the very objectives it is trying to attain.

In conclusion, the work of every manager is basically to plan, organize, integrate and measure accomplishment for the most useful and efficient application of the Company's resources.

The objectives of a Materials and Standards group are in turn intended to avoid valuable engineering time being needlessly spent by each engineer and draftsman in individually investigating, locating and approving components, materials and processes for each project. Our intent is to reduce inventory and obtain better mileage from our design engineers and draftsmen — to free man-hours that otherwise might be engaged in constantly reinventing the wheel.

To this end the responsibilities of management and the objectives of the Materials and Standards program are identical. Can you, your supervisors, your Company afford to overlook these responsibilities?

Electronics In Industry

In the loading of oil tankers, particularly as they increase in size, it is essential to have the load evenly distributed over the ship. Failure to do so may result in the tanker being from several hundreds to a few thousand tons underloaded. To ensure proper loading it has been necessary to turn off the loading pipelines and to have two men go from one side of the tanker to the other, in a boat, to examine the plimsoll lines. A winston servo device, which is electronic, has been developed which enables the loading to be immediately adjusted while the pipelines are still flowing. This oil tanker trim indicator also eliminates the need for the two men in a boat.

Transistors In Radio And Carrier Equipment

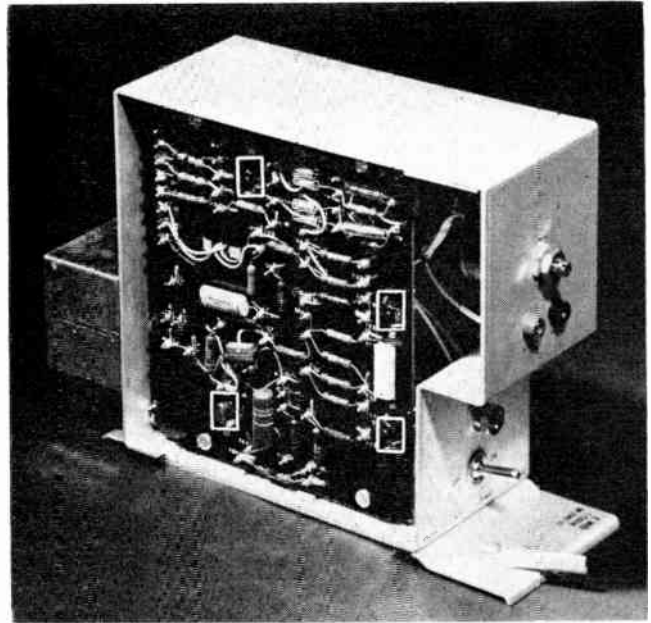

● Fig. 1. Photograph shows locations of transistors in 4559A transmitting unit.

TRANSISTORS are playing an ever-increasing role in carrier and radio equipment. The majority of new equipment now being developed is fully transistorized, with many transistorized units already in the field. One advantage of this equipment that spells cost savings in power plant capacity is the very low current drain, with equipment operating from either 48 or 130 volts DC. Another advantage is that the small space required to mount transistors allows further miniaturization of equipment, thus permitting more to be mounted on one bay.

Transistors of sufficiently low noise figures are now being used in wideband amplifiers in the 45BN cable carrier repeater equipment such as manufactured by the Lenkurt Electric Company. The repeater must amplify a 220 kc band between 40 and 264 kc, and provide a flat gain of 46 db in each direction. The same repeater uses a transistorized crystal oscillator at 304 kc plus transistorized DC amplifier for level control and regulation purposes. A total of 16 transistors plus two vacuum tubes are used, with a total power consumption of only 97 ma at 120 volts! Type NPN Junction Transistors are used due to the availability of positive 130 volts DC via the cable simplex. Grounded emitter circuit configurations are mostly used due to their intermediate value of input and

output impedances. Both series and shunt feedback is used to provide wideband amplification and gain stability. The use of heat sinks attached to the transistors serves to prevent overheating and possible self-destruction of the transistors due to excessive temperatures within the repeater units. A heat sink may be formed by attaching a heavy tinned braid to a transistor and bonding it securely to the chassis to conduct heat away from the transistor. Another system is to use a large mass of metal such as aluminum, attached directly to the transistor.

Other transistorized units now in service include the Type 4580A Frequency Control Shelf for the 45BX2 Carrier System, the Group Amplifier circuit of all 45 Class systems, and the new 53A Order Wire System.

It is interesting to note that transistors have been tested in operation for over 100,000 hours with no deterioration of activity. It is felt that the life of the transistors is practically unlimited, and that the components of a circuit will be the limiting factor in the useable life of a transistorized circuit. The low maintenance costs of this type of equipment will no doubt provide the incentive for transistorization of all carrier equipment within the next few years.

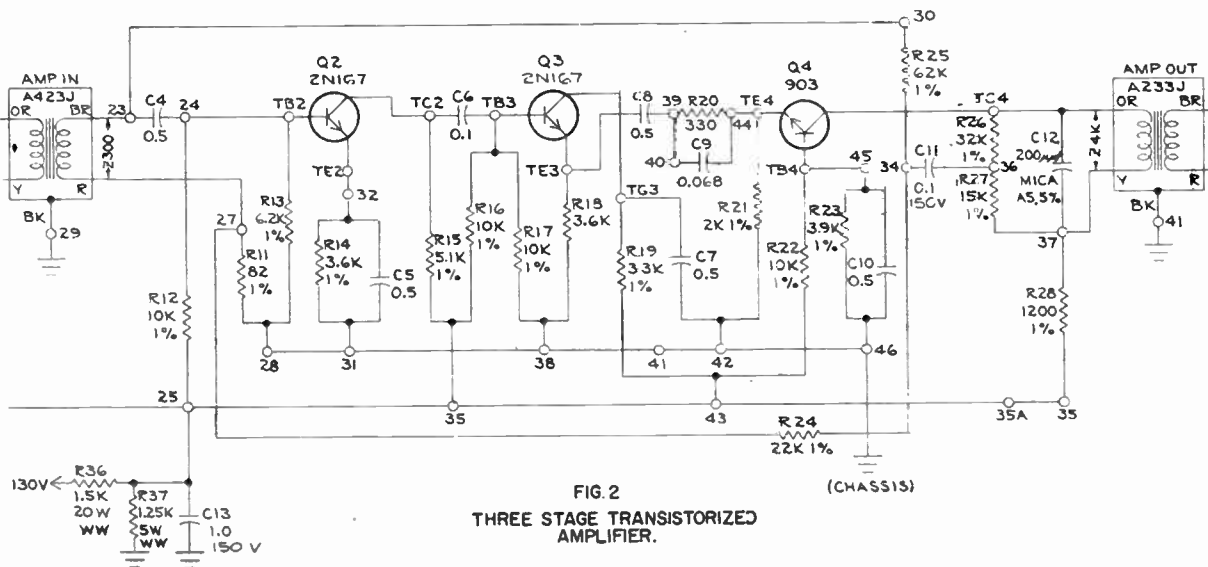

● The crystal oven shown to the right is the result of several years' investigation involving many thousands of hours of temperature recording of performance under all conditions usually encountered in field use.

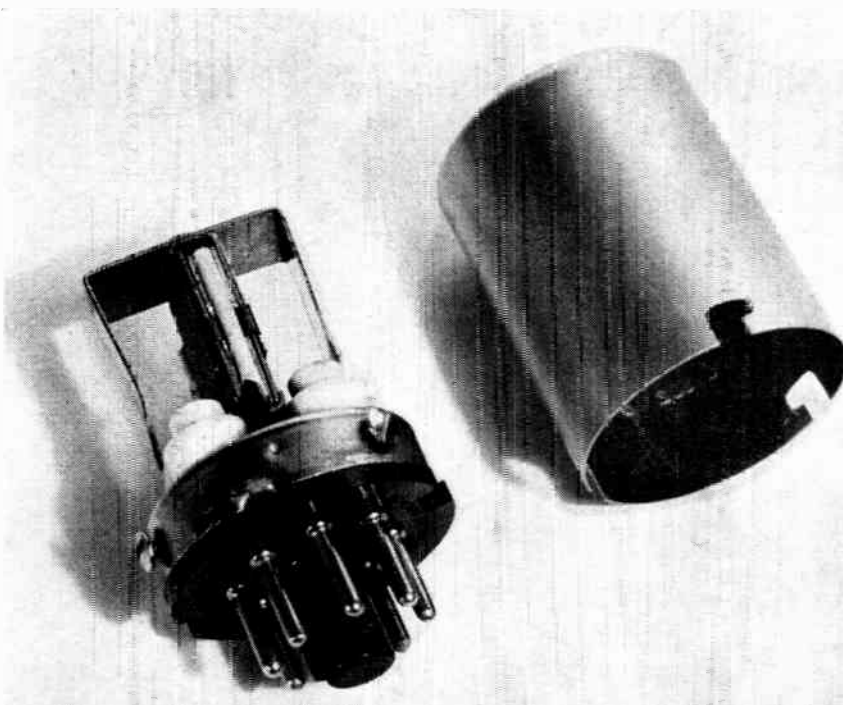

Thermal Design Keynote To Efficiency In Crystal Ovens

RECENT trends in radio communication techniques such as Single Sideband, Very Narrow Band FM in the 150 MC & 450 MC bands and other developments have made it necessary to produce crystal controlled oscillators of extremely low drift characteristics. In cases where the operating temperatures vary over a wide range, these drift tolerances are hard come by with non-temperature controlled oscillators and in order to meet operational requirements it has become increasingly necessary to resort to miniature ovens in which the temperature of the crystals is maintained within close limits.

Crystal ovens of a conventional type, usually octally based and powered from 6.3v. or 12.6v, are not new, but during recent years attempts to produce more satisfactory units which not only offer sufficient control over low temperature ranges, but in addition provide reasonably long life expectancy, have presented some serious problems.

Of the various units offered for sale, the design has been basically similar. A small heater element controlled by a bi-metal thermostat is mounted on an octal base which also provides sockets for two crystal units of the HC-6/U type. Care being taken to reduce heat loss by conduction, the assembly is usually enclosed in a thermal shield to further reduce heat loss by radiation and conduction.

Providing reasonably good design practices are followed, the key to satisfactory performance and long life is the thermostat and its placement within the assembly.

All things being equal, a measure of life expectancy may be predetermined by the thermostat cycling rate. However, in the various designs studied all things are far from equal. In some cases, too close a temperature differential was designed into the unit which required a heater element of higher wattage than desirable.

Inordinately high heat loss due to conduction and

radiation or a combination of both would require a larger heater element than desirable for long life.

Contact material used in the thermostat has a decided influence on both performance and life expectancy. Silver has been a popular choice in the past; however, recent investigations indicate that silver combined with varying amounts of other rare metals will give much cleaner switching leading to life increases of three or four times that usually obtained with silver. In all cases, contamination of the contacts is usually disastrous and while hermetically sealed thermostats would probably be ideal, reasonable protection from obvious contaminants will usually result in a life span of the oven several times in excess of other components used in the equipment.

The crystal oven shown in the accompanying photograph is the result of several years' investigation which involved many thousands of hours of temperature recording of performance under all conditions usually encountered in field use.

Good thermal design combined with simplicity was found to be the keynote of success in these ovens. The thermostat was the subject of much investigation and a compromise design offering a differential more than adequate for present stability requirements, plus features proven to increase life expectancy over previous designs, was incorporated in the unit.

In addition to various test units which have been operating under conditions equivalent to several years of field service, a relatively large number made under controlled production conditions, have been in actual field operation without any failures.

Results of a lengthy development project in the design and construction of crystal ovens have therefore made available to users a unit of proven performance that will meet all service requirements.

● Shown in the photograph is a complete sound-measuring system. At the left is an acoustic calibrator and tone source; center, the sound level meter with microphone mounted on tripod, and at the right an octave-band analyzer.



Noise Measuring Instruments

ACOUSTIC noise is rapidly becoming a characteristic of our civilization. Noise in factories, which may result in hearing damage to personnel, noise at airports (an accompaniment of the jet age), and noise generated by appliances used in the home — all of these are receiving increased attention from management, labor, and the public.

TENTATIVE DAMAGE-RISK CHART

(HEARING LOSS SERIOUS ENOUGH TO AFFECT SIGNIFICANTLY THE ABILITY TO UNDERSTAND SPEECH)

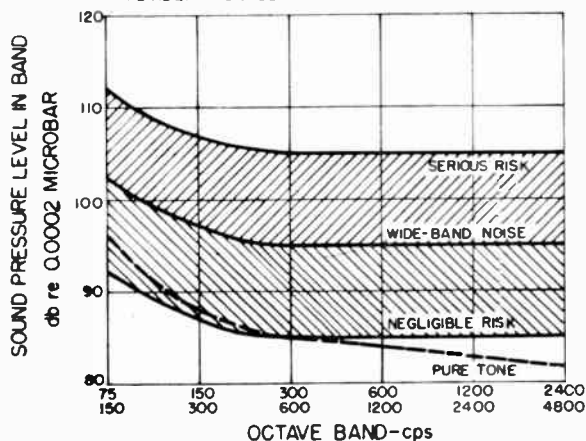

● Chart showing the sound pressure levels in various octave bands, a prolonged exposure of which may produce impediment of hearing.

The first step to noise reduction is noise measurement. Basic instrumentation consists of a sound-level meter and an octave-band analyzer. With these instruments, the noise can be evaluated in terms of loudness to the human ear and of potential damage to hearing. These instruments conform to standard specifications adopted by standardizing bodies composed of representatives from both Canada and the United States.

For rapid surveys to determine whether or not a serious noise problem exists and, if so, to locate the noise sources and affected areas, the pocket-size Sound Survey Meter is usually used. It is widely used by field representatives of insurance and casualty companies for noise surveys in industry. In addition, this device has many other uses, among them the adjustment of public address systems and of sound systems in theaters, demonstrations of acoustic phenomena in classrooms, the instruction of students in the attainment of desired sound levels in speech, choral singing, and orchestra classes.

Electronics in Industry

Photon, Inc. of Cambridge, Massachusetts, recently demonstrated a new and revolutionary method of composing tape for use on the firm's photo-composing machine. The electronic machine is the first major advance in the mechanical processes of printing since the development of the linotype and monotype machines.

A fleet of 25 buses in the Rochester Transit Corporation has been equipped with a new style two-way mobile radio which dispenses of the use of all tubes and the vibrator from the power supply and uses instead an oscillator-transistor setup. This is a development by the Stromberg-Carlson division of General Dynamics Corporation, who state that it should cut maintenance by more than half and reduce the drain on the battery by 30 per cent in the instance of the buses in which the first installation was made.

A new electronic stethoscope has been designed in Britain by Airsonic Limited. This stethoscope permits the doctor to hear the sound he wants to hear and to eliminate others by selecting the frequency of the particular sound. The apparatus is contained in a small box weighing 18 ounces, and is worn suspended from the neck.

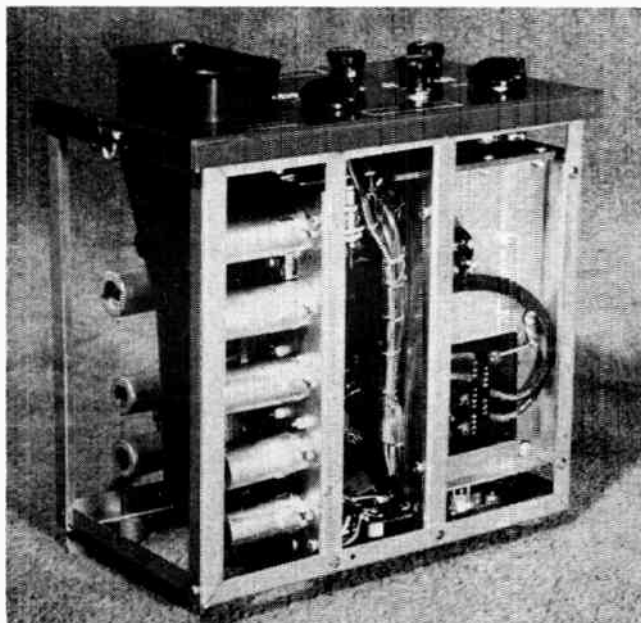

● Fig. 1. Right, the antenna mounts directly above the wheelhouse, the control box hanging beneath deck.

● Fig. 2. Above, the total weight of the cabinet and indicator is 14 lbs. The CRT is a 3SPI.

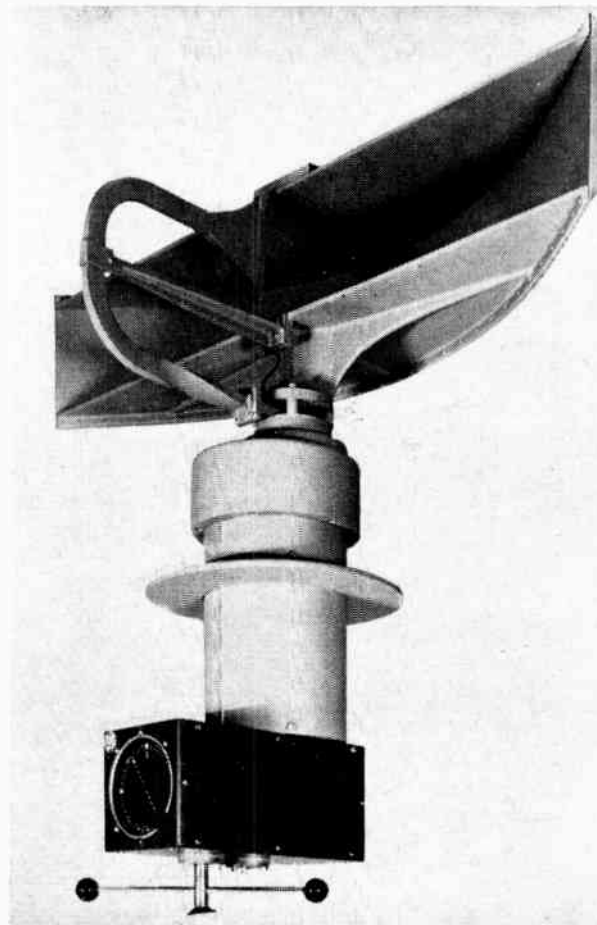

"A" Scan Radar For Small Boats

AN ultra-compact marine radar, the RDM-100, has been designed for small vessels whose size and limited electrical system preclude presently available PPI radars. The RDM-100 uses an "A" scan display for economy of size, power and cost.

The antenna (Figure 1) is positioned manually, its bearing being shown on an azimuth dial. Targets between 50 yards and 16 miles are displayed as deflections on a linear trace.

Although these separate indications of range and bearing are less easy to interpret than the PPI "map", extensive field tests proved that relatively inexperienced personnel can, in fact, navigate satisfactorily with the "A" scan.

Power input was one of the chief design parameters. It was arbitrarily set at 200 watts at first, and then increased to 250 watts during development.

This figure is for a 60-cycle, 117-volt supply. With a newly available d-c to a-c converter, the respective drain from 12 and 32 volt batteries is 30 and 10 amperes, well within the capabilities of most small marine systems.

In spite of the low power input, the transmitted pulse is 8 kw. peak. Its wavelength, duration, and repetition frequency are respectively 3 centimeters, 0.2 micro-seconds, and 1500 per second. Adequate receiver sensitivity is achieved without the use of a balanced mixer or special low-noise IF preamplifier.

The IF frequency is 45 megacycles, with a band-width of 6 megacycles. Tuning is manual. Peak and base clipping are applied to the video signal, to aid in distinguishing weak signals from noise.

The indicator is shown in Figure 2 as an example of the construction techniques employed. The video amplifier, sweep, marker, and CRT supply circuits are all contained in this unit, which is 6 x 9½ x 11½ inches, and weighs 14 pounds. The chasses are pre-assembled, and then connected together electrically for testing and sweep adjustment. Lastly, they are fastened into the frame for mechanical rigidity. Tube changing and fault tracing are performed in the frame which is easily removed for component replacement.

The modulator, transmitter-receiver, and power supply are in separate cabinets. The complete radar, including aerial, weighs approximately 140 pounds.

Electronics In Industry

Revolutionary new electronic equipment which could do the control for town planning mapping of Metropolitan Toronto in two weeks, instead of the three months actually taken, has been acquired by the Photographic Survey Corporation of Toronto, who did the Toronto mapping job. The accuracy of the system is such that the distance from a point in Toronto to a point in St. Catharines could be measured with an error of less than a foot. The new equipment is called a "tellurometer" (literally, an earth measurer). It is the first in Canada and one of the first in North America to be acquired by a commercial survey organization, which can put it at the service of municipalities and various commercial interests.

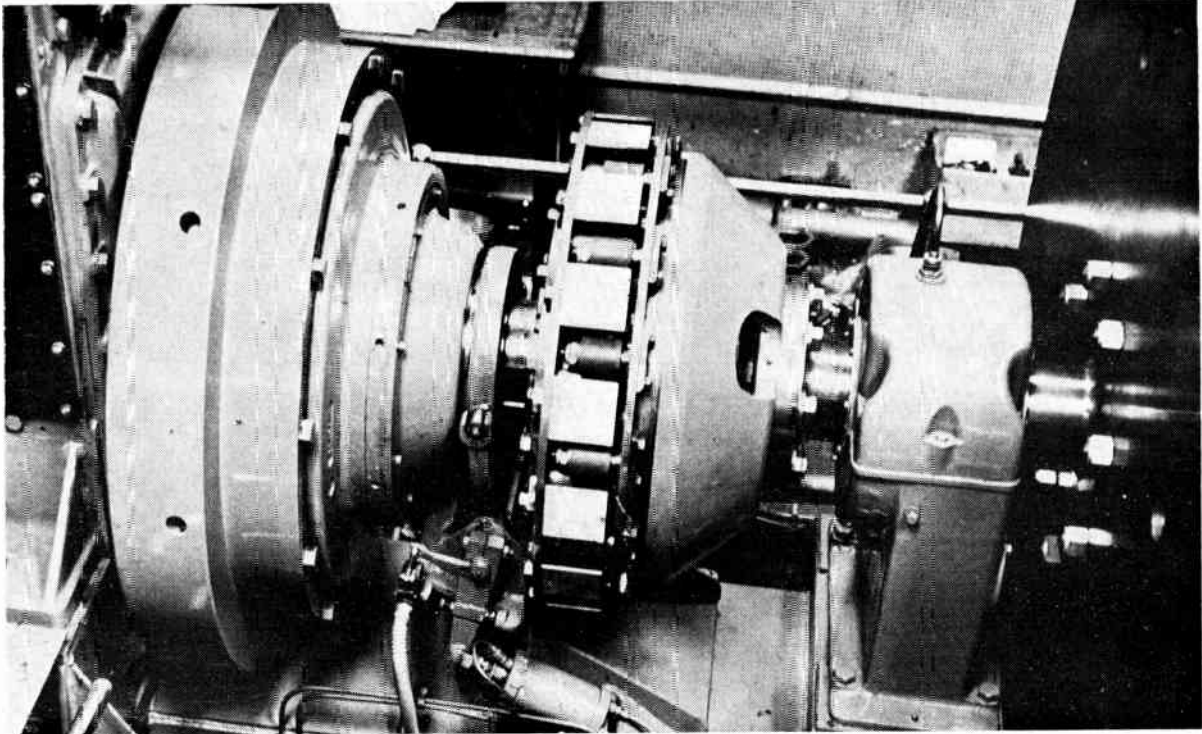

● A view of the nodal damper coupling and air-operated clutch, the latter being coupled directly to the engine flywheel. At the right hand side of the picture the main flywheel can be seen.

Communications Power Source

LARGE capacity (85 to 380 Kilowatts) flywheel, 'no-break' generating plants utilizing medium speed range of diesel engines have been developed to maintain a constant source of power to Canadian telecommunication schemes, telex services, totalizers, electronic computers, Stock Exchange ticker tapes, radar and similar electronic services and for continuous process industries and atomic power generation which, if severed from the mains for only a few seconds, would cause considerable loss.

Recently demonstrated at the Engineering, Marine Welding and Nuclear Energy exhibition in London, England, an 85 KW plant powered a teleprinter service continuously whilst sustaining 360 starts in 10 days.

The basic unit comprises a Blackstone medium speed engine with an air-operated clutch, nodal damper coupling, flywheel of 5'9" diameter and alternator with direct coupled exciter. The engine is provided with fully automatic remote control and protection and on resumption of mains supply is automatically synchronized. The initial speeding up of the flywheel from rest is accomplished by the engine starting on compressed air at 250 lbs. p.s.i. Thereafter the flywheel is kept turning by the mains supply driving the alternator as a synchronous motor; power factor improvement of the consumers' total load can be applied with this arrangement.

Several electrical machine systems can be employed to isolate the alternator from the mains so eliminating the resynchronizing and the possibility of transient conditions.

On failure of the mains supply the air-operated clutch couples the flywheel to the engine and brings it immediately to full speed. The basic requirement of this type of system is an engine of suitable size to accommodate the load at the reduced speed of the flywheel during transition and the nodal damper coupling which is incorporated to minimize mechanical shock when the clutch is engaged.

The size of flywheel used will depend on the droop characteristics required and the average flywheel will have an inertia of approximately 25,000 lbs. ft.². This figure will be adjusted to suit individual requirements, there being a maximum size beyond which this becomes uneconomical.

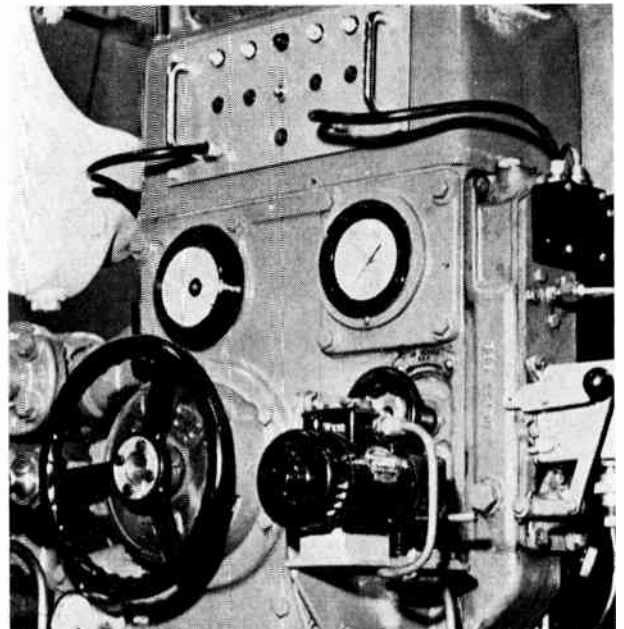

● A view of the control gear end of the engine showing the servo motor control.

Controls For Modern Industry

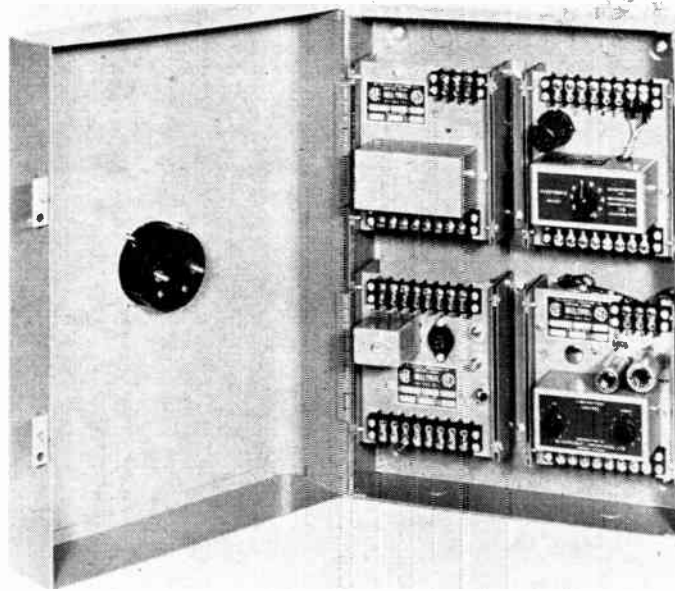

● Typical of the compactness of modern control arrangements is the above combination control unit which incorporates electronic timer, level control, photo-electric control and precision temperature control in one case.

IF an increase of only 1 per cent were made in the production output of existing Canadian manufacturing industries alone, over \$180,000,000 more would be produced.

Although the pace of technical improvement in Canadian industry is much faster today than it has ever been in the past, a great deal of the measurements and control adjustments on industrial machinery are still being carried out by out-moded and inefficient manual and mechanical means. A great deal of human skill is still required in order to achieve, by trial and error, combinations of control settings which provide acceptable end products. Machinery has almost completely replaced human labor in the fabrication of industrial and manufactured products, but the control of these machines is still largely in the hands of human operators. Very serious and costly errors are being made every hour of every day because of the lack of instrument control.

In a wide variety of industries the automatic measurements and control of continuous processes has become a necessity. Most plants benefit from accurate control of any process, providing closer quality control, lower wastage, higher output, lower cost per unit, in short, rapid attainment and maintenance of specification. Electronic devices are firmly established in some industries due to

their value in improving the control of apparatus where different units have to be interconnected or interlocked, their timing altered or accurately measured, load, temperatures, or speed controlled within narrow limits, or where output has to be measured in units or in batches.

Investigation of modern industrial control instrumentation being employed in Canadian industry will reveal such instruments as precision temperature controls reading from 0°C to 500°C; precision interval timing mechanisms reading from .05 secs to 300 secs; precision repeat cycle timing mechanisms with readings of one half of cycle from 0.1 to 60 secs with the other half of cycle from 0.3 to 180 secs; precision delay timing mechanisms reading from .04 to 16 secs; sensitive contact relays; level controls, gaging, photoelectric counting, batching, sorting, positioning, and a host of other products for the automatic control of industrial machinery.

The cost of automation using controls is small, yet the returns in terms of increased quantity and quality of production can be very great indeed. The increase in production following automation is frequently measured not in per cent but in hundreds of per cent. The billions of dollars more that can be produced and earned by Canadian industry await only the decisions to implement more automatic controls.

Smoke Control With Density Meters

STACK-GAS density is of high importance in every boiler plant. First, there is a direct relation between smoke density and combustion efficiency. The presence of smoke indicates that combustion is incomplete and fuel is being wasted. On the other hand, very light gas density shows the presence of excess air in the furnace. This is probably the greatest cause of fuel waste. Experience shows that combustion efficiency is the highest when a slight haze is present in the gases leaving the boiler. This condition cannot be controlled without an instrument. Second, dense smoke is a nuisance to the plant and to the community. In many localities there are smoke nuisance laws, with heavy penalties. Smoke soots up the boiler tube and heating surfaces, making frequent cleaning necessary. Excess soot causes buildings in the neighborhood to deteriorate and costly court

actions may result.

Now however plant operators can use the Smoke Density Meter which measures the density of the smoke passing between a light source and a phototube. In addition to indicating and/or recording the smoke density, the meter operates an alarm circuit whenever the density exceeds the preset value. The unit is completely failsafe and independent of line voltage variations.

Fuel savings of more than 30 per cent can be realized by the use of this instrument.

Based on the same physical principle, the Turbidity Meter measures the light-transmittivity of liquids. This in turn indicates color, turbidity or fine dust loadings of fluid.

The Turbidity Meter is essentially identical to the Smoke Density Meter, but has adjustable range and sensitivity controls, to fit any particular application.



● One-man rapid reconnaissance under difficult conditions is made possible with the revolutionary one-man portable magnetometer.

A Portable Prospecting Magnetometer

PROSPECTING has always been big business but prospectors have never been so well equipped to discover the earth's secrets.

Latest tool for geologists and geophysicists — today's '49ers — is a revolutionary one-man portable magnetometer. The M-49, as the instrument is known, measures the total intensity of the earth's magnetic field. Because it can detect changes in the field, caused by varying sub-surface geological structures and mineral deposits, it has many applications to prospecting. It is said to be as easy to operate as a radio and accurate under the most rugged conditions in mountains, arctic wastes, deserts and marshy swamps.

The versatile little portable M-49 was evolved in Varian research and development laboratories from the proton free precession magnetometer invented by Dr. Russell H. Varian.

The M-49 portable magnetometer frees the modern prospector from former tedious and time consuming

methods of performing magnetic surveys and is equally effective on land, over water, and in the air with the sensing head suspended from weather balloons. Fully transistorized, the M-49 represents the reduction of a complete proton free precession magnetometer to its smallest practical size.

Although reduced to approximately 16 pounds from the original 250 pound Varian station magnetometer, the M-49 contains the same two essential elements. The "coil and sample," sometimes called the sensing head or detector, consists of a coil of wire wound around a bottle of liquid containing hydrogen atoms. The electronic portion which unravels the sensing head's signal, indicates measurements of the earth's magnetic intensity on a direct reading meter.

The instrument is entirely battery operated permitting operation in remote areas and eliminating the problems associated with differing world-wide line voltages and frequencies. The polarizing batteries can be recharged by connecting them to an automobile battery overnight.

According to inventor Dr. Russell Varian, the value of the M-49 is equated to land areas rather than population density or economic conditions.

It is anticipated that the biggest customer for the device will be the exploration geophysicist or geologist who surveys obscure land areas searching for valuable sub-surface ore deposits or information on subterranean structure. With the knowledge of the area's geology and the magnetic data provided by the M-49, the geologist can estimate the location and extent of mineral deposits having magnetic characteristics.

Multiple Function Automatic Tester

A MULTIPLE function automatic tester which makes possible 30 individual wiring checks per minute has been developed to speed production testing of junction boxes. These junction boxes, which contain connection points for inter-equipment wiring, are manufactured for test equipment used by the Armed Forces for bombing and navigational radar systems.

Before the development of the new device, testing of the junction boxes, which contain as many as 400 individual wires and 30 connectors, was done manually. The test operators had to check each point individually.

The device is capable of selecting a maximum of any five points simultaneously for a given test. Each of the five points may be routed to any of 22 separate points: i.e., voltage sources, signal sources, voltage output points, bridges, etc. Tests include continuity (involving broken wires, determining whether the right wires are connected to the right points), megger (the condition of wire insulation) and resistance.

The multiple purpose automatic tester has an average speed of one test every two seconds and a capacity of 900 input points, consisting of 30 connectors of 30 points (terminals) each.

Basically, the instrument consists of three main units:

A tape reader, utilizing standard 8 channel tape, programs the various test procedures by means of perforations punched out on the tape.

In the main body of the machine, selector switches receive information transmitted by the tape reader, routing the switches to the connector terminals or points to be tested. The desired test is then applied to those points. Selection of desired input points, application of required test to points, and the testing are all done automatically.

A "readout" (a serial entry printer) automatically records the test step number and test result.

The multiple function automatic tester can be used not only on junction boxes, but on any units where there is a multiple number of points to be tested.

NOW --- complete supply, repair and replacement service in Canada

on



FM CARRIER SYSTEMS

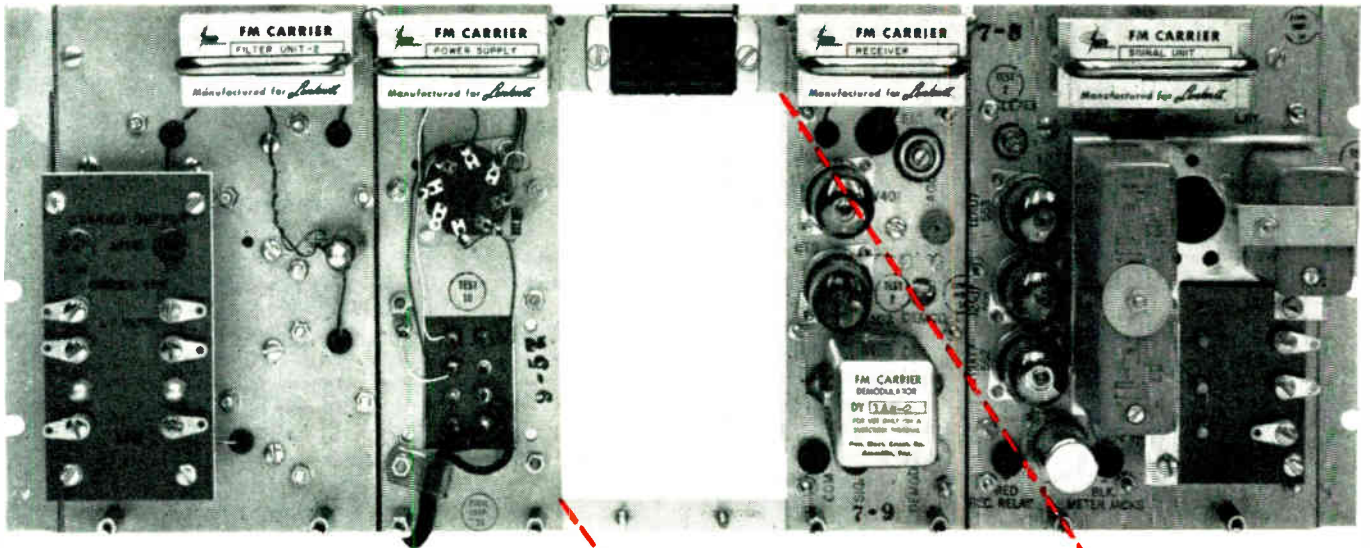

No need to hold back any longer! Service for Panhandle Subscriber Carrier Systems is now being provided—anywhere in Canada. The problem of repairs and rapid replacement of parts has been solved!

Automatic Electric and Lenkurt have teamed to provide a complete supply, repair and replacement service—from coast to coast. Panhandle equipment, including spares and replacements, is available through any Automatic Electric office. And comprehensive repair facilities, plus a complete stock of spare parts, are being maintained by Lenkurt at their modern plant in Vancouver. Apart from its obvious advantages, this new arrangement will eliminate the problem of customs clearance completely.

Panhandle Subscriber Carrier Systems provide a low cost, versatile method of obtaining up to 10 additional subscriber circuits from each existing wire line. Operating frequencies are higher than with most conventional carrier equipment, so coordination doesn't present many problems, even when a Panhandle system is installed on the same pair or pole-lead as existing carrier equipment.

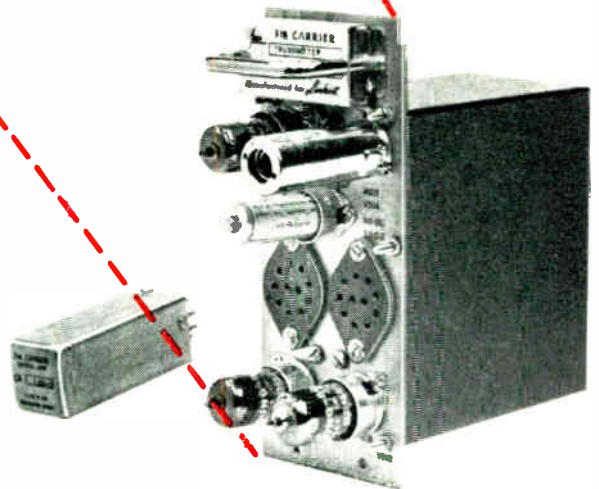

*Write to us for further details,
illustrated literature, etc.*
**Automatic Electric distribute Panhandle
throughout Canada.**

Automatic Electric Sales (Canada) Limited,
185 Bartley Drive, Toronto 16, Ontario.
Branches in Montreal, Ottawa, Brockville,
Hamilton, Winnipeg, Regina,
Edmonton, Vancouver

AUTOMATIC  ELECTRIC

ORIGINATORS OF THE DIAL TELEPHONE



5824

keep in step with Canadian

.....

GO STRO

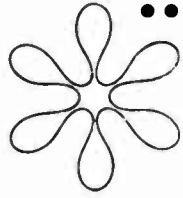

TO MEET REALLY HEAVY GROWTH, ADD A FRAME WITH AS MANY SHELVES OF SWITCHES AS YOU NEED.

IT'S EASY – THE STROWGER WAY!

Strowger automatic telephone equipment is custom built to meet your exact requirements. A highly trained equipment engineer plans every detail of the installation.

- He selects the proper switches and circuits to meet your particular needs.
- Studies the traffic data, and computes the number of switches needed to handle the traffic efficiently and economically.
- Designs the mountings and frameworks, and prepares the central office equipment floor plans.
- Engineers power equipment, manual desks, distributing frames and other apparatus as required.
- Prepares complete instructions and drawings for the departments that will manufacture the equipment.
- Prepares specifications and detailed instructions to guide the installation engineers.

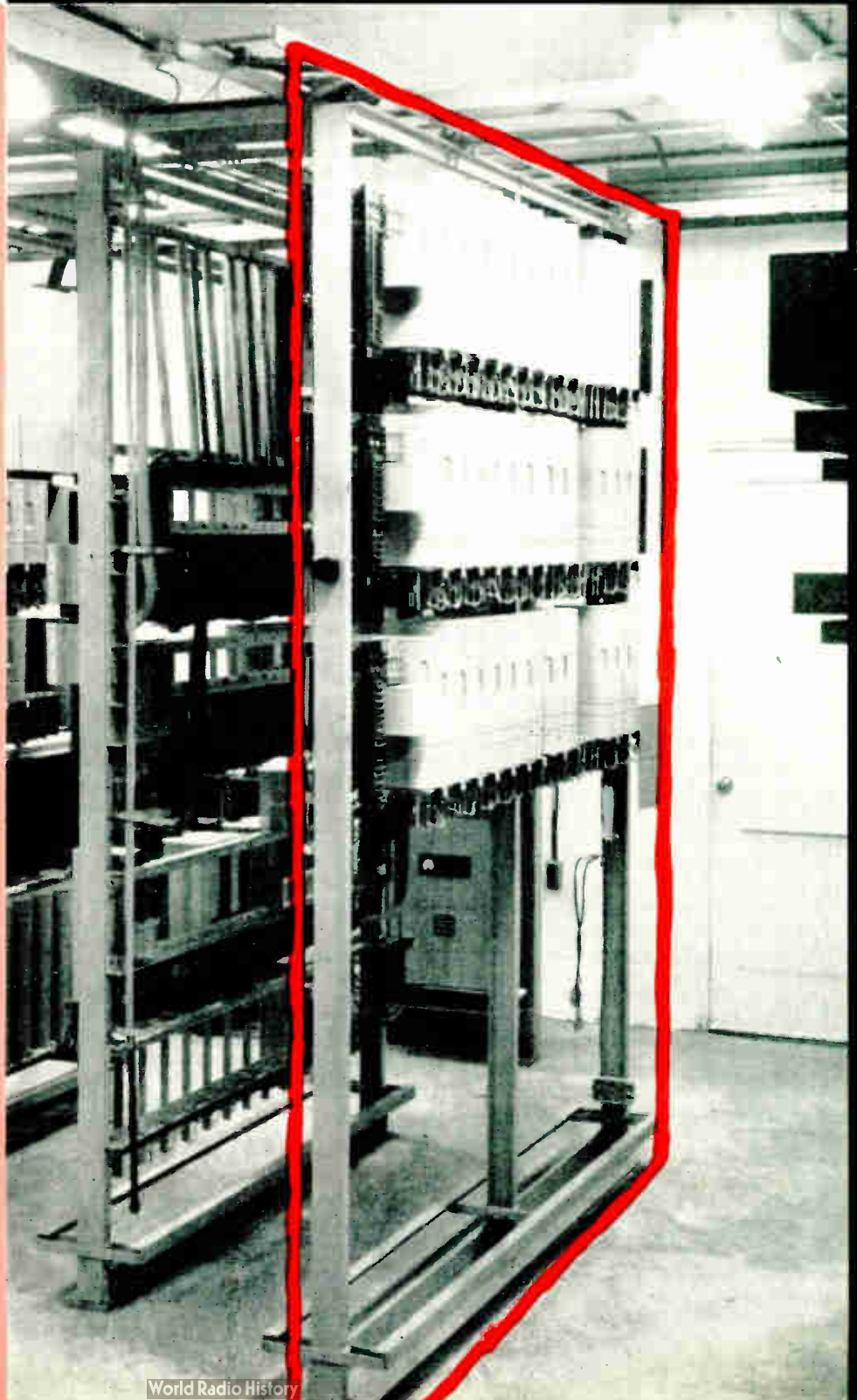

Developments – WGER NOW!

ADD A SWITCH TO TAKE CARE OF MODERATE GROWTH.

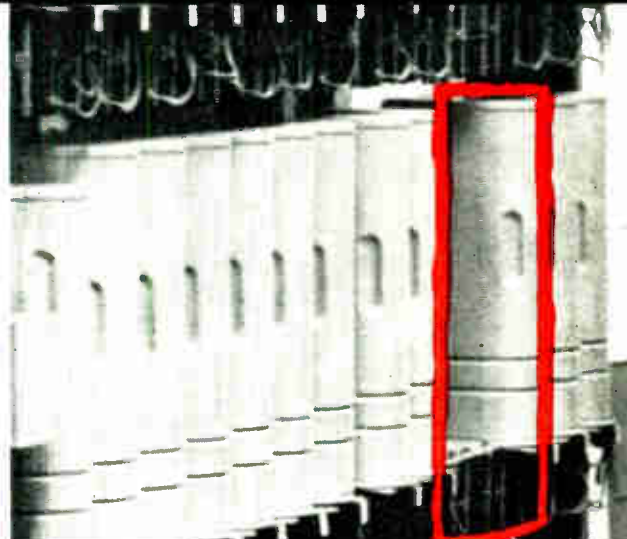

ADD A SHELF OF SWITCHES WHEN LARGER GROWTH OCCURS.

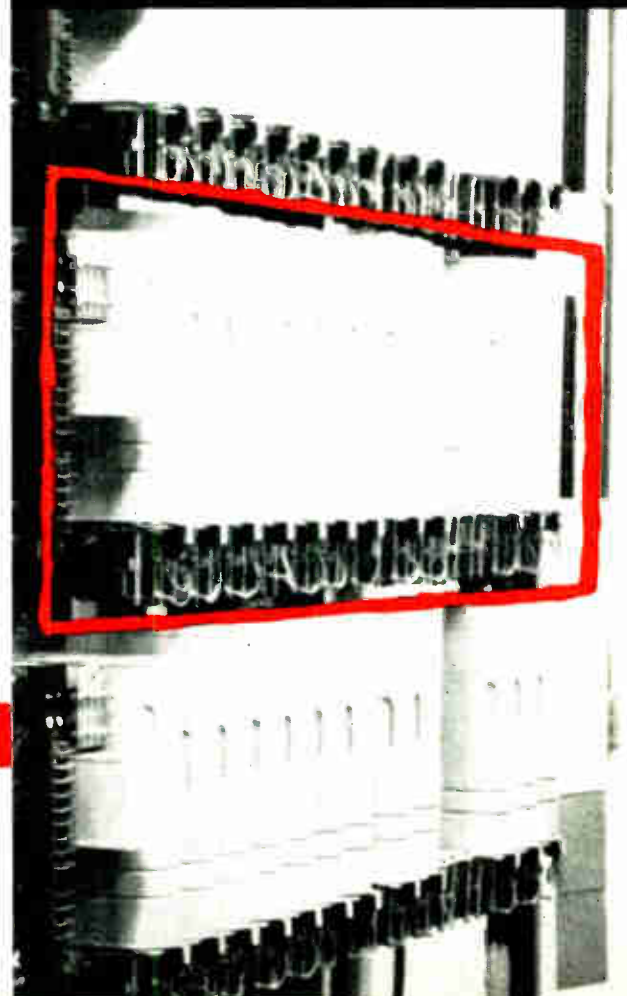

When you're converting to dial, Strowger is your best possible investment. It has been tested and proven in towns and cities in almost every part of the world. Because it incorporates all the latest advances in design and quality construction, it remains absolutely reliable over very long periods. In fact, in some exchanges, Strowger equipment installed 40 years ago, is still in constant use.

The same basic units are used for small and large exchanges. So as your community grows, you buy and install extra equipment the economy way—step by step. You simply add extra switches or banks as you need them. And if your community's growth becomes really spectacular, you install extra frames with any required number of shelves. Strowger has many other important advantages, too. Every item of equipment is designed for extreme ease of maintenance. And the few parts that inevitably wear out with prolonged use—wipers and wiper cords for instance—can be quickly and easily replaced, at very low cost, and without service being interrupted.

Once you've decided on Strowger, all you need do is call Automatic Electric. They will take over from there. From initial planning and layout of buildings, to selection, supply and installation of every item of equipment, Automatic Electric will handle the entire project.

If you would like further information, call or write Automatic Electric today.

Automatic Electric Sales (Canada) Limited, 185 Bartley Drive, Toronto 16, Ontario. Branches in Montreal, Ottawa, Brockville, Hamilton, Winnipeg, Regina, Edmonton, Vancouver.

5827

AUTOMATIC  ELECTRIC

ORIGINATORS OF THE DIAL TELEPHONE



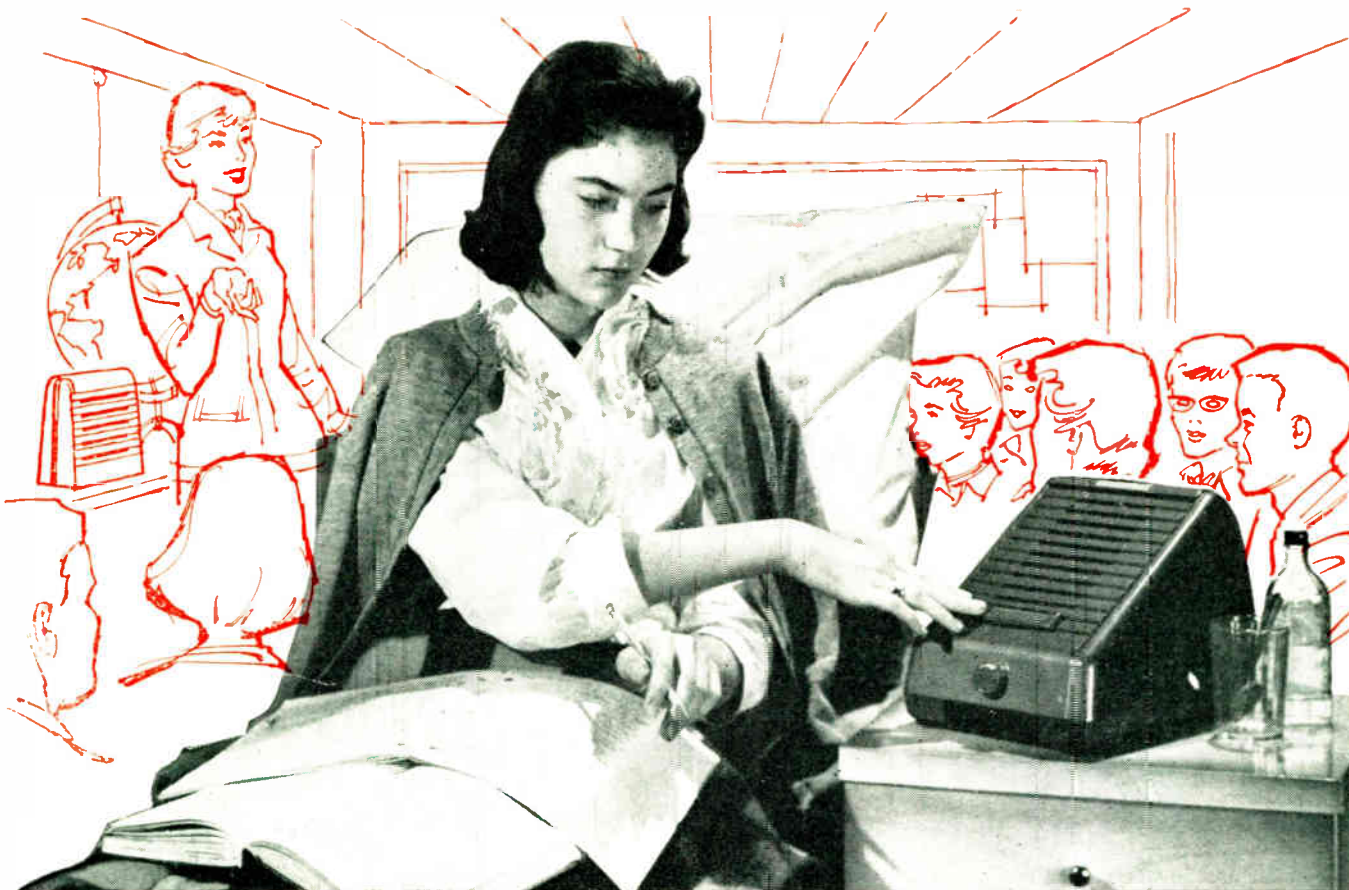

YOU CAN HELP SHUT-IN CHILDREN KEEP UP WITH THEIR CLASSMATES

—with Executone School-to-Home Telephone Systems

To a child, illness or accident can be an overwhelming experience. Being ill and confined to a sick room is only a part of it. He is also shut off from school life, from all normal contact with

children his own age. In various parts of Canada there are thousands of these shut-in children. Luckily, equipment is available that gives the sick child a feeling of belonging again.

The Executone School-to-Home Telephone System, now available in Canada exclusively through Automatic Electric, consists of a small amplifier and two simple, compact units. One is installed in the sick child's home. The other is portable and can be plugged-in in any classroom at the child's school. The two units are linked by ordinary telephone wires through the

nearest exchange, and the child can then take part in day-to-day classroom activities.

Executone School-to-Home Telephone Systems change the child's entire attitude to his handicap, and may easily speed him well on the road to recovery. Already the systems have been highly successful in well over 4,000 cases.

Many Telephone companies are performing an outstanding public service *and* earning additional revenue by making them available in their territory. For further details call or write any Automatic Electric office.



*The Executone Speaker-Microphone
for the classroom*

*Automatic Electric Sales (Canada) Limited, 185
Bartley Drive, Toronto 16, Ontario. Branches in
Montreal, Ottawa, Brockville, Hamilton, Winnipeg,
Regina, Edmonton, Vancouver.*

AUTOMATIC ELECTRIC

SALES (CANADA) LIMITED

For further data on advertised products use page 69.

● Photo at the right shows a Jones & Lamson Turret Lathe being automatically controlled by pre-punched tape.

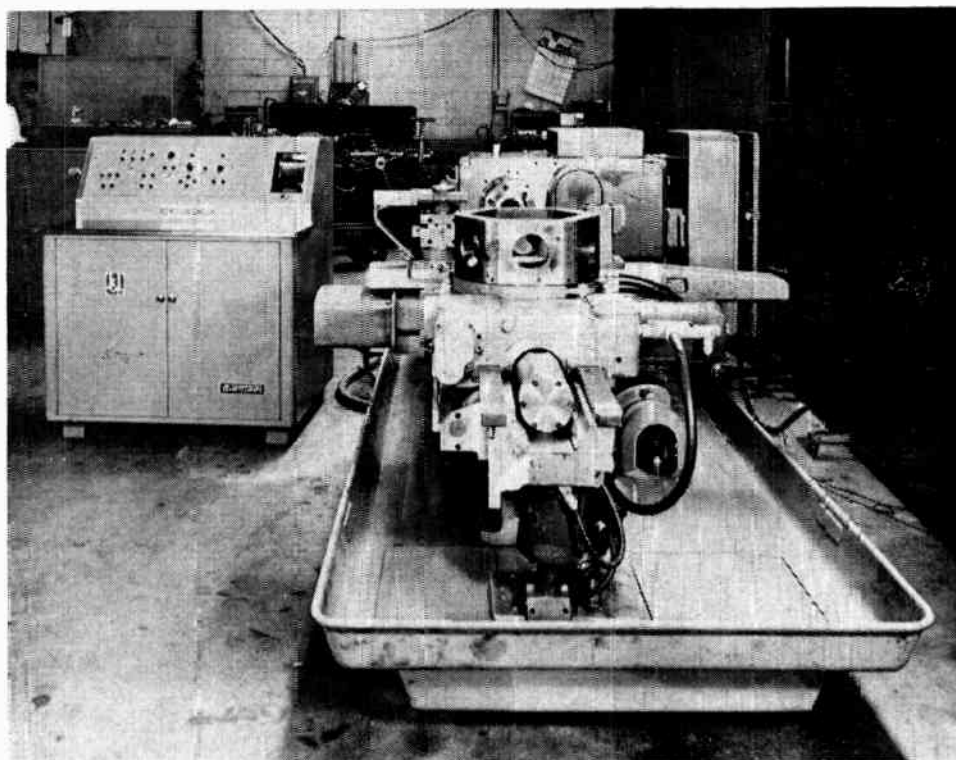

Machining By Punched Tape

A HIGHLY compact punched tape control system called BINOTROL, with wide practical applications for automatic operation of machine tools, valves and other industrial equipment differs from other control devices in several ways. Its simple computer system makes for compact size: the complete control console is no larger than an office desk and the operating principle is digital-to-analog — the reverse of most other systems. It contains few vacuum tubes; and the circuitry is composed mainly of reliable, high-quality, dependable telephone-type relays. It is a functioning, practical control system which is relatively inexpensive and simple to operate.

The first use of the control system was demonstrated by Jones & Lamson Machine Company, Springfield, Vermont, where it operated the Jones & Lamson No. 7 Turret Lathe completely automatically. A coded signal, punched on tape, is fed into the machine and the machine moves to a pre-determined spatial position depending, of course, upon the signal. Instruction signals are punched upon a plastic tape with each signal translated into a binary code number. Each motion of the machine is controlled through 32 possible hole positions — far more than are normally needed for a single operation. With this system the machine starts, stops and re-cycles automatically; the operator need never touch the controls.

This technique of control makes the turret lathe ideal for short repetitive runs. When manually operated, it is not economical to use a turret lathe to turn out one part: set-up time is too long and too costly. Hence, most machine shops make a practice of storing extra parts, or holding up production until a suitable number of parts are needed. With this system, however, down-time is cut to a minimum. The machine is always operating, except

when new parts or new tools are being put on. A process engineer programs the step-by-step operation of the machine for a particular job. These instructions are transmitted to a clerk who punches the required tape, with the aid of a code book. The tape, then, is the job and can be run off immediately or stored for future use. Productivity of the operator and machine are vastly increased.

With this modern machine control technique operator fatigue is eliminated. This is a common source of error on short run jobs. There is also less hazard from flying chips and slivers since the operator's hands need never enter the work area.

On the turret lathe, the equipment controls 16 spindle speeds, turret indexing, cross slide indexing, coolant, hood, chuck and bar feed. All tool motions are completely tape controlled. Lead screw accuracy is controlled to within .001" and cross slide motion to .0005". The machine may also be jogged into position by push-button control and manual cranks.

Electronics In Industry

British railways have recently put into service the first train in the world to be permanently equipped with closed-circuit TV for the entertainment of passengers. With one coach equipped as a soundproof studio, the pictures are seen on 17-inch monitor sets at each end of the passenger coaches, which are also fitted with loudspeakers to provide the accompanying sound.

Punch Press Control Stops Double-Heading

AN electronic press control which eliminates "double-heading" of punch presses and minimizes die breakage and press down time has aroused the interest of management in many industries who are dependent on punch press efficiency in their manufacturing operations. The "die-saver" control, heart of the new system, stops the press from completing its stroke whenever the stamped piece is not properly ejected from the die.

The "die-saver" press control is comprised of two parts — a control panel whose contacts are connected to the press circuit, and a detection unit which consists of a high radio frequency coil mounted on a Cadco cast acrylic tube. The acrylic tube is electronically as well as optically transparent.

The detection unit is attached at the die-face, next to the ejection point. As each piece is ejected, a stream of compressed air blowing through the tube draws the part through the coil, breaking the radio frequency field and thereby closing a set of contacts in the control panel. When a piece fails to eject in the required time, the contacts open and the press stops.

By relieving the operator of the tension of guarding against "double-heading", the press control promotes safety and raises production. Faster automatic feeds are possible, rejects are reduced because operators have more time to inspect stamped parts, and operator fatigue is less. With the electronic controls on duty, operators may control more than one press.

The press control unit may also be used to automate the press and the count stamped parts.

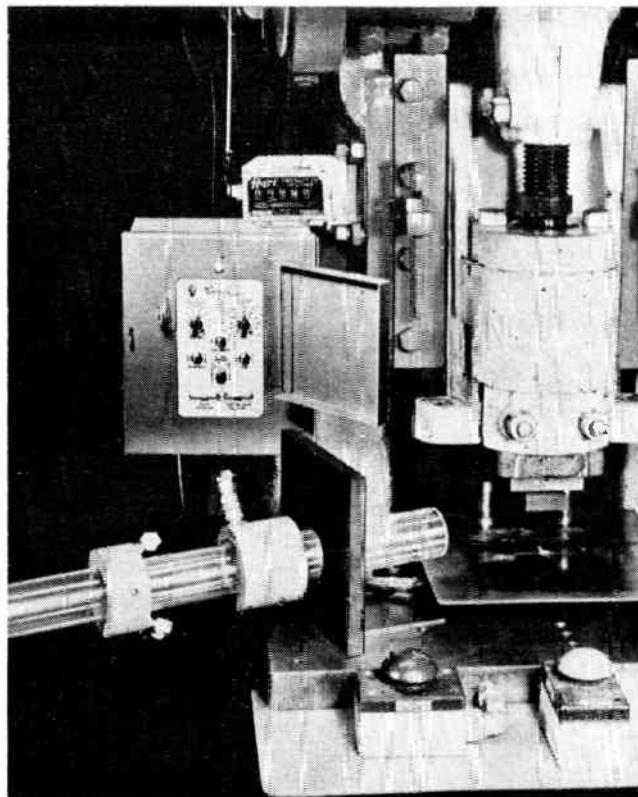

● The electronic press control shown above eliminates double heading of punch presses. The detection unit is attached at the die face.

An important benefit to users of the electronic controls is that shops may bid more closely on delivery dates because of the greater assurance of continuity of production.

The "die-saver" control may be installed on any punch press with "dog", "pin", or air clutch which is electrically operated or can be modified to electrical operation.

The electronic sensing circuit may be adjusted for variations in press speeds and size of stamping through a set of adjustable controls.

Electronic Scanning Simplifies Maintenance

CCHECKING and controlling various steps in production processes now are greatly simplified by the use of an electronic scanning instrument, capable of monitoring up to 25 production points.

The first of these instruments is now in use in a jet engine plant, where it is utilized to check on gear box temperatures during final tests.

The new scanner may be used in any industrial or laboratory process to monitor variables including temperature, level, flow and pressure. It is believed the instrument will find broad application in the steel, automotive, chemical, petroleum, plastic and synthetic fiber industries.

New design characteristics contained in the scanner make possible unparalleled economies in bridging the gap from manual to automatic plant operation. For example, all 25 control points may be set in a matter of minutes by untrained personnel, using a bank of miniaturized slide wires. Individual changes in settings can be made on the same slide wires by simply re-setting a small knob. All set points can be viewed and compared at a glance.

Through an unusual system of pivot arms, hinges and

sliding arms similar to the pull-out shelves in newer refrigerators, all decks of components and other wiring in the scanner are made easily accessible for easy and simplified maintenance.

The scanner is designed to check processes at a speed of either one point or five points a second. A unique built-in "memory" feature enables users to by-pass steps in the process that are not operating. The scanner will "remember" to by-pass these points and will continue to monitor the remainder of the production operation.

In addition, the scanner maintains a continuous check on its own accuracy and operation. In the event of a breakdown of either a component or sensing element, the scanner will sound an alarm, thereby alerting an attendant. The unit also standardizes its scales automatically and continuously, eliminating the need for daily or weekly stoppages for re-calibrating.

The scanner contains 25 sets of red and green indicating lights on the face of the instrument, showing the step under control and also whether the process is functioning properly. A simple two-wire connection to a recording instrument will give users complete records of process operations.

Microtel System For Communications

A NEW type radio system, developed for the 6000 mcs band, has been designed primarily for communication companies; thus its operation from power sources normally found in a toll office or T & R room was a design prerequisite. As a result, the 74A, as the system is known, will operate from 115 volts 50/60 cycles AC, 24/130 volts DC, 48/130 volts DC, or solely from 24 volts or 48 volts DC. This flexibility will result in substantial savings for communication companies, as large capacity 24/130 volts or 48/130 volts battery plants are available in all toll or T & R offices. As battery plants were originally conceived to provide maximum reliability in the advent of AC power failure, so this reliability will be provided for the 74A system.

One 74A transmit-receive assembly requires 24 volts AC or DC plus 130 volts DC for the operation of all equipment except the klystrons. The latter require 6.3 volts plus —300, —437, —750 and —1175 volts DC for the beam and repeller elements. The following panels are used to supply the above voltages, with Figure 1 illustrating the panels required for each power option:

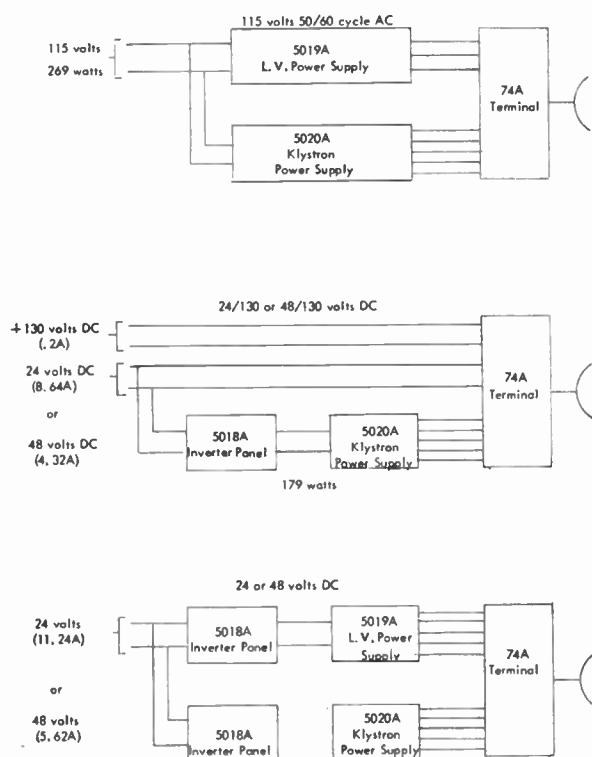

● Figure 1. Power Supply Panels Used with 74A Radio System.

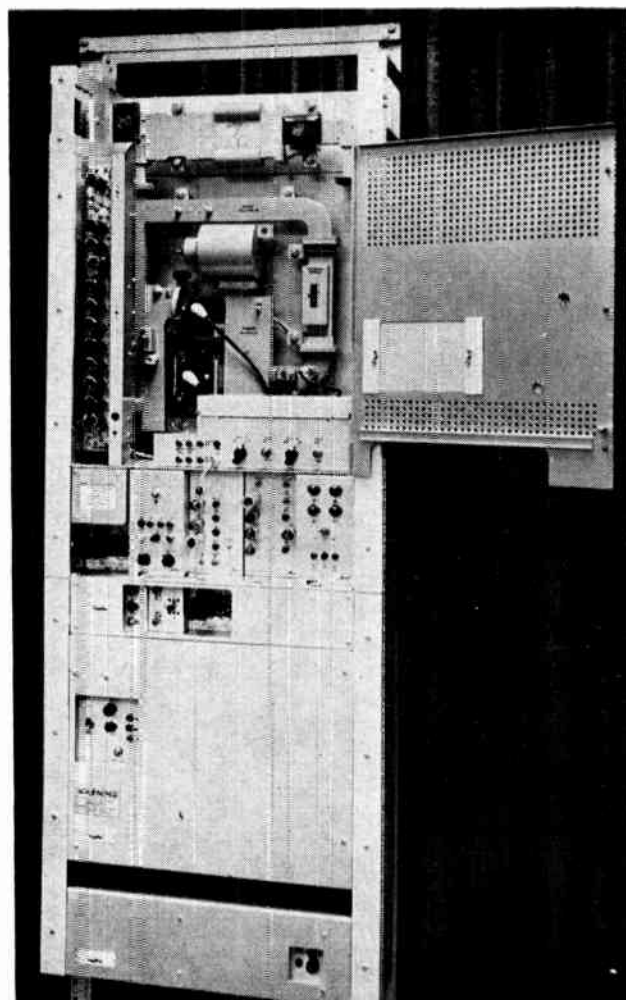

● Photograph of 74A1 Radio Terminal, showing 5020A and 5019A Power Supplies mounted on lower half of relay rack.

- A Type 5020A AC Power Supply Panel, operating from 115 volts AC is used to provide the klystron voltages. The input circuit is fused, with safety interlocks to remove power when the high voltage is exposed. This panel requires 179 watts at 0.8 power factor, inductive.
- A Type 5019A Power Supply Panel, operating from 115 volts AC is used to provide 25.2 volts AC and 130 volts DC for all but the klystrons. This panel requires 90 watts at 0.85 power factor, inductive.
- A Type 5018A Inverter Panel provides a 115 volt AC square wave for operation of the Type 5019A or 5020A Power Supply Panels. This panel will operate from a source of 24 or 48 volts DC. The load power factor may vary from unity to 0.8 inductive. The peak input voltage should not exceed 53 volts including ripple from battery chargers. It is foreseen that the 5018A Inverter Panel will be useful in many other applications where equipment is operated from AC with a DC fallback required.

The 74A radio equipment may be operated from 115 volts 50/60 cycles AC at terminal points when no DC battery plants are available, but it is anticipated that this option will be most used at repeater points. Back-to-back 74A terminals are used at repeater points, providing maximum flexibility for dropping and inserting carrier channels at each point. The most economical first-cost method of providing power for the radio equipment at these locations is to use commercial 115 volts 60 cycle AC, with instant starting AC fallback generators such as "no-breaks" operated from either gasoline or propane supplies.

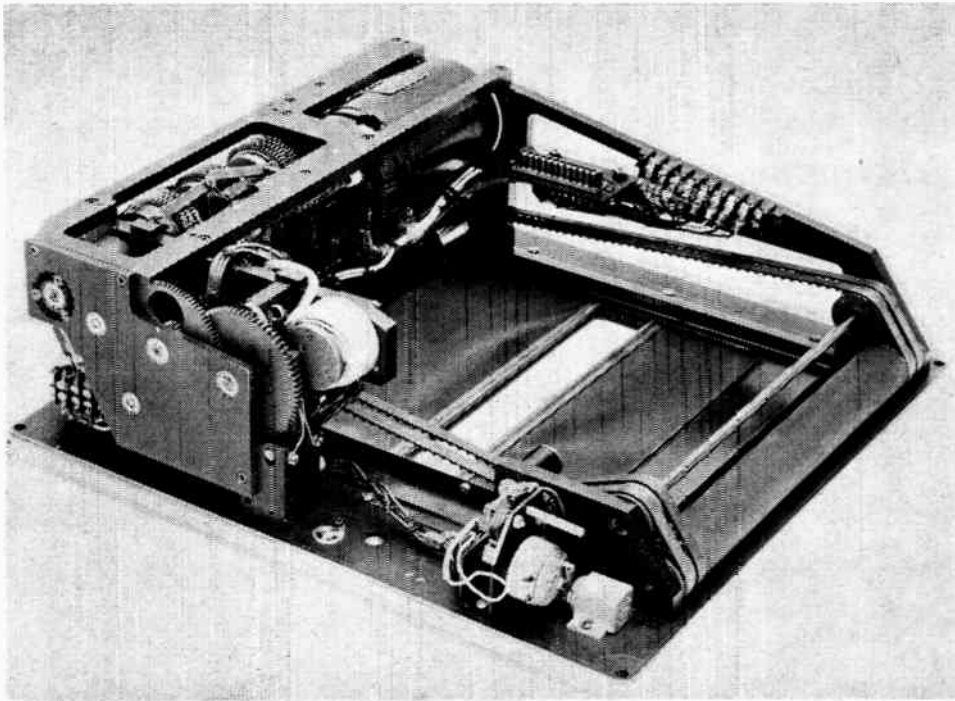

● View of camera shutter mechanism reveals part of the complex electromechanical system in this supersonic aerial camera.

A Supersonic Aerial Reconnaissance Camera

IN modern day aerial photography, the need for more complex camera equipment has grown to such an extent that pilot-photographers must have automatic controls to aid them in the operation of such equipment. Supersonic fighter-reconnaissance jet aircraft taking pictures at low altitudes are making extreme demands upon airborne photographic equipment. The development of the LA-11A Aerial Reconnaissance Camera answers the need for low altitude photographs from very high-speed aircraft. The initial application of this model camera will be in the nose of the McDonnell RF-101 supersonic jet.

The LA-11A takes 9" x 9" pictures using 9½" roll film at rates up to two per second. The camera operates at shutter speeds of from 1/200 of a second to 1/1600 of a second utilizing a focal plane shutter. The camera is mounted in the nose of the aircraft and points forward. The use of a focal plane shutter makes very high shutter speeds possible with a large aperture lens. It stops motion on forward oblique photographs that cannot be satisfactorily compensated for by IMC (image motion compensation). Control of the camera is accomplished from the cockpit by use of the Universal Camera Control System (UCCS) which, by servomechanism control, sets the rate of cycling, starts and stops the camera and changes the exposure. The focal plane shutter is internally co-ordinated with the lens iris. This automatically provides optimum photographic quality throughout the exposure range. For increasing exposures, the shutter operates at top speed until the iris is fully open. The exposure control mechanism then begins to decrease the shutter speed until it reaches 1/200 of a second. The opposite takes place when exposures are decreased. The change from iris to shutter control is effected so smoothly

that the pilot is not aware of the change. Insofar as the camera system is concerned, this frees the pilot from all manual operations except overall exposure setting and cycling interval determination.

The camera has a 12" focal length, fixed focus, and a maximum aperture of f/3.8. With the A-9B film magazine mounted on the camera nearly 500 pictures can be taken on a mission.

The LA-11A is constructed to withstand the most severe camera operating conditions including extreme changes in temperature and humidity. It is reliable at operating temperatures ranges, of from 0 degrees to 120 degrees Fahrenheit, can withstand humidity as high as 95 per cent and prolonged storage temperatures of minus 85 degrees to 165 degrees Fahrenheit. An internal heater maintains operating uniformity. The camera, without magazine but with lens, weighs approximately 37 pounds and is 15" x 15½" x 16½" overall.

Electronics In Industry

A new traffic control system, operated by radar, has been installed at one of the busiest intersections of the city of Hamilton, Ontario. Ordinary traffic signals have been proved impractical at this particular point because of the fluctuations in the flow of traffic during each day. By means of a radar device, connected to an elaborate stoplight system, the main flow of traffic from the city's mountain area to the commercial and industrial districts which lie below is electronically controlled.

Chemical Milling In The Electronics Industry

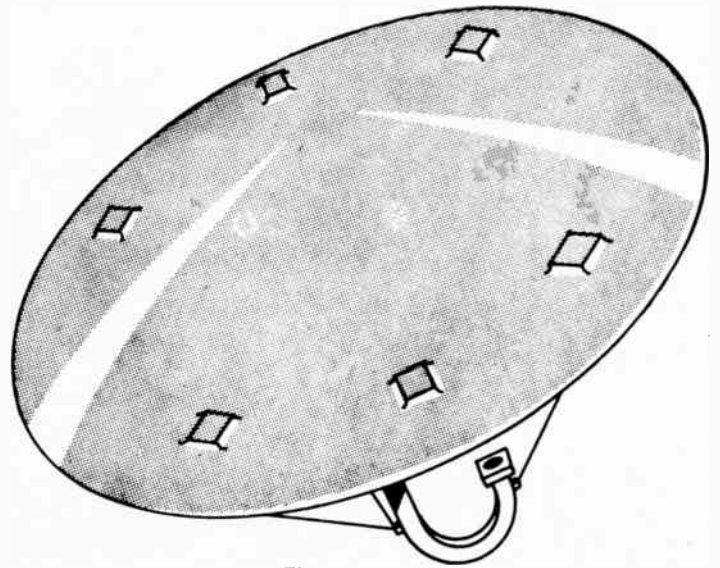

● Figure 1.

CLOSE co-operation between the electronics industry and chemical milling firms has resulted in uses of chemical milling to solve many difficult design and production problems.

Chemical milling, because it produces dimensions to extremely close tolerances, is particularly adaptable to the electronics industry, which requires precise manufacturing techniques.

Reducing the weight of parabolic antennas is an example of chemical milling as utilized in electronics. For most applications, the lightest antenna possible is desired. However, forming operations, used to shape these antennas and attachment problems often limit the minimum thickness. An antenna must be thick enough so that it will not warp during forming operations. However, after forming, chemical milling can be used to reduce the desired thickness down to any dimension. Machining operations on such a contoured part are impossible, so that chemical milling is the only way such weight reductions can be accomplished.

Additional advantages are obtained by leaving chemical milling lands in the areas where the antenna is to be attached to its supporting structure (Figure 1). In this way additional strength is provided at a critical section without any increase in weight.

Etched circuits are the most inexpensive and the most flexible of all types of circuits. Thousands of identical or different circuits can be milled simultaneously in large milling tanks which are also used to mill huge aircraft structural members.

According to a recent survey, etched circuitry is the most popular type of printed circuitry. The first step in the production of etched circuits is the application of a thin coating of copper, varying from approximately .002 inch to .01 inch, on a base board of paper, glass cloth, linen, etc. Photographic, screen or offset printing tech-

niques can be used to apply maskant, which restricts the chemical action, in the form of the circuitry. After masking, the circuit board is soaked in a chemical solution to mill away the exposed areas of the copper. The remaining maskant is removed following etching, and the circuit is ready for the insertion of resistors, capacitors and other circuit elements.

Performance of an electrical circuit is no better than the performance of the links which connect the various components together. In this case the connecting links are the etched circuitry. Therefore, an etched circuit must be produced to finite tolerances for high performance equipment. Under special conditions, chemical milling is currently producing parts with dimensional tolerances of $\pm .000$ inch.

Milling of magnetic materials to specific shapes is an application of chemical milling that shows great promise. Chemical milling does not affect the properties of a magnetized metal, whereas most machining operations destroy some, or all, of the magnetism. In addition, the metals commonly used for magnets are very hard and difficult to machine, but they are easily shaped by chemical milling.

Metal removal from many delicate and intricate wave guides (Figure 2) is an impossible task for machine tools. Therefore, chemical milling is the only means of producing contours and thicknesses required by the designer. The ability of chemical milling to reduce the thickness from formed parts, such as wave guides, has reduced the weight of many airborne components.

There are many other applications of chemical milling in the electronics industry, such as the weight reduction of metal cases for electronic gear. In addition, new applications are expected from the continuing research that is being carried on by the engineers in co-operation with many of the nation's leading electronics firms.

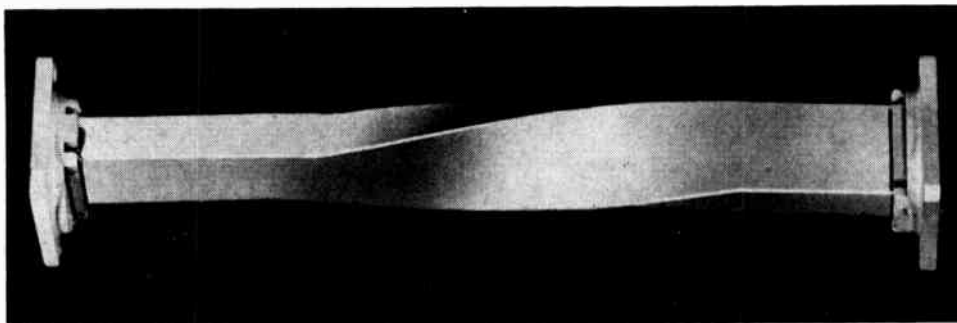

● Figure 2.



The facts are perfectly clear

When you choose PHILCO Industrial Television



Philco Industrial Television has literally dozens of applications: schedules the flow of materials to the production line; time and motion studies; better warehouse control.

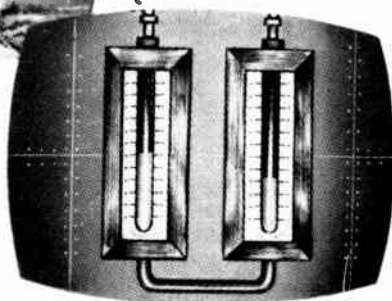

Philco ITV means you can watch for spillage and pile-ups on long conveyer lines; reading meters and gauges in remote spots; watch unloading operations.

Philco, a pioneer of industrial television, is providing industry with an invaluable tool for checking literally dozens of processing and manufacturing operations.

Philco Industrial TV cameras are gradually taking over jobs that humans could never check because of weight, size, climatic or hazardous conditions.

Philco Sales and Service Representatives are being set up all over Canada to assure you of full time operation of your equipment.

WRITE TO DEPARTMENT 'M'

PHILCO **G**OVERNMENT AND INDUSTRIAL DEPT.

DON MILLS, ONTARIO

For further data on advertised products use page 69.

FIRST IN CANADA...

C-G-E now manufactures germanium rectifiers -

reducing price
and increasing
availability

A new Canadian industry is born! A new industry developed to serve the special needs of the electronic equipment manufacturer. Now, from Canadian General Electric . . . semi-conductor products . . . give you three major benefits!

- An appreciable reduction in price due to lowered costs. It is anticipated that price will continue to drop as production facilities expand.
- Greater availability due to a greatly improved stock control. It will be possible to adjust the manufacturing pace to comply with the Canadian market demand.
- Better service because of improved application-engineering knowledge. C.G.E. Engineers will be able to apply the first-hand knowledge — gained in overcoming manufacturing problems — to improve many types of electrical and electronic mechanisms. It is expected that this will lead to a more extensive use of efficient,



compact semi-conductors in all Canadian industry.

The popular IN91-2-3 Series G-E Axial Lead, Low-Current Germanium Rectifiers will be the first to go into Canadian production. Later in the year production of G-E Silicon Rectifiers will be added.

For detailed information on the availability and new low prices of the IN91-2-3 Series G-E Rectifiers and for data on all G-E Semi-Conductors contact your nearest C.G.E. Sales Office or write to Electronic Tube Department, Canadian General Electric Co. Ltd., Dufferin Street, Toronto, Ontario.



**GENERAL ELECTRIC
SEMI-CONDUCTOR
RECTIFIERS**

ELECTRONIC EQUIPMENT AND TUBE DEPARTMENT

1399-158

CANADIAN GENERAL ELECTRIC COMPANY LIMITED

ELECTRONICS & COMMUNICATIONS, MARCH, 1958

For further data on advertised products use page 69.

New Products

New Product specifications published in *Electronics and Communications* have been briefed for your convenience. If you require further information on any of the items published you may readily obtain such by using our Readers' Service, Page 69. Just mark the products you are interested in on the coupon on Page 69 and the information will be in your hands within a few days.

Bobbinless Precision Wire Fixed Resistors

Item 1886

A new line of smaller space factor more stable bobbinless precision wire fixed resistors featuring a unique "floating" element has been developed by C. C. Meredith & Co., Ltd., Streetsville, Ontario.

A new patented winding process now permits resistance elements and contacts to "float" firmly embedded in epoxy resin, forming a monolithic mass. The resistors have a smaller space factor because no bobbin or winding form is needed. Wire

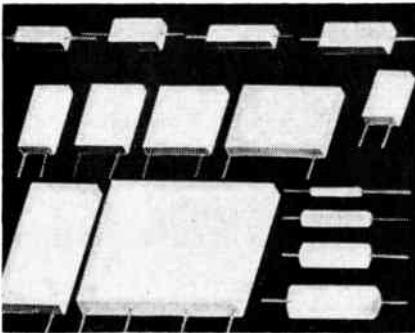

strain is entirely eliminated. Permanent change in resistance is less than 0.2% under most environmental conditions, giving exceptional stability.

The resistors are guaranteed to be in tolerance under normal conditions of measurement. Tolerances down to $\pm 0.05\%$ are available in a wide range of standard sizes depending upon resistance value. Closer tolerance or matched multiples are available on request.

The resistors have low inductance and low capacitance characteristics with reproducible uniform frequency response. Resistance change with humidity (MIL-R-93 moisture resistance test) is less than 0.2%. Resistance change with temperature cycling (MIL-R-93) is less than 0.2%.

The resistors withstand extreme vibration and shock due to unique construction and encapsulation method. Resistance change with load life or 100% overload (MIL-R-93) is less than 0.3%. Low temperature coefficient wire is available. Both rectangular and tubular shapes are offered in a wide range of wattages, dimensions and resistances to meet the required application.

Further details available from C. C. Meredith & Co. Ltd., Streetsville, Ontario, Canada.

Autopilot

Item 1887

The PB20C Autopilot, manufactured by the Eclipse-Pioneer Corporation, an affiliate of the Bendix Corporation, provides automatic flight control for the CL-28 Argus aircraft. Although considerably more complicated and having more facilities than previous autopilots, it is proportionately lighter and occupies proportionately less space. This has been achieved mainly by a reduction in the size of the servo amplifiers. The use of vacuum tubes has been completely abandoned and all such components replaced by transistors or silicon diodes.

Normally in an autopilot, power tubes such as the 6V6 are used to actuate magnetic amplifiers, which in turn control the application of correctly phased power to the variable phase winding of the servo

motor driving the aircraft's control surface. In this autopilot, however, the need for power output tubes, with their attendant power supplies and heat dissipation problems, has been eliminated and their function has been taken over by miniature pairs of toroid coils weighing half as much as the vacuum tube and occupying about one tenth the space.

By miniaturizing all the components it has also been possible to leave some space for the addition of automatic flight control facilities other than the standard function of normal straight flight or pilot controlled manoeuvring. All these transistorized servo amplifiers and magnetic amplifiers are made in the form of small "cards" measuring about 3" x 4½" which can easily be changed for servicing. The additional facilities previously mentioned are also mounted on cards and can be plugged in.

Marketed in Canada through Aviation Electric Limited, P.O. Box 6102, Montreal, P.Q.

Frequency Bridge

Item 1888

The Muirhead D-101-C Frequency Bridge, which employs the Wien bridge circuit, forms a satisfactory and simple means of measuring audio frequencies in the range 100c/s to 12,100c/s. Measurements to an accuracy of $\pm 0.25\%$ are made by means of two decade dials and a continuously variable direct reading dial which covers the interval between adjacent steps on the second decade. Reading accuracy is always better than 0.05%.

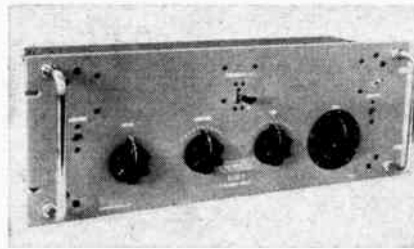

The bridge is assembled on a standard panel for rack mounting. Connections are made to 3-point jacks or standard terminal posts — both facilities being provided.

Telephones are suitable for detecting balance at audio frequencies when a reasonable input voltage is employed; for lower input voltages and frequencies outside the audio range an amplifier can be supplied.

Further details are obtainable from the manufacturers, Muirhead Instruments Limited, Stratford, Ontario.

Analog Digital Converter

Item 1889

A fully transistorized analog to digital converter designed primarily for industrial use is now available for such applications as the scaling of data into engineering units, the linearizing of transducer nonlinearities, and the performing of arithmetic operations for function generation.

Manufactured by Epsco Inc., well known for their military data control systems, the Transicon Datrac is sold in Canada by Computing Devices of Canada Limited.

Features of the Transicon Datrac include: Direct in-line visual readout; absolute value bipolar operation; variable digit rate; high power coded output; three decimal digit data conversion (also up to 12 binary digits); and 0.05% absolute accuracy.

The unit is fully reversible and is capable of both analog to digital and digital to analog operation. The high speed of the unit makes it particularly suitable for measurement of signals in the presence of noise, high speed multiplexed operation and under slave synchronous control of an external controller.

The Transicon Datrac is capable of handling up to 200,000 conversions per second in digital to voltage operation. In voltage to digital operation, the maximum time is five microseconds per binary bit.

Computing Devices of Canada Limited, Box 508, Ottawa 4, Ontario.

Integrated Air Navigation

Item 1890

Today's problems of air navigation are concerned with the safe and expeditious handling of large numbers of aircraft on crowded airways much more than with the simple navigational problem of how to get from A to B.

Two major developments dictate the course for the future. First, the area concept of navigation recommended by the Curtis report in the U.S.A. whereby air routes can be readily established without the new installation of point source aids such as beacons. This feature is of the greatest importance to the steady development of Northern Canada. Furthermore, aircraft on busy routes can be allocated laterally separated parallel tracks and clearly defined holding patterns.

The second major development is Doppler radar, a self-contained navigational aid following the area coverage concept with great flexibility although with a somewhat low and random accuracy largely determined by compass heading reference errors.

These features have all been welded together in DIAN, which is a fully integrated system of Doppler, Decca and Deetra with a common display system. The use of the pictorial display for Doppler greatly simplifies computer problems since geographical lattice and compass variations can be simply incorporated in the chart, which in effect, becomes the computer. The Decca/Deetra provides a high accuracy reference system for correcting the Doppler information while the Doppler will provide a valuable coarse reference for the Decca/Deetra.

This new system is capable of feeding an automatic pilot whilst simultaneously displaying the aircraft position pictorially whereby diversion courses are immediately apparent. The illustration shows the Flight Log Display.

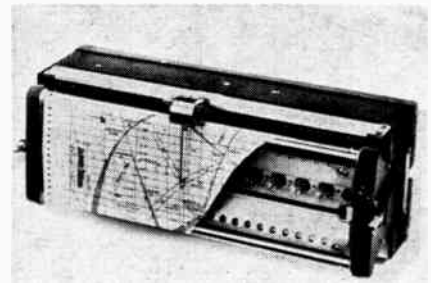

A high capacity data transmission system is also in development for automatically integrating aircraft position with the A.T.C. system on the ground.

Decca Navigator (Canada) Ltd., 272 Dalesford Road, Toronto 14, Ontario.

OUR THANKS

To those readers who have returned E & C circulation verification post-cards.

A REMINDER

To those readers who have *not*, as yet, received or returned verification cards.

PLEASE COMPLETE CARD IN FULL

Our mailing list auditors insist that we have the following information from you:

Your name (printed)
Address
Company
Type of business
Your position
Your signature

A PROPERLY COMPLETED CARD FROM YOU IS YOUR GUARANTEE THAT YOU WILL RECEIVE ALL FORTHCOMING ISSUES OF

ELECTRONICS & COMMUNICATIONS

SPECIFY *Hoyt* METERS

FOR
EVERY
APPLICATION

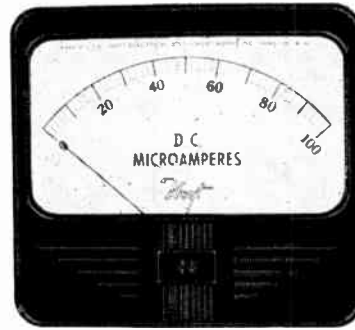

No. 647 illustrated

Be sure of the highest accuracy, dependability, and readability PLUS *economy* with HOYT precision AC and DC instruments — the *complete* line of Panel Meters. Moving coil, rectifier, and repulsion types available in a wide variety of sizes, ranges, cases, and colors. Also, custom-designed (including 400-800+ cycle applications) to meet your most rigid specifications for a *quality* instrument.

Write Export Manager
—new illustrated literature contains descriptions, engineering data, and prices.



Prompt Delivery —
M/A Forms mailed on day of shipment.

Service Facilities —
strategically located in Canada.



ELECTRICAL INSTRUMENTS

Sales Div.: BURTON-ROGERS COMPANY
42 Carleton Street, Cambridge 42, Mass., U.S.A.

immediate delivery on all SILICON RECTIFIERS

SMALLER - COST LESS

*Will take a
King-Size load!*

4 AMP. to 400 AMP.

call WA 4-9301

write

**ELECTRO SONIC
SUPPLY CO. LTD.**

543 YONGE ST., TORONTO 5

your one stop for
automatic control components

FREED PORTABLE MEGOHMMETER MODEL 2030



- 500 VOLT DC TEST POTENTIAL
- TRANSISTOR POWER SUPPLY
- BATTERY OPERATED

The Freed Type 2030 Megohmmeter is a battery operated instrument especially suited for measuring leakage of transformers, motors, cables, condensers and insulating materials wherever the power line is inaccessible or where battery operation is more desirable.

Resistance values are indicated on a 3" expanded scale meter protected against overload. Low resistance in series with component under test provides very short charging time for even the largest condensers. Calibration position provided to check accuracy of 500 volt test potential. The 500 volt test supply is regulated.

- Resistance — 5 Megohms to 10 million Megohms.
- Accuracy — $\pm 3\%$ to 100,000 Megohms $\pm 5\%$ to 10 million Megohms.
- Voltage on unknown — 500 volts DC.
- Self contained — Battery operated.

OTHER MEGOHMMETERS AVAILABLE

- Type 1620 Megohmmeter — 50-1000 volt variable test potential — 0.1 Megohms to 4 million Megohms.
- Type 1620C Megohmmeter — A type 1620 with additional circuitry for testing capacitors.
- Type 1020-B Megohmmeter — A 500 volt fixed test potential, range — 1 Megohm to 2 million Megohms.

Send for NEW 48 page transformer catalog. Also ask for complete laboratory test instrument catalog.

FREED TRANSFORMER CO., INC.

1716 WEIRFIELD ST., BROOKLYN (RIDGEWOOD) 27, N.Y.

For further data on advertised products use page 69.

New Products

Vibron Electrometer

Item 1891

The Model 33B Vibron Electrometer is one of three vibrating condenser amplifiers made by Electronic Instruments Limited, intended for the measurement of small DC voltages and currents derived from high impedance sources.

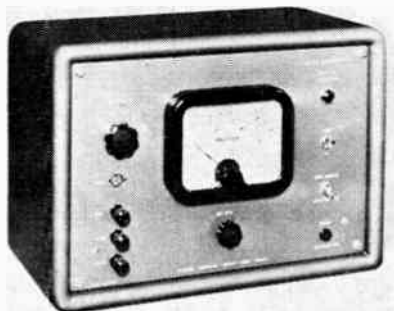

This unit neither generates nor absorbs any current from the component under test, and hence can be used for measurements which are far beyond the capabilities of the conventional DC amplifier. DC voltage measurements are possible from 1 milli-volt to 1 volt, and current measurement down to 10^{-13} amps.

The high stability of the Electrometer — 100 microvolts over 12 hours — is made possible by the unique Vibron Unit, an extremely precise vibrating condenser built to high tolerance.

Typical applications of the Electrometer are ionization current measurement,

measurement of haul effect in transistor research, and null detector applications where precise measurement in high impedance is required.

The unit includes provision for feeding external recording meter and has been designed to be unusually robust and stable in operation.

This instrument is serviced in Canada by Electronic Instruments (Canada) Limited, and sold through their exclusive Canadian sales representatives: The Glendon Company Limited, 44 Wellington Street East, Toronto, Ontario.

Standard Pantograph

Item 1892

Sturdy design has been combined with ease and lightness of operation in the David Dowling Model 713 Bench Engraving Machine for the high class engraving of designs, lettering or numerals. It is a machine that is eminently suitable for the manufacturing of electronic instruments, panels, dials, etc.

The ball bearing spindle is directly connected through a flexible coupling to the electric motor, which by rheostat control, gives stepless speed variations between 6000 and 12000 r.p.m., to suit all materials being engraved. Initial accuracy is maintained indefinitely as spindle is designed to compensate automatically for bearing wear.

The pantograph unit, comprising the cutter, spindle and motor, the pantograph and the tracer, is carried on a rigid arm which is adjustable vertically on the column for workpieces of varying height. A vee slide on the work table provides transverse movement. Both movements have positive locking. The whole pantograph unit is balanced, with adjustable tension, giving a vertical upwards movement, thus ensuring that the cutter is withdrawn clear of the workpiece when the tracer is released by the operator.

The pantograph is of robust construction, with all pivots mounted on ball journals,

giving the high degree of sensitivity necessary for accurate reproduction.

The tracer, which covers the pantograph to follow the outline of the copy, is adjustable for height in the pantograph arm, to suit the work being engraved. A graduated micrometer thimble at the top of the traverse is used to set the required depth of cut.

For further information apply to Empire Engineering Company, 738 Dundas Street East, Toronto, Ontario.

"Pygmy" Connector vs. "AN" Connector

Item 1893

Aviation Electric Limited announces that it is able to supply an assembly facility for type AN connectors. The components for these connectors are manufactured by the Bendix Scintilla Division and are shipped in bulk to Aviation Electric, where they are assembled and receive JCNAAF qualification tests. Orders can be taken for a vast variety of AN connector types, including the new pygmy type connector, so useful in guided missile applications due to their extremely small size and weight.

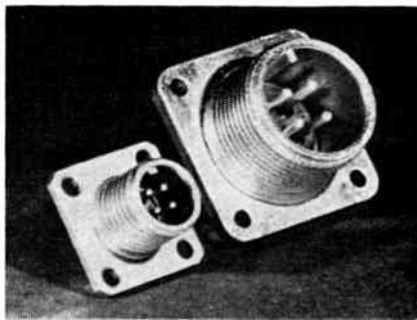

Apply to Aviation Electric Limited, P.O. Box 6102, Montreal, P.Q.

NEW BRITISH ELECTRONIC INSTRUMENTS

- Automatic Frequency Monitors
 - Electronic Counters
 - Capacitance and Inductance Bridges
 - Square Wave and Pulse Generators
 - Adjustable Phase Correction Units
- made by Cinema-Television Ltd., and available in Canada throughout Dawe Instruments.

For an illustrated catalogue with full details of this equipment, write today to:

DAWE INSTRUMENTS LIMITED

CANADIAN DIVISION: 1654 Bank Street, Ottawa, Ontario

5302

ELECTROLYTIC CAPACITORS

Type PC heavy gauge steel case with screw terminals and mounting lugs. High reliability under extreme conditions. Full range of capacities and voltages.

Canadian Sales Representative

WM. T. BARRON

939 Lakeshore Road — Toronto 14, Ont.

Daly Capacitors Limited

FORMERLY DALY-ARROW LIMITED

Manufacturers of Electrolytic Capacitors

140 KENDAL AVE., TORONTO 14, ONT.



It says the answer is alliance SMALL MOTORS

When the job calls for small motors . . . it will pay you to call Alliance . . . the big people in small motors. Stock motors of all types. Special variations and applications engineered to your requirements. Canadian engineering representatives for Howard Industries Inc. of Racine, Wis. For prompt attention, just write or phone

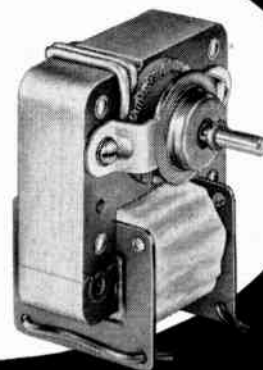

ALLIANCE MOTORS • SCHELL AVE • TORONTO (10) ONT. RE 6124

For further data on advertised products use page 69.

COMMUNICATIONS ISSUE



The May issue of **ELECTRONICS AND COMMUNICATIONS** will highlight the use of Communications in Canada.

Its editorial pages will be devoted to a portrayal of how Canadian business and industry are using to advantage, the products of communications equipment manufacturers and suppliers. The issue will afford a splendid opportunity for communications equipment manufacturers to present the story of their products to the purchasers of this type of equipment. The issue has been planned to have strong appeal to both engineers and management in the Canadian communications industry.

Each month, 10,000 copies of **ELECTRONICS AND COMMUNICATIONS** reach every corner of this field in Canada. A sales message from you in this issue would contribute towards widening the knowledge and increasing the interest in **YOUR** products and services. May we assist you further?

Closing date — May 15th, 1958

★

ELECTRONICS & COMMUNICATIONS
31 Willcocks St. - Toronto 5, Ont.

IS

Automation

YOUR PROBLEM?

USE A **MELTROL** FOR YOUR

Building
BLOCK



TRANSISTORIZED PHOTO
ELECTRIC CONTROL WITH
COUNTER.

MELTROLS are available as photoelectric controls and counters, liquid level controls, sensitive relays, overload controls, speed relays and a wide variety of timers.

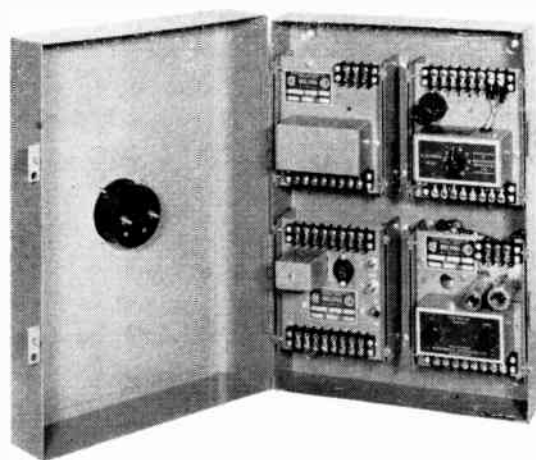

SPECIAL ARRANGEMENT FOR PROCESS CONTROL

MEL can supply — Counters for production and batch counters; smoke indicators and recorders; turbidimeters; brightness meters; metal detectors; programmers; radiation monitors and controls; thickness gauges; speed feed meters and tachometers; ultrasonic cleaners; colour matching instruments; humidity controls; operation recorders; indicating instruments and recorders.

*Custom built instrumentation a specialty.
Write for literature.*

Measurement Engineering Ltd.

ARNPRIOR, ONTARIO. PHONE 400

Montreal, Phone RI. 8-9553
P.O. Box 189
Postal Station "O"

Toronto, Phone HI. 4-8172
P.O. Box 50
Don Mills

New Products

Infra Red Radiation Pyrometer Type TRP1 *Item 1894*

This instrument was developed by the British Thomson-Houston Company as a means of determining the temperature of a surface from a distance by measuring the intensity of the infra-red radiation which that surface emits. The infra-red sensitive element is a lead sulphide cell, which is placed behind a rotating chopper disc in such a manner that it irradiates alternately by the hot surface and by a tungsten filament comparison lamp. An alternating voltage is thus produced across the cell the value of which is zero if the quantity of radiation from the two sources

is the same.

The control circuit adjusts the lamp current and ensures that the alternating cell voltage is kept at a minimum; and it is the lamp current, which is indicated on a meter, which is a function of the sur-

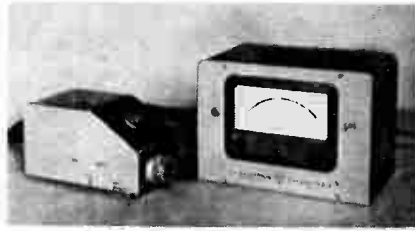

face temperature. Thus the cell is used as a null-detector, and the inherent drift in its sensitivity is unimportant.

The pyrometer uses a transistor circuit to achieve lightness, and it incorporates two components: the Viewing-head and the Control Box. The Viewing-head weighs 4½ lbs. and the Control Box weighs 11 lbs., and power consumption at 60 cycles is approximately 12 watts.

The lead sulphide cell is housed in the viewing-head and the incoming infra-red radiation is focused on it by an objective lens, placed at the inside of an extensible lens tube.

A view finding telescope is provided in the viewing head, in which a moveable mirror behind the objective lens reflects the incoming rays on to a magnifying lens, and a graticule indicates the approximate area irradiating the photocell.

The pyrometer does not measure temperature directly, it responds to the infra-red radiation falling on the photo cell, and the reading is influenced by the emissivity of the surface, the presence of reflected infra-red radiation, the size of aperture fitted, the distance, and the extension of the lens tube.

As the reading depends on many independent variables, the instrument must be calibrated under similar conditions to those under which it is to be used. Such a curve can be obtained with Thermo-couples and a hot plate of appropriate surface finish. The British Thomson-Houston Co. (Canada) Ltd., 766 King Street West, Toronto 2B, Ontario.

Stroboscope Detects Mechanical Difficulties

Item 1895

If one were asked to name the electronic device that has been of greatest benefit to the industries that use machines, the choice would unhesitatingly be the stroboscope. This instrument, which emits brief, accurately-timed flashes of light at an adjustable rate, is useful wherever wheels turn—it measures rotational speed without loading the member being measured; it shows up sources of noise and vibration through slow-motion effects; and it spots faulty operation, also by slow-motion studies.

The small, portable stroboscope manufactured by the General Radio Company and called the Strobotack, is used in the design, operation, and test of motors, machine tools, engines, textile spindles, sewing machines, fans, vacuum cleaners, and many other devices. Its range of speed, as read directly from the scale, is 600-15,000 rpm. By means of multiple relationships it can measure speeds up to 100,000 and down to 60 rpm. When standardized in terms of a frequency-controlled power line, its measurement accuracy is 1% or better. It is CSA approved for use in Canada.



Other General Radio stroboscopes are the STROBOLUME, which emits a very high intensity flash for low-speed work, such as is necessary on printing presses and textile looms; and the MICROFLASH, for high-speed photography at an exposure of 2 millionths of a second.

General Radio Company, 275 Massachusetts Ave., Cambridge 39, Mass., U.S.A.

FOR ANY TYPE — ANY SIZE

BALL AND ROLLER
BEARINGS
AND PILLOW BLOCKS

You can depend on

RAM BEARINGS CANADA LTD.

VANCOUVER WINNIPEG LONDON HAMILTON
TORONTO MONTREAL THREE RIVERS QUEBEC CITY

RAM

NEW DEPARTURE

OILITE

HYATT

HEIM

SHAHER

CARBOLUBE

KAYDON

TIMKEN

TORRINGTON

SEALMASTER

NATIONAL Oil Seals

Catalogues free on request.

Stock deliveries.

Service across Canada.

For further data on advertised products use page 69.

Forget
the
Amplifier

Boost feeble input signals
with compact ultra-sensitive

WESTON
Sensitrol[®]
relays



If your design utilizes an amplifier to boost a minute signal for relay operation — or, if you have “shelved” some new product idea because the cost, space requirement and other drawbacks of amplifiers made the design impractical — Sensitrol relays are for you. For these tiny, ultra-sensitive relays, which operate direct on input signals as slight as 1 millivolt or ½ micro-ampere, and handle substantial wattage at 110 volts, entirely replace amplifiers, vacuum tubes and auxiliary power supplies. They are available with single or double contacts, fixed or adjustable, manual or solenoid reset. For engineering assistance in adapting Sensitrol relays to present products, or new problems you have in mind, call your nearest Weston representative, or write for the Sensitrol bulletin B-25-B . . . to Daystrom Limited, 840 Caledonia Road, Toronto 10, Ontario; 5430 Ferrier Street, Montreal, Quebec, a subsidiary of Daystrom, Incorporated. Or any office of Northern Electric Co. Ltd.

5706

WESTON
Instruments



Between these sizes...

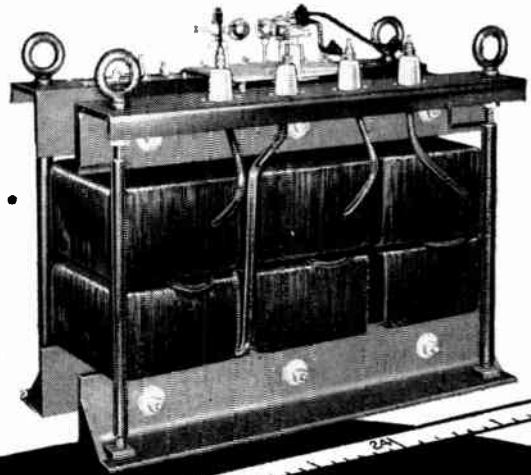

**HAMMOND
TRANSFORMERS**

... to meet every requirement

The miniature transformer, for transistor and vacuum tube circuitry, dealing with energy levels of one-thousandth of a watt; and the 1100 pound, 3 phase, plate transformer are extreme opposites in the Hammond Transformer line.

Between these sizes any specification and power level can be supplied. Engineering and manufacturing facilities are available to meet the most complex and rigid design requirements.

Many hundreds of stock units are available. If your requirement is not met by a stock type Hammond will build a transformer to your own specifications. Enquiries for large or small quantities of “specials” are invited.

RACKS • PANELS • CABINETS • CHASSIS

Fabricated metal parts are produced by Hammond for both industrial, and experimental work, in many stock sizes. Hammond also specializes in “original” metal equipment, built to your own design.

STANDARD ITEMS STOCKED BY LEADING JOBBERS FROM COAST TO COAST

For Catalogues, or further information on “specials” write:-
HAMMOND MANUFACTURING COMPANY LIMITED

H. 57/4 GUELPH, ONTARIO, CANADA

For further data on advertised products use page 69.

New Products

FM Carrier System Unit

Item 1896

It was recently announced by Panhandle Electric Sales Incorporated that their Type FM Subscriber Carrier Systems and equipment will be manufactured for Lenkurt Electric Co. of Canada Limited and distributed in Canada by Automatic Electric Sales (Canada) Limited.

The company states that Panhandle systems, which have been developed and perfected over the past eight years and in widespread use for more than five years, provide a low cost, versatile method of obtaining up to 10 additional subscriber circuits from an existing wire line, or up to 20 such circuits from the same pole-lead. Operating frequencies are higher than with most conventional carrier equipment, so that the systems can be installed on the

same circuit or pole-lead as existing carrier equipment, with little difficulty regarding

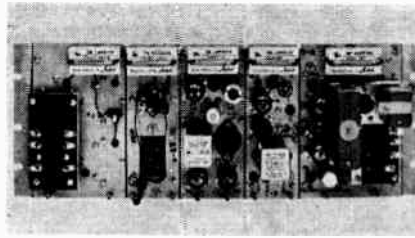

co-ordination. To provide maximum flexibility in application and to simplify field service, the various circuits are grouped in functional units. Each channel is complete in itself so that no common equipment is needed. Crystal-controlled oscillators ensure stable operation and eliminate problems of oscillator drift.

Of particular interest to Canadian users, a complete supply, repair and replacement

service for the entire range of Panhandle carrier systems and equipment has been established by Lenkurt Electric at Vancouver, B.C. For further details, copies of illustrated literature, etc. write to Automatic Electric Sales (Canada) Limited, 185 Bartley Drive, Toronto 16, Ontario.

Ignition Analyzer

Item 1897

A useful item of airborne electronic equipment is a product of the Bendix Scintilla organization and it is marketed and overhauled in Canada by Aviation Electric Limited of Montreal, P.Q. This is the Ignition Analyzer, a unit which is capable of examining individually the wave forms of each pair of spark plugs on the various cylinders of multi-cylinder engines. These wave forms are displayed on a five inch cathode ray tube. The sweep of the tube is synchronized with the rotation of the engine by means of a synchronizing pulse obtained from an auxiliary unit mounted on the engine. This presents each cylinder's wave form in the correct relationship to the order of cylinder firing, and enables any faulty plug to be instantly identified and changed, without the loss of time generally encountered when attempting to locate faulty plugs by removal and testing.

For further particulars write Aviation Electric Limited, P.O. Box 6102, Montreal, P.Q.

Motor Control Panels

Item 1898

To aid manufacturers in obtaining peak production with minimum fear of breakdown, the Canadian Research Institute has devised an electronic Motor Control Panel which actually is a dual control, accommodating two completely separate motors. Each section comprises a motor starter with conventional start-stop push switches. Contact-type ammeters easily resettable from the front, fed from enclosed current transformers, constantly monitor the input.

Should the load on the motor, which can be driving anything from a lathe to a cement mixer to a rubber mill, be below a predetermined minimum, a warning bell sounds. As the load is increased suitably, the bell shuts off. If the load reaches dangerous limits, a buzzer sounds. If the load increases too rapidly for correction, the motor shuts off automatically.

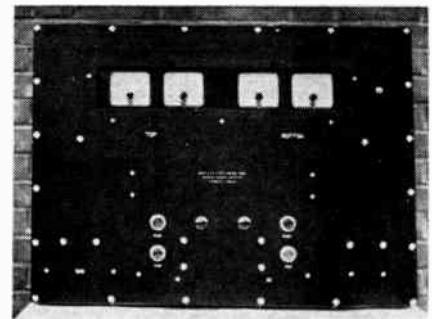

A wide variety of modifications are possible. The warning bell and buzzer are often replaced by relays, solenoids, or electrically activated valves to enable self-correction of the undesirable situation. A case in point is found in the blending of plastic compounds. The mixer is started up at light or no load, and the Motor Control Panel calls for more raw material. As the machine becomes filled to capacity, the panel automatically discontinues feeding. During blending, the viscosity of the mix increases considerably. When this stage is reached, the Motor Control Panel meters in a plasticizing oil in just the desired quantities to keep the body of the mix to the desired specifications. The automatic overload cut-off is always on duty in case of unexpected increase of load.

For further information write Canadian Research Institute, 46 St. George Street, Toronto 5, Ontario.

(Continued on page 71)

FOR INSTANT SSB TESTS —

MARCONI

H.F. SPECTRUM ANALYSER

OA 1094

The Marconi HF Spectrum Analyser provides an instant, panoramic visual presentation of the frequency spectra of signals in the 3 to 30 Mc/s band. It is perfectly suited to measuring single-sideband transmitter and drive-unit characteristics.

In addition, intermodulation distortion, noise level, carrier compression, crosstalk, etc., can be quickly and easily seen and evaluated against the c.r.t. graticule.

A continuously variable sweep width allows observation of a whole broadcasting transmission bandwidth, or of only a few cycles for accurate separation of closely-spaced components. A high order of selectivity assures discrimination between signals of widely differing amplitudes but as little as 50 c/s apart.

Input Frequency Range:	3 to 30 Mc/s in 9 bands with separate fixed frequency input of 3.1 Mc/s
Spectrum Width:	0 to 30 kc/s
Sweep duration:	0.1, 0.3, 1, 3, 10, and 30 sec.
Amplitude Measurement Ranges:	0 to—30 db, and—30 to—60 db, where 0 db represents level of reference signal
Intermediate Frequency Bandwidths:	6, 30 and 150 cps
C.R.T.:	6-inch diameter with long-persistence phosphor

For further details, write: Marconi Instrumentation Dept:
6035 Cote de Liesse Road
Montreal 16, Quebec.

Marconi



CANADIAN MARCONI

COMPANY — Canada's Largest Electronic Specialists

For further data on advertised products use page 69.

News Report

A monthly roundup of news and personnel changes in the Canadian electronics industry.

"Translators" Open Up New Communities Formerly Deprived Of TV

According to Harry Grau of Benco Television Associates Limited of 27 Taber Road, Rexdale, Ontario, there are at least five to six hundred land-locked or "shadow" areas in Canada where reception is impossible with ordinary TV transmission. The difficulty is that TV signals have still to learn how to hop over mountains and reach the communities in the valleys on the other side.

With the development of an ingenious new system known as a "TV Translator", Benco Television Associates have made it possible for two mountain-locked communities to enjoy big-city TV in their own remote areas. During February the first TV Translator in Canada was installed and put into operation at Estcourt, Quebec, receiving Channel 3 at Rimouski and transmitting it in their area on Channel 70 UHF. Later in the same month another TV Translator was put into operation at Clermont, Quebec, picking up Channel 4 Quebec and transmitting it on Channel 75 UHF to the Clermont region.

In operation the TV Translator picks up any standard VHF telecast, converts it to UHF, and retransmits it for viewers in any given community area. Any possible interference is eliminated by converting the TV signal to a different frequency and then transmitting it on a "clear channel".

The equipment may be owned and operated as a community utility, or by individuals. Anyone holding a commercial radio operator's license may be in charge of a Translator station, supervising it by remote con-

trol. A permit for its operation must be obtained from the Government Department of Transport and Communications. The Translator cannot be used to originate or handle additional "commercials" or program material. However, it has its own identification and this is transmitted at regular intervals by automatic equipment.

Head Office Appointments At Canadian Admiral

The appointment of two Product Managers for Canadian Admiral Corporation, Ltd., has been announced by Stuart D. Brownlee, executive vice-president. The new Product Managers will be responsible for the development of marketing programs, advertising and sales promotion objectives, market research and analysis for their respective product lines.

Wally Johnston, Product Manager, Television and Radio, will cover Admiral television, radio, hi-fi, phonos and related products. Keith Comly, Product Manager, Appliances, will cover Admiral refrigerators, ranges, home freezers, air conditioners, automatic dishwashers and dehumidifiers.

Mr. Johnston came to Admiral in 1952 as manager of the Montreal sales branch and was appointed regional manager in 1954. Before joining Admiral, he was television and appliance manager for Anthony Foster & Sons. Mr. Comly has been Traffic Manager of Canadian Admiral Corporation, Ltd., since the company commenced business in 1947.

Replacing Mr. Comly as Traffic Manager, is Doug Wood, formerly traffic assistant. Mr. Wood has been with the traffic department of the company for the past five years.

H. K. Porter Co.'s Federal Division Sells Enfield Cables

Enfield high voltage power and cables will be marketed in Canada by Federal Wire and Cable Division, H. K. Porter Company (Canada) Ltd., according to an announcement by H. F. Nunn, Vice-President and General Manager of Porter.

The signing of an agreement with Enfield Cables Limited, London, England, enables Federal to offer a full range of electrical wire and cable, from the smallest magnet wires to the largest high voltage cables. Manufacturing will be done for Federal at Enfield's works in Middlesex, England. Federal-Enfield cables will include paper insulated, lead sheathed cables to 400-thousand volts.

J. M. Blades, Enfield's resident engineer in Canada, will remain as technical advisor to Federal.

H. K. Porter Company (Canada) Ltd., of Guelph, Ontario, is one of ten divisions of H. K. Porter Company Inc.

New Toronto H.Q. For F. J. Stokes Company

F. J. Stokes Company of Canada Ltd., Canadian subsidiary of F. J. Stokes Corporation, Philadelphia, has moved its Toronto headquarters to 4198 Dundas Street West. Telephone number of the new office is BELmont 2-2301.

Stokes is one of the largest producers of high vacuum processing equipment, plastics molding presses, pharmaceutical machinery, and compacting presses for making powder metal parts and general industrial tableting.

New Appointments For Burndy Canada Ltd.



G. VANDRY



K. F. ROBINSON

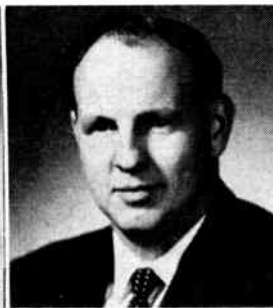

B. A. AMYOT



K. A. LAIDMAN

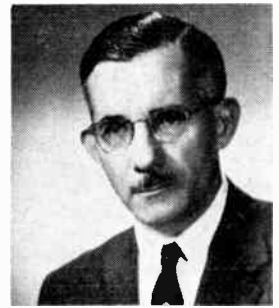

P. LEMESURIER

● A comprehensive study of the marketing and sales operations of Burndy Canada Ltd. has indicated that re-organization along divisional lines will materially assist in improving service to their customers. The appointment of Market Managers for the two divisions has been announced by the General Sales Manager, S. G. Ward. Guy Vandry, formerly Eastern District Sales Manager, has transferred to Toronto where he will act as Market Manager for the Utility-Industrial Division on a national basis. Kenneth A. Laidman has been appointed Market Manager for the Omaton Division, serving the Original Equipment and Aircraft Markets. The above re-organization has necessitated changes in both the Central and Eastern Districts. Peveril C. K. LeMesurier has been appointed Central District Sales Manager (Province of Ontario). Bruneau A. Amyot has been appointed Eastern District Sales Manager (Province of Quebec, Maritimes and Newfoundland). In both cases the Area Managers will be responsible for marketing products for the two divisions. Kenneth F. Robinson has been added to the Central District Sales staff.

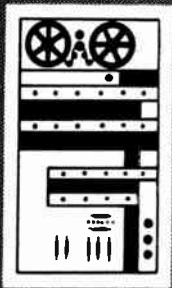

waste

Eight hours to set up an electronic computer. Three seconds for it to solve the problem. One computer component failure and you start all over. Sprague high reliability components are used in computers because they're least likely to fail.

SPRAGUE

**CANADIAN
MANUFACTURING
REPRESENTATIVE**

Micarta Fabricators
Limited

18 Toronto Street
Toronto, Ontario
Phone EMpire 8-4251

CHAS. L. THOMPSON LTD. OPENS WINNIPEG OFFICE

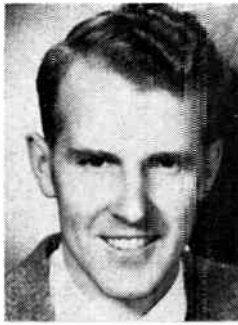

D. T. ELLIOTT

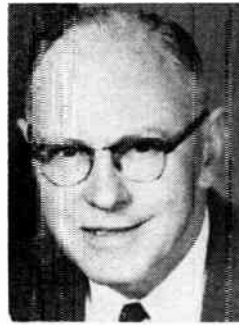

C. L. THOMPSON

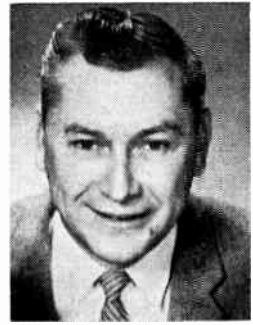

L. J. DOUCETTE

One new office and two new directors for Chas. L. Thompson Ltd., manufacturers' representatives covering western Canada for electronic equipment, means broad expansion of service to customers, according to a recent announcement by Charlie Thompson, company president.

The new office is at 87 King St., Winnipeg, Manitoba, and the two new partners are Dave Elliott and Leo Doucette.

While the Thompson organization has covered the entire western Canada territory for many years from its Vancouver headquarters, establishment of an office and warehouse in Winnipeg means closer contact and better service to customers across the entire territory and particularly from Saskatchewan to the Lakehead.

Leo Doucette will be in charge of the Winnipeg office. He joins Chas. L. Thompson Ltd., as a director after many years of experience selling electronic equipment and supplies. The past five years have been spent in western Canada where he is well known to the trade.

The other new director, Dave Elliott, is equally well known. He has been with Chas. L. Thompson Ltd., for over 11 years.

Charlie Thompson himself is one of the old-timers in this new industry. He has been active in electronics merchandising for over 30 years. In 1944 he became manager of Selkirk Agencies Ltd., which company he took over in 1947.

1958 Electronic Parts Distributors Show

The keen interest taken by Canadian manufacturers and distributors of electronic equipment in the annual Electronics Parts Distributors Show, held annually in May in the Conrad Hilton Hotel, Chicago, is evidenced by the large number of Canadians who attend year-after-year.

Industry members attending this year's show will be introduced to a streamlined three-day event from Monday, May 19, to Wednesday, May 21. Show hours will be from 9 a.m. to 6 p.m. daily, giving industry members full opportunity to visit exhibits and attend important business conferences.

The Canadian headquarters will be set up this year in Room 18 on the fourth floor of the hotel. These headquarters, sponsored by the Canadian Electric Sales Representatives, will open each day at 9 a.m. and will remain in operation during all three days of the show, under C. G. (Jerry) Pointon, chairman of the Association, assisted by John T. Rochford, Canadian headquarters manager, and staff. All Canadian visitors to Chicago are welcome to make the Canadian Room their headquarters and meeting place.

The fifteenth annual Canadian Luncheon, sponsored by the Canadian Electronic Sales Representatives, will be held in the Beverly Room, preceded by an informal reception in the Bel Air Room of the Conrad Hilton at noon on Tuesday, May 20.

MORE ACTIVE! EFFECTIVE!



**THE BEST FOR TV-RADIO WORK . . .
EVERYTHING ELECTRICAL — Kester "Resin-Five"**

Core Solder is better and faster than any solder ever developed. It has an activated flux-core that does a perfect job on all metals including zinc and nickel-plate. The flux residue is absolutely non-corrosive and non-conductive.

Available in all practical Tin-Lead Alloys; 40/60, 50/50 and 60/40 in diameters of $\frac{3}{32}$ ", $\frac{1}{16}$ ", $\frac{3}{64}$ ", $\frac{1}{32}$ " and others.

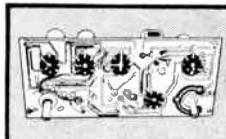

Printed Circuit Soldering
On Copper-etched boards use 60% Tin - 40% Lead Alloy . . . for those that are Silver-surfaced use 3% Silver-61½% Tin-35½% Lead

KESTER SOLDER COMPANY

OF CANADA, LTD., Dept. U Brantford, Canada

For further data on advertised products use page 69.

Jensen SPEAKERS

MANUFACTURED IN CANADA

Let us assist you in designing your HiFidelity Speaker Systems. Simply advise us of your basic speaker requirements, give us a diagram of your cabinet and an approximation of your speaker budget — and our Engineers take over.



**P12P - 12" and P15P - 15"
HEAVY MAGNET
SPEAKER**

Magnet — 1 lb.
Voice Coil — 1½" diameter,
8 or 16 ohms.
Wattage Rating — 16 watts.
Woofer and full range
types available.



**RP-103
HORN TWEETER**
Magnet — 4.64 oz.
Voice Coil — 16 ohms,
1" diameter.
Cycles — 2,000 to 20,000.

For further information write to Department 2.

SPEAKER DIVISION J.R. LONGSTAFFE CO. LTD.

300 CAMPBELL AVENUE

TORONTO

ONTARIO

If You Want a Thermostat That's Rugged...

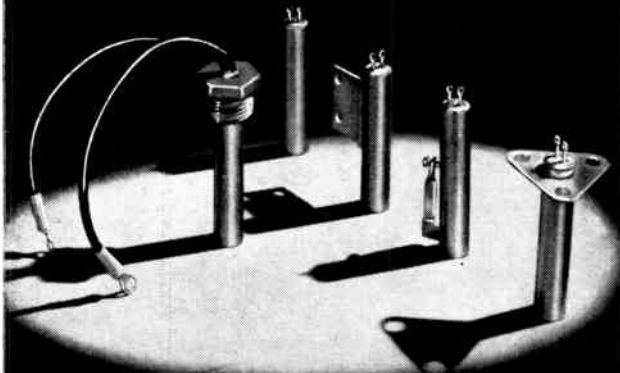

that operates dependably at settings
as low as -40°F. and as high as +300°F....

G-V's C8 Series of hermetically sealed electrical thermostats is specially designed to meet the difficult operating conditions of electronic and aircraft applications. Operating points, regardless of settings, are not changed by exposure to temperatures ranging from -100°F. to +300°F. Shocks up to 150g for 3 milliseconds, vibration of 25g up to 1000 cps, and vibration of 10g up to 2000 cps do not damage these thermostats nor change their setting.

Write for complete technical and application data.

G-V G-V CONTROLS INC.
54 Hollywood Plaza • East Orange, N.J.

Represented in Canada by:
LEONARD ELECTRIC, LTD., 346 Bering Ave., Toronto 18

This handy
Selector
FREE



Saves hours of time if you order or specify sheet-metal cabinets, racks, panels or chassis. With the handy Bud Selector you don't need to go through a catalog or study a lot of details and specifications.

If you're selecting Cabinets Racks, Relay Racks or Cabinets and you know what panel space is required you can quickly determine the correct size and catalog number of the rack or cabinet. Or you can choose the cabinet and rack you desire and easily discover the size and catalog number of panels you need.

When you specify or order standard or special chassis the Bud Selector again quickly gives you the correct catalog number for the exact size and type required.

High quality and prompt service assures you satisfaction when you order Bud Products. See them at your nearest Bud Distributor.

Write us on your letterhead
for your handy Bud Selector.

TENATRONICS, LTD.

Davis Drive, East

Newmarket, Ontario

Exclusive Canadian Representative for



BUD RADIO, INC.

Dept EC, 2118 East 55th Street
Cleveland 3, Ohio

Royal

has the right seat for the job



**MODEL 621
MICRO-HITE
SWIVEL STOOL**
Simply turning the handwheel adjusts seat height effortlessly.



515
(Adjustable leg height)



501
(Stationary—available in various heights)



625
SWIVEL
(Micro-Hite adjustment)

You know that good seating promotes efficiency of office workers—it will do it for factory workers, too. Although Royal factory seating offers virtually all the same posture-type features, *their cost is only a fraction of that of the lowest priced office chair.* Wide range of chairs and stools—adjustable or stationary heights—round or square seats. (Masonite or upholstered). All-welded steel construction. Ten-year structural guarantee.



ROYAL METAL MANUFACTURING CO. LTD.
GALT, CANADA.

I am interested in prices and literature on the following—

- MODEL 515 MODEL 501
- MODEL 625 MODEL 621
- ALL ROYAL FACTORY SEATING

COMPANY

ADDRESS

CITY OR TOWN PROV.

MY NAME 58-B

News Report

Dr. S. H. Ward Joins Inco Research Division

Stanley Herbert Ward, B.Sc., M.Sc., Ph.D., has been appointed to the staff of the Canadian Development & Research Division of The International Nickel Company of Canada, Limited, 55 Yonge Street, Toronto, Ontario.

Dr. Ward will be directly connected with the company's market development and research program, particularly in the Industrial Chemical field and at the same time will help to co-ordinate Inco's program of aid to Canadian education.

A native of Banff, Alberta, Dr. Ward graduated from the University of Alberta in 1939 with a B.Sc. degree and later in 1948 received his M.Sc. degree from the same university. In 1952 he graduated from the University of Texas with a Ph.D., in chemical engineering. During World War II he served overseas for three years as a pilot with the R.C.A.F.

Electromechanical Products Appoints Rep

Radiation Counter Laboratories, Inc., Skokie, Ill., have recently appointed Electromechanical Products of Agincourt, Ontario, to represent them in the Dominion of Canada, according to Charles J. Walsh, RCL sales manager.

DIRECTOR



● The election of the Hon. Leon Méthot, Q.C., B.A., to the board of directors of the Canadian Westinghouse Company, Limited, has recently been announced by George L. Wilcox, president. Appointed to the Senate of Canada in October, 1957, he is a native of Trois Rivières, P.Q. where he still resides and conducts an extensive legal practice.

STANWYCK

Coils for every application in the R.F. Spectrum



R.F. Inductors

Transistor I.F. and Osc. Units



Encapsulated Inductors



Adjustable R.F. Inductor for B.C., H.F. and VHF Service

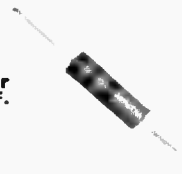

Special Transmitting Inductors



Shielded Variable Inductors



Also complete line of Radio and TV Coils

Stanwyck Coil Products

Limited
HAWKESBURY, ONTARIO

Telephones

Toronto
PL. 7-3253

Hawkesbury
ME. 26651

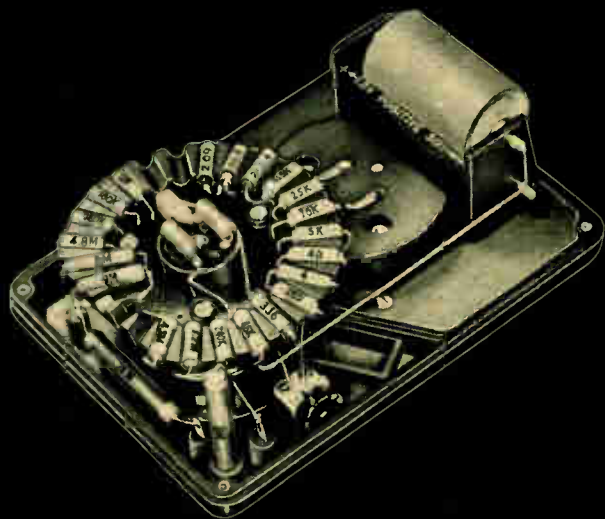

new... most easy to read



- Clear, unbreakable, shadowless front for instant wide vision.
- 5 to 500,000 cps on A.C.
- Continuous resistance reading from 0.1 ohms to 100 megohms.
- Polarity reversing switch.
- *Only one* (king-sized) switch selects both circuit and range—minimizes wrong settings, burnouts.

Only Triplet affords you such a wide choice of VOMs. Whatever your application—broad or limited—there is a Triplet VOM particularly suited for it.

the mighty nine + two

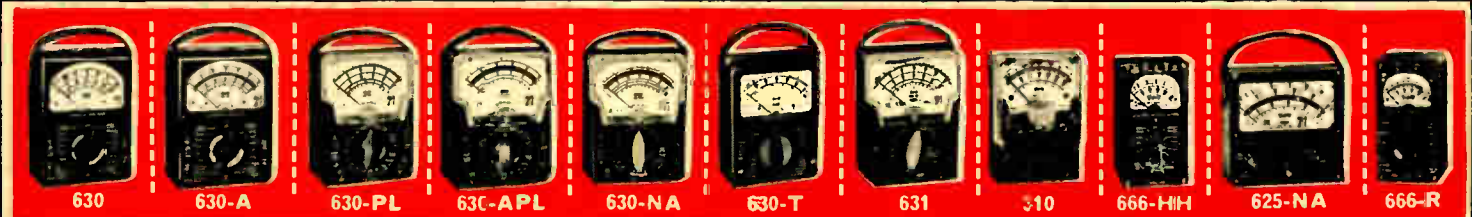

TRIPLET ELECTRICAL INSTRUMENT COMPANY • BLUFFTON, OHIO

LEN FINKLER, 330 Adelaide St. W., Toronto, Ont. • C. M. ROBINSON COMPANY, 189 Market St., Winnipeg; 325 10th Ave., Calgary; 550 Beatty St., Vancouver

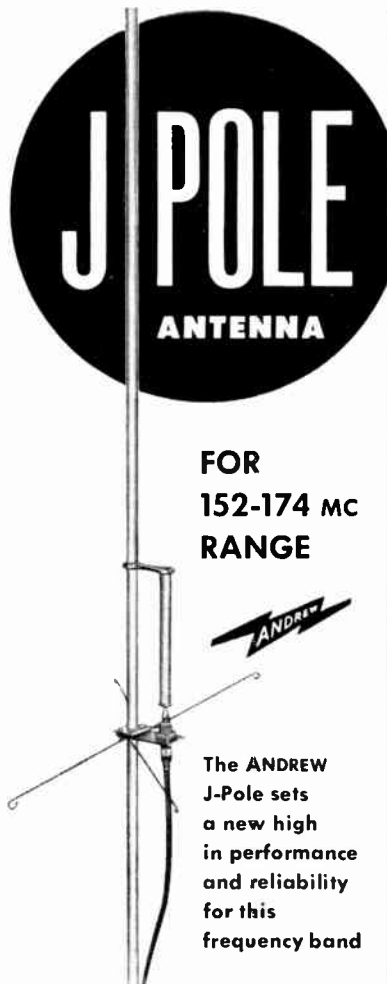

This antenna combines a shunt-fed $\frac{3}{8}$ wave vertical radiator with a unique new impedance matching cable connection giving superior electrical characteristics, yet is priced with the lowest.

CHECK THESE FEATURES

Unity Gain—Gives full gain due to superior mast isolation of $\frac{3}{8}$ wave radiator with ground plane.

Grounded Radiating Element—Lower noise, better lightning protection.

Low VSWR—Special feed connection transforms impedance for accurate match to line.

Rugged—One piece heavy wall brass radiating element and support tube. Rated for 120 MPH. All metal parts are brass or stainless steel.

Weatherproof—Insulator and cable termination are fully weatherproof.

Andrew
ANTENNA
CORPORATION LTD.
WHITBY, ONTARIO

ANTENNAS - ANTENNA SYSTEMS - TRANSMISSION LINES



MANUFACTURED IN CANADA

News Report

Computing Devices Handle Bendix Transistors And Tubes

Sale of transistors and vacuum tubes made by the Red Bank Division of The Bendix Aviation Corporation are to be handled in Canada by Computing Devices of Canada Limited, according to an announcement by CDC Marketing Director W. S. Kendall.

Red Bank transistors have been sold by CDC since the first of the year, and the Red Bank line of electron tubes will be added on April 1st.

Bendix tubes are especially designed for use in rigorous environments. Some types give reliable service at temperatures of 500°C and in conditions of severe vibration. They are built for the most demanding applications in modern weapons systems. Types include receiving, micro-wave, and special purpose gas tubes.

Dr. George Sinclair Appointed Chairman Executive Committee IRE Convention

Dr. George Sinclair, Professor of Electrical Engineering, University of Toronto and President of Sinclair Radio Labs Limited has been appointed Chairman of the Executive Committee formed to handle arrangements for the Institute of Radio Engineers' 1958 Convention and Exposition, one of Canada's largest annual scientific events, to be held here October 8, 9 and 10.

Other members of the Executive Committee are: Past Chairman, C. A. Norris, Remington Rand; Exhibits Chairman, F. G. Heath, Canadian General Electric; Registration Chairman, Eric L. Palin, Ryerson Institute of Technology; Technical Program Chairman, A. P. H. Barclay, Philips Electronics Industries; Local



Dr. George Sinclair

Activities Chairman, E. D. Etches, Radio Valve Company; Advertising Publicity Chairman, Ellerston Jones, Philips Electronics Industries; Finance Chairman, T. M. Lynch, Canadian Marconi; Toronto District Chairman, H. W. Jackson, Ryerson Institute of Technology; Corresponding Secretary, J. M. Toye, Canadian General Electric; Recording Secretary, S. F. Love, Radio Valve Company; Convention Manager, Grant Smedmor.

The Automotive Building in the Canadian National Exhibition grounds will be the site of the 1958 Convention and Exposition. The event will bring together leading scientists and technical experts from Canada, the United States and overseas.

If it's
TOWERS you
need, check
ROHN
FIRST!

AMERICA'S FINEST
COMMUNICATIONS
TOWER OF ITS KIND
... WITH EXCLUSIVE
BUILT-IN ECONOMY

✓ Reduce Costs

—by getting a tower *specifically for your job*. These towers are suitable for use up to 300 feet guyed—or self supporting to 50-60 ft.! ROHN towers are in daily use for micro-wave, radio and dozens of all type communications requirements throughout the U. S.—at big savings—yet more than do the job! Can be used for a multitude of jobs.

✓ Proven design

—get full engineering data to prove superiority. Gleaming, hot-dipped galvanized finish available—stays shiny and new—no painting needed. Design fully tested—proved by thousands of installations. Easily shipped and inexpensively installed. Cross pieces form natural ladder for servicing.

✓ Special Towers

—you're invited to submit your requirements. Towers will be built to your specifications if practical. Let us know your needs—ROHN can satisfy them **BEST** when it comes to towers of this type.

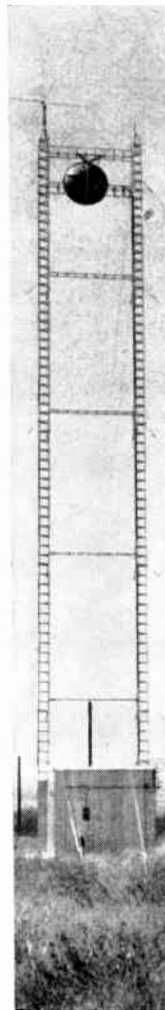

Illustrated here is a micro-wave installation of Rohn No. 40 tower for use by Public Service Company of Colorado for a state-wide communications system—one example of the thousands of ROHN towers now in use.

FREE



Send for new "Specifications & Price" catalog for Rohn Communications Towers. Your inquiry will receive prompt attention. Rohn representatives are coast-to-coast to serve you. Write—phone—wire

ROHN Manufacturing Co.

116 Limestone, Bellevue
Peoria, Illinois

"Pioneer Manufacturers of TV and Communication Towers of All Kinds."

Galileo Galilei
1564-1642



*"Wherever I am,
whatever my need,
They're delivered* to me
with blinding speed!"*



BECKMAN/BREADBOARD PARTS

*For the standard parts
to breadboard your system,
Send for catalog 35E,
where we show 'em and list 'em.*

**Within 3 days of order!*

Beckman

Helipot Corp. Newport Beach, Calif.
a division of Beckman Instruments, Inc.
Canadian Factory: No. 3 Six Points Rd., Toronto 18, Ont.
Sales Representative: R-O-R Associates, Ltd.
1470 Don Mills Road, Don Mills, Ont.

1205

HANNOVER
the most important Market of the
ELECTRICAL INDUSTRY
for heavy equipment and consumer goods
GERMAN INDUSTRIES FAIR
APRIL 27 - MAY 6, 1958
Information and catalogues from:
THE TRIMONT CORP. LTD.
1170 Drummond St., Montreal, Quebec

AMPHENOL

PRINTED CIRCUIT CONNECTORS
143 - 133 SERIES



143 Series



133 Series

- Compact bodies of improved version of diallyl phthalate dielectric.
- New contact, superior in the field.
- 6 available contact tails.
- Can't be overstressed.
- Long contact life.
- Low milivolt drop.
- Contacts can't be set.
- Gold plated, assuring long life.

For further information write to Department 3 for Amform 2599.

AMPHENOL

CANADA LIMITED
300 CAMPBELL AVE.
TORONTO - ONTARIO



No. 80421



No. 80938B

NOW... a Complete Range of

ARROW-HART



Switch Controls

... One hole, quick make, quick break switches for radio and electronic equipment and all your small motor control requirements. Send for your copy of the new, illustrated Bulletin Z-2 today.



ARROW-HART & HEGEMAN
(CANADA) LIMITED

Industry Street, Toronto 15, Ontario — RO. 2-1101
6235 Papineau Ave., Montreal, Que.

Representatives:

Cochrane Stephenson (Western) Ltd., Winnipeg, Colgory,
Edmonton, Vancouver; George C. Robinson, Saint John, N.B.

5701

American Beauty

ELECTRIC
SOLDERING IRON

NEW!

TINY TIP FOR MINIATURE, SUBMINIATURE AND MICRO-TYPE CONNECTIONS.

The slim, new American Beauty "T-12" iron with its plug-in transformer is especially built to solder today's tiny connections easily, accurately and dependably.

This NEW tip-element (about the size of a kitchen match) with its 3/32" tip is built for fast, hot, production-line use—day after day.

Here is the quality-built, economical answer to YOUR miniature soldering problems! Write for literature and prices.

AMERICAN ELECTRICAL HEATER COMPANY

171-H

DETROIT 2, MICHIGAN



RELIABLE, LIGHTWEIGHT, PORTABLE POWER

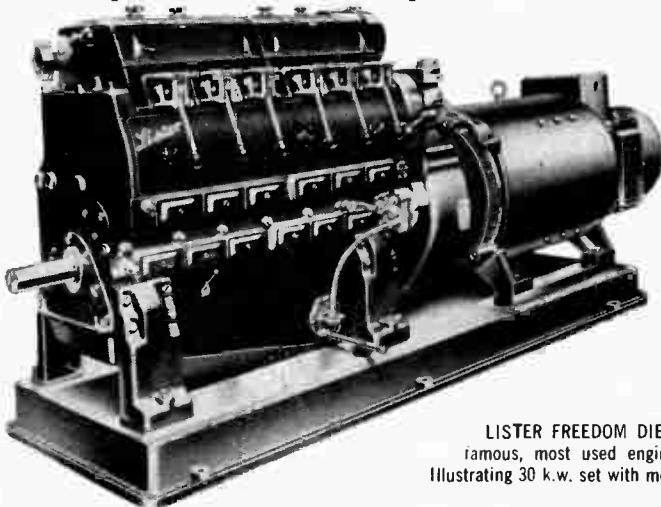

LISTER FREEDOM DIESELS—the most famous, most used engines in industry. Illustrating 30 k.w. set with model FR6 Engine.

Built in a tradition of reliability, Lister-Blackstone engines incorporate the very latest improvements in Diesel design. The full line includes engines from 3½ to 1300 h.p. and there are models for every purpose. Ease of maintenance and economical operation are assured when you specify Lister-Blackstone. Service and spare parts are available from coast to coast.

Write us for the name of your nearest Distributor.

CANADIAN LISTER-BLACKSTONE LIMITED

1921 EGLINTON AVE. E., TORONTO 13 • 3135 WEST BROADWAY, VANCOUVER
25 ST. JAMES ST., VILLE ST. PIERRE, MONTREAL
In the U.S. — Lister-Blackstone Inc., 42-32, 21st St., Long Island City 1, N.Y.

DISTRIBUTORS: B.C. Equipment Co. Ltd., 551 Howe Street, Vancouver; Bruce Robinson Electric (Edm.) Ltd., 10056-109th Street, Edmonton; Medland Machinery Limited, 576 Wall Street, Winnipeg; Russel-Hipwell Engines Ltd., Owen Sound; Consolidated Engines & Machinery Co. Ltd., 5645 Pare Street, Town of Mount Royal, P.Q.; Russel-Hipwell Engines Ltd., 1298 Barrington Street, Halifax; Clayton Construction Co., Ltd., P.O. Box 118, Muir Bldg., St. John's, Nfld.

For further data on advertised products use page 69.

News Report

E. E. Whittaker Expands Canadian Representation

The Electronics Division of Gudebrod Bros. Silk Company, New York, recently announced the appointment of Ernest F. Whittaker of Arnprior, Ontario as Canadian representative.

Mr. Whittaker's broad experience in the field of electronic devices, components and materials is well-known. To this is now added the complete line of top-quality lacing tapes of a variety of dielectric fibers of special interest to the fields of communications and air-borne devices.

Mr. Whittaker was formerly with Measurement Engineering, Ltd., and with MEL Sales, Ltd. He is well known to many members of the Canadian IRE.

Canadian Motorola Electronics Appoints Senior Executives

R. M. Brophy, President, Canadian Motorola Electronics Limited, Toronto, following the recent announcement of the completion of a long-term sales and manufacturing agreement with



G. W. CROSSAN



H. M. REID

Motorola Inc., Chicago, has released details of senior appointments in the company's organization structure.

G. W. Crossan, formerly Marketing Manager, becomes Sales Manager — Mobile Communications. H. M. Reid, formerly Ontario Region Manager, becomes Marketing Manager—Mobile Communications. W. H. Galpin will function as Product Manager and G. H. Dickson fills the position of National Service Manager.

S. G. Paterson, Vice-President, who directs Sales, Marketing and Service activities of the company, stated that improved planning and engineering of complete Mobile Communications Systems of all types will result from the appointments, which bring together a group of experienced and competent specialists in all phases of two-way radio communications.

MANUFACTURERS OF
CUSTOM SHEET METAL PARTS
 FOR THE
RADAR AND ELECTRONICS
INDUSTRY

WRITE ON YOUR LETTERHEAD FOR
 ILLUSTRATED BROCHURE

BISHOP
 SONS AND CO. LTD.

588 EASTERN AVENUE
 TORONTO 8,
 ONTARIO



STRUTHERS-DUNN
RELAYS

FC-4 and FC-6
 MINIATURE
 HERMETICALLY
 SEALED RELAYS



— Subminiature — Hermetically-sealed —
 — available in four-pole and six-pole double-throw. Designed to exceed MIL-R-5757C and to meet MIL-R-25018 specifications. For aircraft, guided missiles and other critical applications. Withstands up to 60 G shock without contact opening and 2,000 foot-pounds shock without contact transfer. Extra sturdy construction.

*For further information write to Dept. 1 for
 bulletin L2406A.*

RELAY DIVISION J.R. LONGSTAFFE CO. LTD.
 300 CAMPBELL AVE., TORONTO, ONTARIO

ELECTRONIC ENGINEERS

There is a rapidly increasing demand for complex electronic equipment for both military and civilian purposes.

To cope with this demand the Canadian Marconi Company is expanding its activities in the design and development of communication and navigational equipment.

As a result of this expansion we now have a need for fully qualified electronic design engineers to work on the development of the following types of electronic equipment.

LAND MOBILE COMMUNICATION
 AERONAUTICAL COMMUNICATION
 RADAR
 COMPUTERS

MARINE COMMUNICATION
 MICROWAVE COMMUNICATION
 NAVIGATIONAL AIDS
 MICROWAVE TUBE ENGINEERING

RADIO DELAY AND MULTICHANNEL ENGINEERING

Starting salary commensurate with education and previous experience.

Applicants should have four or more years previous experience on related work.

Interviews will be arranged promptly. All replies will be treated on a confidential basis.

Send resumé showing educational background and previous professional experience to

CANADIAN MARCONI COMPANY

INDUSTRIAL RELATIONS DIVISION

2442 TRENTON AVE.

MONTREAL, P.Q.

i
n
t
e
r
n
a
t
i
o
n
a
l

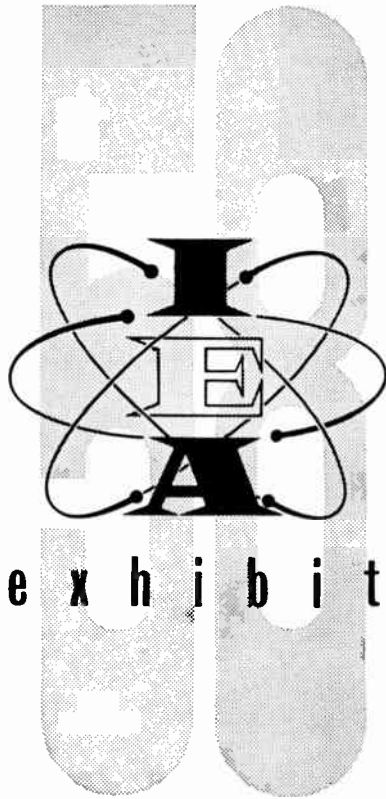

e x h i b i t i o n

INSTRUMENTS
ELECTRONICS
AUTOMATION

16-25 APRIL 1958 LONDON, ENGLAND

You are cordially invited to the 1958 Instruments, Electronics and Automation Exhibition.

MORE THAN 250 BRITISH MANUFACTURERS will be showing the latest and most comprehensive range of exhibits.

OVER 100 OVERSEAS EXHIBITORS will be displaying their achievements in the rapidly developing fields of instruments, electronics and automation.

Note the date NOW.

I.E.A. — the exhibition no progressive industrialist can afford to miss.

A conference will be held throughout the period of the Exhibition. For further details of both Conference and Exhibition contact the nearest British Embassy or Consulate, or write to:

INDUSTRIAL EXHIBITIONS LIMITED
9 ARGYLL STREET, LONDON, W.1, ENGLAND

News Report

General Electric Service Course On Spectrophotometer

The General Electric recording spectrophotometer, a color measuring device, was the subject of a service course, March 24-26, at the Company's Instrument Department, West Lynn, Mass.

Designed for users of the instrument and for other interested persons, the course highlighted servicing, maintenance, calibration and "common trouble-shooting techniques" bearing upon the spectrophotometer and its accessories.

J. E. Detlor Addresses Toronto I.R.E.

On Monday, March 3, the Toronto Section of the Institute of Radio Engineers had, as its guest speaker, J. E. Detlor, P.Eng., Manager, Professional Products, Ampex Corp. of Canada.

Mr. Detlor's subject was "Recent Developments In Video Tape Recording Equipment". He outlined the principles of video tape recording and described techniques of editing and interchanging tapes. Color slides were shown of equipments now in production model stage and Mr. Detlor indicated new applications that are in prospect, including color television.

Management And Industrial Engineering Conference

Under the sponsorship of the Montreal Chapter of the Society For Advancement of Management, a Management and Industrial Engineering Conference was held on March 21 at the Sheraton Mount Royal Hotel in Montreal.

Five speakers, including the Hon. William Hamilton, Postmaster General, addressed the gathering.

The other four speakers were: Dr. Ingo Ingenohl, assistant professor of Industrial Management, Massachusetts Institute of Technology; Fred H. Meyer, vice-president of the New York Division of H. B. Maynard & Co., Management Consultants; George H. Gustat, director, Industrial Engineering Division, Eastman Kodak Co., Rochester, N.Y.; and Claude I. Taylor, manager, Performance Analysis, Sales Department, Trans-Canada Air Lines.

Say You Saw It

Advertised In

Electronics & Communications

A NEW LINE OF
FROM

Precision Test Equipment JERROLD

FOR ACCURATE QUANTITATIVE MEASUREMENTS...
USING SWEEP FREQUENCY GENERATOR TECHNIQUES...

WIDE BAND SWEEP FREQUENCY GENERATOR • MODEL 900



Recommended wherever unusual versatility, high stability and constancy of output are essential. SWEEP WIDTHS—AS WIDE AS 300 MC . . . FROM 200 KC to 1,000 MC.

VHF SWEEP RANGE

Center frequency continuously variable from 0.2 MC to 250 MC. Sweep width continuously variable from a minimum of 0.1 MC, at any center frequency setting, to a maximum of 250 MC at a center frequency setting of 125 MC. Maximum output voltage variation is ± 0.5 db with a minimum output of 0.3 volts RMS into a 50 ohm load.

UHF SWEEP RANGE

Center frequency continuously variable from 275 MC to 900 MC. Sweep width continuously variable from a minimum of 0.1 MC, at any center frequency setting, to a maximum of 100 MC at a center frequency of 275 MC, and to a maximum of 300 MC at a center frequency of 850 MC. Maximum output voltage variation is ± 1.5 db with a minimum output of 0.4 volts RMS into a 50 ohm load.



A HIGH SPEED COAXIAL SWITCH • MODEL FD-30

For the simultaneous display of two channels or voltages on an oscilloscope . . .

Frequency range of coaxial circuit is from DC to 250 MC with a VSWR of less than 1.1 at 50 or 75 ohms impedance. Switch contacts "Mercury-Wetted" with an adjustable switch rate of 30, 15 or 10 cps.

WIDE BAND SWEEP GENERATORS MODELS 95 and 220

Portable, wide-band instruments designed for the test and alignment of LF, IF, and RF circuitry. Available in any portion of the frequency range from 15 KC to 220 MC with a maximum sweep deviation of 5 to 1.

MODEL 95

22 MC to 95 MC. RF output of 1.5 volts within $\pm \frac{1}{2}$ db across a 73 MC band.

MODEL 220

50 MC to 220 MC. RF output of 0.7 within $\pm \frac{1}{2}$ db across a 170 MC band. Top frequency desired denotes model number.

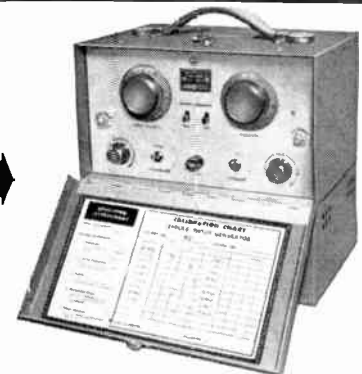

OSCILLOSCOPE PREAMPLIFIER • MODEL SPR-100

The Jerrold Model SPR-100 is an unusual oscilloscope preamplifier featuring a low hum and noise level, excellent stability and 60 cycle square wave response, a built-in detector that is flat from 500 KC to 250 MC, a built-in marker amplifier, and a high gain of 40 db (100 X). The versatility of the unit makes it an excellent companion for oscilloscopes used in RF tests.



Precision Attenuators, Field Strength Meters and Other Test Equipment Available. For further information on these or the above equipment write:

JERROLD ELECTRONICS (CANADA) LTD.

50 WINGOLD AVE. • RUSSELL 1-6174 • TORONTO 19, ONTARIO

In the U.S.A.: JERROLD ELECTRONICS CORP., 23rd and Chestnut Streets, Philadelphia 3, Pa.

All prices and specifications subject to change without notice.



IRC: INSULATED CHOKES

Insulation guards against abnormal atmospheric conditions. Noise and aging negligible. Available in 4 sizes—permitting accurate specification to individual space and electrical requirements. Rugged insulated housings. Applications: filament chokes, plate loads, wave traps, parasitic suppressors, line terminating impedences, cathode chokes, antenna chokes, and grid chokes.

Available in following ranges and types:



- CL $\frac{1}{2}$ (.22 to 1.0 microhenrys)
- CLA (.22 to 7.5 microhenrys)
- CL1 (.47 to 24 microhenrys)
- CL2 (1.0 to 39 microhenrys)

For further information write Department 4 for bulletin H1.

INTERNATIONAL RESISTANCE CO. LTD.

349 CARLAW AVE. TORONTO 8, ONT.

Radiovision Sales Ltd. 325 Tenth Ave. West Calgary, Alta. SALES OFFICES: 492 Somerset St. West Ottawa Ont. 1500 St. Catherine St. West Montreal Que.

ADCOLA
CADUCEUS LIMITED
 REGD. TRADE MARK

MAKERS OF HIGH QUALITY SOLDERING INSTRUMENTS, HAND PYROMETERS, ETC.

Soldering Instruments Available With 1/8", 3/16" and 1/4" Tips

All Voltages Supplied

List No. 64
 3/16" Detach Bit

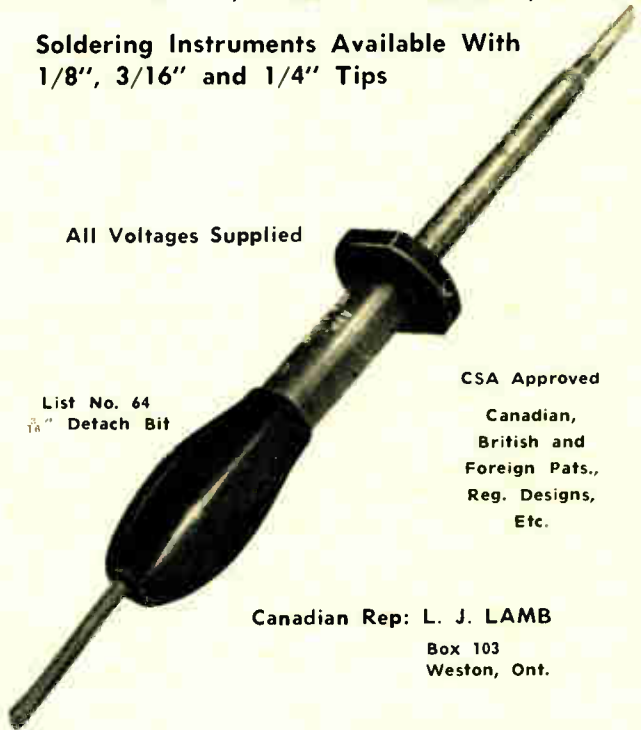

CSA Approved
 Canadian, British and Foreign Pats., Reg. Designs, Etc.

Canadian Rep: L. J. LAMB
 Box 103
 Weston, Ont.

Bendix



PYGMY

MINIATURE ELECTRICAL CONNECTORS

Accommodate 3 times as many circuits as comparable AN arrangements

- 5-Key Polarization on PT Series
- AN Mounting Dimensions
- Lightweight, Compact
- Forged or Bar Stock Shells
- Resilient Inserts
- Closed Entry Sockets
- Moisture resistant
- Vibration resistant
- Heavily Gold-plated Contacts
- Quick Disconnect, Either Series



SCINTILLA DIVISION of
 SIDNEY, N. Y.



Export Sales and Service: Bendix International Division, 205 East 42nd St., New York 17, N. Y.
 Canadian Affiliate: Aviation Electric, Ltd., 200 Laurentian Blvd., Montreal 9, Quebec

PC SERIES

Double Stub Thread



PT SERIES

3-Point Cam Lock



FOUR WIRE TERMINATIONS



"A" General

"E" Open Wire

"P" Putting

"W" Cable

For further data on advertised products use page 69.

INDEX TO ADVERTISERS

Page number is on the right. Key number for use with READER SERVICE CARDS is on the left.

Key No.		Page No.
1.	Adcola Products Ltd.	68
2.	Alliance Motors	52
3.	American Electrical Heater Company	64
4.	Andrew Antenna Corporation Ltd.	62
5.	Arrow-Hart & Hegeman (Canada) Ltd.	63
6.	Automatic Electric Sales (Canada) Ltd.	39
7.	Automatic Electric Sales (Canada) Ltd.	40-41
8.	Automatic Electric Sales (Canada) Ltd.	42
9.	Aviation Electric Ltd.	79
10.	Bach-Simpson Ltd.	6
11.	Bell Telephone Co. of Canada, The	78
12.	Bendix Aviation Corp.	68
13.	Bishop Sons & Co. Ltd.	65
14.	Bud Radio Inc.	59
15.	Burton-Rogers Co.	51
16.	Cambridge Thermionic Corp.	10
17.	Canadian Applied Research Ltd.	8
18.	Canadian General Electric Co. Ltd.	49
19.	Canadian Lister-Blackstone Ltd.	64
20.	Canadian Marconi Co.	3
21.	Canadian Marconi Co.	56
22.	Canadian Marconi Co.	65
23.	Daly Capacitors Ltd.	52
24.	Dawe Instruments Ltd.	52
25.	Daystrom Ltd.	55
26.	Eitel-McCullough Inc.	7
27.	Electro Sonic Supply Co. Ltd.	51
28.	Electronic Associates Inc.	16
29.	Freed Transformer Co. Inc.	51
30.	G-V Controls Inc.	59
31.	General Radio Co.	80
32.	Hammond Manufacturing Co. Ltd.	55
33.	Helipot Corporation	63
34.	Industrial Exhibitions Ltd.	66
35.	International Business Machines Co. Ltd.	13
36.	Jerrold Electronics (Canada) Ltd.	67
37.	Kester Solder Co.	58
38.	Lake Engineering Co. Ltd.	60
39.	J. R. Longstaffe Co. Ltd.	59
40.	J. R. Longstaffe Co. Ltd.	63
41.	J. R. Longstaffe Co. Ltd.	65
42.	J. R. Longstaffe Co. Ltd.	68

(Continued overleaf)

ATTENTION CIRCULATION MANAGER

Please ADD my name to the mailing list for **ELECTRONICS & COMMUNICATIONS** (no obligation).

My Name
(Please print)

Mail copies to my home, or business address as noted below.

Street

City Prov.

If you have recently **CHANGED** your address for receiving copies of **E & C** please note former address here:

Company Nature of Business

Signature Position
3-58 (For card to be valid it must be completed in full, including signature)

PLEASE SEND FURTHER INFORMATION ON THE FOLLOWING NEW PRODUCT ITEMS AS NUMBERED BELOW — USE PRODUCT ITEM NUMBERS

- 1886 1887 1888 1889 1890 1891 1892 1893 1894 1895
 1896 1897 1898 1899 1900 1901 1902 1903 1904 1905
 1906 1907 1908 1909 1910 1911 1912 1913 1914 1915

PLEASE SEND FURTHER INFORMATION ON THE FOLLOWING ADVERTISEMENTS AS NUMBERED BELOW — USE KEY NUMBER

- 1 2 3 4 5 6 7 8 9 10 11 12
 13 14 15 16 17 18 19 20 21 22 23 24
 25 26 27 28 29 30 31 32 33 34 35 36
 37 38 39 40 41 42 43 44 45 46 47 48
 49 50 51 52 53 54 55 56 57 58 59 60

Name Position

Company Nature of Business

Company Address City Prov.
3-58

PLEASE SEND FURTHER INFORMATION ON THE FOLLOWING NEW PRODUCT ITEMS AS NUMBERED BELOW — USE PRODUCT ITEM NUMBERS

- 1886 1887 1888 1889 1890 1891 1892 1893 1894 1895
 1896 1897 1898 1899 1900 1901 1902 1903 1904 1905
 1906 1907 1908 1909 1910 1911 1912 1913 1914 1915

PLEASE SEND FURTHER INFORMATION ON THE FOLLOWING ADVERTISEMENTS AS NUMBERED BELOW — USE KEY NUMBER

- 1 2 3 4 5 6 7 8 9 10 11 12
 13 14 15 16 17 18 19 20 21 22 23 24
 25 26 27 28 29 30 31 32 33 34 35 36
 37 38 39 40 41 42 43 44 45 46 47 48
 49 50 51 52 53 54 55 56 57 58 59 60

Name Position

Company Nature of Business

Street City Prov.
3-58

BUSINESS REPLY CARD
No Postage Stamp Necessary if Mailed in Canada

5c POSTAGE WILL BE PAID BY

ELECTRONICS AND COMMUNICATIONS

31 - 35 Willcocks Street
Toronto 5, Ontario



BUSINESS REPLY CARD
No Postage Stamp Necessary if Mailed in Canada

5c POSTAGE WILL BE PAID BY

ELECTRONICS AND COMMUNICATIONS

31 - 35 Willcocks Street
Toronto 5, Ontario



BUSINESS REPLY CARD
No Postage Stamp Necessary if Mailed in Canada

5c POSTAGE WILL BE PAID BY

ELECTRONICS AND COMMUNICATIONS

31 - 35 Willcocks Street
Toronto 5, Ontario



INDEX TO ADVERTISERS

(Continued)

Key No.		Page No.
43.	Magnetics Inc.	18
44.	Measurement Engineering Ltd.	53
45.	Muirhead & Co. Ltd.	74
46.	Narda Corp., The	21
47.	National Fibre Co. of Canada Ltd.	14
48.	Northern Electric Co. Ltd.	17
49.	Parsons Company, The Ralph M.	4
50.	R & M Bearings Canada Ltd.	54
51.	Radio Communications Equipment & Engineering Ltd.	77
52.	Rogers Majestic Electronics Ltd.	19
53.	Rohn Manufacturing Co.	62
54.	Royal Metal Mfg. Co. Ltd.	60
55.	Sanborn Company	75
56.	Snelgrove & Co. Ltd., C. R.	72
57.	Sprague Electric International Ltd.	58
58.	Standard Telephones & Cables Mfg. Co. (Canada) Ltd.	73
59.	Syntron (Canada) Ltd.	71
60.	Tishbein, O. F.	63
61.	Triplett Electrical Instrument Co., The	61
62.	Tung-Sol Electric Inc.	2
63.	Ward Leonard of Canada Ltd.	20

ACTIVE CIRCULATION

It costs us a lot of active dollars annually to keep our circulation lists up-to date and it's important enough to us that we have them audited every year by CCAB (Canadian Circulations Audit Board Inc.).

Advertisers trust CCAB audited figures so we get more advertisers and YOU get the high standard of editorial you have always wanted to read.

ELECTRONICS and COMMUNICATIONS

is a



audited publication

New Products

(Continued from page 56)

Portable Radar Range Calibrator

Item 1899

The Decca DRC-38 is a compact, rugged, portable, crystal controlled test set used for the precise calibration of range rings in any standard radar plan position indicator. Range calibration at 1/4, 1 and 10 nautical mile intervals is available with an accuracy of the order of .01%.

The front panel carries two output jacks. Three trigger pulses and three calibration pulses can be switched out of the appropriate jack. Connection between the test set and the display to be calibrated is accomplished by connecting the trigger output jack of the calibrator to the trigger input jack of the display and the calibration pulse output of the test set to the video input jack of the display.

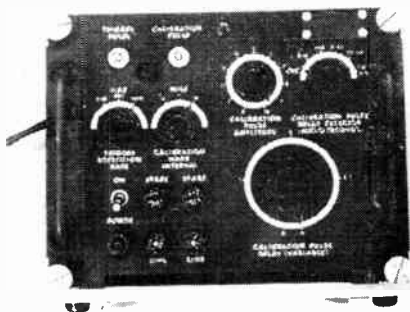

The dimensions of the DRC-38 are only 8 1/2 x 10 1/2 x 10 3/4 inches and it weighs but 25 lbs.

The DRC-38 meets all applicable military specifications and operates from a mains supply of 110V ±15% over a frequency range from 50 to 1800 cycles. Panel markings are edge lit and legible in full daylight or total darkness.

The design, development and production of this instrument was carried out by **Oecca Radar (Canada) Limited, 23 Six Points Road, Toronto 18, Ontario.**

Industrial Analyzer

Item 1900

To supply the need for portable equipment to fill the needs of the industrial electrical worker, the Canadian Research Institute has produced a varied line of Industrial Analyzers to make light work of testing for maintenance men, manufacturers of electrical equipment, home appliances, refrigerators, stoves, motor servicemen, and others, to whom the simplicity of measuring voltage, current, wattage, temperature, resistance is a real boon.

These instruments are made to order in an infinite variety of combinations of ranges and functions, and may be had direct reading in volts, amperes, or watts, A.C. or D.C., frequency, ohms or megohms, degrees Fahrenheit or Centigrade, two and three-wire, single phase, polyphase, and with self-contained or external current transformers. Despite the custom-built nature of the testers, a simplified method of manufacture permits rapid delivery at prices comparable with those of quantity production items.

The Model IA-5 Industrial Analyzer is illustrative of a type of interest to plant maintenance men, radio and electrical repair shops, and manufacturers of small appliances. It permits voltage and current measurement on devices with line cord and plug, with a minimum of connections, the panel being equipped with convenience outlets. Three wire, single, two, and three phase circuits may also be tested. Ranges are 0/150/300/750 A.C. volts, and 0/1/5/10/50 A.C. amperes (which may be extended with external transformers).

Canadian Research Institute, 46 St. George St., Toronto 5, Ontario.

SYNTRON SELENIUM RECTIFIERS

designed for your application

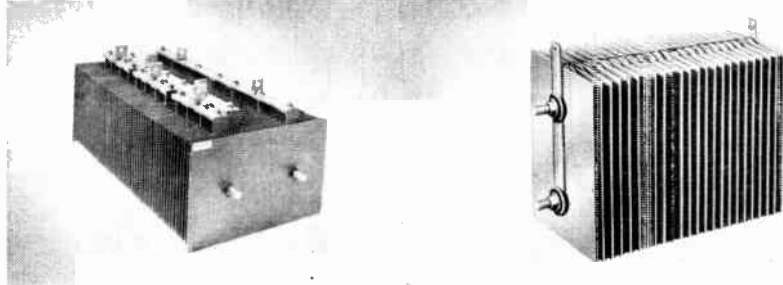

Industrial Power Rectifier Stacks — high efficiency, low maintenance. SYNTRON 12" x 16" cell is the largest cell size in the industry. Designed for arc welders, heavy d-c power supplies, etc.

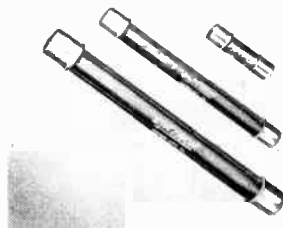

Cartridge Rectifier Stacks — low current, high voltage. Maximum 20 milliamperes, maximum input 15,000 R.M.S. volts.

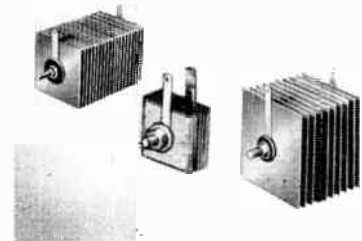

Commercial Rectifier Stacks — Designed for business machines, elevator controls, magnetic chucks, brakes, clutches, vibratory equipment,

—The widest range of cell sizes in the Industry

SYNTRON Selenium Rectifiers are manufactured under laboratory controlled conditions, assuring product uniformity.

SYNTRON Selenium Rectifiers are noted for these exceptional characteristics — lowest voltage drop, lowest leakage current, lowest temperature rise, longest life, greater uniformity from cell to cell and greatest voltage ratings.

Let our application engineers make recommendations for all your rectifier needs.

Other SYNTRON Equipment designed to increase production, cut production costs, improve products

Vibrators
(bins, hoppers, chutes)

Vibratory Feeders

Vibratory Screens

Shaker Conveyors

Vibratory Elevator Feeders

Weigh Feeders

Packers and Jolters

Hopper Feeders

Lapping Machines

Rectifiers

(Silicon and Selenium)

a-c to d-c Selenium Rectifier Units

Electric Heating Panels

Electric Heating Elements

Sinuated Wires

Shaft Seals

Electric Hammers

Concrete Vibrators

Paper Joggers

Our representatives will be glad to work with you in selecting the proper equipment for your operation.

Call your nearest Syntron representative.

For more information write for complete catalog . . . **Free**

E 358

SYNTRON (CANADA) LIMITED

12 MAIN STREET EAST • Dept. K • STONEY CREEK, ONTARIO

QUARTZ CRYSTALS

THEY LOOK ALIKE AND

INITIALLY

MAY TEST ALIKE

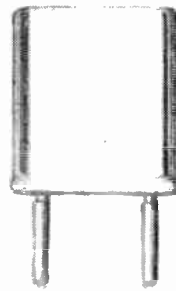
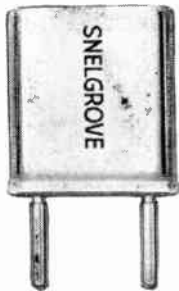

BUT--

There is only one way to tell the best from the rest in quartz crystals because material, workmanship and design are hermetically sealed in and can't be seen or judged.

So there is only one SURE way of selecting quartz crystals of predetermined quality and reliability and that is on the record of their performance and on the reputation of the maker.

SNELGROVE'S record of integrity in the manufacture of top quality quartz crystals is already a tradition with Canada's largest users of quartz crystals. Let this record be your recommendation when specifying quartz crystals. Then you play safe.

Snelgrove—Canada's Frequency Control Specialist. Licensed under Bell System Patents.

C. R. **SNELGROVE** CO. LIMITED

DON MILLS (TORONTO), ONT.

HI. 4-1107-8

New Products

Continuous Viscosity Measurement And Control

Item 1901

The Ultra-Viscoson, an electronic instrument which uses ultrasonic waves to measure the viscosity of liquids continuously and automatically, is a recently developed industrial instrument that will find wide use in the chemical processing industries.

The sensing element is a thin stainless steel blade which is vibrated in the liquid at 28 kc. The computer associated with the probe computes the energy required to cause minute layers of the liquid to slip back and forth over one another, and indicates this energy as viscosity in centipoises X gm./cc.

Peak amplitude of vibration is less than one micron, and the ultrasonic energy in the liquid is in the order of microwatts.

Where temperature varies in the liquid being controlled, an Automatic Temperature Compensator can be added to the system which eliminates the effect of temperature variation over a wide range.

The computer and indicator unit may be mounted remotely, as much as a mile away, from the probe. In cases where a number of points in a system must be monitored, several probes may be connected to a common Multiprobe computer and indicator.

Applications cover every field where viscosity of a fluid is an important variable which must be accurately controlled. Blending of oils in oil refineries, control of adhesive viscosity in sandpaper manufacturing, control of ink viscosity in gravure printing plants, are some typical applications.

The Ultra-Viscoson is manufactured by the Cincinnati Division of the Bendix Aviation Corporation and is sold in Canada by Computing Devices of Canada Limited, Box 508, Ottawa 4, Ontario.

Variable Autotransformer

Item 1902

The variable autotransformer, which was first produced commercially by the General Radio Company in 1933 under the trade name Variac®, is familiar to all electronic engineers as the near-ideal device for adjusting a-c line voltage in testing and in production. Not so well known to many are its manifold uses throughout industry.

Some of these are: Control of process heaters; control of illumination; automatic voltage regulation; control of motor speed.

For process control, the autotransformer is often automatically operated, through pneumatic or hydraulic systems, or motor driven from electrical controllers.

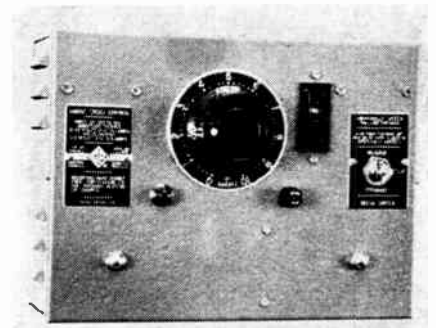

The combination of Variac® Autotransformer and dry-disk rectifiers produces a motor-speed control system that has many advantages — smooth control, good regulation, versatile starting characteristics, and negligible maintenance.

Variac® Autotransformers are approved by the Canadian Standards Association.

General Radio Company, 275 Massachusetts Ave., Cambridge 39, Mass., U.S.A.



a comprehensive
**Telecommunication
 Engineering Enterprise**

The largest telecommunication manufacturing organisation in the British Commonwealth **Standard Telephones and Cables Limited** covers the whole waterfront of telecommunication engineering and is engaged in the research, development, manufacture and installa-

tion of all types of communication and control systems.

The Company is in an unrivalled position to undertake, within its own organisation, the co-ordinated systems-planning of complete communication projects involving inter-dependent systems of various types.

'Standard' productions include:—

**Telecommunication Line Transmission
 Equipment**
Radio Broadcasting Equipment
Radio Communication Equipment
Air Radio Navigational Aids
Supervisory and Remote Control Systems
Railway Communication Apparatus
Railway Control Equipments
Telephone Cable
Sound-Reinforcement Systems
Public and Private Telephone Systems
 (Automatic and Manual)

***Standard Telephones & Cables
 Mfg. Co. (Canada) Ltd.***

9600 ST. LAWRENCE BLVD.. MONTREAL 12. P.Q.

MUIRHEAD

Small size, low weight SIZE 10 SERVOMOTORS

Require less than
1 cubic inch of space
and weigh less than
 $1\frac{1}{2}$ oz

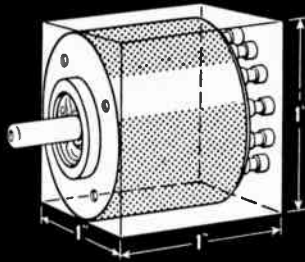

Muirhead size 10 servomotors are now in production, their small size and low weight make them very suitable for miniaturized systems. They conform to standard size 10 frame, giving them an overall diameter of 0.940" max. and overall length from the front face of the spigot to the ends of the connexion tags of 0.978" max., weight is 1.45 oz.

Body material is black dichromate finished stainless steel. The stainless steel spindle is hobbled to produce an involute pinion of 13 teeth, 120 D.P., 0.1245"/0.1240" O.D., 0.1083"/0.1078" P.C.D., 20° pressure angle. Bearings are also of stainless steel. Windings are protected by encapsulation in epoxy resin. Electrical connexions are made by soldering to the connexion tags.

Two models can be supplied, Type 10M 10 A 1 for 115V 400c/s supply and Type 10M 10 A 2 for 26V 400c/s supply, spindle length for these is 0.327" Max. Each of these models has a variation, Type 10M 10 B 1 and Type 10M 10 B 2 respectively, where the spindle length is 0.171" max.

TYPE NUMBER	VOLTAGE RATING		Min. Torque at Stall oz. in.	Min. No. Load Speed rev/min.
	Reference Winding	Control Windings series parallel		
10M 10 A1	115V	36V 18V	0.28	6500
10M 10 B1	115V	36V 18V	0.28	6500
10M 10 A2	26V	26V 13V	0.28	6500
10M 10 B2	26V	26V 13V	0.28	6500

Data Sheets giving full information on request

MUIRHEAD

Manufactured in Canada by

MUIRHEAD INSTRUMENTS LIMITED

STRATFORD · ONTARIO · CANADA Telephone: 3717 & 3718

330/3Ca

New Products

Sigma Unevenness Tester

Item 1903

The EA-UM-1 Sigma Unevenness Tester is claimed to be the first instrument available commercially which will give the coefficient of variation over a definite length of material accurately, easily and automatically, by a statistically correct method of calculation.

The instrument was designed to overcome one of the major problems encountered by the textile industry — to measure the unevenness in weight along a given length of material (yarns, rovings, slivers or tops) and to record quickly and accurately where the unevenness occurs — while the material is still in one piece.

The equipment was developed by Electronic Associates Limited in co-operation with the Ontario Research Foundation.

The measuring circuit is based on the capacitance principle, and the forward plate of the measuring condenser is exchangeable to accommodate a range of material from fine yarn to tops. The output of the measuring circuit is applied independently to an integrator and a recorder.

The total power required by the instrument is approximately 400 watts. The power line frequency must be 60 cycles within the normal tolerance of commercial sources. Nominal operating voltage is 115 volts, but the equipment is provided with regulators to permit a 10 volt variation in this supply before the accuracy of the unit is affected.

Electronic Associates Limited, 4616 Yonge Street, Willowdale, Ontario.

Electronic Time System

Item 1904

To cope with the ever-increasing problems of production control and recording, in terms of time, present-day industry must incorporate accurate, dependable time systems into daily operations.

The Stromberg Electronic Time System is easily installed in existing buildings as well as incorporated into those under construction or contemplated, since its electronic correction and program instrument signals are carried on ordinary lighting circuits.



The Stromberg Electronic Time System provides automatic hourly and twelve hour supervision of clocks, recorders, and automatic program signalling. Individual clocks are synchronous motor operated and may be connected to any convenient 115V, 60 cy. A.C. Line or Outlet. Accurate time system supervision is provided by a synchronous powered movement with 72 hours' reserve operation. Once each hour and each twelve hours, the master unit releases impulses that are superimposed on the power lines by an electronic transmitter. All corrections including full 12 hour correction are completed within one minute.

When programming units are part of the Master Time System they are immediately restored to correct time following a power interruption and signals sound on schedule.

Sold in Canada by Automatic Electric Sales (Canada) Limited, 185 Bartley Drive, Toronto 16, Ontario.

For further data on advertised products use page 69.

two more **UNIT PREAMPLIFIERS**
in the new
SANBORN "450" SERIES

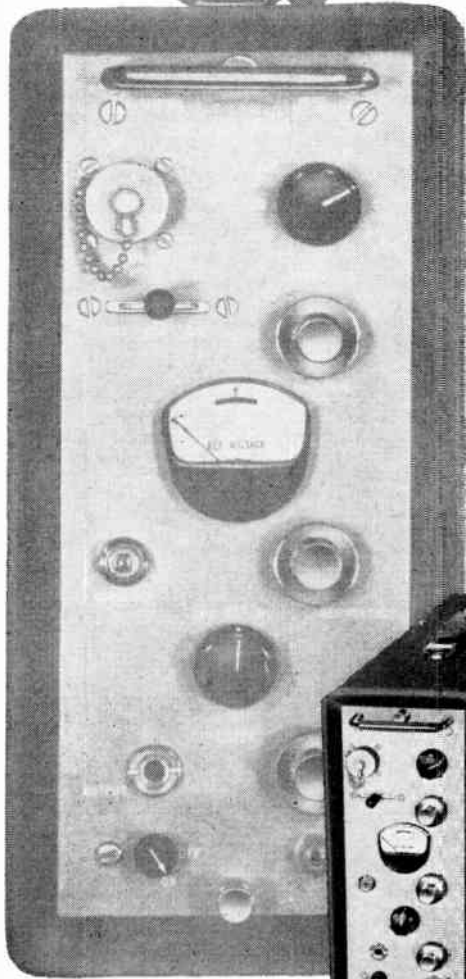

Model 450-1200 Servo Monitor
(Demodulator) Preamplifier



Model 450-1300A
DC Coupling Preamplifier

Here are the newest of the recently introduced Sanborn "450" Series Unit Preamplifiers—compact, lightweight, self-contained instruments for use with optical and tape recorders, wide band scopes, panel meters, computers, etc. (For use with high speed optical galvanometers at frequencies above 500 cps, requiring larger current swings, a transistor output amplifier is built into the 450-1800A True Differential DC type and available as optional equipment on other 450's.) As with all 450 Unit Preamplifiers, the new Servo Monitor and DC Coupling models mount in either individual portable cases or in the four-unit 19" module frame (#354-1100-C2) shown. The 450 designation refers to *unit packaging* of Sanborn 350 Preamplifiers and Power Supplies in individual 450 cases. Loosening two front panel thumbscrews allows quick, simple interchangeability. Since all "450" Preamps use the 350-500 Power Supply (which remains in place at the rear of the frame or case), new requirements necessitate only additional *Preamplifier* units, permitting sizable savings in equipment investment.

The Model 450-1200 is a phase-sensitive demodulator, whose DC output voltage is proportional to the in-phase (or 180° out-of-phase) component of an AC signal with respect to a reference. Precision measurement is realized by such characteristics as negligible quadrature signal error, provision for floating signal and reference inputs, front panel VTVM for accurate calibration signals. The 450-1200 accepts the outputs of resolvers, synchros, differential transformers and other transducers. The 450-1300A is a moderate gain, balanced input—balanced output DC amplifier. Its input circuit performs equally well with single-ended or balanced signals.

The "450" Series Unit Preamplifiers presently include the Model 450-1100 Carrier, 450-1200 Servo Monitor, 450-1300A DC Coupling and 450-1800A True Differential DC types. Following these will be "450" Series Logarithmic and Low Level types. Further data and application information on present models is available on request.

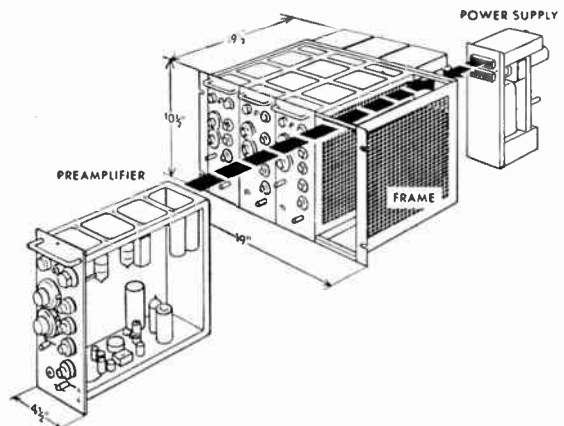

MAJOR SPECIFICATIONS

MODEL 450-1200 SERVO MONITOR PREAMPLIFIER

Sensitivity: 5 mv (in phase) produces 1 volt at output jack under maximum output load conditions
Input Impedance: Signal 100k
Reference 12.5k for 15 volts, 55k for 120 volts
Frequency Response: 3db down at 20% of carrier frequency filter position
Carrier Frequency Filter: Selected by a switch (three positions)
Low 60 cycles
Med 400 cycles
Hi 1000 cycles (5000 cycles optional)
Reference Voltage: Internal selection accepts voltages from 15 to 120 volts
Quadrature Rejection: Ratio better than 100:1
Maximum permissible quadrature before overload indicator lights is twice full scale (in phase)
Calibrate Voltage: 10 millivolts internal (set by meter on panel)
Drift: Less than 0.1% of full scale per hour
Preamplifier Output Jack: =3 volts available into 2.2k minimum load resistance. Output appears across two cathodes at approximately ground potential
Rear inputs and overload indicator lights ore included
Output Impedance: 1k
Overall Linearity: = $\frac{1}{4}$ %
Power Requirements: 115 volts, 50-400 cycles, approximately 35 watts

MODEL 450-1300A DC COUPLING PREAMPLIFIER

Sensitivity: 50 mv produces 1 volt of output jack under maximum output load conditions
Input Impedance: 5 megohms each input side to ground
Input: Single-ended or push-pull
Preamplifier Output Jack: =3 volts into 2.2k minimum load resistance. Output is balanced and appears across 2 cathodes at approx. ground potential
Output Impedance: 1k
Drift: Referred to input 2 mv/hr. line voltages change less than 10%
Frequency Response: 0-20kc
Calibration: 100 millivolts internal
Linearity: = $\frac{1}{4}$ %
Rear inputs included

See the new "450's" and other Sanborn equipment at
Booth 3601-3603 I. R. E. Show

Canadian Representative: R-O-R ASSOCIATES, 1470 Don Mills Road, Don Mills, Ontario

SANBORN COMPANY

INDUSTRIAL DIVISION

175 WYMAN STREET, WALTHAM 54, MASS.

New Products

"Megger" Carrying Case

Item 1905

R. H. Nichols Limited announces that a leather stand case (Cat. 70294) is available for the Series 3 "Megger" Insulation Tester. It allows the tester to be used merely by lifting the lid, and also has a compartment to house the test leads.

This handy piece of equipment derives its name — "Stand Case" — from the fact that the lead compartment forms an effective stand that elevates the tester from the bench, allowing full clearance for the generator handle. A pair of 12 ft. leads are normally supplied with this new case, but as previously, leads are separate items when other cases are ordered.

R. H. Nichols Limited, 2781 Dufferin Street, Toronto, Ontario.

Rechargeable Nickel-Cadmium Batteries

Item 1906

The latest addition to Saft's extensive line of Voltablock hermetically-sealed nickel-cadmium sintered-plate batteries is available from Ward Leonard of Canada Limited. These miniature batteries, smaller than a silver dollar, offer unlimited possibilities in electronic and electrical applications.

These button cells feature rechargeability, hermetic sealing, no maintenance, non-gassing upon recharging, and low internal resistance which allows high discharge. Industrial applications in the aircraft and missile field are for testing, telemetering, radio, emergency lighting, fire alarm systems, etc. In the electronic field, equipment such as instruments and recorders can be made portable. Automatic recharging devices for the cells can be built-in easily.

Operating at normal temperature ranges, the cells are available in 0.25 ma hour and 0.5 ma hour sizes, each with a nominal voltage of 1.2 volts. Cells are of the nickel-cadmium type and are built with sintered plates. Two or more cells can be stacked to obtain a battery of any desired voltage.

The cells are recharged by a constant current equal to $\frac{1}{13}$ of their nominal capacity. It requires 15 hrs. to recharge the BC 0.25 after discharge, and 13 hrs. to recharge the BC 0.5. The BC 0.25 provides 250 ma hrs. of energy, is $\frac{1}{8}$ in. in diam., $\frac{1}{16}$ in. thick and weighs approximately $\frac{1}{2}$ oz. The BC 0.5 provides 500 ma hrs., is $\frac{1}{8}$ in. in diam. and is $\frac{1}{8}$ in. thick. It weighs approximately $\frac{3}{4}$ oz.

For full information contact Ward Leonard of Canada Limited, 1070 Birchmount Road, Toronto, Ontario.

Rectifier Of 10 Amperes Output

Item 1907

Taylor-Leslie Mining & Engineering Corporation Limited announces the development of a facility for the manufacture of silicon devices. This device is a rectifier of 10 amperes output, 200 volts peak, full wave bridge and designated T10A 200 P.I.V. F.W.B. This rating is conservative and is at convection condition (no forced air blast).

The unit can be operated at 150°C with a 10% derating. Although this unit can be operated with 20 amperes at normal ambient, the company prefers to be on the conservative side in its ratings. Reverse leakage at normal ambient should never exceed 20 microamperes and the silicon

elements are hermetically sealed within the capsule.

These rectifiers are available for both single and three phase operation. The physical characteristics are approximately 3" x 3" x 3", weighing 7 ounces.

The unique design permits that, in the event of element failure, the damaged element can be replaced with a new one without damaging or having to discard the device.

Taylor-Leslie Mining & Engineering Corporation Limited, P.O. Box 312, Terminal "A", Toronto, Ontario, Canada.

Catalog Of Oscillographic Recording Equipment

Item 1908

A new 16-page catalog contains descriptions, specifications and prices of all Sanborn "150" Oscillographic Recording Systems and the full line of "150" accessories and unit instruments.

Equipment described includes the 1-, 2-, 4-, 6- and 8-channel systems; the eleven interchangeable, plug-in preamplifiers used in these systems (AC-DC, Carrier, Servo-Monitor, DC Coupling, Log Audio, Low Level, Stabilized DC, AC Wattmeter, 400 Cycle Frequency Deviation, Frequency Meter and RMS Volt/Ammeter); Model 150-3100 Triplexer; portable "150" systems; and systems for analog computer readout, including the 2- to 8-channel 150 style and the new, compact 6- and 8-channel mobile consoles. Unit instruments and accessories such as Recorders, Galvanometers, Dual-Channel Amplifiers, Permapaper chart paper, etc. are also fully described in the new catalog.

Copies are available on request from Sanborn Company, Industrial Division, 175 Wyman Street, Waltham 54, Mass., U.S.A.

High Power Broadband Amplifier Klystron

Item 1909

Eitel-McCullough, Inc., San Bruno, California, manufacturer of Eimac power vacuum tubes, has announced a new six-cavity water-cooled amplifier klystron designated the 6K50,000LQ. Designed for use in the 720 to 980 megacycle range, the 6K50,000LQ delivers 10KW CW power output at 10 megacycle bandwidth with a driving power of only 5 watts and an efficiency of 40 per cent. At 25 per cent efficiency the 6K50,000LQ is effective over a 20 megacycle bandwidth.

The Eimac 6K50,000LQ, formerly the developmental X631, was selected by Federal Telecommunication Laboratories for use in O/H tropospheric equipment built for American Telephone and Telegraph Company and International Telephone and Telegraph Company. This equipment now spans the gap between Florida and Cuba, transmitting TV programs simultaneously with multi-channel telephone service.

Enquiries for further particulars should be addressed to Eimac's Canadian representative, R. D. B. Sheppard, 2036 Prince Charles Road, Ottawa 3, Ontario.

High Temperature Resistor

Item 1910

International Resistance Co. Ltd., announce the addition of type PW-20 Resistors to their product line.

Type PW-20, a high temperature resistor, combines unique design with a high degree of automatic assembly. This resistor offers practical possibilities for cost saving.

It is particularly recommended for the following applications: wattage dissipation of 20 watts or less in free air; wattage dissipation up to 30 watts when mounted against a metal panel; where the operation is at a high ambient temperature for any application requiring low cost, easily installed power resistors.

For further information, write: International Resistance Co. Ltd., 349 Carlaw Ave., Toronto 8, Ontario, for Bulletin P-4.

Transistor Intercommunication Telephone Set

Item 1911

Northern Electric Company Limited announces a new, rugged and portable transistor intercom, designed for complete duplex operation over two pairs of wires. Because of its small size and ease of set-up and operation, this unit is ideally suited for use in telephone, aircraft, construction and other industries.

The set can be used as a permanent intercom, but ideally its full flexibility is apparent when the instrument is used as a communication tool in much the same way as a sound powered or field telephone. However, the transistor intercom has a tremendous advantage in that the units can be positioned or hung up, thereby relieving the operator of the inconvenience of wearing a headset or holding a handset.

The case is made of heavy gage steel and all openings are well protected so that internal damage to the unit from an external source is fairly well eliminated. The transmitter and receiver units each have on-off switches but when the units are plugged together, as would be the case when they are being transported or not in use, microswitches are activated which disconnect the battery. Connecting the transmitter and receiver units to wires or cable pairs is accomplished very simply by means of four foot lengths of heavy line cord terminated in Pee Wee clips.

Four 1.5 volt pen light cells are required for the receiver and one 15 volt Eveready type 411 for the transmitter. The expected life of the receiver and transmitter batteries under operating conditions of eight hours per day is 100 hours. Normal conversation is possible without raising the voice level even in noisy locations, and the operating range is at least one mile over No. 26 gage conductors. The weight of the combined transmitter and receiver units is $4\frac{1}{2}$ lbs. less batteries.

Further information may be obtained from the nearest Northern Electric office.

Twenty-Million Megohmmeter

Item 1912

The E.I.L. Twenty-Million Megohmmeter is one of a series of high resistance measuring units manufactured by Electronic Instruments Limited, with upper limits running from 200,000 to 100,000,000 megohms. The Twenty-Million Megohmmeter has been specifically designed for insulation resistance and condenser leakage resistance measurement.

The instrument measures from $\frac{1}{2}$ megohm to 20,000,000 megohms in six overlapping ranges. Internal test voltages of 85 and 500 volts are used, with provision for the use of external test voltage in value from 1 to 1000 volts.

The instrument has been designed to allow extremely rapid measurement, and the high upper limit of measurement allows the testing of shorter lengths of cable than normally possible, and the measurement of leakage resistance of condensers using teflon and ceramic insulation. The instrument includes several safety features to reduce the risk of shock to careless operators and to discharge any capacitive component after measurement.

The instrument is heavily voltage stabilized to allow maximum accuracy and repeatability. The instrument is designed using the guard principle, so that stray leakage and stray pickup is decisively ignored in measurement.

E.I.L. instruments are serviced in Canada by Electronic Instruments (Canada) Limited, and sold through the exclusive Canadian sales representative: The Glendon Company Limited, 44 Wellington Street East, Toronto, Ontario.



ELECTRONIC INSTRUMENTS

AM/FM MODULATION METER



- Carrier Frequency Range: 2.25 to 600 Mc/s.
- MEASURES to 100% modulation depth and frequency deviations to 100 Kc/s in range 30 c/s to 15 Kc/s.
- Simplicity of operation.
- High accuracy.

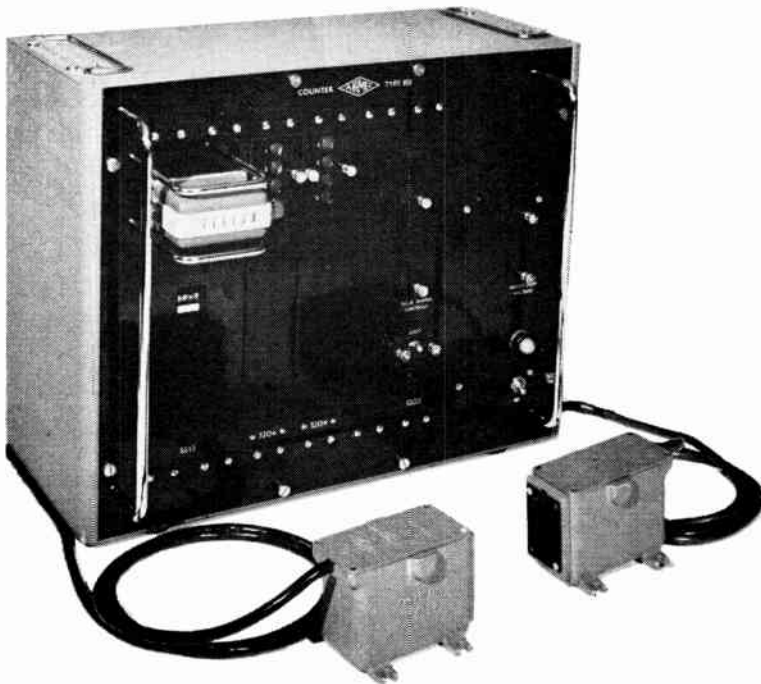
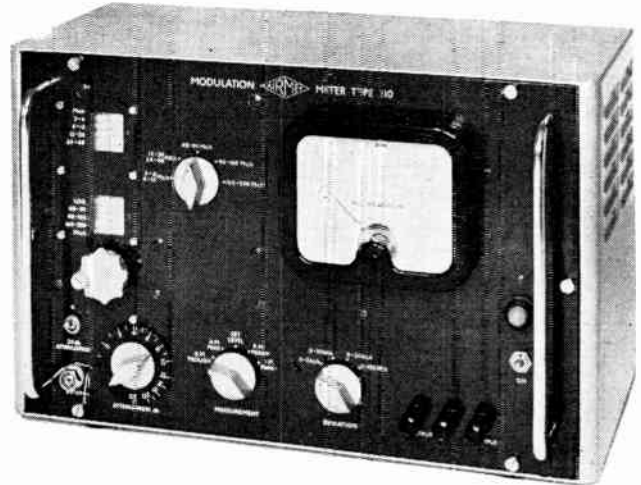

ELECTRONIC COUNTER



- Compact and extremely versatile.
- Counting rate up to 3000/s.
- Counting capacity: 4 billion.
- Applications:
 - Counting**
 - Measuring**
 - Timing**
 - Remote Control**

Airmec Electronic Equipment Includes:

Time and Frequency Meters
Frequency Standards
Ionisation Testers
Oscillators
Signal Generators

Electronic Batch Counters
Electronic Tachometers
Photocell Controls
Temperature and Level Control Equipment
Radio and TV Servicing Equipment

SEND FOR YOUR
COPY OF CATALOG



**RADIO COMMUNICATIONS
EQUIPMENT & ENGINEERING LTD.**

475 METROPOLITAN BLVD., MONTREAL 32

"I find BELL TELETYPE helps Allied Van Lines operate more profitably...give better service!"

Mr. N. Livingstone,
Allied Operations Mgr.



The Allied Van Lines organization embraces 107 Canadian centres

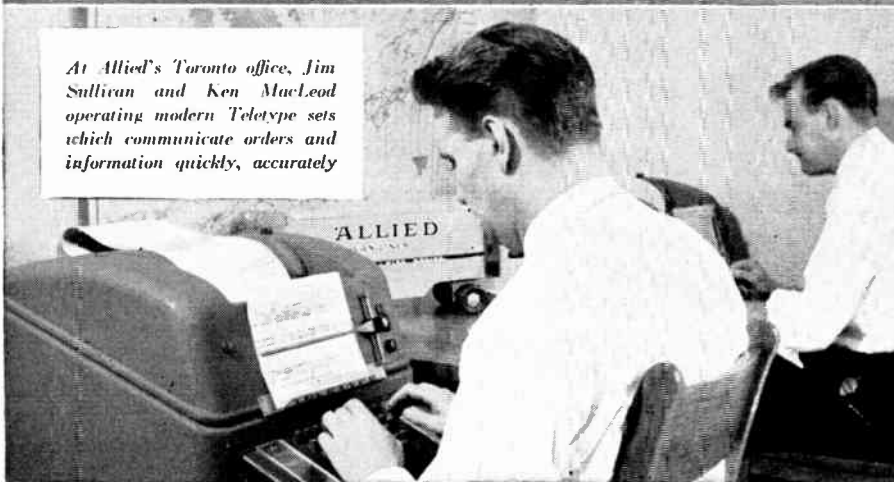

At Allied's Toronto office, Jim Sullivan and Ken MacLeod operating modern Teletype sets which communicate orders and information quickly, accurately

How Bell Teletype helps Allied:

- 1 Communication of orders is faster . . . despatching of trucks is speeded . . . total transit time is reduced.
- 2 "Empty miles" (long return trips without cargo) are more easily avoided . . . substantial cost cuts are achieved.
- 3 Customers can be given advance information on delivery schedules so that they can be prepared to accept delivery and save storage cost at destination.

Can Bell Teletype help you?

A Bell communication representative will be glad to study your particular needs

Call our nearest Business Office.

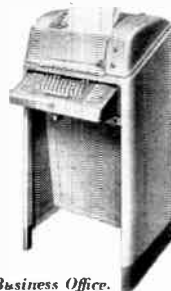

THE BELL TELEPHONE COMPANY OF CANADA

TECHNICAL PERSONNEL AVAILABLE

ACOUSTICS and SOUND ENGINEER.

Age 34, — 1949 University of Budapest. Canadian experience in technical and radio electrical handling of sound recorders. Special experience in optical sound recording and projecting. Can handle Stancil Hoffman, Ampex, Bell, Bellendhauer and Western Electric Equipments with special magnetic tapes systems. Experienced in handling acoustical problems. Reply to Box 517, Electronics and Communications.

MANAGER. P.Eng., age 39. Bus. Adm.

Graduate. Available for responsible position in general management or marketing. Background: Communications, Automotive Batteries, Electrical Appliances, Industrial Electronics. Experience: Production Engineer, Product Sales Manager, Administrative Assistant, Marketing Manager, Commercial Research Manager-Market Research and Industrial Development. Reply to Box 518, Electronics and Communications.

ELECTRONIC ENGINEER: age 40,

sixteen years of experience in development of transmitters, pulse circuitry, installations, several years in supervisory and administrative position in charge of technical, product design and production units. Estimates, schedules, budgets, hiring and customer liaison experience. Salary \$9000 to \$10,000. Reply to Box 519, Electronics and Communications.

ELECTRONIC TECHNICIAN — age

26. Received from the Ryerson Institute of Technology an Electronic Engineering Technicians diploma on completion of three-year course. Has had experience in field of Geophysics in Edmonton, Alberta, where duties involved the completion of Gamma-Ray and Neutron Logs on semi-completed oil wells. Also worked with Toronto firm in field of Aeronautics, servicing and testing the Altitude Controller and the Airspeed Compensator for the Auto-Pilot system of the CF-100 fighter aircraft. Reply to Box 520, Electronics and Communications.

ELECTRONIC ENGINEER — member

IRE, versed in radar, radio and telephone communications, systems facilities, in development, installation and maintenance, sales, supervisory-managerial phases. Especially strong in field or application work. Security clearance up to secret. Desires responsible, challenging position with progressive firm. Reply to Box 521, Electronics and Communications.

INDUSTRIAL EDITOR and WRITER:

age 43, ten years as editor of production management and chemical magazines, plus a year and a half as advertising manager of electrical manufacturer. Personal interest tends toward public and industrial relations, B.A. (mainly in science), (R.C.A.F. as navigator). Reply to Box 522, Electronics and Communications.



Now! HAMLYN

5 and 10-channel HF Radio Equipment

PLUS a Low-Cost HTR-5 Conversion Kit*



ANTENNA CAPACITOR
Model HTRC-5



TRANSMITTER-RECEIVER
Models HTR-5 and HTR-10



CONTROL UNIT
Models HRC-5 and HRC-10

The new HTR-10 Model is the same size, weight and style as the popular HTR-5, but provides 10 preset channels. The new HRC-10 control unit has a 10-position frequency switch.

**For the many HTR-5 models now in use there is a new low-cost conversion kit, making it easy to change the HTR-5 into an HTR-10 Model.*

These HTR-5 and HTR-10 units are ideal for Canadian operations . . . have exceptionally rugged construction, long range and superior trouble-free performance in helicopters, light and medium-size aircraft. Built to military specifications, they are accepted as standard equipment in US Coast Guard helicopters . . . designated as AN/URC-13.

Low price includes unit complete with coils, cable connectors and crystals but less microphone and headset. Delivery from stock. Complete units, service and spares available.

For further information write:
200 Laurentien Blvd., Montreal.
Aviation Electric Limited



FREQUENCY RANGE — 5 or 10 preset channels between 2 and 12 mc.

REMOTE CONTROL — Simultaneous selection of transmitting and receiving frequencies.

HIGH POWER OUTPUT — Conservatively rated from 30 to 50 watts depending on antenna and frequency . . . ensuring maximum range.

LIGHT WEIGHT — Only 34 lbs. complete, including remote control and self-contained power supply.

MODULATION — 100% with speech clipping . . . ensures maximum performance.

ANTENNA TUNING — Either PI or L networks . . . permits set to be tuned into wide range of antennas.

ANTENNA CAPACITOR — A unique antenna terminating capacitor greatly improves antenna loading, thereby improving performance over conventional equipment.

RECEIVING SENSITIVITY — Better than 3 microvolts for 100 milliwatts output.

LOW POWER REQUIREMENTS — At 27.5 VDC input, only 2.8A for receiving and 9.8A for transmitting.

AVIATION ELECTRIC
LIMITED

HALIFAX • MONTREAL • TORONTO • CALGARY • VANCOUVER

5-Kc to 50-Mc



Type 1001-A
Standard Signal
Generator
#860

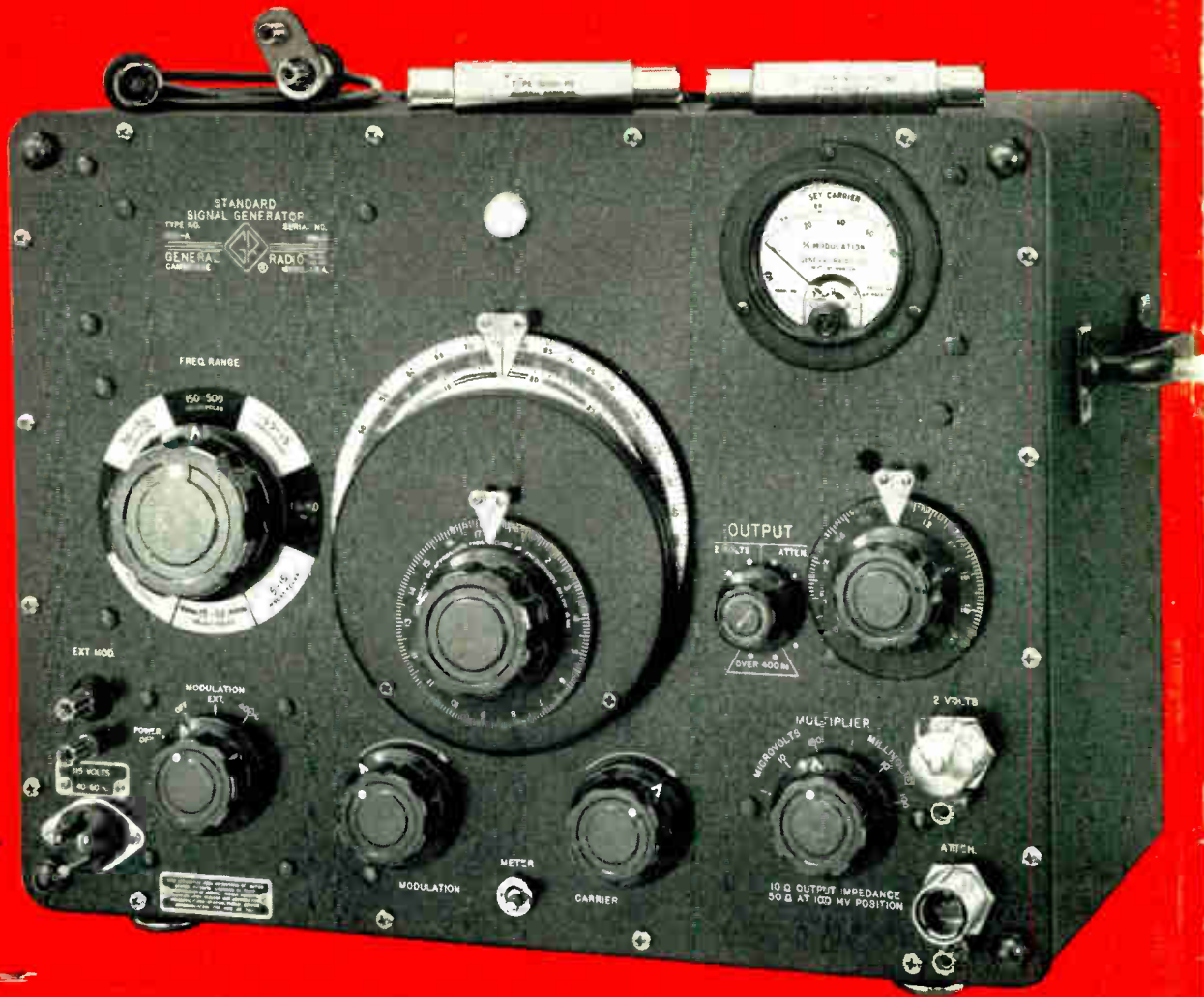

R-F Workhorse of the Industry

This instrument's wide frequency range, excellent shielding, sturdy construction, and low cost make it one of the most popular Standard-Signal Generators available. Simplicity of design has resulted in a very high performance-to-cost ratio. Stability and low drift are assured by high-quality components, low power consumption, and stabilized power supply. Internal modulation is provided over a range of 0 to 80%.

Carrier Frequency Range: 5-kc to 50-Mc in eight direct-reading ranges.

Frequency Calibration: $\pm 1\%$ accuracy; logarithmic variation gives constant precision of setting over most of range.

Incremental Frequency Dial: Indicates frequency increments directly in percent.

Output Voltage: Attenuator Jack: 0.1 μV to 200 mv open circuit, continuously adjustable.
Second Panel Jack: 2-VOLTS to at least 15 Mc.

Output Impedance: Attenuator Jack: 10 Ω except for highest attenuator position where impedance is 50 Ω ; 50 Ω when 40 Ω Series Unit is used, 25 Ω at end of Terminated Cable.
2-VOLT Panel Jack: 300 Ω .

Output Voltage Accuracy: Below 10 Mc: $\pm(6\% + 0.1 \mu\text{V})$ with output dial near full scale.
Above 10 Mc: $\pm(10\% + 0.3 \mu\text{V})$ near full scale.
At 2-VOLTS Jack: $\pm 3\%$ to 15 Mc.

Amplitude Modulation: Adjustable from zero to 80% — indicated on panel meter. Internal modulation is 400 cycles; external modulation from 20 cycles to 15 kc flat within ± 1 db.

Incidental Frequency Modulation: No more than 30 to 300 ppm over most of range at 80% a-m; proportionately less at lower modulation percentages.

Carrier Noise Level: Corresponds to about 0.1% modulation.

Leakage: Stray fields at 1 Mc are less than 1 μV per meter, two feet from generator.

Servicing Feature: Oscillator section plugs into shielded compartment and is easily removed for operation outside the cabinet, making servicing particularly easy.

Accessories Supplied: Double-shielded coaxial cable with G-R 874 Connectors, 50 Ω Termination Unit, 40 Ω Series Unit, 874 Adaptor to banana plug, extra cable and panel connectors, spare fuses, and power cord

Dimensions: 14 $\frac{3}{8}$ " x 20 $\frac{1}{4}$ " x 10 $\frac{1}{16}$ " **Net Weight:** 54 lbs.

GENERAL RADIO Company

Cambridge, Massachusetts, U.S.A.

Canadian Office: 99 Floral Parkway, Toronto 15, Ontario

Arthur Kingsnorth

Richard J. Provan

Repair Service:
Bayly Engineering, Ltd.,
Ajax, Ontario

Telephone: CHerry 6-2171



IRE

NATIONAL CONVENTION

Booths 3302-3310

on display:

... new Transfer-Function Meter for complete investigation of basic transistor properties at vhf and uhf and measurement of other complex transfer functions.

... VHF-UHF Dielectric Measuring Line for accurate and simplified measurement of dielectric constant and loss of solid materials.

... Variable Delay Line based on unique skewed-turn principle.

... Pulse Equipment — Impedance Comparator — D-C Amplifier and Electrometer — Standards — Variacs — and many other measuring instruments.